



From the collection of the

o P<sup>z n</sup>re<sup>m</sup>linger<sup>a</sup>  
v Library  
t s w p

San Francisco, California  
2006





TELEVISION STANDARDS  
AND PRACTICE

*This book is produced in full compliance  
with the government's regulations for con-  
serving paper and other essential materials.*



The National Television System Committee. Seated, left to right: Daniel E. Harnett, William A. MacDonald (alternate), Adrian Murphy, R. H. Manson, E. W. Engstrom, A. N. Goldsmith, Paul C. Raibourn, Donald G. Fink (editor of the *N.T.S.C. Proceedings*), L. C. F. Horle (coordinator of panel activities), W. R. G. Baker (chairman), Martha Kinzie (recording secretary), Allen B. DuMont, T. T. Goldsmith, Jr. (alternate), J. V. L. Hogan, Seymour Turner (observer for Mr. Raibourn), E. F. W. Alexander. Standing, left to right: D. B. Smith, J. E. Brown (alternate), John Howland, A. F. Murray (alternate), B. R. Cummings, Ralph Bown, P. C. Goldmark (alternate). Members not present in the picture are: D. A. Quarles (alternate), Virgil M. Graham (secretary), C. B. Jolliffe (alternate), H. A. Wheeler (alternate), P. J. Herbst (alternate), F. J. Bingley (alternate), George Town (alternate), Harry R. Lubeke, L. C. Smeby (alternate), Albert I. Lodwick.

(Frontispiece.)

# TELEVISION STANDARDS AND PRACTICE

*Selected Papers from the Proceedings  
of The National Television System Committee  
and Its Panels*

EDITED BY  
DONALD G. FINK

FIRST EDITION  
SECOND IMPRESSION

McGRAW-HILL BOOK COMPANY, INC.  
NEW YORK AND LONDON  
1943

TELEVISION STANDARDS AND PRACTICE

COPYRIGHT, 1943, BY THE  
NATIONAL TELEVISION SYSTEM COMMITTEE

---

PRINTED IN THE UNITED STATES OF AMERICA

*All rights reserved. This book, or  
parts thereof, may not be reproduced  
in any form without permission of  
the publishers.*

THE MAPLE PRESS COMPANY, YORK, PA.



## EDITOR'S PREFACE

This volume has been compiled from The Proceedings of the National Television System Committee, on which are based the standards adopted in 1941 by the Federal Communications Commission for commercial television broadcasting in the United States. The original record, 11 volumes totaling approximately 2,000 pages, was prepared by the members of the Committee and its Panels during the period from August, 1940, to March, 1941. It constitutes a thorough and authoritative examination into the technical bases of a public television service.

The distribution of this material was limited to the personnel of the N.T.S.C. Although copies are on file in several of the larger engineering libraries, the record is for the most part inaccessible to the members of the television industry. The Committee, realizing that wider distribution of its reports was desirable, authorized the preparation of a suitably edited version of its record for publication in book form.

The plan adopted in editing the record has been to select reports and papers which directly underlie the official television standards. Since the standards themselves are concerned with the whole of the television system, these papers comprise an authoritative symposium on the engineering problems of the field, one that should prove of value to the engineers on whose shoulders rests the responsibility of providing the equipment for public television service.

The task of selection has not proved easy, involving as it has the reduction of the record to about one-fifth of its original length. The detailed minutes of the meetings have been omitted in favor of reports of direct technical interest. To orient the reader not familiar with the work of the Committee, an introductory chapter has been prepared by the editor.

The editor wishes to acknowledge with gratitude the assistance and counsel of the Editorial Advisory Board of the Committee,

the members of which approved publication of the volume in its present form. Special thanks are due Mr. L. C. F. Horle, who as coordinator of the Committee and its Panels was responsible for compiling and printing the original record, and who in countless ways has eased the task of editing this book.

DONALD G. FINK.

BOSTON, MASS.,  
*December, 1942.*

# CONTENTS

	PAGE
EDITOR'S PREFACE . . . . .	v
FOREWORD BY DR. W. R. G. BAKER, CHAIRMAN, N.T.S.C. . . . .	ix
CHAPTER I	
TELEVISION STANDARDIZATION IN AMERICA . . . . .	1
The Need for Standardization. The R.M.A. Committee on Television. Its Recommendations from 1936 to 1940. The R.M.A. Standards Recommended to the FCC. FCC Action Permitting Limited Commercialization. Beginning of Public Television Service in New York. FCC Withdrawal of Limited Commercialization. The Formation of the N.T.S.C., Its Purpose, Membership, and Organization.	
CHAPTER II	
THE NATIONAL TELEVISION SYSTEM STANDARDS . . . . .	18
Report on the N.T.S.C. to the FCC. Cross Index to the Following Chapters.	
CHAPTER III	
TELEVISION SYSTEMS . . . . .	26
The Record of Panel 1. Tabulation of Television Systems. Outline for Analysis of Television Systems. Questionnaire on Color Television. Report on Flexibility in Television Standards.	
CHAPTER IV	
THE SUBJECTIVE ASPECTS OF TELEVISION. . . . .	46
The Record of Panel 2. Questionnaire. Index. Compilation of Answers to Questionnaire on Black-and-white Television, and on Color Television.	
CHAPTER V	
THE TELEVISION CHANNEL . . . . .	101
The Record of Panel 3. Report on Carrier Spacing. Report on Carrier Spacing with F-m Sound. Report on Experiments with F-m Sound in Television. Reports on Vestigial Sideband Transmission.	
CHAPTER VI	
THE TELEVISION TRANSMITTER . . . . .	134
The Records of Panels 4 and 5. Standards Recommended by Panel 4, with Excerpts from the Panel Report. Definitions Regarding Transmitter Operation. Reports on Rating of the	

Picture Transmitter. Relative Radiated Power on Picture and Sound Signals. Standards Recommended by Panel 5. Report on the Polarity of Modulation. D-c Transmission. Modulation Polarity and Black Level. Polarity and Black Level for F-m Picture Transmissions. Frequency Modulation for the Sound Channel.

## CHAPTER VII

THE TRANSMITTER-RECEIVER RELATIONSHIP. . . . . 162

The Record of Panel 6. The Receiver-attenuation Vestigial Sideband System. Reports on the RA and TA Systems. Audio Pre-emphasis. High-frequency Pre-emphasis of the Video Signal. Report on Logarithmic Transmission Characteristics.

## CHAPTER VIII

THE SCANNING SPECIFICATIONS . . . . . 195

The Record of Panel 7. The Aspect Ratio. The Scanning Velocities and Directions. Report on Frame and Field Frequencies for Television. Frequency Stability of 60-c.p.s. Systems. The Number of Lines in the Image. Recommendation for 525 Lines.

## CHAPTER IX

SYNCHRONIZATION OF THE PICTURE. . . . . 236

The Record of Panel 8. The Methods of Modulation for Picture and Synchronization. Reports on the Methods of Modulation. Subcommittee Findings on Modulation Methods. The Synchronization Waveform. Comparison of Three Waveforms. Synchronization Signal Characteristics. Characteristics of Vertical Separation Circuits.

## CHAPTER X

HORIZONTAL VS. VERTICAL POLARIZATION. . . . . 316

The Record of Panel 9. Summary of the Evidence Favoring Horizontal Polarization. Reports on Factors Influencing the Direction of Polarization. Antennas for Receivers. Self-contained Receiving Antennas. Antenna Design and Application Problems for Transmission.

APPENDIX I . . . . . 361

The Federal Communications Commission's Standards of Good Engineering Practice Concerning Television Broadcast Stations.

APPENDIX II. . . . . 378

FCC Rules Governing Commercial and Experimental Television Stations.

TECHNICAL PAPERS IN THE N.T.S.C. PROCEEDINGS . . . . . 387

INDEX. . . . . 393

## FOREWORD

Because of the inadequacy of the various suggested standards for television, the Federal Communications Commission stated, on May 28, 1940, that "full commercialization of television was promised by the Federal Communications Commission as soon as the engineering opinion of the industry is prepared to approve any one of the present competing television systems."

The Radio Manufacturers Association agreed to set up a committee comprising representatives of all companies and organizations interested in television. The resulting committee—the National Television System Committee—under the sponsorship of the Radio Manufacturers Association, undertook the formulation of a set of standards that would be acceptable to the engineers of the industry.

In the development of a new field such as television, unnecessary standardization would discourage the advancement of the art, whereas intelligent standardization should accelerate progress and encourage competition.

The National Television System Committee undertook its assignment at a time when television standards were in a very confused state. Its first problem was to establish a basis for mutual respect and earnest cooperation. With these basic requirements firmly fixed, the chances were good that those best compromises which are fundamental to all sound standardization would be developed.

The National Television System Committee contrived to be and, in retrospect, most happily shows itself to have been composed of the best engineering brains and experience organized to develop a sincere scientific opinion for presentation to a national regulating body of great and soundly administered power.

That the Federal Communications Commission finally accepted the recommendations of the National Television System\* Committee was in no small degree due to the interest, encouragement,

and personal concern of the Chairman of the Federal Communications Commission, Mr. J. Lawrence Fly.

It is, therefore, with pleasure, that I accept this opportunity to express, for myself and for the members of the National Television System Committee, our appreciation of his part in the work; and to extend to his associates on the Commission, and on its staff, our pleasure at having worked jointly and successfully on so important a project.

W. R. G. BAKER.

BRIDGEPORT, CONN.,  
*November, 1942.*

# TELEVISION STANDARDS AND PRACTICE

## CHAPTER I

### TELEVISION STANDARDIZATION IN AMERICA

The technical arts are usually offered to the public without benefit of standardization. The early histories of the railroads, of electric light and power, and of radio show that these public services were standardized only after bitter experience had proved such a step absolutely necessary. Each was in its first stages a gamble. Only after public approval had been won and the demand for the service had become universal did the need for standards of operation appear.

Television is a notable exception to this tendency. The need for standards had been appreciated long before television was permitted to appear commercially. Governmental authority was given for commercial broadcasting in the United States only after the standards had been debated at length (for some 12 years) in industry committee meetings and in public hearings.

The work of standardization went through a series of technical revolutions and finally culminated in the organization of the National Television System Committee. This committee, in the space of a few months, secured practical unanimity on questions that had split the industry into separate camps of opinion a year previously. The committee accomplished a distinguished piece of work thoroughly and in a short time.

Three causes contributed to the fact that standards for television received close scrutiny prior to commercialization of the art. In the first place, television is an offshoot of sound broadcasting, part and parcel of the radio industry. The radio industry has all too vivid a memory of the chaotic conditions in the early days of broadcasting. Strong industry action in 1925, under the direction of the Federal Radio Commission, produced

such immediate benefit for the public and so enhanced the acceptance of radio that little further proof of the basic necessity of standards was needed.

In the second place, the Federal Communications Commission, carrying on the tradition of the earlier Federal Radio Commission, made good use of its experience in the regulation of public services. The members of the commission insisted that standards for television, as well as for other services, be set only when the members of the industry were in substantial agreement as to the form they should take. The commission took the stand that, prior to such agreement, the art must remain in the experimental stage. The government and the industry agreed that standardization must precede, not follow, the initial offering of the art to the public on a commercial basis.

Finally, and perhaps most fundamentally, television transmission and reception in their very nature demand a greater degree of standardization than is required of sound broadcasting or, for that matter, of most other widespread public services. The lock-and-key relationship between television transmitter and receiver has been overemphasized at times, but its fundamental truth cannot be gainsaid. Public television service without standards is economically and socially unsound if not, in fact, practically impossible.

The fact remains that standardization must be confined to those matters that require it. The dividing line between essential matters and nonessential ones is, however, not an easy one to draw. It is hopeless, for example, to attempt to produce a receiver capable of reproducing all transmissions of any transmitter within range without standards defining the type of scanning to be employed. This is clearly an essential matter. So also is establishing the positions and widths of the channels employed by the transmitters.

The question of the numerical constants employed in scanning, on the other hand, is not so straightforward, since receivers can be built to operate over a range of scanning values. If such a range can be shown to serve a purpose sufficient to justify the cost of obtaining it, the scanning standards might well be written in terms of a range of values rather than in terms of fixed figures. If such variability in standards is shown to be undesirable, fixed values must be selected from among those proposed. In point



of fact, the matter of flexibility in scanning was a matter that occupied much attention in the deliberations of the N.T.S.C.

Such decisions are best made with the judgment of many minds, guided by intelligent foresight and backed by experimental tests of the relative merits of differing proposals. It is thus no accident that even the most obvious problem in standards profits from discussion and observation in committee. Committees are, however, slow to action. Committees dealing with the quasi-permanent setting of standards are the slowest of all, because the responsibility of a wrong judgment lasts a long time.

The history of the National Television System Committee is remarkable, therefore, by virtue of the fact that it accomplished the work of drawing up standards and reporting to the FCC in less than 6 months. During this time, the 168 members of the Committee and the Panels produced reports and minutes totaling 600,000 words, devoted 4,000 man-hours to meetings and an equal time to travel, and witnessed 25 demonstrations of technical matters. This is a monumental record.

The chairman of the FCC, James Lawrence Fly, in opening the meeting on Jan. 27, 1941, paid the following tribute to the committee: "This is another example of the best that is in our democratic system, with the best in the industry turning to on a long and difficult job in an effort to help the government bodies in the discharge of their functions so that a result may be achieved for the common good of all."

#### THE R.M.A. BACKGROUND

Abundant as the record of the N.T.S.C. is, it is clear that the work could not have been accomplished in the time taken, nor could the unanimity of opinion have been assembled, if years of preliminary work on standards had not been carried out by a series of committees formed within the organization of the Radio Manufacturers Association.

#### THE R.M.A. COMMITTEE ON TELEVISION

The R.M.A. Committee on Television was active as early as 1929, before the modern cathode-ray system was fully developed. The early work was primarily one of experimentation with the rudimentary forms of mechanical scanning and occasional reports to the membership of the R.M.A. concerning the current

state of the art. In 1929, the first paper on standards for television was published by Weinberger, Smith, and Rodwin.<sup>1</sup> These early attempts to standardize the art seem highly premature from the standpoint of present developments, as indeed were the early attempts to interest the public in a television service based on low-definition pictures.

By 1935, demonstrations of cathode-ray television employing 343 lines had been made to members of the R.M.A. and to the press. In 1935, the engineering department of the R.M.A. was instructed by its board of directors to determine when it would be advisable to adopt television standards. The investigation by the engineering group was watched with interest by the engineers of the FCC. In 1936, Commander T. A. M. Craven, then chief engineer of the commission, in a letter to the chairman of the standards section of the R.M.A., stated the philosophy that guided the commission and the industry in all the subsequent work:

The engineering department of this commission is very much interested in performance standards for visual broadcasting stations, but it is the feeling of this department that, if possible, various branches of the industry should come to an agreement among themselves prior to any commission action.

It is our present opinion that the ultimate performance standards which are adopted should be such that any receiver manufactured for the public would be capable of receiving any visual broadcasting transmitting station which may be licensed by the commission.

We are interested in information as to whether or not it will be possible for the industry to agree upon any standards in the near future if it were admitted that there has been developed a system which, from the engineering standpoint, would permit satisfactory visual broadcasting.

In the same year, 1936, Commander Craven set forth the necessity for making allocations in the ether spectrum for television stations. The commission announced that hearings would be held, beginning June 15, 1936, to determine a basis for long-time policies in the future allocations of the limited facilities, not only for television but for broadcasting and radio communication as well.

<sup>1</sup> The Selection of Standards for Commercial Radio Television, *Proc. I.R.E.*, 17, 1584 (September, 1929).

Two committees of the R.M.A., one on television standards, the other on allocations, went to work in preparation for these hearings and prepared a joint report that was submitted to the FCC. Concerning allocations, their recommendation was that seven television channels, each 6 Mc/s wide, should be set up in the region between 42 and 90 Mc/s, and that experimental channels should be allocated on a band beginning at 120 Mc/s.

The standards recommended at the time constituted an incomplete list on which substantial agreement had been obtained. The principal features of the recommended system were a 441-line picture sent at a rate of 30 complete pictures per second, interlaced in two fields per frame. Double-sideband transmission was recommended, with 3.25 Mc/s separation between the sound- and picture-carrier frequencies. The aspect ratio of the picture was set at 4:3. The recommended polarity of the transmission was negative. The problem of determining a satisfactory standard for synchronization proved difficult, but it was recommended that the blanking period be one-tenth of the time required to scan a line and to scan one field, for the horizontal and vertical periods respectively. The synchronizing pulses were to occur approximately at the leading edge of the blanking pulses, but no further recommendations were made as to their form. The amplitude of the picture carrier devoted to the synchronizing signals was limited to not less than 20 per cent. The first published report<sup>1</sup> on these standards was prepared by A. F. Murray, then acting chairman of the R.M.A. Committee on Television.

When these proposals are compared with the commercial standards adopted 5 years later, it is clear that the workers who developed them had a clear insight into the problems of the art. The standards now officially in use differ numerically from the early proposals in every particular but the aspect ratio, but the differences are ones merely of degree. The importance of the contribution of the committee members in setting up this list of standards in 1936 can hardly be overemphasized. They determined what matters require standardization in a television system. Only three additional major items relating to picture transmission have been treated by the N.T.S.C., namely, the direction of polarization of the transmitted wave, the transmission

<sup>1</sup> Latest Television Standards as Proposed by R.M.A., *R.M.A. Engineer*, 1, 1 (November, 1936).

of the d-c component, the specification of maximum percentage modulation. With a few exceptions, the members of the committee that drew up these early standards later served as members of the N.T.S.C. organization.

The broader aspects of television policy presented by the R.M.A. to the FCC in these hearings were formulated in a five-point plan by the Committee on Television, as follows:

1. One single set of television standards for the United States, so that all receivers can receive the signals of transmitters within range.

2. A high-definition picture, approaching ultimately the definition obtainable in home movies.

3. A service giving as near nation-wide coverage as possible.

4. A selection of programs—*i.e.*, simultaneous broadcasting of more than one program in as many localities as possible.

5. The lowest possible receiver cost and the easiest possible tuning.

The R.M.A. report also stated:

The commission will have the responsibility of making definite broadcasting assignments, assignments that will ensure the greatest possible service to each locality, assignments that will not lead to any monopoly, assignments that will preserve the American system of competition but which will prevent the creation of so many competitive stations that none will have enough revenue to provide fine programs.

In August, 1936, the FCC announced regulations that opened up the region from 42 to 56 Mc/s and from 60 to 86 Mc/s for experimental transmissions on channels 6 Mc/s wide. The commission took no action on the proposed standards of transmission, however, since the transmissions were to be of experimental nature, and since the standards were then in an incomplete state. Experimental transmissions were authorized also in any 6 Mc/s band above 110 Mc/s, excluding the amateur region from 400 to 401 Mc/s.

In the following years, 1937 and 1938, the R.M.A. Committees worked intensively to round out the list of standards and to obtain agreement on them in all quarters of the industry. A "recommended practice" specifying the horizontal direction of polarization for the transmitted carriers was agreed upon. An upper limit of 25 per cent was placed on the percentage of the

picture carrier devoted to synchronizing. D-c transmission of the background brightness of the picture was specified. Standards for transmission of the sound signal were drawn up. The uncertainty regarding the synchronizing-signal waveform was removed by the adoption of R.M.A. standard T-111, which specified the constant-amplitude system, the vertical pulses being of the serrated form with additional equalizing pulses introduced to improve the interlacing of the frames. In July, 1938, Acting Chairman A. F. Murray was able to report<sup>1</sup> that the complete system of standards had been agreed upon by his committee. These standards were submitted to the FCC, and their official adoption was urged by the R.M.A. Board of Directors, early in 1938.

Only one important change impended. By 1938, it was evident that the single-sideband system of transmission would soon become a practical reality. Lack of a sufficient test of this system in the field had prevented the writing of a definite standard, but in 1938 the frequency separation between sound and picture carriers was increased to 4.5 Mc/s in anticipation of the event, superseding the 3.25 Mc/s separation that had previously been recommended for double-sideband transmission.

The synchronization waveform standard was passed by the Subcommittee on Television Standards, by a vote of 6 to 1, in May, 1938. This standard, together with that specifying negative transmission and that specifying 4.5 Mc/s bandwidth for the picture-signal sideband, was approved by the Television Committee and reported, together with the other standards previously agreed upon, to the R.M.A. Board.

In June, the R.M.A. Board approved the submission of the standards to the FCC, but suggested additional study by the Television Committee for simplification and clarification. In July the Television Committee met for this purpose, carried out the board's recommendations, and then went on to discuss three new standards: the specification of 25 per cent as the maximum carrier amplitude for maximum white in the picture; the specification of rated transmitter power as one-fourth its peak power; and the specification of approximately equal power for the sound and picture transmitters. Since no board meeting was scheduled

<sup>1</sup> R.M.A. Completes Television Standards, *Electronics*, 11, (7), 28 (July, 1938).

at which these additions might be approved, the entire list of standards was submitted to the whole membership of the association in August. No objections to the standards were received, and accordingly on Sept. 10, 1938, all the standards were submitted to the FCC.

On the twenty-eighth of that month, the FCC requested the names of the members of R.M.A. and the individuals who participated in forming the standards, and asked whether the R.M.A. believed the FCC should call formal hearings with respect to the adoption of standards. The R.M.A. complied with this request and suggested that formal hearings should be held. In February, 1939, a committee of engineers of the R.M.A. met informally with the engineering department of the FCC and the technical background of each of the standards was presented. The hearings were not held, however, until January, 1940.

In the meantime activity had commenced in the direction of a public television program service, based on the standards recommended by the R.M.A. In October, 1938, just after the R.M.A. standards were submitted to the FCC, the Radio Corporation of America announced its intention to begin a limited production of television receivers for the public and to start a limited program service based on the R.M.A. standards from the National Broadcasting Company's transmitter in New York. The inauguration of this service was to coincide with the opening of the New York World's Fair, on Apr. 30, 1939. The service planned was limited to a minimum of 2 hr. a week, but it was the first occasion on which the public was to be invited to participate in the development of high-definition television. As such it occasioned considerable notice in the press.

Not all members of the industry considered the RCA plans wise. The Zenith Corporation gave immediate opposition to the plan. The Philco Corporation also opposed the immediate introduction of the art to the public, on the ground that an insufficient number of homes could be served. Other members of the industry, however, made plans to offer receivers to the public in the New York area on or soon after the announced date of the beginning of public service.

Before the eventful day arrived, however, a new standard was approved, which permitted a substantial improvement in the quality of the reproduced picture. This was the standard

specifying vestigial sideband transmission. Throughout the latter part of 1938 it had become increasingly clear that the effective frequency range occupied by the television signal might be increased from 2.5 Mc/s to more than 4 Mc/s, with a proportionate increase in the picture detail, if vestigial sideband transmission were adopted.

Laboratory tests had proved feasible two systems, both of which involved attenuating the picture-carrier signal to one-half its normal voltage. The question was whether the attenuation should occur in the transmitter ("transmitter attenuation," or TA system) or in the receiver ("receiver attenuation," or RA system). After long and active discussion over a period of several months, the RA system was finally adopted as standard, approval being voted by the R.M.A. Committee on Television, Jan. 19, 1939. The opening of the RCA service was then less than 4 months away. The engineers of the NBC transmitter, as well as those preparing receivers for the public, worked overtime to bring the equipment in line with the new standard. The change-over was accomplished within the remaining time, and the NBC transmitter went on the air on schedule. The first program specifically intended for the public (although it had been preceded by many hours of test programs) was appropriately the speech of President Roosevelt as he opened the New York World's Fair.

Throughout 1939 an augmented schedule of programs was maintained by the NBC transmitter in New York. The transmissions conformed in all particulars to the R.M.A. standards then in the hands of the FCC. No official action on these standards had been taken, but it was assumed by most observers that they would eventually be adopted by the commission. This feeling was strengthened by the action of the FCC, in December, 1939, when the commission tentatively adopted new rules governing television broadcasting. These rules modified the then existing prohibition against commercialism and permitted a limited form of program sponsorship under certain conditions. The facilities and funds contributed by sponsors were to be used primarily for experimental development of television program service. Other forms of commercial sponsorship were prohibited. Two classes of stations were set up: Class II offered a scheduled public program service; Class I broadcast on an unscheduled

experimental basis. The rules were adopted pending a public hearing to be held Jan. 15, 1940, at which all those interested were invited to state their views.

At this hearing a break in the ranks of the industry became for the first time clearly apparent. The standards that had been submitted by the R.M.A. the previous year were subject to sharp attack from two organizations. The Allen B. DuMont Laboratories, which was not a member of the R.M.A. and hence had not participated in the forming of the standards, objected that the standards were too inflexible. This organization argued that 441 lines did not provide sufficient detail and urged that a variable number of lines be employed to meet future contingencies. Mr. DuMont urged also that a lower rate of frame repetition than 30 per second was feasible and would permit greater detail in the pictures. He suggested a flexible frame rate between 15 and 30 frames per second. A cathode-ray screen designed to minimize flicker, when a low frame rate was used, had previously been demonstrated by the DuMont organization to the R.M.A. Committee on Television in December, 1939, but the results were deemed inconclusive by the committee.

The second attack came from the Philco Radio and Television Corporation. The recommended practice specifying horizontal polarization was criticized as a wrong choice that would operate to the disadvantage of receivers employing self-contained antennas. Philco also objected to the 441-line standard, suggesting a much higher value (800 lines) and a slightly lower frame rate (24 per second).

Witnesses from other organizations gave full support to the R.M.A. proposed standards. RCA engineers urged that the low frame rate of 15 pictures per second suggested by the DuMont Laboratories would intensify the problem of flicker and blurred motion in the image.

This lack of unanimity on the proposed standards made a deep impression on the members of the commission. On Feb. 29, 1940, the commission issued a report adopting with minor changes the rules concerning commercial operation which had previously been adopted tentatively. Sponsored program service, on a limited basis, was to be permitted on and after Sept. 1, 1940. But the report made no decision concerning the proposed standards; in fact it warned against "freezing" the standards.



The commission's attitude on standardization was summed up in its report:

The commission therefore recommends that no attempt be made by the industry or its members to issue standards in this field for the time being. In view of the possibilities for research, the objectives to be obtained, and the dangers involved, it is the judgment of the commission that the effects of such an industry agreement should be scrupulously avoided for the time being. Agreement upon standards is presently less important than the scientific development of the highest standards within reach of the industry's experts.

Whether or not this attitude was wise is a matter for argument. In any event, with it came a problem of interpretation which the industry found difficult to solve.

The question of interpretation arose from the fact that limited commercial sponsorship of programs was to be permitted before the end of the year, but the standards on which the service was to be operated were not specified. Two courses of action were open: The industry could assume the standards to be in a state of such rapid development that no serious commercial operation, despite the official permission, was possible. Or it could be assumed that the standards were satisfactory as they stood, despite the lack of official approval, and could be used as the basis for plans to commercialize the art.

The second course was adopted by RCA, which announced early in 1940 plans to step up production of television receivers, to reduce prices, and to enlarge the broadcasting schedule. But on Mar. 22, 1940, the FCC announced that it had decided to reconsider, at a hearing to be held Apr. 8, its intention to permit limited commercial operation of television broadcasting stations. The reason given for this action was the commercial activity of the RCA in marketing television receivers. The FCC viewed this action as one tending to freeze the standards on which the receivers and transmitters were then operating (the R.M.A. standards). Such freezing of the standards would, the commission stated, tend to discourage research and experimentation with systems based on, or requiring, other standards.

At the hearing, the DuMont and Philco organizations maintained the positions they had taken previously regarding the R.M.A. standards and agreed that the action of the RCA had

caused them to abandon research with systems outside the scope of the R.M.A. standards. The RCA witnesses stated that they had adopted the R.M.A. standards because they felt they represented the majority opinion of the industry's engineers and were the best standards with which to begin commercial operation. They noted that they were willing, however, to adopt any other standards that might be specified by the commission in licensing transmitters for public-program service. Other witnesses stated that the R.M.A. standards would admit within their scope a large degree of progress and improvement without causing obsolescence of equipment previously sold to the public.

In the FCC report on this hearing, issued in May, the commissioners promised commercialization of the art when the industry was prepared to agree on any one system of broadcasting. The commissioners agreed that the plan of limited commercialization without previously setting the standards was not feasible. The commercial class of station (Class II) set up in the rules was therefore eliminated. In its report the commission stated:

It is, therefore, the conclusion of the commission that in order to assure to the public a television system which is the product of comparative research on known possibilities, standards of transmission should not now be set. It has further been decided that there should be no commercial broadcasting with its deterring effects upon experimentation until such time as the probabilities of basic research have been fairly explored.

In eliminating "limited" commercialization, the report stated:

As soon as the engineering opinion of the industry is prepared to approve any one of the competing systems of broadcasting as the standard system, the commission will consider the authorization of full commercialization.

No time limit can now be set for the adoption of standards. The progress of the industry will largely determine this matter. The commission will continue its study and observation of television developments and plans to make a further inspection and survey in the early fall. Meanwhile the commission stands ready to confer with the industry and to assist in working out any problems concerned with television broadcasting.

This was in May, 1940. Fourteen months later, on July 1, 1941, full commercial operation of television stations began with

the approval of the commission. In the short intervening time the plan for the National Television System Committee had been formulated, the committee assembled, its meetings held, its minutes recorded, technical reports compiled, and its final report delivered to the commission.

The N.T.S.C. standards resulted from a thorough reexamination of every phase of the television art relating to public service. The front displayed by the industry at the conclusion of the committee work was, if not wholly solid, as uniform as any that can be expected to result from a democratic process. The authority of the committee's judgment was manifest at the hearing, held on Mar. 20, 1941, at which their recommendations were made to the FCC. By that time the complexion of the industry had changed from a discord of counterclaims to a concord of expert opinion which left the commission no choice but to acknowledge its value and to proclaim the art open to the public.

The concept of the N.T.S.C. arose in a meeting between Dr. W. R. G. Baker, director of engineering for the R.M.A., and Chairman Fly of the FCC. It was decided to open the deliberations to all members of the industry technically qualified to participate, whether they were members of the R.M.A. or not. A plan designed to segregate the technical work into panels of specially qualified experts was drawn up, and a parliamentary procedure was agreed upon which would reveal clearly the responsibility for the actions taken.

The detailed planning of the N.T.S.C. organization was carried out by three men: Dr. Baker, L. C. F. Horle, in charge of the R.M.A. Data Bureau, and I. J. Kaar, then chairman of the R.M.A. Committee on Television. The soundness of the plan was proved by the efficiency with which the Committee and its Panels functioned.

The organization of the committee members was completed, and its first meeting was held July 31, 1940. At that time the following statement concerning the committee and its organization was issued:

**Reason and Purpose.**—Because of the inadequacy of the various suggested standards for television, it is proposed to establish a committee for the purpose of developing and formulating such standards as are required for the development of a suitable national system of television broadcasting.

This project, sponsored by the R.M.A. in cooperation with the FCC, will be maintained independent of any other organization and will be truly representative of the majority opinion of the industry.

**Committee and Membership.**—Members of the N.T.S.C. will be appointed by the president of the R.M.A., subject to the approval of the executive committee of R.M.A., and will consist of representatives of those organizations broadly interested and experienced in the television field. In addition, there will be included representatives of such national technical organizations as are vitally interested in the research and development of television as well as individuals not associated with any organization, association, or company.

The N.T.S.C. and its component panels will be responsible for the investigation and study of all phases of a national television system. It will concern itself not only with projects that have reached the engineering and developmental stage but also with such research and experimentation as has a bearing on the system aspects and on the broad psychological and physiological aspects of television picture reproduction.

The following organizations have been requested to appoint one representative to the N.T.S.C.:

Bell Telephone Laboratories.  
Columbia Broadcasting System.  
Don Lee Broadcasting System.  
DuMont Laboratories, Inc.  
Farnsworth Television and Radio Corporation.  
General Electric Company.  
Hazeltine Service Corporation.  
John V. L. Hogan.  
Hughes Tool Company.  
Institute of Radio Engineers.  
Philco Corporation.  
Radio Corporation of America.  
Stromberg-Carlson Telephone Mfg. Company.  
Television Productions.  
Zenith Radio Corporation.

A quorum for the N.T.S.C. will comprise 75 per cent of its membership, and a majority vote of those present will be required for the approval of any proposal. The chairman of the N.T.S.C. will have no vote.

**Panel Purpose and Functions.**—The various projects may be assigned to individual members of the N.T.S.C. or to panels appointed by the chairman of the N.T.S.C.

In the operations of the panels, a quorum for any working meeting will comprise 50 per cent of the membership of the panel, and a majority vote of those present will be required for the approval of any proposal. The chairman of a panel may vote only in case of a tie.

In the event of the lack of a quorum present at any announced meeting of either the N.T.S.C. or any of its panels, action may be taken by a majority vote of those present, but such action will not be valid unless, and until, three quarters of the total membership of the N.T.S.C. or panel, as the case may be, approves such action by correspondence.

The members of the panels will be drawn from any company, association, or organization regardless of affiliation and may also include individuals not associated with any organization. The only requirement for membership on any panel is recognized skill, interest, and ability in the assigned project.

The titles and scopes of the initial panels are

1. *System Analysis.*—The analysis of foreign and proposed American television systems.

2. *Subjective Aspects.*—The influence of physiological and psychological factors in the determination of television system characteristics.

3. *Television Spectra.*—Consideration of sound and picture channel widths and locations.

4. *Transmitter Power.*—The consideration of transmitter output ratings, modulation capabilities and the relation between power requirements of picture and sound channels.

5. *Transmitter Characteristics.*—Consideration of essential systems. Characteristics of the transmitter (signal polarity, black level, etc.).

6. *Transmitter-receiver Coordination.*—Consideration of the essential factors requiring coordination in the design of receivers and transmitters (sideband distribution, audio pre-emphasis, etc.).

7. *Picture Resolution.*—Consideration of the factors influencing picture detail (aspect ratio, frame frequency, interlace, line density, etc.).

8. *Synchronization*.—Consideration of methods and means of accomplishing synchronization.

9. *Radiation Polarization*.—Consideration of the factors influencing a choice of the polarization of the radiated wave.

As the work proceeds, additional panels will be appointed as necessity arises.

**Panel Reports**.—Upon the completion and approval of the assigned project by a panel, a final report stating both the majority and minority opinions, together with a complete record of all meetings, will be submitted to the N.T.S.C. for its approval.

**Meetings and Records**.—Meetings of the N.T.S.C. and its panels shall be called at the discretion of the respective chairmen with notification to the members at least 1 week prior to the meeting date.

The chairman of the N.T.S.C. will appoint secretaries for the N.T.S.C. and its component panels.

Detailed minutes will be kept of all meetings and will record the names and votes of all voting, together with a clear statement of any minority opinion.

The minutes of all meetings shall be circulated to those attending the meeting and when approved shall constitute "official minutes."

Official minutes will then be distributed to all members of the N.T.S.C. and its component panels, the engineering department of the FCC and such others as may be approved by the executive committee of the R.M.A.

**Approval and Transmission of Proposed Standards**.—As standards are approved by the N.T.S.C. they will be submitted to the FCC by the board of directors of the R.M.A.

Following the initial meeting of the National Committee, the panel membership was completed, and panel meetings began early in September. By the end of December, the final reports of all the panels had been transmitted to the National Committee. During the first 2 weeks of January, 1941, a coordinating and editing committee prepared a report embodying the standards and other recommendations made by the panels. The National Committee, at its fourth meeting, on Jan. 14, considered these standards at length, modified the wording in certain particulars, and prepared and approved a "progress report," which was presented to the FCC on Jan. 27. The chairmen of the panels

took the stand before the commission at that meeting and outlined in detail the substance of each panel's work and the technical background of the standards under their jurisdiction.

At this progress report meeting it became clear that the members of the FCC were satisfied that substantial agreement had been obtained on all the standards except that specifying 441 as the number of lines and that specifying amplitude modulation for the synchronization signals. Chairman Fly, in summing up the meeting, stated that the question of the synchronization signals and the question of color television were subjects on which further deliberation seemed advisable.

A special subcommittee was then set up to consider the synchronization-signal problem, which had by that time been definitely reopened by experimental tests of a system employing frequency modulation for the synchronizing pulses, which seemed to have merit. Acting on the recommendations of this subcommittee, the National Committee in its final meeting, on Mar. 8, rewrote the standard concerning synchronization, so as to admit the use of frequency modulation. At the same meeting, the committee approved the value of 525 lines as the standard for the number of lines per frame period. The change was based on demonstrations made by the Bell Telephone Laboratories of the small effect on picture quality of the relative resolution in the vertical and horizontal dimensions, as well as on the fact that the larger number of lines would provide a more uniform field of illumination in the reproduced picture.

The final report of the N.T.S.C., delivered to the commission at the hearings on Mar. 20, recommended the standards reported at the progress-report meeting, with the two changes mentioned above. The only opposition given to the standards at that time was put forward by the DuMont Laboratories, which urged that a variable number of lines and frames per second should be used.

Early in May the FCC announced that the N.T.S.C. standards had been adopted officially and that commercial television broadcasting based on these standards would be permitted on and after July 1, 1941.

## CHAPTER II

### THE NATIONAL TELEVISION SYSTEM STANDARDS

The work of the National Television System Committee<sup>1</sup> culminated in the hearing held before the Federal Communications Commission, Mar. 20, 1941. At this hearing the N.T.S.C. presented a report consisting of 22 specific standards and explanatory notes. The text of this report is reproduced in the following paragraphs. Immediately following the report, a brief outline of the standards is presented to correlate the following chapters in which the standards are treated in greater detail.

**Report of the N.T.S.C. to the FCC.**—The text of the N.T.S.C. report is as follows:

The National Television System Committee herewith submits transmission standards for commercial television broadcasting. The N.T.S.C. recognizes the coordinate importance of standardization and the commercial application of technical developments now in the research laboratories. These standards will make possible the creation, in the public interest, of a nationally coordinated television service and at the same time will ensure continued development of the art.

The N.T.S.C. recommends that monochromatic transmission systems other than those embodied in these standards be permitted to operate commercially, when a substantial improvement would result, provided that the transmission system has been adequately field tested and that the system is adequately receivable on receivers responsive to the then existing standards.

<sup>1</sup> The members and alternates of the National Television System Committee were W. R. G. Baker, chairman; V. M. Graham, secretary; Ralph Bown, D. A. Quarles, alternate; Adrian Murphy, P. C. Goldmark, alternate; A. B. DuMont, T. T. Goldsmith, alternate; B. R. Cummings, P. J. Herbst, alternate; E. F. W. Alexanderson, I. J. Kaar, alternate; D. E. Harnett, W. A. MacDonald, alternate; A. I. Lodwick, A. F. Murray, alternate; A. N. Goldsmith, H. A. Wheeler, alternate; John V. L. Hogan, L. C. Smeby, alternate; D. B. Smith, F. J. Bingley, alternate; E. W. Engstrom, C. B. Jolliffe, alternate; R. H. Manson, G. R. Town, alternate; Paul Raiborn, K. Glennan, alternate; John R. Howland, J. E. Brown, alternate.



The N.T.S.C. has broadened its standards on synchronization to permit field tests of several interchangeable systems. It is anticipated that some one of these systems will be found to be superior to the others, and it is, therefore, recommended that at that time the commission's standards be narrowed to require the commercial use of that particular and superior system (see Note A, page 21).

The N.T.S.C. believes that, although color television is not at this time ready for commercial standardization, the potential importance of color to the television art requires that

- (a) a full test of color be permitted and encouraged, and that
- (b) after successful field test, the early admission of color transmissions on a commercial basis coexistent with monochromatic television be permitted employing the same standards as are herewith submitted except as to lines and frame and field frequencies. The presently favored values for lines, and for frame and field frequencies for such a color system are, respectively, 375, 60, and 120.

The proposed standards are as follows:

### I. THE TELEVISION CHANNEL

1. The width of the standard television broadcast channel shall be 6 Mc/s.

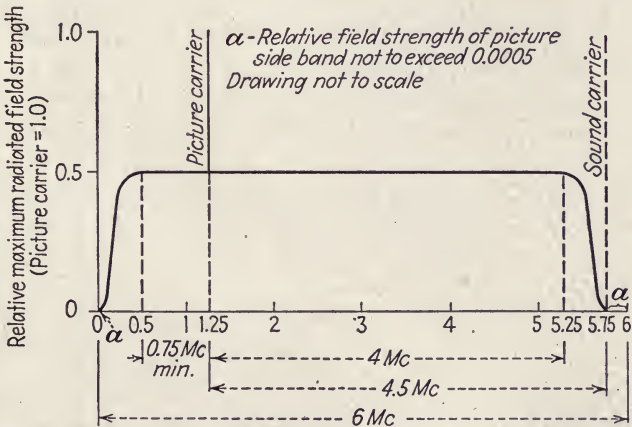

FIG. 1.—Idealized picture transmission amplitude characteristic.

2. It shall be standard to locate the picture carrier 4.5 Mc/s lower in frequency than the unmodulated sound carrier.

3. It shall be standard to locate the unmodulated sound carrier 0.25 Mc/s lower than the upper frequency limit of the channel.

4. The standard picture-transmission amplitude characteristic shall be that shown in Fig. 1.

## II. SCANNING SPECIFICATIONS

5. The standard number of scanning lines per frame period in monochrome shall be 525, interlaced two to one.

6. The standard frame frequency shall be 30 per second, and the standard field frequency shall be 60 per second in monochrome.

7. The standard aspect ratio of the transmitted television picture shall be 4 units horizontally to 3 units vertically.

8. It shall be standard, during the active scanning intervals, to scan the scene from left to right horizontally and from top to bottom vertically, at uniform velocities.

## III. PICTURE SIGNAL MODULATION

9. It shall be standard in television transmission to modulate a carrier within a single television channel for both picture and synchronizing signals, the two signals comprising different modulation ranges in frequency or amplitude or both (see Note A, 1, page 21).

10. It shall be standard that a decrease in initial light intensity cause an increase in radiated power.

11. It shall be standard that the black level be represented by a definite carrier level, independent of light and shade in the picture.

12. It shall be standard to transmit the black level at 75 per cent (with a tolerance of  $\pm 2.5$  per cent) of the peak carrier amplitude.

## IV. SOUND SIGNAL MODULATION

13. It shall be standard to use frequency modulation for the television sound transmission.

14. It shall be standard to pre-emphasize the sound transmission in accordance with the impedance-frequency characteristic of a series inductance-resistance network having a time constant of 100 microseconds.

## V. SYNCHRONIZING SIGNALS

15. It shall be standard in television transmission to radiate a synchronizing waveform that will adequately operate a receiver which is responsive to the synchronizing waveform shown in Fig. 2.

16. It shall be standard that the time interval between the leading edges of successive horizontal pulses shall vary less than 0.5 per cent of the average interval.

17. It shall be standard in television studio transmission that the rate of change of the frequency of recurrence of the leading edges of the horizontal synchronizing signals be not greater than 0.15 per cent per second, the frequency to be determined by an averaging process carried out over a period of not less than 20, nor more than 100, lines, such lines not to include any portion of the vertical blanking signal (see Note B, page 24).

## VI. TRANSMITTER RATINGS

18. It shall be standard to rate the picture transmitter in terms of its peak power when transmitting a standard television signal.

19. It shall be standard in the modulation of the picture transmitter that the radio-frequency signal amplitude be 15 per cent or less of the peak amplitude, for maximum white (see Note C, page 24).

20. It shall be standard to employ an unmodulated radiated carrier power of the sound transmission not less than 50 per cent nor more than 100 per cent of the peak radiated power of the picture transmission.

21. It shall be standard in the modulation of the sound transmitter that the maximum deviation shall be  $\pm 75$  kc per sec.

## VII. POLARIZATION

22. It shall be standard in television broadcasting to radiate horizontally polarized waves.

NOTE A: 1. Practical receivers of the RA type (those which attenuate the carrier 50 per cent before detection) designed for the synchronizing signals shown in Fig. 2 will also receive interchangeably any of the following:

- a. Amplitude-modulated synchronizing and picture signals of the 500-kc vertical synchronizing pulse type (Drawing IV, Fig. 1), Doc. 321R. [Fig. 80, page 282. EDITOR.]



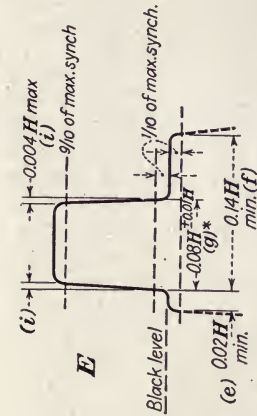

DETAIL BETWEEN E-E IN C

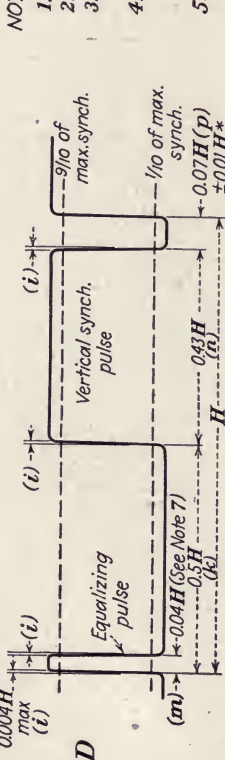

DETAIL BETWEEN D-D IN B

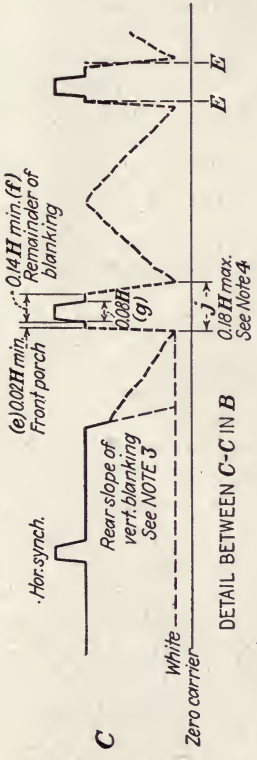

DETAIL BETWEEN C-C IN B

NOTES:

1.  $H$  = Time from start of one line to start of next line
2.  $V$  = Time from start of one field to start of next field
3. Leading and trailing edges of vertical blanking should be complete in less than  $0.1H$
4. Leading and trailing slopes of horizontal blanking must be steep enough to preserve min. and max. values (e+f) and (j) under all conditions of picture content.
- 5.\* Dimensions marked with an asterisk indicate that tolerances given are permitted only for long time variations, and not for successive cycles
6. For receiver design, vertical retrace shall be complete in  $0.07V$
7. Equalizing pulse area shall be between 0.45 and 0.5 of the area of a horizontal sync. pulse

FIG. 2 (continued).

- b. Synchronizing signals of the alternate carrier type with amplitude-modulated picture signals.
- c. Frequency-modulated picture and synchronizing signals.

2. It is proposed that during the commercialization period there be carried out systematic, comparative tests, of all the above-mentioned signals including transmissions from a single location to a number of representative receiving locations and over a reasonable test period. It is further proposed that these tests be directed and coordinated by an accredited committee of the R.M.A. or some other committee suitable to the FCC and that on the completion of these tests there be submitted to the FCC any modifications or additions to the N.T.S.C. standards that may be found desirable.

NOTE B: It is recommended that as progress in the art makes it desirable, the maximum rate of change of frequency of the transmitted horizontal synchronizing signals for studio programs be reduced and that limits be set for transmissions originating elsewhere than in the studio.

NOTE C: It is the opinion of the N.T.S.C. that a picture transmitter not capable of a drop in radio-frequency signal amplitude to 15 per cent or less of the peak amplitude would not be completely satisfactory since it would not utilize the available radio-frequency power to the best advantage. At the same time the N.T.S.C. is aware of the practical fact that it may not be possible for all of the first picture transmitters to satisfy this requirement. It should be possible to satisfy this requirement in picture transmitters for the lower frequency channels of Group A, although, at first, this may not be possible in picture transmitters for the higher frequency channels. After the first operation on the higher frequency channels and as designs progress it should be possible to satisfy it. It is requested that the FCC take cognizance of this situation.

Respectfully submitted,  
W. R. G. BAKER, CHAIRMAN

**Cross Index to Following Chapters.**—The following notes serve to connect the N.T.S.C. standards, enumerated in the preceding report, with the work of the various panels that were engaged specifically in their formulation.

The first four standards, having to do with the dimensions of the television channel, were drawn up by Panel 3 (Chap. V, pages 101-133). The first standard, specifying 6 Mc as the channel width, was assumed as a basis of discussion by all the panels during their deliberations. This assumption arose from the fact that the FCC had previously set up the experimental television allocations on the basis of a 6-Mc channel and had indicated that no increase in this figure could be accommodated. Standard 4 specifying the vestigial sideband transmission characteristic (Fig. 1) was also recommended independently by Panel 6, since this is a matter requiring close coordination between transmitter and receiver (Chap. VII, pages 162-194).

The second group of standards, having to do with the scanning specifications, were drawn up by Panel 7 (Chap. VIII, pages 195-235) with the exception of standard 5, specifying 525 lines as the number of scanning lines per frame period. The recommendation of Panel 7 in this respect was 441 lines. The National Committee, at the meeting of Mar. 8, 1941, considered this matter at some length and finally adopted the recommendation of 525 lines. A brief recommending the latter figure, prepared for the National Committee by D. G. Fink, is printed at the conclusion of Chap. VIII (page 225).

The next group of four standards, 9 to 12 inclusive, were based on recommendations of several panels. Standard 9 was composed by the National Committee, following the recommendation of Panel 8, but allowing the alternative use of frequency modulation for the synchronizing pulses. This latter action followed demonstrations that frequency-modulated signals might be employed with benefit to the performance of this system, and that such signals could be received adequately on receivers designed for amplitude modulation, provided only that the picture-carrier signal was attenuated in the receiver before final detection, so that the frequency-modulation signals would be converted into amplitude modulation. Note A in the report explains this situation further.

The following three standards, numbered 10 to 12 (negative transmission, d-c transmission, and black level fixed at 75 per cent  $\pm$  2.5 per cent), are based on the recommendations of Panel 5 (Chap. VI, pages 134-161), together with that of Panel 8 (Chap. IX, pages 236-315), which specified the black-level percentage in Fig. 2.

Standards 13 and 14, specifying frequency modulation and audio pre-emphasis for the sound transmissions were developed jointly by Panels 5 and 6 (Chaps. VI and VII, pages 134 and 162). The standards on the synchronizing signals (numbered 15 to 17) were developed by Panel 8 (Chap. IX, pages 236-315).

The four standards on transmitter ratings (numbered 18 to 21) were based on the recommendations of Panel 4 (Chap. VI, pages 134-161). Panel 5 also took action on the relative power of the sound and picture signals. The final standard, recommending horizontal polarization is based on the study conducted by Panel 9.

In addition to the specific standards, two panels were engaged in more general investigations. Panel 1 investigated systems in general, including color television. Material abstracted from their report appears in Chap. III. The findings of Panel 2, which investigated the subjective aspects of television system performance, are reproduced in Chap. IV.

## CHAPTER III

### TELEVISION SYSTEMS

To Panel 1<sup>1</sup> of the N.T.S.C. was assigned the task of analyzing the existing systems of television, both American and foreign, and considering proposed systems. Three studies were undertaken by the Panel in carrying out this assignment.

The first was a general study of television systems as such. Included in this work was the compilation of information on existing television systems. An elaborate outline for analyzing television systems was also prepared by the Panel. This outline describes alternate methods of scanning, synchronization, video transmission, and audio transmission. The advantages and disadvantages of each method are listed, together with the controlling advantage or disadvantage in each proposal.

The conclusions reached in this outline are directly in line with the standards finally adopted by the National Committee. For example, unidirectional linear scanning in the horizontal direction, interlaced two to one, is found preferable to the many alternative methods of image analysis. Amplitude separation of the synchronization information, and waveform separation of the vertical and horizontal components are also recommended. The full text of this outline is printed on pages 33-38. It will repay careful study, since it is the most comprehensive comparison of television system proposals ever prepared.

The second study conducted by Panel 1 was concerned with color television. This subject assumed a prominent place in the discussions of the Panel as a result of the excellent demonstrations made by Dr. P. C. Goldmark at the Columbia Broadcasting System Laboratories. Since reports of these demonstrations have been published, only a brief outline of the system is presented here.

The interlaced fields are scanned at the transmitter through red, green, and blue optical filters, in succession, at a rate of 120 fields per second. At the receiver the white light from the picture

<sup>1</sup> The members of Panel 1 were P. C. Goldmark, chairman; J. E. Brown; D. G. Fink; D. E. Harnett; I. E. Lempert; H. B. Marvin; Pierre Mertz; Adrian Murphy; R. E. Shelby; D. B. Smith; and R. F. Wild.



tube is viewed through corresponding filters that rotate synchronously in succession before the fluorescent screen. Every point in the image is thus scanned in the three colors in the space of  $\frac{1}{20}$  sec. This rate of frame repetition is sufficiently high to produce smooth blending of the colors.

Since the field rate is twice as great as in the corresponding black-and-white system, the picture detail is reduced to one-half the value present in the black-and-white image, for a given channel width. The resolutions in the vertical and horizontal directions are maintained approximately equal in the color system by dividing the number of lines by the square root of two. The value proposed for the color system is approximately 375 lines, corresponding to 525 lines in black and white. The reduction in image detail is compensated by the introduction of color values, which reveal contrasts not present in monochrome reproduction.

The minutes of Panel 1 reveal lengthy discussion of the merits of color-television systems, attempting to evaluate the relative importance of the loss of detail and the gain in color values, as well as other technical questions. Demonstrations of the system were viewed by a majority of the N.T.S.C. membership. The opinions of Panels 1, 6, 7, and 8 were assembled in questionnaire form, a summary of which is presented in the report of Panel 1. Near the conclusion of its work, the Panel voted without dissent that "It is the consensus of Panel 1 that color television is not yet ready for the establishment of standards for commercial operation." The Panel also took formal cognizance of the color-television experiments carried on by Dr. Goldmark.

The importance of color television for the future was reflected in the report of the National Committee.

The N.T.S.C. believes that, although color television is not at this time ready for commercial standardization, the potential importance of color to the television art requires that:

- a) A full test of color be permitted and encouraged, and that
- b) After successful field test, the early admission of color transmissions on a commercial basis coexistent with monochromatic television be permitted employing the same standards as are herewith submitted except as to lines and frame and field frequencies. The presently favored values for lines, and for frames and field frequencies for such a color system are, respectively, 375, 60, and 120.

TABLE I.—ANALYSIS OF AMERICAN  
(Systems for band

Number	Designation	Period of operation	When demonstrated	Scanning pattern			Synchronization system (H = horizontal, V = vertical)	
				Lines/frames- fields	Aspect ratio	Type of motion	Percent of carrier	Description of waveform
1	R.M.A. standards	1939-1940	1939-1940	441/30-60	4:3	Linear	20-25	H: Single rectangular pulse V: Serrated with equalizing pulses. See R. M. A. standard M9-211
2	DuMont A (500-ke burst vertical synchronizing pulse).	1939-1940	December, 1939 to date	Variable (see Note A)	4:3	Linear	20-25	H: Rectangular pulse. V: r-f burst during V blank with H superposed
3	DuMont B (Transmission of scanning waveforms).	1938-1939	1939	Variable	4:3	Any (note B)	.....	Synchronizing inherent in transmission of scanning waveforms
4	Hazeltine (FM for synchronizing).	1940	November, 1940	441/30-60	4:3	Linear	100	Any synchronizing wave shape frequency-modulated during H and V blank
5	RCA (507 lines, 495 lines later suggested).	1940	July, 1940	507/30-60 495/30-60	4:3	Linear	20-25	Waveform same as R.M.A.
6	RCA (FM for sound).	1940	November, 1940	441/30-60	4:3	Linear	20-25	R.M.A. M9-211
7	RCA (FM sound, quasi-FM for picture).	1940	October, 1940	441/30-60	4:3	Linear	.....	R.M.A. M9-211
8	RCA (Long integration synchronizing pulse).	1940	October, 1940	441/30-60	4:3	Linear	20-25	Slots in vertical pulse at line frequency. V pulse = 9H
9	Philco (525 lines)	1938-1940	1938-1940	525/30-60	4:3	Linear	Over 25	Waveform same as R.M.A. M9-211
10	Philco (605 lines)	1938-1940	1938-1940	605/24-48	4:3	Linear	Over 25	Waveform same as R.M.A. M9-211
11	Philco (Narrow vertical synchronizing pulse).	1935-1938	Up to 1938	441/30-60	4:3	Linear	20-25	H: Rectangular pulses. V: single narrow rectangular pulse, same level
12	Farnsworth (Narrow vertical synchronizing pulse).	1935-1938	Up to 1938	441/30-60	4:3	Linear	20-25	H: Rectangular pulse. V: single narrow pulse of higher amplitude
13	G.E. (Picture carrier 6 db attenuated).	1938	1938	441/30-60	4:3	Linear	20-25	Same as R.M.A. M9-211
14	Kolorama (225 lines).	1935-1940	May, 1939	225/12-24	6:5	Linear	.....	By transmission pulse and power line
15	"Sound-during-blanking." Single carrier system.	Prior 1940	.....	Note C	Note C	Note C	Note C	Note C. Carrier frequency modulated during horizontal blanking interval with audio frequencies

AND FOREIGN TELEVISION SYSTEMS  
width of 6 Mc or less)

Transmitter characteristics							Other characteristics, apparatus employed, advantages claimed by sponsor, etc. Notes
Polarity of modulation	Carrier attenuation	D-c or a-c transmission	Direction of polarization	Total bandwidth	Picture sideband width	Carrier separation	
Negative	None	D-c	Horizontal	6 Mc	4-4.5 Mc	4.5 Mc	Sound pre-emphasized. Sound and picture carriers of equal power. Standards used sometime by RCA, G.E., Farnsworth, Philco, CBS, Don Lee, General Television Corporation, Zenith, and others
Negative	None	D-c	Not specified	6 Mc	4-4.5 Mc	4.5 Mc	
Negative (note B)	None (note B)	D-c (note B)	Not specified	6 Mc	4-4.5 Mc	4.5 Mc	Note A: Designed for flexibility (continuous variability) in line and frame rates, including 15-30 as lower limit
Negative	None	D-c	Not specified	6 Mc	4-4.5 Mc	4.5 Mc	Note B: Receiver automatically follows changes in scanning motion
Negative	None	D-c	Horizontal	6 Mc	4-4.5 Mc	4.5 Mc	FM modulator required for synchronizing. High synchronizing amplitude developed. Improves picture-modulation capability
Negative	None	D-c	Horizontal	6 Mc	4-4.5 Mc	4.5 Mc	
.....	None	D-c	Horizontal	6 Mc	4-4.5 Mc	4.5 Mc	FM modulator for sound only. 75 kc maximum deviation
Negative	None	D-c	Horizontal	6 Mc	4-4.5 Mc	4.5 Mc	75 kc maximum deviation for sound. 0.75 Mc maximum deviation for picture. Improved transient response reported
Negative	None	D-c	Horizontal	6 Mc	4-4.5 Mc	4.5 Mc	V pulse integrated in R-C circuit of long-time constant. No equalizing pulses used
Negative	None	D-c	Vertical	6 Mc	4-4.5 Mc	4.5 Mc	Sound carriers staggered
Negative	None	D-c	Vertical	6 Mc	4-4.5 Mc	4.5 Mc	Greater horizontal definition due to lower frame rate
Negative	None	D-c	Vertical	6 Mc	4-4.5 Mc	4.5 Mc	
Negative	None	D-c	Not specified	6 Mc	4-4.5 Mc	4.5 Mc	
Negative	6 db	D-c	Horizontal	6 Mc	4-4.5 Mc	4.5 Mc	Narrower band at transmitter, wider band at receiver
Positive	None	D-c	Vertical	100 kc/300 kc	300 kc	.....	Mechanical scanners. Transmitter on band at 2,000 kc
Negative	Note C	D-c	Note C	6 Mc or less	4-4.5 Mc	.....	Note C: Not specified. Audio frequencies substantially higher than one-half line frequency suffer distortion. Investigated by RCA, G.E., Philco. Suggested 1940 by Kallman

TABLE I.—ANALYSIS OF AMERICAN AND

Number	Designation	Period of operation	When demonstrated	Scanning pattern			Synchronization system (H = horizontal, V = vertical)	
				Lines/frames- fields	Aspect ratio	Type of motion	Per cent of carrier	Description of waveform
<b>American Color</b>								
16	CBS (3-color system No. 3).	1940	August, 1940	343/60-120	4:3	Linear	Note D	Adaptable to any synchronizing signal that can control filter disks
16a	CBS combination color and black and white.....	This system same as CBS No. 3, for color transmissions. For black-and-white						
17	CBS (3-color system No. 4).	1940	.....	430/45-180	4:3	Linear	Note D	Note D. Quadruple interlace
18	CBS (3-color system No. 5).	1940	.....	550/30-120	4:3	Linear	Note D	Note D. Quadruple interlace
19	G.E. (2-color system).	1940	November, 1940	441/30-60	4:3	Linear	20-25	R.M.A. M9-211
<b>Foreign</b>								
20	British (BBC) Standard.	1936-1939	1936	405/25-50	5:4	Linear	30	Rectangular H pulses. Serrated V pulse; no equalizing pulses
21	Scophony (British) (In U.S.A. also, in 1940).	.....	1937	405/25-50	5:4	Linear	30	BBC Standard
22	Early Baird (British).	1936-1937	1936	240/25	4:3	Linear	40	8 per cent line synchronizing pulses, single V pulse of 12 lines duration
23	Baird 2-color (British).	.....	March, 1938	120/16.6-100	3:4	Linear Vertical	40	6 to 1 interlace by nonperiodic pulses
24	Baird 3-color (British).	.....	January, 1938	120/16.6-100	3:4	Linear Vertical	40	Same as Baird 2-color system
25	Velocity modulation (Br.).	.....	May, 1934	60-400/25	4:3	.....	30	10 per cent line pulses; frame by ratchet circuit from line
26	French (PTT) standards.	.....	June, 1937	440-445/ 25-50	5:4	Linear	30	.....
27	Barthelemy (French).	.....	June, 1937	450/25-50	5:4	Linear	17 H 34 V	6 lines paired to form V pulse
28	German standards.	.....	1939-1940	441/25-50	5:4	Linear	30	10 per cent line pulses; single 35 per cent V
29	German proposal	.....	1937-1938	441/25-50	5:4	Linear	30	Burst of 1.1 Mc for 20 per cent line duration as V pulse. Square H
30	Italian standards	.....	1939	441/21-42	5:4	Linear	30	Same as German standards
31	Russian standards.	.....	1940	441/25-50	11:8	Linear	20-25	Essentially R.M.A. M9-211

FOREIGN TELEVISION SYSTEMS.—(Continued)

Transmitter characteristics							Other characteristics, apparatus employed, advantages claimed by sponsor, etc. Notes
Polarity of modulation	Carrier attenuation	D-c or a-c transmission	Direction of polarization	Total bandwidth	Picture sideband width	Carrier separation	
Note D	Note D	Note D	Note D	6 Mc	4-4.5 Mc	4.5 Mc	Note D: Not specified. Mechanical filter disks or drums at transmitter and receiver

Television Systems

transmissions, no preference as to specifications is indicated

Note D	Note D	Note D	Note D	6 Mc	4-4.5 Mc	4.5 Mc	Line scan frequency approximately 19,400 p.p.s
Note D	Note D	Note D	Note D	6 Mc	4-4.5 Mc	4.5 Mc	Line scan frequency 15,750 p.p.s. Color coincidences 10 p.s.
Negative	None	D-c	Horizontal	6 Mc	4-4.5 Mc	4.5 Mc	Dichromatic filter disks, synchronizing on power line. Odd lines always one color, even lines always other color

Systems

Positive	None	D-c	Vertical	6 Mc	2.5 Mc	3.5 Mc	Double sideband. 2 c.p.s./sec. tolerance in line frequency for mechanical receivers
Positive	None	D-c	Vertical	6 Mc	2.5 Mc	3.5 Mc	Mechanical scanners, supersonic light valve. Requires BBC tolerance on line synchronizing
Positive	None	D-c	Vertical	5 Mc	1.5 Mc	3.5 Mc	Mechanical scanner at transmitter. Live pickup by film only
Positive	None	D-c	Vertical	5 Mc	2 Mc	3 Mc	Flying spot pickup with rotating color disks. Projected large-screen image
Positive	None	D-c	Vertical	5 Mc	2 Mc	3 Mc	Same but three colors. Laboratory demonstration
Positive	None	A-c	Vertical	3 Mc	1.5 Mc	No sound	CR tube light source on film. Amplitude component added
Positive	.....	D-c	.....	.....	.....	4 Mc	Standards embrace four systems
Positive	.....	.....	.....	.....	.....	4 Mc	Barthelemy interlace; rotating disk synchronizing
Positive	None	D-c	Vertical	5 Mc	2.0 Mc	2.8 Mc	Picture carrier on high side of channel
Positive	None	D-c	Vertical	5 Mc	2 Mc	2.8 Mc	
Positive	None	D-c	Vertical	5 Mc	2 Mc	2.8 Mc	
Negative	None	D-c	Horizontal	6 Mc	4-4.5 Mc	4.5 Mc	Sound carrier lower in frequency than picture

In its order commercializing the art, issued May 3, 1941, the FCC required licensees to submit data on color television. The specific instructions were: "It is further ordered that on or before January 1, 1942, the licensees of television broadcast stations shall submit to the commission complete comparative test data on color transmissions, with recommendations as to standards that may be adopted by the commission for color television." The same order permitted the submission of these data through a committee or organization representing the licensees.

To implement the collection and submission of this information, the R.M.A. appointed in May, 1941, the Subcommittee on Color Television. This subcommittee held seven meetings during 1941. On Nov. 10 of that year, the subcommittee issued a report to the N.T.S.C. Among opinions in the report was the following: "The subcommittee is of the opinion that the present knowledge of the art does not justify the recommending of standards for color television at the present time." Although no specific values of standards then in use were given, the following list of items requiring standardization was presented:

1. Color characteristics of the transmitted signal.
2. Color sequence.
3. Line and frame frequencies and interlace.
4. Phasing pulse.
5. Synchronizing-pulse constants.
6. Transmitted signal output vs. light input (generally referred to as the gamma characteristic).
7. Review of the present black-and-white transmission standards, to determine their relationship to color television.

The third study conducted by Panel 1 concerned flexibility in the scanning specifications. The DuMont Laboratories, Inc., proposed a variable number of lines and a variable number of fields and frames per second. It was argued by the DuMont organization that it might be possible in the future to employ a lower frame rate than was then practical and that the detail of the picture might then be proportionately increased without increasing the width of the channel employed by the system, provided that the system had sufficient inherent flexibility to permit changing the number of lines. This proposal received close scrutiny by the membership of Panel 1. A report on the

subject, printed in the following pages, was drawn up by members of the Panel. A motion was passed by a vote of 5 to 3 that "It is the consensus of Panel 1 that the best standards for black-and-white pictures on the channels below 108 Mc referred to in Motion 6 (a motion previously passed by the Panel referring to experimental tests of color television during hours not devoted to black-and-white transmissions) would be standards using a single value for line frequency and a single value for frame frequency." This vote against flexibility was confirmed by the standards adopted by the National Committee, which recommended the single value of 525 lines and the single value of 30 frames per second.

**Table of Television Systems.**—Table I, an analysis of American and foreign television systems, was prepared by Panel 1.

**Outline for Analysis.**—The "Outline for Analysis of Television Systems" prepared by Panel 1 is as follows:

A single asterisk \* indicates the preferred method, type, or system.  
A dagger † indicates the controlling advantage or disadvantage.

## I. Methods of scanning

### A. Type of motion

#### \*1. Unidirectional linear scanning (uniform velocity)

##### *Advantages*

- †a. Even distribution of detail for a given maximum video frequency
- b. Minor departures from linearity of scanning waveform do not destroy detail (*cf.* bidirectional scanning)
- c. Retrace time available for auxiliary signals

##### *Disadvantages*

- a. Precautions necessary to ensure linearity (true also of bidirectional scanning)
- b. Retrace times not available for transmitting picture detail

#### 2. Bidirectional linear scanning (uniform velocity)

##### *Advantages*

- a. More efficient use of bandwidth due to utilization of retrace interval(s)
- b. In magnetic scanning, peak voltage associated with rapid retrace is avoided

##### *Disadvantages*

- †a. Extremely critical with respect to synchronization and linearity

#### 3. Sinusoidal scanning

##### *Advantages*

- a. Simple, inexpensive deflection circuits

##### *Disadvantages*

- a. Difficult to synchronize
- †b. Does not make equal use of

- b. Relatively free from geometric distortion
- c. Spurious signal greater in storage type camera tubes
- d. Compensation required to obtain uniform brilliance
4. Velocity scanning (brightness inversely proportional to scanning velocity)
- Advantages*
- a. Synchronization is inherent in waveform (no separate synchronizing system necessary)
- b. Brighter high lights
- Disadvantages*
- †a. Wasteful of amplitude and frequency characteristic
- b. Excessive vertical blanking time required
- c. Has not yet been used for direct pickup
5. Spiral scanning
- Advantages*
- a. Utilizes time devoted to horizontal retrace in unidirectional scanning
- b. Make maximum use of screen of circular cathode ray tube
- Disadvantages*
- a. Wasteful of screen area in transmission of rectangular pictures
- b. Difficult to synchronize (for same reason as in sinusoidal scanning)
- †c. Does not make equal use of bandwidth in all portions of picture
- B. Direction of motion of scanning lines (assuming linear scanning)
- \*1. Horizontal
- Advantages*
- †a. Horizontal motion (most commonly encountered) best reproduced without disintegration of raster
- b. Lower line frequency for pictures having greater width than height
- Disadvantages*
- a. Lower audio-frequency limit in single carrier system (sound during blanking) for aspect ratio greater than unity
2. Vertical
- Advantages*
- a. Higher audio-frequency limit in single carrier system (sound during blanking) for aspect ratio greater than unity
- Disadvantages*
- †a. Disintegration of raster with horizontal motion (most commonly encountered)
- b. Higher line frequency with picture having greater width than height
- C. Interlace
1. General
- Advantages*
- †a. Permits use of higher flicker rate without loss of picture
- Disadvantages*
- a. Requires more accurate vertical synchronization



information, with a given bandwidth. (Conversely, allows greater detail with a given frame rate and bandwidth)

b. Introduces optical pairing with motion across the lines (due to motion of eye following action)

c. Possibility of interline flicker being apparent

d. Jagged edges on objects moving in direction of lines

## 2. Simple two to one

### *Advantages*

†a. Easiest form of interlacing to obtain in practice (odd-line system)

### *Disadvantages*

a. Does not make fullest possible use of general advantages. (See C-1-a)

## 3. Multiple (higher than two to one)

### *Advantages*

a. Greater detail available with given minimum flicker rate and given bandwidth

### *Disadvantages*

†a. Difficult to obtain sufficiently accurate synchronizing to avoid pairing

b. Tendency to introduce crawling with certain sequences

c. Interline flicker more apparent (due to lower frequency and greater separation of lines in successive frames)

## D. Aspect ratio

### \*1. 4:3 (standard for projected picture in motion pictures)

#### *Advantages*

†a. Has all advantages found in motion-picture practice

b. Permits scanning of motion-picture film without waste of screen area or distortion of the aspect ratio

#### *Disadvantages*

a. Does not make fullest use of area of circular fluorescent screen

## II. Synchronization

### A. Methods of conveying synchronizing information

#### \*1. Discrimination by amplitude separation of synchronizing from video (composite synchronizing-video signal)

#### *Advantages*

†a. Synchronizing clipping inexpensive and practical in infrablack region

b. Identical transmission time for video and synchronizing

c. Single signal to be handled for both functions

#### *Disadvantages*

a. Makes inefficient use of channel for transmitting synchronizing

b. Lowers picture-modulation capability

#### 2. Discrimination by type of modulation (example, FM for synchronizing)

*Advantages*

- a. More efficient use of product of bandwidth and time
- b. Greater carrier amplitude available for picture modulation
- c. Substantial increase in developed synchronizing-signal amplitude

*Disadvantages*

- a. More complex modulation and demodulation circuits

NOTE: No adequate field test as yet.

- 3. Transmission of entire scanning waveform by separate carrier or subcarrier

*Advantages*

- a. Scanning pattern at receiver automatically follows congruently that at transmitter, with synchronism inherent
- b. Permits changes in definition to suit subject matter, provided receiver is adequately designed

*Disadvantages*

- †a. Picture size affected by signal-strength variations line voltage, interference (not completely overcome by a-v-c)
- b. Noise affects position of received picture elements by altering scanning wave shape

- 4. Transmission of synchronizing pulses on separate carrier or subcarrier

*Advantages*

- a. Less probability of cross modulation between synchronizing and video
- b. Permits full modulation capability for picture signal and synchronizing

*Disadvantages*

- †a. Separate modulator, r-f and demodulator circuits required
- b. Possibility of improper phase displacement between synchronizing and video

B. Separation of vertical and horizontal synchronizing information

\*1. Frequency or waveform separation

*Advantages*

- †a. Does not require additional carrier amplitude for vertical-from-horizontal separation
- b. Will tolerate amplitude distortion in transmission and reception
- c. Permits amplitude limiters to be used to discriminate against noise

*Disadvantages*

NOTE: Disadvantages under examination by Panel 8

2. Amplitude separation

*Advantages*

NOTE: Advantages under examination by Panel 8

*Disadvantages*

- †a. Requires additional carrier amplitude for vertical synchronizing

- b. Less tolerant of amplitude distortion
- c. Requires more critical adjustment of clipping circuit

### C. Method of controlling scanning

#### 1. Self-oscillating scanning generators

##### *Advantages*

- a. Scanning maintains itself in absence of synchronizing signals, thus protecting picture tube
- b. Flywheel effect permits synchronization with weak lock-in
- c. Less sensitive to noise during a portion of cycle

##### *Disadvantages*

- a. Frequency hold-in controls required with weak lock-in
- b. Oscillators subject to loss of synchronism

#### 2. Driven scanning waveform generator

##### *Advantages*

- a. No frequency hold-in control required
- b. Recovers quickly from momentary noise interference
- c. May be made to follow changes in lines and frames over greater frequency range without adjustment

##### *Disadvantages*

- a. Loss of scanning in absence of synchronizing signal; hence protective circuit required for picture tube
- b. More susceptible to random noise and to noise impulses recurring many times per frame

#### 3. Direct amplification of scanning waveforms

See II-A-3 above

### III. Method of transmitting video information

#### A. Methods of modulation

##### 1. Amplitude modulation, double sideband

##### *Advantages*

- a. No sideband filter required at transmitter
- b. Greater tolerance with respect to distortion produced by detuning
- c. Essentially free of amplitude and phase distortion even with high percentage modulation

##### *Disadvantages*

- †a. Wasteful of channel space, *i.e.*, less detail for given bandwidth
- b. Wasteful of transmitter if receiver operated single sideband

##### \*2. Amplitude modulation, vestigial sideband

##### *Advantages*

- †a. More efficient use of channel, *i.e.*, greater detail for given bandwidth
- b. Ether spectrum conserved, for a given detail

##### *Disadvantages*

- a. Sideband filter required
- b. Power wasted in filter, if high level modulation
- c. Some amplitude and phase distortion, dependent on percentage of modulation

3. Frequency modulation, vestigial sideband (fractional deviation ratio)

*Advantages*

- a. Provides more useful transmitter power

*Disadvantages*

- a. More critical as to frequency characteristic of receiver  
 b. Partial amplitude modulation produced, prevents use of limiter

NOTE: No adequate field test as yet.

4. Frequency modulation, double sideband (fractional deviation ratio)

*Advantages*

- a. No amplitude modulation produced; hence limiters might be used to reduce multipath effects

*Disadvantages*

- †a. More channel space required for given picture detail

IV. Method of transmission of sound

A. Separate carrier, amplitude modulated

*Advantages*

- a. Simplicity and ease of separating sight and sound signals at receiver

*Disadvantages*

- a. More susceptible to noise from ignition and other impulse sources  
 b. Channel space required for carrier

B. Separate carrier, frequency modulated

*Advantages*

- a. Improved signal-to-noise ratio for given transmitter power when signal is greater than noise  
 b. More efficient transmitter  
 c. Simplifies television f-m broadcast combination receivers

*Disadvantages*

- a. Channel space required  
 b. Somewhat more expensive receiver  
 c. More critical frequency characteristic and tuning  
 d. Oscillator stability must be better than for AM

C. Single carrier, sound frequency modulated during horizontal blanking

*Advantages*

- a. Conservation of ether spectrum for given picture detail  
 b. Single transmitter (two modulators, however)

*Disadvantages*

- †a. Audio frequency limited to approximately one-half line frequency  
 b. Additional circuits required in receiver  
 c. Possibility of cross modulation between sight and sound

**Questionnaire on Color Television.**—The questionnaire on color television and an abstract of the answers summarizing

opinions of members of Panels 1, 6, 7, and 8 on color television are as follows:

NOTE: Qualified answers to some of the questions were given by many members.

Questions	Answers		
	Yes	No	No answer
<b>A. COLOR ASPECT</b>			
1. Do you prefer color television as demonstrated by the Columbia Broadcasting System to black and white?.....	30	4	4
2. Will the addition of color increase the entertainment value of televised pictures?.....	34	2	3
3. Do you think that color means more to televised pictures than to moving pictures in theaters?.....	17	18	5
4. Do you think the color quality of the color television demonstrated would be acceptable to the public?...	32	3	4
5. Do you think color adds to the apparent resolution of a black-and-white picture?.....	31	7	3
6. Do you think that the apparent resolution of color television as demonstrated is greater than R.M.A. black and white?.....	10	19	8
7. Do you think that the apparent resolution of color television as demonstrated is less than R.M.A. black and white?.....	14	14	9
8. Is the apparent resolution of color television as demonstrated satisfactory?.....	20	12	5
9. Assuming that black-and-white transmission and color transmission will exist simultaneously, do you think that the resolution of color television received in black and white as demonstrated would be acceptable to the public?.....	10	25	6
10. Was the brightness of the color demonstrated in your estimation acceptable?.....	33	4	3
<b>B. RECEIVER REQUIREMENTS</b>			
11. Do you believe the public will pay more for color receivers than for black-and-white receivers?.....	33	2	2
12. How much more do you estimate the public will pay for color receivers than for black-and-white receivers? (Answer in percentage.)*			4

\* Average estimate 25 per cent.

Questions	Answers		
	Yes	No	No answer
13. Should any commercial television receivers be marketed for reception of black-and-white transmission exclusively?.....	31	7	1
14. Should all commercial receivers be able to receive color television as well as black and white?.....	3	34	0
15. Should all commercial black-and-white television receivers be able to receive color television transmission as well as black and white?.....	16	20	2
16. Should all commercial black-and-white receivers be so designed as to be readily convertible into color receivers by the addition of only the color filter disk and its synchronizing gear?.....	7	30	2
17. Are you in favor of having the N.T.S.C. recommend to the R.M.A. that black-and-white receivers should be flexible so as to be able to receive color transmissions in black and white?.....	13	28	0
18. Will the introduction of experimental transmission of color television make the sale of black-and-white receivers more difficult if such receivers are not able to receive such transmission in black and white?....	28	10	3
19. Will the introduction of experimental transmission of color television make the sale of black-and-white receivers more difficult if such receivers are able to receive such transmission in black and white?.....	19	18	4
20. Will the introduction of experimental transmission of color television hamper the commercial progress of television in general?.....	11	24	3
C. TRANSMISSION STANDARDS			
21. Should color transmission be allowed in Group A channels?.....	24	11	3
22. Do you believe the present bandwidth of 6 Mc in Group A channels is adequate for color transmission?	17	16	5
23. Should special r-f channels outside of Group A channels, with a wider bandwidth (8 to 10 Mc) be allotted to color transmission?.....	27	5	6
24. Should any transmission standards for color television be considered at this time?.....	16	25	0
25. Should any transmission standards for color television be adopted at this time?.....	7	32	1
26. Should transmission standards for black-and-white television be influenced by color television considerations?.....	12	26	0

Questions	Answers		
	Yes	No	No answer
27. Should the transmission standards for black-and-white television be fixed independent of color television considerations?.....	27	12	1
28. Should transmission standards for black-and-white television be chosen in accordance with standards for color television (by maintaining the same number of frames and lines, e.g., 2:1 interlaced, 60 frames and 343 lines, or 4:1 interlaced, 30 frames and 550 lines)?	1	36	3
29. Should transmission standards for black-and-white and for color television be so chosen that the change of black-and-white receivers to color reception is made as easy as possible? (By maintaining approximately the same line scanning frequency, e.g., 60 frames, about 300 lines for color, and 30 frames, about 600 lines for black and white)?.....	7	28	3

**Report on Flexibility.**—The “Report on Flexibility” prepared by Panel 1 is as follows:

The term “flexibility,” as applied in connection with a national television system, refers to the ability of the system to operate in more than one manner. The different manners of operation may involve the use of fundamentally different principles of operation, the use of different types of equipment, or the optional use of different numerical values for characteristics that are quantitative in nature.

During the last few years the word “flexible” has been used in various ways to characterize various television systems, proposed transmission standards, and apparatus. Some of the kinds of flexibility that have been proposed are

1. Variation in scanning rates for lines and fields.
2. Wide choice of methods for utilization of signal by various receiver circuits and picture-reproducing devices.
3. Other variations in transmission without obsolescence of receivers, such as flexibility to provide for:
  - a. Amplitude modulation or frequency modulation of picture signal, synchronizing signal, and/or sound signal.
  - b. Transmission of color television (in addition to black and white).
  - c. Vertical or horizontal polarization.
 And others.

Complete flexibility, from one point of view, is obtained by eliminating all standards, and it might be said that in general flexibility tends to be the opposite of standardization in actual practice. The ultimate ideal in flexibility would be attained if a set of transmission standards could be set up permitting the maximum economy and performance in all types of receivers and at the same time accommodating all future improvements in the television art without rendering obsolete any receiver. Since as a practical matter this is not possible, it follows that "flexible" has only a relative meaning as applied to a television system. If all the kinds of flexibility listed above are considered, then none of the systems analyzed by this panel is completely inflexible. Furthermore, it is pointed out that the various kinds of flexibility are not, in general, independent, because an increase in one kind of flexibility often results in a relative decrease in flexibility of another kind. Economic factors, particularly as they affect the placing of an undue burden on the consumer, as well as technical factors are of importance in determining the optimum flexibility for a national television system.

The kind of flexibility that has been most widely discussed is the one permitting variation in scanning rates (*i.e.*, variable number of lines and fields per second). In this connection the word "flexible" has come to have a definite meaning in the minds of some people. However, the word "flexible" alone specifies no technical standard and, therefore, is of no value to the design engineer. Numerical limits must be set, and it is these limits that should be specified if a standard is to be variable.

Two types of flexibility in scanning rate standards are possible: one type is a continuous flexibility of scanning rates between any two limits of line and field frequencies (known as the continuous type); the other type has fixed predetermined discrete values of scanning rates (known as the discontinuous type).

The DuMont Laboratories, Inc., has proposed that the first type, or continuous flexibility, be adopted to allow for future use of the lower frame rates for black-and-white transmission and to provide for the CBS No. 3 color system. The variation in scanning rates required for such continuous flexibility is as follows:

Line frequency.....	7,875 to 20,580 per second (corresponds to 525/30 to 343/120)
Field frequency.....	30 to 120 per second



Some of the advantages and disadvantages of this degree and kind of continuous flexibility, provided all receivers are adapted to operate with such variable standards equally well over the entire range, are

### Advantages.

1. Provides for the possibility of utilizing a frame rate lower than is at present considered feasible (*i.e.*, 15 frames proposed by DuMont) to allow substantially greater definition by a considerably greater number of lines, if in the future the present technical difficulties with flicker and brightness are overcome and if it is found that the increased definition is of greater importance than increased trailing with motion.

2. Provides for variation in line or field rate, or both, if this should become desirable for any other reason, without obsolescence of receivers.

3. Provides for the introduction of color television by the sequential color field method described as CBS No. 3 color system.

4. Allows for the use of optimum combination of definition and field rate for different program conditions.

### Disadvantages.

1. Increases cost of all receivers (added components, additional tests at factory, arrangements for minimizing scanning distortion and nonsynchronous effects over wide range of frequencies).

2. Cost increase probably greatest in magnitude for cheapest receiver (owing to close proximity of components in small cabinet and probably necessary additional shielding for certain frame frequencies).

3. Consumer required to adjust receiver when scanning rates are changed unless fully automatic receiver is used and then, owing to such receiver's greater vulnerability to noise, its use is restricted to a smaller service area.

4. Reduces flexibility in choice of methods for signal utilization circuits and picture-reproducing devices.

5. Certain mechanical receivers (Scophony) are inoperable over wide range of scanning rates.

6. At frame frequencies in the lower part of the proposed range, flicker seems inevitable on presently available picture-reproducing devices at acceptable brightness levels.

7. Does not allow for the best engineering design of a receiver having optimum performance at a single line frequency and a single field frequency.

All the above advantages and disadvantages given for the continuous type of flexibility apply also to the flexibility of the discontinuous type, where the variation is in predetermined discrete steps, if the number of steps is large and covers a large range of line and field frequencies.

The Columbia Broadcasting System has proposed that flexibility of the second type (discontinuous type) be adopted, so that receivers designed for the black-and-white standards that may be adopted will be provided with a control giving fixed predetermined discrete values for the scanning rates, so that the CBS color system No. 3 may be receivable on such a receiver in black and white. This requires, in addition to the fixed predetermined values of the scanning rates for the black-and-white standards another setting on said control for adjusting the scanning rates to the additional predetermined values for the CBS No. 3 color system, namely,

Line frequency.....	20,580 per second
Field frequency.....	120 per second

Some of the advantages and disadvantages of this degree and kind of discontinuous flexibility, in which two predetermined discrete values of scanning rates are employed, provided all receivers are adapted to operate equally well at both of such two predetermined values of scanning rates, are

#### **Advantages.**

1. Provides for the introduction of the CBS No. 3 color system.
2. Allows for more faithful reproduction of motion in black and white at higher field rate.

#### **Disadvantages.**

1. Increases cost of all receivers (added components, additional tests at factory, arrangements for minimizing scanning distortion, and necessity for elimination of impaired resolution due to field rate being 120).
2. Cost increase probably greatest in magnitude for cheapest receiver (owing to close proximity of components in small cabinet

and probably necessary additional shielding for the higher frame frequency).

3. Consumer required to adjust receiver when scanning rates are changed.

4. Certain mechanical receivers (Scophony) may be inoperable on both scanning rates.

5. Does not allow for the best engineering design of a receiver having optimum performance at a single line frequency and a single field frequency.

6. When the transmission is in color, some flicker may be observed when receiving the transmission as a black-and-white picture.

NOTE: These disadvantages apply to a lesser degree in this special case where only one fixed step is proposed as compared with the type of flexibility mentioned previously.

## CHAPTER IV

### THE SUBJECTIVE ASPECTS OF TELEVISION

The report of Panel 2<sup>1</sup> of the N.T.S.C., reproduced in substantially complete form in the following pages, is a unique document. The scope of the work of Panel 2 was defined as "Subjective Aspects. The influence of physiological and psychological factors in the determination of television system characteristics." It is safe to say that in no other branch of the communication art has such a study been attempted on a similar scale. The results represent a full cross section of the available knowledge.

It had long been appreciated that the satisfaction derived from a television service depends on a multitude of factors, many unrelated to the field of electrical science. In the considerations of Panel 2, the observer of a television program was set up as an element in the system, and the characteristics of his visual system were integrally related to its performance.

The membership of Panel 2 comprised 10 members, four from the radio and television fields, the remainder from the fields of physiological optics, photography, ophthalmology, biophysics, and physics. The chairman of the Panel, Dr. Alfred A. Goldsmith, conducted the investigation by the questionnaire method. Copies of 50 questions relating to the subjective aspects of television were circulated to the panel members, who contributed answers in fields with which they were familiar. The replies were collated by the panel chairman and assembled in a composite report, which received the approval of all members. The material contains extensive references to the literature on the subject.

To aid in selecting particular subjects from the body of the report, a list of the questions is reproduced here. Following

<sup>1</sup> The members of Panel 2 were Dr. Alfred N. Goldsmith, chairman; Prof. F. A. Geldard; Prof. A. C. Hardy; Dr. LeGrand H. Hardy; Prof. Selig Hecht; Dr. L. A. Jones; Prof. Knox McIlwain; Dr. Pierre Mertz; Dr. Kenneth Ogle; and Dr. H. A. Wheeler.

this index, each question is stated, followed immediately by the information assembled by the Panel on that topic.

## INDEX TO QUESTIONNAIRE

### BLACK-AND-WHITE TELEVISION

1. Aspect ratio.
2. Range of picture brightnesses.
3. Factors affecting picture brightness.
4. Monochrome picture tint.
5. Picture dimensions vs. number of viewers.
6. Arrangement of viewers.
7. Range of viewing distances.
8. Range of viewing distances vs. picture structure
9. Viewing obliquities.
10. Flicker vs. picture repetition rate.
11. Adequacy of picture resolution.
12. Interlacing effects.
13. Imperfect interlacing.
14. Linear-scanning deficiencies.
15. Interlaced-scanning deficiencies.
16. Oblique resolution.
17. Resolution in various directions.
18. Vertical resolution and number of scanning lines.
19. Visual fatigue.
20. Resolution vs. intelligence content.
21. Contrast range.
22. Gradation ( $\gamma$ ).
23. Interference and noise.
24. Field frequency vs. jerkiness of motion.
25. Field frequency vs. streakiness in motion.
26. Picture storage vs. jerkiness.
27. Picture storage vs. streakiness.
28. Residual images vs. tonal distortion.
29. Residual images vs. field frequency.
30. Bowing of picture edges.
31. Picture-screen convexity.
32. Perspective.
33. Depth of field.

### COLOR TELEVISION

#### General Analysis

34. Pickup spectral response for color television.
35. Reproducer spectral response for color television
36. Color fidelity.
37. Pickup sensitivity loss due to filters.
38. Received-picture brightness loss due to filters.

39. Fusion frequency of color fields.
40. Colored action fringes.
41. Color picture resolution.
42. High-light brightness in color television.
43. Visual fatigue in color television.
44. Effects of color-line interlacing.
45. Visual fatigue in prolonged color-television viewing.
46. Contrast range in color television.
47. Gradation (gamma) in color television.
48. Interference and noise in color television.
49. Color flashes in cyclic color television.
50. Visual fatigue from color flashes.

### ASPECT RATIO

**Question 1.** Considering the shape and nature of the binocular-visual field of view, can there be deduced any preferred *aspect ratio* (ratio of width to height) for television pictures? Are there any other theoretical bases for the selection of any particular preferred aspect ratio?

It might be possible from data on the shape of the binocular-visual field of view to infer what might be a preferred aspect ratio for television pictures. However it must be understood that this is after all only a matter of subjective choice and that the preferred aspect ratio is that which pleases the ultimate viewer the most, whether this choice can be explained or not. Inferences on preferences for television may be drawn from experience in the older graphic arts, *i.e.*, sculpture, painting, drawing, photography, and motion pictures. In considering these it is to be noted that the degree of standardization required in television, by reason of the coded nature of the signal used therein, is reached only in motion pictures. Since the picture aspect ratio has come to be fairly stabilized in that art, it should be possible to apply this experience, and the question reworded to ask, "Is there any characteristic peculiar to television which leads it to prefer a different picture aspect ratio from that which has been standardized for motion pictures?" This preference furthermore would have to be more than vague to be considered seriously, because of the fact that motion pictures are expected to be used as part of television programs, leading to a great practical advantage if the same aspect ratio can be retained. The answer to the new question would seem to be "no."

Although it would be difficult to deduce logically a preferred aspect ratio for television pictures from the facts known about the shape and nature of the monocular and binocular visual apparatus, some of these facts, insofar as they are certain or have been adequately measured, may have a bearing on the problem. These may be cited briefly as follows:

1. *The Isopters of the Retina*.—It is known that the size of the visual field for threshold light discrimination increases with the intensity of the test object. Isopters are the contours of equal thresholds of discernibility. These are irregular egg-shaped concentric lines—the dimensions being greater in the horizontal meridian. Roughly the ratio of the vertical dimensions to the horizontal varies between 1:1 and 1:1.2 [Cf., for example, Ronne, *Arch. Augenheilk.*, **78** (284), 195; Wentworth, H., *Psych. Monographs*, **40** (3) (1930)].

2. *Color Fields*.—In like manner the color fields for equal subjective intensities are crude concentric ellipses. Roughly the ratio of the vertical to the horizontal dimensions would be 1:1.3 [Cf., for example, Abney, *Phil. Trans.*, (A) **190**, 155 (1897). Cf. also Wentworth, *op. cit.*].

3. *Visual Acuity*.—The visual acuity of the retina has been found to differ in the vertical and horizontal meridians, being higher in the horizontal meridian. The ratio of the visual acuity for the vertical to that for the horizontal meridian for the data of the reference given would be roughly 1:1.5 to 1:1.6 [Cf., for example, Wertheim, *Zeit. Psychol.*, **7**, 177 (1894)]

4. *The Vertical-horizontal Illusion*.—In general, equal segments of vertical and horizontal lines appear longer in the vertical meridian. This illusion apparently does not disappear with practice but may actually increase under controlled conditions. However, the general difference is not great, the ratio being very roughly 1:1.1 or slightly greater [Cf., for example, Tschermak, *Ergebnisse Physiol.*, **4**, 517 (1905); Hicks and Rivers, *Brit. Psychol.*, **2**, 243 (1906)].

5. *Field of Fixation*.—Owing to the shape and structure of the eyeball sockets and the attachment of the eye muscles, check ligaments, etc., the field of fixation (*i.e.*, the field swept over in maximum eye movements) is somewhat restricted in the vertical meridian above the visual plane as compared with the horizontal meridian. This varies greatly with individuals. The ratio

of the vertical to the horizontal angular limits of these maximum eye movements above the visual plane may be of the order of 1:1.2.

6. *Fusional Areas*.—Panum's fusional areas of the two retinas are of different extent in the vertical and horizontal meridians, the horizontal being greater. These are small areas on the two retinas within which the images of an object will be fused or seen single; outside these areas the images will be seen double. Although it is stated often that the vertical dimensions of these areas are smaller than the horizontal, it is difficult to find any reliable data. The original experiments were made by Panum.

The problem of the aspect ratio, as has been suggested, can be approached from experimental aesthetics. The problem is quite old, and the following ratios have been set up at different times as being the most pleasing ratio of the vertical to the horizontal dimensions of rectangles:

- 1:  $\sqrt{2}$ ..... The root square rectangle (credited to Pythagoras)
- 3:5..... Rule of 3 to 5 or the "divine proportion"
- 1:  $\sqrt{5}$ ..... Five root rectangle, basis of "dynamic symmetry"
- 1:1.618..... Rectangle of "whirling squares" or "golden section"

The last ratio is obtained by the rule that  $a/b = b/(a - b)$ , where  $a$  and  $b$  are the shorter and longer sides of the rectangle respectively. An experimental value determined by Fechner (*Vorschule der Aesthetik*) on 347 observers showed great variation, but the average was near that of the "golden section." The results are undoubtedly influenced by background patterns. [Cf. Dodge, *Squares and Rectangles*, *Bell Lab. Record*, **10**, 93 (November, 1931).] It was there indicated that the most pleasing proportion, or "golden ratio," is that for which the ratio of the small side to the large one is equal to the ratio of the latter to the sum of the two (or 0.618 to 1). This is somewhat more elongated than the motion-picture-projection aperture aspect ratio (about 11:8 for 35-mm. film, and 4:3 for 16- and 8-mm. film [See *J.S.M.P.E.*, **30**, 249 (March, 1938)]).

From the biophysical point of view, there are several reasons for selecting a picture shape that is wider than it is high. (1) The fovea, or region of sharpest vision of the eye, is about 10 per cent wider than high, and the regions of comparable sensitivity form elliptical contours on the eye. (2) The horizontal muscles



of the eyeball are stronger than the vertical ones. It is therefore much easier to move the eye in a horizontal direction than up and down.

These are physiological reasons for an obviously long artistic experience. Most paintings are wider than high, and the experience of the motion picture bears in the same direction, as already indicated. A ratio of width to height between 5:4 and 4:3 meets the situation.

Psychologically considered, the exact value of the aspect ratio would appear not to be a major limiting factor, at least as far as retinal events are concerned. These are, of course (given the conditions for the operation of the "vertical-horizontal" illusion), in accordance with the effect whereby the vertical dimension will appear to be relatively elongated. Aesthetic considerations might be of importance but presumably no more so than in the case of motion pictures. A variety of experiments in the field of experimental aesthetics would dictate that the "golden section," or an approximation to it, would be most satisfactory. Although this might be of some importance for merchandising, it could hardly be a major determinant for the strictly scientific solution of the problem at hand.

#### RANGE OF PICTURE BRIGHTNESS

**Question 2.** What is an adequate range of *picture brightness* for a given ambient illumination?

It is suggested that in order to simplify consideration of this question the term "range of picture brightness" be broken down into the two parameters necessary to specify it. That is, the first parameter may be given as the maximum high-light brightness and the second as minimum shadow brightness (the latter, considered again in Question 21, being expressible either in absolute units or as a fraction of the former). Bearing on the analogous question for motion pictures, an extensive investigation, conducted by the Society of Motion Picture Engineers in 1936 on both parameters is found in *J.S.M.P.E.*, 26, 489; 27, 127 (1936).

This resulted in a recommendation for motion-picture-theater screens of brightnesses of 7 to 14 foot-lamberts without film but with projector running (when corrected for minimum film densities, this would mean high-light brightnesses of 1 to

10 foot-lamberts). Remarks were also made to the effect that much higher brightnesses had been preferred in the experiments but that some compromise had to be made with practical possibilities.

For television the ambient illumination, if different, is likely to be higher, resulting in a demand for still more brightness. Again, therefore, it would seem as if what is to be considered an adequate brightness will be reached by an economic compromise rather than by a pure subjective desire.

Any ambient or general illumination is bound to interfere with the effectiveness of the picture. At high brightness levels, we recognize a difference in brightness of about 1 part in 100; at the lowest levels, about 1 part in 2 [*Physiol. Rev.*, **17**, 258 (1937)].

If a picture brightness were always 100 times that produced by the ambient illumination, the latter would affect neither the delicate just-perceptible differences in the high lights nor the crude just-perceptible differences in the shadows. Any other ratio must compromise with practical considerations.

#### FACTORS AFFECTING PICTURE BRIGHTNESS

**Question 3.** What known factors, other than ambient illumination, will influence the preferred range of *picture brightnesses*, and what are their effects?

The following analysis is based on psychological factors. Assuming "picture brightness" to mean (or be simply related to) "subjective brightness," the following factors (among others, doubtless) need to be considered: (1) state of retinal dark-light adaptation, and (2) presence or absence of illuminated surround. The first named factor is obviously the more important. Fusion frequency is a function of the state of adaptation, size of retinal image, brightness (perhaps of brightest portion of image, neglecting contrast effects), retinal locus (presumably unimportant in the present instance), and relations with other light stimuli simultaneously present in other parts of the field of view. Visibility of a stationary field is similarly dependent upon the same factors. Dark adaptation is a desideratum for high visibility and perhaps for low fusion frequencies [Lythgoe and Tansley, *Med. Res. Council (Brit.) Rept.* (1929)].

The presence of a uniformly illuminated surround would increase visual sensitivity and discriminability [Cobb and

Geissler, *Psychol. Rev.*, **20**, 425 (1913); Emerson and Martin, *Proc. Roy. Soc. (London)*, **108A**, 483 (1925); Geldard, *J. Gen. Psychol.*, **7**, 185 (1932) and *J. Optical Soc. Am.*, **24**, 299 (1934); Martin, *Proc. Roy. Soc. (London)*, **104A**, 302 (1923)]. However, there are practical and aesthetic considerations in the employment of a surround.

Over-all picture size would also have to be considered in evaluating the above. Particularly, pupil variations would enter, and the evidence is good that pupil control is housed chiefly in the macular region of the retina [Brown and Page, *J. Exp. Psychol.*, **25**, 347 (1939)].

A biophysical study of the same question follows. There are two factors inherent in television that set limits to the picture brightness.

1. *Visual Acuity*.—Visual resolving power varies approximately with the logarithm of the brightness over most of the visual range but tends to reach a maximum at about 50 millilamberts. [Koenig (1897); cf. *Physiol. Rev.*, **17** (1) 271.]

Below this maximum a higher brightness yields a higher resolving power. In the picture, however, the maximum resolution is limited by the height of the scanning line in relation to the distance of the observer. Hence, there is no need to increase the brightness above that which will give a visual resolution represented by this limit. For example, with a 7.3- by 9.8-in. picture and 400 scanning lines, the height of a scanning line represents a visual angle of 1.6 min. to an observer 1 meter away and corresponds to a visual acuity of 0.63. According to the most recent measurements of Shlaer [*J. Gen. Physiol.*, **21**, 165, (1937)] a picture brightness of over 0.3 millilambert should render this visible and spoil the effect, much as the grid of a coarse half tone spoils it. For an observer 2 meters away, the visual acuity is twice as high and becomes apparent above 2 millilamberts picture brightness in the high lights. With a brightness of 10 millilamberts, the observer must be about 2.5 meters so as to avoid the scanning grid as a fixed item in the appearance of the picture.

2. *Flicker*.—The brightness for the best visual resolution implies a limit lowered to the frequency of picture repetition to avoid flicker. This is because the critical fusion frequency of flicker varies with the logarithm of the brightness, as does visual

acuity [Ives, *Phil. Mag.*, **24**, 352 (1912); Hecht and Smith, *J. Gen. Physiol.*, **19**, 929 (1936)].

Thus, if the brightness is higher, the possible visual resolution is greater, but the necessary picture repetition rate is also higher. For a field the size of a television picture and an observer at 2.5 meters, the critical fusion frequency goes up about 12 c.p.s. for every power of 10 increase in brightnesses. Thus for 1 millilambert the critical frequency is about 18 c.p.s.; for 10 millilamberts it is 30.

It would seem possible that two different values, each of preferred picture brightness and range, could be arrived at according to whether the choice was made on the basis of either the instantaneous optimum at the moment of viewing the picture or the optimum considering the visual fatigue resulting from a long period of picture viewing. Another factor affecting preference is of course the subject matter of the picture.

#### MONOCHROME PICTURE TINT

**Question 4.** Considering the factors of minimized visual fatigue, correctness of pictorial reproduction, and desirable "whiteness" of high lights, and "grayness" or "blackness" in the half tones and shadows of a picture, what constitutes quantitatively a preferred and acceptable range of *colors or tints* for satisfactorily "black-and-white" pictures?

No work on the color specification of a monochrome (for the case where this obviously cannot be changed with the subject matter) is known. Although no precise data are available, it is suggested that photographic practices in finishing (sepia, "platinum tone") might be indicative of fairly satisfactory practice.

From the point of view of visual fatigue, there appears no easy way to determine the preferred range of colors for "black-and-white," monochrome pictures. Any analogy with the use of colored glasses to reduce glare and general eye fatigue seems inadequate because of the great and unpredictable differences found among individuals. The preferred range probably varies with the nature of the background. It has been suggested that Priest did some work on this problem, but the specific reference is not known.

## PICTURE DIMENSIONS VS. NUMBER OF VIEWERS

**Question 5.** Taking into account certain factors involved in the viewing of pictures (including the angle of view or subtended solid angle, picture brightness, picture color, change in viewing angle with distance of viewing, change in focusing of the eye resulting from changes in viewing distance, necessary rotation of the head to maintain central viewing of the picture when the head is moved sidewise, permissible obliquity of viewing, and the like), what is regarded as an acceptable range of *picture dimensions* for a given number of suitably placed viewers?

Discussions in the literature that give information on this question are *Fernseh A. G.*, **1** (3), 72 (April, 1939); *J.S.M.P.E.*, **30**, 636 (June, 1938); *Proc. I.R.E.*, **21** (12), 1631 (December, 1933).

The discussion in the first paper parallels most closely the language of the question, although an unequivocal answer in these terms is not given.

The second paper is a report of a study carried out by the Society of Motion Picture Engineers on a few of the more basic viewing conditions in a number of representative motion-picture theaters. The results are given in the form of distributions and averages of the characteristic under survey, and again, as given, the results bear only indirectly on the question as worded. If the original data were still available, it might be possible to correlate the number of seats with the screen size in each theater and thereby arrive more closely at an answer to the question. In any case, it must be further noted that these theaters merely represent commercial instances in which the viewer's preferences are in part balanced by economic considerations. These economic considerations are likely to be different in television, so that the optimum balance in television is not necessarily that observed in motion pictures. Further, of course, some or many of the theaters in the survey may not be in optimum economic balance, and some may even represent poor commercial ventures.

The third paper gives a few brief statements regarding some of the component parts of the question. There is a handy rule mentioned that the optimum field of view is reached when the observer's distance to the screen is equal to four times its height,

and that this figure can be stretched to eight and still give reasonably satisfactory viewing (particularly under home conditions).

There is some question as to whether it might not be desirable to study the component parts of this question separately, such, for example, as preferred size of field of view, minimum preferred viewing distance (resulting from eye accommodation required), maximum permissible departure from perpendicularity in viewing, etc. Some of these are considered in later questions.

Questions 5 to 8 are related and in large measure depend on the factors discussed in Question 3. The viewing distance depends on the size of the picture. For a 7- by 9-in. picture and a 10-millilambert brightness, the viewing distance cannot be less than 2.5 meters if the grid of 400 horizontal lines per picture is to be imperceptible. Obviously, if a lower brightness is used, the grid will not be apparent at nearer positions. A rough rule seems to be that, within ordinary room limits, in order to keep the grid pattern from just showing, one can double the brightness for every 18 in. one moves from the screen.

This has a natural limit at a distance where the height of the scanning line occupies 0.5 min. of visual angle, because this is the maximum visual resolution capacity of the eye even at the highest brightness. For a 7- by 9-in. picture and 400 scanning lines, this limit occurs at a distance of about 3 meters. Beyond that an observer will lose detail no matter what the brightness. Thus, for brightnesses between 2 and 10 millilamberts, observers should sit no nearer than 2 meters and no farther than 3 meters for the best viewing.

Disregarding current engineering and commercial practices with respect to image size in kinescopes, there are clearly the following to be considered: (1) avoiding accommodation and convergence strains by placing the viewer sufficiently far from the screen, and (2) keeping the retinal image large enough to avoid attentional shifts to extraneous objects (room illumination obviously has to be taken into account as well). A balance between (1) and (2) must obviously be realized.

It is possible that useful data would result from the experience that has been had with respect to 16-mm. projectors of the type represented by "library" models, using a small screen, and "business" projectors employing a small, self-contained screen. If such pertinent data are at hand, this is a question a suitable

answer to which would seem to be obtainable by a simple "performance" experiment, after an exhaustive consideration of the possible operant factors.

#### ARRANGEMENT OF VIEWERS

**Question 6.** How should the *viewers* preferably be placed? How should the *pictures* preferably be located?

There is some discussion of this question in *Fernseh A. G.*, 1 (3), 72 (April, 1939). Cinema experiments would also be an aid in answering this question. From the point of view of visual fatigue, the most comfortable position of the observer is one in which the eyes are in symmetrical convergence, with visual plane horizontal or even slightly depressed. Sustained oblique viewing may be fatiguing to the extrinsic eye muscles.

#### RANGE OF VIEWING DISTANCES

**Question 7.** For pictures of a given size, what is regarded as an acceptable range of *viewing distances* for a picture of given dimensions (neglecting fineness of picture structure)?

According to one point of view, the lower limit would seem to be determined by the near point (of accommodation) but, to ensure practically relaxed accommodation and convergence, should need to be as much as 6 meters. Acuity appears to be a function of stimulus distance, within certain limits, increasing on a curvilinear function from 40 cm. to 3 meters [Luckiesh and Moss, *J. Optical Soc. Am.*, 23, 25 (1933)].

Here, neglecting fineness of picture structure, it appears that considerable latitude is allowable. It is questioned by some, in a viewpoint contrary to that expressed above, that the use of the accommodative or convergence functions of the eyes can in itself cause visual fatigue, at least for normal individuals. Hence, it would not seem necessary that the viewing distance be such as to allow for the relaxed accommodation and convergence, for instance, at 6 meters. If one must allow for abnormal eyes, then the elderly person with presbyopic vision who wears bifocal lenses should be taken care of. It is true, of course, that if the angular size of the television picture were small and no other fusible detail on the background were visible, individuals with muscle anomalies, which may be quite general, might experience some ocular fatigue.

This question is in effect one of the component parts of Question 5. The discussion there given indicates a viewing distance of four times the picture height, which may be increased to eight times without being too unsatisfactory.

When the absolute size of the picture is small, there will be a tendency to view it from a greater distance than this because of the effort of accommodation required to focus the eyes on a close object, and the resulting loss in visual acuity. As an extreme case, it would be impossible to view the image at four times its height if this should come out less than the limit of distinct vision [see *J. Optical Soc. Am.*, **23**, 25 (1933)].

If other spectators are present there will be a tendency to view the picture from farther away in order not to obstruct their view, unless the arrangement of seats is extremely well organized.

#### RANGE OF VIEWING DISTANCES VS. PICTURE STRUCTURE

**Question 8.** Considering fineness of the linear structure of television pictures, what may be taken as a satisfactory range of *viewing distances* for a picture of given dimensions?

Two papers give rules that are pertinent to this question. These are *Proc. I.R.E.*, **21**, 1631 (December, 1933) and *Proc. I.R.E.*, **26**, 540 (May, 1928).

The first notes that, "If the total picture size were limited, we would, in viewing this picture, tend to approach it until the picture detail and structure became unsatisfactory." As a matter of observation, this was where the lines and detail structure became noticeable, and, further, approximately where the line structure subtended 2 minutes of arc at the eye of the observer (with simulated television pictures). The second paper notes that "the observer should be far enough from the reproduced image so the fine structure is not obvious."

As a matter of general observation, it would be expected that the optimum distance would be as near as possible (assuming that this is still farther than the limit in Question 7) without the line structure's becoming obtrusive.

This question is also briefly but adequately discussed in Chap. XII of the book by L. R. Lohr, "Television Broadcasting," McGraw-Hill Book Company, Inc., New York (1940).

A similar question arises in considering the photographic enlargements made from films of miniature cameras, where the



appearance of grain in the picture presents a problem. It was frequently argued that a larger picture would be held farther from the eyes than a small one and, with given emulsions, the grain would not be easily seen. However, it is common observation that the observer usually desires to see some particular detail and immediately brings the picture nearer and, formerly at least, often complained of the presence of grain. In the television picture, the mechanical structure of the receiving set usually prevents too close observation. It is possible that experience in the process of printing photographs on newsprint paper would give information in this regard.

From the point of view of mechanical limits to the fineness of detail allowable in the television pictures, the satisfactory range of viewing distances would be the nearest distance at which the line structure is not distractive. The reader is also referred to the discussion of Question 32 in this connection.

#### VIEWING OBLIQUITIES

**Question 9.** "What are the maximum desirable or permissible *obliquities of viewing* both vertically and horizontally of pictures of a given size and at a given distance?"

No specific exact treatment of this question is known. The motion-picture-theater survey referred to in the answer to Question 5 gives some information, but it would seem necessary to go back to the original data to obtain the answer in the terms of the question, and even then it might not be possible.

The first paper referred to in the answer to Question 5 also gives a brief discussion on this question. A maximum horizontal obliquity of 45 deg. is mentioned, but no figure is given for vertical obliquity.

A psychological factor making for greater tolerances in viewing obliquities is that of "shape constancy," in accordance with which objects tend to preserve in perception their natural or known shapes despite considerable geometrical distortion or deviation, both horizontal and vertical. Otherwise stated, there is a "phenomenal regression" to the "real" object, or a tendency to adapt to the distortion. The tolerance would probably have to be worked out experimentally for the kinescope viewing situation, though it is not apparent that the operation of the principle would be any different here. Shape constancy has been treated

by Sheehan, *Arch. Psychol.*, 1938, and by Thouless, *Brit. J. Psychol.*, **21**, 339; **22**, 1 (1931).

The following physiological comments are relevant. In general, sustained asymmetric convergence of the eyes results in some visual fatigue. Usually under such conditions, the head is turned to relieve the need for the asymmetric convergence. If the oblique viewing angle is not too great, the distortion is usually compensated for mentally. It is common experience, however, that when an observer is seated in a theater near the front and at angles somewhat greater than 45 deg., the pictures are distorted, the movements of actors appearing unnatural.

From the point of view of the shape of the binocular field of fixation, in vertical oblique viewing, looking down is undoubtedly less fatiguing than looking up. In general, although varying greatly with individuals, the binocular field of fixation extends 40 deg. upward, 55 deg. downward and 50 deg. on either side laterally. Usually the head is turned if the object fixated requires such angles, and the problem is no longer one of visual fatigue.

#### FLICKER VS. PICTURE REPETITION RATE

**Question 10.** What range or specific values of *picture repetition rate* is necessary to avoid flicker, i.e., what will be the minimal fusion frequency or range of fusion frequencies under known conditions of picture brightness (picture gradation or contrast picture distance or viewing angle, picture color, and the like)?

Question 10 could be expanded to include the fatigue effect of unnoticeable flicker and jerkiness of motion. For instance, many moving pictures do not seem to have much flicker or to be very jerky, yet one finds that watching a moving picture is much more tiring than watching a play. An instructive article on this subject is *The Introduction to the Experimental Study of Visual Fatigue* by Peter A. Snell, *J.S.M.P.E.*, May, 1933.

This question has been partly answered in Question 3. The critical fusion frequency varies with the logarithm of the brightness. It also varies with the logarithm of the area of the flickering object [Granit and Harper, *Am. J. Physiol.*, **95**, 211 (1930)].

Hence, the nearer the observer to the picture, the higher the fusion frequency. A rate of 60 c.p.s. is well above the critical fusion frequencies at maximum brightnesses and large areas.

For the center of vision, color has almost no effect on fusion frequency provided brightness is controlled.

If merely retinal or photochemical "fusions" were involved, most of the data requisite to a satisfactory answer would seem to be at hand. Taking the brightest point in the picture as a reference point, fusion frequencies might be computed with some accuracy. Due allowance should be made for individual differences in fusion points—a matter of some importance in view of the fact that, for a given moderate illumination, different people may have fusion points differing by as much as 12 c.p.s. *Perceptual* fusions are involved here, however, and, fortunately, greater tolerances are probably always provided. The specific data are scant, but on principle it would be predicted that perceptual fusions would be realized at lower repetition rates than those for conventional critical-flicker-frequency determinations.

Picture color would seem to be of little concern, since low saturations would presumably be involved and since no color has a higher fusion frequency than has mixed white light (assuming equal energies, of course).

Although there has been some use in experimental work of flicker cycles other than the block type (*cf.* Ives, *op. cit.*), no experiment is known in which the light phase has had an abrupt onset (fluorescence) and a logarithmic decay (phosphorescence) for a cutoff. This should be studied experimentally to establish the fusion-point vs. illumination relation for this type of exposure, particularly since some range of variation in the decay function exists for different phosphors.

One of the very important parameters affecting the answer to this question and not listed specifically in its language is the wave shape of the brightness as a function of time (which is periodic if the picture is still) of the picture area under view. As an extreme condition, the picture area would be a flat field. With the fluorescent screens that have to a large extent been used in television receivers, the wave shape is approximately an exponential decay curve whose time constant has been made greater or less according to the situation. With this type of wave shape, experiments on minimum fusion frequency have been reported. [*Proc. I.R.E.*, **23**, 295 (April, 1935).]

It has, however, recently been claimed by certain workers in television that luminescent screens are available characterized

by the fact that their decay curve has upward convexity instead of the upward concavity of an exponential decay curve. If such screens are available, their fusion-frequency requirements will presumably be different from those with the approximately exponential decay. As far as is known, no data have been reported on fusion frequencies using a wave shape that is convex upward. To make the answer to this question complete, it would seem, however, as if this knowledge were necessary. Two classifications may be distinguished. First, information would be needed on the fusion frequency for such substances as are actually available at the moment. This could conceivably be carried out with these substances. Second, it may be desirable to know what would be the fusion frequencies for substances having extreme convexity upward or great brightness that could presumably be developed in the future, but cannot now be obtained with available substances. For this it would be necessary to simulate the luminescence, as was done in some of the experiments reported in the reference given immediately above.

#### ADEQUACY OF PICTURE RESOLUTION

**Question 11.** The television picture consists essentially of juxtaposed horizontal lines with delineatory shading along their lengths. Considering this mode of formation of the television image, and considering the nature and wide range of subject matter to be reproduced by television, what constitutes an adequate "*fineness*" of picture structure (expressed in number of horizontal scanning lines included in the height of the picture)?

From a purely subjective point of view, a completely adequate fineness of picture structure would be one giving a picture that was indistinguishable from a picture having an infinitely fine structure. It is perhaps not clear at the moment just what will do this, but it is reasonably clear that such a condition, combined with an adequate angular field of view, leads to a frequency band well beyond what has so far been technically achieved in television.

The consequence is that what constitutes commercially adequate fineness of structure is a compromise between technical excellence and cost. It is not unmistakably clear, and perhaps it never can be, as to what constitutes an optimum compromise. The motion-picture people have adopted three principal solutions in the form, respectively, of 35-, 16-, and 8-mm. film. The

economic factors are so different, however, in television, that it is doubtful to what extent these can serve as guides in estimating an optimum compromise.

Much can be learned from the photoengravers. They find that a good half tone has about 150 dots to the inch and in a very good light can be viewed at 10 in. without seeing the grid. A moderate half tone has about 85 dots to the inch, and the grid becomes apparent at about 18 in. An ordinary newspaper half tone has about 50 dots to the inch. Considering the distance at which television pictures are viewed at present, it is suggested that about 75 lines to the inch of picture would yield an adequately fine structure.

### INTERLACING EFFECTS

**Question 12.** According to current television practice, the field of the picture is scanned first along the odd-numbered lines, and, briefly thereafter, the picture field is again scanned using the even-numbered or "interlaced" lines. The process is then cyclically repeated. This is known as "interlaced scanning" and has as its object, in the instance here described, the reduction of flicker by giving *two* field scanings for *one* picture frame or complete picture. Will any *psychophysical effects* result from *line interlacing* (such as "crawling" in the picture detail, interline flicker, failure of the complete-frame picture resulting from the combined odd-line and even-line scanings to fuse completely into a single image, loss of detail due to limited visual persistence, loss of detail due inherently to the interlaced scanning method)?

It is of course true that, when flicker in a television picture is reduced by the use of an interlacing process, the brightness variation whose frequency is increased is the average of an area broad enough to reach over several scanning lines. If the area under consideration is taken as very small, the frequency remains at the original low value, namely, the complete frame frequency. One may not expect, therefore, particularly for an observer close to the picture, that the flicker advantage resulting from the use of interlacing would be all the advantage obtainable by doubling the frame frequency. A discussion of this appears in *Proc. I.R.E.*, **23**, 295 (April, 1935). The conclusion is there reached that interlacing increases the desirability of not looking at a television picture from too close a position.

There are a number of possible motions that can be depicted in the picture to combine with the interlacing and give peculiar effects. Practically, the motion that seems to be the most noticeable is a slow upward or downward motion of objects (particularly when the center of interest) in the picture. As the eye follows this motion the successive fields do not interlace properly on the retina and so give rise to the type of defect mentioned in Question 13. In the present case it occurs, of course, even with the apparatus functioning perfectly.

The "crawling" referred to in the text of the question means a slow motion of a pattern in the scanning lines through the stationary parts of the picture. It occurs when the multiplicity of interlace is higher than two. It does not occur with a two-to-one interlace, because the velocity of pattern displacement is equal in the two opposite directions, thereby giving an effect, not of motion, but merely of the "interline flicker" discussed above.

#### IMPERFECT INTERLACING

**Question 13.** Assuming that the *interlacing* process in the line scanning is *imperfect* (i.e., that there is a certain degree of steady or intermittent overlap between the successive odd-numbered and even-numbered scanning lines, respectively), what *loss of detail or other defects* in picture quality might be anticipated therefrom?

It was discovered in the early days of telephotograph transmission that to be unobtrusive a scanning pattern must be mechanically extremely accurate and must particularly be free from periodic errors (for that matter, much the same was observed even before this when making engravings by the half-tone process). The effect of a poor interlacing between the two fields that comprise a complete frame is to introduce a periodic error in the complete scanning-line structure. This error can be obtrusive even when it is not large. When it does become large, the additional effect is obtained of a loss of resolution. In the extreme case when the overlap is complete, the resolution is of course reduced to half its value when the system is perfect.

The failure of interlacing makes visible a faint structure of coarse lines superimposed on the inherent structure of fine lines. The coarse lines may be visible at a distance, whereas the fine lines would give the appearance of a flat field. At the same time,

there is a tendency to accentuate the various defects that are usually present in line scanning, notably beads on nearly horizontal lines or steps on nearly horizontal edges. It is thought that these defects appear before there is appreciable loss of resolving power. As a rough estimate, the loss in resolving power would hardly be noticeable unless one set of lines was displaced from perfect interlace by one-half the pitch of adjacent lines in the combined field. The other defects caused by the failure of interlacing become noticeable with much less displacement.

### LINEAR-SCANNING DEFICIENCIES

**Question 14.** Does the *linear-scanning* method of producing television pictures lead to any physiological or psychological limitations or *deficiencies* in comparison with the production of pictures in motion, either by cinematic means or by the direct viewing of a moving scene? (Line interlacing is to be disregarded in the consideration of this question.)

The linear-scanning method of producing television pictures is particularly characterized by three types of departure from the direct viewing of a moving scene. In the first place, any one portion of the picture is viewed intermittently rather than continuously. This type of departure is common to the cinematic process. It leads to possibilities of flicker, as has already been discussed in the answer to Question 10. This is not inherent, however, and may conceivably be controlled, again, as has been mentioned, by operating on the wave shape of the brightness vs. time curve (as an extreme leaving the brightness constant during frame intervals and changing it only at the boundaries of the frame intervals, as is done in certain types of continuous cinematic projector). The departure leads also to another defect, which is inherent and caused by suppression of information as to the condition of the picture between the intermittent views. This defect will vary with the type of motion depicted. Where this is pure translation, the effect of nonuniform velocity, or "jerkiness," is obtained. Where the motion is cyclical, stroboscopic effects are generated, as in the reverse turning of carriage wheels. Where the scene depicts brightness changes rather than geometrical motion, analogous effects are obtained. A gradual transition from one brightness to another is replaced by a jerky

transition, and a cyclical variation in brightness generates a stroboscopic flicker that may have a frequency of alternation entirely different from the original variation.

The second type of departure from direct viewing is that the frame interval boundaries do not occur at the same instant for all portions of the field of view. This represents a departure from the cinematic process and is more closely analogous to the focal-plane method of exposure used in still photography. For sequential scanning, the resulting defects are closely similar to the latter and consist, *e.g.*, in a simple case, in the skewing of a vertical line moving with a horizontal translation. For interlaced scanning, the defect will be discussed in the next question. An additional consequence of this type of departure is that the stroboscopic effects from over-all brightness changes of the scene take on space discrimination in the picture and are translated into spurious stationary or moving bars across the picture.

The third type of departure from direct viewing is that the frame-interval-boundary instants vary discontinuously from scanning line to scanning line down the field of view. This conceivably gives rise to additional jerkiness and stroboscopic effects for vertical motion. Under normal television conditions, the scanning-line frequency is so high and the width of a scanning line so small that the jerkiness is not easily visible, but the stroboscopic effect can be obtained. In the situation where the scene depicts changes of brightness from scanning line to scanning line rather than geometrical motions, the analysis leads to the extraneous patterns in a still picture that are referred to in Question 18.

For all these defects there are limiting conditions that make them impossible to detect. No reference is available, however, of any reasonably comprehensive determination. This is aside from the matter of flicker discussed in Question 10.

From the psychological point of view, no deficiencies or limitations peculiar to the conditions given in either linear or interlaced scanning are known, but it is of interest to ask whether anything is known of eye movements under these conditions. Do eye movements differ in viewing motion pictures and the television screen? The question would find a ready experimental answer, and the answer might be important in predicting possible visual discomfort in viewing. (This also has a bearing on Question 19.)



No reason is known for expecting physiological difficulties with either linear or interlaced scanning.

#### INTERLACED-SCANNING DEFICIENCIES

**Question 15.** Further, does *interlaced scanning*, as a mode of production of moving pictures, lead to any known physiological or psychological *deficiencies* or limitations? If so, how may these effects be minimized?

The principal deficiencies of interlaced scanning per se have already been discussed in Questions 12 and 13. Interlacing does, however, also affect the deficiencies mentioned in Question 14 for progressive scanning. In general, this is in the direction of reducing these deficiencies. For example, the jerkiness referred to is reduced, because the amount of motion in each jerk is halved, and the frequency of the jerks is doubled. Further, the skewing of moving vertical lines would be reduced to one-half. In the scanning of film taken at 24 frames per second for television pictures reproduced at 30 frames per second, it is conceivable that a "limp" may be generated in the jerkiness, namely, that successive alternate jerks be large and small, respectively. This has not been particularly noticed with television pictures, presumably because it occurs too fast.

The difficulty mentioned in Question 13 is overcome by making the scanning pattern more accurate. The other difficulties are generally inherent and difficult to minimize without increasing the frame frequency or number of scanning lines or both.

#### OBLIQUE RESOLUTION

**Question 16.** Assuming a linear structure of the television picture with known resolutions (sharpness of detail) vertically and horizontally, what will be the *resolution* in various *oblique directions*?

The psychological comment may be made that the geometry of the thing would, of course, suggest that, for uniform over-all patterns, resolution should be poorer in the oblique directions, but here, as in Question 10, it should be recalled that perceptual processes are involved. Presumably configurational tendencies would overcome the small reduction in resolution indicated.

On these subjects especially, additional reference is made to the following papers: R. D. Kell, A. V. Bedford, and G. L.

Fredendall, A Determination of Optimum Number of Lines in a Television System, *RCA Rev.*, **5**, 8-30 (July, 1940); H. A. Wheeler and A. V. Loughren, The Fine Structure of Television Images, *Proc. I.R.E.*, **26**, 540-575 (May, 1938).

Kell gives a criterion of resolving power—the diagonal of a rectangle determined by the vertical and horizontal resolving power. In practice, it is considered that this is too unfavorable and that the diagonal resolving power is somewhere between the vertical and horizontal. It is supposed that the desirability of equal vertical and horizontal resolution is most logically based on the corresponding characteristics of the eye. At least this would yield the requirement for very nearly equal resolution. Question 18 has received its most thorough treatment in the Wheeler and Loughren paper, and the conclusions are in reasonable agreement with other authors.

It has been shown [*Bell System Tech. J.*, **13**, 464 (July, 1934)] that the reproduction of a scene by a scanning-line system leads to two classifications of defects in the picture, first a reduction of the detail in the picture, as if it were transmitted by an optical system out of focus, and second a superposition of extraneous patterns not in the original. The first alone is chiefly effective in impairing horizontal resolution, and the two together serve to impair vertical resolution. The paper gives quantitative data on both classifications of defects, including the information required for studying diagonal resolution for a system using progressive scanning. For interlaced scanning, certain modifications have been described in *Telefunken Hausmitteilungen*, **19**, 46 (March, 1938).

The over-all resolution that is obtained in any direction, according to the procedures outlined in the answer to Question 18, will depend upon the particular conventions chosen. This is so, because the two classifications of defects will be weighted differently according to the various conventions. In a general way, the diagonal resolution will be intermediate between the vertical and horizontal.

In view of the answer given to Question 17, it is not believed that a detailed study of this question is of major importance.

#### RESOLUTION IN VARIOUS DIRECTIONS

**Question 17.** Should television pictures have equal *vertical*, *horizontal*, and *oblique resolutions*, and for what reasons?

From one physiological viewpoint, it may be stated that the resolving power of the eye is fairly alike in all meridians. Television pictures should therefore have about the same resolution in all directions.

From another physiological analysis, it was indicated that, from the available data on the resolving power of the eye (*cf.* Question 1), the resolution of television pictures need not be quite as great in the vertical meridian as in the horizontal meridian. However, it must be kept in mind that this difference is more apparent outside the macular region, where the ratio of resolving power in the vertical to that in the horizontal may be 1:1.5. Undoubtedly, the difference is less great in the foveal regions.

The retinal contours of equal resolving power approximate ellipses, and this might assist in answering the question of the oblique resolving power to be desired from television pictures.

A paper on *The Subjective Sharpness of Television Images*, reporting the results of experiments in the Bell Telephone Laboratories, has been prepared by M. W. Baldwin [*Bell System Tech. J.*, **19** (4), 563 (October, 1940)]. The general results had already been very briefly sketched [*J. Applied Phys.*, **10**, 443 (July, 1939)] in the following words:

. . . whenever an engineering optimum is obtained, it means that some quality variable is made a maximum by the proportioning chosen. If the change in the quality variable is continuous and smooth as the proportioning is changed, then there is apt to be quite a range of proportions, on both sides of and near the optimum, where the quality remains very near that at maximum. In terms of the immediate case which we are considering, this means that one may anticipate that the over-all picture quality will not be very sensitive to changes in this distribution of resolutions in the region of the optimum if the product of the two resolutions (itself proportional to the frequency band utilized) is kept constant.

The experiments bear this out and indicate a substantial range over which the resolutions may be distributed without change in the over-all appearance of sharpness in the picture, when the product is kept constant.

This is aside from annoyance caused by view of scanning-line structure and considers merely image resolution. A somewhat larger number of lines, in addition to those needed for resolution, will be required because of the annoyance effect.

## VERTICAL RESOLUTION AND NUMBER OF SCANNING LINES

**Question 18.** It is known that there is an interaction between the linear structure of television pictures and certain types or parts of the fine detail of the image to be reproduced, with resulting distortions or false "interference" patterns of various types. From the known characteristics of this phenomenon, what conclusions can be drawn as to the acceptable range of detail that can be "satisfactorily" reproduced by a television picture composed of a specific *number of scanning lines*?

The words used in the language of this question need specialized definition before it can be discussed. In deciding upon what detail is satisfactorily reproduced, it is first of all necessary to set up a conventionalized detail feature that has a dimension in it that is deemed critical. It is then necessary to set up a conventionalized criterion of what constitutes adequate reproduction of the detail. When the detail is reproduced, with varying values of the critical dimension, the resolving power of the system is determined by the smallest value of the dimension for which all larger values lead to a satisfying of the conventionalized criterion of adequate reproduction. The usefulness of any given pair of conventions (first for the detail and second for what constitutes adequate reproduction) then depends upon how well the results of the test above correlate with the actual performance of the system when in use. In the case of television, this actual performance consists in conveying to the receiving observer as faithfully and as pleasingly as possible the subjective impressions he would get by viewing the original scene.

In optics a variety of conventions have been used for defining resolving power [see, for example, the discussions on resolving power in Hardy and Perrin, "The Principles of Optics" (1932) and Drude, "Theory of Optics," Mann and Millikan translation (1925)]. For television, a similar but greater variety of conventions have been used in the definition of resolving power [*Bell System Tech. J.*, **13**, 464 (1934); *Proc. I.R.E.*, **22**, 1246 (1934); *Proc. I.R.E.*, **26**, 540 (1938); *Telev. Soc. J.*, **2**, 397 (1938); *Bell System Tech. J.*, **19**, 63 (1940); and *RCA Rev.*, **5**, 8 (1940)].

The details of the considerations given in these papers will not be reviewed, but the burden of the discussion is to the effect that, for adequate resolution as defined by each author, the critical

dimension of his chosen test object must be something over one and less than two times the separation between the centers of adjacent scanning lines. As may be expected, the result depends upon the precise conventions chosen.

The next to the last reference does not deal with television as such or in fact directly with the subject immediately in question here. It has been introduced, however, because it illustrates the importance of the check recited above between the results of a conventionalized test and the actual performance of a system whose purpose is to convey a subjective impression. This check has not been carried out for most of the conventions discussed in the other references.

### VISUAL FATIGUE

**Question 19.** Under what circumstances (*i.e.*, what range of constants of the transmission and picture structure) might a television picture produce greater *visual fatigue* than an approximately equivalent cinematic picture or the viewing of an actual moving scene?

It is a matter of more or less common observation that defects in a cinematic picture tend to increase the visual fatigue incident to viewing it. This includes such defects as being out of focus, grainy, too dim, too flat, too contrasty, showing flicker, scratches, or other marrings, geometrical picture unsteadiness (such as weaving and jumping), "travel ghost," and many others, almost too numerous to mention. Television pictures also have their own characteristic defects, again almost too numerous to mention, and it can be inferred that each will tend to increase the visual fatigue incident to viewing the picture.

A television picture is thus bound to produce greater visual fatigue than the viewing of an actual moving scene. The same is true of a cinematic picture compared to an actual moving scene. The reason is that, when viewing an actual scene, the eye is usually exposed to a general illumination that is approximately that of the specific events being examined, whereas, with a cinematic picture or a television picture, the rest of the visual field is much darker than the picture. Under such circumstances, there is a tendency for the production of glare effects. Moreover, there is an actual reduction in the various visual functions such as brightness discrimination, resolving power, and the apprecia-

tion of flicker. The difficulty comes about for several reasons. Part of the eye immediately surrounding the bright picture is much more dark-adapted than the part concerned in looking at the picture. The slight ocular movements that throw the picture on different retinal areas therefore expose the marginal areas now to bright illumination and now to dim illumination, a situation that results in strain. Moreover, because a large part of the retina is in darkness and some of it is in light, contradictory impulses that are set up for the behavior of such things as the pupil and muscles result in visual fatigue.

In addition to possibly altered eye-movement patterns, suggested in Questions 14 to 15, which might induce fatigue, possible accommodative (and associated convergence) strains coming from imperfect interlacing ("beads," "steps," etc.) should be considered.

#### RESOLUTION VS. INTELLIGENCE CONTENT

**Question 20.** Is there any known relationship between the fineness of structure of the television picture (expressed in terms of the number of scanning lines therein) and the *instructional or entertainment value of the picture?*

It is of course clear that there is instructional value and also entertainment in viewing the finer details of many pictures. In a paper by Baldwin, mentioned already in the answer to Question 17, picture quality is measured in terms of the discernibility of increases in over-all sharpness.

#### CONTRAST RANGE

**Question 21.** What *contrast ranges* (ratio of brightness of brightest high light to deepest shadow) are regarded as too low, adequate, and unnecessarily high, respectively?

Certain physiological considerations follow. If the eye is adapted to a given brightness and the light is shut off, it can see immediately afterward only a brightness that is greater than a certain fraction of the original light [Blanchard, *Phys. Rev.*, **11**, 81 (1918). Cf. *Physiol. Rev.*, **17**, 239 (1937)]. This fraction varies inversely with the initial brightness; at 100 millilamberts it is about  $\frac{1}{500}$ ; at 10 millilamberts it is  $\frac{1}{250}$ ; at 1 it is  $\frac{1}{100}$ ; and at 0.1 millilambert it is  $\frac{1}{25}$ . These fractions then give the useful contrast range at any picture brightness, since they record the

maximum range in brightness that the eye can follow on any spot.

Photographically considered, it may be assumed that the best photographic contrast range for prints on glossy paper is usually not better than 80:1; and, in the case of the usual photograph on matte paper, the contrast range is nearer 40:1. It would appear that the adequate range should be between 25:1 and 40:1. The suitable contrast range could, of course, be different depending upon the range of brightness of the scene being televised.

In the symposium of the Society of Motion Picture Engineers, referred to in the answers to Questions 2 and 3 [J.S.M.P.E., 26, 548 (May, 1936)], there was a determination of the contrast ranges for a number of samples of what was judged typical motion-picture film, without comment as to how good or bad these ranges were. It is understood that the figures (they ran from 80:1 to 450:1) represented much better projection conditions than exist generally in motion-picture houses. Television pictures have been generally estimated to show a contrast range of from 10:1 to 30:1, with the 10:1 range considered inadequate [e.g., J.S.M.P.E., 35, 234 (September, 1940)].

#### GRADATION (GAMMA)

**Question 22.** What *gradation* (or "gamma") is regarded as suitable for the reproduced television picture?

Many years ago Dr. L. A. Jones [*Scientific Publications, Kodak Research Laboratories*, 4, 120 (1920)] indicated that a "gamma" of greater than one in the reproduction of a photograph could be used to compensate for the reduced perception of contrast caused by departure from the Weber-Fechner law at the lower brightness level of the reproduction (as compared with the higher brightness level of the original scene). Similarly and in addition, the gamma of a monochrome is increased to compensate for the loss of the color contrast in the original scene.

There is a parameter further involved, not specified in the language of the question, namely, the shape of the relationship curve between the logarithm of the brightness of the reproduction and that of the original. As reported by Dr. Jones (Society of Motion Picture Engineers, Atlantic City Meeting, Apr. 23, 1940) this is not necessarily optimum when linear throughout the range.

For a telecinematograph system as contrasted with a television system, it is to be expected that the photographer has already exercised all his skill in the preparation of the film, and the system should merely duplicate. In such a case, the optimum relationship would be expected to be linear, and the gamma one.

The ideal gamma would therefore be, as elsewhere stated, unity. A lower gamma might be more satisfactory for certain scenes where contrasts are high. It is usually less in photographic prints, being between 0.6 and 0.8, and this may serve as a criterion.

The previous discussion of this question has considered the subjective preference without limitation as to possibilities. If, however, the contrast range possible in a reproduced image is narrow as compared to the original, it may be preferable to reduce the gamma below the otherwise subjective optimum, to avoid cutting off shade differences too much in the blacks and whites.

#### INTERFERENCE AND NOISE

**Question 23.** Interfering signals in television result either when a second (and generally weaker) interfering picture is simultaneously received with the desired signal or when impulsive electrical disturbances (either natural or man-made) produce white or black relatively small spots. The latter give somewhat the effect of flashing "stars" occurring at random over the received picture.

1. What constitutes, in practice, an "interference-free" picture (*i.e.*, a picture that shows no visible or distracting traces of an interfering picture signal that is also present)?

2. What constitutes, in practice, a "noise-free" picture [*i.e.*, one that is free from any noticeable or distracting white (or black) spots due to impulsive electrical disturbances]?

The language of the question is interpreted to refer to (1) what is often called "cross talk," and (2) what is often called "random noise."

1. In an early discussion of television transmission [*Bell System Tech. J.*, 6, 616 (October, 1927)], it was stated that an echo was required to be 25 db lower than the main transmission in order not to be seen. The requirement on an echo is likely to be the most severe when it is well removed from the main picture.



When in this condition, the correlation between the echo and the main picture should have relatively little importance, and the requirement should presumably also serve for cross talk. The figure varies with the quality of the reproduced image and should therefore at the present time be substantially more severe than the old figure. Present figures would be more of the order of those mentioned for noise discussed below.

2. There are two broad types of "noise" that can be distinguished, namely, "single frequency" and "random." A good preliminary report on how much of these two types of noise, respectively, is permissible in a television picture [*Post Office Electrical Engineering J.*, **32** (part 3), 193 (1939)] reaches the general conclusion that the picture is most susceptible to single-frequency noise that leads to almost stationary bars of the rough order of magnitude of 10 per frame. Here a signal-to-noise ratio of something like 50 db (where the video signal is measured peak to peak, and the noise peak to zero) is just visible. This is reduced to some 20 db for much larger numbers of bars. In commenting upon these results, one may say that they depend upon the range and linearity of contrast reproduction in the receiving tube and that, in the region of numbers of bars that is already the most susceptible, specialized pictures with large areas of flat field can be made to show more susceptibility than reported. There would be some room for argument, however, as to how these should be weighted in view of the low frequency of occurrence of such pictures.

With regard to random noise, the conclusion is reached that this would be just visible at about 40 db measured in the same way as above. The same comment holds as above with regard to the contrast reproduction of the tube. The comment with regard to specialized pictures does not hold, because, in this case, flat fields of varying brightnesses were included in the determination.

The successive impulses or groups of impulses constituting random noise may gradually be separated until finally they become quite isolated in time. Under these conditions, some weighting may be considered for the reduced frequency of occurrence of the noise.

It is probable that the interference into the synchronization will be of more interest than interference into the picture. Some

discussion of this subject is given in *Telegraphen und Fernsprech Technik*, 27, 158 (May, 1938).

The previous discussion of "cross talk" has assumed the most severe condition possible, namely, when the interfering and interfered pictures are so nearly synchronized that one moves slowly over the other. Under less severe conditions, the requirements will be more lenient.

#### FIELD FREQUENCY VS. JERKINESS OF MOTION

**Question 24.** A television picture of an object having a component of rapid motion at right angles to the "line of sight" of the observer is to be transmitted and received. The pickup tube in the television camera at the transmitter is assumed, as a simplification, to have ideal picture storage. That is, the scanned image in the pickup tube records, as a composite, all motion within the picture during the time between successive scanings (which is the time corresponding to the "field frequency," or picture-repetition rate).

Suppose that the picture tube at the receiver (on the screen of which the final picture is viewed by the audience) has limited luminous persistence so that the brightness of each received picture field (and of each part thereof) drops to, say, 30 per cent of its initial value in the period of one picture field.

What is the *lowest field frequency* that will result in naturalness, smoothness, and *nonjumpiness* or discontinuities of motion in the picture?

The general subject of this question and the others up to 27, inclusive (really an expansion of Question 14), would seem to have been of considerable importance to motion-picture engineers. Apparently in the days of silent pictures, there was a wide range in frame speeds, both of camera and projector. For several years a proposal was under way for standardizing on a camera speed of 16 frames per second and a projection speed of around 21 frames per second. The indications are that economic considerations played an important part in the setting of these speeds. The fact that the speeds were different shows the power of the observer to adapt himself to a stylization that deliberately departs from nature in the representation of motion. With the advent of sound films, the present standard of 24 frames per

second for both camera and projector was arrived at, apparently based largely on considerations of sound.

Figures 3 and 4 have been prepared to give an understanding of the deficiencies of a television picture in the representation of

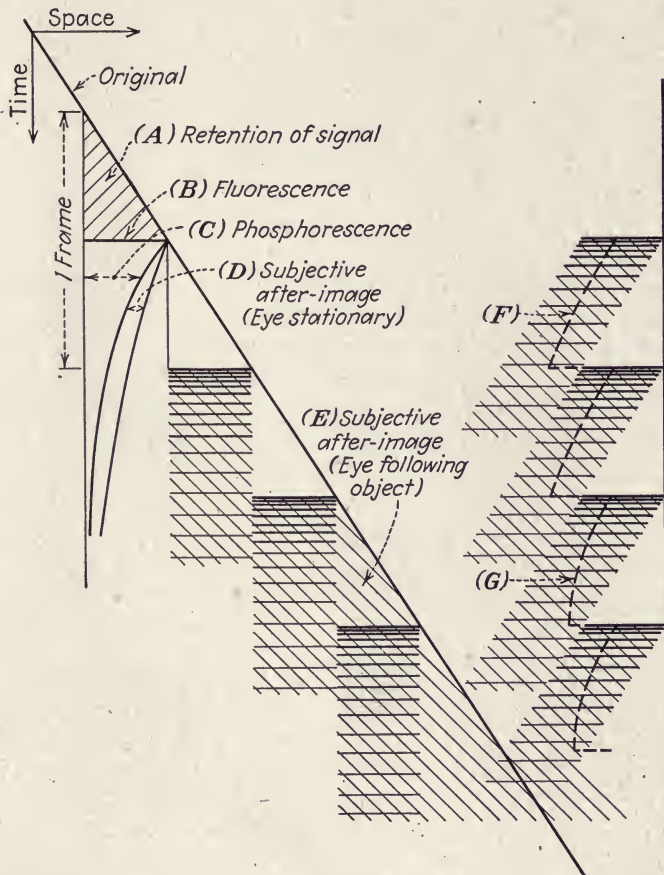

FIG. 3.—Effect of fluorescence, phosphorescence, and subjective after-image in producing discontinuity of motion in television reproduction (Panel 2).

motion and to compare these with the deficiencies in a cinematic picture. In Fig. 3, the diagonal line marked "original" represents the position of a short length of a vertical line (as much as could, for example, be seen in two scanning lines) as it moves from left to right across the field of view. The crosshatched portion A represents the retention of the signal as it exists on

the mosaic of a perfectly storing pickup tube. This signal is then given to a cathode-ray beam, which causes a fluorescence *B* on the receiving tube. The width of this spot is equal to the distance traveled by the original line in the time of scanning of

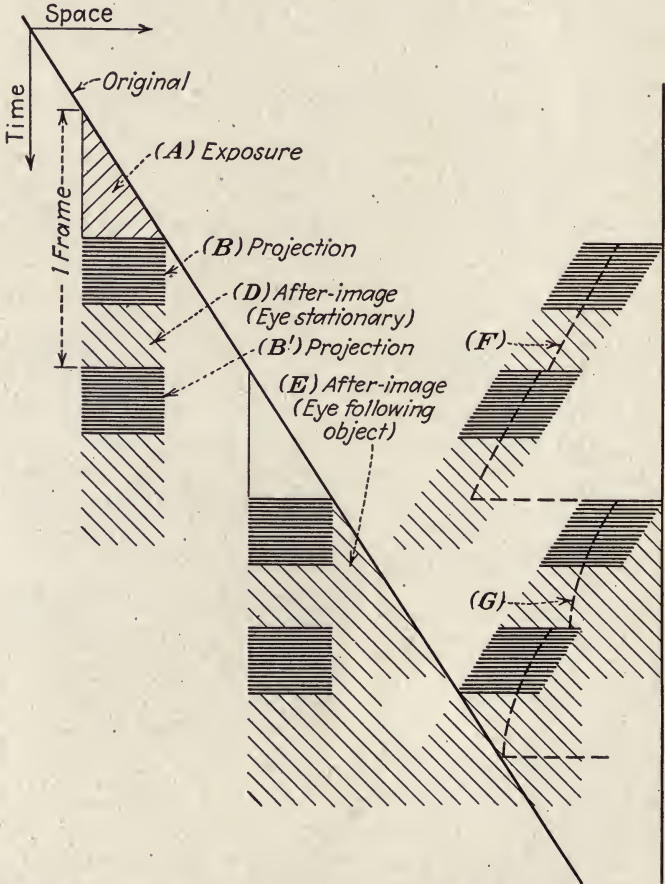

FIG. 4.—Effect of projection interval and after-image in producing discontinuity of motion in motion-picture reproduction (Panel 2).

one field. The fluorescence does not die out immediately but goes through a phosphorescent decay *C*. In the first step depicted, the screen brightness is plotted schematically as a Cartesian coordinate against time. The curve here is meant to

be merely generally representative, not specifically quantitative. In the other steps, the screen brightness is indicated schematically by horizontal shading.

Superimposed on the screen brightness will be the subjective after-image, as it occurs in the eye of the observer. For the present problem, it will be assumed that the time durations are so short that only the early positive after-images will be of consequence. The after-image will depend upon the extent to which the eye follows the motion of the subject depicted. Two extreme cases may be recognized, first where the eye remains absolutely still, and second where it follows the motion of the subject exactly. In the first case, the subjective after-image is located at the same place as the fluorescent and phosphorescent images and merely follows them in time. This is indicated schematically by *D* in Fig. 3. The crosshatching in the second step is merely meant to be diagrammatic. In the second case, the after-image of the fluorescent image is displaced on the screen in the direction and approximately with the velocity of the original. Similarly, the after-image of each elementary part of the phosphorescent image is also displaced in this way. The entire after-image area is thus indicated by the crosshatching *E* in Fig. 3. It is clear that any quantitative study of the brightness of the parts of the after-image would be fairly complex.

At the right-hand side of Fig. 3 is a replot of the discrepancy presented to the eye between the image seen and the original. Some notion of the "jerkiness" of the reproduced motion may be obtained by drawing a dotted line through the successive centers of gravity of the images seen. Where the image seen becomes very faint, the displacement from the preceding image can be given somewhat less than full weight. On this basis, the dotted line *F* gives a rough indication of the jerkiness when the eye does not move, and *G* for when it follows the moving object exactly. A possible additional subjective impression of jerkiness may be obtained by the flickering brightness of the moving object as it goes across the field of view.

An exactly similar diagram has been prepared in Fig. 4 for conventional cinematic reproduction. Here there is only one exposure *A* per complete frame, and it is projected twice on the screen, as indicated by *B* and *B'*. There is no phosphorescent decay. The subjective after-images come somewhat in the same

fashion as for the television image and again are indicated roughly by crosshatching.

The following considerations may be drawn from a study of these sketches:

1. The value of frame frequency at which the jerkiness will disappear will depend upon parameters other than those mentioned in the language of the question. In particular it will depend upon how the subject matter is viewed, upon the complete decay curve for the phosphorescence rather than merely the value after one field interval, upon the brightness and color of the projection, and upon the velocity of the motion. With regard to the last item, the maximum jerkiness does not come at the highest velocity, partly because the contrast of the moving object with the background is diminished, partly because the image is so spread out that it is hard to keep track of its center of gravity, and partly because the eye does not expect to follow the rapid motion so closely. A further variation may be that the subject matter can make a given amount of jerkiness more or less objectionable according to how reasonable it is. That is, a certain amount of jerkiness can well look much more objectionable in depicting the motion of a heavy train than in depicting the flight of an insect.

2. With the hypotheses given in the question, a more lenient requirement with respect to the reproduction of motion may be expected on the frame frequency of a television picture than of a cinematic picture, to the extent largely that ideal picture storage between fields permits correct picture information to be transmitted twice per frame. In the cinematic picture, there is only one exposure per frame, and no information can be obtained between the exposures.

With the above discussion in mind, no numerical values appear available to apply to any of the quantities mentioned to make the jerkiness imperceptible.

A further electrical analysis of Questions 24 to 29 follows: All these questions deal with the reproduction of moving objects by the method of scanning. The question should give greater weight to the principal factor, which is the speed of motion across the field of the picture. Some absolute criteria can be stated that will ensure that the jumpiness will not be any more perceptible than the irregularities of reproduction of still objects.

These criteria can then be compromised with due regard for the improbability of an extreme speed of motion and the tolerance of vision for more distortion of a moving object than of a still object.

The primary absolute criterion is that the motion should not exceed the width of one picture element during one scanning period. There is some question whether the scanning period should be taken as the field period or the frame period in the case of interlaced scanning, and this question also depends on whether the motion is vertical or horizontal. Naturally the more conservative estimates would require that the field period be used in this criterion.

Assuming that there is equal vertical and horizontal resolution and that a reasonably fine structure is employed, such as described in the Wheeler and Loughren paper on this subject, the width of a single picture element is regarded as  $\sqrt{2}$  times the pitch of adjacent scanning lines. If the present system is taken, this rule gives roughly 400 picture elements in the horizontal width of the field. The motion of one picture element in  $\frac{1}{60}$  sec. is a speed that may be expressed as covering the width of a field in about 7 sec.

This time of traversing the width of the picture can be decreased without jumpiness if greater persistence on the scanning spot is employed. As an empirical formula, it is suggested that this time might be multiplied by the logarithmic decrement of the scanning spot per scanning period. This is the natural logarithm of the intensity ratio of the scanning spot from the instant of excitation to a time that is later by one scanning period. In the two cases suggested, namely, a decay to 30 or 60 per cent in a period of one field, this factor would be one or one-half. In other words, the greater persistence would enable the moving object to traverse the width of the picture in 3 or 4 instead of 7 sec.

Of course the persistence of the spot, while it decreases the jumpiness, increases the picture smear of moving objects. The maximum persistence that can be employed therefore depends on the tolerance of the eye in viewing moving objects. It is suggested that the tolerance should be expressed as an absolute time of persistence rather than as a relative factor depending on the period of scanning. It is probable that the best compromise

would be obtained by making the persistence of the spot equal to the persistence of vision.

The ultimate result of applying these criteria is to limit the speed of motion if jumpiness is to be avoided. As a practical matter, this means that rapidly moving objects should be viewed from a greater distance so that the speed of motion on the screen of reproduction does not far exceed the maximum permissible value. With reasonable compromises in effect, it is thought the maximum speed would correspond to moving the object across the field in about 2 sec.

It is notable that the television system is markedly superior to 8-mm. motion pictures at 16 frames per second. In such motion pictures, it is estimated that jumpiness is noticeable if the object moves across the width of the field in less than 5 or 10 sec. It is known that a time of 1 or 2 sec. gives severe jumpiness. The resolving powers of 8-mm. motion pictures and of the present television system (effectively utilized) are not greatly different, the motion pictures being a little superior for black-and-white film and a little inferior perhaps for colored film. The principal difference is in the repetition rate of the picture, which is two or four times as great for television, depending on whether it is based on the frame frequency or on the field frequency.

The field frequency is believed to be the proper one to use in determining the repetition rate or the period of scanning for purposes of moving objects. This is true for double interlacing but probably not for higher orders of interlacing. If this is true, the assumption is implied that the visual resolving power is only half as great for moving objects as it is for still objects. Of course this depends on the speed of motion, but this ratio is roughly true under the conditions discussed above.

A brief psychological discussion follows. Presumably the temporal succession of fields could involve separations greater than those necessary to avoid flicker, and still smoothness of motion might be preserved. All the data on the "phi" phenomenon point in this direction. But it would also doubtless be difficult to specify the lowest field frequency in general. The point of introduction of discontinuity would vary with different contents and patterns, depending upon such unit-forming factors as "structuration" and "meaningfulness."



This question and the following ones (Questions 25 to 29 inclusive) would seem to require some fresh experiments. In addition to the question of the preservation of satisfactory continuity of perceived motion, there seem not even to be available relevant data on avoidance of flicker when fields of two different brightness levels are alternated with each other. Flicker experiments have quite uniformly employed alternate light and completely dark phases, save the poorly controlled ones in which, instead of sector disks, reflected light from papers has been used.

Questions 24 to 29 may also be discussed in terms of shape of the successive light and dark exposures, after-images, persistence, and flicker. There are too many factors unknown here, however, and a series of experiments would probably be more fruitful.

#### FIELD FREQUENCY VS. STREAKINESS IN MOTION

**Question 25.** What is the *lowest field frequency* in Question 24 that shows no obtrusive *picture "smear"* due to tailing, prolongation, or smudging of moving objects in the picture?

Much the same comments may be made here as in Question 24, except perhaps that greater importance can be attached to the extent to which the pickup tube has ideal picture storage. When the picture storage is not ideal, the received picture can show multiple images instead of a simple streak, particularly if the eyes remain stationary.

#### PICTURE STORAGE VS. JERKINESS

**Question 26.** If the luminous persistence in Question 24 is changed so that the brightness of each received picture field drops to say 60 per cent of its initial value in the period of one picture field, what is the *lowest field frequency* that will result in smoothness, naturalness, and *nonjumpiness* or discontinuities of *motion* in the picture?

Since the answers to Questions 24 and 25 did not give numerical values, they still hold for the present two questions, with more emphasis placed upon a long phosphorescence decay time.

#### PICTURE STORAGE VS. STREAKINESS

**Question 27.** What is the *lowest field frequency* in Question 26 that will show no obtrusive *picture "smear"* due to tailing, prolongation, or smudging of moving objects in the picture?

See discussions on Questions 24 to 26.

### RESIDUAL IMAGES VS. TONAL DISTORTION

**Question 28.** When the luminous screen on which each picture field is reproduced has a finite luminous persistence, each picture field is necessarily superimposed on the (fading) remnants or residual images of the preceding picture fields. To avoid appreciable *distortion of picture gradation* or tonal values, what is the maximum permissible *brightness* (in percentage of the initial brightness) *of the residual image* (after a time corresponding to the field frequency)?

It is obvious that the luminous persistence of the screen has no effect if the picture remains absolutely still. If there is motion in the picture, then a long-period luminous persistence gives a false after-image. The long-period after-image seen by the eye is very complicated and alternates between positive and negative (see, for example, "Introduction to Physiological Optics," J. P. C. Southall, 1937). It is also a function of brightness of both the original image and the subsequent background. From a purely subjective point of view, a persistent screen brightness that was of the order of value of the long-period after-image should be acceptable. This should be so considering not only the after-image produced on the eye by the television image, but also the after-image produced on the eye of an observer viewing the original scene.

It is a well-known characteristic of phosphors that they have multiple active elements having different periods and different brightness responses. This makes it almost impossible to specify the long-period decay in terms of the drop after such a short interval of time as a field or a frame interval. It is to be expected, therefore, that the specification for the characteristic would have to be given in terms of a much longer unit of time. Both the after-image and the phosphorescence depend upon the duration of exposure, and presumably some account of this would have to be taken in the specifications.

It is of course quite possible that a curve of decay set by the subjective after-image would be very uneconomical. If this is the case, it would be expected that the requirement ultimately arrived at would be set by an economic compromise.

## RESIDUAL IMAGES VS. FIELD FREQUENCY

**Question 29.** Does the percentage given in Question 28 depend on the *field frequency*; and, if so, in what relationship?

The phenomena discussed in Question 28 are comparatively long period phenomena and would presumably therefore not be seriously affected by the field frequency. If the decay characteristic is specified in terms of one field interval, however, this changes the base time of the specification as the field frequency is changed. For this reason, it would probably be preferable to specify the decay characteristic in terms of seconds.

## BOWING OF PICTURE EDGES

**Question 30.** Television pictures are bounded by a rectangle [in general with the aspect ratio (or ratio of width to height) of 4:3], and with rounded corners (as in motion-picture practice). In certain types of equipment, the sides of the picture are actually convex or bowed outward with a certain amount of curvature. What is the *minimum permissible radius of curvature* of the long and short *sides* of a picture that will still give an impression of acceptable rectangularity and nondistortion?

This is another aspect of a familiar problem in the consideration of optical instruments, namely, pincushion and barrel distortion, in the case of the picture borders. A fairly detailed discussion of this is given in Hardy and Perrin "Principles of Optics," p. 106, 1932. This includes some data for this distortion of a typical photographic objective, but no figures for tolerances are mentioned.

A paper by Ames and Proctor [*J. Optical Soc. Am.*, **3**, 22-84, (1921)] presents a chart for a visual field of 64 deg. (on the longest meridian), showing the distortion in the retinal image. However, what has previously been said about "shape constancy" and the tendency for a good configuration to remain stable (Question 9) seems applicable here also.

The distortion of the eye is usually a "barrel" distortion and hence if applicable to this problem would add to the difficulty. Since the center of interest in a picture is usually centered in the picture, however, it is questionable whether this curvature will have marked distortional effect. The avoidance of dis-

tortion seems more important than the necessity of giving the impression that the picture is rectangular.

#### PICTURE-SCREEN CONVEXITY

**Question 31.** In certain types of television equipment, the picture is produced on a fluorescent screen that is an approximate spherical surface convex, rather than plane, toward the looker. What is the *minimum permissible radius of curvature* of the *screen-carrying surface* that (1) will still produce a "natural" picture and (2) will not restrict, to a noticeable extent, oblique viewing of the picture?

This is analogous to the familiar problem of "curvature of field" in optical instruments, also discussed in the reference mentioned above (see Question 30). No data are known on the numerical tolerances that can be placed upon this defect.

There is evidence that a concave surface enhances the illusion of depth from single pictures, but usually such a surface introduces errors in form that are objectionable. It is believed that the screen should be flat enough to "preserve form."

#### PERSPECTIVE

**Question 32.** The photosensitive surface of the television pickup camera tube (iconoscope) is slightly more than 3 by 4 in. in size, its approximate area being nearly 100 sq. cm. A "close-up view" shows the head and shoulders of an individual, with an approximate height of about 20 in. A "medium view" shows people full length and something of their surroundings, with a height of say 7 ft. A "long shot," or long view, is one wherein heights of about 12 ft. or more are shown in the picture with relatively distant objects. In present television practice, close-up views are made with narrow-angle long-focus lenses (*e.g.*, about 14-in. focal length) at a distance from the subject. Medium views are made with a wide-angle shorter focus lens (*e.g.*, a focal length of 6 to 7 in.). The received pictures in the home are of the order of  $7\frac{1}{2}$  by 10 in. in size. What *focal lengths of lenses* should be used for close-up, medium, and long views in television for *correct perspective* effects?

This question has a definite answer from the theoretical point of view. The correct perspective is obtained only if the angle subtended by the picture in the receiver is the same as that sub-

tended by the object in front of the camera. In other words, it is impossible to obtain the proper perspective with lenses of different focal lengths. Assuming that the viewing distance has an optimum value of about five times the width of the picture in the receiver, it follows that the focal length of the lens and the camera tube should be about five times the width of the image in this tube. The image in the camera tube should be as small as permitted by the graininess or blurring of the camera-tube mosaic screen and scanning spot. Minimizing this image has the advantage of permitting a smaller lens with shorter focal length and resulting much greater depth of focus. The fundamental consideration involved is economy of light energy by reducing the size of the image. This is analogous to the use of a miniature camera, in which light is economized by the small size of the image and the resolving power is retained by the fine grain of the film. An added advantage is a much greater depth of focus for the same intensity of illumination. (It should be here stated that there was not unanimous agreement in Panel 2 on the last statement.)

It might be further added that artists frequently find pictures taken with telescopic lenses more pleasing than those taken with lenses of shorter focal length.

A detailed discussion of the requirements for the correct representation of perspective in still photographs is given in Hardy and Perrin's "Principles of Optics," p. 465. The conclusions there arrived at are the same as mentioned above, namely, that the solid angle subtended by the image at the eye of the viewer must be the same as that subtended by the object at the camera objective.

This raises an interesting question with regard to photographic practice. At the beginning of the chapter in which the reference above occurs, the statement is made that, "A photographer's 'rule of thumb' states that, for ordinary photographs, the focal length of the objective should be approximately equal to the diagonal of the plate." In addition, discussion is given as to the optical difficulties in the design of the objective which result from the choice of such a wide field of view. Then toward the end of the paragraph, it is pointed out that because of this wide field of view it is impossible for one of normal sight to look at a photograph of snapshot size from the distance required to give

correct perspective, because this comes out less than the limit of distinct vision. The interesting question is why this "rule of thumb" has persisted in photography, whether it is due to motives of economy, or whether a systematic subjective advantage is gained by the unnatural enhancement of perspective that results.

It is thought that the basis for the establishment of the photographer's "rule of thumb" was the constant urge to make cameras smaller. Particularly in cameras of the drop-bed type, there is considerable advantage in making the focal length of the objective as short as possible. Most photographers are well aware that the simple procedure of making an enlarged print from the negative is a cure for the distorted perspective of a contact print observed from too great a distance.

It may be mentioned that an instructor at an Army school of photography in 1917 found that most of the enlisted men had vest-pocket Kodaks with objectives having a focal length of approximately 3 in. On many occasions he was asked to explain the almost "stereoscopic" appearance that a contact print assumed when viewed through a retouching glass. Such a lens usually had a focal length in the neighborhood of 3 in., and there is no doubt that, in every case, it was the absence of distortion of the perspective that was observed.

In motion-picture practice, the artificial enhancement of the perspective is not so great as in ordinary photography, inasmuch as the "rule of thumb" here calls for a focal length of camera objective that is twice the diagonal of the film image. Nevertheless this calls for a viewing of a screen picture at a distance of some  $3\frac{1}{2}$  times its height, which is shorter than the normal optimum discussed in Question 8.

Television camera objectives call for viewing distances with distortionless perspective of, respectively, 4.7 and 2 to  $2\frac{1}{3}$  times the picture height. For the picture size mentioned, these mean 35 in., and 15 to 18 in., respectively. The first of these is a comfortable viewing distance, according to the answer to Question 8, but the second, though possible with the accommodation of the normal eye, is somewhat close.

The focal lengths of lenses giving correct perspective for viewing distances of four to eight times the picture height would be, for the 3- by 4-in. photosensitive surface, 12 to 24 in., respectively.

As discussed in Hardy and Perrin, the focal-length condition is merely necessary, not sufficient, for the correct rendering of perspective. An additional condition is considered in the next question.

### DEPTH OF FIELD

**Question 33.** The depth of field obtainable in television is limited by the sensitiveness of the photosensitive surface in the camera pickup tube. It is determined, as usual, by the focal length and relative aperture of the lens in this camera. What is the minimum permissible *depth of field* for naturalness and adequacy of reproduction of pictures of persons at rest or in normal motion for *close-ups*, *medium*, and *long views* as listed in Question 32?

The statement is made by Hardy and Perrin that “. . . the best that can be done is to focus the camera on the subject of principal interest and then to regulate the diaphragm of the objective so that the depth of field in the photograph is the same as it would be to an observer accommodated for this plane. For a symmetrical objective, this condition is fulfilled when its entrance pupil is of the same size as the entrance pupil of the eye of the observer, but again practical considerations usually prevent this condition from being fulfilled.” Of course, in television, where the deficiency in light is keenly felt, the practical considerations will act even more to prevent the condition from being fulfilled.

It would seem that portraiture technique could be followed in this regard, at least for a certain range of subjects and for existing camera-tube sensitivities and available optical methods.

### COLOR TELEVISION

**General.**—Before considering a group of questions dealing specifically with various aspects of color television, the following instructive general analysis is submitted. It should first be pointed out, as will be seen from the nature of the discussions on the questions dealing with color television, that exact and complete information is lacking in that field to a considerably greater extent than in the field of black-and-white television.

The principal difficulty in color television is in deciding whether or not the color system offers an improvement for the same bandwidth allotment. This means that going to a color system from a black-and-white system would entail some loss of resolving

power along with the additional information conveyed by the colors. From a purely mathematical point of view, the total amount of information is proportional to the bandwidth, other factors being equal. In comparing color and black and white, however, we are sacrificing one kind of information in favor of another, *i.e.*, information of detail as against information of color. The question therefore becomes one of determining the marginal utility of each kind of information and compromising to obtain the greatest total utility of both kinds of information. This compromise would have to be made even if we had available three times the bandwidth, because it would not follow that we should retain the present resolving power and devote the additional bandwidth entirely to the benefits of color.

Since a three-color system is the one under present major consideration, the mere fact of changing to a color system means that one-third as much information will be available for fine details. In other words, the resolving power expressed in number of lines is divided by the square root of three or multiplied by 0.58. There is a chance that this resolving power, with the additional benefits of color, might give a more favorable compromise than the present black-and-white system within a 6-Mc bandwidth. There are, however, practical considerations that make such a system unfavorable, because it would increase the scanning rate to 180 fields per second, thereby making it much more susceptible to disturbance from a-c hum. Since this could probably be removed by increasing the cost of the receiver, this factor may be no more important than the additional cost of scanning at higher frequencies and of providing color apparatus.

It is believed further that the color-filter disk large enough to handle the direct viewing of the screen of a picture tube is too large and noisy to be attractive in a home receiver. If this opinion is generally shared, then the present system of color television using a color disk would be practical only in a projection system requiring a much smaller disk. Of course there would be no difficulty in designing a projection system for a small translucent screen in a home receiver, and this would have the added advantage of a flat screen instead of the curved end of a picture tube.

Another compromise that has to be made in a color system is the reduced sensitivity with given illumination and also the



requirement for a proper distribution of colors in the lighting. It seems that the sensitivity of the system is approximately divided by six, because each of the color filters selects about one-third of the spectrum and only passes about half of the light energy in the selected band. Assuming the same amount of illumination, the color television would require operating the camera in a more sensitive condition or using a larger lens aperture and thereby reducing the depth of focus or increasing the subject illumination. This is just another compromise factor that has to be weighed in the evaluation of color television.

Color television is still in its infancy, the present proposals differing very little from those demonstrated years ago. Its progress is delayed largely by the obstacles to extensive field tests, which can be obtained only by adopting promptly some definite system proposed for standardization. This would leave open the potentiality of assigning wider frequency bands to color television on higher carrier frequencies for general use later.

#### PICKUP SPECTRAL RESPONSE FOR COLOR TELEVISION

**Question 34.** Color television is receiving increasing attention and requires precise specifications for its operation. The generally suggested processes at this time are tricolor additive processes with a cyclic succession or recurrence of picture fields in the usual red, green, and blue "primaries." Assuming the color-sensitivity curve of a camera tube (iconoscope) to be known, what should be the *color response curves for the combined red filter and iconoscope, green filter and iconoscope, and blue filter and iconoscope, respectively, for accurate "color separation"?*

A brief discussion of the specifications to be placed on the spectral response of each of the three color-sensitive elements of the pickup [*J. Optical Soc. Am.*, **20**, 11 (January, 1930)] specifies color primaries based on the work of a previous paper [*J. Franklin Inst.*, **195**, 34 (January, 1923)]. Since the time of these papers, there has been a revision of these excitation functions.

The effective color sensitivity of the iconoscope tube when combined with each of its set of three filters depends upon the chromatic properties of the eye of the observer and the nature of the reproduction primaries. The chromatic properties of a normal eye are well known [*Proceedings, Commission International de l'Eclairage*, Cambridge University Press, 1932], and

they vary only slightly with the brightness level, provided it is not too low. Within rather wide limits, the color-sensitivity curves for the iconoscope do not vary to a marked degree with the choice of reproduction primaries. Details regarding the method of determining the proper color-sensitivity curves have been given by Hardy (*J.S.M.P.E.*, October, 1938).

It should be noted that the choice of reproduction primaries has an important influence on the size of the color gamut that can be reproduced. Further, within the realizable gamut, perfect color rendering is theoretically possible in a three-color additive system. However, perfection is not attainable in so simple a manner as is generally assumed. It can be shown that, for any set of real reproduction primaries, the color sensitivity of the iconoscope must take on negative values in certain spectral regions, a result that cannot be achieved with color filters.

Hardy and Wurzburg (*J. Optical Soc. Am.*, July, 1937) have suggested various methods by which the required negative sensitivity can be realized. The simplest of these methods from a practical standpoint is to combine the currents from the three receptors so as to obtain three additive or subtractive combinations of currents that are similar to those which would be obtained by the use of the required but imaginary receptors. In this instance, the three receptors are exposed to the subject at different times, and hence the required combination of their responses would necessitate the use of delay networks. It seems likely that such a network could also be used to compensate for the fact that the image on the kinescope screen does not ordinarily fade to zero brightness in the time allotted to each color.

It is of interest physiologically to recall the experience with Kinemacolor (about 1910), the first commercial colored motion pictures. Although a little flicker was observable and there were brilliant color fringes in rapidly moving objects, the greatest trouble, it is understood, and the one that ultimately limited its use, was the unusual eye fatigue that resulted.

#### REPRODUCER SPECTRAL RESPONSE FOR COLOR TELEVISION

**Question 35.** Assuming that the color-television pictures are similarly reproduced by an additive tricolor process, and that the spectral response or light-emission curve of the receiving tube

(kinescope) is known, what should be the *over-all luminous-output curves* for each wave length or *color* of light for the combined *kinescope* and the red *filter*, the *kinescope* and the green filter, and the *kinescope* and the blue filter?

The discussion of Question 34 is believed to apply here.

### COLOR FIDELITY

**Question 36.** What are the permissible individual or combined tolerances or errors in the curves mentioned in Questions 34 and 35? That is, to what extent are *deviations from the theoretically desirable curves* for the taking *filters* alone, for the reproducing filters alone, or for both (considered as part of the system) permissible?

This question is difficult to answer briefly and specifically. One color within the permissible gamut can always be reproduced perfectly by a proper choice of constants. The seriousness of failure to meet the theoretical requirements depends on the nature of the subject. In any specific case, the errors can always be computed.

An extensive symposium on the subject of color tolerances was held in 1939 under the auspices of the Inter-society Color Council [*Am. J. Psychol.*, 52, 383-448 (July, 1939) and *Am. Dyestuff Rept.*, Aug. 21, 1939]. At this meeting, the two broad means of measuring subjective color differences were discussed (*i.e.*, in terms of the perceptible steps between them, and in terms of the ratios of "sense distances" between them and between objective standards). The problem is complicated because of the three parameters that may vary, namely, the dominant hue, the brightness, and the saturation of the color, and because of the influence of viewing conditions on the perceptions of color difference. Although several tentative techniques were proposed for the specification of color tolerance, no general numerical figures were given, partly because of the lack of data and partly because these depend on the purpose for which the specification is to be used.

A paper describing experimental measurements of the color fidelity of motion-picture film was presented before the Optical Society of America in February, 1940 [Abstract 9, *J. Optical Soc. Am.*, 30, 271 (June, 1940).] Special problems, considered

in the paper, arise when the film is exposed to light of one quality and projected by light of another quality.

#### PICKUP SENSITIVITY LOSS DUE TO FILTERS

**Question 37.** What is the minimum theoretical *decrease in sensitivity* of the *color television camera* as in Question 34, compared to the sensitivity for black-and-white pickup?

The discussion on Question 34 also applies here. This question can be answered, but only after much computation. It is assumed that it is more important to choose reproduction primaries so as to obtain a wide gamut. This fixes the response curves of the iconoscope. It does not determine the "filter factors" of the taking filters unless the spectral sensitivity of the iconoscope is known.

#### RECEIVED-PICTURE BRIGHTNESS LOSS DUE TO FILTERS

**Question 38.** What is the minimum theoretical *decrease in brightness of the reproduced color picture* in Question 35 as compared to black-and-white picture reproduction using the same kinescope?

The answer to this question depends to a considerable extent on the characteristics of available kinescope screens and can be computed on the basis of the corresponding data.

#### FUSION FREQUENCY OF COLOR FIELDS

**Question 39.** In a tricolor cyclic additive process of television, how many *picture fields of each color* will be required per second to *avoid flicker*? (Otherwise stated, what are the fusion frequencies respectively for the red, green, and blue series of pictures, each picture having a duration equal to one-third of the time between it and the next picture of the same color?)

The point of view was expressed that the flicker seems of less importance than the "colored action fringes" of Question 40. A further analysis of Question 39 follows.

As has been explained in the answer to Question 10, the fusion frequency of color fields is a function of a number of parameters, cognizance of which should be taken in an answer. In particular, the language of the question, specifying "each picture having a duration equal to one-third of the time between it and the next picture of the same color," presents an idealized situation. This is not inherently impossible, but, in present realizable practice,

the effective duration of each picture is likely to be considerably less than this. Some study of the effect of the wave shape of the stimulus cycle has been made [*J. Optical Soc. Am.* **6**, 254, 343 (1922), **24**, 91, 107, 299 (1934)].

A study of the variation of fusion frequency with brightness for a number of spectral colors is reported [*Phil. Mag.*, **24**, (series 6), 352 (September, 1912)] in connection with an examination of the possibilities of the flicker photometer in the heterochromatic photometry. The conclusion reached was that broadly the fusion frequency for the various colors was the same when the subjective brightness was the same (above a certain minimum). Indeed in a further study the use of the fusion frequency is examined as a serious possibility for the determination of equality of brightness in heterochromatic photometry [*Phil. Mag.*, **24** (series 6) (December, 1912)].

Another fusion frequency exists with color pictures where the color fields are successive, adding up, for example, to white. Some so far unpublished experiments on this have recently been carried out at the Bell Telephone Laboratories. These were on a flat field with limited field of view, the entire field being illuminated in some cases by successive flashes of color. In other cases, a television field was simulated, with interlaced fields, with the use of opaque line gratings. For the experimental conditions under which the work was carried out, the broad conclusion reached was that the fusion frequencies with white or successive colored flashes followed roughly the same law of variation with the viewed brightness of the field. However, the fusion frequency of the flashes for any given brightness was found to be, for the color flashes, something more than twice the value for the white flashes.

#### COLORED ACTION FRINGES

**Question 40.** In the color television of moving objects, if the picture-repetition rate is insufficiently high, "action fringes" in color will result on the edges of the moving objects. To avoid visible or objectionable *colored action fringes* of this sort, what picture-repetition rates would be required for each of the tricolor component pictures?

The language of the question does not specify this, but it is important to note that not all color television systems are sus-

ceptible of showing color fringes on the edges of moving objects. These will show only when the information for the various color fields is taken from *successive* exposures to the original. In a system where the successive groups of three-color fields are taken simultaneously (e.g., by a "one-shot" type of camera) and similarly reproduced simultaneously, these color fringes should not appear.

No measurements are known of the repetition rates necessary to overcome these color fringes, but it might be expected that an analysis similar to that given for Questions 24 to 27 could provide a critical condition for the evaluation of possibilities. That is, the visibility of the fringes might depend upon how large compared to a picture element is the discrepancy in object position between successive color frames. If the preceding figures are adapted to a 343-line system with 120 color fields per second, a "picture-element" discrepancy between successive color frames is obtained with a motion of the subject taking some  $2\frac{1}{2}$  sec. to cross the field.

Although no quantitative information is available on the repetition rate required to avoid color fringes, it is suspected that the rate of repetition under some conditions would need to be very high.

### COLOR PICTURE RESOLUTION

**Question 41.** In black-and-white pictures, detail or delineation is dependent primarily on the resolution in the picture, *i.e.*, the fineness of line structure of the picture. In color television, color contrasts also exist and add delineatory or intelligence-carrying capabilities particularly for bright and contrasting colored objects. What are regarded as the necessary *number of lines* per picture for adequate quality *in color television*, for red, green, and blue component pictures respectively?

If the thesis of the answer to Question 11 is accepted, namely, that "from a purely subjective point of view, a completely adequate fineness of picture structure would be one giving a picture that was indistinguishable from a picture having an infinitely fine structure;" then the requirement would be at least as severe for color pictures as for black and white. It would really be a little more severe, inasmuch as experiments have been reported [*Elec. World*, 57, 1163 (1911); 58, 450 (1911)] indicating that,

owing to the chromatic aberration of the eye, the visual acuity for objects under monochromatic light is greater than under complex light.

However, as was also mentioned in the answer to Question 11, what constitutes "adequate" resolution for television is really ultimately a compromise between technical excellence and cost. It is obvious that the addition of color gives some contribution to technical excellence, which may permit a deterioration in detail in the ultimate balance. Perhaps the motion-picture people, who have had to face the same problem, may have some contribution here. It would still have to be noted, of course, that the economic factors in the two fields would probably be different.

#### HIGH-LIGHT BRIGHTNESS IN COLOR TELEVISION

**Question 42.** Should color television pictures having white portions therein show the same brightness in such white portions of the picture as would be necessary in the corresponding black-and-white picture, or can this *white brightness* be reduced in view of the existence of surrounding colors? If so, to what extent?

No information appears available on this point.

#### VISUAL FATIGUE IN COLOR TELEVISION

**Question 43.** Considering the various known color deficiencies of normal and abnormal eyes, are any defects, *fatigues*, or other physiological and psychological effects in the viewing of *color-television* pictures to be anticipated?

Data relative to this question seem lacking.

#### EFFECTS OF COLOR-LINE INTERLACING

**Question 44.** In Question 12, line interlacing in television was discussed. In color television, will the effects mentioned in Question 12 become more noticeable or objectionable so far as *psychophysical effects of color-line interlacing* resulting from such line interlacing are concerned?

As already noted in the answer to Question 39, it appears necessary to raise the field frequency, as compared with black and white, to eliminate flicker. One might imagine that real interlacing defects, or apparent ones caused by the following of motion with the eye, could produce horizontal colored lines that would be more objectionable than mere light or dark lines.

## VISUAL FATIGUE IN PROLONGED COLOR-TELEVISION VIEWING

**Question 45.** Are there any known reasons why *color-television pictures* should cause greater or less *fatigue* during prolonged viewing than black-and-white television pictures?

There are perhaps more recent papers, but L. T. Troland's *The Psychology of Natural Color Motion Pictures* [*Am. J. Physiol. Optics*, 7, 375-382 (1926)] is suggestive.

## CONTRAST RANGE IN COLOR TELEVISION

**Question 46.** In *color television*, what *contrast ranges* (ratio of brightness of the brightest high light to that of the deepest shadow) are to be regarded as adequate, too low, and unnecessarily high, respectively?

It is difficult to imagine how a color-reproduction system can operate to reproduce colors accurately if the gamma is greater than one. A higher gamma is used in some subtractive processes to compensate for degradation of purity through the use of dyes or inks that are not ideal. This is not necessary in additive processes and is probably not desirable. With a gamma of one, the brightness range will be the same as that of the subject. It should be noted in this connection that flat lighting is desirable for color photography, and the same probably applies to color television. Presumably, the contrasty lighting for black-and-white photography is an attempt to compensate for the lack of color contrast.

## GRADATION (GAMMA) IN COLOR TELEVISION

**Question 47.** What "gamma" or *gradation range* is regarded as suitable for color-television pictures, and what values are considered to be definitely too low and too high, respectively?

Reference is made to the discussion on Question 46. Further, as was pointed out in the answer to Question 22, the gamma of a monochrome is enhanced to compensate for the loss in color of the original scene and for deviations in the Weber-Fechner law at the lower brightness level of the reproduction. In color reproduction, it is to be expected that the first factor would not be required, and hence the optimum gamma would be reduced as compared with the optimum for a black-and-white reproduction.

In the description of an earlier system of color television [*J. Optical Soc. Am.*, 20, 11 (January, 1930)], it is noted that the



linearity of the channels transmitting the information for the color fields must be carefully controlled to preserve color fidelity, although no numerical limits are given. This would call for a gamma of one, with a tolerance that might permit taking some account of the second factor, mentioned in the paragraph above.

As was mentioned in the answer to Question 22, when the transmission is from film it is to be assumed that the photographer has done his best and the gamma should be one (subject to the comments in the present memorandum, on Question 22, regarding limitations of over-all brightness range).

Where black-and-white pictures are obtained from the scanning of color film, it is to be expected, on the basis of the discussion just given, that the gamma would have to be enhanced a little.

#### INTERFERENCE AND NOISE IN COLOR TELEVISION

**Question 48.** Referring to Question 23, the effects of electrical noise in the reception of *color television* pictures will generally be the production of brightly colored points or streaks having a random distribution over the picture.

1. In color television, what would constitute in practice an "*interference-free*" picture?

2. In color television, what would constitute a "*noise-free*" picture?

No experimental data are known setting limits on these impairments for color television.

#### COLOR FLASHES IN CYCLIC COLOR TELEVISION

**Question 49.** In some forms of tricolor additive television processes, a color filter disk is synchronously rotated in front of the received color-component (black-and-white) pictures. Thus, a red filter appears before the corresponding red-component picture, a green filter before the green-component picture, and a blue filter before the blue-component picture. These filters are generally more or less modified radial sectors on the rotating color disk. It has been observed that when *blinking* the eye and moving the head during the viewing of such tricolor pictures, brilliant *flashes of color* are noted on the picture area, particularly in the case of the brighter red and green filters.

What are the determining or controlling factors in the production of the color flashes mentioned above? Do these factors

include the color-field frequency, the color-filter contours, the direction of passage of the color filters over the picture, the brightness of the picture, the duration of the winking of the eye, the "phase" of the wink (in relation to the position of the color filter), the distance of the filter from the viewer, ambient light conditions, complementary color images visually produced, and visual persistence?

No data appear available on these subjects.

#### VISUAL FATIGUE FROM COLOR FLASHES

**Question 50.** To what extent will the effects described in Question 49 cause either visual *fatigue*, discomfort, or any other physical, physiological, or pictorial effects?

No information on this point was available for submission.

## CHAPTER V

### THE TELEVISION CHANNEL

The responsibility of drawing up specific standards on the disposition of the picture- and sound-carrier signals and their sidebands was delegated to Panel 3.<sup>1</sup> The scope of the Panel was "the consideration of sound and picture channel widths and locations." The recommendations of the Panel are incorporated in N.T.S.C. standards 1 to 4 (see page 19). Briefly stated, these standards specify a channel 6 Mc/s wide; spacing 4.5 Mc/s between the picture and sound carriers; the unmodulated sound carrier 0.25 Mc/s below the high-frequency edge of the channel; and single-sideband transmission of the picture signal in accordance with Fig. 1 (page 19).

The basic channel width of 6 Mc/s was assumed by all panels as a basis of discussion, in conformity with the existing channel assignments of the FCC. Within these limits, considerable latitude was available in the positioning of the carrier signals and their sidebands.

The practicability of single-sideband transmission had been thoroughly demonstrated; hence it was agreed that one of the picture sidebands should extend 4 Mc/s or more from the picture-carrier signal. But whether the upper or lower sideband should be chosen for this purpose was open to question. Moreover, the attenuation of the carrier in single-sideband transmission may occur either at the transmitter (TA system) or at the receiver (RA system). This matter was decided by Panel 6, but it was a necessary topic of discussion in Panel 3. The sound-carrier signal might be placed higher or lower in frequency than the picture-carrier signal. Finally, the sound carrier might be placed close to the picture carrier (with the attenuated picture sideband between them); or the carriers might be separated by a wider spacing (with the unattenuated picture sideband between

<sup>1</sup>The members of Panel 3 were J. E. Brown, chairman; W. F. Bailey; F. J. Bingley; W. L. Dunn; R. S. Holmes; J. R. Howland; H. R. Lubcke; J. O. Mesa; A. F. Murray; H. V. Nielson; R. K. Potter; C. A. Priest; Robert Serrell; Paul Ware; R. F. Wild; C. F. Wolcott; and R. S. Yoder.

them). The Panel decided in favor of the wide spacing between sound and picture carrier, as is shown in Fig. 1.

Since none of these matters was particularly controversial the Panel was able to complete its work in less than 2 months. The subjects for discussion were assigned to members of the Panel, who prepared reports on the matters enumerated above. Several of these reports are reproduced in the following pages.

**Report on Carrier Spacing.**—The relative merits of spacing the picture and sound carriers at 4.5 Mc/s as against 1.25 Mc/s (wide spacing vs. narrow spacing) are discussed in the following report prepared for the Panel by R. S. Holmes. The report points out that the wide spacing places rather severe requirements on the design of filter circuits in the receiver to suppress interference from the sound signal of the adjacent channel, but that the narrow spacing imposes the same difficulty with respect to the sound signal of the desired station. In the narrow spacing system, beat notes between picture and sound carriers fall within the video band, whereas, in the wide spacing system, the corresponding beat frequency falls outside the video band. The decision made by the Panel in favor of wide spacing is based on the assumption that adjacent channels would not be generally assigned in the same locality, and hence the adjacent channel interference should not assume importance, compared to that inherent in a single channel.

#### TELEVISION CARRIER SPACING<sup>1</sup>

Considerable work has been done in the laboratory and in field tests on a television system in which the sound and picture carriers are spaced 4.5 Mc apart, with the picture carrier attenuated 50 per cent at the receiver for sesqui-sideband operation in a 6-Mc channel. This condition of operation for a typical channel is shown in Fig. 5. In this figure, both the radio frequency and typical intermediate frequency are used as the abscissa. The intermediate frequency is plotted on the basis that the heterodyne oscillator is located 8.25 Mc above the radio-frequency sound-carrier frequency. Thus, while the sound carrier is at a higher radio frequency than the picture carrier, it is at a lower intermediate frequency.

<sup>1</sup> R. S. Holmes, RCA Manufacturing Company, Inc.

One important requirement for satisfactory operation with this system is that the selectivity of the picture channel in the receiver must be such that there is sufficient rejection against the accompanying sound carrier and against the adjacent channel sound carrier. Although adjacent channels are not now assigned in the same service area, this possibility should be considered in any study of the make-up of the television channel.

It has been found that a rejection ratio of approximately 500:1 is satisfactory to prevent interference between carriers of equal strength when their frequency relation is such that a stationary beat pattern would be produced in the picture by the interference. If it is assumed that the accompanying sound-carrier strength is equal to the picture-carrier strength, a receiver-rejection ratio of 500:1 will be sufficient to prevent beat interference between them. Since the adjacent channel sound carrier may, however, be of any strength, some precaution should be taken in receiver design to prevent beat interference from this source. For purposes of comparison, an adverse signal-strength ratio of 10:1 has been assumed in Fig. 5, so that receiver rejection of 5,000:1 is required. This may or may not be sufficient to give satisfactory performance, depending on the actual signal ratio encountered at the specific receiver location.

Another requirement in receiver selectivity is that the carrier must be attenuated 50 per cent and that the slope of the characteristic near the picture carrier must not be too steep.

These requirements practically define the complete selectivity characteristic of the receiver. A curve fulfilling the requirements has been drawn schematically on Fig. 5.

The pass band of the receiver is limited by the available frequency range between the sound and picture carriers, and by the rejection requirement. Receivers having the characteristic shown in Fig. 5 have been built, and their performance has been satisfactory.

The picture-transmitter selectivity must be such that it will pass without appreciable amplitude or phase distortion all frequencies that are accepted by the receiver, *i.e.*, it must enclose the receiver pass characteristic. Also it must not radiate sufficient signal either into the accompanying sound channel or into adjacent channels to cause interference. A transmitter char-

acteristic similar to that shown in Fig. 5 has been found to give satisfactory performance.

Although the system shown in Fig. 5 has been found to give satisfactory performance, it has certain theoretical disadvantages

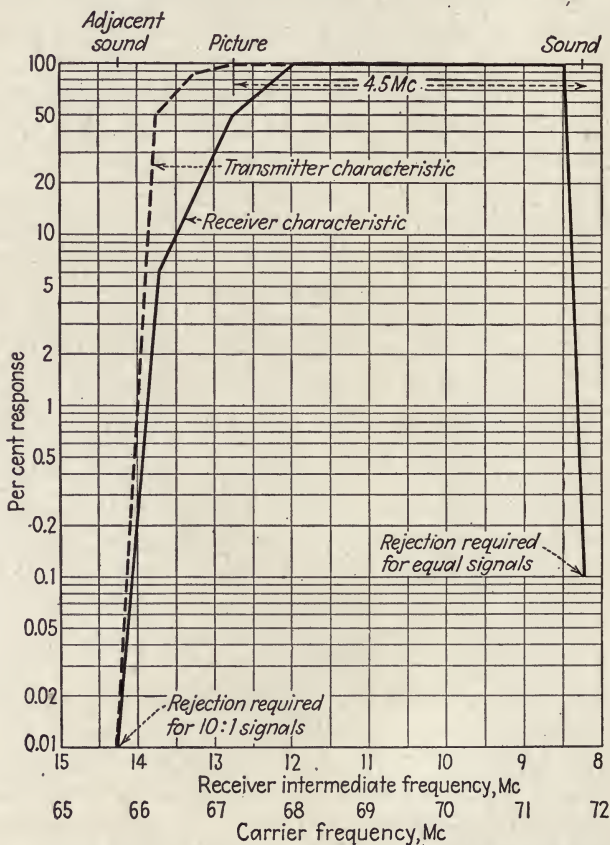

FIG. 5.—Disposition of a typical television channel, showing transmitter and receiver characteristics in relation to sound and picture carriers spaced 4.5 Mc. (R. S. Holmes.)

so far as the receiver-design problem and system performance are concerned. For the condition of interference from an adjacent television sound carrier, which for the frequency spacings shown will be located 1.50 Mc below the desired picture carrier, the rejection requirements are very severe. Since 1.5 Mc is within the required pass band of the video amplifier of the receiver, all

the rejection must be obtained ahead of the second detector, *i.e.*, in the i-f or r-f circuits. This rejection for an adverse ratio of 10:1 in signal strength must be 5,000:1. If the adverse ratio is higher, the rejection must be still greater. Also, for the television channels in which another service is located just below the channel, the interfering carrier may be at some other frequency, and a sharp rejector at a frequency corresponding to 14.25-Mc receiver i-f frequency would not be effective in eliminating it.

Elimination of the beat interference from the accompanying sound carrier is easy, because the ratio of signal strengths under normal conditions will be 1:1, and the beat frequency (4.5 Mc) is fixed and is above the required pass band of the video amplifier, so that rejectors may be placed in the video amplifier. Also, the spot-size limitations of the kinescope will aid in eliminating the effects of this interference.

Thus the rejection problem is decidedly unbalanced; the least rejection is required where it is easiest to obtain, and the greatest rejection is required where it is most difficult to obtain.

Another disadvantage of the system of Fig. 5 is that the required receiver r-f bandwidth is the same regardless of the type of receiver being considered. That is, the r-f bandwidth of a low-priced receiver, which might have a restricted i-f and video bandwidth, must still include both picture and sound carriers, even though a considerable portion of the frequency band between them might not be used.

Some of these disadvantages can be overcome and other advantages obtained by a rearrangement of the channel as indicated in Fig. 6. The essential feature of this rearrangement is that the picture-carrier frequency has been moved up to a position 1.25 Mc below the accompanying sound carrier, and the lower instead of the upper picture sideband is transmitted. The slope of the left side of the receiver characteristic is the same in Fig. 6 as it was in Fig. 5. The video band that is accepted is approximately the same as for Fig. 5.

It is obvious from inspection that the rejection problem of the two sides of the receiver characteristic have been equalized so that the least rejection is required where it is hardest to get and vice versa. Also it is obvious that the required r-f bandwidth is more nearly equal to the net video bandwidth; thus, for low-priced receivers, the radio frequency as well as the intermediate

frequency and video pass band may be restricted. This will result in increased gain and improved signal-to-noise ratio.

In the case of interference from services other than television on adjacent channels, the interfering carriers may be at any

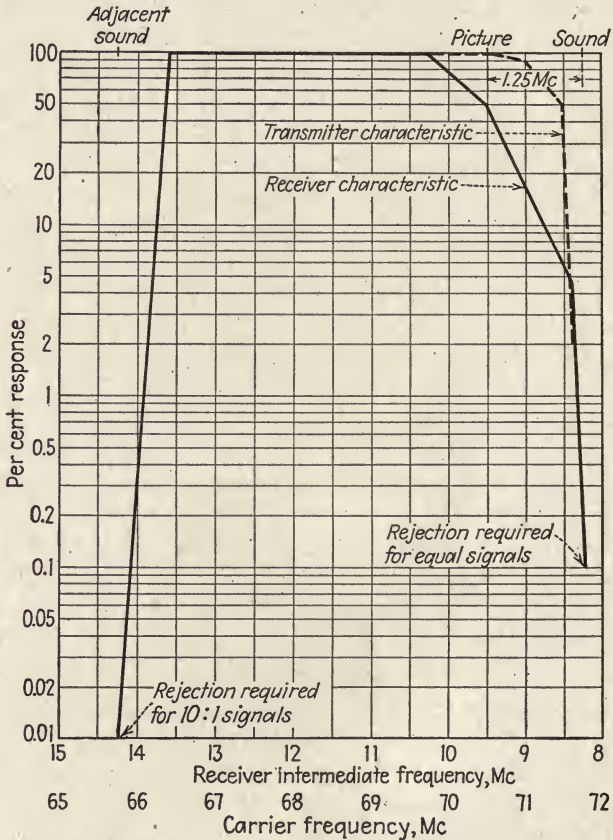

FIG. 6.—Picture and sound carriers "close spaced," *i.e.*, 1.25-Mc separation. (R. S. Holmes.)

frequency and are therefore not readily subject to elimination by sharp rejector circuits.

For channels 2, 4, and 6, the interference would be at a lower radio frequency (higher intermediate frequency) than the picture pass band. For the wide spacing condition (Fig. 5), the interference could be at the edge of the channel, 1.25 Mc from the picture carrier. For channels 3, 5, and 7, the interference would



be at a higher radio frequency (lower intermediate frequency). For the narrow spacing condition (Fig. 6), the interference could be at the edge of the channel, 1.5 Mc from the picture carrier. For channel 1, the interference could be on either side.

Thus, for this type of interference, there is less likelihood of trouble with the narrow spacing, because the nearest possible interference is 1.5 instead of 1.25 Mc away, and it is at an intermediate frequency lower instead of higher than the pass band.

It would be possible to have a control on the receiver that would reduce interference from the next lower adjacent channel for the close spacing condition by restricting video bandwidth. This would be effective regardless of the exact carrier frequency of the interfering signal.

The advantages and disadvantages of this system compared to that of Fig. 5 may be listed as follows (some of these have not been mentioned in the foregoing discussion):

#### ADVANTAGES OF CLOSE SPACING

##### 1. Rejection.

- a. The nearest possible interfering carrier is the accompanying sound carrier, which bears a standardized ratio to the picture carrier.
- b. The adjacent channel sound carrier is so far removed in frequency that it may be partially rejected in the video amplifier, and the actual rejection required will be reduced by kinescope spot-size limitations.
- c. The sharpest rejection required is against a carrier falling *below* the pass band of the intermediate amplifier. It is well known that it is easier to attain and maintain a certain selectivity on the lower frequency side of a pass band.
- d. A control could be provided in the receiver to increase the rejection against the lower adjacent channel, at the expense of video bandwidth (detail control).
- e. There is less likelihood of interference from services other than television on adjacent channels.

##### 2. Radio-frequency characteristic.

The bandwidth requirement for the r-f amplifier is a function of the net video band passed.

##### 3. Transmitter filter.

- a. If the transmitter filter does not sufficiently attenuate the unused side bands, the interference produced will fall on the accompanying sound (not the adjacent sound).
- b. The transmitter filter attenuation requirements are not so severe. It must simply attenuate sufficiently to eliminate interference on its own sound channel, not on some other and possibly much weaker service.

## DISADVANTAGES OF CLOSE SPACING

## Video beat.

Neglecting the possible interference of adjacent channels, the remaining interference is from the accompanying sound. This interference will be in the form of a possible beat note between sound and picture carriers owing to insufficient rejection in the receiver or cross modulation in either the transmitter or receiver. The effect would be more objectionable at 1.25 than at 4.5 Mc.

## OTHER CONSIDERATIONS

## Cross modulation.

## 1. Produced in receiver owing to overload.

A low-frequency beat note (in the video band) could be produced on the picture modulation by overload in the head end of the receiver. This will occur most frequently for the close spacing operation but could be readily cured by an attenuating pad in the antenna circuit.

For wide spacing, the trouble could occur when there is a strong carrier on the lower adjacent channel. In this case, it might be impossible to cure the trouble and still receive the desired station.

Actual cross modulation, *i.e.*, transfer of modulation from one carrier to another owing to overload, would be equally troublesome for either spacing.

## 2. Produced in the transmitter.

This could occur if sufficient signal from the sound transmitter were picked up in the early stages of the picture-transmitter video amplifier. The cross beat and cross modulation would occur together. The cross beat would be more objectionable for close spacing; cross modulation would be the same for either spacing. In either case, it should not be tolerated in the transmitter design.

## SPURIOUS RADIATIONS

Under certain conditions a spurious signal whose frequency is equal to the difference between the sound- and picture-carrier frequencies might be generated at or near the transmitter owing to some type of rectification. Although this should be cured in either case, the effect will be more serious for close spacing, where the radiation would be in the standard broadcast band rather than at 4.5 Mc.

## SERVICE TESTS

The system of Fig. 5 using wide spacing has been thoroughly field tested over a period of many years, and its performance characteristics are well known. The system of Fig. 6 using narrow spacing has been tested in the laboratory, where its performance was found to be satisfactory and in accord with the analysis given above.

## SUMMARY

In comparing the merits of wide spacing with those of narrow spacing, it may be stated briefly that, so far as interference is concerned, the advantage

lies with wide spacing when only a single isolated channel is being considered; but, when there is interference from adjacent channels to be eliminated, whether it be from another television station or from other services placed at random, the receiver problem is simplified by the use of narrow spacing.

There is an advantage in narrow spacing in low-priced receivers in that the radio frequency as well as the intermediate frequency and video bandwidth may be reduced, and in expensive receivers in that the space available for the useful picture sideband (plus guard band) is 4.75 instead of 4.5 Mc.

**Report on Carrier Spacing with F-m Sound.**—The foregoing report by Mr. Holmes does not specifically consider the use of frequency modulation on the sound carrier. A report relating to the effect of FM, prepared by J. O. Mesa, is reproduced below. The conclusion is reached that the use of f-m sound does not increase the available width for the picture-signal sideband; hence the spacing between picture and sound carriers should remain the same whether FM or AM is used for the sound channel. Three cases are considered: receiver attenuation with wide spacing; receiver attenuation with narrow spacing; and transmitter attenuation with narrow spacing.

#### MEMORANDUM ON CARRIER SPACING FOR A FREQUENCY-MODULATED SOUND CARRIER<sup>1</sup>

In examining the suitable possibilities for carrier spacing and sideband energy distribution for a composite television signal within a 6-Mc band having an f-m sound carrier, the most obvious disposition would probably be one similar to the R.M.A. standard M9-215 except that the sound carrier is frequency-modulated. The type of f-m wave considered is similar to the standard for the 42- to 50-Mc band.

The problem of eliminating the sound interference from the picture is essentially that of providing the necessary attenuation at the frequencies that comprise the sound carrier and its sidebands. From this consideration, there is no evidence to indicate that the attenuation that must be provided at the sound-carrier frequencies need be different when an f-m sound carrier is used from that required when the a-m wave is used. A different interference pattern results in each case, but both patterns are objectionable. While the interfering a-m carrier causes broad horizontal bands that drift vertically, the interfering f-m carrier

<sup>1</sup> J. O. Mesa, Stewart Warner Corporation.

causes a fine shimmering disturbance that covers the entire picture area. The former is more noticeable from a distance, but the latter is more destructive to picture detail. If the sound carrier is so displaced as to fall on the slope of the receiver-picture pass band, the appearance of the interference is the same for the two types of signals. This is due to the fact that when a pure f-m wave is passed through a frequency-distorting transducer, a-m components are produced.

The cost of the receiver sound channel will, in general, be greater for the f-m carrier than for the a-m carrier, although future improvement in f-m receiver design may show the way to reduce or remove this price differential. Since no extension of

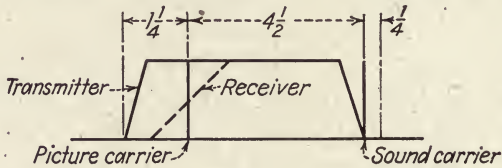

FIG. 7.—Disposition of the carriers and sidebands, with 4.5-Mc. separation between sound and picture carriers. (J. O. Mesa.)

available picture sideband width may be expected, this increase of cost must be balanced against such advantages in signal-to-interference ratio as accrue owing to the use of FM of the sound carrier. It would be reasonable to expect that the improvement would be less noticeable in areas having large field strength, in which the picture detail is not damaged by interference, and more noticeable in areas having small field strength, in which the picture detail is poor. The direction of the improvement, then, is toward making the sound signal relatively better when the quality of the picture does not warrant it.

A second disposition of the carrier's merit may be obtained by utilizing the picture sideband opposite the sound carrier instead of that adjacent to the sound carrier. Figures 7 and 8 show a comparison of the two systems. Figure 7 represents an idealized version of the transmitter and receiver pass bands for the R.M.A. signal and Fig. 8 the corresponding pass-bands for the second arrangement. The advantages of this system were discussed in a memorandum attached to the Minutes of Meeting of the R.M.A. Subcommittee on Television Standards, Nov. 9, 1938.

In this case, the carrier beat note is within the video pass band. The interference pattern of an unmodulated sound carrier appears as a series of vertical bars. Drifting horizontal bands appear, as before, when this carrier is amplitude-modulated, and the fine uniform pattern appears when it is frequency-modulated. In the latter case, as the deviation is increased and, as a result, the carrier and low-order sideband component amplitudes

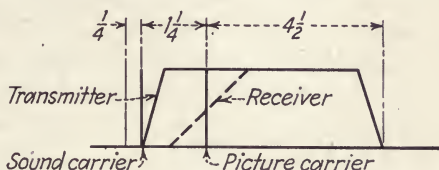

FIG. 8.—Disposition of carriers and sidebands, with 1.25-Mc separation between sidebands. (J. O. Mesa.)

decrease, these vertical bars become fainter. Again, it is necessary to attenuate the carrier and sideband frequencies equally in the picture channel for either type of modulation in order to obtain equally good pictures. As before, mistuned traps that locate the sound carrier on the slope of the picture pass band “demodulate” the carrier to produce visible signal components in the form of drifting bands. As a result, no increase of usable picture bandwidth may be expected by frequency-modulating the sound carrier.

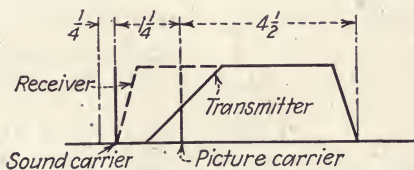

FIG. 9.—Carrier and sideband arrangement, with 1.25-Mc separation and transmitter attenuation (TA) system. (J. O. Mesa.)

A third disposition that is worth considering is shown in Fig. 9. In this case, the picture-carrier attenuation with respect to its high-frequency signal sideband is introduced at the transmitter while the receiver pass band is such as to transmit the picture carrier with an amplitude equal to that of its high-frequency signal sideband. The merits and disadvantages of this system were discussed in the memorandum attached to the Minutes of

Meeting of the R.M.A. Subcommittee on Television Standards, Nov. 9, 1938, in the minutes of R.M.A. Subcommittee on Television Receivers, Nov. 9, 1938, and in a memorandum attached to the Minutes of Meeting of the R.M.A. Committee on Television, Jan. 19, 1939, entitled The Choice of R.M.A. Transmission Standards.

In this case, the necessary pass-band shape comparisons are the same as in the previous cases, and no appreciable improvement in picture bandwidth may be expected. For this arrangement, the receiver design could be made easier if it were found feasible to increase the slope of the transmitter filter cutoff in the region of the picture carrier without introducing objectionable nonlinear phase shift at the transmitter.

#### SUMMARY

Three dispositions of carriers for a composite television signal having an f-m sound carrier are noted. It is believed that no improvement in available picture bandwidth may be expected by the substitution of FM for AM of the sound carrier, and the desirability of the substitution will depend on a balance between increase of receiver cost against improvement of signal-to-interference ratio.

**Report on Experiments with F-m Sound in Television.**—A report by W. L. Dunn, printed below, states results of tests made with a laboratory television system employing f-m sound and a-m picture signals. It was found that the filter requirements to suppress sound interference from the adjacent channel are about the same whether FM or AM is used for the sound transmission.

#### TESTS OF A TELEVISION SYSTEM WITH AMPLITUDE MODULATION ON THE VISION CARRIER AND FREQUENCY MODULATION ON THE SOUND CARRIER<sup>1</sup>

Frequency modulation of the sound carrier of a television system has been proposed. FM and its concomitant advantages are well known and need not be discussed here. What advantages a system would offer the public by having a relatively noise-free sound reproduction, with not so noise-free picture reproduction, cannot be answered here. The problem is essen-

<sup>1</sup> W. L. Dunn, Belmont Radio Corporation.

tially to determine what requirement must be met in transmitter and receiver to satisfy best either the a-m or f-m sound carrier.

#### SUMMARY OF INVESTIGATION

The requirements to satisfy the a-m case are, of course, more or less familiar. It appears a logical course to start with a receiver transmitter design that is considered satisfactory for a-m vision and a-m sound systems and determine what design requirements must be satisfied for equally satisfactory operation, in the case of a-m vision, f-m sound systems.

The present arrangement of vision-sound carrier frequencies and guard bands appears to be as good an arrangement as can be conceived.

Given the transmitter characteristic R.M.A. M9-215, it seems axiomatic that for equal orders of interference (in the vision channel of a receiver) between an f-m sound carrier and a-m vision carrier, as compared with an a-m sound carrier and a-m vision carrier, radiating equal carrier powers, the rejection-circuit selectivity to f-m sound should result in the same carrier attenuation and the conversion to AM should not exceed that of the corresponding a-m case.

This implies, and tests prove, that an f-m wave will require the same depth of carrier attenuation as an a-m wave, with a band-rejection rather than peaked-rejection characteristic. The band-rejection width required is intimately related to the deviation ratio of the f-m wave. This is true for equal carriers for both types of modulation. Because of the greater carrier power inherent in an f-m transmitter, approximately twice the carrier voltage will be delivered to an f-m receiver, requiring an additional 6 db attenuation for carrier and side bands of the f-m wave. However, it seems reasonable that, because of the superior service of an f-m system, the transmitter power be reduced 6 db, which will still give superior service without increasing the total required attenuation of the receiver.

Simplification in the required sound-rejection circuits would be possible by using an f-m channel of less than 200 kc; however, since this channel width is already standard for the f-m spectrum, it would appear undesirable to restrict it for television sound channels. That 200-kc bands should be standard for the television sound channels is obvious from the apparent ease with

which receivers could be built for reception of both the present f-m broadcast spectrum stations and the present television stations.

The evaluation of interference in the sound channel, owing to the a-m vision carrier, is in favor of the f-m sound carrier, the merit factor being a function of the limiter and frequency-amplitude conversion circuits, and to the extent of undesirable FM in the vision carrier.

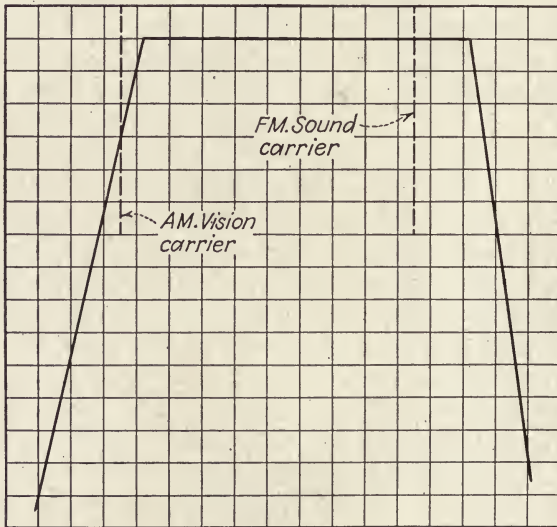

FIG. 10.—Idealized channel for use of frequency-modulated sound carrier in conjunction with amplitude-modulated picture carrier. (W. L. Dunn.)

The above conclusions regarding interference have been analyzed and are representative of tests conducted on experimental setups.

#### SOUND INTERFERENCE IN VISION CHANNEL

The proposed system shown in Fig. 10 will first be discussed. Although it is not workable, it indicated the evolution to the requirements mentioned above.

Assuming a perfectly uniform amplitude and phase characteristic extending through the f-m sound channel, then the f-m signal would arrive at the vision detector undistorted in any way, and no sound modulation would be recovered at this detector.



However, this case has been analyzed for low modulation indexes, which is a case practically comparable to an a-m wave, and numerous interfering beat phenomena are to be expected in the vision channel. The case assumed no modulation of the sound channel, and the visible response patterns are as follows:

1. The original vision-modulating frequency  $\cos ut$ .
2. Twice the original modulation frequency,  $\cos 2ut$ . This would always be present without the sound carrier.
3. A frequency equal to the difference in picture and sound carriers,  $\cos (s - p)t$ .
4. Two accompanying sidebands, to (3) above modulated at picture-modulation frequency.

$$\cos [(w - p)t - ut] + \cos [(w - p)t + ut].$$

Other responses fall outside the vision acceptance curve.

It follows then that the response characteristic shown above, assuming there is no conversion of the f-m wave to AM in the vision channel, would still result in interference phenomena. In practice, it would be difficult to obtain perfect freedom from a-m conversion, and more interference would result. An additional d-c component would be contributed to the vision diode varying with the sound-carrier intensity. Demodulation effects would occur especially in localities where there exist relatively large discrepancies between vision and sound intensities.

Actual tests on a system shown in Fig. 10 produce all the interference phenomena indicated, with perhaps the worst effects resulting from the sound-carrier direct-current in the vision diode load. Considerable conversion to AM of the f-m wave was indicated on the picture raster and monitoring oscilloscope. (Incidentally this appears to be an excellent way of checking the vision channel for amplitude and phase irregularities.)

Results of this test indicate that the system of Fig. 10 is unworkable and that attenuation must be provided in the vision channel against the f-m sound channel. Correspondingly, a receiver having good operation characteristics for a-m sound was subjected to an f-m sound carrier. The actual response from antenna to diode for the vision channel is shown in Fig. 11.

For a given order of interfering sound voltage in the vision channel for a-m sound carrier case (1.5 volts at picture tube grid), 8 db less f-m sound-carrier input voltage was required for the same order of interference. Frequency excursion of 80 ke plus or minus was used in the f-m transmitter. The a-m carrier was modulated 30 per cent. The vision carrier was 56 db below 1 volt, unmodulated. Four hundred-cycle modulation was used in both sound-carrier cases.

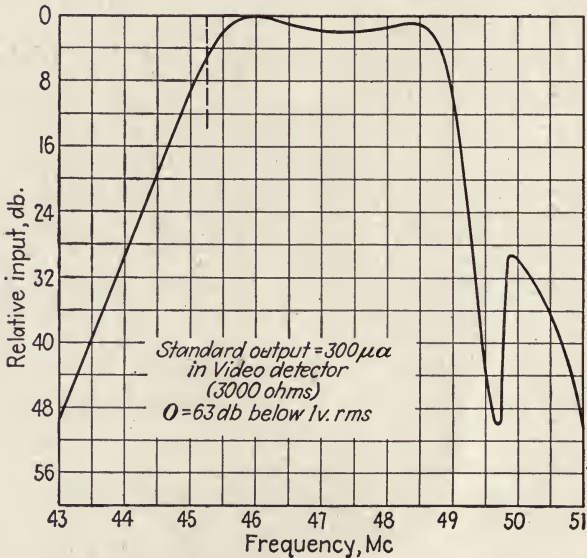

FIG. 11.—Actual response curve of vision channel from antenna to diode, of experimental receiver X-466 (No. 1), on the 44- to 50-Mc channel. (W. L. Dunn.)

Interference in each case was almost entirely the sound audio-modulation frequency. Tweets due to beat phenomena were absent. If the sound-carrier frequency is at the minimum response point for the sound channel rejector, the sidebands will not be so highly suppressed, as indicated on the selectivity curve of Figs. 11 and 12. Beat interference has been essentially suppressed because of the higher order of carrier attenuation. Because of the peaked and unsymmetrical shape of the sound-rejection curve, conversion to AM results, which gives audio-frequency interference patterns. Table II and Fig. 13 show

the effects of various tuning and adjustments for receiver 1 of Fig. 11 and receiver 2 of Fig. 12, for both f-m and a-m sound modulation. Table II shows the sound-carrier intensities required to produce standard peak-to-peak interference for the various carrier frequencies. The composition of the resulting

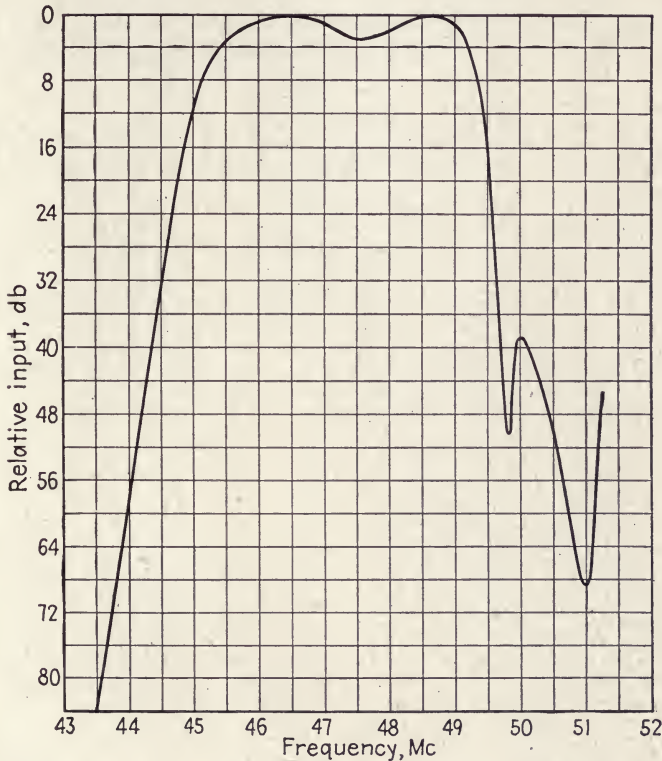

FIG. 12.—Actual response curve of vision channel from antenna to diode, receiver X-567 (No. 2), 44- to 50-Mc channel. (W. L. Dunn.)

waveforms is shown in Fig. 13 for the various frequencies and types of modulation used.

Table II for receiver 1 indicates that, for equal detuning at 49.75 Mc of the a-m and f-m case, the f-m interference increases in greater proportion. It becomes comparable to the a-m case only with very small frequencies deviations (1 kc).

Table II for receiver 2 shows greater interference orders for identical orders of detuning than does receiver 1. However, an examination of the selectivity curves for these receivers in the vicinity of 49.75 Mc yields a ready answer, *i.e.*, receiver 2 has much steeper sides.

Tests on interference from the lower channel sound carrier, 43.75 Mc, gave nearly equal orders of interference for the two types of modulation. This is to be expected because of the high

TABLE II

For constant comparative output, sound carrier input is given in decibels below 1 volt. Unmodulated. Video carrier input at 45.25 Mc, 56 db below 1 volt

Signal	Frequency of sound carrier, megacycles					
	49.75	49.65	49.85	43.75	48.9	49.35
Television set X466 No. 1:						
30 per cent AM.....	22 db	32 db	26 db	30 db	70 db	
80 kc FM.....	30	42	37	30	75	
30 kc FM.....	24	38	31	30	74	
1 kc FM.....	19	30	25	30	74	
Attenuation*.....	50	44	39	35	6	
Television set 567 No. 2:						
30 per cent AM.....	18	18	18	30		42 db
80 kc FM.....	35	45	38	27		58
30 kc FM.....	28	38	34	28		52
1 kc FM.....	20	32	28	28		50
Attenuation*.....	51	40	40	72		6

\* Attenuation of the signal due to rejection circuits in the receiver.

order of attenuation at this frequency and because of the much more gradual slope. Table II shows results of tests on two receivers at this frequency for the two modulation cases.

From the results mentioned above, it would appear desirable in the f-m case to design the vision-sound attenuation for band rejection in order to prevent an undue increase in a-m modulation level. Here a choice might be desirable between the width of the rejection band and steepness of the skirts. Very steep sides are desirable only when the complete signal can be contained in the band-rejection region for normal variations of tuning and local oscillator drifts. Steep sides in regions where

appreciable video information may exist is of course detrimental to vision detail.

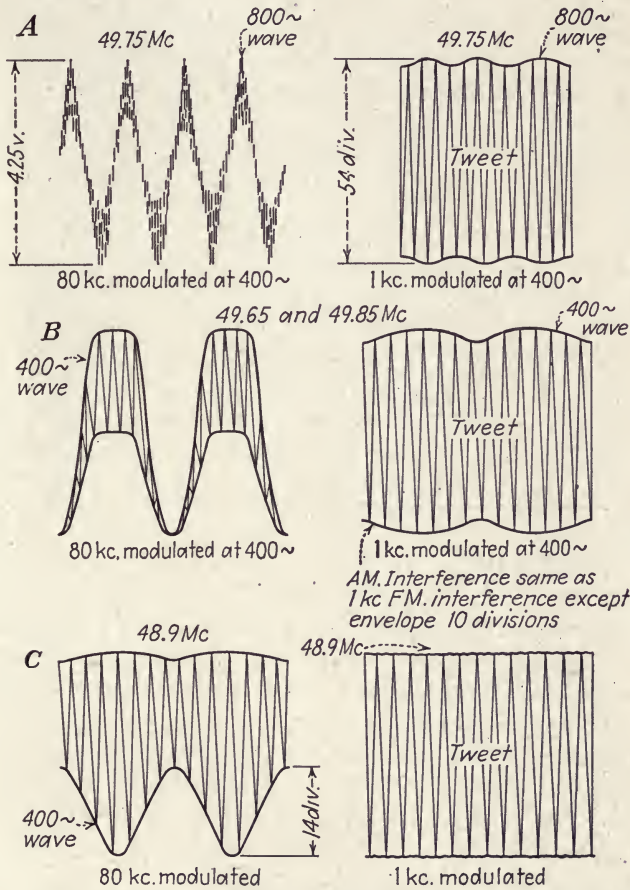

FIG. 13.—Beat and audio-frequency waveforms for sound-carrier interference. (W. L. Dunn.)

### VISION INTERFERENCE IN F-M SOUND CHANNEL

A typical f-m receiver was used for this test and tuned to 49.75 Mc. A picture signal carrier at 45.25 Mc. was then impressed upon it and resulting interference measured, with the vision modulation at approximately 4.5 Mc. to give a beat note in the receiver output. Table III shows a difference of

26 db in favor of the f-m receiver, compared to the same receiver switched over for a-m modulation. Since the normal amplitude suppression features of FM are the only considerations in evaluating this particular test, they certainly require no detailed explanation. Table III gives results of the test mentioned above. Figures 14, 15, and 16 show the characteristics of the f-m sound receiver used.

Since the television f-m sound receiver used was a completely self-contained unit in no way connected to the vision channel,

TABLE III

Interference in sound channel due to video side bands beating against sound carrier. Test consists of comparing audio voltage due to normal modulation of sound carrier and audio beat voltage produced by unmodulated sound-carrier beating with sideband produced by 4.5 Mc modulation of vision carrier. Each sound carrier 50 db below 1 volt

	Audio	Noise	Interference and noise
30 kc FM, volts.....	15	0.2	0.8
30 per cent AM, volts.....	15	1.8	15

it is desirable to discuss how they should be interconnected for receiver design economy. It would appear best to follow the pattern of television all-a-m systems, *i.e.*, a common preselector circuit for sound and vision, a common mixer and some means of removing the sound intermediate frequency from the vision intermediate frequency. This would require that the preselector be reasonably wide to include the sound carrier and that the vision intermediate frequency not be too sharp. In the matter of cross talk that might take place in the first detector, no checks have been conducted. However, it seems reasonable that no more cross talk would occur between an f-m wave and an a-m wave than would occur in a dual a-m system. Mr. Holmes of RCA, in the First Minutes of Panel 3, stated that no trouble with cross talk was experienced in tests with f-m sound and a-m vision.

**Reports on Vestigial Sideband Transmission.**—The following reports by R. F. Wild and Robert Serrell relate to the charac-

teristics of the filters employed at the transmitter to obtain single-sideband transmission. It is pointed out that the sideband

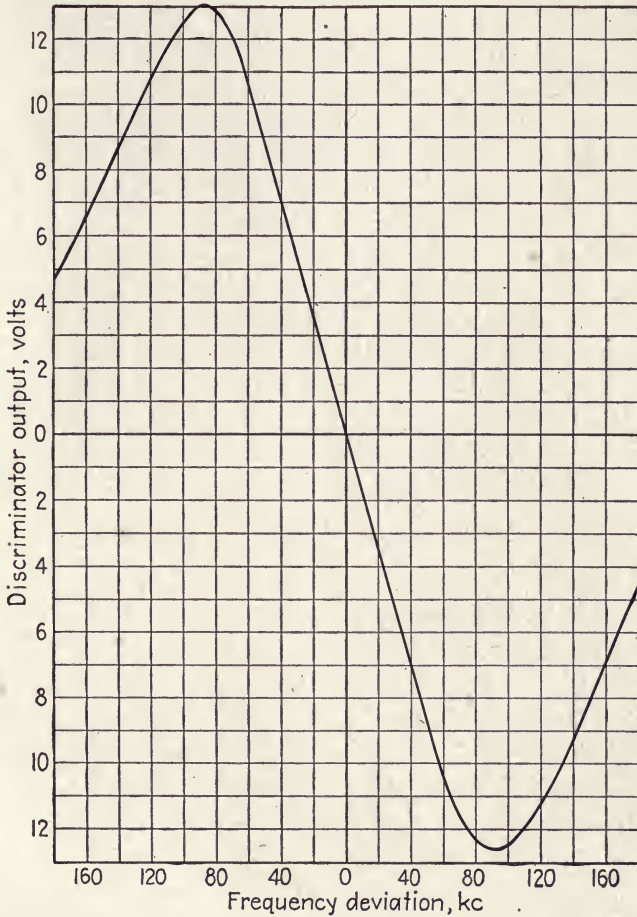

FIG. 14.—Discriminator-detector characteristic of receiver X-563. (W. L. Dunn.)

distribution specified in Fig. 1 (page 19) does not impose serious difficulties in filter design but that the problem becomes more difficult on the higher frequency channels.

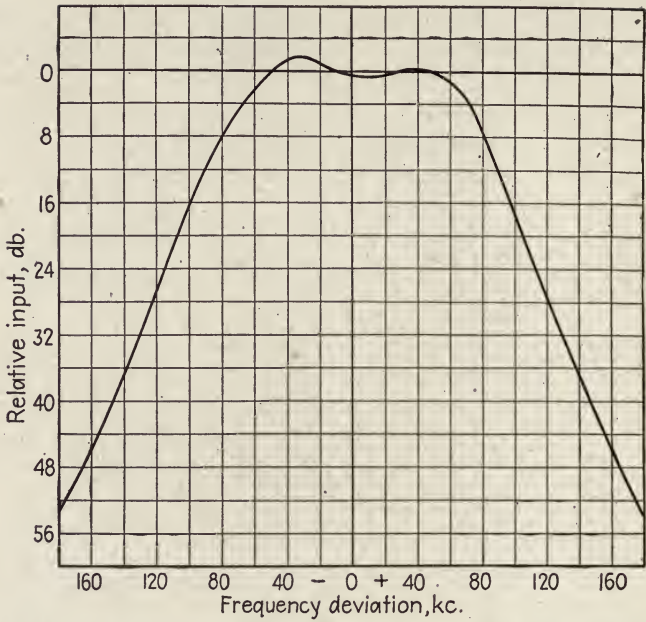

FIG. 15.—Sound-channel bandpass characteristic to limiter grid, receiver X-563. (W. L. Dunn.)

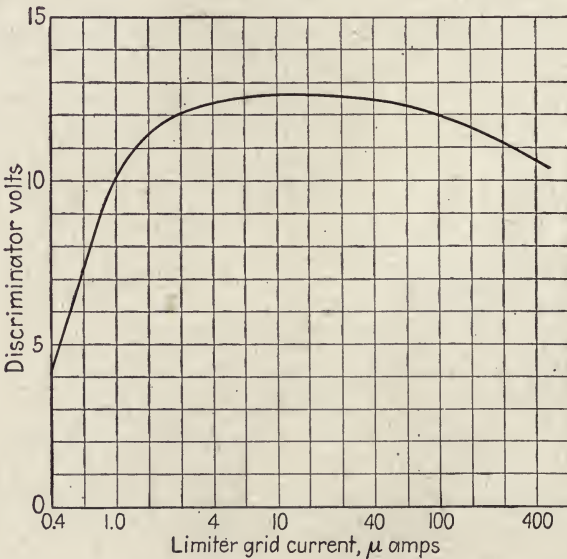

FIG. 16.—Limiter characteristic, taken at 2,859 kc. (center frequency 2,900 kc.), receiver X-563. (W. L. Dunn.)



SIDE BAND FILTER CHARACTERISTICS<sup>1</sup>

The purpose of this report is to outline the characteristics of single-sideband filters insofar as they determine the manner in which a television channel shall be utilized.

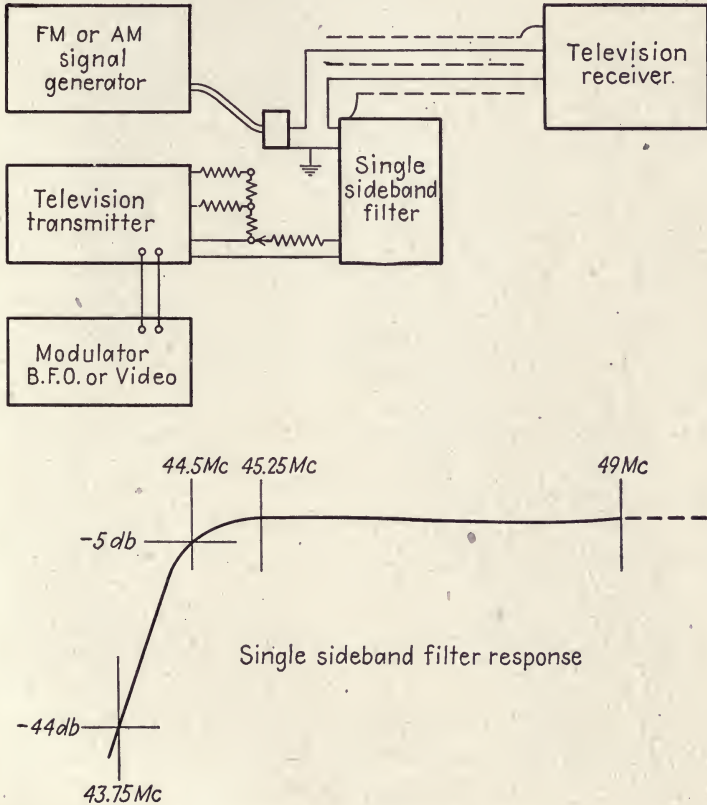

FIG. 17.—Block diagram of setup used in testing the use of f-m sound signals. (W. L. Dunn.)

There are two general types of single-sideband transmission. One of these involves attenuation of the carrier at the receiver (designated as the RA type). This is the scheme of transmission now covered by R.M.A. standard M9-215. The second type involves attenuation of the carrier at the transmitter (designated

<sup>1</sup> R. Serrell, Columbia Broadcasting System, Inc.

as the TA type). It is the immediate concern of Panel 6 (Coordination of Transmitter and Receiver) to decide which of these two methods of transmission shall be recommended. Panel 3 is concerned with the manner in which the available bandwidth shall be utilized. For the purpose of discussion, therefore, the properties of both methods will be considered briefly.

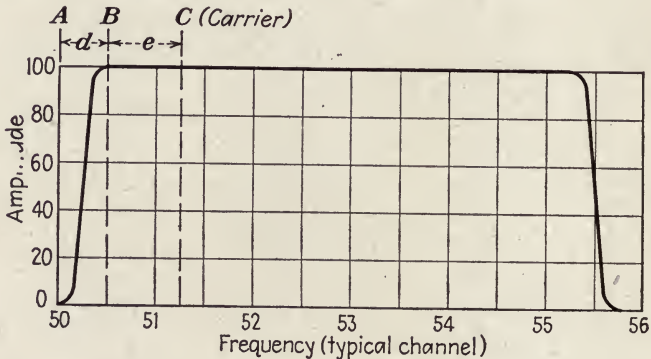

FIG. 18.—Amplitude characteristic of the picture transmitter, for receiver-attenuation (RA) type transmission. (*R. Serrell.*)

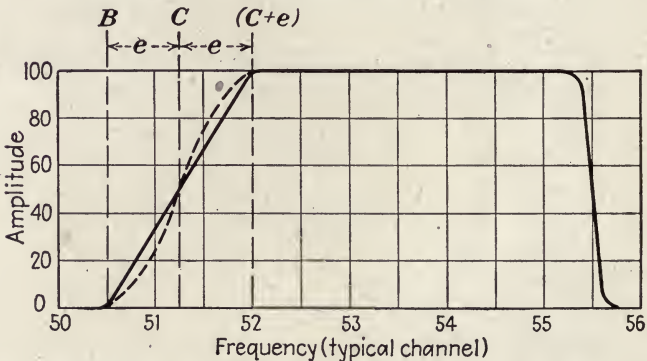

FIG. 19.—Receiver response characteristic for the picture channel, with RA-type transmission. (*R. Serrell.*)

Let us consider type RA first: At the transmitter, the sideband filter characteristics must be such that the amplitude of the radiated signal be as shown in Fig. 18. For all video frequencies lower than  $e$  (the band  $B$  to  $C$ ), double-sideband transmission takes place. The lower sideband of the picture signal is progressively attenuated in the frequency range  $d$  (from  $B$  to  $A$ ), and radiation at frequencies lower than  $A$  is small.

The characteristics of a type RA receiver (Fig. 19) must be complementary to that of the transmitter, *i.e.*, the response of the receiver must be

1. Zero (or sufficiently low) at frequencies lower than  $B$ .
2. 50 per cent at the frequency  $C$  (carrier).
3. 100 per cent at frequencies higher than  $(C + e)$ .

These conditions are imposed by the transmitter characteristics. The only variable is the shape of the response curve between frequencies  $B$  and  $(C + e)$ . It is not necessary, of course, that this be a straight line. It is sufficient that the response of the receiver to any two frequencies  $(C + f)$  and  $(C - f)$  (where  $f < e$ ) should add up to 100 per cent.

In the TA type of transmission the transmitter and receiver characteristics are simply interchanged. At the transmitter, the design factors to be specified are now

1. The width of frequency band  $e$  (position of carrier).
2. The amount of transmission that can be tolerated at frequencies lower than  $B$ .

Here, as for the receiver in the RA system, the shape of the characteristic between frequencies  $B$  and  $(C + e)$  does not matter, provided that amplitudes at frequencies equidistant from the carrier add up to 100 per cent.

At the receiver, conditions imposed by the transmitter characteristics are

1. That the response be 100 per cent at all frequencies higher than  $B$ .
2. That the response be zero (or sufficiently low) at all frequencies lower than  $A$ .

Considerably more data are available to this writer on filters for type RA transmission than for type TA. This discussion will therefore be confined to filters designed for the former method.

Three factors should be specified in the design of a filter for type RA transmission:

1. The width of frequency band  $e$  (position of carrier).
2. The width of the frequency band required for full attenuation.
3. The amount of transmission that can be tolerated at frequencies lower than  $A$ .

The first of these factors does not really enter into the problem, since it determines only the frequency at which the filter shall

operate. The other two are the only filter characteristics that determine the manner in which energy shall be distributed in the channel.

Of these factors, R.M.A. standard M9-215 specifies only No. 2. This is given as  $\frac{1}{2}$  Mc. No attenuation is specified for frequencies lower than  $A$ . For the frequency  $A$ , the amount of transmission that can be tolerated is specified as 0.1 per cent of the maximum amplitude.

It is believed that the standards to be formulated by Panel 3 should definitely specify the amount of transmission that can be tolerated at frequencies *below*  $A$ . The reason for this, of course, is that it is easy to design a filter having a high attenuation for the frequency  $A$  and relatively little attenuation beyond. This is not what is required. What is required is that all the lower sideband energy that exists at frequencies extending from  $A$  to approximately  $(A - 2.75)$  Mc shall be so attenuated as to cause no serious interference in the lower channel.

When a given television channel is bounded by another television channel of lower frequency, it is useful to incorporate in the sideband filter an additional "notch" filter. This filter is intended to provide high attenuation of the lower picture sideband at the frequency of the sound carrier of the lower channel. This is a simple means of decreasing the interference that might otherwise exist.

It must be pointed out, however, that four television channels in group  $A$  are not bounded by a television channel of lower frequency. These are

Channel 1, 50 to 56 Mc, bounded on the low side by an f-m band.

Channel 2, 60 to 66 Mc, bounded on the low side by an amateur band.

Channel 4, 78 to 84 Mc, bounded on the low side by a government band.

Channel 6, 96 to 102 Mc, bounded on the low side by a government band.

In the case of these four channels, effective attenuation of the lower sideband cannot be obtained so simply.

It is believed that it is not practically possible to maintain as high an attenuation as 1,000 to 1 (in amplitude) over that part of the lower sideband that extends below  $A$ . This figure represents a power ratio of 60 db, and it is seriously doubted that such a high attenuation is necessary. The sideband energy generated at frequencies lower than  $A$  is always small.

In the light of the experimental results that have been obtained, it is believed that an attenuation of 40 db (100 to 1 in amplitude) would constitute a much more practical standard. For channels 3, 5, and 7, this attenuation could be increased, if necessary, by means of a notch filter tuned to the frequency of the sound carrier in the adjacent channel.

In practice, it does not seem that any serious difficulties have been experienced in obtaining complete cutoff within  $\frac{1}{2}$  Mc, as specified by the R.M.A. standard. It must be borne in mind, however, that if the bandwidth required for complete cutoff is made narrower, it will be considerably more difficult to maintain high attenuation over the lower part of the suppressed sideband.

With the RA system of transmission, the receiver does not respond to any signal of frequency lower than  $B$ . The shape of the cutoff curve between  $B$  and  $A$  and the phase shift that may exist in the region of cutoff are therefore unimportant.

#### Bibliographical References

- ECKERSLEY, P. P.: Asymmetric Side Band Broadcasting, *Proc. I.R.E.*, September, 1938.
- GOLDMAN, STANFORD: Television Detail and Selective Side Band Transmission, *Proc. I.R.E.*, November, 1939.
- HOLLYWOOD, J. M.: Single Side Band Filter Theory with Television Applications, *Proc. I.R.E.*, July, 1939.
- KELL and FREDENDALL: Selective Side Band Transmission in Television, *RCA Rev.*, April, 1940.
- NERGAARD, LEON S.: A Theoretical Analysis of Single Side Band Operation of Television Transmitters, *Proc. I.R.E.*, October, 1939.
- POCH, W. J., and D. W. EPSTEIN: Partial Suppression of One Side Band in Television Reception, *Proc. I.R.E.*, January, 1937
- Television Transmitters, *Electronics* (March, 1939).

#### FILTERS FOR VESTIGIAL SIDEBAND TRANSMISSION IN TELEVISION<sup>1</sup>

In order to utilize as much as possible of the restricted 6-Mc television channel for transmission of a wide-band television picture signal, it has been proposed and generally accepted to adopt vestigial sideband transmission.

<sup>1</sup> R. F. Wild, Farnsworth Television and Radio Corporation.

Various theoretical and experimental investigations of the effects of single-sideband transmission on the television picture quality have been made.<sup>1</sup>

Of the various methods proposed, the one described in the R.M.A. standard M9-215 places at the transmitter the most stringent requirements for suppression of the frequency normally occupied by the undesired sideband, whereas the most lenient requirements are placed at the receiver, in the interest of simplified receiver construction.

The method of transmission just referred to requires a carrier attenuation of 1 to 1,000 within a frequency band of 0.5 Mc at the low-frequency end of the transmission channel. The upper cutoff of the transmitted frequencies can be readily effected in the video-frequency amplifiers. The standard above referred to prescribes attenuation of 1 to 1,000 but does not specify this attenuation in terms of power or voltage. If the attenuation is taken in terms of voltage, it would be 60 db; if in terms of power, 30 db; and the requirements given later on would have to be halved.

Since attenuation within a given range of frequencies is more easily accomplished at lower frequencies than at higher frequencies, it would be relevant to define the sharpness of cutoff of a filter in decibels divided by the ratio of bandwidth over which attenuation is effected to the cutoff frequency expressed in per cent. Hence, if a given attenuation within a given frequency band at 50 Mc requires a sharpness of filter cutoff of  $60 \text{ db} \times f/\Delta f \times 100$ , the same condition at 100 Mc would require a sharpness of filter cutoff of  $120 \text{ db} \times f/\Delta f \times 100$ . Thus, the term  $\text{db} \times f/\Delta f \times 100$  is directly indicative of the filter cutoff requirements.

Most theoretical considerations are based on idealized filter characteristics and assume a phase shift having linear relation with respect to frequency, hence resulting in a uniform time delay of all signal frequencies. A sharp cutoff of the transmitter filter, however, is the cause of a nonlinear phase relation in the transmission range, and, therefore, the time delay is no longer

<sup>1</sup> Poch, W. J., and D. W. Epstein: *RCA Rev.*, **1**, 19 (1937); Smith, Trevor, and Carter, *RCA Rev.*, **3**, 213 (1938); Goldman, S., *Proc. I.R.E.*, **27**, 725 (1939); Nyquist and Pfeiffer, *Bell System Tech. J.*, 1940, 63; Kell and Fredenhall, *RCA Rev.*, **4**, 425 (1940).

uniform but assumes appreciably different values for different frequencies, as is illustrated by the curve  $T$  of Fig. 20. The curve  $A$  shows the attenuation of a filter having a cutoff of  $60 \text{ db} \times f/\Delta f \times 100$  and a cutoff frequency of 50 Mc. The curve  $T$  shows the time delay  $d\phi/d\omega$  as a function of frequency, calculated in accordance with a formula recently published by H. W. Bode.<sup>1</sup> The time delay  $T$  is proportional to the sharpness of the filter cutoff, expressed in  $\text{db} \times f/\Delta f \times 100$  and inversely proportional to the cutoff frequency. The curve shows that the delay reaches values above 1 microsecond in the immediate

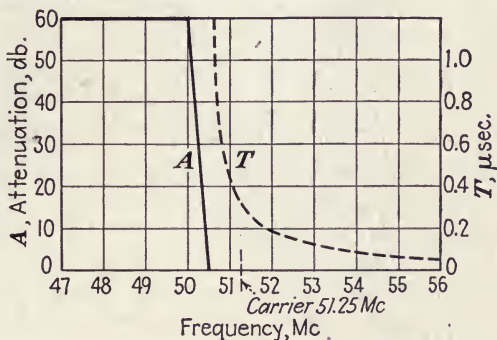

FIG. 20.—Time delay ( $T$ ) and attenuation ( $A$ ) as functions of frequency of an ideal filter for vestigial sideband transmission. (R. F. Wild.)

vicinity of 50.5 Mc. The time delay  $T$  changes very rapidly from 1 microsecond to 0.2 microsecond in the neighborhood of 51.25 Mc, which is assumed to be the carrier frequency. Since 0.15 microsecond is approximately the time allotted to a picture element in a system of 441 lines per frame and 30 frames per second, the differences in time delay for the various frequencies may be objectionable.

Two effects will have to be considered; first, the effect of the differences in time delay in the region above 52 Mc, in which only a single sideband is utilized; and, second, the difference in time delay in the neighborhood of the carrier, where both sidebands, when demodulated at the receiver, must be in proper phase.

In practice, various methods are employed for attenuating the undesired sideband; in each case, however, the energy of this

<sup>1</sup> *Bell System Tech. J.*, July, 1940, p. 426.

sideband must be dissipated in some way. In accordance with one method, the picture signal is modulated upon an intermediate carrier having a frequency lower than that of the final carrier. The undesired sideband of the intermediate carrier can be suppressed by means of a filter having a relatively gradual cutoff or a low value of  $\text{db} \times f/\Delta f \times 100$ . Such filters are comparatively simple and introduce less phase distortion than filters having a sharper cutoff. After the final modulation stage, an undesired sideband must also be suppressed, but, again, the filter requirements are not very stringent. It is said, however, that this method imposes rather severe requirements on the linearity of the transmission system used.

Another method includes the steps of modulating the final carrier directly with the television signal and attenuating the undesired sideband by means of a filter arranged between the power amplifier output and the antenna.

A filter used by NBC has been described recently.<sup>1</sup> This filter comprises two complementary portions, one of which transmits the desired sideband to the antenna, while the other portion transmits the undesired sideband to a dissipating resistor. This filter is designed to have a constant ohmic impedance throughout the transmission and attenuation range and is also provided with a "notching" filter for improving the sharpness of cutoff.

A filter has been built in the Farnsworth laboratories which is likewise intended for use between the power amplifier output and the antenna. This filter is basically a conventional  $m$ -derived structure in which, however, all elements are realized by transmission line sections. The impedance of the filter is constant and ohmic only within its transmission range and is reactive in the attenuation range, so that the energy of the unwanted sideband is dissipated in the power-amplifier tubes rather than by a separate dissipating resistor. Although this procedure places an additional load on the power amplifier tubes, conditions are not unfavorable, since the amount of power to be dissipated is rather small, as will be shown presently.

<sup>1</sup> Television Transmitters, *Electronics*, March, 1939; I.R.E. Convention 1939, *Electronics*, October, 1939; Paper delivered by Dr. G. H. Brown of RCA at the I.R.E. Fall Convention, 1939.



The frequency components of the synchronizing signals are assumed to be transmitted within the range of double-sideband transmission so that only attenuation of sideband frequencies produced by picture signals will be considered in the following. With 100 per cent peak carrier amplitude for synchronizing-signal peaks and with 20 per cent of the peak carrier amplitude reserved for synchronizing signals, it may be assumed that maximum modulation of the carrier by a picture signal results in excursions between 20 and 80 per cent of the carrier peak amplitude. The amplitude of the unmodulated carrier is 50 per cent of the peak amplitude, and the modulation factor for maximum picture contrast is 60 per cent. The sideband amplitude is, therefore, 30 per cent of the unmodulated carrier amplitude, or 15 per cent of the carrier peak amplitude for synchronizing signals, which means that the power in one sideband is 2.25 per cent of the peak power developed during the occurrence of a synchronizing signal and 3.5 per cent of the power for continuous operation on 80 per cent peak carrier amplitude, or black level.

The assumptions made for this computation can be varied in many respects, but it will always be found that the sideband power to be dissipated is but a small percentage of the maximum power to be delivered by the transmitter.

The numerical data published on filters for vestigial sideband transmission are meager. Some data are available on the NBC filter, referred to above, which was designed for operation in the channel between 44 and 50 Mc. The filter loss is said to be nearly zero at and above 45 Mc, and the attenuation 40 db at 43.75 Mc, and 23 db at 41 Mc. The sharpness of cutoff is, therefore, at least  $14 \text{ db} \times f/\Delta f \times 100$  or better. This cutoff is accomplished by means of a three-section filter in conjunction with a special notching filter.

The Farnsworth filter is a two-section filter and was built for the channel extending from 66 to 72 Mc. Figure 21 shows some of the filter characteristics, curve *A* indicating the computed values of attenuation, curve *T* the delay time, and curve *Z* the characteristic impedance, all as a function of frequency, computed on a dissipationless basis. It can be shown, however, that the dissipation will cause only minor changes. Since tests

have not yet been completed, the only measured curve is the curve  $A_1$ , showing the measured attenuation. Actually, not the attenuation proper was measured but the voltage across a load resistor, while the grid of the power amplifier tube working into the filter was excited by a constant voltage. Therefore, only the differences in attenuation are relevant, and the total curve has been arbitrarily located so as to give  $A_1 = \text{zero}$  at its minimum. Moreover,  $A_1$  includes whatever filtering effect may

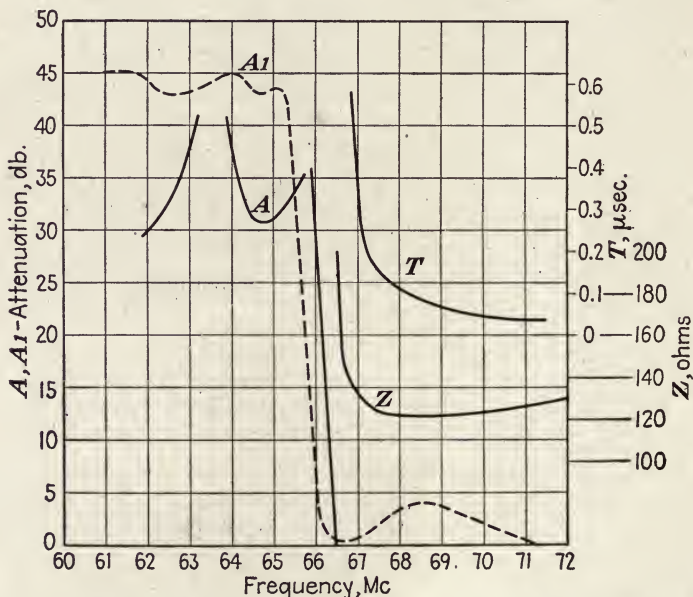

FIG. 21.—Time delay ( $T$ ), attenuation ( $A$ ,  $A'$ ), and characteristic impedance ( $Z$ ), of the Farnsworth vestigial sideband filter. (*R. F. Wild.*)

be inherent in the tuning and coupling elements in the plate circuit of the power amplifier tube. This accounts for the fact that the attenuation loss as measured is higher than that calculated for the filter proper. The measured curve  $A_1$  is also shifted by about 0.5 Mc against the computed curve  $A$ , since the final measurements were taken with a slightly different tuning of the filter. This, incidentally, shows that the filter can be tuned within narrow limits.

The variations in the measured attenuation  $A_1$  in the transmission range are probably due to incorrect matching of the

load resistor to the filter. Curve  $A_1$  shows that the attenuation in the range below 65.2 Mc is at least 39 db above its maximum value in the range from 66 Mc upward. This would indicate a sharpness of cutoff of  $39/0.8 = 49$  db per Mc or

$$32 \text{ db} \times f/\Delta f \times 100.$$

No phase measurements have been made as yet.

These figures show that a transmitter characteristic as proposed by the R.M.A. standard M9-215, if interpreted to relate to power, can be readily obtained. If, however, the standard is interpreted to relate to field strength, rather expensive filtering arrangements would be necessary.

## CHAPTER VI

### THE TELEVISION TRANSMITTER

The standards having to do with the signals radiated by the transmitter were assigned to two groups, Panels 4 and 5. The work of these panels is so closely related that they are grouped together in the present chapter. Panel 4 was charged with "the consideration of transmitter output ratings, modulation capabilities, and the relation between the power requirement of the picture and sound channels." The scope of Panel 5 was "Consideration of essential systems. Characteristics of the transmitter (signal polarity, black level, etc.)." In the following paragraphs, the standards and reports of Panel 4 are presented first, followed by those of Panel 5.

The standards recommended by Panel 4<sup>1</sup> are those numbered 18, 19, and 20 in the N.T.S.C. report. These standards specify that the rating of the transmitter shall be in terms of its peak power when transmitting a standard television signal, that the signal for maximum white be not greater than 15 per cent of the maximum carrier amplitude, and that the sound-signal radiated power be not less than 50 per cent, or more than 100 per cent, of the picture-signal radiated power. These standards follow the recommendations of the Panel except in one particular. The Panel recommended that the sound power be one-eighth to one-quarter of the picture power, whereas the National Committee revised this standard on the ground that the stronger sound signal would simplify the design of the f-m sound portion of the receiver without materially increasing the difficulty of separating the sound signal from the picture signal.

The reasoning underlying the standard on transmitter power rating is given in the following excerpt from the panel report:

It was the consensus of the Panel that the output rating of the picture transmitter should be based on a value which has a definite and signifi-

<sup>1</sup> The members of Panel 4 were E. W. Engstrom, chairman; R. Serrell; W. H. Sayre; L. M. Leeds; B. E. Schnitzer; J. E. Brown; P. J. Herbst; L. C. Smeby; N. F. Schlaack; E. G. Ports; and J. A. Hutcheson.

cant meaning. When the d-c component of the picture signal is transmitted and negative modulation is used there are two significant levels which could be used, black level and synchronizing peaks. The peak value was chosen because it is the one reference value which is not tied in with other functions of the transmitter.

It is not necessary in practical operation for the transmitter to maintain peak power continuously, and consequently the transmitter might not be capable of maintaining this power level for measurement purposes. However, it is necessary that the transmitter be capable of maintaining black level, without synchronizing pulses. Observation of black-level to peak-signal ratio on an oscillograph with a standard television signal modulating the transmitter will then determine the peak power of the transmitter. This corresponds to the practice of measuring the unmodulated power of a sound transmitter and determining the peak power with modulation by observation on an oscillograph.

Concerning the standard specifying 15 per cent or less for maximum white modulation, the panel report has the following explanation:<sup>1</sup>

The Panel felt that the adoption of a standard for modulation capability of the picture transmitter is necessary in order to ensure optimum use of the channel. High per cent modulation capability of the transmitter permits the attainment of a greater service area with respect to the interference area. The design of the receiver is also simplified if it is not required to operate on a signal having low maximum per cent modulation.

It was the opinion of the Panel that a picture transmitter not capable of at least 85 per cent modulation would be unsatisfactory since it would not utilize to the best advantage the available radio frequency power. At the same time the Panel is aware of the practical situation that it may not be possible for all of the first picture transmitters to meet this standard. It should be possible in picture transmitters for the lower frequency channels in Group A<sup>2</sup> to meet this standard, although it may not be possible for picture transmitters for the higher frequency channels in Group A to meet it at first. After the first operation on the higher frequency channels and as designs progress it should be possible

<sup>1</sup> It will be noted (see p. 137) that the panel recommendation on the definition of percentage modulation is "the percentage of maximum carrier amplitude below the peak." Thus 85 per cent modulation is represented by a carrier amplitude equal to 15 per cent of the peak value.

<sup>2</sup> Group A: The channels from 50-108 Mc inclusive. These channels were assumed by the panels to be those on which commercial operation would take place.

to meet it. The Panel requests that this present practical design consideration be passed on to the Federal Communications Commission with this standard so that the commission may be cognizant of this situation.

When the relative power devoted to sound and picture transmissions was under consideration by the Panel it had not been decided whether amplitude modulation or frequency modulation would be used for the sound transmission. Consequently separate standards were written to cover the two cases. The following excerpt from the panel report states the reasons underlying the two considerations:

In view of the fact that the use of frequency modulation on the sound channel was being given consideration by several panels, this Panel adopted separate standards for the conditions of amplitude and of frequency modulation for the sound transmission. The standard to be retained is the one corresponding to the standard finally adopted for sound modulation.

It was the consensus of the Panel that the service areas of the sound and picture transmissions should be made substantially equal. Using amplitude modulation for picture and sound transmissions, this condition is in general realized when the unmodulated power of the sound transmission is one-quarter of the peak power of the picture transmission.

There is evidence to indicate that interference may be more disturbing subjectively in the sound than in the picture, and, since the service area of the transmission, sound or picture, will be determined by the acceptability of the service with respect to noise interference, it was the feeling of the Panel that this 1:4 ratio of radiated power should be regarded as setting a minimum value for the sound transmission.

The Panel felt that there should be some tolerance in the ratio of radiated powers to accommodate the limited choice of high power vacuum tubes and the design restrictions of transmitters and antennas. The two to one range adopted in the standard is established not for the purpose of permitting careless or variable conditions of operation but rather to permit licensing television transmitters having specific ratios of picture and sound transmissions within the two to one range after the conditions of operation are determined in each case in a manner similar to that already prescribed for high-frequency broadcasting.

If frequency modulation is used for the sound transmission, the Panel felt that the service area would be little, if any, greater than if amplitude modulation were used, although the signal-to-noise ratio within the service area would be greater. Both from the standpoint of coincident

service areas and from the standpoint of receiver design it appeared desirable to accept the advantage of frequency modulation principally as an improvement in signal-to-noise ratio rather than as an opportunity to reduce the relative power of the sound transmission. Since, however, there is an appreciable advantage in signal-to-noise ratio in the use of frequency modulation, the recommended range of radiated power ratio was made lower than in the case of amplitude modulation.

The relative power in the sound and picture transmissions continued to occupy the attention of the N.T.S.C. after its report was issued. At the N.T.S.C. meeting of Nov. 11, 1941, the R.M.A. Subcommittee on Television Transmitters reported that it had under consideration the desirability of lowering the minimum sound power to 20 per cent of the picture-signal power, from the previous minimum value of 50 per cent specified in the FCC standards. The lower value was thought to provide a closer equivalence of the service areas of the sound and picture signals.

**Definitions Regarding Transmitter Operation.**—In addition to recommending standards of operation, Panel 4 developed three definitions of terms that clarify the meaning of the standards. The definitions are as follows:

*Percentage Modulation.*—The percentage modulation of an a-m picture transmitter shall be defined as the reduction, in percentage, from the peak r-f output.

*Peak Powers.*—Peak power shall be defined as the power averaged over an r-f cycle corresponding to peak amplitudes.

*Radiated Power.*—The radiated power as specified in these standards shall be determined by taking into consideration both transmitter power and antenna power gain. Thus a station having a transmitter supplying 10 kw. to an antenna of unity power gain would be considered to have the same radiated power as one supplying 2.5 kw. to an antenna having a power gain of 4.

Panel 4 also recommended that the door be left open to the use of other transmission systems as follows:

In view of the recent disclosure and laboratory demonstration of frequency modulation picture transmission, it is the consensus of Panel No. 4 that, in order to encourage the development of the television art, the recommended standards now being formulated shall not preclude the use of any transmission system, such as frequency or phase modulation, on the first seven channels, and that such a transmission system shall be admitted to regular service operation even though

specific standards relative thereto are not then formulated; provided the transmission system has received adequate field test and is receivable upon receivers responsive to the existing standards.

**Reports by Panel Members.**—The procedure adopted in arriving at the standards recommended by Panel 4 involved the preparation of reports by members of the Panel on each of the questions. The substance of these reports is contained, for the most part, in the excerpts already quoted. Additional data are contained, however, in the following brief reports, which are reproduced in full:

#### METHOD OF RATING TELEVISION PICTURE TRANSMITTER POWER<sup>1</sup>

The present method of rating the power of a television picture transmitter is to divide the peak power output by four and call this the power of the transmitter.

The figure for the power rating arrived at by this method has no particular significance in view of the fact that there is no function of picture transmission which revolves around this value in the present practice of using d-c transmission.

It was therefore the consensus of Panel 4 that some value for the power of the picture transmitter should be used which has a significant meaning. Two methods of rating the picture transmitter were discussed. These were (1) using the power at black level and (2) using the peak power of the transmitter. In view of the variation in the portion of the power output used for the synchronizing impulses by different transmitters, it was decided that plan (1) would not be the best method. Plan (2), *i.e.*, rating the picture transmitter in peak power output, was adopted by the committee because it meets the requirement that it is not a fictitious value and that it is the one reference value that is not tied in with other functions of the transmission. The one objection raised to using this method is that most picture transmitters cannot boost the carrier up to full peak power output for measurement purposes. It is not necessary to do this. All picture transmitters will put out black level continuously, and power can be measured without the synchronizing impulses. An observation in an oscilloscope, with the synchronizing impulses on, will then determine what the peak power is. This

<sup>1</sup>L. C. Smeby, National Association of Broadcasters.



practice is similar to that now used with a-m sound transmitters where power measurements are made at unmodulated carrier and the peak power output is determined by modulating the transmitter and observing the results on an oscilloscope or other measuring device.

The Panel wishes to point out that in Europe television picture transmitter power is rated in peak power.

The subject of how to take field measurements of a television station that is in regular operation transmitting a picture is closely allied with picture-transmitter power rating. When making field measurements of a picture transmitter, the panel suggests that a field intensity meter be used which is calibrated in root-mean-square values of the instantaneous maximum peak amplitude. The measurement of peak picture-transmitter power and the measurement of picture-transmitter field strength will then go hand in hand.

#### RELATIVE RADIATED POWER FOR WIDE-BAND FREQUENCY-MODULATED SOUND AND AMPLITUDE-MODULATED PICTURE<sup>1</sup>

Panel 4 has recommended that the picture transmitter be rated in terms of its peak power output when transmitting a standard television signal. F-m sound transmitters are conveniently rated in terms of unmodulated carrier power. The following discussion and recommendation conforms with this proposal.

To obtain approximately equivalent coverage from the associated picture and wide-band f-m sound transmitter when each is transmitting its normal signal, it is the belief of the writer that the radiated carrier power output of the sound transmitter should be substantially one-eighth of the peak radiated power of the picture transmitter. It should be noted that the use of wide-band FM gives a signal-to-noise ratio improvement of at least 17 db over an a-m sound transmitter of twice the carrier power. Obviously the carrier power of the sound transmitter could be further reduced materially and still maintain some improvement in signal-to-noise ratio. However the Panel believes that the major part of the gain in signal-to-noise ratio obtained by the use of FM should be reserved to give greater freedom from noise and only a small part utilized for the reduction of transmitter

<sup>1</sup> L. M. Leeds, General Electric Company.

power. This will be self-evident when it is realized that the cost of the f-m transmitter is relatively unimportant with respect to that of the studio and picture transmitter.

Because of the limited choice of high-power vacuum tubes and the design restrictions of transmitters and antennas, there should be some tolerance in the ratio of relative radiated transmitter powers. With f-m sound, it may be necessary to employ band rejection filters instead of peak rejection filters for the associated and adjacent channel sound, and hence any unreasonable increase in relative sound power cannot be tolerated.

The writer therefore recommends that the unmodulated radiated carrier power of the f-m sound transmitter be one-eighth to one-fourth of the peak radiated power of the a-m picture transmitter.

#### RELATIVE RADIATED POWER FOR AMPLITUDE-MODULATED PICTURE AND AMPLITUDE-MODULATED SOUND<sup>1</sup>

Panel 4 has recommended that the picture transmitter be rated in terms of its peak power output when transmitting a standard television signal. Sound transmitters are conveniently rated in terms of unmodulated carrier power. The following discussion and recommendation conforms with this proposal.

To obtain approximately equivalent coverage from the associated picture and sound transmitter when each is transmitting its normal signal, it has been the writer's experience that the instantaneous peak radiated power output capabilities should be substantially the same. Under this condition, the unmodulated radiated carrier power of the sound transmitter is one-fourth of the peak radiated power of the picture transmitter. Experimental evidence demonstrates that noise in the sound is more objectionable than noise in the picture. Consequently it is felt that this 1:4 ratio of power should be regarded as setting a minimum value of sound transmitter output.

There should be some tolerance in the ratio of relative radiated transmitter powers to accommodate the limited choice of high-power vacuum tubes and the design restrictions of transmitters and antennas. It is obvious, however, that to allow an unreasonable increase in relative sound power will complicate the

<sup>1</sup>L. M. Leeds, General Electric Company.

construction of the sound-carrier rejection filter and the adjacent channel rejection filter in the receivers.

The writer therefore recommends that the unmodulated radiated carrier power of the a-m sound transmitter be one-fourth to one-half of the peak radiated power of the a-m picture transmitter.

#### POWER RATIO OF SOUND AND PICTURE CHANNELS<sup>1</sup>

The Panel has recommended that, when using AM in both the picture transmitter and the sound transmitter, the unmodulated sound-carrier power be from one-fourth to one-half the peak power of the picture transmitter.

Several factors enter into this recommendation. It is the belief of the Panel that this proposed standard complies with the policy adopted by the Panel regarding coincidence of service areas for picture and sound. The desirability of this policy unanimously adopted by the Panel seems unquestionable, since television sound without picture would have little entertainment value, and the picture minus sound would usually leave much to be desired. Experience under a wide variety of conditions in the reception of television signals complying with the proposed standard has indicated that the above philosophy will be met by the power ratio recommended.

Considerations in the design of receivers, particularly in the r-f and i-f stages, make it optimum to have the picture and sound signals of approximately the same magnitude.

The proposed standard satisfactorily meets this requirement. It is considered practicable that in some cases the prescribed power ratio will be achieved by transmitters of the required power feeding into the same antenna or into antennas of equal gain, whereas, in other instances, the ratio of radiated power may be established by having the sound antenna, for example, designed with a higher radiation efficiency than the picture antenna and using a lower power sound transmitter. Thus, where the picture channel utilized a transmitter power of 10-kw. peak and an antenna having a power gain of unity, it would be satisfactory to use for the sound channel a transmitter having a power of from 2.5 to 5 kw. and a sound antenna having unity

<sup>1</sup> R. M. Morris, National Broadcasting Company.

power gain. It would also be satisfactory to install a 1-kw. sound transmitter and an antenna having a power gain of from 2.5 to 5.

This example also indicates the latitude in design that is included in the proposed standard for reasons of facilitating design. The 2 to 1 range in the recommended ratio is established not for the purpose of permitting careless operation or variable conditions of operation once a television transmitter is established, but rather to facilitate design and proper interrelation of antenna gain and transmitter power. It would be considered practicable to license television transmitters for specific ratios (within the prescribed range) after the conditions of operation were determined in each case. Such tests might be made under a construction permit, providing the 2 to 1 flexibility. The same reasoning was applied to the case where the picture channel is amplitude-modulated, but the sound is frequency-modulated on a basis similar to that already prescribed for high-frequency broadcasting.

It was felt that experience had already indicated that, when using FM, the service radius was little if any greater than when using AM, although the signal-to-noise ratio in the received signal would be higher. From the standpoint both of coincidence of service areas and of receiver design, it appeared desirable to accept the advantage of FM as an improvement in signal-to-noise ratio rather than as an opportunity to reduce power in the sound channel of the television transmitter. Since, however, there is an appreciable advantage in signal-to-noise ratio in the use of FM, the recommended range of radiated power ratio was made 3 db lower than in the case of AM.

Although this condition of operation has not been specifically tested in television service, it is felt that there has been sufficient experience in the use of FM to make it feasible to anticipate the possible desire on the part of other N.T.S.C. panels to adopt standards incorporating f-m sound. The panel has, therefore, recommended that, when using AM in the picture channel and FM in the sound channel, the ratio of peak power in the picture channel to unmodulated carrier power in the sound channel should be between 8:1 to 4:1.

The desirability of a standard with respect to power ratio lies in the information it gives the receiver manufacturers as to

design of rejection filters, reduction of cross modulation, etc. It is recognized that variations in the apparent ratio as received will vary at different locations owing to differences in propagation at the two frequencies. This variation, together with the ratio of powers as radiated, enters into the design of receivers.

The report by R. S. Holmes, discussing the relative merits of AM and FM for television sound, printed on page 156, was submitted to Panel 4, although prepared primarily for Panels 5 and 6.

#### RECOMMENDATIONS AND ACTIONS OF PANEL 5<sup>1</sup>

The standards recommended by Panel 5 are incorporated in the N.T.S.C. report as standards 10, 11, 13, and 21. These standards specify the negative polarity in modulation, d-c transmission of the picture background, and FM for the sound signal with  $\pm 75$ -kc maximum deviation.

There was unanimous agreement that the polarity of picture modulation should be negative, *i.e.*, that a decrease in the initial light intensity should cause an increase in the radiated power. Panel members prepared separate reports on this subject, each of which mentioned two basic factors giving superiority to the negative polarity: The tube complement in the final stage of the picture transmitter can be used more efficiently and hence provide a higher output power with negative modulation; and the negative system offers a reference level on which a simple automatic gain control may operate. Several members mentioned the fact that slightly superior operation of the synchronization system could be obtained in the presence of noise, with positive modulation, but that the noise in this case produced predominantly white flashes in the picture (whereas the corresponding flashes are black in negative modulation), which more than offset the advantage in synchronization.

**Report on the Polarity of Modulation.**—The following report by R. D. Kell is one of several prepared by panel members on the polarity of modulation.

<sup>1</sup>The members of Panel 5 were B. R. Cummings, chairman; W. F. Bailey; F. J. Bingley; J. E. Brown; R. L. Campbell; P. C. Goldmark; P. J. Herbst; J. A. Hutcheson; R. D. Kell; L. M. Leeds; H. R. Lubeke; A. F. Murray; and N. F. Schlaack.

## A DISCUSSION OF THE RELATIVE MERITS OF NEGATIVE AND POSITIVE TRANSMISSION<sup>1</sup>

### TRANSMITTER POWER GAIN

The original reason for using negative modulation was the power advantage to be had at the radio transmitter. The transmitter was operated with the 100 per cent modulation capability reserved for picture signal, and the carrier was then overmodulated in the direction of increased power by the synchronizing pulses.

In a modern television transmitter where black level is held at a fixed carrier power independent of picture signal, a worthwhile power gain is had by using negative modulation. With a given set of tubes in the power amplifier of the transmitter, an increase of 30 per cent in power can be obtained with negative modulation as compared to that obtainable with positive modulation. The method of calculating this power gain is shown in the appendix to this report.

### THE EFFECT OF INTERFERENCE ON THE RECEIVER

After the adoption of television standards in England, where positive transmission was decided upon, the whole subject of polarity of transmission was thoroughly investigated, because this was one of the few items where disagreement existed between European and American television practice. Tests were made in which a television system was operated alternately on positive and negative transmission with different amounts of interfering signal present at the input to the receiver.

At high signal inputs where the peak noise did not greatly exceed the picture signal, operation was satisfactory for both polarities of modulation. With low signal inputs where the peak noise signal greatly exceeded the picture signal, it was found that the synchronizing was less affected when using positive transmission than when using negative transmission. However, the interference was much more objectionable in the picture when positive transmission was used. The interference appeared as bright lines and dots scattered over the picture. Owing to the defocusing of the scanning spot, the bright spots on the picture were many times the size of the normal scanning spot.

<sup>1</sup> R. D. Kell, RCA Manufacturing Company, Inc.

In the tests of negative transmission, the interference appeared as predominantly black spots in the picture. The peaks of the interference signal drive the grid of the kinescope "blacker than black," producing spots in the picture that were much less objectionable than the white spots produced by the interference with positive transmission. However, the effect of the interference was found to be more objectionable on synchronizing when negative transmission was used. In all the different tests conducted under various conditions of interfering signal, there was little or no choice as to polarity of transmission. The effect of the interfering signal was considered to be equally objectionable in the picture or synchronizing depending upon the polarity of transmission.

Other tests on picture stability with line-voltage variations were made. These did not show any advantage of one polarity over the other. Tests were also made on the overload characteristics of the receiver. The receiver was adjusted for proper operation with a minimum signal. The signal input to the receiver was then increased until operation was no longer satisfactory. The range between the minimum and maximum signal was found to be the same for either polarity of transmission.

The results of the tests may be summarized as follows:

The effect of interfering signals is about equally objectionable with either polarity of transmission. The synchronizing difficulties of negative transmission are offset by the more noticeable effect of the interference in the picture with positive transmission. With either polarity of transmission, it is possible to reduce the effects of interference on both the picture and synchronizing by the proper use of limiter circuits in the receiver. From the tests that were made, it was decided that the decision as to which type of transmission should be used should be based on other considerations of one polarity over the other.

The remaining major consideration is the use of an automatic volume control. With negative transmission, a very simple and effective a-v-c circuit can be built into the receiver. It is possible, however, to design an automatic volume control for positive transmission. It will be inherently more complicated. Its performance will also be inferior and its cost greater than that of an automatic volume control designed for negative transmission.

Since all tests have shown that technically there is no choice between positive and negative transmission in regard to receiver performance, the transmitter power gain, the a-v-c complexity and cost should determine the choice of polarity.

It is therefore recommended that negative be adopted as standard.

#### APPENDIX

The plate dissipation in the final power amplifier of the transmitter is proportional to the summation of the squares of the voltage ordinates of the transmitted wave.

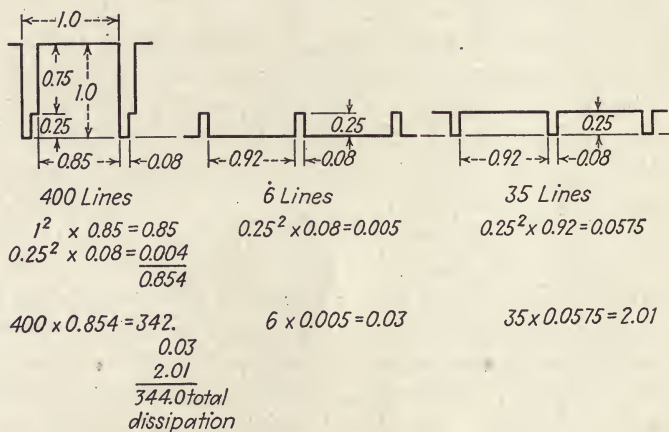

FIG. 22.—Video-signal waveform for maximum power (an all-white picture) with positive transmission. (R. D. Kell.)

With positive transmission, the condition of maximum dissipation occurs with an all-white picture. This is represented in Fig. 22. The dissipation per frame is the sum of the dissipation during the picture, vertical blanking, and vertical synchronizing.

With negative transmission, the condition of maximum dissipation occurs with a black picture. This is represented in Fig. 23. Here, again, the dissipation per frame is the sum of that during picture, vertical blanking, and vertical synchronizing time. The ratio of plate dissipation for the two types of modulation is 1.3:1. Stated in other words, a given transmitter can radiate 30 per cent more power when negative modulation is used.



## DIRECT-CURRENT TRANSMISSION

Panel 5 recommended that the black level in the picture be represented by a definite carrier level independent of light and shade in the picture: This recommendation was unanimously supported by the panel members on the grounds that constant black level, on which the synchronizing signals are imposed, offers a constant base on which the synchronization circuits can operate, thus providing stable synchronization in the presence of variations in picture brightness. The constant level also offers

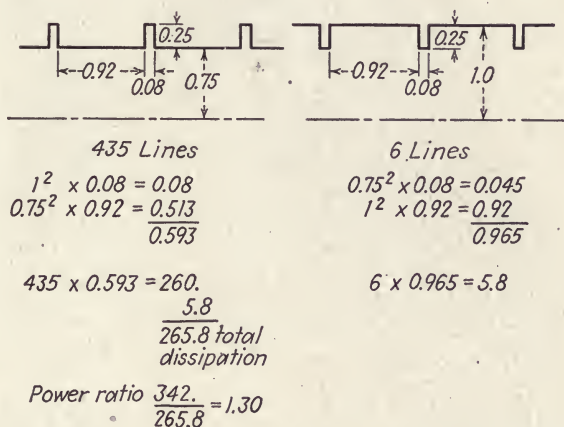

FIG. 23.—Video-signal waveform for maximum power (an all-black picture) with negative transmission. (R. D. Kell.)

a stable base for use in automatic gain control circuits. Finally, and most important, when the black level is constant, the full modulation range of the transmitter may be used for the peak-to-peak picture signal. If a-c transmission (variable black level) is used, only approximately one-half of the modulation capability can be devoted to the peak-to-peak signal, thus greatly reducing the effective power output of a given tube complement in the transmitter.

**Report on D-c Transmission.**—The following report prepared by R. D. Kell, one of several on the subject by various panel members, presents the reasoning underlying the recommendation in favor of d-c transmission.

### A DISCUSSION OF THE MERITS OF THE INCLUSION OF BLACK LEVEL IN THE TRANSMITTER CARRIER<sup>1</sup>

Practically all the early television transmitters transmitted only the a-c components of the picture. At that time, it was not considered important that the true background component of the picture be transmitted. Later circuits were developed by means of which the background component of the picture could be reproduced at the receiver while still using a-c transmission. However, as the transmitters were improved in performance, it was found from a practical point of view that circuit constants had to be employed when a-c transmission alone was used that would also make possible the transmission of the background component of the picture with minor circuit changes. This was largely because circuit constants required for satisfactory operation were determined by variations in supply voltages and other disturbing factors. By modifying the transmitter so that each half-tone value of the picture was represented by a definite carrier power level, it was found that the difficulties due to power-line fluctuations could be eliminated. This was accomplished by having circuits of such construction that they held either black level or the peaks of the synchronizing pulses at a definite power output, regardless of picture content or power-supply voltage fluctuations.

A power advantage is also had by the transmission of the d-c component of the picture. For a given tube complement in the final power amplifier or the transmitter, a considerable increase in effective power can be obtained if the peaks of synchronizing represent a definite carrier amplitude. If it is assumed for the purpose of discussion that the transmitter amplitude characteristic is linear, then the entire characteristic will be utilized by the combined picture and synchronizing signal. The peaks of synchronizing will be at one end of the characteristic and the whitest parts of the picture at the other end of the characteristic, provided the d-c component is transmitted. This is merely another way of stating that each half-tone value represents a definite carrier power. If an a-c system is used, the synchronizing pulses and picture signal shift in position on the transmitter characteristic due to the changes in the position of the signal with

<sup>1</sup> R. D. Kell, RCA Manufacturing Company, Inc.

respect to the a-c axis. These changes depend on the waveform of the picture signal. This means that, when a-c transmission is used, sufficient leeway must be left to accommodate the shifting in position of the video signal on the amplitude characteristic. This is discussed fully in the appendix of this report. Calculations show that a transmitter having approximately a 50 per cent greater voltage output capability is required if only the a-c picture components are transmitted as compared with a transmitter that transmits both the d-c and a-c components. Therefore, there is a gain of over 2 to 1 in the effective power output of a given transmitter if the half tones of the picture correspond to definite fixed carrier power outputs. This increase in effective power is obtained without increasing the interference range of the transmitter.

When considering the actual amplitude characteristic of the transmitter, a considerable portion of the characteristic is curved to such an extent that it would not be usable if only the a-c components of the video signal were transmitted. This is because synchronizing pulses would fall on different sections of the curved output characteristic depending upon the content of the picture. This would result in synchronizing pulses being transmitted at different amplitudes, depending upon picture content. With d-c transmission, the linear part of the characteristic can be reserved for the picture signal proper and the synchronizing signal allowed to fall on that curved portion of the characteristic which was unusable with a-c transmission. The fact that the characteristic is curved simply means that a greater amplitude of synchronizing voltage must be applied to the output tubes in order to secure the required amplitude of synchronizing pulse in the output circuit.<sup>1</sup> If it is assumed that the synchronizing occupies 25 per cent of the total voltage characteristic, the d-c transmission system allows a 25 per cent increase in effective output voltage or a power increase of approximately 50 per cent by thus utilizing the nonlinear portion of the transmitter characteristic. This gain of 50 per cent and the previously mentioned gain of over 2 to 1 are additive so that an actual increase in effective power of the transmitter of about 2.5 to 1 is realized when the half tones of the picture represent fixed

<sup>1</sup> It is here assumed that some type of synchronizing signal is used whose wave shape is not altered by saturation.

power-output levels. As stated previously, both these gains are had with the d-c system transmission without increasing the interference range of the transmitter.

In a receiver using a given i-f tube complement, an output voltage of 50 per cent more can be obtained before overloading difficulties are encountered when the d-c system of transmission is used. The reasons for this are the same as those given for the increased transmitter power output. This makes possible a higher video-signal level at the output of the second detector of the receiver.

Since the half-tone values of the picture represent definite voltages through the i-f system of the receiver, limiters may be employed in the receiver operating either on the peaks of the synchronizing pulses or the white level, depending upon the polarity of transmission. It has been found that limiters of this type are very effective in reducing the effect of interfering signals, such as motor-vehicle ignition, on both the picture and the synchronizing. Other types of limiters may also be employed on the output circuit of the second detector where each half-tone value is represented by a definite d-c voltage. If a-c transmission is employed, an automatic volume control of the conventional type may be used in the receiver. The automatic volume control employed with d-c transmission measures from the peaks of the synchronizing pulses when negative modulation is employed. In practice, it has been found that this is a very simple and satisfactory method of operating the automatic volume control. If positive transmission is employed, the a-v-c problem becomes more difficult, because the control voltage must be obtained from the signal corresponding to black level.

To summarize these various items: The transmission of the d-c component makes possible the construction of transmitters of improved performance as regards stability of radiated signal. It provides a more effective use of a given transmitter, thereby increasing its service area without increasing its interference range. It makes possible a slightly greater useful output from a given i-f amplifier system in a receiver before overloading occurs. It makes possible the use of limiters of various types in the receiver to reduce the effect of interfering signals such as motor-vehicle ignition. With negative transmission, it makes possible the use of a simple and satisfactory a-v-c circuit in the receiver.

From the above considerations, it is felt that the transmission of black level at a fixed power output independent of picture content is a desirable feature of a satisfactory television system. It is therefore recommended that "the inclusion of black level in the transmitted carrier" be made a television transmission standard.

## APPENDIX

The complete video signal corresponding to an all-white picture is shown in Fig. 24A. The position of the a-c axis is such that

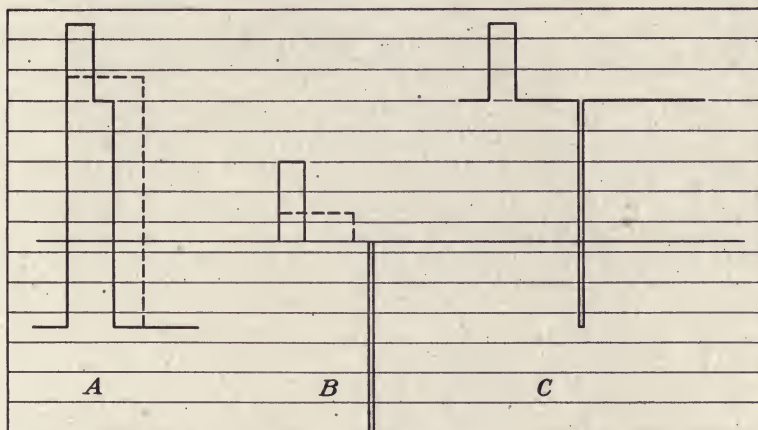

FIG. 24.—(A) Video signal corresponding to an all-white picture. (B) Signal for an all-black picture, except for a small white area. (C) Same as (B) except that d-c transmission is employed. (R. D. Kell.)

the area between the signal and the axis is the same on both sides. This is after the correction has been made for the area of the vertical blanking and synchronizing. The effective area is shown by the dashed lines. Figure 24B is a video signal corresponding to a picture that is all black except for a small white area. These two signals represent the two extremes in picture signal as regards the position of the signal with respect to the a-c axis.

The total amplitude of the signal from the peak of the synchronizing pulse to the peak of white is 10 units for both signals. Because of their difference in position with respect to the a-c axis, there must be an amplitude range throughout the system

of 15 units. When a d-c system is employed, the peaks of the synchronizing pulses are at a fixed position independent of picture content, and an amplitude range of 10 units is sufficient for both types of picture as shown at Figs. 24A and 24C. This ratio of 10:15 is the voltage gain obtainable by using d-c transmission. This represents a power gain of  $15^2/10^2 = 2.25$  times.

**Report on Modulation Polarity and Black Level.**—W. F. Bailey offered the following report, which summarizes briefly the reasons for negative modulation and d-c transmission, from a point of view slightly different from that adopted by Mr. Kell in the foregoing paragraphs.

#### INFORMATION OF POLARITY OF MODULATION AND INCLUSION OF THE BLACK LEVEL IN THE TRANSMITTED CARRIER<sup>1</sup>

The Hazeltine Service Corporation has used negative polarity of modulation in its experimental television equipment since 1938. Prior to that time, both positive and negative polarities were used in tests. It feels that negative polarity of modulation is desirable for the following reasons:

1. A simple automatic-gain-control system is possible, because, with the black level stabilized at a definite carrier level, the synchronizing-signal peaks may be detected to provide the automatic-gain-control voltage.

2. The design of large transmitters is made simpler since the transmitter will operate at maximum power output only during synchronizing peaks and, in the worst case of an all-black picture, operates at from 55 to 65 per cent of its peak power during the remaining time. With positive polarity of transmission, pictures such as cartoons would require operation of the transmitter at peak power output for as much as 80 per cent of the time.

3. The presence of impulse noise, such as ignition interference, has a less objectionable effect upon the picture, since, predominantly, it causes the picture to go black. Noise of this form in a positive-polarity modulation system causes white splotches to appear upon the picture, and these are objectionable since they often cause the picture-tube beam to defocus because of high amplitude, thus making a white splotch with a diameter equal to the width of several scanning lines.

<sup>1</sup> W. F. Bailey, Hazeltine Service Corporation.

4. Satisfactory synchronization is obtainable with negative polarity of modulation with the present standards.

5. The use of negative polarity of modulation would allow the use of interspersed AM and FM in the signal, such that the vision carrier could be frequency-modulated during the transmission of synchronizing information. Theoretical analysis has indicated that large improvements in synchronizing behavior could be obtained with such a system.

With synchronizing information transmitted as at present, positive polarity of modulation seems to offer some advantages in synchronizing performance. This is probably because the tips of synchronizing peaks occur at zero carrier. Since zero carrier is one limit of the synchronizing pulses, the problem of obtaining clean synchronizing information in the receiver is simplified and a system that clips on only one side can be used.

Bursts of noise of a certain amplitude and phase may drive the signal to zero and produce spurious synchronizing pulses, but most of the noise of the same phase either will not drive the signal to zero and thus will have no effect, or else will drive the carrier beyond zero and produce two narrow spurious pulses.

With the negative-polarity system used at present, bursts of noise of the correct amplitude and phase will drive the carrier well above the synchronizing peak level and thus produce a spurious pulse regardless of the noise pulse amplitude, provided it is above a certain level. In such a system, to obtain separated synchronizing signals that have no larger spurious pulses produced by noise, it is necessary to use double limiting, one operation on the positive side and the other on the negative side of the pulses. A simple double limiter, however, will not duplicate the performance of the positively polarized system, since the large bursts of noise may come through as spurious pulses of considerable width rather than as two relatively narrow pulses as in the positively polarized system. A remedy for this is to design the circuit that limits the tips of the synchronizing pulses to have a characteristic such that, with increasing input, the output at first rises and then decreases. With a circuit having this sort of characteristic, it would seem that the synchronization performance of the two polarities of modulation could be made identical with the present standards.

The Hazeltine Service Corporation has, since the summer of 1937, operated its experimental television equipment with the black level included in the transmitted carrier. By this is meant that the carrier level is stabilized at a definite value for black.

Our feeling is that stabilizing black at a definite carrier value is advantageous for the following reasons:

1. Synchronizing performance is more satisfactory in the presence of changes in average picture brightness. The stabilization of the carrier at a definite level for black allows the receiver engineer more leeway in design, since either direct coupling, or a-c coupling with the d-c component reinserted, may be used in the video and synchronizing channels following detection.

2. A relatively simple automatic-gain-control system, operating on the synchronizing-signal peaks, is possible if negative polarity of modulation is also used.

3. In any channel of the television system, whether it transmits a modulated carrier wave or the video signal, it is necessary that the characteristic have a working range of substantially twice the peak-to-peak signal excursion when the d-c component is not transmitted, whereas in a system in which the d-c component is transmitted, the working range need be only as large as the peak-to-peak signal excursion. This means that, in the case of a transmitter, one that does not transmit the d-c component must be capable of radiating substantially four times the same peak power, for the same sideband intensity, that a transmitter in which the black level is stabilized would radiate. In a receiver, the same reasoning holds, and both the i-f stages and the video stages must be capable of handling twice the signal voltage or four times the power for an a-c coupled system as compared to a d-c coupled system.

#### MODULATION AND BLACK LEVEL FOR F-M PICTURE TRANSMISSIONS

Panel 5 considered the possible future use of FM for transmitting the picture signal. The N.T.S.C. standard 9 does in fact make provision for such transmissions, although commercial transmitters have not taken advantage of this type of transmission (see page 261). The Panel recommendations for f-m picture signals were that "a decrease in initial light intensity



should cause an increase in the radiated frequency" and that "the black level be represented by a definite radiated frequency with respect to the channel limits, independent of the light and shade of the picture." These specifications correspond in their practical effect to the a-m standards discussed above.

### FREQUENCY MODULATION FOR THE SOUND CHANNEL

The recommendation of Panel 5 in respect to the type of modulation for the sound signal was a distinct departure from previous standards and as such was the subject of much discussion in the panel meetings. In the latter stages of this discussion, two joint meetings of the Panel were held with Panel 6. The final vote showed 9 in favor of specifying FM for the sound signal, and 3 against.

The considerations of the Panel revolved on several points. The advantages of FM for high-fidelity local sound broadcasting service were well appreciated and had resulted in the promulgation of commercial standards by the FCC for such service. But it was not clear that FM for television sound could be judged purely on its merits as a sound broadcasting medium, since its inclusion in the television channel might have other effects. One possibility was that an increase in interference between sound and picture signals might occur owing to the wider frequency spectrum of the f-m sound signal. This situation would require more elaborate filtering means in the receiver to secure separation between picture and sound signals. The other points were the comparative costs of f-m and a-m receivers and the critical nature of f-m tuning. These three points were brought out in the panel report as follows:

From the discussion on a-m versus f-m transmission for the sound channel, it appeared that there were three major considerations, which are summarized below:

1. Whether or not f-m sound transmission could be considered independently on its merits, presumably resulting in the same conclusions as were arrived at in the spring FCC meetings, or whether the use of such transmissions in a television channel brought about additional considerations which might alter the previous conclusions.

2. The comparative costs of f-m and a-m receivers.

3. The difficulty of maintaining exact tuning in f-m receivers particularly at the higher frequencies.

With regard to point 1, the observations of a number of the members of the Panel indicated, without exception, that no evidence of interference between the sound and picture channels was experienced when using FM for the sound channel, and that the f-m sound channel could be accommodated within the 6 Mc band. These observations gave substantial backing to the belief that the sound channel could be considered independently on its merits.

With regard to point 2, the fact that f-m receivers as such cost more than a-m receivers was recognized by the Panel, but it appeared to be the consensus that this difference in cost was not great and that intensive development on television receivers as a whole would in any event appreciably reduce their cost in years to come, and that therefore the additional cost of FM at this time was probably not of great importance. This viewpoint was not unanimous.

With regard to point 3, this matter was realized to be of considerable importance and might work some hardship on receiver development engineers, but the consensus was that the matter is one which would yield to further development.

**Report of the Use of Frequency Modulation for the Sound Channel.**—The following reports summarize the arguments respecting the use of FM for the sound channel. The first is by R. S. Holmes, a member of Panel 3, and hence was presented initially to Panel 3. The second, by L. M. Leeds, was prepared for Panel 5.

#### A DISCUSSION OF THE RELATIVE MERITS OF AMPLITUDE-VS. FREQUENCY-MODULATED WAVE TRANSMISSION OF THE SOUND IN TELEVISION SIGNALS<sup>1</sup>

##### GENERAL

The use of f-m wave transmission for the sound signal in television suggests itself as a result of the adoption of FM for broadcasting in the ultra-high-frequency channel from 42 to 50 Mc. The relative merits of FM vs. AM as such are not discussed here, but the effects of such transmissions on the operation of the television system and on apparatus design are considered.

##### THE TELEVISION SYSTEM

In experimental television systems, it has been customary to have the a-m sound and picture transmitters radiate carriers

<sup>1</sup> R. S. Holmes, RCA Manufacturing Company, Inc.

of approximately equal power. This resulted in a system which, from the technical standpoint, was balanced, with respect to both apparatus requirements and system performance. Extensive service tests on such systems have indicated that, with equal power radiated, the service areas of the sound and picture transmitters practically coincide. That is, at locations where there is no interference present in the picture, the sound is also free from interference; at locations where the picture is rendered practically unrecognizable by noise, the sound is also practically unusable.

For some conditions, however, it has been found that subjectively a given amount of interference is more disturbing in the sound than in the picture. The service range of the television system will be determined by the acceptability of the service with respect to noise interference. Hence, improving the noise immunity of the sound relative to the picture might result in an increase in the service area. If the sound transmission were changed from AM to FM and the transmitter power kept the same, whatever improvement in noise reduction resulted would be reflected in improved system performance and increased service area.

If, on the other hand, the transmitter power were reduced when the change was made, not only would this subjective improvement be lost but the maximum sensitivity of the receivers would have to be increased to make them capable of receiving the weaker sound carrier at the fringe of the service area. This would increase the cost of the receiver.

It therefore seems desirable to maintain the equal power ratio between sound and picture if the change is made to f-m sound.

The deviation for f-m broadcast in the 42- to 50-Mc band has been set at  $\pm 75$  kc, and it seems highly desirable to assume the same standard for television. This would permit the use of the same receiver components for the two services in combination receivers.

#### APPARATUS

**Transmitter.**—In an a-m sound transmitter, the complexity and cost of the modulator is a function of the transmitter power. In an f-m transmitter, the cost and complexity of the modulation

equipment is nearly independent of the output power. For this reason, the cost of an f-m transmitter does not increase as rapidly with power as does that of an a-m transmitter. This indicates that, for low power, the a-m transmitter costs less, whereas, for high power, the f-m transmitter costs less. The crossing point, where the two cost the same, is in the neighborhood of 1 kw.

**Receivers.**—1. *Sound Interference in the Picture.*—It has been found to be most economical in receiver design to eliminate sound interference from the picture by using sharp rejectors in the picture i-f amplifier. These rejectors are tuned to the sound intermediate frequency. The rejection ratio obtained with simple circuits is a function of the bandwidth of the rejectors. The actual rejection ratio on a receiver having two rejector circuits, such as the TRK-120, is approximately 50 db for a bandwidth of 50 kc. This is sufficient attenuation to eliminate sound interference from the picture when AM is used on the sound carrier. This rejection band is sufficient to take care of such practical factors as frequency drift, production alignment, etc., as evidenced by long service tests on this type of receiver.

In laboratory tests on one of these receivers, using f-m sound with 150-kc total deviation and field strength equal to the picture, no interference between sound and picture was observed. The rejection ratio at 150-kc bandwidth was approximately 40 db.

2. *Television Receiver Design.*—In order to obtain full noise-reduction advantages in receiving f-m wave transmission, it is necessary to use a balanced discriminator, and it may be desirable to use an amplitude limiter. The discriminator offers the same problems in the sound side of a television receiver as in any f-m receiver. In either case, the circuits are somewhat more complicated and costly than the corresponding circuits in an a-m receiver.

If an amplitude limiter is used, it will also increase the cost of the receiver. In order for the limiter to be effective on weak signals, the receiver gain must be considerably greater than if a-m wave transmission were used. Thus the cost of the receiver is increased by the addition of the limiter and also by the addition of more amplifier stages to increase the gain.

Owing to its inherent action, the limiter will generate harmonic frequencies. These harmonic frequencies will fall in some of the

television channels and, unless the limiter is shielded sufficiently to prevent it, they will beat with the incoming picture carrier and produce interference patterns on the picture. The effect will be more troublesome in the picture than in the sound because of the greater bandwidth. Special precautions in filtering and shielding will be required to prevent this trouble. This "harmonic beat" is quite serious. It has been encountered in some receivers designed for reception of a-m signals, even though there was only a detector to produce the harmonics. The magnitude of the harmonics produced in a limiter is much greater than that of those produced in a simple detector.

If the limiter is omitted from the receiver, the noise-reducing possibilities of FM will be reduced unless great care is exercised in the design and in the individual alignment of the receivers.

Thus the improvement in performance possible with FM is accompanied by an increase in the cost of the receiver.

3. *Combination Frequency-modulated-wave Sound and Television Receiver.*—If it is desired to combine a television receiver with a receiver for f-m broadcast reception in the 42- to 50-Mc band, more of the sound parts will be common if the television sound is also frequency-modulated. The cost of such a combination receiver will be less with f-m television sound than with AM. It is desirable, of course, to use the same i-f amplifier for both sound receivers, and this may entail some compromise regarding the selection of the intermediate frequency.

### THE TELEVISION CHANNEL

Aside from the wider band occupied by the f-m sound transmission, the considerations determining the placement of the carriers within the channel are not affected by the use of f-m sound. This change is so small compared to the 6-Mc width of the channel that it should not materially affect the carrier locations.

### FREQUENCY MODULATION VS. AMPLITUDE MODULATION FOR TELEVISION SOUND<sup>1</sup>

This memorandum discusses the relative merits of using FM to transmit the television sound.

<sup>1</sup> L. M. Leeds, General Electric Company.

## ASSUMPTIONS

If FM is employed, it should be wide band (*i.e.*,  $\pm 75$ -kc swing).

## ADVANTAGES OF F-M SOUND

**1. Lower Power Transmitter.**—For coverage of appreciably higher grade, the f-m sound transmitter needs a carrier rating of only approximately one-half that of an a-m sound transmitter. Obviously the carrier power of the f-m sound transmitter could be further reduced materially and still maintain some improvement in signal-to-noise ratio. However, it is the writer's belief that the major part of the gain in signal-to-noise ratio obtained by the use of FM should be reserved to give greater freedom from noise and only a small part utilized for the reduction of transmitter power.

**2. Cost of Sound Transmitter.**—For a transmitter of one-half power rating, the f-m sound transmitter is much cheaper than the a-m transmitter.

**3. Noise Reduction.**—The f-m sound transmitter with one-half the carrier rating of the a-m transmitter will give an improvement in signal-to-noise ratio of at least 17 db.

**4. F-m Broadcast Reception.**—It is obviously a simple matter to provide for reception of the f-m broadcast band; thus the receiver performs a dual function and gives the purchaser more for his money.

## DISADVANTAGES OF F-M SOUND

**1. Receiver More Expensive.**—An f-m receiver, to be truly effective, should be of high gain. This, plus the additional components needed, makes the f-m receiver the more expensive.

**2. Filtering of Associated and Adjacent Channel Sound.**—With a-m sound, peak rejection filters in the video intermediate frequency are capable of eliminating the associated and adjacent channel sound interferences. With FM, these filters may have to be of the band elimination type.

## DISCUSSION

The signal-to-noise ratio improvement of at least 17 db is extremely important, since this is an over-all system gain of such great importance as to far outweigh any incidental apparatus

advantages or disadvantages of the transmitter or receiver. This is especially true in light of past experience, which indicates that considerable degradation of the picture will be tolerated if the accompanying sound is absolutely free from the usual objectionable noises.

With f-m sound for television, the receivers can easily be so built as to provide for the reception of the f-m broadcast band. It is believed that this dual function, which the receiver can perform, thus giving the purchaser more for his money, far outweighs any disadvantage of receiver cost.

The use of f-m sound to accompany the television picture is sound and forward-looking engineering practice making maximum utilization of available knowledge and the present technical state of the radio art.

#### CONCLUSION

Wide-band FM should be employed for the television sound.

## CHAPTER VII

### THE TRANSMITTER-RECEIVER RELATIONSHIP

Since the whole purpose of television standardization is to set up guides in the engineering of transmitters and receivers as parts of a system, it was appropriate to set up a panel particularly to investigate the receiver-transmitter relationship. Panel 6<sup>1</sup> was assigned this task, in the following words:

The treatment of the essential factors of coordination in the design and operation of television transmitters and receivers. Among these are included such matters as the degree of pre-emphasis to be employed in the sound channel in the receiving equipment; the basically similar treatment to be given the video sidebands in the transmitter and the corresponding treatment to be given in the receiver; and associated or similar problems.

The Panel initially took action on two standards, numbered 4 and 14 in the N.T.S.C. report, which specify the "receiver-attenuation" method of vestigial sideband transmission, and the use of pre-emphasis of the higher audio frequencies in the sound signal. After its joint meetings with Panel 5 concerning the use of FM for the sound channel, Panel 6 approved a standard identical to that recommended by Panel 5, specifying FM for the sound channel, with  $\pm 75$ -kc maximum deviation. In addition to its action on these standards, the Panel conducted a study of the contrast and tonal gradation characteristics of television transmission. No standard on this subject was proposed, but a "recommended practice" was drawn up, suggesting the use of a substantially logarithmic relationship in the transmitter between initial light intensity and the amplitude of the carrier.

<sup>1</sup> The members of Panel 6 were I. J. Kaar, chairman; E. F. W. Alexander-son; F. J. Bingley; J. E. Brown; N. P. Case; Madison Cawein; J. N. Dyer; T. T. Goldsmith, Jr.; Herman Greenburg; D. D. Israel; A. G. Jensen; R. D. Kell; P. J. Larsen; H. R. Lubcke; A. F. Murray; G. R. Town; and U. A. Sanabria.



**The "Receiver-attenuation" Vestigial Sideband System.**—The question of the type of vestigial sideband transmission has already been treated in Chap. V, since this subject was under consideration by Panel 3, which investigated the positions of the sound and picture carriers and the disposition of their sidebands. Panel 6, on the other hand, considered a matter that required joint action of transmitter and receiver engineers, *i.e.*, the manner of attenuation of the picture carrier. After some discussion, Panel 6 unanimously recommended the receiver-attenuation system (RA) as being superior to the transmitter-attenuation system (TA). The standard is given in graphical form in Fig. 1.

**Reports on the RA and TA Systems.**—Three reports comparing the advantages of the RA and TA systems of vestigial sideband transmission were prepared by the panel members. Excerpts from a report by S. W. Seeley are reproduced below, because they constitute an excellent introduction to the concept of vestigial sideband transmission. Following this, a report by R. D. Kell is reproduced as representing the detailed analysis and conclusions on which the panel judgment is based.

#### A COMPARISON BETWEEN TWO POSSIBLE TYPES OF VESTIGIAL SIDE BAND TELEVISION TRANSMISSION<sup>1</sup>

##### EXPLANATION

Any type of purely amplitude modulation of an r-f carrier produces symmetrical pairs of sidebands evenly disposed about the carrier. Thus, each side frequency above the carrier has its counterpart as a mirror image below the carrier frequency. The fact that such symmetry exists is an immediate indication of the fact that one-half of each pair (in other words, all side frequencies on one side of the carrier) could be dispensed with and no intelligence would be lost. Stated differently, if there were something contained in one set of sidebands that was not found in the other, as is often the case in FM, we might conclude that both sets were necessary for the transmission and reproduction of the original modulation and that single-sideband transmission was impractical if not impossible. Such is not the case.

Obviously then a great saving in transmission bandwidth is possible if one set of side frequencies can be dispensed with at

<sup>1</sup> S. W. Seeley, RCA License Laboratories.

the transmitter. If one set were entirely lacking, the total transmission band would be just half as wide as for double side transmission.

Unfortunately no method is known for modulating a transmitter in such fashion that only one set of side frequencies is produced. It appears to be almost axiomatic that it is an impossibility. Thus we must resort to filters to remove the unwanted side energy. It is truly axiomatic that no practical filter can have high attenuation at frequencies up to a certain value and zero attenuation beyond. In other words, there must of necessity be a certain frequency interval over which the characteristics of the filter change from zero attenuation to full attenuation. In a practical sense, this means that we cannot build a filter through which we can pass our carrier plus double-sideband signal and have it emerge with the carrier and upper side frequencies unaltered but with all the lower side frequencies, even those just a few cycles away from the carrier, entirely removed.

Thus the question of just where the filter will start to attenuate and just how rapidly the characteristic rises to maximum attenuation is one of the subjects for discussion here.

Before taking up that point, however, one more pertinent fact should be mentioned.

If an a-m carrier frequency is modulated with a tone (for instance) and a pair of sidebands is thereby set up, the subsequent removal of one of the side frequencies leaves the carrier modulated to only one-half the original extent.

Therefore, if we set up a filter to cut off as much as possible of one band of side frequencies, but with the stipulation that the carrier and other set of sidebands must not be affected, we know that some of the unwanted sideband frequencies that lie very close to the carrier are not going to be removed. Thus the extent of modulation caused by sidebands very close to the carrier is unaffected, whereas the amount of modulation by the higher frequencies (which produce side frequencies further removed from the carrier) will be halved. This, of course, would make it somewhat troublesome to reproduce correctly the original composite modulation were it not for the fact that cooperating, or complementary, filter characteristics in the transmitter and the receiver can serve to even out the discrepancy

between the high- and low-frequency modulations of the transmission in order to reproduce the original signal correctly.

Item *A* of the agenda of Panel 6 is then concerned with the matter of just how the transmitter and receiver filter characteristics shall cooperate.

Consider first Fig. 25. Let us assume that the solid curve is the pass characteristic of a filter that is connected between the output stage and the antenna at the transmitter. The modulated output of the final stage covers a band between *A* and *B* with the carrier at *C*. At the output of the filter, all frequencies between *A* and *D* have been suppressed so that no frequency lower than *D* is radiated.

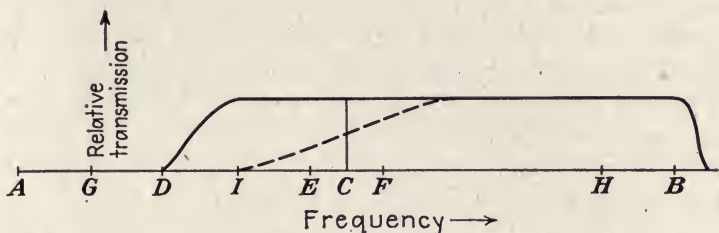

FIG. 25.—Channel arrangement for RA-type transmission. (*S. W. Seeley.*)

Under these conditions, neither of a pair of sidebands residing at *E* and *F* has been affected, and, therefore, modulation at the frequency that produced the *EF* pair has not been altered. On the other hand, modulation at the modulating frequency that would produce a pair of sidebands at *G* and *H* has been halved since *G* has been removed altogether.

Let us suppose now that in the receiver there is also a filter that has a more gradual slope than that at the transmitter and starts cutting even above the carrier frequency as shown by the dashed line. This filter not only removes most of the lower side frequencies but also attenuates the carrier to one-half its full value and attenuates some of the upper sideband. Now to examine the over-all result. The carrier has been halved so that a single sideband of any pair could not modulate it 100 per cent. Of the pair of side frequencies residing at *E* and *F*, one has been cut to about 25 per cent and the other to 75 per cent. The sum of these two is equal to unity and thus could produce full modulation of the reduced carrier energy. Of the pair of

side frequencies at  $G$  and  $H$ , one is still removed altogether and the other is transmitted (and received) with full intensity. Therefore the remaining sideband energy at this frequency can also modulate the carrier fully. Thus the modulation characteristics of the transmitted signal can reproduce the original with true fidelity.

From the above description, it should also be obvious that the two filter characteristics could be interchanged; the solid line would then represent the receiver characteristic and the dotted line the transmitter characteristic, and the over-all result would be the same. This then gives us two alternatives from which to choose, and the rest of this discourse will be concerned with the advantages and disadvantages of these two modes of so-called "vestigial sideband" operation. For the sake of brevity, we may call these two systems RA and TA, RA standing for receiver attenuation and signifying the fact that the carrier frequency is attenuated to one-half value in the receiver, and TA standing for the transmitter attenuation, implying that the carrier-frequency attenuation occurs at the transmitter.

#### ADVANTAGES AND DISADVANTAGES OF EACH SYSTEM

In Fig. 26, the curve marked RA shows the pass characteristic of the filter between the final stage and the antenna in the RA system. Enough of the lower sideband is transmitted without attenuation so that all frequencies that are passed to any extent by the receiver filter are untouched. However, the final stage is putting out peak power equivalent to a carrier of the amplitude shown with 100 per cent modulation. Then, if that transmitter is changed over to the TA type in which the filter is usually placed ahead of the final stage, the final stage still has about the same peak power capabilities and can still deliver a carrier of the same amplitude with peaks of modulation equivalent to 100 per cent. Thus the TA transmission characteristic when drawn to the same scale might be somewhat as shown by the dashed curve of Fig. 26. Here the peak carrier voltage is shown to be the same for RA and TA, but the upper sidebands of TA are radiated with twice the amplitudes that they have in the RA case. Then, since doubling the amplitude of a sideband in the region of  $H$  would result in doubling the detected modulating voltage in a receiver, if the carrier amplitude remains the same, it is apparent

that operation with the TA system would allow the gain control of the television receiver to be retarded to a point where the thermal agitation potentials and other types of interference are cut in half while still getting the same amplitude of picture signal that would be received with the system with the gain control of the receiver on full. Or, stated another way, it would be possible to receive a picture with the same degree of interference

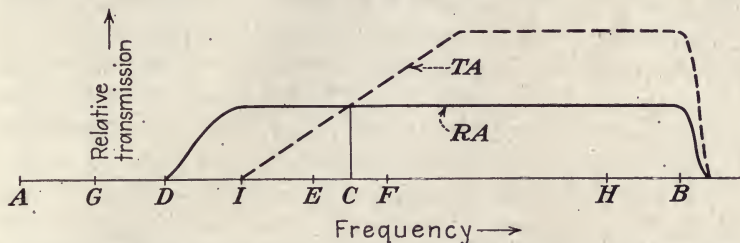

FIG. 26.—Comparison of RA and TA systems, showing transmitter characteristics in the two cases. (S. W. Seeley.)

at a greater distance from the transmitter. Stated still another way, neglecting some of the limitations that will be dealt with shortly, changing from the RA system of operation to the TA system is the equivalent of increasing the power of the transmitter by a factor of 4. Also, since the carrier power has not actually been increased, its possible interference to other services has not been altered. This means that its service area is

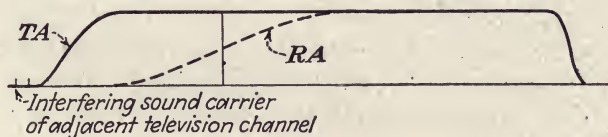

FIG. 27.—Receiver characteristics for the RA and TA types of transmission. (S. W. Seeley.)

increased without materially altering its nuisance area. These factors are important.

Consider the receiver characteristics for a moment. The so-called "filter" of the receiver consists of the coupling elements between stages of the i-f amplifier. The i-f pass characteristic for the two cases is shown in Fig. 27. An examination of this figure indicates that the receiver's i-f pass band is considerably wider in the case of TA operation. Furthermore, the slope of

the side of the characteristic on the side toward the point marked "interfering sound carrier of adjacent television channel" must be steeper. The wider pass band and the steeper slope decrease the gain per stage in a TA receiver and may require more and better "traps" to prevent interference from out of channel signals. From this standpoint, then, it appears that receivers of the RA type are less costly to build. This likewise is important.

However, both the argument in favor of TA, which sets forth its apparent transmitter power gain, and the argument favoring RA just mentioned are mitigated considerably if all their limitations are examined in detail. Since other arguments concerning them appear to have either a subsidiary or a minor bearing on the matter, the two above will be analyzed first.

First, concerning the transmitter characteristics, it can be seen that the filter for TA operation must precede the final stage, since otherwise one-half of the carrier voltage (three-fourths of the carrier power) would be dissipated and the wanted sideband energy would be equal to rather than greater than that in the RA case.

This being the case, it is obvious that the final stage cannot be grid-modulated, as is often done with RA operation, but must act as a linear amplifier of energy that has been modulated in a previous stage, since the filter must act on modulated r-f energy. In a transmitter using grid modulation of the final power amplifier, modulated radio frequency does not exist except in the output circuits of the final stage.

Then, if the filter is to precede the final power amplifier, that stage must be operated over only that portion of its characteristic which is truly linear in order that cross-modulation products will not reintroduce unwanted sideband energy. This then may considerably decrease its actual peak power output, since in the RA case the grid-modulated final is frequently operated well beyond the upper bend in its characteristic by the synchronizing signals, which have been previously overemphasized. If the synchronizing signals alone can utilize a portion of the characteristic with RA transmission, which cannot be used for TA transmission, the TA case suffers by a factor of from 0.56 to 0.64 in peak power output.

On the other hand, this difficulty can be partly overcome by supplying increased r-f driving power for the grids in the TA case

to drive them farther into the positive grid region and thus give them better linearity. Again, this may result in a driver stage with nearly the same power capabilities as the final, which of itself seems uneconomical.

The net result of all these factors, plus the fact that the wider pass band of the receiver admits impulse interference in direct proportion to its width and random electron noise in proportion to the square root of its width, is that the signal-to-noise ratio in the receiver with TA is the equivalent of increasing the RA transmitter power not by 4 to 1 but more probably by a factor somewhere between 2.4 and 3.0.

The argument about less costly receivers with RA operation is mitigated by the fact that the slope of the cutoff through the region of the carrier in an RA receiver is somewhat critical and must be adjusted rather carefully in each chassis. There is also the possibility that, if this slope is too great, inaccuracies in tuning or drift of the circuits can mar picture reception. Furthermore, since the over-all bandwidth in a TA receiver is seldom more than 25 per cent greater than in an RA receiver, a two-stage i-f system would not suffer too greatly in gain. The gain of a stage can usually be considered to be inversely proportional to its bandwidth. In the matter of additional steepness of attenuation, it is usually necessary to supply a trap of the infinite attenuation type in any event, so the only drawback is a slightly increased susceptibility to so-called "sound in the picture" caused by mistuning toward the next lower television channel. This last argument can be offset to some extent by the fact that a TA transmitter filter starts its attenuation farther up in the band and thus can more easily prevent radiation outside its own channel.

Additional factors bearing on the matter include the relative complexity of monitoring equipment at the transmitter and of signal-generating equipment for test and service work.

Referring again to Fig. 26 it has been previously pointed out that any pair of sidebands radiated from a TA transmitter add up to a value that is directly proportional to the magnitude of the modulating frequency. This is true regardless of whether one of the pair has been entirely removed and the other left at full strength or whether they both lie immediately adjacent to the carrier, so that for all practical purposes we may say they have

both been attenuated to one-half their former value. Therefore a simple diode with a resistance load, which cannot distinguish between upper and lower sidebands, could act as a monitoring circuit for a TA transmitter and give a true indication of the quality of the picture being transmitted. In monitoring the signals in the antenna circuit of an RA transmitter, it is necessary to use a filter of the same characteristics as an RA receiver. This is then open to question, since it is difficult to distinguish between transients that are actually in the transmitted signal and those which might be developed in the monitor filters. To obviate this difficulty, monitoring of an RA transmitter is often done ahead of the filters that feed the antenna, at which point the signal has both sidebands intact. This, however, has also been questioned as not being truly representative of the transmitted picture.

Referring again to Fig. 25, let us assume that the solid curve is the transmitter characteristic and the dashed curve is that of the receiver, in other words, normal RA operation. It will be seen that the i-f amplifier of the receiver does not pass any of that portion of the band which is attenuated at the transmitter. Thus the signal at the video detector of the receiver would be unaltered if the transmitter filter were removed and both sidebands transmitted in their entirety. This being the case, television signal-generating equipment for laboratories and for production and service work can neglect the RA transmitter type of filter and produce a straightforward double-sideband picture signal for test purposes. This point is fairly important, since, although it is easy to design the sloped carrier attenuating filters at 10 to 15 Mc such as are used in the i-f circuits of a receiver, the test-signal generators for TA receivers would have to have either adjustable filters or a series of fixed filters for frequencies up to more than 100 Mc where the entire slope interval would approximate 1 per cent of the operating frequency.

## THE RELATIVE MERITS OF TRANSMITTER AND RECEIVER ATTENUATION<sup>1</sup>

### INTRODUCTION

To make a proper decision between the RA and the TA system of television requires the consideration of many factors involving the entire television process from transmitter to receiver. These

<sup>1</sup> R. D. Kell, RCA Manufacturing Company, Inc.



various considerations involve economic as well as technical factors.<sup>1</sup>

Perhaps the best way to study the problem is to list all the known advantages and disadvantages of both systems and then to analyze in detail each item so as to evaluate properly all the points involved.

### TRANSMITTER MODULATION CAPABILITIES

With both the TA and RA systems, the same power output at the carrier should be obtainable from a given pair of output tubes. At the lower modulating frequencies (up to 1 Mc) 100 per cent modulation is obtained for both types of transmission. At the higher frequencies (above 1 Mc), the carrier is modulated 50 per cent in the RA system and 100 per cent in the TA system. This results in a two to one gain for the TA system in signal-to-noise ratio at the higher modulating frequencies. This improvement in signal-to-noise ratio is obtained without increasing the interference range of the transmitter. This particular point is considered to be a major point favoring the TA type of transmission.

### TRANSMITTER CONSTRUCTION

With the RA system, the final power amplifier may be grid-modulated. This circuit arrangement requires only a single r-f circuit in the transmitter sufficiently wide to pass the carrier and sidebands. All other circuits may be designed as Class C amplifiers operating at maximum efficiency. This results in a transmitter containing a minimum of tubes and circuits, for a given power output. With the TA system, a series of linear amplifiers must be operated with coupled circuits having sufficient bandwidth to pass the carrier and associated sidebands. The efficiency of each stage is reduced because of two factors, the bandwidth requirement and the linear amplifier requirement.

If a carrier power equal to that obtained with the RA system is to be obtained from the same tubes with the TA system, the

<sup>1</sup> The abbreviation RA is used in this discussion to denote the system of television transmission in which the carrier is attenuated 6 db at the receiver. The abbreviation TA is likewise used to denote the system in which the carrier is attenuated 6 db at the transmitter.

tubes must be operated over a portion of their characteristic that is not linear, since this is the practice with the RA system.

This nonlinearity is sufficient to require an auxiliary filter between the power amplifier and antenna to remove the undesired sideband components that are recreated by the nonlinearities existing throughout the amplifier system. The physical size of this filter is determined by the power it must pass and not by the power it must dissipate. This means that a filter of comparable size must be used in the output of the power amplifier with either RA or TA transmission.

It is believed that there are more technical problems involved in a transmitter of the TA type than in one of the RA type. A transmitter of the RA type will be also more nearly equivalent to a conventional broadcast transmitter from the operator's point of view. These differences, however, are such that they should have little influence on the decision between the RA and TA systems.

#### THE TRANSMITTER MONITOR PROBLEM

With the TA system, a simple rectifier coupled to the transmitting antenna will supply a video signal that represents the transmitter output. Because of the proximity of the sound antenna, this coupling will usually be to the antenna transmission line instead of to the picture antenna itself.

With the RA system, two types of transmitters are possible; those in which the sideband characteristic is obtained following the power amplifier and those in which the sideband characteristic is produced at a low level followed by a power amplifier. In the type of transmitter where the sideband attenuation takes place at a low level, a monitor having a characteristic similar to a receiver must be employed.

In a transmitter such as that at the Empire State building where the sideband attenuation takes place after the power amplifier, a simple rectifier may be used, provided it secures its r-f energy ahead of the sideband filter. The nature of the filter is such that any defect is as apparent at the filter's input as at its output. For this reason, it is believed that this is a satisfactory method of monitoring the transmitter output.

From these facts, little if any evidence pertaining to the transmitter monitoring problem can be considered as influential in the choice between TA and RA transmission.

RECEIVER TUNING REQUIREMENTS

With the RA system, a change in tuning shifts the position of the carrier on the side of the i-f characteristic, resulting in a change of picture quality. A shift of  $\pm 100$  kc from the 6-db point can be had before the quality of the picture suffers appreciably. This shift of 200 kc changes the carrier response only

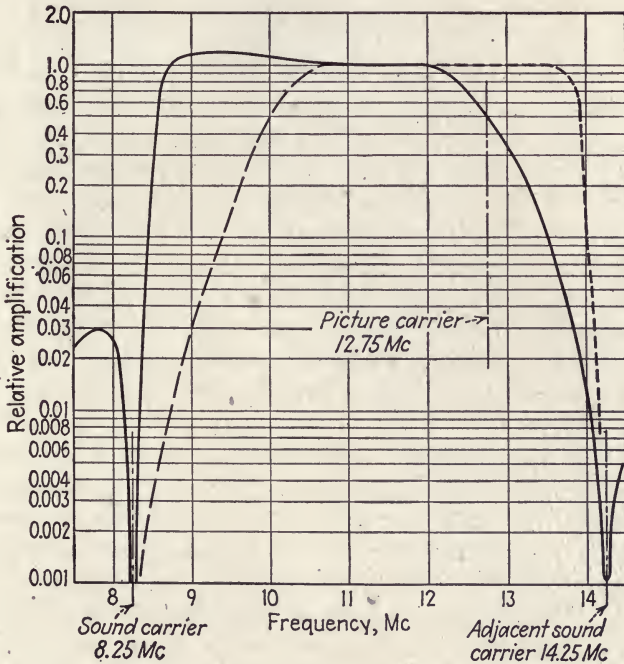

FIG. 28.—Picture amplifier characteristic. (R. D. Kell.)

from 42 to 56 per cent on an average receiver. The i-f characteristic of an average receiver is shown in Fig. 28.

Practically, the tuning position of the receiver is determined not by the position for the best picture but by the reception of sound and minimum cross talk of sound into the picture. This is readily apparent from the comparison of the sound channel rejector bandwidth as compared with the 200-kc range through which the picture may be tuned without appreciably affecting the picture quality.

With the TA system, the proper tuning for sound and minimum cross talk of sound into the picture governs the accuracy with which the receiver must be tuned.

As a result, since the same factors govern the accuracy with which the receiver must be tuned, there is no basis for choice of one system over the other when considering the receiver tuning requirements.

### THE RECEIVER ALIGNMENT PROBLEM

In a receiver of the RA type, the slope of the i-f characteristic is such that the addition of a single rejector circuit is sufficient to eliminate the adjacent sound. Experience has shown that in order to secure adequate rejection of the associated sound, two rejectors are required when a cutoff in the order of 500 kc is required. In the TA type of receiver, this cutoff is required on the adjacent sound side of the i-f characteristic as indicated by the dotted curve of Fig. 28. Since approximately the same attenuation for the two sound carriers is required and the steepness of the characteristic is the same on the two sides, two rejector circuits are required for the adjacent sound when the TA system is used.

With the RA type of receiver, the alignment problem of the i-f circuits to position the carrier at the 6-db point has proved to be a minor one in production, and it is believed that this alignment problem is no more difficult than the alignment of the additional rejector required for the adjacent sound in the TA type of receiver. The rejector alignment problem for the associated sound is identical in both types of receiver. From these facts, there is little to influence the choice between an RA and an TA system.

### TEST EQUIPMENT

With an RA system, the pass band of the transmitter is such that it includes the entire receiver pass band without appreciable amplitude or phase distortion. This means that the performance of the receiver is the same as if both side bands were present in the received signal. With this type of receiver operation, the r-f signal can be obtained from a conventional modulated r-f amplifier. The associated and adjacent sound r-f channels

may be simply mixed with the output of the modulated r-f amplifier to produce a complete test signal.

With the TA system, part of the lower side must be removed in the test equipment. This may be accomplished by means of a filter in the final output of the signal generator. Or, perhaps, a more practical method would be to shape the side-band characteristic at an intermediate frequency and then heterodyne to the final frequency. The associated and adjacent sound channels could be added as intermediate frequencies before heterodyning to the final carrier frequency.

From these comparisons, it is seen that the test equipment required for the TA system is slightly the more complex of the two. However, the difference is such that little weight should be given to the test equipment requirements when making a decision between the RA and TA systems.

#### RECEIVER BANDWIDTH REQUIREMENTS

In a receiver of first quality, an i-f amplifier of five stages is required to utilize the full available bandwidth. In a receiver of this class, the sensitivity should be such that an input of 100 microvolts is sufficient to modulate the kinescope fully.

From the solid curve of Fig. 28, which shows the i-f characteristic for an RA type of receiver of this quality, the bandwidth at 90 per cent is seen to be 3.5 Mc. For the same picture fidelity, the bandwidth must be increased to the dashed curve of Fig. 28 or to 5.1 Mc at 90 per cent when using the TA system.

This increase in bandwidth reduces the gain per stage for the TA receiver to 69 per cent of that of the RA receiver. For the complete i-f system of five stages, the gain is only 16 per cent of that of the RA receiver. This six to one reduction in gain requires an additional i-f stage to bring the sensitivity back to the required value of 100 microvolts.

In a receiver of second quality as represented by the dashed-line curve of Fig. 28, an i-f amplifier of three stages is required for a bandwidth of 2.5 Mc at a sensitivity of 500 microvolts. It is seen that, for the RA receiver, a bandwidth of 1.7 Mc at 90 per cent is required as compared to a bandwidth of 3.4 Mc at 90 per cent for the TA receiver. This difference in bandwidth reduces the gain per stage to 50 per cent for the TA receiver as compared to that of the RA receiver. For the required three stages, the

gain is reduced to 12 per cent. This eight to one reduction in gain requires an additional i-f stage as does the receiver of first quality.

In a first-quality receiver, the reduction in gain per i-f stage for the TA system is not great, owing to the wide pass band. However, owing to the number of i-f stages involved, the over-all percentage reduction in gain is essentially the same as that in the second-quality receiver where the difference in bandwidth for the RA and TA systems is large and there are fewer i-f stages. This means that in general an extra i-f stage is required to maintain a given sensitivity in all quality classifications of receivers. The nature of the added cost is such that it will change little for receivers of differing qualities, which means that, in the cheaper receiver, the difference in cost between the TA and RA receiver will be a greater percentage than in the more expensive models.

An additional rejector tuned to the adjacent sound is also required in both classifications of receivers when the TA system is used. The nature of this circuit is also such that little difference in cost can be expected between the rejectors used in the different price class receivers. Here, again, the percentage increase in cost becomes greater in the lower price receivers.

After careful cost analysis, it is believed that the extra cost to the receiver purchaser of the extra i-f stage, the additional rejector and the extra cost of circuit alignment required in the TA receiver as compared to an RA receiver will be between \$4 and \$5. It appears also that this figure is almost independent of the purchase price of the receiver.

This subject of receiver cost is one of the most important when considering the choice between an RA and a TA system.

#### FIELD TEST EXPERIENCE

With the exception of the General Electric Company, it is believed that all the field experience in this country has been with the RA system. All the transmissions by RCA in its field tests in the New York area have been with the RA system. The problems of transmitter and filter design have been solved satisfactorily for the RA system as proved by over a year of regular program transmission. A sufficient number of receivers have been constructed by production methods to assure the practicability of this type of receiver construction. Sufficient experience

with production receiver test and circuit alignment problems has been had to assure satisfactory receiver performance in the home.

### SUMMARY

After reviewing all the points affecting the choice between an RA or a TA system, there are found to be only three really outstanding items of importance. Of these, one favors the TA system and the other two the RA system. The one favoring the TA system is transmitter modulation. By using the TA system, a given transmitter, because it is more effectively modulated, has a greater ratio of service range to interference range than a transmitter operating on the RA system. This is an important point, since there are a scarcity of channels, and each should be utilized to the fullest extent with a minimum interference area so as to allow a duplication of frequencies at a minimum distance.

The outstanding items favoring the RA system are field test experience and receiver cost. Sufficient field experience has been had with the RA system to assure satisfactory operation of all the components of the complete television system.

The comparative receiver cost is a most important item of the group. Fundamentally, a receiver for the TA system must pass a wider band of frequencies than is required of the RA type receiver. This requirement is inherent and will always make the TA receiver the more expensive of the two. At present, this difference in purchase price appears to be in the order of \$4 to \$5. However, even if this difference in cost is reduced in the future by a factor of two to one, it is still of sufficient importance to justify fully the use of the RA system. This is in agreement with the sound policy of making all standards for television place the least possible burden on the receiver, which must be purchased eventually by the public in large quantities when television finally matures. It is, therefore, recommended that a television system be adopted in which the carrier is attenuated 6 db at the receiver.

### AUDIO PRE-EMPHASIS

The standard recommending pre-emphasis of the sound transmission modulation according to the impedance-frequency characteristic of a series inductance-resistance network having a time

constant of 100 microseconds is explained in the following excerpt from the panel report:

It can be shown that in a sound broadcasting system the interfering effect of noise can be reduced by emphasizing the higher frequencies at the transmitter. This is because the amplitudes of the higher audio-frequency components of speech and music are commonly markedly less than the amplitudes of the lower audio frequencies, while the amplitudes of most radio noise are far more nearly independent of frequency. In

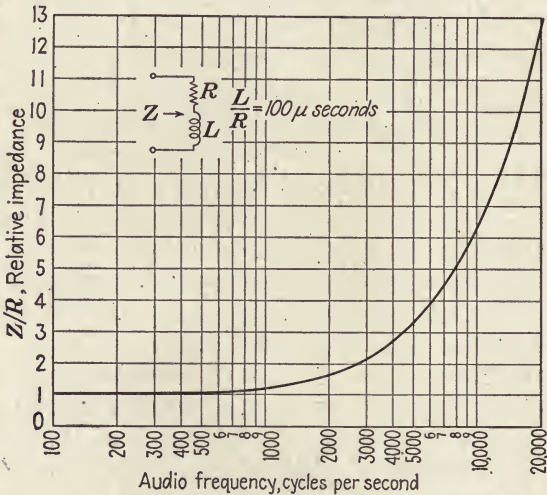

FIG. 29.—The impedance-frequency characteristic referred to in the standard specifying audio pre-emphasis.

order, therefore, to improve the ratio of signal to noise it is desirable to emphasize the higher frequencies at the transmitter by their greater amplification at that point in the system and, in the correct fidelity of transmission of all frequencies, by their correspondingly lesser amplification in the receiver. This is commonly termed "pre-emphasis" of the higher frequencies. A paper was presented on this subject.

The paper referred to was High Frequency Pre-emphasis by J. L. Hathaway (*Electronics*, November, 1931, p. 29). For convenience, the impedance-frequency characteristic referred to is shown here as Fig. 29. The standard coincides with that adopted for commercial f-m broadcasting in the FCC rules governing that service. Prior to the vote on the f-m sound standard, it had been intended that the pre-emphasis standard



would apply in the same form whether AM or FM was finally adopted for the sound signal. Consequently when the Panel voted in favor of FM for sound transmission, no further consideration was given to the pre-emphasis standard.

**High-frequency Pre-emphasis of the Television Signal.**—A related problem in the picture signal was considered in the following report by A. G. Jensen. It deals with the pre-emphasis of the video signal at the higher video frequencies.

#### PRE-EMPHASIS OF THE HIGHER FREQUENCIES IN A TELEVISION CHANNEL<sup>1</sup>

In considering the question of pre-emphasis in a television channel for radio broadcasting, the problems encountered are radically different from those met in line transmission of television signals. In line transmission of such signals, the Bell Telephone Laboratories has used pre-emphasis both in the case of video transmission over short distances and also for carrier transmission over longer distances.

In video transmission over cable pairs, pre-emphasis is advantageous, because the interfering effect of noise increases sharply with frequency, owing to the rising attenuation characteristic of the line. In carrier transmission, pre-emphasis also gives some noise advantage, but here it is further helpful in minimizing certain problems of intermodulation peculiar to a carrier system involving a double modulation process.

In broadcasting, on the other hand, it may be assumed that the noise level is substantially flat throughout the band,<sup>2</sup> and, owing to the peculiar transient character of television signals and the strict phase requirements on television transmission networks, it is uncertain whether pre-emphasis will prove to be an advantage in this case, at least from a noise standpoint alone.

In audio circuits, pre-emphasis has been used for several years. In such audio transmission, the problem is greatly facilitated by the fact that the peak energies in the audio spectrum add up approximately on a power basis or, in other words, that the signals do not exhibit any fixed phase relationship throughout the band. This has been verified experimentally, both for voice

<sup>1</sup> A. G. Jensen, Bell Telephone Laboratories.

<sup>2</sup> This is not taking into account any weighting factor introduced by the eye of the observer.

signals and for orchestral music, and it is readily seen that, on this basis, a substantial noise advantage may be obtained if the level of the low energy components in the high-frequency region are raised at the transmitting end and lowered correspondingly at the receiving end, thereby making the effective signal-to-noise ratio substantially constant over the entire band.

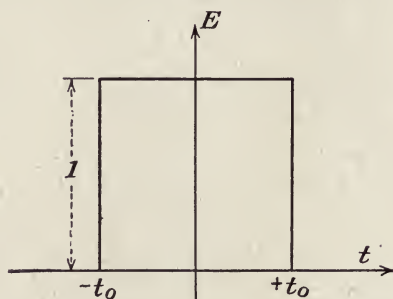

FIG. 30.—The square pulse applied to the input of the various filters. The pulse has unity amplitude and a duration of  $2t_0$ .

In television transmission, the advantages to be obtained from pre-emphasis are much more limited because of the transient or pulse-like character of television signals. It is no longer permissible to assume a random phase relationship between signal components in different parts of the band, and the result is that the high-frequency components of a pre-emphasized signal pulse

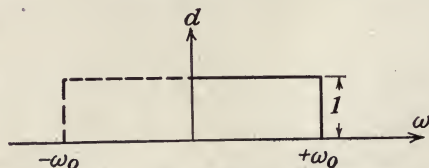

FIG. 31.—The admittance characteristics,  $d$  vs.  $\omega$ , of a flat passband filter, with unity admittance within the passband. The phase characteristic,  $\phi(\omega) = k\omega$ , is uniform within the same limits.

will now add up to give much higher peaks than in the case of audio signals. The problem of peak overloading at the transmitter will therefore act as a severe limitation to the use of pre-emphasis in this case.

Figures 30 to 43 illustrate a series of idealized cases of pre-emphasis. It is assumed that an original square-topped pulse,

as shown in Fig. 30, is passed through an idealized low-pass filter with or without pre-emphasis at the higher frequencies. If such a pulse is passed through the flat filter shown in Fig. 31, the result is an output signal plotted in Fig. 32.

In this and all the following examples, it is assumed that the width of the pulse is about 12 picture elements or about one-half the width of a line-equalizing pulse in a 441-line system. It is furthermore assumed that the phase shift is linear with frequency (or zero) throughout the entire filter band.

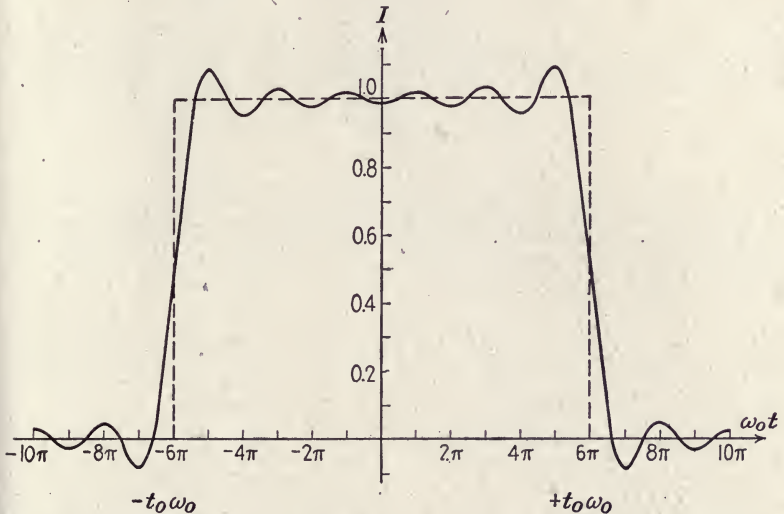

FIG. 32.—Response of the filter of Fig. 31 to the pulse of Fig. 30. The peak-to-peak amplitude of the reproduced pulse is 1.18.

It is seen from Fig. 32 that the original peak-to-peak amplitude of the pulse has been increased from 1 to 1.18, but this increase will probably be slightly less in an actual filter that does not cut off sharply at the top frequency.

Let us now assume that the pulse is passed through a filter with the same amplitude characteristic as shown in Fig. 31 but with a constant phase shift of  $\pi/2$  through the entire band. The output current in this case is shown by the curve of Fig. 33. It is seen that the signal has completely changed character and that it now has two large peaks at  $t = -t_0$  and at  $t = +t_0$ . The original pulse is shown by dashed lines in the figure.

This example serves to illustrate the importance of phase distortion in a television transmission channel and, although the case chosen is very extreme, it will generally be found that the addition of phase distortion serves to increase the peaks of the

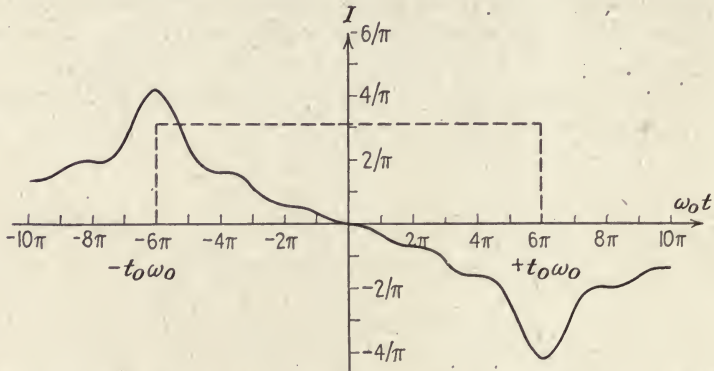

FIG. 33.—The response of the flat filter to the square pulse, when the filter phase characteristic is  $\phi(\omega) = \pi/2$ . The peak-to-peak amplitude is thereby increased to 2.68. The loss in signal to noise at the low frequencies is 7 db, at the top video frequency 7 db.

signal; or, in other words, that in order to keep the peak-to-peak value as low as possible, it is generally advantageous to phase-equalize all the filters and predistorting networks.

Let us next consider the output current when the square-topped

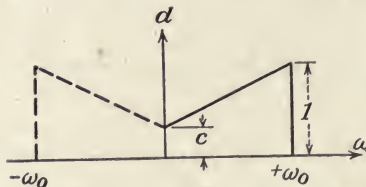

FIG. 34.—Admittance characteristic of a predistorting filter with linearly sloping top. The admittance increases from the value  $c$  at zero frequency to unity at  $\omega_0$ . The phase characteristic is uniform,  $\phi(\omega) = k\omega$ .

pulse is sent through a predistorting network as shown in Fig. 34. Assuming a linear phase shift in this network, the output current shown in Figs. 35, 36, and 37 for different values of the admittance  $c$  at zero frequency. For  $c = 0$  we get the curve shown in Fig. 35 and for  $c = 0.1$  the curve shown in Fig. 36, where the dashed line indicates the response to a pulse sent through a flat filter with an

admittance of  $c = 0.1$  over the band.

The peak-to-peak value in Fig. 36 is 0.5, and, in order to raise this to the original peak value of 1.18, the predistorer may be followed by an amplifier with a flat gain of 7.5 db. This leaves

a gain in signal-to-noise ratio of  $+7.5$  db at the top frequencies and a loss of  $20 - 7.5 = 12.5$  db at the lowest frequencies, assuming a flat noise spectrum. The application of predistortion in this case therefore results in a net loss as far as the over-all signal-to-noise ratio is concerned.

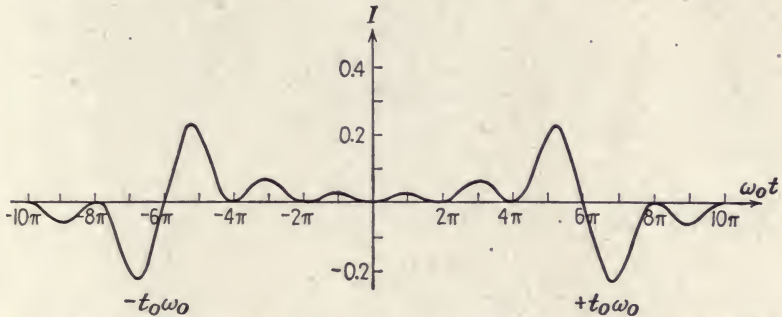

FIG. 35.—Response of the filter of Fig. 34 to the square pulse, for  $c = 0$  and  $\phi = 0$ . The peak-to-peak amplitude is 0.465. The gain in signal to noise at the top frequency is 8 db, but the loss at zero frequency is infinite.

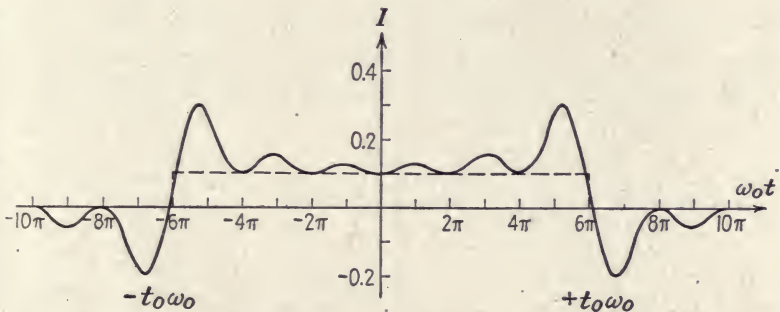

FIG. 36.—Response of the filter of Fig. 34 to the square pulse, with  $c = 0.1$  and  $\phi = 0$ . The peak-to-peak amplitude is 0.5. The gain in signal to noise at the top frequency is 7.5 db, the loss at zero frequency 12.5 db.

The same type of predistorter with a total predistortion of 10 db over the band, or  $c = 0.315$ , results in the curve shown in Fig. 37. In this case, the top frequency gain is 4 db and the low frequency loss is 6 db.

As a further example, there is shown in Fig. 38 the response to a pulse transmitted through the network in Fig. 34, assuming a flat phase shift of 90 deg. through the band and  $c = 0$ . By comparing Fig. 38 with Fig. 35 it is seen that the peak-to-peak value has thereby been increased by 3 db.

For a similar network with  $c = 0.1$ , the peak value of the output signal is one-tenth of the peak value in Fig. 33 plus nine-tenths of the peak value in Fig. 38, or a total peak-to-peak

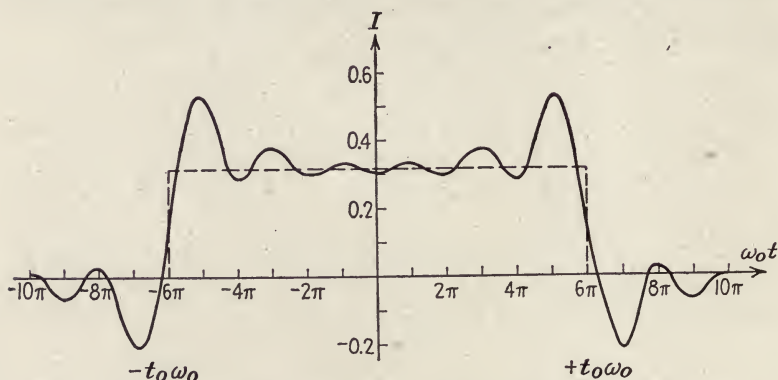

FIG. 37.—Response of the filter of Fig. 34 to the square pulse, for  $c = 0.5$  and  $\phi = 0$ . The peak-to-peak amplitude is 0.735. The signal to noise gain at the top frequency is 4 db, whereas the loss at zero frequency is 6 db.

amplitude of 0.840. This is about 5 db greater than the peak-to-peak value of the signal in Fig. 36 for the same network with linear phase shift. These two examples serve as further illus-

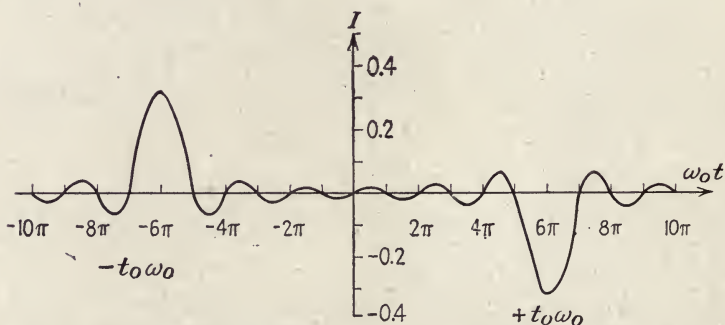

FIG. 38.—Response of the filter of Fig. 34 to the square pulse, for  $c = 0$  and  $\phi = \pi/2$ . The peak-to-peak amplitude is 0.635. The gain in signal to noise at the top frequency is 5 db, but the loss at zero frequency is infinite.

trations of the fact that phase distortion in a network will in general increase the peak values.

In Fig. 39 is shown a predistorting network in which the pre-emphasis varies as the square of the frequency, and the output

current is shown in Figs. 40 and 41. In Fig. 41, it is assumed that the total predistortion is 20 db or  $c = 0.1$ , and it is indicated that we now get a gain of 11 db at the top frequency and a loss of 9 db at the lowest frequency. This might be taken to indicate a slight net gain in signal-to-noise ratio over the band, but, assuming a flat effective noise band, it will be found upon integration that the effective signal-to-noise ratio over the entire band is actually less than before predistortion.

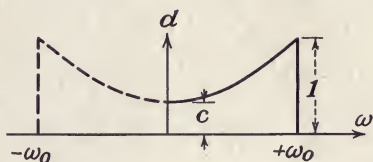

FIG. 39.—Admittance characteristic of a predistorting filter with admittance increasing as the square of the frequency, from admittance  $d = c$  at zero frequency to unity at the top frequency. Phase characteristic  $\phi(\omega) = k\omega$ .

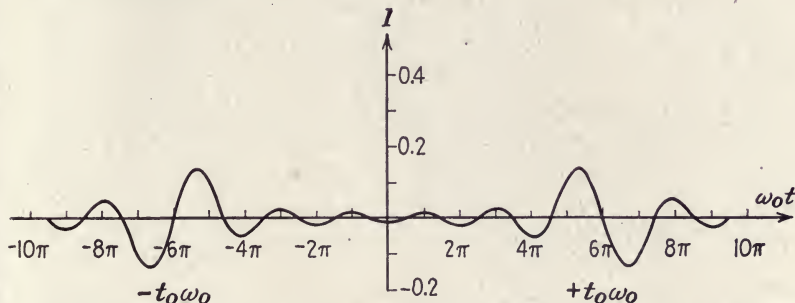

FIG. 40.—Response of the filter of Fig. 39 to the square pulse, for  $c = 0$ , and  $\phi = 0$ . The peak-to-peak amplitude is 0.275. The gain in signal to noise at the top frequency is 12.5 db, whereas the loss at zero frequency is infinite.

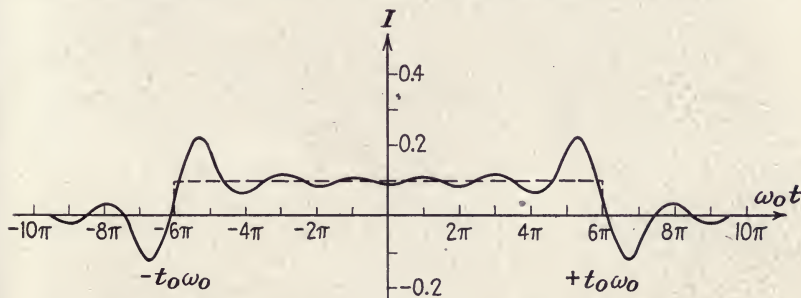

FIG. 41.—Response of the filter of Fig. 39 to the square pulse, for  $c = 0.1$  and  $\phi = 0$ . The peak-to-peak amplitude is 0.34. The gain in signal to noise at the top frequency is 11 db, whereas the loss at zero frequency is 9 db.

One further example is shown in Figs. 42 and 43 giving the output current through a network with an admittance varying

as the third power of the frequency. It will be noticed that the peak values here are somewhat smaller than in the previous curve of Fig. 39.

Before leaving these examples, it should be mentioned that, in a phase-equalized network, the peak-to-peak value of the predistorted pulse will generally increase as the pulse is narrowed.

This may be seen quite easily from Fig. 36. If the pulse is narrowed to a width of  $2\pi$  on the  $\omega_0 t$  scale (two picture elements), then the two primary positive peaks will add up directly and produce a resulting peak-to-peak value of about 0.75, thus reducing the gain at the top frequency to about 4 db instead of 7.5 db as shown on the figure.

In a network with phase distortion, on the other hand, the peak value may sometimes increase with the widths of the pulse. Thus, for the case illustrated in Fig. 33 the peak-to-peak amplitude is 2.7. For a narrow pulse of the width of two picture elements, the peak-to-peak amplitude would decrease to 1.5,

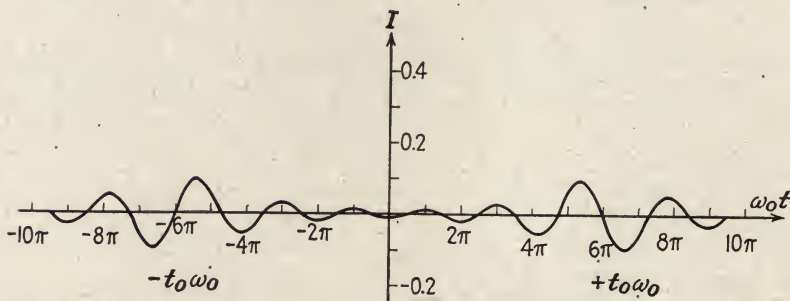

FIG. 42.—Admittance characteristics of a predistorting filter with admittance increasing as the cube of the frequency from  $d = c$  at the zero frequency to unity at the top frequency. Phase characteristic  $\phi(\omega) = k\omega$ .

FIG. 43.—Response of the filter of Fig. 42 to the square pulse, for  $c = 0$  and  $\phi = 0$ . Peak-to-peak amplitude 0.2. Gain in signal to noise at top frequency is 15.5 db; loss at zero frequency is infinite.

and, for a pulse half a line wide (441-line system), it would increase to 4.7.

It was mentioned in the foregoing that the peak-to-peak value of a pre-emphasized signal is generally lowered by careful phase equalization. As a special example in which this is not the case,



we may mention a minimum phase network that pre-emphasizes the higher frequencies at the rate of 12 db per octave.<sup>1</sup> Such a network is characterized by a constant phase shift of 180 deg. throughout the band, and complete phase equalization would therefore only reverse the polarity of the signal without affecting its shape.

It should be kept in mind that the illustrations given in the foregoing are purely theoretical and are meant only as illustrations of the general effect of predistortion. In actual filter networks, the fact that some phase distortion is unavoidably present will generally tend to increase the peaks somewhat, whereas the peaks may be lowered somewhat by the fact that the filters do not have sharp cutoffs.

It should further be mentioned that no account has been taken of the additional peaks inherent in vestigial sideband transmission. Assuming that the sideband is shaped at the transmitter, these latter peaks will be present at the transmitter output and may be safely chopped off in the last stage without impairing the received signal. The same, however, is not the case with the peaks introduced by predistortion. If the predistortion peaks are partially cut off by transmitter overload and if the receiver incorporates a restoring network conjugate to the predistorter at the transmitter, then the final received signal will show negative peaks, or dips, instead of the original peaks introduced by the predistortion.

The indications of the foregoing would seem to be that predistortion of the television signal is not advantageous from a noise standpoint and will probably result in a net loss. The introduction of weighting factors because the susceptibility of the eye to noise is different for different parts of the frequency spectrum will change conditions somewhat, and it is of course conceivable that some moderate form of pre-emphasis would result in an over-all improvement of the received picture. To determine the shape and amount of such pre-emphasis, however, would undoubtedly call for a series of experimental tests.

In the case of television broadcasting, there is one other factor that may change the picture, and that is the receiver cost. If, for instance, we use at the transmitter a predistorting network

<sup>1</sup> See Fig. 3 in H. W. Bode, Relations between Attenuation and Phase in Feedback Amplifier Design, *Bell System Tech. J.*, July, 1940.

as shown in Fig. 39, then the restoring network at the receiver will result in an over-all receiver characteristic that slopes downward toward the higher frequencies with an amplification at the top frequency of only one-tenth that at the lowest frequency. A receiver with this type of transmission characteristic may prove to be considerably cheaper than a receiver with a substantially flat band, and it is possible that this consideration alone would make it advisable to use some moderate amount of predistortion, at least over the upper part of the frequency band.

One more factor that should be kept in mind in considering this question is the problem of automatic gain control at the receiver. With the present system of negative modulation at the receiver, the synchronizing pulses would all have peaks on them if predistortion were used, and these peaks may make the automatic gain control uncertain in operation unless the restoring network at the receiver is inserted ahead of the point where the automatic-gain-control voltage is obtained. Finally, it is of course essential that restoring take place before amplitude separation of the synchronizing signals.

#### REPORT ON THE LOGARITHMIC TRANSMISSION CHARACTERISTIC

Panel 6 adopted the following as a recommended practice: "It is recommended as good engineering practice for normal transmission that the output voltage versus brightness characteristic be substantially logarithmic." In support of this recommendation the panel report states:

It can be shown that in a picture transmitting system the interfering effect of noise can be reduced by emphasizing at the transmitter the picture elements of lower brightness and by the converse procedure at the receiver. This can be done by the employment of a camera and associated equipment, the electrical output of which does not vary in direct proportion to the brightness of the picture element being transmitted but which, as the brightness increases uniformly, increases less than proportionately. Such a characteristic may be described as "logarithmic." If the scene being transmitted is to be reproduced by the receiver with acceptable fidelity, the receiving equipment must provide brightness of reproduction greater than in direct proportion to the output of the camera and its associated equipment. Such a characteristic may be described as "exponential." In view of the uncertainty as to the future developments in the fields of camera tubes and picture tubes, it is

desired that a guide post based on sound theory which will point to the desired direction of development be provided. Since it is practical to produce and to employ equipment of widely different characteristics, no more precise formulation of the relations here discussed than is given above is desired. For these reasons the terms "logarithmic" and "exponential" are here so loosely used.

The following report by R. D. Kell is one of several prepared for the panel on the subject of the logarithmic transmission characteristic.

#### THE RELATIVE MERITS OF A TELEVISION SYSTEM HAVING A LINEAR TRANSMISSION CHARACTERISTIC AND A SYSTEM HAVING A LOGARITHMIC CHARACTERISTIC<sup>1</sup>

##### INTRODUCTION

The contrast sensitivity of the eye may be determined experimentally by changing the brightness of a small area in the field

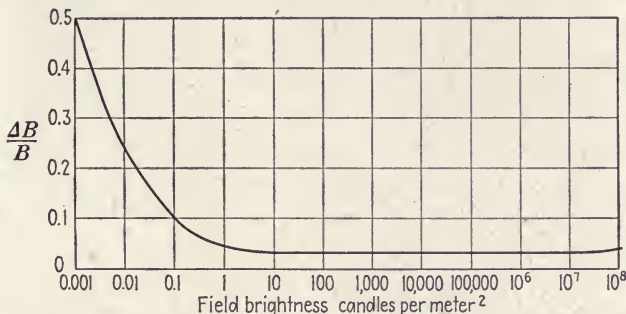

FIG. 44.—Variation in contrast sensitivity of the eye with field brightness. (From Hardy and Perrin, *Principles of Optics*.)

of view until it is just noticeably different from the surrounding field. The variation in the contrast sensitivity with field brightness may be conveniently represented by  $\Delta B/B$ , where  $B$  is field brightness and  $\Delta B$  is the change in brightness.

If the variation in contrast sensitivity is plotted against field brightness, as shown in Fig. 44, it is found that the eye has nearly uniform contrast sensitivity over a range of about 1 to 100,000 candles per square meter. This means that the eye is sensitive to a constant percentage change and not to a change of absolute light values over practically the entire useful range of illumination. If this fact is made use of in a television system, an increase

<sup>1</sup> R. D. Kell, RCA Manufacturing Company, Inc.

in effectiveness of the television transmission may be realized with regard to spurious signals equivalent to approximately a tenfold increase in transmitting power.

### THEORETICAL CONSIDERATIONS

In a television receiver, an interfering signal, whether receiver hiss or externally picked up signals, has a random distribution with respect to the half-tone values of the picture. If the receiver amplitude characteristic is linear, the light on the receiving screen at any instant is directly proportional to the voltage input to the receiver. An interfering signal will therefore produce spurious light changes having the same absolute values in all picture areas independent of the half-tone values. The interfering signal will represent a greater percentage change in light value in the shadows than in the high-light areas of the picture, and, since the eye is sensitive to percentage changes, the interfering signal will be more objectionable in the shadows than in the high lights. To secure the greatest possible immunity from spurious signals, the receiver amplitude characteristic should be such that a given amount of interfering signal is uniformly objectionable in all half-tone values of the picture. This desired immunity to interfering signals is obtained if the interfering signal produces a constant percentage change in screen brilliancy at all half-tone values.

Stated in another way, if the change in input voltage is  $\Delta V$  due to noise and the corresponding change in screen brightness is  $\Delta B$ , the change in brightness  $\Delta B$  for a given  $\Delta V$  should be proportional to the screen brightness  $B$ . This may be written

$$\Delta B = KB \Delta V \quad (1)$$

or

$$\frac{\Delta B}{B} = K \Delta V \quad (2)$$

Integrating (2)

$$\int \frac{dB}{B} = \int K dV \quad (3)$$

$$\log_e B = KV + C \quad (4)$$

Equation (4) shows that, if the logarithm of screen brightness is proportional to the input voltage of the receiver, the desired amplitude characteristic is obtained.

Figure 45 shows a comparison between a linear receiving system (a), an ideal logarithmic characteristic (b), and a type 1803 kinescope characteristic (c). From these curves, it is seen that if the receiver is designed in such a way as to have a linear characteristic up to the kinescope grid, the kinescope char-

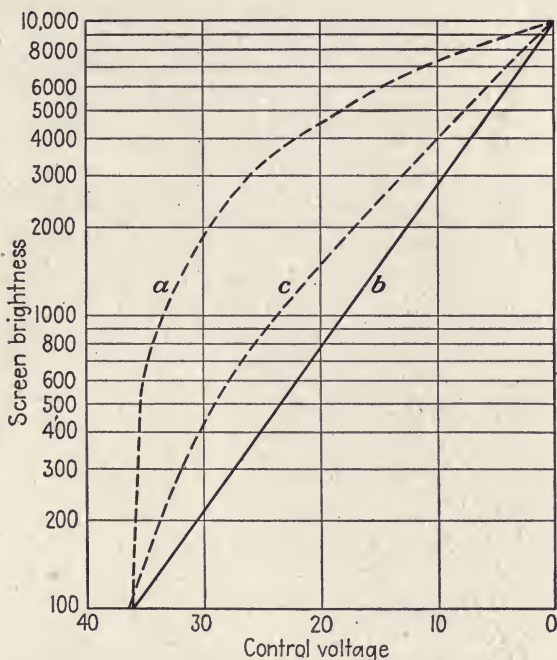

FIG. 45.—Comparison of receiver brightness-transfer characteristics: (a) linear system; (b) logarithmic system; (c) type 1803 kinescope. (R. D. Kell.)

acteristic approaches reasonably close to the desired logarithmic characteristic.

When an iconoscope is used as a pickup device, an amplitude vs. light input characteristic is introduced into the system, which very nearly corrects for the nonlinearity of the receiving cathode-ray tube. Characteristics of two iconoscopes are shown in Fig. 46. Figure 47 shows the over-all operating characteristic of a system from light input into the iconoscope through the transmitter and receiver to the light output on the kinescope screen.

## EXPERIMENTAL RESULTS

To measure the signal-to-noise ratio improvement that could actually be realized in practice, tests were made on a television system whose amplitude characteristic could be changed from linear to approximately logarithmic (that of the kinescope). The circuit arrangement is shown in Fig. 48. At the trans-

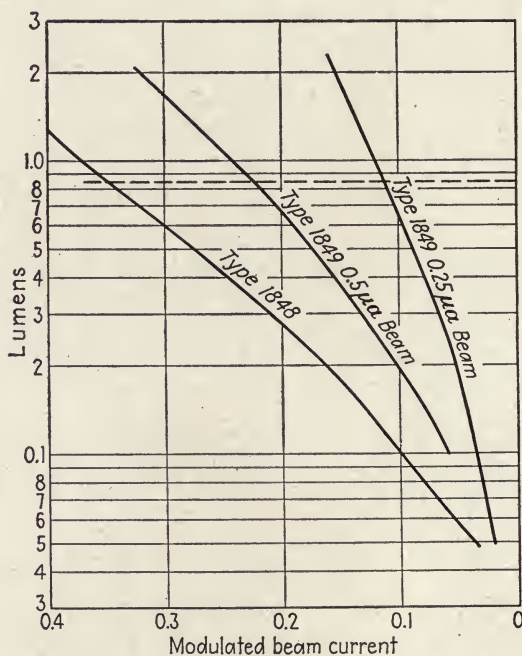

FIG. 46.—Iconoscope characteristics, light vs. modulated beam current. (R. D. Kell.)

mitter, an orthicon, which has a linear amplitude characteristic, was used as the pickup device. An amplifier that had an amplitude characteristic, which, when combined with the kinescope, gave a linear light output vs. volts input, was inserted in the amplifier system. This combination of orthicon, amplifier, and kinescope was then a television system having an over-all linear amplitude characteristic or a gamma of unity. As a source of noise, a Type TRK-12 television receiver was used. The output of the receiver was applied to an amplifier and switching

arrangement so that, in one test position, the noise could be added to the signal between the linear transmitter and the linear receiver (amplitude-distorting amplifier and kinescope).

The other switch position introduced the noise between the nonlinear transmitter and nonlinear receiver, where the nonlinear receiver characteristic was that of the kinescope. In the first

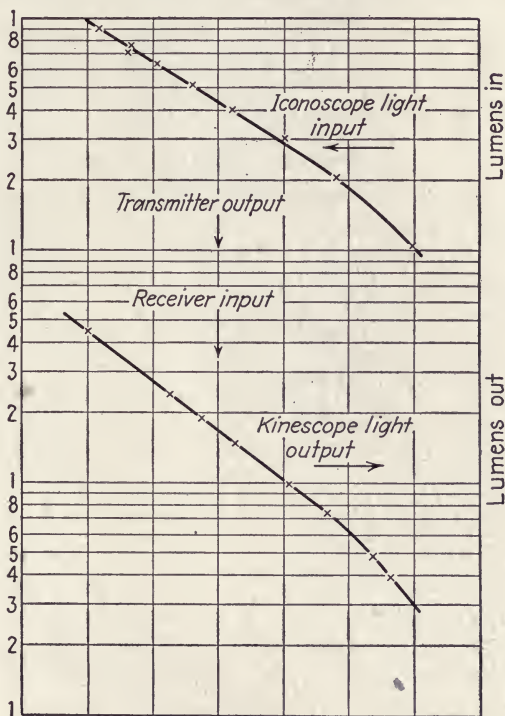

FIG. 47.—Combined transmitter and receiver transfer characteristics from input light to output light. (R. D. Kell.)

case, the system was equivalent to a linear transmitting system and a linear receiving system with the noise introduced between the two. In the second case, the system was equivalent to a transmitter having approximately a logarithmic characteristic and a receiver having the amplitude characteristic of the standard RCA 1803 kinescope. In the test, the signal and noise were measured by means of cathode-ray oscillograph at the input to the nonlinear amplifier. The two noise inputs were adjusted

by viewing the reproduced picture until the noise appeared to be the same for both test conditions. Comparisons were made between the two systems at various noise levels. The results of the tests are shown in Fig. 49. Curve *A* is the linear system, and curve *B* is the logarithmic system. From these curves, it is seen that a gain in signal-to-noise ratio of over 3:1 is obtained at all measured values of signal-to-noise ratio. This is equivalent

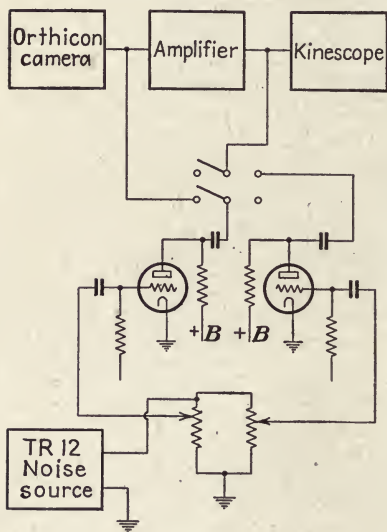

FIG. 48.

FIG. 48.—Test setup for determining television-brightness-transfer characteristics. (R. D. Kell.)

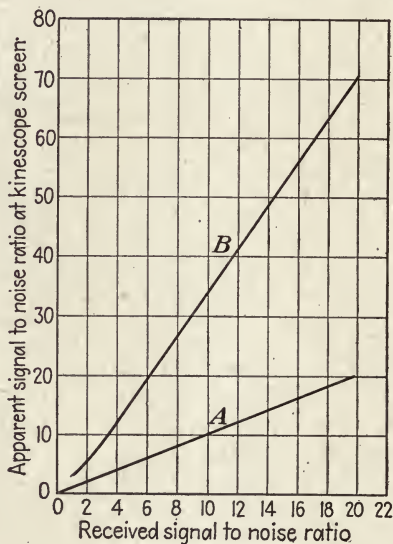

FIG. 49.

FIG. 49.—Relationship between the received signal to noise ratio, and the visually apparent signal to noise ratio as viewed on the receiver screen. (R. D. Kell.)

to an effective power gain in the order of 10:1, without increasing the interference range of the transmitter.

It is understood that the law of transmission discussed above is not directly related to the over-all light-input, light-output characteristic, which is sometimes referred to as gamma. This gamma relation is of an artistic nature and should not be a subject for standardization. It can, however, be said that the transmitting system should have that relation of voltage output to light input which will produce the desired artistic effect when viewed on a receiver having the specified logarithmic characteristic.



## CHAPTER VIII

### THE SCANNING SPECIFICATIONS

To Panel 7<sup>1</sup> were assigned two of the most controversial issues before the N.T.S.C., as well as two of the least controversial. The first two were the number of lines per complete picture period and the number of frames and fields per second. The second two were the aspect ratio and the type and direction of scanning. That the aspect ratio (ratio of width to height in the reproduced picture) should conform to the 4:3 ratio standardized in the motion pictures was accepted without argument, as was the fact that linear scanning should be employed at constant velocity from left to right and top to bottom of the picture. These standards, embodied in the N.T.S.C. report as numbers 7 and 8, were passed unanimously. But the standard specifying the number of frames and fields per second as 30 and 60, respectively (number 6 in the N.T.S.C. report), was a subject of prolonged discussion and demonstrations. So was the standard specifying the number of lines per frame period (number 5 in the N.T.S.C. report). In this last standard, the recommendation of the Panel was modified by the National Committee, revising the number upward from 441 to 525 lines.

The specific charge to the Panel read: "To study and report on the factors influencing the provision of suitable detail in television picture reproduction." Interpreted broadly, this instruction included a study of the whole field of scanning, including aspect ratio, frame and field frequencies, interlace, number of lines per picture, and the linearity of scanning, all of which formed the subject of standards recommended by the Panel. The subject matter of the Panel was of wide interest to all factors in the industry, and consequently the membership list of 22 was the largest of all the Panel groups.

<sup>1</sup> The members of Panel 7 were D. E. Harnett, chairman; C. T. Allen; M. W. Baldwin, Jr.; A. V. Bedford; J. E. Brown; G. Burroughs; M. Cawein; R. B. Dome; W. L. Dunn; J. N. Dyer; A. V. Loughren; H. R. Lubcke; J. O. Mesa; A. F. Murray; P. Raibourn; R. E. Rutherford; J. M. Sanabria; D. B. Smith; A. D. Sobel; G. R. Town; C. F. Wolcott; R. S. Yoder.

**The Aspect Ratio.**—The recommendation of the Panel that the standard aspect ratio of the transmitted picture be 4 units horizontally and 3 units vertically was based on several studies made by the panel members, two of which are reproduced below. These studies pointed out that benefit would derive from the fact that standard motion-picture film could be transmitted in 4 by 3 frame without waste of the picture area. There are other important factors in the choice. The aspect ratio affects the other scanning standards, particularly the number of lines required to utilize the television channel at a given frame-repetition rate. The relative preference of different picture shapes was also considered from an aesthetic point of view, although no sharply drawn distinction was made on this basis.

**Reports on the Aspect Ratio.**—The following reports by Madison Cawein and G. R. Town are supplementary to each other, as the author of the second states. They sum up the considerations that led to the adoption of the 4:3 ratio.

#### DISCUSSION OF ASPECT RATIO<sup>1</sup>

Various shapes of television pictures have been given consideration in the past. Most important of these shapes are the rectangular and circular shapes, both of which are pleasing to the eye and have been a standard pattern of picture frames for centuries.

The circular picture naturally suggested itself at an early date in the television art. This was primarily because the simplest form of picture-reproducing tube is a circular form, and the form of lens images is also circular. Many early television patents read on systems of spiral scanning, including spiral interleaf systems. All these systems exhibit greater circuit complexities than the system of rectilinear scanning, which is especially adapted to rectangular pictures.

The circuit complexities were concerned with maintaining a uniform speed of scanning spot and a uniform brilliance of picture from the center to the circumference. The brightness level at the center of the picture presents an almost insuperable difficulty in spiral scanning systems.

In 1936, Prof. Allan Hazeltine conceived the idea of adapting a rectilinear scanning system to the circular form of picture, instead of using spiral scanning. His system was invented with

<sup>1</sup> Madison Cawein, Farnsworth Television and Radio Corporation.

the idea that there was a possible advantage to conservation of light energy at transmitter and receiver, inasmuch as all parts of the picture would be symmetrically disposed around the center of interest, the information transmitted in the corners of a picture being of little value. He thought also that the public might react favorably to a circular picture. His system, in which the blanking intervals were modulated, was more wasteful of time than the R.M.A. system of rectilinear scanning, since only  $\pi/4$  of the cycle was useful. To avoid this fault, the occurrence of the blanking intervals would have to be modulated, which also would lead to considerable circuit complexity.

The almost universal rectilinear system of uniform-speed scanning is a straightforward system with the obvious advantages of uniformity of illumination, constancy of deflection frequency, and conservation of time. Conservation of time results in economy of ether space for the transmission of picture information. In addition, this system has the advantage that a number of years of experience have been devoted to the development and test of the electrical circuits that are adapted to it.

In adopting a rectilinear system of scanning, the question of aspect ratio arises. The aspect ratio is the ratio of horizontal to vertical dimensions of the rectangle and is expressed mathematically by the cotangent of the angle between the diagonal and the base of the rectangle.

There would be a slight economy of the surface of circular fluorescent screens if a square picture with aspect ratio of unity were transmitted. This economy results from the fact that a square is the largest rectangle that can be inscribed in a circle. The area of the inscribed rectangle in terms of radius of circle  $R$  and aspect ratio  $A$  is expressed mathematically by the formula

$$\text{Area} = \frac{4R^2A}{1 + A^2}$$

This function is maximum at a value of  $A$  equal to unity but decreases very slowly as  $A$  departs from unity.

A square is not particularly pleasing to the eye. The ancient Greeks, who were aesthetically minded, believed that the most pleasing right triangle was the triangle with sides in proportion as 5:4:3. It is a fact that a rectangle of aspect ratio 4:3, which contains the 5:4:3 proportion of line, is quite pleasing to the eye.

Through the centuries, designers have shown that they concur in this belief by their continued use of the 4:3 rectangle. The area of such a rectangle inscribed in a circle differs by only 4 per cent from an inscribed square, so that there is little choice between the two, as far as wasted area is concerned.

A rectangular picture would seem to be a logical form for a television picture on the technical grounds of circuit simplicity and experience. An aspect ratio of 4:3 has been in use by the motion-picture industry, can be justified on aesthetic grounds, and has no technical disadvantages. In view of experience, an aspect ratio of 4:3 would make a good standard for recommendation to the FCC.

#### NOTES ON ASPECT RATIO<sup>1</sup>

These notes on aspect ratio were prepared prior to the receipt of Mr. Cawein's paper. Since a number of factors other than those discussed by Mr. Cawein are considered in these notes, it is felt worth while to submit them as supplementary to Mr. Cawein's paper.

In setting the standard aspect ratio to be used in television, at least seven factors should be considered. These factors are discussed briefly in the following notes.

#### PICTURE SHAPE

It would be possible to use a picture of almost any desired geometrical shape. However, if a rectangular shape is chosen, the deflecting circuits are greatly simplified. With any other scanning pattern, the circuits are complicated by the necessity of varying the amplitudes of successive lines, of introducing varying compensation for nonlinearity of sweep, or of compensating for varying brightness at different parts of the screen. Hence, in the interests of simplification of design, economy of manufacture, and ease of adjustment of deflection circuits, a rectangular picture shape should be chosen.

#### ORIENTATION OF RECTANGLE

Aspect ratio is defined as the ratio of picture width to picture height. If the aspect ratio is unity, the rectangle degenerates

<sup>1</sup> Dr. George R. Town, Stromberg-Carlson Telephone Mfg. Company.

into a square. If the aspect ratio is greater than unity, the rectangle has its longer edges horizontal. If the aspect ratio is less than unity, the rectangle has its longer edges vertical.

There seem to be good reasons for choosing an aspect ratio greater than unity. Since most of man's activities occur in a horizontal plane, it is reasonable that there should be more freedom of motion horizontally than vertically. Thus, if the rectangle has its longer side horizontal, it will best accommodate average scenes in which action takes place.

The fact that the aspect ratio used in motion-picture practice is greater than one is evidence that a "horizontal rectangle" is well adapted to the portrayal of a wide variety of events. Practically all dramatic events are presented on stages that allow considerable freedom of horizontal motion but little freedom vertically. Practically all sporting events contain much more motion in a horizontal plane than in a vertical plane. The only important exception to the general rule is that a vertical rectangle is much better adapted to portraying the human face or full-length view of a single person or of a very small group of persons. However, no serious limitation is imposed by the use of the horizontal rectangle.

The orientation of the rectangle has an influence on the problem of scanning. Assume that system *A* uses a horizontal rectangle of aspect ratio  $K$  ( $K > 1$ ) and that system *B* uses a vertical rectangle of aspect ratio  $1/K$ . If the pitch of the scanning lines is the same in the two cases, the line frequency in system *B* will be  $K$  times that in system *A*, and the amplitude of the horizontal sweep will be  $1/K$  times as great. Since it is often difficult to secure adequate horizontal sweep output, the use of a vertical rectangle offers an attractive possibility. However, these factors are of less commercial importance than the program factors previously mentioned.

#### PICTURE AREA

It is obvious that it is desirable to make a large portion of the picture-tube screen area available for the picture. It is easily shown that the area of a rectangle inscribed in a circle will be a maximum if the aspect ratio is unity, *i.e.*, if the inscribed rectangle becomes a square.

Let  $a$  = long side of a rectangle inscribed in a circle.

$b$  = short side of a rectangle inscribed in a circle.

$r$  = radius of the circle.

$K$  = aspect ratio =  $a/b$ .

$A$  = area of the inscribed rectangle =  $ab$ .

$A_m$  = area of the maximum inscribed rectangle.

= area of the inscribed square.

It then follows that

$$A_m = 2r^2$$

$$\frac{A}{A_m} = \frac{2ab}{a^2 + b^2} = \frac{2}{K + (1/K)}$$

In Fig. 50, the ratio  $A/A_m$  is plotted as a function of  $K$ . The second curve of Fig. 50 indicates the value of  $1 - (A/A_m)$  or the fractional loss in area due to the fact that  $K$  differs from unity.

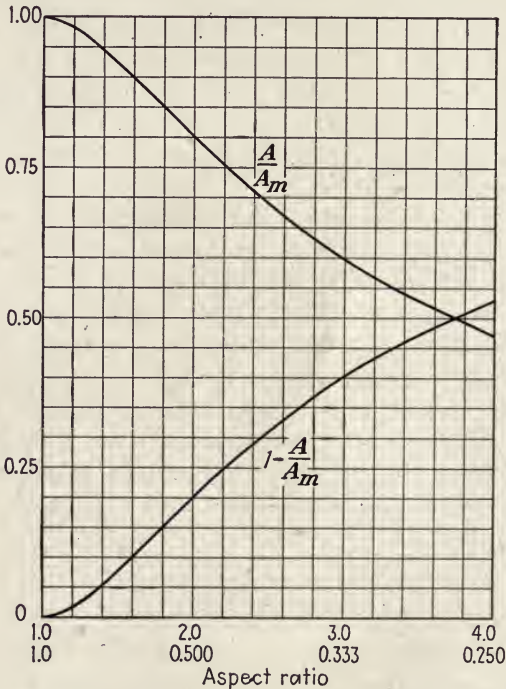

FIG. 50.—Relationship between picture size and aspect ratio. (G. R. Town.)

If the "lost" area is to be limited to 5 per cent, it is evident that the aspect ratio should be less than 1.4:1.

## RELATION BETWEEN ASPECT RATIO AND RESOLUTION

If it is assumed that a fixed frequency band is available for the transmission of television signals, the possibility exists that the available resolution might depend upon the aspect ratio.

The nominal cutoff frequency  $f_c$  of a television scanning system is given by

$$f_c = cf_v N^2 K$$

where  $f_v$  = frame frequency.

$N$  = number of lines per frame.

$K$  = aspect ratio.

$c$  = constant.

$$N = \sqrt{\frac{f_c}{cf_v K}} = \sqrt{\frac{f_c b}{cf_v a}}$$

Assuming that the available bandwidth and frame frequency are fixed

$$N \propto \sqrt{\frac{b}{a}}$$

The available resolution in a picture may be measured in a number of ways. Wheeler and Loughren [*Proc. I.R.E.*, **26** (5), 540-575 (May, 1938)] have studied the images of an infinitely narrow vertical and of an infinitely narrow nearly horizontal line as indices of the limiting amount of resolution. Kell, Bedford, and Fredendall [*RCA Rev.*, **5** (1), 8-30 (July, 1940)] used as an index the rate of rise of images of vertical and nearly horizontal boundaries.

Let  $d_h$  = horizontal linear distance occupied by the image of a sudden disturbance of either of the above types.

$d_v$  = vertical linear distance occupied by the image of a sudden disturbance of either of the above types.

$t$  = time required by  $d_h$ .

$f_h$  = line frequency.

$T_h$  = period of horizontal sweep =  $1/f_h$ .

$mT_h$  = time for active portion of horizontal sweep.

$a$  = picture width.

$b$  = picture height.

$A$  = picture area.

Referring to either of the articles cited above, it is seen that  $d_v$  is proportional to the line pitch.

$$d_v \propto \frac{b}{N}$$

or

$$d_v = \frac{sb}{N}$$

$s$  = constant of proportionality = approximately 1.4

If aperture distortion is neglected for the present, it follows from either of the articles that the time  $t$  depends only on the characteristics of the filters, etc., in the transmission channel. These are fixed for a given channel width and transmission system. Hence,  $t$  is a constant.

$$d_h = \frac{at}{mT_h}$$

$$T_h = \frac{1}{f_h} = \frac{1}{Nf_v}$$

Hence

$$d_h = \frac{f_v Nat}{m}$$

$$\frac{d_h}{d_v} = \frac{f_v ta N^2}{msb}$$

But

$$\frac{a}{b} = K = \frac{f_c}{cf_v N^2}$$

Hence

$$\frac{d_h}{d_v} = \frac{tf_c}{msc} = \text{constant}$$

Or, the ratio of vertical to horizontal resolution is independent of the aspect ratio.

Substituting the equation for  $N$  in the expressions for  $d_h$  and  $d_v$ , the results are

$$d_h \propto \sqrt{ab}$$

$$d_v \propto \sqrt{ab}$$

Thus, both the horizontal and vertical widths of confusion are proportional to the square root of the picture area.



The true criterion of picture resolution is the ratio of picture area to area of confusion. Thus,

$$Q \propto \frac{A}{d_h d_v} = \text{constant}$$

where  $Q$  is a measure of resolution.

Thus, resolution is independent of picture size and of aspect ratio.

The effect of aspect ratio on aperture distortion remains to be discussed. It is obvious that the greater the speed of the scanning spot, the less will be the aperture distortion (see, for example, Fig. 3 in the article by Kell, Bedford, and Fredendall). Hence, the problem is to determine the effect of aspect ratio on horizontal scanning speed.

Let  $v_h$  = horizontal spot speed

$$v_h = \frac{a}{mT_h} = \frac{aNf_v}{m}$$

Substituting

$$N \propto \sqrt{\frac{b}{a}}$$

the result is

$$v_h \propto \sqrt{ab}$$

$$v_h \propto \sqrt{A}$$

Hence, as the aspect ratio increases from unity, aperture distortion decreases; but the decrease is not great for usual values of the aspect ratio.

In all the above equations, it should be noted that  $f_c$  is a constant, *i.e.*, a fixed frequency band is assumed. The frame frequency  $f_v$  is also assumed constant, being fixed by considerations entirely separate from the question of aspect ratio.

#### MOTION-PICTURE TRANSMISSION

In motion pictures, the standard aspect ratio is 4:3. If the same ratio is used in television, the full area of a motion-picture frame may be used efficiently as subject matter for television transmission. If any other aspect ratio is chosen, either one edge of the picture will be cut off or the received picture will not completely fill the rectangular mask area of the picture-tube

screen. Since neither of these alternatives is desirable, an aspect ratio of 4:3 is seen to have a distinct advantage over any other.

#### EASE OF COMPUTATION

If the aspect ratio is 4:3, it is easy to compute the received picture dimensions from the diameter of the picture tube, the width being 80 per cent and the height 60 per cent of the screen diameter. Although such a consideration should not be a determining factor, it nevertheless is an advantage of this particular ratio.

#### ARTISTIC CONSIDERATIONS

It is possible that the exact ratio of the dimensions of a rectangle may be important from the artistic standpoint. In an article entitled *Dynamic Symmetry in Radio Design* [*Proc. I.R.E.*, 20 (9), 1481-1511 (September, 1932)], A. Van Dyck has indicated that cabinet designs built around certain definite ratios of dimensions combine artistically with component elements having associated ratios of dimensions. If such design methods are used, the value of the aspect ratio should be chosen in harmony with these methods. Van Dyck showed that the following ratios of dimensions of rectangles (aspect ratios) are particularly "powerful." The most "powerful" ratios are underlined.

1.000	<u>1.414</u>	<u>2.4472</u>
1.118	<u>1.4472</u>	<u>2.472</u>
1.1545	<u>1.528</u>	<u>2.618</u>
1.191	<u>1.618</u>	<u>2.764</u>
1.2236	<u>1.7135</u>	<u>2.809</u>
<u>1.236</u>	<u>1.809</u>	<u>2.8944</u>
<u>1.309</u>	<u>1.854</u>	<u>3.236</u>
•1.382	<u>2.236</u>	<u>3.427</u>
1.4045	<u>2.309</u>	<u>3.618</u>

In spite of the acceptance of these ratios by at least a certain number of industrial designers, it is seriously doubted that the average person would prefer a television receiver cabinet "properly" designed and producing a picture having an aspect ratio of 1.309 to a similar receiver "improperly" designed and producing a picture whose aspect ratio is 1.333 (4:3). Rectangles

having aspect ratios of 1.309 and 1.333 are shown in Figs. 51 and 52, respectively. These are based on a picture-tube screen diameter of 12 in.

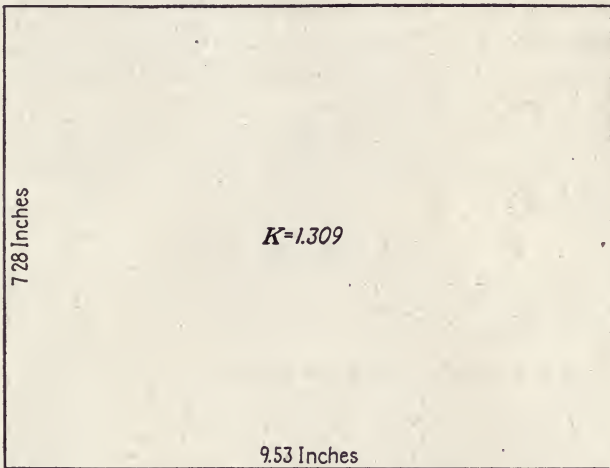

FIG. 51.—Picture frame having an aspect ratio of 1.309, a "preferred" figure in dynamic design. (G. R. Town.)

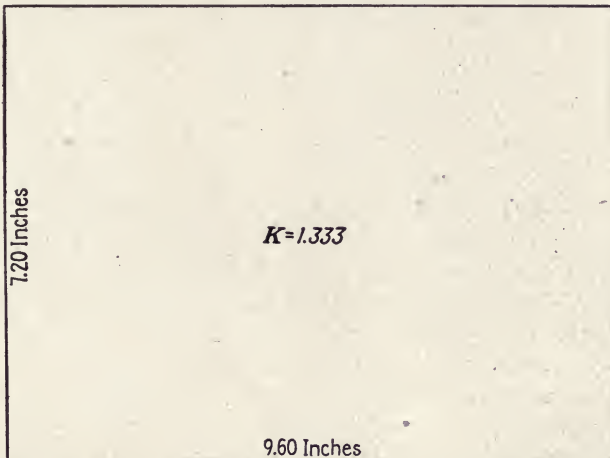

FIG. 52.—Frame with aspect ratio of 1.33, corresponding to the N.T.S.C. standard. (G. R. Town.)

### CONCLUSIONS

1. The picture should be rectangular in shape with the long side of the rectangle horizontal.

2. In order to make efficient use of a round picture-tube screen, the aspect ratio should be less than 1.4:1.

3. With a fixed frequency bandwidth and frame frequency, the available picture resolution is independent of the aspect ratio.

4. The ratio 4:3 permits most efficient use of motion-picture film. It also has the slight advantage of permitting easy mental computation of picture sizes.

5. The ratio 1.309 may possibly have advantages from the standpoint of artistic design, but it is believed that these advantages are slight.

#### RECOMMENDATION

It is recommended that the aspect ratio (ratio of picture width to picture height) be 4:3.

#### THE SCANNING VELOCITIES AND DIRECTIONS

The recommendation of uniform scanning velocities from left to right and top to bottom was made without protracted discussion. In the panel report, the statement is made simply that recommendation is "based upon a need for agreement between transmitter and receiver to give faithful reproduction of pictures insofar as the comparative shapes and dimensions of objects in the scene are concerned." For a more detailed confirmation of the desirability of linear scanning at constant velocity, reference may be made to the Outline for Analysis of Television Systems, prepared by Panel 1 (see Chap. III for the text of this outline). In this outline, unidirectional linear scanning at constant velocity is given preference over all other methods of scanning (such as bidirectional, sinusoidal, velocity, and spiral scanning), because this type of scanning produces an even distribution of detail, makes full use of the video bandwidth, and offers reasonable tolerance in the performance of the synchronization system. The retrace time between successive lines is not available for picture information, but use is made of this interval to permit the transmission of synchronization signals. The Panel 1 outline also recommends the horizontal direction for the lines, because horizontal motion is much more common than vertical motion and is more clearly depicted when the lines lie in this direction. Vertical motion across the line structure often produces an effect known as optical pairing of

the lines, which arises from the persistence of vision in the eye and reduces the apparent detail in that direction.

### THE FRAME AND FIELD FREQUENCIES

The decision to recommend a frame rate of 30 pictures per second and a field rate of 60 interlaced fields per second was reached after long discussion by a vote of 15 to 1 (5 members absent). The alternative, proposed by Rutherford as representative of the DuMont Laboratories, was the establishment of a frame rate not lower than 15 per second, with 30 fields per second. The feasibility of this lower rate (which would permit doubling the picture detail) was urged on the basis that cathode-ray fluorescent screens could be produced which would store sufficient energy from one frame to the next to avoid excessive flicker and would also have sufficiently rapid decay to avoid carry-over of the detail of one frame to the next, which would result in "smearing" of the motion. The Panel viewed several demonstrations of pictures reproduced with phosphors developed to display the storage and rapid decay required for 15-frame-per-second operation. The majority of the Panel voted that the performance of these phosphors was not acceptable. Measurements were made on the phosphor decay characteristics to show that the storage and decay requirements were inherently opposed to each other.

Six reports bearing on the subject of the frame and field frequencies were submitted by the Panel with their report. Several of these, or their substance, have appeared in technical periodicals and hence are not reproduced here. An unpublished report that states the case for the field and frame frequencies of 30 and 60 per second, prepared by A. V. Bedford, is reproduced below.

#### FRAME AND FIELD FREQUENCIES FOR TELEVISION<sup>1</sup>

It is well known that in a television system the bandwidth required to transmit a picture having equal resolution in the vertical and horizontal directions is proportional to the square of the number of scanning lines. The bandwidth is also proportional to the frame-repetition frequency.

<sup>1</sup> A. V. Bedford, RCA Manufacturing Company, Inc.

It follows then that, if other things are equal, the number of lines in an efficient system should vary inversely as the square root of the frame frequency. To be more specific, if an efficient 30-frame system had 441 lines, a change to 24 frames would ideally allow the use of 494 lines (which is 12 per cent more). Similarly, a change from 30 frames to 15 frames would ideally allow the use of 622 lines (which is a gain of 41 per cent) with corresponding theoretical gains in resolution.

Actually, because of the various aberrations in the present types of pickup and receiving tubes, only a small portion of the theoretical gains in resolution indicated by the above figures could be obtained by decreasing the number of frames and increasing the number of lines above 441. Nevertheless, it is likely that tubes having greater resolution will be developed, making it desirable that the standardized frame frequency be as low (and the number of lines as high) as other conditions allow.

The minimum acceptable frame frequency for a television broadcast service is determined by the flicker that occurs if the field frequency is too low. As a result of interlaced scanning, the field frequency is made twice as high as the frame frequency, and the bandwidth required for elimination of flicker is reduced by two.

In addition to flicker, if the frame frequency is too low, the effects of jerkiness or smear or both become objectional when there is rapid motion in the picture subject. At 15/30<sup>1</sup> the effect of flicker is very bad with ordinary receiving cathode-ray tubes having relatively short retentivity screens, whereas at 30/60 the flicker is essentially negligible.

By using long-retentivity screens, the flicker effect may be greatly reduced though not eliminated to a satisfactory degree at 15/30, but the smear becomes objectional in moving subjects because of luminescence retained during the scanning of subsequent frames. Though research on the subject has been intensive for the past ten or more years and thousands of materials have been investigated, all the luminescent materials investigated have had very gradual decay of luminescence after cessation of excitation by the electron beam. In order to provide com-

<sup>1</sup> When two numbers are written in this manner in this discussion, they will refer to the frame frequency and the field frequency respectively, as for 15 frames per second and 30 fields per second in this example.

pletely uniform illumination and thereby eliminate the basic physical phenomena that cause flicker at low frame frequencies, it would be necessary that the luminescence remain constant for the time of scanning a whole frame. Of course in order to have a minimum of smear when the subject of the transmitted picture moves or changes, it is necessary that the light instigated by scanning each area of each frame be spent before the same area is scanned in the next frame. Then, to attain the ideal elimination of flicker, the retentivity of the luminescent material should be 100 per cent for a time equal to a frame and drop immediately to zero. It is not intended to imply that any retentivity short of this ideal would not be helpful in making a low frame frequency acceptable. Neither is it to be assumed that the availability of a suitable material with such ideal retentivity would *necessarily* make a frame frequency of 15 per second acceptable.<sup>1</sup> Actually the light from luminescent materials starts decaying *immediately* upon cessation of excitation, at a relatively high rate, and then decays at a lower and lower rate, approximately following the exponential law that prevails in many natural phenomena. From the shape of the delay characteristic curve, it would seem that after each excitation the luminescent materials were impishly committed to do as little as possible to retain uniform brightness for each single frame and still doggedly determined to persist and "haunt" the following frames.

The curves presented to the Panel by H. W. Leverenz<sup>2</sup> show that the critical flicker frequency for flicker from a screen having three-fourths of its cycle "on" at a uniform level and one-fourth of its cycle "off" is only 13 per cent higher than for a screen having one-fourth of its cycle "on." Then it is evident that a really high degree of retentivity is required to make a significant contribution toward reduction of flicker. In other words, the time of each frame must be "filled up" with essentially uniform brightness. Interpreted practically, this means that unless the decay curve can be radically changed in

<sup>1</sup> The effect of continuous motion must be retained by a reasonably high frame frequency.

<sup>2</sup> Curves showing "Critical Flicker Frequency in c.p.s. vs. Ratio of Light Phase to Period" in paper titled Cathodeluminescence as Applied to Television by H. W. Leverenz of RCA Manufacturing Company, Inc. Paper presented to Panel 7 of N.T.S.C.

shape, the "hangover" of any frame into the succeeding frames will be objectionable if the retentivity is made adequate to allow an appreciable reduction in repetition rate. It therefore would seem illogical to adopt television standards that depend for proper utilization upon any discovery as unlikely as that of a satisfactory long-retentivity luminescent material.

This review will be found to support the recommendation for a 30/60 scanning rate, partly because the 60-c.p.s. field frequency divides a whole number of times into the power frequency most used in this country. The advantage of this relation can be shown best by studying the weakness of a system that does not have this relation, namely, the 24/48 system. The objections arise because the 60-cycle power and 120-cycle harmonics of the power circuit inadvertently get into the television system. This cross talk, which would be called "hum" in audio circuits, will be called "ripple" here. The ripple voltages enter the television circuit through the *B* supply and the high-voltage anode supply. The effect of ripple is also impressed directly upon the cathode-ray transmitting and receiving tubes by stray electric and magnetic fields arising from heater wiring, power transformers in the television power supplies, and outside electric appliances and circuits. The ripple may simultaneously affect at the 60- and 120-cycle rates any or all of the following properties of the received picture:

1. Field deflection.
2. Line deflection.
3. Brightness produced by the beam.

Figures 53A to 53E, which are from a paper<sup>1</sup> published in 1936, illustrate the effects of ripple upon the scanning line positions for a 24/48 picture and for a 30/60 picture.

Though the figures are largely self-explanatory, it is desirable to point out the major difference in the effect for the two different field-scanning rates. As an example, in the case of the 24/48 picture, it is shown in Fig. 53B that the spurious horizontal displacement is different for various scannings of lines that should ideally occupy the same location. (It is explained that each two of the pairs of lines marked 1 and 3, 4 and 2, and 3 and 1, respec-

<sup>1</sup> Kell, R. D., A. V. Bedford, and M. A. Trainer, Scanning Sequence and Repetition Rate of Television Images, *Proc. I.R.E.*, **24** (4), 559-576 (April, 1936).



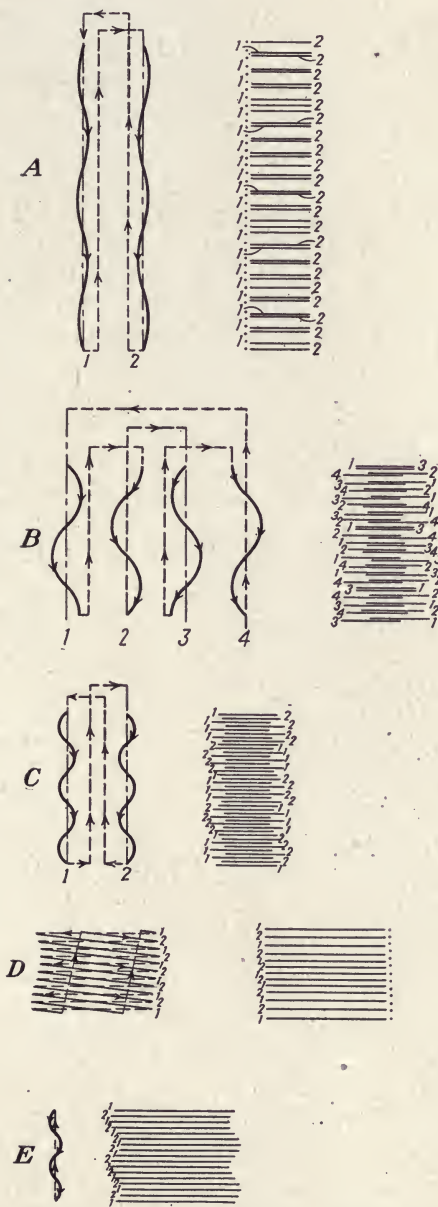

FIG. 53.—Effects of 120-c.p.s. ripple voltage on scanning-line positions, taken from Kell, Bedford, and Trainer. (A. V. Bedford.)

tively, actually coincide in the portions where they overlap but were drawn slightly separated so that their horizontal positions could be shown.) Each pair of lines (such as 4 and 2) would contain identical variation of light, which should coincide, along their length (assuming for the present that the picture subject to be transmitted is stationary). Since a complete cycle of scanning including the spurious deflection occurs in  $\frac{1}{12}$  sec., eyes cannot shift fast enough to make the light variations register on the retina.<sup>1</sup> Hence it is evident that blurring of the picture in the horizontal direction would occur. If the relative shifting between the two lines were as much as 25 per cent of the scanning-line pitch, it is estimated that the average horizontal resolution would be lowered by an amount sufficient to offset the calculated gain of 12 per cent horizontal resolution, which was ideally attained by changing from a 30/60 to a 24/48 rate.

Figure 53D shows the horizontal shifting of lines by 60-cycle ripple for a 30/60 picture. It is noted that no faulty registration is obtained because the spurious displacement is identical for each vertical deflection cycle. If, for example, the relative spurious deflection were 25 per cent of the line pitch, there would be a fixed sinusoidal distortion of the received picture, which would amount to about 0.0042 in. between the positive and negative extremes for a picture 10 in. wide. From experience, it is known that a distortion of the scanning pattern of ten or twenty times this amount is scarcely noticeable if it is fixed (as when the transmitter and receiver power supplies are synchronous) and is not objectionable even if it drifts as much as 1 cycle per second owing to nonsynchronous power supplies.

Thus, for 24/48 scanning, it would require the ripple to be reduced to one-tenth or one-twentieth the value that is acceptable for 30/60 to just break even in useful resolution. The cost of obtaining and maintaining even this reduction of ripple in the receivers, cameras, transmitters, and relays would be an appreciable handicap to television.

Figures 54 to 60 are extracted from a paper<sup>2</sup> by E. W. Engstrom relating to tests he conducted on flicker. Figures

<sup>1</sup>If the eye followed or attempted to follow the spurious shifting, the muscular fatigue would probably be unbearable.

<sup>2</sup>Engstrom, E. W., A Study of Television Image Characteristics—Part Two, *Proc. I.R.E.*, **23** (4), 295-310 (April, 1935).

56 to 60 show the data for "just noticeable flicker" taken with a special film and projector arranged to simulate the exponential decay of light. Figure 57 shows the exponential light-transmitting characteristic of the various types of film used (illustrated in Fig. 56). (The variation of light with respect to distance

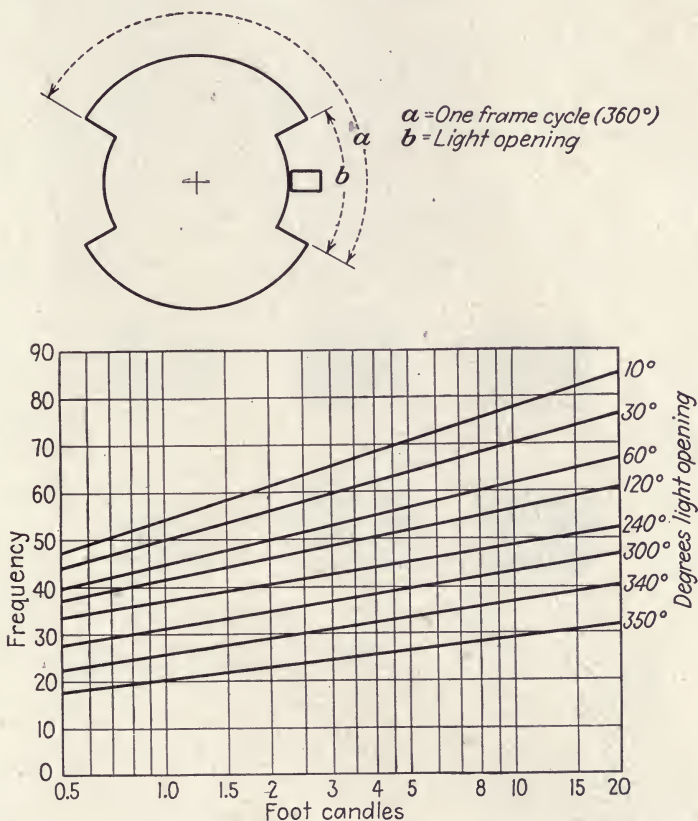

FIG. 54.—Conditions for just-noticeable flicker, with sector disk test, taken from E. W. Engstrom. (A. V. Bedford.)

shown in Fig. 57 became a change with respect to time when the film was passed uniformly through a gate.) Curve A of Fig. 59, which is for 10 foot-candles of average screen illumination, indicates that 44 fields per second are required for a luminescent material that would require the time of two fields for the light to decay to 1 per cent of its initial value. The "two field" is

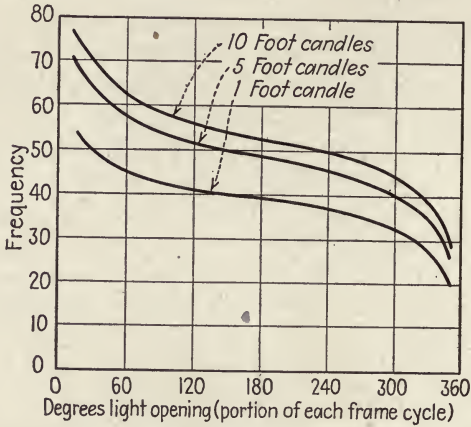

FIG. 55.—Degrees opening of sector disk vs. frequency for just-noticeable flicker. (A. V. Bedford.)

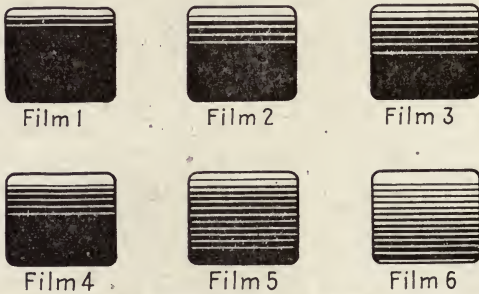

FIG. 56.—Sample frames of special films for flicker tests. (A. V. Bedford.)

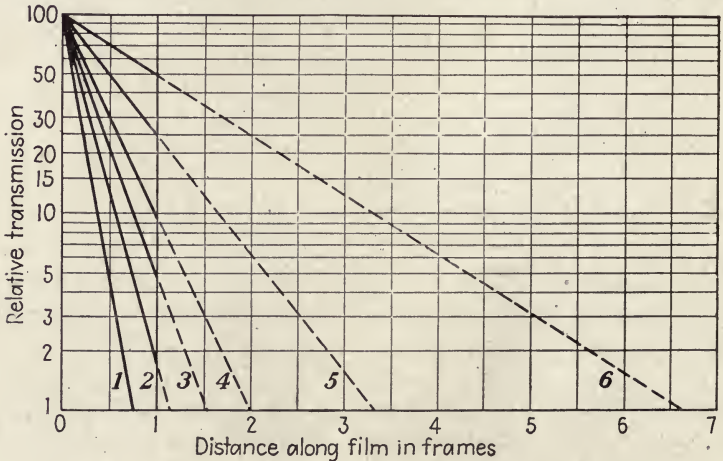

FIG. 57.—Characteristics of the special films. (A. V. Bedford.)

significant in that it is the time for transmission of one frame in interlaced scanning. The "1 per cent" remaining value of light is a value that is considered to have negligible effect. Hence

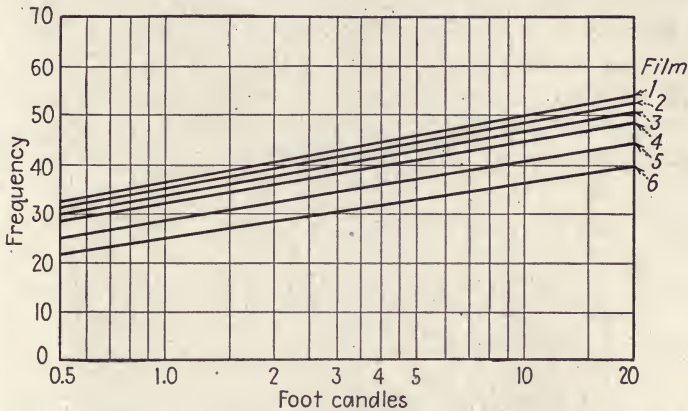

FIG. 58.—Conditions for just-noticeable flicker, with special film test, frame frequency vs. brightness. (A. V. Bedford.)

it might be considered that such a television picture with 44 fields per second would not have a serious hangover and that it would not flicker at this reasonable value of screen brightness.<sup>1</sup>

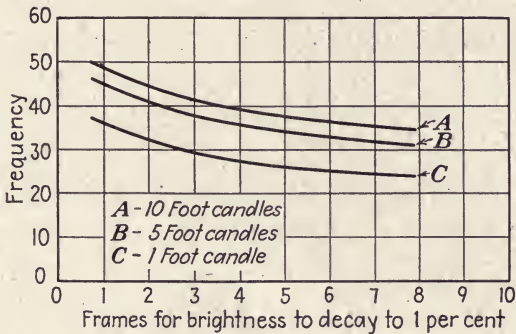

FIG. 59.—Same as Fig. 55, but frequency vs. number of frames required for brightness decay to one per cent. (A. V. Bedford.)

There is no number for the field frequency between 30 and 60 which has a favorable relation to the 60-cycle power supply.

<sup>1</sup> Other tests by Engstrom using a kinescope with willemite luminescent material indicated the need for 50 fields at 20 foot-candles for "just noticeable flicker."

Furthermore the requirement for even an exponential decay luminescent material having the desired time of decay to eliminate flicker might offer serious restrictions to tube development. It is also considered desirable and likely that pictures of the future will be much brighter (for use in well-lighted rooms) and so tend to increase the flicker.

Any increase in the frame frequency up to at least 30 (with the corresponding field frequency of 60) is helpful in obtaining more satisfactory portrayal of picture subjects in motion.

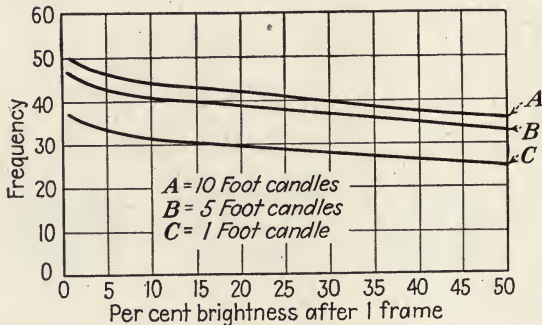

Fig. 60.—Same as Fig. 55, but frequency vs. percentage brightness after one frame. (A. V. Bedford.)

From the foregoing consideration, it is recommended that an interlaced picture with a frame frequency of 30 per second and a field frequency of 60 per second be used for television broadcasting.

#### REPORT ON FREQUENCY STABILITY OF 60-CYCLE SYSTEMS<sup>1</sup>

Inasmuch as the recommended frame and field frequencies of 30 and 60 per second are based on the 60-c.p.s. power frequency commonly available in the United States, an investigation into the stability of the power frequency in various localities was undertaken. The following brief report on the subject was compiled by G. R. Town.

#### FREQUENCY STABILITY IN TYPICAL 60-CYCLE POWER SYSTEMS<sup>1</sup>

At the first meeting of Panel 7 of the National Television System Committee, the question arose as to how much the

<sup>1</sup> Dr. George R. Town, Stromberg-Carlson Telephone Mfg. Company

frequency in typical power systems varies from the nominal value of 60 cycles. Some data relative to this matter are given in Table IV.

These data were computed from frequency-recorder charts that were kindly furnished by S. B. Morehouse of Leeds and Northrup Company. A large amount of equipment for measuring and controlling power-supply frequency is designed and manufactured under the supervision of Mr. Morehouse.

Seven records were studied. The conditions under which they were taken follow:

Chart 1.—Small isolated system under normal manual frequency control. Typical of a small municipality or large apartment house or hotel having its own power plant. Probably the worst condition that will normally be encountered.

Chart 2.—Large interconnected power system under manual frequency control.

Chart 3.—Small interconnected power system under manual frequency control (Lower Colorado River Authority System).

Chart 4.—Same system as Chart 3 but taken after installation of automatic frequency control.

Chart 5.—Large interconnected system under automatic frequency control (Ohio Power Company).

Chart 6.—Large interconnected system under automatic phase angle control (Pacific Northwest Interconnection).

Chart 7.—Moderate size isolated system under automatic frequency control. Very severe sudden changes in load (Montana Power Company).

It is believed that the data in the table are self-explanatory.

The following general information was supplied by Mr. Morehouse:

The normal base frequency in this country is 60 cycles, but there are certain sections which operate at different frequencies. The bulk of the generation in the Niagara Falls area is 25 cycles. This is tied into the 60-cycle system through frequency changer sets, but they are not of the synchronous-synchronous type. There is a considerable portion of the New York Metropolitan area on 25 cycles, but this is slowly being converted for use on industrial loads only. In the St. Louis area there is also a large bulk of 25-cycle generation. A considerable portion of the Pacific Coast is served by the Southern California Edison Company and the generation is at 50 cycles, but this is rigidly

tied in with the 60-cycle system which is under automatic frequency control so that this 50-cycle base is closely maintained. There are other scattered sections with odd frequencies such as the 30-cycle systems in Minnesota, but fortunately these serve a limited area.

TABLE IV.—VARIATION OF FREQUENCY IN TYPICAL 60-CYCLE POWER SYSTEMS

Chart number	Length of record, hours	Average frequency, cycles	Maximum frequency, cycles	Minimum frequency, cycles	Standard deviation $\sigma$ , cycles	Average range of frequency over 1-hr. period, cycles	Frequency limits, cycles, relative to average, exceeded	
							50% of time	10% of time
1	5½	60.27	60.82	59.66	0.22	0.85	±0.15	±0.36
2	5¾	60.01	60.23	59.82	0.07	0.28	±0.05	±0.11
3	5	60.02	60.21	59.89	0.05	0.21	±0.03	±0.08
4	4	60.00	60.06	59.88	0.03	0.12	±0.02	±0.03
5	22	60.00	60.09	59.91	0.03	0.12	±0.01	±0.03
6	10	60.0	60.3	59.5	0.10	0.40	±0.07	±0.16
7	10	60.0	60.75	59.35	0.24	0.92	±0.16	±0.38

#### THE NUMBER OF LINES PER PICTURE PERIOD

The Panel action regarding the number of lines in the standard television picture was a recommendation that the figure be set at 441. The vote on this standard in the Panel was 13 to 3 (5 absent). One minority opinion favored 525 lines, one an adjustable number of lines, and the third had "a slight preference for 495 lines."

The majority opinion, to quote the panel report, was based on

(1) the optimum use of the channel bandwidth to provide essentially equal horizontal and vertical resolution; (2) the cost of a receiver for 441 lines as compared to one for a higher number of lines is somewhat lower due to the lower requirements of the line scanning system and power supply; (3) the cost of the receiver for 441 lines may be reduced by reducing the bandwidth without suffering as rapid degeneration as in a system using a larger number of lines. (Since the saving in cost is small, some of the members felt that this point should be neglected.)



(4) while the number of lines might be increased to something over 500 lines without an appreciable reduction in detail under favorable conditions, the effect of echoes which degrade the horizontal detail without affecting the vertical detail makes it desirable to reduce the number of lines; and (5) while the higher number of lines makes the line structure less noticeable, in the judgment of the majority the best over-all compromise between the first four and the fifth item above leads to the selection of 441 lines.

This recommendation was tentatively approved by the National Committee in its progress report to the FCC. But in the final report of the National Committee, the recommendation was for 525 lines. The minutes of the National Committee reveal the reasons stated by the members for the change. The statement by J. V. Hogan is typical. The minutes record that

Mr. Hogan stated that he had previously voted for 441 lines believing this to give an adequate television picture; and that while he still believes this to be the case he had changed his vote on the basis of his own experience and that of the Bell Telephone Laboratories with respect to the relative horizontal and vertical resolution, and on the basis that 525 lines is slightly preferable with respect to line structure.

The experience of the Bell Telephone Laboratories, referred to in the above statement, was revealed by M. W. Baldwin, Jr., a member of the Panel, in his paper *The Subjective Sharpness of Simulated Television Images*, which was submitted to the Panel and later published in the *Bell System Technical Journal*. Since this paper has been published, a brief résumé is given here, consisting of the Introduction and Summary, and the Exposition of the Method, with the principal figures. This paper had a great effect on the judgment of the members of the National Committee, since it showed that, with pictures having a quality comparable to present-day television images, the relative degree of horizontal and vertical resolution could be varied over a considerable range without loss of the apparent picture quality.

## THE SUBJECTIVE SHARPNESS OF SIMULATED TELEVISION IMAGES<sup>1</sup>

### INTRODUCTION AND SUMMARY

Of the many factors that influence the quality of a television image, the one that is generally indicative of the value of the

<sup>1</sup> M. W. Baldwin, Jr., Bell Telephone Laboratories, Inc.

image and the cost of its transmission is the resolution, or sharpness. This resolution factor has always been reckoned in purely objective terms, such as the number of scanning lines or the number of elemental areas in the image or the width of the frequency band required for electrical transmission at a given rate. The subjective value of sharpness has not previously been considered. Some recent tests with a small group of observers, using out-of-focus motion pictures in a basic study of the visual requirements on images of limited resolution, have thrown new light on the evaluation of resolution and sharpness. The results appear of sufficient interest, particularly when interpreted in terms of television images, to warrant this presentation. The word "sharpness" will be used in the sense of a subjective or psychological variable, with a strict technical significance in keeping with our experimental method, and the word "resolution" will be used in the sense of an objective or physical variable.

As images become sharper, their sharpness increases more and more slowly with respect to the objective factors, and the need for equal resolution in all directions becomes less and less. With images of present television grade, the tolerance for unequal horizontal and vertical resolutions is already remarkably wide. These conclusions are supported by our experiments with small-sized motion pictures viewed at a distance of 30 in., about four times the picture height. Since the visual acuity may be expected to increase somewhat for viewing distances greater than 30 in., we infer that our conclusions may be applied only qualitatively to the case of larger sized pictures.

#### EXPOSITION OF METHOD

Image sharpness is to be measured by subjective test, employing psychometric methods that have been used widely in the measurement of other subjective values. Test images are to be projected onto a screen from 35-mm. motion-picture film in such a way that the resolution of the image can readily be varied over a substantial range, and with provision for making the horizontal resolution different from the vertical. The use of motion pictures instead of actual television images permits sharpness to be studied independent of other factors and facilitates the experimental procedure.

The relationship between the television image and the motion picture that simulates it will be determined on the basis of their subjective equality in sharpness. For that purpose, a television image reproduced by an apparatus<sup>1</sup> of known characteristics is to be compared with a projected out-of-focus motion picture of the same scene, under the same conditions of size, viewing distance, brightness, and color. (The motion picture will in general be superior in the rendition of tone values and in respect to flicker and will of course not show the scanning-line structure

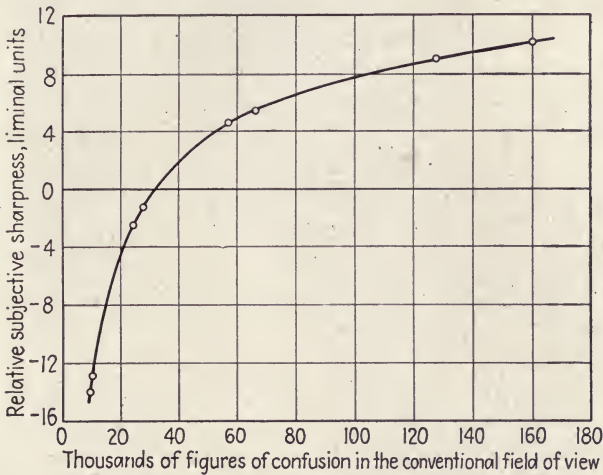

FIG. 61.—Sharpness of motion pictures as a function of resolution. The conventional field of view is a rectangle whose height is  $\frac{1}{4}$  the viewing distance and whose width is  $\frac{4}{3}$  the height. Reference sharpness is approximately that of a 240-line, 24-frame per second, 806-kc television image. Curve based on 270 observations at a viewing distance of 30 in. (*M. W. Baldwin, Jr.*)

of the television image or any of the degradations commonly encountered in electrical transmission.) When the two images are judged to be equally sharp by the median of a group of observers, the size of the figure of confusion of the motion picture is to be taken as the measure of the resolution of the compared television image.

The figure of confusion of the motion picture is that small area of the projected image over which the light from any point in the film is spread. Every point produces its own figure of confusion,

<sup>1</sup> The television apparatus comprised a mechanical film scanner and an electronic reproducing tube designed specifically for television.

of proportionate brightness, and the overlapping of the figures in every direction accounts for the loss of sharpness. When the projection lens is "in focus," the figure of confusion is a minimum one set by the aberrations of the optical system and by diffraction effects. As the lens is moved away from the "in-focus" position, the figure of confusion becomes larger and assumes the shape of the aperture stop of the projection lens. If the illumination

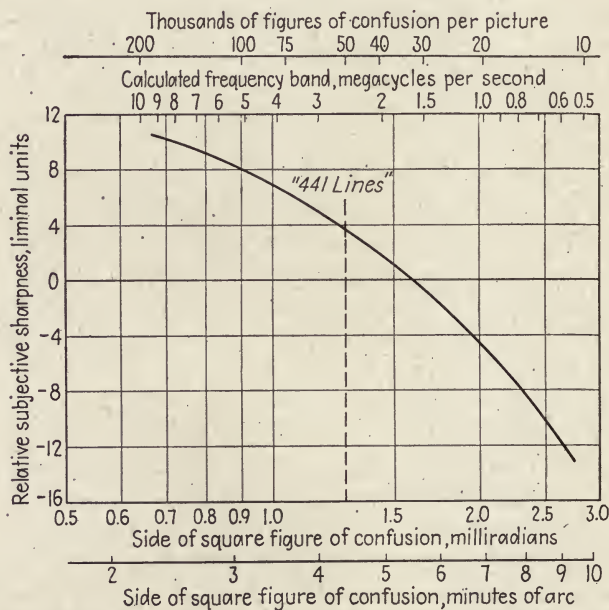

FIG. 62.—Sharpness of motion pictures at a viewing distance of 30 in. The frequency band is calculated on the basis of a 10- by 7½-in. television picture, 30 frames per second, with 15 per cent horizontal and 7 per cent vertical blanking, under condition of equal vertical and horizontal resolutions. (M. W. Baldwin, Jr.)

of the aperture stop is uniform, this larger figure of confusion is a well-defined area of uniform brightness. A rectangular aperture stop, at the projection lens, whose height and width could be varied reciprocally so as to maintain constant area of opening, and a calibrated microscope to measure the departure of the lens from the "in-focus" position were used in the test. Thus images of various degrees of sharpness and of unequal horizontal and vertical resolutions could be produced.

This method of specifying the resolution of an image in terms of the size of the figure of confusion affords an important advantage. It avoids the necessity for postulating any particular relation between the resolution and the spatial distribution of brightness values about originally abrupt edges in the image. The variety of such relations assumed by others has led to a variety of conclusions with respect to resolution in television. Subjective comparison of images has been found to yield results of fairly small dispersion.

Consider now the measurement of sharpness in subjective terms. Here are no familiar units of measurement, no scales or meters, and no agreement as to the meaning of a statement that one image looks twice as sharp as another. It can be said of two images only that (1) one image looks sharper than the other, or (2) the two images look equally sharp. When the images are quite different, there will be agreement by a number of observers that the one image is the sharper. When the images are not different in sharpness, there may be some judgments that one of them is the sharper, but these will be counterbalanced in the long run by an equal number of judgments that the other is the sharper. When the images are only slightly different in sharpness, an observer may reverse his judgment from time to time on repeated trials, and he may sometimes disagree with the judgment of another observer. It is within this region of small sharpness differences, in the interval of uncertain judgments where the observer is sometimes right and sometimes wrong with respect to the known objective difference, that it becomes possible to set up, on a statistical basis, a significant quantitative measure of sharpness difference.

Suppose that, in judging two images of almost equal sharpness, the observers have been instructed to designate either one or the other of the images as the sharper; *i.e.*, a judgment of "equally sharp" is not to be permitted for the present. An observer who discerns no difference in sharpness is thus compelled to guess which image is sharper, and his guess is as likely to be right as it is to be wrong, with respect to the known objective difference. Suppose, further, that the sharpness difference has been made so small that only 75 per cent of the judgments turn out to be right, the remaining 25 per cent being wrong. On the basis that these wrong judgments are guesses, we must pair them off with an

equal number of the right judgments, so that 50 per cent of the total are classed as guesses. The other 50 per cent are classed as real discriminations. (The pairing of an equal number of the right judgments with the wrong judgments goes back to the equal likelihood of right and wrong guesses; it affords the best estimate we can make of the number of guesses.) When real discrimination is thus evidenced in one-half of the observations,

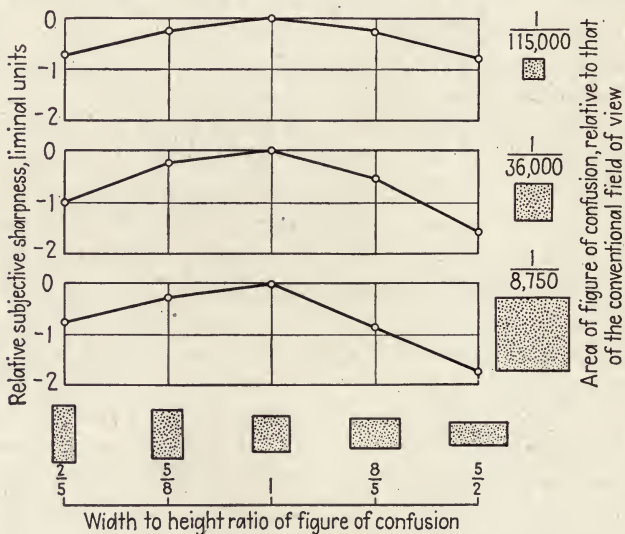

FIG. 63.—Sharpness of motion pictures as a function of the relative values of horizontal and vertical resolution. Field of view as in Fig. 61. Each point represents 150 observations at 30 in. (*M. W. Baldwin, Jr.*)

*i.e.*, when 75 per cent of the judgments are right and 25 per cent of them are wrong, the difference in resolution will be designated as the *difference limen*.<sup>1</sup>

It is seen that the value of the limen is arrived at statistically, taking into account the variability of individual judgments. Differences smaller than the limen are not always imperceptible, nor are larger differences always perceptible.

<sup>1</sup> The term "limen" is frequently used in psychometry in lieu of older terms such as "just-noticeable-difference," "threshold value," "perceptible difference," etc. It has the virtue that its meaning may be precisely defined in terms of the particular experimental method under consideration, without the extraneous significance that might attach to the more commonplace words.

The difference in sharpness, or in sensory response, which corresponds to a difference of one limen in resolution may be said to be one unit on the subjective scale of measurement. This may be called a *liminal unit*.<sup>1</sup> It will be understood that the word liminal has here a particular and precise significance, by reason of the one to one correspondence between the liminal unit and the statistically derived value of the difference limen. A liminal unit of sharpness difference may be considered as the median of a number of values of sensory response to a difference of one limen in resolution.

### REPORT RECOMMENDING THE VALUE OF 525 LINES

After the meetings of Panel 7 were formally closed, and following the progress report meeting before the FCC, Dr. Baker requested D. G. Fink to prepare a brief summarizing the relative desirability of 441 lines and 525 lines. This brief, which became a part of the record of the National Committee, is included here as a summary of the factors that underlie the choice finally made by the National Committee. Other papers on the subject of image quality, prepared by the panel members, have appeared in the periodical literature.

### THE RELATIVE UTILITY OF 441 LINES, 495 LINES, AND 525 LINES AS STANDARDS FOR TELEVISION IMAGES<sup>2</sup>

**1. Introduction.**—Examination of the proceedings of the panels of the N.T.S.C. reveals that the choice of the number of lines per frame is one of the standards on which some degree of disagreement exists, between members of panels and between the panels themselves. Panel 7, to which the matter was specifically assigned, voted finally 13 to 3 in favor of 441 lines. Panel 1, in an informal vote, showed a preference for some number above 500 lines by a vote of 6 to 3. Panel 2, in a unanimously approved report, gave indirect support to a value in the neighborhood of 550 lines, basing this finding on purely subjective con-

<sup>1</sup> There seems to be no accepted name for such a unit. Guilford calls it simply "a unit of measurement on the psychological scale." In discussing the measurement of sensory differences that are equal to each other but not necessarily of liminal size, the terms "sensory value" and "scale value" have been used.

<sup>2</sup> Donald G. Fink, McGraw-Hill Publishing Company, Inc.

siderations. At the meeting before the FCC on Jan. 27, this divergence of opinion prompted the commissioners to question the panel chairman at some length concerning the desirable number of lines. As a result, this standard is one that the writer believes should be reconsidered before the N.T.S.C. makes its final recommendations.

**2. Purpose.**—This brief examines the factors that must be considered in arriving at the most satisfactory compromise. The conclusion reached is that the value of 525 lines is a better choice than 441 lines.

**3. Basic Factors Affecting Image Quality.**—The experience of television engineers has indicated that the most important factor affecting the quality of television images is the width of the communication channel employed. Next in importance are the photographic quantities of brightness, contrast range, and tonal gradation, all of which are largely independent of the standards used and hence are not considered here. The question of the relative degree of resolution available in the horizontal and vertical directions is a matter of secondary importance over rather wide limits, as the statistical studies carried out by the Bell Telephone Laboratories have shown. Other factors include the rigidity of the synchronizing performance of the system; the type and sharpness of channel cutoff; the shape of, and distribution of energy in, the scanning spots in camera and picture tubes. Factors often cited as affecting the quality of the image are the conditions of viewing the image, such as viewing distance relative to the picture size, the viewing angle, and ambient illumination. It is clear that these factors, though important, do not affect the inherent quality of the image. They simply indicate the degree to which the inherent quality of the image may be appreciated by the viewer.

**4. Aspects of Image Quality Affected by the Number of Lines per Frame.**—When the width of the communication channel and the number of frames per second have been established, the choice of the number of lines affects the inherent image quality in only two ways, *i.e.*,

*a.* The relative degree of resolution in the vertical and horizontal dimensions.

*b.* The space between the lines, for a given spot size in the picture tube, relative to the picture height.



In general, as the number of lines is increased, using a given channel width and given number of frames per second, (1) the vertical resolution increases in proportion, and the horizontal resolution decreases in inverse proportion; and (2) the space between the lines decreases in inverse proportion.

**5. Aspects of Signal Utilization Affected by the Number of Lines.**—As the number of lines is increased, the displacement between the true image and any ghost image that may be present, owing to reflections, is increased in proportion. Thus a signal mixed with reflections may be better utilized with a low number of lines because the image and the ghost images may not be so clearly visible as separate entities.

As the number of lines is increased, the necessity for employing the full width of the communication channel is emphasized. Increasing the number of lines lowers the horizontal resolution, and any curtailment of the channel width further reduces the horizontal resolution. If both reductions occur at once, the horizontal resolution may be lowered to the point where a definite degradation of picture quality occurs, beyond that due to the curtailment of bandwidth.

**6. Apparatus Characteristics Affected by the Number of Lines.** As the number of lines is increased, for a given number of frames per second, the line-scanning frequency increases in proportion. When electric deflection is employed, no substantial increase in horizontal-scanning generator power is entailed. When magnetic deflection is employed, the horizontal scanning power for a given deflection system increases approximately as the first power of the line-scanning frequency (assuming a high  $L/R$  ratio in the scanning coils). The peak scanning voltage likewise increases with the first power of the line-scanning frequency.

As the number of lines increases, the amount of frequency division required in the synchronizing-signal timing system increases, but this is not an important factor, provided that the number of lines chosen is not composed of large integral factors. The number of lines chosen should be composed of as small a number of small odd integral factors as possible.

When the number of lines is increased, the speed of horizontal scanning motion is increased in proportion, for a given number of frames per second. Hence the distribution of light along and across the line is thereby affected to a secondary degree. The

total amount of light on the screen is not affected, however, for a given accelerating voltage, beam current, and phosphor conversion efficiency.

**7. The Relative Importance of Image Quality, Signal Utilization, and Apparatus Limitations.**—In evaluating the relative importance of the effects noted in 4, 5, and 6 above, it is necessary, first, to have a sound philosophy concerning the functions of standardization. In the opinion of the writer, the basic principle governing the setting of standards is that they should not limit, any more than is absolutely necessary, the future progress of the art. The corollary to this principle is that standards should be set up, insofar as possible, in terms of unchanging fundamentals, *i.e.*, standards should not be set up in terms of temporary conditions or restrictions that are amenable to improvement. For example, our present inability to utilize the full width of the communication channel in any except expensive receivers is a temporary condition. It should not be given primary consideration in the setting of standards. Moreover, the effect of signal reflections, although admittedly a matter of greater difficulty, is still a matter of utilizing the signal, and it can be improved by research into antenna structures. The physiological and psychological aspects of human vision, however, cannot be changed.

Accordingly, the fundamental physiological and psychological aspects of picture quality should be given first consideration, since these fundamentals are unchanging. The degree to which the signal is utilized should be considered secondarily, because this is a matter affecting the utility of the public investment in equipment, which must be viewed from the long-range point of view, even though the investment is renewed and enlarged as time goes on. The apparatus limitations should take third place, because they are amenable to direct improvement through research and engineering, within a period short compared to the life of the public investment in equipment.

Accordingly, it is evident that the factors of vertical vs. horizontal resolution and the visibility of line structure deserve first consideration. The visibility of ghost images and the degree to which the channel width is used are secondary. Finally, the required amount of scanning power, the complexity of synchronizing-signal generators, and the distribution of light in the

scanning spot are tertiary, because they are subject to improvement through engineering development.

**8. Comparison of Suggested Numbers of Lines.**—The specific values of number of lines considered here as a basis of discussion are chosen, first, in terms of the requirement that they be factorially comprised of a small number of small odd integral factors. This requirement gives a sufficient latitude of choice so that it cannot be regarded as a restriction on the performance of the system. The six specific values between 400 and 600 lines are given in Table V.

TABLE V

Number of lines	Factors	Line frequency in percentage of that for 441 lines (13,230 c.p.s.)
405	$3 \times 3 \times 3 \times 3 \times 5$	92
441	$7 \times 7 \times 3 \times 3$	100
495	$3 \times 3 \times 5 \times 11$	112
507	$3 \times 13 \times 13$	115
525	$3 \times 5 \times 5 \times 7$	119
567	$3 \times 3 \times 3 \times 3 \times 7$	129

**9. Comparison on the Basis of Apparatus Limitations.**—Considering these values from the standpoint of apparatus limitations, the values of 495 and 507 have the disadvantage of high integral factors. Practical synchronizing timing circuits can be built, however, using frequency division as high as 13. The other values, having integral factors no larger than 7, are to be preferred so far as this aspect is concerned. When magnetic scanning is used, the higher numbers of lines require proportionate increases in scanning generator power. However, even the highest number mentioned, 567 lines, requires only 29 per cent more power than would 441 lines. Although many present receiver designs are close to the limit of the capabilities of the horizontal scanning output tubes used, there is no reason why this defect cannot be remedied in forthcoming designs. A reduction of the picture-tube second-anode voltage will suffice to restore the scanning amplitude in receivers already in the hands of the public, if insufficient margin in the horizontal scanning generators is available.

It appears, therefore, that none of the above apparatus limitations indicates a compelling advantage in any of the six values, except that a slight preference might be accorded to 441 lines and 525 lines on the score of low integral factors. The 525-line figure requires 19 per cent more horizontal scanning power than 441 lines.

**10. Comparison on the Basis of Signal Utilization.**—Comparing the six values from the standpoint of displacement of ghost images, the additional displacement is in direct proportion to the increase in horizontal scanning velocity, *i.e.*, the same percentages shown for line frequency in the table above. For example, if the image and its ghost are displaced one spot width with 441 lines, they will be displaced 1.19 spot width for 525 lines. It is extremely improbable that this increase in displacement could affect the appearance of the image to any serious degree except when viewing a test pattern and then only in the region of greatest image definition. If the additional displacement is to be discerned by the eye, the viewing distance must be one-sixth ( $0.19/1.19$ ) of that which will reveal the spot width itself. Although the writer has not viewed demonstrations of this effect, it would appear, from theoretical considerations at least, that its importance has been greatly exaggerated.

Concerning the utilization of the full channel width, the several values of numbers of lines should be compared on the basis of their effect on horizontal resolution. If 441 lines is taken as the basis of comparison, a change to 525 lines increases the vertical resolution by 19 per cent and decreases the horizontal resolution by 16 per cent ( $1/1.19$  of its value at 441 lines). This percentage reduction in horizontal resolution would be equaled by a reduction in width of the channel from 4.0 to 3.36 Mc. However, the utilization of the channel width in the cheaper receivers now amounts to about 2.5 Mc, which would reduce the horizontal resolution by some 37.5 per cent relative to the value available at 4.0 Mc. It thus appears that the reduction in horizontal resolution due to increasing the number of lines is small compared to that commonly encountered due to curtailment of bandwidth.

It still remains a fact that the sum of the reductions in horizontal resolution due to both increasing the number of lines and curtailing the bandwidth may produce a serious loss of picture

quality, since the sum of the two percentages calculated above for 525 lines and 2.5 Mc (16 and 37.5 per cent) exceeds the range of tolerance over which the resolution ratio has a second-order effect on picture quality.

This is the first serious objection to increasing the number of lines thus far uncovered in this discussion. Here, however, the writer believes the matter should be decided not on the basis of present apparatus limitations but on the basis of probable future accomplishments. If the number of lines remains at 441 lines, the cheaper receiver of the present day will undoubtedly be favored. But at the same time, the urge to improve the cheap receiver of today will be limited by the fact that there is not so much to be gained by increasing the width of the communication channel employed.

Moreover, it is not consistent standardization policy to determine one standard (the number of lines) on the basis of 2.5 Mc, or any other value lower than 4.0 Mc, when another standard specifically defines 4.0 Mc as the maximum unattenuated video frequency. It would seem to make much better sense to standardize on the basis of 4.0 Mc, admitting that this penalizes the cheap receiver of today and then turn to the job of improving the cheap receiver tomorrow, until it is fully capable of doing as well as the expensive receiver of today. This competitive process of improvement is almost inevitable if the door is left open for such improvement.

**11. Comparisons on the Basis of Image Quality.**—We come finally to the most basic comparison, that relating to the influence of the number of lines on inherent picture quality. The basic consideration is the relative degree of horizontal and vertical resolution. Before this matter can be discussed, the ratio between the vertical resolution and the number of lines in the picture must be established. Opinions on this ratio vary greatly, from perhaps 0.5 for a poor picture tube to perhaps 0.9 on an excellent picture tube under conditions obtaining in a monitor circuit. The value depends greatly on the perfection of interlacing (synchronization) and on the scanning spots employed. Personal observation of the writer has indicated substantially perfect vertical resolution up to 350 lines on the monitor screens of the National Broadcasting Company System. The number of active lines (441 less those blanked) in this case was 414 lines.

A later personal observation indicated resolution up to 370 lines before the wedge structure breaks up completely. This is an observation of a monitor image under substantially ideal conditions and may be taken as close to the best possible performance for a 441-line image. R-f transmission and reception lower the ratio to  $350/414 = 0.845$  and possibly to  $300/414 = 0.725$  or lower. Assuming resolution vertically to be equal to 0.8 of the number of lines gives a figure of  $414 \times 0.8 = 331$ , which is believed by the writer to be conservative. If the number of lines is increased to 525 lines, on a comparable basis the number of active lines is 492. The vertical resolution is  $492 \times 0.8 = 394$  lines. As a final case, if 495 lines is taken as the standard number of lines per frame, on a comparable basis the vertical resolution is  $465 \times 0.8 = 372$  lines.

The desirable relation of the horizontal resolution to the vertical resolution is that they should be equal. Although the Bell Laboratories studies have shown that the two resolutions may be unequal over rather wide limits, before picture quality is degraded, these limits extend approximately equally above and below the condition of equal resolution. Thus the sound basis for standardization purposes is that the resolutions in the two directions be made the same. No arguments for any other procedure, except those of expediency involving present apparatus limitations, have come to the attention of the writer. Accordingly the horizontal resolution is here taken equal to the vertical resolution for the three values of numbers of lines.

The fundamental video frequency resulting from the scanning of alternate black and white picture elements is equal to half the number of elements divided by the time of scanning them. The number of elements per line is equal to the horizontal resolution times the aspect ratio. The time of scanning the line is equal to the period of the line-scanning frequency, less the time during which the spot is blanked (0.14 per cent minimum according to N.T.S.C. standard 15). Using these quantities for calculation, Table VI reveals the highest fundamental video frequency associated with the values of 441, 495, and 525 lines.

The values in col. (VI) of Table VI are to be compared with the video bandwidth actually available, according to N.T.S.C. standard 4. This standard specifies unattenuated sidebands to a point 4.0 Mc from the carrier, and fully attenuated signal

at 4.5-Mc separation. Midway between these two limits, at 4.25 Mc, the signal amplitude may be expected to have useful amplitude.

The extent to which this useful signal amplitude may be used is governed by the permissible degree of oscillatory overshoot that results from employing a sharp cutoff at the channel edge. In the writer's opinion, standardization is best served by using the channel width to the utmost, even at the expense of a high degree of overshoot, because channel width is the most precious

TABLE VI

(I)	(II)	(III)	(IV)	(V)	(VI)
Number of lines per frame	Line frequency at 30 frames per second 30(I) c.p.s.	Vertical and horizontal resolution lines	Picture elements per line $\frac{4}{3}$ (III)	Active scanning time per line $\frac{1 - 0.14}{(II)}$ microseconds	Maximum fundamental video frequency $\frac{1}{2} (IV)/(V)$ Mc/s
441	13,230	331	441	65	3.38
495	14,850	372	495	58	4.27
525	15,750	394	525	55	4.78

quantity in the system. Moreover, a gradual cutoff can be used, thus reducing the overshoot, without destroying the ability of the system to reproduce, at reduced contrast, detail corresponding to sideband frequencies at the channel limits.

From this point of view, the value of 495 lines is to be preferred, as offering the closest approach to equality in horizontal and vertical resolution within the given channel limits. Next in order of preference is 525 lines (0.53 Mc in excess of 4.25 Mc), and finally 441 lines (0.87 Mc less than 4.25 Mc).

It should be remarked that these conclusions are based on the use of a horizontal resolution equal to 0.8 of the number of active lines, which is a conservative figure. If either the value recommended some years ago by Engstrom (0.64) or the value later derived by Wheeler and Loughren (0.7) had been used, the order of preference would then be 525 lines, 495 lines, and 441 lines, all other considerations remaining the same. The maximum fundamental video frequency [col. (VI) above] for 525 lines with the Wheeler and Loughren figure, for example, is 4.16 Mc.

In no case does 441 lines satisfy the criterion of equal vertical and horizontal resolution, unless a bandwidth considerably less than 4.0 Mc is assumed, which as previously stated is inconsistent with the other standards.

The final consideration affecting picture quality is the appearance of the line structure of the image. Here, again, the degree of difference in line separation involved between the figures 441 and 525 is 19 per cent, or approximately one-fifth, of the line pitch. Although this is a small amount, it may have an important effect on the uniformity of the field of illumination presented by the scanning lines, since, in general, the dark space between lines in a typical well-focused picture tube is small compared to the line width itself. To cite an ideal case, if the lines have a uniform distribution of light and are separated by a space equal to one-fifth the line separation, the line structure would be visible at a distance of roughly twice the picture height, at 441 lines. At 525 lines, on the same basis, the line structure would not be visible at all, since the decrease in line spacing would bring the lines perfectly adjacent and a flat field of illumination would result.

The desirability of obtaining a flat field is not widely appreciated among set owners, inasmuch as most users of television receivers adjust the focusing control to make the lines appear sharpest, rather than to obtain the most nearly uniform field of light. The nonuniformity of field thus incurred may have a very detrimental effect on the vertical resolution, since the spurious patterns ("beads") analyzed by Mertz and Gray are very much aggravated when there is an appreciable space between lines.

Increasing the number of lines has the advantage that, with a scanning spot focused to a width smaller than the line pitch, the flatness of field is improved by decreasing the distance between the lines. In the last analysis, spot width, line pitch, and flatness of field are matters primarily of apparatus development. In a properly designed receiver, the scanning spot should not be focusable to a width much smaller than the line pitch. Moreover, when greater control is established over the distribution of energy within electron beams, it seems likely that a flat field of illumination may be obtained under conditions dictated by considerations other than spot size and line pitch.



The only conclusion to be drawn, as previously stated, is that the use of a higher number of lines permits obtaining a flatter field whenever the spot width is smaller than the line pitch. The desirability of such a small spot is, of course, dictated by the necessity of maintaining the horizontal resolution at a maximum.

**12. Summary and Conclusion.**—Of the six values of number of lines considered, 405 and 567 are discarded as being well outside the optimum range for the 30-frame-per-second and 4.0-Mc-maximum-unattenuated-signal standards. The number 507 is not considered, because it contains two large integral factors,  $13 \times 13$ , which involve difficulties in synchronizing-signal generation and because the value is not sufficiently different from 495 lines. The order of preference of the remaining three figures 441, 495, and 525 is summarized in Table VII.

TABLE VII

Number of lines per frame	Synchronizing signal generation	Equality of <i>H</i> and <i>V</i> resolution (at ratio of 0.8)	Equality of <i>H</i> and <i>V</i> resolution (at ratio of 0.7)	Flatness of field	Total
441	1	3	3	3	10
495	2	1	2	2	7
525	1	2	1	1	5

If all the factors enumerated in Table VII are considered on an equal basis, 525 lines is clearly preferable. If twice as much weight is given to the fundamental matter of relative resolution as is given to the other factors, even with vertical resolution considered as 0.8 of the number of active lines, 525 still has a slight edge. If three times as much weight is put on this item, 495 lines has the highest degree of preference.

The value of 441 lines, on the basis of the above analysis, is clearly too low. The choice between 495 and 525 lines must be made on the relative weight placed on the factors enumerated in this report. The choice between the two is close, but it would appear that 525 lines has the slight preponderance of advantage, on the technical considerations here discussed.

Accordingly it is recommended that the final recommendation of the N.T.S.C. for standard 5 should be as follows: "No. 5. The standard number of scanning lines per frame period in monochrome shall be 525, interlaced two to one."

## CHAPTER IX

### SYNCHRONIZATION OF THE PICTURE

To Panel 8<sup>1</sup> was assigned the task of considering "methods and means of accomplishing synchronization." The substance of the Panel's recommendations, with some modifications, appears in the N.T.S.C. report in the standards numbered 9, 15, 16, and 17.

Standard 9 specifies the use of either FM or AM in the television signal, either method, or both methods together, being permissible in the synchronizing-signal portion as well as in the picture-signal portion, provided only that the two portions of the signal occupy different ranges of modulation on a single carrier. This standard, as written, permits nine combinations of modulation methods, three of which are mentioned in the note appended to standard 9, and two of which have found application in commercial broadcasting since the FCC issued the standards. The two commercially used methods are (1) AM for picture signal and synchronization signal, and (2) the "alternate carrier system"—AM for the picture signal with FM and AM combined for the synchronizing signal. A third method, the use of FM for picture as well as synchronization signals, has been tested and reported on the R.M.A.-N.T.S.C. Subcommittee on Synchronization, which carried on the work of Panel 8, as outlined on page 261. The other possibilities have not been investigated actively.

Standard 15 specifies the basic synchronization waveform, but in so doing it leaves the door open to use any other waveform that will offer substantially equal performance without requiring a change in the receivers then in the hands of the public. The note appended to standard 9 mentions a second waveform, the 500-kc horizontal synchronizing pulse advocated by the DuMont

<sup>1</sup> The members of Panel 8 were T. T. Goldsmith, Jr., chairman; W. Auerbacher; A. V. Bedford; J. E. Brown; Lee DeForest; A. B. DuMont; P. C. Goldmark; P. J. Herbst; H. Hoge; A. G. Jensen; A. V. Loughren; H. R. Lubeke; R. H. Manson; K. McIlwain; R. E. Moe; A. F. Murray; J. R. Poppele; R. J. Rockwell, and D. B. Smith.

Laboratories, as one such alternative proposal. This waveform, as well as the waveform specified in Fig. 2 of standard 15, has found use in commercial broadcasting. The 500-kc waveform has, however, been used only in the a-m system, whereas the waveform of Fig. 2 has been used with AM as well as with the alternate-carrier system.

The remaining two synchronization standards, 16 and 17, specify tolerances in the frequency and rate of change of frequency, respectively, of the horizontal synchronization pulses. The principal purpose of the tolerances is to permit the use of nonelectronic (*i.e.*, mechanical) means of scanning, for large-screen television. Note *B*, appended to standard 17, calls attention to the desirability of further restricting the tolerances in the future.

**The Method of Modulation.**—The type of modulation recommended by Panel 8, for picture as well as synchronization signals, was the simple a-m system, which had received a thorough field test during several years. The alternate-carrier system (using FM as well as AM) had been proposed by Loughren some time before, but it had not been field-tested when the panel report was prepared. Accordingly the Panel voted, by a unanimous vote of the 13 members present, to recommend AM.

After the panel report had been issued, but before the N.T.S.C. drew up its final report, the Philco Corporation reported successful tests of the alternate-carrier system which indicated, in the presence of a weak received signal, more reliable synchronization than was provided by AM. On the basis of this report and demonstrations of the new system, the National Committee rewrote the standard to permit either the a-m or the alternate-carrier signals to be used. At the same time, the standard was written so as to permit FM of the picture signal as well, since laboratory tests by the RCA Laboratories had shown possible advantages in the system not offered by the other alternatives.

A standard that permits as many as nine different combinations of modulation could hardly be looked upon as a standard were it not for the fact that any of these nine possibilities could be received interchangeably on a vestigial sideband receiver that attenuates the carrier 50 per cent before detection. Since this type of receiver was in general favor and was in fact the type of receiver specifically adapted to use in connection with the ampli-

TELEVISION SYNCHRONIZING WAVEFORM

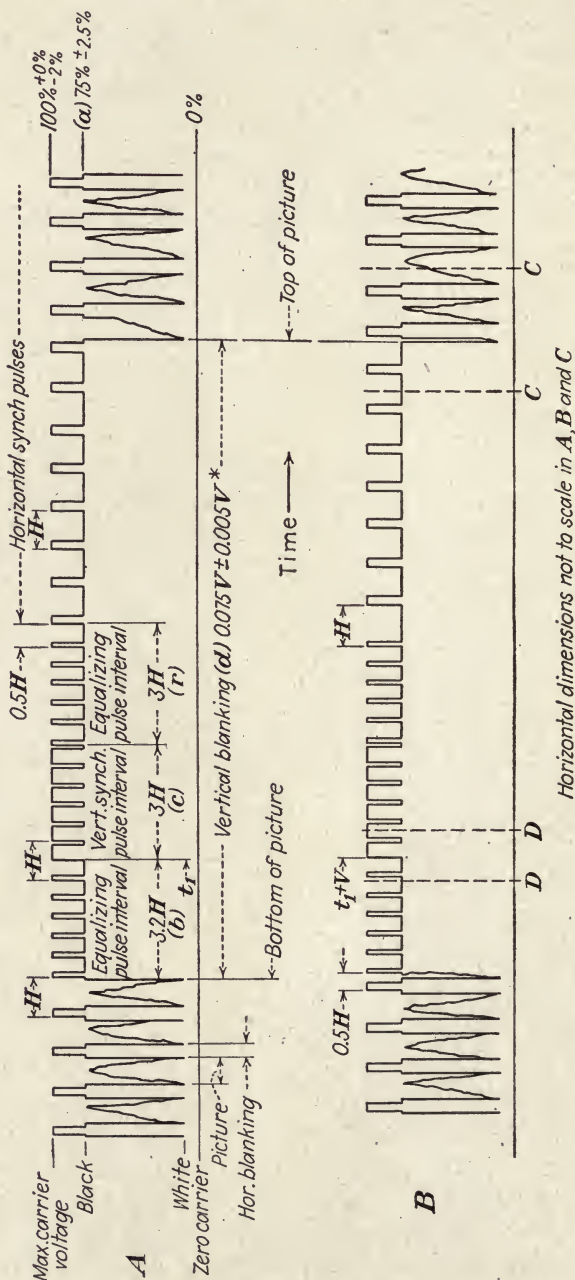

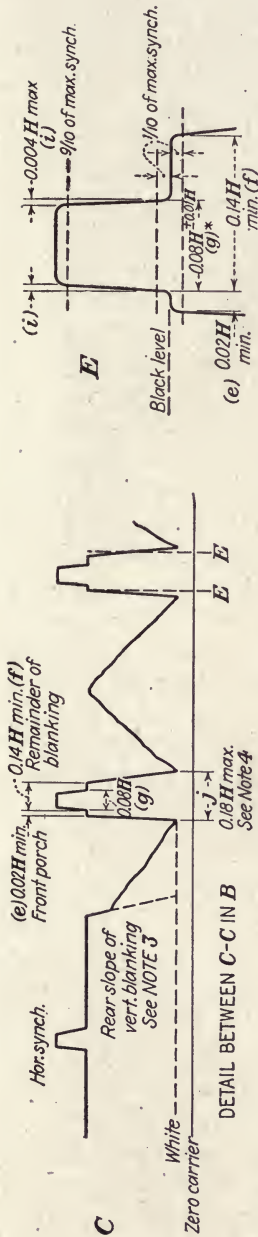

DETAIL BETWEEN E-E IN C

NOTES:

1.  $H$  = Time from start of one line to start of next line
2.  $V$  = Time from start of one field to start of next field
3. Leading and trailing edges of vertical blanking should be complete in less than  $0.1H$
4. Leading and trailing slopes of horizontal blanking must be steep enough to preserve min. and max. values (e+f) and (j) under all conditions of picture content
5. There shall be no overshoot on front or rear slopes of any pulses
- 6\* Dimensions marked with an asterisk indicate that tolerances given are permitted only for long time variations, and not for successive cycles
7. For receiver design, vertical retrace shall be complete in  $0.07V$
8. Equalizing pulse area shall be between  $0.45$  and  $0.5$  of the area of a horizontal sync pulse

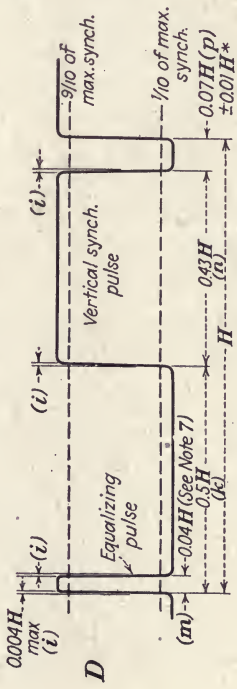

DETAIL BETWEEN D-D IN B

Fig. 64.—Television synchronizing waveform as originally proposed by Panel 8, in its final report. Substantially the same, except for minor changes in wording, as the final standard (Fig. 2).

tude characteristic of Fig. 1 in standard 4, it was deemed reasonable to permit the use of the several systems until some compelling advantage could be found for one particular system.

To aid in studying this question, following the issuance of the standards by the FCC, a subcommittee of the R.M.A. engineering department was set up particularly to follow the synchronization question. This subcommittee recorded in its minutes late in 1941 that the alternate-carrier system of synchronization displayed an annoying echo image pattern whenever the signal was received over two or more paths of different lengths. However, substantially complete eradication of the echo pattern was found to be possible when a system known as "phase switching" was used. The echo pattern associated with the use of FM for the picture signal, which was also observed by the subcommittee, was found to be incapable of removal and so troublesome that the subcommittee reported against the use of FM for the picture signal. This latter action was reported to the National Committee, but no official recommendation had been made at the time of going to press. As it stands, therefore, the specifications of standard 9 are in full force, although only two proposals possible under it have found technical adherents.

**Reports on the Methods of Modulation.**—Two reports reproduced below bear on the subject of the various types of modulation possible under standard 9. The first, by R. D. Kell, is a general analysis of the possible combinations of AM and FM. The second deals with the alternate-carrier system in two papers, one by A. V. Loughren, who originated it, and a second, by D. B. Smith, outlining the echo-pattern neutralization scheme.

#### A DISCUSSION OF VARIOUS COMBINATIONS OF AMPLITUDE AND FREQUENCY MODULATION FOR TELEVISION TRANSMISSION<sup>1</sup>

The purpose of this memorandum is to enumerate several possible combinations of AM and FM as applied to television and to point out the relative merits of these different combinations. The receiver is assumed to have the standard frequency characteristic heretofore used for vestigial sideband a-m reception, and, for the cases involving AM of the picture signal, the vestigial sideband method is assumed to be used. For the cases involving FM, the gradual cutoff portion of this characteristic

<sup>1</sup> R. D. Kell, RCA Manufacturing Company, Inc.

is used as the discriminator for final conversion to AM. The synchronizing and picture signals are to be separated after detection on the basis of amplitude, in the usual way. It is assumed that the transmitter, when operated under the various conditions, has a peak voltage capability of four units and a continuous output voltage rating of three units. In other words, the synchronizing pulses may reach an amplitude of four units, but, for the picture-signal portion of the transmission, whether frequency- or amplitude-modulated, the peak amplitude may be only three units. This is a very close approximation to the results that obtain in practice under Class *B*, or linear, operating conditions.

1. In the first method considered, conventional AM for both picture and synchronizing is used. It is assumed for the comparison of the various methods that the receiver receiving this signal with the carrier fixed at the half-amplitude point of the receiver frequency characteristic receives a total of four units of signal, one unit of synchronizing, and three units of picture.

2. If the transmitter is frequency-modulated with the same ratio of synchronizing and picture, the transmitter peak voltage is limited to three units, since this is also the maximum continuous output voltage. These three units of transmitter voltage produce a signal of six units in the receiver when the carrier is received at the upper knee of the receiver frequency characteristic, which corresponds to the peak of the synchronizing pulse. These six units are divided one and one-half for synchronizing, four and one-half for picture.

3. Method 3 is a combination of AM for the picture signal and FM for the synchronizing. The maximum picture signal corresponding to the maximum continuous output voltage is again three units. The shift in frequency to the upper knee of the receiver frequency characteristic produces three units of synchronizing. This makes a total signal of six units, half of which is synchronizing.

4. Method 4 utilizes AM for the picture with both AM and FM for the synchronizing pulses. The maximum of three units of picture is received with the carrier at the half-amplitude point of the receiver frequency characteristic. The carrier amplitude is increased to four units during the synchronizing pulse, and, at the same time, the frequency is shifted to the upper knee of

the receiver frequency characteristic. This results in one unit of synchronizing from the amplitude change and four units from the frequency shift, making a total of five units of synchronizing. This signal, combined with the three units of picture, makes a total signal of eight units.

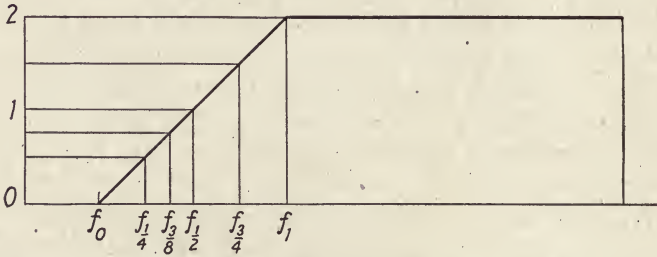

FIG. 65.—Idealized receiver-frequency characteristic. (R. D. Kell.)

5. Method 5 is a combination of FM for the picture signal and AM for the synchronizing signal. The three units of picture voltage available from the transmitter produce six units of picture signal at the output of the receiver with black level at the upper knee of the receiver frequency characteristic. The one unit of synchronizing amplitude change produces two units

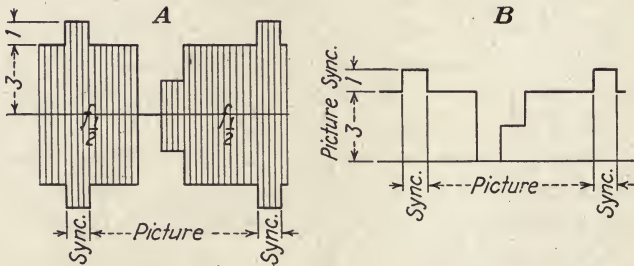

FIG. 66.—Transmitter-output waveforms, method 1. (R. D. Kell.)

of synchronizing at the output of the receiver, since it is received at the upper knee of the receiver frequency characteristic. This combination makes available at the output of the receiver six units of picture and two units of synchronizing, or a total signal of eight units.

6. Method 6 is a combination of both AM and FM for the picture signal, with only AM for the synchronizing signal.



The three units of picture signal at the transmitter are received, because of the frequency shift to the knee of the receiver frequency characteristic, as six units of picture signal. The one unit of synchronizing transmitted is received as two units because the carrier is at the frequency corresponding to black level or at the knee of the receiver frequency characteristic. This combination makes available at the output of the receiver six units of picture and two units of synchronizing.

7. The final combination to be considered here makes use of AM and FM on both the picture and synchronizing signals. This differs from the preceding method only in that some of the available frequency swing is taken from the picture signal and used for synchronizing.

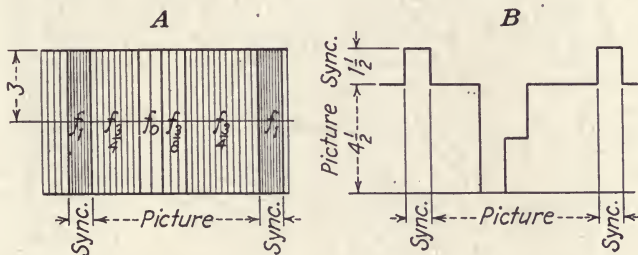

FIG. 67.—Transmitter-output waveforms, method 2. (R. D. Kell.)

The peak signal at the transmitter is four units. Because of the FM, this peak signal is received at the knee of the receiver frequency characteristic, where it produces a signal of eight units. If, for example, black level is established at the three-quarters-amplitude point on the receiver frequency characteristic, then this total signal of eight units will be divided  $3\frac{1}{2}$  for synchronizing and  $4\frac{1}{2}$  for picture.

Figures 65 to 72 may help in visualizing the situation for each of the foregoing cases. Figure 65 is an idealized frequency characteristic of the receiver, *i.e.*, relative response as a function of radio frequency. Figures 66 to 72 inclusive show the transmitter output waveforms before any attenuation of one sideband, for the different cases. The envelope is shown, together with the radio frequency, schematically represented for convenience by parallel lines instead of sine waves. The frequency of each part of the wave is indicated with reference to Fig. 65. A simple picture consisting of broad vertical bands of black, white,

gray, and black has been assumed for convenience. Figures 66A to 72A, inclusive, show the corresponding received waveforms after detection but before the separation of the picture and synchronizing signals. These waveforms are deduced by assuming ideal detection such that the true envelope of the original a-m wave is recovered. For the cases involving FM, the rate of frequency change is assumed to be slow enough so that the simple "instantaneous-frequency" picture of FM is valid.

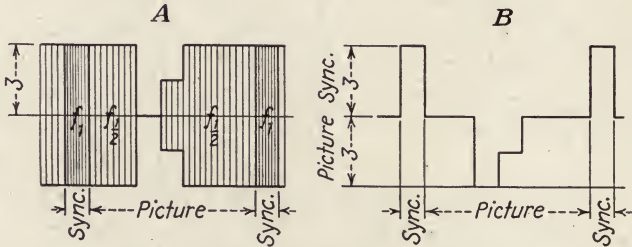

FIG. 68.—Transmitter-output waveforms, method 3. (R. D. Kell.)

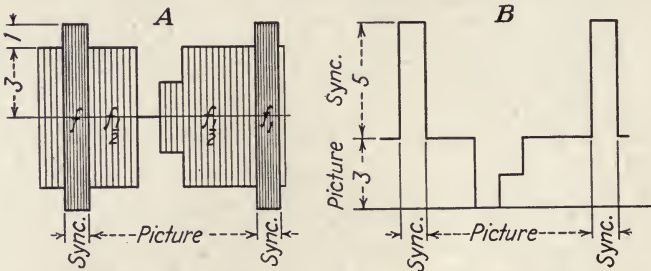

FIG. 69.—Transmitter-output waveforms, method 4. (R. D. Kell.)

The following observations may be made after studying Figs. 66 to 72.

1. AM is at a disadvantage compared with FM for the picture, because of the necessity of operating with the carrier at the half-amplitude point to minimize distortion in the vestigial sideband method.

2. The synchronizing signal must be amplitude-modulated in order to utilize the full capability of the transmitter.

3. The superposition of both kinds of modulation, for either picture or synchronizing, cannot result in increased total signal.

4. If the combined modulations, as in Methods 6 and 7, are each linear, as has been assumed in the diagrams, the resulting picture characteristic will be nonlinear (parabolic).

To summarize the characteristics of the various combinations, Table VIII is helpful.

From Table VIII, it is seen that the present practice of using AM (1) for both picture and synchronizing produces the poorest

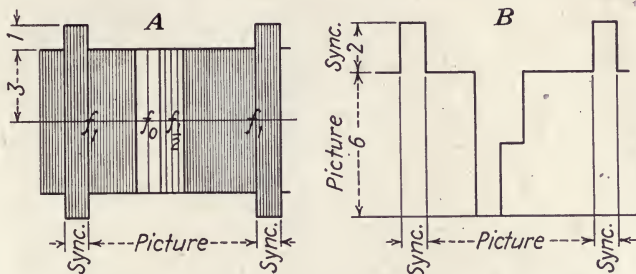

FIG. 70.—Transmitter-output waveforms, method 5. (R. D. Kell.)

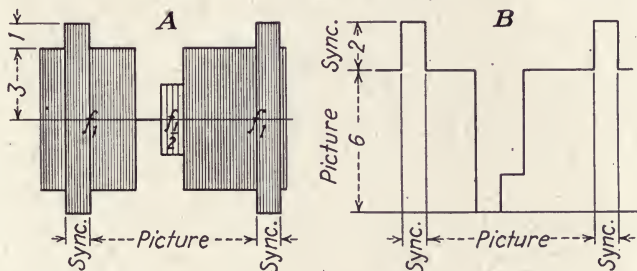

FIG. 71.—Transmitter-output waveforms, method 6. (R. D. Kell.)

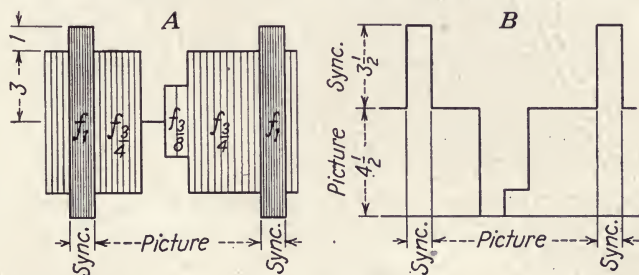

FIG. 72.—Transmitter-output waveforms, method 7. (R. D. Kell.)

results. It is also seen that the use of AM alone for the picture with either FM or FM plus AM for the synchronizing improves the synchronizing signal but does not improve the picture signal. An improvement in picture signal is obtained only where FM is used to transmit the picture signal. Since the results of

combinations 6 and 7 can be obtained with the simpler arrangement of 5, where FM is used to transmit the picture signal and AM is used for the synchronizing, these combinations need not be considered further.

TABLE VIII

Type of modulation	Total received signal	Synchronizing signal	Picture signal
1. AM.....	4	1	3
2. FM.....	6	1½	4½
3. AM on picture, FM on synchronizing.....	6	3	3
4. AM on picture, AM and FM on synchronizing.....	8	5	3
5. FM on picture, AM on synchronizing.....	8	2	6
6. AM and FM on picture, AM on synchronizing.....	8	2	6
7. AM and FM on picture, AM and FM on synchronizing....	8	3½	4½
8. (2) Class C operation.....	8	2	6
9. (5) Class C operation plate-modulated.....	10.67	2.67	8

All combinations with the exception of FM for both picture and synchronizing (2) and FM for picture and AM for synchronizing (5) involve linear or grid-modulated amplifiers. These two excepted combinations may be operated Class C with a sufficient improvement in efficiency to raise the output from 6 to 8 units in (2) and to 8 units for the picture signal alone in (5) or a total signal of 10.67 units, when plate modulation is used for the synchronizing signal.

#### INFORMATION ON FREQUENCY AND AMPLITUDE MODULATION INTERSPERSED IN A TELEVISION SIGNAL<sup>1</sup>

##### INTRODUCTION

In the transmission of television synchronizing signals, there are advantages to be secured by utilizing the capabilities of FM, even though the picture signal is still transmitted in the present

<sup>1</sup> A. V. Loughren, Hazeltine Service Corporation. This material is composed in large part of an abridgment of an article in *Electronics* for February, 1940.

manner by AM. It is proposed that this improvement be considered for standardization after its apparent advantages are confirmed by suitable field tests. This proposal is applicable to any form of synchronizing pulse but gives much more freedom in the choice of their pattern and in the choice of methods of separating the vertical and horizontal pulses.

#### DISCUSSION OF SYSTEM

Figure 73 shows the transmitter arrangement for the present R.M.A. signal, in which both picture and synchronizing signals

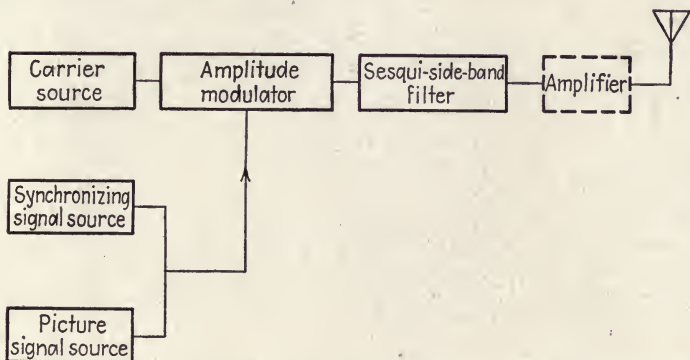

FIG. 73.—Arrangement of transmitter components for R.M.A. standard signal.  
(A. V. Loughren.)

are transmitted by AM. The amplifier shown dotted at the right may be used or omitted, depending on the power level at which the modulator operates; if used, it may include frequency changing means as well as amplifier elements.

Figure 74 shows the transmitter arrangement for the new signal. Separation of the modulation processes for the two signal components and introduction of a frequency modulator are the only essential changes in the transmitter as compared with Fig. 73.

An example of the use of the interspersed-modulation principle will illustrate both the method of practicing it and some of its advantages. The radiated wave of this example will be formed by modulating the amplitude of the radiation in accordance with R.M.A. standards except that no synchronizing information is applied (the retrace intervals are just black) and also modulating the frequency of the radiation with the R.M.A. composite synchronizing signal, using the transmitter of Fig. 74. The fre-

quency excursion should preferably be about 2 Mc in the direction of the major sideband. In other respects, such as sesqui-sideband operation, the radiated wave of this example agrees with R.M.A. standards except that the steepness of the slopes on the synchronizing pulses will be reduced by perhaps 25 or 50 per cent from their present magnitudes in order to retain all f-m sidebands within the uniform transmission band of the transmitter and thus avoid second-order a-m terms associated with the synchronizing signals.

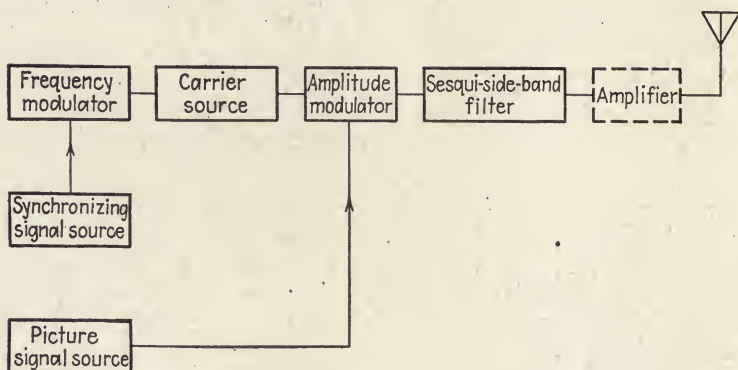

FIG. 74.—Transmitter arrangement for frequency and amplitude modulation interspersed. (A. V. Loughren.)

If this new signal is applied to a conventional television receiver, certain differences in operation result as compared with the R.M.A. signal. The conventional receiver is assumed to attenuate the signal carrier 6 db in its i-f circuits and to perform the synchronizing-signal amplitude selection at a point in the receiver later than the introduction of this attenuation. In consequence, the synchronizing-pulse amplitude will exceed the black level by two to one both at the picture-tube grid and at the point of amplitude selection as compared with the normal margin of four to three or five to four. As a consequence, amplitude selection is made very much easier. The d-c restoration level in the picture circuit is appreciably altered as compared with R.M.A. signal operation, and a readjustment of the brightness control is necessary. In other respects, the operation of the receiver will be normal unless the i-f channel to the synchronizing circuits has an appreciable decrease in gain at the frequency of

the synchronizing pulse, in which case realignment of that channel is required.

A receiver designed specifically for the new signal is shown, in block form, in Fig. 75. The picture channel along the upper line of the diagram may be entirely conventional. It appears preferable, however, to depart from the conventional practice to the extent of not attenuating the carrier 6 db prior to detection but instead providing suitable attenuation in the low-frequency portion of the video amplifier characteristic. This practice permits taking advantage of having the d-c restoration at black rather than at some "infrablack" level.

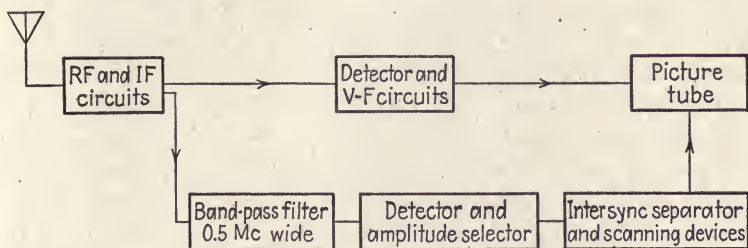

FIG. 75.—Receiver arrangement for the a-m and f-m interspersed signal. (A. V. Loughren.)

Since the synchronizing signal includes no a-m components, as radiated, it is necessary that the receiver circuits provide frequency selection prior to detection. In the conventional receiver whose operation was described above, the 6-db carrier attenuation played this role. The new receiver will show much better signal-to-noise ratio and a further gain in margin of amplitude selection of synchronizing from picture, by using a band-pass filter tuned to the i-f synchronizing pulses for this frequency selection; the width of pass band is a compromise between noise acceptance and signal delay and is set at 0.5 Mc. This element is shown in the lower row of apparatus in Fig. 75. In the output from this filter, synchronizing pulses are present with a margin of at least four to one as compared with picture components, and the subsequent amplitude selection offers no difficulty.<sup>1</sup>

<sup>1</sup> The 4:1 ratio arises from the following:

1. Synchronizing is radiated 2 Mc off the carrier, but at peak radiation intensity.
2. Video sidebands in the synchronizing-filter pass band may be repre-

Further, the relatively narrow pass band and the wide amplitude margin produce a major improvement in the synchronizing signal-to-noise ratio.

Contrasting the system of the above example with the R.M.A. standard system, the new system has the following advantages:

1. Without increasing the peak transmitter power, an increase in picture signal is obtained that corresponds to a 60 or 70 per cent increase in peak transmitter power; the received picture signal-to-noise ratio is improved to the same extent.

2. An entirely new method of synchronizing-signal selection is now available. Since the synchronizing information is now concentrated in a frequency band approximately 2 Mc above the carrier, frequency selection may be employed prior to detection to increase materially the margin of selection for synchronizing signals.

3. The synchronizing signal may be selected in the receiver with an amplitude margin over picture components in its own frequency band of four to one in the new signal as against four to three (or five to four) in the standard signal.

4. The received synchronizing signal-to-noise ratio shows an improvement corresponding roughly to the amplitude-selection comparison of (3).

5. The radiated wave now has no "infrablack" amplitude. Consequently, d-c restoration arrangements at the receiver can be based on the black level rather than on some arbitrarily "infrablack" level. To make use of this possibility, it is necessary that the equalizing circuit provided in the receiver to correct for the missing sidebands be located in the video-frequency rather than i-f circuits.

It is interesting to note that the new signal requires no explicit sharing of the available amplitude range at the transmitter. Instead, advantage is taken of the fact that the maximum intensity of any one sideband cannot exceed one-fourth the maximum intensity of the complete signal. By use of FM, the radiation may be shifted in frequency during synchronizing intervals to a region where this margin becomes effective. The modulation

---

sented, in the worst case, by a single sideband at synchronizing frequency.

3. The maximum intensity of a single sideband, in a modulated wave, cannot exceed one-fourth of the maximum intensity of the complete signal. (The exceptions to this latter rule are not significant in this case.)



capabilities of the signal are only partially utilized by AM, so there is still room for the FM representing the synchronizing signals.

### THE INTERSPERSED-MODULATION PROPOSAL

The standardization proposal presented here differs from the example already given in that it takes more advantage of the possibilities inherent in interspersing. Field- and line-synchronizing signals are represented by different f-m excursions of the carrier and may therefore be separated from each other as

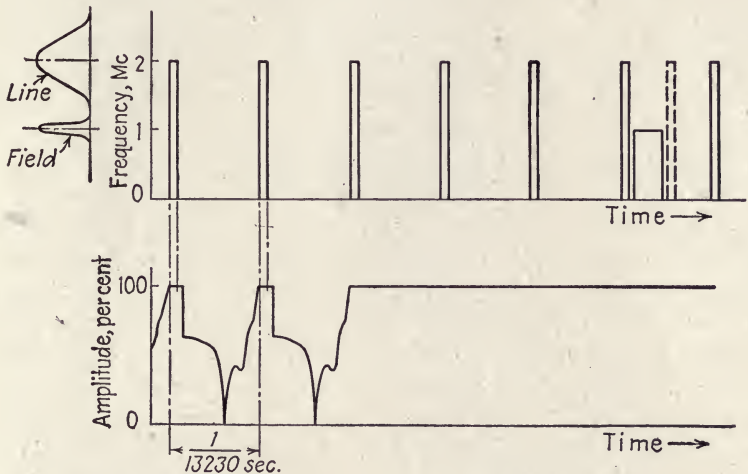

FIG. 76.—Modulation content of the interspersed f-m and a-m signal. (A. V. Loughren.)

well as from the picture by frequency selective means prior to their detection in the receiver. As a consequence of this separation, it is possible to operate the receiver automatic volume control from the line-synchronizing signal rather than from the composite synchronizing signal, as is the practice when the R.M.A. synchronizing wave is used, with the resulting advantage that the a-v-c time constant, instead of being long compared to the picture period, is long only compared with the line period. The transmitter shown in the block diagram of Fig. 74 is suitable for radiating this signal.

Figure 76 shows the modulation content of the signal. The upper portion of the diagram represents the f-m synchronizing

information, and the lower portion shows a-m picture signals. Standard R.M.A. practice has been followed in the construction of this signal where suitable. For example, the line-blanking interval is 15 per cent, and the line-synchronizing signal duration 8 per cent, respectively, of the line period. The field-synchronizing signal consists of a single broad pulse; since it is completely distinguished from line pulses by its frequency of transmission, it appears to be unnecessary to provide equalizing pulses and a long duration signal for use with slow integrating circuits. The field pulse has such duration that it does not interfere with transmission of line pulses in either field of the interlaced scan; a single line pulse of the alternate field is shown, dotted, immediately after the field pulse, to illustrate this relation.

Suitable pass-band characteristics for synchronizing-signal selection in the receiver are shown at the left of the diagram. A relatively narrow pass band for field-frequency pulses is centered 1 Mc from the carrier, and a relatively wide pass band for line-frequency pulses is centered 2 Mc from the carrier. The width of the line pass band represents a compromise between reduction of noise on the one hand and delay in synchronizing-signal transmission on the other. For the line-synchronizing pulses, relatively little delay is tolerable; a bandwidth of 0.5 Mc is used. Relatively great delay may be permitted in the field-synchronizing signal channel; here the bandwidth is reduced to the point where it is determined by system frequency tolerance requirements. The choice of frequency deviation for the line pulses is a compromise between best transmission conditions for synchronizing signals and the desirability of limited bandwidth for inexpensive receivers. A logical compromise here seems to be 2 Mc. Frequency deviation for field pulses is chosen to produce minimum interference from both picture- and line-synchronizing signals; it is accordingly half of the line-pulse deviation.

A receiver for use with this proposed signal is shown in Fig. 77. The upper line of the diagram may be patterned after a conventional receiver or may preferably employ low-frequency attenuation in the video circuits rather than carrier attenuation in the i-f circuits. The two lower rows of apparatus are in general similar, each including its frequency selector, its detector and amplitude selector, and its corresponding scanning generator. The line-frequency circuit, however, includes the a-v-c connection

back to the i-f circuits, which is required if advantage is to be taken of the system's adaptability to fast automatic volume control.

The system of the proposal includes all the advantages enumerated in the preceding section of this report, and in addition makes intersynchronizing separation prior to detection possible and advantageous; the a-v-c time constant may be decreased to one-hundredth of the value currently required, with a consequent

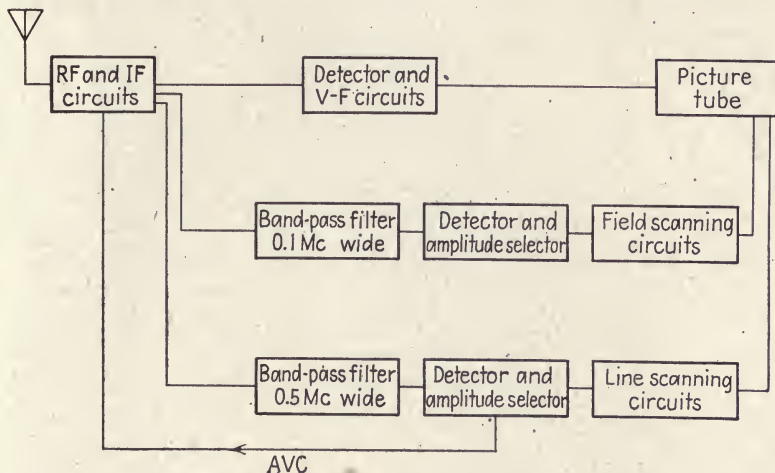

FIG. 77.—Receiver designed for the signal shown in Fig. 76. (A. V. Loughren.)

decrease in the duration of disturbances caused by bursts of noise interference or by power-line transients.

The advantages of transmitting the synchronizing signals by interspersed FM are based on fundamental principles that lead to more effective utilization of the transmitter power. The added freedom of design in the synchronizing circuits of the receiver is attractive, and its potentialities far exceed those realized in the examples described.

#### A REPORT ON THE NEUTRALIZATION OF LONG-DELAYED ECHOS<sup>1</sup>

One of the problems in television transmission, which obtains with any type of modulation, is that of long-delayed echoes, corresponding to path differences of several miles. Since the speed of propagation of the radio wave is roughly 1,000 ft. per

<sup>1</sup> D. B. Smith, Philco Corporation.

microsecond, a path difference of say 3 or 4 miles may produce echoes delayed by 15 or 20 microseconds. In magnitude these echoes are usually quite faint, owing to the greater path length and the fact that the path for echoes often causes somewhat more attenuation of the signal by being lower in height than the path of the direct signal. On the other hand, because the blanking and synchronizing signals are of greater amplitude than the remainder of the signal, they sometimes appear in the picture as a result of these long-delayed echoes. The system to be described here will substantially eliminate these long-time echoes.

### ECHO MECHANISM

An echo appears on the picture by combining with the picture carrier, *i.e.*, the echo signal will add or subtract from the particular picture carrier depending upon the exact phase relation at the given instant between the two signals. Fortunately, this phase relation depends only upon the differential difference in path length between the direct and reflected signals. The only way in which this length can be appreciably varied is by variation of the placement of the reflector causing the echo, but, since this is usually a high building, bridge, gas tank, hill, or similar object, it is not likely to move. Hence the phase relationship remains constant.

### ECHO CANCELLATION

Echo cancellation is obtained by reversing the phase of the echo with respect to the picture carrier successively in time relation. This phase reversal causes the successive echoes to balance each other out. This obtains regardless of the method of transmission used. That is, it has been found satisfactory with AM and with alternate-carrier synchronization and is believed to be applicable to complete FM. In other words, since the time of delay is precisely the same in all successive echoes, which follows from the fact that the differential distance is the same, a phase change between the echo signal and the picture signal obtains only when it is caused at the transmitter, and, when so caused, it becomes an implicit part of the signal regardless of where it is received. Further, if one phase relation between the blanking-synchronizing pulse and the carrier causes a light echo, the opposite phase relation will cause a dark echo, and the super-

positioning of the two will eliminate the weaker signal, *i.e.*, the echo, leaving only the stronger, *i.e.*, the desired signal, except for second-order effects caused by amplitude nonlinearity in the transmission system.

### TIME RELATIONS

The essential factor is that the phase relation between the synchronizing signal and the picture carrier be changed by 180 deg. between successive frames. For example, two fields might be transmitted with no change, producing say a light echo, and then with a 180-deg. phase change giving a dark echo. Or, in the first case, the phase might be advanced by 90 deg. and in the second retarded by 90 deg., thus giving an effective 180-deg. phase relationship. Alternatively, the phase change can take place after alternate lines in time sequence, which, in an odd line system, gives the desired consecutive phase reversal between time-successive, geometrically identical lines. This last system has the advantage that it breaks the echo signal so completely as to eliminate any trace of flicker. Effectively it interlaces the echoes both in time and in space relation.

### SEQUENCE OF CHANGE

The phase reversal may occur in any of several time positions. One method is bodily to change the phase of one synchronizing-blanking pulse by causing the first phase reversal just as the blanking begins and then again reversing the phase or bringing it back to normal just as the blanking pulse ends. In this case, the next successive blanking pulse would be unchanged, the third changed, the fourth unchanged, etc. A second method is to change the phase only at the end of successive blanking pulses, in which case the phase of the picture carrier is reversed as between successive lines; or, in either of the above instances, the phase can be alternately advanced and retarded by 90 deg. to give the 180-deg. phase relation.

### APPARATUS

The phase changes described above can be obtained in any of several ways. One method that has been satisfactory is to form two sources of signal differing only in the desired phase relation, applying each of these signals to two tubes having a common

output and then switching between the two sources by alternately biasing one tube off and the other on. For example, in some field tests using the first time sequence above described and a 180-deg. phase change, the two sources were opposite sides of a push-pull circuit; these sources were used to energize two tubes having a common output stage. One tube was energized by a short pulse signal occurring at half the line frequency and of duration to cover the blanking and synchronizing pulse. The other tube was energized by the opposite of this signal so that only one tube was transmitting at a time. This circuit function is called amplitude switching and can be used in any of the above sequences by forming proper switching signals.

A second method of phase changing is by prolonged FM. Since phase is the integral of frequency with respect to time, and the frequency of an oscillator is changed by a deviator and held for a time interval, the oscillator will accumulate the desired phase shift and will continue to have that phase shift with respect to its original value from then on. For example, an increase in frequency of  $\frac{1}{8}$  Mc/s held for 2 microseconds will produce a phase change of 90 deg. Likewise a frequency change of  $\frac{1}{6}$  Mc held for  $1\frac{1}{2}$  microseconds will produce the same phase change. In a standard receiver, these shifts produce modulations that correspond at the blanking level to 12 and 18 per cent, respectively, and can be counterbalanced by oppositely arranged AM. These phase changes can be obtained in the transmitter by the use of appropriate pulse signals properly timed with respect to the line synchronizing.

It is not necessary to continue the changes during the vertical pulse period, since echoes of the vertical synchronizing-signal cannot get into the picture. For this reason, the pulse signals causing the phase changes should be blanked out during the vertical synchronizing period.

#### SUMMARY

The above systems have been tried in laboratory tests. Some of them have been field-tested at high power using Philco television station W3XE and have been found quite effective. They are not proposed for standardization at this time but are mentioned to show a form of improvement that can be made within the present standards.

## SUBCOMMITTEE FINDINGS ON MODULATION

The following excerpts from the minutes of the R.M.A.-N.T.S.C. Subcommittee on Synchronization describe recent demonstrations on this subject. These minutes, although approved by the subcommittee members, have no other official standing and are reproduced merely to recount the work that has been done since N.T.S.C. standard 9 was written.

## FROM MINUTES OF MEETING SEPT. 25, 1941

The R.M.A. Subcommittee on Synchronization assembled about 9 miles from the Philco television station WPTZ-W3XE to witness a demonstration of the alternate-carrier method of synchronization, with and without echo suppression, in comparison with straight AM.

The receiver used in the demonstration was a Philco model built to R.M.A.-N.T.S.C. specifications. As a first test, the transmitter was transferred at 15-sec. intervals from straight AM to alternate carrier with echo suppression. The signal level at the first grid of the receiver in this test was about 200 microvolts.

Noise from (1) a doorbell buzzer, (2) a movie-projector motor, and (3) a vacuum-cleaner motor was introduced by connecting the equipment to the power circuit to which the receiver was attached. In each case, the noise produced complete loss of synchronism when the transmitter radiated straight AM. The loss of synchronism was limited to the displacement of a few lines, or to an over-all loss in definition without loss of synchronism, when the transmitter was radiating alternate carrier with echo suppression.

It was explained that the carrier shift employed for the synchronization pulses was 2.5 Mc, *i.e.*, beyond the full extent of the slope of the RA characteristic, and that the developed synchronizing amplitude (with AM plus FM) was accordingly as great as five times that available from straight AM. It was explained that the use of the alternate-carrier system introduces certain peculiarities when echoes of the synchronizing signals are of appreciable amplitude. The effect arises because the frequencies of the image signal and the synchronizing signal are not the same. When the echo of the synchronizing is delayed so that it appears

on the true image, a beat frequency is generated. This beat frequency makes itself visible as a series of alternate vertical black and white striations, with spacing corresponding to the beat frequency. These striations were clearly evident in the image when the echo-suppression system was not employed.

The echo suppression, which reduced the striations to the point where they were substantially invisible, is accomplished by reversing the phase of the transmitted carrier at the beginning and end of each blanking period on alternate lines. This phase reversal causes the black portions of the striation to become white, and vice versa, so that each striation, in a single field, consists of alternate black and white segments. Moreover, at the conclusion of two complete frames, a given point on the striation has passed through one black phase and one white phase, so that the net effect is a neutral gray indistinguishable from the remainder of the scanning pattern. Except for the residual effects of interline flicker within the striation, therefore, the striations are rendered invisible. This effect was demonstrated by operating the transmitter continuously on alternate carrier and turning the echo suppression phase switching on and off at 15-sec. intervals. The striations were clearly visible in the absence of the phase switching but became invisible, except when viewed from a distance of a few inches, when the phase switching was introduced.

The phase switching was accomplished by the use of two r-f amplifiers in the transmitter, one that used an artificial transmission line of sufficient length to introduce a delay equal to one-half of a carrier cycle. By means of an electronic switch operating at one-half the line frequency (15,750 c.p.s.), first one and then the other of these amplifiers was biased off, while the opposite amplifier was allowed to conduct. The modulated r-f signal was thereby passed alternately through the two amplifiers.

It was pointed out that this rapid reversal of phase constituted FM of an impulsive character that introduced a transient capable of making its presence known as a bright vertical line at the left or right edge of the picture. Two such lines were observed when the echo-suppression switching was employed. The bright line at the left-hand edge measured somewhat more than  $\frac{1}{4}$  in. wide (on a 9-in. picture tube). This line was explained in terms of the transient f-m pulse produced by phase switching. The bright



line at the right-hand edge was not explained, since, if the phase were alternately advanced and retarded, the transient at the right should be in the direction of black. Later in the discussion, A. W. Loughren suggested that, if the phase should be continuously advanced to produce a transient in the direction of black, the effect would be merely an undetectable shift in the frequency of the transmitter. Moreover, if the switching were to occur during the horizontal blanking period, as was proposed by Philco, the effect of such a black transient would not be harmful, provided that the synchronizing signal had by then completed itself (*i.e.*, the phase switching should occur during the "back porch" of the horizontal blanking). It was agreed that the Philco engineers would pursue experiments in this direction and would endeavor to report the results at the next meeting of the committee.

To show the effect of the echo suppression more clearly, the deviation employed in the alternate-carrier transmissions was reduced, producing a lower beat frequency and correspondingly wider spacing between the striations. Using straight AM, with high contrast and reduced brightness to show the echo of the blanking period most clearly, the frequency of the transmitter was then shifted 30 kc, which revealed a shift in the position of the echo image.

A film was reproduced to show on program material the relative performance of straight AM and alternate carrier with and without echo suppression. The beats were clearly visible in the absence of phase switching, with alternate carrier. No bad effects were noted with straight AM, although the synchronization in this case was, as demonstrated earlier, much more subject to the effects of noise.

A change was then made in the transmitter to produce a straight f-m signal with deviation of  $\pm 750$  kc. As a first test, the image was removed and parabolic shading signal introduced. This produced a marked system of multiple echoes and beats, which had the general appearance of the Newton's rings of optical interference. The shape and number of these rings could be varied over wide limits by tuning the receiver or by varying the amplitude and position of the parabolic shading signal, etc. To show the effect on program material, the film previously used was run off. The Newton's rings effect was extremely annoying,

especially since the rings had no evident geometrical relationship to the subject matter of the image. It was evident that eyestrain would result from prolonged viewing under these conditions.

The remainder of the test period was given over to an examination of the effect of antenna placement on the performance of the alternate-carrier systems. It was found that the use of different antennas, and in particular changing the position and orientation of a single antenna, produced large variations in the relative signal strength of the image portions of the signal compared with the synchronizing (infrablack) portions. Antenna orientations could be found that produced substantially zero synchronizing amplitude, or substantially zero picture amplitude, or various intermediate combinations, as evidenced by the trace of the video signal on a cathode-ray oscillograph.

This effect was explained by the fact that the synchronizing signal and picture signal employ, in effect, totally different carrier frequencies. In the presence of signal reflections, the standing wave pattern may produce cancellation of one carrier at the antenna location while a strong signal exists on the other carrier frequency at the same location. The problem of bringing in both carriers at once is similar to that of making one antenna orientation serve equally well for two a-m transmitters on different channels. It was pointed out that the adjustment to reduce either the picture or synchronizing carrier to zero was a critical one, but that wide relative variations occurred over a range of antenna orientations.

Near the conclusion of the tests, the antenna was lowered to within 4 ft. of the ground. The signal level at the first grid was then found to be less than 50 microvolts. A recognizable picture, in synchronism, could then be obtained with the alternate carrier transmissions, but not with straight AM.

#### FROM MINUTES OF MEETING, NOV. 6, 1941

The subcommittee attended a demonstration in the laboratories of the National Broadcasting Company, New York City. R. E. Shelby presided and explained that the Empire State Station was operating with a completely f-m transmitter of approximately 800 watts power output. This transmitter (with the exception of the input terminal equipment, the vestigial sideband filter, and the antenna) is completely separate from the a-m

transmitter used on regularly scheduled programs. The receiver used for the first part of the demonstration was a standard TRK-120 RCA receiver built to R.M.A.-N.T.S.C. specifications. No f-m limiter was used.

As a first test, the r-f output of the transmitter was fed to the receiver over a coaxial cable, about 1.3 miles long, which introduced an attenuation, at the carrier frequency, of about 50 db. The signal level at the receiving end was adjustable. The coaxial cable was used to eliminate the effects of multipath transmission. Horizontal resolution corresponding to a frequency limit of 4 Mc was obtained, and the picture quality was generally excellent. It was pointed out that conditions similar to these could be obtained in favorable suburban receiver locations. This test employed the test chart only.

In the second test, the coaxial line was replaced by the Empire State radiator, and a receiving antenna on the ninth floor of the RCA Building. The ether path introduced multipath reflections, which produced beat-note echo patterns of such magnitude as to be clearly visible 10 ft. or more from the receiver. The amplitude of the video signal was then varied up and down, introducing greater and less r-f frequency deviation. As was noticed in the Philco demonstration in a previous meeting, this variation of video amplitude caused a marked displacement of the echo patterns and changed their intensity over a wide range. The visual signal was then removed. The blank raster showed the characteristic beat pattern resulting from multipath echos of the horizontal blanking signal. The synchronizing signal deviation was about 0.4 Mc.

A film, an edition of the March of Time, was then run off, with the transmitter operating over the ether path. Pronounced and annoying echo patterns, which had no evident connection with the geometry of the image, were observed. The system was then changed over to the coaxial line connection. No echo patterns were observed, and the image quality was excellent.

The picture was then removed and the blank raster used to simulate alternate-carrier conditions. The characteristic beat-echo pattern resulting from the horizontal blanking signal was then neutralized by a phase-shifting system employing FM to obtain the phase shift. The phase shift was introduced by adding a pulse to the rear edge of every other horizontal synchro-

nizing signal, in the back porch of the blanking interval. This pulse was of fixed width but of variable height. The height was adjusted until the phase shift corresponding to the FM of the pulse was 180 deg. at the carrier frequency. This shift succeeded in neutralizing the echo image, in the same manner as was described in the minutes of the previous meeting of the subcommittee (page 257). However, since the phase shift always occurred in one direction, namely, in the black direction, no white bar was observed. On close viewing, crawling of the image was noticed in the portions of the image where neutralization was taking place, owing to the effects of interline flicker.

The transmitter was then changed over to AM using the main NBC transmitter, with the same antenna system. The March of Time film was run off again. The multipath effects were then hardly noticeable, and the appearance of the picture was very much improved compared with the same system using straight FM. The contrast between the two systems was very marked and decidedly in favor of AM. The horizontal resolution was again that corresponding to a 4-Mc signal, although not quite so crisp as in the f-m transmissions.

R. D. Kell then demonstrated a receiver, an RCA TRK-120 with an automatic frequency-control circuit incorporated in the vertical and horizontal synchronizing circuits. The new receiver was compared with the standard receiver, on straight a-m transmissions of the test chart. It was found that, with a weak r-f signal, the improved receiver retained rigid horizontal synchronization, even in the presence of severe noise from an electric razor, whereas the standard receiver showed jagged edges on all vertical elements in the image. Mr. Kell explained that the new synchronizing circuit made use of two pairs of trapezoidal waves, generated in opposite phase, one pair generated from the horizontal scanning generator, the other from the vertical generator. Diodes are used to measure the peak value of the synchronizing signal, which is imposed on the trapezoidal waves. If the synchronizing signal is on the upper flat-top portion of the wave, the voltage generated in the diode is used to control the frequency of the scanning blocking oscillator so as to move down the sloping portion of the wave; whereas, if the synchronizing pulse is the bottom flat portion of the wave, the diode causes the

frequency of the blacking oscillator to move in the opposite direction. The equilibrium position of the synchronizing pulse is midway up the slope of the trapezoidal wave. The same equilibrium position is found on the trapezoidal wave of opposite phase, so the net equilibrium position of the pulse is found at the bottom of the V produced by the superposition of the two trapezoidal waves. This position of equilibrium is found regardless of the height of the synchronizing pulse; hence the trapezoidal wave frequency and the incoming synchronizing-signal frequency are constrained to have the same value, regardless of noise. The time constant of the a-f-c control is made of the order of 0.1 sec. The scanning thus maintains a constant frequency over a corresponding period, and the picture cannot fall out of step except as a whole. Thus the only effect on scanning noted from noise is an occasional motion of the picture, bodily, upward or downward on the picture tube. The system seeks the correct frequency whether the instantaneous frequency is too high or too low, so that such displacements always correct themselves automatically.

It was evident that the new synchronizing circuit displayed the same improvement of horizontal resolution in the presence of noise as had the alternate-carrier signal previously demonstrated by Philco.

### THE SYNCHRONIZATION WAVEFORM

Three synchronization waveforms occupied the attention of the Panel: The form shown in Fig. 2, called the N.T.S.C. waveform, a simplified version of the N.T.S.C. waveform, and the 500-kc pulse waveform. A definitive comparison of these three waveforms was drawn up by T. T. Goldsmith and A. V. Bedford, and the result was reviewed for presentation to the Panel by A. G. Jensen. This report summarizes the relative advantages of the three systems. The N.T.S.C. waveform was retained as a standard of reference in the N.T.S.C. standard 15, but the 500-kc waveform was specifically admitted, in Note A to standard 9, as being capable of operating receivers that were responsive to the N.T.S.C. waveform. The report by Goldsmith, Bedford, and Jensen is as follows:

REPORT ON SYNCHRONIZATION WAVEFORMS<sup>1</sup>

The following summary has been compiled in order to present more fully the comparative details concerning the three a-m synchronizing signals under consideration by this panel.

The three types of synchronizing signal discussed are,

1. The 500-kc vertical-pulse (v-p) signal described and analyzed in two panel reports submitted by the DuMont Laboratories and dated, respectively, Sept. 6, 1940, and Nov. 25, 1940. (It is understood that the carrier frequency for the vertical pulse is not exactly 500 kc but some suitable harmonic of the line frequency located in the vicinity of 500 kc.)

2. The present form of R.M.A. synchronizing signal.

3. The simplified R.M.A. synchronizing signal as described and analyzed in a panel report submitted by the RCA Company.

It is felt that there are many points of agreement concerning these signals and that therefore it will be easiest for the Panel to come to final conclusions if these points of agreement are stated specifically.

There may also be points under question that will be brought to light in this form for further consideration by the Panel. It is proposed that these disputed points be presented to A. G. Jensen, who will analyze them and present them, as an impartial observer, to the Panel for consideration.

The signals are analyzed from three standpoints; namely, amplitude separation, vertical-synchronizing properties, and horizontal-synchronizing properties. Since there are several ways of utilizing each of these signals, the advantages and limitations of each type of signal for these methods of application are discussed at some length.

Table IX following the more detailed discussion is a summary in which, of course, the statements are not in great detail, but it will serve as a compact summary for rapid analysis and comparison of the three signals.

## AMPLITUDE SEPARATION

**Vertical Pulse Separation.**—All three types of synchronizing signal depend upon amplitude separation to a greater or lesser

<sup>1</sup> A. V. Bedford, RCA Manufacturing Company, Inc., and Dr. Thomas T. Goldsmith, Jr., Allen B. DuMont Laboratories. Reviewed by A. G. Jensen, Bell Telephone Laboratories.

degree to separate the synchronizing signal from the composite video signal, because the picture may be of such character as to mimic the synchronizing pulses and therefore otherwise interfere with the synchronization. However, the picture is more likely to contain subject matter that would be indistinguishable from the simple "low-frequency" vertical pulse of the R.M.A. and the simplified R.M.A. signal than to contain 500-kc components, which would be indistinguishable from the carrier type pulse of 500-kc v-p signal. Hence, if other things are equal, the opening of the gate of the amplitude separator for the 500-kc vertical may be made wider in the direction of the picture signal without such serious consequence when a burst of noise shifts the composite signal with respect to the gate "opening." Noise is then less likely to cause the vertical to miss the gate, owing to either low-frequency or high-frequency noise, and thereby prevent transmission to the vertical oscillator.

(This advantage of the 500-kc v-p signal probably accounts for the admittedly better performance of the 500-kc vertical pulse in Haddonfield, for extremely bad interference rendered the picture signal almost unusable.)

Other separator arrangements have come to light since the demonstration, which would undoubtedly improve the noise immunity obtained with each of the three types of signal appreciably, as follows:

For the 500-kc v-p separator, the use of a certain degree of accentuation of the 500-kc component by a tuned circuit before the amplitude separator would improve the signal-to-noise ratio of the signal through the separator, without serious danger of cross talk from the picture signal, although individual vertical and horizontal separators would then be required. (This device was not used in the demonstrations, though Mr. Bedford previously had understood that it was. Separate vertical and horizontal separators were used, but without any deliberate previous frequency selection.)

For the R.M.A. and the simplified R.M.A. signal, a great reduction of the pass band before the vertical separator is applicable by the use of a separate vertical separator that need not transmit the horizontal pulses. This theoretically allows the pass band at the vertical separator of 60 c.p.s. to 600 kc to be reduced to 60 c.p.s. to about 4 kc with a corresponding

reduction of noise reaching into the opening of the separator gate. The vertical blanking before the vertical pulse in the R.M.A. and in the simplified R.M.A. signals serves as a complete guard to prevent the picture cross-talking into the vertical synchronization if an inductance-compensated RC filter circuit is used. (In the demonstrations, because only a single separator was used for vertical and horizontal pulses, this advantage was not obtained.)

It is evident from the foregoing that the vertical synchronization performance provided by all three types of signal could be improved beyond that demonstrated during the field trials.

**Horizontal-pulse Separation.**—For the amplitude separation of the horizontal pulses, the 500-kc v-p signal is at some disadvantage in that, if the wave shape of the 500-kc serrations is to be approximately retained at the separator (see Fig. 78), the admission frequency band must be wide enough to include at least the second harmonic, which is 1,000 kc. This higher fidelity may result in some increase in receiver cost and will also increase noise susceptibility.

The horizontal separator for the R.M.A. and the simplified R.M.A. signals, on the other hand, needs only to pass frequencies up to the order of 600 kc (depending upon the length of blanking before the horizontal pulses in the signal). Less noise thereby passes through the gate of the separator, during the "picture interval"<sup>1</sup> as well as during the vertical blanking interval.

Of course, the bandwidth can be reduced after separating the horizontals, as much with the 500-kc v-p signal as with the other types, but it is then too late to obtain the maximum noise-reducing benefits of band limiting.

On the other hand, if the bandwidth of the 500-kc v-p signal is limited to a top frequency of 500 kc before the horizontal separator, then the waveshape during the vertical interval is altered so that the 500-kc peaks in the horizontals extend about 18 per cent above the normal synchronizing-wave peaks, and the 500-kc downward peaks during the time between horizontals extend down about 18 per cent below the normal blanking level (see Fig. 79). The gate of the horizontal separator thus would have to be either set to allow small amounts of picture and noise

<sup>1</sup> "Picture interval" here means the time interval from the end of one vertical blanking interval to the beginning of the next.



to pass or else "closed" so that the horizontals obtained during the vertical by use of the 500-kc rejection filter after separation,

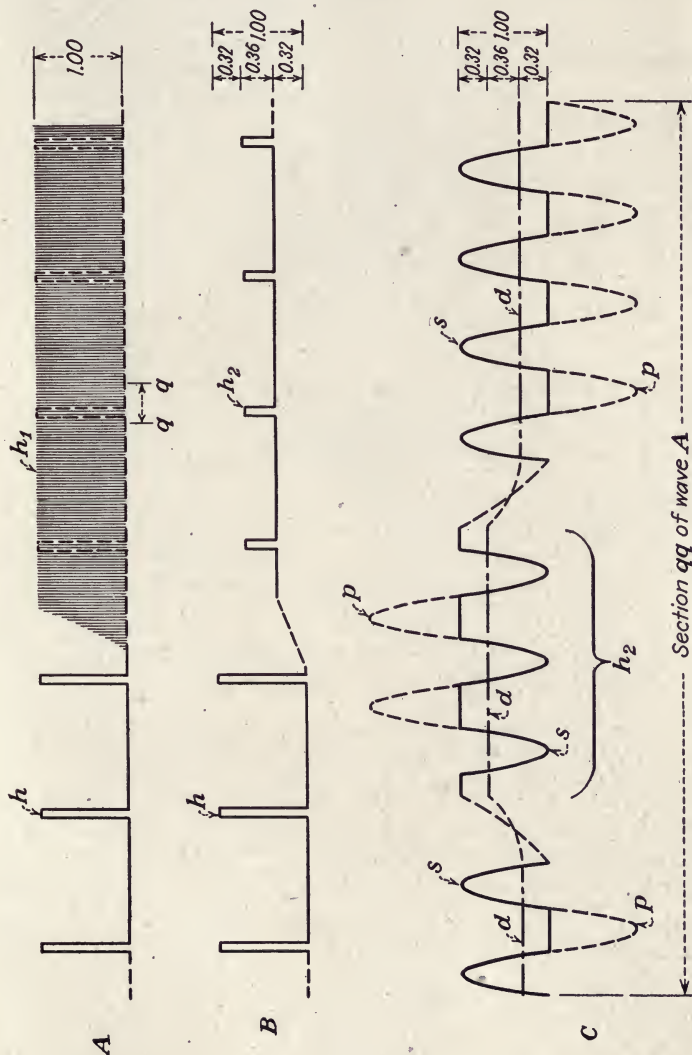

are reduced still further than to the 36 per cent peak-to-peak value given elsewhere in this discussion.

The above disadvantage of the 500-kc v-p horizontals has not been observed experimentally, but it should exist unless the

utilizing circuits have some discriminating properties that have not been explained.

It would undoubtedly be possible to provide special circuits controlled by the isolated vertical pulses in such a way that the horizontal synchronizing signal during vertical synchronization is increased to normal level. With this arrangement, the noise susceptibility during the "picture interval" would not be impaired in order to accommodate the horizontal pulses during the vertical synchronizing interval.

**D-c Inserters.**—With all three types of signal, it is essential that the limiting device that separates the horizontal syn-

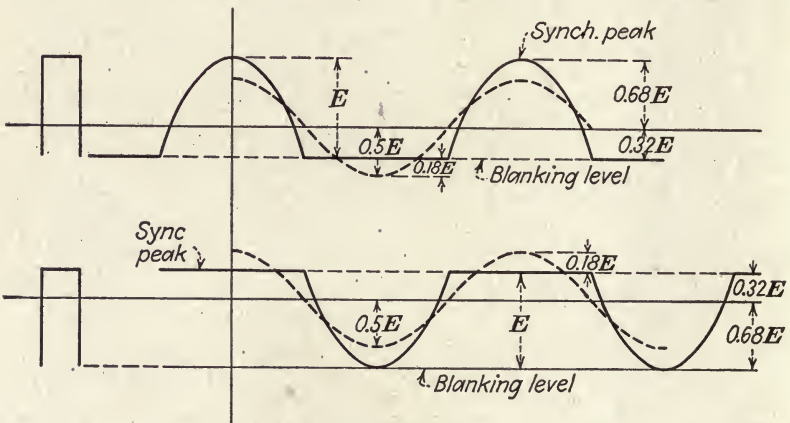

Fig. 79.—Detail of the 500-ke vertical pulse. (A. V. Bedford and T. T. Goldsmith, Jr.)

chronizing pulses from the picture signal should retain an essentially fixed level with respect to the peaks of the pulses, regardless of changes in picture subject that would alter the relative position of the a-c axis of the wave. So-called "d-c inserters," which are generally diodes responsive to the synchronizing-pulse peaks, are used to restore the low-frequency and d-c component of the signal ahead of the amplitude separator, thereby effectively controlling the clipping level. If the receiver has good fidelity down to 60 c.p.s., the time constant of the "d-c inserter" can be long and the clipping level is not readily disturbed by brief bursts of noise. If the low-frequency response is not retained by the video circuits, it may be largely restored by providing a short time constant in the "d-c inserter," though

restoration is somewhat incomplete especially during the vertical. With the fast "d-c inserter," the clipping level is more readily disturbed by a short burst of noise, but the recovery after such disturbance is much quicker so that only a part of the picture may be out of synchronism if the disturbance has, for example, a 60-c.p.s. recurrence rate.

It is not intended to determine here which type of d-c inserter is the better since either is applicable to each of the three types of signal under consideration. As an aid to understanding the behavior of the receivers demonstrated in the field tests, it is pointed out that the 500-kc v-p receivers employed good low-frequency fidelity with a "slow d-c inserter," whereas the other receivers had poor low-frequency fidelity and employed "fast d-c inserters."

### VERTICAL SYNCHRONIZING PROPERTIES

**General.**—For all practical purposes, each of the three signals makes adequate provision for the normal transmission, reception, and isolation of even and odd vertical synchronizing pulses, which are sufficiently alike and free of the effect of the horizontal pulses to allow good interlacing.

The vertical synchronization is satisfactory with any of the three types of synchronizing signals for all noise conditions where the picture is unquestionably usable. This fact is confirmed by the Passaic and Haddonfield tests and many other individual observations.

Under extreme noise conditions at both Passaic and Haddonfield, the 500-kc v-p signal produced a more steady picture vertically.

**Short-time Integration.**—The R.M.A. is adapted for isolation by short-time integration, thus allowing accuracy of timing by yielding a pulse with a relatively steep wave front, which rises to nearly maximum in the time of the order of one line. In this case, the equalizing pulses are essential in providing consecutive vertical signals of a high degree of symmetry.

The simplified R.M.A. signal is not adapted to short-time integration, since it would not provide symmetry.

The 500-kc v-p signal may be used by *RC* integration, in which case the 500-kc slots reduce its energy to about 35 per cent of that of an unslotted square wave, whereas the R.M.A. slots

reduce the energy to about 84 per cent, and the simplified R.M.A. slots reduce the energy to about 92 per cent. With short  $RC$  integration, the dissymmetry provided by the 500 kc would be objectionable. Therefore the 500-kc v-p signal is best adapted for isolation by resonant circuits that provide a form of "integration." In this sense, of course, short-time integration is entirely satisfactory.

**Medium Integration.**—Using medium integration, the R.M.A. signal provides a symmetrical pulse with less abrupt rise but with greater immunity to high-frequency noise by virtue of a narrower frequency band. This degree of integration is exemplified by the TRK-120, which uses three cascade-connected  $RC$  circuits with a time constant of 41 microseconds each.

Medium integration of the simplified R.M.A. signal will provide usable pulses but with a slight lack of symmetry.

Medium integration using a tuned circuit with a  $Q$  of 100 for the 500-kc v-p signal allows good symmetry and an acceptance band of about 10 kc, thus reducing the admission of random noise.

**Long Integration.**—Long integration of the order of six lines time constant begins to introduce a slight dissymmetry with the R.M.A. signal but does reduce the amplitude of the admitted high-frequency noise.

Long integration of the simplified R.M.A. signal yields the best symmetry of consecutive field pulses. The long integration provides excellent immunity to high-frequency noise.

For the 500-kc vertical pulse, long integration in the form of resonant circuits having a  $Q$  of the order of 500, although it provides a narrow noise-acceptance band, is practical only with some form of regeneration. However, a similar effect of slow build-up of the synchronizing pulse may be obtained by the use of a tuned transformer of medium  $Q$  of say 100, loaded by a diode in series with an  $RC$  circuit that damps out short-duration excitation but allows build-up of energy with the persistent application of the resonant carrier. It is true that a wider band of persistent noise can get through such a circuit than would pass through a coil which in itself had the high  $Q$  of the order of 500.

**"Kickback" Differentiation.**—The R.M.A. signal can be used with a form of integration followed by "kickback" differentiation

to yield precise vertical synchronizing pulses in the manner used by the General Electric Company in certain receivers. This method takes advantage of the long duration of the vertical blocks of signal and depends on the double frequency slots for providing symmetry.

The simplified R.M.A. cannot be used in this kickback manner because its blocks of energy are not individually symmetrical in successive fields, although a satisfactory over-all symmetry is achieved by long integration.

The 500-kc v-p signal is not adaptable to "kickback" differentiation.

**Bandwidth Limiting.**—A considerable amount of bandwidth limiting before clipping can be applied with advantage in noise discrimination to all three signals. With the R.M.A. signal, the slight "integration" of the composite signal by providing synchronizing amplifiers with response only to 600 kc has already been treated. If separate channels with individual clippers are provided (with their added cost), then the vertical information can be passed through a channel having a narrow pass band from say 60 to 4,000 cycles, with subsequent clipping to remove the picture components, thus attaining more noise immunity for the vertical than when the signal has a single clipper for the composite waveform.

The simplified R.M.A. signal can utilize bandwidth limiting prior to clipping also, provided a considerable vertical front porch is made part of the standard waveform (the early drawing by Mr. Bedford has been changed in this respect). The front porch is necessary to prevent picture variations from being carried over into the vertical synchronizing interval through the narrow pass-band circuits.

In the case of the 500-kc v-p signal, the bandwidth limiting prior to clipping takes the form of a resonant band-pass circuit that limits the signal accepted to about 10 kc in the region of 500 kc, thus improving the noise immunity. Indeed, with the 500-kc selection, it is not necessary to clip the signal except for the possibility of the presence of persistent 500 kc in the picture itself. It is conceded that, if other things were equal, it would be advantageous to place the pass band around 500 kc rather than in the low frequencies, in light of the kinds of disturbance that actually exist in television reception. However, as long

as a high-frequency carrier is used for transmission of the pulse, it is essential that pass-band circuits for the carrier pulse be twice as wide as the band required in the final rectified pulse.

The 500-kc v-p signal with resonant selection does not require the vertical front porch as a guard region for "forgetting" the picture region, as is required with the simplified R.M.A. signal. Therefore the front porch time may be reclaimed for picture time, reducing the period of vertical blanking, provided the operation of motion-picture equipment is made rapid enough to allow such reduction in vertical blanking.

The 500-kc v-p signal is well adapted to resonant isolation from the horizontals with immediate application as an r-f carrier to the grid of the blocking oscillator tube, in which case the blocking oscillator tube when conducting literally closes the gate to further input signal of either carrier or noise, yielding very uniform discharge cycles.

**Summary for Vertical.**—In summarizing the relative advantages of the three types of signal in regard to vertical synchronizing alone, it is evident that all types can obtain further noise immunity by frequency-band limitation before amplitude separation provided separate vertical and horizontal separators are used. All types of signal transmit the equivalent of a telegraphic "dot" for vertical synchronization, the 500-kc v-p signal transmitting the "dot" by a subcarrier. In either the R.M.A. or the 500-kc v-p signal, suitable filters, either *RC* or *LC* types, respectively, are used to integrate the amplitude-separated signals over any reasonable desired range, with similar restriction of the pass band and noise reduction for each chosen degree of integration (except that the 500-kc v-p signal over-all band must be twice as wide, because two sidebands of the subcarrier must be admitted). To counterbalance this effect, the 500-kc v-p signal has its pass band more favorably situated in the video spectrum in view of the low-frequency surges that occur in practical receivers. Very important is the fact that either signal can be made to provide good *vertical* synchronization to the limit of the service area as determined by the noise disturbance of the picture itself.

Vertical synchronization has generally been observed to be definitely superior to horizontal synchronization in the presence of strong noise, for all three types of signal. Theoretical con-

siderations have led to the conclusion that the superiority of the vertical over the horizontal may be due to a basic handicap of the horizontal caused by its higher frequency, though improvements in the vertical can and will be made from time to time. For this reason, we feel that that signal should be adopted which impairs the horizontals the least in the process of providing the vertical synchronizing information.

### HORIZONTAL SYNCHRONIZING PROPERTIES

The horizontal synchronizing pulses are essentially the same for all three types of signal except during the vertical blanking time. Hence so far as the signal outside the vertical blanking is concerned, the horizontal pulses can be utilized by differentiation, "as is" or by slight "integration." However, failure of horizontal synchronization during the vertical generally reacts upon the picture and therefore must be considered.

During the vertical pulses, all three types of signal make different provisions for horizontal synchronizing, and the provisions made are not ideal for any of the three types of signal.

**Differentiation.**—Differentiation has been the most commonly used method in the past, and the R.M.A. signal provides pulses during the vertical which are like those occurring during the remaining time, except that they are of double frequency (because of the equalizing pulses). Practically, for use by differentiation, this double frequency is harmful only in a so-called "flexible receiver" for variable standards and then only by making the oscillator trigger at double speed during this period, if the synchronizing signal applied to the oscillator is made so high as to "pull" the oscillator over a two to one speed range or more. (However, for such operation, the recovery can be made quickly enough to be nearly harmless, as in the RCA "driven" receiver.)

Any blocking oscillator of reasonable design will have a frequency stability high enough to avoid drift in its free-running frequency to as low as half the synchronous frequency. Therefore, by differentiation, the R.M.A. signal provides horizontal synchronization that is in no practical sense impaired by the vertical pulse and is therefore suitable for use in a receiver without manual horizontal frequency control. (The use of differentiation probably does not provide the maximum noise

immunity, but it has been found satisfactory in service and field tests of the greatest scope.)

The simplified R.M.A. signal has essentially the same efficiency for horizontal synchronization when isolated by differentiation as cited above for the R.M.A. signal. It differs from the R.M.A. in that the double-frequency pulses are not present, which would be an advantage only for a "flexible" receiver.

The 500-kc v-p signal is adapted for isolating horizontal synchronizing pulses by differentiation provided the 500-kc component is first removed by a filter. The synchronizing pulses obtained during the vertical by filtering and differentiating alone are about 36 per cent of those obtained during picture time, but, by suitable non-linear-amplitude devices, all isolated pulses can be made uniform (see Fig. 78). The noise immunity of the horizontals is then reduced only for the time of the vertical. This is a greater disadvantage in receivers having a free-running horizontal frequency very close to synchronous frequency. If, in such a receiver, noise causes "fall-out" during the vertical, then the horizontal oscillator will not drift into synchronization for an appreciable length of time. For example, if the free-running oscillator frequency is approximately 2 per cent below synchronous, the upper quarter of the picture would be out of synchronism immediately following a fall-out during the vertical.

**Synchronization with Pulses "As Is."**—The R.M.A. signal is adapted for use for horizontal synchronization "as is" (*i.e.*, without either differentiation or integration) when applied effectively between the grid and cathode of a blocking oscillator tube. The leading portion of all pulses, which is the effective portion with this mode of operation, is identical for all horizontal deflection cycles, but the trailing portions of various pulses differ. Hence, the horizontal synchronization is entirely unimpaired during the vertical if the operating conditions are made such that the trailing portions of the pulses are not effective. The trailing portions of the vertical pulses extend to a time 8 per cent of a line ( $0.08 \cdot H$ ) before the useful leading edge of the next following pulse. Hence, it is required that the free-running frequency of the horizontal oscillator be between 0.92 and 1.00 times the synchronous frequency. If this requirement is met, the double-frequency pulses are not objectionable either.



The simplified R.M.A. signal is adapted for horizontal synchronization "as is," with the same limitations of free-running frequency as the R.M.A. signal.

The 500-kc v-p signal is adapted for horizontal synchronization nominally "as is," by first filtering out the 500-kc component to remove the serrations from the horizontal pulses. In doing this, the horizontal pulses, during the vertical, are reduced to 36 per cent of the height of the other horizontals as measured from the horizontal pulse peaks down to the adjacent "pedestal" level (see Fig. 78). By the somewhat difficult process of clipping at suitable levels after filtering, a signal is obtained in which the horizontals are equal and uniform. The signal, therefore, is applicable for either "driven" oscillators for flexible receivers or for lightly driven oscillators with near-synchronous free-running frequency.

However, the signal thus obtained is more subject to the effects of noise during the vertical than at other times, because high-frequency noises during the actual horizontal pulses as well as noise occurring between the horizontal pulses can more readily "reach" into the clipped level. Also, the presence of low-frequency noise or surges can more readily cause the desired section of the signal to "duck down" or "bob up" and escape the clipping level. This lesser noise immunity during the vertical would not be objectionable for the "driven" oscillator receiver, because recovery of synchronization would occur quickly after a "fall-out" during the vertical. The disadvantage will occur for an oscillator set near synchronism, as was cited for the 500-kc v-p signal with differentiation.

**Integration.**—The R.M.A. signal, the simplified R.M.A. signal, and the 500-kc v-p signal are all adapted for horizontal synchronization by integration by  $RC$  networks or other circuits. Use of the three signals by integration is attended by the same requirements and limitations, respectively, that were given for the signals when used "as is."

With the R.M.A. signal, a lesser degree of integration of the horizontals must be used because of the narrowness of the equalizing pulses as compared to the simplified R.M.A. signal and the 500-kc v-p signal.

For example, if a single stage of  $RC$  integration with time constant of 0.03 H is used, the integrated equalizing pulses will

be reduced to only about 80 per cent of the integrated normal horizontals.

However, if a suitable single stage of inductance-compensated  $RC$  circuit is used for the "integration," then the equalizing pulses can be integrated to yield the same amplitude as the normal horizontals.

**Conclusion.**—It should be pointed out that, when integration is used for the horizontals of any of the three types of signal, the horizontal triggering time may be delayed (depending upon oscillator frequency setting) and thus reduce the time allowed for horizontal retrace. However, reasonable circuits are known, operating on the a-f-c principle, which can cause triggering in advance of the synchronizing pulse and thus would be practical for high-quality receivers where integration is desired to yield greater noise immunity.

The use of synchronizing amplifiers having reduced high-frequency response comprises a sort of "integration," which is used in the interest of economy in many present receivers. In order to facilitate this practice and prevent the picture's cross-talking into the horizontal synchronization, it is hereby proposed that the blanking before the pulse (sometimes called the "front porch") be lengthened to at least 0.02 H, which is equally advantageous for any of the three signals.

#### PRACTICAL CONSIDERATIONS

One of the several practical features that was not treated in the above discussion is the cost and complication of the synchronizing-signal generator. Of all three signals, the 500-ke v-p signal is the least complicated to generate because the wave, though not simple in shape, is produced by rather simple electric circuits. The simplified R.M.A. signal is next, and the R.M.A. is the most complicated because of the addition of the double-frequency pulses. It should be appreciated that a great deal of the complication of the synchronizing-signal generator is required merely to obtain reliable and accurate master pulses of the 13,230- and 60-cycle frequencies having a synchronous relation with the power system and hence is independent of which of the three types of signal are generated. Portability of the apparatus is probably more important than low cost.

TABLE IX.—SUMMARY

	R.M.A. signal	Simplified R.M.A. signal	500-kc v-p signal
<b>Vertical:</b>			
Interlace . . . . .	O.K.	O.K.	O.K.
Low noise synchronization . . . . .	O.K.	O.K.	O.K.
Medium noise (pictures usable) . . . . .	O.K.	O.K.	O.K.
Very bad noise (pictures of doubtful utility)	Workable but unsteady	Same as R.M.A.	Steady
Known to be adaptable to significant improvement beyond that demonstrated? . . . . .	Yes	Yes	Yes
Adaptable to cheap receiver with acceptable performance? . . . . .	Yes	Yes	Yes
Adaptable to better receiver with better performance? . . . . .	Yes	Yes	Yes
<b>Horizontal:</b>			
Requirements for use by differentiation	Free-running frequency must remain between 0.5 and 1.0 times synchronous frequency	Free-running speed from zero to synchronous speed	Must filter out 500-kc component before differentiating
Effect of vertical on horizontal when differentiated	None	None	Horizontal is weakened and is more susceptible to noise during vertical
Requirements for use "as is"	Free-running frequency must be between 0.92 and 1.0 times synchronizing frequency	Free-running frequency must be between 0.92 and 1.0 times synchronizing frequency	Must remove 500-kc component. No free-running frequency lower limit, thereby facilitating "driven" type receiver
Effect of vertical on horizontal when used "as is"	Slight increase in noise susceptibility during narrow width of equalizing pulses	None	Amplitude reduced to 36 per cent
Requirements for use by integration	Free-running frequency must be between 0.92 and 1.0 times synchronizing frequency	Same as for R.M.A.	No free-running frequency lower limit
Effect of vertical on horizontal when signal is integrated	Equalizing pulse reduced to 80 per cent for <i>RC</i> . None for <i>LRC</i> integration	None	Amplitude reduced to 36 per cent
Bandwidth before the amplitude separator admitting noise during entire time.	0.6 Mc	0.6 Mc	1.2 Mc

More important is the cost and performance of the receivers in which extreme simplification is sought in order to reach the great low-price market that must be the basis for a national television service.

#### STATEMENT TO PANEL 8<sup>1</sup>

It has been agreed that both the R.M.A. signal and the 500-kc v-p signal as demonstrated provided vertical synchronization that was at least almost good enough to be above reproach for those conditions of noise in which the picture was not useless because of noise in the picture. It was also agreed that the vertical synchronization was very much better than the horizontal insofar as the effect on picture quality and resolution is concerned.

Dr. Goldsmith and the author described in a joint report (pages 264-278) simple methods that they agreed would significantly improve the vertical further for either type of signal. (Tests in the RCA laboratories since the demonstration have determined the validity of the methods as applied to the R.M.A. signal.) It was also agreed that the vertical in general has an inherent advantage over the horizontal. (This is due to the smaller absolute accuracy of timing required, which in turn can be obtained with a more narrow frequency band with its smaller admission of noise.) It is therefore believed that the horizontal synchronization provides the most important basis for a choice between the R.M.A. and the 500-kc v-p signal.

Figure 78 demonstrates that the horizontal pulses of the 500-kc v-p signal are greatly reduced during the vertical and that, to obtain even these weakened pulses, it is required that the frequency band admitting noise and signal to the amplitude separator be approximately twice as great as for the R.M.A. signal. The greater noise admitted owing to this bandwidth directly increases the noise susceptibility of the horizontal during picture time as well as during the vertical. (It is true that the 500-kc v-p signal can if desired be used with a bandwidth limitation before amplitude separation the same as for the R.M.A. signal, but Dr. Goldsmith has not recommended it because it entails noise susceptibility due to other effects.)

The horizontals provided by the 500-kc v-p signal are further subject to noise because of their reduced amplitude, even though,

<sup>1</sup> A. V. Bedford, RCA Manufacturing Company, Inc.

by a precise job of clipping out the center of the wave  $B$  of Fig. 78 (in the joint report), all output pulses can be made identical. This can be seen in the figure by observing that noise on the peaks such as  $h_2$  can reach into the clipped out section more readily than noise on the normal horizontal peaks such as  $h$ .

Hence it is evident that the isolated horizontals obtained from the 500-kc v-p signal are considerably more susceptible to noise for all the picture time and have even more susceptibility during the vertical.

Now consider the horizontals for the R.M.A. signal. Triggering of the oscillator is caused by the front portion of each pulse occurring at the horizontal frequency, regardless of which of the three methods of treatment is used. It is only necessary that the free-running oscillator frequency be such that double-frequency pulses and the trailing ends of the vertical pulse do not cause spurious triggering. The limitations of free-running frequency were agreed upon in the joint report.

If differentiation is used, the free-running frequency can be between 50 and 100 per cent of synchronous frequency. This requirement is so lenient that even the cheapest oscillator should meet it without difficulty. Hence the double-frequency pulses will not interfere with the design of a receiver without manual speed controls. Differentiation provides a very satisfactory method of operation, as was demonstrated by the standard TRK-120 receiver in the Passaic and Haddonfield tests. It will also be seen by a study of circuits that an R.M.A. receiver using differentiation to provide really uniform horizontals for all the time can be made less expensive than a receiver for 500-kc v-p signals, which has all the tubes and circuits for the various processes that are necessary to obtain moderately good horizontals during the vertical.

If it is desired to use the R.M.A. signals "as is" integrated with the hope of higher noise immunity that might be expected in a better receiver, the oscillator stability must be such that the free-running frequency is between 92 and 100 per cent of synchronous, or else manual "frequency control" must be provided. Actually only reasonable precautions are necessary to obtain this stability.

The most straightforward well-known method available for improving the horizontal immunity to noise is to apply less

isolated synchronizing signal and correspondingly less noise to the horizontal oscillator in the receiver. (This has been done to advantage in many receivers in the Camden area working on the Empire State signal.) This, however, requires a closer setting of free-running frequency which can be provided in any one of many ways.

With such proper procedure in design, to get further noise immunity, a "fall-out" of horizontals during the vertical is more objectionable, because recovery is slow and a disturbance extends well into the top of the picture. Here again the better type of receiver is favored by the R.M.A. signal, which was found to provide uniform synchronization during the vertical when the free-running-frequency requirements are met.

In conclusion, it has been shown that (1) the horizontal synchronizing performance should be favored in choosing the synchronizing signal; and (2) the R.M.A. signal provides more nearly noise-free and effectively more uniform horizontal synchronizing signals than does the 500-kc v-p signal, both in the inexpensive class of receiver and in the better class of receiver.

Therefore the R.M.A. type of synchronizing signal is recommended for adoption by Panel 8 of the N.T.S.C.

#### RECOMMENDATION TO MEMBERS OF PANEL 8<sup>1</sup>

In brief summary, we have carefully studied three synchronizing waveforms, namely, the R.M.A., the simplified R.M.A., and the 500-kc carrier-pulse type of signal. Upon analysis, we find that all three signals have certain deficiencies in respect to the horizontal synchronization, but, on careful analysis, it is seen that the 500-kc signal can produce uniform horizontal signals of equal amplitude with suitable clipping and of equal duration, capable of use with differentiation, as is, or by slight integration. The signal further allows complete range of synchronization and freedom from restrictions as to specific free-running speeds.

The vertical synchronizing information has a variety of means of utilization, all of which are capable of excellent performance. Both theory and test show that it is inherently more precise than the R.M.A. or simplified R.M.A. waveforms under the actual television operating conditions encountered in the field.

<sup>1</sup> Allen B. DuMont, Dumont Laboratories, Inc.

It is very definite that this signal is fundamentally simple to generate and therefore adaptable to lightweight equipment of extremely dependable performance.

I hereby recommend that the 500-ke v-p carrier type of synchronizing signal be accepted by this panel for national television standardization.

#### OTHER REPORTS ON SYNCHRONIZATION

Two reports are reproduced in the following pages: "Synchronizing Signal Characteristics" (with particular reference to the 500-ke pulse system) by Campbell and Lempert; "Characteristics of Vertical Synchronizing Signal Separator Circuits" by G. R. Town.

#### SYNCHRONIZATION-SIGNAL CHARACTERISTICS<sup>1</sup>

##### INTRODUCTION

In setting standards for a nation-wide television service, as much room as possible must be left for future improvements. One has only to look at the 1920 loud-speaker, which is still capable of performance on sound-broadcast service today, to realize the problem that confronts the television engineer. It is obvious that pictures 10 years from now are going to be an enormous improvement over today's performance. The immediate problem to consider, then, is "Will our sets of today work on the vastly improved signals of 2, 5, or even 10 years hence?"

One of the considerations has to do with synchronization. It seems logical therefore, to incorporate as much flexibility in lines and frames as possible, in order to make the receivers of today (or next year) capable of "seeing into the future." This brings up the automatic synchronization type of receiver. Even without flexibility, the automatic receiver is a practical necessity, for it is probable that the public will not accept speed controls for very long.

Basically the automatically synchronized receiver problem is one of signal-to-noise ratio. The early fathers of present-day radio were confronted with the same problem in establishing the first transoceanic communication service. A great deal of water has passed over the dam since. One thing is certain, however, and that is that phenomenal improvements in signal

<sup>1</sup> R. L. Campbell and Irving Lempert, Allen B. DuMont Laboratories, Inc.

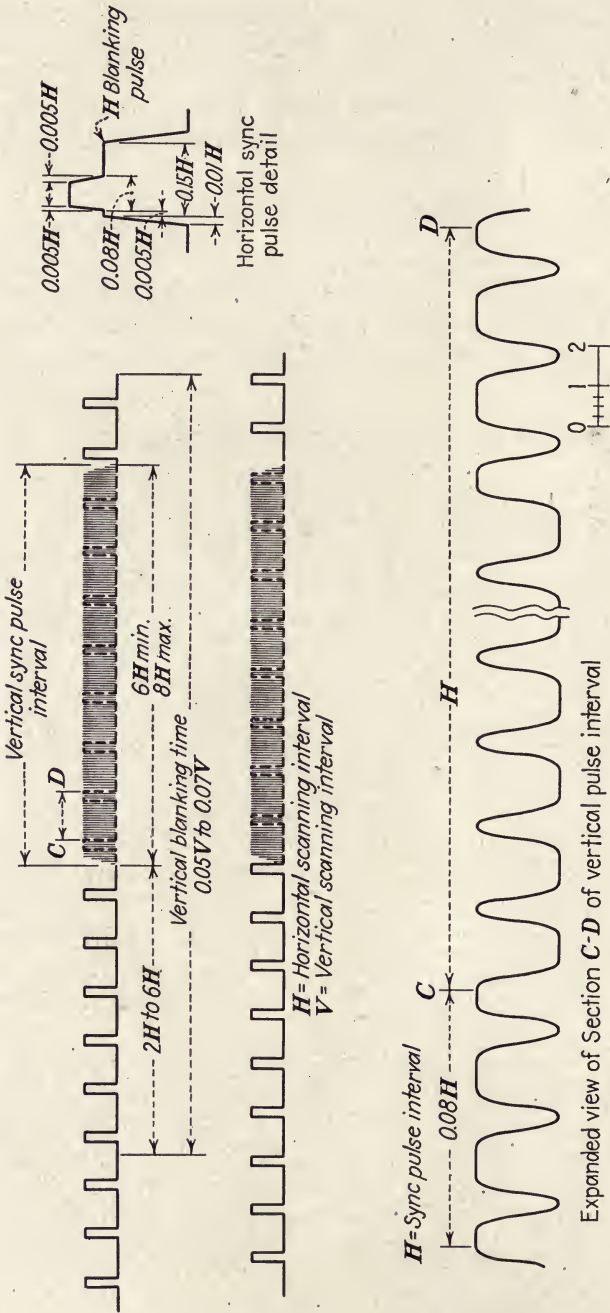

Microsecond scale  
Expanded view only

Fig. 80.—The DuMont synchronizing waveform. (Campbell and Lempert.)



transmission and other achievements in the radio, automobile, or any modern industry were not accomplished by proving that "it can't be done."

One approach to the signal-to-noise problem is to study the characteristics of various synchronizing signals and to cross-check these studies with experimental verification that often leads to conclusions not easily found by purely theoretical means.

Among the aims of the DuMont laboratories has been the development of a flexible synchronizing system that will allow future improvements to be incorporated in the television system and still require little or no change in receiver sweep circuits. Several different types of synchronizing signal were proposed, and many were tried experimentally during the course of these investigations. In addition, several hundred receiving sets were built to receive the NBC transmissions from the Empire State building and were placed in the hands of the public. The combined results of the above experiences have led us to believe that the type of synchronizing wave shown in Fig. 80 is the most satisfactory for adoption at the present time.

The advantages of the signal shown in Fig. 80 will now be reviewed briefly; they are:

1. The use of the h-f pulses for vertical synchronization permits the use of a highly efficient method of synchronizing-signal isolation (namely, use of resonant circuits) based on certain well-known principles and years of experience in the radio-communication field.

2. Because the field pulses can be isolated so well, tighter field oscillator lock-in can be used without detrimental effects on the synchronizing performance.

3. The possibility of "driven" vertical sweep circuits is not ruled out by this type of signal, since better exclusion of low-frequency noise components is attained than when an l-f type of pulse is used.

4. The line pulses during the field scanning interval need not be penalized in order to allow transmission of field synchronizing information.

5. In the case of the R.M.A. and the "long-integration" pulses, differentiation of the horizontal signal is necessary in order to exclude the l-f components of the vertical signal. The h-f type of pulse has little or no "audio" frequency components in the transmitted signal.

6. A much simpler synchronizing-signal generator is possible with the type of wave shown in Fig. 80, since only two separate signals are involved in making up the composite synchronizing wave.

7. Field tests of this type of signal have been carried out for over a year on several different low-power transmitters (50 watts and less), and satisfactory reception with respect to synchronizing stability has been attained with this low power up to distances of 15 miles.

8. Field tests on high power using the Empire State transmitter definitely proved the h-f pulse type of field synchronizing signal

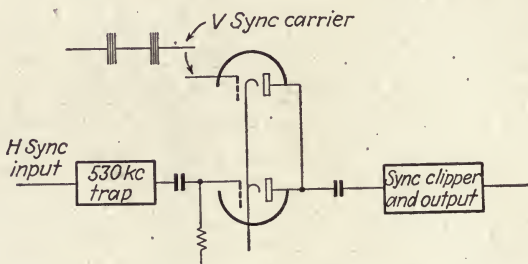

FIG. 81.—Circuit for removal of the 530-kc component in horizontal pulse. (Campbell and Lempert.)

superior to either the R.M.A. or ultra-long-time integration signals. This was found to be the case on vertical synchronizing stability with a weak signal in the presence of noise at a remote location from the transmitter.

#### THE COMPOSITE SYNCHRONIZING-SIGNAL WAVE

**Points in Connection with Development of Synchronizing Wave in Fig. 80.**—In the early stages of development of this synchronizing wave, a frequency of 264.6 kc was used for the field-carrier pulses, principally because equipment for generating the carrier at this frequency from the line pulses was already available. The signal used was essentially the same as shown in Fig. 80, with the exception that the pulse-carrier frequency was lower. A considerable number of tests and trials indicated very promising results, with respect to vertical synchronizing stability, horizontal tear-out, and especially operation on driven circuits.

However, it was felt that the vertical synchronizing energy content could be improved if the gaps between the half-wave cycle were filled in. Accordingly, a circuit using high-speed full-wave rectification such as that shown in Fig. 82 was developed. The output of this circuit mixed with the line pulses was then transmitted to the receiver, and the associated circuits were retuned to 529 kc (approximately). Considerable difficulty was experienced with low-frequency components introduced in the rectification circuits, and the disturbance to the horizontal synchronizing was found to be greater, while no gains in vertical synchronizing performance were noted.

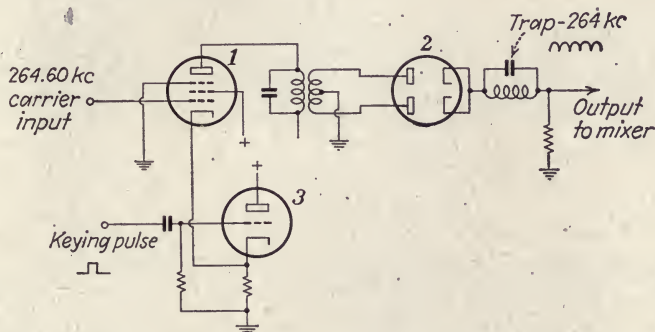

FIG. 82.—Full-wave rectified carrier circuit for vertical synchronizing pulse wave (Campbell and Lempert.)

Following these tests, the carrier at the synchronizing generator was shifted to 529 kc, and half loops of this carrier were transmitted at this frequency for vertical synchronization. This arrangement was found to operate in essentially the same way as the previous arrangement using 264 kc, excepting that, as would be expected, the tuning was found to be less critical, owing to the increase in frequency separation between the two types of synchronizing information. The simplicity of circuits involved and the quality of the field synchronizing performance led to the conclusion that the half-wave type of carrier pulse was adequate. Consideration of the full-wave type of field pulse has further led to the conclusion that trouble would be experienced owing to the higher order harmonics involved in maintaining this wave.

Another scheme that has been considered a logical development is to eliminate the possible harmonics in the line synchronizing

information falling within the field-pulse band. Before mixing, a filter was inserted in the mixing amplifier (Fig. 81) operating on the line pulses to attenuate components in the region of the field-pulse carrier. It was interesting to note that mistuning and other poor adjustments at the receiver could be tolerated more when this filter was used on the synchronizing generator. It is admitted that the harmonics in question might be reintroduced in the case of severe distortion in the transmission channel, but it is also worthy of mention that, with the proper adjustment at the receiver, no difference in performance could be noted with the filter in or out.

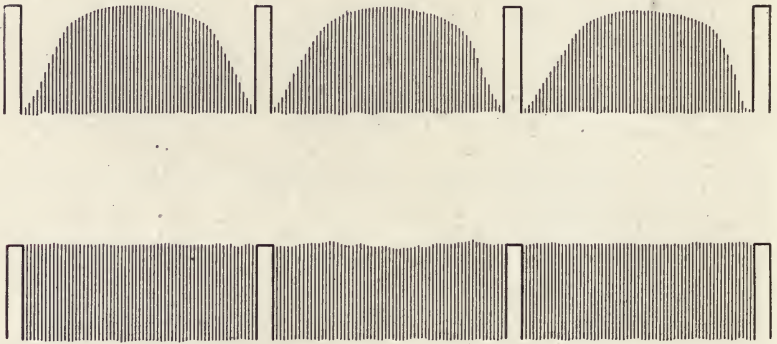

FIG. 83.—High-frequency vertical synchronizing pulse wave, with notches for insertion of the horizontal pulses. (*Campbell and Lempert.*)

Although some disturbance to the line pulses during the field-pulse interval can be attributed to the chopping of the pulses by the field-pulse energy, in general the effects are not serious with proper treatment of the line-pulse wave train at the receiver. It is possible to isolate the line pulse so well that, even when tight lock-in is used, or on completely driven type circuits, it is difficult to ascertain where the field pulse occurs when the field scanning is dropped to half speed and the edges of the scanning raster are observed with no modulation on the cathode-ray tube grid.

During the course of development, however, it was considered desirable to test the signal with the field-carrier pulses notched during the line-pulse interval. A serious difficulty crops up here, however, in that a strong modulation at the line frequency occurs in the field-pulse wave. This required special circuits

at the receiver to maintain the interlace quality, and in general the improvement in the line pulses did not appear as would be expected. Figure 83 shows the signals that were used during these tests.

Because the modulation in the field-carrier pulses by the line frequency made the receiver more critical as to interlace stability, it was decided to notch the carrier pulses at twice line frequency in order to improve the symmetry. This was done, and, although an improvement in vertical interlace stability was noted at the receiver with the double-frequency serrations, a serious defect

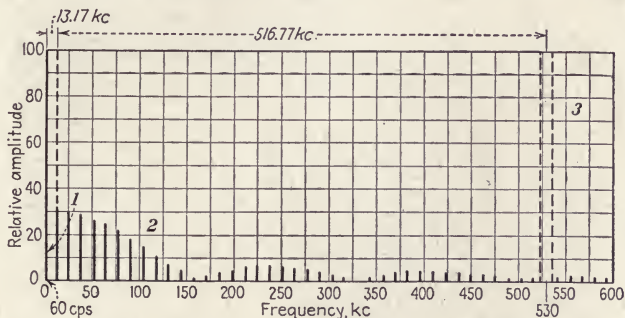

FIG. 84.—Frequency spectra: (1) low-frequency nonserrated field pulse; (2) 8 per cent line pulse, 13,230 c.p.s.; (3) high-frequency field pulse. (Campbell and Lempert.)

cropped up in the horizontal circuit owing to the twice-line-frequency component.

Therefore, it was concluded that the wave of Fig. 80 was the best all-round signal in that it gave a practically symmetrical field pulse at the receiver and satisfactory continuous line pulses without the necessity for complex apparatus at the synchronizing generator, which would perform additional operations on the synchronizing wave at the expense of either field- or line-synchronizing stability.

**Frequency Spacing between Different Types of Synchronizing Information.**—Figure 84 shows why it is much easier to isolate the field pulses when h-f carrier pulses are used. As can be seen, the frequency separation between low-frequency type field-pulse fundamental and the line-pulse fundamental is approximately 13.17 kc. In the case of the h-f type of pulse, this separation is much greater, since the fundamental of the line

pulses is 516 kc away from the carrier-pulse fundamental. In this discussion, the harmonics introduced by serrating the l-f type pulse and all the frequency components of the equalizing pulses that are a part of the vertical synchronizing information have been ignored. This is principally due to the fact that a theoretical and/or measured analysis on that part of the R.M.A. type of signal used for vertical synchronizing information is not available at this time.

### SEPARATION OF THE SYNCHRONIZING COMPONENT FROM THE PICTURE COMPONENT

In Fig. 85 is shown a synchronizing separating circuit that "clips" or "skims" the synchronizing component from the video component of the television signal. Referring to this diagram,

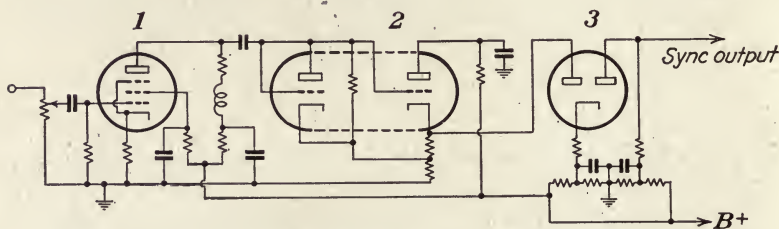

FIG. 85.—Synchronizing separator circuit. (Campbell and Lempert.)

tube No. 1 acts as an amplifier to furnish the proper phase and amplitude of signal. Tube No. 2 is a combined d-c level control and synchronizing separator driver. The actual separation is done in tube No. 3, which is a low-impedance diode acting as a synchronizing clipper and noise limiter.

This type of circuit has little if any tendency to block in the presence of noise and is not critical to level. Measurements on this circuit indicate that adequate separation of the synchronizing component is maintained when the input video signal is varied from approximately 0.25 to 5 volts or more.

It is interesting to note that, although this circuit separates equally well on synchronizing signals of either the l-f or h-f type of pulse, it can be adjusted to "clip" only a small portion of the synchronizing signal, and, when this is done, no ill effects on the field synchronizing performance are observed when such clipping is applied to signals having the h-f type field pulse.

Further, the separation is done in relatively low impedance circuits, and, therefore, will not "block" in the presence of strong noise signals. When the output of this circuit is used to feed a tuned circuit type of field synchronizing selector (operating on the h-f type of pulse), extremely stable vertical synchronization is obtained even under abnormal noise conditions and using a high degree of lock-in.

### VERTICAL OR FIELD SYNCHRONIZATION

As a result of many experimental and theoretical observations, the h-f type of pulse was found to be superior for field syn-

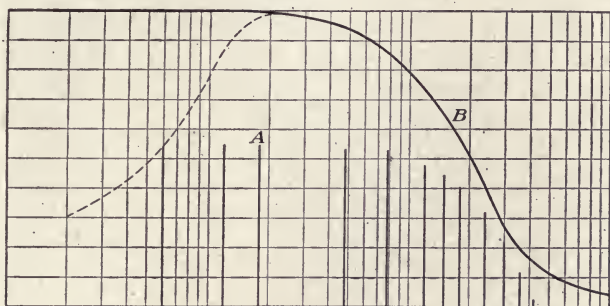

FIG. 86.—(A) Calculated wave analysis of the low-frequency type of pulse; (B) calculated response of low-frequency selector circuit. (Campbell and Lempert.)

chronization, chiefly because of the l-f character of artificial noise signals and like disturbances.

**Driven Circuit Operated from Low-frequency Types of Field Pulses.**—Because of the l-f components of many types of noise, signal variations, and power-line fluctuations, it is quite difficult to isolate a field synchronizing signal of the l-f type and exclude the above-mentioned disturbances. Consequently, a tightly locked, or "driven," field synchronizing circuit will "bounce" when certain noise signals occur. The reason for this is that the transmission path for field synchronizing information is responsive to the above-mentioned disturbances.

Referring to Fig. 86, this can be explained further by noting the response characteristic of a circuit designed to filter out an l-f type pulse. A harmonic analysis of a square pulse corresponding in duration to the R.M.A. T-111 pulse (neglecting

the serration at twice line frequency) is also shown. Although the network will transmit most of the l-f energy in this type of pulse, it is equally responsive to components of noise in this region.

#### **Driven Circuits Operated from h-f Type Field Pulses.—**

Experimental observations have been made in this respect, and it has been found that the disturbing factors in general are the l-f variations in the channel that come through with the signal. Now, in the case of h-f selection, the circuit used will exclude such variations; and the system becomes more stable in this respect. It can be argued that an l-f disturbance will modulate the h-f type of pulse and thus cause trouble, but, if such an effect did occur, it could easily be remedied by using saturation type limiting, similar to that used in f-m systems. A noteworthy observation is that the carrier pulses can be distorted in almost any fashion and still be restored to substantially sinusoidal shape through use of a tuned amplifier. In this respect, the carrier-pulse system can be likened to the well-known Class C system for r-f amplifiers.

Figure 87 shows a synchronizing separator circuit that works very well for applying the synchronizing wave of Fig. 80 to blocking oscillator type sweep circuits (in the figure, 4 and 6 are the blocking oscillator tubes).

The free-running frequency of the field oscillator (tube 6) can be made as low as one-fifth to one-tenth of the synchronized frequency without encountering difficulty in respect to either interlace or synchronizing stability. It will be noted that a "clipper" (tube 2) of the type shown in Fig. 85 is used for separation of the synchronizing component from the video component.

**Antinoise Circuit for Field Synchronization.—**A circuit for aiding in prevention of premature firing of the vertical circuit is shown in Fig. 88. Dr. T. T. Goldsmith has already pointed out that a blocking-tube oscillator has noise-limiting properties after firing when operated from a tuned circuit. In the circuit referred to above, noise limiting on sharp peaks of short duration between firing intervals is accomplished by means of a diode in series with an *RC* network, which is shunted across the tuned circuit used to select the h-f type of vertical pulse. The time constant in series with the diode is adjusted so that the field-pulse



wave reaches a maximum before the end of the field-pulse interval. Thus, sharp peaks of noise whose duration is shorter than the synchronizing interval will be effectively grounded by the diode. This type of limiter differs from the "gate" type in that it operates on noise pulses below as well as above the

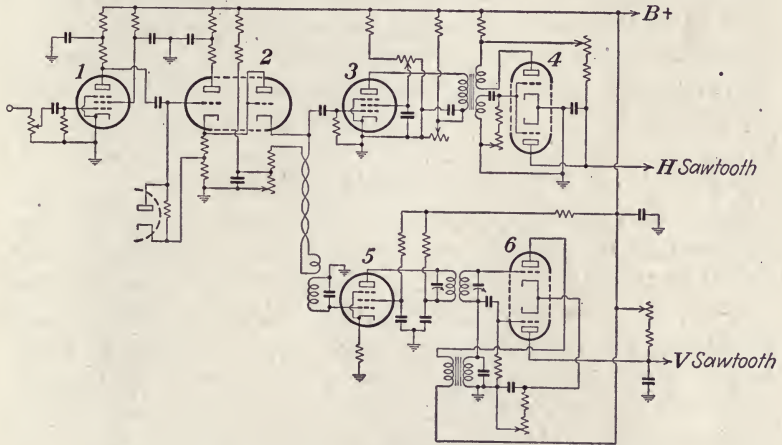

FIG. 87.—Pulse separator circuit. (Campbell and Lempert.)

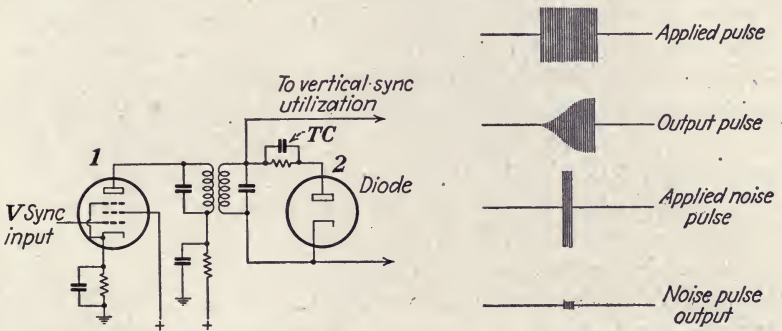

FIG. 88.—Noise-reduction circuit for vertical synchronizing. (Campbell and Lempert.)

signal amplitude. A closer examination of the circuit shows that it is similar in many respects to the "long-time integration" circuits proposed by Bedford, but having the marked advantage that the transmission channel for vertical synchronizing does not allow passage of components of noise that lie in the audio-frequency spectrum.

The use of such a circuit would be one method of obtaining an equivalent time constant of 500 microseconds without resorting to costly if not practically impossible coil designs to obtain the effective time constant. However, because of the wide frequency spacing, together with high signal-to-noise energy content, no such effective time constant is needed in connection with the h-f type of vertical pulse wave, and it is useless to pursue this point further. In passing, however, it should be mentioned that the circuit of Fig. 88 was used in our experimental driven receiver about a year ago and showed an advantage on certain types of noise.

### HORIZONTAL SYNCHRONIZATION

Analysis of synchronizing-pulse waveforms and certain types of circuits that have been considered essential to satisfactory line synchronization performance with the R.M.A. synchronizing wave show that some sacrifice is involved in synchronizing stability and noise immunity. Also it is quite evident that loose lock-in is essential because of the fact that the vertical synchronizing information replaces the horizontal synchronizing pulses during the vertical synchronizing pulse interval, and the synchronizing wave is further disturbed by the presence of equalizing pulses. It will be shown that loose lock-in is necessary only from a standpoint of noise because of the peculiar operations to which the horizontal synchronizing pulses must be subjected in order to get continuous horizontal synchronizing (except for the presence of equalizing pulses from the R.M.A. synchronizing wave train).

In the case of the r-f type of vertical pulse, no sacrifice of horizontal synchronizing energy is involved during the normal line-synchronization intervals. Because this type of synchronizing wave is designed for frequency selection rather than "wave-front" selection, it is possible to utilize the horizontal pulses at the receiver without resorting to differentiating or integrating operations that may involve a considerable loss in energy.

In both the R.M.A. and "long-integration" type of synchronizing wave, there are a considerably greater number of l-f components owing to the vertical synchronizing information inserted in the horizontal wave train than with a signal using an h-f vertical pulse. Since these l-f components are many cycles

closer to the horizontal synchronizing information than the frequency content of the h-f type of pulse, it follows that a better job of separation can be done on the signals having the wider frequency spacing.

**Differentiation of Line Synchronizing Pulses.**—An examination of the R.M.A. synchronizing signal shows that loosely locked oscillators are required for this type of wave. Because of the presence of the field pulses and the equalizing pulses in the line synchronizing wave train, considerable l-f signal component is introduced into the line oscillator circuit unless differentiation of this signal is employed. The differentiating process wastes a good deal of the transmitted line-synchronizing pulse energy, as will be evident from Fig. 89.<sup>1</sup> It has been claimed that loosely locked-in oscillators are less susceptible to noise, but, if the reasons for loose lock-in on some line-synchronization circuits are examined, the following becomes apparent:

1. Differentiation of line-synchronizing signals tends to decrease the signal-to-noise ratio and thus inherently requires a loose lock-in.

2. With the R.M.A. type of pulse, differentiation is necessary in order to exclude relatively low frequency component of the field pulse from disturbing the separated line-synchronizing wave train.

3. The R.M.A. type of pulse further requires a loose lock-in because of the double-frequency pulses and serrations during the field-pulse interval.

Figure 89 shows a theoretical wave analysis of an 8 per cent horizontal pulse, and plotted on this same sheet is a response curve of a commonly used differentiation network.<sup>2</sup> It is readily apparent from inspection of these curves that a great deal of the synchronizing information in the horizontal pulses is excluded by the network, and consequently the signal-to-noise ratio must suffer. This explains in part why loose lock-in is not only desirable but essential with this type of circuit.

It should be pointed out here that the differentiation process is applied to each and every line pulse and that the signal-to-

<sup>1</sup> For simplicity in illustration, the relative amplitudes of harmonics given in Figs. 84, 89, and 90 are all shown as positive sign.

<sup>2</sup> See Fig. 12, pp. 14, 15, 16, *Practical Television* by RCA; also *RCA Service Manual*, Model TRK 120.

noise ratio is consequently reduced during all intervals of horizontal synchronization.

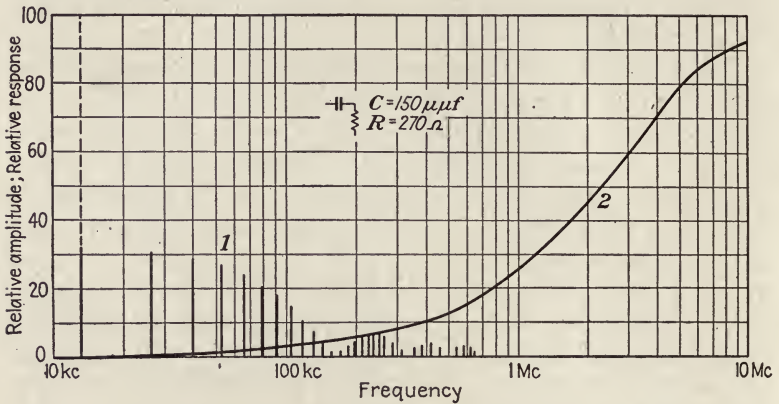

FIG. 89.—(1) Calculated harmonic analysis, 8 per cent 13,230-c.p.s. square pulse; (2) frequency response curve, typical differentiation network. (Campbell and Lempert.)

**High-speed Integration of Line Pulses.**—Figure 90 shows an improvement to be gained in signal-to-noise ratio if the frequency

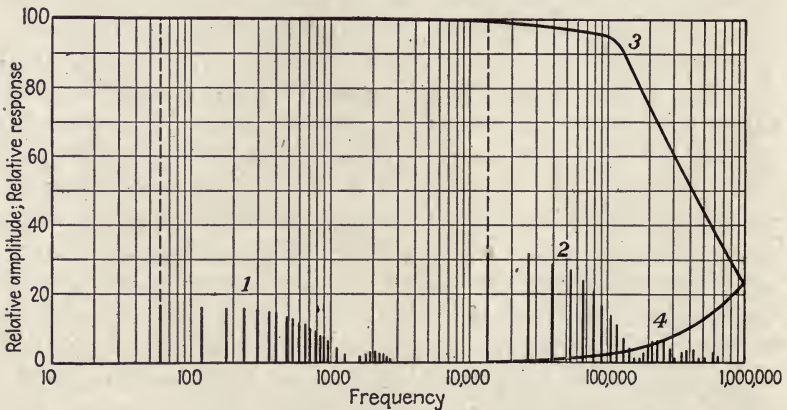

FIG. 90.—(1) Calculated harmonic analysis of the low-frequency wave, 700- $\mu$ sec. duration, 60 c.p.s.; (2) calculated harmonic analysis of 8 per cent 13,230-c.p.s. horizontal synchronizing wave; (3) response curve, typical high-speed integration circuit; (4) response curve, 150- $\mu\mu f$  270-ohm differentiation circuit. (Campbell and Lempert.)

response of the selective circuit is made to fall off beyond the region of high energy content of the horizontal synchronizing

pulses. Two disadvantages can be noted here if the R.M.A. synchronizing wave is used.

1. The system is then responsive to the field synchronizing energy, because the principle of differentiation is no longer used.

2. Early triggering of the line pulses is prevented owing to the delay introduced by the integrating network.

In general, it appears that high-speed-integration networks would be somewhat more desirable with loosely locked-in oscillators, but they have the disadvantage of being capable of passing the discontinuity in the R.M.A. synchronizing waveform (namely, the vertical synchronizing information), and consequently will cause trouble in tightly locked or driven line oscillator system.

### NOISE IMMUNITY

There are three main types of interference commonly encountered in television reception: interference that is continuous and has no particular predominant frequency; interference at a particular frequency; and strong impulse interference. Examples of interference of the first type are thermal noise, tube noise, and the aggregate of many interfering signals from different sources, such as might be received at a poor location some distance from the transmitter. Examples of interference having a particular predominant frequency or band of frequencies after detection are diathermy (which is usually modulated at 60 cycles), sound broadcasting (which gives interference at audio frequencies after detection), and radio-telegraph signals. Ignition noise is typical impulse interference.

The first type of interference referred to above is usually assumed to be random in nature, *i.e.*, to have no predominant frequency or band of frequencies. It has been shown that the random noise accepted by a circuit of given gain is proportional to the width of its pass band. Hence, the most desirable type of signal for discriminating against random noise would be one having a maximum of its energy in a minimum bandwidth. With the 500 kc pulse, practically all the energy is concentrated in a narrow channel in the vicinity of 500 kc, and this channel is in the unattenuated portion of the band-pass characteristic of the resonant circuit. At either side of this channel, the gain of the circuit decreases very sharply. All the usable energy

is passed, with a minimum of extraneous energy. This efficient selection is in sharp contrast to that of the l-f "integrating" circuits used for synchronizing pulses such as the R.M.A. pulse, where the band-pass characteristic of the selective circuit is very broad, thus attenuating useful signal energy in the upper part of its band, but at the same time passing extraneous energy due to poor cutoff characteristics of such systems.

Another important type of interference is that type which has a definite frequency or frequencies after detection. The commonly encountered interference of this type is all of comparatively low frequency. Examples are sound modulation, 60-cycle modulation of diathermy, and telegraphic keying. Interference of this type falls in the pass band of the vertical separating circuits for the R.M.A. synchronizing signal. It will therefore affect vertical synchronization, particularly in inexpensive receivers without elaborate clipping circuits. The usual effect of l-f interference is to displace the entire signal, so that the clipper circuits clip the synchronization off at a different point than usual. This will result in serious interference with vertical synchronization in less expensive receivers that do not have the elaborate clipping circuits, because the amplitude of this vertical pulse will change, and the slow integrating circuit will therefore require a different length of time to bring the signal up to the amplitude needed for triggering. Even the most elaborate receivers, with clipping circuits designed to keep the pulse amplitude constant regardless of displacement of the pulses, will suffer under strong interference, since the blanking and video will be passed by the clippers and by the integrating circuit.

On the other hand, the 500-kc signal is separated by a resonant circuit that will not accept low frequencies; its rise is sufficiently rapid to reduce greatly the effect of any change in its amplitude on the time of triggering, and video and blanking cannot get into the synchronizing under any conditions. By applying the video signal directly to the resonant circuit, without the use of a clipper, it is possible to separate the vertical synchronization even if it should be displaced from the normal infrablack level into the picture portion of the video signal.

Horizontal synchronization, in the presence of l-f interference, can be maintained undisturbed by using short-time constant d-c restoration circuits prior to the clippers.

The use of a resonant circuit for separation of synchronizing also gives extremely good discrimination against impulse type noise. The type of discrimination attainable is indicated by Fig. 91, where the response of a typical resonant circuit to an infinitely sharp wave front is shown. The ratio of maximum noise to synchronizing pulse in this typical example is 50:1. This sharp square impulse is typical of impulse noise encountered in the field. Since the horizontal synchronizing pulses are also

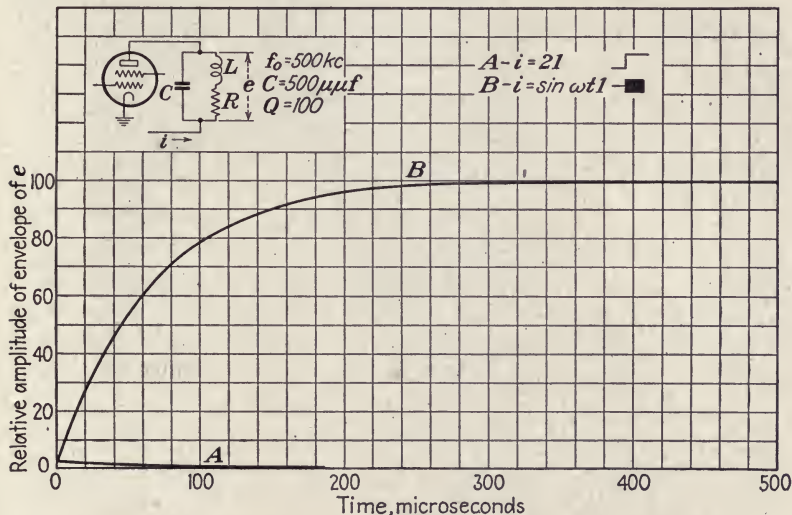

FIG. 91.—(A) Response of resonant circuit to square pulse; (B) response of resonant circuit to 500-kc square carrier pulse. (Campbell and Lempert.)

of this nature, it is apparent that they can have little effect upon vertical synchronization.

#### SUMMARY

The DuMont synchronizing signal has the following characteristics:

1. The vertical synchronization is very little affected by interference.
2. The 500-kc resonant, vertical synchronizing separator circuits do not pass l-f interference.
3. The synchronizing signal combines the advantages of a sharp wavefront vertical pulse providing accurate synchronization, and of continuance of the synchronizing pulse for a con-

siderable time after the rise, thus ensuring against complete loss of synchronism if a disturbance occurs just at the usual triggering time.

4. A vertical pulse with a steep wave front is obtained at the receiver without the sacrifice of freedom from interference required with *RC* integrating circuits.

5. The steeper wave front of the final vertical synchronizing pulse gives better interlace performance.

6. The horizontal pulses can be utilized directly without performing any operation upon them, or they can be integrated. (They could also be differentiated, of course, if differentiation should ever be desirable for any reason.)

7. Complete separation of horizontal and vertical synchronizing information is attained with simple and economical circuits.

8. Simpler circuits and fewer tubes are required for utilizing the 500-kc signal as compared with the three or four tubes frequently used to obtain satisfactory vertical performance with the R.M.A. signal.

9. The efficient separation of vertical from horizontal synchronizing information and the relative immunity from interference makes tighter lock-in possible, so that the speed controls may be left off the panel of receivers and adjusted once at the factory, thus relieving the customer of the need for constant adjustment of "hold-in" controls.

10. Driven sweep circuits are made possible by the elimination of double-frequency pulses, the increased efficiency of separation, and the steeper front of the final synchronizing pulse.

11. The r-f carrier-pulse synchronizing signal is adaptable to a large number of means of utilization such as direct integration, as with the R.M.A. pulse; selection by resonant transformer with radio frequency fed directly to blocking oscillator grid; resonant selection followed by detection with integration; resonant selection, detection with integration, and then differentiation; and even resonant circuit selection without prior clipping if desired.

12. The synchronizing generator for the DuMont synchronizing signal is much simpler than that for the R.M.A. or long-integration signal.

13. Field tests with this signal have been carried on for nearly two years with excellent results.



14. The practicability of obtaining reliable interference for operation with this synchronizing signal under extremely adverse conditions has been demonstrated in field tests directly comparing the DuMont signal and associated equipment with the R.M.A. signal and associated equipment, and with modified R.M.A. (ultra-long-integration) signal and associated equipment.

The Allen B. DuMont Laboratories, Inc., upon the basis of the merits of this synchronizing signal, both theoretically and experimentally, hereby recommend that this r-f carrier pulse type of synchronizing signal be adopted for national use by Panel 8 of the National Television System Committee.

#### CHARACTERISTICS OF VERTICAL-SYNCHRONIZING-SIGNAL SEPARATOR CIRCUITS FOR TELEVISION RECEPTION<sup>1</sup>

Synchronizing-signal separator circuits should possess two characteristics.

1. The rate of build-up of separated signal should be rapid.
2. A high signal-to-noise ratio should result.

For low resultant noise, the bandwidth of the circuit should be small, *i.e.*, area under the curve relating the amplitude response to the frequency should be small. This minimizes the acceptance of noise, though the actual noise resulting in practical operation depends also on the distortion of the incident noise in the frequency spectrum of interest. The following discussion does not concern itself with this last factor, since it is assumed that the noise is uniformly distributed throughout the frequency spectrum.

The rate of build-up of a signal depends on the ability of the circuit to pass h-f components of the incident signal. Hence, wide band circuits are needed if the rapid rates of rise of incident waveforms are to be maintained.

It is evident that, under the conditions here assumed, the requirements for rapid build-up and low noise are mutually exclusive. Hence, the most suitable circuit is the one that gives the most rapid rate of rise for a given bandwidth. Or, for a given rate of rise of signal, the best circuit is the one with the smallest bandwidth.

A study was made of the characteristics of a number of typical circuits. The results of this study accompany the figures that follow. A summary of the results is given below.

<sup>1</sup> George R. Town, Stromberg-Carlson Telephone Mfg. Company.

- I. Single-section low-pass filter
  - Case A. *RC* filter, constant voltage supply
  - Case B. *LR* filter, constant voltage supply
  - Case C. *RC* filter, constant current supply
- II. Two-section low-pass filter
  - Case D. *RC* filter, constant voltage supply; identical sections
- III. Tuned circuit
  - Cases *E, F*. Series tuned circuit, constant voltage supply; d-c and sinusoidal applied voltage
  - Case *G*. Parallel tuned circuit, constant current sinusoidal supply
  - Cases *H, I*. Practical parallel tuned circuit, constant current supply; d-c and sinusoidal applied current
- IV. Coupled circuits
  - Case *J*. Coupled tuned circuits, constant voltage supplied to primary; identical circuits
  - Case *K*. Coupled tuned circuits in general

The following general conclusions may be drawn:

**1. Build-up Characteristics.**—The voltage builds up across the output element in accordance with the following equation:

$$e = K(1 - e^{-\frac{t}{T}}) \quad (1)$$

This equation is followed exactly in Cases *A, B, and C* and approximately in Case *D*. In Cases *F, G, I, and J*, this equation relates to the envelope of the rising voltage and is followed exactly in Cases *F* and *G* and approximately in Cases *I* and *J*. In this equation, *T* is the time constant of the circuit. The values of *T* for the various circuits are given in the following discussion.

**2. Bandwidth.**—The amplitude response vs. frequency characteristic is given approximately by the following equation, where  $E_f$  is the r-m-s output voltage at frequency *f* and  $E_0$  is the r-m-s output voltage at resonance or at zero frequency.

$$\frac{E_f}{E_0} = \frac{1}{a(1 + jbT \Delta\omega + c)} \quad (2)$$

In this equation, *T* is the time constant of the circuit, and  $\Delta\omega$  is equal to  $2\pi$  times the change in frequency from resonance or from zero.

In most cases, *a* and *b* are approximately unity and *c* is approximately zero, so that, to a first-order approximation

$$\frac{E_f}{E_0} = \frac{1}{1 + jT \Delta\omega} \quad (3)$$

The simplified equation is exact for Cases *A*, *B* and *C* and is very nearly exact for cases *F*, *G*, and *I* (and *E* and *H*). In Case *D*,  $a = 1$  and  $c = 0$ , but  $b = 1.15$ . In the case of coupled circuits, Case *J*, the values of the constants depend on the degree of coupling. In this case,  $a$  is approximately unity and  $c$  approximately zero. The value of  $b$  is unity for critical coupling and 1.6 for half critical coupling.

**3. Conclusions.**—It might appear that for a given value of  $T$ , all circuits (except the coupled circuits with low coupling) have identical frequency-response characteristics and hence result in the same noise susceptibility. This, however, is not the case, since the response curve of low-pass filters extends upward in frequency from zero, whereas the response curve of tuned circuits extends both upward and downward from resonance. Hence, with the one exception noted above, the total noise acceptance band of tuned circuits is twice as great as that of low-pass filters. The correction factors  $a$ ,  $b$ , and  $c$  involved in Eq. (2) do not nullify this conclusion but rather make the conclusion more nearly exact, for the correction factors are usually such as to raise the curve slightly on one side of resonance and lower it correspondingly on the other side. Hence, the integrated area beneath the response curve of a tuned circuit is almost exactly twice that beneath the curve of a single-stage low-pass filter having the same time constant. (The area beneath a two-stage filter curve is slightly less than in the case of a single-stage filter, as  $b = 1.15$ .)

In coupled circuits with low (half critical) coupling, the noise acceptance is not so great as in a single-tuned circuit, as  $b = 1.6$ . However, the area is still greater than that beneath a low-pass filter curve, since  $b$  is less than 2. Also, the output voltage is decreased to 80 per cent of maximum output. If the circuit is set up for maximum output (critical coupling), the area beneath the curve is still twice that beneath the response curve of a low-pass filter.

The physical reason for the fact that, with a given rate of rise, a tuned circuit has twice the bandwidth of a low-pass filter, may be seen from the following considerations:

Consider a d-c impulse  $1$  (the Heaviside unit function) impressed on a low-pass filter. Let the frequency characteristic of this impulse be given by

$$i = f(\omega) = \frac{1}{2} + \frac{1}{\pi} \int_0^{\infty} \frac{1}{\omega} \sin \omega t d\omega \quad (4)$$

The rate of rise of the output waveform depends on the response of the filter to the upper frequencies, and, for a given frequency-response characteristic, a fixed wave shape results. Next, consider a sinusoidal wave suddenly impressed on a tuned circuit. The equation for such an impulse is

$$e_a = [E_m \cos (\omega_0 t - \theta)]I \quad (5)$$

Thus, the resulting wave is amplitude-modulated with sidebands extending in both direction from  $\omega_0$ , the amplitude of each upper or lower side frequency being one-half that of the corresponding frequency in Eq. (4). Thus, for a given rate of rise, in order to collect the energy in both upper and lower sidebands, the frequency-response curve for a tuned circuit must be identical with that of the low-pass filter but must extend in both directions from the resonant frequency and thus must be twice as susceptible to noise.

Another conclusion may be drawn from the derivations on the following pages. Considering tuned circuits, in every case (single or coupled circuits), the relationship between time constant and  $Q$  is

$$Q = \pi f_0 T \quad (6)$$

where  $f_0$  is the resonant frequency. Thus, to give the same noise immunity as a low-pass filter having a time constant of 120 microseconds, the coil in a circuit tuned to 529 kc must have a  $Q$  of 200. If  $T$  is 500 microseconds, the corresponding value of  $Q$  is 830. Such values of  $Q$  are impracticable unless regeneration is employed.

The general conclusions to be drawn are (1) that, for a given rate of rise of signal, tuned circuits are more susceptible to noise than are low-pass filters; and (2) that, for noise immunity comparable to that obtained with normal low-pass filters, the required tuned circuit coil  $Q$  is impracticably high.

## I. SINGLE-SECTION LOW-PASS FILTER

### CASE A. RC FILTER, CONSTANT VOLTAGE SUPPLY (FIG. 92)

Applied voltage at 1, 2 =  $E1$

$$iR + \frac{1}{C} \int i dt = E1$$

At 3, 4, voltage =  $e$

$$e = \frac{1}{C} \int i dt$$

$$e = E(1 - \epsilon^{-\frac{t}{RC}})$$

Let  $T =$  time constant =  $RC$ .

$$e = E(1 - \epsilon^{-\frac{t}{T}})$$

Let constant a-c voltage be applied at 1, 2.

$E_f =$  output voltage at 3, 4 at frequency  $f$

$E_0 =$  output voltage at 3, 4 at frequency zero

$$\frac{E_f}{E_0} = \frac{1}{1 + j\omega RC} = \frac{1}{1 + j\omega T} \quad \omega = 2\pi f$$

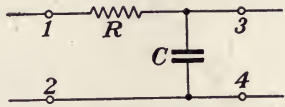
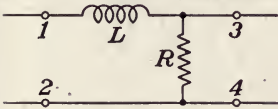

FIG. 92.—RC filter, constant-voltage supply. (G. R. Town.)

CASE B. LR FILTER, CONSTANT VOLTAGE SUPPLY (FIG. 93)

Applied voltage at 1, 2 =  $E1$



$$iR + L \frac{di}{dt} = E1$$

At 3, 4, voltage =  $e$

$$e = iR$$

$$e = E(1 - \epsilon^{-\frac{R}{L}t})$$

FIG. 93.—LR filter, constant-voltage supply. (G. R. Town.)

Let  $T =$  time constant =  $\frac{L}{R}$ .

$$e = E(1 - \epsilon^{-\frac{t}{T}})$$

Let constant a-c voltage be applied at 1, 2.

$$\frac{E_f}{E_0} = \frac{1}{1 + j\omega(L/R)} = \frac{1}{1 + j\omega T}$$

CASE C. RC FILTER, CONSTANT CURRENT SUPPLY (FIG. 94)

Applied current at 1, 2 =  $I1$

$$\frac{e}{R} + C \frac{de}{dt} = I1$$

$$\left(\frac{1}{R} + Cp\right) e = I1$$

At 3, 4

$$e = IR(1 - \epsilon^{-\frac{t}{RC}})$$

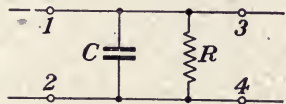

FIG. 94.—RC filter, constant-current supply. (G. R. Town.)

Let  $T =$  time constant  $= RC$ .

$$e = IR(1 - \epsilon^{-\frac{t}{T}})$$

Let constant a-c current be applied at 1, 2

$$\begin{aligned} E_f &= \text{output voltage at 3, 4 at frequency } f. \\ E_0 &= \text{output voltage at 3, 4 at frequency zero.} \\ \frac{E_f}{E_0} &= \frac{1}{1 + j\omega CR} = \frac{1}{1 + j\omega T} \end{aligned}$$

## II. TWO-SECTION LOW-PASS FILTER

CASE D. RC FILTER, CONSTANT VOLTAGE SUPPLY (FIG. 95)

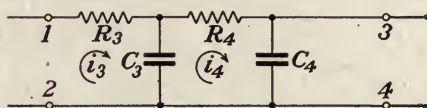

FIG. 95.—RC filter, constant-voltage supply, two-section, low-pass. (G. R. Town.)

Applied voltage at 1, 2  $= E1$

$$\begin{aligned} \left(R_3 + \frac{1}{C_3 p}\right) i_3 - \frac{1}{C_3 p} i_4 &= E1 \\ -\frac{1}{C_3 p} i_3 + \left(R_4 + \frac{1}{C_3 p} + \frac{1}{C_4 p}\right) i_4 &= 0 \\ i_4 &= \frac{E}{C_3 R_3 R_4} \frac{1}{p^2 + p \left(\frac{1}{R_4 C_3} + \frac{1}{R_4 C_4} + \frac{1}{R_3 C_3}\right) + \frac{1}{R_3 R_4 C_3 C_4}} \end{aligned}$$

If  $R_3 = R_4 = R$  and  $C_3 = C_4 = C$ ,

$$\begin{aligned} p_{1,2} &= -\frac{3 \mp \sqrt{5}}{2RC} \\ i_4 &= \frac{E}{\sqrt{5} R} \left( \epsilon^{-\frac{0.382}{RC} t} - \epsilon^{-\frac{2.618}{RC} t} \right) \end{aligned}$$

$$e = \text{voltage at 3, 4} = \frac{1}{C} \int i_4 dt$$

$$e = E \left( 1 + 0.171 \epsilon^{-\frac{2.618}{RC} t} - 1.171 \epsilon^{-\frac{0.382}{RC} t} \right)$$

$$\text{Let } T_1 = \frac{RC}{0.382} = 2.618RC.$$

$$T_2 = \frac{RC}{2.618} = 0.382RC$$

$$e = E(1 + 0.171\epsilon^{-\frac{t}{T_2}} - 1.171\epsilon^{-\frac{t}{T_1}})$$

Since

$$1.171 \gg 0.171 \quad \text{and} \quad T_1 \gg T_2,$$

$$e \doteq E(1 - 1.17\epsilon^{-\frac{t}{T_1}}) \doteq E(1 - \epsilon^{-\frac{t}{T_1}})$$

Let constant a-c voltage be applied at 1, 2.

At 3, 4

$$\frac{E_f}{E_0} = \frac{1}{\frac{1/(\omega^2 C^2)}{R^2 + 1/(\omega^2 C^2)} + j3\omega RC}$$

Let  $X_f$  = reactance of  $C$  at frequency  $f$  (absolute magnitude).

$Z_f$  = impedance of  $R$  and  $C$  in series at frequency  $f$  (absolute magnitude).

$$\frac{E_f}{E_0} = \frac{1}{(X_f^2/Z_f^2) + j3\omega RC}$$

At low frequencies,  $Z_f \doteq X_f$ .

At high frequencies,  $3\omega RC \gg 1$  and  $\frac{X_f^2}{Z_f^2}$  is negligible.

Hence,

$$\frac{E_f}{E_0} \doteq \frac{1}{1 + j3\omega CR} = \frac{1}{1 + j1.15\omega T_1}$$

### III. TUNED CIRCUIT

CASE E. SERIES TUNED CIRCUIT, CONSTANT VOLTAGE D-C SUPPLY

(FIG. 96)

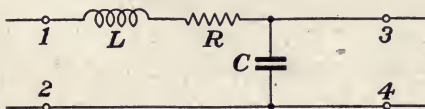

FIG. 96.—Series-tuned circuit, constant-voltage d-c supply. (G. R. Town.)

Applied voltage at 1, 2 =  $E1$

$$Ri + L \frac{di}{dt} + \frac{1}{C} \int i dt = E1$$

Assume (1) Initial current = 0; (2) Initial voltage  $e$  at 3, 4 = 0;  
 (3) High  $Q$  coil; (4) High  $Q$  capacitor.  
 As a result of assumptions (3) and (4),

$$\omega_0 = \frac{1}{\sqrt{LC}}$$

where  $\omega_0 = 2\pi f_0$  and  $f_0 =$  resonant frequency.

$$e = E(1 - \epsilon^{-\frac{R}{2L}t}) \cos \omega_0 t$$

The equation of the envelope is

$$e_e = E(1 \pm \epsilon^{-\frac{R}{2L}t})$$

Let  $T =$  time constant  $= \frac{2L}{R}$ .

$$e_e = E(1 \pm \epsilon^{-\frac{t}{T}})$$

#### CASE *F*. SERIES TUNED CIRCUIT, CONSTANT VOLTAGE SINUSOIDAL SUPPLY

Same circuit as Case *E*.

Applied voltage at 1, 2 =  $E_m \cos(\omega t - \theta)1$

$$Ri + L \frac{di}{dt} + \frac{1}{C} \int i dt = E_m \cos(\omega t - \theta)1$$

Voltage at 3, 4 =  $e$

Assume (1) Initial current = 0; (2) Initial voltage  $e = 0$ ;  
 (3) High  $Q$  coil; (4) High  $Q$  capacitor; (5) All losses occur in  
 coil— $Q$  of  $C$  much greater than that of the coil; (6) Applied  
 frequency = resonant frequency;  $f = f_0$ .

$$e = QE_m(1 - \epsilon^{-\frac{R}{2L}t}) \sin(\omega_0 t - \theta)$$

where  $Q = Q$  of the coil  $= \frac{\omega_0 L}{R}$

The equation of the envelope of this voltage is

$$e_e = \pm QE_m(1 - \epsilon^{-\frac{R}{2L}t})$$

Let  $T =$  time constant  $= \frac{2L}{R} = \frac{2}{\omega_0} Q = \frac{Q}{\pi f_0}$ .

$$e_e = \pm QE_m(1 - \epsilon^{-\frac{t}{T}})$$



In the circuit of Cases *E* and *F*, let a constant a-c voltage be applied at 1, 2.

Let  $E_f$  = r.m.s. output voltage at 3, 4 at frequency  $f$ .

$E_0$  = r.m.s. output voltage at 3, 4 at resonant frequency  $f_0$ .

$\omega = 2\pi f$ ,  $\omega_0 = 2\pi f_0$ ,  $\Delta\omega = \omega - \omega_0$ .

$R_0$  = value of  $R$  at frequency  $f_0$ .

Assume (1) High  $Q$  coil; (2) High  $Q$  capacitor; (3) All losses occur in coil— $Q$  of capacitor much greater than that of the coil; (4)  $Q$  of coil constant with respect to frequency.

$$\frac{E_f}{E_0} = \frac{1}{\left(\frac{\omega}{\omega_0}\right)^2 + jT \Delta\omega + j\frac{T}{2} \frac{(\Delta\omega)^2}{\omega_0}}$$

If  $\Delta\omega$  is small in comparison with  $2\omega_0$ .

$$\frac{E_f}{E_0} \doteq \frac{1}{\left(\frac{\omega}{\omega_0}\right)^2 + jT \Delta\omega} \doteq \frac{1}{1 + jT \Delta\omega}$$

CASE *G*. PARALLEL TUNED CIRCUIT, CONSTANT CURRENT SUPPLY, SINUSOIDAL SUPPLY (FIG. 97)

Applied current at 1, 2 =  $I_m \cos(\omega t - \theta)1$

At 3, 4

$$\begin{aligned} e &= i_R R \\ &= L \frac{di_L}{dt} \\ &= \frac{1}{C} \int i_C dt \\ \frac{1}{R} e + \frac{1}{L} \int e dt + C \frac{de}{dt} &= I_m \cos(\omega t - \theta)1 \end{aligned}$$

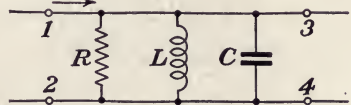

FIG. 97.—Parallel-tuned circuit, constant-current supply. (*G. R. Town.*)

Assume (1) Initial voltage  $e$  at 3, 4 = 0; (2) Initial current = 0; (3) High  $Q$  capacitor; (4) High  $Q$  coil; (5) All losses occur in capacitor— $Q$  of coil much greater than that of the capacitor; (6) Applied frequency = resonant frequency;  $f = f_0$ .

$$e = I_m R (1 - e^{-\frac{t}{2RC}}) \cos(\omega_0 t - \theta)$$

The equation of the envelope of this voltage is

$$e_e = \pm I_m R (1 - e^{-\frac{t}{2RC}})$$

Let  $T =$  time constant  $= 2RC$ .

$$e_e = \pm I_m R (1 - e^{-\frac{t}{T}})$$

Let  $Q = Q$  of capacitor  $= \omega_0 CR$ .

$$Q = \frac{\omega_0}{2} T = \pi f_0 T$$

Let a constant a-c current be applied at 1, 2.

Assume (1) High  $Q$  coil; (2) High  $Q$  capacitor; (3) All losses occur in capacitor— $Q$  of coil much greater than that of the capacitor; (4)  $Q$  of capacitor constant with respect to frequency. At 3, 4

$$\frac{E_f}{E_0} = \frac{1}{\frac{\omega}{\omega_0} + jT \frac{\omega_0}{\omega} \Delta\omega + jT \frac{(\Delta\omega)^2}{2\omega}}$$

If  $\Delta\omega$  is small in comparison with  $2\omega_0$

$$\frac{E_f}{E_0} \doteq \frac{1}{\frac{\omega}{\omega_0} + jT \frac{\omega_0}{\omega} \Delta\omega} \doteq \frac{1}{1 + jT \Delta\omega}$$

#### CASE H. PRACTICAL PARALLEL TUNED CIRCUIT, CONSTANT CURRENT D-C SUPPLY (FIG. 98)

Applied current at 1, 2  $= I1$

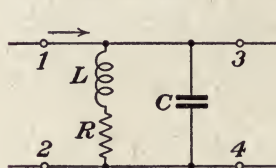

FIG. 98.—Practical parallel-tuned circuit, constant-current d-c supply. (G. R. Town.)

$$\left( \frac{1}{R + Lp} + Cp \right) e = I1$$

The voltage  $e$  at 3, 4 is

$$e = \frac{R + Lp}{LC \left( p^2 + \frac{R}{L} p + \frac{1}{LC} \right)} I1$$

$$e = IR - IZ_{L0} e^{-\frac{R}{2L}t} \cos(\omega_0 t + \phi)$$

where  $\omega_0 = 2\pi \times$  resonant frequency  $= 2\pi f_0$ .

$Z_{L0} =$  impedance of  $L$  and  $R$  in series at resonance.

$$\tan \phi = \frac{\omega_0 L}{R}$$

The only assumption (other than the initial current and voltage are zero) is that the  $Q$  of the coil is high, *i.e.*

$$\frac{1}{LC} \gg \frac{R^2}{4L^2} \quad \text{or} \quad \omega_0 = \frac{1}{\sqrt{LC}}$$

The equation of the envelope of this voltage is

$$e_e = IR \left( 1 \pm \frac{Z_{L0}}{R} \epsilon^{-\frac{R}{2L}t} \right)$$

Let  $T =$  time constant  $= \frac{2L}{R} = \frac{2Q}{\omega_0} = \frac{Q}{\pi f_0}$

where  $Q$  is the  $Q$  of the coil  $\left( \frac{\omega_0 L}{R_0} \right)$

$$e_e = IR \left( 1 \pm \frac{Z_{L0}}{R} \epsilon^{-\frac{t}{T}} \right)$$

Since  $Q$  is large

$$\frac{Z_{L0}}{R} \doteq Q$$

and

$$e_e \doteq IR(1 + Q\epsilon^{-\frac{t}{T}})$$

CASE I. PRACTICAL PARALLEL TUNED CIRCUIT, CONSTANT CURRENT SINUSOIDAL SUPPLY

Same circuit as Case H.

Applied current at 1, 2 =  $I_m \cos(\omega t - \theta)1$

$$I_m \cos(\omega t - \theta)1 = I_m \frac{p^2 \cos \theta + p\omega \sin \theta}{p^2 + \omega^2} 1$$

$$e = \frac{(R + Lp)(p^2 \cos \theta + p\omega \sin \theta)}{\left( p^2 + \frac{R}{L}p + \frac{1}{LC} \right) (p^2 + \omega^2)} \frac{I_m}{LC} 1$$

Assume (1) Initial current = 0; (2) Initial voltage at 3, 4 = 0;

$e = 0$ ; (3) High  $Q$  coil;  $Q = \frac{\omega_0 L}{R} \gg 1$ ;  $\omega_0 = \frac{1}{\sqrt{LC}}$ ; (4) All

losses occur in coil;  $Q$  of capacitor much greater than that of coil;

(5) Applied frequency = resonant frequency;  $\omega = \omega_0$ .

$$p_{1,2} = \pm j\omega_0 \quad p_{3,4} = -\frac{R}{2L} \pm j\omega_0$$

The steady state solution comes from the first two roots,  $p_{1,2}$ . It is

$$e_{1,2} = I_m Z_{L0} Q \sin (\omega_0 t - \theta + \phi)$$

where the symbols have the same meaning as in Case *H*.

The transient term, from the roots  $p_{3,4}$ , is

$$\begin{aligned} e_{3,4} = \frac{4I_m Z_{L0} Q \epsilon^{-\frac{R}{2L}t}}{4 + 9/(4Q^2)} & \left\{ \sin (\omega_0 t - \theta - \phi) \right. \\ & + \frac{1}{4} \cos \phi \sin (\omega_0 t + \theta) \\ & - \frac{1}{8} \cos \phi \cot \phi [\cos (\omega_0 t - \theta) + \sin \omega_0 t \sin \theta] \\ & \left. + \frac{3}{16} \cos \phi \cot^2 \phi [\sin (\omega_0 t - \theta) + \sin \omega_0 t \cos \theta] \right\} \end{aligned}$$

If  $Q$  is large, this expression may be simplified by neglecting  $9/4Q^2$  in comparison with 4 and by noting that

$$Q = \tan \phi = \frac{1}{\cot \phi} \doteq \frac{1}{\cos \phi}$$

$$\begin{aligned} e_{3,4} = I_m Z_{L0} Q \epsilon^{-\frac{R}{2L}t} & \left\{ \sin (\omega_0 t - \theta - \phi) + \frac{1}{4Q} \sin (\omega_0 t + \theta) \right. \\ & - \frac{1}{8Q^2} [\cos (\omega_0 t - \theta) + \sin \omega_0 t \sin \theta] \\ & \left. + \frac{3}{16Q^3} [\sin (\omega_0 t - \theta) + \sin \omega_0 t \cos \theta] \right\} \\ & \doteq I_m Z_{L0} Q \epsilon^{-\frac{R}{2L}t} \sin (\omega_0 t - \theta - \phi) \end{aligned}$$

The total voltage at  $e$  is  $e_{1,2} + e_{3,4}$ .

$$e = I_m Z_{L0} Q [\sin (\omega_0 t - \theta + \phi) + \epsilon^{-\frac{R}{2L}t} \sin (\omega_0 t - \theta - \phi)]$$

Since  $Q$  is large,  $\phi$  is very nearly 90 deg. With this assumption

$$e = I_m Z_{L0} Q \cos (\omega_0 t - \theta) (1 - \epsilon^{-\frac{R}{2L}t})$$

The equation of the envelope of this voltage is

$$e_e = \pm I_m Z_{L0} Q (1 - \epsilon^{-\frac{R}{2L}t})$$

Let  $T =$  time constant  $= \frac{2L}{R} = \frac{Q}{\pi f_0}$ .

$$e_e = \pm I_m Z_{L0} Q (1 - \epsilon^{-\frac{t}{T}})$$

In the circuit of Cases *H* and *I*, let a constant a-c current be applied at 1, 2.

At 3, 4

$$\frac{E_f}{E_0} = \frac{1}{\omega_0 \left[ 1 + jT \Delta\omega + jT \frac{(\Delta\omega)^2}{2\omega_0} + j \left( \frac{\omega}{\omega_0} \right)^2 \frac{1}{Q} \right]}$$

This result is based on the following assumptions: (1) High *Q* coil; (2) High *Q* capacitor; (3) Losses all occur in the coil—*Q* of the capacitor much greater than that of the coil; (4) *Q* of the coil constant with respect to frequency.

If it is further assumed that  $\Delta\omega$  is small in comparison with  $2\omega_0$ ,

$$\frac{E_f}{E_0} \doteq \frac{1}{\omega \left[ 1 + j \left( T \Delta\omega + \frac{\omega^2}{\omega_0^2} \frac{1}{Q} \right) \right]} \doteq \frac{1}{1 + jT \Delta\omega}$$

#### IV. COUPLED TUNED CIRCUITS

CASE *J*. IDENTICAL SERIES TUNED PRIMARY AND SECONDARY, CONSTANT D-C VOLTAGE APPLIED TO PRIMARY (FIG. 99)

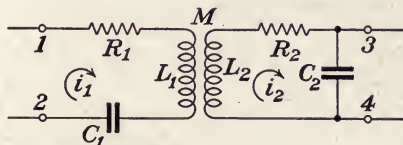

FIG. 99.—Identical series-tuned primary and secondary, constant d-c voltage applied to primary. (*G. R. Town.*)

Applied voltage at 1, 2 =  $E1$

$$\begin{aligned} \left( R_1 + L_1 p + \frac{1}{C_1 p} \right) i_1 - M p i_2 &= E1 \\ - M p i_1 + \left( R_2 + L_2 p + \frac{1}{C_2 p} \right) i_2 &= 0 \end{aligned}$$

$$i_2 = \frac{EMp^3}{p^4(L_1L_2 - M^2) + p^3(R_1L_2 + R_2L_1) + p^2 \left( R_1R_2 + \frac{L_1}{C_2} + \frac{L_2}{C_1} \right) + p \left( \frac{R_1}{C_2} + \frac{R_2}{C_1} \right) + \frac{1}{C_1C_2}}$$

If  $R_1 = R_2 = R, L_1 = L_2 = L, C_1 = C_2 = C$

$$i_2 = \frac{EMp^3}{(L^2 - M^2) \left[ p^4 + \frac{2RL}{L^2 - M^2} p^3 + \frac{R^2 + 2L/C}{L^2 - M^2} p^2 + \frac{2R/C}{L^2 - M^2} p + \frac{1}{C^2(L^2 - M^2)} \right]}$$

Because of the complexity of the equation, the complete solution will not be found. Enough work will be done to find the values of the exponents in the transient terms. Thus, the rate of build-up of output voltage can be determined. The exponential terms are determined by the roots of the denominator when the latter is equated to zero.

Since the desired output is high and the desired bandwidth is small, the coupling will be critical or somewhat less. With high  $Q$  coils, it therefore follows that  $M^2$  will be much less than  $L^2$ . Also,  $2L/C$  is much greater than  $R^2$ . Under these conditions, the resonant frequency is given by the expression

$$\omega_0 = \frac{1}{\sqrt{LC}}$$

The denominator then becomes

$$p^4 + \frac{2R}{L} \left( 1 + \frac{M^2}{L^2} \right) p^3 + 2\omega_0^2 \left( 1 + \frac{R^2C}{2L} + \frac{M^2}{L^2} \right) p^2 + \frac{2R}{C(L^2 - M^2)} p + \frac{1}{C^2(L^2 - M^2)} = 0$$

The roots may be found as follows: Assume

$$\begin{aligned} P_1 &= -a + jm & P_2 &= -a - jm \\ P_3 &= -b + jn & P_4 &= -b - jn \end{aligned}$$

Applying the rules for the composition of coefficients

$$\sum p_i = -2a - 2b = -\frac{2R}{L} \left( 1 + \frac{M^2}{L^2} \right)$$

$$\sum_{i \text{ to } j} p_i p_j = a^2 + 4ab + b^2 + m^2 + n^2 = 2\omega_0^2 \left( 1 + \frac{R^2C}{2L} + \frac{M^2}{L^2} \right)$$

Assume  $m = n = \omega_0$ . (If this is not true, the results contain an easily applied correction factor.)

$$a + b = \frac{R}{L} \left( 1 + \frac{M^2}{L^2} \right)$$

$$a^2 + 4ab + b^2 = 2\omega_0^2 \left( \frac{R^2 C}{2L} + \frac{M^2}{L^2} \right)$$

To indicate the order of magnitude of the terms, let

$$f_0 = 529,200 \text{ c.p.s.}$$

$$Q_p = Q_s = \frac{\omega_0 L}{R_0} = 66.5$$

$$C = 400 \mu\mu f$$

Then

$$L = 226 \mu h$$

$$R = 11.3 \text{ ohms}$$

$$K_c = \text{critical coupling} = \frac{1}{\sqrt{Q_p Q_s}} = 0.0150$$

If

$$K = K_c \quad M = 3.39 \mu h$$

$$K = \frac{1}{2} K_c \quad M = 1.70 \mu h$$

$$a + b = 5.00 \times 10^4$$

$$a^2 + 4ab + b^2 = 3.74 \times 10^9 \quad \text{for } K = \frac{1}{2} K_c$$

$$= 7.47 \times 10^9 \quad \text{for } K = K_c$$

The solutions are

$$a = b = 2.50 \times 10^4 \quad \text{for } K = \frac{1}{2} K_c$$

$$\left. \begin{aligned} a &= 2.50 \times 10^4 + j6.1 \times 10^4 \\ b &= 2.50 \times 10^4 - j6.1 \times 10^4 \end{aligned} \right\} \text{for } K = K_c$$

A consideration of the equations for  $a$  and  $b$  shows that if

$$K = \frac{1}{2} K_c, \quad a - b = 0 \quad (1)$$

$$K < \frac{1}{2} K_c, \quad a - b \text{ is real} \quad (2)$$

$$K > \frac{1}{2} K_c, \quad a - b \text{ is imaginary} \quad (3)$$

In the first and second cases,  $\omega_0 = \frac{1}{\sqrt{LC}}$  gives the "natural frequency" of the system. In the third case, the natural frequencies are different, but not greatly so for values of  $K < K_c$ . In the case under consideration, the correction factor for  $\omega_0$  is  $\pm 6.1 \times 10^4$  for  $K = K_c$ . This compares with the nominal value of  $\omega_0$  of  $3.32 \times 10^6$ .

In the first and third cases, all oscillatory terms have equal attenuation factors ( $a = b$ ). In the second case, which is not of great practical importance,  $a$  and  $b$  are slightly different with one greater and one less than normal.

Thus, for all practical cases ( $\frac{1}{2}K_c < K < K_c$ )

$$a' = b' = \frac{R}{2L} \left( 1 + \frac{M^2}{L^2} \right) \quad a', b' = \text{real parts of } a, b$$

Let  $T =$  time constant

$$T = \frac{1}{a'} = \frac{2L}{R} \left( 1 - \frac{M^2}{L^2} \right)$$

For practical values of  $Q$

$$T = \frac{2L}{R} = \frac{Q}{\pi f_0}$$

Let a constant a-c voltage be applied at 1, 2

At 3, 4

$$\frac{E_f}{E_0} = \frac{1}{\frac{\omega^2}{\omega_0^2} \left\{ 1 - \frac{Q^2}{1 + K^2/K_c^2} \left[ \frac{2\omega_0 \Delta\omega + (\Delta\omega)^2}{\omega^2} \right]^2 + j \frac{2Q}{1 + K^2/K_c^2} \left[ \frac{2\omega_0 \Delta\omega + (\Delta\omega)^2}{\omega^2} \right] \right\}}$$

For critical coupling,

$$\frac{E_f}{E_0} = \frac{1}{\frac{\omega^2}{\omega_0^2} \left\{ 1 - \frac{\omega_0^2 T^2}{8} \left[ \frac{2\omega_0 \Delta\omega + (\Delta\omega)^2}{\omega^2} \right]^2 + j \frac{\omega_0 T}{2} \frac{2\omega_0 \Delta\omega + (\Delta\omega)^2}{\omega^2} \right\}}$$

If  $\Delta\omega$  is small in comparison with  $2\omega_0$

$$\frac{E_f}{E_0} = \frac{1}{\frac{\omega^2}{\omega_0^2} - \frac{1}{2} \frac{\omega_0^2}{\omega^2} T^2 (\Delta\omega)^2 + jT \Delta\omega} \doteq \frac{1}{1 + jT \Delta\omega}$$

If  $K = \frac{1}{2}K_c$ ,

$$\frac{E_f}{E_0} = \frac{1}{\frac{\omega^2}{\omega_0^2} \left\{ 1 - \frac{T^2 \omega_0^2}{5} \left[ \frac{2\omega_0 \Delta\omega + (\Delta\omega)^2}{\omega^2} \right]^2 + j \frac{4}{5} \omega_0 T \frac{2\omega_0 \Delta\omega + (\Delta\omega)^2}{\omega^2} \right\}}$$



If  $\Delta\omega$  is small in comparison with  $2\omega_0$ ,

$$\frac{E_f}{E_0} = \frac{1}{\frac{\omega^2}{\omega_0^2} - \frac{4}{5} \frac{\omega_0^2}{\omega^2} T^2 (\Delta\omega)^2 + j \frac{8}{5} T \Delta\omega} \doteq \frac{1}{1 + j1.6T \Delta\omega}$$

In obtaining these expressions, the following assumptions were made: (1) High  $Q$  coils; (2) High  $Q$  capacitors; (3) Losses all occur in the coils— $Q$  of the capacitors much greater than that of the coils; (4)  $Q$  of the coils constant with respect to frequency.

At resonance, the r.m.s. secondary current  $I_0$  is

$$I_0 = \frac{j\omega_0 M E_1}{R_0^2 + \omega_0^2 M^2} = \frac{jE_1}{QR_0} \frac{K}{\frac{1}{Q^2} + K^2}$$

If

$$K = K_c = \frac{1}{Q}, \quad I_0 = \frac{jE_1}{2R_0}$$

If

$$K = \frac{1}{2} K_c = \frac{1}{2Q}, \quad I_0 = j \frac{2E_1}{5R_0}$$

Thus, the output voltage is reduced 20 per cent by changing  $K$  from  $K_c$  to half that value.

#### CASE $K$ . COUPLED IDENTICAL CIRCUITS WITH SINUSOIDAL SUPPLIES

These cases were not worked out. However, if a constant voltage sinusoidal e.m.f. is applied to the circuit of Case  $J$ , the transient solution will contain the same exponentials as in the case considered. Moreover, a comparison of Cases  $E$ ,  $F$ ,  $G$ ,  $H$ , and  $I$  indicates that, in all coupled circuits except the constant-current fed, pure parallel case, the time constant is the same as in Case  $J$ , *i.e.*,

$$T = \frac{2L}{R} \left( 1 - \frac{M^2}{L^2} \right)$$

In the case of pure parallel tuned coupled circuits with constant current supply, the same comparisons indicate that the time constant is

$$T = 2RC \left( 1 - \frac{M^2}{L^2} \right)$$

## CHAPTER X

### HORIZONTAL VS. VERTICAL POLARIZATION

The charge to Panel 9<sup>1</sup> read "consideration of the factors influencing the choice of polarization of the radiated wave." The conclusion reached by the Panel, that the polarization should be horizontal, is incorporated in the last of the N.T.S.C. standards, number 22. Before arriving at this conclusion, the panel members considered the effect of the direction of polarization in five basic categories: The effect (1) on the propagation of the television signal, (2) on the noise and interference, (3) on the design of receiving antennas, (4) on the design of transmitting radiators, and (5) on the relationship of the television sound service to the f-m broadcasting service.

The Panel first decided that the direction of polarization chosen should apply to all television stations, since the evidence clearly showed that a single receiving aerial performed best only on the direction of polarization for which it was designed. The Panel also recommended that the same direction of polarization be employed for f-m broadcasting as for television sound.

The crux of the matter then remained the direction of polarization itself. On this matter, there were at first two sharply divided camps of opinion, favoring vertical and horizontal polarization, respectively. By the time the Panel concluded its deliberations, however, sufficient evidence had been assembled to bring about substantial agreement that there was a slight preponderance of advantage for the horizontal direction.

The reports prepared for the Panel are voluminous. A summary of the evidence was prepared by Dr. G. R. Town from the

<sup>1</sup>The members of Panel 9 were D. B. Smith, chairman; Andrew Alford; J. E. Brown; C. R. Burrows; J. N. Dyer; H. C. Forbes; H. J. Heindel; R. S. Holmes; C. Huffman; C. M. Jansky, Jr.; A. V. Loughren; H. R. Lubcke; H. T. Lyman; R. H. Manson; F. J. Bingley; J. R. Poppele; R. S. Yoder.

Panel records and from other sources in the literature. This report follows:

### COMPARISONS BETWEEN HORIZONTAL AND VERTICAL POLARIZATION FOR TELEVISION TRANSMISSION<sup>1</sup>

(TABLE IX)

#### SUMMARY

**Propagation or Field Strength at the Receiver.**—The data with respect to this factor are conflicting. Some data tend to confirm theoretical predictions, and other data are contradictory to theory. It is probable that the fairest conclusion is that, for conditions encountered in the field, neither polarization has a marked advantage over the other.

**Variation in Field Strength. *Multipath Reflections.***—Both theoretical and experimental results show horizontal polarization to be superior.

***Fading.***—The little information available indicates vertical polarization to be superior.

***Miscellaneous.***—Vertically polarized waves are less affected by overhead wires, which are predominately horizontal. Horizontally polarized waves are probably less affected by changes in ground constants.

**Noise.**—No evidence indicates vertical polarization to be superior at practical receiving antenna locations. Most evidence indicates the superiority of horizontal polarization, although some indicates no advantage to either.

**Signal-to-noise Ratio.**—If neither polarization is preferable from the standpoint of signal strength and horizontal polarization results in lower noise, it follows that horizontal polarization gives a higher signal-to-noise ratio.

**Transmitting Antenna.**—Considering the simplest possible types of nondirective antennas, the vertical dipole has advantages of simplicity, concentration of energy in a horizontal plane, and probably slightly greater power gain. Considering more complex and more satisfactory structures, turnstiles for use with horizontal polarization have greater power gain for a given vertical length of structure, more uniform impedance characteristics, greater low angle radiation, freedom from coupling to

<sup>1</sup> Dr. George R. Town, Stromberg-Carlson Telephone Mfg. Company.

adjacent sound antennas, better mechanical construction and improved appearance. Field experience indicates that it is possible to design and construct satisfactory antennas for either type of polarization. On the whole, horizontal transmitting antennas are doubtless preferable.

**Receiving Antennas.**—Horizontal polarization is preferred from the standpoints of the horizontal directivity of the simple horizontal dipole, freedom from balancing difficulties and probable greater freedom from stray pickup on built-in antennas. Simple vertical dipoles have the advantages of being nondirective in the horizontal plane, of giving discrimination against noise originating below them, of being much more satisfactory for use in autos and of probably being more acceptable to the public from the standpoint of appearance. Suitable directivity in both horizontal and vertical planes may be obtained with either polarization by use of reflectors and directors. On the whole, neither polarization shows a marked advantage, but what advantage there is must be given to vertical polarization.

Factor	Preferable Polarization
Propagation.....	Neither
Multipath reflections.....	Horizontal
Fading.....	Vertical
Miscellaneous variation in field strength.....	Vertical
Noise.....	Horizontal
Signal-to-noise Ratio.....	Horizontal
Transmitting antenna.....	Horizontal
Receiving antenna.....	Vertical

In considering these conflicting requirements, multipath reflections, signal-to-noise ratio, and receiving antenna are of major importance. It appears that horizontal polarization is preferable. This conclusion is strengthened by the fact that vertical polarization is only slightly better from the standpoint of the receiving antenna.

#### CONCLUSION

Horizontal polarization is preferable for television transmission.

## COMPARISONS BETWEEN HORIZONTAL AND VERTICAL POLARIZATION FOR TELEVISION TRANSMISSION

## PROPAGATION OR FIELD STRENGTH AT THE RECEIVER

Horizontal	No difference	Vertical
Theoretical		
	No appreciable difference over plane earth with high transmitting antenna at receiving antenna heights of over 30 ft.	Higher field strength over plane earth with high transmitting antenna at receiving antenna heights of 30 ft. or less
General experimental		
Higher field strength on the average over typical land conditions Higher field strength above 3 Mc (probably no measurements at u.h.f.) Higher field strength	No difference at u.h.f.	Higher field strength
Specific experimental		
At typical receiving antenna locations at 81 to 86 Mc and 140 to 145 Mc, field strength averaged 1.7 db higher At a 10 ft. mobile receiving antenna at 50, 84, and 142 Mc, field strength averaged 4.3 db higher Higher field strength at 50 to 1,000 Mc over sea water Higher field strength over dense forests at 230 Mc Higher field strength beyond horizon: at 100 Mc in regions behind	No difference on W3XE at high signal levels (1,200 $\mu$ v and above) No difference at 92 Mc on paths from New York City to Suffern, N. Y., and to Long Island points No difference at 50 Mc over land at antenna heights of 100 ft. or more No difference over land No difference above 50 Mc for optical path No difference above 30 Mc with very high antennas over sea water or land	Higher field strength on W3XE at medium and low signal levels. 120 to 1,200 microvolts, 3.5 db; 20 to 120 microvolts, 6.8 db Higher field strength between 30 and 150 Mc with very low antennas, especially when transmission is over sea water Higher field strength at 50 Mc over land at antenna heights of 10 ft. or less 6 db higher field strength at 230 Mc with transmitting antennas up to

COMPARISONS BETWEEN HORIZONTAL AND VERTICAL POLARIZATION FOR  
TELEVISION TRANSMISSION.—(Continued)

Horizontal	No difference	Vertical
<p>intervening hills, at 410 Mc at 113 miles, 8,000 ft. below line of sight</p> <p>Higher field strength at high antennas</p> <p>With Hertzian dipole, less energy is absorbed in the earth with horizontal polarization</p>		<p>one wave length in height. Advantage decreases to 0 db as transmitting antenna height is increased</p> <p>Higher field strength below 50 Mc over land or sea water, between 50 and 1,000 Mc over land 9 db higher field strength for diffracted waves in the shadow of a ridge</p> <p>Higher field strength at 60 to 75 Mc, especially beyond the horizon</p> <p>Higher field strength 400 ft. from transmitting antenna. 1.6 db at 100 Mc, 0.2 db at 30 Mc</p>

VARIATION IN FIELD STRENGTH

Fixed Position and Time. Field Strength Varies Irregularly with Changes in Frequency Due to Multipath Reflections

<p>Theoretical. Horizontally polarized waves reflected less efficiently from vertical surfaces of low conductivity</p> <p>Less variation over a band from 176 to 182 Mc. Ratio of maximum to minimum field strength was 1.89 with vertical polarization and 1.32 with horizontal</p> <p>Less variation over bands of 81 to 86 Mc and 140 to 145 Mc. At 81 to 86 Mc, ratio</p>		
---	--	--

COMPARISONS BETWEEN HORIZONTAL AND VERTICAL POLARIZATION FOR TELEVISION TRANSMISSION.—(Continued)

Horizontal	No difference	Vertical
of maximum to minimum field strength was 2.97 with vertical polarization and 1.86 with horizontal. At 140 to 145 Mc, the ratios were 3.38 and 2.12, respectively Less reflections at 63 and 125 Mc Less reflections at 50, 84, and 142 Mc in the city		

Fixed Frequency and Position. Field Strength Varies Irregularly with Time Owing to Fading

	Fading may be reduced by using outputs from differently polarized antennas. (Measurements probably not made at u.h.f.) Earth's magnetic field rotates the plane of polarization. Effect predicted by theory and noted experimentally at 7.5 Mc No difference at 1,760 Mc	At 60 and 200 Mc over a 70-mile path over sea water, fewer fades per minute and less amplitude range of fading. Also less "airplane" fading Less fading above 3 Mc (probably no measurements at u.h.f.) Less fading at 150 Mc over sea water. No difference over land
--	--	---

Fixed Frequency and Time. Field Strength Varies Irregularly with Changes in Position of Receiving Antenna  
 Variation due to changing values of ground constants.

Less affected by varying ground constants; less affected by perfect and imperfect earth Less variation in the city owing to different effect of reflections at different locations		At antenna heights of less than one-eighth wave length, antenna radiation resistance is less affected by ground conditions; at 59 to 98 Mc, no significant difference in propagation over
---	--	---

## COMPARISONS BETWEEN HORIZONTAL AND VERTICAL POLARIZATION FOR TELEVISION TRANSMISSION.—(Continued)

Horizontal	No difference	Vertical
		ground and fresh water using vertical polarization and heights of transmitting and receiving antennas of approximately 2 meters Less affected by overhead wires, which are predominately horizontal

NOISE  
Theoretical

Less noise received from a noise source radiating equally at all polarizations located at a height of 3 ft. above ground. Advantage decreases as receiving antenna is raised, being 12.1 db at 10 ft., 7.5 db at 30 ft., 5.9 db at 50 ft. and 2.0 db at 100 ft. if the source is 100 ft. horizontally from the receiving antenna

Polarization has no effect on internal receiver noise

## General Experimental

Less noise in general, less man-made static, less noise with high antennas, less noise from 6 to 100 Mc

## Experimental—ignition

From 40 to 100 Mc, average of 3.4 db less ignition peak field strength at receiving

From 140 to 450 Mc, no average difference in ignition peak field strength at receiving

Ignition noise 6 db less at points directly above an auto



## COMPARISONS BETWEEN HORIZONTAL AND VERTICAL POLARIZATION FOR TELEVISION TRANSMISSION.—(Continued)

Horizontal	No difference	Vertical
antennas 35 ft. high, 100 ft. from a Long Island road Ignition noise 6 db less at ground level at reasonable distances from auto Ignition interference less in London at 45 Mc Motorboat ignition noise much less over sea water at 17 Mc	antennas 35 ft. high, 100 ft. from a Long Island road No difference in ignition noise at typical receiving antenna locations at reasonable distances from auto	

## Experimental—diathermy

Diathermy 9.5 to 12.5 db less from 41 to 50 Mc at New York World's Fair; 6 to 12 db less from 100 to 185 Mc in New York City	No difference at 19 Mc	
--	------------------------	--

## Experimental—noise in general

At 50 Mc at 10 typical television receiving antenna locations, noise averaged 2 db less. Ignition noise showed greatest difference, sometimes being as much as 6 db less Noise noticeably less at 79 Mc in Camden, N. J.		
---	--	--

SIGNAL-TO-NOISE RATIO  
Theoretical

Higher ratio at 45 and 100 Mc for typical practical conditions considering only external or both external		Higher ratio at 45 and 100 Mc for receiving antennas only a few feet above ground. Especially true as height of
---	--	---

COMPARISONS BETWEEN HORIZONTAL AND VERTICAL POLARIZATION FOR  
 TELEVISION TRANSMISSION.—(Continued)

Horizontal	No difference	Vertical
and internal noise for all receiving antenna heights greater than a few feet. Noise source is assumed equally polarized in all directions. Transmitting antenna is assumed at a great height at a great distance		transmitting antenna is decreased. An external noise source equally polarized in all directions is assumed. Also, higher ratio considering internal receiver noise only

## Experimental

Definitely higher ratio implied by RCA data, which indicate higher field strength and less noise In general, higher ratio Higher ratio above 3 Mc (Probably no measurements at u.h.f.)		Definitely higher ratio implied by Philco data, which indicate higher field strength and equal noise
---	--	--

## TRANSMITTING ANTENNA

## Power gain

For a given vertical length of array, turnstile antenna gives greater power gain in a horizontal plane		Simple vertical dipole has 1.5 db greater power gain than a single element turnstile antenna located in free space
--	--	--

## Impedance characteristic

Easier to design and construct for a flat impedance characteristic over a wide frequency band, especially when crossed dipoles are used to obtain a nondirective radiation characteristic		
---	--	--

## COMPARISONS BETWEEN HORIZONTAL AND VERTICAL POLARIZATION FOR TELEVISION TRANSMISSION.—(Continued)

Horizontal	No difference	Vertical
Radiation pattern		
		Nondirective radiation pattern in a horizontal plane with simplest type of antenna
Angle of radiation		
Greater low angle radiation, using a multi-element turnstile antenna		Simple vertical dipole concentrates more energy in a horizontal plane than does a simple horizontal dipole or single element turnstile
Picture and sound channels		
Picture and sound antennas may be located on same supporting structure with no coupling between them		
Mechanical considerations		
Much better, especially from the standpoint of supporting the elements and maintaining electrical symmetry. Also, requirements of the building codes are more easily satisfied		
Appearance		
W2XBS antenna much more pleasing than that of the London transmitter		

## COMPARISONS BETWEEN HORIZONTAL AND VERTICAL POLARIZATION FOR TELEVISION TRANSMISSION.—(Continued)

Horizontal	No difference	Vertical
Field experience		
Operation of the W2X-BS antenna satisfactory	At W3XE, both horizontal and vertical antennas were designed and constructed to give approximately the same power gain and radiation pattern without great difficulty	
RECEIVING ANTENNAS		
<p>Simplest form is directive in the horizontal plane, permitting discrimination against (a) interfering signals, (b) reflected signals, and (c) noise arriving from directions other than that of the desired signal</p> <p>Note that "discrimination against noise is in most cases far more important than increasing the signal strength"</p>	For single-channel reception, directivity in both the horizontal and vertical planes may be obtained by the use of reflectors and directors with either polarization	<p>Simplest form is non-directive in the horizontal plane, permitting reception from transmitters located in various directions</p> <p>Simplest form is directive in the vertical plane, permitting discrimination against noise originating below the level of the antenna</p>
Construction		
Easier to balance with respect to transmission line and ground	Mechanical erection of a good antenna probably equally difficult	Much more satisfactory for use in autos
Built-in antennas		
Directional built-in antennas require less shielding		
Appearance		
		Probably more acceptable to the public

BIBLIOGRAPHY<sup>1</sup>REFERENCES THAT WILL BE OF INTEREST IN CONNECTION WITH POLARIZATION  
AND PROPAGATION OF ULTRA-HIGH-FREQUENCY WAVES

- STRUTT, M. J. O.: Radiation from Antennae as Affected by the Properties of the Ground, *Ann. Physik*, Apr. 6, 1929, Parts A and B, pp. 721-772.
- DRAKE, F. H., and RAYMOND M. WILMOTTE: On the Daylight Transmission Characteristics of Horizontally and Vertically Polarized Waves from Airplanes, *Proc. I.R.E.*, December, 1929, pp. 2242-2258.
- PETERS, H.: Measurements in the Radiation Field of a Dipole Aerial, *E.N.T.*; October, 1930, pp. 378-386.
- UDA, S., T. SEKI, K. HATAKEYAMA, and J. SATO: Radio Telephony with Ultra-short Waves, *J.I.E.E. (Japan)*, September, 1931, pp. 643-645.
- JONES, L. F.: A Study of the Propagation of Wavelengths between Three and Eight Meters, *Proc. I.R.E.*, March, 1933, pp. 349-386.
- TREVOR, B., and P. S. CARTER: Notes on Propagation of Waves below Ten Meters in Length, *Proc. I.R.E.*, March, 1933, pp. 387-426.
- ENGLAND, C. R., A. B. CRAWFORD, and W. W. MUMFORD: Some Results of a Study of Ultra-short-wave Transmission Phenomena, *Proc. I.R.E.*, March, 1933, pp. 464-492.
- ESAU, A., and W. KOHLER: Propagation of 1.3 m. Waves, *Hochfrequenz-technik und Elektroakustik*, May, 1933, pp. 153-156.
- SCHELLING, J. C., C. R. BURROWS, and E. B. FERRELL: Ultra-short-wave Propagation, *Proc. I.R.E.*, March, 1933, pp. 427-463.
- MUYSKENS, H., and J. D. KRAUS: Some Characteristics of Ultra-high-frequency Transmission, *Proc. I.R.E.*, September, 1933, pp. 1302-1316.
- HERSHBERGER, W. D.: Seventy-five-centimeter Radio Communication Tests, *Proc. I.R.E.*, July, 1934, pp. 870-877.
- TREVOR, B., and R. W. GEORGE: Notes on Propagation at a Wavelength of Seventy-three Centimeters, *Proc. I.R.E.*, May, 1935, pp. 461-469.
- HOLMES, R. S., and A. H. TURNER: An Urban Field Strength Survey at Thirty and One Hundred Megacycles, *Proc. I.R.E.*, May, 1936.
- SCROGGIE, M. G.: Television and the Aerial, *Wireless World*, August, 1936, pp. 198-200.
- CARTER, P. S., and G. S. WICKIZER: Ultra-high-frequency Transmission between the RCA Building and the Empire State Building in New York City, *Proc. I.R.E.*, August, 1936, pp. 1082-1094.
- COLWELL, R. C., and A. W. FRIEND: Ultra-high-frequency Wave Propagation over Plane Earth and Fresh Water, *Proc. I.R.E.*, January, 1937, pp. 32-37.
- BEVERAGE, H. H.: Some Notes on Ultra-high-frequency Propagation, *RCA Rev.*, January, 1937, pp. 76-87.
- BURROWS, C. R.: Radio Propagation over Plane Earth—Field Strength Curves, *Bell System Tech. J.*, January, 1937, pp. 45-75.
- BURROWS, C. R.: The Surface Wave in Radio Propagation over Plane Earth, *Proc. I.R.E.*, February, 1937.

<sup>1</sup> D. B. Smith, chairman of the Panel.

- ENGLAND, C. R., A. B. CRAWFORD, and W. W. MUMFORD: Ultrashort-wave Transmission and Atmospheric Irregularities, *Bell System Tech. J.*, October, 1937, pp. 489-519.
- NORTON, K. A.: The Physical Reality of Space and Surface Waves in the Radiation Field of Radio Antennas, *Proc. I.R.E.*, September, 1937.
- NIESSEN, K. F.: Choice between Horizontal and Vertical Dipole Aerials for Minimum Earth Absorption with Given Wavelength and Type of Soil, *Ann. Physik*, November, 1938, pp. 403-418.
- SMITH-ROSE, R. L.: Some Aspects of the Propagation of Ultra-short Waves, *Telev. Soc. J.*, December, 1938, pp. 475-485.
- GEORGE, R. W.: A Study of Ultra-high-frequency Wide-band Propagation Characteristics, *Proc. I.R.E.*, January, 1939, pp. 28-35.
- SMITH-ROSE, R. L., and A. C. STRICKLAND: Ultrashort Wave Propagation. Comparison between Theory and Experimental Data, *Wireless Engineer*, March, 1939, pp. 111-120.
- PETERSON, H. O.: Ultra-high-frequency Propagation Formulas, *RCA Rev.*, October, 1939, pp. 162-167.
- WICKIZER, G. S.: Mobile Field Strength Recordings of 49.5, 83.5, and 142 Mc from Empire State Building, New York—Horizontal and Vertical Polarization, *RCA Rev.*, April, 1940, 387-398.

## REFERENCES NOT RELATING TO THE PROBLEM BUT IN THE SAME FIELD

- ZENNECK, J.: Propagation of Plane Electromagnetic Waves along a Plane Conducting Surface and Its Bearing on the Theory of Transmission in Wireless Telegraphy, *Ann. Physik*, September, 1907, pp. 846-866.
- SOMMERFELD, A.: Propagation of Waves in Wireless Telegraphy, *Ann. Physik*, March, 1909, pp. 665-736.
- WATSON, G. N.: Diffraction of Electric Waves by the Earth, *Proc. Roy. Soc.*, October, 1918, pp. 83-99.
- PICKARD, G. W.: The Polarization of Radio Waves, *Proc. I.R.E.*, April, 1926, pp. 205-212.
- LANGE, E. H.: Note on Earth Reflection of Ultra-short Radio Waves, *Proc. I.R.E.*, April, 1929, pp. 745-751.
- STRUTT, M. J. O.: Reflection Measurements with Ultra-short Electric Waves and with Acoustic Waves, *E.N.T.*, February, 1930, pp. 65-71.
- UDA, S.: Radiotelegraphy and Radiotelephony on Half-meter Waves, *Proc. I.R.E.*, June, 1930, pp. 1047-1063.
- STRATTON, J. A.: The Effect of Rain and Fog on the Propagation of Very Short Radio Waves, *Proc. I.R.E.*, June, 1930, pp. 1064-1074.
- WILMOTTE, R. M.: Formulae for the Radiation Distribution of Aerial Systems, *J.I.E.E.*, September, 1930, pp. 1174-1190.
- JONAST, R.: Some Details Relating to the Propagation of Very Short Waves, *Proc. I.R.E.*, March, 1931, pp. 479-488.
- NAMBA, S., E. ISO, and S. UENO: Polarization of High-frequency Waves and Their Direction Finding, *Proc. I.R.E.*, November, 1931, pp. 2000-2019.
- PFETSCHER, O., and R. BECK: Communication with 1.3 m. Waves, *Physik. Z.*, March, 1932, pp. 242-244.

- SMITH-ROSE, R. L., and J. S. MCPETRIE: Propagation along the Earth of Radio Waves on a Wavelength of 1.6 Meters, *Proc. Phys. Soc. London*, July, 1932, pp. 500-508.
- ECKERSLEY, T. L.: Direct-ray Broadcast Transmission, *Proc. I.R.E.*, October, 1932, pp. 1555-1579.
- HOLLINGSWORTH, J.: Characteristics of Short-wave Propagation, *J.I.E.E.*, March, 1933, pp. 229-248.
- TREVOR, B. and P. S. CARTER: Propagation of Waves below 10 Meters, *Proc. I.R.E.*, March, 1933, pp. 387-426.
- Electromagnetic Field at a Distance from the Transmitter-short Waves, *J. Télégraphique*, April, 1933, pp. 96-99.
- FELDMAN, C. B.: The Optical Behavior of the Ground for Short Radio Waves, *Proc. I.R.E.*, June, 1933, pp. 764-801.
- BAKER, W. G., and A. L. GREEN, The Limiting Polarization of Downcoming Radio Waves Traveling Obliquely to the Earth's Magnetic Field, *Proc. I.R.E.*, August, 1933, pp. 1103-1131.
- WISE, W. H.: Dipole Radiation Theory, *Physics*, October, 1933, pp. 354-358.
- GREEN, A. L.: Polarization of Sky Waves in the Southern Hemisphere, *Proc. I.R.E.*, March, 1934, pp. 324-343.
- SMITH-ROSE, R. L.: Electrical Measurements on Soil with A.C., *J.I.E.E.*, August, 1934, pp. 221-237.
- EPSTEIN, P. S.: Bending of Electromagnetic Micro-waves below the Horizon, *Proc. Natl. Acad. Sci.*, January, 1935, pp. 62-68.
- BURROWS, C. R., L. E. HUNT, and A. DECINO, Ultra-short Waves in Urban Territory, *Elec. Engr.*, January, 1935, pp. 115-124.
- BURROWS, C. R.: Radio Propagation over Spherical Earth, *Proc. I.R.E.*, May, 1935, pp. 470-480.
- ENGLAND, C. R., A. B. CRAWFORD, and W. W. MUMFORD: Further Results of a Study of Ultra-short-wave Transmission, *Bell System Tech. J.*, July, 1935, pp. 369-387.
- HULBURT, E. O.: The Ionosphere, Skip Distances of Radio Waves and the Propagation of Microwaves, *Proc. I.R.E.*, December, 1935, pp. 1442-1506.
- BURROWS, C. R., A. DECINO, and L. E. HUNT: Ultra-short-wave Propagation over Land, *Proc. I.R.E.*, December, 1935, pp. 1507-1535.
- NORTON, K. A.: The Propagation of Radio Waves over the Surface of the Earth and in the Upper Atmosphere, Part I, *Proc. I.R.E.*, October, 1936.
- STRAFFORD, F. R. W.: Experiments with Television Aerials, *Wireless World*, Oct. 16, 1936, pp. 394-396.
- WUEDENSKY, B.: Diffractive Propagation of Radio Waves, *Tech. Phys. U.S.S.R.*, 1936, pp. 915-925.
- WISE, W. HOWARD: The Physical Reality of Zenneck's Surface Waves, *Bell System Tech. J.*, January, 1937, pp. 35-44.
- ECKERSLEY, T. L.: Ultra-short-wave Refraction and Diffraction, *J.I.E.E.*, March, 1937, pp. 286-304.
- VON HANDEL, P., and W. PFISTER: Ultra-short-wave Propagation along the Curved Earth's Surface, *Proc. I.R.E.*, March, 1937.

- HULL, R. A.: Air-mass Conditions and Beveling of U.H.F. Waves, *Q.S.T.*, June, 1935, pp. 3-8, and May, 1937.
- DENT, H. B.: Television Aerials, *Wireless World*, May 28, 1937, pp. 506-508.
- NIESSEN, K. F.: A Refinement in the Sommerfeld Formula for the Propagation from a Small Vertical Dipole, *Ann. Physik*, August, 1937, pp. 569-584.
- NIESSEN, K. F.: A Differentiation between the Two Sommerfeld Formulae for the Propagation from a Vertical Dipole, *Ann. Physik*, August, 1937, pp. 585-596.
- NORTON, K. A.: The Propagation of Radio Waves over the Surface of the Earth and in the Upper Atmosphere, Part II, *Proc. I.R.E.*, September, 1937.
- PETERSON, H. O., and D. R. GODDARD: Field Strength Observations of Transatlantic Signals, 40 to 45 Megacycles, *Proc. I.R.E.*, October, 1937.
- WUEDENSKY, B.: Diffractive Propagation of Radio Waves, *Tech. Phys. U.S.S.R.*, 1937, pp. 579-591.
- BURROWS, C. R., A. DECINO, and L. E. HUNT: Stability of Two Meter Waves, *Proc. I.R.E.*, May, 1938.
- ECKERSLEY, T. L., and G. MILLINGTON: Application of the Phase Integral Method to the Analysis of the Diffraction and Refraction of Wireless Waves round the Earth, *Phil. Trans. Roy. Soc. London*, June, 1938, pp. 273-309.
- VAN DER POL, B., and H. BRENNER: Results of a Theory of the Propagation of Electro-magnetic Waves over a Finitely Conducting Sphere, *Phil. Mag. Supp.*, June, 1938.
- PETRIE, J. S., and B. G. PRESSEY: Method of Using Horizontally Polarized Waves for the Calibration of Short Wave Field Strength Measuring Sets by Radiation, *J.I.E.E.*, August, 1938, pp. 210-215.
- BLUMLEIN, DAVIS, BROWNE, and GREENE: The Marconi E.M.I. Television System, *J.I.E.E.*, December, 1938, pp. 758-801.
- MACNAMARA, T. C., and D. C. BIRKINSHAW: London Television Service, *J.I.E.E.*, December, 1938, pp. 729-757.
- ROCARD, Y.: Attenuation of Ultrashort-wave Field on Crossing Rivers, *Compt. rend.*, December, 1938, pp. 1191-1192.
- CONKLIN, E. H.: 56-megacycle Reception via Sporadic-E-Layer Reflections, *Proc. I.R.E.*, January, 1939.
- GODDARD, D. R.: Observation on Sky-wave Transmission on Frequencies above 40 Megacycles, *Proc. I.R.E.*, January, 1939, pp. 12-15.
- GEORGE, R. W.: Field Strength Measuring Equipment for Wide-band U.H.F. Transmission, *RCA Rev.*, April, 1939, pp. 431-440.
- GODDARD, D. R.: Transatlantic Reception of London Television Signals, *Proc. I.R.E.*, November, 1939.
- CROSBY, M. G.: The Service Range of Frequency Modulation, *RCA Rev.*, January, 1940, pp. 349-371.
- HALLER, G. L.: Free Space Propagation Measurements at 75 Mc., *J. Franklin Inst.*, February, 1940, pp. 165-180.



**Reports on Factors Affecting Polarization.**—Of the many papers prepared by the panel members, the following have been selected as representative: Factors Influencing the Choice of Polarization by F. J. Bingley; Horizontal vs. Vertical Polarization for Television, by H. H. Beverage; Antennas for Television Receivers, and Field Tests Relating to Built-in Antennas, by W. L. Carlson; and Antenna Design and Application Problems, by C. W. Hansell. Several other papers have received prior publication, and the remainder must be omitted for lack of space.

#### **FACTORS INFLUENCING THE CHOICE OF POLARIZATION OF THE RADIATED WAVE FOR TELEVISION-NETWORK SERVICE<sup>1</sup>**

The objective of any study of wave polarization should be to consider all the factors of the two types of polarization with respect to both the usefulness of the signal transmitted and the advantages and disadvantages of the type of polarization employed. On the one hand, consideration must be given to the technical qualities of the service, such as freedom from noise, quality of the picture, etc., and on the other, to the cost to the customer, the universality of the service, etc. The extensive field tests that Philco has conducted with both types of polarization have demonstrated that, on the basis of present knowledge, satisfactory television receivers with either built-in antennas or external antennas can be provided with either type of polarization and, further, that the difference in service between the two is so slight as to be inconsequential. Hence the deciding factor should be the economic considerations that now obtain in the industry.

#### **COMPARISON OF SIGNAL INTENSITY**

From a technical standpoint, the first requirement is that of signal strength. Theoretical calculations<sup>2</sup> show that, near the ground level in open space, the signal strength with vertical polarization will always exceed that of horizontal polarization. These theoretical calculations are in accord with the extensive experience and series of measurements made by Philco over a period of 8 years during which time they have been on the air with each type of polarization about an equal amount of time.

<sup>1</sup> F. J. Bingley, The Philco Corporation.

<sup>2</sup> See, for example, K. A. Norton, Statement on Ultra-high Frequency Propagation before the FCC, Jan. 15, 1940.

During the last year, W3XE has had two interchangeable antennas, one horizontal and one vertical. The input impedance and average power gain of both antennas are the same. Hence comparative tests, in which polarization is the only factor changed, can and have been made. As far as is known, W3XE is the only high-power television station that has been thus adapted to make comparative field tests under actual conditions. Some 440 measurements at an antenna height of 9 ft. made at locations spaced over the entire service area of W3XE show that, near the transmitter in regions where the field strength is somewhat greater than  $1,250 \mu\text{v/m}$ , the signal intensities are equal for both horizontal and vertical polarization. For the region where the signal level lies between 125 and  $1,250 \mu\text{v/m}$ , the vertical signal is stronger by about 3.7 db, and, for signals less than  $125 \mu\text{v/m}$ , the vertical is stronger by about 6.4 db. These results are in accordance with theoretical predictions. It is believed that the data reported by Wickizer and George<sup>1</sup> for an antenna height of 10 ft. are inconsistent with those reported by George H. Brown in the same document and are in error. The above data are of primary importance in automobile reception of f-m broadcasting.

#### COMPARISON OF SIGNAL INTENSITY UNDER ACTUAL CONDITIONS

However, antennas for television receivers will be located largely within the rooms of homes or on the roofs. Under these conditions, which differ from those outlined above, further measurements made in different homes show that this advantage for vertical polarization is not maintained. Several rooms in some seven different homes were thoroughly explored with small loops and dipole antennas of the type used for built-in antennas. Hundreds of measurements of signal intensity and observations of picture quality showed no significant advantage for vertical polarization on the average, though some locations were found where vertical transmission gave better results and others where horizontal polarization was preferable. These tests did show, however, that, although there is some loss of signal strength within the building and considerable distortion of the polarization, nevertheless there is every reason to believe that acceptable

<sup>1</sup> Wave Polarization for Television, RCA Manufacturing Company, Inc., *N.T.S.C. Doc. 171R*.

service with either type of polarization and with convenient built-in antennas can be obtained.

#### NOISE COMPARISONS UNDER INDOOR HOME CONDITIONS

Measurements of ignition noise within buildings showed a similar diversity of results. Locations were noted where vertical polarization was definitely preferable, and about an equal number of locations were found where horizontal polarization was better. By selecting the proper locations, a good case could be built up for either choice, but, taking the unbiased result of all locations, there seems to be no preference one way or the other. It is interesting to note, however, that the effect of the building seems to be to attenuate the ignition noise about as much as the useful signal, which is encouraging from the point of view of built-in antennas.

#### COMPARISON OF EXTERNAL ANTENNAS

In those cases where outside antennas will be employed, observations of signal level and picture quality at many different locations again showed no substantial difference as between the two types of polarization. In many locations, a nondirectional antenna will be desired, in which case vertical polarization is preferable, but in many others advantage can be taken of the more convenient directional characteristics afforded with horizontal polarization. If more complicated antenna arrays are employed, there is no significant difference.

#### COMPARISON OF GENERAL NOISE CONDITIONS

Similar observations have been made concerning ignition noise and the noise level in general. The theoretical calculations included in the paper by George H. Brown<sup>1</sup> are believed to be unduly weighted in favor of horizontal polarization. For example, in Figs. 9 and 10, the principal factor contributing to his over-all comparison is the curve of the noise source at a great distance away and 3 ft. aboveground. This noise source is assumed to lay down a signal comparable with the useful signal or the interference from passing automobiles, etc. No noise source of such power now exists. For example, if one considers

<sup>1</sup> Wave Polarization for Television, RCA Manufacturing Company Inc., *N.T.S.C. Doc. 171R.*

a location 5 miles from a transmitting station of 5-kw. power and antenna height of 300 ft., a noise source at the same distance but 3 ft. above ground would have to radiate power in the order of 50,000,000 watts to produce an interfering signal of the same level. And, even if the source were much closer, an impossible amount of power would be required to produce interference. On the other hand, if the same curves are computed for noise sources closer to the antenna, say 100 ft., 50 ft., and 25 ft., then it will be found that vertical polarization is preferable, particularly at the higher frequencies. This is even more true if the weight given each curve is allocated in accordance with the normal attenuation of a signal from a source at the given distance. The net over-all conclusion that can be made is that, at low frequencies and with noise sources away from the antenna, horizontal polarization has a slight advantage, and, with higher frequencies and noise sources close at hand, vertical polarization is theoretically better.

#### SUMMARY OF TECHNICAL RESULTS

Hence on the basis of signal intensity, ignition noise interference, the quality of the received picture, and the likelihood of service with built-in antennas, we have found that, as an over-all result, there is no particular advantage with either type of polarization, although some locations will favor one choice and others the other.

#### COMMERCIAL CONSIDERATIONS

The convenience of the user will, however, be affected by the type of polarization employed. The receiving antenna will have to be polarized in the same manner as the transmitted wave, particularly if an outside antenna is employed. Vertical polarization requires vertical loops for built-in antennas and vertical dipoles for outside antennas. With horizontal polarization, it will be necessary to use loaded dipoles for built-in antennas or horizontal dipoles for outside service. The user will want to use the same antenna for as many services as possible. This has been amply proved by commercial experience.

1. With the introduction of foreign and short-wave services in domestic receivers, cumbersome antenna arrays to accommodate these services (although providing good technical per-

formance) were not commercially successful. However, simple all-wave antennas that provide for all services with the same pickup device were highly successful and are widely used.

2. With the introduction of built-in antennas, those which provided only broadcast service and required an outside antenna for short-wave reception were not successful. However, with the introduction of built-in antennas for short wave as well as broadcast reception, the self-contained antenna became popular.

3. The trend to the single all-wave built-in loop is a convincing proof of the public demand for simplicity and over-all service from radio antennas.

In the long run, the customer will demand the same antenna convenience for his television receiver.

#### COORDINATION WITH OTHER SERVICES

Since standard broadcasting is vertically polarized, it requires the use of vertical loops for built-in antennas. If FM and television broadcasting were also vertically polarized, complete uniformity among all three services would obtain. If the present trend in FM to horizontal polarization continues in spite of the automobile requirement, then this uniformity cannot be had in any case. As between the two, it is Philco's feeling that television should be coordinated with FM, because the coverage and antenna requirements are so similar.

#### HORIZONTAL VS. VERTICAL POLARIZATION FOR TELEVISION<sup>1</sup>

This memorandum is an attempt to summarize briefly the relative merits of horizontal vs. vertical polarization for u-h-f transmission, with particular reference to television. These comments are based on the experience of RCA Communications, Inc. There are many variable factors involved, and it is often difficult to set down quantitative data for any given conditions. Any quantitative data mentioned in this report are necessarily an average based on a considerable number of observations.

#### PROPAGATION

The theory of u-h-f propagation has been worked out fairly completely by several individuals and has been well summarized

<sup>1</sup> H. H. Beverage, RCA Communications, Inc.

in convenient form by K. A. Norton of the FCC.<sup>1</sup> The general conclusion from the theory is that, for the usual conditions encountered in practice, there is little difference between the propagation of horizontally and vertically polarized waves on frequencies above 40 Mc for transmission overland. Vertical polarization is superior when the antennas are a few feet from the ground. For oversea transmission, where the conductivity is great, vertical polarization produces markedly superior transmission for very low antennas. This superiority disappears as the antennas are elevated.

The general theory, of course, applies to a path free of obstructions, and, for this assumed condition, the experimental observations agree remarkably well with the theory. Actually, most transmission paths have irregularities and obstructions that may cause the observed field strength to be above or below the theoretical value and may also show different field strengths for horizontal vs. vertical polarization. On the average, it has been the experience of RCA Communications that the field intensity for horizontal polarization will average appreciably higher than the corresponding field intensity for vertical polarization; antenna heights, power, and other factors remain the same. One fairly comprehensive series of mobile recordings on frequencies of 49.5, 83.5, and 142 Mc has been reported by G. S. Wickizer.<sup>2</sup> He found that the average for all observations on all frequencies was 4.3 db in favor of horizontal polarization.

#### MULTIPATH

The ultra-high frequencies are readily reflected by objects such as buildings. The reflected waves may travel over paths differing considerably in length from the direct path, thus resulting in addition at some frequencies and partial cancellation at other frequencies. Since a television channel occupies a considerable band of frequencies, the transmission may vary considerably over the band, and displaced images may appear. A series of observations at several locations in and around New

<sup>1</sup> Summary of Statement by K. A. Norton on Ultra-high-frequency Wave Propagation, Television Hearing, Jan. 15, 1940.

<sup>2</sup> Mobile Field Recordings of 49.5, 83.5, and 142 Mc from Empire State Building, New York—Horizontal and Vertical Polarization, *RCA Rev.*, April, 1940, pp. 387-398.

York City were made by R. W. George<sup>1</sup> in which the frequency of the transmitter was varied between 81 and 86 Mc and also between 140 and 145 Mc. He found that the secondary-path reflections were stronger and more troublesome with vertical polarization. The geometric mean of the ratio of maximum to minimum field strength over the 5-Mc bands explored is a measure of the secondary-path reflections. For both bands observed, the ratio was 60 per cent higher for vertical polarization.

### NOISE

Many years ago, when frequencies between 6 and 20 Mc were put into use for point-to-point communication, it was found that local noises were reduced by using horizontally polarized receiving antennas instead of vertically polarized antennas. Accordingly, horizontally polarized receiving antennas for point-to-point communication have long been used as standard in the plant of RCA Communications, Inc. This same advantage was found to hold for frequencies above 20 Mc, becoming less marked at frequencies above 100 Mc. Measurements on ignition noise, comparing horizontal vs. vertical polarization, have been reported by R. W. George on frequencies between 40 and 450 Mc.<sup>2</sup> On frequencies up to 100 Mc, the ignition noise was 2 to 6 db less with horizontally polarized receiving antennas.

### RECEIVING ANTENNAS

For best results in most locations, it will probably be found desirable to erect an outside antenna. There would seem to be little difference in the cost of erecting a simple dipole whether it is horizontally or vertically polarized. For point-to-point operation, the horizontally polarized antenna is preferred, since, in general, it has the following advantages: (1) higher signal intensity, (2) lower noise, (3) symmetry to earth, which makes it easier to balance a two wire transmission line, (4) directivity, which is often useful in eliminating multipath reflections and concentrated sources of noise. All these factors excepting

<sup>1</sup> A Study of Ultra-high-frequency Wide-band Propagation Characteristics, *Proc. I.R.E.*, January, 1939, pp. 28-35.

<sup>2</sup> Field Strength of Motor Car Ignition between 40 and 450 Megacycles, Presented before Joint U.R.S.I.-I.R.E. Meeting, Washington, D.C., Apr. 26, 1940.

directivity should also apply to a broadcasting service. The directivity of the horizontal antenna is a handicap when it is desired to receive from all directions. However, the directivity is an advantage for eliminating reflections and concentrated noise, and, when this is necessary, it is more difficult to accomplish with a vertical array, since the latter would have more elements.

### TRANSMITTING ANTENNAS

When it is desired to transmit equally in all directions on a narrow band of frequencies, a vertically polarized antenna is unquestionably a simple solution mechanically. However, it is not a simple matter to construct a vertical antenna with a flat impedance characteristic over such a wide band of frequencies as is required for television. It is still more difficult to obtain a flat impedance characteristic with a vertical antenna array having appreciable power gain.

When it is desired to radiate equally in all directions with horizontal polarization, the usual practice is to erect the equivalent of two horizontal dipoles at right angles fed in phase quadrature from the transmission line. Although this construction is more difficult mechanically than the simple vertical antenna, it has a very important advantage electrically. The quadrature phasing of the radiators results in a tendency for the reactance and resistance variation of one radiator to balance the corresponding variations of the other radiator at the transmission-line feed point, thereby making the impedance characteristic flat over a wider band of frequencies. By proper design, it is feasible to construct a horizontally polarized antenna substantially flat over a band of frequencies covering several television channels. The television antenna on the Empire State building is an example of this type of construction. It has been described by N. E. Lindenblad.<sup>1</sup> The horizontally polarized antenna can be built up readily into arrays for power gain with good electrical characteristics and rugged mechanical construction.

### CONCLUSION

Although a satisfactory television broadcasting service can undoubtedly be had using vertical polarization, it seems to the

<sup>1</sup> Television Transmitting Antenna for Empire State Building, *RCA Rev.*, April, 1939; Antennas and Transmission Lines at the Empire State Television Station, *Communications*, May, 1940.



writer that, from the standpoint of propagation, horizontal polarization has many worth-while advantages that more than offset its disadvantages. The advantages of horizontal polarization vs. vertical polarization are (1) somewhat higher field intensity for most conditions likely to be encountered in a broadcast service, (2) less multipath reflection of particular importance in urban areas, (3) less man-made noise on frequencies below 100 Mc, (4) receiving antennas easier to balance with respect to transmission line and ground. Directivity an advantage in locations where multipath reflections and concentrated sources of noise exist, (5) transmitting antennas have better impedance characteristic vs. frequency due to quadrature cancellation. Power gain more readily obtained with good frequency characteristic and rugged mechanical construction.

The outstanding advantage of vertical polarization is the simplicity of the nondirectional transmitting and receiving antennas. In the opinion of the writer, this advantage does not compensate for the numerous disadvantages of vertical polarization. Furthermore, it is probable that this outstanding advantage of vertical polarization will tend to disappear as time goes on, since simple forms of horizontally polarized antennas, both directive and nondirective, will undoubtedly be invented.

#### ANTENNAS FOR TELEVISION RECEIVERS<sup>1</sup>

This discussion relates to television receiving antennas for reception of vertically and horizontally polarized waves. Designs and performance of outdoor and built-in antennas are discussed. Field tests relating to practical reception with built-in antennas are reviewed.

#### OUTDOOR ANTENNAS

The future "outdoor" antennas for television may be divided roughly into two classes: first, those which are designed for broad coverage over the complete television band; secondly, those which are designed for reception of one channel with a high degree of directivity. The former will be most popular in those areas served by two or more television stations on different channels. The latter will be desirable in locations served by only one television station and in locations where reflections, local noise,

<sup>1</sup> W. L. Carlson, RCA Manufacturing Company, Inc.

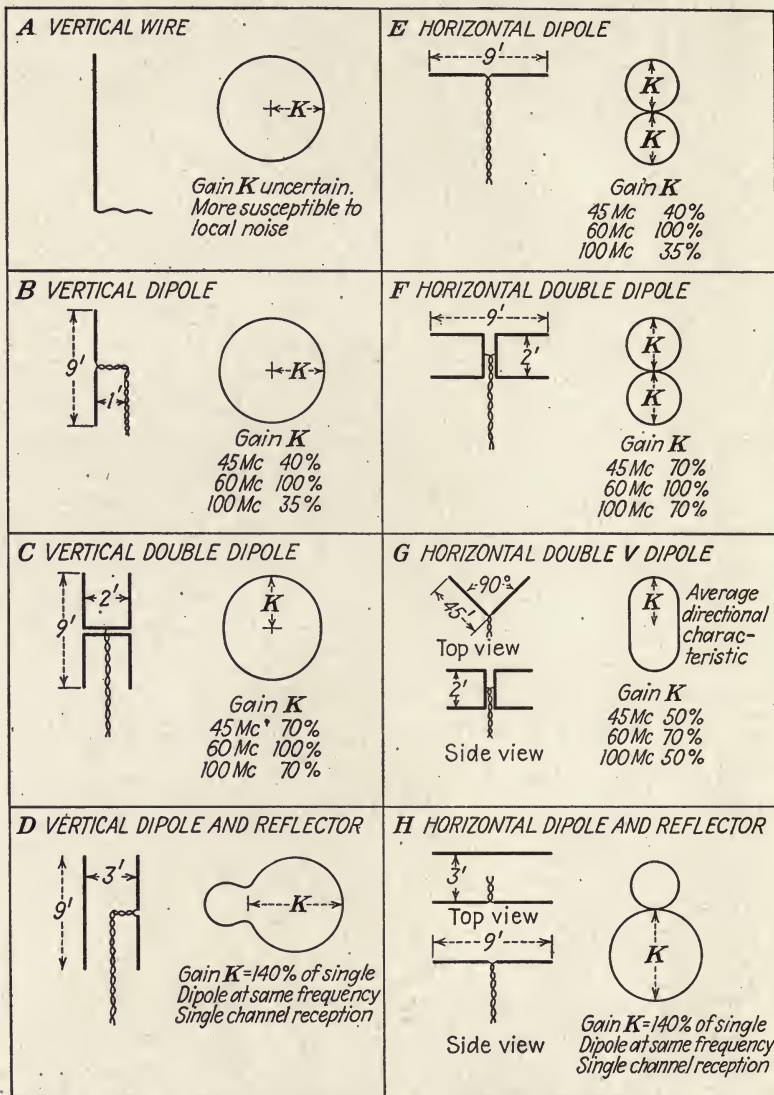

FIG. 100.—Various forms of outdoor television receiving antennas for vertical and horizontal polarization. (W. L. Carlson.)

or low field strength require a special antenna for reception of each station.

There are shown in Fig. 100 four antennas for reception of vertically polarized waves and four antennas for reception of horizontally polarized waves.

Figure 100A is the ordinary vertical-wire antenna 20 to 40 ft. long, which for appearance and low-cost considerations is preferred. The serious objections to this antenna are that it lacks the property of discriminating against interference and that the voltage delivered to the receiver will vary widely over the television frequency band.

Figure 100B is the conventional vertical half-wave dipole. This antenna is nondirectional and has limited frequency coverage. The antenna rods should be supported at least 1 ft. from the transmission line, as indicated in the sketch, to aid interference reduction and to improve signal strength.

Figure 100C is a double vertical half-wave dipole which gives the same performance at resonance as the single dipole *B* but has the added advantage of wider frequency coverage.

Figure 100D is a single vertical half-wave dipole with reflector giving a fairly high degree of directivity and selective response for one station reception.

Figure 100E is the corresponding single dipole of *B* mounted for reception of horizontally polarized waves. Compared to *B*, it is better balanced for interference reduction and has the well-known figure-8 directional pattern.

Figure 100F is the same as antenna *E* with the double set of rods which broadens the response characteristic as for antenna *C*.

Figure 100G is the same as *F* but with the one-fourth wave rods at 90 deg. relation instead of 180 deg. This antenna sacrifices maximum response in favor of nondirectional response. The directional characteristic will in general approach that of antenna *F* at the low-frequency end of the television frequency band and that of antenna *C* at the high-frequency end of the television frequency band.

Figure 100H is the same as antenna *D* mounted horizontally. It should be noted that the directional patterns of these two antennas *D* and *H* are similar but not identical.

The outdoor wide frequency coverage antennas for reception of vertically polarized waves have the advantage of being

nondirectional without sacrificing sensitivity. The outdoor antennas for reception of horizontally polarized waves have the advantage for reduction of interference and multiple images by reason of their directional properties and better balance to transmission line and surrounding objects. There does not appear to be any outstanding difference in appearance between the better performing vertical and horizontal type antennas.

### BUILT-IN ANTENNAS

A television receiving antenna confined within the console cabinet may be directional with means for orienting its directional characteristics, or the antenna may be nondirectional. In either case, means should be provided for resonating the antenna to each television channel through associated circuits connected with the channel selecting means.

A vertical loop may be employed as a bidirectional antenna for reception of vertically polarized waves and a horizontal dipole for bidirectional reception of horizontally polarized waves. For nondirectional reception a vertical dipole or a capacity element terminated through a coupling inductance to chassis ground may be employed for vertical polarization and a horizontal loop for nondirective horizontally polarized waves.

A directional built-in antenna with means for rotating its directional characteristic can be employed to discriminate against interference including undesired reflections. The nondirectional type of built-in antenna is least expensive and usually will occupy less cabinet space.

Two experimental built-in type antennas have been adapted to the RCA TRK-120 television receiver chassis. The first is a vertical loop type antenna. The two turns are in parallel and connected to an inductance through a wave-change switch. The antenna circuit functions as a full-wave resonant circuit and is coupled to a conventional input resonant circuit. The circuits are designed to give a band-pass characteristic of about 5 Mc width. The second is a horizontal dipole with end capacity load. It connects to an inductance that couples to an input resonant circuit, as in the case of the loop design. These antennas both have a figure 8 pattern in the horizontal plane. Both are rotatable about a vertical axis. The loop is  $10 \times 14.5$

in. The dipole ends are 8.5 in. square and separated by 12 in. Both rotate within the same cabinet space.

Provision was made through the wave-change switch for operating the sets on half-wave dipole antennas through a transmission line in the conventional manner on the old number 1 channel and the number 3 channel. Also the built-in loop and loaded dipole circuits were arranged for operation on these two channels through the operation of the wave-change switch.

#### FIELD TESTS ON BUILT-IN ANTENNAS

Table X gives the field strengths as recorded in various locations in the vicinity of New York on television reception from Station W2XBS operating in the old number 1 channel. Both the conventional half-wave dipole connected to a standard input circuit through a short transmission line and the loaded dipole antenna were rotated for maximum and minimum readings at each location.

The loop set that was not intended for directional reception of horizontally polarized waves was also field-tested at the same locations. The average signal input to the receiver was 50 per cent higher from the loaded dipole than from the loop set tipped over on its side (loop horizontal).

The tests also revealed that the loop in its normal position and turned broadside to the direction of arrival of the signal gave on an average the same output as the loaded dipole in its normal position of operation and oriented for maximum response. This means that the loop under test responded to vertically polarized waves when turned edge-on to the direction of wave propagation and responded to horizontally polarized waves when turned broadside. This is an objectionable feature in that the loop would respond to horizontally polarized interference or reflections arriving broadside to the loop when it was oriented for reception of vertically polarized waves arriving edge-on to the loop. The reason for this result is not certainly known. It may be due to the loop acting as a horizontal dipole.

The loaded dipole exhibited a similar defect but to a much less degree. It responded to vertically polarized waves when rotated to a position end-on to the direction of wave propagation. This was due to taking the dipole connections off from the lower

TABLE X.—RECEPTION OF W2XBS 45.25 Mc HORIZONTALLY POLARIZED

Location	Distance in miles	Position in building	Microvolts input				Ratio Half-wave dipole to loaded dipole	Comments
			Loaded dipole		Half-wave dipole			
			Min.	Max.	Min.	Max.		
Princeton, N. J.....	46	First floor	...	...	.....	13	The antenna above the roof has reflector and is 40 ft. high. Fair television service is obtained on this installation	
			...	7	.....	33		
			...	...	.....	100		
Cranford, N. J.....	18	Above roof	4	12	24	50	The regular antenna above the house gives good television service at this location	
			...	...	12	215		
			43	87	450	600		
South Orange.....	15	In yard, same height	...	...	...	...	At this location, there was a secondary image which could be eliminated by dipole rotation. Good results on the half-wave dipole and fair results on the loaded dipole	
	In yard	6	31	.....	175	5.6		
Teaneck.....	10	First floor	...	...	.....	...	Location shielded by rising ground toward transmitter. Reception good on half-wave dipole but poor on loaded dipole	
Manhattan (26 E. 93rd Street)	3	Tenth floor (position 1) Tenth floor (position 2) (On side away from transmitter)	...	94	.....	525	Position 1 and 2 in same room, 15 ft. apart. Fair picture in No. 2 position for each antenna when oriented for minimum images	
			60	560	1,075	1,875		
			150	1,550	700	3,750		
Manhattan (75 Varick Street)	2	Sixteenth floor (On side toward transmitter)	...	...	.....	...	Excellent picture on both antennas. Moving back into building gave poor results	
Manhattan (711 Fifth Avenue)	1.3	Twelfth floor (position 1) Twelfth floor (position 2)	...	...	.....	7	Test position No. 2 on south side of building gave fair pictures	
			450	3,000	1,500	18,750		
Manhattan (RCA Building)	0.75	Fifty-third floor Fifty-second floor	60	150	90	625	Fifty-third floor position was on side facing transmitter. Good pictures were obtained. Fifty-second floor on opposite side of building gave very poor picture owing to multiple images	
			...	...	...	...		

sides of the capacity end sections instead of from the middle of the sections.

Tests were conducted in Haddonfield, N. J., on both horizontally and vertically polarized television transmissions. These tests were from Philco Station W3XE on the third channel (67.25 Mc). The receiver was about 10 miles from the transmitter and located on the second floor of the frame dwelling. The dwelling was on high ground with no other homes immediately adjacent. The tests' results are shown in Table XI.

TABLE XI

Time	Polarization	Type antenna	Microvolts input	
			Min.	Max.
1. 7/1/40	Horizontal	Half-wave dipole	..	375
2. 7/1/40	Horizontal	Built-in loaded dipole	46	185
3. 9/19/40	Vertical	Half-wave dipole	..	205
4. 9/19/40	Vertical	Half-wave dipole	..	480
5. 9/19/40	Vertical	Built-in loop	20	150
6. 9/19/40	Vertical	Built-in loop	35	120

Tests 4 and 6 were with the antennas moved 3 ft. from positions for Tests 3 and 5. The quality of picture received was about in proportion to the field strength recorded. The horizontal half-wave dipole gave two times the signal of the built-in loaded dipole. The average vertical half-wave dipole reading was 2.5 times the average loop reading. The chassis and antenna units were located immediately adjacent but not in the television cabinet.

During the investigations the field strength of Stations W3XIR in Philadelphia was measured on 42.14 Mc and that of WFIL in Philadelphia on 560 kc in different rooms of the same dwelling located in Haddonfield; N. J. Both stations were transmitting vertically polarized waves and are located in about the same direction from Haddonfield. The minimum and maximum field strengths recorded on each floor are given in Table XII.

These tests indicate the order of field-strength variations that may be expected within a dwelling from television and standard-broadcast frequencies.

These field tests indicate that, in metropolitan areas like Manhattan, the service of built-in antennas for television will be generally limited to locations facing the transmitter and preferably within line of sight. The limitation restricting their services will be mainly multiple images. Built-in antennas are likely to be most serviceable in residential districts where the field strength immediately above the dwelling is at least ten times the value needed for satisfactory service on an outdoor antenna.

TABLE XII

	W3XIR 42Mc	WFIL 560 kc
First floor	78-218	19,100 to 22,600
Second floor	183-283	17,000 to 19,700
Third floor	291-470	

Experience with built-in antennas for television and previous experience with small-size directive antennas operating at 130 Mc leads to the conclusion that, if there is any advantage worthy of consideration as affecting the polarization standard, loaded dipoles and horizontally polarized waves are the preferred combination. This conclusion is reached because of the difficulties that have been experienced in holding the gain up and preventing horizontally polarized wave reception on loop antennas.

#### FIELD TESTS RELATING TO BUILT-IN RECEIVING ANTENNAS FOR HORIZONTAL AND VERTICAL POLARIZATION<sup>1</sup>

This is a supplement to the RCA report Wave Polarization for Television and more particularly to that part relating to built-in receiving antennas.

A small portable transmitter with loop antenna was set up in three different locations, 1T, 2T, and 3T, adjacent to a residential frame dwelling (see Fig. 101). The television chassis with loop and loaded dipole antennas, described on pages 342-343, were tested in three different locations within the dwelling on the first floor and in one location in the field adjacent to the house. Maximum and minimum antenna microvolts (by rotating the

<sup>1</sup> W. L. Carlson, RCA Manufacturing Company, Inc.



antennas) were recorded for both antennas and with both polarizations. The data obtained are recorded in Table XIII.

The average effect of the house on reception is shown by a comparison of the readings obtained outdoors, with the transmitter in position 1T and the receiver in position 4R, as recorded in the second to last line, with the average readings obtained with the receivers indoors and the waves arriving from three different directions, as computed in the last line. The high reading 189 for reception of vertically polarized waves on the dipole evidently was due to distortion of the plane of polarization within the dwelling. The average maximum vertically polarized

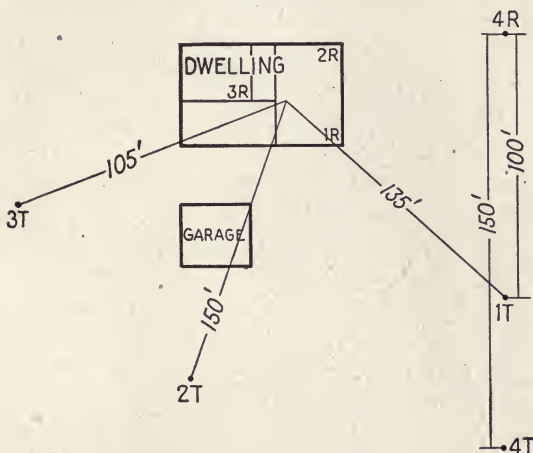

FIG. 101.—Map of test sites. (W. L. Carlson.)

signal received in the house on the loop dropped to 155 microvolts as compared to 377 microvolts at position 4R in the field. The maximum horizontally polarized signal, as received in the house on the dipole antenna, was in some cases greater than that obtained outdoors at position 4R, and the average indoor signal was the same as for outdoors. The response to horizontal polarization on the loop as recorded in the second to last column is discussed later.

Analysis of these data indicate that four positions of test (1T1R, 1T2R, 2T2R, 2T3R) favored vertical polarization, and that four positions of test (1T3R, 2T1R, 3T1R, 3T2R) favored horizontal polarization, with the receivers located within the dwelling. One position (3T3R) has no choice. This conclusion

is on the basis of choosing the transmission polarization and its corresponding type of receiving antenna that gave the best results for each receiver location and with each transmitter location. This rating takes into account the amplitude of the desired signal received and the discrimination against undesired signals of either polarization. The test with the receiver located in the field favored vertical polarization.

The tests confirm the generally accepted opinion that reception conditions vary widely in different locations within a building at ultra-high frequencies.

TABLE XIII.—FIELD TEST FROM PORTABLE TRANSMITTER ON 69 Mc.

Transmitter position	Receiver position	Vertical polarization				Horizontal polarization			
		Dipole		Loop		Dipole		Loop	
		Max.	Min.	Max.	Min.	Max.	Min.	Max.	Min.
1T	1R	221	55	215	50	75	5	63	13
1T	2R	125	42	125	13	125	17	38	26
1T	3R	125	62	38	20	101	23	44	13
2T	1R	161	45	113	51	161	60	130	41
2T	2R	161	16	76	23	17	6	32	5
2T	3R	68	10	88	38	51	17	63	13
3T	1R	177	75	169	40	247	45	125	32
3T	2R	87	17	26	18	195	10	33	13
3T	3R	110	75	204	40	210	45	88	33
4T	4R			225					
1T	4R	62	62	337	44	161	29	95	38
*	*	189	57	155	45	163	33	93	28

\* Average for transmitter positions 1, 2, 3 and receiver positions 1, 2, 3, corrected for 100-ft. separation.

It was observed that a person moving about the room in the vicinity of the receiver had considerably more effect on the signal strength received from vertically polarized waves than on that from horizontally polarized waves. Evidently the body acts as a vertical dipole that absorbs and distorts the wave. An electrostatic shield placed around the loop did not reduce this effect.

In the previous report, mention was made of the reception of horizontally polarized waves on a vertical loop turned broadside

to the transmitter. It was thought at the time that this might be caused by the loop acting as a dipole, in which case it could be shielded to avoid this reception. Subsequent tests showed that shielding did not affect this response.

A. H. Turner offered the theory that this response was due to the differences in field strength at the top and bottom of the loop, *i.e.*, due to the vertical voltage gradient of the horizontally

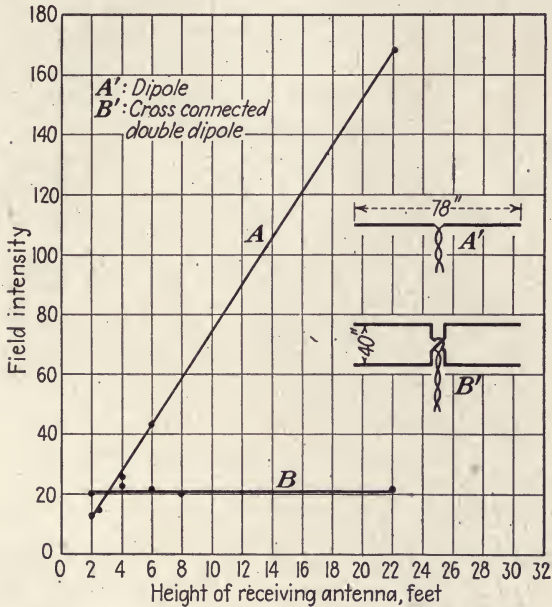

FIG. 102.—Field intensities as a function of height. Receiving antenna rods horizontal and oriented broadside to transmitter; transmitter loop horizontal,  $2\frac{1}{2}$  ft. above ground and 100 ft. from receiving antenna. (W. L. Carlson.)

polarized wave. If this theory is correct, the response will remain constant with height of loop above ground so long as the rate of change of field strength with height remains constant. Tests were made in an open field using a standard horizontal dipole to measure the variation of field strength with height (see curve A of Fig. 102). A pair of cross-connected dipoles  $B'$  were used instead of a loop to measure the response to the voltage gradient. The dipoles were in effect functioning as the top and bottom parts of a loop. The output was practically constant as the antenna was raised from 2 to 22 ft. (see curve B, Fig. 102).

This experiment appears to confirm the voltage gradient theory for loop reception of horizontally polarized waves.

A test was made to determine the effect of mounting a multiple-turn loop suitable for standard broadcast reception in the center of the loaded dipole antenna. The axes of both antennas were in the same plane. The presence of the loop made no measurable difference in reception on the dipole at 69 Mc. With vertical polarization on the television band, two loops may be mounted

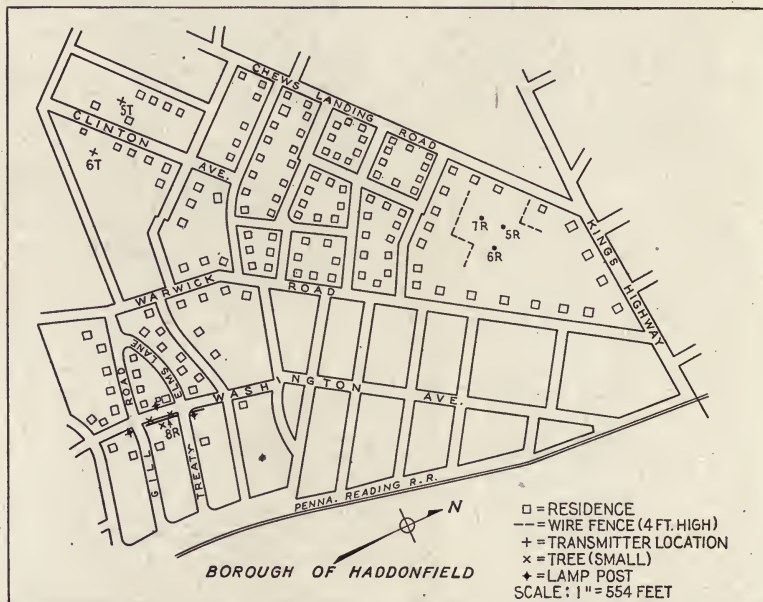

FIG. 103.—Map of test sites. (W. L. Carlson.)

at right angles, or, as has been suggested, the same loop may serve for both television and standard broadcast reception. Employing the same one- or two-turn loop for standard broadcast and for television has the merit of simplicity in design but has the disadvantage of poorer performance on the standard broadcast band. If a loop for the standard broadcast band is added to the loaded dipole or loop for television, no extra cabinet space is required.

Transmitter loop was  $2\frac{1}{2}$  ft. aboveground. Receiver loop and loaded dipole were  $6\frac{1}{3}$  ft. aboveground. Field strength of vertically polarized wave at receiver position 4R was 3.5 times

the field strength of the horizontally polarized wave. The figures indicate microvolts output from receiving antennas. The loaded dipole is 1.5 times more sensitive than the loop at a given field strength.

The relative field strength of vertically and horizontally polarized waves passing through mainly residential areas has

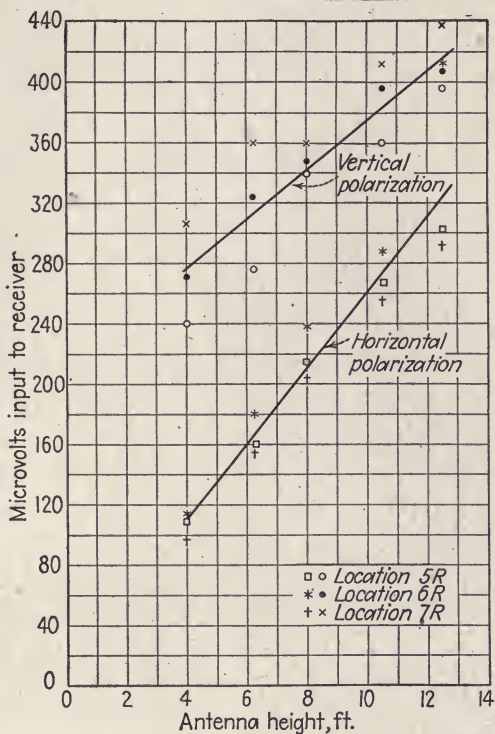

FIG. 104.—Field survey of signal strength, 69 Mc, comparing horizontal and vertical polarization. (W. L. Carlson.)

been investigated. For these tests, a half-wave dipole receiving antenna was located remote from the receiver and buildings so as to minimize the effect of local surroundings.

Figure 103 is a partial map of Haddonfield, N.J. The small test transmitter previously referred to with loop radiator was placed in position 5T, 5 ft. aboveground. The receiving dipole antenna was placed in a field at locations 5R, 6R, and 7R, and at different heights of from 4 to 12.5 ft. The transmitter ground site was at about 40 ft. higher elevation than the receiving

locations with most of the rise occurring toward the transmitter. Receiver location R3 was about 3 ft. higher than locations R1 and R2. The transmission distance was 0.6 mile. The data obtained are recorded in Fig. 104. The distance between receiving locations was about 150 ft.

From transmitter position 6T in Fig. 103, another test was made with the receiver dipole progressively moved along the sidewalk marked 8R on Washington Avenue. The transmitter was 5 ft. aboveground, and the receiver was 6 ft. 3 in. above the

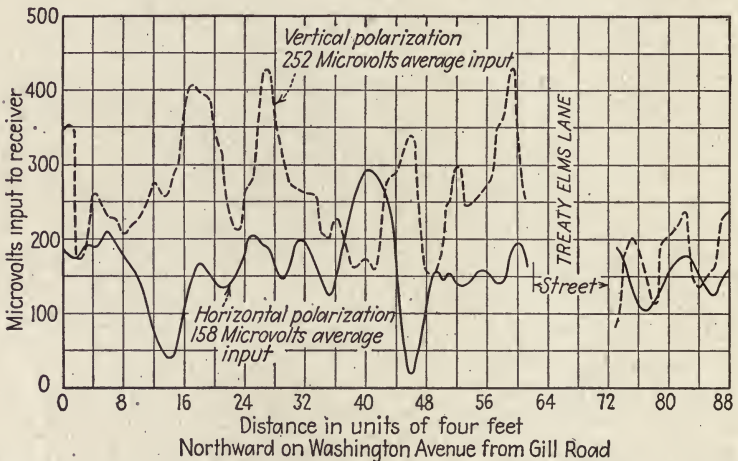

FIG. 105.—Variation of signal strength with distance, 69 Mc, comparing vertical with horizontal polarization. (W. L. Carlson.)

walk. The terrain between receiver and transmitter was fairly regular. The receiver location was about 10 ft. higher at Gill Road than at Treaty Elms Lane. There were no overhead power lines in the vicinity of the receiving location. The transmission distance was 0.4 mile. The results of these tests are shown in Fig. 105. The distance from the sidewalk to the houses across the road was 100 ft.

Further tests were conducted with the portable transmitter located 10 ft. above the roof of RCA Manufacturing Company building 5. The loop antenna was about 110 ft. aboveground. Figure 106 gives the field strengths recorded at the Camden Airport and in a field immediately beyond the airport. There were few buildings intervening along the transmission path.

The terrain was practically level throughout the transmission path. From the site at 9R and 10R, substantially the same results were obtained for horizontally polarized waves. The field strength for vertically polarized waves was considerably less at location 10R compared to location 9R. This may have been due to the metal fence bounding the airport.

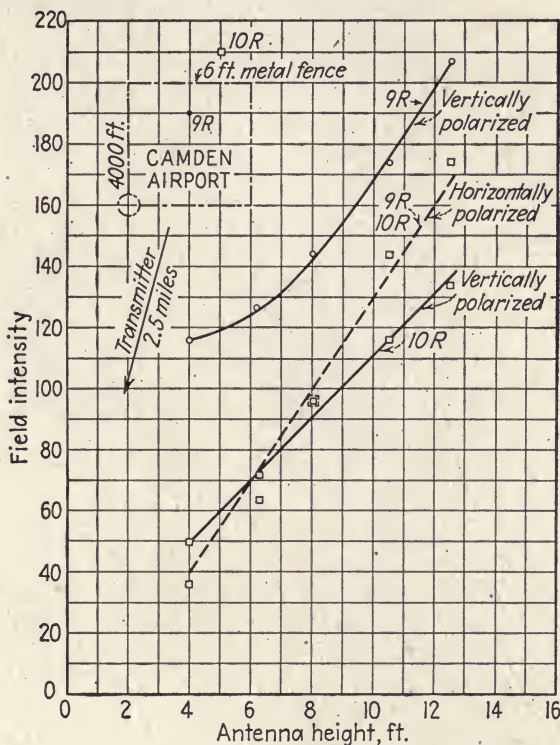

FIG. 106.—Field strengths at 69 Mc, recorded at Camden, N.J., airport and vicinity. (W. L. Carlson.)

Other observations were made with the receiver located in Knight Park, Collingswood, N.J. (see Fig. 107). The transmitter was in the same location on Building 5 in Camden. Here again there is close agreement in recorded data for horizontal polarization at two points, 11R and 12R, which were separated about 300 ft. On vertical polarization, the field strength was considerably higher in location 11R, which was remote from trees. It was found that the proximity of trees affected the

performance on vertically polarized waves considerably more than on horizontally polarized waves. The terrain was fairly regular over the transmission path. There were a fairly large number of low buildings between transmitter and receiver.

Figure 108 is the result of tests with the receiver located on the outskirts of Camden in back of a two-story solid block of houses. This location was about 2 miles from the transmitter on building 5

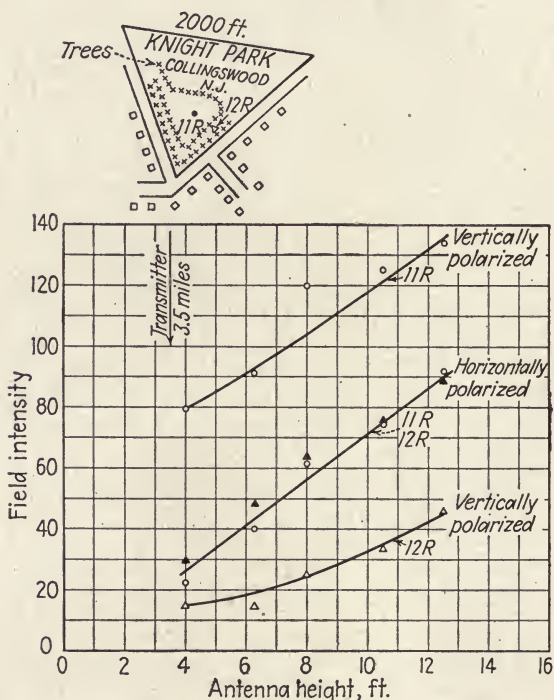

FIG. 107.—Field strengths in Knight Park, Collingswood, N.J.

with fairly uniform terrain between transmitter and receiver. The territory between transmitter and receiver was practically solidly two- and three-story brick dwellings. Readings were taken about every 5 ft. while the receiving antenna at 6 ft. 3 in. elevation was progressively moved from the sidewalk in front of the middle of the block across the street and into a vacant lot. A power line ran parallel to the street, as illustrated in Fig. 108. Power and telephone wires along the streets affect horizontally polarized wave reception more than vertically



polarized wave reception when in the vicinity of the receiving antenna.

During this survey, it was observed that the effect of a person standing within about 20 ft. of the vertical dipole on vertical polarization reception was noticeable. As the person approached to within a few feet of the antenna, the signal strength recorded would vary as much as 50 per cent. The corresponding variation in signal strength with horizontal polarization and horizontal dipole was in the order of 10 per cent.

The survey shows that the receiving locations, which were practically free from the influence of local obstructions, gave a

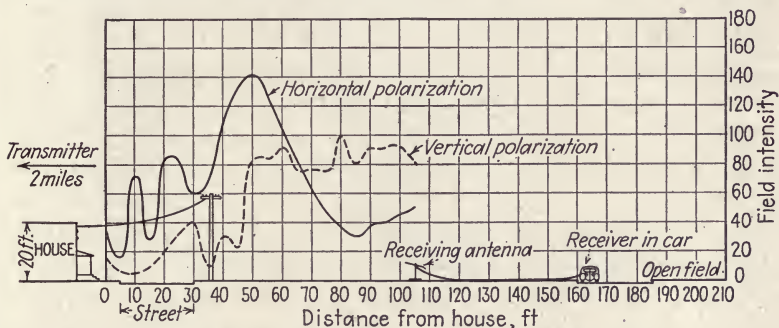

Fig. 108.—Variation in signal strength with distance, built-up section in outskirts of Camden. (W. L. Carlson.)

field-strength ratio of about 2:1 in favor of vertical polarization with the receiver antenna height of 6.25 ft. The locations referred to are 5R, 6R, 7R of Fig. 104, 9R of Fig. 106, and 11R of Fig. 107.

The locations where the received signals were influenced by local obstructions were less favorable for vertical polarization. The average ratio of field strengths was approximately 1:1 for the receiver antenna height of 6.25 ft. The locations referred to are 1R, 2R, 3R of Fig. 101, 12R of Fig. 107, the tests recorded in Fig. 105 and 108, and probably 10R of Fig. 106.

#### ANTENNA DESIGN AND APPLICATION PROBLEMS AS AFFECTED BY POLARIZATION OF TELEVISION BROADCAST TRANSMISSION<sup>1</sup>

It is possible to design transmitting and receiving antennas for television and sound broadcasting with either vertical or

<sup>1</sup> C. W. Hansell, RCA Communications, Inc.

horizontal polarization. However, based upon accomplished development, it appears that horizontal polarization permits equivalent, or better, results to be obtained with simpler, cheaper, safer, and less unsightly structures than are permitted by vertical polarization.

#### TRANSMITTING ANTENNA REQUIREMENTS

Television transmitting antennas, in order to provide the greatest possible service areas, will usually be placed on the top of the highest structure or on the highest point from which a view may be had of the area to be served. In most communities, the top of the highest building in the city or town will be the preferred location.

When this location is chosen, it becomes necessary to take into account the codes and ordinances set up for protection of the public and to provide antennas of such a design that mechanical failures and falling of parts into the streets will be virtually impossible.

The appearance of the antenna system and the manner in which it blends in with the architecture of the building that supports it are important. Owners of high buildings have almost invariably made a heavy investment in appearance and will be unwilling to permit erection of any antenna system that detracts from it.

Each antenna must be able to withstand the worst conditions of lightning, ice, and wind without mechanical failure and without interruption to service. Freedom from service interruptions in most parts of the United States will require provision for melting ice from the antennas by electrical heating.

Each antenna system must provide for the radiation of power from both vision- and sound-modulated transmitters without introducing sufficient coupling between transmitters to produce intermodulation effects between them. This requires the use of two independent uncoupled radiating systems on the same structure or the provision of feeder circuits by means of which both transmitters may be coupled to one radiating system without introducing coupling between the transmitters.

In nearly every case, the radiating systems will be located at a considerable distance above and away from the transmitters so that the transmission lines must be employed between transmitters and antennas. The time required for the waves to

travel over the transmission lines will be so great that any considerable electrical reflections at the ends would cause an antenna system as a whole, including the transmission line, to present undesirable variations in impedance at the transmitter terminals for different frequencies within the required frequency band and would cause multiple images and distortions in the images. To overcome this effect, each vision-radiating system, with its associated circuits, must match the characteristic impedance of its transmission line and prevent substantial reflections of waves at all frequencies within the required band.

Since the most desirable locations for television broadcasting will also be the most desirable for sound broadcasting on frequencies above 30 Mc, a further desirable characteristic of television antenna systems is that they permit the addition of a third independent radiating system to accommodate sound broadcasting or that they provide frequency bands great enough to permit coupling a sound transmitter to one of the radiating systems through frequency selective filters. By this arrangement, the greatest number of listeners in any given area may be provided with the best possible service on both television and sound.

In nearly every case, it will be desired to radiate substantially equal signal strength in all horizontal directions and to employ vertical directivity that will increase the radiation horizontally as much as possible. Therefore, as a general rule, television broadcasting systems should have no horizontal directivity but should have considerable vertical directivity. Furthermore the directivity should be substantially the same for all frequencies within the required band.

**Examples of Horizontally Polarized Television Transmitting Antennas.**—An antenna system believed to come nearer to meeting all television broadcasting requirements than any other, with the possible exception of vertical directivity, is that provided by RCA Communications, Inc., to the National Broadcasting Company for installation at the top of the Empire State building in New York City. This antenna system, its characteristics, and the problems met in its development have been described in two papers by N. E. Lindenblad (Television Transmitting Antenna for Empire State Building, *RCA Rev.*, April, 1939; Antennas and Transmission Lines at the Empire State Television Station, *Communications*, May, 1940).

The Empire State building antenna is an example of a system that provides great bandwidth for vision transmission, independent uncoupled radiators for vision and accompanying sound, provision for melting ice, a mechanical design adequate to meet safety requirements of a city, and appearance acceptable to the owners of the world's tallest building.

The vision-radiating system of the antenna has a bandwidth adequate to accommodate, in addition to the television transmitter, one or more f-m sound transmitters, coupled through frequency selective filters. If a vertical antenna is to be provided on the same structure for some other service, a vertical radiator may be substituted for the lightning rod at the top of the structure and will operate without coupling to the other two radiating systems.

Since the Empire State building antenna system was installed, RCA Communications, Inc., has completed and tested an experimental model of another horizontally polarized antenna system designed to provide for greater vertical directivity. In this system, an array of broad band "turnstile" radiators is mounted on a central mast, and provision is made to radiate power of both the vision and sound transmitters from all radiators simultaneously. This is done through balanced feeder circuits that result in opposite phase rotations of currents in the turnstile elements for the two transmitted currents. With this system, mechanical considerations in each case will set the limit to the amount of vertical directivity. Other examples of horizontally polarized television transmitting antennas are the following:

1. Antenna system of the Columbia Broadcasting System on the Chrysler Building, New York City. This antenna is shown and described in the March, 1939, issue of the magazine *Electronics*.

2. Antenna systems of the General Electric Company, illustrated on the cover of *The General Electric Review* for May, 1939, in the magazine *Communications* for December, 1939, on the cover of the magazine *Electronics* for March, 1940, and in *The General Electric Review* for October, 1940.

**Examples of Vertically Polarized Television Transmitting Antennas.**—An outstanding example of vertically polarized television broadcasting antenna is that developed for the London television station of the British Broadcasting Company. This antenna, located on Alexandra Palace, was a joint development

of Marconi's Wireless Telegraph Company, Ltd., and Electric and Musical Industries, Ltd. It was in daily use, giving a public television service, from Nov. 2, 1936, until the beginning of the war between Britain and Germany.

The vision-radiating system of this antenna was good enough to meet the British standard of 25 frames per second, 405 lines per frame, and an image aspect ratio of 1.25. Information concerning the electrical features of the system may be found in a paper by E. C. Cork and J. L. Pawsey of Electric and Musical Industries, Ltd., entitled Long Feeders for Transmitting Wide Side Bands, with Reference to the Alexandra Palace Aerial-feeder System. This paper was read before the Institution of Electrical Engineers (British) in December, 1938.

It has been observed that the natural tendency among radio engineers who have not had to solve the television-transmitting-antenna problems is to underestimate those problems. Antennas for narrow band transmitters, operated singly, or antennas for television reception have been so easy to set up and operate that it is hard to realize the serious difficulties involved in providing for television and simultaneous sound transmission.

In attempting to work out vertically polarized antennas, equivalent to arrays of dipoles in one line, a number of antenna models have been constructed. One of these, made up of a series of overlapping tubes, tapering to smaller diameters toward the top, provided a clean and adequate mechanical arrangement. It provided uniform radiation in all horizontal directions and a large amount of vertical directivity.

Other antenna models have been constructed that provide concentric conductor arrangements around central supporting tubular masts to provide the equivalent of in-line arrays of vertical dipoles. In appearance, the dipoles may be likened to beads on a vertical string. They may be thought of as modifications into continuous surfaces of cylindrical radiator arrays such as were used in the Alexandra Palace antenna.

RCA Communications, Inc., engineers have been working on the development of both vertically and horizontally polarized television broadcast transmitting antennas for about 6 years. From this experience, it now appears that the difficulties associated with the design and construction of the antennas are more formidable when vertical polarization is used.

As is illustrated by the construction of the British Alexandra Palace and the Philco antennas, vertical polarization requires radiators to be circularly disposed on some kind of outriggers on a central mast rather than on the mast itself. Furthermore the minimum number of radiating units, mounted on a central mast, required for each radiator system, in order to approach a circular horizontal directive characteristic, is twice as great in vertically polarized antennas as it would be in horizontally polarized antennas. These factors multiply the mechanical forces to be dealt with, increase the cost, and detract from appearance.

In the vertically polarized antennas, the placement of radiators on a circle instead of at a common central point detracts from the directivity toward a horizontal plane and tends to introduce an additional variation in directivity with variation in frequency. Although it need not be a serious factor if small spacings are used, the arrangement employed by Philco does not have a theoretically uniform radiation in all horizontal directions but tends to have a four-cornered, or four-sided, directive pattern.

It may be well to point out that the problem of reducing transmission line reflections at the antenna, which would produce distortions and secondary images in the pictures, is far more important in transmitting antennas than it is in receiving antennas. In television transmission, it is not practical to maintain an impedance match between the transmitter and the transmission line for all modulation levels or to rely upon transmission line attenuation to suppress the effects of reflections. Although receiving antennas can be made to operate satisfactorily with bad mismatch between antenna and line by employing impedance matching at the receiver or a line of high attenuation, no substantial mismatch can be tolerated between transmitting antennas and their lines. Waves leaving the transmitter must travel over the line and through the radiators out into space with substantially no electrical discontinuities in the process, throughout the required broad frequency band.

These considerations, combined with the fact that technical imperfection at a transmitter is as important in detracting from service as are equal imperfections in thousands of receivers, require that television transmitting antennas be treated as instruments of precision.

## APPENDIX I

### FEDERAL COMMUNICATIONS COMMISSION STANDARDS OF GOOD ENGINEERING PRACTICE CONCERNING TELEVISION BROADCAST STATIONS

(Television Channels 1 to 18, Both Inclusive)  
Effective Apr. 30, 1941

#### I. DEFINITIONS

1. *Amplitude modulation* (AM) means a system of modulation in which the envelope of the transmitted wave contains a component similar to the waveform of the signal to be transmitted.

2. *Antenna field gain* means the ratio of the effective free space field intensity produced at 1 mile in the horizontal plane from the antenna expressed in millivolts per meter for 1 kw. antenna input power, to 137.6.

3. *Aspect ratio* means the numerical ratio of frame width to frame height, as transmitted.

4. *Black level* means the amplitude of the modulating signal corresponding to the scanning of a black area in the transmitted picture.

5. *Center frequency* (as applied to FM) means the frequency of the carrier wave with no modulation. (With modulation, the instantaneous operating frequency swings above and below the center frequency. The operating frequency with no modulation shall be the center frequency within the frequency tolerance.)

6. *Color transmission* means the transmission of television signals that can be reproduced with different color values.

7. *Field frequency* means the number of times per second the frame area is fractionally scanned in interlaced scanning.

8. *Frame* means one complete picture.

9. *Frame frequency* means the number of times per second the picture area is completely scanned.

10. *Free space field intensity* means the field intensity that would exist at a point in the absence of waves reflected from the earth or other reflecting objects.

11. *Frequency modulation* (FM) means a system of modulation of a radio signal in which the frequency of the carrier wave is varied in accordance with the signal to be transmitted while the amplitude of the carrier remains constant.

12. *Frequency swing* means, when used with respect to FM, the instantaneous departure of the carrier frequency from the center frequency resulting from modulation.

13. *Interlaced scanning* means a scanning process in which successively scanned lines are spaced an integral number of line widths, and in which

the adjacent lines are scanned during successive cycles of the field frequency scanning.

14. *Monochrome transmission* means the transmission of television signals that can be reproduced in gradations of a single color only.

15. *Negative transmission* means that a decrease in initial light intensity causes an increase in the transmitted power.

16. *Polarization* of a linearly polarized radio wave is the direction of the electric vector as radiated from the transmitting antenna.

17. *Positive transmission* means that an increase in initial light intensity causes an increase in the transmitted power.

18. *Progressive scanning* means a scanning process in which scanning lines trace one dimension substantially parallel to a side of the frame and in which successively traced lines are adjacent.

19. *Scanning* means the process of analyzing successively, according to a predetermined method, the light values of picture elements constituting the total picture area.

20. *Scanning line* means a single continuous narrow strip containing high lights, shadows, and half tones which is determined by the process of scanning.

21. *Synchronization* means the maintaining of one operation in step with another.

22. *Vestigial sideband transmission* means a system of transmission in which one of the generated sidebands is partially attenuated at the transmitter and radiated only in part.

23. *Visual frequency* means the frequency of the signal resulting from television scanning.

## II. TELEVISION TRANSMISSION STANDARDS

### THE TELEVISION CHANNEL

1. The width of the standard television broadcast channel shall be 6 Mc/s.

2. It shall be standard to locate the visual carrier 4.5 Mc/s lower in frequency than the unmodulated aural carrier.

3. It shall be standard to locate the unmodulated aural carrier 0.25 Mc/s lower than the upper frequency limit of the channel.

4. The standard visual transmission amplitude characteristic shall be that shown in Fig. 109.<sup>1</sup>

5. The standard number of scanning lines per frame period shall be 525, interlaced two to one.<sup>2</sup>

6. The standard frame frequency shall be 30 per second, and the standard field frequency shall be 60 per second.<sup>2</sup>

<sup>1</sup> In the use of any type of transmission permitted under standards 9 and 15, the emissions (aural and visual) must be kept strictly within the 6-Mc band authorized.

<sup>2</sup> The presently favored values for lines and for frame and field frequencies for experimentally field-testing color transmission are, respectively, 375, 60, and 120.



7. The standard aspect ratio of the transmitted television picture shall be 4 units horizontally to 3 units vertically.

8. It shall be standard, during active scanning intervals, to scan the scene from left to right horizontally and from top to bottom vertically, at uniform velocities.

9. It shall be standard in television transmission to modulate a carrier within a single television channel for both picture and synchronizing signals,

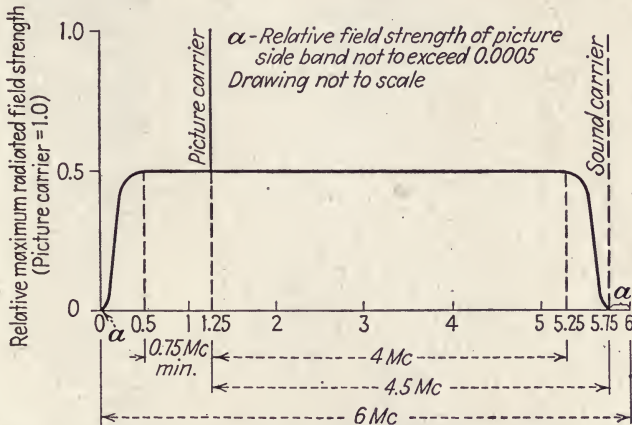

FIG. 109.—Drawing I, Federal Communications Commission, Standards of Good Engineering Practice, Concerning Television Broadcast Stations, 1941.

the two signals comprising different modulation ranges in frequency or amplitude or both.<sup>1</sup>

10. It shall be standard that a decrease in initial light intensity cause an increase in radiated power.

11. It shall be standard that the black level be represented by a definite carrier level, independent of light and shade in the picture.

12. It shall be standard to transmit the black level at 75 per cent (with a tolerance of  $\pm 2.5$  per cent) of the peak carrier amplitude.

#### AURAL SIGNAL MODULATION

13. It shall be standard to use FM for the television transmission with a maximum frequency swing of 75 kc.

<sup>1</sup> Practical receivers of the RA type (those which attenuate the carrier 50 per cent before detection) designed for the synchronizing signals shown in Fig. 110 will also receive interchangeably any of the following: (a) A-m synchronizing and picture signals of the 500-kc vertical synchronizing pulse type (see Fig. 111); (b) Synchronizing signals of the alternate carrier type with a-m picture signals; (c) F-m picture and synchronizing signals.

Each of the above signals will be permitted over a reasonable period for transmitting regularly scheduled programs as required by Sec. 4.261 (a) of the Rules and Regulations Governing Television Broadcast Stations.

TELEVISION SYNCHRONIZING WAVEFORM FOR AMPLITUDE MODULATION

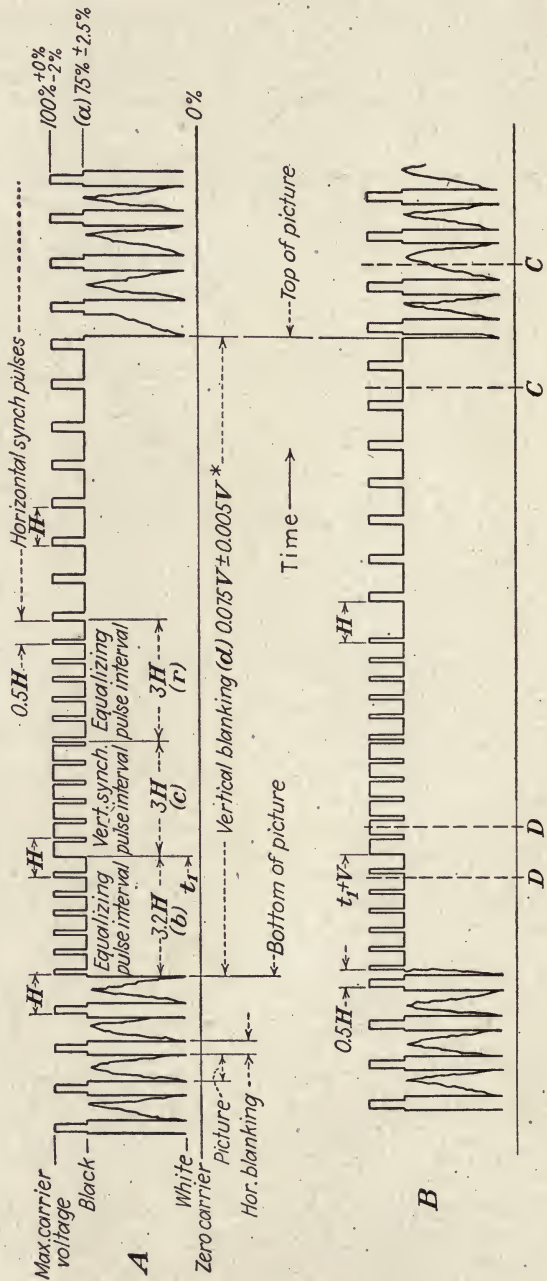

Horizontal dimensions not to scale in A, B and C

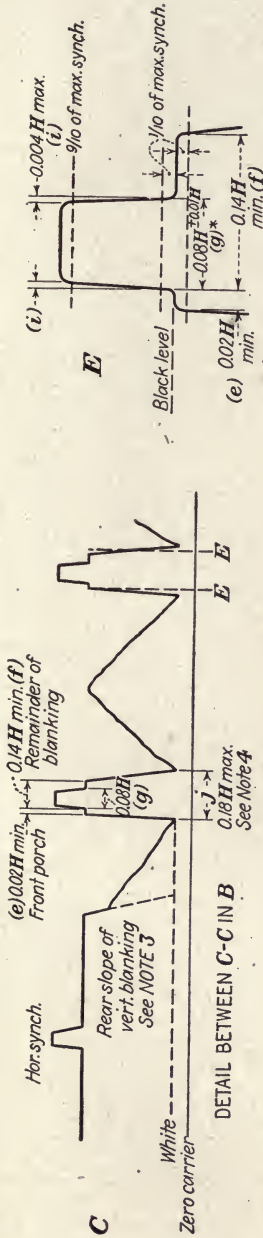

DETAIL BETWEEN E-E IN C

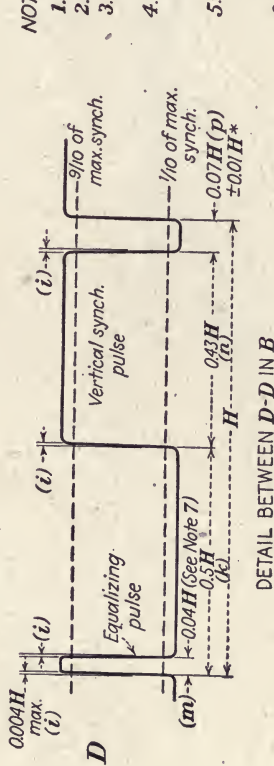

NOTES:

1. H = Time from start of one line to start of next line
2. V = Time from start of one field to start of next field
3. Leading and trailing edges of vertical blanking should be complete in less than  $0.1H$
4. Leading and trailing slopes of horizontal blanking must be steep enough to preserve min. and max. values (e + f) and (j) under all conditions of picture content
5. \*Dimensions marked with an asterisk indicate that tolerances given are permitted only for long time variations, and not for successive cycles.
6. For receiver design, vertical retrace shall be complete in  $0.07V$
7. Equalizing pulse area shall be between  $0.45$  and  $0.5$  of the area of a horizontal sync. pulse

Fig. 110.—Drawing II, Standards of Good Engineering Practice, 1941.

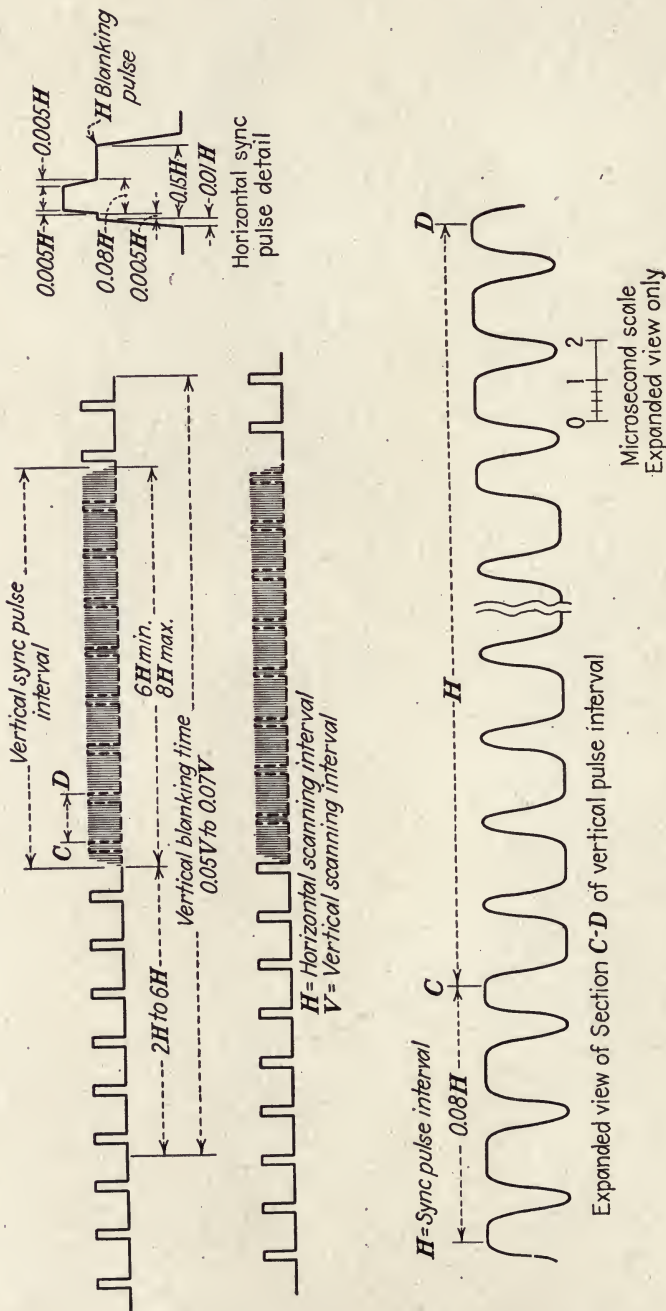

Fig. 111.—Drawing III, Standards of Good Engineering Practice, 1941.

14. It shall be standard to pre-emphasize the sound transmission in accordance with the impedance-frequency characteristic of a series inductance-resistance network having a time constant of 100 microseconds.

#### SYNCHRONIZING SIGNALS

15. It shall be standard in television transmission to radiate a synchronizing waveform that will adequately operate a receiver that is responsive to the synchronizing waveform shown in Fig. 110.

16. It shall be standard that the time interval between the leading edges of successive horizontal pulses shall vary less than 0.5 per cent of the average interval.

17. It shall be standard in television studio transmission that the rate of change of the frequency of recurrence of the leading edges of the horizontal synchronizing signals be not greater than 0.15 per cent per second, the frequency to be determined by an averaging process carried out over a period of not less than 20 or more than 100 lines, such lines not to include any portion of the vertical blanking signal.

18. It shall be standard to rate the visual transmitter in terms of its peak power when transmitting a standard television signal.

19. It shall be standard in the modulation of the visual transmitter that the r-f signal amplitude be 15 per cent or less of the peak amplitude, for maximum white.

20. It shall be standard to employ an unmodulated radiated carrier power of the aural transmission not less than 50 per cent or more than 100 per cent of the peak radiated power of the picture transmission.

21. It shall be standard in television broadcasting to radiate signals having horizontal polarization.

### III. CHANGE OR MODIFICATION OF TRANSMISSION STANDARDS

The Commission will consider the question whether a proposed change or modification of transmission standards adopted for television would be in the public interest, convenience, and necessity, upon petition being filed by the person proposing such change or modification, setting forth the following:

- (a) The exact character of the change or modification proposed;
- (b) The effect of the proposed change or modification upon all other transmission standards that have been adopted by the Commission for television broadcast stations;
- (c) The experimentation and field tests that have been made to show that the proposed change or modification accomplishes an improvement and is technically feasible;
- (d) The effect of the proposed change or modification in the adopted standards upon operation and obsolescence of receivers;
- (e) The change in equipment required in existing television broadcast stations for incorporating the proposed change or modification in the adopted standards, and

(f) The facts and reasons upon which the petitioner bases his conclusion that the proposed change or modification would be in the public interest, convenience, and necessity.

Should a change or modification in the transmission standards be adopted by the Commission, the effective date thereof will be determined in the light of the considerations mentioned in subparagraph (d) above.

#### IV. ENGINEERING STANDARDS OF ALLOCATION

(a) Plan of allocation. Section 4.221 provides that television broadcast stations will be licensed on the basis of the ESR<sup>1</sup> of the visual transmitter. The actual service area of television broadcast stations is dependent on the transmitter power, the height of the transmitting antenna, the characteristics of the antenna, the topography, and the channel on which operation is proposed. The commission will, insofar as practical, require television stations to render a satisfactory service to the city or metropolitan area in which the main studio is located, in accordance with Sec. 4.223 (a).

The following field intensities are considered adequate for the areas indicated:

Area	Median Signal Intensity for Service
Built-up city areas—business districts.....	5 mv/m
Residential and rural areas.....	0.5 mv/m

The field intensity indicated is the field intensity on peaks of the synchronizing pulse of a standard television signal, calculated on the basis of the visual transmitter power as defined in Sec. 4.209.

It is recognized that the signal strength will vary considerably throughout a given area at substantially equal distances from the transmitting antenna. The above values are considered to represent median values of field intensity, *i.e.*, signal exceeded over 50 per cent of the distance.

The significant value of power for allocation purposes is the effective radiated power of the visual transmitter. Insofar as possible the service area of the aural channel shall substantially coincide with the service area of the visual transmitter. To determine the effective radiated power, it is necessary to find the antenna input power by subtracting from the transmitter output power the loss in the vestigial sideband filter and the transmission line. The effective radiated power is the antenna field gain squared times the antenna input power. The basis for licensing is the ESR, which is equal to the product of the square root of the effective radiated power times the antenna height in feet above the ground level.

(b) The service area is established as follows: On a topographic map, at least 8 radials separated by approximately 45 deg. are drawn in the several directions from the proposed location of the transmitter. From these radials there should then be plotted profile graphs for each radial. An appropriate scale should be used with distance in miles from the antenna

<sup>1</sup> The term "ESR" is derived from "effective signal radiated."

plotted as abscissa and the elevation as ordinate in feet plotted by 40- to 100-ft. contour intervals. The profile graphs should then be divided into sections with respect to the distance in miles, each sector being not more than approximately one-tenth of the roughly estimated distance to the desired service contour, and from these sectors the average elevation for each sector or several sectors may be readily determined. This map and the profile graphs are then used in the determination of the radii of the service area of television broadcast stations as set out below.

(c) To determine the radii of the service contour, the charts contained in Appendix I should be used. The height of the transmitting antenna used in connection with Figs. 112, 113, and 114 should be the proposed height of the antenna above the average elevation between the antenna and the 5 mv/m or 0.5 mv/m contour, whichever is under investigation. This determination, of course, involves the assumption of the antenna height above the average elevation, and from this assumption a determination is made of the distance to the desired contour. The average elevation over the distance just found to the desired contour may then be determined and checked with the assumed height. If the assumption was in error, it may then be modified and the problem repeated to reduce the error in the distance to the desired contour. This cut-and-try process must be repeated until the error is negligible.

The foregoing process of determining the extent of the 5 mv/m or 0.5 mv/m contours should be followed in determining the boundary of the predicted service area. The boundaries of the service area of both the 5 mv/m and 0.5 mv/m contour must be determined and submitted with each application for a television broadcast station.

(d) The distances along each radial to the 5 mv/m and the 0.5 mv/m contours should be plotted on a suitable map, such as a sectional aeronautical chart, or equivalent. The area within each contour should then be measured (by planimeter or other approximate means) to determine the area which the proposed station will serve.

(e) In the determination of the population served by television broadcast stations, it is considered that cities having over 10,000 population and located between the 5 mv/m and 0.5 mv/m contours do not receive adequate service. Minor civil division maps (1940 census, if available) should be used in making population counts, excluding cities not receiving adequate service. Where a contour divides a minor division, uniform distribution of population within the division should be assumed in order to determine the population included within the contour, unless a more accurate count is made.

## V. OBJECTIONABLE INTERFERENCE

Section 4.223 (c) requires that the proposed station shall not suffer interference to such an extent that its service will be reduced to an unsatisfactory degree. Objectionable interference will be considered to exist when the signal strength of the undesired station exceeds 0.005 mv/m at the 0.5 mv/m contour of the desired station. Objectionable adjacent channel interference will be considered to exist when the signal strength of the undesired

station exceeds 0.25 mv/m at the 0.5 mv/m contour. At other field intensities, the following ratios of desired to undesired signal shall govern:

Channel Separation	Ratio of Desired to Undesired
Same channel.....	100:1
Adjacent channel.....	2:1

## VI. TRANSMITTER LOCATION

The transmitter location should be as near the center of the proposed service area as possible consistent with the applicant's ability to find a site with sufficient elevation to provide service throughout the area set out in Part IV of these standards. Location of the transmitter at a point of high elevation is necessary to reduce to a minimum the shadow effect on propagation due to built-up city areas, hills, and other obstructions which may reduce materially the intensity of the station's signals in a particular direction. The transmitter site should be selected consistent with the purpose of the station, *i.e.*, whether it is intended to serve a small city, a metropolitan area, or a large region. In general, the transmitting antenna of a station should be located at the most central point at the highest elevation available. Where a directive antenna is used, a central location may not be desirable and, in fact, the availability of suitable sites may make necessary use of directive antennas. The antenna height above the average elevation of the service area is the most important factor in obtaining coverage with a television broadcast station. Doubling the height of the antenna is equivalent to increasing the power by four times. The power is only one of several important factors (see page 379).

The transmitter site should be selected such that the 5 mv/m contour encompasses all the urban population within the area proposed to be served and the 0.5 mv/m contour provides the maximum obtainable service consistent with the characteristics of the area desired to be served. Although no standards with respect to blanket area are established, every precaution must be taken not to locate a station in a residential area.

## VII. OPERATING POWER, DETERMINATION, AND MAINTENANCE

(a) Section 4.248 requires that the operating output power (no picture) and the requirements for maintenance thereof of each television broadcast station shall be determined in accordance with the Standards of Good Engineering Practice.

- (1) Indirect measurement by means of the plate input power to the last radio stage in accordance with (b) below, or
- (2) By measurement of the antenna or transmission line current or voltage required to deliver the necessary power to the antenna system.

(b) The operating output power determined by indirect measurement of the plate input power of the last radio stage is the product of the plate voltage ( $E_p$ ), the total plate current of the last radio stage ( $I_p$ ), and the factor of 0.20, *i.e.*

$$\text{Operating power} = E_p \times I_p \times 0.20$$



(c) The licensee of each television broadcast station shall maintain the plate input power of the transmission line current or voltage within the prescribed limits of the authorization except that, in an emergency due to causes beyond the control of the licensee, it becomes impossible to operate with the full authorized output power, the station may be operated at reduced power for a period not to exceed 10 days, provided that the commission and the inspector in charge shall be notified in writing immediately after the emergency develops.

### VIII. EQUIPMENT

(a) The general design of television broadcast transmitting equipment, including studio equipment, connecting links, transmitter, vestigial side-band filter and antenna shall be in accordance with the following principles. For points not specifically covered, the principles set out shall be followed:

- (1) The maximum rated power as determined under Sec. 4.242 is in accordance with the requirements of Sec. 4.221.
- (2) The equipment is capable of satisfactory operation transmitting a standard television signal in accordance with Part II of these standards.
- (3) The equipment is capable of satisfactory operation at the authorized operating output power or the proposed operating power (with a frequency swing of  $\pm 75$  kc; or 100 per cent AM). At any frequency between 50 and 15,000 cycles (at a swing of 75 kc; or 100 per cent AM) the combined audio-frequency harmonics generated by the transmitting system shall not be in excess of 2 per cent (r.m.s. value).
- (4) The aural transmitter and associated studio equipment shall be capable of transmitting a band of frequencies from 30 to 15,000 cycles within 2 db of the level at 1,000 cycles.
- (5) The noise in the output of the aural transmitter in the band 50 to 15,000 cycles shall be at least 60 db below the audio-frequency level corresponding to 100 per cent modulation.
- (6) The frequency controls of the aural and visual transmitters shall be such so as to maintain the carrier frequencies within  $\pm 0.01$  per cent.
- (7) The visual transmitter shall be designed to meet the following requirements when transmitting a standard television signal (to be supplied after information is furnished by the industry as to minimum performance requirements of television broadcast stations).

### IX. MONITORS

The licensee of each television broadcast station shall provide the frequency monitors necessary to measure the carrier frequencies of the aural and visual transmitters. The frequency monitor shall be capable of maintaining an accuracy of at least 0.005 per cent of the carrier frequencies.

The licensee of each television broadcast station shall require at the transmitter a visual monitor showing the picture being transmitted. In addition, each station shall provide an oscilloscope to ensure that the signal radiated is in accordance with the television transmission standards.

### DESCRIPTION OF CHARTS FOR DETERMINING THE SERVICE AREA AND THE INTERFERENCE RANGE OF A TELEVISION BROADCAST STATION

Figures 112, 113, and 114 may be used in the following way for determining for a 30-ft. receiving antenna the distances to the 5,000, 500, and  $5 \mu\text{V}/\text{m}$  contours of a television broadcast station operating on channels 1 to 8, inclusive. For channels 7 and 8, Figs. 113 and 114 may be used directly; for channels 1 to 6, inclusive, it will be necessary to determine the expected ranges on 46, 105, and 165 Mc; these values are then plotted as a function of frequency and the range for the desired channel read from the resulting curve at the channel mid-frequency. Examples of the types of curves obtained are shown in Fig. 115, which, however, covers a much wider frequency range than would be obtained by the above process. The powers shown on Fig. 115 are effective radiated powers and only the 5 and  $500 \mu\text{V}/\text{m}$  contours are shown.

Figure 112 may be used in the following manner for determining the expected distances to the 5,000, 500, and  $5 \mu\text{V}/\text{m}$  contours at 46 Mc. These distances are determined by the values of the transmitting antenna height, the antenna power, and the antenna field gain. The effective power to be used in connection with the chart is determined by multiplying the antenna power by the square of the antenna field gain. To determine the distance to the  $5 \mu\text{V}/\text{m}$  contour, follow the horizontal line corresponding to the antenna height over to the 45-deg. line corresponding to the effective power (for  $5 \mu\text{V}/\text{m}$ ) and proceed vertically downward to determine the value of  $\theta$  corresponding to  $5 \mu\text{V}/\text{m}$ . Now proceed vertically upward to the curved line corresponding to the antenna height and thence horizontally to the left to read off the distance to the  $5 \mu\text{V}/\text{m}$  contour. The values of  $\theta$  corresponding to the 5,000 and  $500 \mu\text{V}/\text{m}$  contours are determined by dividing the value of  $\theta$  already determined for the  $5 \mu\text{V}/\text{m}$  contour by 1,000 and 100, respectively; thus

$$\theta_{5,000} = \frac{\theta_5}{1,000} \quad \text{and} \quad \theta_{500} = \frac{\theta_5}{100}$$

Now proceed upward at these new values of  $\theta$  to the curved line corresponding to the antenna height and thence horizontally to the left to read off the corresponding distances of the 5,000 and  $500 \mu\text{V}/\text{m}$  contours.

Figures 113 and 114 may be used in a similar manner except that the value of  $\theta$  is first determined for the  $500 \mu\text{V}/\text{m}$  contour and the corresponding values of  $\theta$  for the 5,000 and  $5 \mu\text{V}/\text{m}$  contours are determined by means of the following relations:

$$\theta_{5,000} = \frac{\theta_{500}}{10} \quad \text{and} \quad \theta_5 = 100\theta_{500}$$

The value of  $\theta$  (on Fig. 112) corresponding to other values of field intensity may be obtained by means of the following formula:

$$\theta = h \times P^{1/2} \times G \times \left( \frac{50}{F} \right) \quad (\text{Fig. 112})$$



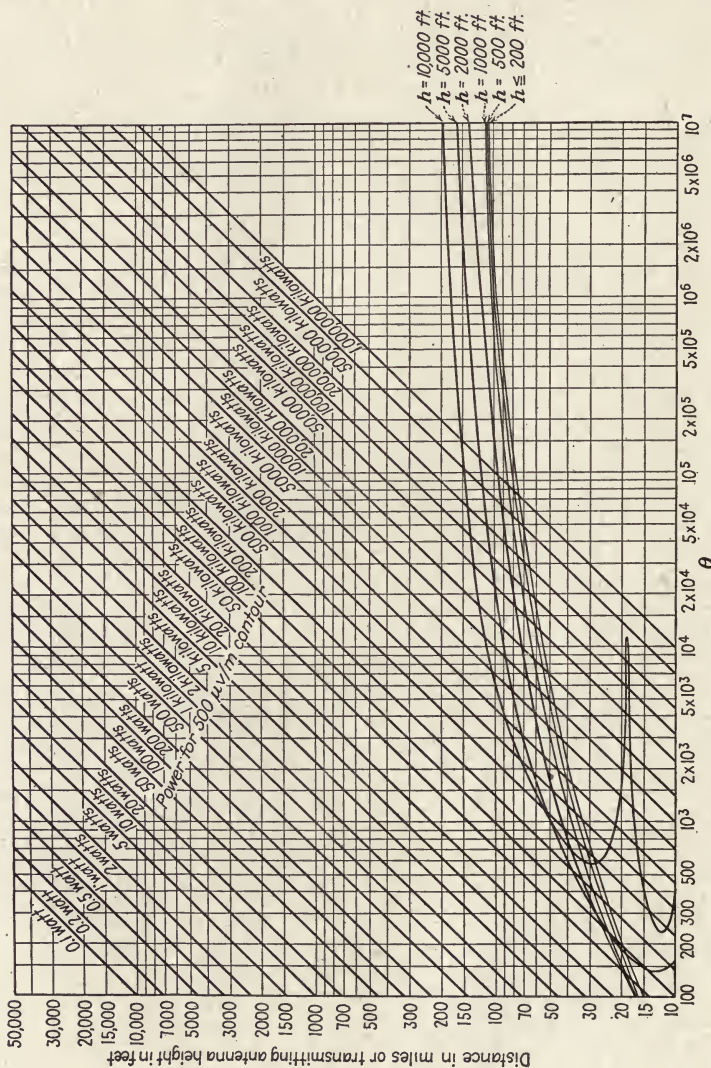

Fig. 113.—Signal range for high-frequency broadcast stations, 105 Mc (II).

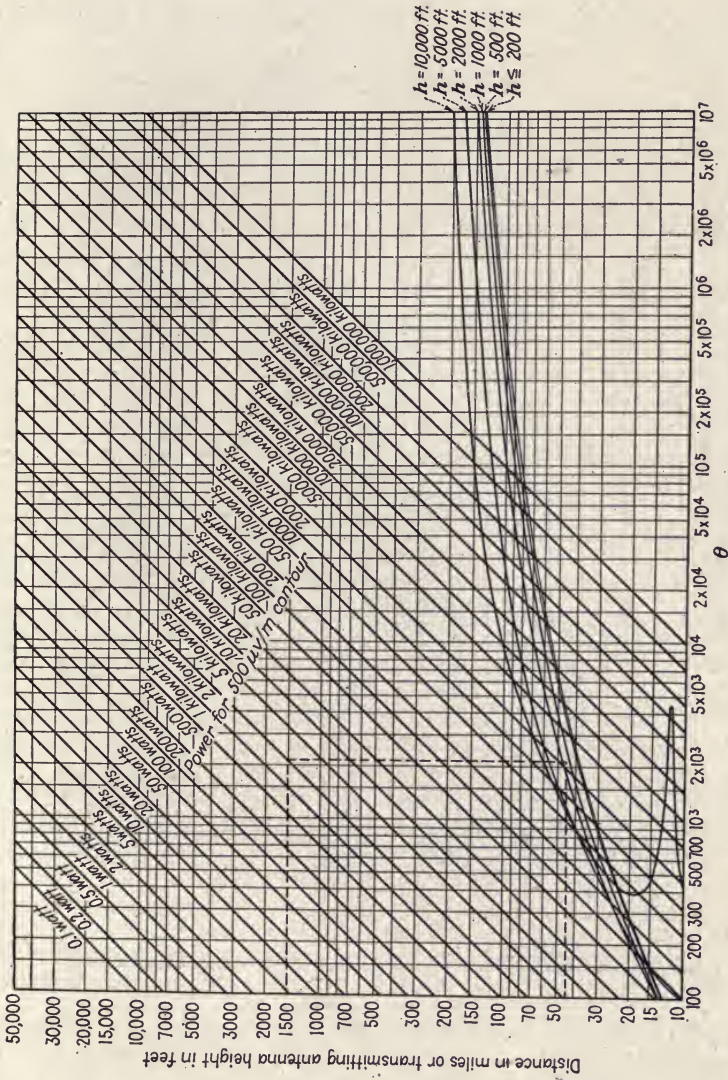

Fig. 114.—Signal range for high-frequency broadcast stations, 165 Mc (III).

while the value of  $\theta$  (on Figs. 113 and 114) is determined by the following formula:

$$\theta = h \times P^{1/2} \times G \times \left( \frac{500}{F} \right) \quad (\text{Figs. 113 and 114})$$

In the above formulas,  $h$  = transmitting antenna height expressed in feet;  $P^{1/2}$  = square root of the antenna power expressed in kilowatts;  $G$  = antenna field gain;  $F$  = desired field intensity expressed in microvolts per meter.

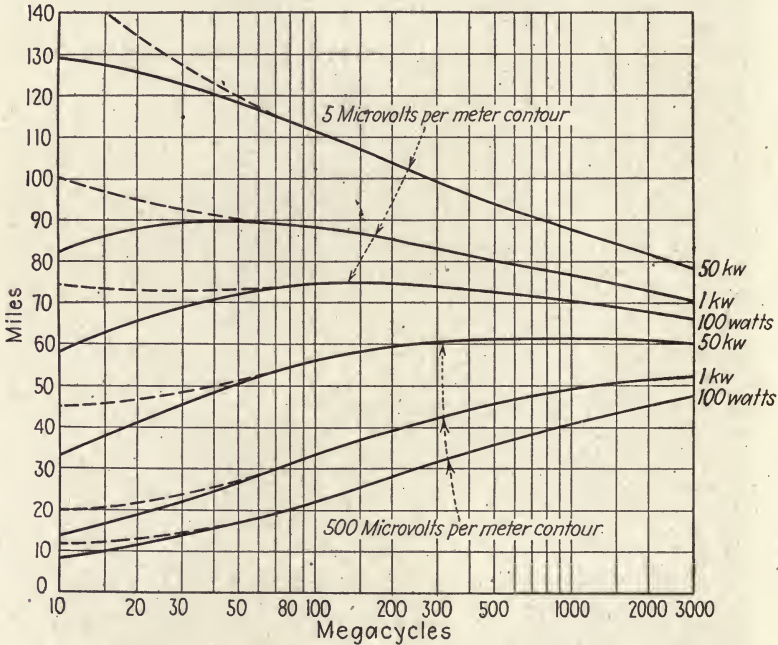

FIG. 115.—Signal range for high-frequency broadcast stations (IV).

### REQUIREMENTS FOR CONTOUR MAPS IN ESTABLISHING SERVICE AREAS FOR TELEVISION BROADCAST STATIONS

Part IV (b) of the standards sets out the procedure to be followed in considering the effect of topography on the service areas of proposed television broadcast stations. Profile graphs must be drawn along at least eight radials from the proposed site of the station. These profiles should be equal to or greater in length than the radii of the roughly estimated service area. They are divided into not less than ten equal sectors and the average elevation of each sector determined. In no case should the length of a sector be in excess of 5 miles.

The profile for a sector should be plotted by contour intervals between 40 and 100 ft. and where the information permits at least 10 points should

be plotted, *i.e.*, the distances should be indicated corresponding to the various contours. In instances of very rugged terrain where the use of contour intervals of 100 ft. would result in several points in a short distance, 200 or 400-foot intervals may be used in this distance. On the other hand, where the terrain is fairly uniform or gently sloping, the smallest contour interval indicated on the topographic map should be used although only a relatively few points may be available in a given sector. After the profile has been charted for a sector, the average elevation therein shall be determined by one of several approximate means. For example, the elevations at equally spaced points in a sector may be averaged or the average determined by means of a planimeter. The median elevation (elevation exceeded for 50 per cent of the distance) in some cases would give more accurate results for the purpose and may be used.

The elevation or contour intervals shall be taken from the U. S. Geological Topographical Quadrangle Sheets for those sections of the country where such maps are available. If such maps are not published for the area in question, the next best topographic information available shall be used. Such information may be obtained for certain sections of the country from topographic maps available from the Tennessee Valley Authority, Department of Agriculture (Soil Conservation maps), and the Bureau of Public Roads (Highway Planning maps), other United States government departments and state and local governmental agencies. Railroad depot elevations and highway elevations from road maps may also be used. The data from the sectional aeronautical charts will be accepted where no better information is available; however, these maps show only the 1,000-ft. contour intervals. Bench marks indicated on the aeronautical charts can be used to find approximate elevations between 1,000-ft. intervals at some points along a radial.

The commission will not ordinarily require the submission of the topographical maps beyond 15 miles from the site, but the maps must include the principal city or cities to be served. However, the source of the topographical information used beyond this distance should be indicated. If it appears necessary, the commission may require the submission of the detailed supporting information.

Each application shall be accompanied by a map showing the 5 and 0.5 mv/m contours of the proposed station. For this purpose, the sectional aeronautical charts or their equivalent having a convenient scale may be used. This map shall show the radials along which the expected field strength has been determined. In computing the area within the 5 and 0.5 mv/m contours large bodies of water should be excluded (oceans, gulfs, sounds, bays, large lakes, etc., but not rivers).

## APPENDIX II

# RULES AND REGULATIONS GOVERNING COMMERCIAL TELEVISION BROADCAST STATIONS

### DEFINITIONS

Sec. 4.201.—*Television broadcast station* means a station licensed for the transmission of transient visual images of moving or fixed objects for simultaneous reception and reproduction by the general public.<sup>1</sup>

Sec. 4.202.—*Television broadcast band* means the bands of frequencies allocated for television broadcast stations.

Sec. 4.203.—*Television channel* means a band of frequencies 6,000 kc wide, which may be designated by channel numbers as in Sec. 4.224 or by the extreme lower and upper frequencies.

Sec. 4.204.—*Television transmission standards* means the standards that determine the characteristics of the television signal as radiated by a television broadcast station.

Sec. 4.205.—*Standard television signal* means a television signal conforming with the television transmission standards set forth in the Standards of Good Engineering Practice for Television Broadcasting Stations, Appendix I.

Sec. 4.206.—*Television transmitter* means the radio transmitter or transmitters for the transmission of both visual and aural signals.

Sec. 4.207.—*Visual transmitter* means the radio equipment for the transmission of the visual signal only.

Sec. 4.208.—*Aural transmitter* means the radio equipment for the transmission of the aural signal only.

Sec. 4.209.—*Visual transmitter power* means the peak power output when transmitting a standard television signal.

Sec. 4.210.—*Service area* means the area in which the signal is not subject to objectionable interference or objectionable fading. (Television broadcast stations are considered to have only one service area; for determination of such area, see Standards of Good Engineering Practice for Television Broadcasting Stations, Appendix I.)

Sec. 4.211.—*Main studio* as to any television broadcast station means the studio from which the majority of the local programs originate, or from which a majority of the station identification announcements are made.

### ALLOCATION OF FACILITIES

Sec. 4.221.—*Basis for License*.—Television broadcast stations will be licensed on the basis of the effective signal radiated (ESR) from the visual transmitter in accordance with the following:

<sup>1</sup> The transmission of synchronized sound (aural broadcast) is considered to be an essential phase of television broadcast, and one license will authorize both visual and aural broadcasts.



ESR is equal to the square root of the power times the antenna field gain times the height of the antenna above the surrounding area. The power is measured in kilowatts, the gain in voltage ratio, and the antenna height in feet above surrounding area.

Sec. 4.222.—*Time of Operation.*—Television broadcast stations will be licensed only for unlimited time operation.

Sec. 4.223.—*Showing Required.*—Authorization for a new television broadcast station or increase in facilities of an existing station will be issued only after a satisfactory showing has been made in regard to the following matters:

(a) That the service area and population which the applicant proposes to serve are computed in accordance with Appendix I (Standards of Good Engineering Practice for Television Broadcast Stations). (The service area shall be consistent with and serve adequately the city or community proposed to serve in keeping with technical feasibility of coverage. The application shall be accompanied by an analysis of the computation of the service area as set forth in the application. No application for construction permit for a new station or change in service area of an existing station will be accepted unless a definite site, details of proposed antenna, and other data required by the application form are supplied.)

(b) That objectionable interference will not be caused to existing stations or that if interference will be caused the need for the proposed service outweighs the need for the service which will be lost by reason of such interference.

(c) That the proposed station will not suffer interference to such an extent that its service would be reduced to an unsatisfactory degree. (For determining objectionable interference, see Appendix I, Standards of Good Engineering Practice for Television Broadcast Stations.)

(d) That the technical equipment proposed, the location of the transmitter, and other technical phases of operation comply with the regulations governing the same, and the requirements of good engineering practice (see technical regulations here and Appendix I, Standards of Good Engineering Practice for Television Broadcast Stations).

(e) That the applicant is financially qualified to construct and operate the proposed station.

(f) That the applicant has available adequate sources of program material for the rendition of satisfactory television broadcast service.

(g) That the proposed assignment will tend to effect a fair, efficient, and equitable distribution of radio service among the several states and communities.

(h) That the applicant is legally qualified, is of good character, and possesses other qualifications sufficient to provide a satisfactory public service.

(i) That the facilities sought are subject to assignment as requested under existing international agreements and the rules and regulations of the commission.

(j) That the public interest, convenience, and necessity will be served through the operation under the proposed assignment.

Sec. 4.224.—*Channel Assignments.*—The channels or frequency bands set forth below are available for assignment to television broadcast stations:

(a)

Channel number	Kilocycles	Channel number	Kilocycles
1	50,000–56,000	10	186,000–192,000
2	60,000–66,000	11	204,000–210,000
3	66,000–72,000	12	210,000–216,000
4	78,000–84,000	13	230,000–236,000
5	84,000–90,000	14	236,000–242,000
6	96,000–102,000	15	258,000–264,000
7	102,000–108,000	16	264,000–270,000
8	162,000–168,000	17	282,000–288,000
9	180,000–186,000	18	288,000–294,000

(b) Stations serving the same area will not be assigned channels adjacent in frequency.

(c) One channel only will be assigned to a television broadcast station.

Sec. 4.225.—*Experimental Operation.*—Television broadcast stations may conduct technical experimentation directed to the improvement of technical phases of operation and for such purposes may utilize a signal other than the standard television signal subject to the following conditions:

(a) That the licensee complies with the provisions of Sec. 4.261 with regard to the minimum number of hours of transmission with a standard television signal.

(b) That no transmissions are radiated outside of the authorized channel and subject to the condition that no interference is caused to the transmissions of a standard television signal by other television broadcast stations.

(c) If objectionable interference would result from the simultaneous operation of a television broadcast station operating experimentally and an experimental broadcast station, the licensees shall make arrangements for operation to avoid interference.

(d) No charges either direct or indirect shall be made by the licensee of a television broadcast station for the production or transmission of programs when conducting technical experimentation.

Sec. 4.226.—*Multiple Ownership.*—No person (including all persons under common control)<sup>1</sup> shall, directly or indirectly, own, operate, or control more than one television broadcast station, except upon a showing (1) that such ownership, operation, or control would foster competition among television broadcast stations or provide a television broadcast service distinct and separate from existing services, and (2) that such ownership, operation, or control would not result in the concentration of control of television broadcasting facilities in a manner inconsistent with public interest, convenience,

<sup>1</sup> The word "control," as used herein, is not limited to majority stock ownership but includes actual working control in whatever manner exercised.

or necessity; *provided, however*, that no person (including all persons under common control), shall directly or indirectly, own, operate, or control more than one television broadcast station that would serve substantially the same service area; and provided, further, that the commission will regard the ownership, operation, or control of more than three television broadcast stations as constituting a concentration of control of television broadcasting facilities in a manner inconsistent with public interest, convenience, or necessity.

Sec. 4.227.—*Normal License Period.*—All television broadcast station licenses shall be issued so as to expire at the hour of 3 A.M., Eastern Standard Time, and will be issued for a normal license period of one year, expiring Feb. 1.

## EQUIPMENT

Sec. 4.241.—*Maximum Rated Power; How Determined.*—(a) The maximum rated carrier power of standard television transmitters shall be the same as the manufacturer's rating of the equipment. (b) The maximum rated carrier power of composite television transmitters shall be the sum of the applicable commercial ratings of the vacuum tubes employed in the last radio stage.

Sec. 4.242.—*Maximum Power Rating and Operating Power.*—The commission will authorize the installation of a television transmitter having maximum power rating equal to the operating output power in accordance with Sec. 4.221.

Sec. 4.243.—*Monitors.*—The licensee of each television broadcast station shall operate at the transmitter:

(a) A frequency monitor independent of the frequency control of the transmitter. The monitor shall meet the requirements set forth in Appendix I, Standards of Good Engineering Practice for Television Broadcast Stations;

(b) A modulation monitor to determine that the radiated television signal complies with the television transmission standards set forth in Appendix I, Standards of Good Engineering Practice for Television Broadcast Stations.

Sec. 4.244.—*Required Transmitter Performance.*—The external performance of television broadcast transmitters shall be capable of radiating a standard television signal meeting the minimum requirements prescribed by the commission contained in Appendix I, Standards of Good Engineering Practice. The transmitters shall be wired and shielded in accordance with the good engineering practice and shall be provided with safety features in accordance with the specifications of Article 810 of the current National Electrical Code as approved by the American Standards Association.

Sec. 4.245.—*Indicating Instruments.*—The operating output power of television broadcast stations shall be measured by instruments having an acceptable accuracy.

Sec. 4.246.—*Auxiliary and Duplicate Transmitters.*—The provisions of Secs. 3.63 and 3.64 of the rules governing standard and h-f broadcast sta-

tions shall also govern the use of auxiliary and duplicate transmitters for television broadcast stations.

Sec. 4.247.—*Changes in Equipment and Antenna System.*—(a) No changes in equipment shall be made (1) that would result in emission of signals outside of the authorized television channel; (2) that would result in the external performance of the transmitter being in disagreement with that prescribed by the commission in the Standards of Good Engineering Practice (Appendix I) provided that for experimental transmissions equipment changes may be made which would not render the transmitters incapable of radiating a standard television signal for the required minimum number of hours. (See Sec. 4.261.)

(b) Specific authority<sup>1</sup> is required for a change in any of the following: (1) increase in the maximum power rating of the transmitter; (2) replacement of the transmitter as a whole; (3) location of the transmitter antenna; (4) antenna system, including transmission line, which would result in a measurable change in service area or would affect the determination of the operating power by the direct method. If any change is made in the antenna system or any change made which may affect the antenna system, the method of determining operating power shall be changed immediately to the indirect method; (5) relocation of main studio if new location is outside of the borders of the city, state, District of Columbia, territory, or possession. (6) operating power delivered to the antenna.

(c) Specific authority,<sup>2</sup> upon filing *informal* request therefor, is required for the following change in equipment and antenna: (1) Indicating instruments installed to measure the antenna current or transmission line, except by an instrument of the same type, maximum scale reading and accuracy. (2) Minor changes in the antenna system or transmission line which would not result in an increase of service area. (3) Changes in the location of the main studio except as provided for in subsection (b) 5.

(d) Other changes, except as above provided for in this section or in Standards of Good Engineering Practice for Television Broadcast Stations (Appendix I) prescribed by the commission may be made at any time without the authority of the commission, provided that the commission shall be promptly notified thereof, and such changes shall be shown in the next application for renewal of license.

Sec. 4.248.—*Operating Output Power; How Determined.*—The operating output power, and the requirements for maintenance thereof, of each television broadcast station shall be determined by the Standards of Good Engineering Practice for Television Broadcast Stations.

## OPERATION

Sec. 4.261.—*Minimum Operating Schedule.*—(a) The licensee of each television broadcast station shall maintain a regular program operating schedule transmitting a standard television signal for a total of 15 hours per week.

<sup>1</sup> Formal application required.

<sup>2</sup> Informal application by letter may be made.

On each day, except Sunday, there shall be at least 2 hours program transmission between 2 P.M. and 11 P.M., including at least 1 hour program transmission on 5 weekdays between 7:30 P.M. and 10:30 P.M.

(b) The aural transmitter of a television broadcast station shall not be operated separately from the visual transmitter except for experimental or test purposes and for purposes incidental to or connected with the operation of the visual transmitter.

Sec. 4.262.—*Station Identification.*—(a) A licensee of a television broadcast station shall make station identification announcement, aurally and visually (call letters and location) at the beginning and ending of each time of operation and during operation on the hour.

(b) Identification announcements during operation need not be made when to make such announcement would interrupt a single consecutive speech, play, or any type of production. In such cases, the identification announcement shall be made at the first interruption of the entertainment continuity and at the conclusion thereof.

Sec. 4.263.—*Motion-picture Film.*—All motion-picture film employed in the broadcasts of a television broadcast station must be briefly described as such either at the beginning of the program in which such film is used or immediately prior to the broadcast of the film. Where the film broadcast is of more than 15 minutes duration, it shall also be briefly described as such either at the end of the program or immediately following the broadcast of the film.

Sec. 4.264.—*Logs.*—The licensee of each television broadcast station shall maintain program and operating logs and shall require entries to be made as follows:

(a) Program log

1. Entry of the time each station identification is made.
2. Entry briefly describing each program broadcast under the heading "outside pickup," "studio production," and "motion-picture film," or combination thereof.
3. Entry showing that each sponsored program has been announced as sponsored, paid for, or furnished by the sponsor.
4. Entry showing name of each sponsor and commodity advertised.

(b) Operating log (when transmitting a standard television signal).

1. Entry of the time the station begins to supply power to the antenna and the time it stops.
2. Entry of the time the program begins and ends.
3. Entry of each interruption to the carrier waves, cause and duration.
4. Entry of the following each 30 minutes.
  - (i) Operating constants of the last radio stages.
  - (ii) Frequency monitor readings.

(c) Log of experimental operation when transmitting other than a standard television signal.

1. Entry of the time the station begins to supply power to the antenna and the time it stops.
2. Short description of the broadcast made and its technical purpose.

Sec. 4.265.—*Logs; Retention of.*—Logs of a television broadcast station shall be retained by the licensee for a period of 2 years, except when required to be retained for a longer period in accordance with the provisions of Sec. 2.54.

#### BROADCASTS BY CANDIDATES FOR PUBLIC OFFICE

Sec. 4.281.—The provisions of Secs. 3.421 to 3.424, inclusive, of the Rules and Regulations Governing Standard and High Frequency Broadcast Stations shall also govern television broadcast stations.

#### RULES AND REGULATIONS GOVERNING EXPERIMENTAL TELEVISION BROADCAST STATIONS<sup>1</sup>

Sec. 4.71(a).—*Defined.*—The term “experimental television broadcast station” means a station licensed for experimental transmission of transient visual images of moving or fixed objects for simultaneous reception and reproduction by the general public.<sup>1</sup>

(b) Under these rules for experimental television broadcast stations, the commission will authorize experimental television relay broadcast stations for transmitting from points where suitable wire facilities are not available, programs for broadcast by one or more television broadcast stations. Such authorization will be granted only to the licensee of a television broadcast station.

Sec. 4.72.—*Purpose.*—A license for an experimental television broadcast station will be issued for the purpose of carrying on research and experimentation for the advancement of television broadcasting which may include tests of equipment, training of personnel, and experimental programs as are necessary for the experimentation.

Sec. 4.73.—*Licensing Requirements, Necessary Showing.*—A license for a television broadcast station will be issued only after a satisfactory showing has been made in regard to the following:

(1) That the applicant has a definite program of research and experimentation in the technical phases of television broadcasting, which indicates reasonable promise of substantial contributions to the developments of the television art.

(2) That upon the authorization of the proposed station the applicant can and will proceed immediately with its program of research and experimentation.

(3) That the transmission of signals by radio is essential to the proposed program of research and experimentation.

(4) That the program of research and experimentation will be conducted by qualified personnel.

(5) That the applicant is legally, financially, technically, and otherwise qualified to carry forward the program.

<sup>1</sup> The transmission of synchronized sound (aural broadcast) is considered an essential phase of television broadcast, and one license will authorize both visual and aural broadcast.

(6) That public interest, convenience, or necessity will be served through the operation of the proposed station.

Sec. 4.74.—*Charges.*—No charges either direct or indirect shall be made by the licensee of an experimental television station for the production or transmission of either aural or visual programs transmitted by such station except that this section shall not apply to the transmission of commercial programs by an experimental television relay broadcast station for retransmission by a television broadcast station.

Sec. 4.75.—*Announcements.*—(a) Station identification.—A licensee of a television broadcast station shall make station-identification announcement aurally and visually (call letters and location) at the beginning and ending of each time of operation and during operation on the hour.

(b) At the time station-identification announcements are made, there shall be added the following:

“This is a special television broadcast made by authority of the Federal Communications Commission for experimental purposes.”

Sec. 4.76.—*Operating Requirements.*—(a) Each licensee of a television broadcast station shall diligently prosecute its program of research from the time its station is authorized.

(b) Each licensee of a television station will from time to time make such changes in its operations as may be directed by the commission for the purpose of promoting worth-while experimentation and improvement in the art of television broadcasting.

Sec. 4.77.—*Frequency Assignment.*—(a) The following groups of channels are available for assignment to television broadcast stations licensed experimentally:

Channel number	Group A, kilocycles	Channel number	Group B, kilocycles	Group C
1	50,000–56,000	8	162,000–168,000	Any 6,000-kc band above 300,000 kc excluding band 400,000 to 401,000 kc
2	60,000–66,000	9	180,000–186,000	
3	66,000–72,000	10	186,000–192,000	
4	78,000–84,000	11	204,000–210,000	
5	84,000–90,000	12	210,000–216,000	
6	96,000–102,000	13	230,000–236,000	
7	102,000–108,000	14	236,000–242,000	
		15	258,000–264,000	
		16	264,000–270,000	
		17	282,000–288,000	
		18	288,000–294,000	

(b) No experimental television broadcast station will be authorized to use more than one channel in Group A except for good cause shown. Both aural and visual carriers with sidebands for modulation are authorized, but no emission shall result outside the authorized channel.

(c) No persons (including all persons under common control) shall control directly or indirectly, two or more experimental television broadcast stations (other than television relay broadcast stations) unless a showing is made that the character of the programs of research require the licensing of two or more separate stations.

(d) A license for an experimental television broadcast station will be issued only on the condition that no objectionable interference will result from the transmissions of the station to the regular program transmissions of television broadcast stations. It shall at all times be the duty of the licensee of an experimental television broadcast station to ascertain that no interference will result from the transmissions of its station. With regard to interference with the transmissions of an experimental television broadcast station or the experimental or test transmissions of a television broadcast station, the licensees shall make arrangements for operations to avoid interference.

(e) Channels in Groups *B* and *C* may be assigned to experimental television stations to serve auxiliary purposes such as television relay stations. No mobile or portable station will be licensed for the purpose of transmitting television programs to the public directly.

Sec. 4.78.—*Power*.—The operating power of a television station shall be adequate for but not in excess of that necessary to carry forward the program of research and in no case in excess of the power specified in its license.

Sec. 4.79.—*Reports*.—(a) A report shall be filed with each application for renewal of station license which shall include a statement of each of the following:

- (1) Number of hours operated.
- (2) Full data on research and experimentation conducted including the type of transmitting and studio equipment used and their mode of operation.
- (3) Data on expense of research and operation during the period covered.
- (4) Power employed, field intensity measurements and visual and aural observations and the types of instruments and receivers utilized to determine the service area of station and the efficiency of respective types of transmissions.
- (5) Estimated degree of public participation in reception and the results of observations as to the effectiveness of types of transmission.
- (6) Conclusions, tentative and final.
- (7) Program for further developments in television broadcasting.
- (8) All developments and major changes in equipment.
- (9) Any other pertinent developments.

(b) Special or progress reports shall be submitted from time to time as the commission shall direct.



# TECHNICAL PAPERS IN THE N.T.S.C. PROCEEDINGS

(Papers marked with an asterisk are contained in this book)

	PAGE
<i>National Committee Proceedings:</i>	
Report of the N.T.S.C. to the Federal Communications Commission, Jan. 27, 1941 (Document 401R)	
*"Lest We Forget," by Paul Raibourn (Document 407R)	
<i>National Committee Proceedings, Supplement No. 1:</i>	
*Report of the N.T.S.C. to the Federal Communications Commission, Mar. 20, 1941 (Document 509R).....	18
*The Relative Utility of 441 Lines, 495 Lines, and 525 Lines as Standards for Television Images, by D. G. Fink (Document 505R)	225
Exceptions of Metropolitan Television, Inc., to the Recommendations of the N.T.S.C. (Document 511R)	
*A Discussion of the Various Combinations of Amplitude and Fre- quency Modulation for Television Transmission, by R. D. Kell (Document 512R).....	240
*A Report on the Neutralization of Long-Delayed Echoes, by D. B. Smith (Document 510R).....	253
<i>Panel 1:</i>	
Report of the Panel (Document 305R)	
*Analysis of American and Foreign Television Systems (Document 305R, Appendix A).....	28
*Outline for Analysis of Television Systems (Document 277R).....	33
Report on Digest of Letters on Color Television. (Document 340R)	
*Tabulation of Answers to Color Television Questionnaire, by Paul J. Larsen (Documents 300R and 341R).....	38
Color Television Bibliography, by R. E. Shelby, D. E. Harnett and Pierre Mertz (Document 203B)	
*Report on Flexibility (Document 339R).....	41
Foreign Television Systems, by D. E. Harnett (Document 104R)	
Multiplexing Synchronizing Pulse on Sound Carrier, by J. E. Brown (Document 113L)	
Television Systems Experimentally Investigated by RCA, by R. E. Shelby (Document 118R)	
Philco Television Systems, by D. B. Smith (Document 122R)	
The DuMont Television System (Document 148R)	
Foreign and BTL Television Systems, by Pierre Mertz (Document 175R)	

- Characteristics of Various American Television Systems, by D. G. Fink (Documents 201R and 201RA)  
 Reports on Television Systems Used in the Farnsworth Laboratories and German Television Systems (Document 204R)  
 Transmission of Audio and Video Modulation on a Common Carrier, by H. E. Kallman (Document 205R)  
 Report of the Television Committee of the Society of Motion Picture Engineers (Document 209R)

*Panel 2:*

- \*Report of the Panel (Document 311R)..... 46

*Panel 3:*

- Report of the Panel (Document 243R)  
 \*Report on Filters for Vestigial Sideband Transmission in Television by R. F. Wild (Document 108R)..... 127  
 \*Sideband Filter Characteristics, by R. Serrell (Document 167R)... 123  
 Relative Spacing of Picture and Sound Carriers in the Television Channel, by C. A. Priest (Document 140R)  
 \*Television Carrier Spacing, by R. S. Holmes (Document 160R)... 102  
 Position of Sound Carrier, by R. K. Potter (Document 156R)  
 \*A Discussion of the Relative Merits of Amplitude vs. Frequency Modulated Wave Transmission of the Sound in Television Signals, by R. S. Holmes (Document 159R)..... 156  
 Frequency Modulation vs. Amplitude Modulation for Sound, by C. A. Priest (Document 141R)  
 \*Memorandum on Carrier Spacing for a Frequency Modulated Sound Carrier, by J. O. Mesa (Document 136R)..... 109  
 Television Receiver Considerations with F-m Sound Channels, by Ray Yoder (Document 187R)  
 \*Tests of a Television System with Amplitude Modulation on the Vision Carrier and Frequency Modulation on the Sound Carrier, by W. L. Dunn (Document 186R)..... 112  
 Modulation of Synchronizing and Sound Signals upon the Same Carrier, by F. J. Bingley (Document 119L)  
 Information on the Use of Frequency and Amplitude Modulation Interspersed in a Television Signal, by W. J. Bailey (Document 130R)  
 The DuMont Television System, by Paul Ware (Document 163R)

*Panel 4:*

- Report of the Panel (Document 252R)  
 \*Reports by Messrs. Leeds, Serrell, Holmes, Smeby, and Morris (Document 214M)..... 138

*Panel 5:*

- Report of the Panel (Document 332R)  
 Inclusion of Black Level in the Transmitted Carrier, by F. J. Bingley, (Document 120L)  
 Negative vs. Positive Modulation, by F. J. Bingley (Document 121L)

Negative vs. Positive Modulation, by J. E. Brown (Document 123L)	
Amplitude vs. Light Characteristic, by R. D. Kell (Document 125L)	
Negative vs. Positive Modulation and Transmission of the Black Level, by P. C. Goldmark (Document 126R)	
*Information on Polarity of Modulation and Inclusion of Black Level in the Transmitted Carrier, by W. F. Bailey (Document 129R).....	152
Negative Modulation and Transmission of Black Level, by A. F. Murray (Document 132L)	
Experience and Opinion Regarding Negative vs. Positive Modulation and Inclusion of the Black Level in the Transmitted Signal, by N. F. Schlaack (Document 133R)	
D-c vs. A-c Transmission and Positive vs. Negative Picture Modulation, by L. M. Leeds (Document 137R)	
Report on Experience and Opinions Regarding Negative vs. Positive Modulation and the Transmitted Carrier, by R. L. Campbell (Document 142L)	
Polarity of Transmission, by J. A. Hutcheson (Document 143L)	
Inclusion of Black Level in the Transmitted Carrier, by P. S. Herbst (Document 144R)	
Television Transmitter Amplitude Characteristic, by P. S. Herbst (Document 145L)	
*A Discussion of the Relative Merits of Negative and Positive Transmission, by R. D. Kell (Document 157R).....	144
*A Discussion of the Merits of the Inclusion of the Black Level in the Transmitted Carrier, by R. D. Kell (Document 158R).....	148
*Frequency Modulation vs. Amplitude Modulation for Television Sound, by L. M. Leeds (Document 191R) .....	159
<i>Panel 6:</i>	
Report of the Panel (Document 283R)	
*Comparison between Two Possible Types of Vestigial Sideband Transmission, by S. W. Seeley (Document 127R) .....	163
*Pre-emphasis of the Higher Frequencies in a Television Channel, by A. G. Jensen (Document 154R).....	179
Gradation of Television Pictures, by Heinz Kallman (Document 161R)	
*A Discussion of the Relative Merits of a Television System Having a Linear Transmission Characteristic and a System Having a Logarithmic Characteristic, by R. D. Kell (Document 162R).....	189
High-Frequency Pre-emphasis, by J. L. Hathaway (Document 182R) Previously published in <i>Electronics</i> , November, 1939, page 29.	
Transmission Characteristic, by L. M. Leeds (Document 183R)	
*A Discussion of the Relative Merits of a System of Television in which the Carrier is Attenuated at the Transmitter as Compared to a System in which the Carrier is Attenuated at the Receiver, by R. D. Kell (Document 184R).....	170

Discussion on the Proposal for a Logarithmic Transmitter Characteristic, by G. W. Fyler (Document 224R)

*Panel 7:*

Report of the Panel (Documents 289R and 344R)

German Literature on Motion and Number of Frames per Second (Document 101R)

\*Aspect Ratio, by Madison Cawein (Document 128R)..... 196

\*Subjective Sharpness of Simulated Television Images, by M. W. Baldwin (Documents 138R and 138RAB). Published in full in the *Bell System Technical Journal* ..... 219

Quality in Television Pictures, by P. C. Goldmark and J. N. Dyer (Document 153R). Published in full in the *Proceedings of the Institute of Radio Engineers*, 28, 343 (August, 1940).

\*Frame and Field Frequencies for Television, by A. V. Bedford (Document 173R)..... 207

Characteristics of Phosphors Demonstrated to Panel 7, by T. T. Goldsmith, Jr., and R. Rutherford (Document 178R)

\*Notes on Aspect Ratio, by G. R. Town (Document 180R)..... 198

\*Frequency Stability in 60-Cycle Power Systems, by G. R. Town (Document 181R)..... 216

Notes on Optimum Number of Lines for a Television System, by D. B. Smith (Document 227R)

RCA Technical Papers Relating to Choice of Lines and Frames for Television (Document 170R). Previously published papers.

*Panel 8:*

Report of the Panel (Document 325R)

\*Information on Frequency and Amplitude Modulation Interspersed in a Television Signal, by A. V. Loughren (Document 115R).... 246

Bibliography Relating to Synchronization and Interlacing, by Paul J. Larsen (Document 131B)

Description of CBS Color Television (Document 139R)

DuMont Synchronizing Signal, by T. T. Goldsmith, Jr. (Document 147R)

Synchronizing Pulse Amplitude Considerations, by A. G. Jensen (Document 155R)

An Automatic or Flexible Television Receiver for Operation on the Standard RMA Synchronizing Signal, by K. R. Wendt (Document 172R)

Synchronization in Television, by A. V. Bedford (Document 174R)

\*Synchronizing Signal Characteristics, by R. L. Campbell and I. Lempert (Document 321R)..... 281

\*Characteristics of Vertical Synchronizing Signal Separator Circuits for Television Reception, by G. R. Town (Document 327R)..... 299

\*Comparison of Three Amplitude Modulated Synchronizing Signals, by A. V. Bedford and T. T. Goldsmith, Jr. Reviewed and Presented to the Panel by A. G. Jensen (Document 320R)..... 264

Panel 9:

Report of the Panel (Document 293R)	
*Bibliography, Polarization and Propagation of Ultra High Frequency Waves, by D. B. Smith (Document 107B) . . . . .	327
*Factors Influencing the Choice of Polarization of the Radiated Wave for Television Network Service, by F. J. Bingley (Document 179R) . . . . .	331
*Wave Polarization for Television, by H. H. Beverage and G. H. Brown and others (Document 171R) . . . . .	335
*Field Tests Relating to Built-in Receiving Antennas for Vertical and Horizontal Polarization, by W. L. Carlson (Document 249R)	346
*Comparisons between Horizontal and Vertical Polarization for Television Transmission, by G. R. Town (Document 282R) . . . . .	317
The W3XE Vertical and Horizontal Transmitting Antennas, by D. B. Smith (Document 281R)	
Notes on Radiation Polarization of Television Transmission, by J. R. Poppele (Document 228)	
Ultrahigh-Frequency Loop Antennas, by A. Alford and A. G. Kandoian (Document 292R). Published in <i>Electrical Engineering</i> , November, 1939.	
*Antenna Design and Application Problems as Affected by Polarization of Television Broadcast Transmission, by C. W. Hansell (Document 248R) . . . . .	355
A Turnstile Antenna for Television Broadcasting, by G. H. Brown (Document 248R)	
A Turnstile Antenna for UHF Broadcasting, by G. H. Brown (Document 248R)	



## INDEX

### A

- Abney, 49
- Action fringes, colored, 95
- Adjacent channel interference, 102
- After-image, 78, 79, 84
- Alexanderson, E. F. W., 18*n.*, 162*n.*
- Allen, C. T., 195*n.*
- Allocation, engineering standards, 368
  - of facilities, 378
- Alternate carrier system, 24, 236, 237
- Ambient illumination, 52
- American television systems, 28, 29
- Amplitude characteristic, picture transmission, 20
- Amplitude-modulated picture, radiated power for, 140
- Amplitude-modulated sound, radiated power, 140
- Amplitude modulation, definition, 361
  - vs. frequency modulation for sound transmission, 136
  - synchronizing waveform for, 22
  - on vision, 112
- Amplitude separation, 35, 36, 264
- Amplitude- vs. frequency-modulated wave transmission, relative merits of, 156
- Antenna design as affected by polarization, 355
- Antenna field gain, 361
- Antennas, built-in, 342
  - for television receivers, 339
- Aperture distortion, 202
- Arrangement of viewers, 57
- Aspect ratio, 5, 20, 28, 35, 48, 195, 196, 198, 361
  - artistic considerations, 204

- Aspect ratio, effect of, motion picture transmission, 203
  - and picture size, relationship between, 200
  - and resolution, relation between, 201
- Attenuation of a filter for vestigial sideband transmission, 129
- Audio-frequency waveforms, 119
- Audio pre-emphasis, 25, 177
  - impedance-frequency characteristic, 178
- Auerbacher, W., 236*n.*
- Aural signal modulation, 363
- Aural transmitter, 378
- Automatic gain control, 152, 188
- Auxiliary and duplicate transmitters, 381

### B

- Bailey, W. F., 101*n.*, 143*n.*, 152*n.*
- Baker, W. R. G., 13, 18*n.*, 24
- Baldwin, M. W., Jr., 69, 195*n.*, 219*n.*
- Bandwidth, 29, 90, 300
  - limiting, 271
  - picture, with frequency-modulated sound, 111
- Barrel distortion, 85
- Basis for license, 378
- Beat interference, 105, 116
  - waveforms, 119
- Beat-note echo, from multipath reflections, 261
- Bedford, A. V., 67, 195*n.*, 207*n.*, 210*n.*, 236*n.*, 264*n.*, 278
- Beverage, H. H., 335*n.*
- Bibliography, polarization, 327
- Bingley, F. J., 18*n.*, 101*n.*, 143*n.*, 162*n.*, 331*n.*

- Black level, 20, 25, 134, 361  
 for FM picture transmissions, 154  
 inclusion of, in the transmitted carrier, 152  
 to peak-signal ratio, 135  
 in the transmitter carrier, 148
- Bode, H. W., 129, 187*n*.
- Bown, Ralph, 18*n*.
- Brightness, picture, factors affecting, 52
- Brightness loss due to filters, 94
- Brightness-transfer characteristic, 194
- Brown, G. H., 130*n*.
- Brown, J. E., 18*n*., 26*n*., 101*n*., 134*n*., 143*n*., 162*n*., 195*n*., 236*n*.
- Build-up characteristics, 300
- Built-in antennas, field tests on, 343  
 receiving antennas, field tests relating to, 346
- Burroughs, G., 195*n*.
- C
- Camera tube, 86
- Campbell, R. L., 143*n*., 281*n*.
- Carlson, W. L., 339*n*., 346*n*.
- Carrier amplitude for maximum white, 7
- Carrier attenuation, 29, 128
- Carrier separation, 19, 29, 101
- Carrier spacing, for a frequency-modulation sound carrier, 109  
 report on, 102
- Carriers, close-spaced, 106  
 and sidebands, disposition with 4.5-Mc separation, 110
- Carter, P. S., 128*n*.
- Case, N. P., 162*n*.
- Cawein, Madison, 162*n*., 195*n*., 196, 196*n*.
- Center frequency, 361
- Channel, allocation of, 6  
 idealized, for use of frequency-modulated sound, 114  
 television, 19, 101
- Channel assignments, 380
- Channel edge, sharp cutoff, 233
- Channel width, 5, 227
- Characteristic impedance of vestigial sideband filter, 132
- Cinematic picture, deficiencies in, 77
- Close-spaced carriers, 106
- Close spacing, advantages of, 107  
 disadvantages of, 108
- Cobb, 52
- Color fidelity, 93
- Color fields, 49  
 fusion frequency of, 94
- Color filter, 90
- Color flashes, 95  
 in cyclic color television, 99  
 visual fatigue from, 100
- Color fringes, 92
- Color line interlacing, effects of, 97
- Color parameters, 93
- Color picture resolution, 96
- Color response curves, 91
- Color sensitivity curves, 92
- Color system, CBS No. 3, 42, 44
- Color television, 19  
 Columbia Broadcasting System, 26  
 contrast range in, 98  
 cyclic, color flashes in, 99  
 general, 89  
 gradation in, 98  
 high-light brightness in, 97  
 interference and noise in, 99  
 pickup spectral response for, 91  
 questionnaire, 38  
 reproducer spectral response for, 92  
 R.M.A. Subcommittee on, 32  
 visual fatigue in, 97, 98
- Color transmission, 361
- Colored action fringes, 95
- Colored motion pictures, 92
- Columbia Broadcasting System, color television by, 26
- Comparative tests of synchronization signals, 24
- Contour maps, requirements for, in establishing service areas, 376
- Contrast range, 72  
 in color television, 98



- Contrast sensitivity of eye, variation in, 189  
 Convexity, picture screen, 86  
 Craven, Commander T. A. M., 4  
 Crawling, 63  
 Cross index to N.T.S.C. standards, 24  
 Cross modulation, 108  
 Cummings, B. R., 18*n.*, 143*n.*
- D
- D-c inserters, 268  
 D-c transmission, 7, 25, 29, 147  
   automatic volume control, 150  
   ratio of voltage gain, 152  
   video-signal level at second detector, 150  
 Decay characteristic, 85  
 Definitions, 361, 378  
   of percentage modulation, 135*n.*  
   regarding transmitter operation, 137  
 DeForest, Lee, 236*n.*  
 Depth, of field, 89  
   of focus, 87  
 Diathermy, 323  
 Difference limen, 224  
 Differentiation, 273  
   kickback, 270  
 Direction of polarization, 29  
 Directions and scanning velocities, 206  
 Discrimination by types of modulation, 35  
 Disposition of carriers and sidebands, with 1.25-Mc separation, 111  
 Dodge, 50  
 Dome, R. B., 195*n.*  
 Double sideband, amplitude modulation, 37  
   transmission, 5  
 Driven circuits, from h-f field pulses, 290  
   from l-f field pulses, 289  
 DuMont, A. B., 18*n.*, 236*n.*, 280  
 Dunn, W. L., 101*n.*, 112, 112*n.*, 195*n.*
- Dyer, J. N., 162*n.*, 195*n.*  
 Dynamic symmetry, 204
- E
- Echo cancellation, 254, 258  
 Echoes, long-delayed, neutralization of, 253  
 Eckersley, P. P., 127  
 Emerson, 53  
 Engstrom, E. W., 18*n.*, 134*n.*, 212*n.*, 233  
 Epstein, D. W., 127, 128*n.*  
 External antennas, comparison of, 333  
 Experimental operation, 380  
 Experimental television broadcast stations, rules and regulations governing, 384  
 Eye, chromatic properties of fatigue, 91
- F
- Fatigue, visual, 71  
 Federal Communications Commission (FCC), 361  
 Federal Radio Commission, 1  
 Field of fixation, 49  
 Field frequency, 76, 82, 207, 361  
   vs. jerkiness of motion, 76  
   psychological discussion, 82  
   vs. residual images, 85  
   vs. streakiness in motion, 83  
 Field intensities as a function of height, 349  
 Field strength, variation in, 317, 320, 321  
 Field strengths at 69 Mc., 353  
 Field survey of signal strength, 351  
 Field test experience, RA vs. TA, 176  
 Field test from portable transmitter, 348  
 Figure of confusion, 221  
 Filter, attenuation at channel edge, 126

- Filter, built in the Farnsworth laboratories, 130  
 characteristics, sideband, 123  
 flat passband, 180  
 low-pass, single-section, 302  
 two-section, 304  
 predistorting, 182  
 admittance increasing as the cube of the frequency, 186  
 as the square of the frequency, 185  
 used by NBC, 130
- Filter cutoff, sharpness of, 128
- Filters, pickup sensitivity loss due to, 94  
 received-picture brightness loss, due to, 94  
 for vestigial sideband transmission, 127
- Fink, Donald G., 25, 26*n.*, 225*n.*
- 500-kc vertical synchronizing pulse, 21*n.*
- Flat field, 234
- Flexibility, report on, 41
- Flicker, 43, 45, 53, 65, 77, 78, 208  
 frequency, 209  
 just-noticeable, conditions for, 214  
 vs. picture repetition rate, 60  
 stroboscopic, 66
- Fluorescence, effect of, in flicker, 77
- Fluorescent screens, economy of surface, 197
- Fly, James Lawrence, 3, 13
- Focal length, of lenses, 86  
 of objective, 87
- Foreign television systems, 30, 31
- Frame, definition, 361
- Frame frequency, 20, 80, 207, 361
- Frame repetition, rate of, in color system, 27
- Frames, per second, 5, 10, 67, 195
- Fredendall, G. L., 68, 127, 128*n.*
- Free-space field intensity, 361
- F-m, and a-m, interspersed, 153  
 vs. a-m sound, receivers, 158  
 transmitter, 157  
 broadcasting, 178
- F-m, broadcasting, relationship to television sound service, 316  
 deviation, 157  
 picture signal demonstration, 260  
 picture signal, deviation of  $\pm 750$  kc, 259  
 picture transmissions, modulation and black level for, 154  
 for sound channel, 162  
 sound channel, vision interference, 119  
 sound signals, setup used in testing, 123  
 sound in television, 112  
 wave, conversion to a-m, 115  
 deviation ratio, 113
- F-m sound, advantages of, 160  
 disadvantages of, 160
- Frequencies, field, 207  
 frame, 207
- Frequency, variation of, in typical 60-cycle power system, 218
- Frequency assignment, 385  
 stability of 60-cycle systems, 216  
 swing, 361
- Frequency-modulated picture signals, 24  
 sound and television receiver, 159
- Frequency modulation, 20, 25, 361  
 and amplitude, interspersed, 246  
 vs. amplitude modulation for television sound, 159  
 double sideband, 38  
 picture transmission, 137  
 on sound, 112  
 sound channel, 155  
 for synchronizing, 25  
 vestigial sideband, 38
- Fusion frequency of color fields, 94
- G
- Gain per stage, RA receiver, 175  
 TA receiver, 175
- Gamma, 73, 99, 194
- Geissler, 53
- Geldard, F. A., 46*n.*, 53

- Ghost image and true images, displacement between, 227
- Glennan, K., 18*n*.
- Goldman, Stanford, 127, 128*n*.
- Goldmark, P. C., 18*n*., 26*n*., 143*n*., 236*n*.
- Goldsmith, Alfred N., 18*n*., 46*n*.
- Goldsmith, Thomas T., Jr., 18*n*., 162*n*., 236*n*., 264*n*.
- Gradation, in color television, 98  
of tonal values, 84
- Graininess, 87
- Granit, 60
- Greenburg, Herman, 162*n*.
- H
- Hansell, C. W., 355*n*.
- Hardy, A. C., 46*n*., 70, 85, 87, 89, 92
- Hardy, LeGrand H., 46*n*.
- Harnett, D. E., 18*n*., 26*n*., 195*n*.
- Harper, 60
- Hathaway, J. L., 178
- Hazeltine, Allan, 196
- Hecht, Selig, 46*n*., 54
- Herbst, P. J., 18*n*., 134*n*., 143*n*., 236*n*.
- Hicks, 49
- High-light brightness in color television, 97
- Hogan, John V. L., 18*n*.
- Hoge, H., 236*n*.
- Hollywood, J. M., 127
- Holmes, R. S., 156*n*., 101*n*., 102, 102*n*.
- Horizontal resolution, 232  
synchronizing signals, rate of change of frequency of, 21
- Horizontally polarized waves, 21
- Horle, L. C. F., 13
- Howland, John R., 18*n*., 101*n*.
- Hutcheson, J. A., 134*n*., 143*n*.
- I
- Iconoscope characteristics, 192
- Image quality, aspects affected by the number of lines per frame, 226
- Image quality, basic factors affecting, 226  
comparisons of number of lines on the basis of, 231  
signal utilization and apparatus limitations, relative importance of, 228
- Image sharpness, measured by subjective test, 220
- Index to questionnaire, Panel 2, 47
- Indicating instruments, 381
- Integration, 275  
long, 270  
medium, 270  
short time, 269
- Intelligence content vs. resolution, 72
- Interference, 75  
beat, 105, 116  
in color television, 99  
effect of, on receiver, 144  
and noise, 74  
objectionable, 369  
range, charts for determining, 372  
sound, in the picture, 158  
in the sound channel, owing to a-m vision carrier, 114  
in TA and RA, 169
- Interlace, 34
- Interlaced scanning, 361  
deficiencies, 67
- Interlacing effects, 63  
effects of color-line, 97  
imperfect, 64
- Interline flicker, 63
- Intermediate frequency, 102
- Interspersed AM and FM, 153
- Israel, D. D., 162*n*.
- J
- Jensen, A. G., 162*n*., 179, 236*n*., 264*n*.
- Jerkiness, 65, 79  
of motion, vs. field frequency, 76  
vs. picture storage, 83
- Jolliffe, C. B., 18*n*.
- Jones, L. A., 46*n*., 73

## K

- Kaar, I. J., 13, 18*n.*, 162*n.*  
 Kell, R. D., 67, 127, 128*n.*, 143,  
 143*n.*, 144*n.*, 147, 148*n.*, 162*n.*,  
 170, 189*n.*, 210*n.*, 240*n.*  
 Koenig, 53

## L

- Larsen, P. L., 162*n.*  
 Leeds, L. M., 134*n.*, 139*n.*, 140*n.*,  
 143*n.*, 159*n.*  
 Lempert, Irving E., 26*n.*, 281*n.*  
 Leverenz, H. W., 209*n.*  
 Limen, difference, 224  
 Liminal unit, 225  
 Limited commercialization, 12  
 Line or field rate, variation in, 43  
 Linear characteristic, and logarithmic  
 characteristic, relative merits of,  
 189  
 Linear scanning, bidirectional, 33  
 deficiencies, 65  
 unidirectional, 33  
 Lines, color system, 27  
 per frame, 5, 10, 20, 25, 43, 195  
 picture, to the inch, 63  
 relative utility of 441, 495 and  
 525, 225  
 space between, 226  
 Lodwick, A. I., 18*n.*  
 Logarithmic characteristic, and linear  
 characteristic, relative merits of,  
 189  
 Logarithmic relationship between  
 initial light intensity and carrier,  
 162  
 Logarithmic transmission charac-  
 teristic, 188  
 Logs, 383  
 Lohr, L. R., 58  
 Long-retentivity screens, 208  
 Loughren, A. V., 68, 81, 195*n.*, 233,  
 236*n.*, 246*n.*  
 Lubeke, H. R., 101*n.*, 143*n.*, 162*n.*,  
 195*n.*, 236*n.*

- Luckiesh, 57  
 Lythgoe, 52

## M

- MacDonald, W. A., 18*n.*  
 McIlwain, Knox, 46*n.*, 236*n.*  
 Main studio, 378  
 Mann, 70  
 Manson, R. H., 18*n.*, 236*n.*  
 Martin, 53  
 Marvin, H. B., 26*n.*  
 Maximum deviation, sound trans-  
 mitter, 21  
 Maximum power rating and operat-  
 ing power, 381  
 Maximum speed, moving object, 82  
 Maximum white, per cent of peak  
 amplitude for, 21  
 Mechanical receivers, 43  
 Meetings and records, 16  
 Members and alternates of the  
 N.T.S.C., 18*n.*  
 Mertz, Pierre, 26*n.*, 46*n.*  
 Mesa, J. O., 101*n.*, 109, 195*n.*  
 Method of rating transmitter power,  
 138  
 Millikan, 70  
 Minimum operating schedule, 382  
 Minimum rated power, how deter-  
 mined, 381  
 Modulation, capabilities, transmit-  
 ter, TA vs. RA, 171  
 capability, 135  
 combinations, 246  
 for f-m-picture transmissions, 154  
 frequency and amplitude, inter-  
 spersed, 246  
 various combinations of ampli-  
 tude and, 240  
 interspersed, advantages, 250  
 modulation content of, 251  
 receiver arrangement for, 249  
 transmitter arrangement for, 248  
 methods, combinations of, 236  
 polarity of, 143  
 in the transmitted carrier, 152  
 subcommittee findings on, 257

Modulation, for synchronizing,  
method of, 237

Moe, R. E., 236*n*.

Monitor, transmitter, TA vs. RA,  
172

Monitors, 371, 381

Monochrome picture tint, 54

Monochrome transmission, 362

Morehouse, S. B., 217

Morris, R. M., 141*n*.

Moss, 57

Motion-picture film, 383  
transmission, effect of aspect ratio,  
203

Motion-pictures, sharpness of, under  
conditions of equal vertical  
and horizontal resolution, 222  
as a function of the relative  
values of horizontal and verti-  
cal resolution, 224  
as a function of resolution, 221

Multipath reflections, beat-note echo  
patterns, 261

Multipath transmission, 336

Murphy, Adrian, 18*n*., 26*n*.

Murray, A. F., 5, 18*n*., 101*n*., 143*n*.,  
162*n*., 195*n*., 236*n*.

## N

Negative transmission, 25, 146, 362  
effect of interference, 145  
and positive transmission, relative  
merits of, 144

Nergaard, Leon S., 127

Neutralization of long-delayed  
echoes, 253

Nielson, H. V., 101*n*.

Noise, 75, 179, 190, 316, 317, 322,  
337  
in color television, 99  
comparisons under indoor condi-  
tions, 333  
conditions, general, comparison  
of, 333  
effect on picture, 152  
effect on synchronizing, 295  
and interference, 74

Normal license period, 381

Norton, K. A., 336

N.T.S.C., members, 14, 18*n*.  
organizational plan, 13  
standards, cross index to, 24

Number of frames, 195

Number of lines, 195  
apparatus characteristics affected  
by, 227  
aspects of image quality affected  
by, 226  
aspects of signal utilization af-  
fected by, 227  
comparison of, suggested, 229  
per picture, 218

Nyquist, 128*n*.

## O

Oblique resolution, 67

Ogle, Kenneth, 46*n*.

Operation, 382

Operating output power, how deter-  
mined, 382  
power, determination and mainte-  
nance, 370

Outdoor antennas, 339

Outline for analyzing television sys-  
tems, 26, 33

## P

Page, 53

Panel 5, recommendations and ac-  
tions, 143

Panel purpose and functions, 15

Panel reports, 16

Peak power, 138  
definition, 137  
picture transmitter, 21

Percent modulation, 135  
definition, 137  
of peak amplitude for maximum  
white, 21

Periodic error in scanning structure,  
64

Perrin, 70, 85, 87, 89

Perspective, 86

Pfleger, 128*n*.

- Phase, reversal, sequence of change, 255  
 shift, 128, 181  
 switching, 258
- Phosphorescence, 84  
 effect of, in flicker, 77
- Phosphors, characteristics of, 84
- Pickup spectral response for color television, 91
- Picture, area, 199  
 brightness, factors affecting, 52  
 range of, 51  
 dimensions vs. number of viewers, 55  
 lines to the inch, 63  
 radiated power for, 139  
 repetition rate vs. flicker, 60  
 resolution, 15  
 adequacy of, 62  
 sensitivity loss due to filters, 94  
 sideband, 29  
 signal modulation, 20  
 radiated power, 134  
 size, 53  
 and aspect ratio, relationship between, 200  
 shape, 198  
 storage, ideal, 80  
 vs. jerkiness, 83  
 vs. streakiness, 83  
 structure, viewing distances vs., 58  
 tint, monochrome, 54  
 transmission, amplitude characteristic, 20  
 frequency modulation, 137
- Picture-screen convexity, 86
- Pickup tubes, aberrations in, 208
- Poch, W. J., 127, 128*n.*
- Polarity, of modulation, 29, 143  
 of transmission, 20  
 use of an automatic volume control, 145
- Polarization, 6, 21, 362  
 choice of, for television-network service, 331  
 comparisons between horizontal and vertical, 316, 317, 319, 320, 335
- Polarization, factors affecting, 331
- Poppele, J. R., 236*n.*
- Ports, E. G., 134*n.*
- Positive transmission, 362
- Potter, R. K., 101*n.*
- Power, at black level, 138  
 increase by utilizing the nonlinear portion of transmitter characteristic, 149  
 ratio of sound and picture channels, 141
- Pre-emphasis, audio, 177  
 in audio circuits, 179  
 of the higher frequencies in picture signal, 179  
 sound transmission, 20
- Priest, C. A., 101*n.*
- Proctor, 85
- Product of two resolutions, 69
- Progressive scanning, 362
- Projection interval, effect of, in flicker, 78
- Propagation, 316, 317
- Q
- Quarles, D. A., 18*n.*
- R
- RA system, 9, 21*n.*, 123, 124, 165  
 vs. TA, advantages and disadvantages of, 166  
 field test experience, 176  
 receiver alignment problem, 174  
 receiver bandwidth requirements, 175  
 test equipment, 174  
 and TA types, receiver characteristics, 167  
 and TA systems, 163  
 comparison of, 167
- Radiated power, 140  
 definition, 137  
 for picture, 139  
 for sound, 139
- Radiation efficiency, 141  
 polarization, 16

- Radio frequency, 102  
characteristic, 107
- Raibourn, Paul, 18*n.*, 195*n.*
- Random noise, 75
- Range of picture brightness, 51
- Rate, of change of frequency of horizontal synchronizing signals, 21  
of frame repetition in color system, 27
- Rated transmitter power, 7
- Rating of the transmitter, 134.
- Ratio, of carrier power of sound transmission to the picture transmission, 21  
of peak power in picture channel to unmodulated sound channel, 142  
of radiated powers, tolerance in, 136
- Receiver alignment, RA vs. TA, 174
- Receiver attenuation, vestigial side-band system, 163
- Receiver bandwidth, RA vs. TA, 175
- Receiver brightness-transfer characteristics, comparison of, 191
- Receiver cost, 187
- Receiver tuning requirements, TA vs. RA, 173
- Receivers, television, antennas for, 339
- Receiving antennas, 318, 326, 337  
built-in, field tests relating to, 346  
design of, 316  
vertical and horizontal polarization, various forms of, 340
- Receiving tubes, aberrations in, 208
- Reduced sensitivity, in color system, 90
- Rejection, 107  
ratio, 103
- Relative merits of negative and positive transmission, 144
- Report, of the N.T.S.C. to the FCC, 18
- Reports, 386
- Reproducer spectral response for color television, 92
- Required transmitter performance, 381
- Requirements, equipment, FCC, 371
- Residual images, vs. field frequency, 85  
vs. tonal distortion, 84
- Resolution, 208  
and aspect ratio, relation between, 201  
color picture, 96  
horizontal, 81  
vs. intelligence content, 72  
oblique, 67  
picture, adequacy of, 62  
in various directions, 68  
vertical, 81  
in the vertical and horizontal dimensions, 226
- Resolving power, 90
- Response patterns, visible, 115
- Retina, isopters of, 49
- R-f bandwidth, required receiver, 105
- Ripple, power supply, effect of, 210  
voltage on scanning-line positions, effects of, 211
- Rivers, 49
- R.M.A. Committee on Television, 3  
Subcommittee on Color Television, 32  
television policy, 6
- Rockwell, R. J., 236*n.*
- Rodwin, 4
- Ronne, 49
- Rutherford, R. E., 195*n.*
- Rules and regulations, governing experimental television broadcast stations, 384  
television broadcast stations, 378  
television broadcasting, 9
- S
- Sanabria, U. A., 162*n.*, 195*n.*
- Sayre, W. H., 134*n.*
- Scanning, 2, 80, 362  
direction of motion of, 34  
and velocity, 20

- Scanning, linear, deficiencies, 65  
 methods of, 33  
 sinusoidal, 33  
 spiral, 34  
 type and direction of, 195
- Scanning generator, driven, 37  
 power, horizontal, 227  
 self-oscillating, 37
- Scanning line, 362  
 positions, effects of 120-c.p.s.  
 ripple voltage on, 211
- Scanning lines, number of, and vertical resolution, 70
- Scanning pattern, 28
- Scanning specifications, 20, 25, 195
- Scanning spot, logarithmic decrement, 81
- Scanning velocity, 34
- Scanning velocity and directions, 206
- Scanning waveforms, direct amplification, 37  
 by separate carrier, 36
- Schlaak, N. F., 134*n.*, 143*n.*
- Schnitzer, B. E., 134*n.*
- Screen brightness, 190
- Screens, long-retentivity, 208
- Seeley, S. W., 163*n.*
- Selectivity characteristic of receiver, 103
- Selectivity picture-transmitter, 103
- Separation, amplitude, 264  
 horizontal pulse, 266  
 of synchronizing component from picture component, 288  
 vertical pulse, 264
- Separator circuits, synchronizing, characteristics of, 299
- Serrell, Robert, 101*n.*, 123, 134*n.*
- Service area, 378  
 charts for determining, 372  
 requirements for contour maps, 376  
 of sound and picture, 136
- Service radius, using FM, 142
- Service tests, 108
- Shape constancy, 59, 85
- Sharpness, measurements of, in subjective terms, 223
- Sharpness, subjective, of simulated television images, 219
- Sheehan, 60
- Shelby, R. E., 26*n.*
- Shlaer, 53
- Sideband, attenuating, 129  
 filter characteristics, 123  
 picture-signal, 7
- Signal intensity, comparison of, 331  
 for maximum white, 134
- Signal-to-noise ratio, 317, 323  
 visually apparent, 194
- Signal polarity, 134
- Signal range for high-frequency broadcast stations, 373
- Signal strength, field survey of, 351  
 variation with distance, 352, 355
- Simulated images, subjective sharpness of, 219
- Single-frequency noise, 75
- Single-sideband transmission, 7  
 RA system, 101  
 TA system, 101
- 60-cycle systems, frequency stability of, 216
- Size of picture, 58
- Smear, 83, 209  
 picture, of moving objects, 81
- Smeby, L. C., 18*n.*, 134*n.*, 138*n.*
- Smith, D. B., 4, 18*n.*, 26*n.*, 54, 128*n.*, 195*n.*, 236*n.*, 253*n.*, 327
- Snell, Peter A., 60
- Sobel, A. D., 195*n.*
- Sound, attenuation, band rejection, 118  
 carrier, 20  
 channel, frequency modulation, 155  
 frequency modulated during horizontal blanking, single carrier, 38  
 frequency modulation vs. amplitude modulation, 159  
 interference in the picture, 158  
 in the vision channel, 114



- Sound, signal modulation, 20  
 transmission pre-emphasis, 20  
 transmitter maximum deviation, 21
- Sound radiated power for, 139
- Sound-signal radiated power, 134
- Southall, J. P. C., 84
- Spacing, television carrier, 102
- Spiral scanning, 196
- Spurious radiation, 108
- Standard television signal, 378
- Standards, of allocation, 368  
 approval and transmission of, 16  
 of good engineering practice, 361  
 National Television System, 18
- Station identification, 383
- Streakiness in motion, vs. field frequency, 83  
 vs. picture storage, 83
- Stroboscopic flicker, 66
- Subjective aspects, 15, 25, 46
- Synchronization, 16, 19, 35, 236, 362  
 alternate-carrier, demonstration of, 257  
 horizontal, 292  
 horizontal pulses, tolerances in, 237  
 with pulses "as is," 274  
 system, 28  
 waveform, 236, 263  
 report on, 264
- Synchronization signal, composite, 284
- Synchronization-signal characteristics, 281
- Synchronizing, automatic frequency control, 262  
 horizontal, 273  
 information, frequency spacing between, 287  
 modulation, 20  
 pulses, 5  
 line, differentiation of, 293  
 on separate carrier, 36  
 separation of vertical and horizontal, 36  
 separator circuits, characteristic of, 299
- Synchronizing, signals, 21, 367  
 500-ke vertical pulse, 264  
 in negative-polarity system, 153  
 R.M.A., 264  
 simplified R.M.A., 264  
 system, DuMont, advantages, 283  
 vertical, 269  
 noise-reduction circuit for, 291  
 waveform for amplitude modulation, 22  
 DuMont, 282  
 as originally proposed by Panel 8, 239  
 tabular comparison, 277
- System analysis, 15
- Systems, American Color Television, 30, 31  
 American and foreign, analysis of, 28, 29, 30, 31  
 in general, 25  
 television, outline for analysis of, 33
- T
- TA system, 9, 111, 124  
 vs. RA, transmitter construction, 171  
 transmitter monitor problem, 172  
 receiver tuning requirements, 173  
 relative merits of, 170
- Tannsley, 52
- Television broadcast band, 378  
 broadcast stations, 378  
 rules and regulations, 378  
 carrier spacing, 102  
 channel, 24, 101, 159, 362, 378  
 disposition of a typical, 104  
 signal, high-frequency pre-emphasis, 179  
 spectra, 15
- Television systems, 26  
 transmission standards, 378  
 transmitter, 378
- Television Transmitters, R.M.A.  
 Subcommittee on, 137



Viewing distances, range of, 57  
Viewing obliquities, 59  
Visible response patterns, 115  
Vision channel, sound interference  
in, 114  
Vision interference in f-m sound  
channel, 119  
Visual acuity, 49, 53  
Visual fatigue, 71  
in color television, 97, 98  
from color flashes, 100  
Visual frequency, 362  
Visual transmitter, 378  
power, 378

## W

Ware, Paul, 101n.  
Waveform, beat and audio-fre-  
quency, 119

Waveform separation, 36  
Waveform synchronization, 263  
report on, 264  
Weber-Fechner law, 73, 98  
Weinberger, 4  
Wentworth, H., 49  
Wertheim, 49  
Wheeler, H. A., 18n., 46n., 68, 81,  
234  
Wickizer, G. S., 336  
Width, of the standard television  
broadcast channel, 19  
Wild, R. F., 26n., 101n., 127n.  
Wolcott, C. F., 101n., 195n.  
Wurzburg, 92

## Y

Yoder, R. S., 101n., 195n.









