

GIFT OF

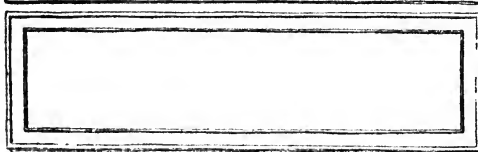
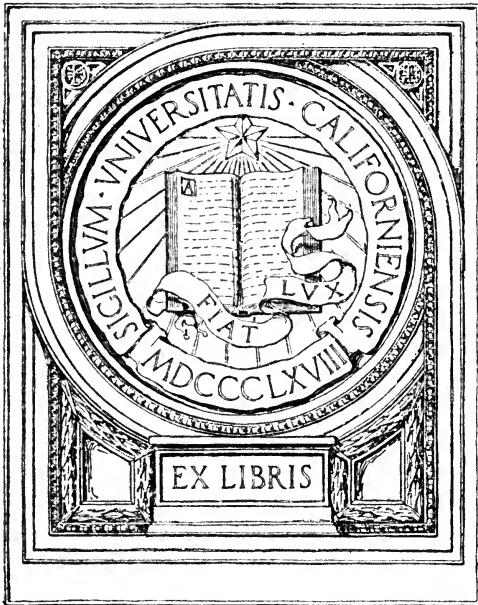

TESTING OF
ELECTRO-MAGNETIC MACHINERY
AND OTHER APPARATUS

•The  Co. •

TESTING OF
ELECTRO-MAGNETIC MACHINERY
AND OTHER APPARATUS

BY

BERNARD VICTOR SWENSON, E.E., M.E.,
OF THE UNIVERSITY OF WISCONSIN

AND

BUDD FRANKENFIELD, E.E.
OF THE NERNST LAMP COMPANY

VOLUME I.

DIRECT CURRENTS



New York:
THE MACMILLAN COMPANY
LONDON: MACMILLAN & Co., LTD.

1909

TK 147
28
v. 1

Gift of

.....

COPYRIGHT, 1904

By THE MACMILLAN COMPANY

Set up, electrotyped and printed January, 1904
Reprinted August, 1905; October, 1907;
March, 1909

THE
MACMILLAN
COMPANY

PRESS OF
THE NEW ERA PRINTING COMPANY,
LANCASTER, PA.

PREFACE.

This book was written because the authors have felt the need of a treatise of this nature, and because others have expressed a similar feeling.

The treatise will be in two volumes and is intended for use as a college text-book and also as a work of reference for engineers. The procedure followed is that which has been used for some years in the dynamo laboratories at the University of Wisconsin, but the treatment is of a character which makes it suitable for general use in other institutions. The field covered by the present volume is that of direct-current electromagnetic machinery and apparatus, and is almost exclusively confined to dynamo-electric machinery. It is assumed that due instruction in precise electrical measurements has been previously received in a course which is adapted to suit the requirements of the electrical engineer. The text refers in numerous places to various books and publications so as to make it serviceable in connection with any first-class college course in direct-current dynamo machinery. This also adds to the value of the treatise as a reference book. The second volume (which is in course of preparation) will deal with alternating current machinery and apparatus.

The treatment of each experiment is self-contained. Stress is laid on this feature, as it is believed to be of marked value in a work of reference; and, in a text-book, it allows the instructor great latitude in arranging a course to suit the individual needs of his students. The order of experiments adopted is a convenient one to follow in the college laboratory, but it may be judiciously changed as dictated by convenience, without injuring the proper sequence of the work.

A dynamo laboratory course should be designed to fix the theories learned in the class room or lecture room, at the same time giving as much of the commercial side of testing as is possible without sacrifice to the teaching of fundamental principles; and it should also be designed to develop self-reliance, resourcefulness and ingenuity in the student. Success in the latter function depends largely upon the personality of the instructor. He must hold himself in reserve rather than give a student a fact that can reasonably be obtained by working for it; he must encourage every spark of originality that can be found; and he must instill into his students his own enthusiasm and love for science. At the same time the spectacular worker must be curbed by an inflexible insistence that all regular laboratory work be performed in a thorough manner. The authors believe that the method of this book is truly in harmony with the above proposals.

Many young men enter the laboratory with no previous experience in the practical operation of dynamo machinery and apparatus. They may be able to transform equations, prove theorems, and talk intelligently about characteristic curves, but are often entirely at sea in applying their knowledge to a concrete case in the laboratory. For this reason, the major portion of the treatment of each experiment is devoted: (1) To a review of the theory; (2) to the particular experimental method involved; and (3) to practical applications of the particular subject. The experimental observations required for the test are enumerated under the heading "Data." This has been found of great assistance in making the laboratory work thorough. Questions which bear directly upon the subject are asked at the end of many of the experiments. These are introduced with the object of stimulating independent thought and observation, and they therefore bear upon important though less evident relations of the phenomena involved. The authors believe that real value arises from formal questions only where

they relate to matters which require more than perfunctory thought in composing the answers. The questions, as laid down, have been proved by use to be a valuable and stimulating feature, which results in gain to even the best of students.

It has been the aim to impart a thoroughly practical knowledge of dynamo machinery and apparatus; a knowledge that can be relied upon during the operation of machinery and which will lead to quick and accurate conclusion in emergency. Mathematical analysis has been avoided except where it adds to clearness. The nomenclature is in accordance with present standards so far as they have been adopted. A key to the nomenclature is given at the beginning of the book. Where subscripts are employed, their significance is stated in the text.

In making references, the aim has been to indicate where collateral reading matter may be found. It should not be considered that the authors necessarily support statements found in these publications, other than those contained in the direct references. It has been found advisable to make abbreviations in giving references. A list of references, with these abbreviations indicated, has therefore been introduced.

The matter presented under the headings "Preliminary" and "Instruments" has resulted from the necessity of familiarizing the experimenter with the many general features in connection with dynamo testing and the care and use of instruments.

While many of the experiments considered are common to College Electrical Laboratories, a considerable number have been the result of the development of the dynamo laboratory course at the University of Wisconsin. A common criticism of books on dynamo machinery is that the conditions of temperature and sparking are not sufficiently emphasized. These features are bug-bears in engineering departments devoted to the commercial design of dynamos, and have therefore been given prominence in this treatise.

Appendix A, relating to Shop Tests, has been introduced with the idea of grouping together and emphasizing those tests and

methods of measurement which are employed in the testing department of a manufacturing concern. Appendix B, the Standardization Report of the American Institute of Electrical Engineers (introduced by permission of the Institute), is considered a necessary adjunct to a dynamo testing manual.

The subject matter of this book has gone through several editions in the form of mimeographed notes and each edition has been revised, after a year's trial. The treatment of the subject is therefore based on personal experience as well as on the theory of education. This experience covers a period of ten years and is largely the result of the authors' connection with laboratory and class instruction in the Universities of Wisconsin and Illinois and in Pennsylvania State College. On the other hand, it is believed that the practical value of the treatise is due in marked degree to the experience of the authors, not only in the designing and testing departments of manufacturing concerns, but also in the designing, construction and testing of plants containing electrical machinery and apparatus.

Acknowledgment is due to Mr. Murray C. Beebe, Chemist of the Nernst Lamp Company, who, while Instructor at the University of Wisconsin, wrote as co-author a considerable proportion of the matter in the earlier mimeographed editions. Indebtedness to Professor Dugald C. Jackson, for his friendly interest, his counsel and encouragement is best acknowledged by the inscription contained on a separate page.

The authors are under obligations to Assistant Professor John W. Schuster and Mr. George C. Shaad, of the Electrical Engineering Department at the University of Wisconsin, to Assistant Professor William H. Williams, of the University of Illinois, and to Professor Arthur H. Ford, of the Georgia School of Technology, for their kindness in the reading of proof and in criticising copy. Further acknowledgment is due to the many students who have felt free to point out mistakes in the mimeo-

graphed notes and make suggestions for the improvement of individual experiments.

While due care has been exercised in the editing of this work, it is probable that errors will be found and the authors will feel grateful if such are called to their attention.

August, 1903.

U

PROFESSOR DUGALD C. JACKSON, C.E.

TEACHER, ENGINEER AND AUTHOR

TABLE OF CONTENTS.

NOMENCLATURE	xiii
LIST OF REFERENCES.....	xv
LIST OF EXPERIMENTS.....	xix
PRELIMINARY	I
INSTRUMENTS	13
EXPERIMENTS	47
APPENDIX A, SHOP TESTS	36I
APPENDIX B, STANDARDIZATION REPORT (A. I. E. E.)....	38I
Index	4II



NOMENCLATURE.

- A*, Area.
B, Susceptance.
 \mathfrak{B} , Magnetic Induction.
C, *c*, Capacity.
D, *d*, Unknown Quantity.
E, *e*, Electrical Pressure.
F, *f*, Force.
f, Frequency.
 \mathfrak{F} , Magneto-motive Force.
G, *g*, Conductance.
 \mathfrak{H} , Magnetizing Force.
I, *i*, Current.
J, Intensity of Magnetization.
K, Moment of Inertia.
K, *k*, Constant.
L, Coefficient of Inductance.
l, Length.
M, Mass.
m, Strength of Pole.
 \mathfrak{M} , Magnetic Moment.
N, *n*, Number of Turns.
NI, *ni*, Ampere Turns.
O, Origin.
P, Power (Electrical or Mechanical).
p, Pressure, Pull.
 p_1 , Number of Pairs of Poles.
 p_2 , Number of Pairs of Armature Paths.
Q, *q*, Quantity.
R, *r*, Resistance.
 \mathfrak{R} , Magnetic Reluctance.

- S , Number of Armature Conductors.
- s , Surface.
- T , Torque.
- t , Time, Temperature.
- U, u , Unknown Quantity.
- V , Volume, Revolutions per Minute.
- v , Velocity, Leakage Coefficient.
- W , Weight.
- W, w , Work, Electrical Energy.
- X, x , Reactance.
- Y, y , Admittance.
- Z, z , Impedance.
- α , Acceleration, Angle.
- β , Angle.
- γ , Conductivity.
- δ , Deflection.
- ϵ , Base of Napierian Logarithms.
- η , Efficiency, Hysteresis Coefficient.
- θ , Angle, Deflection.
- κ , Magnetic Susceptibility.
- μ , Magnetic Permeability.
- π , Ratio of the Circumference of a Circle to its Diameter.
- ρ , Magnetic Reluctivity.
- σ , Resistivity.
- τ , Time Constant.
- ϕ , Magnetic Flux.

LIST OF REFERENCES.

1. ABBOTT. The Electrical Transmission of Energy. By A. V. Abbott.
2. AM. ELEC. American Electrician. New York.
3. TRANSACTIONS A. I. E. E. Transactions of the American Institute of Electrical Engineers. New York.
4. ARMAGNAT. Instruments et Methodes de Mesures Electriques Industrielles. 1902 Edition. By H. Armagnat.
5. ARNOLD'S "DYNAMOS." Die Gleichstrommaschine. By E. Arnold.
6. ARNOLD'S "ARMATURE WINDING." Die Ankerwicklungen und Ankerkonstruktionen der Gleichstrom-Dynamomaschinen. Third Edition. By E. Arnold.
7. BLONDEL AND DUBOIS. La Traction Électrique sur Voies Ferrées. Volumes 1 and 2. By André Blondel and F. Paul DuBois.
8. CARHART AND PATTERSON. Electrical Measurements. By H. S. Carhart and G. W. Patterson.
9. CARUS-WILSON. Electro-Dynamics. The Direct Current Motor. By C. A. Carus-Wilson.
10. CROCKER. Electric Lighting. Vols. 1 and 2. By F. B. Crocker.
11. CROCKER AND WHEELER. The Practical Management of Dynamos and Motors. By F. B. Crocker and S. S. Wheeler.
12. DUBOIS. The Magnetic Circuit in Theory and Practice. By H. DuBois; translated by Atkinson.
13. ELEC. WORLD. Electrical World. New York.
14. ELEC. W. AND E. Electrical World and Engineer. New York.
15. ELEK. TECH. ZEIT. Elektrotechnische Zeitschrift. Berlin.

16. EWING. Magnetic Induction in Iron and Other Metals. 1900 Edition. By J. A. Ewing.
17. FISHER. The Potentiometer and its Adjuncts. By W. C. Fisher.
18. FISHER-HINNEN. Continuous Current Dynamos. By J. Fisher-Hinnen.
19. FLATHER. Dynamometers and the Measurement of Power. By J. J. Flather.
20. FLEMING. Handbook for the Electrical Laboratory and Testing Room. By J. A. Fleming.
21. GERARD. Electricity and Magnetism. By Eric Gerard; translated by Duncan.
22. GESAMMELTE ABHANDLUNGEN. Gesammelte Abhandlungen. By G. R. Kirchhoff.
23. GRAY. Absolute Measurements in Electricity and Magnetism. By Andrew Gray.
24. HAWKINS AND WALLIS. The Dynamo. By C. C. Hawkins and F. Wallis.
25. HENDERSON. Practical Electricity and Magnetism. By John Henderson.
26. HOPKINSON'S "PAPERS." Original Papers on Dynamo Machinery. By John Hopkinson.
27. HOPKINSON'S "DYNAMOS." Dynamo Machinery. By John Hopkinson.
28. HOUSTON AND KENNELLY. Electro-Dynamic Machinery. By E. J. Houston and E. A. Kennelly.
29. JACKSON'S "DYNAMOS." A Text-Book on Electro-Magnetism and the Construction of Dynamos. By D. C. Jackson.
30. JACKSONS' "ALTERNATING CURRENTS." Alternating Currents and Alternating Current Machinery. By D. C. Jackson and J. P. Jackson.
31. JACKSONS' "ELECTRICITY AND MAGNETISM." Elementary Electricity and Magnetism. By D. C. Jackson and J. P. Jackson.

32. JOURNAL I. E. E. Journal of the Institution of Electrical Engineers. London.
33. KAPP'S "DYNAMOS." Dynamos, Alternators and Transformers. By Gisbert Kapp.
34. KAPP'S "DYNAMO CONSTRUCTION." Dynamo Construction; Electrical and Mechanical. By Gisbert Kapp.
35. KAPP'S "TRANSMISSION." Electric Transmission of Energy. By Gisbert Kapp.
36. KEMPE. A Handbook of Electrical Testing. By H. R. Kempe.
37. LONDON ELEC. The Electrician. London.
38. LONDON ELEC. ENG. Electrical Engineer. London.
39. LONDON ELEC. REV. Electrical Review. London.
40. LONDON ENG. Engineering. London.
41. LYNDON. Storage Battery Engineering. By Lamar Lyndon.
42. MAXWELL. A Treatise on Electricity and Magnetism. By J. Clerk Maxwell. Vols. 1 and 2.
43. MUNRO AND JAMIESON. A Pocket-Book of Electrical Rules and Tables. By John Munro and Andrew Jamieson.
44. NICHOLS. A Laboratory Manual of Physics and Applied Electricity. Vols. 1 and 2. Edited by E. L. Nichols.
45. NIPHER. Electricity and Magnetism. By F. E. Nipher.
46. PARHAM AND SHEDD. Shop and Road Testing of Dynamos and Motors. By E. C. Parham and J. C. Shedd.
47. PARR. E. E. T. Electrical Engineering Testing. By G. D. Aspinwall Parr.
48. PARR. P. E. T. Practical Electrical Testing. By G. D. Aspinwall Parr.
49. PARSHALL AND HOBART. Electric Generators. By H. C. Parshall and H. M. Hobart.
50. PHIL. MAG. The London, Edinburgh and Dublin Philosophical Magazine and Journal of Science. London.
51. PHIL. TRANS. Philosophical Transactions of the Royal Society of London. London.

52. POGGENDORF'S ANNALEN. *Annalen der Physik und Chemie.* By J. C. Poggendorf. Leipzig.
53. PRO. ROYAL SOC. *Proceedings of the Royal Society of London.* London.
54. SHELDON. *Dynamo Electric Machinery.* By Samuel Sheldon.
55. SLINGO AND BROOKER. *Electrical Engineering for Electric Light Artisans and Students.* By W. Slingo and A. Brooker.
56. STANDARDIZATION REPORT. *The Standardization of Electric Generators, Motors and Transformers.* Report of the Committee to the American Institute of Electrical Engineers. Accepted June 20, 1902. New York.
57. STEWART AND GEE. *Elementary Practical Physics. Electricity and Magnetism.* Vol. 2. By Balfour Stewart and W. W. H. Gee.
58. THOMPSON'S "DESIGN." *Design of Dynamos.* By S. P. Thompson.
59. THOMPSON'S "DYNAMOS." *Dynamo-Electric Machinery.* By S. P. Thompson. Fifth Edition.
60. THOMPSON'S "LECTURES." *Lectures on the Electro-Magnet.* By S. P. Thompson.
61. THOMPSON'S "LESSONS." *Elementary Lessons in Electricity and Magnetism.* By S. P. Thompson.
62. THOMSON. *Elements of the Mathematical Theory of Electricity and Magnetism.* By J. J. Thomson.
63. TRADE BULLETINS. *Bulletins, Pamphlets, and other descriptive matter sent out by Manufacturers of Dynamo Machinery, Instruments and other Apparatus.*
64. TREADWELL. *The Storage Battery.* By Augustus Treadwell.
65. UNDERWRITER'S RULES. *Rules and Regulations of the National Board of Fire Underwriters.*
66. WIENER. *Practical Calculation of Dynamo-Electric Machines.* By A. E. Wiener.

LIST OF EXPERIMENTS.

1.	MEASUREMENT OF RESISTANCES OF ARMATURES AND FIELDS BY FALL OF POTENTIAL METHOD....	47
2.	MEASUREMENT OF INSULATION RESISTANCE OF A DYNAMO	50
3.	STUDY OF THE WINDINGS AND CONNECTIONS OF DYNAMOS AND MOTORS.....	53
✓ 4.	ADJUSTMENT OF BRUSHES OF DYNAMOS AND MOTORS	55
5.	DETERMINATION OF THE CONSTANT OF A BALLISTIC GALVANOMETER BY THE CONDENSER METHOD....	57
6.	DETERMINATION OF THE CONSTANT OF A BALLISTIC GALVANOMETER BY A STANDARD SOLENOID.....	59
7.	MAGNETIZATION AND PERMEABILITY TESTS OF IRON BY THE ROWLAND METHOD.....	62
8.	MAGNETIZATION AND PERMEABILITY TESTS OF IRON BY THE HOPKINSON METHOD.....	67
9.	MAGNETIZATION AND PERMEABILITY TESTS OF IRON BY TRACTIVE METHODS.....	72
10.	MAGNETIZATION AND PERMEABILITY TESTS OF IRON, USING THE EWING PERMEABILITY BRIDGE..	85
11.	HYSTERESIS TESTS OF IRON BY THE BALLISTIC METHOD	91
12.	HYSTERESIS TESTS OF IRON, USING A HYSTERESIS TESTER	98
13.	THE EFFECT OF REVERSAL OF ROTATION AND REVERSAL OF EXCITATION ON THE DIRECTION OF PRESSURE OF A DYNAMO.....	105
14.	STARTING OF SHUNT AND SERIES MOTORS ON CONSTANT PRESSURE CIRCUITS.....	106
15.	REVERSAL OF MOTORS. COMPARISON OF THE DIRECTION OF ROTATION AS A MOTOR WITH THAT OF THE SAME MACHINE RUN AS A DYNAMO, THE CONNECTIONS REMAINING THE SAME.....	111
16.	CALIBRATION OF AN AMMETER BY COMPARISON WITH A STANDARD AMMETER.....	112
17.	CALIBRATION OF A VOLTMETER BY COMPARISON WITH A STANDARD VOLTMETER.....	119

18.	CALIBRATION OF AN AMMETER BY MEANS OF A KELVIN BALANCE	122
19.	CALIBRATION OF A VOLTMETER BY MEANS OF A KELVIN BALANCE	125
20.	CALIBRATION OF AN AMMETER BY THE POTENTIOMETER METHOD.....	127
21.	CALIBRATION OF A VOLTMETER BY THE POTENTIOMETER METHOD.....	131
22.	CALIBRATION OF AN AMMETER, USING A COPPER VOLTAMETER	133
23.	CALIBRATION OF A VOLTMETER, USING A COPPER VOLTAMETER	138
24.	MAGNETIZATION CURVES OF DYNAMOS.....	141
25.	DETERMINATION OF DEPTH OF AIR GAP OF A DYNAMO FROM ITS MAGNETIZATION CURVE.....	144
26.	LEAKAGE COEFFICIENT OF A DYNAMO OR MOTOR..	146
27.	EXTERNAL CHARACTERISTIC OF A SEPARATELY EXCITED DYNAMO	149
28.	EXTERNAL CHARACTERISTIC OF A SHUNT DYNAMO,	152
29.	EXTERNAL CHARACTERISTIC OF A SERIES DYNAMO,	156
X 30.	EXTERNAL CHARACTERISTIC OF A COMPOUND DYNAMO	158
31.	EXTERNAL CHARACTERISTIC OF A DIFFERENTIAL COMPOUND DYNAMO	159
32.	DERIVATION OF THE LOSS LINE OF A SHUNT DYNAMO FROM ITS MAGNETIZATION CURVE AND EXTERNAL CHARACTERISTIC.....	160
33.	DERIVATION OF THE LOSS LINE OF A SERIES DYNAMO FROM ITS MAGNETIZATION CURVE AND EXTERNAL CHARACTERISTIC.....	162
34.	COMPOUNDING OF A SHUNT DYNAMO FROM ITS MAGNETIZATION CURVE, EXTERNAL CHARACTERISTIC AND LOSS LINE.....	163
35.	ARMATURE CHARACTERISTIC OF A SHUNT DYNAMO,	165
36.	COMPOUNDING OF A SHUNT DYNAMO FROM ITS ARMATURE CHARACTERISTIC.....	166
37.	COMPOUNDING OF A SHUNT DYNAMO BY THE METHOD OF ADDED TURNS.....	167
✓ 38.	ADJUSTMENT OF COMPOUNDING OF A DYNAMO BY SHUNTING THE SERIES WINDING.....	170

39.	ADJUSTMENT OF COMPOUNDING OF A DYNAMO BY CHANGING THE SPEED.....	172
40.	EXTERNAL CHARACTERISTIC OF AN ARC DYNAMO..	174
41.	EXPERIMENTAL DETERMINATION OF THE NUMBER OF FIELD TURNS ON A DYNAMO.....	178
42.	MAGNETIC DISTRIBUTION IN THE AIR GAP OF A DYNAMO OR MOTOR; SINGLE PILOT BRUSH METHOD,	180
43.	MAGNETIC DISTRIBUTION IN THE AIR GAP OF A DYNAMO OR MOTOR; DOUBLE PILOT BRUSH METHOD,	183
44.	MAGNETIC DISTRIBUTION BY THE METHOD OF INSTANTANEOUS CONTACT	185
45.	MAGNETIC DISTRIBUTION BY THE BALLISTIC METHOD	190
46.	MAGNETIZATION CURVE OF A SHUNT DYNAMO AT FULL LOAD CURRENT	194
47.	COMPOUNDING A DYNAMO FROM ITS NO LOAD AND FULL LOAD MAGNETIZATION CURVES.....	195
48.	SPARKING TEST OF A DYNAMO OR MOTOR.....	196
49.	RELATION OF SPEED TO PRESSURE IN A SEPARATELY EXCITED DYNAMO.....	201
50.	RELATION OF SPEED TO PRESSURE IN A SHUNT DYNAMO	202
51.	RELATION OF SPEED TO PRESSURE IN AN ARC DYNAMO	204
52.	STATIC TORQUE TEST OF A MOTOR.....	206
53.	RELATION OF SPEED TO PRESSURE AT THE ARMATURE TERMINALS OF A SHUNT MOTOR; CONSTANT EXCITATION	208
54.	RELATION OF SPEED TO EXCITATION IN A SHUNT MOTOR	210
55.	RELATION OF SPEED TO TERMINAL PRESSURE IN A SHUNT MOTOR.....	213
56.	REGULATION OF A SHUNT MOTOR ON A CONSTANT PRESSURE CIRCUIT	217
57.	STUDY OF A SEPARATELY EXCITED MOTOR RUN BY A SERIES DYNAMO.....	219
58.	STUDY OF A SHUNT MOTOR RUN BY A SERIES DYNAMO	221
59.	OPERATION OF A SERIES MOTOR ON A CONSTANT CURRENT CIRCUIT	221
60.	OPERATION OF A SEPARATELY EXCITED MOTOR ON A CONSTANT CURRENT CIRCUIT.....	226

61.	OPERATION OF A SERIES MOTOR ON A CONSTANT PRESSURE CIRCUIT.....	231
62.	REGULATION OF A CUMULATIVE COMPOUND MOTOR ON A CONSTANT PRESSURE CIRCUIT.....	236
63.	REGULATION OF A DIFFERENTIAL COMPOUND MOTOR ON A CONSTANT PRESSURE CIRCUIT.....	238
64.	REGULATION OF A SINGLE SERIES MOTOR RUN FROM A SIMILAR SERIES DYNAMO.....	239
65.	TEMPERATURE TEST OF A DYNAMO OR MOTOR.....	245
66.	EFFICIENCY OF A MOTOR BY THE PRONY BRAKE METHOD	252
67.	EFFICIENCY OF A DYNAMO OR MOTOR BY THE CRADLE DYNAMOMETER	255
68.	EFFICIENCY OF A DYNAMO OR MOTOR BY THE STRAY POWER METHOD	258
69.	SEPARATION OF THE TOTAL STRAY POWER INTO ITS COMPONENTS	263
70.	VARIATION OF STRAY POWER WITH SPEED; USEFUL FLUX CONSTANT.....	269
71.	VARIATION OF STRAY POWER WITH USEFUL FLUX; SPEED CONSTANT.....	271
72.	RATING OF A SHUNT MOTOR FOR MEASUREMENT OF POWER	274
73.	HOPKINSON OPPOSITION METHOD OF TESTING DYNAMO MACHINES	277
74.	KAPP OPPOSITION METHOD OF TESTING DYNAMO MACHINES	283
75.	POTIER OPPOSITION METHOD OF TESTING DYNAMO MACHINES	287
76.	HUTCHINSON OPPOSITION METHOD OF TESTING DYNAMO MACHINES	293
77.	BLONDEL OPPOSITION METHOD OF TESTING DYNAMO MACHINES.....	300
78.	CONNECTION AND OPERATION OF SHUNT DYNAMOS IN PARALLEL.....	304
79.	CONNECTION AND OPERATION OF SERIES DYNAMOS IN PARALLEL.....	308
80.	CONNECTION AND OPERATION OF COMPOUND DYNAMOS IN PARALLEL.....	311
81.	CONNECTION AND OPERATION OF ARC DYNAMOS IN SERIES	314

82.	CONNECTION AND OPERATION OF TWO DYNAMOS ON A THREE WIRE SYSTEM.....	316
83.	REGULATION TEST OF A THREE WIRE DYNAMO.....	319
84.	EXPERIMENTAL ILLUSTRATION OF THE ACTION OF A BOOSTER.....	324
85.	EXPERIMENTAL ILLUSTRATION OF THE OPERATION OF A MOTOR WHOSE FIELD IS SUPPLIED BY ARMATURE REACTION.....	325
86.	LOCATION OF FAULTS IN ARMATURES.....	326
87.	EFFICIENCY AND REGULATION OF A MOTOR-GENERATOR	329
88.	EFFICIENCY AND REGULATION OF A DYNAMOTOR..	332
89.	RELATION OF SPEED TO EXCITATION IN A SHUNT OR SEPARATELY EXCITED MOTOR, WHEN THE RESISTANCE DROP IN THE ARMATURE CIRCUIT IS GREATER THAN THE COUNTER PRESSURE.....	336
90.	CALIBRATION OF A THOMSON INTEGRATING WATT-METER	338
91.	TESTS OF FUSES	342
92.	TESTS OF DIRECT CURRENT CIRCUIT BREAKERS....	346
93.	STUDY OF CONSTANT PRESSURE ARC LAMPS.....	348
94.	STUDY OF CONSTANT CURRENT ARC LAMPS.....	350
95.	TEST OF A TRACTIVE ELECTRO-MAGNET.....	351
96.	TEST OF A STORAGE CELL.....	356



ELECTRO-MAGNETIC MACHINERY.

PRELIMINARY.

To derive the greatest good from the laboratory course, the experiment assigned should be studied carefully before attempting to obtain data. Determine what results are sought or what theoretical considerations are to be brought out by the experiment. Examine the instruments and apparatus until familiar with them. Systematic and careful work will result in an ultimate saving of time and greater good from the work. Where two or more students work on an experiment, the connections should be looked over and understood by each.

In all of his laboratory work the student should develop self-reliance and resourcefulness. *If he begins by running to his instructor for the solution of every little difficulty, his progress later in the course will be seriously impeded.*

GENERAL METHODS.

Before proceeding on any experiment, make a sketch of the connections; then connect *accordingly*. In planning these connections the instruments should be so placed as to read with the greatest accuracy. The sketch should involve fuses or other necessary protective devices. Possible emergencies should be considered and the course of action decided upon, before beginning a test. Before starting any test on a dynamo or motor, the peripheral speed of the pulley should be computed unless it is known to be within safe limits; a maximum of 5500 feet per minute is permissible. All belt lacings should be in-

spected. Care should be taken that all apparatus is accelerated slowly, as rapid acceleration may cause a belt to part or run off, or may even break a pulley. Never stand in front of a belt while it is running. Never sit on a belt, lean against it or stand on it. The reason is obvious.

In wiring up apparatus, never use a wire smaller than No. 10 B. and S. gauge, except for voltmeter leads or the leads to the pressure coils of wattmeters. Current carrying wires should be bared and scraped a sufficient length to make a half turn after insertion in the terminal or binding post. This bending insures continuity of circuit even if the screws work loose. Where a wire is wrapped around a screw a washer should be placed next to the screw head unless the latter is of a diameter sufficient to cover the wire. Pressure leads are usually stranded conductors. Care should be taken that the ends of the strands do not touch the metallic cases of instruments or the frames of machines.

Before taking observations the apparatus should be tested over the desired working limits unless the experimenter is certain these limits are attainable. For example, certain observations are to be taken on a dynamo operating from full load to no load. Not only should the instruments used be of such range as to give accurate readings at all desired points, but the auxiliary apparatus such as regulating resistances, power-consuming devices, etc., should operate within safe temperature limits and should be sufficiently adjustable. If this precaution is not taken the experiment may be prematurely stopped, and possibly with disastrous results. Again, it may not be possible to obtain a sufficient number of observations, because of lack of adjustment of auxiliary apparatus. Commercial apparatus, such as dynamos, transformers, etc., are subject to temperature tests, which should be made in accordance with the rules of the American Institute of Electrical Engineers.* Furthermore, no observations showing

* Standardization Report, Appendix B.

commercial performance should be taken until the apparatus has attained its working temperature. In the college dynamo laboratory limited time usually precludes the necessary preliminary temperature run. Many observations depend upon temperature, and, if made at any other than the *working temperature*, will not represent operating conditions. Methods of compensating for these errors will be considered later in special cases. However, since compensation is not always possible, the experimenter should keep this temperature effect in mind, and in making any commercial tests, *should insist upon a preliminary temperature run*. All overload observations are worthless, unless the machine is at normal full load temperature when the overload run is begun.

All resistance measurements should include readings of temperature so that the temperature correction may be made if necessary.

It is often possible to do two or more experiments simultaneously. In this case the written report of each experiment should be complete in itself; *i. e.*, it is not advisable to use such expressions as, "the apparatus used was the same as in previous experiments," or "the data were the same as in experiment —." While this may seem an unnecessary repetition, it makes the report more valuable for future reference.

Always explain any symbols used which are not standard.

Checking results is often entirely overlooked, but its importance can not be too strongly emphasized.

CURVES.

Results are often more clearly shown when represented graphically. In fact, important deductions may be entirely overlooked when a mass of tabulated data alone is considered.

The curve sheet, as far as practicable, should contain data sufficient to make it independent of the rest of the report. The scales should be so chosen and the curves so plotted that the sheet will be used to the best advantage in bringing out the

results desired; at the same time no scale should be chosen so large as to show in glaring prominence the errors of personal equation. The scale should be indicated at regular intervals and all figures or letters should be placed inside the margin of the cross-section paper; or, if outside, care should be taken that a sufficient space is left for binding. The readings represented on the curve sheet should be indicated by small circles or otherwise, and, as a rule, a smooth curve should be drawn, following what seems to be a locus of the points, rather than a jagged curve connecting the observed points.

The lettering on the curve sheet should indicate the nature of the curves, the machine or apparatus experimented upon, its rating, the name of the experimenter, and the date. If several curves appear upon the same sheet, they should be numbered and proper explanation of them made on the curve sheet.

SWITCHBOARD CONNECTIONS.

In making switchboard connections, form the habit of connecting to the source of power *last*. This is important in high tension work for personal safety. By making all other connections *first*, no "live" wires need be handled until the final connections are made, whereas if the power connections are made first, every lead handled will be "live." Be sure all connections are according to sketch and instruments of proper range are used. Depend upon it, any "hit or miss" plan is liable to result disastrously.

ORIGINAL DATA.

The necessity of making the original data as complete and clear as possible can not be too strongly emphasized. Otherwise important data may be overlooked and it becomes necessary to perform the experiment a second time, either in whole or in part. Oftentimes important deductions may be drawn in the light of some later experiment which were not thought of

at the time the data were taken; hence the desirability of keeping the record in convenient shape and of making it so self-explanatory in character that it may be depended upon for future reference.

THE WRITTEN REPORT.

The most essential features to be considered in the written report are clearness, completeness, accuracy and neatness. The student who is careful to observe these will be forming habits which he will find necessary to success in his later professional work.

Each report should contain:

- a.* The names of the writer and the person or persons with whom the experiment was performed; the writer's name being underscored or set out prominently.
- b.* The date of the experiment.
- c.* The number of the experiment and its title.
- d.* The object.
- e.* List of apparatus tested, with maker's name and rating; and manufacturer's name of each instrument used, with its range and number.
- f.* Diagrams of connections used, carefully drawn and lettered.
- g.* Full description of apparatus tested.
- h.* Theory of the experiment, method employed and references to the authorities for assumptions made or equations used, and a sample calculation of a deduced result.
- i.* Given, observed and calculated data in neat tabular form.
- j.* Deductions from data, expressed graphically when possible.
- k.* Discussion of the experiment in general, pointing out possible sources of error, methods of eliminating error, difficulties encountered and methods of overcoming them, accuracy of the method, and any other points of interest which may arise for each special case.
- l.* Discussion of the results and conclusions drawn.

These features may best be shown in a sample report. A simple experiment in the testing of an incandescent lamp has been chosen and the various points are brought out briefly. The student will readily comprehend that in many cases his written report should be much more exhaustive.

January 23, 1903. JOHN B. AVERY with $\left\{ \begin{array}{l} \text{A. L. TURNER,} \\ \text{M. K. FISHER.} \end{array} \right.$

EXPERIMENT Z.

BEHAVIOR OF AN INCANDESCENT LAMP UNDER INCREASING PRESSURE.

Object. The object of this experiment is to study the action of a 110-volt 16-candle-power lamp when subjected to a steadily increasing terminal pressure, starting with a low value and continuing until the lamp burns out:

Apparatus and Instruments.

16-candle-power 110-volt American incandescent lamp.

16-candle-power 110-volt Edison Standard lamp, Number 3.

Weston direct-current ammeter, No. 12792, range 0-1 ampere.

Weston direct-current voltmeter, No. 24709; range 0-15, 0-150 volts.

Weston direct-current voltmeter, No. 35304; range 0-150, 0-300 volts.

Krüss Standard Reichsanstalt Precision Photometer with 300-centimeter bar.

Lummer-Brodhun Photometric Screen.

Switches and Rheostats.

220-volt, 150-ampere hour Storage Battery.

Connections.

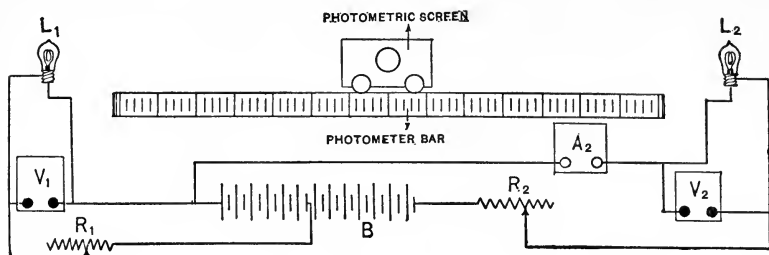

Fig. Za. Diagram of Connections.

Description of Lamp Tested. The lamp tested was a single coil, anchored filament, Edison base incandescent lamp, manufactured by the American Lamp Company. It was rated at 16 candle power with an efficiency of 3.1 watts per candle when supplied with 110 volts. The lamp was carefully examined with regard to symmetry of bulb, straightness of stem, loose connections, etc., and found to be free from imperfections.

Theory and Method. The incandescent lamp is based upon the principle of raising the temperature of an electrical conductor by means of an electric current traversing it. As the lamp filament has resistance, power is supplied to it and in a given time a certain amount of energy is transformed into heat. The temperature of the filament therefore rises to the point where the heat radiated and conducted away is equal to that supplied in the same time. If the power supplied is increased by increasing the current through the lamp, the electrical energy transformed into heat increases and therefore the temperature increases until thermal equilibrium is again established.

In Figure Za the lamp under test is shown at the right end of the photometer bar, while L_1 , the standard lamp, is at the left end.

The photometer and photometric screen were described in the report on Experiment S. The lamp L_1 was standardized in Experiment S and was found to be 15.9 candle power at

109 volts. It was run under these conditions throughout the present test.

The general method of testing was like that in previous experiments of a similar nature and may be briefly outlined as follows. The standard lamp L_1 was maintained constant at 15.9 candle power by keeping the pressure at its terminals constant at 109 volts. The pressure across L_2 was first adjusted to 90 volts and the current and candle power readings were taken. The pressure was then raised ten volts at a step, until the lamp burned out, and a series of current and candle power readings were taken. In each case the pressure was adjusted as rapidly as possible and then maintained constant for ten seconds before another increase was made.

The photometric reading was taken as soon as the pressure adjustment had been made. Two readings were taken for each pressure, the screen being reversed for the second reading, and their average was used in the final calculation.

The general formula for the determination of the luminous intensity of a light source is

$$L_2 = L_1 \frac{d_2^2}{d_1^2}, *$$

where L_2 = the light source under test,

L_1 = the standard light source,

d_2 = distance from L_2 to the photometric screen,

and d_1 = distance from L_1 to the photometric screen.

As a sample calculation, take the readings when the normal pressure of 110 volts was supplied the lamp under test. The observed data were:

Volts.	Current.	Average Photometer Reading.
110	0.450	149.0

* Stine's "Photometrical Measurements," p. 28.

The candle power may be obtained from the formula given above by substituting the values as follows:—

$$L_2 = 15.9 \left(\frac{300 - 149.0}{149.0} \right)^2$$

$$L_2 = 16.4 \text{ candle power.}$$

Instead of multiplying these ratios out each time, use is made of a light ratio table in which the numerical value of the parenthetical expression is given direct for every division of the photometer bar.

The watts are obtained directly by the product of the current and pressure for any one reading. The watts per candle are then obtained by dividing the watts by the corresponding candle power reading. Thus, at 110 volts, the lamp took 49.5 watts, and the watts per candle were 3.00.

Data.

Volts.	Current.	Watts.	Average Photometer Reading.	Light Ratio.	Candle Power.	Resistance.	Watts per Candle Power.	
90	0.350	31.5	199.0	0.258	4.1	257	7.70	
100	0.400	40.0	174.0	0.524	8.3	250	4.88	
110	0.450	49.5	149.0	1.030	16.4	245	3.00	
120	0.495	59.4	128.0	1.810	28.8	243	2.01	
130	0.545	70.8	114.0	2.660	42.3	239	1.75	
140	0.590	82.6	100.0	4.000	63.6	237	1.32	
150	0.630	94.5	88.0	5.800	92.2	238	1.04	
160	0.675	108.0	78.0	8.100	129.0	237	0.86	
170	0.720	122.5	72.0	10.000	159.0	236	0.79	
180	0.760	136.8	66.0	12.600	200.0	237	0.66	
190			Lamp Filament Broke at Coil.					

Standard lamp was run at 15.9 candle power throughout the test.

General Discussion. The sources of error in photometric measurements in general were discussed at some length in Experiment S. An additional source of inaccuracy enters into the present experiment in that the standard lamp and the lamp under test differ in the quality of light emitted. This is especially marked as the pressure on the lamp under test becomes

high, and it is difficult to get a satisfactory setting of the screen, because at no position do the two sources produce the same luminous effect upon the screen.

This difficulty might be avoided to some extent by the use of a screen such as the Grosse Mixture Photometer or by employing a Flicker Photometer, but in either case other inaccuracies are liable to result.

One difficulty experienced was in the adjustment of the pressure to an exact desired value. This was due to the comparatively few steps on the rheostat. The rheostat used had but fifty steps, and one having a continuous gradation would have been much better.

Discussion of Results and Conclusions. The data obtained and calculated show several interesting results, which may best be discussed with reference to the curve sheet Figure Zb. All data have been plotted with reference to candle power which is represented by the abscissas.

First is the very rapid increase of the candle power with an increase in pressure applied to the lamp. At 110 volts the candle power was practically normal while an increase of 10 per cent. in the pressure almost doubled the candle power, and the lamp gave 12.5 times normal candle power at 180 volts, but burned out shortly after the reading was taken.

It was to be expected that the current would rise as the voltage increased since the carbon filament resistance does not change greatly after it reaches a luminous temperature. The resistance of carbon decreases with an increase of temperature and this is nicely shown by the resistance curve.

The watt curve would naturally be similar to the pressure and current curves. This curve is interesting in that it shows the very rapid rise in candle power with a comparatively slight increase in the amount of power supplied.

The efficiency of the lamp is again brought out in the watts per candle power curve. It must be remembered in this con-

nection that watts per candle is really the inverse of efficiency and that a high value of watts per candle means a low efficiency, and vice versa.

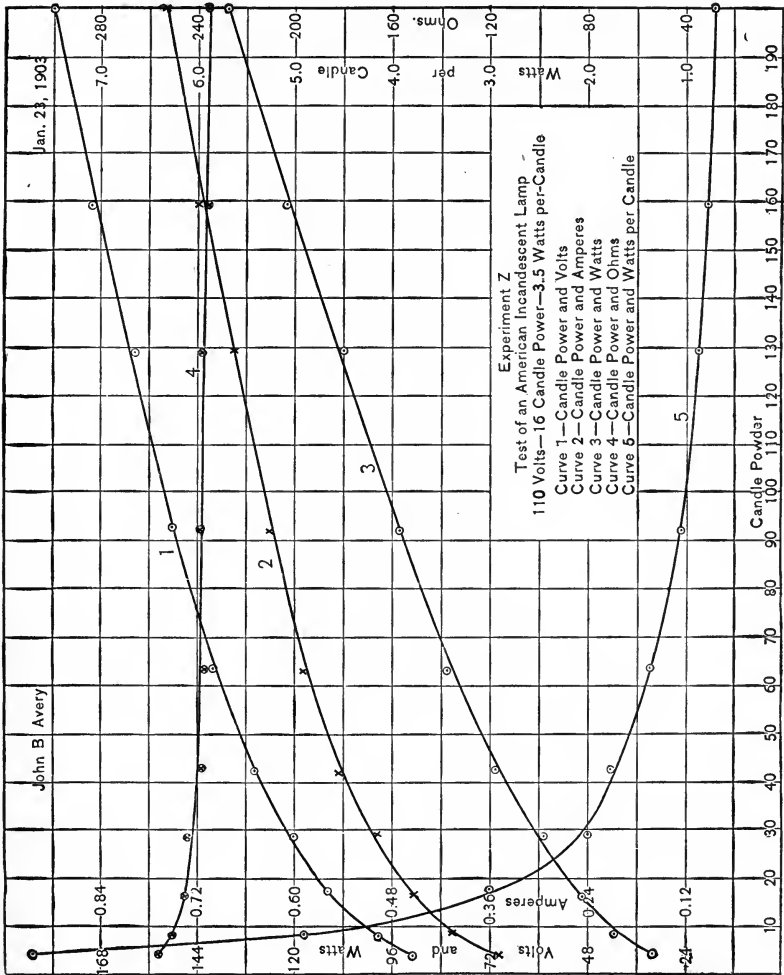

Fig. Zb. Graphical Representation of Incandescent Lamp Test.

Since the intensity of the light emitted increases rapidly with increasing temperature, high temperatures should be employed and the substance used should possess a high fusing

point. Furthermore, the heat should be concentrated within a small space, to avoid cooling effects as far as possible. The material used should therefore be a moderate or a poor conductor of electricity. Carbon has been most commonly employed for filaments, although other substances, such as platinum and iridium, have been used. There have been many experiments in recent years in the use of titanium and substances of a similar nature in the place of carbon.

In conclusion, the experiment shows that an incandescent lamp will withstand a pressure approximately double its normal rating for a short time and give many times its rated candle power, but that the strain is very severe and the filament is impaired, if not actually ruptured.

It is shown that the efficiency becomes higher as the impressed pressure increases. It was also observed that the light emitted became whiter with increasing pressure.

The general conclusion is that incandescent lamps should be run at as high a pressure as is warranted by the conditions of service.

INSTRUMENTS.

It is not the intention here to give a detailed description of all indicating instruments which might be met with in the laboratory, but rather to classify them, and briefly to outline the advantages and disadvantages of the different classes. The details of construction of the various instruments and other particulars concerning them may be found in the catalogs of instrument makers.

Instruments are best classified by considering the principles upon which they operate; for each type, when so classified, may have particular points of merit which fit it especially for certain kinds of work.

QUALITIES OF A GOOD INSTRUMENT.

The important things to consider about an instrument are:

a. Accuracy. This requires that the instrument be theoretically correct in principle; it should be simple, and well constructed.

b. Portability. This quality is of importance where the instrument is to be used in commercial testing, or in fact in any instrument not intended for switchboard use. A strictly portable instrument should be ready for immediate use, without adjustment or careful leveling.

c. Aperiodicity. When instruments are used on circuits in which the measured quantities fluctuate, the desirability of an aperiodic or "dead beat" instrument is at once apparent. To allow simultaneous readings to be taken from several instruments, the needles should come to rest quickly. In general, the moving parts should be light, to reduce friction and to make the instrument capable of responding readily.

Instruments such as ammeters, voltmeters, and wattmeters, should have a natural period of vibration which is many times greater than the time of fluctuation inherent in the circuit measured. For example, the time of vibration of the needle of an instrument used on an alternating or a pulsating current circuit, should be many times the period of the pressure wave. This property is exaggerated in the ballistic galvanometer, while in the oscillograph it is minimized to the greatest possible extent.

Instruments may be made aperiodic by the use of air vanes or vanes moving in oil, or by means of short-circuited conductors moving in magnetic fields.

d. Friction. Both mechanical friction and hysteresis (molecular friction) have the same effect upon the readings of an instrument. On increasing values the readings will be too low, while on decreasing values they will be too high, by an amount dependent upon the friction. Practically all instruments manufactured at present are provided with light moving parts and jewelled bearings, and little or no iron, which would be subjected to a changing magnetic field, is used in their construction.

e. Direct Reading. Instruments should be direct reading, for convenience and general efficiency.

f. Economy of Operation. This means that all pressure coils must be of high resistance and all current coils of low resistance.

ALTERNATING CURRENT INSTRUMENTS.

An important consideration in instruments for alternating current circuits is that they shall indicate the same on all frequencies. This requires that they be so designed that their self-inductance is small, and in pressure coils the true resistance must differ from the impedance by a quantity negligible in value.

Unless special precaution be taken to properly dispose the metal used in their construction, eddy currents will be set up

which will exert a disturbing influence, and the instruments will have to be calibrated for each frequency used.

Any iron interposed in the magnetic circuit of an alternating current instrument must be of such quality and so disposed that hysteresis and eddy currents will not have an opportunity to affect the readings.

The common instruments of good grade are constructed to give indications correct to at least one-half percent, and with proper care will retain this accuracy and require very little attention.

Aside from the question of accuracy of the instrument *per se*, hysteresis and eddy currents both increase the power absorbed, and thereby introduce errors when a set of readings is taken with several instruments in a circuit. Furthermore, an ammeter may have such a large impedance drop that the voltmeter, if connected on the power side of the ammeter, will indicate a pressure appreciably higher than the true pressure of the apparatus; or again the voltmeter may take so much current, that if connected on the load side of the ammeter, the latter will indicate a current appreciably larger than the true current of the load.

CLASSIFICATION OF INSTRUMENTS.

Electrical Instruments may be classified according to the principles upon which they operate:

1. Solenoid and Plunger Type.
2. Magnetic Vane Type.
3. Electro Dynamometer Type.
4. D'Arsonval Galvanometer Type.
5. Astatic Type.
6. Electrostatic Type.
7. Hot Wire Type.
8. Miscellaneous.

Solenoid and Plunger Type. In this type of instrument, the deflection of the needle is caused by the magnetic attraction of

an iron core into a solenoid. This force of attraction is generally balanced by a weight attached to the movable part, or by a spring. The instrument must be calibrated by passing a known current through it, or else by subjecting it to a known electrical pressure, depending upon whether it is to be used as an ammeter or a voltmeter; and it is essential that an instrument of this class be calibrated for both increasing and decreasing readings, on account of hysteresis in the plunger.

Instruments of this class were among the first used and

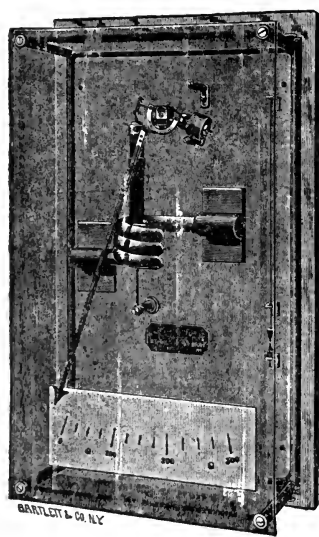

Fig. A. Westinghouse Station Ammeter. (Old Type.)

are still found in use as switch-board instruments where great accuracy is not considered essential. The movable parts of such instruments are apt to be heavy, and on account of their inertia and the difficulty of doing away with friction, they are apt to be sluggish in their movements. They may be used on both direct and alternating current circuits, but the alternating and direct current readings will differ and one calibration will not hold for different frequencies. The effective value of the alternating wave is indicated by such instruments.

Examples.—Ayrton and Perry Instruments; Brush Arc Ammeter; Westinghouse Station Ammeters and Voltmeters (old type); Edison Station Ammeters and Voltmeters; General Electric Potential Indicators and Current Indicators.

This type of instrument has been practically abandoned except for current and pressure indicators used in connection with circuits where the greater accuracy of the more expensive instruments is not essential. Figures A and B show two instruments of this class.

Magnetic Vane Instruments. Instruments of this type depend for their indications upon the action of a magnetic field set up by the current of the circuit, upon a small piece of magnetic material mounted so as to move freely within the field.

Some instruments of this class are constructed, in which the magnetic vane is mounted eccentrically in the magnetic field, so that, as the strength of the field changes, the vane seeks a new position which is indicated by a pointer moving over a scale.

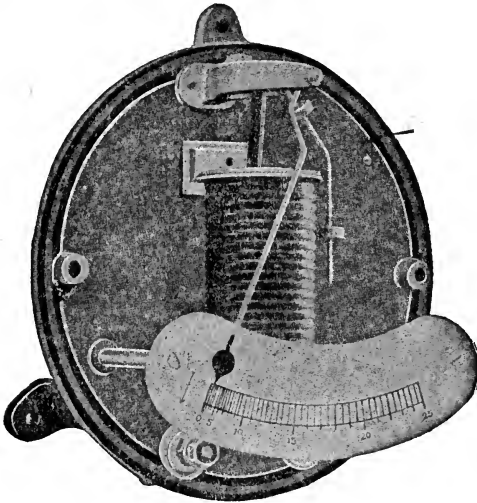

Fig. B. General Electric Current Indicator.

Another common way is to mount a small vane of soft iron in the magnetic field set up by the solenoid in such a way that, when the pointer is at zero, the vane takes a position partly across the path of the lines of force. The position of the vane, relative to the magnetic field, is kept constant by means of a torsion head which carries the index. A magnetic field set up by the coil will tend to turn the vane in a position in which it will offer a better path for the lines of force. For a given angular position this turning moment is proportional to the square of the current in the coil. For this reason such instru-

ments have unevenly divided scales. They may be used on direct or alternating current circuits, in the latter case indicating the effective value of the alternating wave. Their indications will be dependent upon the frequency, unless care is taken to reduce the hysteresis and also the eddy currents of the vane to a minimum, when the variation becomes negligible.

When used on direct current circuits, they will be affected by stray magnetic fields or masses of iron in close proximity, and hence, are rather unsatisfactory for direct current work.

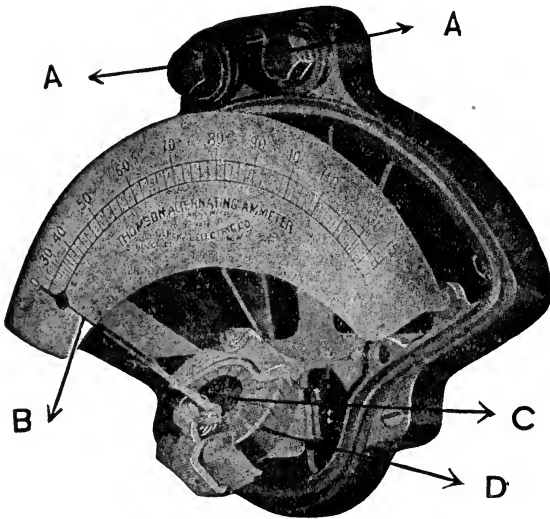

Fig. C. Thomson Inclined Coil Ammeter.

In using them for such work, special precautions must be taken to see that they are not in the neighborhood of any such field or any large mass of magnetic material. The direction of the current through the instrument should be reversed and the two readings taken without changing the position of the instrument with respect to surrounding objects, the average of the two readings being the correct one. When used on alternating current circuits they serve admirably, and several

commercial instruments of this class are manufactured which are reliable and permanent in their indications.

Examples.—Thomson Inclined Coil Ammeters and Voltmeters; Hoyt Ammeters and Voltmeters.

The Thomson instruments belong to the first mentioned class where the vane is mounted eccentrically. An ammeter of this type is shown in Figure C. It is direct reading and has a fairly uniform scale. The inclined coil is shown at *D*, and *C* is the movable magnetic vane to which is attached the

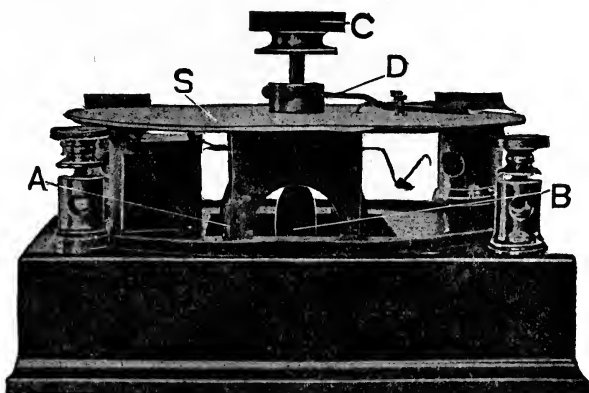

Fig. D. Hoyt Ammeter.

pointer *B*. The binding posts *AA* are connected directly to the inclined coil.

In the Hoyt instruments the field is symmetrical and the force deflecting the vane is balanced by means of two small differential spiral springs mounted on a torsion head to which the pointer of the instrument is attached. Figure D shows a Hoyt ammeter with the outer case removed. The coil which sets up the magnetic field is shown at *A* with the magnetic vane *B* inside of it. The torsion head is shown at *C*, and attached to it is the pointer *D*, moving over the scale *S*.

Electro-Dynamometer Type. Instruments of this class have a fixed and a movable coil of fine or heavy wire, depend-

ing upon the use intended. When used as a voltmeter, the two coils are of fine wire, and when as an ammeter, they are of heavy wire, and in either case are connected in series. When used as a wattmeter, the movable or pressure coil is of fine wire and the fixed or current coil is of heavy wire, the two being independent electrically.

When used as an ammeter or a voltmeter, the current passes through the fixed coil setting up a magnetic field proportional to the current. The same current passing through the movable coil also sets up in it a field proportional to itself. These two coils are mounted in planes which are at right angles to each other, so the fields set up are at right angles and thus react upon each other, tending to force the two coils into the same plane. Since the force exerted is proportional to the product of the strengths of field, it must be proportional to the square of the current flowing in the coils.

When used as a wattmeter the fixed or field coil is wound with large wire and few turns, and is connected in series with the circuit in which the power is measured. The total current of the circuit flowing through this coil, sets up a field proportional to itself. The movable coil is of fine wire and is connected in shunt with the circuit. This coil has in series with it a high non-inductive resistance. The resistance of the "pressure coil" circuit remaining constant, the current flowing through it, and hence the field set up by it, are proportional to the pressure impressed upon its terminals. These two magnetic fields reacting upon each other produce, in the case of a direct current circuit or a non-inductive alternating circuit, a deflecting force proportional to the product of the currents in the coils, and hence produce a deflection of the movable coil which is proportional to IE , the power of the circuit. When a difference of phase exists between pressure and current in an alternating current circuit, the currents in the two coils are not acting in unison; and the deflection is proportional to $IE \cos \theta$, where θ is the phase difference.

Instruments of this class necessarily have some self-inductance which would make them dependent upon the frequency of the circuit if used as voltmeters or wattmeters but by careful designing they may be made reliable. When used as ammeters they are, of course, independent of frequency since the amount of current is practically determined by other parts of the circuit. These instruments are not nearly so dead beat as is desirable. They are equally good on direct and alternating current circuits provided proper precautions be taken, when used for direct current measurements, against stray fields and masses of iron. On alternating circuits the effective value of the wave is indicated.

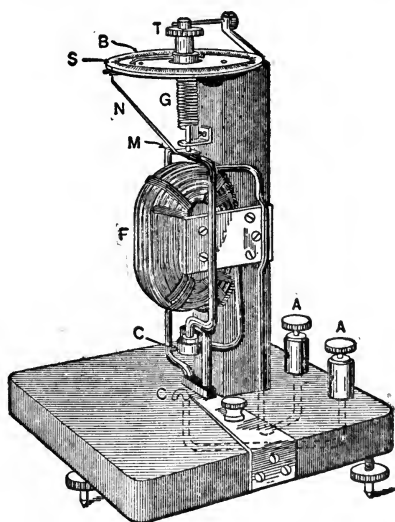

Fig. E. Siemens Dynamometer.

Examples. — Siemens Dynamometer; Kelvin Balance; Weston Alternating Current Voltmeter; Hoyt Wattmeter; Thomson Wattmeter; Weston Wattmeter.

A familiar instrument is the Siemens electro-dynamometer which is shown in Figure E. The coil *F* is fixed and the coil *M*, at right angles to *F*, is hung from a jewelled bearing so that it is free to turn. The ends of the movable coil dip into two mercury cups *CC*, the connections being such that the fixed and movable coils are in series between the binding posts *AA*. When a current flows in the coils the deflecting force is balanced by means of a spiral spring *G* mounted on a torsion head *T* to which the pointer *B* is also attached. The pointer *N* serves to indicate the proper balancing position of *B* and the stops *S* prevent the movable coil from turning too far if

the turning moment is not balanced. The Siemens Dynamometer often has to be used with a constant; that is, the scale is uniformly divided into any number of convenient divisions and in measuring volts or amperes, the true reading equals the square root of the scale indication multiplied by a constant. In measuring watts the reading equals the scale indication multiplied by a constant. In measuring current or pressure the two coils are in series; doubling the current or pressure doubles the current in both coils and therefore increases

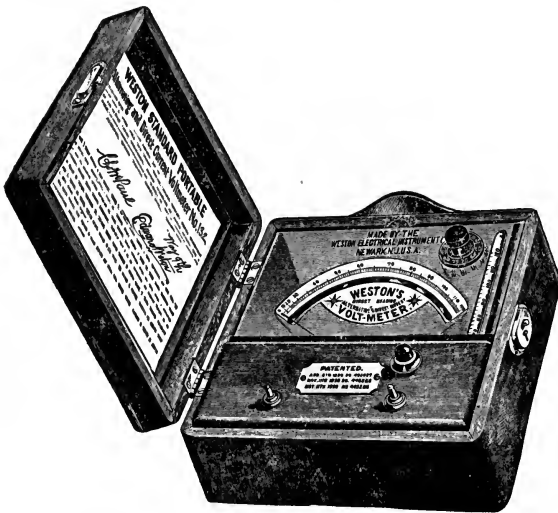

Fig. Fa. Weston Alternating Current Voltmeter.

the torsional effect to four times its original value. This is not the case in using the instrument as a wattmeter.

The Kelvin balance is fully described in connection with Experiments 18 and 19 and, therefore, will not be considered in detail here. The force of gravity is used to balance the force between the fixed and movable coils which is set up by the current flowing in them. Here also the square root of the scale reading must be used if the scale is graduated uniformly.

In portable instruments constructed on the dynamometer principle the graduations are made directly in the desired electrical units.

The Weston alternating current instruments are of the dynamometer type and are direct reading. In series with the windings of voltmeters is placed a small wire resistance which may be adjusted so as to keep the total resistance of the instrument constant regardless of the temperature. Two ranges

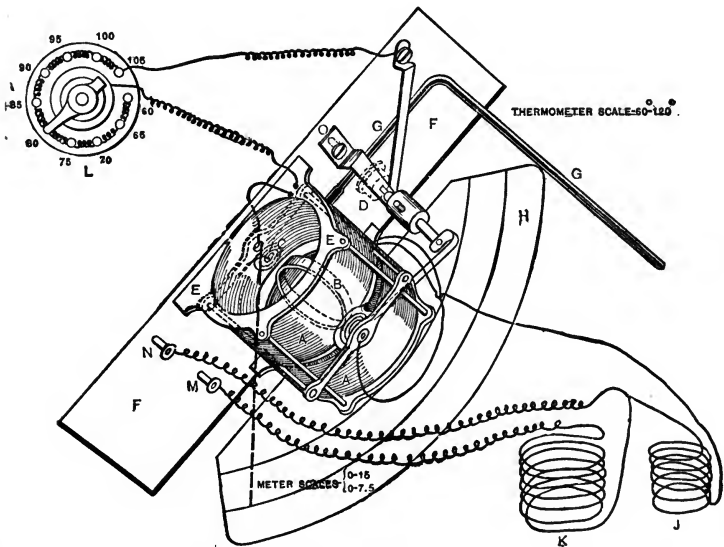

Fig. Fb. View of Interior of Weston Alternating Current Voltmeter from Below.

are often provided in one instrument by connecting in a third terminal at some intermediate point of resistance. A Weston Alternating Current Voltmeter is shown in Figures Fa, Fb and Fc. *AA* are the fixed or field coils and *CC'* are two spiral springs (oppositely coiled), placed at the top and bottom of the movable coil *B*, which is mounted between jewelled bearings. The springs serve the double purpose of restraining device and conductors for the current to and from the movable coil. *L* is a variable resistance used to adjust for temperature, and *GG* is a thermometer

with its bulb in close proximity to the windings of the instrument. The pointer *P* moves across the scale *HH*, as coil *B* is deflected. *M*, *N*, and *O* are the terminal posts, and *D* is the contact key. The instrument shown has a double scale; the posts *N* and *O* being for the low reading scale, and *M* and *O* for the high reading scale. *J* and *K* are high, non-inductive resistances. This instrument is also accurate on direct-current circuits and is termed by the manufacturers an "alternating and direct-current voltmeter."

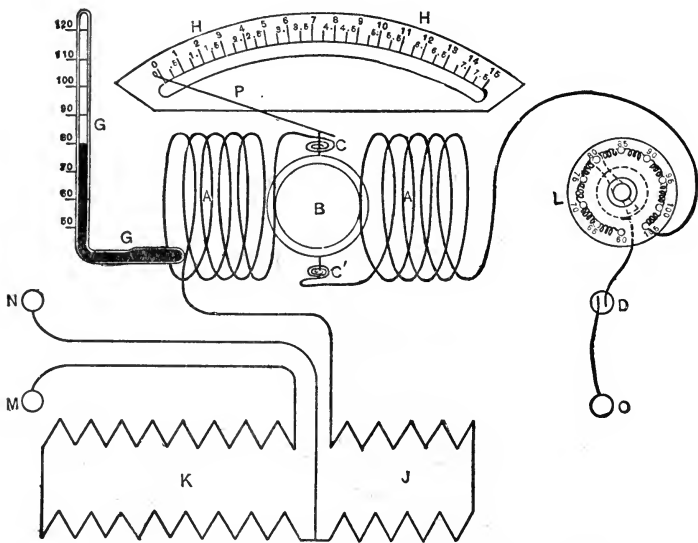

Fig. Fc. Connections of Weston Alternating Current Voltmeter.

Figure G is a diagram of the connections in a Weston wattmeter, for all purposes where the current and pressure coils are connected to the same circuit. *MM* are the leads from the generator or other source of pressure and *CD* are the terminals of the load which is supplied with the power measured. The current coil is connected between the binding posts *AB*, while the pressure coil is connected in series with a non-inductive resistance and a "compensating coil," to the binding posts

ab which are connected directly across the line *CD*. With these connections, the current which flows through the pressure coil must also pass through the current coil even though no power is being absorbed in the circuit. The deflection produced by this pressure coil current may cause an error of four or five units, which in low reading instruments is too large to be neglected. The compensating coil is stationary and is

LAMPS OR OTHER TRANSLATING DEVICES

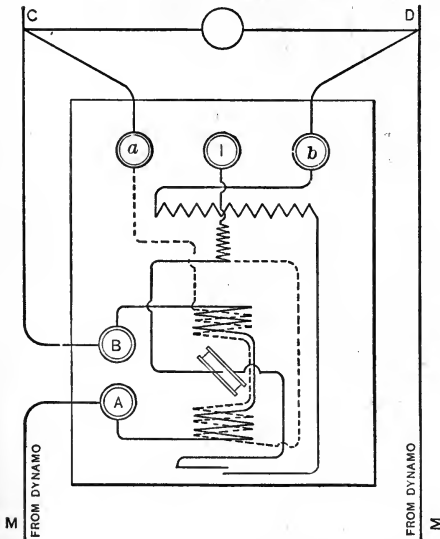

Fig. G. Weston Wattmeter Connections (same circuit).

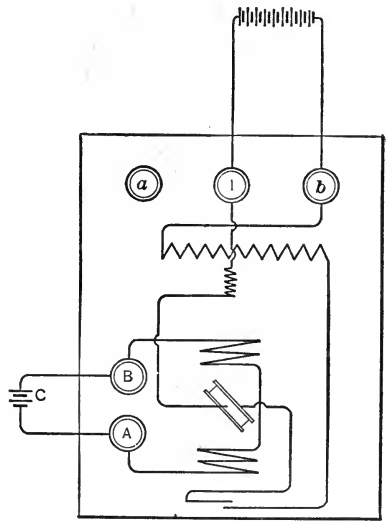

Fig. H. Weston Wattmeter Connections (independent circuits).

wound over the current coil, but in such a direction that the field set up by it just neutralizes that produced by the pressure coil current flowing in the current coil.

Figure H shows the connections for all purposes where the current and pressure coils are connected to independent circuits, as in calibrating or checking the instruments, and when used in conjunction with pressure transformers. In this case the source of pressure is connected between binding post *b* and a third post *I*, which cuts out the compensating coil and

introduces an equivalent resistance. These instruments are direct reading and have uniformly divided scales.

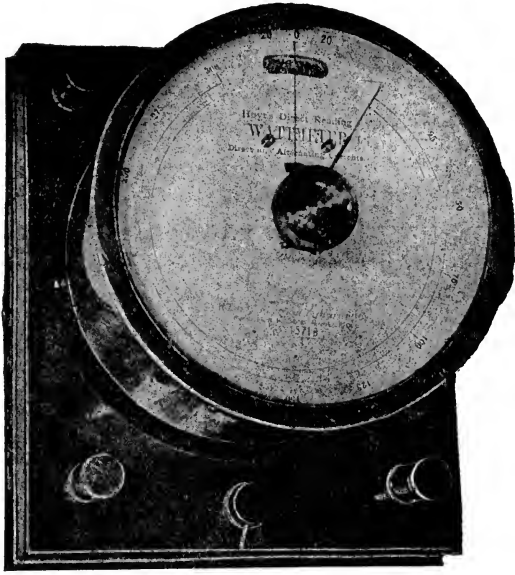

Fig. 1a. Hoyt Wattmeter.

Figures 1a and 1b show views of a Hoyt wattmeter. *BB* is the movable or pressure coil, which is normally at right angles to the fixed or current coil *A*. A non-inductive resist-

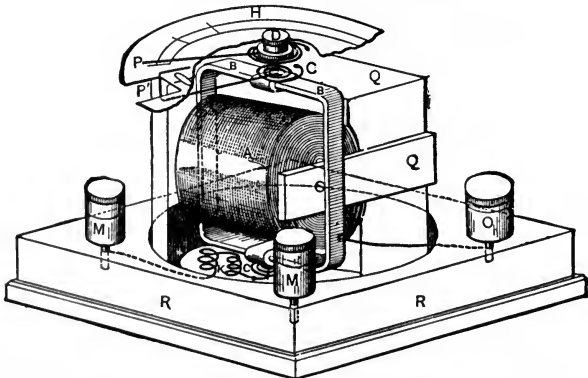

Fig. 1b. General Construction of Hoyt Wattmeter.

ance K is placed in series with the pressure coil. D is the torsion head by means of which the springs CC may be so turned as to bring the movable coil into the zero position. This position is indicated by the pointer P' . The pointer P , which is attached to the torsion head, shows the reading of the instrument if the adjustment is such that the movable coil is in the zero position. MM are the pressure coil binding



Fig. Ja. Thomson Wattmeter.

posts, while OO (one of which is hidden) are the binding posts for the current coil. R and Q are the base and supports of the instrument.

A Thomson wattmeter is shown in Figures Ja and Jb. The instrument is similar to the Thomson magnetic vane instrument in that the fixed or current coil, A , is inclined. Instead of the magnetic vane, however, the movable or pressure coil, B , is

employed. This coil is mounted between jewelled bearings and is controlled by a spiral spring mounted above the coil. The current is led to and from the movable coil by two small springs (oppositely coiled), which are also mounted above the coil. The pointer *C* indicates the position of the coil. The instrument is direct reading and the scale is uniformly graduated. The binding posts *DD* connect with the current coil. The pressure coil is connected, in series with a high non-

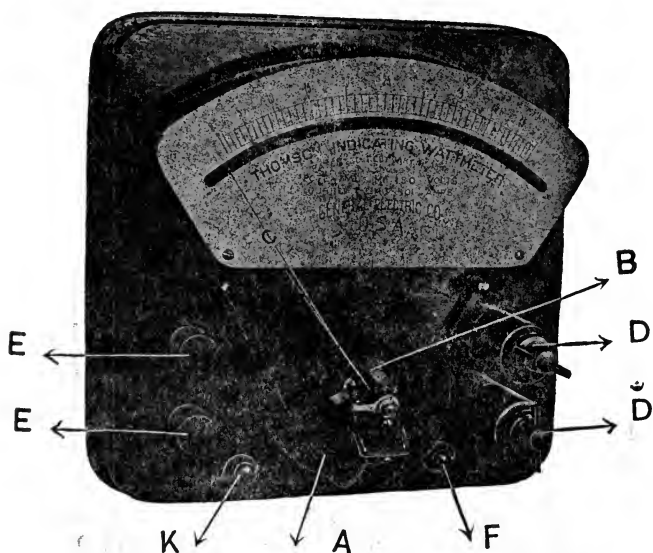

Fig. Jb. Thomson Wattmeter.

inductive resistance and the contact key *K*, to the binding posts *EE*. The button *F* operates a friction brake which controls the movement of the pointer and movable coil.

D'Arsonval Galvanometer Type. Instruments of this type are used only on direct current circuits. A constant field is maintained by a permanent magnet. A light movable coil, to which a pointer is attached, is mounted in this field.

The field set up by the movable coil is slight in comparison to that maintained by the permanent magnet, so that its dis-

torting effect does not affect the accuracy of the instrument. These instruments are very accurate and are not easily affected by stray magnetic fields. Since the deflection is produced by the current of the movable coil acting upon the constant field of the permanent magnet, these deflections are proportional to the current in the movable coil; thus giving a uniformly divided scale, provided the movement of the coil is limited. Constancy of calibration depends upon permanency of the magnets. A great deal of attention has been given this matter by instrument makers. These instruments are made aperiodic by winding the movable coil over a single turn of strip copper or aluminum which forms a closed circuit.

Examples.—Jewell Ammeters and Voltmeters; Keystone Ammeters and Voltmeters; Weston Ammeters and Voltmeters.

Notable among this type are the direct current instruments of the Weston Electrical Instrument Company. Figure K shows a detail view of the mechanism, with a portion of one of the pole pieces removed. The movable coil *C* is of fine wire and is mounted between jewelled bearings so as to turn in the narrow annular space between the pole pieces of the permanent magnet *MM* and the soft iron cylindrical core placed between these pole pieces. The purpose of the pole pieces and cylindrical core is to afford a good magnetic circuit and to distribute the field uniformly so that the scale divisions shall be equal. The deflecting force is balanced by a pair of differentially acting spiral springs *DD* which at the same time afford a path for the current to the movable coil. The pointer *B* is attached to the movable coil and moves across the scale as the coil is deflected from the zero position.

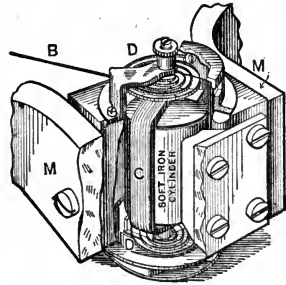

Fig. K. Mechanism of Weston Direct Current Instruments.

Figure La shows a general, and Figure Lb a diagrammatic view of a Weston voltmeter. *MMM* is the permanent magnet, *C* the movable coil, and *D* is one of the spiral springs. The pointer *B*, attached to the movable coil, deflects across the scale *S*. These instruments take approximately one one-hundredth part of an ampere to deflect the needle the full scale reading. The pressure which will cause this deflection is regulated by the amount of resistance *E*, *e* in series with the movable coil.

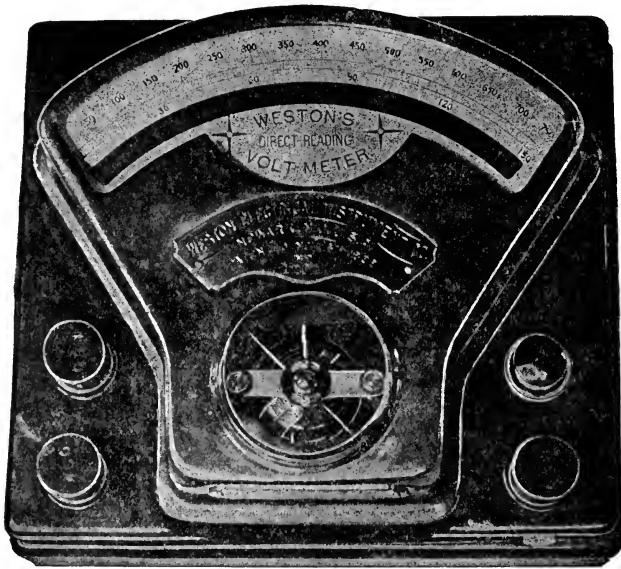

Fig. La. Weston Direct Current Voltmeter.

The voltmeter in the figure has two scales, the lower one of which corresponds to a connection to the binding posts *A*, *a*; and the upper scale should be read when the binding posts *A*, *A'* are used. With the connection to the binding posts *A*, *a* the movable coil is in series with the resistance *e*; while with the connection to *A*, *A'* the movable coil is in series with not only the resistance *e* but also the resistance *E*. In some Weston voltmeters, where one scale is very low reading, the resist-

ance e is used only in connection with the low reading scale. In the instrument shown, with a scale ratio of 20 to 1, the total resistance between binding posts for the high reading scale must be 20 times that for the low reading scale. The key K is for the purpose of opening the voltmeter circuit when the instrument is not in use.

Weston ammeters are nothing more than low reading voltmeters which measure the fall of potential across a low re-

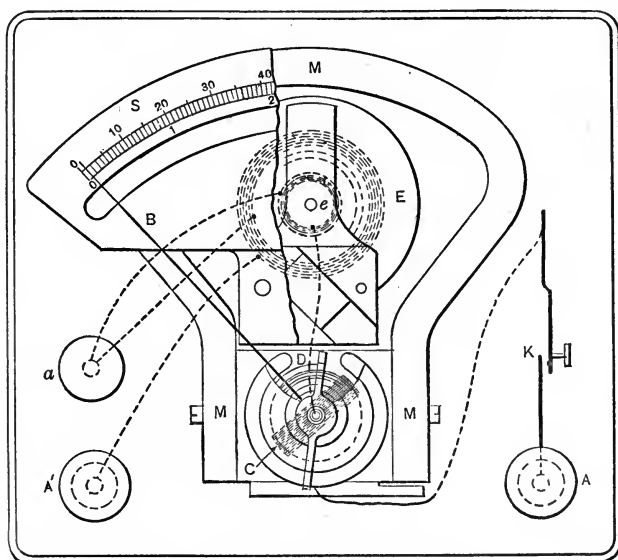

Fig. Lb. Weston Direct Current Voltmeter Connections.

sistance or "shunt" placed in series with the circuit. The fall of pressure across this shunt is proportional to the current; hence, all that is necessary is to calibrate the instrument to read in amperes instead of volts and one instrument may have as many ranges as there are shunts or different resistances. These shunts are made of an alloy having a low temperature coefficient of resistance. A Weston ammeter is shown in Figure M. The general arrangement of magnet, movable coil, springs, pointer and scale, is the same as in the voltmeter. The mov-

ble coil is directly connected to the binding posts *A, A*. The heavy leads *W, W* connect the low resistance shunt *E* across the binding posts and therefore across the movable coil. The shunt *E* is generally wound around the magnet *MM*. This shunt is wound non-inductively and is placed upon the magnet merely for economy in winding space.

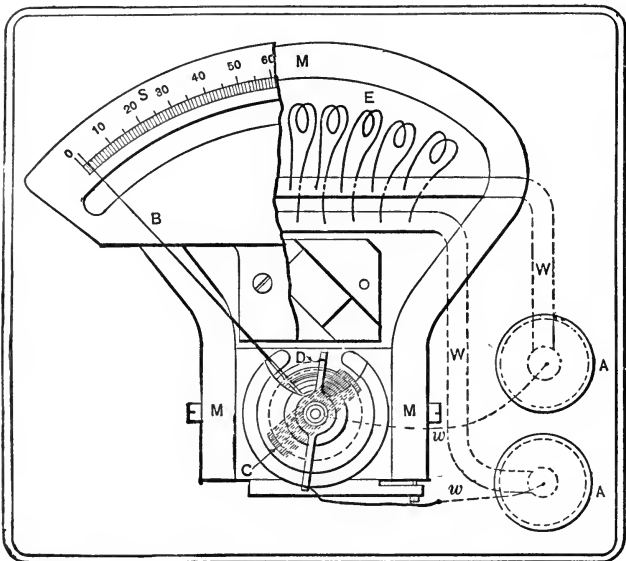

Fig. M. Weston Direct Current Ammeter Connections.

Astatic Instruments. Here the well-known principle of the astatic galvanometer is employed. In the D'Arsonval galvanometer type of this instrument the movable element or armature is mounted in an astatic magnetic field. One arrangement of this field consists of two permanent horseshoe magnets, one mounted on each side of the armature shaft in such a manner that the flux of each magnet is in a direction parallel to the shaft. The astatic arrangement consists in so placing the magnets that their fluxes are in opposite directions. The armature is so wound that the torque is exerted in the same

direction by each field. This construction eliminates the inaccuracies due to stray magnetic fields. In the case of stray fields one magnet would be reinforced and the other weakened to the same degree, and the torque upon the armature would remain unchanged. The damping and the retarding devices may be the same as in any D'Arsonval galvanometer type of instrument.

Example.—Thomson Astatic Ammeters and Voltmeters.

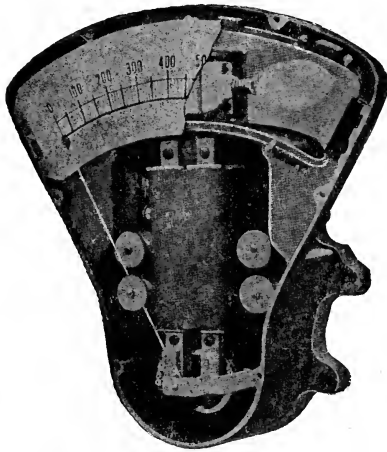

Fig. N. Thomson Astatic Voltmeter.

In the Thomson Astatic Instruments, Figure N, electromagnets are employed instead of permanent magnets. The armature is wound upon an aluminum disc which serves to make the instrument aperiodic. Two small pieces of soft iron are mounted rigidly upon the shaft and in such relation to the electromagnets that the attraction upon them tends to hold the needle normally at zero. These form the restraining device and take the place of the usual springs. As each piece of iron is acted upon by one of the electromagnets, the restraining device is also astatic. The electromagnets are separately excited. As both the armature and the restraining device receive their magnetism from the same electromagnets, a variation in

the exciting current does not affect the accuracy of the instrument. The use of electromagnets governing both armature and restraining device avoids inaccuracies arising from changes in permanent magnets. It might seem that the use of an electromagnet unduly increases the power consumption of the instrument. This, however, is no material objection, since these instruments are made primarily for switchboard use.

Electrostatic Instruments. Instruments of this type have been perfected largely through the efforts of Lord Kelvin. They are independent of frequency, take but little power, are particularly suited to measurement of high pressures and are made to measure pressures which range between 50 and 50,000 volts. They are used on both alternating and direct current circuits, giving effective values of the alternating current waves. The principle embodied in their construction is that of attraction between two plates (or two sets of plates), one fixed and the other movable, which are charged by connection to the two legs of the circuit. The metallic circuit is not completed through the instrument, a feature which commends it for use as a ground detector, in that one set of plates or vanes may be left permanently grounded without causing a ground on the line. The range of the instrument is limited only by the striking distance of the medium or dielectric between the vanes. The amount of surface necessary to give the vanes depends upon the range of the measurements. The deflecting force is proportional to the product of the charges on the vanes. Due to this and to the fact that the movable vanes change position with respect to the fixed ones, the scale is unevenly divided, and the indications can not be relied upon until the amount of deviation from the theoretical law is determined by comparison with a standard instrument. These instruments are generally used as voltmeters and ground detectors.

Examples.—Kelvin Vertical Electrostatic Voltmeter; Kelvin Multicellular Electrostatic Voltmeter; Kelvin Electrostatic

Balance; Stanley Electrostatic Voltmeter; Electrostatic Ground Detectors.

Figure O shows a Kelvin Vertical Electrostatic Voltmeter. The insulated quadrants are supported with their plates vertical, and only one large vane is used. This movable vane is supported in a vertical position on knife edges, so that the plane of its motion is parallel to the two fixed plates which form the insulated quadrants. At the upper end is a pointer

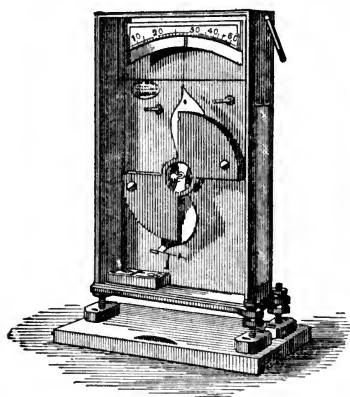

Fig. O. Kelvin Electrostatic Voltmeter
(vertical type).

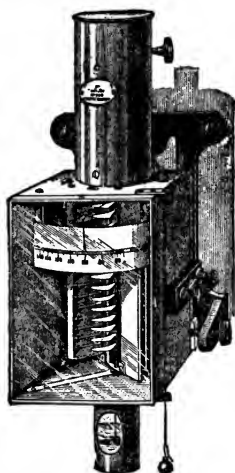

Fig. P. Kelvin Electrostatic Voltmeter
(engine room type).

moving over the scale and at the lower end is a knife edge for supporting weights used for different scales. The scale has a given graduation, usually 0 to 60, and a set of three weights is provided. The smallest set gives a reading of 50 volts, the second, 100 volts, and the third 200 volts per division of the scale. These instruments are adapted particularly to high pressures. Figure P shows a Kelvin multicellular Electrostatic Voltmeter (Engine Room Type). In this instrument there is a large number of quadrants and movable vanes, one above the other. This makes a stronger rotative tendency and

consequently these instruments may be used to measure low pressures. They are commonly graduated with a working range between 50 and 150 volts.

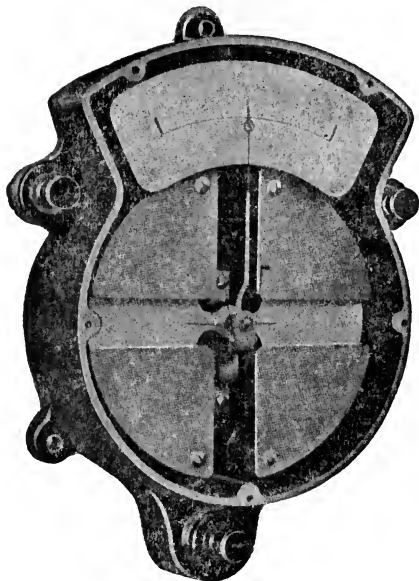

Fig. Q. General Electric Electrostatic Ground Detector.

Figure Q shows a General Electric Electrostatic Ground Detector. Four quadrants of sheet metal are rigidly fixed in position and form a cylindrical space for the accommodation of a vane to which is attached an indicating needle. The two lower quadrants are connected internally to the lower binding posts for ground, and the upper two respectively to the right- and left-hand binding posts for connections to the lines.

The vane with its needle is pivoted at the center of the circle formed by the four quadrants and is slightly counterweighted so as to stand normally at the zero or central position on the scale. The operation of the device depends on the tendency of the movable vane to place itself so as to give the greatest condenser capacity. When no ground exists on the line the

metal vane lies across the shortest path between the positive and negative quadrants (the upper right and left), and consequently in a horizontal position with the pointer at the center of the scale.

If either side of the system be grounded, the lower quadrants cease to be neutral. The system is then unbalanced and the metal vane, in taking a new position, deflects the needle to

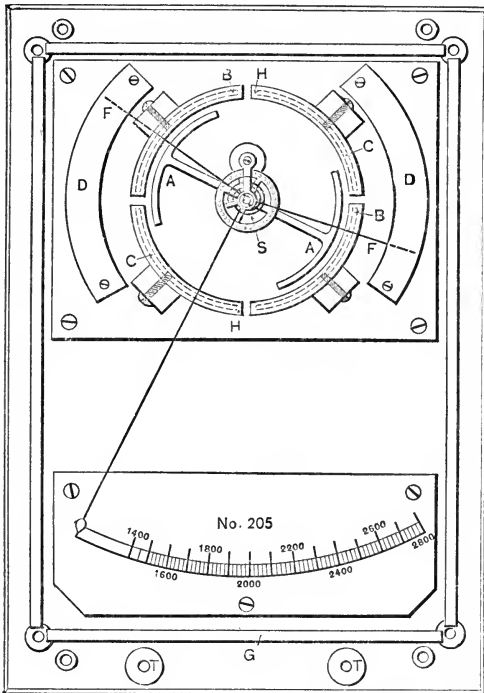

Fig. R. Stanley Electrostatic Voltmeter.

the right or left depending on which side is grounded. For example, suppose the line connected to the upper left hand quadrant is grounded. The upper left and the two lower quadrants then have a common potential which differs from that of the upper right quadrant. The result is that the movable vane rotates to the right, placing itself in the position of greatest

condenser capacity. If the ground is slight the deflection of the movable vane is small. The moving mechanism is insulated and has no electrical connection with either side of the line or with the ground.

Figure R shows a Stanley Electrostatic Voltmeter. *AA* is the movable vane, and *BB* and *CC* are the fixed vanes. The fixed vanes *BB* and the movable vane *AA* are connected together and to one pole of the circuit. The other fixed vanes *CC* are connected to the other pole. As like charges repel and unlike charges attract, the movable vane *AA* is repelled by *BB* and attracted by *CC*. The movable vane is supported on knife-edge jewels and its movement is controlled by the spring *S*. The moving parts are carefully balanced so that slight changes from the perpendicular do not affect the readings of the instrument. The fixed vanes *BB* and *CC* are embedded in hard rubber *H*. This covering of hard rubber confines the charge and prevents it from leaking to other parts of the instrument. Two fans *FF*, attached to the movable vane and enclosed in the damping boxes *DD*, make the instrument aperiodic. All the working parts are mounted on hard rubber, securing highest insulation. For convenience in calibration two plugs *TT* are placed on the instrument, by means of which a portable standard voltmeter can be introduced into the circuit and the readings compared.

Hot Wire Instruments. These depend for their indications upon the expansion of a wire, due to the heating effect of a current passing through it. They are connected to the circuit in the usual manner, and the current causing the heating is proportional to the current or pressure of the circuit, depending upon the resistance of the instrument and the manner of connecting it in the circuit. Figure S illustrates the general principle of a hot wire instrument.

The heat produced by a current equals I^2R , hence the linear expansion of the wire and the deflections should be nearly proportional to the square of the current, thus giving unequal

scale divisions. The expanding wire is kept taut by a spring, and motion is transmitted to a needle through a suitable multiplying device.



Fig. S. Simple Hot Wire Ammeter.

Such instruments are unaffected by stray magnetic fields, are aperiodic, and may be used in the neighborhood of running machinery, or on ship-board, as they are little affected by vibration. They may be used on either direct or alternating current circuits, being independent of frequency on the latter and giving the effective value of the wave. On the other hand, they take considerable power and are not readily made portable. The temperature of the room and the radiating capacity of the wire and enclosing case have an influence upon their indications. There is usually a means provided for readily setting the needle at zero.

Examples.—Cardew Voltmeter; Olivetti Ammeters and Voltmeters; Stanley Ammeters and Voltmeters.

The Cardew voltmeter, Figure T, was at one time largely used to measure alternating pressures. Its indications are dependent upon the expansion of a fine platinum-silver wire through which the current passes. This wire is from 8 to 12 feet long and is strung back and forth in the tube portion of the instrument. Its resistance is sufficiently high to give indications up to 150 volts and for higher

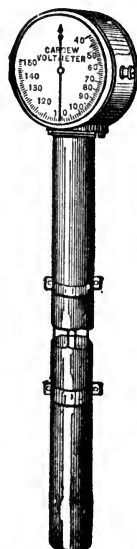

Fig. T. Cardew Voltmeter.

pressures additional or resistance tubes are used. The wire is held taut by a spring and any increase in length due to expansion causes a movement which is transmitted to the pointer through a suitable multiplying and translating mechanism. An adjusting screw is provided for setting the pointer for the zero reading.



Fig. U. Stanley Hot Wire Ammeter.

Figure U shows a Stanley hot wire ammeter. These instruments are provided with shunts, only a small proportion of the total current passing through the wire which in expanding deflects the pointer. Like the Cardew instrument the pointer is liable to be thrown out of adjustment and an adjusting screw is provided. When separate shunts are provided, care must be taken to use with each ammeter the shunt and leads numbered the same as the instrument, as each instrument is calibrated for its own shunt and leads. The leads should not be cut or their resistance changed in any way, as this will change the reading of the instrument. If the leads are too long the surplus should be wound back and forth and not coiled, as coiling introduces a self-inductive effect which may

change the indications of the instrument when measuring alternating currents.

USE OF INSTRUMENTS.

Good instruments are expensive and delicate, and their permanency depends almost entirely upon the care used in handling them.

After connecting up a circuit, go over the connections carefully to see that no chance exists for accident to the instruments or apparatus; for it is extremely easy, through carelessness or thoughtlessness, to be unfortunate enough to burn out an instrument when a little care would prevent it. Do not put an instrument in the circuit when uncertain whether or not its current carrying capacity will be exceeded. If you are uncertain, use an instrument which you know has sufficient range and then change for a lower reading one, later if desirable. Where the capacity of an ammeter or wattmeter may be momentarily exceeded, as in starting a motor, it is advisable to short circuit the current coil by means of a switch. It is often good policy to use short circuiting switches in connection with ammeters and the current coils of wattmeters so that the instruments may be readily taken out of the circuit, without breaking it.

Makers of ammeters and voltmeters have so designed them that their current carrying capacity will not be exceeded so long as the pointer is on the scale. In using wattmeters, care must be taken not to exceed the capacity of either the current or the pressure coils, conditions frequently arising when it is possible to exceed the safe limit with the pointer still on the scale or even at zero. This may be the case on an inductive or a capacity circuit, or when one of the coils is disconnected.

No conductor should be allowed to touch the case of the instrument. While ordinarily the winding is not supposed to be connected with the case in any way, a breakdown is likely to result if a conductor is permitted to come in contact with it.

It often happens that a pressure must be measured which is higher than the range of the instrument at hand. For measurement of potentials as high as 1000 or 2000 volts, either direct or alternating, a multiplier is used, which is nothing more than a high non-inductive resistance placed in series with the voltmeter. The readings of the instrument must be multiplied by a constant which equals the ratio of the *total* resistance divided by the voltmeter resistance. If a multiplier is to be used in connection with a wattmeter, care must be taken that the pressure coil of the wattmeter is connected directly to the line which is connected to the current coil, as in Figure

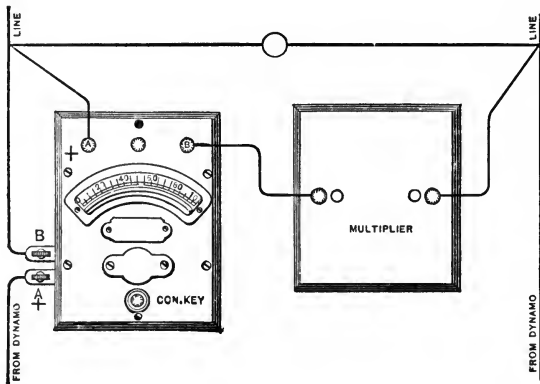

Fig. V. Wattmeter and Multiplier.

V. If the multiplier and wattmeter pressure coil are interchanged, practically the whole line pressure is placed between the current and pressure coil windings within the instrument, and a burn out is almost inevitable if the pressure is high. In high pressure alternating current circuits it is possible to keep the instrument entirely free from the high tension mains. Pressure transformers are used to reduce the pressure for voltmeters and the pressure coils of wattmeters. Current transformers are used, sometimes to reduce the current in the instrument, and sometimes to free it from the tension of the line. In switchboard work, current transformers are generally used

on circuits above 2200 volts. In testing, ammeter and watt-meter current coils are frequently placed directly in the high tension line. Figure W shows a high tension pressure transformer, and a current transformer is represented in Figure X.

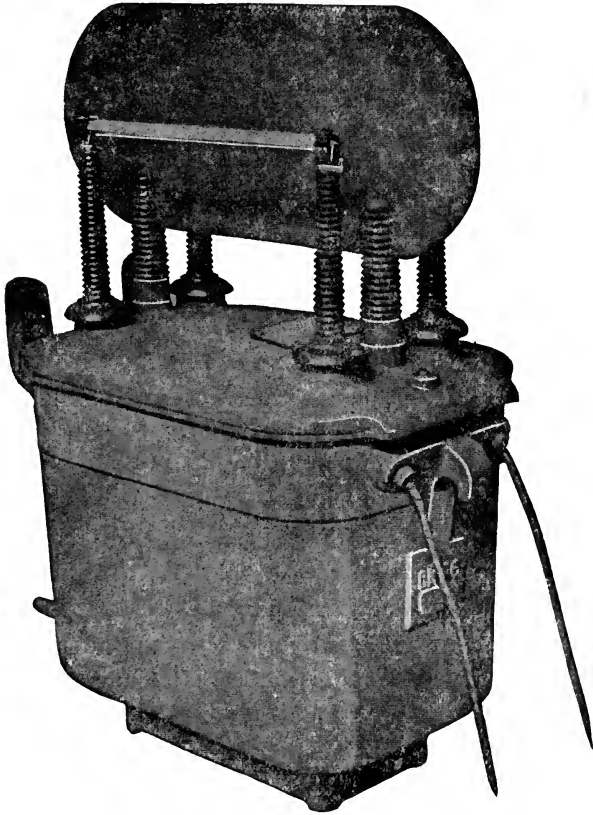

Fig. W. High Tension Pressure Transformer.

When transformers are used with voltmeters or ammeters no inaccuracies are introduced provided the transformers are not loaded to such an extent as to cause a drop in their regulation. Where any doubt exists the instrument should be calibrated with its transformer.

The primary and secondary pressures of a transformer are practically in opposition at light loads but they are not quite

so when there is an appreciable load. This introduces an additional error when wattmeters are used with transformers. Unless the latter are very lightly loaded, the wattmeter should be calibrated in connection with its transformers.

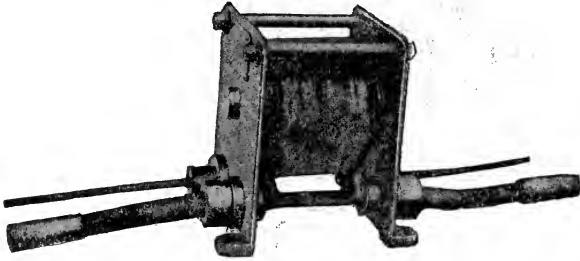

Fig. X. Current Transformer.

In connecting instruments to electrical circuits, care should be taken that they be so placed that the power taken by one does not materially affect the indications of the others. They should be placed at least six inches apart.

Where an ammeter and voltmeter are used for measuring power in a circuit taking a small current, do not connect the voltmeter on the load side of the ammeter. If so connected, the ammeter will indicate not only the load current but the voltmeter current in addition. The observer can easily tell if any error is introduced by this method of connection by noting any change in the ammeter reading when the voltmeter key is depressed. When the load takes a large current at a very low pressure, the voltmeter should be connected on the load side of the ammeter. If connected on the source side of the ammeter, the drop across the latter will be comparable with that across the load. The test for this error would be to connect the voltmeter both ways and to note any difference in its indications.

A wattmeter should be connected according to the diagram furnished by the maker. The instrument is calibrated for this particular connection and any other will give erroneous readings. When a pressure transformer is used in connection with

a wattmeter, its primary should generally be connected on the source side of the current coil.

Mention has been made of inaccuracies due to stray magnetic fields. The effect is to cause instruments to indicate either too high or too low, according as the stray fields tend to strengthen or weaken the normal field of the instrument. A simple test for the presence of stray fields is to turn the instrument through an angle of from 90° to 180° , and to note any change in its indications. If a stray field is detected the natural remedy is to remove the instrument from its influence. Where this is not feasible, as in the dynamo testing department of a factory, protection may be assured by placing the instrument within an iron-clad case. Where a case of this kind is not at hand, it may be easily improvised.

Stray electrostatic fields are generally present about high tension circuits. Electrostatic instruments, being generally furnished with metallic cases, are protected from external influences. Electromagnetic instruments are usually affected by strong electrostatic fields and when used on high tension circuits one remedy is to ground one terminal of the instrument on its case. As has been stated, this is a dangerous proceeding and should be resorted to only when it is known that the instrument windings are adequately insulated. Touching the case of any high tension instrument, while it is in circuit, is extremely dangerous. If it is necessary to tap the case to prevent the needle from sticking this should be done with a rod of insulating material. Above all, a lead pencil should be avoided.

The necessity for calibrating instruments cannot be too strongly emphasized. In all precise work they should be calibrated both before and after using. Portable instruments are usually guaranteed by the makers to be accurate within one-fifth of one percent. While there is no questioning the guarantee, it should be remembered that instruments are often used under conditions which affect their permanency. Even

for ordinary testing, requiring an accuracy of within only one or two percent, calibrations should be made at frequent intervals. A calibration is ordinarily plotted in a curve, using actual readings as abscissas, and corrected readings as ordinates. Where greater precision is required, it is better to plot the instrumental error as ordinates, and the actual readings as abscissas, care being taken to indicate the sign of the error.

NO. 1. MEASUREMENT OF RESISTANCES OF ARMATURES AND FIELDS BY FALL OF POTENTIAL METHOD.

References. Abbott, p. 230; Sheldon, p. 264; Fleming, p. 265; Carhart and Patterson, p. 95; Nichols, vol. 1, p. 194; Jackson's "Electricity and Magnetism," p. 179; Parham and Shedd, p. 145; Slingo and Brooker, p. 135.

Object. The object of this experiment is to measure the resistances of armatures and fields of various machines, to familiarize the student with the ordinary method of making these tests, and also to give an idea of the relative value of these resistances in several types of machines.

Method. The most convenient way to make the measurements is by the fall of potential method. This results directly from Ohm's Law.

$$I = \frac{E}{R} \quad \text{or} \quad R = \frac{E}{I}$$

where I is the current and E the potential difference at the terminals of the resistance R . If a known current is passed through the resistance, and the fall of pressure across it accurately measured, the value of R may be readily determined from the equation given above. As a check the current should be varied through a considerable range and the corresponding values of E taken. If the temperature of the resistance remains constant, the ratio $E \div I$ should be the same for all observations. To eliminate errors in reading the instruments, a number of observations should be taken and the average resistance used for the final result. If the resistances at normal operating temperature are desired the machine should first be heated up. In obtaining "cold" resistances, care should be taken not to

use currents great enough to raise the temperature of the windings.

The proper ranges of the ammeter and voltmeter depend entirely upon the value of the resistance to be measured. Thus

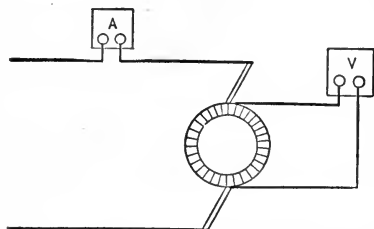

Fig. 1A. Connections for Measurement of Armature Resistance.

a low resistance, such as that of an armature, will require a high reading ammeter and a low reading voltmeter, while a shunt field will require a low reading ammeter and a high reading voltmeter. In using

this method of measurement, it will always require judgment

to select instruments whose ranges are suited for the currents or pressures used. It is advisable and almost always necessary to have an extra resistance such as a water rheostat or lamp-bank in the circuit in series with the resistance to be measured, by means of which the current may be adjusted to any desired value.

In measuring a low resistance, connect the voltmeter directly across the resistance measured, Figure 1A; in measuring a

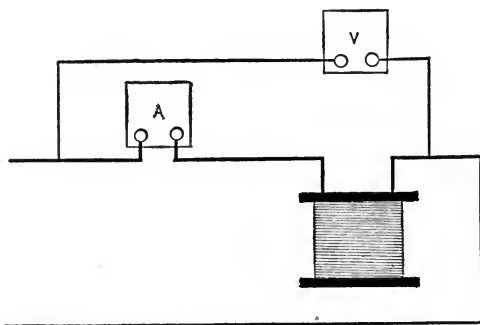

Fig. 1B. Connections for Measurement of Field Resistance.

high resistance connect the voltmeter so as to measure the drop of both the resistance and the ammeter, Figure 1B. By a low resistance is meant one where the voltmeter current is inappreciable in comparison with the measuring cur-

rent; by a high resistance is meant one where the drop in the ammeter is inappreciable in comparison with that across the resistance.

Where very accurate measurements are required allowance may be made for the voltmeter current or ammeter drop.

In the measurement of armature resistances, the connections should be made at the + and — terminals of the armature and measurements of pressure taken across commutator segments that lie under brushes of unlike polarity. Where more than two sets of brushes are used, the drop should be taken across commutator segments that lie under each pair of brushes of unlike polarity and the average of these pressures should be used in the final calculation.

Brush contact resistance may be found by placing one terminal of the voltmeter on a brush as close to the commutator as possible, without touching it, and the other on the commutator directly in line with the center line of brush contact. The brush contact resistance with the armature stationary is not the same in value as when the machine is operating. This operating contact resistance has been found to vary practically inversely with the current, thus making the drop nearly constant regardless of the load. The only accurate way of measuring this operating value is by first short-circuiting the commutator segments on one another, and then measuring the drop either from brush to brush, or from one brush to an auxiliary brush bearing upon the rotating commutator.

If a field circuit or in fact any circuit of high self-inductance be broken suddenly, a pressure will be set up in the same direction as the pressure applied to the circuit; and usually of a value many times that of the original pressure applied. This is due to the sudden withdrawal of the magnetism threading the coil. This pressure is likely to puncture the insulation of the coil, or of the voltmeter windings, and is also liable to bend the voltmeter needle by throwing it violently off the scale. To avoid troubles of this kind it is wise to first open the key

of the voltmeter and then to break the field gradually, thus "drawing out the arc" gently; for the rise in pressure depends on the quickness of the break. It also depends on the amount of magnetism and on the square of the number of turns in the coil. A safe way to open the circuit of a large coil of many turns is to decrease the current gradually by the insertion of resistance or by reducing the pressure of the source of supply. Another method sometimes used is to shunt the coil by a high resistance, placing the field switch outside of the shunt. There is thus a path afforded for the field discharge. A closed circuited turn of low resistance wound concentric with the coil is also effective in dissipating this stored up magnetic energy. A simple means of carrying this method out in practice is to wind the coil on a spool of copper.

Connections. See Figures 1A and 1B.

Data. Measure the resistances of the armature windings and field windings of several types of machines, as series, shunt, and compound. Take readings for each resistance at several currents and average the computed resistances of each winding.

Explain. Why it is desirable that the armature and brush contact resistances should be as low as possible.

Why a high pressure machine will have a higher armature resistance than one of the same output and speed, designed for a low pressure.

No. 2. MEASUREMENT OF INSULATION RESISTANCE OF A DYNAMO.

References. Abbott, p. 232; Parham and Shedd, p. 194; Sheldon, p. 263; Parshall and Hobart, p. 43; Parr, E. E. T., p. 120; Wiener, p. 85; Thompson's "Dynamos," p. 752; Carhart and Patterson, p. 86; Crocker and Wheeler, p. 95.

Object. The object is to measure the total insulation resistance of a machine as well as the insulation resistance of its several windings.

Theory and Method. All substances are to some degree electrical conductors. No matter how carefully the armature conductors are insulated from the armature core or the field winding from the field core, the resistance between the conductor and core can not in any case be infinite, but must have some finite value, although in well constructed machines this resistance may amount to several megohms.

It is always advisable to test insulation by using a pressure which is at least equal to the pressure which the insulation will have to withstand; and for break down tests it is general practice to use for this purpose a pressure of from two to ten times the normal pressure to which the insulation is subjected.

A convenient and practical method of testing the insulation resistance of low pressure dynamos is by use of a high resistance voltmeter and a moderately high pressure. The method depends upon the fact that a current flows between conductor and core, when these are at a difference of potential, and this current will be inversely proportional to the resistance of the insulation. If the amount of this current can be measured it is an easy matter to calculate the resistance of the insulation directly from Ohm's law.

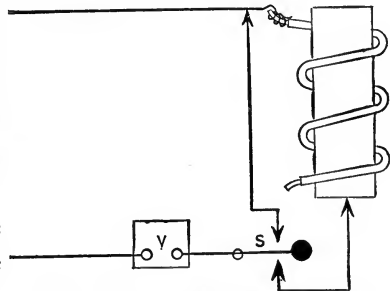

Fig. 2. Connections for Measurement of Insulation Resistance.

If a voltmeter be used as shown in Figure 2, so that it may either measure the total impressed pressure or be placed in series with the insulation, sufficient data may be taken from which to calculate the insulation resistance.

Let E = total pressure,

e = reading of voltmeter when in series with the insulation resistance,

R = insulation resistance,

and r = voltmeter resistance,

I = current when voltmeter and insulation resistance are in series.

Then

$$I = \frac{e}{r} = \frac{E}{R + r},$$

or

$$R = r \frac{E - e}{e}.$$

If a high pressure machine is not available, the insulation resistance of the dynamo may be measured in the same manner as described above by using the pressure of the machine itself.

The insulation resistance measured in this way is what might be called the working insulation resistance. It differs in value from that measured with an external pressure because all parts of the windings are not at the same difference of potential from the frame. For example in a multipolar machine with salient poles there is a gradient of potential difference, the coils next to the machine terminals being under greater stress than those midway of the series of coils. This method is not a convenient one for locating faults, but if used for this purpose the insulation resistance should be measured from each terminal of the machine.

One of the most important factors that determines insulation resistance, is the amount of moisture retained by the insulating material. It is the experience of every one familiar with the construction of dynamo machinery that a low insulation resistance may be greatly improved by baking the coils and thus driving out moisture. Insulation resistance is therefore of little value in determining the practical insulating properties of a given material, the break down test being the only reliable one. It may be used, however, as a guide, or as a means of locating a fault. For example, if in the test of the general insulation of a machine, a dead ground or a particularly low resistance is indicated, this fault may be localized by testing out the several windings separately.

Apparatus. It is desirable to use a pressure of 500 volts to obtain good results on a machine designed for 110 or for 220 volts. A Weston direct current voltmeter reading to 600 volts has a resistance of from 60,000 to 80,000 ohms and is very satisfactory for this work.

Show. A diagram of the connections you would make if you were to use the pressure generated by the machine itself in measuring the insulation resistance.

Explain. If there is even a slight ground on the line from which pressure is taken, why it is necessary to insulate the frame of the machine from the ground.

Why a high resistance voltmeter is necessary in this experiment.

Questions. A Weston voltmeter has a double scale; one 0-3 volts and the other 0-600 volts. The voltmeter resistances for the two scales are 300 and 60,000 ohms respectively. If the insulation resistance is 6 megohms, and the line pressure is 500 volts, which voltmeter connection would give the greater deflection of the pointer? Which would lead to the more accurate insulation resistance computation? If the insulation resistance were defective and equal to but 1000 ohms, what would be the result if the low scale were used?

Give. The maximum value of the insulation resistance which could be determined with the voltmeter used, and show your method of reasoning.

No. 3. STUDY OF THE WINDINGS AND CONNECTIONS OF DYNAMOS AND MOTORS.

References. Thompson's "Dynamos," p. 47; Jackson's "Dynamos," pp. 97 and 105; Sheldon, pp. 44 and 69; Parshall and Hobart, p. 60; Parham and Shedd, p. 30; Arnold's "Armature Winding," pp. 39 and 79; Fisher-Hinnen, pp. 20 and 80; Crocker, vol. 1, p. 306; Wiener, pp. 35 and 87; Slingo and Brooker, p. 324.

Object. A study of the windings and connections is to be made in order to become familiar with the different types of machines and to obtain data which may be found useful in some of the later experiments.

Data. As far as possible, give the following data for each machine examined: pressure, speed, capacity in K. W. or H. P., number of commutator bars, number of armature coils, number of turns per coil, number of layers of wire on armature (or the way the coils are built up in slots), approximate depth of air gap, type of armature winding and whether coil-wound or otherwise.

If multipolar, give number of poles, state whether consequent or salient.

Give position of field coils. If the machine is multipolar, state the number of paths in the armature winding.

Give kind and number of brushes; also area of contact per ampere, and amperes per unit area of contact.

Tell whether the machine is shunt, series or compound wound. If compound, whether cumulative or differential, long or short shunt.

Give any other points of interest you may notice.

In order to determine the number of turns per coil on the armature, it may be necessary to make a few resistance measurements. If the number of turns cannot be ascertained by inspection, the resistance of the armature should be determined from brush to brush. To obtain the number of layers on a smooth core armature, count the number of wires in the upper layer and calculate the resistance of a single layer by computing approximately the length of wire in a single layer. The number of layers is determined by dividing the resistance of all the wire on the armature, if placed in *series*, by the calculated resistance of a single layer. Remember that in any closed coil armature the resistance of all the armature wire in series is equal to the resistance of the armature multiplied by the square of the number of paths. Be careful to determine

whether a conductor is made up of a single wire or two or more in parallel. This may often be determined by observing the number of wires which terminate in the commutator segments. If a conductor is made up of two wires in parallel, this should be taken into account.

Find the size of wire and determine the number of circular mils per ampere.

The size of wire, number of layers and number of turns per layer should be determined by similar methods for each field winding.

These resistance measurements if used with good judgment, together with the clues which careful observation will disclose, will generally enable one to determine all the winding data desired.

No. 4. ADJUSTMENT OF BRUSHES OF DYNAMOS AND MOTORS.

References. Parshall and Hobart, p. 145; Sheldon, p. 77; Thompson, pp. 80 and 770; Jackson's "Dynamos," p. 158; Fisher-Hinnen, p. 38; Arnold's "Dynamos," p. 274; Arnold's "Armature Winding," p. 193; Kapp's "Dynamos," p. 261; Hawkins and Wallis, p. 359; Houston and Kennelly, p. 179; Slingo and Brooker, p. 316; Wiener, p. 30; Crocker, vol. 1, p. 316.

Object. The object of this experiment is to set the brushes in the correct position and to carefully shape them to fit the commutator, so that sparkless commutation may be obtained. This should be done for a machine using carbon brushes, and also for one using copper brushes.

Theory and Method. If one set of the armature conductors is connected in radial planes to the commutator segments, the brushes (assuming no armature reactions) will rest upon commutator segments which are half way between the pole

pieces. It is advisable, where possible, to have all brushes in plain sight so that any fault in commutation will attract immediate attention. Many windings adapt themselves best to this mode of winding or connection. If the windings and connectors are in sight, the position of the brushes to give the maximum pressure can at once be determined. Armature reactions tend to cause a forward displacement of the brushes in a generator and a backward displacement in a motor. Eddy currents shift the magnetic field slightly in the direction of rotation in both generator and motor, but this effect is of academic interest only. The result is that the forward displacement in the case of a generator is theoretically greater than the backward displacement in the case of a motor. In bipolar machines the brushes should be set diametrically opposite on the commutator, and in multipolar machines they should be placed a distance apart equal to the pitch of the poles. The number of commutator bars should be counted and the brushes set accordingly; or in some cases the adjustment may be made by mechanical measurement. In all cases the brushes should be carefully filed or ground to fit the commutator. Carbon brushes are most conveniently ground while in the brush holders, by moving a piece of sand-paper back and forth between commutator and brushes, thus grinding them to the exact shape desired.

A shop method for fitting brushes in large machines is to cover the commutator with sand-paper, the sand-paper being pasted on with shellac and its surface made continuous by means of a scarf joint. The brushes are set in position and the machine rotated slowly, usually by means of a motor.

In all cases it should be seen that the brush holders work easily, and that the tension of the springs is so adjusted that the brushes bear with the proper pressure upon the commutator. In adjusting, the effect of gravity upon the tension of the different brushes should be considered. After carefully adjusting the brushes, the machine should be started and the brushes

shifted to the position of least sparking. As the effect of armature reaction increases with the load, it may be found necessary to alter the position of the brushes as the load changes. This is an undesirable characteristic and is not often found in modern machines. In either a dynamo or a motor the brushes should be set at the maximum displacement the machine will stand without sparking at no load. This insures a wider range of load with sparkless commutation but is not applicable to a reversible machine. The brush pressure is generally from one to three pounds per brush, depending upon the size of brush and the general conditions. It may be approximately determined by means of a spring balance provided with a hook which catches under the brush or with some means of clamping to the brush, but a little experience in "feeling" pressure by raising the brushes with the hand will give far more satisfactory results.

Data. Obtain data concerning output in K. W. and H. P., terminal pressure, full load current, speed, general dimensions of commutator, and brush area. Measure the brush pressure.

NO. 5. DETERMINATION OF THE CONSTANT OF A BALLISTIC GALVANOMETER BY THE CONDENSER METHOD.

References. Parr, P. E. T., p. 139; Fisher-Hinnen, p. 183; Jackson's "Dynamos," p. 46; Henderson, p. 227; Carhart and Patterson, p. 88; Abbott, p. 205; Armagnat, p. 531; Sheldon, p. 254; Fleming, p. 173; Nichols, vol. 1, p. 221; Nichols, vol. 2, p. 197; Nipher, p. 335; DuBois, p. 301; Kempe, p. 68; Stewart and Gee, vol. 2, p. 360; Thompson's "Lessons," p. 424; Thomson, p. 369.

Object. A ballistic galvanometer is used in several of the following experiments and a careful determination of its constant is necessary.

Theory and Method. When magnetic measurements are made the galvanometer cannot be used in the ordinary way, since there are no steady currents set up. Transient currents, however, can be set up, and the resulting quantities of electricity are proportional to the changes in magnetism. We thus have to deal with impulses and consequently must note the throw or first swing of the galvanometer, which will be proportional to the impulse. Galvanometers are best suited for this purpose if the movable part is made quite heavy in comparison with that of an ordinary galvanometer, and such are called ballistic galvanometers. Another requisite is that the

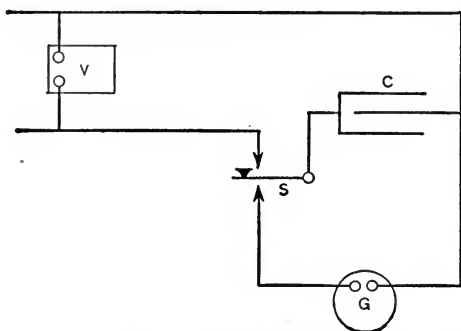

Fig. 5. Connections for Ballistic Galvanometer Constant by Condenser Method.

damping effect be minimized. The moving system should be so heavy that the needle will not have moved through any considerable angle before it has received the total impulse due to the transient current.

The unit of capacity is the *farad*, and is defined as that capacity which, if charged to a potential of one volt, contains one coulomb of electricity. Thus Q equals CE , where Q , C , and E represent, respectively, the quantity, capacity, and pressure of the charged condenser. If the pressure and capacity are known, Q may be obtained. If the condenser is discharged through a ballistic galvanometer and the deflection noted, the constant of the galvanometer may be obtained by dividing

the quantity Q by the deflection θ . If the capacity of the condenser is given in *microfarads*, Q equals CE divided by 1,000,000.

Apparatus. A condenser of known capacity; a ballistic galvanometer; a voltmeter of suitable range to measure the pressure of the charging circuit; and a discharge key.

Connections. See Figure 5.

Data. The data to be taken consist of a series of observations of the deflection, θ , corresponding to various values of Q . For each value of Q a number of observations should be taken of θ , and the average of these used in obtaining the value of the constant of the galvanometer. The value of Q should be varied so as to give data for the entire range of the galvanometer.

Curve. Plot a curve, taking as abscissas the deflections of the instrument, and as ordinates the values of the constant corresponding to the various deflections. If the constant is the same for all deflections, the points of the curve will lie in a straight line parallel to the X axis, and the galvanometer is suitable for ballistic work.

Q may be varied either by means of a condenser of variable capacity, or by using a condenser of fixed capacity and varying the pressure of the charging circuit.

Explain. Why the constant may not be the same for all deflections of the galvanometer.

No. 6. DETERMINATION OF THE CONSTANT OF A BALLISTIC GALVANOMETER BY A STANDARD SOLENOID.

References. Ewing, p. 62; Parshall and Hobart, p. 3; Parr, P. E. T., p. 138; Sheldon, p. 255; Jackson's "Dynamos," p. 47; Henderson, p. 223; Carhart and Patterson, p. 88; Nichols, vol. 2, p. 199; Fleming, p. 173; DuBois, p. 301; Nipher, p. 335;

Stewart and Gee, vol. 2, p. 360; Kempe, p. 68; Thompson's "Lessons," p. 334; Thomson, p. 369.

Object. As in Experiment 5, the object is to calibrate a ballistic galvanometer, and, as a check on the accuracy of the methods, the same instrument may be calibrated in both experiments.

Theory and Method. A known current is passed through a solenoid of known constants. By means of a switch the circuit may be made and broken, or the current reversed at will. If the solenoid has a length of not less than six times its diameter, the field within the solenoid, at the middle, may be taken as equal to

$$\mathcal{H} = \frac{4\pi N_1 I}{10l},$$

where N_1 is the number of turns, I the current in amperes, and l the length of the coil in centimeters. If a test coil of known cross-sectional area be inserted in this field, the total number of lines threading the coil will be $\phi = \mathcal{H}A$ where A is the area of the test coil, in square centimeters. Suppose that the

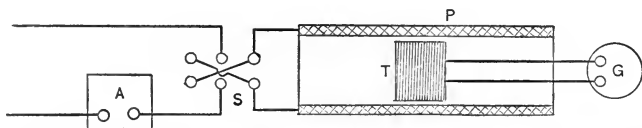

Fig. 6. Connections for Ballistic Galvanometer Constant by Standard Solenoid.

ballistic galvanometer be inserted in the test coil circuit, as shown in Figure 6. If there is a change in the primary current, there will be a change in the number of lines of force which thread the test coil, and a quantity of electricity will flow through the test coil circuit, which will be directly proportional to the change in the number of lines of force threading the test coil, and inversely proportional to the resistance of the secondary or test coil circuit. If the primary current be reversed, the average pressure induced in the test coil will be

$$e = \frac{2\phi N_2}{10^8 t}$$

where ϕ is the total magnetic flux through the test coil, N_2 is the number of turns in the test coil, t the total time taken in reversing the magnetism ϕ and e the average pressure in the test coil during the time t . The quantity of electricity which flows in the test coil circuit when the primary current is reversed is

$$Q = et \div R = \frac{2\phi N_2}{10^8 R}$$

coulombs, where R is the total resistance of the test coil circuit, including the galvanometer. Since

$$Q = K\theta, K = Q \div \theta = 2\phi N_2 \div 10^8 R\theta = \frac{8\pi N_1 N_2 I A}{10^9 l R \theta}.$$

If instead of the current in the primary being reversed, the circuit is merely closed and opened, the sum of the two deflections should be used if the above formula is to be applied, or the mean of the deflections at make and break may be taken, provided 4 is used instead of 8 in the formula.

Apparatus. The apparatus necessary consists of a standard solenoid of known dimensions, uniformly wound, and of a known number of turns; an ammeter; a reversing switch; a ballistic galvanometer of known resistance; and a test coil of known constants as regards number of turns, sectional area and resistance.

Connections. See Figure 6.

Data. The galvanometer should be calibrated throughout its entire range as in Experiment 5. This may be done by taking observations for various current values in the standard solenoid. Several observations should be taken for each value of current and their mean used. The resistance of the test coil may be obtained by the fall of potential method, or by means

of the Wheatstone bridge. The fall of potential method is fully explained in Experiment 1. The galvanometer resistance is usually given with the instrument.

Curves. A calibration curve should be drawn for which the values of the constant may be taken as ordinates, and the corresponding values of the angle of deflection or scale reading as abscissas. If the curve is parallel to the axis of abscissas it shows that the instrument is suitable for ballistic work.

Suggestions. If the fall of potential method be used in obtaining the resistance of the test coil, care should be taken that the current sent through it is not sufficiently strong to heat it appreciably, since this would cause the coil to have a greater resistance than it had in the test.

State. The advantages and disadvantages of this method, in comparison with that of Experiment 5.

Explain. Why the magnetic circuit of the standard solenoid must be free from iron. What errors would arise in using a shorter solenoid?

No. 7. MAGNETIZATION AND PERMEABILITY TESTS OF IRON BY THE ROWLAND METHOD.

References. Kirchhoff, "Gesammelte Abhandlungen," p. 223; Rowland, *Phil. Mag.*, 1878, vol. 46, p. 140; Ewing, pp. 64 and 356; Thompson's Lectures, p. 59; Parr, P. E. T., p. 154; Jackson's "Dynamos," p. 40; Sheldon, p. 251; Nichols, vol. 1, p. 201; Carhart and Patterson, p. 308; DuBois, p. 105; Henderson, p. 283; Parshall and Hobart, p. 3; Slingo and Brooker, p. 248.

Object. In order to design a dynamo with any degree of accuracy it is necessary to know the magnetization curves of the iron used in its construction.

The inductive method of testing the magnetic properties of iron is one of the standard methods used in practical engineer-

ing work. The Ring Inductive method, due originally to Kirchhoff, is the oldest of these methods, and is the one considered in this experiment. This inductive method is more often called the Rowland method, as Professor Rowland was the first to apply it in a series of tests.

Theory and Method. There are several ways of conducting inductive tests but they all depend primarily upon the setting up of a transient current in a test coil. The quantity of electricity is proportional to the total change in magnetic induction. By measuring the quantity of electricity and knowing the relation it bears to the change in magnetism, the latter may be obtained and the magnetic induction determined. The general arrangement of apparatus is shown in Figure 7.

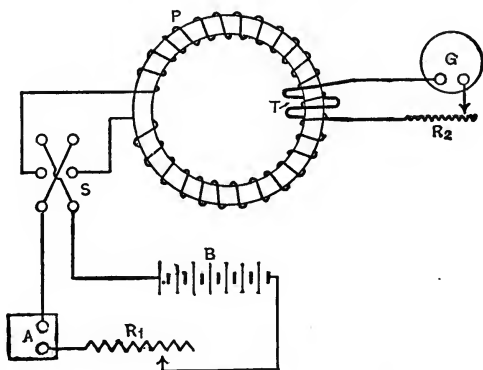

Fig. 7. Connections for Rowland Method of Testing Iron.

A sample of the iron to be tested is made in the form of a ring and wound uniformly with a magnetizing coil P which is connected through a reversing switch S , an ammeter A , and a variable resistance R_1 , to a pressure source B . A test coil T is also wound on the ring and connected, through a variable resistance R_2 , to the ballistic galvanometer G . It will be assumed that this galvanometer has been calibrated by one of the methods given in Experiments 5 and 6.

The value of the magnetizing force \mathcal{H} is obtained directly from the formula

$$\mathcal{H} = \frac{4\pi N_1 I}{10l},$$

where $N_1 I$ represents the ampere turns of the magnetizing coil P and l is the mean length of the magnetic circuit.

The value of \mathcal{H} is greater than the average for the inner portion of the ring and less for the outer portion, due to the difference in length for the same total number of ampere turns. The result is that the magnetic induction is greater than the average in the inner portion and less in the outer portion of the ring. The difference in density is not in proportion to the difference in the value of \mathcal{H} (except for straight line magnetization curves) but is inversely proportional to the magnetic reluctance of the path in each case. The test ring should therefore have a small radial depth in comparison with its mean diameter, so that there will be but a small difference in the length of the path for various parts of the ring.

The value of the magnetic density \mathcal{B} , for a given value of \mathcal{H} , is obtained by suddenly reversing the circuit in the magnetizing coil P and noting the deflection of the galvanometer G .

The quantity of electricity in the test coil circuit, as shown in Experiment 6, is

$$Q = \frac{2\phi N_2}{10^8 R},$$

where ϕ is the total magnetic flux at the moment the reversal is made, N_2 is the number of turns on the test coil, and R is the total resistance in the test coil circuit.

From the galvanometer calibration,

$$Q = K\theta,$$

where K is the constant and θ the deflection of the galvanometer. Substituting and solving for the flux,

$$\phi = \frac{10^8 R K \theta}{2 N_2}.$$

The magnetic induction is then obtained by dividing the total flux by the area of the cross section of the ring. The formula becomes

$$\mathcal{B} = \frac{10^8 RK\theta}{2AN_2}.$$

If the *make-and-break* method is used, the formula becomes

$$\mathcal{B} = \frac{10^8 RK\theta}{AN_2}$$

The permeability is then readily obtained for any value of \mathcal{B} from the relation

$$\mu = \frac{\mathcal{B}}{\mathcal{H}}.$$

Apparatus. There should be provided a sample of the iron to be tested, made up in the form of a ring of convenient dimensions, and wound with exciting and test coils; a calibrated ballistic galvanometer, a source of exciting pressure, an ammeter, a reversing switch, and two or more variable resistances.

Connections. See Figure 7.

Data. If the galvanometer is not already calibrated this should be done by one of the methods shown in Experiments 5 and 6. See that the resistance in the galvanometer circuit is sufficient to keep the deflection on the scale when the maximum current reversal takes place. Take a series of ten or more sets of observations of galvanometer deflections for various exciting currents ranging from a low value to the maximum desired excitation, using the method of reversals. Take two observations for each value of exciting current, making the direction of the reversal opposite in the two cases, and use the average. Take a sufficient number of dimensions of the ring to determine the length of the magnetic circuit and the cross section. Measure the resistance of the secondary circuit.

Calculate. The cross section of the ring and the length of the magnetic circuit. Calculate the values of \mathcal{B} , \mathcal{H} and μ for each of the various circuits used.

Curves. Plot a magnetization curve, taking values of \mathcal{B} as ordinates and values of \mathcal{H} as abscissas. Also plot a permeability curve, using values of \mathcal{B} as ordinates and values of μ as abscissas.

Suggestions. Some form of damping device is desirable to bring the galvanometer needle to rest quickly after a reversal has been made and the reading taken.

Besides the method of *reversals*, the *step by step* and the *make and break* methods have been used. The first of these is considered in Experiment II.

The *make-and-break* method differs from the method of *reversals* in that the circuit is *made* and *broken* instead of *reversed*. The mean of the throws for *make* and *break* is recorded. The principal objection to this method is that residual magnetism is not eliminated.

Questions. How would you correct for an error due to the test coil having a larger mean area than the cross-sectional area of the iron ring?

Why is it not advisable to shunt a ballistic galvanometer used in measuring transient currents?

What form of damping device have you found convenient to use with a ballistic galvanometer?

Dynamo designers, when using the English system of units, find it convenient to plot their \mathcal{B} - \mathcal{H} curves in lines of force per square inch and ampere-turns per inch of magnetic circuit. What constants would you use to make this transformation in scale?

No. 8. MAGNETIZATION AND PERMEABILITY TESTS OF IRON BY THE HOPKINSON METHOD.

References. *Phil. Trans.*, 1885, vol. 176, p. 455; Jackson's "Dynamos," p. 41; Sheldon, p. 252; Fisher-Hinnen, p. 183; Gerard, p. 369; DuBois, p. 335; Parr, P. E. T., p. 158; Thompson's "Lectures," p. 64; Armagnat, p. 539; Carhart and Patterson, p. 314; Henderson, p. 290; Nipher, p. 342; Parshall and Hobart, p. 5.

Object. Some of the objections to the Rowland Method, Experiment 7, are that the test specimen is hard to make and wind, and that the winding process must be repeated for each piece tested. These difficulties have been overcome in the Hopkinson Bar and Yoke Apparatus.

Theory and Method. Although, from a physicist's standpoint the Rowland Method, considered in Experiment 7, is a very good one, it has two decided defects when viewed from an engineering standpoint. The most serious objection to the method is that there is no certainty that the magnetic qualities of a ring are the same as those of the iron from which the sample has been taken. In fact it is generally probable that the magnetic properties of such a sample have been changed in the casting or forging of the iron into this ring-shaped piece.

The second objection is that it becomes necessary to wind each sample with both a primary and a secondary coil. This necessitates a considerable amount of material, time and labor, and is quite out of the question in the commercial application. Samples of iron for commercial testing can best be made up in the form of short rods and bars. If these were wound with exciting and testing coils directly, considerable difficulty would be experienced with the self-demagnetizing action caused by the free end surfaces. Such effect is entirely eliminated in the case of the ring-shaped specimen as there are no free ends.

Dr. John Hopkinson was the first to devise a method of using the straight short test pieces and still to practically eliminate all self-demagnetizing action of the ends. This he accomplished by providing a heavy soft iron yoke for the return path of the magnetic circuit, thus practically reducing to zero the magnetic reluctance between the extreme ends of the

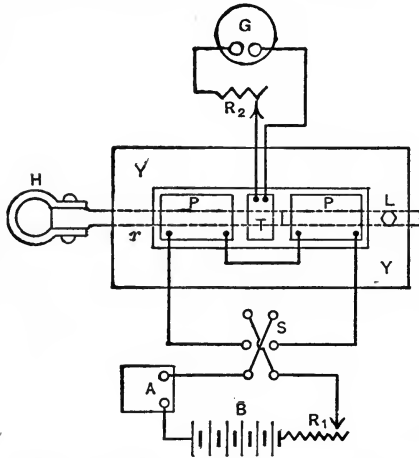

Fig. 8A. Connections for Hopkinson Method of Testing Iron.

test pieces. The bar and yoke, and the general arrangement of apparatus for making magnetic tests, are shown in Figure 8A. The heavy yoke YY is made of soft iron of high permeability. The test piece r runs entirely through the yoke. In the original Hopkinson apparatus the test piece was divided near the center, one part being held in position by the set screw L and the other part being provided with a handle H . The two exciting coils PP are supplied from a pressure source B through a variable resistance R_1 and an ammeter A . The test coil T is connected to the ballistic galvanometer G through a variable resistance R_2 .

The apparatus may be used in several ways. In his first experiments, Hopkinson arranged the apparatus so that one of the two test pieces could be suddenly pulled out, by means of a handle H , to the point where the test coil T would be released and then suddenly forced out of the field by means of a spring. The transient current set up in the test coil is a measure of the flux which had existed within the test specimen before the change was made. In this case residual magnetism effects are entirely eliminated from the reading,

although the test specimen may possess a considerable residual effect. The general formula is exactly the same as that developed in Experiment 7 except that the constant 2 is eliminated because there is no reversal of magnetism. It may be expressed as follows:

$$\mathcal{B} = \frac{10^8 RK\theta}{AN_2},$$

where \mathcal{B} = magnetic induction per sq. cm.,

R = total resistance in test coil circuit,

K = galvanometer constant,

A = cross-sectional area of the test specimen, in sq. cms.,

and N_2 = number of turns on the test coil.

The division of the test piece is obviously a bad feature, especially as it comes right at the point where the test coil is placed.

By using the method of reversals, as in Experiment 7, a solid test piece may be employed which runs entirely through the yoke. In this case the formula

$$\mathcal{B} = \frac{10^8 RK\theta}{2AN_2},$$

developed in Experiment 7, should be employed.

As in Experiment 7, the *step-by-step* method or the *make and break* method, may also be used; in which case the formula becomes

$$\mathcal{B} = \frac{10^8 RK\theta}{AN_2}.$$

The value of \mathcal{H} , as in Experiment 7, is obtained directly from the formula

$$\mathcal{H} = \frac{4\pi N_1 I}{10l}.$$

where $N_1 I$ represents the ampere turns of the magnetizing coils PP and l is the length of the test specimen between the inner edges of the yoke.

This formula is correct only upon the supposition that the magnetic reluctance is negligible in the remainder of the magnetic circuit. This is nearly correct when the test specimen is inferior in its magnetic qualities and the section of the yoke is large in proportion.

If the magnetic properties of the yoke are known, its total magnetic reluctance may be determined for a given magnetic induction, \mathcal{B} , in the test specimen.

The total magneto-motive force exerted is

$$M.M.F. = \frac{4\pi N_1 I}{10}.$$

This is used in forcing the magnetism through the test specimen, between the inner edges of the yoke; and in the yoke itself. The general relation is

$$M.M.F. = \Sigma \mathcal{H}l = \mathcal{H}_1 l_1 + \mathcal{H}_2 l_2,$$

where \mathcal{H}_1 = The magnetizing force per cm. of length in the test piece,

\mathcal{H}_2 = magnetizing force per cm. of length in the yoke,

l_1 = length of the path in the test piece,

and l_2 = length of the path in the yoke,

If the magnetic properties of the yoke and the general dimensions of the apparatus are known, all values except \mathcal{H}_1 are given, and \mathcal{H}_1 may be obtained from the expression

$$\mathcal{H}_1 = \frac{\frac{4\pi N_1 I}{10} - \mathcal{H}_2 l_2}{l_1},$$

or

$$\mathcal{H}_1 = \frac{4\pi N_1 I}{10 l_1} - \frac{\mathcal{H}_2 l_2}{l_1}.$$

In any event, there is a slight error in assuming that the magnetism leaves the bar and enters the yoke at a certain point.

Having obtained the value of \mathcal{B} by any of the methods considered above, the permeability may be readily obtained, for any value of \mathcal{B} , from the relation: $\mu = \mathcal{B} / \mathcal{H}$.

A modification of the original apparatus of Hopkinson, shown in Figure 8B, has been used to a considerable extent in practice, especially abroad.

It really amounts to a combination of the Rowland ring and the Hopkinson yoke methods. The test sample is made up in the form indicated, constituting both bar and yoke of the Hopkinson apparatus.

The advantage over the ring method is that the exciting and test coils may be used for any number of samples. The advantage over the Hopkinson method is that there is no error introduced, due to the yoke, which is in this case a part of the test piece. It is necessary to know the mean length of the magnetic path and the area of cross section of the path at all points.

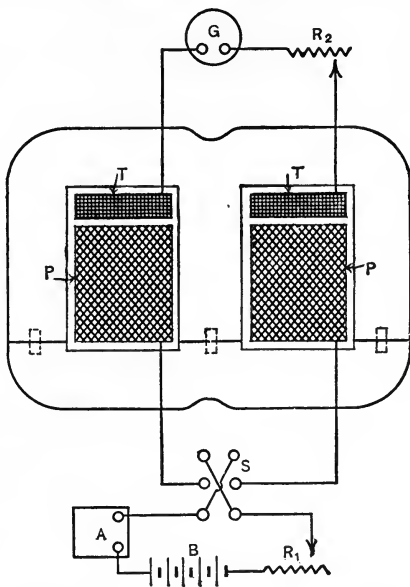

Fig. 8B. Hopkinson Apparatus (modified form).

Apparatus. There should be provided a sample of the iron to be tested, made up in the form of one or two rods of the proper length and diameter. If the divided rod method is used, great care should be taken to insure good contact of the end surfaces which come together. The rods should fit snugly into the yoke. The yoke should be a heavy forging of soft Swedish iron. A convenient size of test specimen is a rod one half an inch in diameter and about 18 inches long. In this case the yoke should be made up of iron about $2\frac{1}{2}$ inches by $3\frac{1}{2}$ inches, and with as short a magnetic path as is practicable.

In addition to the test pieces and yoke, there are also necessary a calibrated galvanometer, a source of exciting pressure,

an ammeter, a reversing switch, and two or more variable resistances.

Connections. See Figures 8A and 8B.

Data. If the galvanometer is not already calibrated, this should be done by one of the methods shown in Experiments 5 and 6. See that the resistance in the galvanometer circuit is sufficient to keep the deflection on the scale when the maximum flux is being measured.

Take a series of 10 or more sets of observations of galvanometer deflections, for exciting currents ranging from a low value to the maximum desired excitation, using the method of suddenly removing the coil from the field. Take two observations for each value of exciting current, and use their average.

Calculate. The values of \mathcal{B} , \mathcal{H} , and μ for each of the various currents used.

Curves. Plot a magnetization curve, taking values of \mathcal{B} as ordinates and values of \mathcal{H} as abscissas. Also plot a permeability curve, using values of \mathcal{B} as ordinates and values of μ as abscissas.

Suggestion. As in Experiment 7, some form of damping device is desirable to bring the galvanometer to rest quickly after an observation has been taken.

Question. How would you correct for the test coil having a larger mean area than the cross-section of the iron test piece?

Explain. How an error is introduced in having two parts to the test piece which join near the test coil.

No. 9. MAGNETIZATION AND PERMEABILITY TESTS OF IRON BY TRACTIVE METHODS.

References. Maxwell, vol. 2, article 642; Ewing, pp. 260 and 374; Fisher-Hinnen, p. 184; Jackson's "Dynamost," p. 46; Thompson's "Lectures," p. 68; Sheldon, p. 253; DuBois, p.

345; Parr, E. E. T., p. 217; Armagnat, p. 549; Carhart and Patterson, p. 303; Henderson, p. 293.

Object. Tractive methods of obtaining the magnetic properties of iron are unaffected by stray fields and are suitable for factory tests on this account. They also have the advantage that the readings of magnetic induction may be quickly taken and that the test pieces may be made in convenient shapes and sizes.

Theory and Method. Tractive methods of measuring magnetic induction depend upon Maxwell's law, which may be expressed as follows:

$$F = \int \frac{\mathcal{B}^2 dA}{8\pi},$$

where F = force in dynes,

\mathcal{B} = magnetic induction per sq. cm.,

and dA = increment of cross-sectional area in square cms.

When the density is uniform,

$$F = \frac{\mathcal{B}^2 A}{8\pi},$$

A being the cross section. This is the law showing the tension along the magnetic lines of force. This tension manifests itself wherever joints occur in the iron, and has a tendency to make such joints tight and thus decrease their magnetic reluctance. In the case of an air gap it represents the tension tending to shorten the length of the magnetic path by bringing the iron portions nearer together.

When a permanent magnet is used, the pull may be expressed by the simple formula given above, where \mathcal{B} represents the total number of lines per square centimeter of cross-sectional area at the point of contact. This is also true in the case of an electromagnet where the exciting current has been reduced to zero and the attraction is due to residual magnetism only.

In the case of an electromagnet where the exciting current is constant and the exciting coils are not divided so as to move relatively to each other, the magnetic induction which is effective in the tractive effort is

$$\mathcal{B} - \mathcal{H},$$

where \mathcal{H} represents the magnetizing force per centimeter of length or the magnetic density which would result if the iron were not present. In the ordinary form of the tractive electro-magnet, therefore, the pull is more accurately expressed by the formula

$$F = \frac{(\mathcal{B} - \mathcal{H})^2 A}{8\pi}.$$

Under ordinary conditions of design and operation, \mathcal{H} is very small in comparison with \mathcal{B} and the original formula for tractive effort may be employed without appreciable error. In using the tractive method for the determination of the magnetic induction throughout a wide range of values both of magnetic induction and magnetizing force, however, it is often desirable to make use of the more exact formula.

Several devices, based upon the tractive effort, have been proposed and used to a greater or less extent.

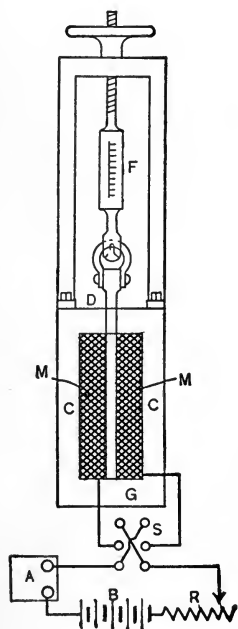

Fig. 9A. Thompson Permeameter.

Thompson Permeameter. Probably the simplest of the various tractive devices used to measure the magnetic properties of iron is that which its inventor (S. P. Thompson) has styled the "Permeameter." This apparatus and its auxiliaries, arranged for a test, are shown diagrammatically in Figure 9A.

It is similar to the Hopkinson apparatus described in Experiment 8, in that a small rod D is used as a test piece and a heavy soft iron yoke CC is used to complete the magnetic circuit and eliminate end effects. The exciting coil MM is connected to a pressure source B through an ammeter A , a variable resistance R and a reversing switch S . One end of the test specimen is carefully surfaced off and makes contact with the yoke at G , at which point the yoke is also carefully surfaced so as to make a good magnetic contact between the yoke and the test specimen. The other end of the test specimen passes up through the yoke and is attached to the spring balance F . The apparatus is generally arranged so that the pull may be exerted gradually either by means of a lever arm or by some form of hand wheel.

The general method of procedure is to adjust the exciting current to the desired value and then to find the force necessary to overcome the magnetic attraction at G . If the force is measured in grams and the area of contact in square centimeters, the value of \mathcal{B} becomes

$$\mathcal{B} = 157 \sqrt{\frac{F}{A}} + \mathcal{H}.$$

If the force is measured in pounds and the area in square inches, the value of \mathcal{B} (still per sq. cm.) becomes

$$\mathcal{B} = 1317 \sqrt{\frac{F}{A}} + \mathcal{H}.$$

The general similarity of the Thompson permeameter and the Hopkinson apparatus described in Experiment 8 has already been pointed out. The two forms of apparatus are often combined. The Thompson permeameter may be readily converted into the Hopkinson apparatus by slightly altering the coil MM to make room for a small test coil which embraces the test specimen just above the contact G . The Hopkinson apparatus may be used as a permeameter by the simple addi-

tion of the apparatus for measuring the pull. Either apparatus may be used in both ways at the same time.

The magnetizing force in the permeameter is expressed by the formula

$$\mathcal{H} = \frac{4\pi N_1 I}{10l},$$

where N_1 = the number of turns on the exciting coil,

I = current in the exciting coil,

and l = the length of the specimen between the inner surfaces of the yoke.

The same sources of error relative to the value of l , enter here that were considered in the case of the Hopkinson yoke method of testing iron, Experiment 8.

There are several sources of error in obtaining \mathcal{B} by the permeameter. However carefully the contact surfaces be polished, experiment has shown that the conditions of the ideal slit are not obtained but that irregularities occur. Again, on account of the polished surfaces, the natural adhesion may be considerable, so that the lifting power may be too great, especially with weak magnetization. Also the loosening of contact occurs gradually and first gives way in one place, so that the resistance of the weakest part and not the mean resistance, is determined.

Finally, the joint is in a position where the magnetic lines diverge in passing into the yoke and consequently the formula for tractive effort does not give the proper value for \mathcal{B} . This may be remedied to a considerable extent, as was suggested by Ewing, by making the joint at the middle of the bar as in the Hopkinson apparatus.

Fisher-Hinnen Magnetic Tester. This apparatus is shown in Figures 9B and 9C. It was designed primarily as a shop apparatus to test short specimens which might be cut directly from a piece of iron to be used in the construction of dynamo machinery. Results sufficiently accurate for ordinary comparative shop tests may be obtained and the method possesses

the advantages of simplicity and rapidity of operation. The sample bars tested in the original apparatus were 80 millimeters in length and 500 square millimeters in cross-sectional area.

In Figure 9B, *D* is the test specimen which just fits between the pole pieces *GG* of the yoke *CC*. About the test piece is an

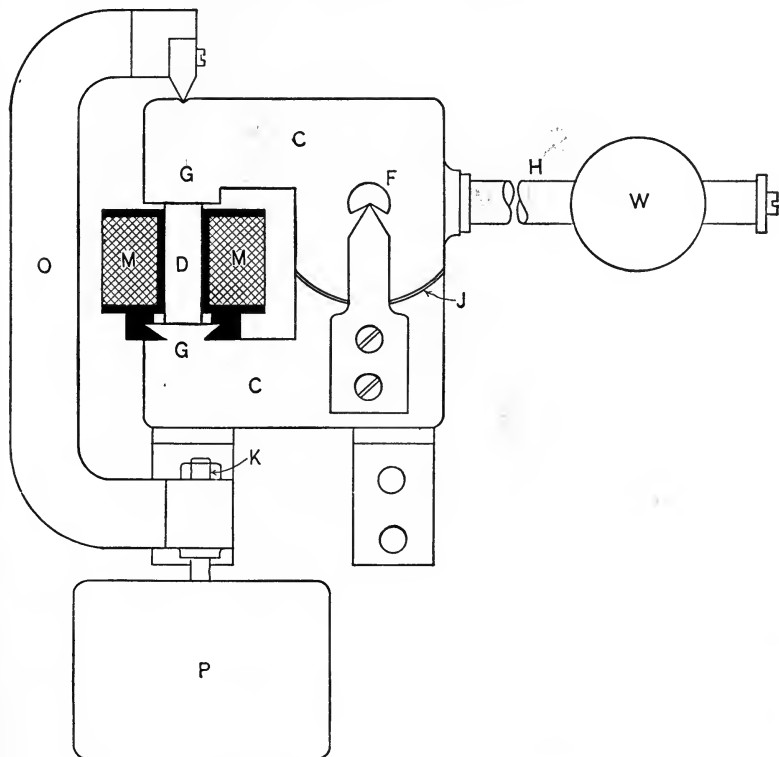

Fig. 9B. Fisher-Hinnen Magnetic Tester.

exciting coil *MM*, through which current is supplied and adjusted in the ordinary way. The yoke *CC* is divided, the lower portion being fixed and the upper part swinging upon knife edges *F* at front and back, thus maintaining the air gap *J* constant no matter what the position of the upper portion of

the yoke may be. The pole surfaces GG , as well as the ends of the test bar, must be made true. When the test specimen is in place and the current is turned on, the tension along the magnetic lines causes an attraction between the test piece and the poles GG . The tractive effort is measured by adjusting the weight W to the proper point on the lever arm H . The suspension arm O is used in calibrating the instrument and also, by means of the adjustable stop K , prevents the upper portion

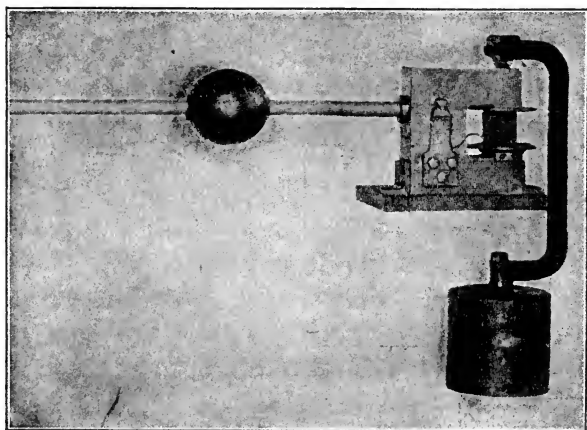

Fig. 9C. Fisher-Hinnen Magnetic Tester.

of the yoke from moving appreciably when the magnetic tension is overcome.

If the suspension arm O and weight P are not removed, the apparatus is calibrated by placing various known weights on P and balancing this pull by moving W out on the arm H . The zero reading will then be the point where the weight W just balances the suspension arm O and weight arm P . These latter may be removed for the higher readings, in which event the true reading is the scale reading plus the weights of O and P .

Two general methods of testing may be employed. The weight on the lever arm may be adjusted for a given predeter-

mined value of \mathcal{B} and the current decreased until the contact at G is broken. Another method is to adjust the exciting current to a given value and then alter the position of the weight until the rupture occurs. In either case care should be taken that the lever arm is in a horizontal position when the readings are taken.

The first method of performing the test has the objection that the values of \mathcal{B} will be too high for given values of magnetizing current, due to the hysteresis effect in the iron with the descending current.

If the second method is used all hysteresis effect may be eliminated by taking two readings for any one value of magnetizing current, one adjustment being made with increasing current, the other with decreasing current.

In his original apparatus, Fisher-Hinnen used a test piece 25.3 millimeters in diameter or 5 square centimeters in cross-sectional area. If the effect of \mathcal{H} be neglected in the traction formula, it becomes

$$F_{(\text{grams})} = \frac{\mathcal{B}^2 A}{25,000}.$$

If the area be taken as 5 sq. cm., as above, and the weight expressed in lbs., the formula is

$$F_{(\text{lbs.})} = \frac{\mathcal{B}^2}{5000 \times 453.6},$$

or

$$\mathcal{B} = 1506\sqrt{F}.$$

Figure 9D shows a curve giving the pull in pounds for various values of \mathcal{B} per square centimeter for a test piece having a cross-sectional area of 5 square centimeters.

For large values of \mathcal{B} the magnetizing force \mathcal{H} within the test specimen may be obtained from the formula

$$\mathcal{H} = \frac{4\pi NI}{10l},$$

where NI = number of exciting ampere turns,
and l = the length of the test piece.

In this formula the magnetic reluctance of the yoke CC , air gap J , and contact surfaces GG are neglected. For low mag-

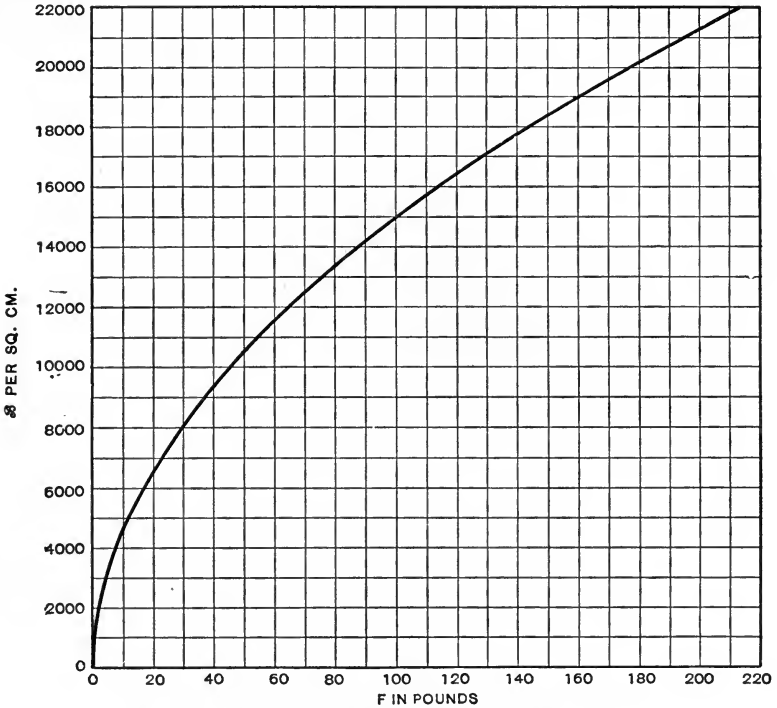

Fig. 9D. Calibration Curve for Fisher-Hinnen Magnetic Tester.

netizations this can not be done without appreciable error and Fisher-Hinnen found for his apparatus, that

$$\frac{1.8}{1000} \mathcal{B} + \frac{0.9}{1000} \mathcal{B}$$

ampere turns had to be added to overcome the reluctance of these parts. With a test piece one centimeter instead of eight centimeters in length this becomes

$$\frac{0.22}{1000} \mathcal{B} + \frac{0.116}{1000} \mathcal{B}.$$

The first term considers the reluctance of the yoke CC , and the second term that of the air gaps.

Du Bois Magnetic Balance. This is an apparatus in which there is no actual separation of iron surfaces in contact, thus

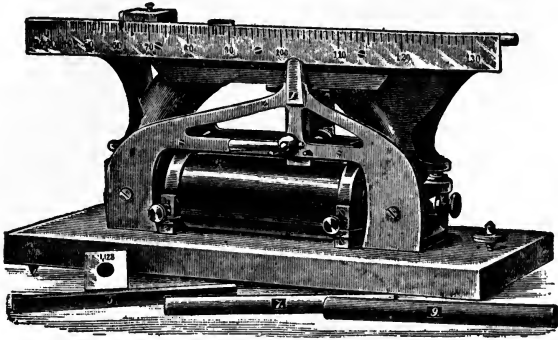

Fig. 9E. Du Bois Magnetic Balance.

eliminating some of the objections referred to above. It is shown in Figures 9E and 9F. The test bar T is 15 cms. long and 1.128 cms. in diameter or 1 sq. cm. in cross-sectional area.

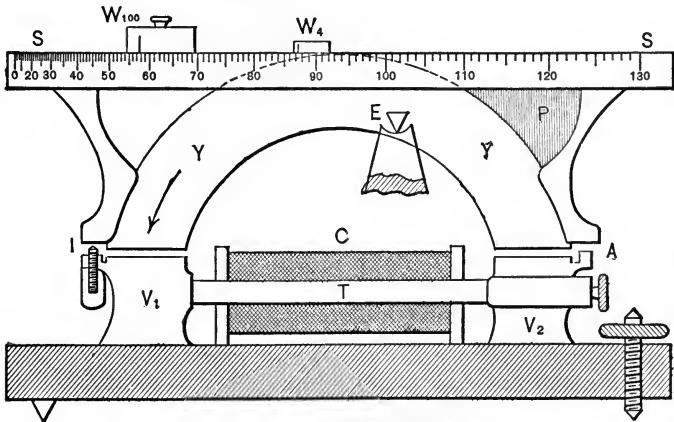

Fig. 9F. Du Bois Magnetic Balance.

The test bar is placed between the two pole pieces V_1 , V_2 , and the magnetic circuit is completed through the air gaps and

yoke YY . The yoke swings about a knife edge E which is placed eccentrically. Equilibrium under conditions of zero magnetization is produced by means of the counter weight P .

The magnetic attractions at the two air gaps are equal, by reason of the symmetrical arrangement. Because of the unequal lever arms, however, the torsion anti-clockwise is greater than the clockwise torsion. This difference in moments is measured by moving the weights WW along the scale arm SS .

The magnetic equilibrium is inherently unstable, but by trial a definite reading is obtained by moving the sliding weights to the position at which the yoke is just detached from the adjustment screw I . Excessive movement is prevented by the stop A . The value of \mathcal{B} is obtained from the balance reading. The value of \mathcal{H} is obtained from the formula

$$\mathcal{H} = \frac{4\pi NI}{l},$$

where NI = the ampere turns on the exciting coil,
and l = length of the test specimen.

This value of \mathcal{H} has to be corrected for the effects of the yoke and air gaps. A curve is furnished with each instrument showing the apparent and true values of \mathcal{H} for various values of \mathcal{B} .

The instrument is calibrated by testing a standard bar, the magnetic qualities of which are known.

Ewing Magnetic Balance. This apparatus is designed to test samples of iron and steel for a single value of \mathcal{H} which Ewing has taken at 20 c.g.s. units. This value has been chosen as being the best one to give a general idea of the comparative merits of the various kinds of iron and steel used in the construction of dynamo machinery.

For many purposes a single determination, at a sufficiently high magnetizing force, is all that is necessary to show the permeability of the specimen and how it compares with other

test pieces. This is because the general form of the $B-H$ curve does not differ greatly in the iron used in commercial apparatus. This magnetizing force is sufficiently low to make



Fig. 9G. Ewing Magnetic Balance.

a wide distinction between good and poor iron, and, on the other hand, it is sufficiently high to indicate the relative merits of the various kinds of iron tested when subjected to high magnetizing forces.

The Ewing Balance is shown in Figures 9G and 9H. The test rod D is a turned bar, $\frac{1}{4}$ inch in diameter and 4 inches long.

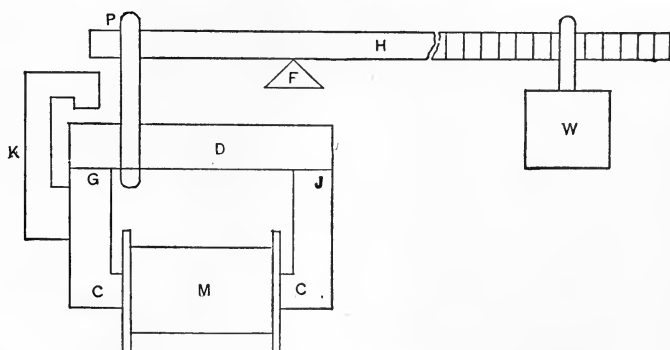

Fig. 9H. Ewing Magnetic Balance.

It rests horizontally upon the two poles G and J of the magnet CC , which is excited by a constant current through the coil M of such a value as to make the magnetizing force in the rod

about 20 c.g.s. units. The pole J has a V-shaped notch for the bar to rest in, and the other pole has a slightly convex surface, so that the side of the rod touches it at one point only. The rod requires no preparation beyond turning it to the proper diameter. Its cylindrically turned side touches the convex pole piece in a perfectly definite manner as long as it is free from dirt and rust, and it may be removed and replaced without altering the character of the contact.

To measure the tractive force at the point of contact, a lever arm H is used, one end of which is connected to the specimen by the link P . The fulcrum F is at the pole J , which latter acts as a magnetic hinge. The weight W is moved along the lever arm to the point where the magnetic pull at G is balanced.

This instrument is calibrated by testing various standard rods, the magnetic properties of which are known.

It is so designed that the scale is a linear one. The pull varies at a greater rate than the value of \mathcal{B} . On the other hand, with the better samples, more of the magnetizing force is taken up in the part of the magnetic circuit which lies without the test piece. By proper designing, these two effects may be made to neutralize so that the scale becomes linear.

A standard is supplied with each instrument and, in making a test, the standard is first placed in the balance and the magnetizing current is adjusted to the value at which the tractive force in the rod is such that the weight W stands at the place on the beam corresponding to the known value of \mathcal{B} which a force of 20 c.g.s. units produces in the standard. The sample to be tested is then placed in the balance and a reading taken, the current remaining the same as for the standard piece.

Data. Make magnetic tests of several samples of iron, using one of the pieces of apparatus described above. If practicable, take readings over a wide range of magnetic induction and for both increasing and decreasing values of the magnetizing force.

Curves. If a series of values of \mathcal{B} have been obtained in any one piece of iron, plot the \mathcal{B} - \mathcal{H} and \mathcal{B} - μ curves. Also plot a curve using \mathcal{B} as ordinates and ampere turns per centimeter as abscissas.

Suggestion. It is desirable to make tests upon the same kind of iron, using various tractive methods. In this way comparative results may be obtained which will prove of value in deciding upon the relative merits of the various pieces of apparatus.

Show. What factors enter into the determination of the true values of \mathcal{B} and \mathcal{H} in the apparatus used, and explain clearly just how these true values are obtained.

NO. 10. MAGNETIZATION AND PERMEABILITY TESTS OF IRON, USING THE EWING PERMEABILITY BRIDGE.

References. Ewing, p. 366; Parshall and Hobart, p. 5; *London Elec.*, vol. 37, p. 11, vol. 38, p. 110, vol. 43, pp. 19 and 41; *Elec. World*, vol. 28, p. 695.

Object. The dynamo designer is continually in need of information regarding the magnetic properties of the iron with which he is working. A simple and rapid working method sufficiently accurate for design purposes is therefore necessary. The Ewing Permeability Bridge is designed with this object in view.

Theory and Method. This is a method of obtaining the magnetization curve of a sample of iron, by comparison with a standard test piece whose magnetic qualities have been determined.

Figure 10A is a general view, Figure 10B is a representation of the bridge proper, and Figure 10C is a diagram showing the connections to the magnetizing coils, through the controlling dials and switches.

Two magnetizing coils, *A* and *B*, are wound on brass spools placed side by side, and are connected in series. One coil *A*, in which the standard is placed, has 100 turns or 50 turns active, according to how the connection *F* (Figure 10C) is made. The other coil *B*, which is around the test piece, has 210 turns in all. Of this number 10 are connected to the dial *G*, 100 to the dial *H*, and 100 between the 0 and 100 posts of the switch *J*. By this arrangement, any desired number of

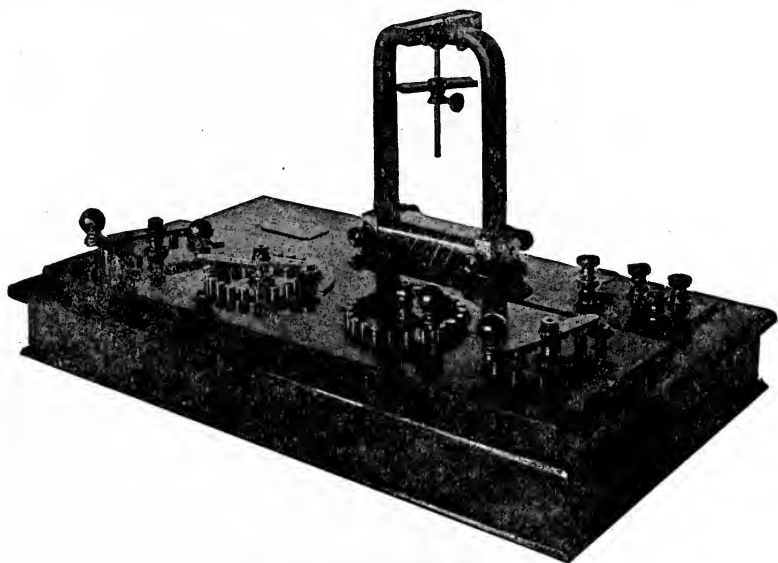

Fig. 10A. Ewing Permeability Bridge.

turns of this coil may be cut into the circuit. The coils are so connected that the resultant magnetism forms a closed magnetic circuit through the two test rods, by way of the heavy soft iron yokes, as shown by the arrows. In other words, the coils are also in series magnetically. *LL* are the terminals and *K* is a reversing switch.

To compensate for the resistance which is cut into or out of the circuit when turns are added to or subtracted from the variable coil, an exactly equal but external resistance is cut out of or into the circuit automatically, as the dial switches

are manipulated. These resistances are shown at MM and NN on dials G and H , respectively. The resistance P is likewise introduced into the circuit when the 100 turns between the 0 and 100 posts of switch J are cut out.

In Figure 10C, with switches F and J both thrown to 100 and with dial switches G on 3 and H on 40, the current enters the + binding post L , passes through K , 3 turns of coil B , 7 resistances MM , 40 turns of coil B , 6 resistances NN (each equal to the resistance of 10

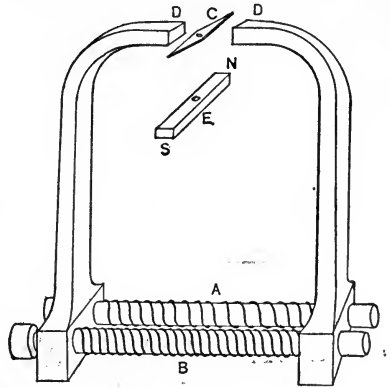

Fig. 10B. Sketch of Ewing Bridge.

turns of coil B), 100 turns of coil B , switch J , switch F , 100 turns of coil A , switch K , and out at the - binding post L . In this case there are 100 magnetizing turns on the standard and 143 turns on the test specimen.

Suppose the standard and the test pieces to be of exactly the same material. In this case, when any given current flows through the magnetizing coils, the coils should have the same number of turns each to produce the same degree of magnetization in both pieces of iron. It is evident, then, that to produce the same number of lines in a piece of less permeability than the standard, more magnetizing force, or, in other words, more turns will be required around the test piece than around the standard, the current being the same in the two coils. Similarly, fewer turns will be required to produce the same number of lines in the test piece, if it be of better material, magnetically, than the standard. If a certain current I produces a certain number of lines of force ϕ in the standard, and if, for example, 120 I ampere turns are necessary to produce the same number of lines ϕ in the test piece, there will be sufficient data to locate the position of one point on the

magnetization curve of the test piece. This is precisely what is done in using the permeability bridge. A certain current is passed through both magnetizing coils, and the number of active turns around the test piece is varied until the magnetic induction is the same in both pieces. This condition is detected by observing the compass needle *C*, Figure 10B, mounted between two iron horns *DD*, which project up from the yokes into which the standard and test pieces are clamped. When the magnetic flux is the same in both pieces, there will be no

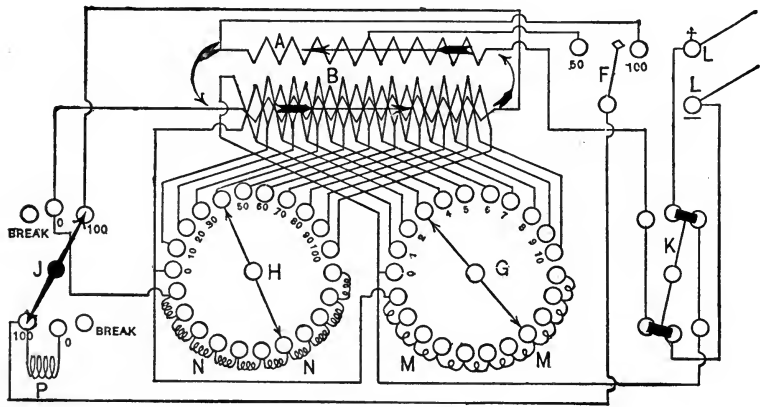

Fig. 10C. Connections of Ewing Permeability Bridge.

magnetic difference of potential between the two yokes, and no leakage of magnetism across the horns of the instrument, and the compass needle will not be deflected. This process of balancing is to be performed for each of the values of current given in the table for the standard. To get rid of all effects of residual magnetism in the test pieces, yokes, and horns, the current is frequently reversed, during the process of balancing, by means of the reversing key. There may be a transient "kick" of the compass needle even when the bridge is balanced, due to the difference in the time rate with which the test pieces take up their magnetism, but the adjustment of turns should be made so that no permanent deflection of the

needle is apparent on reversing the current. It will be found necessary, during the process of balancing, to set the needle at zero by means of the controlling magnet E before each reversal of the current.

In testing iron of poor magnetic quality it is necessary, in order to obtain a balance, to use only 50 turns around the standard.

The test pieces are 12.56 cm. long between the yokes and are $\frac{3}{8}$ of an inch in diameter. The magnetizing force exerted upon the standard, per ampere of current, is

$$\mathcal{H} = \frac{4\pi N}{10l} = \frac{12.56 \times 100}{10 \times 12.56} = 10 \text{ c.g.s. units.}$$

In testing with low magnetizing forces, allowance must be made for the magnetic reluctance of yokes and joints; for a current in amperes, slightly more than 0.1 \mathcal{H} is required to produce the given magnetizing force \mathcal{H} . In order to take this into consideration, a table is furnished with the standard, stating the values of current necessary to produce given values of magnetic induction in the standard, and the corresponding true values of \mathcal{H} in the test piece, after correcting for these extra reluctances. The proper mode of procedure, then, is to balance the bridge for each value of current given in the table. Assume that the standard takes 0.22 of an ampere to produce a magnetizing force \mathcal{H} equal to 1.9 and that the value of \mathcal{B} in the standard equals 2000. If, on balancing, it is found that 120 turns are required around the test piece, to produce a value of \mathcal{B} equal to 2000, the magnetizing force for the test piece must be 1.2 times 1.9, or 2.28. The standard provided with the instrument is usually of wrought iron or steel. In testing cast iron, a cast iron standard should be used. If this is not at hand a suitable standard may be made as follows.

A piece of wrought iron is first carefully compared with the standard and its magnetization curve drawn. Then this test piece is reduced in cross-section, which will make its magnetic re-

luctance greater. If, for example, the cross-section is 0.4 of the original value, the same magnetizing force which produced ϕ lines before, will now produce only 0.4 ϕ .

Apparatus. The apparatus necessary consist of the permeability bridge, samples of iron, storage cells or other constant source of electrical pressure, lamp bank or other resistance for controlling the current, and an ammeter reading to about 10 amperes.

Connections. See Figure 10C.

Data. The bridge should be balanced and the readings taken for each of the values of the current given in the table accompanying the standard, or for currents approximating these values, so as to insure a convenient spacing of the points along the unknown curve.

DATA FOR HIGH PERMEABILITY STANDARD NO. 109 L, USED AT THE UNIVERSITY OF WISCONSIN. (100 TURNS ON THE STANDARD.)

$B.$	$H.$	Current in Amperes.
2,000	1.9	0.22
4,000	2.4	0.29
6,000	2.9	0.35
8,000	3.5	0.44
10,000	4.5	0.55
11,000	5.3	0.64
12,000	6.3	0.76
13,000	8.1	0.95
14,000	10.7	1.24
15,000	17.2	2.00
16,000	31.0	3.40
17,000	59.0	6.40
17,500	80.0	8.50
18,000	110.0	11.50

Curves. Draw magnetization curves for all the pieces tested, as well as for the standards employed. The corresponding permeability curves are also to be drawn.

Suggestion. If the currents used are not the same as those in the table, computation will be facilitated by plotting an I -curve for the standard. In fact it does not pay to take the time required to adjust the currents to the exact values given in the table.

State. Any errors you think might arise either in the method itself or in using the secondary standard for cast iron.

Devise. An electric analogy to the Ewing magnetic balance, using two sources of electric pressure and a galvanometer and explain the action.

NO. II. HYSTERESIS TESTS OF IRON BY THE BALLISTIC METHOD.

References. Ewing, pp. 93, 356 and 360; C. P. Steinmetz, *Transactions A. I. E. E.*, vol. 9, 1892, pp. 3 and 621; Gerard, p. 87; DuBois, pp. 225, 301 and 332; Carhart and Patterson, p. 311; Jackson's "Dynamos," p. 69; Sheldon, p. 256; Parr, P. E. T., p. 162; Armagnat, p. 542; Thompson's Design, p. 9; Thompson's "Lectures," p. 75; Thompson's "Dynamos," p. 133; F. G. Bailey, *Proc. Royal Soc.*, vol. 60, 1896, p. 182; R. Beattie and R. C. Clinker, *London Elec.*, vol. 37, 1896, p. 723; J. A. Ewing, *London Elec.*, vol. 43, 1899, pp. 19 and 41.

Object. Hysteresis loss in iron plays an important part in determining the heating and the efficiency of electrical apparatus subject to rapidly varying magnetic density. It is, therefore, important to know the constants for computing this loss. The ballistic method is the standard method for testing hysteresis loss.

Theory and Method. When a piece of magnetically neutral iron is placed within a solenoid, and the current increased from zero to a value op , Figure 11A, the magnetism will rise along the curve oa to a value pa . On decreasing the current to zero, the

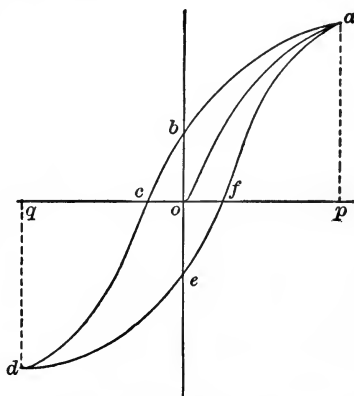

Fig. 11A. Magnetic Cycle or Hysteresis Loop.

magnetization will fall along the curve ab to the value ob , representing the retentiveness of the iron. Reversing the current and increasing it to a value oc , this magnetism is reduced to zero and

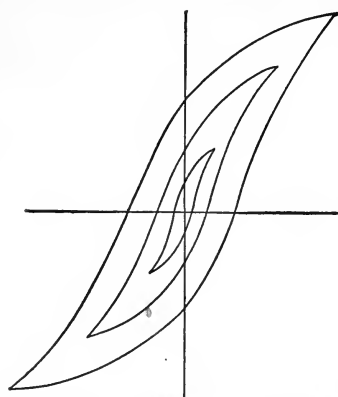

Fig. 11B. Hysteresis Loops with Various Maximum Magnetic Inductions in the same Iron.

oc represents the coercive force of the iron. On further increasing the current to a value oq , equal numerically to op , the magnetism rises in reverse direction to a value qd , equal in value to pa . If the current be now decreased to zero, reversed, and again increased to value op , a curve $defa$, will be described symmetrical with the curve $abcd$, and forming with it a closed loop, known as the hysteresis loop.

The area of this loop represents a loss of energy which may be represented by the formula

$$\int_{-\mathcal{B}_1}^{\mathcal{B}_1} \mathcal{H} d\mathcal{B},$$

the proof of which may be found in some of the references.

\mathcal{B}_1 is here the common value of the two maxima of density and \mathcal{H} the instantaneous value of the magnetizing force. If several loops are traced, with varying maximum values of \mathcal{B}_1 for the same piece of iron, the losses will be represented by the respective areas, Figure 11B.

Steinmetz has shown that these areas vary as the 1.6 power of the magnetic density, or

$$\int_{-\mathcal{B}_1}^{\mathcal{B}_1} \mathcal{H} d\mathcal{B} = K\mathcal{B}^{1.6}.$$

The power lost in hysteresis is

$$P = \eta Vf\mathcal{B}^{1.6} \times 10^{-7},$$

where η is the hysteresis coefficient,

V is the volume of the iron in cubic centimeters,

f is the frequency of reversal in cycles per second,

and P is the power in watts.

The following is a table of values of η for various qualities of iron and steel.

Best wrought iron and steel sheets.....	0.001
Good soft wrought iron and steel sheets.....	0.002
Ordinary soft iron.	0.003
Annealed cast steel.....	0.008
Ordinary cast steel.	0.012
Ordinary cast iron.	0.016
Hard cast iron and tempered cast steel.....	0.025

In the calculation of hysteresis losses it is convenient to have the corresponding values of \mathcal{B} and $\eta \mathcal{B}^{1.6}$. The following table has been made out to facilitate this computation. The value of the coefficient η has been taken at 0.001. Any other value of the coefficient may be substituted by multiplying by the ratio of this value to 0.001.

TABLE OF VALUES OF $\eta \mathcal{B}^{1.6}$ ($\eta = 0.001$).

\mathcal{B}	$\eta \mathcal{B}^{1.6}$	\mathcal{B}	$\eta \mathcal{B}^{1.6}$	\mathcal{B}	$\eta \mathcal{B}^{1.6}$	\mathcal{B}	$\eta \mathcal{B}^{1.6}$
500	20.8	8,000	1,758	15,500	5,064	23,000	9,523
1,000	63.1	8,500	1,936	16,000	5,328	23,500	9,856
1,500	120.7	9,000	2,122	16,500	5,596	24,000	10,194
2,000	191.3	9,500	2,314	17,000	5,871	24,500	10,536
2,500	273.3	10,000	2,512	17,500	6,150	25,000	10,882
3,000	365.8	10,500	2,716	18,000	6,433	25,500	11,232
3,500	468.3	11,000	2,925	18,500	6,722	26,000	11,587
4,000	579.8	11,500	3,141	19,000	7,015	26,500	11,945
4,500	700.1	12,000	3,363	19,500	7,312	27,000	12,308
5,000	828.6	12,500	3,589	20,000	7,615	27,500	12,675
5,500	965.1	13,000	3,822	20,500	7,922	28,000	13,045
6,000	1,109.0	13,500	4,060	21,000	8,233	28,500	13,420
6,500	1,261.0	14,000	4,303	21,500	8,549	29,000	13,798
7,000	1,420.0	14,500	4,552	22,000	8,869	29,500	14,181
7,500	1,583.0	15,000	4,806	22,500	9,192	30,000	14,568

This formula for hysteresis loss applies to the special case of equal and opposite magnetizations, induced by a magnetizing force that varies from a maximum in one direction to an equal

maximum in the opposite direction, and with a regularity in the time of each cycle. It represents the condition of the core of an alternating current transformer when one of the coils is connected to a source of alternating current.

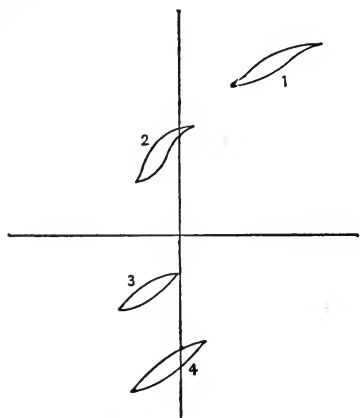

Fig. 11C. Isolated Hysteresis Loops Produced by Pulsating Currents and Unsymmetrical Alternating Currents.

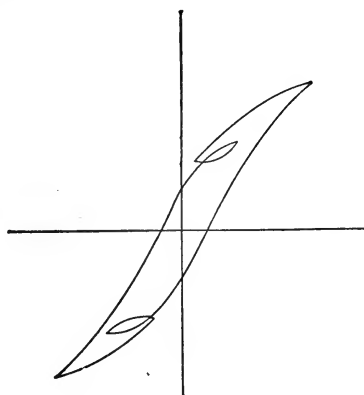

Fig. 11D. Magnetic Cycle Produced by Alternating Current with Toothed Wave.

It is conceivable how a pulsating current could produce loops like 1 and 3, Figure 11C, or how an alternating current with current values that are different for the two directions could produce the loops 2 and 4. Figure 11D represents a magnetic cycle produced by an alternating current which, at a certain critical value while on the decrease, suddenly rises and then falls off to zero and reverses. In all these cases the formula would have to be modified to suit the conditions.

Again, in the armature core of a direct current dynamo or motor, the conditions are still different. The magnetizing force is constant, and the change of the direction of magnetization is caused by the rotation of the iron core.

Swinburne suggested that, according to Ewing's theory of magnetism, a piece of iron rotated in a constant magnetic field, would exhibit little or no hysteresis if the field was very

strong. This was later shown experimentally to be true by Bailey, Beattie, Clinker and others.*

The results show that the loss reaches a maximum when \mathfrak{B} is about 17,000 lines per square centimeter, for iron such as is used in armature cores, and that it reduces to a minimum value at about 22,000; and from there on it remains nearly constant. This is of interest to the designer because the densities in armature teeth often run above 22,000.

The term hysteresis, as applied to a piece of iron rotating in a magnetic field of constant value, is objectionable on account of the root meaning of the word. *Molecular friction* has been introduced and is finding favor as a term descriptive of this distinct phenomenon.

In making the test the ring method should be used, connections being made as in Figure 7, excepting that in addition to the reversing switch a graduated resistance is added, portions of which may be cut in or out suddenly without interrupting the circuit, thus decreasing or increasing the exciting current by steps. By this means the increments of magnetism are measured for ascending and descending values of excitation. It is called the "step by step" method. Great care must be used in taking observations, as errors are in this case cumulative. The reversing switch is used merely to reverse the excitation as it passes through the zero value.

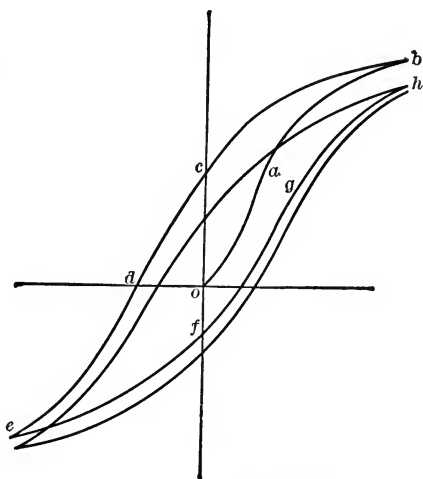

Fig. 11E. Effect of Residual Magnetism on Hysteresis Loop.

* See references.

The effect of residual magnetism in displacing the X axis with reference to the hysteresis loop, is interesting in this connection. Suppose, Figure. IIE, that the iron is entirely free from magnetism at the start, and that the initial magnetizing curve is oab . As the magnetizing force is reduced, reversed, and brought to a maximum again, the curve passes through the points $bcde$. As the magnetizing force is again reduced, it is seen that there is some residual magnetism of in the reverse direction to that which was first present. The result is that the returning portion fgh of the hysteresis loop falls below the initial curve oab and the loop is not quite closed. If the reversal process is again carried out, the hysteresis loop obtained will fall slightly below the first one. If this process is repeated a number of times, the difference between any one loop and the one immediately preceding it becomes very small and they finally merge into one common reëntrant hysteresis loop.

Data. Remove any residual magnetism in the test ring by first magnetizing it beyond the residual and then reversing the current in the exciting coil a number of times, at the same time gradually reducing it to zero. After the residual magnetism has been removed, adjust the pressure source and the controlling resistances to give the range of variation necessary for the desired hysteresis loop. Then pass the iron through several cycles before taking any measurements. The number of cycles necessary to produce a closed loop varies with the iron and the maximum magnetizing force used, but in general eight or ten cycles will be found sufficient.

Using the step by step method, take a series of observations of sufficient number to trace the curve $oabcdefa$. Using a different maximum exciting current, trace several hysteresis loops, as $abcdefa$, Figure IIA.

If the constant of the galvanometer is not known, determine it by one of the methods shown in Experiments 5 and 6.

Measure the ring carefully so as to be able to calculate its

volume and cross-section. Note the number of turns in both the primary and secondary windings. Measure the resistance of the secondary circuit.

Cautions. Be careful that all the readings are accurate; any errors made at one step will appear in all successive readings.

The galvanometer resistance will probably have to be adjusted for great sensitiveness, so as to measure a small increment of magnetism; be careful not to make or break the circuit while the galvanometer circuit is closed.

If it is found on an inspection of the results that some of the observations are not close enough together, demagnetize the iron and retrace the curve, without taking observations until the space to be filled is reached. This is readily accomplished by watching the exciting current.

Calculate. The cross-section and volume of the ring. Calculate the values of \mathcal{B} and \mathcal{H} from the formulas given in Experiment 7. The *increments* of \mathcal{B} will be given in this case and not the total values.

Calculate from each measured area of the hysteresis loop, the value of

$$\int_{-\mathcal{B}}^{\mathcal{B}} \mathcal{H} d\mathcal{B}.$$

This is done by multiplying the area of the loop by the proper constants according to the scales of abscissas and ordinates. For instance, suppose the cross-sectioning be in millimeters and a unit of the magnetizing force \mathcal{H} is represented by two millimeters, and each millimeter on the scale of ordinates represents a value of magnetic induction \mathcal{B} equal to 200 lines per square centimeter, then the value of the definite integral will be expressed by the relation

$$\begin{aligned} \int_{-\mathcal{B}}^{\mathcal{B}} \mathcal{H} d\mathcal{B} &= \text{area of loop in sq. mms.} \times 200 \times \frac{1}{2} \\ &= 100 (\text{area of loop in sq. mms.}). \end{aligned}$$

Calculate the value of the coefficient η for each loop, and also the loss in watts due to hysteresis for a frequency of 60 cycles per second.

Curves. Plot curves of your calculated values of \mathcal{B} and \mathcal{H} .

Show. That the areas of the hysteresis loops vary as the 1.6 power of the magnetic induction.

Explain. How tests might be made on iron to determine the hysteresis loss for the conditions under which a dynamo armature operates.

Why it is that we may expect a small hysteresis loss when an armature core is rotated in a very strong magnetic field.

Explain, using a curve, how iron is demagnetized by an alternating exciting current of gradually decreasing value.

No. 12. HYSTERESIS TESTS OF IRON, USING A HYSTERESIS TESTER.

References. J. A. Ewing, *Journal I. E. E.*, vol. 24, 1895, p. 398; H. F. Parshall and H. M. Hobart, *London Eng.*, vol. 65, 1898, p. 40; J. A. Ewing, *London Elec.*, vol. 43, 1899, pp. 19 and 41; Frank Holden, *Elec. World*, vol. 25, 1895, p. 687; Parshall and Hobart, p. 9; Sheldon, p. 260; Armagnat, p. 559.

Object. In electromagnetic apparatus containing iron which is continuously subjected to rapid changes in magnetic density, the hysteresis loss becomes an important factor from the standpoints of efficiency and temperature. The object is to determine the hysteresis loss in various samples of iron such as are used in the parts of apparatus which are subjected to these fluctuating densities. The Ewing, Holden, and other hysteresis testers offer means of rapidly doing this.

Theory and Method. A number of hysteresis testers have been devised at various times. Some of these show the hysteresis loss when iron is revolved in a fixed magnetic field, as in the armature core of a dynamo, while others give more nearly the loss due to hysteresis when the magnetism passes

through a zero value in reversing, as in the core of a transformer. The Holden Hysteresis Meter is an example of the former while the Ewing Hysteresis Tester is of the latter class. In the Ewing tester the magnetic circuit varies as the test piece is rotated, and the conditions, therefore, are not the same as in the transformer.

Ewing Hysteresis Tester. This instrument, Figure 12A, consists essentially of two parts, the carrier and the permanent magnet. The iron to be tested is cut into strips, the number required depending upon the thickness of the sheet. If transformer iron of the usual gauge is tested, six or seven of these strips may be used; whereas, if the somewhat thicker iron used in armatures is tested, a smaller number of the strips will be needed. The bundle of iron strips is then placed in the carrier and rotated, by means of a friction pulley and driving wheel, between the poles of the permanent magnet. The result is that its magnetism is periodically reversed. The work done in reversing the magnetism, due to the hysteresis loss, causes a mechanical moment to be exerted by the revolving sample upon the magnet. The latter, being supported upon knife edges in line with the axis of the carrier, tends to follow the sample, and is deflected through an angle which is proportional to the work expended per cycle. Since a certain amount of work is done for each reversal, whatever the frequency, the deflection is independent of the speed, pro-

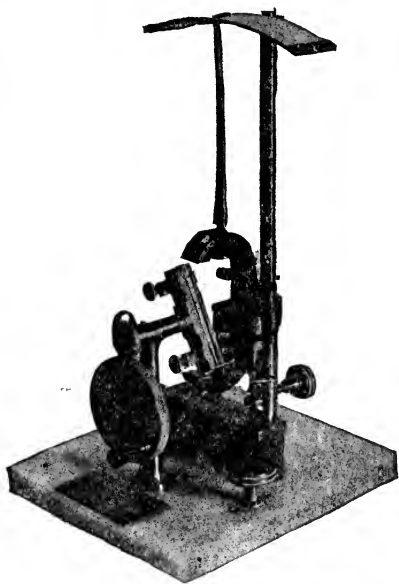

Fig. 12A. Ewing Hysteresis Tester.

vided the latter is not sufficiently high to cause appreciable eddy current effects, or not so low as to cause a periodic movement of the needle. The magnet is damped to prevent swinging, by means of a vane which dips into a reservoir of oil.

This method of determining hysteresis loss consists in a comparison of the deflection produced by the sample, with those of standard test pieces whose hysteresis losses are known. Deflections are proportional to the hysteresis of the iron, even if the samples compared are of widely different qualities. The exact mode of procedure is as follows.

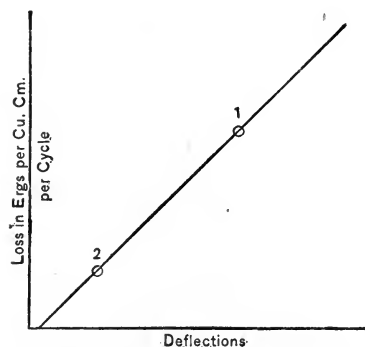

Fig. 12B. Calibration Curve of Ewing Hysteresis Tester.

Two standards are furnished with the instrument, which have widely different hysteresis losses. The deflections produced by both of these are plotted on cross-section paper, Figure 12B, using the given hysteresis losses as ordinates and the deflections obtained as abscissas. A straight line is drawn through the points thus obtained. The test sample

is then placed in the carrier, its deflection obtained and the point on the above mentioned line, corresponding to this deflection, is marked. The hysteresis loss for the test sample is then shown by the ordinate of this point. The strips for the test sample should be the exact length of the standard, and may be taken about five eighths of an inch wide.

The data given for the two standards, used at the University of Wisconsin, are as follows:—

<i>Standard.</i>	<i>Hysteresis loss in ergs. per cu. cm. per cycle.</i>
1	2,775
2	325

This loss is based on the assumption that \mathcal{B} equals 4000.

The loss at any other value of \mathcal{B} is easily obtained from the law

$$\text{Hysteresis loss} = K\mathcal{B}^{1.6},$$

where K is a constant.

In taking data, observe the deflections, first of the two standards, and then of several test samples. A number of observations should be taken, and the deflections read in both directions for each sample. To eliminate any zero error, the total or double deflection should be used.

The results obtained should be shown in tabulated form, and losses indicated in *watts per cu. cm. per cycle per second*.

The only graphical representation is the above mentioned straight line. The points for each of the samples tested should be indicated on the curve sheet.

In handling standards be careful not to bend them, as this changes the hysteresis constant.

The total flux of a permanent magnet is constant. The proportion of this flux which passes through the test pieces depends upon the relative reluctances of the test piece and the surrounding leakage paths.

The samples should be built up so as to have approximately the same cross-section as the standard pieces. An exactly equal cross-section is not necessary, since it has been shown experimentally that the deflection will be almost exactly the same, even with considerable variation in the cross-section of the test sample.

Holden Hysteresis Meter. This instrument, shown in Figure 12C, measures the hysteresis loss in sheet iron discs or rings, resulting from a rotation of the magnetic field with respect to the iron under test. Here the ordinary conditions are reversed, and the magnet rotates. The test rings are held by a fiber frame so as to be concentric with a vertical shaft which works freely on a pivot bearing at its lower end. The rings have an outside diameter of about 3.5 inches, a width of about 0.5 inch, and are built up to a thickness of about one half

inch. The hysteresis loss is measured by the magnetic drag on the core, which is free to turn against the restraining action of a helical spring surrounding the shaft and attached to it at one end. A pointer attached to the spring is mounted at the upper end of the shaft and moves over a circular scale, showing the force exerted upon the spring to bring the ring back to the zero position. The spring having been calibrated, the hysteresis loss may be readily determined.

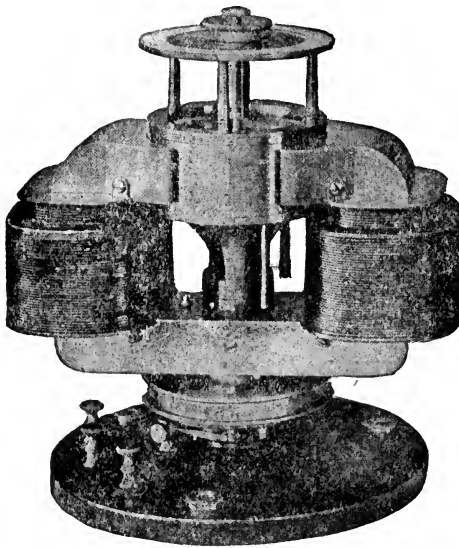

Fig. 12C. Holden Hysteresis Meter.

A pressure coil, which surrounds but does not touch the ring, has its terminals connected to a voltmeter through a two part commutator which revolves with the magnet. The number of turns on the coil, the cross-section of the sample, the speed of the revolving magnet, and the constant of the voltmeter being known, the magnetic induction in the ring may be determined.

Carried on the shaft below the magnet is a pulley which is belted to the source of power. In operating, the de-

flections to be produced on the voltmeter at a given speed, with the desired inductions in the ring, are first determined. The speed ordinarily used is 500 revolutions per minute. The magnet being run at the desired speed, the field current is adjusted until the calculated deflection is produced on the voltmeter, and then the force exerted upon the helical spring, necessary to keep the ring in the zero position, is read by means of the pointer on the scale.

The scale reading represents the total loss, which is due to hysteresis and eddy currents combined. By varying the angular velocity of the magnet, maintaining the same induction, additional data may be obtained by means of which the eddy current loss may be separated and subtracted. This separation depends upon the

fact that the power lost due to hysteresis, with constant induction, varies directly as the speed, while the eddy current loss varies as the square of the speed. From the data obtained the power lost in watts per cu. cm. per cycle per second is calculated for the various speeds at the same induction. These results are plotted as shown by

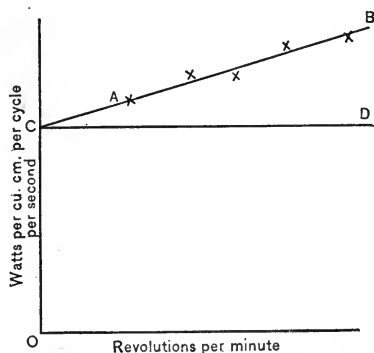

Fig. 12D. Separation of Hysteresis and Eddy Currents in the Holden Method.

the line *AB* in Figure 12D, using watts lost per cu. cm. per cycle per second as ordinates and speeds as abscissas. If the curve is continued until it strikes the *Y* axis at *C* and the line *CD* is drawn parallel to the *X* axis, the ordinate *OC* will represent the loss in watts per cu. cm. per cycle per second due to hysteresis.

A modified form of the Holden Hysteresis Meter, shown in Figure 12E, employs electro-magnets of such high reluctance that practically all the magneto-motive force is used up in the magnetic path outside of the sample ring. In this case there is

no need of a separate determination of the induction for each test, as a given magnetizing current will produce the same magnetic induction in all cases. As seen from the figure, the electro-magnet is changed into two of much greater length, and of a cross-section about one third that of the sample ring. The air gap is made as small as possible, so that there is but little leakage. In this form the rings are allowed to rotate in opposition to the action of the spring and to carry a pointer over the scale, so that the instrument is direct reading.



Fig. 12E. Holden Hysteresis Meter (modified form).

In general, a correction has to be made for volume and cross-section, since the rings do not, owing to varying thickness, make piles of the same height.

Data. Make a series of tests with both testers, if practicable, using the same kinds of iron and taking the same magnetic inductions.

Tabulate all data and separate the eddy current from the hysteresis loss, in the test with the Holden tester, by taking readings of total loss at the same induction but at different speeds, as described above.

Curves. In the separation of the eddy current loss from the hysteresis loss, in the test with the Holden tester, plot a curve for each induction used, taking speeds as abscissas and watts lost per cu. cm. per cycle per second as ordinates.

Explain. The fact that the deflection does not vary appreciably, even with a considerable change in the cross-section of the test sample, in the case of the Ewing tester.

Why it is so essential that the length of the test sample should be exact, when using the Ewing tester.

Why the calibration curve of the Ewing tester does not necessarily pass through the origin.

Describe. The method employed in calibrating the Holden hysteresis meter.

Show. By an example, taking two speeds, one of which is twice the other, that the method of separation of losses shown in Figure 12D gives a division in which one loss varies directly as the speed and the other as the square of the speed.

Compare. The results obtained by hysteresis testers with those obtained on the same iron by using the ballistic method.

Discuss. The relative advantages and disadvantages of the different methods of measuring the power lost due to hysteresis.

No. 13. THE EFFECT OF REVERSAL OF ROTATION AND REVERSAL OF EXCITATION ON THE DIRECTION OF PRESSURE OF A DYNAMO.

References. Houston and Kennelly, p. 303; Fisher-Hinnen, p. 125; Thompson's "Dynamos," p. 22; Sheldon, p. 16; Jackson's "Dynamos," p. 99; Wiener, p. 9; Hawkins and Wallis, p. 39; Kapp's "Dynamos," p. 145; Arnold's "Armature Windings," p. 3; Arnold's "Dynamos," p. 3.

Object. One of the most common occurrences in practice is the reversal of the direction of rotation of a dynamo. Perhaps it even more frequently occurs that the excitation is reversed, as this sometimes happens accidentally. It is, therefore, necessary that the effect of these reversals be thoroughly understood.

Method. The effect of the direction of rotation upon the direction of pressure is determined by separately exciting the

field, and noting the direction of the deflection of a direct current voltmeter when the armature is rotated first in one direction and then in the other. If the fields are strongly magnetized, rotation by hand will suffice.

Reverse the field excitation and determine its effect on the direction of generated pressure.

A self excited machine will pick up in only one direction, unless the residual magnetism be reversed by some external means.

Explain. The reasons for the different results obtained, and devise a general rule or explanation.

Show. By the aid of diagrams, just what would have to be done with the connections of a machine if it were necessary, for any reason, to change the direction of its rotation, without changing the polarity of its terminals. Consider series, shunt and compound wound machines.

No. 14. STARTING OF SHUNT AND SERIES MOTORS ON CONSTANT PRESSURE CIRCUITS.

References. Houston and Kennelly, p. 297; Fisher-Hinnen, pp. 106 and 124; Sheldon, p. 69; Thompson's "Dynamo," p. 486; Carus-Wilson, pp. 60 and 94; Wiener, p. 423; Parham and Shedd, p. 36.

Object. A motor may be conveniently used as a source of power in many of the experiments which follow. It is desirable to understand the simple principle of the motor and also the precautions to be observed in starting and operating one.

Theory and Method. When a motor is running it has all the essential characteristics of a dynamo, and its armature generates a pressure proportional to the speed and to the magnetism. This pressure opposes the impressed pressure and is called the counter electromotive force of the motor. The current in the armature is equal to the difference between these

pressures divided by the armature resistance. This resistance is always made as low as possible, and the resistance drop for normal full load current is very small in comparison with the counter pressure under working conditions. When the armature is stationary there is no counter pressure, and the current is equal to the impressed pressure divided by the armature resistance. Under this condition, if the normal pressure is impressed upon the armature, an excessive current will flow and disastrous results may follow. It is therefore necessary to introduce an additional resistance in series with the armature during the time the motor is coming up to speed. Such a starting resistance is especially necessary if the motor is started under a heavy load. It should be variable and so arranged as to be completely in circuit at the time the current is turned on, and entirely cut out after the motor has attained its normal speed. The resistance drop in the starting box takes the place of the counter e. m. f. of the armature.

To start a series motor, a variable resistance is placed in the circuit and gradually cut out as the motor comes up to speed. A series motor should be started under load. If started on light load the field may become so weak, due to the small exciting current, that the armature will attain an abnormal speed.

In starting a shunt motor, the field must be fully excited. This may be tested by holding a screw-driver or a piece of iron in the leakage field. The controlling resistance is placed in the armature circuit only, as shown in Figure 14A. In motor starting boxes, the resistances are generally so proportioned that the armature current at the moment of starting is equal to 150 percent of the full load current.

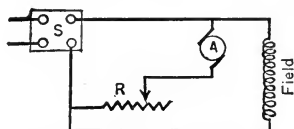

Fig. 14A. Shunt Motor with Starting Resistance.

The proper method of starting a shunt wound motor is to first close the main switch and then gradually cut out the re-

sistance in the starting box as the armature comes up to speed. When the lever arm is turned to its limit, all of the resistance has been cut out and the armature has the full pressure of supply impressed upon it. The armature should be running at or near normal speed before the resistance is cut out entirely. The motor should not be run for any length of time at any intermediate point of the starting box unless the resist-

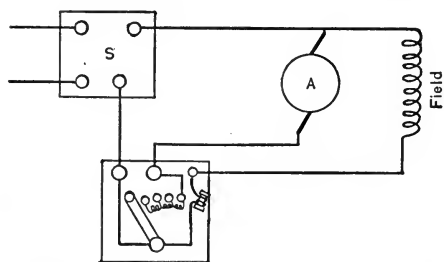

Fig. 14B. Shunt Motor with Automatic Release Starting Box.

ance has been especially designed for controlling the speed of the motor.

In stopping the motor the main switch should be opened first and then, if the starting box has no automatic release, the lever arm should be thrown back. Insurance

companies require that starting boxes be provided with an automatic release. The reason for this is that much damage has resulted in the past because of the lever arm being left in the running position when the machine is stopped. This itself is not injurious but very often the motor is started up again with the resistance entirely cut out and the result is that the full pressure of the generator is impressed upon the armature while it is stationary and disastrous results are likely to follow. The automatic release is shown in Figure 14B. It consists essentially of a small electro-magnet, the exciting coil of which is placed in series with the field circuit of the motor, a soft iron armature or keeper on the lever arm, and a spring attached to the lever arm in such a way that it is in tension when the arm is turned on. As soon as the main switch is closed, the coil of the electro-magnet is excited, and when all the resistance is cut out, the soft iron keeper is attracted by the electro-magnet and the lever is held in this position against the tension of the spring. In stopping the motor, the main switch is opened,

and when the motor slows down, the electro-magnet releases the lever and the spring carries it back to the starting position. This automatic release operates not only if the main circuit is opened but also if the field circuit is accidentally broken. If the field circuit be accidentally broken in Figure 14A, the armature will at once accelerate to an abnormal speed, and in fact is liable to fly to pieces. This is due to the fact that, in order to supply the required counter electromotive force on residual magnetism, a high speed is necessary.

The reason for opening the main switch first in stopping the motor is that then the field magnetism is gradually reduced as the motor slows down. Although the supply is cut off from the mains, the generator action of the armature continues to supply field excitation until the retaining magnet no longer holds the lever against the action of the spring. It is not dangerous to break the field circuit at a low excitation. If, on the other hand, the armature circuit is broken by means of the starting box, opening the main switch will then break the field circuit suddenly. This is undesirable because the potential energy contained in the magnetic field must escape in the form of an electric current, set up by the pressure of self-induction which is the result of the change in magnetism when the field circuit is broken. The quicker the break, the greater will be the pressure generated; that is, the intensity factor of the energy, or the pressure, will be greater since the energy must be dissipated in a shorter time. In large machines where the amount of this magnetic energy is considerable, the pressure of self induction will often be sufficient to puncture the insulation of the field winding.

Many commercial starting boxes are now so connected that the field is not excited until the lever is moved to the first resistance notch. The mere closing of the main switch does not excite the field in this case. This modification is the result of experience with people who form the habit of shutting down a motor by forcing the lever over to its initial position,

without opening the main switch, thus leaving the field on during idle hours without the ventilation due to the fanning action of the armature. This may also happen if the power is cut off and again turned on after the motor has been automatically stopped. Figure 14C shows the connections for a

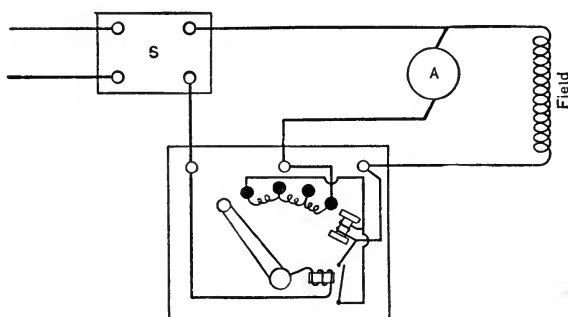

Fig. 14C. Shunt Motor with Overload Release Starting Box.

shunt motor starting box provided with an overload release. This release consists of an electromagnet in series with the armature, which operates its keeper at a predetermined value of the armature current. The keeper closes a local switch which short circuits the coil of the retaining magnet.

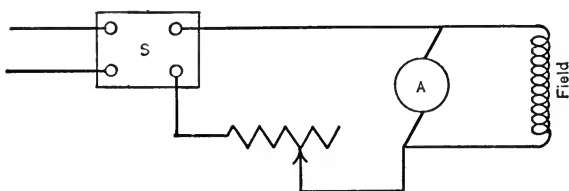

Fig. 14D. Shunt Motor with Faulty Connections.

Data. Start several shunt motors with starting boxes of different design. Start a series motor. Record your experiences.

Caution. In accelerating motors do it slowly; the power required to accelerate rapidly is comparatively great and may cause a belt to run off its pulleys or possibly to break.

Shunt motors, in testing departments and laboratories, are often operated separately excited. This should be avoided if possible, for a circuit breaker cannot be depended upon to act quickly

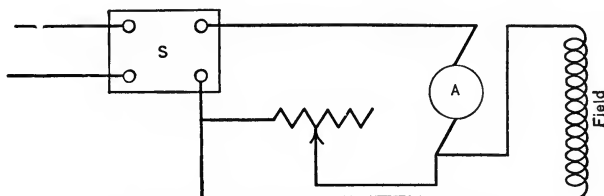

Fig. 14E. Shunt Motor with Faulty Connections.

enough on a failure of excitation. When separate excitation is used every precaution should be taken to prevent failure of the excitation.

Questions. Beginners often connect shunt motors as shown in Figures 14D and 14E. What will happen in each case?

No. 15. REVERSAL OF MOTORS. COMPARISON OF THE DIRECTION OF ROTATION AS A MOTOR WITH THAT OF THE SAME MACHINE RUN AS A DYNAMO, THE CONNECTIONS REMAINING THE SAME.

References. Fisher-Hinnen, p. 125; Houston and Kennelly, p. 304; Arnold's "Dynamos," p. 190; Sheldon, p. 161; Thompson's "Dynamos," p. 486; Carus-Wilson, pp. 60 and 94; Parham and Shedd, p. 36; Wiener, p. 423; Hawkins and Wallis, p. 68.

Object. The comparison between generator and motor conditions not only gives a clearer conception of principles; but also shows what dynamos have their direction of rotation reversed if, for any reason, they become motors while in operation.

The effect upon the direction of rotation, for both series and shunt motors, is to be observed for each of the following conditions.

- (a) When the current in the field is reversed.
- (b) When the current in the armature is reversed.
- (c) When the currents in both field and armature are reversed.

Method. First run the machine as a dynamo with field connections such that it will "pick up" as a self excited machine. Then take off the belt and, leaving all connections on the machine the same, run it as a motor, the positive terminal of the line being connected to what was the positive generator terminal; and note the direction of rotation. Reverse the field current. With the field excited in the original direction, reverse the armature current. With the connections of both armature and field as they were originally, reverse the impressed pressure.

If the observations are made in the reverse order by running as a motor first, some trouble may be experienced in making the dynamo "pick up." The results obtained should be tabulated and a general rule devised which will explain all the cases described above.

Show. By simple diagrams, how to connect, or how to change the connections, if necessary, of the following generators so that they shall have the same direction of rotation as motors and the same positive terminal. Shunt Generator—Shunt Motor. Series Generator—Series Motor. Cumulative Compound Generator—Cumulative Compound Motor. Differential Compound Generator—Differential Compound Motor.

No. 16. CALIBRATION OF AN AMMETER BY COMPARISON WITH A STANDARD AMMETER.

References. Nichols, vol. 2, p. 58; Parr, E. E. T., p. 5.

Object. Ammeters used in connection with the testing of dynamo machinery are liable to considerable error in their scale readings and this error often changes from time to time. It therefore becomes necessary, especially where a large

amount of testing is done, to make frequent calibrations. This is accomplished with greatest readiness by comparing the instrument with a standard ammeter, the accuracy of which is known.

Theory and Method. The comparison is made by placing the ammeter under test in series with the standard ammeter, as shown in Figure 16A, the circuit being so arranged that the current may be varied as desired, throughout the range of the ammeter under test. The pressure source should be steady. A storage battery is preferred.

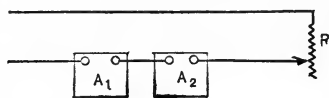

Fig. 16A. Calibration of an Ammeter.

Any ammeter of suitable range, which has been carefully standardized, may serve as the reference instrument. This standardization should be done either by the Potentiometer method described in Experiment 20 or by the Voltmeter method described in Experiment 22.

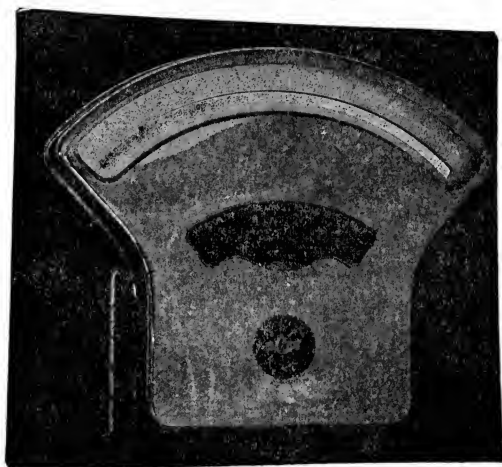

Fig. 16B. Weston Laboratory Standard Milli-Voltmeter.

Probably the best form of standard ammeter for direct current work is the Weston Laboratory Standard, Figure 16B.

These instruments are considerably larger than the ordinary Weston portable instruments, and are equipped with spirit levels and thermometers. They have a 12 inch scale and a pointer which is 8 inches long. The dividing lines of the scale are connected together by means of diagonal lines drawn through six concentric arcs placed equally distant from each other, Figure 16C. This arrangement permits the position of the pointer to be read accurately, to 0.2 of a scale division.

Like the Weston portable ammeter described on page 31, it is essentially a milli-voltmeter which measures the fall of

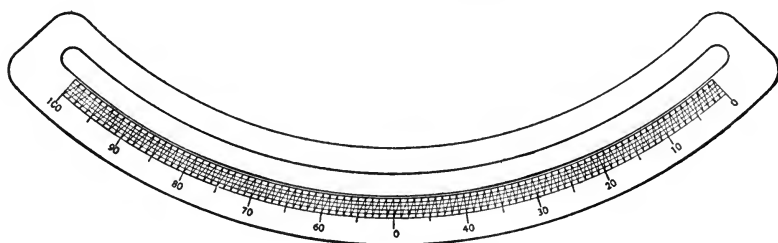

Fig. 16C. Scale of Weston Laboratory Standard Instruments, one-third size.

potential across a low resistance or "shunt" placed in series in the circuit. It differs from the portable type in being larger and in having the shunt separate. Several different scales may be obtained for the same instrument by providing several standard shunts. Such a shunt box is shown in Figure 16D.

For example, suppose the shunt box contains standard shunts of 1, 5, 10, 20, 50 and 100 amperes. This would mean that by making connections with the 1 ampere shunt, a full scale deflection on the instrument would be obtained with 1 ampere in the main circuit; and so on, for all shunts available, thus giving an extremely accurate instrument of very wide range.

Figure 16E shows the general arrangement of the shunt box, and also its connection to the standard milli-voltmeter and the

circuit in which the ammeter to be tested is placed. The connections are shown for using the 0 to 1 ampere scale.

The bus bar is a heavy copper terminal common to all shunts and the binding post *B* attached to it forms the posi-

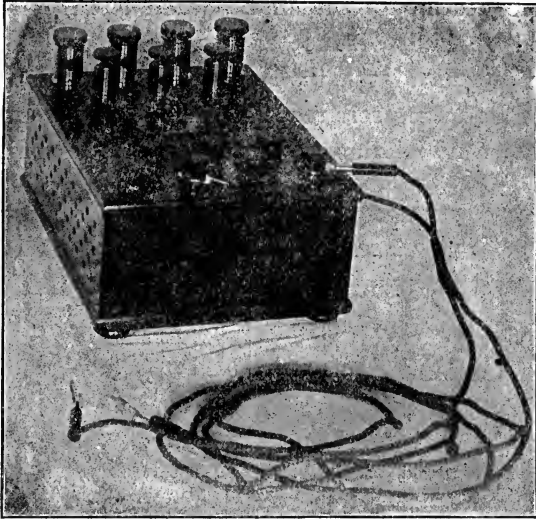

Fig. 16D. Shunt Box for Weston Laboratory Standard Milli-Voltmeter.

tive terminal of the shunt box. The other terminal of each shunt is brought to a separate binding post which forms the negative terminal of the shunt box when this particular shunt is used. These constitute the center row of posts marked 1, 5, 10, 20, 50, and 100, to indicate the full scale reading of the standard ammeter in each case.

The lower row of binding posts is for connection to the standard ammeter (milli-voltmeter) and the posts are marked to correspond with the shunts to which they are connected. The post *C* is always the $+$ terminal of the instrument. The resistances $R_1, R_2, R_3, R_4, R_5, R_6,$ and R_7 are for purposes of adjustment in standardizing the instrument at the factory, and have a fixed value after adjustment. A standard set of leads

for connecting the ammeter to the shunt box accompanies each instrument.

The temperature coefficient of the alloy used in the construction of these shunts is stated by the manufacturers to be less than 0.001 percent per degree Centigrade, so that even a considerable heating of the shunt, when left in circuit for a long period of time, will not appreciably affect the accuracy of the indications of the instrument. To prevent excessive heating the manufacturers recommend that the shunt be short-circuited when no readings are taken, if it is to remain in cir-

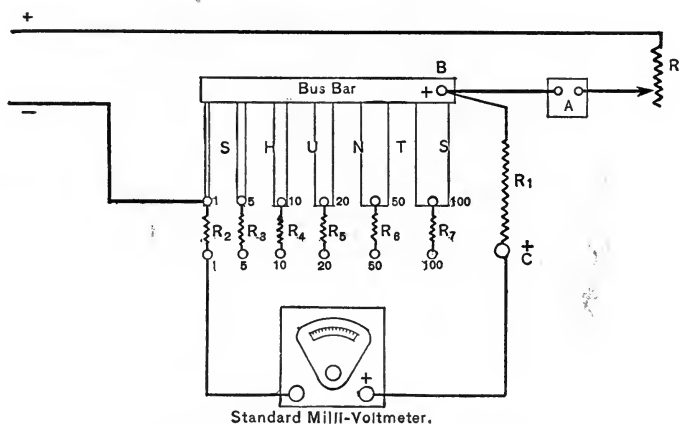

Fig. 16E. General Arrangement of Shunt Box.

cuit for more than half an hour. The indications are guaranteed to be correct within one tenth of one percent for a range of 10 degrees above or 10 degrees below 21 degrees Centigrade.

The method of representing the results of the calibration differs, as applied commercially. Some companies plot their calibration curves as in Figure 16F, where the abscissas represent the scale readings of the instrument under test. In this case, with equal scales, for ordinates and abscissas, a 45-degree line passing through the origin is the locus of the readings if the instrument under calibration is correct.

Another method of representing the calibration, and one which is favored by some companies, is that shown in Figure 16G, where the abscissas are the readings of the instrument; and the ordinates, above and below the center datum line, represent the amounts to be added to or subtracted from the indications of the instrument to make the readings correct.

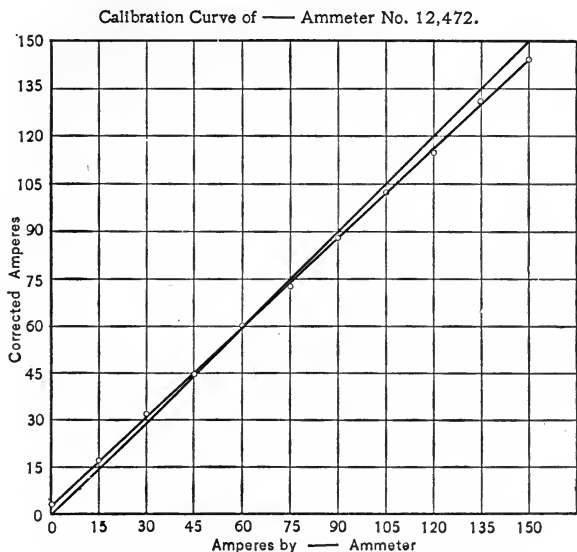

Fig. 16F. Ammeter Calibration Curve.

In some cases the testing department does not furnish a curve showing the error throughout the range for direct current instruments, but gives simply a correction constant by which all readings are to be multiplied to obtain the correct values.

The general practice of large companies is to check their working instruments once a week, or oftener if necessary. Calibration cards are then made out as in Figures 16F or 16G, and these cards accompany the instruments so that the corrected readings may be readily obtained.

Data. Connect the ammeter under test in series with the standard ammeter and a variable resistance R , and to a suit-

able source of current. Note any zero error in either instrument. Start at a low reading and check at least ten points on the scale between zero and the maximum scale indication, taking *simultaneous* readings of the two instruments in all cases. Make similar readings going down the scale.

Curves. Plot a curve taking the calibrated ammeter readings as abscissas and the standard ammeter readings as ordinates. Plot a second curve taking the calibrated ammeter readings as abscissas and the values to be added or subtracted as ordinates.

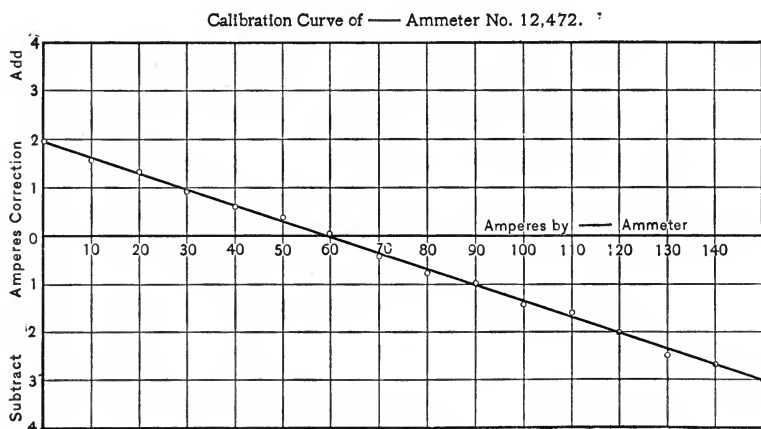

Fig. 16G. Ammeter Calibration Curve.

If the ascending and descending scale readings do not differ materially for given points, take the average of the two readings at any one point for the true reading. If there is a marked difference in this particular, plot separate curves for ascending and for descending values.

Explain. The great importance of making frequent calibration of instruments, especially when they are used almost continuously as in large manufacturing establishments. Show why it is necessary to take simultaneous readings of the two instruments compared.

No. 17. CALIBRATION OF A VOLTMETER BY COMPARISON WITH A STANDARD VOLTMETER.

References. Nichols, vol. 2, p. 59; Parr, E. E. T., p. 18.

Object. The object is to afford a ready means of quickly checking the accuracy of a voltmeter by comparing with a standard, the accuracy of which is known.

Theory and Method. The comparison is made by placing the voltmeter under test in parallel with the standard voltmeter, as shown in Figure 17A, the circuit being so arranged that the pressure across the voltmeters may be varied as desired throughout the range of the voltmeter under test.

Any voltmeter of suitable range, which has been carefully standardized, may be used as the reference instrument. This standardization should be done either

by the Potentiometer method, described in Experiment 21, or by the Voltmeter method described in Experiment 23.

Probably the best form of standard voltmeter for direct current work is the Weston Laboratory Standard, Figure 17B. This instrument is similar to the Weston portable voltmeter but differs in being larger. The resistance, also, for a given scale reading, is nearly double that in the Weston portable so that the current taken is only about one half as great.

These instruments, like the portables, may possess self contained resistances, and in some instances three scales are provided in this manner. Thus the same instrument may have a

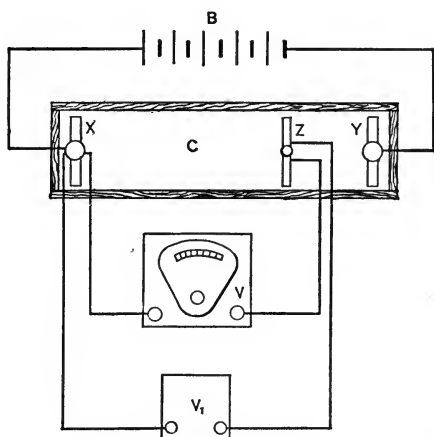

Fig. 17A. Calibration of a Voltmeter.

full scale deflection indicating 3, 15, or 150 volts, according to the connections made. Usually the + terminal is common, and the — terminals for the various scales are independent.

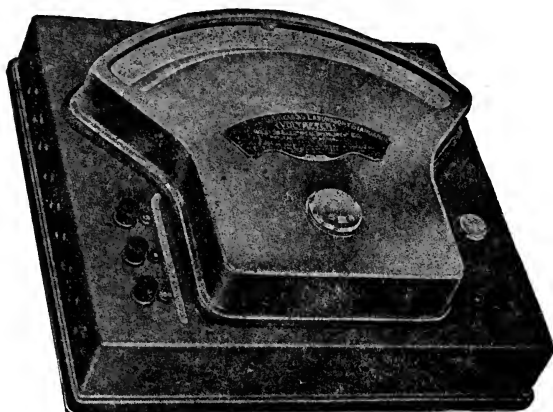

Fig. 17B. Weston Laboratory Standard Voltmeter.

Any number of higher scale readings may be obtained by the use of a multiplier, Figure 17C. This consists essentially of a standardized resistance which is placed in series with the voltmeter and so reduces the pressure across the voltmeter in a known ratio. Thus, if the resistance in the voltmeter for the 150 volt scale is 27,340 ohms and it is desired to measure up to 750 volts, the total resistance in the voltmeter circuit must be 5 times 27,340 or 136,700 ohms, since the same current will throw the pointer to the end of the scale in either case. This means that the multiplier must contain 109,360 ohms.

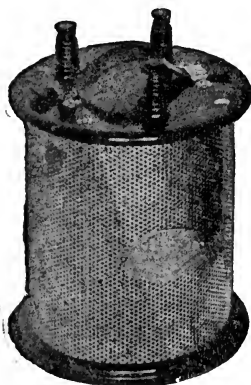

Fig. 17C. Multiplier for Weston Laboratory Standard Voltmeter.

The temperature coefficient of the wire used in the resistances is very low and the manufacturers guarantee the indications to be accurate to within one tenth of one

percent for a range of 10 degrees above to 10 degrees below 21 degrees Centigrade, unless temperature corrections are otherwise specified.

The two general methods of representing the results of the calibration which were discussed in Experiment 16 apply to voltmeter calibrations. The voltmeters are calibrated at stated intervals and calibration cards are filled out and accompany the instrument.

Data. Connect the voltmeter under test, V_1 , in parallel with the standard Voltmeter V , and supply them with a variable pressure of suitable range. This latter may be accomplished by impressing upon the two end plates X and Y of the liquid rheostat C a pressure from the battery B which is equal to or slightly greater than the maximum scale reading on the voltmeter to be calibrated. Then by connecting one common terminal of the voltmeters to one of the end plates X and the other to a movable plate Z , any desired voltage can be impressed on the two voltmeters.

Start at a low reading and check at least ten points on the scale between zero and the maximum scale indications, taking simultaneous readings of the two instruments in all cases. Take similar readings going down the scale.

Curves. Plot a curve taking the calibrated voltmeter readings as abscissas and the standard voltmeter readings as ordinates. Plot a second curve taking the calibrated voltmeter readings as abscissas and the values to be added or subtracted as ordinates, using a central datum line as shown in Figure 16G for an ammeter calibration.

If the true readings for given points of ascending and descending values do not differ materially, take the average of the two readings at any one point for the true reading. If there is a marked difference in this particular, plot separate curves for ascending and for descending values.

Explain. How an error may occur in the calibration if two voltmeters are provided with contact keys and first one and then the other is read; even if the supply pressure remains constant.

No. 18. CALIBRATION OF AN AMMETER BY MEANS OF A KELVIN BALANCE.

References. Fleming, p. 360; Parr, E. E. T., pp. 7, 8 and 350; Gray, p. 95; Carhart and Patterson, p. 141; Henderson, p. 162; Parr, P. E. T., p. 274; Armagnat, p. 238; Thompson's "Lessons," p. 393; Jackson's "Electricity and Magnetism," p. 188; Slingo and Brooker, p. 130.

Object. As the Kelvin Balance is recognized as a standard instrument, the object is to learn its use in calibrating an ammeter.

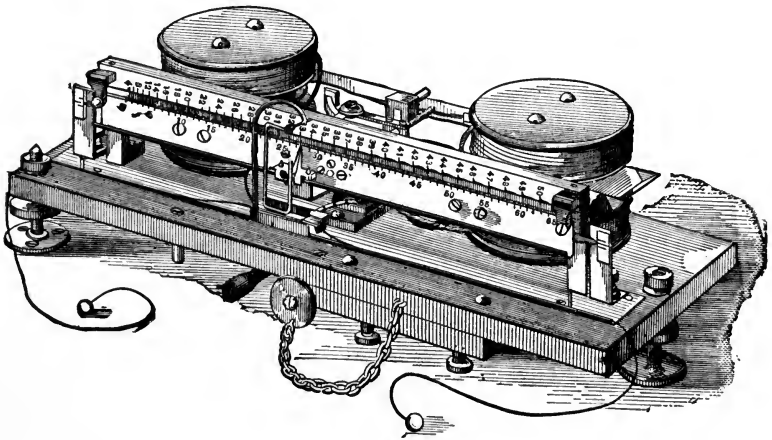

Fig. 18A. Kelvin Centi-Ampere Balance.

Theory and Method. There are a number of different types of Kelvin balances, the simplest of which is probably the Centi-ampere Balance, shown in Figures 18A and 18B. In this

instrument there are six coils which are connected in series, between the terminals *TT*. The two center coils *XX* are movable, while the other four coils are fixed. The current flows through the coils in such a direction (shown by the arrows) that the right hand end of the movable system is forced upward. The movable coils are suspended by fine, flexible wire which serves at the same time to carry the current to these coils. This movement of the coils is balanced by known weights which may be slid along the scale mounted on the movable system. The moment acting upon the beam is proportional to the product of the currents in the two coils;

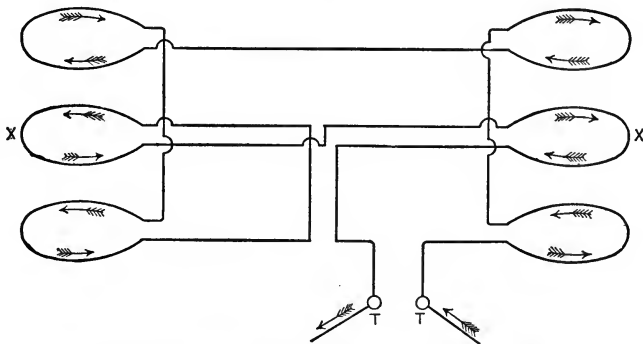

Fig. 18B. Kelvin Centi-Ampere Balance Connections.

and further, since the coils are connected in series, this moment will be proportional to the square of the current.

The movable scale is a uniformly divided one. A fixed or inspectional scale, mounted above the movable one, is graduated so that its divisions are the doubled square roots of the divisions of the movable scale. The constants of the instrument must be multiplied by the fixed scale reading to obtain the current. By means of the fixed scale, a rough idea of the current may be had without calculation.

The Composite Balance, shown diagrammatically in Figure 18C, may be used as a Centi-ampere Balance to measure small currents up to one ampere, or it may be used as a Hekto-

ampere Balance to measure large currents up to several hundred amperes. *XX* are movable coils wound with fine wire; *NN* are fixed fine wire coils; and *DD* are fixed coils wound with a few turns of heavy wire. If used as a centi-ampere balance the terminals *B* and *C* are used and the fixed fine wire coils *NN* are thrown in series with the movable coils *XX* by throwing the switch marked *S* to the side marked *volt*.

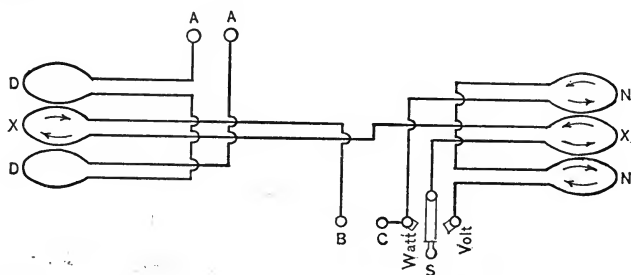

Fig. 18C. Kelvin Composite Balance Connections.

To use the instrument as a hekto-ampere balance, the current to be measured is sent through the large wire fixed coils whose terminals are marked *AA*. A current of about 0.25 of an ampere is sent from a separate source (preferably storage cells) through the movable coils only, the switch *S* being turned to the side marked *watt*. The direction of the current in the coils should be such that the right hand end of the beam is forced upward. This upward force is balanced by known weights as before, their constants being given on the assumption that 0.25 ampere is flowing through the movable coil. Any other known value of current may be used in the movable coil provided it be remembered that the constants of the weights vary inversely with the current in the movable coil. To measure the current in the movable coil, it is necessary to have a standard ammeter in the circuit, or the balance itself may be employed for the purpose if used as a centi-ampere balance. It is well, however, to have an ammeter in the cir-

cuit to see that the current remains constant after the measurement has once been made in this way.

In using the balance, the suggestions given in the pamphlet accompanying the instrument, regarding the corrections for temperature, should be carefully observed.

Data. Connect the ammeter under test in series with the Kelvin balance and a variable resistance, and to a suitable source of pressure. Note any zero error in the ammeter and adjust the zero of the balance. Start at a low reading and check at least ten points on the scale between zero and the maximum scale indication, taking *simultaneous* readings of the two instruments in all cases. Take similar readings going down the scale.

Curves. A calibration curve should be drawn from the data, using the readings of the balance as ordinates, and the readings of the ammeter as abscissas. Make the comparison for a sufficient number of points in the range of the instrument to permit of a good curve. A second curve should be drawn using errors as ordinates and ammeter indications as abscissas. The sign of the errors should be indicated.

Suggestion. Three or four storage cells and a field rheostat are most convenient to use in supplying and regulating the auxiliary current in the movable coil.

Explain. Why a counterpoise is used. What tests are necessary to obtain the constant when the carriage is used without weights and with a suitable counterpoise.

No. 19. CALIBRATION OF A VOLTMETER BY MEANS OF A KELVIN BALANCE.

References. Fleming, p. 360; Parr, E. E. T., pp. 21, 22 and 350; Gray, p. 95; Henderson, p. 162; Carhart and Patterson, p.

141; Armagnat, p. 238; Parr, P. E. T., p. 274; Jackson's "Electricity and Magnetism," p. 188; Thompson's "Lessons," p. 393; Slingo and Brooker, p. 130.

Theory and Method. To calibrate a voltmeter, the balance is used as a centi-ampere instrument. If the resistance of the balance is known, the pressure impressed upon its terminals is $E = Ir$, r being the resistance of the fine wire coils in series, and I the current due to the pressure E .

This permits of pressure readings up to about thirty volts. If higher pressures are to be measured, an extra resistance, or multiplier, is furnished with the balance and is placed in series with it.

The voltmeter to be calibrated is placed across both the resistance and balance as shown in Figure 19. Incorrect readings would result if the voltmeter were placed across the extra

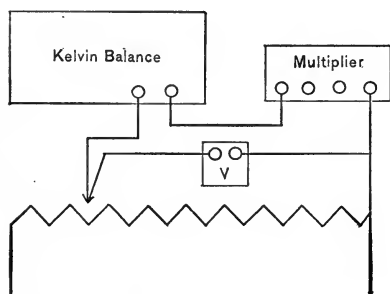

Fig. 19. Calibration of a Voltmeter by Kelvin Balance.

resistance only, for the balance would then measure the current through the voltmeter in addition to that in the resistance. The current in the multiplier must never be allowed to exceed half an ampere. Some means of varying the pressure on the voltmeter terminals is necessary.

Figure 19 shows a convenient method of doing this. A pressure which is at least as high as the highest reading of the voltmeter is impressed upon the terminals of a rheostat, it being necessary to have but a small current flowing through it. There is a uniform fall of pressure from terminal to terminal, and, by connecting the instruments across one terminal and a movable intermediate point, as shown, any desired pressure may be impressed upon the instruments.

Data. Corresponding readings of voltmeter and balance should be taken throughout the entire range of the voltmeter, temperature corrections being made.

Curves. A calibration curve should be drawn, using the readings of the balance as ordinates and the indications of the voltmeter as abscissas. A curve should also be drawn using errors as ordinates and the readings of the voltmeter as abscissas.

Explain. Why corrections for temperature are necessary in the calibration of a voltmeter and not in that of an ammeter.

Why it is necessary to keep the voltmeter circuit closed until after the balance reading has been taken.

No. 20. CALIBRATION OF AN AMMETER BY THE POTENTIOMETER METHOD.

References. *Poggendorf's Annalen*, vol. 54, 1841, p. 161; Fisher, pp. 4 and 11; Fleming, pp. 134 and 372; Parr, E. E. T., pp. 11 and 326; Parr, P. E. T., p. 96; Armagnat, p. 473; Kempe, p. 195; Trade Bulletins.

Object. Where laboratory standards and Kelvin balances are not available, and also in standardizing these standard instruments, methods of calibration must be employed which do not involve instruments already calibrated. Such methods may be called *primary* and those involving the use of a standard instrument may be called *secondary* methods. The potentiometer method permits of the calibration of an ammeter with great accuracy throughout its entire range, and hence is admirably adapted to the standardization of laboratory standards and Kelvin balances.

Theory and Method. The fall of potential method is used in measuring the current, a standard resistance being employed. The pressure across this resistance is measured by comparison with the e. m. f. developed by a standard cell.

In Figure 20A, J is the standard resistance, A is the ammeter to be calibrated, and W is a variable resistance for controlling the current supplied to A and J in series from a separate source not shown. CDF is a carefully selected and calibrated high resistance wire of uniform cross-section, which is stretched over a scale as in the slide wire bridge. Any desired difference of potential is maintained between the ends CF by means of the battery B and the adjustable resistance R . As but a single standard cell is used, however, the potential difference between C and F is generally adjusted to 1.5 volts and the scale divided into 1500 divisions.

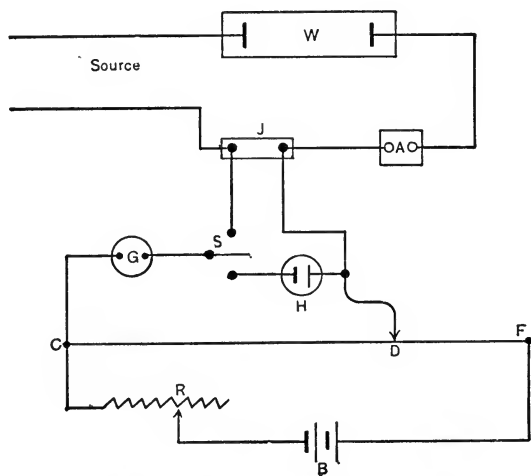

Fig. 20A. Calibration of an Ammeter by Potentiometer Method.

The standard cell is shown at H , the connections being such that either the e. m. f. of the standard cell or the pressure across the standard resistance J may be thrown on the wire between the terminal C and the adjustable contact D by operating the switch S .

The general method of operation may be best shown by an example. Suppose the e. m. f. of the standard cell is 1.434 volts at 15° C., and that the temperature is adjusted to this

value. The cell is thrown in circuit with the contact *D* at the point 1,434 on the scale and the "drop" in the wire *CF* adjusted so that there is no deflection of the galvanometer *G*, care being taken that like terminals of *B* and *H* are connected to *C*. Under this condition the total drop from *C* to *F* is exactly 1.5 volts or 1/1,000 volt per scale division. The switch *S* is then thrown over and the drop across *J* measured. Suppose this balance occurs at the 1,200 mark on the scale. The drop across *J* is then 1.2 volts. If *J* is a standard resistance which is exactly 0.02 ohms, the current in *J* must be

$$I = \frac{1.2}{0.02} = 60 \text{ amperes.}$$

The ammeter *A* should indicate 60 amperes as it is in series with the standard resistance *J*. By the use of several standard resistances, ammeters of various ranges may be calibrated in this way.

Instead of putting the entire resistance *CF* in the form of a slide wire, a common way is to use the method shown in

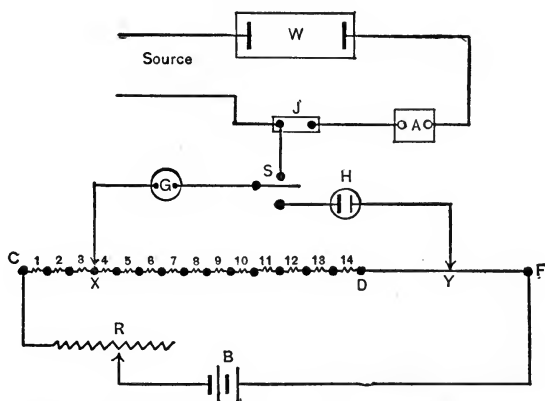

Fig. 20B. Calibration of an Ammeter by Potentiometer Method.

Figure 20B. Between *C* and *D* are fourteen equal resistances in series having contact points between them; and between

D and F is a uniform straight wire the resistance of which is equal to one of the resistances between C and D . The wire DF has a scale dividing it into 1,000 parts. By having both contact points X and Y movable, any pressure may be obtained between them from zero to the pressure across CF , by steps of $1/15,000$ of the total. Thus, if the pressure across CF is adjusted to 1.5 volts, as is usually the case, any pressure from 0 to 1.5 volts may be obtained by steps varying by $1/10,000$ of a volt.

The accuracy of the potentiometer readings depends largely upon the uniformity of the slide wire and upon the accuracy with which the resistance CDF may be subdivided. The improved forms devised by Crompton, Elliott, Fleming, Leeds, Nalder, Wolff and others have various ways of overcoming the difficulties involved.

Data. Standardize an ammeter by the potentiometer method, employing one of the improved forms or using the simple arrangement shown in Figures 20A and 20B. Take observations for at least ten points on the ammeter scale and for both increasing and decreasing values of current.

Curves. Plot a curve taking the calibrated ammeter readings as abscissas and the corrected amperes as ordinates. Plot a second curve taking the calibrated ammeter readings as abscissas, and the values to be added or subtracted as ordinates.

If there is no material difference in the ascending and descending values, take the average of these for a given scale reading. If there is a material difference, plot curves for both ascending and descending values.

Describe. The potentiometer used in your experiment, showing particularly the methods employed in making the finer adjustments and bringing out the points in which it appears to be superior to the simple form or to other improved forms of potentiometers. Show fully its applicability to the measurement of current.

No. 21. CALIBRATION OF A VOLTMETER BY THE POTENTIOMETER METHOD.

References. *Poggendorf's Annalen*, vol. 54, 1841, p. 161; Fisher, pp. 6, 11, and 149; Fleming, pp. 134, 429, and 443; Parr, E. E. T., pp. 16, 23, and 323; Parr, P. E. T., p. 96; Armagnat, p. 473; Kempe, p. 195; Trade Bulletins.

Object. The potentiometer permits of the calibration of voltmeters over the entire scale with great accuracy, the standard of comparison being the electromotive force of a single standard cell. A cell of the Carhart-Clark type is a simple, portable and inexpensive standard, and may be relied upon to be correct within one tenth of one percent, if properly used.

Theory and Method. As in the calibration of an ammeter, the potentiometer method of calibration of a voltmeter depends upon the comparison of the fall of potential across a known standard resistance, with the electromotive force of a standard cell.

The general arrangement of apparatus is shown in Figure 21, where V is the voltmeter under calibration, S is a pressure source, and L is a liquid resistance by means of which a variable pressure may be obtained at the voltmeter terminals.

The voltmeter is connected directly to the terminals of a standard high resistance $MOPN$ which is suitably subdivided

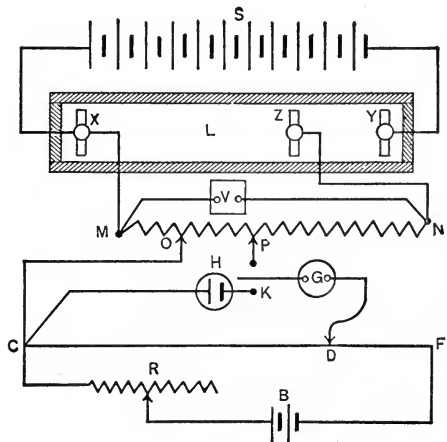

Fig. 21. Calibration of a Voltmeter by the Potentiometer Method.

and calibrated so that the terminal impressed pressure may be readily obtained, provided the pressure is known between any two given points OP .

CDF is a carefully selected and calibrated high resistance wire of uniform cross-section, which is stretched over a scale as in the slide wire bridge. Any desired difference of potential is maintained between the ends CF by means of the battery B and the variable resistance R . As but a single standard cell is used for comparison, the potential difference between C and F is generally adjusted to 1.5 volts, and the scale divided into 1,500 divisions.

The standard cell is shown at H , the connections being such that either the electromotive force of the standard cell or the fall of potential across OP may be placed between the terminal C and the adjustable contact D , by means of the switch K .

Suppose the e.m.f. of the standard cell is 1.434 volts at 15° C., and that this is the temperature of the cell at the time of calibration. The cell is thrown in circuit with the contact D at the point 1,434 on the scale and the pressure at the terminals CF is adjusted until there is no deflection of the galvanometer G , care being taken that like terminals of B and H are connected to C . This will be the condition when the pressure difference between C and F is exactly 1.5 volts, or $1/1,000$ volt per scale division.

Suppose the voltmeter under calibration indicates to 150 volts and that the 120 volt point on the scale is being checked. The contact points OP may be adjusted so that the pressure across them is the one-hundredth part of the terminal pressure of the resistance MN . This pressure may now be impressed across CD and the contact D moved until the galvanometer shows no deflection. Suppose this reading shows 1.23 volts across OP . The pressure across the terminals of the standard resistance $MOPN$ must then be 123 volts and this is the corrected voltmeter reading.

As described in Experiment 20, the resistance CF may be so arranged that only a fraction of it is made up in the form of a slide wire. This is shown in Figure 20B.

As stated in Experiment 20, the accuracy of potentiometer readings depends largely upon the uniformity of the resistances over which the fall of potential is measured and upon the accuracy with which they may be subdivided. Various improved forms have been devised.

Data. Standardize a voltmeter by the potentiometer method, employing one of the improved forms, or using the simple arrangement shown in Figure 21. Take observations for at least 10 points on the voltmeter scale, and for both increasing and decreasing values of pressure.

Curves. Plot a curve, taking the calibrated voltmeter readings as abscissas and the corrected volts as ordinates. Plot a second curve, taking the calibrated voltmeter readings as abscissas, and the values to be added or subtracted as ordinates. If there is no material difference in the ascending and descending values, take the average of these for a given scale reading. If there is a material difference plot curves for both ascending and descending values.

Describe. If you have not already done so in connection with the report on Experiment 20, describe the potentiometer used in your experiment, showing particularly the methods employed in making the finer adjustments and bringing out the points in which it appears to be superior to the simple form and to other improved forms of potentiometers. Show fully its applicability to the measurement of pressure.

No. 22. CALIBRATION OF AN AMMETER, USING A COPPER VOLTAMETER.

References. Thomas Gray, *Phil. Mag.*, vol. 22, 1886, p. 389; A. W. Meikle, *London Elec.*, vol. 20, 1888, p. 571; H. J.

Ryan, *Transactions*, A. I. E. E., vol. 6, 1889, p. 322; Fleming, p. 342; Nichols, vol. 1, p. 166; Parr, E. E. T., p. 14; Parr, P. E. T., pp. 121 and 331; Gray, p. 162; Henderson, p. 151; Carhart and Patterson, pp. 156 and 161; Jackson's "Electricity and Magnetism," p. 164; Armagnat, p. 498; Munroe and Jamieson, p. 117; Thompson's "Lessons," p. 230.

Object. Where laboratory standards and Kelvin balances are not available, and also in the standardization of these instruments, methods of calibration must be employed which do not involve instruments already calibrated. The voltameter method of measuring current permits of the calibration of an ammeter with accuracy, and hence it has been used to a considerable extent in the standardization of instruments.

Theory and Method. A large number of experiments by various investigators has demonstrated that with proper precautions current measurements based upon the electrolysis of silver or copper may be made with an accuracy to within one tenth of one percent of the correct value.

The electrolysis of silver nitrate with silver anode and cathode is generally favored for the measurement of small currents and is also considered by some authorities to give more accurate results than the copper voltameter for measurements of larger currents, especially in the hands of experienced experimenters. However, for currents above ten amperes, the electrolysis of copper sulphate with copper anode and cathode is generally employed. This is not only because of the excessive cost of the necessary materials, but also because of the greater difficulties of operation when using the silver voltameter. As the copper voltameter is the easier to manipulate and gives the greater accuracy, except in the hands of experienced observers, it is the one considered in this and the following experiment. The general arrangement of apparatus for the calibration of an ammeter is shown in Figure 22A. The copper voltameter is shown at *F* and consists of two cop-

per plates *C* and *D* dipped into a vessel containing a copper sulphate solution. The current passing through this cell also passes through the ammeter *A* which is under calibration. The source of pressure is the battery *B*, and the current is controlled by the variable resistance *R* and the switch *S*.

If the current flows from *C* to *D* the solution is decomposed, the metal from the solution being deposited upon the cathode *D*, and the acid part of the compound attacking the anode *C* and forming a new portion of the compound which is dissolved in the solution. If there were no chemical actions ex-

cept that caused directly by the current, the anode should be expected to lose exactly the same amount of metal as the cathode gains in a given time. The loss of the anode is not as reliable a measure of the current as the gain of the cathode, however, as bits of metal are liable to be loosened from the anode and fall off. The oxidation is also greater on the anode.

Anodes and Cathodes.—The size of the plates may be varied within wide limits if the copper voltameter is used, without greatly interfering with the quality of the deposit. The cathodes should present about 50 square centimeters of surface per ampere of current. It is advisable to have the anode somewhat larger than the cathode, as the resistance at the anode becomes variable if the current density is high. A very

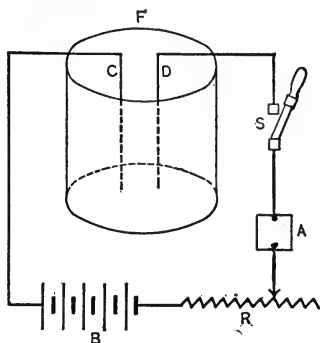

Fig. 22A. Calibration of an Ammeter by the Voltameter Method.

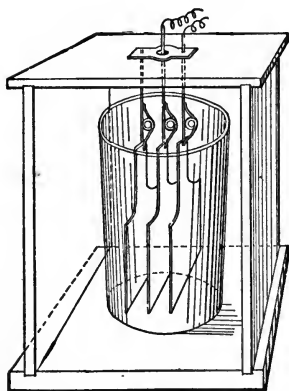

Fig. 22B. Copper Voltameter.

convenient arrangement is that shown in Figure 22B where there are three plates, the center one being the cathode and the two outer ones constituting the anode.

The plates are usually made of pure sheet copper, all corners being rounded off and the surfaces cleaned and polished with sandpaper, and washed in pure water slightly acidulated with sulphuric acid. Great care should be taken in the preparation of the cathode, but it is unnecessary to spend much time in the preparation of the anode. The cleansing process should be done immediately before using the plates.

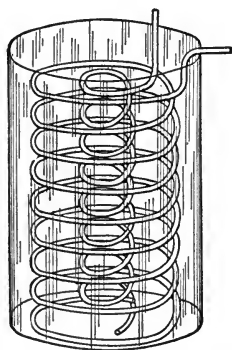

Fig. 22C. Spiral Coil Voltameter.

The spiral coil voltameter* has been very successfully employed in the standardization of instruments. The copper plates are replaced by two spiral coils made of copper wire, as shown in Figure 22C. Here the outer coil constitutes the anode and the inner one the cathode. This form has the advantage that the wire is more generally avail-

able and that it may be more readily cleaned than the sheet copper.

Solution.—The solution should be of a density preferably between 1.10 and 1.18, but it is not advisable to use a saturated solution because there is then risk of crystals forming on the plates. The addition of one percent of free sulphuric acid has a tendency to produce greater uniformity in results. There should be about 1000 cubic centimeters of solution per ampere of current.

Trial Cathode.—A common method of operation is to make up an extra cathode exactly similar to the one used in the test, the object being to place this extra cathode in the voltameter for the purpose of adjusting the current to the proper amount

* See H. J. Ryan in references.

before the cathode used in the test is inserted. Some experimenters prefer to place the working cathode in the voltameter for adjusting the current and then to remove, dry and weigh the cathode again before proceeding with the test. By this latter method a slight deposit is formed on the cathode, which is indicative of the general character of the deposit resulting from the test.

The weight in grams deposited by one ampere in one second is called the electro-chemical equivalent. From experiments conducted in Lord Kelvin's standardizing laboratories in Glasgow it was found that the electro-chemical equivalent depends upon the current density at the cathode and upon the temperature of the electrolyte. The following table* gives the proper electro-chemical equivalent in grammes per coulomb for copper. It is seen that the true value is not far from 0.000328, and that it decreases slightly both for a decrease in cathode current density and for a rise in temperature.

The Electro-chemical Equivalent of Copper in Grammes per Coulomb.

Current Density at Cathode Surface in Sq. Cm. per Amp.	Temperature of the Electrolyte.				
	2° C.	12° C.	23° C.	28° C.	35° C.
50	0.0003288	0.0003287	0.0003286	0.0003286	0.0003282
100	0.0003288	0.0003284	0.0003283	0.0003281	0.0003274
150	0.0003287	0.0003281	0.0003280	0.0003278	0.0003267
200	0.0003285	0.0003279	0.0003277	0.0003274	0.0003259
250	0.0003283	0.0003278	0.0003275	0.0003268	0.0003252
300	0.0003282	0.0003278	0.0003272	0.0003262	0.0003245

It is advisable to use two voltameters in series, the one acting as a check on the other.

Data. Calibrate an ammeter for one or more points on its scale by means of the copper voltameter. Carefully prepare

* See A. W. Meikle in references.

the voltameter for the measurements desired, following the suggestions given above.

Carefully weigh the cathodes on a balance weighing to milligrams, and insert them in the voltameter after having adjusted the current to the proper value by using the trial cathodes. Note the time at which the circuit is closed. The run should be for thirty minutes or more, depending upon the current density at the cathode.

Maintain the current as constant as practicable during the run and take readings of the ammeter at intervals of one minute or less. Take the mean of these readings as the indication of the instrument. Note the time at which the circuit is opened. Take the temperature of the electrolyte. Remove the cathodes, dry carefully and reweigh them.

Calculate. The current, using the proper value of the electro-chemical equivalent as given in the table. Obtain the value of current for each voltameter independently and take the mean if they give approximately the same results. If they differ materially the test should be repeated.

No. 23. CALIBRATION OF A VOLTMETER, USING A COPPER VOLTMETER.

References. Thomas Gray, *Phil. Mag.*, Vol. 22, 1886, p. 389; A. W. Meikle, *London Elec.*, Vol. 20, 1888, p. 571; H. J. Ryan, *Transactions*, A. I. E. E., Vol. 6, 1889, p. 322; Fleming, p. 343; Nichols, Vol. 1, p. 166; Parr, E. E. T., p. 14; Parr, P. E. T., pp. 121 and 331; Gray, p. 162; Henderson, p. 151; Carhart and Patterson, pp. 156 and 161; Jackson's "Electricity and Magnetism," p. 164; Armagnat, p. 498; Munroe and Jamieson, p. 117; Thompson's "Lessons," p. 230.

Object. The voltameter method permits of the accurate calibration of a voltmeter, and is not dependent upon instruments already standardized.

Theory and Method. As in Experiment 22, the calibration depends upon a measurement of current by the electrolysis of copper, and all the general directions and precautions considered in that experiment should be observed here also.

Two general methods of procedure are available. Either the voltmeter V may be placed in series with the voltameter F , as in Figure 23A, or it may be shunted across a standard resistance S , placed in series with the voltameter, as shown in Figure 23B.

In the first method, if the resistance of the voltmeter is known, and the current for a given deflection is obtained by the voltameter, the true pressure reading may be determined by the application of Ohm's law, and may be compared

with the indication of the instrument. The disadvantage here is that voltmeters take but a very small current, and the increase of the weight of the cathode is very slight unless the run be extended over a considerable period of time.

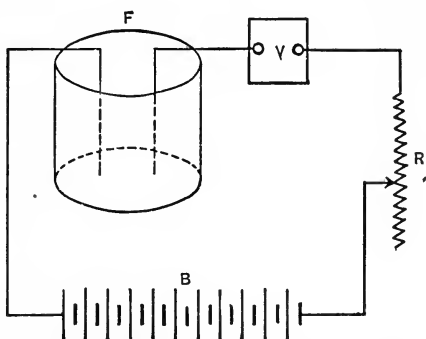

Fig. 23A. Calibration of a Voltmeter by the Voltmeter Method.

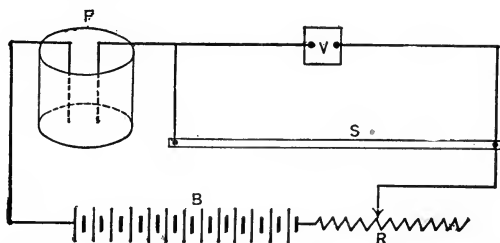

Fig. 23B. Calibration of a Voltmeter by the Voltmeter Method.

By using a comparatively low standard resistance in Figure 23B, a current may be obtained through the voltameter sufficiently large to produce an appreciable deposit on the cathode

in a reasonable time. For example, a 30 ohm standard resistance, capable of carrying 5 amperes without undue heating, would permit of the calibration of a 150 volt voltmeter at its full scale reading. By the use of several standard resistances of different values, each of 5 amperes capacity, various points on the scale of the voltmeter might be checked up with equal accuracy.

In making the calibration in this way, care should be taken to correct for any increase in the value of the standard resistance, due to rise in temperature. The data necessary for this correction will generally accompany the resistance.

Correction should also be made for the current traversing the voltmeter, as the current through the voltmeter is the sum of the currents through the voltmeter and standard resistance. For example, suppose the current as measured by the voltmeter is 4.96 amperes, and that the resistance of the standard is 30 ohms at the temperature attained under the test conditions. Suppose also that a 150-volt instrument is under calibration and that its resistance is 15,000 ohms. The joint resistance is

$$R = \frac{30 \times 15,000}{15,000 + 30} = 29.94 \text{ ohms,}$$

and the pressure at the terminals is

$$E = IR = 4.96 \times 29.94 = 148.5 \text{ volts.}$$

If the voltmeter indication is 150 volts, it indicates too high at this point by 1.5 volts. If several points on the scale are checked, a calibration curve may be drawn. If but the one point is calibrated, the readings of the instrument throughout the scale are multiplied by a correction constant, K , determined for the point calibrated. In the example given, the correction constant would be

$$K = \frac{148.5}{150} = 0.99.$$

Data. Calibrate a voltmeter for one or more points on the scale by means of the copper voltameter, using the method shown in Figure 23B. Carefully prepare the voltameter for the measurements desired, following the suggestions given in Experiment 22.

Carefully weigh the cathodes on a balance weighing to milligrams, and insert them in the voltameter after having adjusted the current to the proper value by using the trial cathodes. Note the time at which the circuit is closed. If the current used is approximately 5 amperes, the run should be from thirty to sixty minutes. Maintain the current as constant as practicable during the run and take readings of the voltmeter at intervals of one minute or less. Take the mean of these readings as the indication of the instrument. Note the time at which the circuit is opened. Take the temperatures of the electrolyte and the standard resistance. Remove the cathodes, dry carefully and reweigh them. If not already known, measure the voltmeter resistance.

Calculate. The current passed through the voltameter, using the proper value of the electro-chemical equivalent as given in the table in Experiment 22. Obtain the value of current for each voltameter independently and take the mean, if they give approximately the same result. If they differ materially, the test should be repeated.

Make the temperature correction for the standard resistance and calculate the joint resistance in parallel. From this and the current measured by the voltameter, compute the pressure at the terminals of the voltmeter.

Calculate the correction constant of the voltmeter.

No. 24. MAGNETIZATION CURVES OF DYNAMOS.

References. Hopkinson's "Papers," Vol. 1, p. 84; Hopkinson's "Dynamos," p. 79; Fisher-Hinnen, p. 192; Jackson's "Dynamos," p. 195; Sheldon, p. 270; Houston and Kennelly,

p. 211; Arnold's "Dynamos," p. 423; Nichols, Vol. 2, pp. 14 and 17; Parr, E. E. T., p. 145; Parham and Shedd, p. 426; Wiener, p. 478; Thompson's "Design," p. 37; Thompson's "Dynamos," p. 128; Kapp's "Dynamos," p. 259; Du Bois, p. 195; Hawkins and Wallis, p. 333.

Object. The magnetization curves for a series and also for a shunt dynamo are to be obtained by the method described.

Theory and Method. The magnetization curve, sometimes called the internal characteristic, shows the relation between the magnetizing force and the corresponding pressure generated by the armature.

As it is possible to measure the pressure generated in the armature only when the current flowing in it may be neglected, it is seen that in a series dynamo, the exciting current must be supplied from a separate source. In a shunt dynamo it makes practically no difference whether the machine is self or separately excited, since in the first case the "drop" due to the exciting current, which is supplied by the armature, may be neglected.

Since the number of armature conductors is constant and the speed remains the same throughout the experiment, the pressure at the terminals varies directly with the useful magnetic flux.

In order to obtain the magnetization curve it is necessary to run the dynamo at its normal speed and to take readings at the terminals of the armature, of the pressures corresponding to the various values of current in the field. A series of such readings should be taken for both increasing and decreasing values of field current. These two curves will not coincide, owing to the hysteresis effect of the iron of the field cores. In obtaining data for the rising curve, be careful not to exceed the value of the field current for the desired reading. If for any reason the desired value is exceeded, the field current should be lowered to the starting point and then brought up

to the desired value. Similar precautions are necessary in taking readings for the descending curve, care being taken not to reduce the current more than necessary and then raise it again. Should this happen, start again from the maximum point of the curve.

The speed of the armature may vary some while the pressure readings are being taken. If this occurs the pressure readings should all be reduced to a common speed, by considering that the pressure is directly proportional to the speed.

Apparatus. An ammeter and a voltmeter of suitable range, a speed counter and a resistance for varying the field current.

Data. Readings should be taken of pressure, speed and field current from zero up to normal field excitation or beyond and then for decreasing values, back to zero. Ascertain the winding data of the machine. Take a curve from a series machine and from a shunt machine.

Curves. A curve should be plotted which shows the relation between the number of ampere turns on the field and the resulting number of lines of force threading the armature for both ascending and descending currents.

Suggestion. If the resistance is in series with the field, a high resistance will be found necessary in order to obtain readings at low values of excitation. High resistances of sufficient carrying capacity are not always at hand. A convenient method is to place a variable resistance of a maximum value several times the resistance of the field in parallel with the field, and to place a second resistance in series with this combination. The paralleled resistance should be used only in obtaining low values of the excitation.

Question. Given a 500 volt dynamo, with at least two shunt field coils, a 250 volt circuit from which to take exciting current, a 250 volt voltmeter, and an ammeter of suitable range, how would you obtain the magnetization curve running up to normal magnetization?

No. 25. DETERMINATION OF DEPTH OF AIR GAP
OF A DYNAMO FROM ITS MAGNETIZATION
CURVE.

References. Nichols, Vol. 2, p. 89; Jackson's "Dynamos," p. 197; Fisher-Hinnen, p. 191; Thompson's "Dynamos," p. 150; Parr, E. E. T., p. 172; Thompson's "Design," p. 136; Hopkinson's "Dynamos," p. 80; Hopkinson's "Papers," Vol. 1, p. 87; Arnold's "Dynamos," p. 205; Hawkins and Wallis, p. 289; Wiener, p. 208.

Object. The object is to determine the depth of the air gap of a dynamo by calculation, after having obtained experimentally the complete hysteresis loop of the magnetization curve. This is of interest principally to the designer.

Theory and Method. The magnetic circuit of a dynamo may be considered as made up of three parts; the field magnets, the air gap and the armature core. Consequently, for any given value of the magnetic induction in the air gap, the *total* magnetizing force due to the ampere turns of the field must be equal to the sum of the separate magnetizing forces necessary in the three parts of the magnetic circuit. For low values of magnetic induction, the permeability of the iron in the armature core and fields is so great that the magnetizing force expended in these parts of the circuit may be neglected, in comparison with that expended in the air gap, without appreciable error.

Since the magnetic permeability in the air gap is unity, its magnetization curve must be a straight line which passes through the origin of coördinates. To get the slope of this line, it is best to take a complete hysteresis loop of the magnetization curve of the dynamo, preferably running the maximum excitation well beyond the normal value. If points on the curve be taken close together for values of excitation below the knee of the magnetization curve, it will be found

that the two sides of the hysteresis loop will be parallel straight lines for quite a distance above and below the origin. A straight line drawn through the origin parallel to these sides, as in Figure 25, will represent the air gap magnetization curve.

To take this hysteresis loop, it is best to start at the maximum excitation, decreasing the field current to zero and then reversing it; after which it is again increased to the same maximum value in the opposite direction. This gives one half of the loop. The other half may be obtained in a similar manner. It is necessary to separately excite the dynamo, and at the same time care should be taken to vary the field current continuously as in taking any magnetization curve. The loop should be plotted in terms of electrical pressure, E , and field ampere turns per pair of poles, NI .

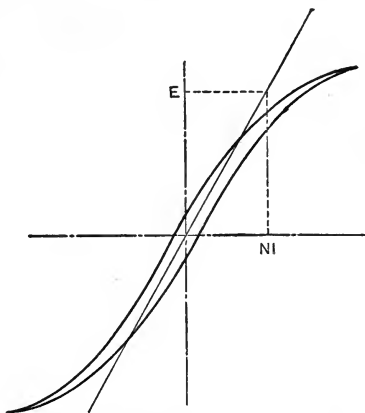

Fig. 25. Magnetization Curve for Air Gap Determination.

Let ϕ = number of lines of force entering armature from one north pole,

A = area pole face plus fringing area in sq. cms.,

N = number of field turns per pair of poles,

I = field current,

$2l$ = double length of air gap.

Then
$$\phi = \mathcal{H}A = \frac{4\pi NIA}{20l}.$$

But
$$E = \frac{S\phi V p_1}{10^8 \times 60 p_2},$$

where S = number of armature conductors,

V = r. p. m.,

p_1 = number of pairs of poles,

p_2 = number of bifurcations (pairs of paths) in armature.

$$\therefore \phi = \frac{E \times 60 \times 10^8 \times p_2}{SVp_1} = \frac{4\pi NIA}{20l}$$

$$\therefore l = \frac{4\pi NIASVp_1}{(20 \times 60 \times 10^8)Ep_2} = \frac{1.0472NIASVp_1}{10^{10}Ep_2}$$

Suggestion. A method in use in some factories is as follows. The iron is first made magnetically neutral by exciting the field to a point beyond the residual magnetism and then decreasing the excitation while it is being rapidly reversed. The magnetization curve, if now taken, will start at the origin and the straight part of the curve below the point of saturation will be parallel to, if not coincident with, the air gap magnetization curve. This is a shorter method, but experience does not indicate an accuracy equal to that of the method described above.

Data. Readings of pressure, speed, and field current should be taken for a complete hysteresis loop. If the speed varies, reduce all pressure readings to a common speed before plotting the curve.

Curves. Plot a complete hysteresis loop between pressure as ordinates and ampere turns per pair of poles as abscissas. Draw a line representing the air gap magnetization curve.

Calculate. The length of the air gap from any point on the air gap magnetization curve.

No. 26. LEAKAGE COEFFICIENT OF A DYNAMO OR MOTOR.

References. Hopkinson's "Papers," Vol. 1, p. 97; Hopkinson's "Dynamos," p. 98; Nichols, Vol. 2, p. 67; Parr, E. E. T., p. 168; Ives, *Elec. World*, Vol. 19, 1892, p. 12; Sheldon, p. 260; Wiener, p. 261; Fisher-Hinnen, p. 160; Jackson's "Dynamos," p. 134; Thompson's "Dynamos," p. 150; Crocker, Vol. 1, p.

305; Thompson's "Design," p. 18; Houston and Kennelly, p. 132; Parshall and Hobart, p. 119; Kapp's "Dynamos," p. 247; Thompson's "Lectures," p. 140; Kapp's "Dynamo Construction," p. 16; Carhart and Patterson, p. 319; Du Bois, p. 197; Hawkins and Wallis, p. 278; Slingo and Brooker, p. 322.

Object. The leakage coefficient is of considerable importance in the design of the magnetic circuit of a dynamo. A method of determining the leakage coefficient is therefore of value.

Theory and Method. The magnetic flux in any part of the magnetic circuit of a dynamo may be determined by means of a ballistic galvanometer which is connected to the terminals of a secondary coil, consisting of a few turns wound around that part of the magnetic circuit to be tested. Several turns are wound tightly around the armature so as to include all the useful lines of force passing from pole to pole and those only, the armature being stationary. The fields are connected to a source of pressure sufficient to excite them to their normal value. A switch, preferably a reversing switch, should be placed in the field circuit. When the field current is reversed the ballistic galvanometer will be deflected, due to the current induced in the secondary coil because of the change of the magnetic flux enclosed by it. If a single throw switch is used the sum of the make and break deflections should be taken.

The deflections obtained from the test coil on the armature are proportional to the useful flux, ϕ_a .

Deflections should be taken in the same way from a similar exploring coil, so placed on the field as to include the total flux corresponding to the flux threading the first coil. These observations will represent ϕ_t .

The leakage coefficient

$$v = \frac{\phi_t}{\phi_a} = \frac{\text{second deflection}}{\text{first deflection}}.$$

Some engineers use the reciprocal of this expression.

It is advisable to use the same number of turns and the same size and length of wire in the test coils in order that the total resistance of the test coil circuit may have the same value in each case.

It may be found convenient to use different numbers of turns in the test coils. This is permissible, provided the readings be corrected to the same number of turns and the resistances of the two coils be of the same value. If the resistances are unequal the deflections for one coil should be reduced to the same terms as the other by multiplying by the inverse ratio of the *total* resistance of the two test coil circuits.

In large machines, especially those whose fields are wound for high voltage, it is dangerous to break the field circuit suddenly. This may be avoided by suddenly interposing a resistance in the field circuit, this resistance being so proportioned that the exciting current is changed by a small but definite amount.

Another method applied to large machines is to use a small exciting current which is either cut off or reversed. This avoids the heavy field discharge but is not accurate because the leakage coefficient is smaller at the low magnetic potentials, due to small exciting currents, than at normal excitation.

The method which is advised here for large machines is to connect a small resistance, arranged so that it can be short-circuited by the closing of a switch, in series with the field. The field is fully excited with the switch closed. Suddenly opening the switch introduces the resistance into the circuit and causes a sufficient "kick" at the ballistic galvanometer, without the heavy self-inductive discharge.

The leakage coefficient is somewhat greater in a machine under load, due to armature reactions, than when the armature is stationary and without current. Tests made by the method described, however, have been found sufficiently accurate for purposes of design.

It is not always convenient to use a ballistic galvanometer in this test. A millivoltmeter may be used, provided the test coil current be so proportioned that the deflections are near the maximum scale reading. This precaution should be taken; for, while the number of coulombs per scale division is nearly constant for the upper portion of the scale, it is quite variable for the lower portion.

Suggestion. This general method may be used for investigating the leakage in various parts of a magnetic circuit. In order to have the test coil circuit of the same resistance, it is advisable to first wind the coil having the longest mean turn. After taking the necessary readings the coil may be unwound and the same wire used for the other coil.

Data. Using one of the methods recommended, take a number of readings with the two test coils properly located.

Calculate. The leakage coefficient from the averages of the readings.

Questions. Where would you place the field test coil on a machine of the Manchester type, and wherein would the test differ from that of a machine with salient poles? Why is it dangerous to suddenly break the field circuit of a large machine?

No. 27. EXTERNAL CHARACTERISTIC OF A SEPARATELY EXCITED DYNAMO.

References. Sheldon, p. 94; Parr, E. E. T., p. 133; Arnold's "Dynamos," p. 431; Fisher-Hinnen, p. 189; Jackson's "Dynamos," p. 200; Thompson's "Dynamos," p. 230; Kapp's "Dynamos," p. 253.

Object. This experiment is performed to show the inherent pressure regulation of a separately excited dynamo.

Theory and Method. An external characteristic of a dynamo shows the relation between terminal pressure and load,

or terminal pressure and current in the external circuit. The principal value of this curve is that it shows the regulation of the machine, and in fact it is often called the regulation curve.

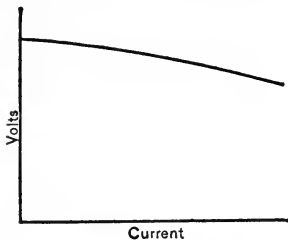

Fig. 27A. External Characteristic of a Separately Excited Dynamo.

The form of the curve depends mainly upon the manner in which the field is connected. Thus, the external characteristic of a separately excited dynamo will always have the general form shown in Figure 27A, although it may vary greatly as to the relative values of pressure and current.

To obtain this curve, data are taken with the machine running at normal speed, with brushes in a fixed position, and with constant excitation. The external resistance is varied from open circuit to such a value as will give at least full load current. As the external resistance is decreased, the current increases and the terminal pressure gradually decreases. This fall in terminal pressure is due to three causes:

First, as the current is increased, the armature drop increases by an amount proportional to the current.

Second, the brush drop, while inappreciable at no load, soon increases to a value which remains practically constant for all loads.

Third, armature reactions weaken and distort the field, both effects tending to reduce the generated pressure.

Hysteresis in the field, due to the demagnetizing effect of armature reaction, tends to cause a lower pressure for a given current if the adjustment is made by decreasing the load than would result if made by increasing the load. The effect of armature reaction may be shown by taking two sets of observations, in one of which the brushes are set somewhat in advance of the neutral position.

Regulation is defined as the percent change in pressure from full load to no load, the pressure being normal at full load.

In practice this curve is taken from full load to no load, and is expressed in volts as ordinates and percent load as abscissas. For purposes of comparing dynamos of different voltages and capacities the curves should be plotted with percent of normal pressure as ordinates and percent load as abscissas. In this experiment curves are also taken for both increasing and decreasing loads in order to show something of the physics of the dynamo. The total characteristic curve should be drawn. This is a curve representing the relation between total generated pressure and total armature current. This curve may be obtained for the separately excited dynamo by drawing the armature IR drop line and adding its ordinates to those of the external characteristic.

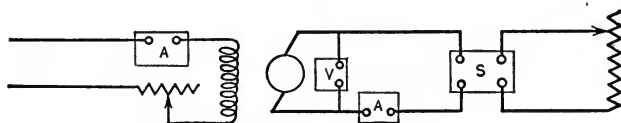

Fig. 27B. Connections for Characteristic Curve of a Separately Excited Dynamo.

Data. Connecting as in Figure 27B, take readings of external current, terminal pressure, field current and speed, under the following conditions:

First, starting at full load current and normal pressure throw off the load and read the no load pressure, being careful that the speed is normal for each set of readings.

Second, starting at no load, without changing the adjustment from that of the last set of readings, gradually increase the current to full load value, and then decrease it slowly to no load, taking a number of readings each way. Care should be taken that the speed and exciting current are constant for all readings.

Third, setting the brushes at a position somewhat in advance of normal, take a series of readings, as before, for increasing values of load.

Fourth, measure the resistance of the armature.

Fifth, measure the brush lead in geometrical degrees and note the number of poles.

Curves. With pressure as ordinates and current as abscissas, plot an external characteristic from the data taken. From the external characteristic and the armature IR drop line, construct the total characteristic.

Calculate. The percent regulation from the full load—no load data.

Question. What are the advantages and disadvantages of this method of excitation?

No. 28. EXTERNAL CHARACTERISTIC OF A SHUNT DYNAMO.

References. Jackson's "Dynamos," p. 202; Parr, E. E. T., p. 141; Nichols, Vol. 2, p. 17; Sheldon, p. 101; Fisher-Hinnen, p. 193; Thompson's "Dynamos," p. 210; Arnold's "Dynamos," p. 438; Kapp's "Dynamos," p. 253; Hawkins and Wallis, p. 332; Slings and Brooker, p. 342.

Object. To determine the inherent regulation of a shunt dynamo.

Theory and Method. To determine the regulation of a shunt dynamo, adjust the machine to normal voltage, at full load and normal speed. Without altering the adjustment of the field rheostat throw off the load and read the terminal pressure, being certain that the speed is normal. The regulation is determined by the percent rise in voltage.

To obtain the external characteristic the external resistance is gradually decreased from open circuit to short circuit, the speed and the resistance of the field circuit remaining constant, and simultaneous values of terminal pressure and load current are taken throughout the operation. The regulation curve is that portion of the external characteristic between the full load and no load observations.

The external characteristic of a shunt dynamo takes the general form shown in Figure 28A. As the external resistance is decreased, the current at first increases and the terminal pressure falls. The fall in terminal pressure is due to three causes:

First, as the current is increased, the armature "drop" increases by an amount which is proportional to the current.

Second, as the pressure falls off at the brushes, the current in the fields is decreased and less pressure is generated in the armature, because of a weaker field.

Third, the armature reactions weaken the field and still further decrease the pressure generated.

A point is finally reached where there is an actual decrease of current as the resistance is decreased, and the curve bends back upon itself as shown in the figure. This curve cuts the X-axis to the right of the origin because of the pressure generated by the armature, due to the residual magnetism of the fields.

It is often the case with well-designed dynamos that it is impossible to obtain the entire curve, since it does not begin to bend backward until such a value of current is reached as would excessively overload the machine. As it is difficult to make corrections for speed in taking a characteristic curve, this factor should be kept constant. To do this speed readings should be taken frequently.

It is seen from an inspection of the curve that there is a critical point on the upper portion just before the bend is reached. If, now, the resistance is decreased, there will be a

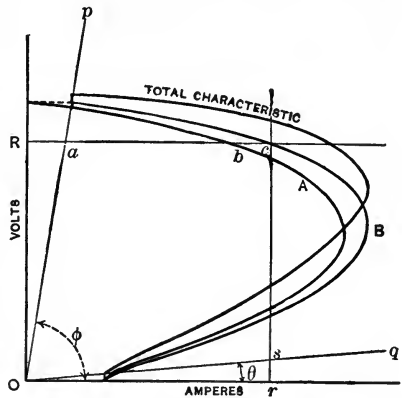

Fig. 28A. Characteristic Curve of a Shunt Dynamo.

comparatively large fall of pressure at the brushes and when the turn is completed, very small changes of resistance will cause great changes both in pressure and current. When the critical point is reached the brushes may be short-circuited without danger to the armature. On the other hand, a sudden short circuit before the critical point is reached is dangerous; because there will be a great rush of current before the field magnetism has had time to die down.

Since the field resistance remains constant throughout the experiment, the value of the field current may be determined for each reading of pressure. By adding these values of current to the corresponding values of current observed in the external circuit, a curve may be plotted showing the relation between the armature current and terminal pressure. From this data, knowing the armature resistance, the IR drop in the armature may be calculated for the various values of armature current. By adding these calculated values to the observed values, another curve may be plotted which shows the relation between the total pressure generated by the armature and the total current. Such a curve is called the total characteristic.

These two curves may be obtained graphically as shown in Figure 28A. Curve A represents the external characteristic which is plotted from the observations of external current and pressure. The line op is drawn so that $\tan \varphi$ equals the resistance of the shunt field circuit. Consequently, at any terminal pressure as OR , the intercepted abscissa Ra must represent the field current. Therefore, by adding this to the external current corresponding to this pressure, as bc , points are obtained for the curve B which represent variation of armature current with the pressure at the brushes. The line oq may now be drawn such that $\tan \theta$ equals the armature resistance.

Then at any armature current Or , the intercepted ordinate rs must represent the drop of pressure in the armature, which,

added to the curve *B*, gives a curve showing the relation between the total pressure and current. This is the total characteristic.

Data. Connections should be made as indicated in Figure 28B. Adjust the terminal pressure to normal value at full load and rated speed. Throw off the load and take the pressure, being certain that the speed is still normal. Then adjust the field rheostat to obtain normal pressure on open circuit, and take readings while the external resistance is varied from

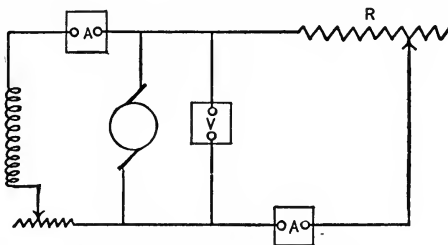

Fig. 28B. Connections for Characteristic of a Shunt Wound Dynamo.

open circuit to short circuit. The reason for adjusting to normal pressure on open circuit is that this is the condition necessary for the compounding experiment 34. The field resistance should be kept constant throughout the experiment. After short circuiting, the external resistance should be gradually increased to open circuit and readings taken as before. Field current readings should be taken throughout the experiment. Measure the resistance of the armature at the brushes. Measure the brush lead in degrees and note the number of poles.

Caution. Do not open the external circuit while the curve is being taken. If this is done below the critical point, and the circuit again closed there is danger of a "burn out." In any case the data will be impaired.

When these observations are made for commercial purposes the machine should be at normal temperature.

Calculate. The percent regulation from the full load—no load observations.

Curves. Plot an external characteristic, using terminal pressure as ordinates and load current as abscissas. Show this curve for both decreasing and increasing external resistance. Plot a total characteristic, using the decreasing resistance observations.

Explain. The difference in the external characteristics of well designed and poorly designed dynamos, from the standpoint of regulation. Why there is danger of a "burn out" as mentioned in the caution.

No. 29. EXTERNAL CHARACTERISTIC OF A SERIES DYNAMO.

References. Jackson's "Dynamos," p. 200; Nichols, Vol. 2, p. 14; Hopkinson's Papers, Vol. 1, p. 47; Parr, E. E. T., p. 136; Sheldon, p. 98; Fisher-Hinnen, p. 191; Thompson's "Dynamos," p. 202; Hopkinson's "Dynamos," p. 26; Arnold's "Dynamos," p. 432; Houston and Kennelly, p. 210; Kapp's "Dynamos," p. 253; Hawkins and Wallis, p. 340; Slingo and Brooker, p. 335.

Object. To determine the inherent regulation of a series dynamo.

Theory and Method. As was mentioned in Experiment 27, the manner in which the field is connected determines the general shape of the external characteristic. In the case of the series machine the entire current of the circuit flows through the fields. The result is that when the external circuit is open, there is no excitation and the only pressure generated is that due to the residual magnetism. As the resistance in the external circuit is reduced, more and more current flows through the fields, and the result is a curve resembling the magnetization curve. It falls below this curve, however, because of the effect of resistance and armature reactions. These may have so great an influence that a point will be reached where there

will be an actual decrease of terminal pressure as the current rises in value.

In obtaining data it is necessary that the brushes remain in one position throughout the experiment.

The resistance of the field and armature should be obtained and the IR drop calculated for each value of current in the external circuit. These, when added to the external characteristic, will give the total characteristic, which would coincide with the magnetization curve if there were no armature reactions.

These values may be obtained graphically and the total characteristic plotted.

The speed does not enter here in a simple ratio, and corrections for its variations are inaccurate. Consequently, it is necessary to keep the speed constant.

Data. Readings of speed, current and terminal pressure should be taken with both decreasing and increasing values of external resistance, in order to show the hysteresis loop. These readings should also be taken to a point considerably beyond the point of maximum pressure. Measure the total resistance of the machine. Measure the brush lead in degrees and note the number of poles.

Curves. Plot both the external and the total characteristics.

Suggestion. It is dangerous to break the main circuit of a high pressure series dynamo because of the severe self-inductive discharge which follows, due to the decreasing magnetism of the fields. If, however, the fields are short circuited, the pressure falls immediately and the machine may be cut out of the circuit without danger.

Explain. What effect doubling the speed has upon the external characteristic curve.

What effect would doubling the number of field turns have? Why the ascending and descending curves cross.

No. 30. EXTERNAL CHARACTERISTIC OF A COMPOUND DYNAMO.

References. Nichols, Vol. 2, p. 25; Parr, E. E. T., p. 145; Jackson's "Dynamos," p. 216; Arnold's "Dynamos," p. 443; Sheldon, p. 103; Thompson's "Dynamos," p. 239; Fisher-Hinnen, p. 196; Kapp's "Dynamos," p. 253; Hawkins and Wallis, p. 343; Thompson's "Design," p. 123; Slingo and Brooker, p. 343.

Object. To determine the inherent regulation of a compound dynamo.

Theory and Method. [A compound dynamo partakes of the nature of a shunt and of a series dynamo. If the shunt and the series field turns act together magnetically the machine is said to be compounded cumulatively, and is commonly called a compound dynamo. Such a generator will regulate for constant terminal pressure or may even give a rise in pressure with increasing load. If the pressure rises, the machine is said to be overcompounded. This is the type in general use in so-called constant pressure service, the rise in pressure being so proportioned as to compensate for line loss in the distribution system. Compound dynamos are connected either with long or short shunt, but the long shunt connection is more commonly used.]

Data. Adjust the terminal pressure to normal value at full load and rated speed. Throw off the load and read the pressure, being sure that the speed is still normal. To obtain the characteristic curve, read terminal pressure, speed, shunt field current, drop across shunt winding, and load current. The readings should be started with the field rheostat as set, and the load varied from zero to 50 percent overload. The data should be repeated for decreasing values of load. As corrections for speed are not practicable, the same should be kept constant at normal value. Measure the resistance of arma-

ture plus series field. Measure the brush lead in degrees and note the number of poles.

Cautions. It is especially dangerous to short-circuit a compound machine. When the observations are made for commercial purposes the machine should be at normal temperature.

Calculate. The percent regulation from the full load—no load observations.

Curves. Plot an external characteristic, using terminal pressure as ordinates and load current as abscissas. Show this curve for both ascending and descending values of the load. Plot a total characteristic, using the decreasing load observations.

Question. Can a dynamo be compounded to compensate for a given drop in speed of the prime mover, as the load comes on?

Explain. The effect upon the regulation curve of a compound machine if it is run above or below its normal speed, the comparison being made on the basis of field rheostat adjustment for equal no load pressures.

No. 31. EXTERNAL CHARACTERISTIC OF A DIFFERENTIAL COMPOUND DYNAMO.

References. Nichols, Vol. 2, p. 26; Jackson's "Dynamos," p. 222.

Object. To determine the inherent regulation of a differential compound dynamo.

Discussion. If, in a compound dynamo, the series turns are opposed magnetically to the shunt turns, the machine is said to be differentially compounded. While this form of winding is often used in motors, it has little commercial application in the case of a generator. As generators are sometimes connected differentially through accident in assembling, or otherwise, it is of importance to know how a differential winding affects the regulation.

Suggestion. The compound dynamo used in Experiment 30 may be used, the field windings being connected differentially.

Data. Adjust the field rheostat to give normal pressure at no load and normal speed. Read terminal pressure, speed, load current, shunt field current and drop across shunt field winding, while the external resistance is varied from open circuit to short circuit, and the reverse. Speed should be maintained constant. Measure the resistance of the armature plus the series field. Measure the brush lead in degrees and note the number of poles.

Curves. Plot curves for both ascending and descending values of pressure, using terminal pressure as ordinates and load current as abscissas.

Compare. These curves with the external characteristic curves taken on the same machine operated as a shunt dynamo.

Question. If a compound dynamo is found to be differentially connected, would you change the shunt or the series connections and why?

No. 32. DERIVATION OF THE LOSS LINE OF A SHUNT DYNAMO FROM ITS MAGNETIZATION CURVE AND EXTERNAL CHARACTERISTIC.

References. Jackson's "Dynamos," pp. 202-207; Arnold's "Dynamos," p. 439; Sheldon, p. 101.

Theory and Method. The loss line is a curve which shows the loss of pressure in the armature for various values of current in the external circuit. A simple method of deriving it is by graphical means as follows.

The external characteristic and the magnetization curve are plotted on the same sheet as in Figure 32. These should be taken with the brushes *set in the same position*. The ordinates

of both curves should be pressures developed at the armature terminals and should be plotted to the same scale. The abscissas should represent load current and field current, respectively, plotted to any convenient scale.

A line OR is drawn from the origin to a point on the magnetization curve. This is called the field resistance line and should make an angle with the X axis whose tangent is $E \div i$, where E is the terminal pressure and i is the field current corresponding to this pressure. Since the field resistance remains constant, any point on the line, OR , must show the pressure impressed upon the field terminals for the corresponding field current.

By projecting the open circuit pressure as shown by the external characteristic, horizontally upon the magnetization curve, the point R is at once obtained. The reason for this is obvious; for on open circuit, practically the full pressure developed by the armature is impressed upon the field terminals.

To locate a point on the loss line for a current I in the external circuit, the corresponding point E' is marked on the external characteristic. This terminal pressure is available in forcing current through the field windings, and by projecting the point E' horizontally upon the line OR , a point E'' is located which shows at once the value Od of the current in the fields when the current I flows in the external circuit. It has been found in obtaining the magnetization curve that the current Od will develop a pressure in the armature which is

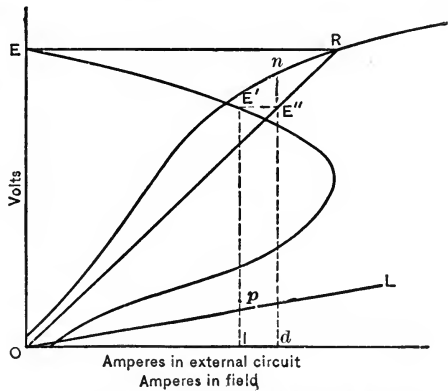

Fig. 32. Derivation of the Loss Line of a Shunt Dynamo.

shown by the ordinate dn . The ordinate $I\phi$ of the loss line corresponding to the current I is then shown by the difference between the ordinates dn and IE' , or $E''n$. Other points on the loss line may be obtained in a similar manner.

Data. If the external characteristic and magnetization curves have not been taken in previous experiments for the same shunt machine, such curves should be obtained. Measure the combined resistance of armature and brushes.

Curves. Draw the loss line from the above data and show fully the graphical method employed. Also draw a line showing the drop in pressure due to armature resistance, for different values of *armature* current.

Explain. Just what losses are represented in the loss line and show to what extent they may be separated.

NO. 33. DERIVATION OF THE LOSS LINE OF A SERIES DYNAMO FROM ITS MAGNETIZATION CURVE AND EXTERNAL CHARACTERISTIC.

References. Jackson's "Dynamos," p. 201; Fisher-Hinnen, p. 85; Sheldon, p. 98; Thompson's "Dynamos," p. 202.

Theory and Method. The external characteristic and the magnetization curve should be taken with the brushes in the same position for the two curves. In taking data for the external characteristic, the pressure is measured at the terminals of the machine for various values of current in the external circuit. The total pressure generated in the armature is greater than the measured pressure by an amount equal to the loss of pressure in the machine itself due to armature resistance and reactions. If the armature reactions are slight, the difference of the ordinates of the two curves will practically equal the current multiplied by the total resistance of the machine. The loss line is derived by plotting both curves on the same sheet, to the same scale, and then taking as ordinates the difference between the ordinates of the two curves.

If the armature reactions are of appreciable magnitude, the ordinates of the loss line will be greater than those of a line which shows the loss of pressure due to the resistance of the windings only.

Data. If the external characteristic and magnetization curves have not been taken in previous experiments for the same series dynamo, they should be obtained. Measure the total resistance of the machine.

Curves. Draw the loss line from the above data, and show fully the graphical method employed. Also draw a line showing the drop in pressure, due to the total resistance of the machine, for different values of current.

No. 34. COMPOUNDING OF A SHUNT DYNAMO FROM ITS MAGNETIZATION CURVE, EXTERNAL CHARACTERISTIC AND LOSS LINE.

References. Jackson's "Dynamos," p. 217; Houston and Kennelly, p. 213.

Object. To determine the number of series turns necessary to make a dynamo regulate for constant pressure, using its magnetization curve, shunt external characteristic, and loss line.

Theory and Method. The external characteristic of a shunt dynamo is concave to the X-axis over the working portion of the curve, the fall of pressure being due to armature resistance, armature reactions, and decrease in field current. All three curves are plotted on the same sheet as in Figure 34, with volts as ordinates, the same scale being used. The abscissas of the external characteristic and the loss line are load currents, plotted to the same scale. The abscissas of the magnetization curve are field currents plotted to any convenient scale.

To compound for a current I which corresponds to a point p on the external characteristic, the loss line OL and field

resistance line OP are drawn as shown. When a current I flows in the external circuit, a pressure is impressed upon the field terminals which is represented by the ordinate dN of the field resistance line. Of the total fall of pressure at the terminals, that due to armature resistance and reactions is represented by QN , while

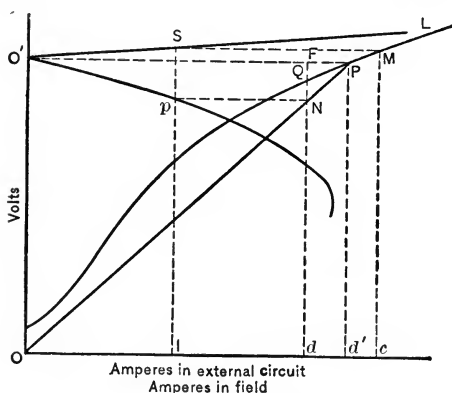

Fig. 34. Graphical Method of Compounding a Shunt Dynamo.

that due to the decrease of the shunt field current is QF .

To cause the terminal pressure of the machine to remain constant, the magnetization curve must be worked at a point M obtained by projecting horizontally the point S of the loss line, which

corresponds to a current I in the external circuit. This shows that the magnetizing current must be increased from Od' to Oc , or the field ampere turns must be increased by an amount equal to $d'c$ multiplied by the number of shunt turns N . The number of series turns would then equal N times $d'c$ divided by I . This number of series turns will be strictly correct for only one value of I unless the magnetization curve is a straight line between the points used. The number of turns required for any degree of overcompounding may be obtained in a similar manner by using, instead of the loss line, a line which has an additional slope depending upon the percentage of overcompounding desired.

Data. If the magnetization curve and the external characteristic of the same shunt machine have not been obtained, they should be taken. The loss line may be obtained from these two curves as shown in Experiment 33.

The number of shunt turns should be known. If this is not available, it may be determined approximately as in Experiment 41.

Caution. It should be remembered that the magnetization curve and external characteristic are to be taken with the brushes set in the same operating position.

Calculate. The number of series turns necessary to over-compound the dynamo 10 percent at full load.

Curve. Using this same number of series turns determine graphically the compound characteristic from the magnetization curve. It will be sufficient to locate points at $\frac{1}{4}$, $\frac{1}{2}$, $\frac{3}{4}$, 1, and $1\frac{1}{4}$ load. This may be done by reducing the total ampere turns at each load to shunt ampere turns, and then considering the amount of variation of the magnetization curve from a straight line, from no load to full load.

Explain. Why, when a shunt dynamo is started up and its field circuit is closed, the terminal pressure rises to a certain value and remains constant.

No. 35. ARMATURE CHARACTERISTIC OF A SHUNT DYNAMO.

References. Nichols, Vol. 2, p. 23; Jackson's "Dynamos," p. 213.

Object. The regulation of a shunt generator to constant terminal pressure at all loads by varying the field excitation.

Theory and Method. The armature characteristic is a curve which shows the field current necessary to keep the terminal pressure of the machine constant throughout its range of load. To obtain this curve the dynamo is run at normal speed. A low reading ammeter and a suitable field rheostat are placed in the shunt field circuit. An ammeter of sufficient range to indicate the full load current of the machine is placed in the external circuit in series with some form of variable

resistance such as a water rheostat or a lamp bank. A voltmeter is placed across the terminals of the machine. It is well to start at full load and normal pressure. Simultaneous readings of the field current, load current, speed, and the terminal pressure are taken for decreasing values of load. As the load is decreased the terminal pressure tends to rise. This is due to decreased armature reactions and IR drop and the consequent increased shunt current. The terminal pressure should be maintained constant by increasing the resistance of the field circuit.

Speed and pressure readings are necessary; although they do not enter directly into the curve, speed and pressure should be kept constant.

Data. Take readings of field and load currents, speed and pressure from full load to no load, terminal pressure and speed being maintained constant. The brushes should be fixed in their normal position. Measure the armature resistance. Measure the brush lead in degrees and note the number of poles.

Curve. Plot a curve between field current and load current, using the former as ordinates.

Explain. Points of difference in the action of "long shunt" and "short shunt" compound wound machines.

No. 36. COMPOUNDING OF A SHUNT DYNAMO FROM ITS ARMATURE CHARACTERISTIC.

References. Nichols, Vol. 2, p. 84; Jackson's "Dynamos," p. 215; Parr, E. E. T., p. 152.

Object. As stated in the preceding experiment, it is possible to determine the number of series turns necessary to compound a shunt dynamo from its armature characteristic, if the number of shunt turns is known.

Theory and Method. If the armature characteristic is not a straight line the machine can be compounded perfectly for only one value of current in the external circuit.

In obtaining the armature characteristic, the additional field current necessary to keep the terminal pressure of the machine constant under various loads is found. Since the number of shunt turns is known, the additional number of ampere turns is also known. In a compound machine, the current traversing the series turns is known. The number of these turns required to compound the machine must equal $Ni \div I$, where N is the number of shunt turns, i the additional shunt field current, and I the current of the series winding.

It must be remembered that a fixed number of series turns will compound for one speed only and that at a higher or a lower speed the machine will over or undercompound as the case may be. The armature characteristic is not a straight line, but the number of series turns is calculated for the full load observations.

Data. If the armature characteristic is not already obtained for the required conditions of compounding, the full load and no load observations should be obtained as in the previous experiment. The number of shunt field turns should be obtained. If this is not available, it may be determined approximately as in Experiment 41.

Explain. The points of difference in the action of "long shunt" and "short shunt" compound wound machines.

No. 37. COMPOUNDING OF A SHUNT DYNAMO BY THE METHOD OF ADDED TURNS.

References. Parham and Shedd, p. 318; Nichols, Vol. 2, p. 85; Jackson's "Dynamos," p. 216; Sheldon, p. 113; Thompson's "Dynamos," p. 238.

Object. In compounding a dynamo from its armature characteristic, it is necessary to know the number of shunt turns. In practice, when an experimental determination of the series turns for compounding is required, the number of

shunt turns is seldom known, and the method of added turns is then the most available.

Theory and Method. This is a modification of the method of compounding from the armature characteristic. The machine is first wound with a known number of turns of insulated wire. These turns should be placed as nearly as possible so as to occupy the same surface on the frame as that of the proposed series coils. The dynamo is then adjusted to normal voltage, at no load and rated speed. Full load current is then thrown on and a current from an external source sent through the auxiliary winding and its value adjusted so as to give the required voltage at the brushes, care being taken that the speed is at rated full load value. If it is not possible to tell from an inspection of the shunt winding and from the polarity of the brushes, the proper direction of the auxiliary current will be made apparent from the first test. In calculating the required number of series turns, divide the ampere turns in the experimental winding by the load current. An allowance should be made for drop in the series field winding. This is easily done by making the full load voltage in the test equal to the desired terminal voltage plus the proposed loss. The size of wire should then be calculated to give this proposed drop, or at least, not to exceed it; due consideration being given to a safe current density. The number of series turns thus obtained will be that required when the dynamo is operated *short shunt*. If it is intended to make the winding long shunt, a resistance equal to that of the proposed series winding should be placed in one of the leads next to the armature and the terminals of the shunt field winding should be connected, one to the load end of this resistance, and one to the other armature terminal.

This method may be used without an auxiliary current, the load current of the machine itself being employed. To do this the temporary series turns should be of cross-section large enough to carry the full load current without overheating and,

preferably, larger. The number of turns should be large enough to make the machine overcompound beyond the desired limit. A variable resistance shunt is then placed around these series turns and adjusted so as to give the required compounding. An ammeter is connected so as to measure the current in the auxiliary winding. This method has an advantage in that if connected long or short shunt in the test, the calculated series turns will be practically correct for that condition in permanent operation.

In both methods if long shunt is used an allowance should be made, theoretically, for the shunt current in the series winding. This, however, is of small moment.

In multipolar dynamos with salient poles it should be remembered that each pole is generally wound with a certain number of turns, plus a half turn; *i. e.*, $5\frac{1}{2}$, $6\frac{1}{2}$, etc. This is for convenience in connecting the several series coils.

Data. Using one of the above methods, adjust the shunt current for normal pressure at no load and rated speed. Adjust the current in the auxiliary winding to give the required voltage at full load current and speed. Measure the space allowable for series turns and make a drawing from which the mean length of turn may be obtained.

Calculate. The number of series turns necessary to compound for the required terminal pressure under full load conditions. Also calculate the resistance of the winding, the current density, and the drop, and check with the assumed drop. If the two do not agree within an allowable error, make a second computation. The current density in the series turns should be about 1,000 amperes per square inch.

Question. Why should the experimental winding occupy approximately the same position on the field core as that intended for the permanent series winding?

No. 38. ADJUSTMENT OF COMPOUNDING OF A DYNAMO BY SHUNTING THE SERIES WINDING.

References. Parham and Shedd, p. 321; Sheldon, p. 112; Thompson's "Design," p. 132.

Object. It often occurs, either in the factory or after the machine has been placed in service, that the number of series turns is somewhat larger than necessary for the degree of compounding desired. In such cases the compounding may be adjusted to the required value by shunting the series winding.

Theory and Method. The magnetic qualities of iron used in the construction of dynamos frequently turn out poorer than the test specimens indicate. In such cases more series turns are required for compounding.

When special machines are built to come up to a certain guarantee this becomes a matter of considerable importance. In order to insure proper compounding such machines are generally designed with more series turns than are necessary, provided the iron is standard. Again, in standard sizes, sometimes the over-compounding may be higher than is desired.

In all such cases the shop method of regulating the degree of compounding is by shunting a variable resistance across the series field and adjusting this shunt experimentally. Special clamps are fastened to the terminal blocks of the series winding. These clamps are so constructed that they will take one or more strips of German silver. The dimensions of these strips depend upon the practice of the manufacturer. Due consideration is given the cross-section and radiating surface, however, so that there will be no danger of over-heating when the shunt is in operation in its finished form. Generally the adjustment is made by varying the length of strip between clamps. The machine is run at rated speed and the shunt field rheostat adjusted so that the terminal pressure is normal on open circuit. With the shunt field

resistance remaining constant, full load is thrown on and the terminal pressure brought to the desired value by adjusting the resistance of the shunt across the series winding. After this adjustment is made, the German silver shunt is cut off to the proper size and made up in finished form.

The adjustment can be made for only one load and degree of compounding. It is usually made for full load and in such cases the terminal pressure will be high for points between no load and full load, because the magnetization curve is always concave to the axis of current, for working values. This rise in pressure at intermediate points can be reduced by using a shunt with a high temperature coefficient. The result is that for low currents the shunt resistance is smaller in proportion to the series winding than for large currents. Consequently, a greater part of the total current goes through the series turns at full load than at lighter loads; the result being a more nearly uniform terminal pressure. This arrangement will be effective only when the changes in load are gradual, so that the temperature of the shunt will have time to change. In the case of street railway generators, where the load varies rapidly over wide ranges, such a device would have but little effect.

Data. Place a variable shunt across the series field of an over-compounded machine. Run the machine at rated speed and adjust the terminal pressure to its normal value on open circuit. Take readings of speed, terminal pressure and shunt field current. Throw on full load current, adjusting the terminal pressure to the required value by varying the resistance shunted across the series field. Take readings of terminal pressure, speed, shunt field current, and load current.

Caution. If the winding is long shunt and the compounding is to be adjusted for constant pressure and speed, care should be taken that the shunt field current and speed are the same when both sets of observations are made.

No. 39. ADJUSTMENT OF COMPOUNDING OF A DYNAMO BY CHANGING THE SPEED.

References. Jackson's "Dynamos," p. 223; Parham and Shedd, p. 323; Parr, E. E. T., p. 153.

Object. An adjustment of the compounding is sometimes necessary when the conditions are such as to preclude the use of a shunt to the series turns. An example of this is when the amount of compounding is to be increased beyond that obtained when the machine is operated at normal speed without a shunt. Again, the operation of compound machines in parallel cannot be effected when the series coils are shunted, except in a special case.

Theory and Method. Most compound machines are operated at, or just above, the bend in the magnetization curve. Any slight change in the shunt current such as that due to a change in the temperature will thus produce but a small change in the terminal pressure. If the magnetization curve were a straight line, a given number of series ampere turns would produce exactly the same magnetic flux no matter what point on the magnetization curve represented the no load flux. Therefore, the smaller the flux at no load, the greater the *percent* of increase in flux at full load.

If now, the number of lines of force be decreased, the armature will have to rotate faster than before to give no load voltage and the compounding of the machine will be increased at all loads. If the speed be decreased, there will be a reduction in compounding.

In an actual dynamo the fact that the magnetization curve is a line concave to the X-axis, merely reduces the effect. At a lower magnetization than normal the series ampere-turns will not add so great a flux as would be the case were the curve a straight line, drawn from the point of normal magnetization to the origin, and the compounding will be less. At a higher magnetization the compounding will be reduced by a smaller amount.

From this it is seen that to increase the percent of compounding an increase of speed is necessary and that it may be decreased by decreasing the speed. A given change may be effected by trial and approximation, or, if the magnetization curve and external characteristic are known, a graphical solution similar to that of Experiment 34 may be used.

The amount of increase in compounding is limited by the amount of weakening the field will stand with sparkless operation. The temperature conditions are somewhat improved owing to reduction of core loss and increased windage, even though the output has been augmented, due to the increased full load pressure. It is assumed that the mechanical strength of the parts will not be exceeded.

The amount of decrease in compounding is limited by the shunt field resistance. The speed must not be reduced to a point where there is no leeway for regulating the shunt field rheostat. Temperature conditions may determine the limit, the core loss being increased and the windage decreased.

Data. Let the increase in compounding be five percent. Adjust the machine for normal voltage at full load and rated speed. Throw on full load current. Keeping this constant, increase the speed until the full load pressure is slightly more than the required amount. Read the speed. Throw off the load, and with the speed at its last full load value, adjust the field rheostat for normal no load pressure. Repeat the operation until both full load and no load pressures correspond. Record the final speed.

Let the reduction in compounding be five percent (it is assumed the dynamo is capable of this). Starting with normal voltage and speed at no load throw on full load current. Keeping this constant, reduce the speed until the voltage is slightly above that required. Take the speed. Throw off the load and readjust the field rheostat for normal no load pressure at the last speed. Repeat the operation until the pressure is right for both full load and no load. Record the speed.

Suggestion. Either change in compounding may be effected even with a given drop in speed from no load to full load.

No. 40. EXTERNAL CHARACTERISTIC OF AN ARC DYNAMO.

References. Thompson's "Dynamos," p. 445; Sheldon, p. 129; Fisher-Hinnen, p. 235; Jackson's "Dynamos," p. 225; Parham and Shedd, p. 249; Nichols, Vol. 2, p. 28; Crocker, Vol. 1, p. 330; Crocker and Wheeler, p. 163; Hawkins and Wallis, p. 338; Slingo and Brooker, p. 330; Houston and Kennelly, p. 217.

Object. Although arc machines have not the importance they once had, they are still used to a considerable extent. It is therefore desirable to study their action in general. This may be done by taking characteristic curves.

Theory and Method. A series arc machine must be so constructed that it will always maintain a constant current in the line, between the limits of normal full load and short circuit. The lamps themselves are provided with regulating mechanisms which are designed to produce proper automatic feeding of the carbons, provided the current is constant. Since the resistance of the line may vary, due to lamps being cut out or due to changes in the length of arc of lamps burning, and as the dynamo speed may fluctuate, it is necessary that the machine be provided with a regulating mechanism which will maintain the current constant.

In all modern series arc machines (except the Westinghouse) this is accomplished, in whole or in part, by shifting the brushes and thus increasing or decreasing the effect of armature reactions, as the load is varied. Arc machines are therefore designed with a relatively large number of armature ampere turns. In the Westinghouse arc machine the armature reactions and armature self-inductance are made so great that the regulation for constant current is reasonably close, without the necessity of a brush-shift-

ing device. The armatures are generally ring wound, as such windings are more easily insulated than drum windings. The fields of such machines are relatively small and all iron is worked at high density in order to obtain uniform regulation over a wide range.

Arc machines are series wound, as this method of field excitation may be made to give a more nearly inherent constant current regulation than any other, and because it is also best adapted for automatic constant current regulation. An exception to this is the Westinghouse machine, which, owing to its peculiar design, is best separately excited.

The external characteristic of a series arc dynamo, with the automatic regulator cut out, would have the general form shown

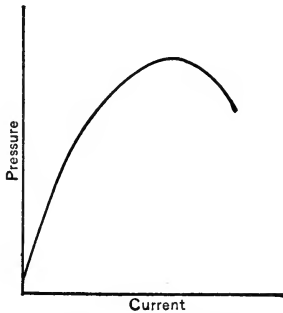

Fig. 40A. Characteristic of Series Dynamo with Large Armature Reactions.

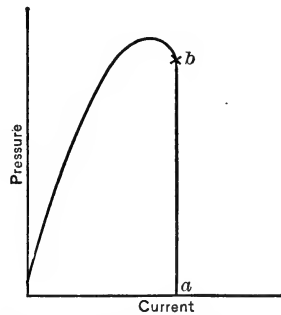

Fig. 40B. Characteristic of a Constant Current Arc Dynamo.

in Figure 40A; that is, it would be a series characteristic which would droop toward the X-axis for large values of current, due to high saturation in the iron and excessive armature reactions.

The automatic regulator in all cases operates to maintain the current constant for values of external resistance lower than that at which the inherent drooping occurs. The result is a characteristic curve such as is shown in Figure 40B, the portion $a b$ being the working part of the curve. Between these limits the current is constant at the desired value and the ordinate $a b$ would be the terminal pressure at full load.

The complete characteristic curve can usually be taken experimentally, although generally, under practical operating conditions the line resistance is not so high that the normal current is prevented from flowing.

Although a number of arc machines have been successful in a commercial way, they differ materially in many features, notably, in the method of armature winding, the shape and arrangement of field magnets, and the automatic regulator.

As has been stated, the armatures of arc machines are almost invariably ring wound. Some companies have used the closed coil Gramme ring winding while others have employed open coil ring windings. Although open coil armatures are not used on other than arc machines they have been successfully used with this class of dynamos. In fact, two of the most widely used arc dynamos, the Brush and the Thomson-Houston, have open coil armatures. Such windings seem to be especially adapted to this field of work, partly because they have very simple commutators, consisting of few segments and permitting of a considerable air space between them for insulation; and partly because of the fluctuating character of the current, due to the small number of coils on the armature. Because of the simple commutator with air insulation, although very high pressures are generated and considerable sparking occurs at the brushes, no very detrimental effects occur, and the machines are industrially successful. The fluctuating current produced by these machines seems to have a tendency to cause the lamps to regulate better than is the case when an absolutely steady current is supplied.

Regulators. Space does not permit of detailed descriptions. Although there have been about a dozen types of arc dynamos in commercial use in this country, by far the major part of the work has been done by less than half this number. The most widely used machines have been the Brush, Thomson-Houston, Wood, Western Electric, Westinghouse, and Excelsior dynamos.

Data. Starting with the machine on short circuit, take readings of external current, terminal pressure, and speed, for

various loads up to full load. If practicable, continue the readings, increasing the external resistance to open circuit. Carefully study the action of the regulator throughout the run. If the regulating devices possess two or more electric paths, as in the Brush regulator, place additional ammeters and voltmeters so as to investigate the changes in current and pressure in these parts as the load is varied. If practicable, take a characteristic curve with the regulator cut out. This curve should be taken preferably with the brushes in the position of maximum pressure. Measure the armature and field resistance, and also the resistances of the various electrical devices contained in the regulator.

Cautions. Some types of arc machines are shut down by short-circuiting the field; in the Thomson-Houston dynamo the armature is short-circuited. Keep the short-circuiting switch closed except when the machine is under load. Be very careful not to break the external circuit when this switch is open. Arc machines have a large self-induction in both armature and field, and since they are in series a high e. m. f. of self-induction is set up if the circuit is suddenly broken when the machine is supplying a load. This effect is apt to be more pronounced in closed coil armature machines than in the open coil types, due partly to the fact that some of the armature coils are not in circuit in the open coil type, thereby reducing the self-inductance, and partly to the fact that the open coil machine "spills over" at the commutator, that is, the sparking causes the individual coils to become more or less short circuited. It is for this latter reason that the Brush multicircuit arc machine does not exhibit full machine voltage at a break when it occurs in one of the circuits.

Curves. Plot an external characteristic, using terminal pressure as ordinates and external current as abscissas. If data have been obtained showing the inherent regulation without the regulator, plot a second curve showing the simple series characteristic. If electrical readings have been taken for the regulator itself, plot curves using these readings as ordinates and external

resistance as abscissas. In this case indicate the full load resistance.

Diagrams. Draw sketches showing the magnetic circuit of the machine, the armature winding, and the complete action of the regulator.

Explain. The complete action of the regulator.

NO. 41. EXPERIMENTAL DETERMINATION OF THE NUMBER OF FIELD TURNS ON A DYNAMO.

Object. The field winding data of a machine is not always available. The number of field turns may be approximately determined by experiment.

Theory and Method. Although the general method applies to the determination of any field winding, the application is made most frequently to a shunt field. Series field windings, being composed of comparatively few turns of heavy wire, are often readily determined by observation.

The number of lines of force threading the armature of a dynamo at no load, depends upon the number of ampere turns on the field. The pressure developed varies directly with the number of lines of force threading the armature.

If the fields are excited by means of the two different windings at different times and the same pressure is obtained at the armature terminals in each case, speed and other conditions remaining the same, the number of ampere turns producing the field in each case must be the same.

A known number of turns of wire are wound over the regular field winding. The machine is run on open circuit at constant speed, and the field excited by a current of known value in the temporary winding, and the pressure generated by the armature is noted. If a shunt field winding is being investigated, it may be excited from the armature direct without appreciable error. In the case of a series winding the excitation must be from a

separate source as any appreciable armature current will cause errors in the result. The exciting current in the temporary winding should be from a separate source. The field is then excited by means of the permanent winding, and the pressure is adjusted to the same value as before.

Knowing the number of turns of the auxiliary winding and the value of the exciting current in each case, the number of field turns is found from the relation $N_a = NI \div i$, where N_a is the unknown number of turns, N the number of auxiliary turns, I the current in the auxiliary winding and i the current in the field winding.

Suggestions. In order that the leakage paths may be considered the same for both windings, care must be taken that the auxiliary winding is evenly distributed and made to cover the same space as is occupied by the regular winding.

The number of turns on a field spool can be determined by an alternating current method. Remove the spool from the machine and wind a secondary coil of known turns on the middle portion of the coil. This will make an air core transformer. Connect the field to an alternating current source and measure the pressure of supply and also that of the terminals of the auxiliary coil. The turns in the two coils are in direct proportion to the pressure, provided there is no magnetic leakage. Errors in the readings, due to magnetic leakage, may be accounted for by taking a second set of observations with the auxiliary coil as the primary; the average of the two sets of observations being used to obtain the number of field turns.

Data. Record the number of turns of the auxiliary winding. Run the machine at normal speed on open circuit. Take a series of observations of terminal pressure for various currents in the temporary winding. Take a corresponding set of observations of terminal pressure with the fields excited by means of the permanent winding. Take readings of speed in all cases, and correct all data to a constant speed. The pressure developed for

given currents in the permanent winding may be obtained from the magnetization curve, Experiment 24, provided the brushes are set in the same position.

Calculate. The number of field turns from each set of observations. Take the average of these values as the correct number of turns.

No. 42. MAGNETIC DISTRIBUTION IN THE AIR GAP OF A DYNAMO OR MOTOR; SINGLE PILOT BRUSH METHOD.

References. Jackson's "Dynamos," p. 209; Nichols, Vol. II, p. 64; Sheldon, p. 262; Parr, E. E. T., p. 161; Thompson's "Dynamos," p. 64; Parham and Shedd, p. 428; Arnold's "Dynamos," p. 242; Fisher-Hinnen, p. 38; Kapp, p. 284; Hawkins and Wallis, p. 351; Wiener, p. 31.

Object. Sparking and brush displacement depend to a considerable extent upon field distortion in the air gap, due to the armature current. This effect may be investigated by taking a series of readings around the commutator by the aid of a pilot brush.

Theory and Method. Armature reactions, a knowledge of which is of especial importance to the designer, may be experimentally investigated in several ways. One method is to measure the rise in pressure on the commutator from a minus to a plus brush, and to determine the distribution of magnetism in the air gap from this data. By investigating both no load and full load conditions, the distortion of the field due to armature reactions may be shown.

One terminal of a voltmeter is connected to one of the brushes of the machine. The other terminal of the voltmeter is connected to a small auxiliary brush which may be moved around the commutator. Its position, relative to the main brushes, is determined by means of a graduated arc. The machine is run under normal

conditions as to speed and terminal pressure. Two sets of observations are taken, one under no load conditions and the other at full load. The voltmeter must be capable of indicating the full pressure of the machine. Pressure readings are taken at frequent angular intervals. The *increments* of pressure, as the pilot brush is moved around the commutator, are the pressures in the armature coils that are added to the voltmeter circuit. If the angular distance the brush is moved is constant, these pressures may be taken as directly proportional to the average magnetic induction in which the added armature coils have been passing. If the relative positions of commutator bars and corresponding armature conductors are known, the field distribution curve may be obtained.

The accuracy of the method is somewhat impaired because of the variable position of the pilot brush with reference to the moving commutator bars, the pressure indicated being an average for the given position of the brush. It should also be noted that the voltmeter readings are due to conductors lying under two poles and therefore the distribution curve shows the averages of the distributions under two poles.

Curves taken with no load and with full load will differ because of the distortion of the field, due to armature reactions.

Data. Run the machine at rated speed and normal pressure, under no load. Take pressure readings for positions of the pilot brush every ten electrical degrees around the commutator, from brush to brush. The angular pitch of the poles constitutes 180 electrical degrees. Place full load upon the machine, again adjusting the terminal pressure to its normal value, and take a similar set of pressure readings. The second set of observations should be made with the brushes set at the position of least sparking, and the machine should be run at rated speed. It is desirable to take readings entirely around the commutator if possible, and thus compare the distribution of flux under the various pole faces, but this is not always practicable.

In each case note the positions of the poles and brushes for a given position of the pilot brush. Also note the connections of the armature conductors to the commutator bars.

Caution. It may be found that the readings in the neighborhood of the brushes are unreliable, due to the reactions of the short-circuited coils. If readings are taken from a minus to a plus brush only, observations on both sides of each brush should be obtained, in order to accurately locate the zero points.

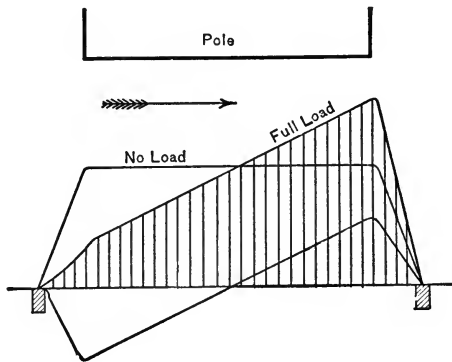

Fig. 42. Magnetic Distribution under a Pole Face.

Curves. Plot the integrated pressure curves, using the measured pressures as ordinates and electrical degrees as abscissas. Draw corresponding curves which show the *increments* in pressure for the various positions of the pilot brush. These increments had better be derived from the curves and not from the readings directly. Construct a curve by taking the differences of the ordinates of the curves which show the increments in pressure for no load and full load, as shown in Figure 42.

The positions of poles and brushes, and the direction of rotation should be indicated on the curve sheet.

Explain. What is represented by the curve drawn from the difference in ordinates of the no load and full load distribution curves.

No. 43. MAGNETIC DISTRIBUTION IN THE AIR GAP OF A DYNAMO OR MOTOR; DOUBLE PILOT BRUSH METHOD.

References. Jackson's "Dynamos," p. 210; Nichols, Vol. II, p. 63; Sheldon, p. 262; Parr, E. E. T., p. 160; Thompson's "Dynamos," p. 64; Parham and Shedd, p. 432; Arnold's "Dynamos," p. 242; Fisher-Hinnen, p. 38; Kapp, p. 284; Hawkins and Wallis, p. 351; Wiener, p. 31.

Object. In Experiment 42 the distribution of magnetism was represented by increments of pressure obtained from differences between large magnitudes nearly equal in value. Greater accuracy results when these increments are measured directly. This is accomplished by the use of two pilot brushes.

Theory and Method. The two pilot brushes are insulated from each other and mounted a fixed distance apart in an auxiliary brush holder, their tips bearing upon the commutator. A convenient distance between pilot brushes is the width of one commutator segment. Their position relative to the main brushes and to the poles is determined by means of a graduated arc. A low reading voltmeter is connected across these pilot brushes and observations are taken for various positions around the commutator. The pressures indicated by the voltmeter are the pressures generated in the coils connected to the commutator bars spanned by the pilot brushes. If the brushes are kept a constant distance apart, these pressures are directly proportional to the magnetic induction at the part of the field occupied by these intercepted coils. If the relative position of commutator bars and corresponding armature conductors is known, the field distribution curve may be obtained.

As in Experiment 42, the accuracy of the method is somewhat impaired because of the variable position of the moving commutator bars with reference to the pilot brushes, the pressure indicated being an average for an angular distance equal to the pitch between commutator bars.

Data. Run the machine at rated speed and normal pressure at no load. Take pressure readings for positions of the pilot brushes every ten electrical degrees around the commutator, from brush to brush. The angular pitch of the poles constitutes 180 electrical degrees. Place full load upon the machine, again adjusting the pressure to its normal value, and take a similar set of pressure readings. The second set of observations should be made with the brushes set at the position of least sparking. It is desirable to take readings entirely around the commutator if possible, and thus compare the distribution of the flux under the various poles, but this is not always practicable.

In each case note the positions of the poles relative to the brushes, and also note the connections of the armature conductors to the commutator bars.

Caution. It may be found that the readings in the neighborhood of the brushes are unreliable, due to the reactions of the short-circuited coils. If readings are desired from a minus to a plus brush only, observations on both sides of each brush should be obtained, in order to accurately locate the zero points of the curve.

Curves. Plot curves showing the distribution of magnetism for both no load and full load, using pressures as ordinates and electrical degrees as abscissas. Show the position of the brushes, the direction of rotation, and the position of the poles on the curve sheet. Construct a curve by taking the differences of the ordinates of the no-load and full-load curves, as shown in Figure 42.

Compare. The relative merits of the single and double pilot brush methods.

Show. That the pressures measured between the pilot brushes really represent the increments of pressure which are used in Experiment 42 to show the distribution of magnetism.

No. 44. MAGNETIC DISTRIBUTION BY THE METHOD OF INSTANTANEOUS CONTACT.

Reference. Jackson's "Dynamos," p. 211.

Object. This is a modification of the double pilot brush method, Experiment 43. Its advantage is the elimination of errors due to the prolonged contact of a commutator segment with a pilot brush.

Theory and Method. Here the magnetic distribution is obtained by determining the instantaneous pressure generated in a single armature coil, for various angular positions of the coil. One commutator bar is connected to an insulated ring *A*, Figure 44A, mounted on the shaft. The other commutator bar is con-

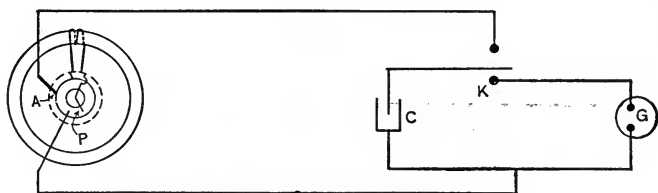

Fig. 44A. Instantaneous Contact Method of Magnetic Distribution Testing.

nected to an insulated revolving pin *P* or to some other form of contact device. The brush which makes contact with the revolving pin is so arranged that the contact may be made at any desired point in the revolution. A condenser *C* and a ballistic galvanometer *G* are so arranged that the condenser may be either charged by the pressure generated in the coil, or it may be discharged through the galvanometer.

If the contact device is set in a given position and connections to the condenser are made, the latter receives a succession of charges and almost instantly the charge becomes $Q = CE$ where Q is the quantity of electricity stored up in the condenser, C is its capacity and E is the instantaneous pressure between the terminals of the coil for the given position. If the capacity of the

condenser is known, the pressure at the terminals of the coil may be obtained from the formula

$$E = \frac{Q}{C}.$$

Q is determined from the constant of the galvanometer and its throw.

By making various settings of the contact device a series of observations may be taken extending over 180 electrical degrees or more. If the method of connecting the armature coils to the commutator, and the positions of brushes and pole pieces for a given setting of the contact device are noted, the field distribu-

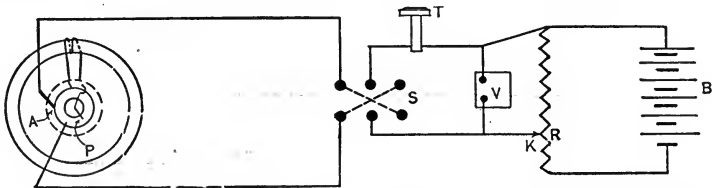

Fig. 44B. Connections for Potentiometer Method of Magnetic Distribution Testing.

tion curve may be drawn and the proper positions of the brushes and pole pieces indicated. By taking observations for both no load and full load conditions, the effect of armature reactions may be investigated.

This method gives the total pressure generated in the coil, only on condition that the machine is running on open circuit. Otherwise the pressure at the coil terminals is less than the generated pressure by the IR drop in the coil.

Potentiometer Method.—The potentiometer method may be employed, the connections being as shown in Figure 44B. S is a reversing switch; T , a telephone receiver or a capillary electrometer; V , a voltmeter; B , a separate source of pressure; and R , a resistance. The contact maker is set in a given position and the coil pressure is balanced by moving the contact K , along the resistance R . A sharp click is heard in the telephone receiver when the contact is made unless a balance exists. The

balancing pressure is read by the voltmeter V . The point of absolute silence in the telephone is difficult to determine, but a position of minimum sound may be determined by moving the contact point from positions of loud sound on each side of the balancing point. The mean of the two voltmeter readings thus obtained is the correct reading. The same proceeding should be followed when a capillary electrometer is used. The telephone receiver, however, is the more rapid instrument. The independent source B should produce a pressure fully as high as the maximum pressure generated in the coil. The advantages of this method are rapidity and directness of reading, without sacrifice of accuracy.

Test Coil Method.—Instead of using one of the armature coils, a test coil of small wire may be wound on the armature and connected directly to the contact device. If the armature is drum wound, the test coil should embrace 180 electrical degrees; if ring wound the test coil may be wound over an armature coil. Either the ballistic galvanometer or the potentiometer method may be employed. If the latter method is used it is not necessary to have a separate source of pressure across the resistance R , Figure 44B. In fact it is advantageous to use the pressure of the machine itself, as in this case any slight variations in pressure generated in the coil, due to variations in speed, etc., occur also in the total machine pressure and a balance is more readily obtained.

Other advantages of the test coil method are that the observations are not affected by armature IR drop when a load is thrown on; and that they are not affected by the short circuiting of the armature coils during commutation, except in so far as mutual induction enters. An advantage over the armature coil method is that in the case of a drum winding the test coil may be made to cover 180 electrical degrees.

Contact Makers.—A number of contact makers have been devised but mention will be made of two only; the water contact device and the Adams' contact maker.

The water contact, devised by Professors Ryan and Bedell, is shown in Figure 44C. *S* is the shaft and *B* one of the bearings of the machine; *R* is an insulated metallic ring and *D* a rubber or

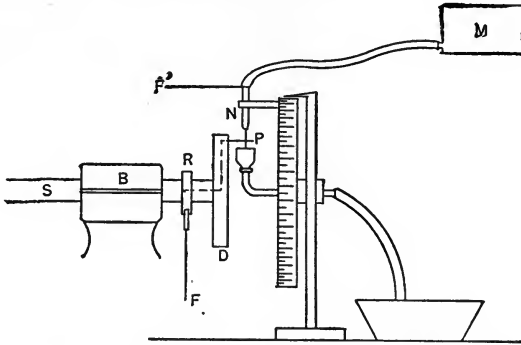

Fig. 44C. Bedell and Ryan Contact Maker.

wood disc mounted upon the shaft; *P* is a metallic pin (usually a steel needle) fastened to the disc and electrically connected to the ring *R*; *N* is a nozzle connected by means of a rubber tube to a reservoir *M* containing a saline solution. The nozzle is attached to a graduated disc which turns on an axis coincident with that of the shaft *S*. When the jet of water (saline solution) from the nozzle is cut by the pin *P* the contact forms a closed circuit between the terminals *FF'*. The point at which contact

is made is determined by noting the reading on the graduated disc with reference to a fixed point.

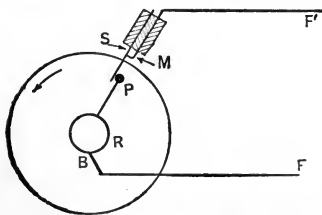

Fig. 44D. Adams Contact Maker.

reduced to a minimum. *P* is a hardened steel pin which closes the circuit between terminals *FF'* when it comes in contact with the spring *S*; the circuit being from *F* through the brush *B* and slip ring *R* to the pin *P* and through the spring *S* and stiff

metallic strip M to F' . But almost immediately with this closing, the circuit is opened by the separation of S and M . Thus the same blow that closes the circuit opens it almost simultaneously.

Data. Unless otherwise directed, arrange to take data by using one of the armature coils and the potentiometer method, as shown in Figure 44B. Run the machine on open circuit at rated speed and pressure. Take readings of instantaneous pressure in the exploring coil every ten electrical degrees for at least 180 electrical degrees. The pitch between consecutive north and south poles constitutes 180 electrical degrees. Place full load upon the machine, adjust the brushes if necessary, and see that the speed and terminal pressure are normal. Take a second set of observations similar to the first. Note the connection of the armature coils to the commutator and the position of the brushes and pole pieces relative to a certain contact setting for both no load and full load conditions.

Caution. When an armature coil is used it should be remembered that the observed pressures under load are less than the total pressures. Correction may be made by remembering that the pressure lost is $e = IR$ where R is the resistance of the coil and I the current in the coil. This correction cannot be made for the interval when the coil is being commutated. To get the true readings for the position of the coil when under commutation it is necessary to use the test coil method. Even in this case the reading at this point is somewhat affected by mutual induction.

Curves. Plot curves showing magnetic distribution for both no load and full load, using pressures as ordinates and electrical degrees as abscissas. Indicate the relative positions of brushes and pole pieces for both the no load and full load conditions. Plot a curve, taking as ordinates the differences between the no load and full load distribution curves.

No. 45. MAGNETIC DISTRIBUTION BY THE BALLISTIC METHOD.

Object. In the previous methods the magnetic distribution was obtained by measuring the pressure generated in a coil revolving in the magnetic field. Here the armature is at rest, the magnetism threading a coil is measured for various angular positions of the coil, and the magnetic distribution calculated from these data. This method is available where it is not convenient to rotate the armature.

Theory and Method. A test coil consisting of several turns of fine wire is wound on the armature, and its terminals are connected to a ballistic galvanometer. If the armature is ring wound, the coil is wound directly over one of the armature coils; if drum wound, the test coil should embrace 180 electrical degrees. The armature remains at rest throughout the experiment. If the field is excited to its normal value and the excitation suddenly reversed, the deflection of the galvanometer will be proportional to the number of lines of force threading the test coil for the given position. It should be remembered in this connection that it is dangerous to break the field circuit of a large machine, especially one of high terminal pressure. In such cases the field magnetism may be suddenly increased or decreased a certain amount by short circuiting or interposing a given resistance in the field circuit. A method which does not require a change in field magnetism is described later.

If the field current is raised to the same value each time before reversing, a series of observations may be obtained which show the magnetism threading the exploring coil for various angular positions. By noting the positions of the brushes and poles relative to a given position of the exploring coil, a curve may be drawn, such as curve *A*, Figure 45, showing the magnetism enclosed by the coil at various positions.

The ordinates of curve *A* represent the magnetism threading the coil and the abscissas represent the angular positions of the

coil relative to the pole pieces. It is evident that, for equal small displacements of the test coil, the *change* in the magnetism threading it represents the *density* of the field in which the conductors of the test coil lie. If the armature were rotating, this change would be due to the cutting of magnetism by both sides of the test coil. Since the two sides of the test coil are similarly situated under north and south poles, being 180 electrical degrees apart, the change may be considered proportional to the density under either pole at the point in question. This is on the assump-

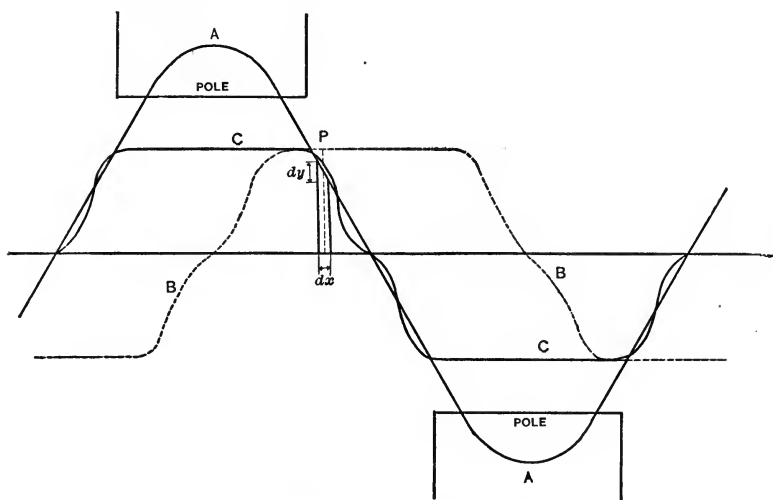

Fig. 45. Magnetic Distribution by Ballistic Method.

tion that the field distribution is the same under all poles. In a Gramme ring wound test coil, the maximum enclosure of magnetism is obtained when the coil is midway between the poles. Hence, a curve showing the actual density at the various points may be drawn by taking as ordinates the change (increments) in the ordinates of curve *A*, for equal displacements. Curve *B* has been obtained in this manner. The construction of curve *B* from curve *A* is quite simple. The ordinate for any point *P* in curve *B* is obtained by considering the change in ordinate dy of curve

A for a corresponding change in abscissa, dx . The scale of ordinates of curve B may be quite different from that of A . The change in abscissas dx should be taken the same in obtaining the values of ordinates at various points in the curve, and should be so small that the curvature of A has not changed appreciably within the increment. The ordinate for the curve B is the one at the center of the increment dx in each case. If a test coil embracing 180 electrical degrees is employed, the *center* of the test coil is considered with reference to the poles in curve A , while the *conductors* of the test coil are considered with reference to the poles in B . The center of the coil is 90 electrical degrees from the conductors. The result is that the true position of the distribution curve, relative to the poles, is 90 electrical degrees from that shown by curve B . Curve C , similar to B but displaced from it 90 electrical degrees, would therefore represent the field distribution with respect to the pole pieces. In the case of a Gramme ring test coil, curve A will be displaced 90 electrical degrees from the position shown in the diagram and the deduced curve, B , will occupy the correct position relative to the poles.

Narrow Test Coil Method.—Instead of using a test coil, embracing 180 electrical degrees, investigations of this nature have been made by means of a narrow test coil, embracing but a few electrical degrees, but extending the length of the pole pieces in the direction of the armature shaft. Two methods of operation are available in this case. One is to reverse or alter the field magnetism as described above. The other method is to maintain the field constant and to suddenly remove the coil from the field. In either case a ballistic galvanometer is used and readings are taken for various positions of the coil relative to the pole pieces. The narrow test coil gives readings directly proportional to the magnetic density at the point considered. Its accuracy, however, is dependent upon the test coil being very narrow, as the deflec-

tion must be considered as proportional to the field density at the center of the coil for a given position. The advantages of this method over the first one are that the magnetic distribution under each pole may be investigated independently, the deflections are directly proportional to the magnetic densities, and the reversal of the field or even a change in the field magnetism is unnecessary.

Both methods have the disadvantage that actual running conditions are not shown, since it is necessary to keep the armature stationary. These methods have been used to some extent in investigating distribution at no load. Full load current may be sent through the armature, the latter being clamped in the desired positions, and observations taken as before, but the method is hardly applicable.

Data. Wind a test coil on the armature. If the latter is drum wound the coil should embrace 180 electrical degrees. Connect the terminals to a ballistic galvanometer and take a series of readings of galvanometer deflections for various angular positions of the coil, the field current being adjusted to the same value before reversal in all cases. Take readings every 10 electrical degrees for 180 electrical degrees or more. Note the relative positions of the pole pieces and brushes for a given position of the test coil.

Caution. If the machine is large and especially if the field is wound for high pressure, it is dangerous to reverse or break the field current. In such a case use either the method of interposing a given resistance in the field circuit, or the narrow test coil method with the field constant.

Curves. Draw the curve of total magnetism, Curve *A*, Figure 45, using electrical degrees as abscissas. Draw the curve of increments, Curve *B*, and indicate the positions of pole pieces and brushes. If the narrow test coil method is used, the data for curve *B* is obtained directly.

No. 46. MAGNETIZATION CURVE OF A SHUNT DYNAMO AT FULL LOAD CURRENT.

Object. To show the effect of armature reactions at various field excitations and to furnish data for compounding the machine.

Theory and Method. The machine may be either separately or self excited, and readings of terminal pressure for various field currents are taken over as wide a range as possible without injurious sparking or heating. Separate excitation is preferable. In order to avoid appreciable hysteresis effects it is best to take the readings for small changes in field current; the changes in armature reaction, due to the slight changes of armature current when the field current is being adjusted, will then be minimized. The armature current may be brought back to its original value after each field adjustment and before the final readings are taken. While it is preferable to run the test at normal speed this is not necessary. If speed readings vary, all voltages should be reduced to a constant speed before plotting the curve. The ordinates of this curve will be less for a given field current than those of the no load magnetization curve, due to armature reactions and armature IR drop.

Data. Maintaining the speed constant, at normal value, with brushes set for normal running position, first send a small current, from a separate source, through the field winding and throw on full load current; providing the machine will stand it without injurious sparking. If not, increase the field current until sparking disappears, being careful that full load current is not exceeded. Having found the lowest field excitation that will permit sparkless operation at full load current, read terminal pressure, field current, armature current, and speed. Increase the field current slightly, being careful that the rise in armature current is a small percent, and then bring the armature current back to its original value. Proceed in this manner until consid-

erably beyond normal terminal pressure, and then reverse the process.

Curve. Plot a curve for both ascending and descending values, using field current as abscissas and terminal pressures at normal speed as ordinates.

No. 47. COMPOUNDING A DYNAMO FROM ITS NO LOAD AND FULL LOAD MAGNETIZATION CURVES.

Object. To determine the number of series turns necessary to compound a shunt dynamo for a given pressure at full load.

Theory and Method. The no load and full load magnetization curves are both plotted on the same sheet and to the same

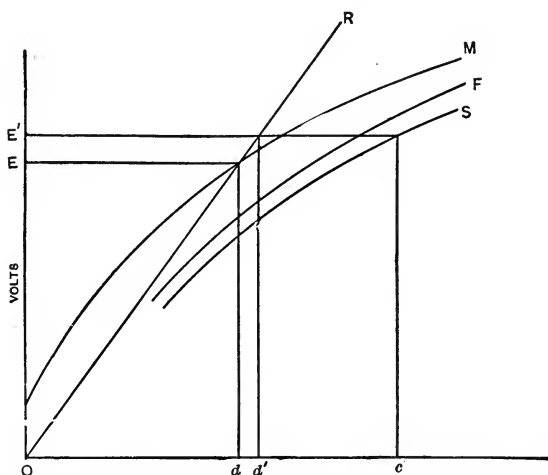

Fig. 47. Compounding from Full Load and No Load Magnetization Curves.

scale, as in Figure 47. M is the no load magnetization curve and F is the magnetization curve at full load current. If the dynamo is to be compounded, a certain drop must be allowed for the series turns. The drop produced in this case is represented by the constant difference in the ordinates of the curves F and S .

Let OE represent the no load pressure. Then Od will be the shunt field current at no load. If the required terminal pressure at full load is OE' , the corresponding shunt current will be Od' . This is determined by the intersection of a horizontal line through E' with the shunt field resistance line OR . But the amount of shunt current which would be required to bring the full load pressure up to OE' , would be Oc . The deficit of ampere turns $d'c \times N$, where N is the number of shunt turns, must be made up by the series winding. The number of series turns required will be

$$N_s = \frac{d'c \times N}{I},$$

where I is the full load armature current of the machine. This represents the condition for long shunt connection, or to be accurate, represents a load current equal to I less the shunt current Od' .

Data. If the no load and full load magnetization curves have not been obtained for the same machine, as in Experiments 24 and 46, they should be taken. The average of the ascending and descending curves should be used in each case.

Caution. Both curves should be taken with brushes in *running* position. The no load magnetization curve will not be the same in this case as the one from which useful flux may be calculated, unless the running position of the brushes is without angular displacement.

Calculate. The number of series ampere turns required for a 5 percent over-compounding at full load and an assumed drop in the series winding of $\frac{1}{4}$ percent.

No. 48. SPARKING TEST OF A DYNAMO OR MOTOR.

References. Standardization Report; Fisher-Hinnen, p. 223; Jackson's "Dynamos," p. 171; Sheldon, p. 83; Arnold's "Dynamos," p. 239; Thompson's "Dynamos," p. 78; Parshall

and Hobart, p. 145; Houston and Kennelly, p. 179; Wiener, p. 297; Hawkins and Wallis, p. 351; Kapp, p. 261; Crocker and Wheeler, p. 120; Crocker, Vol. 1, p. 316; Thompson's "Design," p. 159; Slingo and Brooker, p. 316.

Object. To determine the limit of load a machine will stand without shifting the brushes from their no load position.

Theory and Method. The requirement that brushes remain in a fixed position throughout the range of load, was considered, in the early days of dynamo-electric machinery, quite unreasonable. Not until the general introduction of the motor was its necessity fully realized. The advent of the electric railway, probably more than anything else, stirred inventors to greater effort in this direction. Here the motors must operate in an almost inaccessible position and the generators, especially in small plants, are subjected to violent fluctuations of load. The introduction of toothed armatures and carbon brushes was probably the chief factor in bringing modern machines to their present state of perfection. Dynamos and motors are now regularly furnished by manufacturers, under a guarantee to stand 25 percent overload without sparking, and the limit of continuous load is now determined, as it should be, by temperature. The amount of research that has been done on sparking is enormous; and yet, the dynamo designer of to-day finds it one of the most uncertain factors with which he has to deal. He allows a greater margin in his pre-determinations than for any other electrical requirement, except insulation. While this indicates room for improvement, the factors of safety are still much less than those required by the mechanical properties of the materials used in dynamo construction.

The two most common factors that determine the sparking limit are: field distortion, due to armature reaction, and the self-inductive discharge of armature coils under commutation.

Field distortion may be reduced, or even suppressed, by a number of special devices, among which are the Lundell split-pole

construction, the Thompson-Ryan winding, and the Sayers' winding; but the most common method is to use a design involving a toothed armature construction with a high tooth density, or a pole piece so shaped that its tips are worked at a high density. A long air gap is often used for the same purpose. Sometimes several of these elements are combined in one design; sometimes only two. The idea is to get a large number of ampere-turns in that portion of the magnetic circuit affected by the armature ampere-turns, thus making the latter small in proportion.

The self-inductive effect depends on the square of the number of turns in one armature coil, on the area enclosed by the coil, on the reluctance in the magnetic circuit of the armature ampere-turns, on the number of lines of force emanating from one pole, on the distribution of these lines, on the resistance of the path of short circuit, and on the frequency of the machine. It may be minimized by the use of a small number of turns per coil, a multipolar construction, a short armature core, a stiff tooth density or even a stiff core density, a high density in the poles next to the face, a long air-gap, a wide slot, a pole so shaped that there will be a shading of the magnetism in the interpolar space (*i. e.*, a gradual change from north magnetism to south magnetism), a spiral slot, or a skewed pole piece. The resistance of the path of short circuit may be increased by the use of high resistance brushes (usually carbon), or the use of high resistance connections to the commutator bars. A low speed and small number of poles reduces the effect of frequency. Some of these devices are opposed and a good design is naturally a compromise.

Another cause of sparking is sometimes found in an armature construction involving two or more coils per slot. A wide slot is thus gained and the labor account in manufacture is somewhat reduced; but there is a continual shifting or oscillation of the geometrical neutral plane, and unless the interpolar space is wide, unless there is a "wide neutral," there is likelihood of a blackening of the commutator segments. When a commutator shows

a pitting or a blackening of every other segment, a three-coil-per-slot winding is almost certain to be found. This construction is not decried, but it should be used with proper precautions.

Another cause, inherent in multiple-path, multipolar armatures, is eccentricity of alignment or some other cause of unequal reluctance of the various magnetic circuits. This may be understood by regarding a multiple-path armature as two or more like armatures operated in parallel and at the same speed. If each does not generate the same pressure, does not cut the same number of lines of force, the high pressure windings will tend to overpower those of lower pressure, causing them to motor. They will be overloaded as a result, and there will be a vicious sparking at the commutator; "bucking" as it is called. There are several remedies for this. The one in general use is that of conductors connecting armature bars or wires that are normally at equal potential. The result of this construction is that when there is any asymmetry of magnetism, from any cause whatever, alternating currents are set up in the local circuits thus formed that lag somewhat behind the pressures causing them, and these magnetize the poles that are weak, demagnetize those that are strong, and make the field symmetrical. This improves the operation as to sparking, and equalizes the magnetic pull of the poles on the armature. The device is often called an equalizer or a cross-connected winding. It is commonly used on low tension machines of 100 K. W. capacity or over. On smaller machines it is well to examine the armature for eccentricity and the poles, if cast, for blow holes at the bore, and for symmetry in form.

Exploration curves, Experiments 42, 43, 44, and 45, are useful in determining whether the poles are of proper shape to resist skewing due to armature reactions, or to shade the magnetism properly; and to show if the cause of sparking is due to too great a span of the brushes.

Still another cause of sparking may be found in too great a voltage between commutator segments. The remedy lies with the design. It is seldom advisable to operate a machine at more

than eighteen volts per segment, and a less amount is usually found in practice.

The current density of commutation is an important factor in the sparking of a dynamo. No hard and fast rule can be made, but it is good practice not to exceed 30 amperes per square inch of brush contact with carbon brushes, or 150 amperes per square inch with copper brushes.

The mechanical causes of sparking: vibration, high and low bars, hard or soft mica, etc., are too obvious to be treated at length. Defects of this kind are none the less important, and should always be watched for and guarantees secured against their development.

To make a sparking test of a dynamo or motor operating in only one direction of rotation, the brushes should be set for no load with as much dynamo lead or motor lead as possible without materially reducing the pressure as a dynamo, or materially increasing the speed as a motor, and without sparking. Load is then gradually applied, all the brushes being closely watched until sparking is noticed. The load is still further increased until the sparking becomes injurious, when the current is noted which is just below this critical point. Injurious sparking may be recognized by the color of the sparks.

Reversible machines are used mostly as motors. A sparking test on a reversible dynamo or motor should be made for each direction of rotation and with the brushes set central.

Data. Set the brushes of a dynamo as indicated above and determine the range of absolutely sparkless operation, and also the range over which it will run practically sparkless. Determine these same limits with the brushes set at the geometrical neutral plane. Repeat the tests, using the same machine; first as a motor having only one direction of rotation, and second, as a reversible motor. Examine the brush surfaces for pitting, and also observe the condition of the commutator. Note any other features that affect the sparking limit.

Suggestions. The machine should be operated with the same field connection in all cases; *i. e.*, if a cumulative-compounded dynamo, it should be operated as a cumulative-compound motor.

The brushes should be fitted perfectly before starting the test and the machine ought to be at normal temperature.

A machine may sometimes be greatly improved by trying different kinds and grades of brushes and brushes of different thicknesses.

Questions. In what order would you arrange series, shunt, cumulative compound and differential compound motors, sparkless operation being the criterion?

In a multipolar machine which would you expect to give the better results, a two-path or a multiple path armature winding?

Which is the better, an armature having a large number of coils of few turns, or one having a small number of coils of many turns?

Two armatures, exactly alike, are revolved in fields of the same strength, one at twice the speed of the other. Does the difference in voltage developed tend to affect sparking? Assuming the same armature current, would you expect the difference of speed to be of advantage to either?

No. 49. RELATION OF SPEED TO PRESSURE IN A SEPARATELY EXCITED DYNAMO.

References. Thompson's "Dynamost," p. 179; Nichols, Vol. 2, p. 83; Sheldon, p. 94.

Object. To show experimentally that the pressure is directly proportional to the speed, other factors in the formula for pressure being constant.

Theory and Method. The pressure developed in the armature of a dynamo is given by the formula

$$E = \frac{S\phi V p_1}{10^8 \times 60 p_2}$$

Under the conditions of the experiment, all of the factors on the right-hand side of the equation are constants except the value of the speed. The pressure developed, then, should be directly proportional to the speed, provided no current is taken from the armature. When current is taken, reactions enter which cause a diminution of the pressure, and this becomes greater as the current is increased.

The field of the machine is excited to its normal value from some external source. Simultaneous readings of speed and terminal pressure are taken, the machine operating on open circuit. The speed should be varied from a low value to one somewhat above normal and data taken for a number of points throughout the range.

Data. With the field normally excited, obtain simultaneous readings of speed and terminal pressure on open circuit, for speeds varying from a low value to one considerably above normal.

Curve. Plot a curve between terminal pressure and speed using the latter as abscissas.

Explain. How the curve would be affected if a constant current were taken from the armature.

No. 50. RELATION OF SPEED TO PRESSURE IN A SHUNT DYNAMO.

References. Nichols, Vol. 2, p. 83; Thompson's "Dynamo," p. 213; Fisher-Hinnen, p. 91; Sheldon, p. 102.

Object. To show the relation of speed to terminal pressure when the exciting current varies with the pressure.

Theory and Method. The theory is best illustrated by a graphical treatment. In Figure 50, M_1 is the magnetization curve at normal speed and OR the field resistance line for rated pressure at no load. This curve is plotted with volts as ordinates and field current as abscissas. M_2, M_3, M_4 and M_5 are the mag-

netization curves at $1\frac{1}{4}$, $\frac{3}{4}$, $\frac{1}{2}$ and $\frac{1}{4}$ speeds, respectively. They are obtained from M_1 by taking the ordinates in direct proportion to the speeds. The intercepts T_1 , T_2 , T_3 , T_4 , and T_5 of these curves with the field resistance line, determine the simultaneous values of field current and terminal pressure at the respective speeds. To obtain a speed-pressure curve all that is necessary is to adopt a scale for speed as abscissas and project the points T_1 , T_2 , etc., horizontally upon the vertical lines drawn through points

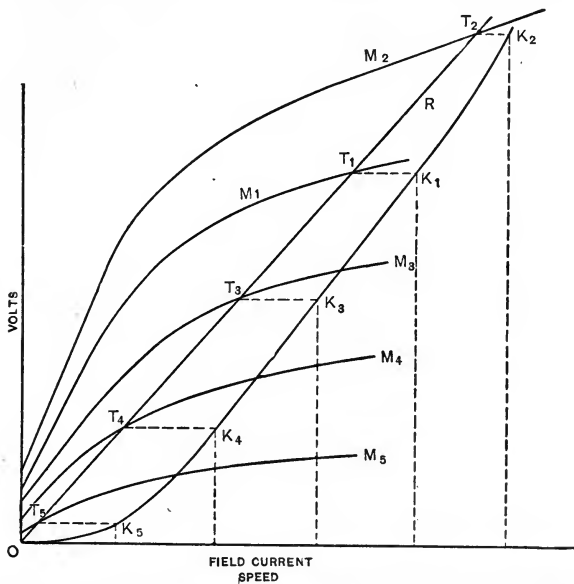

Fig. 50. Derivation of the Speed-Pressure Curve of a Shunt Dynamo.

on the X axis representing the corresponding speeds. A curve drawn through the points K_1 , K_2 , etc., thus obtained, represents the relation between pressure and speed.

The derived magnetization curves need not be taken at the particular speeds here adopted, but enough curves should be drawn to give good results.

In determining the relation between speed and pressure experimentally, it is best to begin at the highest speed and run down.

This avoids the difficulty experienced in making a shunt dynamo "pick up" at a speed far below normal value.

Data. Adjust the field resistance to give normal pressure at rated speed. This is merely for convenience. Increase the speed to the maximum value desired and take simultaneous readings of field current, terminal pressure and speed for speeds ranging from the maximum down to zero. The reference magnetization curve, M_1 , should then be taken for decreasing values of pressure and normal speed, starting from the maximum field current, or it may be obtained from the other data by correcting for speeds.

Suggestion. The reference magnetization curve considered was taken at normal speed. The magnetization curve at any speed may be used, however, provided that speed is known.

Caution. The field is likely to undergo a considerable change in temperature during this test. The field should really be heated up before the test; but as this requires considerable time, the field circuit resistance should be maintained constant by adjusting the rheostat.

No. 51. RELATION OF SPEED TO PRESSURE IN AN ARC DYNAMO.

References. Parham and Shedd, p. 246; Thompson's "Dynamos," p. 445; Fisher-Hinnen, p. 235; Sheldon, p. 129.

Object. Arc dynamos are frequently run at speeds other than the rated speed. Again, it often occurs that the machine is considerably larger than necessary. These considerations, in addition to the fact that the speed of the machine generally decreases as the load is increased, give importance to the relation between speed and automatic current regulation in an arc dynamo.

Theory and Method. Since arc machines are series wound, the tests must be under load; that is, with a closed external cir-

cuit. If the external resistance is adjusted to a value equal to or greater than its value for full load and normal speed, it will be found that the regulator produces no effect and the machine acts as a simple series generator would under like conditions; namely, for speeds between zero and normal. If, however, the external resistance is adjusted to a smaller value than that for full load at normal speed, it will be found that after a certain speed has been attained, the regulator comes into action and an increase in speed does not produce an increase in either the terminal pressure or the current. The speed at which the regulator comes into action varies directly with the external resistance; that is, if the external resistance has been adjusted to one-half of the full load value, the critical speed is approximately equal to one-half the normal speed.

Data. Adjust the external resistance to the normal full load value. This may be determined by observation of pressure and current. Take a series of observations of speed, current, and terminal pressure, for various speeds, varying from a low value to the normal value or above. Adjust the external resistance to one-half the normal full load value and take a similar set of readings. In both cases carefully observe the action of the regulator and take such readings as are practicable.

Curves. Plot curves in each case showing the relation between external current and speed, and also between terminal pressure and speed, using speed as abscissas.

Questions. If an arc machine is operating a lamp circuit which is 80 percent of its normal capacity, how much approximately might the speed of the machine fall off without affecting the operation of the lamps?

If it were desired to operate a few more lamps than the normal full load number for the machine, how could the machine be made to carry them in a satisfactory manner?

If an arc machine is supplying a maximum load which is but two thirds of its capacity at normal speed, would it be advisable from the standpoint of efficiency, to run it at a reduced speed?

No. 52. STATIC TORQUE TEST OF A MOTOR.

References. Carus-Wilson, p. 8; Houston and Kennelly, p. 251; Thompson's "Dynamos," p. 103; Fisher-Hinnen, p. 14; Hawkins and Wallis, p. 60; Parr, E. E. T., p. 188; Nipher, p. 177; Kapp's "Dynamos," p. 50.

Object. To investigate the static torque or the rotary effort which a motor armature exerts when it is supplied with a current and the fields of the motor are excited.

Theory and Method. When a conductor carrying a current is placed in a magnetic field and at right angles to the lines of force, it is acted upon by a force $f = Il\mathcal{B}$, where I is the current in the conductor, \mathcal{B} the magnetic induction and l the active length of conductor. If f is expressed in pounds, \mathcal{B} in lines of force per square inch, and l in inches, the formula becomes: $f = 8.85 Il\mathcal{B} \times 10^{-8}$. The torque of a motor is the turning moment due to this force, and is usually expressed in *pound-feet*.

The length of active wire in a given armature remains a constant quantity. Therefore, the torque exerted varies directly with the strength of the field and with the armature current. With a given field and a given current in the armature, the armature torque will be the same whether the armature is stationary or rotating. However, when rotating, the torque available at the pulley is not the total torque because some force is necessary to overcome the effects of hysteresis, eddy currents, and mechanical friction. When an armature is stationary, and has a current flowing in it, the power taken is all expended in I^2R loss. If the fields are excited, there is a torque exerted under these conditions; but since there is no motion, no power is developed. On the other hand, when the motor is running under load, it has impressed upon its armature a pressure E and the power supplied is EI , where I is the armature current. If the armature resistance is r , the resistance drop is Ir , and the counter pressure is $e = E - Ir$. Since all the power supplied to the armature, except the I^2R loss, is expended in the rotary motion, and as this power

is the product of the armature current and the counter pressure, the following equation is obtained:—

$$eI = 1.356 \frac{2\pi V}{60} T = 0.142 VT,$$

where V is the number of revolutions per minute, and T is the total torque expressed in pound-feet. If the percentage of the total torque lost in overcoming hysteresis, eddy currents and friction is known, the torque available at the pulley may be calculated.

In order to bring out fully the relation between the excitation, armature current and torque, not only should the torque corresponding to the various armature currents for the given field excitation be determined, but also similar data for different field excitations. The torque may be easily measured by means of a

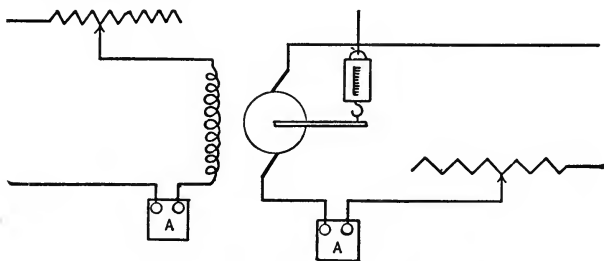

Fig. 52. Connections for Static Torque Test of a Motor.

spring balance and a lever arm attached to the armature shaft, as represented in Figure 52. The excitation of the fields should remain constant for any one set of observations.

Data. Obtain readings of armature current and the force exerted on the balance for normal field current and for one excitation 25 percent above normal and one 25 percent below normal. Maintain the excitation constant in each case and vary the armature current from a value somewhat greater than normal, to zero. Measure the lever arm.

Cautions. Make certain as to the direction of the torque before sending a large current through the armature.

Be certain that the lever is level and that the balance pulls at right angles to it.

Curves. Using armature current as abscissas, plot curves between torque in pound-feet and armature current.

Suggestions. It is desirable to have the lever arm used in measuring the torque, just one foot in length. Then if the spring balance reads in pounds, the torque in pound-feet is numerically equal to the number of pounds read on the balance.

As the bearings are likely to bind on the shaft, it is advisable to tap the lever lightly before reading the balance.

In toothed or pierced core armatures the conductors are not situated in the strong field as in the case of smooth cores and are not acted upon by the torque as determined above; the armature core, and not the conductors, possesses the rotary effort.

Explain. Why the torque curve is a straight line. Why the torque, for a given armature current, does not vary directly with the field excitation.

Calculate. For the condition of normal field excitation, and normal full load armature current, what the output of the machine would be (in H. P.) at normal speed, assuming that eight percent of the torque is exerted in overcoming friction, hysteresis, and eddy current losses. Knowing the armature resistance, calculate the pressure necessary to impress upon the machine under these conditions.

No. 53. RELATION OF SPEED TO PRESSURE AT THE ARMATURE TERMINALS OF A SHUNT MOTOR; CONSTANT EXCITATION.

Object. A useful relation is shown here and its advantages and limitations as a method of speed control are illustrated.

Theory and Method. The fields of the motor should be excited to their normal value. The armature is to be connected in series with a rheostat or lamp bank to the same or to another source of electrical pressure. An ammeter should be placed in

the field circuit and its indication should be kept constant throughout the experiment. A voltmeter is placed across the armature terminals and an ammeter placed in the armature circuit. The motor should be started gradually and the speed varied from a minimum running value up to or above normal speed. This is accomplished by gradually decreasing the resistance in the armature circuit.

The armature being run light, the speed should be nearly proportional to the impressed pressure, but strictly speaking, it varies as the counter e.m.f., $e = E - IR_a$.

It might seem that this offers a good method for speed control of variable speed motors. The field being excited to normal value for all speeds there is no reason for any difficulty from sparking, except when the speed becomes so high that the self-inductive pressure of a coil under commutation becomes prohibitive.

There are many applications of this method, but it has its limitations as well as its advantages.

If a motor be operating at no load and at partial speed, a rheostat being in the armature circuit, there will be a drop in the impressed pressure at the brushes the moment a load is thrown on. This is due to the increased IR drop in the rheostat, caused by the armature current. The inherent regulation of the motor is thus destroyed by the addition of the rheostat. Furthermore, the I^2R loss in the rheostat is large and the efficiency of operation is thus reduced. Rheostatic control, then, is limited to constant load working, or to that class of work requiring no inherent regulation; and in either case, to applications where economy of power is no object.

If the armature voltage is changed by changing the pressure of a dynamo connected to the armature, or by some similar means, the inherent regulation is still preserved and the efficiency maintained at a high value. Such applications are found in the Leonard systems of control, the most common of which is known as the Multivoltage system.

The output of a motor is limited by its heating. The core losses are less at the low speeds but the ventilation is also less. It therefore follows that the rating of a motor controlled by changing the armature voltage varies almost directly with its speed and the applications of this method are most efficient where the output required varies with the speed.

Data. Maintaining a constant field excitation, take no load readings of field current, armature current, pressure at brushes, line pressure and speed, for brush pressures varying from the lowest value at which the motor will run to one considerably above normal, varying the speed by rheostatic control. With the machine at about half speed throw on a load and take a set of readings. Without removing the load raise the armature pressure to its initial value, and take another set of readings.

Suggestion. This test should really be made with the machine at normal temperature. Some means should be provided in the laboratory for compensating for the rise of field resistance due to heating during the test. A finely divided field rheostat will serve to regulate the field current to a constant amount.

Calculate. The waste energy in the armature rheostat for the two load conditions.

Curves. A curve should be plotted, taking brush pressure as ordinates and speed as abscissas.

Plot a curve between armature watts and speed, using speed as abscissas.

Explain. Why, in this system, the stray-power increases more rapidly than the speed.

No. 54. RELATION OF SPEED TO EXCITATION IN A SHUNT MOTOR.

References. Fisher-Hinnen, p. 122; Parham and Shedd, p. 478; Sheldon, p. 163; Thompson's "Dynamos," p. 503.

Object. A useful relation is shown here and its advantages and limitations as a method of speed control are illustrated.

Theory and Method. The motor is connected up in the usual manner, except that it has a rheostat placed in its field circuit. When the motor is started, the field resistance should be entirely cut out so that the field may be as strongly magnetized as possible, thus giving the maximum starting torque. After the machine has been brought up to speed, the armature rheostat is cut entirely out and the first reading is taken with the field rheostat short circuited. It is seen that by this arrangement the field excitation may be varied without altering the pressure applied to the terminals of the armature. From the formula

$$E = \frac{S\phi V p_1}{10^8 \times 60 \times p_2},$$

or

$$V = \frac{E}{\phi} \times \text{a constant},$$

it is seen that when the counter pressure is constant the speed varies inversely with the magnetic induction. This condition practically obtains when the machine is running light. When the motor armature is running without load, the power supplied to it is expended in losses. These losses are hysteresis, eddy currents, I^2R losses in the armature conductors and brushes, mechanical friction at the bearings and commutator, air resistance, windage, and field I^2R loss. The armature I^2R losses may be neglected for no load conditions. The friction losses vary directly as the speed and are practically independent of the field excitation. Windage varies nearly as the cube of the speed, but is generally so small as to be of little consequence. The eddy current losses vary as the square of the speed and as the square of the magnetic induction. The hysteresis loss varies as the speed and as the 1.6 power of the magnetic induction. The speed varies inversely with the magnetic induction. It therefore follows that the eddy current loss remains constant and that the hysteresis loss varies as $1/(\text{speed})^{0.6}$.

As a means of speed control, this method is used to a considerable extent. It has the advantage of high efficiency because

the total fixed loss tends to remain constant. The inherent regulation is good at all speeds, and is likely to improve at the high speeds, due to the greater effect of armature reactions. The rating of the machine remains nearly constant.

The method is limited, however, to a low range of speed because of the liability to spark when the field is weakened. A range of three to one is about the highest used in practice. This requires a very expensive machine and 1.3 to 1 is more common.

Data. Starting with no load and the field excited normally and maintaining a constant terminal pressure, read speed, field current, armature current and terminal pressure for speeds varying from the initial value to one representing the highest safe peripheral velocity. With the speed at the maximum value throw on a load and observe the sparking. Take a set of readings at a load just below that limited by injurious sparking. Reduce the speed to a minimum and repeat the observations.

Caution. Before beginning the experiment measure the diameter of the armature and compute the speed corresponding to a peripheral velocity of 5,000 feet per minute. It is not advisable to run beyond this; 6,000 feet per minute is a permissible maximum for a toothed armature of exceptionally solid construction.

The commutator is generally the weakest part of an armature; but as commutators are now built, they will not be injured if the surface velocity of the armature is kept within the limits specified.

Curves. Using speed as abscissas plot curves with field current, watts in field circuit, armature watts and total watts, as ordinates.

Show. That if the armature has a very large hysteresis loss, it is possible to have a decrease of the no load armature current as the speed increases. That the friction losses are not entirely independent of the load if the armature is not situated in a perfectly symmetrical field.

No. 55. RELATION OF SPEED TO TERMINAL PRESSURE IN A SHUNT MOTOR.

Reference. Arnold's "Dynamos," p. 442.

Object. Shunt motors are generally used for constant speed service under variable loads. Such motors are often operated from power circuits where the pressure is subject to considerable fluctuation. Again, the supply pressure may be quite different from that for which the motor was designed. These considerations give importance to the relation between speed and terminal pressure in a shunt motor.

Theory and Method. A shunt motor is brought up to normal speed in the usual way. When the armature is up to speed, the starting rheostat is cut out of the circuit. The test is begun with a pressure considerably above normal impressed upon the field and armature. The pressure is gradually reduced to zero and a series of observations of speed, terminal pressure, and armature and field current is made. The only point of difference in the operation of the motor in this and in Experiment 53, is that the pressure across the field, and consequently the field current, decreases as the pressure across the armature decreases, instead of remaining constant.

It is interesting to trace out the relation of the experimentally determined curve to the reluctivity curve of the magnetic circuit. It is known that the pressure impressed upon the armature is equal to the counter e.m.f. plus the armature IR drop. For no load conditions the armature IR drop is small and may be neglected without appreciable error. Under this assumption the impressed and counter pressure are equal and the following equation holds:

$$E = \frac{S\phi V p_1}{10^8 \times 60 p_2}.$$

Then

$$V = \frac{K_1 E}{\phi},$$

where K_1 is a constant.

Since the field resistance r is constant, the field current is

$$i = \frac{E}{r} = K_2 E,$$

where K_2 is a constant.

Also ϕ may be expressed as follows:

$$\phi = \frac{4\pi NiA\mu}{l},$$

where μ is the permeability of the magnetic circuit as a whole.

$$\therefore \phi = K_3 i \mu,$$

where K_3 is a constant.

Therefore:

$$V = \frac{K_1 E}{\phi} = \frac{K_1 E}{K_3 i \mu} = \frac{K_1 E}{K_2 K_3 E \mu} = \frac{K}{\mu},$$

where K is a constant.

It is seen from this that the speed is inversely proportional to the permeability of the magnetic circuit.

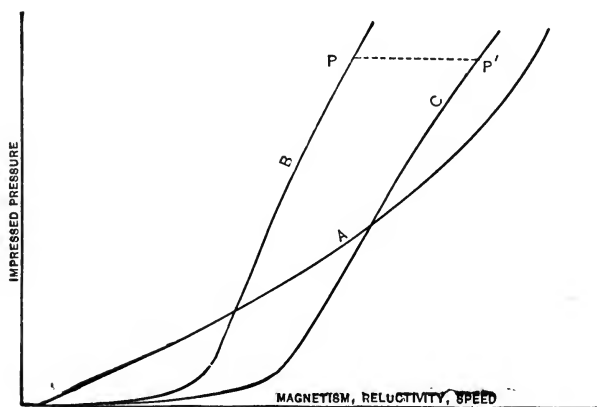

Fig. 55. Derivation of the Speed-Pressure Curve of a Shunt Motor.

The speed-pressure curve may be investigated graphically as follows. If impressed and counter pressures are considered equal, the speed-pressure curve may be obtained from the magnetization curve of the machine.

In Figure 55, A represents the magnetization curve of the machine, taken in the ordinary way at normal speed. Since the field resistance remains constant in the present experiment, the field current is directly proportional to the terminal pressure impressed upon both armature and fields. As the speed-pressure curve is to be deduced, the magnetization curve has been represented with values of ϕ as abscissas and corresponding values of pressure across the field as ordinates. From the analytical discussion above

$$\frac{I}{\mu} = \frac{K_3 i}{\phi} = \frac{K_3 E}{r\phi} = \frac{K_4 E}{\phi},$$

where K_4 is a constant.

Curve B represents the relation between I/μ and E . This is really a curve between I/μ and magnetizing current. Such a curve is called a reluctivity curve. Proportional values of I/μ , for corresponding values of E , are obtained by dividing E by ϕ and plotting to a convenient scale of abscissas.

This is the speed-pressure curve if the speed scale corresponds to the I/μ scale. If this is not the case the speed-pressure curve C is directly deduced by changing the abscissa scale to the desired value. The point P on curve B , representing normal speed and pressure, will be the point P' on curve C , representing normal pressure and speed according to the new scale of abscissas. Other points may be located by changing the abscissas in the same proportion.

The impressed and counter pressures being assumed equal in the above discussion, the speed-pressure curve for the shunt motor will be practically the same as that of the shunt generator, Experiment 50. A comparison of the curves shown in Figures 50 and 55 shows the similarity, although the graphical constructions are different.

A set of curves should be drawn as in the preceding experiment, taking the impressed pressures as abscissas and the speed and currents in the armature and field as ordinates. A consideration of the general form of the curve leads to some interesting

deductions. In the first place the upper portion of the curve is the only practical working portion, since the low field magnetization causes excessive sparking. For the upper portion of the curve the speed varies nearly in direct proportion to the impressed pressure.

The friction of bearings, brushes and air varies almost directly with the speed, and is quite independent of the load. The windage varies nearly as the cube of the speed but is generally negligible. The hysteresis loss varies as the speed and as $B^{1.6}$; therefore, it increases more rapidly than the speed. The eddy current loss varies as the square of the speed and as the square of the magnetic induction; therefore, it increases more rapidly than the square of the speed. The result is that if the speed is raised much above normal by increasing the pressure, the losses become excessive. The inherent speed regulation for a given pressure is good. This method of varying the speed has no commercial application except within narrow limits; for low speeds the weak field causes excessive sparking, while for high speeds the losses become excessive. However, the experimental investigation shows the action of a shunt motor when subjected to a fluctuating supply pressure, or when run at other than rated pressure, both of which conditions are liable to occur in practice.

Data. Start the motor in the ordinary manner and adjust the pressure to a value considerably above normal. Run the machine at no load and take a series of observations of speed, terminal pressure, total current, and field current for various impressed pressures down to the minimum pressure at which the armature will rotate. From this point repeat the observations for increasing pressure.

Suggestion. It is desirable to construct the speed-pressure curve graphically as shown above and to compare it with the experimentally determined curve. Compare the two curves for descending values of pressure. If such a magnetization curve has not been taken, the data for it may be deduced directly from the data of the experiments. Either ϕ may be used as ordinates,

or if the armature winding is not known, the corresponding values of terminal pressure at *normal speed* for given field currents, may be substituted.

It is advisable to use the same machine as was used in determining the speed characteristic of a shunt dynamo, Experiment 50.

Curves. Plot a speed-pressure curve, taking speed as abscissas. Plot curves showing the relation of armature watts and of total watts to speed, using speed as abscissas.

Question. Why not start at zero pressure and gradually increase the pressure to the normal value, omitting the starting box altogether?

No. 56. REGULATION OF A SHUNT MOTOR ON A CONSTANT PRESSURE CIRCUIT.

References. Houston and Kennelly, p. 282; Carus-Wilson, p. 61; Fisher-Hinnen, p. 121; Sheldon, p. 174; Thompson's "Dynamos," p. 512; Blondel and Du Bois, Vol. 2, p. 78; Crocker and Wheeler, p. 63.

Object. For general use a constant speed motor is the one required, and the system of distribution is a constant pressure system. The shunt motor answers the requirements very closely and is the most commonly used. It is, therefore, of practical importance to know its operating characteristics.

Theory and Method. The speed of a shunt motor has been shown to be directly proportional to its counter e.m.f.,

$$e = E - IR_a.$$

When the motor is running light, e and E are nearly equal. If a load be applied the resisting torque exceeds the impelling torque, the machine will slow down and a larger armature current will be permitted to flow. This increases the IR drop in the armature and reduces the counter e.m.f. still more. This will con-

tinue until the increment of torque due to the increased armature current is exactly balanced by the decrement of counter e.m.f. It is thus seen that a shunt motor will slow down as the load is applied. In reality, the brushes generally have a motor lead and the reaction of the armature current upon the field, with its consequent diminution of the field magnetism, causes the motor to maintain a more nearly constant speed than would be indicated by the above equation. To determine the regulation curve, run the motor under normal pressure, taking care that this pressure remains constant throughout the test. By means of a Prony brake,* apply various loads to the machine, and take corresponding speed and current readings.

In order to investigate the effect of the armature resistance upon the speed regulation, take a second set of observations with an additional resistance, about equal to the armature resistance, introduced into the *armature circuit*. Terminal pressure should, in this case, be taken so as to include the drop through the inserted resistance.

It is advisable to use the same machine as was used in the static torque test.

Data. Starting with a load somewhat beyond full load of the machine, take readings of speed, total current, field current, terminal pressure, and brake pull for various loads down to zero and back. Inserting a resistance in the armature circuit about equal to the armature resistance, repeat the experiment for increasing loads, starting with the same brake torque as before. Terminal pressure and field current should be maintained constant. Measure the lever arm of the brake.

Caution. This experiment should be performed with the motor at normal temperature. As this is not practicable in the laboratory, the increase in field resistance due to temperature may be compensated for by inserting in the field circuit a finely divided rheostat with sufficient resistance to vary the field current about

* See Experiment 66.

20 percent. The test should then be made with a field current constant at 20 percent less than its "cold" value. This will not do for a commercial test, however. In addition, where it is desired to compare the cold and hot speed curves, care should be taken that the brushes have the same lead cold as hot. The cold readings should be taken rapidly so that the machine does not have time to heat up. If the lead changes during the temperature run, a cold speed curve should be taken with the brushes in the working position after the motor has cooled down. The amount of overload may be estimated roughly from the total current.

Curves. Using speed as ordinates plot curves of load in horse power and torque in pound-feet. Plot a curve between torque and *armature* current, using torque as ordinates.

Compute. The percent regulation from the full-load, no-load observations.

Suggestion. Where it is desired to compare the regulation of motors of different capacities, the load and the speed should be plotted in percent of their full load values.

Compare. The running torque curve with the static torque curve as obtained in Experiment 52.

Explain. Why armature reactions tend to improve the regulation. What effect a rise of temperature has on the speed of a shunt motor both as regards the armature circuit and the field circuit.

Question. Neglecting armature reactions, a speed intake curve would be a straight line. What would be the form of a speed output curve, and why?

No. 57. STUDY OF A SEPARATELY EXCITED MOTOR RUN BY A SERIES DYNAMO.

Object. The engineer often meets with peculiar phenomena in the course of his professional career, and he is called upon

to explain them. This experiment represents a class of combinations liable to occur accidentally, and its object is to gain experience in investigating such conditions, and in applying theoretical reasoning to their solution.

Method. A series generator is connected directly in series with the armature of a motor whose field is separately excited to normal value. Machines should be chosen which are approximately of the same voltage. A direct current ammeter having its zero at the center of the scale should be placed in the series circuit, or, if this is not available, two ammeters should be used, one being connected to read positively while the other reads negatively. A central zero direct current voltmeter should be placed across the terminals of the series dynamo or two voltmeters may be used in a manner similar to the two ammeters. Where two instruments are used, only the most robust construction, such as is found in switch-board instruments, is permissible. The generator should be supplied with a field short-circuiting switch by which, when desired, it may be prevented from generating. The fields of the motor should be separately excited and then the circuit closed and the result noted. Pocket compasses may be used to advantage to note the polarity of the fields of the generator and motor and any periodic actions should be timed and otherwise measured. All the facts connected with the behavior of the machines should be carefully noted. Place a light load on the motor, such as a friction load on the pulley, and note all results.

Data. Record such data as may seem useful in explaining the action.

Caution. A motor having carbon brushes should be used and it is preferable to set the brushes in the neutral plane.

Explain. The action observed, using a series of diagrams giving the successive changes which take place at no load. Also explain the effect of loading the motor.

No. 58. STUDY OF A SHUNT MOTOR RUN BY A SERIES DYNAMO.

Object. The engineer often meets with peculiar phenomena in the course of his professional career, and he is called upon to explain them. This experiment serves as an example of what may be met in dynamo machinery, and its object is to gain experience in the investigation of the causes of such unusual conditions.

Method. A series dynamo is connected directly to a shunt motor of about the same normal voltage. The dynamo is provided with a short-circuiting switch around the field for shutting down at will. A central zero direct current ammeter, or two ammeters with polarities opposed are connected in series with the line; and a central zero direct-current voltmeter, or two voltmeters with polarities opposed are connected across the terminals of the generator. Pocket compasses should be used to note any changes in the polarities of the fields of either motor or generator. Any periodic actions of either machine should be timed with reference to any such actions in the other and such other measurements taken as may seem advisable. A light load, such as friction on the pulley, should be applied to the machine and its effect noted.

Data. Record such data as may seem useful in explaining the action.

Caution. A motor having carbon brushes should be used and it is preferable to set them in the neutral plane.

Explain. The action observed and draw a set of diagrams showing the successive changes which take place at no load. Explain the effect of a load on the motor.

No. 59. OPERATION OF A SERIES MOTOR ON A CONSTANT CURRENT CIRCUIT.

References. Houston and Kennelly, p. 283; Thompson's "Dynamost," p. 506; Crocker and Wheeler, p. 68.

Object. Although the practical application of the series motor on a constant current circuit has never been extensive, and is now almost obsolete, it is sometimes met with and a study of the operation is interesting from a theoretical point of view.

Theory and Method. The motor is placed directly in a constant current circuit, an ammeter being connected in series with the motor and a voltmeter placed across its terminals.

The torque exerted by the motor depends upon the formula

$$T = SI\phi,$$

where T , S , I and ϕ represent respectively, torque, armature conductors, armature current and magnetism threading the armature. This shows that the total torque is constant for a constant current, and is independent of the speed.

If the opposing torque, when the armature is stationary, is less than the product $SI\phi$ the motor will start and the speed will increase until the total opposing torque due to friction, windage, hysteresis, eddy currents and external load is just equal to this value. The result is that for small values of external or pulley torque the internal or lost torque is large, and vice versa. The friction torque is practically constant for all speeds, excepting for very low speeds where the brush and bearing frictions are apt to be high in proportion. The windage torque is nearly proportional to the square of the speed but this factor may generally be neglected. The torque necessary to turn the armature against hysteresis is constant for all speeds in this case, since the magnetism is constant and the hysteresis loss itself depends directly upon $\mathcal{B}^{1.6}$ and upon the speed. The torque necessary to overcome eddy currents varies directly with the speed in this case, since the eddy current loss itself depends upon \mathcal{B}^2 and upon the square of the speed.

Neglecting windage and assuming constant magnetism, the torque-speed relations are shown in Figure 59A, where speeds are taken as ordinates. The abscissa OB represents the total torque $T = SI\phi$, and the line BD represents the curve showing

the relation between total torque and speed. The distance AB represents the torque necessary to overcome the friction and hysteresis, both of which remain constant for all speeds. The abscissa OA represents the torque necessary to overcome eddy currents and external load, the sum of which remains constant for all speeds; and the line AC represents the curve showing the relation between speed and the combined torque of eddy currents and load. Since the torque necessary to overcome eddy currents varies directly with the speed, it will be zero when the armature is stationary. Its curve of variation with the speed is shown by

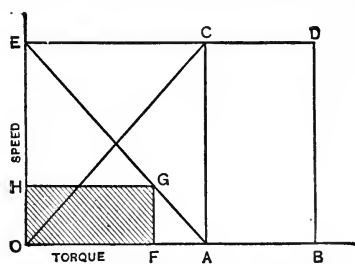

Fig. 59A. Series Motor on a Constant Current Circuit.

a line OC passing through the origin and crossing the curve AC at a certain critical speed OE , which may be called V . For a given speed the distance to the speed curve OC represents the torque necessary to overcome eddy currents; while the horizontal distance from the speed curve at this point to the curve AC represents the corresponding torque at the pulley. As the sum of the torque at the pulley and that necessary to overcome eddy currents is constant and equal to OA , the curve AE represents the pulley or load torque for various speeds.

There are two points of zero output. One is where the pulley torque plus the torque necessary to overcome hysteresis and starting friction is equal to or greater than the impelling torque $SI\phi$. The other is where the speed is so great that the impelling torque is balanced by the internal resisting torque alone, the machine running with no load. This point is reached at the critical speed $OE = V_1$, where the eddy current torque curve OC cuts the torque curve AC . The power output is the product of the pulley torque and speed and would be represented for any speed OH by the area of the rectangle $OFGH$. The maximum output would occur when this rectangle is a maximum, which is obviously at

half the critical speed V_1 . This is also the point at which the work torque and eddy current torque are equal, and, therefore, the point at which the power necessary to overcome eddy currents is equal to the power delivered at the pulley.

These general relations hold true only upon the assumption that the friction torque and the magnetism are constant for all speeds, and that windage may be neglected. The friction torque varies with the speed to some extent, although in general it may be considered constant. The magnetism may vary under actual operating conditions due to any changes occurring in the armature reactions. The windage may be appreciable in armatures of certain construction.

From the above discussion it is seen that if a simple series motor is used the efficiency decreases very rapidly for the high speeds, due to the rapid increase in the power lost as the speed rises.

The principal application of the series motor on a constant current circuit has been in the use of comparatively small stationary machines run on series arc circuits. From the above discussion it is seen that the speed increases very rapidly for light loads, and may become excessive. In using such a motor in practice it is necessary to employ a governor to keep the speed constant as the load varies. Usually the governor accomplishes this by shifting the brushes and thus varying the effects of armature reaction. In some cases it actuates a lever which cuts in or out a portion of the field winding as the load varies. In both cases the total torque is made large for heavy loads and small for light loads, due to the increase or decrease of magnetism threading the armature. The result is that the efficiency of the machine is considerably higher for light loads than would be the case without the governor. This application is now practically abandoned because of the better adaptability of shunt and compound motors on constant pressure circuits.

Data. Use a simple series motor without a governor and make connections as in Figure 59B, where G is a constant current

generator, M is the motor, and S is the short circuiting switch. A variable shunted resistance may be substituted for the short circuiting switch. Take readings of pulley torque, speed, current, and terminal pressure, varying the pulley torque so as to obtain speeds varying from zero to the safe maximum value. Measure the lever arm of the brake.

Cautions. Start with a pulley torque large enough to keep the armature stationary when the motor short-circuiting switch is open; otherwise the machine may speed up beyond a safe limit. The armature peripheral speed should not exceed about 5,000 feet per minute, unless of specially rigid construction, when the peripheral speed may be allowed to reach 6,000 feet per minute.

Compute. The output in horse-power, for the various speeds for which data were taken.

Curves. Plot a curve showing the relation between pulley torque and speed, using speed as ordinates and torque in pound-feet as abscissas. Plot a curve between output and speed, using speed as ordinates. An efficiency curve may be plotted if desired, using speed as ordinates.

Suggestions. If a constant current source is not available, a constant pressure source may be used. In this case it is necessary to place a controlling resistance in *series* with the motor and to adjust the current to a constant value for each reading. If a series motor supplied with a speed governor is available, it is desirable to test it both with the governor cut out and with it in operation.

Question. A motor is started and stopped by means of a short circuiting switch. Is there any difference in the quickness

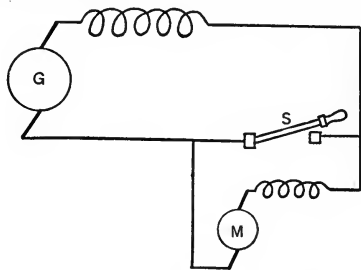

Fig. 59B. Connections for a Series Motor on a Constant Current Circuit.

of action required of the dynamo regulator in the two operations?

No. 60. OPERATION OF A SEPARATELY EXCITED MOTOR ON A CONSTANT CURRENT CIRCUIT.

Object. Although the separately excited motor operated on a constant current circuit is not met with in practice, a modification of this arrangement has been extensively used in direct current integrating wattmeters. The study is not only interesting because of this connection, but it is also of value from a theoretical point of view.

Theory and Method. Three general lines of investigation are available:

First, the field may be maintained constant, and the speed varied by changing the pulley torque.

Second, the speed may be maintained constant, and the pulley torque varied by changing the field excitation.

Third, the torque may be maintained constant and the speed varied by changing the field excitation.

The first condition, when the field current remains constant, is the same as when both field and armature are supplied from the same current source, Experiment 59. In fact, all of the general relations set forth in that experiment hold here, and it is unnecessary to give consideration to this method.

Under the second condition, where the speed is constant, the total impelling torque is

$$T = S\phi I = K\mathcal{B},$$

where S = total armature conductors,

ϕ = magnetism threading armature,

I = armature current,

\mathcal{B} = magnetic induction in armature,

K = constant.

Neglecting windage, the resisting torque may be divided as follows:

- Friction torque = K_1 ,
- Hysteresis torque = $K_2\mathfrak{B}^{1.6}$,
- Eddy current torque = $K_3\mathfrak{B}^2$,
- Pulley torque = T_L .

The torque of windage is constant for constant speed, but may generally be neglected. It may be included in the value of friction torque.

Since the impelling and resisting torques are equal and opposite, the pulley torque is

$$T_L = K\mathfrak{B} - K_1 - K_2\mathfrak{B}^{1.6} - K_3\mathfrak{B}^2.$$

This relation is shown graphically in Figure 60A, where torque is taken as ordinates and field current as abscissas. The curve $K\mathfrak{B}$, showing the relation between impelling torque and field current, has the general form of the magnetization curve of the motor. The friction torque remains constant for all field cur-

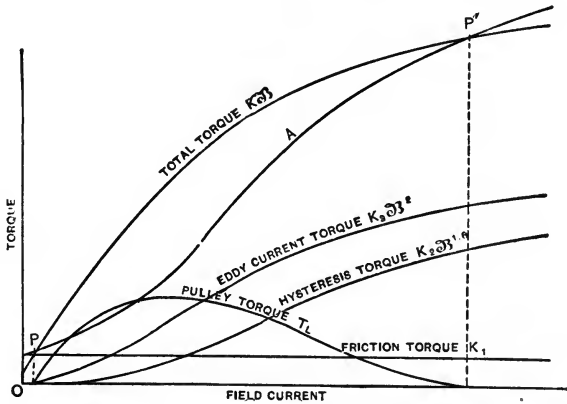

Fig. 60A. Separately Excited Motor on a Constant Current Circuit.

rents and is shown by the curve K_1 . In a similar manner, the hysteresis and eddy current torques are shown by the curves $K_2\mathfrak{B}^{1.6}$ and $K_3\mathfrak{B}^2$ respectively.

Curve A shows the relation between field current and the sum of the torques of friction, hysteresis, and eddy currents. The

differences between the ordinates of curve $K\mathcal{B}$ and curve A represent the torque available at the pulley for various values of field current.

It is seen that there are two critical points P and P' where the curves intersect. For values of field current less than that at the point P and greater than that at P' , the pulley torque is less than the combined resisting torque of friction, hysteresis and eddy currents at the speed assumed, and the motor will slow down. At these two points the machine runs at the assumed speed with no torque exerted at the pulley. For intermediate values of field excitation the torque exerted at the pulley, if the speed is maintained constant, is represented by the differences in the corresponding ordinates of the two curves. These values of pulley torque are represented by curve T_L of the diagram. Since the speed is constant, curve T_L also represents the relation between the H. P. delivered at the pulley, and the field current.

Under the third condition, where the pulley torque is constant, the total impelling torque is, as before,

$$T = S\phi I = K\mathcal{B}.$$

Neglecting windage, the resisting torque may be divided as follows:—

$$\begin{aligned} \text{Friction torque} &= K_1, \\ \text{Hysteresis torque} &= K_2 \cdot \mathcal{B}^{1.6}, \\ \text{Eddy current torque} &= K_3 \mathcal{B}^2 V, \\ \text{and pulley torque} &= T_L. \end{aligned}$$

The eddy current torque is the only one dependent upon the speed. Since the impelling and resisting torques are equal and opposite, the eddy current torque is

$$K_3 \mathcal{B}^2 V = K\mathcal{B} - K_1 - K_2 \mathcal{B}^{1.6} - T_L.$$

This relation is shown graphically in Figure 60B. As in Figure 60A, the curve $K\mathcal{B}$ shows the relation between impelling torque and field current. The friction and pulley torques are both constant and their sum is represented in curve K_4 . Curve

$K_2\mathcal{B}^{1.6}$ represents the relation between hysteresis torque and field current. Curve A represents the sum of the torques of friction, pulley, and hysteresis for various field currents. The differences between the ordinates of curve $K\mathcal{B}$ and curve A represent the torque available for turning the armature against eddy currents, for various values of field current.

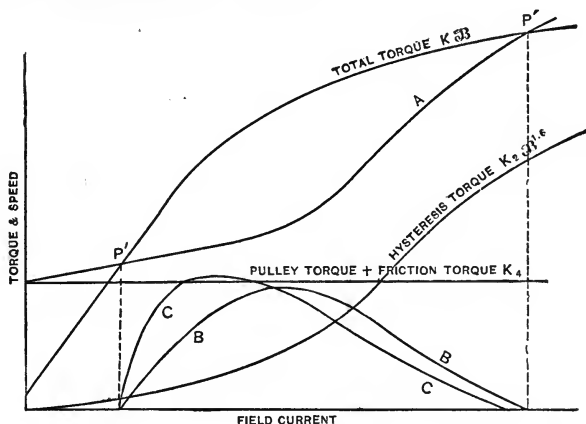

Fig. 60B. Separately Excited Motor on a Constant Current Circuit.

It is seen that there are again two critical points, P and P' , where the curves intersect. For values of field current, less than that at the point P and greater than that at P' , the impelling torque is less than the resisting torque of friction, pulley, and hysteresis, and the speed becomes zero. At these points the resisting and impelling torques are just equal at zero speed, and there is no torque available for eddy currents. For intermediate values of field current the torque available for turning the armature against eddy currents is shown in curve B , the ordinates of which represent the differences in corresponding ordinates of curve $K\mathcal{B}$ and curve A .

Since the eddy current torque is

$$K_3\mathcal{B}^2V,$$

the speed at which the armature rotates, corresponding to a given field current, will be the ordinate of curve B divided by $K_3\mathcal{B}^2$.

If a scale of speeds be taken as ordinates, the relation between speed and field current is shown by the curve *C*. The speed will rise rather abruptly with increasing field current until a maximum speed is attained. It will then gradually fall off, reducing to zero when the second critical point is reached.

The pulley torque being constant, the relation between the H. P. output of the motor and the field current, is also shown by curve *C*.

Data. Supply the armature from a constant current source and arrange to vary the field current. First, starting with a low value, raise the field current to a point where the armature rotates at a moderate speed with no load. Place a small load on the machine by means of a Prony brake, and increase the field current until the speed reaches the first value. Take a series of readings in this manner, increasing the field until the point is reached where the machine again runs at the given speed with no load, maintaining the speed constant throughout the test. Observe field current, speed, armature volts, and torque at the pulley.

Second, starting with a low value, raise the field current to a point where the armature is on the point of turning against a given pulley torque. Increase the field current slightly and note the speed when the pulley torque is adjusted to the given value. Take a series of readings in this manner, increasing the field until the point is reached where the speed again reduces to zero with the given pulley torque. Observe the field current, speed, armature volts, and torque at the pulley.

If the speed rises too high with the assumed pulley torque, increase this torque and take a new set of observations.

Measure the lever arm of the brake.

Caution. Use the short-circuiting switch on the arc generator to throw on and off the armature current.

Curves. Plot a curve showing the relation between pulley torque and field current for the constant speed condition. Plot a curve showing the relation between speed and field current for

the constant pulley torque condition. Plot curves for both conditions showing the relation of H. P. output and field current.

No. 61. OPERATION OF A SERIES MOTOR ON A CONSTANT PRESSURE CIRCUIT.

References. Carus-Wilson, p. 95; Fisher-Hinnen, p. 105; Houston and Kennelly, p. 286; Blondel and Du Bois, Vol. 2, p. 85; Thompson's "Dynamos," p. 507; Sheldon, p. 185; Parshall and Hobart, p. 232.

Object. The series motor is so largely used on constant pressure circuits in connection with street railway and automobile work, and for general hoisting purposes, that its operation under such conditions is a question of considerable importance.

Theory and Method. The conditions existing during the starting period, when an external resistance is placed in series with the motor, were considered in Experiment 14. Here it is desired to study the action of the motor when the pressure across the terminals is maintained constant.

This is the condition which exists in the case of an electric railway motor when the controlling resistance is cut out and the car is running under varying conditions as to load, grade, curves, etc.

The relation between impressed pressure, current, and counter pressure is

$$E = e + IR,$$

where E = impressed pressure,

e = counter pressure,

I = current,

and R = total resistance of the machine.

This formula does not take into consideration the fact that the brush drop remains practically constant for all values of current. However, the error thus introduced in the discussion which follows is inappreciable.

The maximum current occurs when e equals zero. In this case

$$I = E/R.$$

This current is far in excess of the maximum allowable full load current if normal pressure is impressed, and is considered in the discussion only to bring out the theory more clearly.

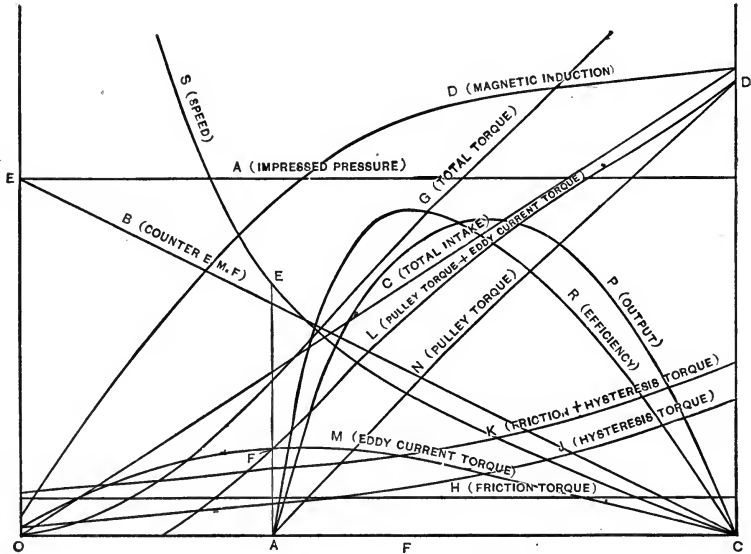

Fig. 61. Series Motor on a Constant Pressure Circuit.

The limiting value of counter pressure would occur when I equals zero. In this case

$$e = E.$$

It will presently be seen that the counter pressure never reaches this value.

The operation of series motors, especially those used for traction purposes, is quite commonly considered with reference to the current.

In Figure 61 are represented curves of torque, speed, output, efficiency, etc., referred to current as abscissas. The maximum

current I_m is represented by the abscissa OC . The ordinate OE represents the impressed pressure, and curve A shows the relation between impressed pressure and current.

Curve B represents the relation between current and counter pressure, although, as has been stated, the higher values are never reached except in theory. Curve C represents the variation of the total intake with the current. The ordinates are obtained by multiplying the corresponding values of current by the constant impressed pressure.

Curve D shows the relation between current and magnetic induction in the armature. This is in reality the total characteristic of the machine when run as a dynamo; since the reactive effect of the armature current must be taken into account. In this connection it is to be noted that series motors are generally operated reversible with the brushes set in the neutral plane, only cross-magnetizing action entering. Having the magnetic induction and the counter pressure, the speed curve S is directly deduced from the relation

$$e = \frac{S\phi V p_1}{10^8 \cdot 60 p_2} = K_1 \mathfrak{B} V,$$

where K_1 is a constant.

Then

$$V = \frac{e}{K_1 \mathfrak{B}}.$$

Therefore the values of speed may be obtained by dividing the counter pressures by corresponding values of \mathfrak{B} multiplied by K_1 . The higher values of speed are never reached except in theory. The maximum speed will be shown later to be at the point E , where the current has the value OA .

The total impelling torque is

$$T = S\phi I = K_2 \mathfrak{B} I,$$

where K_2 is a constant.

The relation between impelling torque and current is shown by curve *G*. This is obtained by multiplying the various ordinates of the magnetic induction curve by the corresponding values of current and by the constant K_2 .

The resisting torque may be divided as follows:

$$\text{Friction torque} = K_3,$$

$$\text{Hysteresis torque} = K_4 \mathcal{B}^{1.6},$$

$$\text{Eddy current torque} = K_5 \mathcal{B}^2 V,$$

$$\text{Pulley torque} = T_L,$$

where K_3 , K_4 , and K_5 are constants.

The friction torque is represented by curve *H*. The hysteresis torque is represented by curve *J*, where the ordinates are obtained by multiplying the values of $\mathcal{B}^{1.6}$ by K_4 . Curve *K* represents the sum of the friction and hysteresis torques.

Since the resisting and impelling torques must be equal and opposite, the following relation holds.

$$T_L + K_5 \mathcal{B}^2 V = T - K_3 - K_4 \mathcal{B}^{1.6}.$$

Curve *L* represents the sum of the eddy current torque and the pulley torque for various currents. It is obtained by subtracting the ordinates of curve *K* from the corresponding ordinates of curve *G*.

The value of the counter e.m.f. is

$$e = K_1 \mathcal{B} V.$$

$$\therefore \mathcal{B} V = K_6 e \text{ where } K_6 \text{ is a constant.}$$

If this value be substituted in the formula for eddy current torque, there results

$$\text{Eddy current torque} = K_5 \mathcal{B}^2 V = K_5 K_6 \mathcal{B} e = K_7 \mathcal{B} e,$$

where K_7 is a constant.

Curve *M* represents the eddy current torque and is obtained by multiplying together corresponding ordinates of curve *B* and curve *D*, and multiplying these products by the constant K_7 .

The point *F*, where curves *L* and *M* intersect, is the point at

which the eddy current torque just balances the impelling torque available for pulley torque and eddy currents. The pulley torque at this point is consequently zero. The abscissa to this point, OA , represents the minimum current which will be supplied to the armature, and the corresponding ordinate AE of the speed curve represents the maximum speed the motor will attain with the given impressed pressure.

For currents between the values OA and OC the pulley torque is represented by curve N , which is obtained by subtracting ordinates of curve M from the corresponding ordinates of curve L .

The relation between output and current is shown by curve P , obtained by multiplying together corresponding ordinates of the curves of speed and pulley torque. There are two zero points in the output curve; one at the current OA , when the pulley torque is zero and the speed is AE , and the other at the current OC , when the speed is zero and the pulley torque is CD .

The relation between efficiency and current is shown by the curve R , which is obtained by dividing the output at the various currents by the corresponding values of intake obtained from curve C . It is to be observed in this connection that the maximum efficiency occurs at a smaller current than that which will produce the maximum output.

The various values in the diagram have been chosen arbitrarily to bring out the theory. In an actual motor the abscissa OA is less in proportion than represented in the diagram. Also, the maximum working current would be about the value OF , considerably less than the possible maximum, OC .

Data. Connect the motor, through a starting resistance, to a source of constant pressure equal to the rated voltage of the motor. Place a brake on the motor and gradually cut out the starting resistance; being careful that the torque at the pulley is not large enough to cause an excessive current to flow, and also that it is not so small that the motor speed rises abnormally. When the resistance is all cut out, adjust the pulley torque so that

the maximum current allowable is taken by the motor. Take readings of pulley torque, speed, current, and terminal pressure for torques varying from this initial value to zero or to as low a value as may be obtained without an excessive rise in the speed. Measure the lever arm of the brake.

Cautions. Modern series motors, such as street railway or hoisting motors, are, in general, never intended to run at normal pressure with no load. Measure the diameter of the armature and compute the speed that will produce a peripheral velocity of 4,000 feet per minute, if smooth cored; and 5,000 feet per minute, if toothed cored. Do not exceed 6,000 feet even with the firmest construction.

Curves. Plot curves between current and pulley torque, speed, H. P. output, and efficiency. Use current as abscissas.

Explain. What would be the effect, when the motor is running under load, of commutating (short-circuiting) a portion of the field winding.

No. 62. REGULATION OF A CUMULATIVE COMPOUND MOTOR ON A CONSTANT PRESSURE CIRCUIT.

References. Jackson's "Dynamos," p. 222; Parham and Shedd, p. 492.

Object. The cumulative compound motor is used quite extensively in certain classes of work, and a study of its operating characteristics is essential.

Theory and Method. The cumulative compound motor partakes of the characteristics of the series motor and the shunt motor. Like the series motor it possesses great starting torque and operates on overload without sparking. It also slows down in speed as load is applied, but not so much. On light load the motor runs at a speed determined almost entirely by the shunt winding, and there is no danger of the machine running away as in the case of the series motor.

The starting current of a cumulative motor is less than that of a shunt motor and the acceleration to maximum speed is slower. On a fluctuating load the motor accommodates its speed to the changes of load and thus keeps down the heavy rushes of current so common in shunt motors. This is a valuable feature where lights and power are taken from the same circuit and where constancy of speed is not required.

Where the starting torque required is heavy and the running torque light, controllers for these motors are sometimes so arranged as to cut out either all or part of the series turns after full speed has been attained. The result is an improvement in inherent speed regulation.

Data. Maintaining the terminal pressure at rated value, take readings of speed, terminal pressure, total current and brake pull from full load to no load and back. Measure the lever arm of the brake.

If the motor is not officially rated as a cumulative compound machine, full load should be determined from the rated current of the machine.

Suggestion. It is advisable to use the same machine as was used in Experiment 56 and to plot the regulation and the torque curves to the same scales.

Compute. The percent regulation from the full load—no load readings.

Curves. Plot a curve between speed and horse-power output, using the latter as abscissas. Plot a curve between speed and torque, using speed as ordinates. An efficiency curve may be plotted if desired.

Questions. Power is applied to the pulley of a cumulative compound motor until it is driven above normal no load speed; does it operate as a cumulative compound dynamo?

What is the difference between the action of a long shunt and a short shunt cumulative compound motor? Name two applications for which the cumulative compound motor is especially adapted.

No. 63. REGULATION OF A DIFFERENTIAL COMPOUND MOTOR ON A CONSTANT PRESSURE CIRCUIT.

References. Jackson's "Dynamos," p. 222; Carus-Wilson, p. 65; Houston and Kennelly, p. 286; Parham and Shedd, p. 492; Sheldon, p. 174; Crocker and Wheeler, p. 67.

Object. As the differential compound motor is used to a limited extent and as a cumulative compound motor is often connected differentially by mistake, it is well to learn its characteristics.

Theory and Method. The speed of a motor is

$$V = \frac{E - IR}{K\phi},$$

where K is a constant. If ϕ be varied at the same rate as $(E - IR)$, the motor will run at a constant speed at all loads. A differential compound motor, due to the demagnetizing ampere turns of its series winding, may be made to regulate for almost constant speed at all loads and will run at exactly the correct speed for a particular load. It may even be made to increase in speed as the load comes on. Its regulation curve will not generally be a straight line.

Such a motor is likely to spark, burn out, or reverse under heavy loads, because of the weakening of the field by the series ampere turns. Its starting torque is weak, and if started under a heavy load it is likely to burn out or to start in the wrong direction. In any case the starting current is excessive. In order to avoid the difficulty at starting, the controllers of differential motors are so arranged as to short-circuit the series turns until speed is attained. Shunt motors with moderate armature resistance and with the brushes set for a motor lead will generally regulate close enough for all practical purposes.

Data. Maintaining the terminal pressure at rated value, take readings of speed, terminal pressure, total current, and brake

pull from full load to no load and back. Measure the lever arm of the brake.

If the motor is not rated as a differential motor, the full load should be determined from the rated current of the machine.

Caution. It is advisable to fuse the motor circuit or to protect it with a circuit breaker.

Curves. Plot a curve between speed and output in horse power, using the latter as abscissas. Plot a curve between speed and torque, using speed as ordinates. An efficiency curve may be plotted if desired.

Suggestion. If possible use the same machine as was used in Experiments 56 and 62 and plot the regulation and the torque curves to the same scales.

Question. What is the difference in operation between a long shunt and a short shunt differential motor?

No. 64. REGULATION OF A SINGLE SERIES MOTOR RUN FROM A SIMILAR SERIES DYNAMO.

References. Kapp's "Transmission," p. 199; Fisher-Hinnen, p. 102; Houston and Kennelly, p. 286; Thompson's "Dynamos," p. 509.

Object. Before the general introduction of alternating currents, methods of transmission of power to a distance by means of direct currents were the only ones available. Although alternating currents are generally employed on the transmission lines of the present day, there have been some recent direct current installations. The single series generator operating a similar series motor has been used, and is interesting from a theoretical standpoint.

Theory and Method. The principal advantage of this system is that, if the generator and motor are properly designed relative to each other, the speed of the motor will remain practically constant over a wide range of load, provided the generator speed

remains constant. This condition may be realized even when there is considerable line resistance in the circuit. Another advantage is that the efficiency is fairly uniform for the higher values of load. It is not necessary that the motor and generator be designed to operate at the same speed.

The theory may be considered in much the same general way as that of the series motor operated from a constant pressure circuit, Experiment 61. The operation is considered from the standpoint

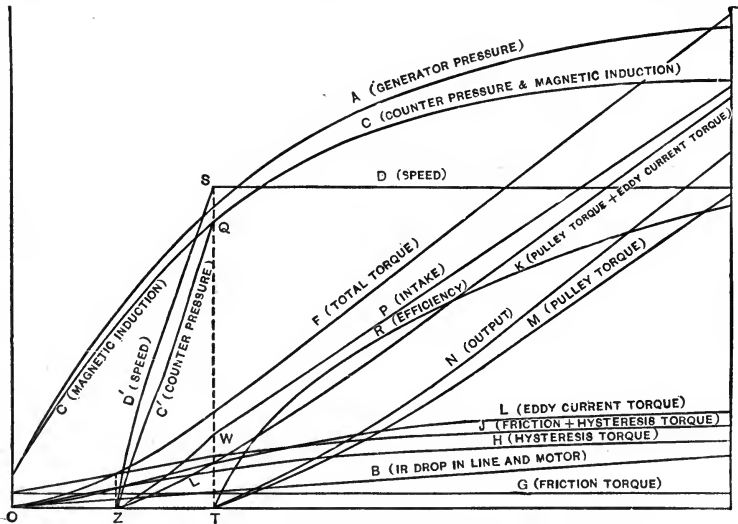

Fig. 64. Series Motor Run From a Similar Series Dynamo.

of current variation. In Figure 64 are represented curves of torque, speed, output, efficiency, etc., referred to current as abscissas.

Curve *A* represents the external characteristic of the generator under normal conditions. It is immaterial if the generator speed decreases somewhat as the load comes on, provided the decrease is perfectly definite and produces the required characteristic. Curve *B* represents the *IR* drop in the line and in the motor. Curve *C* shows the relation between the current and the generated pressure of the motor when run as a generator at its rated speed.

This generated pressure is

$$e = \frac{\phi S V \rho_1}{10^8 \cdot 60 \rho_2} = KV\mathfrak{B} = K_1\mathfrak{B},$$

where K and K_1 are constants, and \mathfrak{B} is the magnetic induction in the armature. Curve C , therefore, also represents to a different scale the relation between current and actual magnetic induction in the motor armature under working conditions.

If the differences in the corresponding ordinates of curves A and C are equal to the IR drop (curve B), then curve C represents, in addition, the variation of motor counter pressure with the current, under working conditions. This follows from the relation

$$E = e + IR.$$

If all of these conditions are fulfilled, the motor will maintain a uniform speed, within limits. This is evident because the counter pressure differs from the magnetic induction only by a constant. Therefore,

$$e = K_1\mathfrak{B} = KV\mathfrak{B}.$$

$$\therefore V = \frac{K_1}{K} = K_2,$$

where K_2 is a constant.

Curve D represents the relation of motor speed to current. It will be shown later that the point S on the speed curve is a critical point and that for smaller values of current than its abscissa, OT , the speed falls off rather abruptly and becomes zero at a certain critical current, OZ . Since the counter pressure depends both upon the speed and the magnetic induction, it will also be found that the counter pressure falls off abruptly from the point Q to a zero value at the current OZ . These relations may be more clearly seen from a consideration of the impelling and resisting torques for various currents.

Curve F represents the relation between total torque and current. This relation is shown directly by the formula,

$$T = S\phi I = K_3 I \mathcal{B},$$

where K_3 is a constant.

The various ordinates of curve F are obtained by multiplying the corresponding values of current and magnetic induction and multiplying these products by the constant K_3 .

Curve G shows the relation of friction torque to current. This relation is shown by the formula

$$\text{Friction torque} = K_4,$$

where K_4 is a constant.

Curve H shows the variation of hysteresis torque with the current. The relation is

$$\text{Hysteresis torque} = K_5 \mathcal{B}^{1.6},$$

where K_5 is a constant.

The various ordinates of this curve are obtained by multiplying the corresponding values of $\mathcal{B}^{1.6}$ by K_5 .

Curve J represents the sum of the hysteresis and friction torques. Curve K represents the difference between total torque and the combined torques of friction and hysteresis. Neglecting windage, curve K represents the sum of the eddy current and pulley torques.

The current OZ , therefore, produces an impelling torque which is just sufficient to overcome the torques of friction and hysteresis, and the motor is on the point of starting.

Curve L represents the relation of eddy current torque to current, considering the speed constant at the rated value TS . It is obtained from the equation

$$\text{Eddy current torque} = K_6 \mathcal{B}^2 V,$$

by multiplying the values of \mathcal{B}^2 by $K_6 V$. The point W , where curve L intersects curve K , is a critical point. The corresponding abscissa OT represents the current taken by the motor when

running with no load, at the rated speed. Curve L' , which is the portion of curve K lying below the point W , represents the torque available for overcoming eddy currents for values of current between OZ when the motor is on the point of starting, and OT when it is running at rated speed with no pulley load. Curve D' , showing the rise in speed, may be directly deduced from this curve by considering the relation

$$\text{Eddy current torque} = K_6 \mathfrak{B}^2 V.$$

K_6 is known and the values of \mathfrak{B} may be taken directly from the induction curve C . The rise in counter pressure, curve C' , may be obtained in a similar manner from the relation

$$e = KV\mathfrak{B}.$$

K is known, the values of V are taken directly from curve D' , and those of \mathfrak{B} from curve C .

The variation of pulley torque with the current is shown by curve M , which is obtained by subtracting the ordinates of curve L from those of K .

Curve N represents the output of the motor and is obtained by multiplying the corresponding values of pulley torque by the speed. Curve P shows the intake and its ordinates are the products of the corresponding values of current and terminal pressure at the motor. The latter curve is not shown on the diagram but has been taken half way between the generator pressure curve and the counter pressure curve. That is, the assumption has been made that the line and motor resistances are equal. Any other division of the resistance might have been made. Curve R shows the efficiency and is obtained by taking directly the ratios of the ordinates of curves N and P .

The action may be briefly summed up as follows. When the current reaches the value OZ , the motor starts and the speed becomes normal when the current equals OT , provided there is no load on the machine. Between the current OT and the maximum current of the machine, the speed remains constant and the output and efficiency are shown by curves N and R .

It is to be observed that the lowest point on the generator pressure curve represents a larger pressure than that necessary to cause a current OZ to flow when the motor is at rest. Also that the pressure produced by the generator when the current OZ is supplied is far in excess of that necessary to produce this current unless the motor is running at a considerable speed. The result is that, unless the point Z is much nearer the origin than shown in the diagram, an excessive current will flow at the time of starting and a severe strain will be placed upon both generator and motor. The remedy for this is to use a starting resistance in getting the motor up to speed.

Some difficulty has been experienced in the practical use of this system because of the surging action between generator and motor when the load fluctuates, due to the self-inductance in the machines. A remedy for this is to place a high non-inductive resistance across the generator terminals. The self-inductive discharges are then taken up by this resistance. Such a resistance has also been employed in adjusting the motor counter pressure curve to the desired value relative to the generator pressure curve.

Data. Connect a series motor through a starting resistance to a similar series generator. If the external characteristic of the generator does not bear the relation to the counter pressure curve of the motor which is required for inherent speed regulation, make the adjustment as nearly as possible by shunting the generator by means of a non-inductive resistance. Bring the motor up to speed by gradually cutting out the starting resistance. Read the speed, current, and motor pressure. Take a series of observations of speed, current, and pulley torque, increasing the torque to the value which will produce the maximum safe current. Measure the lever arm of the brake. The readings may be taken with an added resistance, representing line resistance, in series with the motor.

Curves. Plot curves showing the relation of pulley torque, speed, terminal pressure, output, intake, and efficiency, to current. Plot values of current as abscissas.

No. 65. TEMPERATURE TEST OF A DYNAMO OR MOTOR.

References. Standardization Report; Arnold's "Dynamos," p. 532; Houston and Kennelly, p. 199; Sheldon, p. 39; Jackson's "Dynamos," pp. 107 and 138; Fisher-Hinnen, p. 59; Thompson's "Dynamos," p. 752; Parham and Shedd, p. 295; Thompson's "Design," p. 113; Wiener, pp. 126 and 368; Hawkins and Wallis, p. 394.

Object. So many faults are developed in dynamo machinery on account of excessive temperature that a heating limit should be specified for all machines purchased and a test made to see that the guarantee is met.

Discussion. Too much emphasis cannot be laid on the subject of heating. In the academic study of the dynamo it is the one important feature most likely to be neglected. Laboratory periods are too brief to permit the making of three to eight-hour runs before taking the general operating characteristics of machines, and the student is likely to lose sight of the fact that the performance of a machine "hot" is the standard for practical operation. All regulation and sparking tests should be made and all losses measured after this stationary temperature has been reached; for it is the performance of the machine under continuous operation that is important. Overload readings are practically worthless unless the machine is at normal full load temperature at the time of the test.

The ultimate temperature attained by any part of a dynamo depends on a number of conditions; the number of watts lost in that part, its radiating surface, the temperature of contiguous parts, the circulation of air in the vicinity, due either to the fanning action of rotating parts or to some other cause, and the initial temperature of the surrounding atmosphere. A stationary temperature is attained when the amount of heat generated is exactly equal to the quantity dissipated. The heat is dispersed by radiation and convection.

Temperature rise, according to A. I. E. E. standardization report, is referred to a standard room temperature of 25° C. and a correction of one half percent should be made, in computing the rise, for each C.° of room temperature above or below the standard.* The limits of temperature specified for the various parts, operation being assumed at full rated capacity, are the results of years of experience, and hence the standard of good practice.

Temperatures are measured by thermometers or, in the case of electrical circuits, are computed from the rise in resistance. It is advisable to take temperature both ways when possible, the higher measurement being used unless otherwise specified. Temperature rise can be computed from resistance measurements by the formula

$$t = \frac{R - R_t}{0.0042},$$

where t is the rise in C.°, R the final resistance and R_t the resistance at room temperature.

“The thermometer indicating the room temperature should be screened from thermal radiation emitted by heated bodies, or from draughts of air. When it is impracticable to secure normal conditions of ventilation on account of an adjacent engine, or other sources of heat, the thermometer for measuring the air temperature should be placed so as fairly to indicate the temperature which the machine would have if it were idle, in order that the rise of temperature determined shall be that caused by the operation of the machine.”

(It is well to take several room temperatures, the thermometers being placed with special care on different sides of the machine at a distance sufficient to indicate the normal temperature of the room. When large machines are tested at least four room thermometers are advisable. They should be read at intervals during the temperature run.)

“The temperature should be measured after a run of sufficient duration to reach practical constancy. This is usually from six

*Section 28, Standardization Report, Appendix B.

to eighteen hours, according to size and construction of the apparatus. It is permissible, however, to shorten the time of the test by running a lesser time on overload in current and voltage, then reducing the load to normal, and maintaining it thus until the temperature has become constant."

"In apparatus intended for intermittent service, as railway motors, starting rheostats, etc., the rise of temperature should be measured after a shorter time, depending upon the nature of the service, and should be specified."

"In apparatus which by the nature of their service may be exposed to overload, as railway converters, and in very high voltage circuits, a smaller rise of temperature should be specified than in apparatus not liable to overloads or in low voltage apparatus. In apparatus built for conditions of limited space, as railway motors, a higher rise of temperature must be allowed."*

With regard to the last class of apparatus, it should be remembered that cotton insulation will stand only a certain amount of continued baking, and if used a higher depreciation should be expected. Mica is far better.

A compound wound dynamo will be assumed in considering this subject, and the causes of heating of the various parts taken up in detail.

Bearings. A minute discussion of the cause of heating in bearings would fill many pages. The amount of energy converted into heat depends in general on the coefficient of friction, on the pressure per unit area of projected surface, and the surface velocity at the rubbing surfaces. The temperature attained depends on the opportunity offered for the escape of this heat. Proper lubrication (coefficient of friction) is the important feature under the control of the attendant.

A thermometer should be placed, if possible, down through the oil opening and the bulb should rest on the shaft and against the bearing next to the shaft. Where this is impossible it should rest

* Standardization Report, Appendix B.

on the oil ring. It is also advisable to take a temperature reading on the bronze or babbitted portion of the bearing next to the shaft on the end farthest from the machine.

A temperature rise of 40° C. is permissible.

Commutator and Brushes. The loss developed in a commutator is largely due to friction of the brushes and I^2R loss of brush contact, the I^2R loss in the commutator bars being slight. Modern commutators being of large diameter, the friction is larger than in the old type machines. The radiating surface is also larger. Excessive temperature oxidizes a commutator, thus causing sparking and producing undue expansion and contraction in the bars, working them loose. Temperature readings should be taken at each end of, and at an intermediate point on, a commutator. A rise of 55° C. by thermometer is permissible for both commutator and brushes.

Armature Core. Molecular friction and eddy currents are the sources of loss in an armature core. All heat due to these causes must first travel to the surfaces before it can be dissipated. The temperature of the interior of a core is therefore likely to be higher than the surface. Inasmuch as iron "ages" due to excessive temperature, *i. e.*, the coefficient of molecular friction permanently increases, it is advisable to run the temperatures of armature cores somewhat below the allowable limit, unless a guarantee against "aging" can be furnished.

Armatures on open type machines should be thoroughly ventilated. Windage is cheap, and a goodly amount of it is conducive to cool operation. Thermometers should be placed on the core at the middle and at each end of its length and at least one temperature reading should be taken in the ventilating space where this is possible.

Armature cores should not exceed in temperature a rise of 50° C. by thermometer.

Armature Winding. The conductors of an armature are heated by the I^2R loss, due to the load on the machine, and the

active length of each conductor is in addition heated by eddy currents in the copper and from the core, if the latter be at a higher temperature. The I^2R loss of commutation, due to the self-inductive discharge of the commutated coils, also aids in the rise of temperature.

A high temperature gradually carbonizes the cotton insulation on the conductors, and may ultimately cause a burn out.

The rise by resistance measurement should not exceed 50° C. This rise will be the average rise of the winding, for it stands to reason that the bottom conductors will be warmer than those on the surface.

Field Windings. The temperature of a field coil is influenced by the I^2R loss, by the hysteresis and eddy current losses at the pole faces and by windage. A thick coil will get warmer than a thin one for the same loss and the same radiating surface. Series coils are preferably made of copper ribbon wound on edge. There is then no inner layer at high temperature as is of necessity the case in a shunt winding. The shunt field spools of large machines are sometimes built up in ventilated form.

The standard rise is 50° C. by resistance for all field coils.

Leads and Contacts. In modern machines these are generously designed and seldom operate at the limit, 55° C. It is not necessary to measure this rise, unless the parts are uncomfortable to the touch.

Equalizer Connections. Multiple path armatures are often provided with equalizer connections; *i. e.*, copper wires or bars connecting conductors that are normally at the same potential. The temperature of the equalizer connectors should be taken where this is possible. A rise of 55° C. by thermometer is permissible.

Series Field Shunt. The temperature of the series field shunt should be taken after the machine has reached a stationary temperature and the compounding has been adjusted for this temperature. Before taking this temperature the shunt should be

wound with cord and bundled up in a manner imitating as nearly as possible the final condition in which the shunt is arranged for shipment. A limit of 55° C. is allowable, but it is the practice of most manufacturers to run at a rise of from 35 to 40 degrees.

Frame and Other Parts. The rise here should not exceed 40° C. by thermometer.

The Test. In taking temperature readings by thermometer, the bulb of the instrument should be blanketed so as to protect it from draughts. Waste is often used, but putty is better as its use will show a higher temperature. To tell when a machine has reached a constant temperature, thermometers are laid on the various stationary parts, their bulbs being then blanketed with putty and bound in place by means of adhesive tape. Care should be taken that no putty gets between the bulb and the part where temperature is measured. The machine is then loaded up and the speed, current, output and terminal pressure maintained constant. When the temperatures cease to rise the run is finished. Another check is given by the shunt current and terminal pressure. When these cease to fall, the temperatures have become constant. After the machine has been stopped the thermometers will show a rise of temperature due to the absence of ventilation. These readings should be taken as the final temperatures. Thermometers should be laid on the armature core and commutator and blanketed with moderately warm putty, on stopping the machine. The putty may be kept in readiness by placing a lump of it on a bearing or on a warm part of the frame during the run. It is well to make a sketch showing the points on the armature and commutator at which temperature readings were taken.

Data. Measure the armature resistance "cold," and also the temperature of the armature core. Start the test at full load and normal speed. Take readings of load current, shunt field current, series field current, terminal pressure, drop across shunt and series field coils, shunt and series field temperatures, and frame, bearing, and room temperatures. These readings should

be taken every half hour until constant temperature is reached. Terminal pressure, load current and speed should be kept constant for a dynamo; terminal pressure and output in a motor.

After constant temperatures are reached, stop the machine and measure the temperatures at each end and at the middle of the commutator surface, at the surface of the armature (on the iron if toothed), in a ventilating space, and at a pole tip; the leading tip, if a motor; the trailing, if a dynamo. Measure the temperature of the series field shunt, and that of the equalizer connections. Readings should also be taken of the maximum temperatures of the fixed thermometers. Measure the armature and field resistances.

Suggestions. The most economical way of loading is a three-machine method. When a motor is tested by this means either its efficiency (or its full load armature current), or the efficiencies of the two other machines must be known.

Before shutting down a machine for the final readings everything should be in readiness, as quick work is required.

Many manufacturers adopt what is known as a "Compromise Heat Run,"* in order to save time and energy. This form of test generally consists of a run with both current and pressure above normal values. The temperature of a machine will rise rapidly under this condition and the time of the run as well as the total amount of energy used can be greatly reduced. This kind of a test is used on standard machines that have been tested time and again in the regular way and the exact program is determined by a comparison with the regulation run. While a compromise test is permissible under such conditions, it should never be allowed as an acceptance test of a single machine.

Calculate. The rise in temperature from resistance measurements. Correct all temperature rises to a standard room temperature of 25° C.

* Appendix A.

Curves. Plot curves of corrected temperature rise for all temperatures observed during the run and for the temperatures calculated from resistance measurements.

Question. Will the output of a machine be the same for use as a generator and as a motor, if run under the same conditions as to speed and temperature?

No. 66. EFFICIENCY OF A MOTOR BY THE PRONY BRAKE METHOD.

References. Parham and Shedd, p. 488; Thompson's "Dynamo," p. 754; Parr, E. E. T., p. 186; Sheldon, p. 273; Flather, p. 19.

Object. This is a common method of obtaining motor efficiency when it is desired to observe the working conditions.

Theory and Method. The machine to be tested is run as a motor and the intake measured by means of electrical instruments; the output in mechanical power is measured by some form of absorption dynamometer.

This usually consists of a band or clamp of some sort which grips the pulley, or, preferably, a special brake wheel. Any desired amount of power may be absorbed by adjusting the grip of the clamp upon the pulley. The unknown torque which is exerted by the motor from the brake beam, is balanced by suspending known weights upon the brake beam, or the beam may be supported by a spring balance or an ordinary platform scale, and the pull measured directly. The latter methods are preferable. The torque in pound-feet as measured is equal to $p \times l$, where p is the pull in pounds exerted by the brake beam upon the scale and l is the length in feet of the lever arm, measured from the center of the shaft. The horse power absorbed by the brake is

$$\text{H. P.} = \frac{2\pi Vlp}{33,000},$$

where V is the speed in revolutions per minute.

To keep the brake pulley cool, it will be found necessary to lubricate its outer surface and to supply water to the inside of it. The best results are obtained when the water is supplied steadily at the rate of evaporation.

Figures 66A and 66B show a form of rope brake which has been found very satisfactory. Figure 66A shows a photograph of the motor under test with the brake mounted on a pair of platform scales, to measure the torque. The details of the brake are

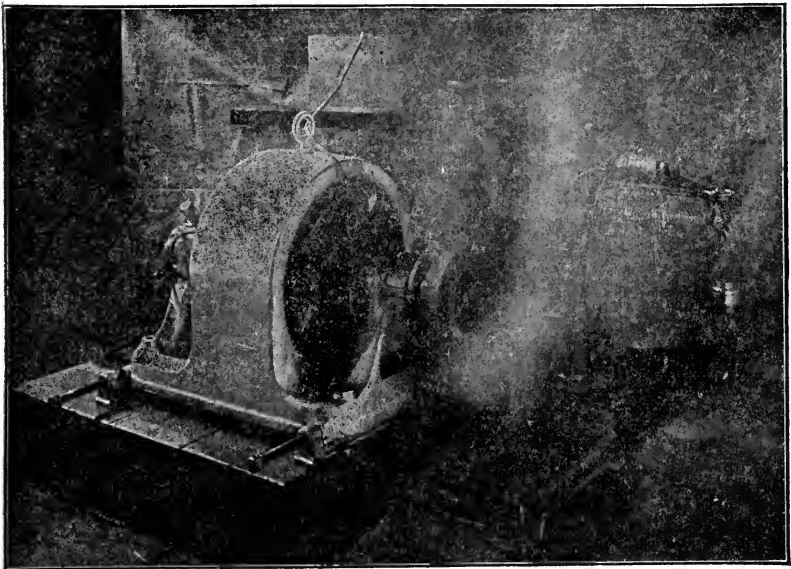

Fig. 66A. Motor Under Test by Prony Brake Method, Showing Steam Arising from the Pulley.

somewhat obscured in this view by the steam arising from the pulley. Figure 66B shows the brake in position with the motor armature stationary. Here the scales have been omitted in order to bring out the brake details more clearly.

When a rope brake is used, the lever arm is taken as the radius of the pulley plus the radius of the rope when taut.*

*There appears to be some question as to the accuracy of this assumption in the case of flexible ropes, especially those which are not stranded. Ex-

Data. Keep the terminal pressure constant, and take simultaneous readings of terminal pressure, total current, speed, and brake pull, from full load to no load. Measure the lever arm of the brake.

Curve. Plot an efficiency curve with commercial efficiency in percent as ordinates and load in horse power as abscissas.

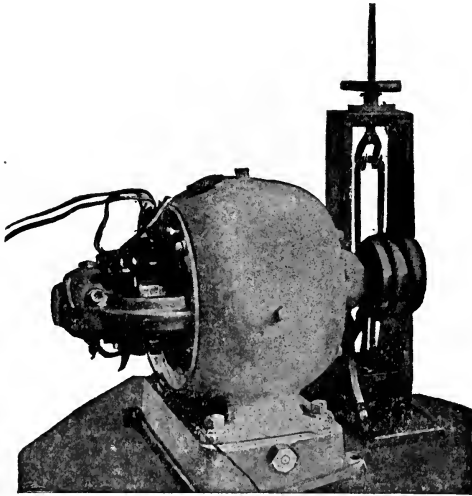

Fig. 66B. Motor with Rope Brake in Position.

Compare. The accuracy of this method with that of one in which the losses are measured directly and the efficiencies calculated from these losses.

If the efficiency of the same machine has been determined by any other method, make a comparison of the curves and account if possible for any discrepancy.

periments made in the Electrical Laboratories of the University of Wisconsin, using fairly new manila rope of various diameters, show that the radius of the rope should be added to the radius of the pulley in tests where such ropes are employed.

No. 67. EFFICIENCY OF A DYNAMO OR MOTOR BY THE CRADLE DYNAMOMETER.

References. C. F. Brackett, *Transactions A. I. E. E.*, Vol. 1; Nichols, Vol. 2, pp. 32, 40, and 42; Thompson's "Dynamost," p. 756; Flather, p. 106; Jackson's "Dynamost," p. 258.

Object. This is a laboratory method of obtaining efficiency under working conditions; it is well to understand it.

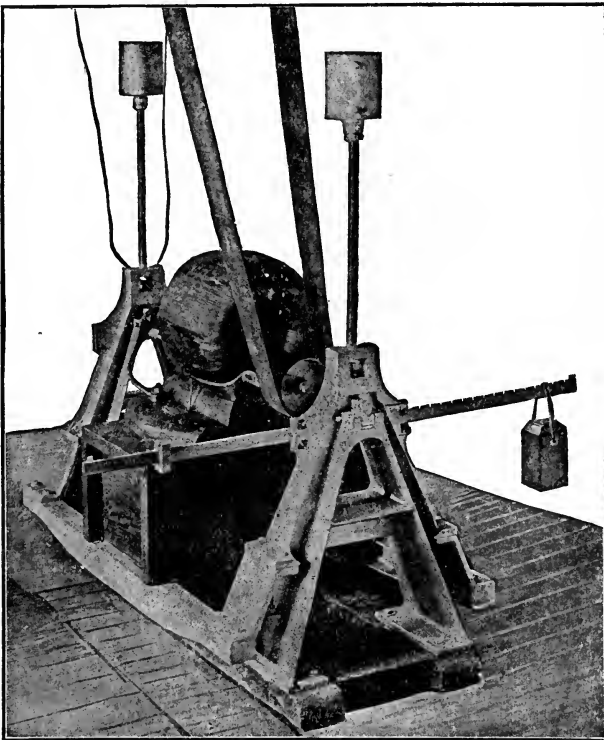

Fig. 67. Dynamo Mounted on a Brackett Cradle Dynamometer.

Theory and Method. This apparatus, Figure 67, is usually called the Brackett dynamometer, after its inventor, Professor C. F. Brackett. It is a form of transmission dynamometer.

The machine to be tested is mounted upon a swinging platform which turns upon knife edges. These knife edges and the center line of the shaft must be in the same straight line so that the swinging platform and the armature of the machine have the same axis of rotation. The correctness of the measurement depends very largely upon the accuracy with which this adjustment is made. A good way of making this adjustment is as follows.

Two equal weights are attached to the ends of a strap, and the strap is hung over the pulley of the machine. The machine is adjusted so that the weights cause no deflection of the dynamometer. A balance should exist for positions of the pulley 180° apart. This eliminates irregularities in the pulley. The weights together should be heavy enough to equal the maximum belt pull (through the center of the shaft) of the machine. If a balance is obtained with weights of this size it will then be assumed that loading the machine will not change its sensitiveness in this respect.

By means of large counter weights mounted upon vertical standards attached to the suspended platform, the center of gravity of the entire movable portion, including the machine to be tested, may be raised or lowered at will. These weights should be adjusted so as to bring the center of gravity slightly below the axis of suspension; the system is in stable equilibrium when its center of gravity is below the axis of suspension of the movable portion. The sensitiveness of the apparatus increases as the center of gravity approaches this axis. When the machine is run as a dynamo by means of a belt, the drag of the armature upon the pole pieces and also the friction of the bearings and brushes, all tend to rotate the entire movable portion about the axis of suspension. The dynamometer is balanced and the pointer set at zero with the belt removed from the pulley of the machine. When the belt is replaced and the machine driven, the pointer will be deflected. If the fields are not excited, this deflection is due solely to the friction losses which occur. This rotative tendency is balanced, and the pointer brought back to zero, by means of a weight

sliding upon a lever arm attached to the suspended platform. Thus the unknown torque due to the friction, etc., is balanced by a known moment which is the product of the weight and the distance through which it was moved. From these data, knowing the speed of the machine, it is an easy matter to calculate either the intake of a dynamo, or the mechanical output of a motor. It should be observed that in the case of a dynamo, the dynamometer measures the entire power supplied to the machine, whereas, when a motor is tested, the dynamometer measures only the output of the machine, which excludes the losses.

It should also be noted that the lever arm is equal to the distance which the sliding weight has been moved from its initial position with the belt off. When extra weights are used, their lever arms are equal to the distances measured from the axis to their points of suspension.

The power as measured in horse-power is represented by the equation

$$H. P. = \frac{2\pi l W V}{33,000} ,$$

where H. P. = the horse power,

l = the length of the lever arm (in feet),

W = the weight used (in pounds),

and V = the number of revolutions per minute.

The driving belt is generally arranged vertically, but this is not necessary if the knife edges are constructed to resist a side pull. If the belt pull is up, the sensitiveness of the machine is affected the same as though the center of gravity were raised; if down, the effect is that of lowering the center of gravity.

The commercial efficiency of the machine when operating as a dynamo may be determined by running the machine at various loads and measuring the intake by means of the dynamometer and the output by means of suitable electrical instruments. If a motor is tested, the intake is measured electrically and the dynamometer indicates the output.

Data. After adjusting the machine and dynamometer as instructed, read the lever arm and weight required to produce a balance when the machine is not running and the belt is off. Take readings of speed, terminal pressure, total current, lever arm and balancing weight (if this varies) from full load to no load. The terminal pressure or the speed should be maintained at the rating depending upon whether the machine is a motor or a generator.

Curve. Plot a curve between output and efficiency, using the latter as ordinates.

Explain. Why the losses in the machine are measured by the dynamometer when the machine is operated as a generator and are not when it is run as a motor.

No. 68. EFFICIENCY OF A DYNAMO OR MOTOR BY THE STRAY POWER METHOD.

References. Jackson's "Dynamos," p. 254; Nichols, Vol. 2, pp. 37 and 39; Thompson's "Dynamos," p. 758; Parr, E. E. T., p. 177; Sheldon, p. 272.

Object. When efficiency tests are made frequently, it becomes important from the standpoint of economy, to use a method that consumes the least possible amount of power. The method should also be accurate.

Theory and Method. In the stray power method the losses of the machine are first determined and the efficiency is calculated from these data. To get the efficiency at any assumed load the total loss at that load should be known.

The method will first be described as applied to a shunt motor. Let it be further assumed that the motor runs at a constant speed, and that it is at normal working temperature. The corrections necessary for a drop in speed and the application of the method to a shunt or a compound generator will be considered later.

There are three kinds of losses:

I. Losses that vary as the armature current.

2. Losses that vary as the square of the armature current.

3. Constant losses.

There is only one loss that varies directly as the armature current: the I^2R loss of brush contact (contact between brushes and commutator). The resistance of brush contact has been found to vary almost inversely with the armature current, hence the brush drop is practically constant for all loads and the loss will vary directly as the armature current.

The I^2R loss in the rest of the armature circuit varies directly as the square of the current therein, and the resistance used in calculation of this loss should be the resistance of armature winding, leads, contacts, etc., all at normal temperature.

The I^2R loss in the field is constant at all loads, the terminal pressure being assumed constant.

Stray power includes all mechanical friction of air, bearings and brushes, windage, and eddy current and hysteresis losses. These are all constant at a constant speed.

In giving the method of test, it will perhaps make it clearer to follow out the steps in the test of a specific motor.

The motor is a four-pole, 110-volt, 5 horse-power machine, running at 1,000 r. p. m. The full load current is 41.5 amperes, of which 1.5 amperes is field current. It has been running for four hours at full load and is found to have reached a constant temperature, the thermometer on the field coils and the field current both having been steady for the last half hour.

Field Loss. The voltmeter across the terminals of the machine reads exactly 110, and the reading of the ammeter is 1.5. The field loss is, therefore, $110 \times 1.5 = 165$ watts.

Loss in Leads and Contacts. With a low reading voltmeter, tests are now made for loss in the lead wires of the machine and their contacts. The drop is found to be negligible.

Armature Resistance. The motor is now shut down and the armature resistance measured. A low reading voltmeter is connected across segments that are under brushes of opposite polarity, the contact being made on the segments, not on the brushes.

This being a four brush machine, voltmeter readings are taken under each pair of brushes. Four such readings are possible. This resistance is measured with five or six different currents. The average is 0.25 ohm.

Stray Power. The machine is again started up as a motor without belt or load. The voltage is adjusted to 110, and it is found that the armature current is 2.42 amperes. The watts consumed by the armature are hence $110 \times 2.42 = 266.2$. Of this $2.42^2 \times 0.25 = 1.45$ watts are used up as I^2R loss. This leaves nearly 265 watts as the stray power.

Brush Drop. The low reading voltmeter is again called into requisition. It is provided with a pair of flexible cords terminating in stiff, pointed copper rods about six inches long. Arrangements having been previously made, the machine is shut down and started up as a separately excited dynamo without load. One of the copper points is held on a brush close to the commutator, the other on the commutator opposite the center of this brush. This central position is determined by shifting the point on the commutator until the voltmeter reads zero. Full load current is thrown on, care being taken not to change the position of the point. The voltmeter reading is found to be very unsteady, and a condenser of about one microfarad capacity is then shunted across its terminals, the trial being made again. This time a fairly steady reading of 1.25 volts is obtained, and it is found to be about the same for all the brushes, and also for various loads, excepting at currents below four amperes, where it appears to be negligible. Thus no correction need be made for brush drop in the stray power measurements. The total brush drop is then $1.25 \times 2 = 2.5$ volts.

Efficiency Calculation. The efficiency curve of the machine may now be calculated. Assuming an armature current of 10 amperes, the total intake in current will be $10 + 1.5 = 11.5$ amperes, and the efficiency will be

$$\eta = \frac{\text{output}}{\text{intake}} = \frac{\text{intake} - \text{losses}}{\text{intake}}.$$

$$\therefore \eta = \frac{(110 \times 11.5) - 265 - 165 - (10 \times 2.5) - (10^2 \times 0.25)}{110 \times 11.5}$$

$$= \frac{785}{1265} = 62.1\%$$

The rated output of the machine being five horse-power, or 3,730 watts, the load at this assumed current will be

$$\frac{785}{3730} = 21\% \text{ of full load.}$$

The efficiency at any other current may be found in a similar manner, but the computation may be simplified by a graphical construction. In Figure 68 the armature current is plotted as abscissas and the losses in watts as ordinates.

The first line from the bottom represents the 265 watts stray power; the next line above it is drawn at a distance representing 165 watts, the field loss. Both these losses are shown to remain the same regardless of the armature current. The other losses vary; the brush I^2R directly with the current, as shown by the slanting straight line, and the armature I^2R as the square of the current, as represented by the distances between the slanting and curved lines. The distances between the slanting line and the upper curved line are calculated for several currents, their values being plotted and a curve thus drawn.

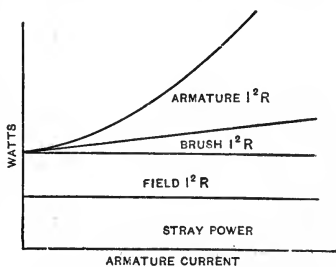

Fig. 68. Stray Power Test of a Shunt Motor.

The sum of all the losses at any assumed armature current can now be obtained by reading the vertical distance at that current from the base line to the upper curve.

There are other losses which are seldom mentioned in works on dynamo machinery. They vary, according to some unknown law, with the load, and are neglected in the stray power test

except in so far as they may occur in machines running at no load. Fortunately they are all negligible in well designed machines.

One is the I^2R loss in coils under commutation, the loss which is due to the self inductive discharge of a coil while it is short-circuited by a brush. This is reduced to a minimum when the brushes are set central.

Another is the I^2R loss due to local currents in cross connected armature windings. By this is meant the connection, in multiple path armatures, of conductors that are theoretically at the same potential. This loss is nil in a perfectly balanced magnetic circuit.

There are also the hysteresis and eddy current losses due to pulsation of armature reaction.

A shunt motor falls off in speed somewhat as the load is increased. To correct for this the IR drop in the total armature circuit should be known and the stray power should be taken at brush voltages equal to the counter e.m.f. at the several loads at which the efficiency is calculated; or better still, a curve between armature voltage and stray power may be taken.

In the case of a generator, it is necessary to know its regulation curve before simultaneous values of current and voltage may be assumed. The total ampere turns at any load must also be known as well as the corresponding speeds. Generators are generally designed for a drop in speed. The stray power test should be made at the proper excitation and speed for each load, or curves between stray power and speed, for various constant excitations, and between stray power and armature volts for various constant speeds, may be taken and from these the stray power at any simultaneous values of total voltage, speed and excitation may be obtained.

The efficiency of a generator is obtained from the formula

$$\eta = \frac{\text{output}}{\text{intake}} = \frac{\text{output}}{\text{output} + \text{losses}}$$

Data. The machine being at operating temperature, obtain the various simultaneous values of excitation, speed, terminal pressure and external current of the machine from the regulation test. Measure the resistances of the electrical circuits. Measure the stray power under a sufficient range of conditions to obtain its value for any assumed load. Measure the brush drop.

Suggestion. Where great accuracy is not important, the brush drop need not be measured but the resistance of the armature circuit should then include brush contact resistance, armature stationary. The procedure is otherwise the same as described above for the five horse-power shunt motor.

Curves. Plot curves between armature current and the various losses. Plot a curve between efficiency in percent and load in watts or horse-power, depending on whether the machine is a generator or a motor.

Questions. What is the effect of temperature on eddy current losses?

A generator is tested by the stray power method and the losses as measured are low, due to instrumental errors. The same machine is tested under load and both intake and output measured. The intake as measured is also low, due to instrumental errors of the same *percentage*. Which method gives efficiencies the more nearly to the truth and why?

Assuming three kinds of losses as stated at the outset, where does the point of maximum efficiency occur?

Does the shunt field loss in a generator (either shunt or compound wound) generally remain constant, independent of the load, and why?

No. 69. SEPARATION OF THE TOTAL STRAY POWER INTO ITS COMPONENTS.

References. Arnold's "Dynamos," p. 503; Jackson's "Dynamos," p. 254; Thompson's "Dynamos," p. 761.

Object. A knowledge of the values of the individual losses in a dynamo or motor is useful to the designer. It is also of importance to the more general electrical engineer to know how to separate the several losses, as he is thus able to tell just wherein a machine is deficient if its efficiency is low.

Theory and Method. Stray power is the power expended in turning the armature of a dynamo or motor, when the field is excited and there is no current in its armature winding. The components of stray power are, bearing friction, brush friction, air friction, windage, molecular friction or hysteresis in the armature and pole pieces, and eddy current losses in the armature and pole pieces.* For a given adjustment of the field current the aggregate of these losses remains constant so long as the speed is constant.

All mechanical friction varies directly with the speed.

Bearing friction depends on the weight of the rotating part, its accuracy of balance, alignment of the bearings, the material and polish of the rubbing surfaces, the surface velocity of the shaft, lubrication and temperature.

Air friction depends mostly on the conformation of the armature and of contiguous parts of the machine.

Brush friction has the same factors as bearing friction, the pressure of the brushes on the commutator taking the place of armature weight.

Windage depends largely on the speed for a given type of machine. Theoretically, this factor varies as the cube of the speed, for the amount of air moved depends directly on the speed and the resistance to motion on the square of the speed.

Hysteresis varies as the 1.6 power of the magnetic induction and directly as the speed, the "quality" of the iron, and its volume.

* There are additional hysteresis and eddy current losses in the pole pieces due to pulsation of armature reactions when there is a current in the armature. These losses should really be classed as stray power. They are difficult to determine and are so small that they are generally neglected.

The eddy current loss varies as the square of the speed and as the square of the magnetic induction. This may be shown theoretically. Take the case of an armature core.

Certain parts of the iron, notably the teeth, cut more lines of force than other parts, and a potential difference is developed just as in the armature conductors. If there be a closed electrical circuit connecting the parts at a difference of potential, a current will flow equal, at any instant, to this pressure divided by the resistance of the circuit. This resistance is constant after normal temperature is reached; therefore, the current will vary directly as the pressure; and the product of current and pressure, the watts, will vary as the pressure squared. Since pressure is proportional to speed and to magnetic flux, the eddy current loss will vary as the square of the speed, and as the square of the magnetic density.

Armature cores are laminated at right angles to the conductors to reduce the eddy current loss. The laminations being very thin, it is evident that doubling the thickness of a core disc makes very little difference in the total resistance of the eddy current circuit, while the voltage producing eddy currents, is doubled. Thus, within limits, the eddy current loss is practically proportional to the square of the thickness of laminations. It is also proportional to the volume of iron and inversely proportional to its specific resistance. The losses may be separated by the following procedure.

Drive the machine under test by a rated motor or through some form of transmission dynamometer. A rated motor is one whose efficiency is known. It may be rated as described in Experiment 72. If used, it is best to connect directly to the load through a flexible coupling. Such a coupling is easily made, and with a fair alignment the question of belt loss is eliminated.

First drive the machine unexcited at normal speed, being sure that lubrication, alignment, and brush tension are all in the best possible *working condition*. It is assumed that the machine is at working temperature. The power absorbed is used up in fric-

tion of air, bearings and brushes, and in windage. Raise the brushes from the commutator and the power absorbed will be friction of air and bearings, and windage. The difference between the two power readings will be brush friction. Leaving the brushes up excite the machine to normal value from a separate source, at the same time being sure that the speed is at rated value, and the additional power absorbed will be hysteresis and eddy current losses.

To separate the eddy current loss the machine should be driven at another speed, the field excitation remaining the same.

Let V_1 = first speed,

V_2 = second speed,

P_1 = power at speed V_1 ,

P_2 = power at speed V_2 ,

P_h = hysteresis loss at unity speed,

P_e = eddy currents at unity speed,

and P_f = air and bearing friction + windage at unity speed.*

Then

$$P_1 = P_f V_1 + P_h V_1 + P_e V_1^2,$$

and

$$P_2 = P_f V_2 + P_h V_2 + P_e V_2^2.$$

Therefore

$$P_e = \frac{P_1 V_2 - P_2 V_1}{V_2 V_1^2 - V_1 V_2^2},$$

and

$$P_e V_1^2 = \frac{(P_1 V_2 - P_2 V_1) V_1}{V_1 V_2 - V_2^2}.$$

Also

$$P_f + P_h = \frac{P_2 V_1^2 - P_1 V_2^2}{V_2 V_1^2 - V_1 V_2^2},$$

and

$$P_f V_1 + P_h V_1 = \frac{P_2 V_1^2 - P_1 V_2^2}{V_2 V_1 - V_2^2}.$$

* It is here assumed that windage varies with the speed. If the power absorbed in windage is insignificant, the error is negligible. This is the case in most machines.

$$\therefore P_h V_1 = \frac{P_2 V_1^2 - P_1 V_2^2}{V_2 V_1 - V_2^2} - P,$$

where P is the power absorbed, at the speed V_1 , with brushes raised and fields unexcited. In order to check the work it is best to make this test at three speeds. Thus three pairs of equations may be established and three values of P_e , P_f and P_h computed.

The eddy current loss may be separated by a graphical method, which is generally less liable to error than the analytical one.

The machine under test is driven as a motor *with its brushes set central*, and with the field normally excited. The pressure on the armature is varied, and simultaneous readings are taken of armature pressure, armature current, and speed. Knowing the resistance, the counter e.m.f. is easily obtained in each case. If a curve be plotted between armature current and counter e.m.f. as

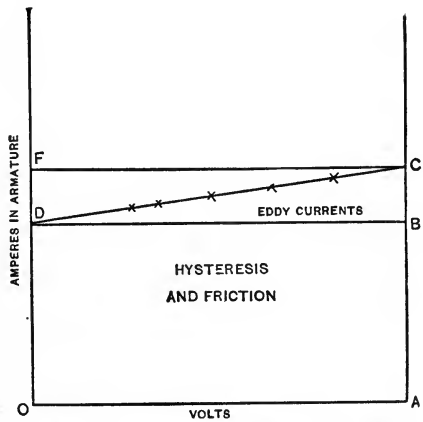

Fig 69. Separation of Losses by the Stray Power Method.

DC , Figure 69, the points should lie in a straight line, providing windage is negligible.

Speed and counter e.m.f. are proportional. If OA be the counter e.m.f. at normal speed, the product of OA and the ordinate AC will be the stray power at this speed. The rectangle $OACF$ represents this power. Since hysteresis and friction losses vary directly with the speed, if eddy current losses were not present, a curve between armature current and counter e.m.f. would be a horizontal line; the watts would then vary directly with the speed and the armature current would remain constant.

If eddy current losses alone were present, the curve would be a slanting straight line starting from the origin, current and

pressure thus increasing directly as the speed, and watts as the square of the speed.

If now the curve between current and pressure of an armature possessing all three losses be produced until it intersects the Y axis as at D in the diagram, and if horizontal lines be drawn from the points D and C , the rectangles $OABD$ and $DBCF$ will represent respectively the watts consumed in friction and hysteresis, and in eddy currents, $OD \times OA$ will be the watts absorbed in hysteresis and friction, including brush friction, and $DF \times OA$ the watts lost in eddy currents. The current OD represents that necessary to produce a torque just equal to the torque of the mechanical friction plus the torque of molecular friction in the iron when the field is at normal excitation, and the armature at rest. The coefficients of mechanical and molecular friction are in this case assumed to be the same as the running coefficients.

The current is so slight when the armature is running light, it is generally allowable to neglect the IR drop and plot observed volts as abscissas.

The same method of separation may be applied to a machine driven as a dynamo. It is not even necessary that the armature have a winding, for results may be obtained as follows.

Divide the power absorbed at each speed by the speed. Plot speed as abscissas and (power/speed) as ordinates. A little consideration will show the analogy to the case of a motor.

Data. Drive the machine under test by a rated motor or through a transmission dynamometer. Having previously adjusted the brush tension, and made certain of good alignment and lubrication, measure the power absorbed at normal speed. Maintaining the speed constant, raise the brushes, and again measure the power. Excite the fields to normal value and drive the machine at several different speeds (either as a generator or as a motor) and measure the power absorbed at each speed.

Caution. Do not disturb the commutator surface by wiping or oiling during the test, after having once put it in good working

condition. Anything of this kind is likely to change brush losses considerably.

Curve. Plot a curve similar to that of Figure 69, and draw the rectangles representing the separate losses.

Tabulate. The various losses measured.

No. 70. VARIATION OF STRAY POWER WITH SPEED; USEFUL FLUX CONSTANT.

Object. A knowledge of the variation of stray power under these conditions is useful to the designer.

Theory and Method. The law of variation of stray power with speed, ϕ being constant, depends upon the relative values of the several component losses; still it is remarkable how closely it holds for commercial machines of different makes. The total stray power will always vary as some power of the speed between one and two, providing windage is not a predominant factor.

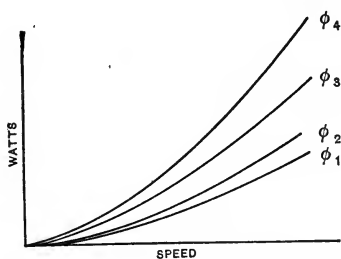

Fig. 70A. Variation of Stray Power with Speed.

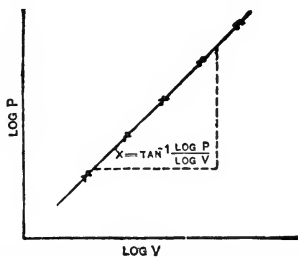

Fig. 70B. Variation of Stray Power with Speed.

This statement is not mathematically correct, inasmuch as the total stray power is

$$P = K_f V + K_h V + K_e V^2,$$

where K_f , K_h , and K_e refer to friction, hysteresis, and eddy current losses, respectively. A single function of V cannot theoretically replace the several functions excepting for one set of values. The values of the constants K_f , K_h , and K_e , however, are in the

present case such that a single function may be substituted, without serious error, over the working range of the observations.

In Figure 70A, several curves are plotted between stray power and speed for different fixed values of ϕ . These curves are obtained in the usual way, each for a different field excitation.

Let P be the stray power.

Then $P = KV^x$.

Where V is the speed, K is a constant, and x the unknown exponent.

$$\text{Log } P = x \log V + \log K,$$

which is the equation of a straight line whose tangent is x . Plotting a curve with values of $\log P$ as ordinates and $\log V$ as abscissas, a straight line is obtained as in Figure 70B; and the slope of this line will be the required value of x .

The value of K may now be obtained by substituting in the equation

$$K = \frac{P}{V^x}$$

the value of x and any simultaneous observed values of P and V .

K may also be obtained by means of simultaneous equations.

$$\text{Log } P_1 = x \log V_1 + \log K,$$

$$\text{Log } P_2 = x \log V_2 + \log K,$$

whence

$$\log K = \frac{\log P_1 \log V_2 - \log P_2 \log V_1}{\log V_2 - \log V_1},$$

where the subscripts refer to specific observations.

Data. Drive the machine as a motor with brushes set central and obtain simultaneous readings of brush pressure, armature current and speed, for various values of brush pressure, the field excitation being normal and constant in value. Repeat the observations for field currents above and below normal value. Measure the armature resistance and obtain the number of arma-

ture conductors. The machine may be driven as a dynamo, and the stray power measured by a rated motor or by some form of transmission dynamometer.

Caution. The brushes should be set on the neutral plane and the commutator should not be oiled or wiped during the test.

Calculate. The stray power from the observed values of armature current and the corresponding values of counter e.m.f. Compute the value of x for each field current, taking the average obtained from several speed observations. Calculate the value of K for each field excitation from several sets of readings.

Curves. Plot curves of stray power and speed for each value of ϕ .

Plot curves between $\log P$ and $\log V$ for each value of ϕ and compare the values of the tangents of these curves. If they agree closely, take their average as the required exponent. Establish the equation for stray power for each value of ϕ .

Question. Under what practical conditions would the law found in this experiment be useful?

No. 71. VARIATION OF STRAY POWER WITH USEFUL FLUX; SPEED CONSTANT.

Object. A knowledge of the variation of stray power under these conditions is of value to the designer.

Theory and Method. This law depends on the relative losses at a given speed. The total stray power will vary as some power of the useful flux between one and two, for windage in this case is constant. Figure 71A shows several curves of stray power for different constant values of speed. These data may be taken by adjusting the pressure in direct proportion to the magnetic flux, but errors are thus introduced due to hysteresis in the field. A more accurate way is to take curves between stray power and speed for given fixed values of ϕ , as in Experiment 70, Figure 70A, and to derive the required curve therefrom.

The test may also be made by driving the machine as a dynamo, the power being measured mechanically. This is in some respects

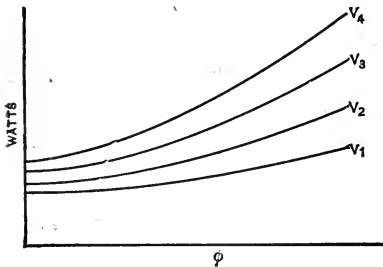

Fig. 71A. Variation of Stray Power with Magnetism.

preferable. It has the advantage that observations are readily taken with weak fields as well as strong ones, and the disadvantage of not being so convenient to make ready for accurate work.

Let P be the stray power,

$$\text{Then } P = K_1 + K_2 \phi^x,$$

where K_1 is the constant loss due to friction and windage, K_2 is a constant, and x is the unknown exponent.

Let P_w be the loss due to hysteresis and eddy currents.

Then

$$P_w = K_2 \phi^x,^*$$

and

$$\log P_w = x \log \phi + \log K_2.$$

This is the equation of a straight line whose tangent is x . Plotting values of $\log P_w$ as ordinates and $\log \phi$ as abscissas, a straight line is obtained, as in Figure 71B. The tangent of the angle which this line makes with the X axis is the required value of x .

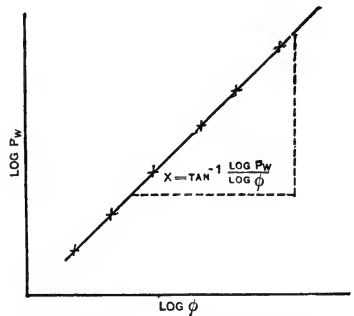

Fig. 71B. Variations of Stray Power with Magnetism.

The value of K_1 may be obtained by driving the machine from a mechanical source, the fields being unexcited.

* This is not mathematically correct for

$$P_w = K_3 \phi^{1.6} + K_4 \phi^2$$

where K_3 and K_4 refer to hysteresis and eddy current losses, respectively. A single function of ϕ cannot be substituted theoretically for the two functions, but the constants are of such values in a dynamo machine, over the working range, that this may often be done without appreciable error.

Knowing the value of K_1 , the value of P may be obtained by subtraction.

ϕ is obtained by calculation from the observed voltage, the speed and the known number of conductors on the armature.

The value of K_2 may be obtained by substitution after x has been determined, or it may be found by taking simultaneous equations for known values of $\log P_w$ and $\log \phi$.

Data. Drive the machine from a rated motor or through a transmission dynamometer. Measure the power absorbed, field unexcited, at normal speed. This gives the loss due to friction and windage. Holding this speed at a constant value measure voltage, speed, and intake for various field excitations, separate excitation being used.

Repeat the experiment at speeds above and below normal value. Obtain the number of armature conductors, and the constants of the instrument for measuring the power.

If, when the field is excited, the machine is driven as a motor, the power should be measured as in Experiment 70.

Caution. The brushes should be set on the neutral plane and the commutator should not be oiled or wiped during the test.

If driven as a motor, the useful flux should not be reduced to such an extent as to cause a dangerous speed.

Calculate. The stray power from the intake measurements. Compute the value of ϕ for each set of readings. Calculate the value of K_2 for each speed.

Curves. Plot curves between stray power and ϕ for each value of speed.

Plot curves between $\log P_w$ and $\log \phi$ for each speed and compare the tangents of these curves. If they agree closely, take their average as the required exponent. Establish the equation for stray power for each value of speed.

Questions. If the same machine is used in Experiments 70 and 71, would the exponents have the same value in each case or would they be unequal? Give reasons.

Under what practical conditions would the law found in this experiment be useful?

No. 72. RATING OF A SHUNT MOTOR FOR MEASUREMENT OF POWER.

Object. A motor is so convenient as a source of mechanical power in experimental work that if a simple method of determining its output, under all conditions of voltage and excitation, is known, the trouble and loss of time incident to the use of transmission dynamometers will be dispensed with.

Theory and Method. In applying a motor to the measurement of power, the intake is measured with electrical instruments, and the output is calculated by multiplying by the efficiency at this particular value of intake. This method applies to any form of electric motor, and the motor becomes what might be termed a translating dynamometer. A shunt motor, however, is most convenient for general purposes inasmuch as it is capable of a wide range of speed control. In this case it is preferable to determine the losses under as wide a range of conditions as is likely to be met in operation, and to subtract the sum of the losses that apply to any one set of observations from the intake.

The efficiency curves are not drawn in this case, only the curves of stray power and armature I^2R loss being necessary.

If used for a continuous load the motor should be rated at normal temperature and it should not be used as a dynamometer unless heated up. If used for a short time only, the motor may be rated cold, or if in service long enough to show an appreciable rise in temperature, it will generally be sufficiently accurate to rate it at an average temperature.

The resistance of the armature circuit is first measured at the desired temperature and a curve plotted between armature current and I^2R loss.

For fine work the brush drop may be determined as in Experiment 68. In this case a curve is plotted between I^2R loss of

brush contact and armature current, or the ordinates of this curve may be added to those of a curve between I^2R loss in the rest of the armature circuit, and current. These curves are shown in Figure 72A. For ordinary work the total resistance of the armature circuit may be used and brush drop need not be separated. The error will usually be slight.

The machine is then excited from the mains and the field current measured. A rheostat is then placed in the armature circuit and the speed is varied over a wide range by manipulating the rheostat. The intake of the armature is measured by means of a voltmeter and an ammeter, corrections being made for arma-

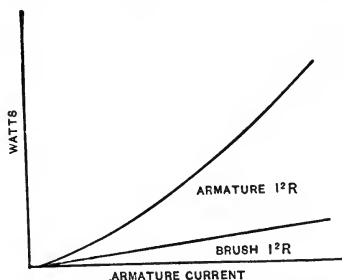

Fig. 72A. Rating of a Shunt Motor for Power Measurement.

ture I^2R loss. A field rheostat is then placed in the field circuit and a similar set of observations taken at a smaller field current, and so on, the field being weakened to the smallest value that will permit of sparkless operation under load. It is advisable to experimentally determine the minimum field current before starting the test. Safe peripheral velocity should also be kept in mind.

Curves are then plotted between stray power and field current and between stray power and speed as in Figure 72B. By this system of curves an accurate interpolation for field currents other than those of the test, or for speeds other than those of the test is possible; a curve between stray power and field current at an intermediate speed may be drawn by referring to the watt-speed curves and a curve between stray power and speed at an intermediate field current may be drawn by referring to the watt-field current curves.

In applying the rated motor to the measurement of power, it is connected to its load by means of a belt or preferably a flexible coupling. A variable resistance is placed in the armature circuit

and one in the field circuit, both resistances being so arranged that they may be short circuited. Ammeters are placed in both the armature and the field circuits and a voltmeter is connected across the armature terminals. The speed is adjusted to the desired value by means of the field rheostat if possible; if not, by means of the armature rheostat. Having fixed the speed, the

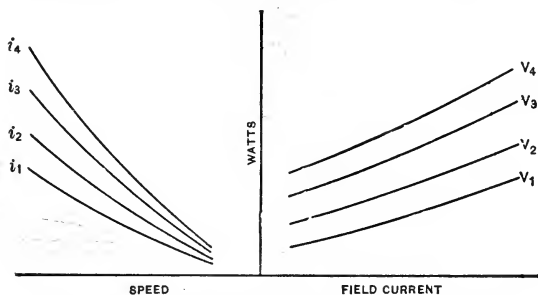

Fig. 72B. Rating of a Shunt Motor for Power Measurement.

field current is maintained constant. The armature rheostat must not be used except in the case of a constant load. Where the load fluctuates the proper speed must be obtained by means of pulleys, gearing, or field regulation, or else the armature should be independently connected to a generator whose pressure may be regulated. The brushes should be kept on the neutral plane, thus avoiding losses in the short-circuited coils. A motor that requires shifting of the brushes is not adapted for use as a rated motor.

For any observed values of armature current, speed and field excitation, the output will be the armature intake minus the I^2R losses of brushes, leads, and armature winding, at the observed armature current, minus the stray power at the observed excitation and speed.

Suggestions. This same method may be applied to the rating of a generator to be used for testing motors, instead of a friction brake or a transmission dynamometer, but its application is not so general nor is it so convenient, because of the difficulty of absorbing the power at low pressures.

Data. Having made certain that the machine is at the desired working temperature, obtain by trial the minimum value of field current that will permit of sparkless operation at full load armature current. Without shifting the brushes from the neutral position, measure the armature resistance. Take the temperature of the armature.

Obtain readings of armature current, armature pressure, field current and speed for a wide range of armature pressure and for various constant values of field current, from normal value or above, to the minimum value for sparkless operation; or to the limiting safe value of speed should this be the determining factor.

Caution. Before taking any readings adjust the brushes and the adjustable parts of the machine to the best possible working condition. If the brushes are not set on the neutral plane, the I^2R loss of the coils under commutation will vitiate the results.

Curves. Plot curves of armature I^2R and brush I^2R losses, using armature current as abscissas. Plot curves between stray power and speed for various field currents, and between stray power and field current for various speeds. Mark the temperature of the armature on the curve sheet.

Question. Why is it impracticable to regulate the speed by means of an armature rheostat when the load fluctuates?

No. 73. HOPKINSON OPPOSITION METHOD OF TESTING DYNAMO MACHINES.

References. Hopkinson's "Papers," Vol. I, p. 106; Hopkinson's "Dynamos," p. 112; *Phil. Trans.*, 1886, ii, p. 347; *London Elec.*, 1886, Vol. XVI, p. 347; *London Elec. Rev.*, 1886, Vol. XVIII, pp. 207 and 230; Jackson's "Dynamos," p. 257; Thompson's "Dynamos," p. 758; Blondel and Du Bois, Vol. 2, p. 367; Carus-Wilson, p. 84.

Object. It is customary to make temperature, regulation, and efficiency tests of machines before they leave the factory, and

such tests are often made at other times. In testing large machines the facilities are often inadequate for either supplying or dissipating the power necessary in making full load tests. Again, where large numbers of machines are tested, it is a matter of importance to use such methods as will cause as little waste of power as possible, and still give accurate results under working conditions. Where a companion machine like the one under test is available, the two machines may be run in opposition, the one as a generator, and the other as a motor, and any desired load circulated between them, the *losses only* being supplied from a separate source. Several methods of this kind have been devised, the first suggested being the one here considered.

Theory and Method. In the Hopkinson method the two like machines are coupled both electrically and mechanically, so that power is supplied from the generator to the motor electrically

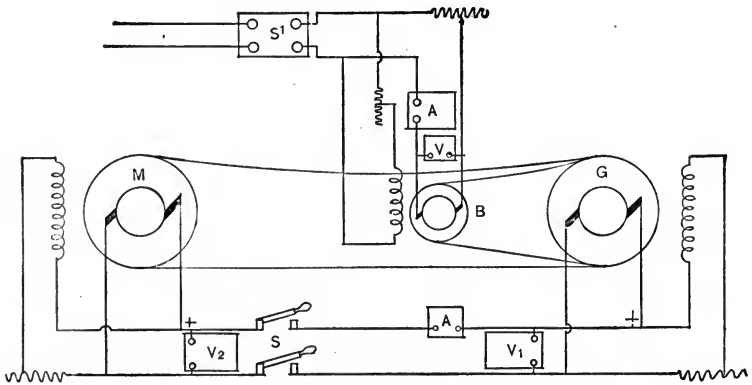

Fig. 73. Hopkinson Method of Testing Dynamo Machines.

and from the motor to the generator mechanically; the losses being supplied from a separate mechanical source. This method is best adapted to generator tests, as the adjustments are more difficult to make in motor testing. The discussion will be first considered from the standpoint of generator testing.

Figure 73 shows the connections for shunt machines, *G* being the generator under test, and *M* a machine like *G* in all respects.

G and M are mechanically and electrically coupled. The losses are supplied by the auxiliary motor B , which has been rated as in Experiment 72.

The three machines are brought up to speed by starting the auxiliary motor B in the usual manner, the switch S being open. Care should be taken to be certain that the machines G and M are in *electrical opposition* and that their terminal pressures are equal before the switch S is closed.

After the adjustment is made and the switch S closed, an interchange of power between M and G may be brought about by weakening the motor field and strengthening that of the generator. In this case the motor tends to speed up and drive the generator mechanically; the latter, in turn, having the higher pressure, drives the motor electrically. If it is necessary to shift the brushes, the forward lead on the generator should be balanced by an equal backward lead on the motor.

Since regulation and efficiency tests are made after the temperature run, the latter test will be considered first.

Temperature. If a temperature run only is made, the machines need not be alike. For a generator test the load should be adjusted to the normal rated value by a proper manipulation of the field rheostats of M and G , care being taken that the generator terminal pressure is normal. The speed should also be maintained normal by adjusting the auxiliary motor B . These conditions should be kept constant throughout the run.

If a motor is tested, it is necessary to make such adjustment that the motor will be supplied with normal full load current at rated pressure. The motor field is not changed, the load being adjusted by varying the generator field excitation. It will generally be found that the full load speed is slightly less than the no-load value on account of the inherent regulation of the motor.

Regulation. The speed, terminal pressure and output of the generator under test are adjusted to the normal values at full load. The load is then gradually reduced to zero, the speed being

kept constant, and readings of pressure are taken for various loads.

The method is not well adapted to motor regulation tests because of the difficulty of adjusting. A motor regulation test may be made, however, by adjusting to normal full load current at normal terminal pressure, and reading the speed; then, reducing the load to zero, the pressure being constant, taking readings of speed.

Efficiency. The adjustments are the same as in the regulation test and, in fact, the data for the two parts may be taken at the same time. The calculation for efficiency is as follows.

If—

IE_1 = power delivered by G to M ,

P_l = I^2R loss in the leads between G and M ,

P_b = belt loss between M and G ,

P_{a_1} = I^2R loss in armature of G ,

P_{a_2} = I^2R loss in armature of M ,

P_{f_1} = I^2R loss in field of G ,

P_{f_2} = I^2R loss in field of M ,

P_{s_1} = Stray power loss of G ,

P_{s_2} = Stray power loss of M ,

P_B = power supplied by B (belt loss deducted),

then

$$P_B = P_l + P_b + P_{a_1} + P_{a_2} + P_{f_1} + P_{f_2} + P_{s_1} + P_{s_2}.$$

If P_{s_1} and P_{s_2} are considered equal,

$$P_{s_1} = P_{s_2} = \frac{P_B - (P_l + P_b + P_{a_1} + P_{a_2} + P_{f_1} + P_{f_2})}{2}.$$

The loss P_l may generally be neglected and the loss P_b may be assumed as about two percent of the power transmitted if a belt is used. It is preferable to use a flexible coupling, in which case P_b is eliminated. A rigid coupling, unless the machines are carefully aligned, often leads to increased friction losses.

The efficiency of the generator G is

$$\eta = \frac{IE_1}{IE_1 + P_{a_1} + P_{f_1} + P_{s_1}}.$$

If the motor and generator stray power losses cannot be considered equal, the stray power loss of the motor should be known.

If a motor is tested, and the losses are as above, E_2 being the pressure at the motor terminals,

$$IE_2 = \text{the power supplied the motor.}$$

The power delivered at the motor pulley is

$$IE_2 - (P_{a_2} + P_{f_2} + P_{s_2}),$$

and the motor efficiency is

$$\eta = \frac{IE_2 - (P_{a_2} + P_{f_2} + P_{s_2})}{IE_2}.$$

It is sometimes impracticable to measure the I^2R losses and in such cases approximate and more simple formulas may be used. The belt loss is deducted, the loss in the connecting leads is considered negligible, and the remainder of the power supplied as equally divided between M and G . Then the total loss in either the generator or the motor is

$$\frac{1}{2}(P_B - P_b).$$

The efficiency of the generator is

$$\eta = \frac{IE}{IE + \frac{1}{2}(P_B - P_b)},$$

where IE is the electrical power transmitted from G to M .

This approximate formula gives values which are too high. The losses in the generator are all normal, but those in the motor are too low.

The efficiency of a motor is

$$\eta = \frac{IE - \frac{1}{2}(P_B - P_b)}{IE}.$$

This approximate formula gives values which are too low. The motor losses are all normal, but those of the generator are all too high.

Data. Using two similar shunt machines, make connections as shown in Figure 73. With the switch S open, bring the machines up to speed by means of the auxiliary motor B . Adjust the terminal pressures of M and G , see that they are in opposition, and close the switch S . Adjust G to the normal full load terminal pressure, current, and speed. Take readings of power supplied by the auxiliary motor B , terminal pressure at generator and at motor, current in generator and motor fields, speed and current supplied to motor from generator. Without regulating the field rheostat of the generator, repeat the observations for decreasing loads down to no load. Measure the hot resistances of the armatures of M and G .

Caution. In order to insure safety, be certain that circuit breakers or other suitable safety devices are placed both in the supply circuit and in the motor-generator circuit.

Calculate. The efficiency of the generator at each load, assuming the stray power losses to be the same in the two machines. Compute the percent regulation from the full load—no load observations.

Curves. Plot curves of regulation and efficiency of the generator, using percent load as abscissas.

Questions. Why does weakening the field of M cause it to act as a motor?

What losses are measured here that are not measured in the stray power method of efficiency testing?

Why should the brush leads on the motor and generator be made equal in the case of an efficiency test?

If the efficiency test of a compound generator is made by an opposition method, would you use a shunt or a compound motor, and why? If a compound motor is used, would you run it cumulative or differential, and why?

If the efficiency test of a compound motor is made, would you use a shunt or a compound generator, and why? Answer for both cumulative and differential compound motors.

No. 74. KAPP OPPOSITION METHOD OF TESTING DYNAMO MACHINES.

References. *London Elec. Eng.*, Jan. 22, 1892; *London Elec.*, July 5, 1895; Jackson's "Dynamos," p. 256; Thompson's "Dynamos," p. 759; Parr, E. E. T., p. 182; Parham and Shedd, p. 433; Carus-Wilson, p. 87.

Object. This method, like that of Hopkinson, permits of making temperature, regulation, and efficiency tests under full load conditions, with a comparatively small amount of power supplied.

Theory and Method. The Kapp method is similar to that of Hopkinson, except that the losses are supplied electrically instead of mechanically. This is an advantage in efficiency testing especially, since the power supplied may be more accurately meas-

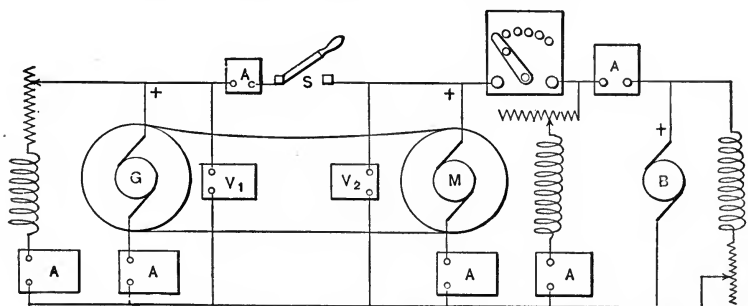

Fig. 74. Kapp Method of Testing Dynamo Machines.

ured and it avoids the necessity of rating a motor. Again, very often the third machine may be dispensed with, the losses being supplied by the shop mains.

This method is more applicable to motor than to generator testing, because of the greater difficulty in adjustments in the testing

of generators. The discussion will therefore be first considered from the standpoint of motor testing.

Figure 74 shows the connections for shunt machines; M being the motor under test, and G a machine like M in all respects. M and G are mechanically and electrically coupled. The losses are supplied by the auxiliary generator B .

With M and G coupled mechanically, and the switch S open, the best method of procedure is to start M as a motor in the usual manner, the power being supplied by B . The pressure of G is then made equal to that of M and the switch S closed, care being taken that the two machines are in electrical opposition.

After the adjustment is made and the switch S closed, an interchange of power between M and G may be brought about by weakening the motor field and strengthening that of the generator. In this case the motor tends to speed up and drive the generator mechanically; the latter, in turn, having the higher pressure, drives the motor electrically. The tests will be considered in the order of temperature, regulation, and efficiency.

Temperature. The full load armature current of the motor under test should be known. Maintaining the terminal pressure and field of M normal, adjust the armature current to full load value by varying the field of G . It will generally be found that the full load speed is slightly less than the no load value, on account of the inherent regulation. It is the practice of some companies to adjust the motor speed to its normal value under full load and to test regulation by noting the *rise* in speed at no load. After the adjustments are made the conditions should be maintained constant throughout the test.

If the generator G is under test, its load should be adjusted to normal rated value by a proper manipulation of rheostats in the fields of G and M , care being taken that the generator terminal pressure is normal. The speed should also be maintained normal by adjusting the auxiliary generator B .

Regulation. The brushes should be set with equal and opposite angles of lead. For a motor test, adjust to normal full

load current and pressure on the motor and read the speed. Gradually reduce the load to zero, maintaining the terminal pressure and field constant, and take readings of speed for various loads.

If the generator G is under test, the load should be adjusted to normal rated value at normal speed and terminal pressure. Without regulating the generator field rheostat, the load is gradually reduced to zero and readings of terminal pressure are taken.

Efficiency. The adjustments are the same as in the regulation test and, in fact, the data for the two tests may be taken at the same time. The calculation for efficiency is as follows.

If—

I_2E_2 = total electrical power received by M ,

P_l = I^2R loss in the leads between G and M ,

P_b = belt loss between M and G ,

P_{a_1} = I^2R loss in the armature of G ,

P_{a_2} = I^2R loss in the armature of M ,

P_{f_1} = I^2R loss in the field of G ,

P_{f_2} = I^2R loss in the field of M ,

P_{s_1} = stray power loss of G ,

P_{s_2} = stray power loss of M ,

P_B = power supplied M by auxiliary generator B ,

then

$$P_B = P_l + P_b + P_{a_1} + P_{a_2} + P_{f_1} + P_{f_2} + P_{s_1} + P_{s_2}.$$

If P_{s_1} and P_{s_2} are considered equal,

$$P_{s_1} = P_{s_2} = \frac{P_B - (P_l + P_b + P_{a_1} + P_{a_2} + P_{f_1} + P_{f_2})}{2}.$$

The loss P_l may generally be neglected and the loss P_b may be assumed about two percent of the power transmitted if a belt is used. It is preferable to use a flexible coupling, in which case P_b is eliminated.

The efficiency of the motor M is

$$\eta = \frac{I_2E_2 - (P_{a_2} + P_{f_2} + P_{s_2})}{I_2E_2}.$$

If the motor and generator stray power losses cannot be considered equal, the generator stray power loss should be known.

If a generator is tested and the losses are as above, I_1E_1 being the generator output, the efficiency is,

$$\eta = \frac{E_1I_1}{E_1I_1 + (P_{a1} + P_{f1} + P_{s1})}.$$

Where it is impracticable to measure the I^2R losses, approximate and more simple formulas may be used. The belt loss is deducted, the loss in the connecting leads is considered negligible, and the remainder of the power supplied is assumed as equally divided between M and G . Then the total loss in either motor or generator is

$$\frac{1}{2}(P_B - P_b).$$

The efficiency of a motor is

$$\eta = \frac{I_2E_2 - \frac{1}{2}(P_B - P_b)}{I_2E_2},$$

where I_2E_2 is the total electrical power delivered to M .

This approximate formula gives efficiencies which are too low. The losses in the motor are normal, while those in the generator are too high.

The efficiency of a generator is

$$\eta = \frac{I_1E_1}{I_1E_1 + \frac{1}{2}(P_B - P_b)},$$

where I_1E_1 is the output of G .

This approximate formula gives efficiencies which are too high. The generator losses are all normal, but those of M are too low.

Data. Using two similar shunt machines, make connections as in Figure 74. With the switch S open, bring the machines G and M up to speed by driving M as a motor from B . Adjust the terminal pressures of M and G , see that they are in opposition, and close the switch S . Adjust M to its normal full

load current at normal pressure and take readings of speed, currents in generator and motor armatures and fields, pressure at armature terminals, and current supplied by the auxiliary generator. Repeat the observations for decreasing loads down to no load on the motor, maintaining the terminal pressure and field of the motor constant. Measure the hot resistances of the armatures of M and G .

Caution. In order to insure safety, be certain that circuit breakers or other suitable safety devices are placed both in the supply circuit and in the motor-generator circuit.

Calculate. The efficiency of the motor at the various loads, assuming the stray power losses to be the same in the two machines. Compute the percent speed regulation of the motor from the full load—no load observations.

Curves. Plot curves of regulation and efficiency of the motor, using percent load as abscissas.

No. 75. POTIER OPPOSITION METHOD OF TESTING DYNAMO MACHINES.

Reference. Blondel and Du Bois, Vol. 2, p. 367.

Object. One of the objections to the Kapp method, Experiment 74, is that the I^2R losses in the armatures and fields are somewhat different in the two machines. In the method here considered the armature current is the same in the two machines and, therefore, the I^2R losses in the armatures are equal. It retains the advantage of economy of power.

Theory and Method. The Potier method is similar to the Kapp method in that all of the losses are supplied electrically. It differs in that the stray power and armature I^2R losses are supplied by means of an electrical source in *series* with the generator. The method is somewhat more applicable to motor than to generator testing, because of less difficulty in making the adjustments, and a motor test will be considered first in the discussion.

In Figure 75, M is the motor under test and G is a generator which is like M in all respects. Their fields are separately excited from an independent source H . G and M are belted or mechanically coupled, and their armatures are connected in elec-

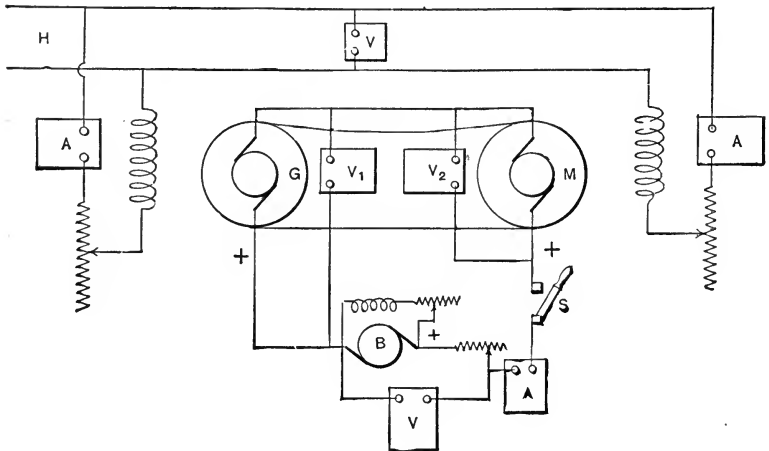

Fig. 75. Potter Method of Testing Dynamo Machines.

trical opposition through the auxiliary source B , the pressure of which aids that of the generator G and opposes that of the motor M .

This auxiliary source may be either a low voltage generator or a storage battery. In either case it must have a current capacity equal to the full load current of the machine tested.

The impelling torque of M must be greater than the retarding torque of G in order that M may drive G mechanically. The retarding torque of G is

$$T_1 = KI\phi_1,$$

and the impelling torque of M is

$$T_2 = KI\phi_2$$

where I is the common armature current, ϕ_1 is the magnetism given the generator, and ϕ_2 that given the motor.

In order to obtain an excess torque in the motor it therefore becomes necessary to excite its field *higher* than the excitation of the generator field. The formula for resultant torque is

$$T = KI\phi_3,$$

where ϕ_3 represents the excess magnetism given the motor M .

The machines M and G are started by giving M a stronger field excitation than that of G and closing the switch S , making sure that the pressure of the auxiliary source B aids that of G . The current in the armature circuit at the time of starting may be regulated by adjusting the pressure of B . The machines will start rather slowly unless there is considerable difference in their excitations. If B is capable of giving normal pressure, the machines may be brought up to normal speed at no load by leaving G unexcited and giving M its normal excitation. However, B is generally a low voltage machine and it becomes necessary to excite G in order to obtain normal speed and pressure. If the motor M is under test, its field should be made normal when the speed has attained approximately normal value. The normal terminal pressure and desired load are then obtained by adjusting the auxiliary pressure source B and the field rheostat of G .

If the generator G is being tested, the speed and load are adjusted by varying the field of M and the auxiliary source B , and the terminal pressure of G is made normal by adjusting its own field. The tests will be considered in the order of temperature, regulation, and efficiency.

The machines M and G may be brought up to speed by driving M as a motor from the independent source H which supplies its fields, the switch S being open. Machines G and B are then adjusted so that their combined pressure is equal and opposite to that impressed upon M , the switch S is closed, and the connection of the independent source with the armature of M is broken.

Temperature. The full load armature current of the motor under test should be known. After the machines have been

brought up to speed, adjust the field of M to its normal value and then its terminal pressure to rated value at full load current. After the adjustments are made the conditions should be maintained constant throughout the test.

If the generator G is under test, the load, terminal pressure and speed of G should be made normal by a proper manipulation of the fields of M and G and by adjusting the pressure of the auxiliary.

Regulation. For a motor test, adjust M to normal full load current and pressure, and read the speed. Gradually reduce the load to zero, maintaining the terminal pressure and field constant, and take readings of speed for the various loads.

If the generator G is under test, the load should be adjusted to normal rated value at normal speed and terminal pressure. Without regulating the generator field rheostat, the load is gradually reduced to zero, and readings of terminal pressure are taken.

Efficiency. The adjustments are the same in the regulation test, and, in fact, the data for the two tests may be taken at the same time. The calculation for efficiency is as follows.

Let

$IE_2 =$ power supplied motor armature,

$P_l = I^2R$ loss in leads between G and M ,

$P_b =$ belt loss between M and G ,

$P_{a_1} = I^2R$ loss in armature of G ,

$P_{a_2} = I^2R$ loss in armature of M ,

$P_{f_1} = I^2R$ loss in field of G ,

$P_{f_2} = I^2R$ loss in field of M ,

$P_{s_1} =$ stray power of G ,

$P_{s_2} =$ stray power of M ,

and $P_B =$ power supplied by auxiliary generator B .

The power P_B is the product of the armature current and the pressure E measured across the leads connecting the auxiliary generator B to G and M .

Then

$$P_B = P_l + P_b + P_{a_1} + P_{a_2} + P_{f_1} + P_{f_2} + P_{s_1} + P_{s_2}.$$

If P_{s_1} and P_{s_2} are considered equal,

$$P_{s_1} = P_{s_2} = \frac{P_B - (P_l + P_b + P_{a_1} + P_{a_2})}{2}.$$

The loss P_l may generally be neglected, and the loss P_b may be assumed as about two percent of the power transmitted if a belt is used. It is preferable to use a flexible coupling, in which case P_b is eliminated.

The efficiency of the motor M is

$$\eta = \frac{IE_2 - (P_{a_2} + P_{s_2})}{PE_2 + P_{f_2}}.$$

If the motor and generator stray power losses cannot be considered equal, the generator stray power loss should be known.

If a generator is tested, the efficiency is

$$\eta = \frac{IE_1}{IE_1 + (P_{a_1} + P_{f_1} + P_{s_1})}.$$

Where it is impracticable to measure the I^2R losses, approximate and more simple formulas may be used. The belt loss is deducted, the loss in the connecting leads is considered negligible, and the remainder of the power supplied is assumed as equally divided between M and G .

The stray power loss plus armature I^2R loss, in either generator or motor, is

$$\frac{1}{2}(P_B - P_b).$$

The approximate efficiency of a motor is

$$\eta = \frac{IE_2 - \frac{1}{2}(P_B - P_b)}{IE_2 + P_{f_2}}.$$

This formula gives efficiencies which are too high. The losses of the motor are all normal, but those of the generator are too low.

The approximate efficiency of a generator is

$$\eta = \frac{IE_1}{IE_1 + \frac{1}{2}(P_B - P_b) + P_{f_2}}$$

This formula gives efficiencies which are too low. The losses of the generator are all normal (the armature I^2R loss is slightly reduced because of the separate excitation), but those of the motor are too large.

Data. Using two similar shunt machines, make connections as in Figure 75. Close the switch S , adjust M with a strong field and G with a weak field, and bring the machines up to speed by adjusting the fields of M and G and also the pressure supplied by the auxiliary generator B . Be sure that the machines have equal and opposite brush leads. Adjust M to its normal full load current at normal field and terminal pressure, and take readings of speed, armature current, field current and pressure of both M and G , and pressure supplied by the auxiliary generator B . Repeat the observations for decreasing loads down to no load on the motor, maintaining the terminal pressure and field of the motor constant. Measure the hot resistances of the armatures of M and G .

Caution. In order to insure safety, be certain that circuit breakers or other suitable safety devices, are placed both in the supply circuit and in the motor-generator circuit.

Calculate. The efficiency of the motor at various loads, assuming the stray power losses to be the same in the two machines. Compute the percent speed regulation from the full load—no load observations.

Curves. Plot the curves of regulation and efficiency of the motor, using percent load as abscissas.

No. 76. HUTCHINSON OPPOSITION METHOD OF TESTING DYNAMO MACHINES.

References. *London Elec. Eng.*, 1893; Blondel and Du Bois, Vol. 2, p. 368.

Object. The object here, as in Potier's Method, is to obtain an opposition method which will permit the losses in the two machines being made more nearly equal than in the Hopkinson and Kapp methods. By the present method the fields are maintained equal and, consequently, the stray power is the same in the two machines. It retains the advantage of economy of power.

Theory and Method. In the method due to Potier the armature currents of the two like machines are the same but the fields are necessarily different and so the stray power, as well as the field I^2R loss, is not equally divided. Here the fields receive the same excitation, and, since the machines are mechanically connected, the stray powers may be considered equal. The armature I^2R loss, however, is somewhat larger in the motor than in the generator.

The theory will be considered first from the standpoint of a motor test. In Figure 76, M is the motor under test, and G is a machine like M in all respects. H is an electrical source whose pressure is equal to or slightly greater than the normal pressure of the motor tested. M and G are mechanically coupled. Their fields are excited from the source H and are both adjusted equal to the normal excitation of the motor M . The armatures of M and G are electrically connected through the auxiliary source B , the pressure of which aids G in supplying the desired working current to the armature of M . B may be either a low voltage generator or a storage battery. In either case it must have a current capacity equal to the full load current of the machine tested. The motor armature is also supplied from the source H , and the power necessary to overcome stray power for both ma-

chines is received from this source. The excess I^2R loss in the armature of M is equally divided between the sources B and H .

In starting, the switch S_2 is left open, S_1 is closed and the machines M and G brought up to speed by starting M as a

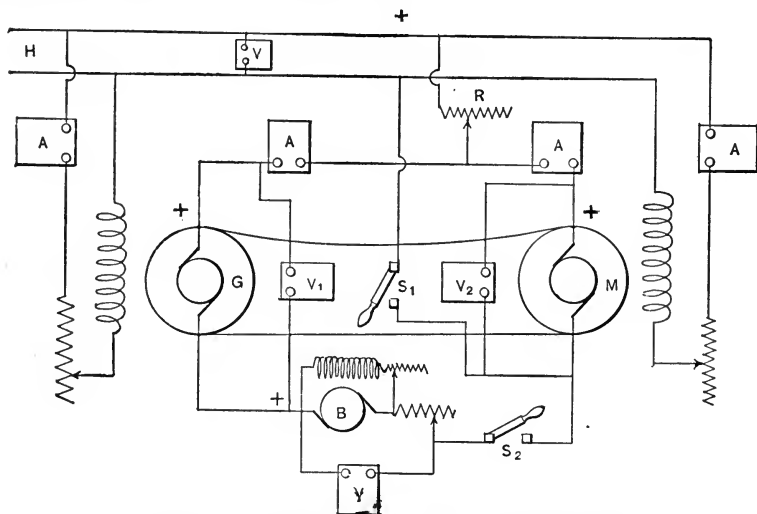

Fig. 76. Hutchinson Method of Testing Dynamo Machines.

motor in the usual way from the mains H . The field of M is made normal and that of G equal to it. E_2 , the armature pressure of M , is made normal; the sum of pressures E and E_1 is made equal to E_2 , and the switch S_2 closed.

The machines M and G are loaded by increasing the pressure E . The immediate result is a larger I^2R drop in the motor armature and a consequent fall in counter e.m.f., since the pressure E_2 is maintained constant by the source H . A slight adjustment of the variable resistance R may be found necessary as the load is adjusted. The only condition which would permit of the current in the mains H being reversed would be that the auxiliary B developed a pressure greater than that of H . For economy, B is essentially of a low pressure and there is no probability of such an occurrence.

Let

$I_1 =$ current in armature of G ,

$I_2 =$ current in armature of M ,

and $I =$ current supplied by source H .

Then $I_2 = I_1 + I$ and the total I^2R loss in the armature of M is

$$I_2^2R = I_1^2R + 2I_1IR + I^2R.$$

The *pressure drop* due to ohmic resistance is

$$I_2R = (I_1 + I)R = I_1R + IR.$$

The part of the power supplied the armature of M by source B is

$$I_1I_2R = I_1^2R + I_1IR.$$

The remainder of the I^2R loss in the armature of M , which is

$$I^2R + I_1IR = I(I_2R)$$

must therefore be supplied from the source H .

It is seen that each source supplies the I^2R loss it would cause independently, and that the excess I^2R loss is divided equally between them.

It will be shown later that the source H also furnishes the total stray power losses for both machines.

Let $E' =$ generated pressure of G .

Then $E' =$ counter pressure of M , since the two machines are alike, and are running at the same speed and have the same field excitation.*

$$\therefore E' = E_1 + I_1R = E_2 - I_2R,$$

where R is the resistance of the armature of either G or M .

*It is seldom that two machines have exactly the same magnetization curves, even though built alike. The essential feature is to have the same total flux in each armature. This may be assured by adjusting the fields for the same open circuit pressure with the brushes set at equal and opposite angles of lead. Correction can easily be made for any difference in field loss.

$$\therefore E_2 - E_1 = R(I_1 + I_2),$$

$$\therefore E = RI_1 + RI_2,$$

and the power supplied to both G and M by source B is

$$EI_1 = I_1^2R + I_1I_2R,$$

where E is the pressure supplied by the auxiliary source B .

That is, the entire power supplied by source B is used up in I^2R losses in the armature circuits of M and G .

The total power supplied M from G and B is

$$I_1E_2 = I_1E' + I_1I_2R.$$

But I_1E' is also the total electrical power generated in the armature of G . The factor I_1I_2R , as shown above, is the I^2R loss of armature M supplied from source B .

Therefore, the power delivered to M from G and B , *which is effective in turning the armature*, is just equal to the total converted power in G .

The total power supplied M from source H is

$$IE_2 = IE' + I_2IR.$$

The portion I_2IR has been shown to be I^2R loss. The power IE' is effective in turning the armature. Since all power has been accounted for except stray power,

$$2P_s = IE',$$

where $2P_s$ is the total stray power of machines M and G .

It is evident that the stray power must be supplied from source H when the question of torque is considered. If the source H were disconnected from the armature circuit, the current in the armatures of G and M would be the same. Since the fields are the same and the armatures are just alike, the torque in each would be

$$T = KI_1\phi = K_1I_1,$$

and there would be no rotation.

The tests will be considered in the order of Temperature, Regulation, and Efficiency.

Temperature. If the motor M is tested, its full load armature current should be known. Maintaining the terminal pressure and field of M normal, adjust the armature current to full load value by varying B . The field of G should be equal to that of M . It will generally be found that the full load speed is slightly less than the no load value, on account of the inherent regulation. After the adjustments are made the conditions should be maintained constant throughout the test.

If the generator G is under test its load should be adjusted to normal rated value at rated speed and terminal pressure. The load may be adjusted by varying the pressure of B . The speed may be adjusted by varying the pressure impressed by source H .

Regulation. For a motor test, adjust M to normal full load current and pressure and read the speed, being certain that the field is normal. Gradually reduce the load to zero, maintaining the terminal pressure and field constant, and take readings of speed for various loads.

If the generator G is under test, the load should be adjusted to normal rated value at normal speed and terminal pressure. Without regulating the generator field rheostat, the load is gradually reduced to zero and readings of terminal pressure are taken.

Efficiency. The adjustments are the same as in the regulation test, and in fact the data for the two tests may be taken at the same time. Care should be exercised, however, that the fields of the machines M and G are adjusted to the same value, or, if the magnetization currents are not alike, to the same open circuit pressures. This is of importance in the efficiency test. The calculation for efficiency follows.

If

I_2E_2 = total power delivered to armature of M ,

P_{a_1} = I^2R loss in armature of G ,

P_{a_2} = I^2R loss in armature of M ,

P_f = I^2R loss in field of either M or G ,

P_s = stray power loss in either M or G ,

P_H = power supplied by auxiliary source H ,

then

$$P_s = \frac{P_H - II_2R}{2}.$$

The efficiency of the motor M is

$$\eta = \frac{I_2E_2 - (P_{a_2} + P_s)}{I_2E_2 + P_f}.$$

If a generator is tested, I_1E_1 being the generator output, the efficiency is

$$\eta = \frac{I_1E_1}{I_1E_1 + (P_{a_1} + P_f + P_s)}.$$

Where it is impracticable to measure the I^2R losses in the armature circuit, approximate and more simple formulas may be used.

Let

P_B = power supplied by auxiliary source B ,

and

P_b = belt loss between M and G .

The loss P_b may be assumed as about 2 percent of the power transmitted if a belt is used. This may be taken as 2 percent of the intake of the motor armature. It is preferable to use a flexible coupling, in which case this loss is eliminated. Then the total power supplied the armatures of M and G is

$$P_B + P_H - P_b.$$

This may be assumed to be equally divided between the two machines. The efficiency of a motor is

$$\eta = \frac{I_2E_2 - \frac{1}{2}(P_B + P_H - P_b)}{I_2E_2 + P_f}.$$

This formula gives values which are somewhat too high, since the armature I^2R loss in M is greater than that in G .

The efficiency of a generator is

$$\eta = \frac{I_1 E_1}{I_1 E_1 + \frac{1}{2}(P_B + P_H - P_b) + P_f}.$$

This formula gives values which are somewhat too low, since the armature I^2R loss in G is less than that in M .

Data. Using two like shunt machines, make connections as in Figure 76. With the switch S_2 open and the field of G unexcited, close the switch S_1 and bring machines M and G up to speed by starting M in the usual manner. Adjust the armature pressure and the field of M to their normal values and bring the excitation of G to the same value as that of M . Adjust B so that the sum of the pressures E and E_1 equals E_2 and close switch S_2 . Adjust M to its normal full load current by raising the pressure of B , being careful that M receives normal pressure and current; also that the field of G is the same as that of M . Take readings of speed, current supplied motor armature, current from auxiliary source H , field currents of M and G , terminal pressure of M , and motor speed. Repeat the observations for decreasing loads down to no load on the motor, maintaining the terminal pressure of M and both fields constant. Measure the hot resistances of the armatures of M and G .

Caution. In order to insure safety, be certain that suitable safety devices are placed in both the supply circuit and the motor-generator circuit. Be sure that the brush leads of the two machines are equal and opposite.

Calculate. The efficiency of the motor at the various loads. Compute the percent speed regulation of the motor from the full load—no load observations.

Curves. Plot curves of regulation and efficiency of the motor, using percent load as abscissas.

Question. In what manner are the results affected by the fact that the armature currents of M and G are not equal?

No. 77. BLONDEL OPPOSITION METHOD OF TESTING DYNAMO MACHINES.

Reference. Blondel and Du Bois, Vol. 2, p. 370.

Object. In the opposition methods shown in Experiments 73, 74, 75, and 76, either the armature or the field conditions were not exactly the same in the two machines. In this method similar losses may be adjusted exactly the same if the machines are alike. It retains the advantage of economy of power.

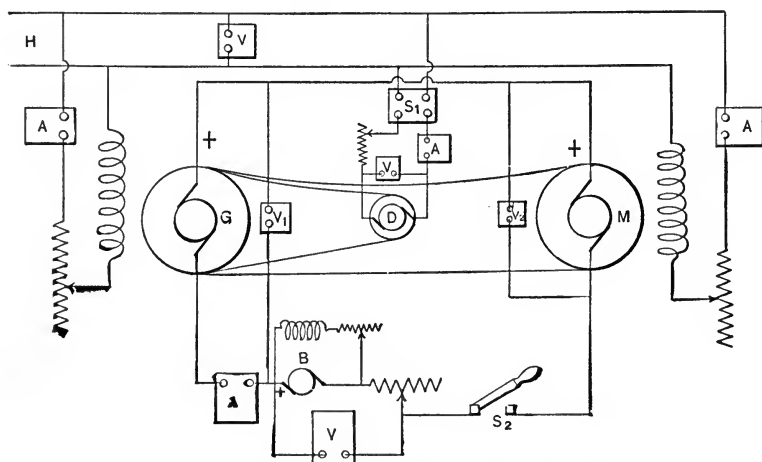

Fig. 77. Blondel Method of Testing Dynamo Machines.

Theory and Method. The arrangement is somewhat similar to that of Hutchinson, except that the stray power losses are supplied mechanically instead of electrically. The general theory will be considered from the standpoint of a generator test. In Figure 77, *G* is the generator under test and *M* is a machine like *G* in all respects. *M* and *G* are mechanically coupled. Their fields are excited from a separate source *H*, and each is adjusted to the normal excitation of the generator *G*. The armatures of *G* and *M* are electrically connected through the auxiliary source *B*, the pressure of which aids *G* in supplying the desired working

current to the armature of M . This auxiliary may be either a low voltage generator or a storage battery. In either case, it must have a current capacity equal to the full load current of the machine tested. The stray power losses of both machines are supplied by the auxiliary motor D which may be connected mechanically to either G or M , and which has been rated as in Experiment 72.

In starting, the switch S_2 is left open, S_1 is closed, and the machines M and G are brought up to speed by starting D in the usual manner. The speed being normal, the fields of G and M are excited and the switch S_2 closed, the pressure of B being low. The armature current is adjusted to the normal full load value of the *armature* of G . The speed is maintained normal by adjusting the motor D . The terminal pressure of G is made normal by adjusting its field rheostat, and the field of M is brought to the same value.

Since the fields of M and G are equal, and they are run at the same speed, the counter pressure in M is equal to the generated pressure in G , assuming like magnetization curves. If the magnetization curves are not alike the adjustment should be made for equal open circuit pressures. A correction for the unequal field currents is then easily made.

$$\text{Then } E' = E_1 + IR = E_2 - IR,$$

where

E' = generated pressure in G or M ,

I = armature current,

• R = resistance of either armature,

E_1 = terminal pressure of G ,

E_2 = terminal pressure of M .

The following relations also hold true.

$$E_1 + E = E_2,$$

$$\therefore EI = (E_2 - E_1) I,$$

where E is the added pressure and EI the added power from source B .

$$\therefore EI = 2I^2R.$$

That is, the power taken from source B supplies the I^2R losses in the armatures.

The total converted power in the armature of G is $E'I$. But this is also the total power available in the armature of M to turn it against its own stray power, the stray power of G , and the converted power in G . The result is that the motor D must supply the stray power of both machines and the belt losses incident thereto.

The tests will be considered in the order of temperature, regulation, and efficiency.

Temperature. If the generator G is under test, adjust its armature current, terminal pressure and speed to normal full load values. It should be remembered that since the shunt field is separately excited, the load current should be made greater than normal by an amount equal to the shunt current. After the adjustments have been made the conditions should be maintained constant throughout the test.

If the motor M is under test, its full load armature current should be known and the terminal pressure, armature current, and field current of M should be maintained at normal values. It will generally be found that the full load speed is slightly less than the no load value, on account of the inherent regulation of the motor.

Regulation. For a generator test the speed, terminal pressure, and armature current should be adjusted to the normal full load values. The load is then gradually reduced, the speed being kept constant, and readings of pressure are taken for various loads. The lowest reading, corresponding to open circuit, is when the current has the same value as the shunt field current.

If a motor is tested, it should be adjusted to normal full load current with normal terminal pressure and field excitation, and the speed taken. Then the load is reduced to zero, the terminal pressure and field being kept constant, and readings of speed taken at various loads.

Efficiency. The adjustments are the same as in the regulation test, and, in fact, the data for the two tests may be taken at the same time. In the efficiency test it is necessary that the field of the companion machine be adjusted to the same value as that of the machine under test, or, if the magnetization curves are not quite alike, that the open circuit pressures be made equal. The calculation for efficiency is as follows.

If

IE_1 = power delivered by generator armature,

P_l = I^2R loss in leads between G and M ,

P_b = belt loss between M and G ,

P_a = I^2R loss in either armature,

P_f = I^2R loss in either field,

P_s = stray power loss in either machine,

P_B = power supplied by B ,

P_D = power delivered by D (belt loss deducted),

then

$$P_a = \frac{P_B - P_l}{2},$$

and

$$P_s = \frac{P_D - P_b}{2}.$$

The loss P_l may generally be neglected, and the loss P_b may be assumed as about two percent of the power transmitted if a belt is used. It is preferable to use a flexible coupling, in which case P_b is eliminated.

When the generator G is under test, the efficiency is

$$\eta = \frac{IE_1 - P_f}{IE_1 + P_a + P_s},$$

since the machine ordinarily excites its own field.

When the motor M is under test, the efficiency is

$$\eta = \frac{IE_2 - P_a - P_s}{IE_2 + P_f}.$$

Data. Using two similar shunt machines, make connections as in Figure 77. With the switch S_2 open and the fields of M and G unexcited, close switch S_1 and bring M and G up to speed by starting D in the usual manner. Excite the fields of G and M equally and close the switch S_2 , being careful that the pressure of B is low and that it is connected so as to aid G in driving M . Bring the armature current of G to normal full load value by varying B . Adjust the speed of G to its normal value by means of D and adjust the terminal pressure of G to normal full load value by varying its field excitation. Bring the field of M to the same value as that of G . Take readings of speed, armature current, field current, and terminal pressure of G , and power supplied by B and D . Repeat the observations for decreasing loads down to no load on the generator, maintaining the speed and field excitation of both machines constant. Remember that no load on the generator is obtained when the armature current is equal to the field current.

Cautions. Be sure that the motor brushes have the same backward displacement as the generator brushes have forward displacement, if brush shifting is necessary.

In order to ensure safety, be certain that circuit breakers or other suitable devices are placed in both the supply circuit and the motor-generator circuit.

Calculate. The efficiency of the generator G at various loads. Compute the percent regulation from the full load—no load observations.

Curves. Plot the curves of regulation and efficiency of the generator, using percent load as abscissas.

No. 78. CONNECTION AND OPERATION OF SHUNT DYNAMOS IN PARALLEL.

References. Fisher-Hinnen, p. 93; Jackson's "Dynamos," p. 231; Thompson's "Dynamos," p. 766; Crocker, Vol. 1, p. 346;

Sheldon, p. 218; Parham and Shedd, p. 306; Crocker and Wheeler, p. 50; Houston and Kennelly, p. 222; Slingo and Brooker, p. 351.

Object. Shunt dynamos are so frequently operated in parallel in central stations for electric lighting that a study of the factors which enter into their successful parallel operation is of importance.

Theory and Method. In order that two or more dynamos shall operate successfully in parallel, their characteristics must be alike; *i. e.*, for any percent of load the pressures of the machines must have the same value. Another requisite is that the machines must be so inter-connected that at all loads the division of load is in stable equilibrium. When these two conditions are fulfilled the machines will divide the load in proportion to their capacities and there will be no "pumping" or "hunting." Figure 78A shows a method of connection using single pole switches. Machine *A* is on the bus bars and *B* is about to be thrown in

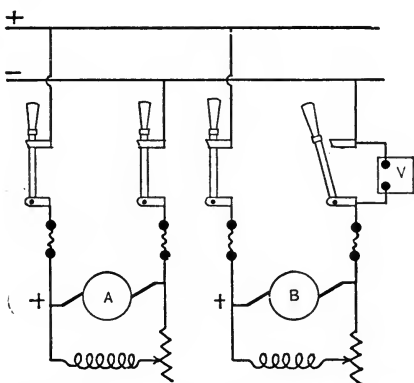

Fig. 78A. Connection of Shunt Dynamos in Parallel.

parallel. *A* and *B* are so connected that their polarities are opposed. Machine *B* is brought up to speed, the left hand switch closed, and a voltmeter is shunted around the other switch. The field of *B* is then adjusted until the voltmeter reads zero.

The two machines are now delivering the same pressure and the switch may be closed without any current flowing either into or out of *B*. If the field current of *B* is now raised, it will begin to take load, and *A* will begin to lose load. As the load is taken off *A*, its pressure will rise, due to the shape of its characteristic, and this should be kept constant by hand regulation. When the pressure of *B* has been raised until it takes its share of the load, the two machines will operate satisfactorily, providing their external characteristics are alike. It will be found necessary to adjust the field rheostat of *B* from time to time until constant temperature is attained. Assuming both machines at working temperature, stability of load division is insured on account of the form which is taken by the external characteristic of a shunt dynamo. If for any reason the load on *A* is increased, its pressure will fall and this will shift a greater proportion of the load on *B*. Assuming that the characteristics are not exactly alike, the machines may be adjusted to divide the load proportionally at full load and a slight variation in pressures at intermediate loads is permissible, the only effect being an unproportional division of load. This is no great objection so long as neither machine is overloaded. The load may always be proportionally divided, however, by field rheostat regulation.

In order to cut a machine out of circuit its field current is gradually reduced, the pressure on the other machines being maintained constant by hand regulation, until it delivers little or no current; its switch may then be opened. A dynamo should never be cut out if the total load is greater than the aggregate capacity of the other machines.

There are various methods of using a voltmeter for throwing machines in parallel. One is to use an instrument with its zero in the middle of the scale. The deflection of the needle will then indicate whether the machine is above or below the pressure of the bus bars. Another method is to use a differential voltmeter. One winding is connected permanently to the bus bars and the

other is switched in across the terminals of the generator to be paralleled. When the voltmeter reads zero, the machine is in condition to be thrown in. Figure 78B illustrates this method. The plug *P* is used for connecting the instrument to any particular generator when it is paralleled.

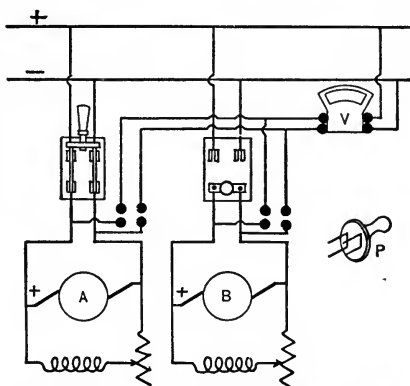

Fig. 78B. Connection of Shunt Dynamos in Parallel.

Zero methods have the inherent fault that the condition for parallelism is indicated in case of a broken circuit in the voltmeter connections, and disastrous results have followed through faults of this nature. The differential voltmeter is not likely to give trouble from this cause, however, for both circuits would have to be open at the same time. In order to avoid all chance of a false indication, a single voltmeter is frequently used, provided with a multiple point switch, so that it may be thrown on the bus bars or on any machine to be paralleled. Thus the instrument may be connected successively to the bus bars and to the oncoming generator. When both pressures read the same, the machine may be thrown in.

Data. Using dynamos of the same rating and voltage, load the first machine to about three-fourths its capacity. Bring the second machine up to the voltage of the first. Make certain of its polarity and throw it in. Maintaining the bus bar pressure

constant, gradually change the entire load from the first machine to the second; finally weaken the field of the first machine until it becomes a motor.

Adjust the external circuit and the machines so that each is at full load and without changing the rheostat of either machine, throw off the external load by increments and take readings of load current, field current, terminal pressure, and speed on each machine.

Suggestion. In order to eliminate any question of speed regulation of the prime movers, it is best to drive both generators from the same source.

Curves. Using total current as abscissas, plot curves of bus bar pressure, and of load current and field current in each machine.

Explain. Any variation in the division of load.

Question. How should the lead wires from the dynamos to the bus bars be proportioned when machines of different capacities are operated in parallel?

No. 79. CONNECTION AND OPERATION OF SERIES DYNAMOS IN PARALLEL.

References. Jackson's "Dynamos," p. 236; Crocker, Vol. 1, p. 347; Sheldon, p. 221; Thompson's "Dynamos," p. 766; Crocker and Wheeler, p. 51.

Object. While series dynamos are not connected in parallel in commercial use, a study of their action under this condition will aid in an understanding of the operation of compound machines in parallel.

Theory and Method. If series dynamos were connected in parallel by simply connecting their terminals to the bus bars, the division of load would be in unstable equilibrium over the greater part of the load range, even if the characteristics were alike.

Figure 79A represents the external characteristic of a series dynamo. If two machines were in parallel and working on any load less than that represented by the point of maximum pressure, P , any decrease in load on one machine would be accompanied by a fall in its pressure and a rise in pressure of the other machine. The first machine would almost instantly lose its entire load and would be reversed, and the second would be short-circuited at the instant of reversal. At loads beyond the point P the equilibrium would be stable.

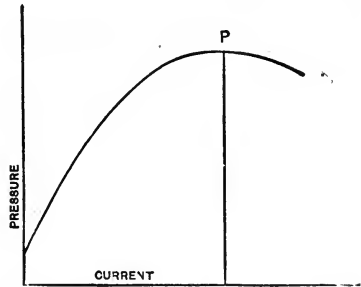

Fig. 79A. External Characteristics of a Series Dynamo.

Where two like dynamos are used, stability is insured by connecting them up for mutual excitation as in Figure 79B. Here

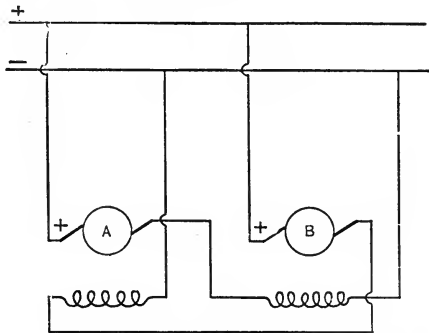

Fig. 79B. Series Dynamos in Parallel. (Mutual Excitation.)

the chief advantages of parallel operation are lost, for one machine cannot be cut out of circuit without interruption of service.

Figure 79C indicates a method of overcoming this difficulty. Here the terminals of the field next to the armatures are permanently connected electrically by a low resistance conductor called

an equalizer bar. The field windings are always left in parallel and are so designed that each dynamo is at maximum pressure when the plant is at full load.

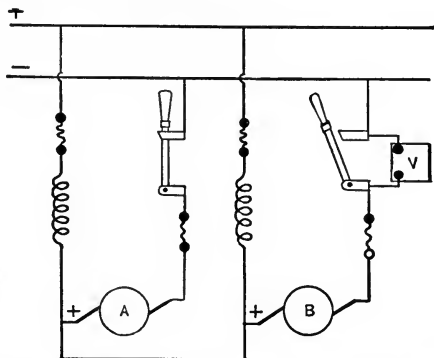

Fig. 79C. Series Dynamos in Parallel. (Equalizer Connection.)

Suppose that *A* is operating alone and that the current capacity of its armature is about to be exceeded, due to an increasing load. Machine *B* is started up and when it has reached normal speed it will be delivering the same voltage as *A* (for its field is already excited to the proper value), and its switch may be closed. Any number of dynamos may be paralleled by this method, and the only fluctuation in pressure at the bus bars will be that due to a change in armature drop. This fluctuation will be the less the greater the number of machines under load. To shut down a generator all that is necessary is to open its switch, but this should not be done unless the total load is within the aggregate rating of the other machines.

Data. Connecting two like series machines as in Figure 79C, load one up to its armature current capacity; then bring the second up to speed and parallel it. The voltmeter *V* will read zero when "speed" is obtained. Increase the load until both armatures are at rated current capacity. Take readings of total current, bus bar pressure, current in each machine and equalizer current for the entire run, being sure to catch the readings just before and after the second machine is paralleled.

Suggestion. In order to eliminate any question of speed regulation in the prime movers, it is best to drive both generators from the same source.

Caution. Throw off the load *gradually*. One machine may be cut out of the circuit when both are at half load.

Question. What would happen if the second machine were cut in with a double pole switch? If it were cut out with a double pole switch?

No. 80. CONNECTION AND OPERATION OF COMPOUND DYNAMOS IN PARALLEL.

References. Fisher-Hinnen, p. 100; Jackson's "Dynamos," p. 237; Thompson's "Dynamos," p. 767; Sheldon, p. 222; Crocker, Vol. 1, p. 348; Parham and Shedd, p. 331; Houston and Kennelly, p. 223; Crocker and Wheeler, p. 52; Slingo and Brooker, p. 354.

Object. Compound generators, operated in multiple, are used in all except the very largest electric light plants and almost exclusively in street railway and other power plants. A knowledge of the factors controlling their successful operation in parallel is therefore of importance.

Theory and Method. The compound dynamo is generally designed for a rise in pressure sufficient to make up for feeder losses. Its external characteristic in this case has an upward slope. In isolated instances, an even compounding will be found and the characteristic curve will be a nearly horizontal line. If two generators having characteristics either horizontal or sloping upward were paralleled by simply connecting together terminals of like polarity, there would be no stability of load division. By use of a low resistance equalizer E , Figure 80, the required stability is assured, just as in the case of series machines, Experiment 79.

Suppose machine A is carrying the load alone, and that this load has increased enough to demand the services of B . B is

first started up. Its equalizer switch S_e is then closed. This brings the potential of the machine to that of the positive bus bar. The switch S_1 is then closed. This excites the series field to its proper proportional amount. The shunt field current is now regulated until the voltage of B is the same as that of the bus bars. The switch S_2 may now be closed and the machine may be made to take load by increasing its pressure by means of the field rheostat. To shut down a generator the process is reversed.

There are several modifications of this method of connection.

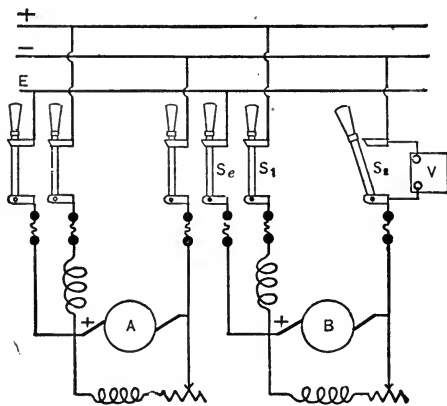

Fig. 80. Connections of Compound Dynamo in Parallel.

The most obvious is to combine switches S_e and S_1 in a double pole switch, thus reducing the number of operations by one. This method and the one shown in the diagram have the advantage that during periods of light load when a high over-compounding is not needed, some of the current may be diverted from the series coils of the active machine into those of the idle machines, thereby effecting a change in the automatic regulation.

Another modification is to combine the three switches into one triple pole switch, still further reducing the number of operations. In this case the equalizer blade is made to project beyond the other blades so as to close the equalizer circuit first. It

would be still better to graduate the three blades so that they close in the order S_2 , S_1 , S_3 . Where the triple pole switch is used, it is best to close it when the pressure is just a little below that of the bus bars, but the difference should be slight. This obviates to some extent the sudden taking of load by the oncoming machine and gives the attendant an opportunity to make adjustments and minimize the drop in the bus bar pressure.

The differential voltmeter is commonly used in paralleling compound machines. The operation is an easy one and does not require the care in adjustment of pressure that is necessary for paralleling shunt generators of close regulation.

Data. Using machines of the same rating and pressure, load one machine up to its rated capacity under normal conditions of speed and pressure. Bring the second machine up to speed and equalize it. Adjust its pressure and throw it in. By means of field adjustment on both machines, gradually shift the load from the first to the second, being careful to maintain the external circuit constant as to current and pressure. Adjust the machines and the external circuit so that each generator is under full load at rated pressure and speed. Without changing the field rheostats, throw off the total load by increments. Take readings of bus bar pressure, total current, and equalizer current, and of load current and field current for each machine during the entire run.

Suggestions. The insertion of an ammeter in the equalizer circuit is likely to introduce an appreciable resistance and furthermore, an instrument with a central zero is necessary. The equalizer current may be derived by inserting ammeters in each lead of one machine and subtracting the series coil current from the load current. If the difference is positive the other machine is receiving the equalizer current; if negative, it is received by the dynamo having the two ammeters. The added resistance of the ammeter in the lead from the series coil may or may not be negligible. If not, it will cause the equalizer current to change

from normal value. This may be compensated for by the addition of an equal resistance in the corresponding lead of the other machine.

Problem. Two dynamos are connected in parallel and it is found that they do not divide the load in proportion to their capacities. A determination of their external characteristics shows that one machine overcompounds too much. Three methods are proposed for reducing the amount of this compounding:

- (a) Shunting the series field.
- (b) Adding resistance to the leads.
- (c) Reducing the speed.

Discuss each method from every practical standpoint and tell if any are inoperative.

No. 81. CONNECTION AND OPERATION OF ARC DYNAMOS IN SERIES.

References. Jackson's "Dynamost," p. 234; Crocker, Vol. I, p. 351; Thompson's "Dynamost," p. 765; Sheldon, p. 221; Parham and Shedd, p. 246; Crocker and Wheeler, p. 59; Slingo and Brooker, p. 349.

Object. The connection of arc machines in series should be regarded as an emergency measure and not as good practice. The experiment is given merely to show how this may be successfully accomplished.

Theory and Method. Suppose that for some reason a large number of lights is demanded along the line of a series arc circuit. If the demand is a temporary one the best way to meet it is to increase the pressure on the circuit. This may be done by running two machines in series. If the two dynamos were so connected and no precautions taken, there would be a tendency on the part of the automatic regulators to act at the same time. Arc machine regulators are far from being perfect mechanisms at best, and the inevitable result would be a "hunting" or see-saw-

ing of the regulators. To obviate this, the regulator of one generator is locked in the position of maximum pressure, while that of the other is allowed to work freely.

Ordinarily, the regulator of one dynamo would be fixed in a position to deliver a pressure a little below the minimum demanded, and the two machines would be started up and shut down together, but in case the demand for high pressure is for a few hours only, on an all night circuit, it will be economical to operate the second machine during the hours of heavy load only. This requires that it be introduced into and cut out of the circuit without interruption of service.

Suppose machine *A*, Figure 81, is working, and that the demand of the load calls for a higher potential than it is able to furnish. The external circuit terminates in the spring jacks, *a*,

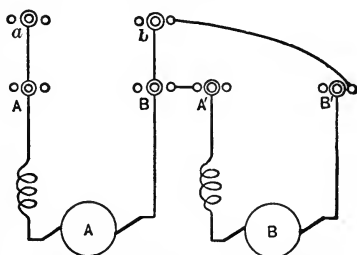

Fig. 81. Connection of Arc Dynamos in Series. }

b, of the switch board, and it is plugged up to the spring jacks, *A*, *B*, which are connected to the generator *A*. Dynamo *B*, terminating in jacks, *A'*, *B'*, may be plugged up to *b*, *B*, by means of the transfer receptacles of the jacks. *B* is now started up with its regulator in position for operation on short circuit, the regulator of machine *A* is locked in its present position and the cord connecting *b* and *B* is removed. The regulator of *A* may now be moved so as to throw a slight load on *B* and then fastened permanently in this position; when the regulator of *B* will take care of the circuit. Connections may then be made over the circuit *BA'B'b* to the regular receptacles, and the transfer plugs removed.

To take a machine out of circuit, the reverse process is followed.

Data. Load up an arc machine to nearly full load. Connect a second machine as in Figure 81 and set the regulators as

described. Remove the jumper and lock the regulator of the first machine in such a position that a slight load is transferred to the other. Increase the total load until both machines are at full load. Take readings of current and of the voltage delivered at the terminals of each machine. Throw off the load gradually, cutting out the added machine at the proper time.

No. 82. CONNECTION AND OPERATION OF TWO DYNAMOS ON A THREE WIRE SYSTEM.

References. Crocker, Vol. 1, p. 352; Crocker, Vol. 2, p. 71; Houston and Kennelly, p. 221; Fisher-Hinnen, p. 104; Abbott, p. 425; Crocker and Wheeler, p. 61; Slingo and Brooker, p. 703.

Object. The three wire system is used almost exclusively in the business districts of large cities, and to some extent in isolated plants. It is desirable to study the factors that affect regulation in this system.

Theory and Method. Figure 82A represents a three wire system. *A* and *B* are the two dynamos connected in series. These machines are connected to a three wire line terminating in a center of distribution, *D*. These three wires are called feeders and the center wire is called the neutral. The resistance of each outside feeder is represented by R and that of the neutral by $2R$, the latter being usually half the cross-section of an outside feeder. The receiving devices are so distributed in a system of this kind that the currents are nearly equal and the amount of copper required in the line is then much less than that required for a two wire system of the pressure of either dynamo. In this case it is only 31.25 percent based on equal energy loss for a balanced system. If the system is balanced there will be no neutral current; if not, a current will flow in the neutral wire equal to the excess of current in one side over that in the other, and it will have a direction to or from the station according as the positive machine or the negative machine is carrying the

greater load. So long as the system is balanced the pressures E_A and E_B will each equal half the total E_{AB} providing the two dynamos have like external characteristics. If one is loaded more than another there will be a difference in the two pressures

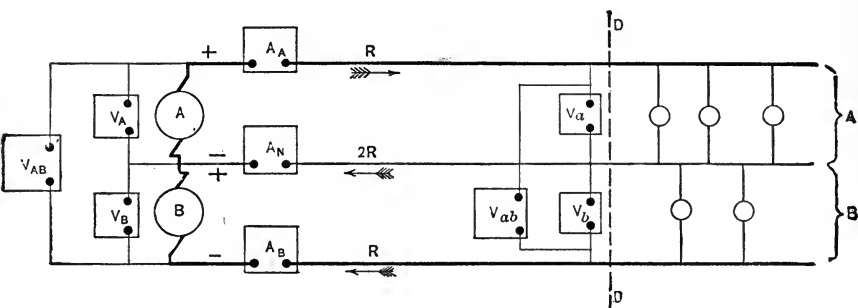

Fig. 82A. Connections for Test of Two Dynamos Operated on a Three-Wire System.

unless each dynamo has a straight characteristic parallel to the X axis.

To investigate the effect of the line resistance in determining the regulation at D ,

Let

$$I_A = \text{current on } A \text{ side.}$$

$$I_B = \text{current on } B \text{ side.}$$

$$I_N = I_A \sim I_B = \text{neutral current.}$$

$$E_\alpha = \text{pressure on } A \text{ side at } D.$$

$$E_\beta = \text{pressure on } B \text{ side at } D.$$

Assume the condition $I_A > I_B$.

$$\text{Then } E_\alpha = E_A - I_A R - 2I_N R.$$

$$E_\beta = E_B - I_B R + 2I_N R.$$

This is shown graphically in Figure 82B, where e_α , e_β and e_n are the resistance drops in the A , B and neutral wires. Not only are unequal drops subtracted from the two sides but the neutral drop is in series with the pressure of one side and in opposition to that of the other, thus causing a difference from the normal regulation equal to twice its value. For this reason all variable

loads such as motor loads should be connected across the outer wires where the line effect will be the same on both sides of the system. Any slow changes of load can be taken care of by hand regulation of the separate machines. Pressure wires are usually run from the distribution centers to the station.

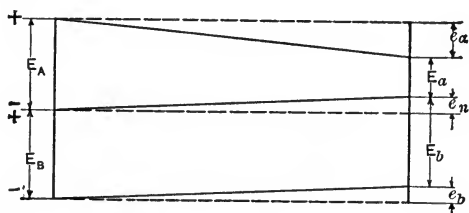

Fig. 82B. Effect of Line Resistance on Pressure Regulation in a Three Wire System.

In showing these effects experimentally two like machines should be used. It is preferable to drive them from the same prime mover. They may be either shunt or compound wound. An artificial line may be made of coils of german silver or iron wire. The line drop may be obtained by calculation or preferably by measuring the drop for each line with a low reading voltmeter.

Data. Obtain E_A , E_B , E_{AB} , E_a , E_b , E_{ab} , e_a , e_b , e_n , I_A , I_B , and I_N , under the following conditions:

1. From full load to no load with the two sides balanced, and starting with E_{AB} normal.
2. Starting with balanced full load, decrease load on A side to zero, maintaining I_B constant.
3. With zero load on A side and full load current on B side, decrease I_B to zero.
4. Starting with full load I_A and half load I_B , decrease I_A to zero, maintaining I_B constant.
5. Take a current I_{AB} from the outer wires equal to half load current. Start with full load current on the A side and reduce I_{AB} to zero, maintaining the current due to the load on the A side at a constant value equal to half load current.

Caution. Under each condition maintain the adjustments of the field rheostats constant and the same as that of condition I.

Curves. Plot curves for E_A , E_B , E_{AB} , E_a , E_b , E_{ab} , e_a , e_b , and e_n , using the following currents as abscissas:

Case (1) $I_A (= I_B)$.

“ (2) I_A .

“ (3) I_B .

“ (4) I_A .

“ (5) I_{AB} .

Calculate. The percent regulation at the center of distribution and at the station end of the line for each side of the line and for the total pressure, for each condition.

No. 83. REGULATION TEST OF A THREE-WIRE DYNAMO.

References. Fisher-Hinnen, p. 250; Crocker, vol. 2, p. 74; Alexander Rothert, *Elek. Tech. Zeit.*, vol. 18, 1897, p. 230; Alexander Rothert, *Elec. World*, vol. 28, 1896, p. 569; Sheldon, p. 212; Abbott, p. 430.

Object. The advantages of a three-wire generator, in place of two dynamos connected to a three-wire system, are obvious. As the vital point in the operation of a system of this kind is regulation, this is the first test to be made before selecting a three-wire machine.

Theory and Method. A common form of three-wire dynamo is illustrated in Figure 83A. The distinctive feature of this machine is that its armature has two equal windings connected in series, the neutral wire of the line being connected to the lead joining the two armature windings. This machine regulates somewhat better than two shunt dynamos without hand regulation. So far as the pressures at the dynamo are concerned, the armature reaction due to a load on one side affects the pres-

tures on both sides equally, so that the only unbalancing of pressures is that due to the difference in armature IR drops. A generator of this type may be compounded, and the most convenient arrangement of the series coils is to place half the coils in each leg of the circuit and to mount them on alternate poles.

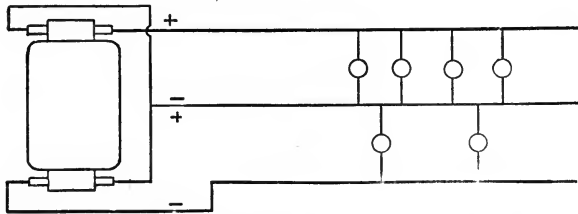

Fig. 83A. Three-Wire Dynamo with Two Commutators.

Its principal disadvantage is that it does not automatically regulate for a balance of pressures and there is no means of independently regulating them by hand.

Figure 83B illustrates a system which was originally suggested by Müller, and improved by Kingdon, Dettmar and Rothert.

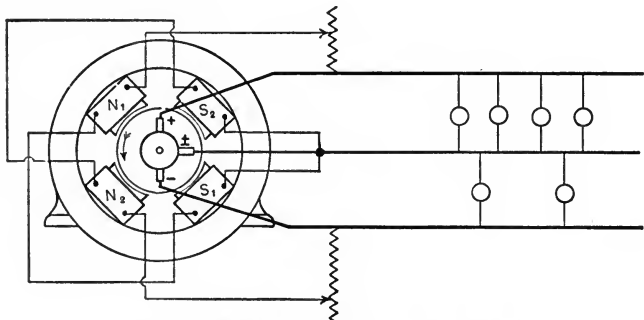

Fig. 83B. Dettmar and Rothert Three-Wire Dynamo.

Here the machine is virtually a two-pole dynamo, although there are four polar projections. The armature has a two-pole winding. The portions of the field ring between unlike poles must be large enough to accommodate the entire magnetic flux of a pair of poles, and the radial depth of the armature must be twice

as large as it would be if the machine were operated as a four-pole dynamo. Except for structural reasons and appearance sake, the portions of the field ring between like poles might be omitted entirely. The neutral brush is, in this case, located between the south poles S_1 and S_2 . It could be placed between the poles N_1 , and N_2 ; but brushes should not be placed at both positions and connected together. The neutral current should never be large enough in practice to demand more than the one brush. If the poles N_1N_2 and S_1S_2 were merged into two solid poles, a neutral placed at either position would spark viciously; the separation gives the effect of a large notched pole and the commutation takes place in a field of practically zero value.

On a balanced load, the armature reaction would produce an enfeeblement of the poles N_1S_1 (leading tips), and a reinforcement of the poles N_2S_2 (trailing tips); the pressure on the positive side would rise and that on the negative side would fall. An excess of current on the positive side would tend to demagnetize the poles N_1S_1 , causing the pressure on the negative side to fall. An excess of current on the negative side would tend to strengthen the poles N_2S_2 , causing the pressure on the positive side to rise. The regulation may be accomplished by exciting the poles N_2S_2 from the negative side and the poles N_1S_1 from the positive side of the three-wire circuit, and inserting variable resistances in each circuit as shown in the figure.

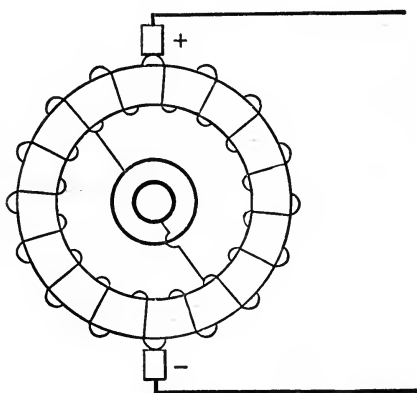

Fig. 83C. Armature Connections of Dobrowolsky Three-Wire Dynamo.

This system is applicable to multipolar dynamos of more than four poles, but unless the number of pairs of poles is an *even*

number, the yoke and armature cross-sections become excessive. One disadvantage of this machine is its excessive weight.

The design illustrated in Figures 83C and 83D is due to Dobrowolsky. These figures indicate a two-pole construction. Points in the armature winding 180 electrical degrees apart are tapped by conductors leading to collector rings. An impedance coil having an iron core is connected to the collector rings by means of brushes. This coil is of low resistance but its counter e. m. f. of self-induction is so great that the alternating current supplied from the collector rings is of a small value, and very little power

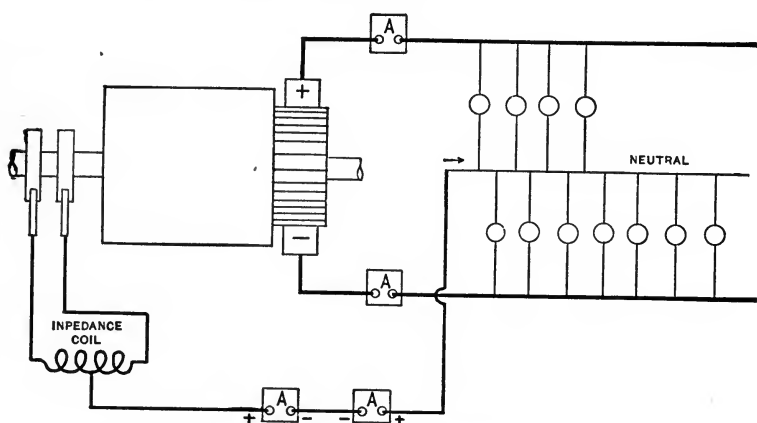

Fig. 83D. General Connections of the Dobrowolsky Three-Wire System.

is lost due to this current. A point midway between the terminals of this coil will normally be at a potential which is midway between those of the two brushes on the commutator. A wire may be connected to this point, and the receivers connected between this wire and either of the mains, thus forming a three-wire system. Any excess of current on one side over that on the other will be carried by means of the neutral wire and the impedance coil, and will be properly distributed within the winding. While the impedance coil prevents an excessive alternating current, it permits a direct current to flow unretarded. Independent regulation of the pressures on the two sides of the system cannot

be effected with the connections as shown, though there are modifications which will permit it. This generator, like the double commutator machine, may be compounded by placing the alternate series coils in opposite legs of the circuit.

In a large system, independent regulation is not so vital as in a small one, for the feeders may be arranged with double-throw switches and a balance obtained by shifting the feeders from one side to the other, as the occasion or the season of the year demands. There are also special methods, using auxiliary machines, such as motor-compensators, whereby the pressures on the two sides may be regulated automatically.

Data. Observe the three pressures delivered by a three-wire dynamo and the currents in the three leads under the following conditions:

1. From full load to no load balanced condition.
2. Starting with balanced full load, gradually decrease the load on one side to zero.
3. Starting with full load on one side and no load on the other, decrease the load on the first side to zero.

Curves. Using pressures as ordinates, plot curves of the three pressures against the following currents as abscissas:

- Case (1) load current.
- (2) current on variable side.
- (3) current on variable side.

Compare. These results with similar curves obtained in Experiment 82. Describe the machine used and account for any differences in the curves.

Diagrams. Draw a diagram of a six-pole three-wire dynamo of the Dettmar-Rothert type, showing the magnetic paths. Do the same for an eight-pole machine with a two-pole armature winding and for an eight-pole machine with a four-pole armature winding.

Question. How would you connect a compound winding on a machine of the Dettmar-Rothert type?

No. 84. EXPERIMENTAL ILLUSTRATION OF THE ACTION OF A BOOSTER.

References. Sheldon, p. 216; Crocker, Vol. 2, p. 67; Houston and Kennelly, p. 322; Lyndon, p. 244.

Object. As boosters are used in large central stations both in light and in power work, a study of their action is of importance.

Theory and Method. In central stations it is frequently found necessary to supply the longest feeders with a higher pressure than that supplied the shorter ones in order to make up for the loss of pressure in the feeders themselves. When this is the case, use is often made of a so-called booster or compensator, placed in series with the feeder whose pressure is to be raised. This is a generator wound for comparatively low pressure and high current, which is driven at constant speed either by a motor or by an engine.

In large lighting stations it is customary to operate several sets of bus bars at different pressures, a separate booster being employed in the mains leading to the auxiliary bus bars. The boosters are not generally made automatic, since hand regulation is preferred. The booster fields are excited from the main bus bars and the feeder pressure is regulated by varying the field excitation of the booster.

In railway work, where the load fluctuates rapidly between wide limits, and exact regulation is not essential, the booster is made automatic in its action. This is accomplished by using a series wound booster, its terminal pressure being approximately equal to the loss in the line. If the compensation is correct for maximum load, it will be high for intermediate loads, due to the fact that the external characteristic of the booster is a line concave to the X axis.

For the experimental illustration, a series dynamo may be operated as an automatic booster on a variable load. A constant pressure generator should be used as the main source of

pressure and a resistance should be inserted between the booster and the variable load to serve as the long feeder.

Data. Make connections as shown in Figure 84, where G is a constant pressure generator, B is a series dynamo used as a booster, R is a fixed resistance which serves in place of the long feeder and L is the variable load. The booster is driven by a motor whose speed may be readily adjusted. Place the

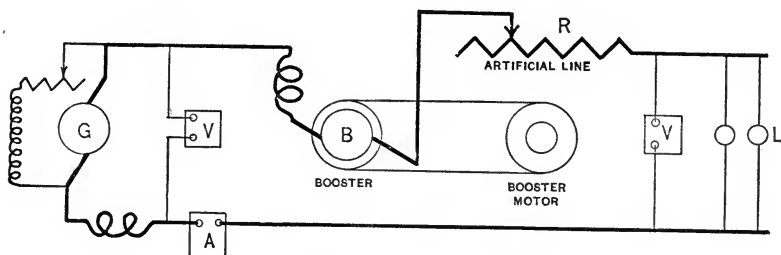

Fig. 84. Connections for Illustration of Booster Action.

maximum load on the machines and bring the pressure at the load equal to that at G by adjusting the speed of B and the resistance R . Take readings of current, pressure at L , pressure at G , and speed of B . Maintaining the speed of B , the resistance of R , and the terminal pressure of G constant, gradually reduce the load to zero and take readings of the pressure at L for various currents.

Curves. Plot a curve showing the variation of pressure at L with the load, using current as abscissas.

Questions. Under what conditions might it be advisable to use B as a "crusher" instead of a "booster"? How could a "crusher" be made to operate?

No. 85. EXPERIMENTAL ILLUSTRATION OF THE OPERATION OF A MOTOR WHOSE FIELD IS SUPPLIED BY ARMATURE REACTION.

Object. The desire here is to investigate a peculiar phenomenon rather than to show any practical application.

Theory and Method. It is often possible to operate a motor without field excitation. This is especially true when the armature reactive effect is comparatively large, as in the case of an arc machine.

If the fields are unexcited and a pressure is impressed upon the armature the latter will begin to rotate if the brushes are displaced somewhat from the neutral position. The direction of rotation is the same as that of brush displacement. This action is due to the field set up by the armature current.

In some cases it is possible, after the armature has been started to rotate, to shift the brushes to, or even slightly back of, the neutral plane, without reversing the direction of rotation. If the brushes are shifted still farther back, the armature reverses its direction of rotation.

Data. Select a machine with large armature reactions. Leaving the field unexcited, and with the brushes in the neutral position, impress a low pressure upon the armature, taking care that the permissible maximum armature current is not exceeded. Shift the brushes from the neutral plane to the point where the armature begins to rotate. Advance them still further and note the results. Shift the brushes back slowly to the point where the armature will just continue to rotate in the same direction as before. Shift them back of this point and allow the armature to speed up in the reverse direction. Again shift the brushes to the point where the armature just continues to rotate without reversal. Note such data as may seem useful in explaining the action.

Explain. The action observed and draw diagrams showing the conditions as they exist at the various stages.

No. 86. LOCATION OF FAULTS IN ARMATURES.

References. C. E. Gifford, *Transactions A. I. E. E.*, Vol. 12, 1895, p. 260; C. D. Parkhurst, *Transactions A. I. E. E.*, Vol. 11, 1894, Appendix.

Object. It is necessary to localize a fault in an armature winding before repairs are attempted; otherwise the cost of repairing will be excessive.

Theory and Method. This subject has been worked up most elaborately, but only the more general methods, such as are applicable in the repair shop, will be given here.

Grounds. A ground is easily located by connecting one pole of a battery to the shaft of the machine; the other, through an ammeter, to a commutator segment. This end is moved from segment to segment until the ammeter reads a maximum; the ground will be on one of the coils connected directly to that segment. The right coil may be selected by testing on adjacent segments.

If it is desired to use a commercial circuit as a source in this test, a resistance must be connected in series with the fault, and the method will then lack sensitiveness. To obviate this difficulty, a low reading voltmeter may be used to measure the drop around the fault, which may then be located by a comparison of resistances.

Short Circuits. To locate a short-circuited coil, a current is sent through the armature by means of the brushes and a low reading voltmeter is connected to two adjacent segments. This connection is best made by means of two pilot brushes a fixed distance apart, which may be revolved around the commutator, thus testing the pressure between each segment and its neighbors. If the "short" is a bad one, the voltmeter will read low across the two segments that are connected with the faulty coil.

Another method is to use a telephone receiver or a galvanometer instead of the voltmeter and to break the main circuit for each setting of the auxiliary brushes. The intensity of the click in the receiver, or the range of the throw of the galvanometer, will indicate the location of the short.

Another method which possesses the advantage of rapidity is to use an alternating current circuit. with the same connections,

the telephone receiver being used as the detector. In applying this, the armature should be mounted on a couple of horses and should not be close to masses of iron. The short-circuited coil will be indicated by a diminution of sound.

A rapid method for use in factories is to mount the armature in an alternating field furnished by a coil of wire wound around a laminated core that is bored to fit the armature. By turning the armature slowly, the coil which is short-circuited may be brought into the field and the heavy alternating current induced in this coil will cause it to heat and smoke sufficiently to enable the fault to be localized.

Open Circuit. To locate an open circuit a low pressure is impressed on the brushes and a voltmeter capable of reading this pressure is bridged across adjacent segments. The voltmeter will read zero across any pair of segments in the path of the fault except the two between which the fault lies. Here it will read the impressed pressure. It will read the drop across coils, between segments in any path that is intact. If there are two or more open circuits in one path the voltmeter may read zero at all points. This may be obviated by bridging several segments, by turning the armature slowly, or by attaching one terminal of the voltmeter to one of the main brushes and gradually moving the other terminal toward the other main brush.

The galvanometer or the telephone with the make and break connection may also be employed, the maximum throw or the loudest click being heard when the fault is bridged.

The telephone and the alternating current may also be used, and maximum sound will occur when the fault is bridged.

Suggestion. Where a number of armatures of the same size are tested, as in factories or in a street railway repair shop, jigs may be made for holding the auxiliary brushes and a saving of time effected.

Data. Take an armature having at least one ground, one short circuit, and one open circuit, the exact locations of which

are known to the instructor. It is preferable to use a machine having its segments numbered. Locate the faults by any convenient methods that will not destroy the armature or permanently mark the several locations.

No. 87. EFFICIENCY AND REGULATION OF A MOTOR-GENERATOR.

References. Crocker, Vol. 2, p. 95; Sheldon, p. 215; Abbott, p. 431.

Object. To study the distinguishing characteristics of this useful piece of machinery.

Theory and Method. A motor-generator consists of two distinct machines, an electric motor and a generator, that are mechanically connected. The machines are usually direct connected, but they may be belted or geared in any convenient manner. They may rest on a common base or possess other mechanical features in common, but the essential feature is that they be electrically independent and have independent magnetic circuits.

Motor-generators are used to transform electrical power of one kind into electrical power of another kind. They may transform from one pressure to another, from constant pressure to constant current, or the reverse; from alternating current to direct; from alternating current of one frequency or pressure to alternating current of another frequency or pressure; and so on. These machines find application in numerous ways. They are used for electrolytic work, in this case usually transforming a common power or lighting pressure at a moderate current into a lower pressure and a higher current. In multiple wire systems they are used as balancers, compensators, or equalizers as they are variously termed. A motor driven booster is a motor-generator. A common application is the transformation from alternating current to constant direct current.

The efficiency of a motor-generator is the relation of the generator output to the motor intake. The simplest way to find its curve is to measure these two quantities directly for various loads, the conditions such as pressure, or frequency of the motor being maintained normal. This method has the disadvantages common to all direct methods; as the total quantities are measured, an instrumental error, or an error in the reading of an instrument, enters directly into the ratio.

The stray power method, therefore, is advised. If both machines of the set are of the direct current type, the efficiency curve of each machine may be obtained as in Experiment 68, and their curves plotted. In computing the efficiency of the unit, it should be borne in mind that the power required to supply the generator losses is furnished by the motor and must come through the motor at a loss in that machine. This also applies to any losses in the mechanical connection. A simple method of computation is to plot the *combined* losses against the generator output. The efficiency at any output will then be that output divided by the same quantity plus the combined losses. A modification that is more convenient for reference is obtained by plotting the efficiency curves of each machine against generator output, as abscissas. The combined efficiency at any load is then the product of simultaneous ordinates of the curves at this particular load. Any losses in the mechanical connections should in this case be charged to one of the machines.

The regulation of the unit involves the regulation of both machines, the speed regulation of the motor and the pressure or current regulation of the generator, depending on whether it is a constant pressure or a constant current machine. It is usually sufficient to measure the regulation directly, the motor being supplied with power at normal conditions. In case the unit is large and it is desired to economize power, the regulation curve may be computed from no load measurements, but the process is long and intricate and lacks accuracy. In case two units of the same kind are available, the generators may be opposed and the motors

opposed and the losses made up electrically or mechanically by a modification of one of the opposition methods, Experiments 73, 74, 75, 76, and 77. The units should be alike in all respects for the efficiency test but they need not be for the regulation test.

In order to carry out a test of this kind a mechanical connection between the units is necessary. This may often be provided by using a pulley to act, for the time being, as a coupling for each unit.

Where the regulation or heat run only is desired, each half of the unit may be opposed to a standard machine. In this case it is necessary either to couple direct to the standard machine or to provide the machine under test with a pulley. This same arrangement may be used for the efficiency measurement by the direct method.

Data. Measure the efficiency and regulation of a direct current motor-generator for various loads from zero to 25 percent overload by the direct method, using volt-ampere readings, the conditions of the supply circuit being normal for all loads.

Measure all the losses as in the stray power method, for various loads, and also measure the resistances. Separate the losses as far as possible in the time at your disposal.

Caution. If the unit is not at normal temperature make such corrections for the temperature effects as have been suggested in previous experiments on regulation and efficiency. It should be borne in mind, however, that accurate corrections are difficult, perhaps impossible, to make, and the machine should be at its operating temperature when great accuracy is desired.

Calculate. The efficiency of the unit for various loads from the direct readings and from the stray power measurements. Also the percent regulation from the full-load no-load readings.

Curves. Plot an efficiency curve of the unit for each method of measurement, both curves being plotted to a common set of axes. Plot a curve, using efficiency by direct measurement as

ordinates and efficiency by the stray power method as abscissas, and mark the points along this curve, of 25, 50, 75, 100, and 125 percent load. Plot a regulation curve of the unit.

Question. What factors determine the selection of the speed of a motor-generator?

No. 88. EFFICIENCY AND REGULATION OF A DYNAMOTOR.

References. Sheldon, p. 208; Crocker, Vol. 1, p. 94; Wiener, p. 452.

Object. To study the distinguishing characteristics of this useful piece of machinery.

Theory and Method. A dynamotor is a dynamo-electric machine used as a transformer of power, having but one magnetic field and two armatures or two armature windings on the same core. The latter construction is the common one.

Dynamotors are used for the same purposes as motor-generators, but their field of application is more limited as is evident from a consideration of the fact that both armature windings are mounted in the same field. Independence of regulation of the two generated pressures is not obtainable and there is not nearly the flexibility of application. They are, therefore, used more as balancers, or compensators on multiple wire systems, and to perform similar automatic functions. In small sizes they have application as telephone ringers and the like. While the field of usefulness is limited in comparison with that of the motor-generator, the dynamotor has several distinct advantages.

The single field structure is by no means twice the size of the field structure of one machine of a motor-generator of the same capacity and speed. This means a saving in weight and a saving in field I^2R loss. The armature windings are practically of the same cross-section as they would be in two independent machines, so that the size of armature required is the same as that of a machine of double the output. Comparing this with the

two independent machines, the armature will not be twice the weight of one of the independent armatures, and the core loss will therefore be less than the core loss of a motor-generator. The friction will also be less on account of the decreased weight. It will furthermore be reduced because but two bearings are necessary, while the motor-generator is usually constructed with from three to four, the result being a more or less imperfect alignment. The dynamotor therefore is not only more efficient but is cheaper to construct.

Another advantage lies in the relative magnitude of armature reactions. In the motor-generator each armature has the usual reactions. In the dynamotor current enters the motor end against the generated pressure, and leaves the generator end with the generated pressure. The ampere-turns of the motor end exceed those of the generator end by an amount equal to the current necessary to supply the stray power, multiplied by the number of turns on the motor armature winding. This excess is all there is of armature reaction, because the armature ampere-turns are of opposite sign in the two windings. A dynamotor is therefore capable of withstanding a greater overload without sparking than a motor-generator of the same capacity and similar characteristics of design.

The efficiency of a dynamotor is the relation of the output divided by its intake. Its curve may be found by measuring these two quantities electrically for various conditions of load and plotting their ratio against the load.

A more accurate method, however, is the stray power method, Experiment 68. In this case the loss should be plotted against the output current, and in computing the armature I^2R losses it should be borne in mind that the following relations hold.

$$E_g = \text{generated pressure in generator winding} - \text{drop in generator armature circuit,}$$

$$E_m = K \times \text{generated pressure in generator} + \text{drop in motor armature circuit,}$$

$$I_g = \frac{\text{output}}{E_g},$$

$$I_m = \frac{\text{output} + \text{stray power} + \text{armature } I^2R \text{ losses}}{E_m},$$

where

E_g = pressure at generator terminals,

E_m = impressed pressure,

I_g = generator armature current,

I_m = motor armature current,

K = ratio of motor turns to generator turns.

This assumes that the field is excited from the motor end. If excited from the generator end, the field watts should be added to the numerators of the two above equations for the calculation of armature currents. This method of excitation is seldom used because some special means of starting must be provided, so as to magnetize the field before the armature current is turned on.

The regulation of a dynamotor is practically dependent on but one factor, the IR losses in the armature windings. Armature reaction is negligible. The ratio of transformation is therefore nearly constant, and the only effect that could be obtained by compounding would be a change in speed, with change of load. The regulation curve may be obtained by taking the pressure at the generator terminals for various loads, the motor pressure being maintained normal. If the brush drops and armature IR losses are known, the regulation curve may be computed with a fair degree of accuracy.

When conditions are such as to require an economy of power in the testing of a dynamotor, a modification of the opposition methods of Experiments 73, 74, 75, 76, and 77 may be used. The two armature windings may be opposed to standard machines and the losses made up mechanically or electrically. The absence of a pulley on the dynamotor is no serious drawback except in efficiency measurements. Even here the direct measurements may be used; but to apply the opposition method, two

like dynamotors with special extended shafts for pulleys would have to be used. There are few cases which would warrant the necessary expense.

Data. Measure the efficiency and regulation of a dynamotor by the direct method, using volt-ampere readings at each end, and for a range of load from zero to 25 percent overload, the pressure at the motor terminals being maintained constant.

Measure all the losses as in the stray power method, for various loads, and also measure the resistance. Separate the losses as far as possible in the time at your disposal.

Caution. If the machine is not at normal temperature, make such corrections as have been suggested in previous experiments on regulation and efficiency. Normal temperature should be the condition if accuracy is of great importance, as in an acceptance test.

Calculate. The efficiency of the machine for various loads from the direct readings and from the stray power measurements. Calculate the percent regulation from the full load and no load readings.

Curves. Plot an efficiency curve of the machine for each method of measurement, the two curves being drawn to the same axes. Plot a curve, using efficiency by direct measurement as ordinates and efficiency by the stray power method as abscissas; mark the points, along this curve, of 25, 50, 75, 100, and 125 percent load. Plot a regulation curve.

Questions. This machine has been written up from the standpoint of a constant pressure system. Could a dynamotor be designed to deliver and receive constant currents, and if so, how would it start, take load, etc.?

How is a dynamotor applied to the multiple voltage systems of power distribution?

**No. 89. RELATION OF SPEED TO EXCITATION IN
A SHUNT OR SEPARATELY EXCITED MOTOR,
WHEN THE RESISTANCE DROP IN THE
ARMATURE CIRCUIT IS GREATER THAN
THE COUNTER PRESSURE.**

Object. In this experiment it is desired to become familiar with a relation which has a practical bearing on the action of the Thomson integrating wattmeter, which is considered in Experiment 90.

Theory and Method. Under ordinary conditions of operation, a motor develops a counter pressure which is nearly equal to the impressed pressure. For example, consider a 5 horse-power, 110 volt shunt motor running at normal speed and at full load. The resistance in the armature circuit will probably not exceed 0.25 ohms, and the current supplied the armature would probably not be greater than 40 amperes. The counter pressure would then be

$$e = 110 - (40 \times 0.25) = 100 \text{ volts.}$$

Assume the speed of this machine to remain unchanged and that the magnetism is decreased ten percent. The counter pressure would then fall to 90 volts and the armature current would be

$$I_a = \frac{110 - 90}{0.25} = 80 \text{ amperes.}$$

That is, a decrease of magnetism of ten percent has increased the armature current one hundred percent. But the impelling torque, which is proportional to the product of the magnetism and the armature current, has been increased to one hundred and eighty percent of its first value, and the armature will speed up.

Consider the same motor with a total resistance of 2.5 ohms in the armature circuit, and connected to a 110 volt pressure source. Suppose also that the machine has the same field as

before and that the armature current necessary to run the machine with the given load is again 40 amperes. Then the counter pressure is

$$e = 110 - (40 \times 2.5) = 10 \text{ volts.}$$

Assume again that the speed of the machine remains unchanged, and that the magnetism is decreased ten percent. The counter pressure would then fall to nine volts and the armature current would be

$$I_a = \frac{110 - 9}{2.5} = 40.4 \text{ amperes.}$$

That is, a *decrease* of magnetism of ten percent has *increased* the armature current one percent. But the impelling torque, which is proportional to the product of the magnetism and the armature current, has been *decreased* to 90.9 percent of its first value, and the armature will *fall off* in speed.

If the counter pressure becomes so small that it may be neglected in comparison with the resistance drop, it is evident from the above discussion that the impelling torque will vary *directly with the magnetism*, increasing as the field is made stronger.

Again, if the motor has no iron in its magnetic circuit, the impelling torque will *increase* in direct proportion to the *increase* in field current. The Thomson meter, described in Experiment 90, is such a motor.

Data. Run a shunt wound motor with normal voltage at the armature terminals and load it so that the armature takes approximately its full load current. Vary the field excitation over a considerable range, taking simultaneous readings of field current and speed.

Insert a high resistance in the armature circuit and take a similar set of observations of field excitation and speed, varying the former over the same range as before. The machine should be loaded as before so that its armature receives approximately full load current.

Curves. Plot curves of speed against field excitation, using the latter as abscissas.

No. 90. CALIBRATION OF A THOMSON INTEGRATING WATTMETER.

References. Houston and Kennelly, p. 313; Sheldon, p. 182; Jackson's "Electricity and Magnetism," p. 202; Abbott, p. 217; Trade Bulletins.

Object. The object is to become familiar with the Thomson wattmeter and to determine its accuracy throughout its working range.

Theory and Method. An integrating wattmeter sums up the energy supplied to a circuit in a given time, its indications generally being in watt hours. The Thomson instrument consists essentially of a small motor whose armature speed is directly proportional to the power supplied the metered circuit at any instant, and a revolution counter. The total number of revolutions in a given time is proportional to the total watt hours supplied to the circuit in that time, provided the instrument is properly adjusted.

The speed of the rotating part at any instant must be proportional to the number of watts supplied at that instant. The rotation must then be due to the combined effect of the current and pressure of the metered circuit. In the Thomson meter the rotation is due to the combined effect of two coils, one of which is the pressure coil; the other, the current coil. The rotating part, or armature, is the pressure coil and it is placed in series with a high non-inductive resistance and connected directly across the circuit, Figure 90A.

This armature rotates in the field set up by the series coil, and the instrument is in reality a small commutating motor. The counter-pressure set up by the armature is negligible with respect to the IR drop in the pressure circuit. The current in the pres-

sure coil circuit is therefore directly proportional to the impressed pressure. As there is no iron in the magnetic circuit, the field set up by the current coil is directly proportional to the current in the metered circuit.

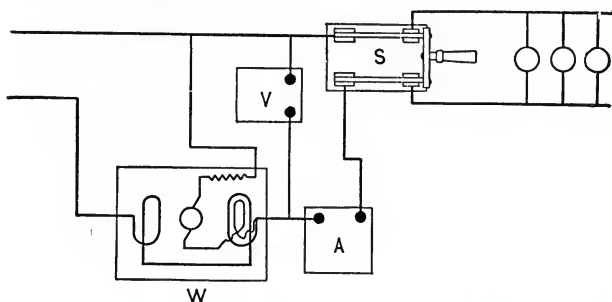

Fig. 90A. Connections for Calibration of a Thomson Integrating Wattmeter.

The impelling torque is

$$T = KS\phi i,$$

where K is a constant,

S is the number of armature conductors,

ϕ is the magnetism threading the armature,

and i is the armature current.

In this case, if the impressed pressure remains constant, the formula reduces to

$$T = K_1\phi = K_2I,$$

where K_1 and K_2 are constants, and I is the load current.

This relation is shown by Curve A, Figure 90B.

Although friction is eliminated as far as practicable, it is not a negligible quantity, and must be compensated for if accuracy is

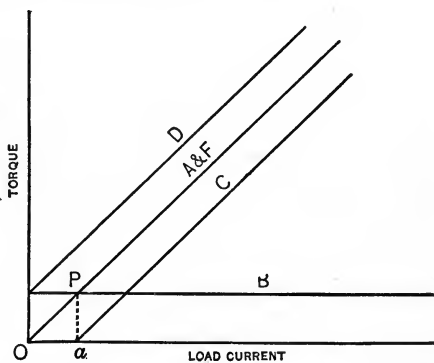

Fig. 90B. Relation of Torque and Current in Thomson Wattmeter.

desired. This is accomplished in the Thomson meter by means of a small coil connected in series with the armature circuit, and placed within one of the main field coils.

The torque necessary to overcome friction is constant and is represented by Curve *B* in Figure 90B. If no compensation for friction were made, the armature would not begin to rotate until the impelling torque, due to load current, equalled the friction

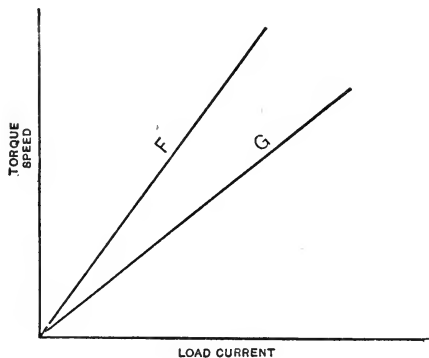

Fig. 90C. Variation of Torque and Speed with Load Current in Thomson Wattmeter.

torque. This is the torque due to the load current Oa in the figure and curve *C* represents the torque available for driving the retarding device. If the auxiliary field coil has just sufficient effect to balance the friction torque, the meter will be upon the point of starting with zero load current. Curve *D* represents the total impelling torque when the compensating coil is used and Curve *F* (which is the same as Curve *A*) represents the impelling torque after that necessary to overcome friction has been deducted. Curve *F* is also shown in Figure 90C.

Since the speed of a motor rises to the point where the impelling torque is just equal to the resisting torque, it becomes necessary to provide a retarding torque proportional to the speed. The speed then becomes proportional to the load current, provided the pressure is constant and that friction may be neglected.

The retarding device consists of a copper or aluminum disc, mounted on the armature shaft, and revolving between the poles of permanent magnets. By this arrangement eddy currents are set up in the disc when it is revolved. These eddy currents are directly proportional to the speed, since the resistances of their paths are constant, and the pressures tending to set them up vary with the speed because the magnetism is constant. But the retarding torque of these eddy currents is

$$T_e = K_3 I_e = K_4 V,$$

where K_3 and K_4 are constants,

I_e represents the eddy currents,

and V represents the speed of the disc.

In Figure 90C, Curve F represents the impelling torque available for driving the disc against eddy currents. Since this is a straight line passing through the origin, and since the speed of the disc rises to the point where the impelling and retarding torques balance, the speed is shown by the formula

$$V = \frac{T_e}{K_4},$$

and will be represented by curve G , which is also a straight line passing through the origin. It is thus seen that if the line pressure remains constant, the speed of the meter armature will vary directly with the load current.

If the impressed pressure varies, the current in the armature is changed in direct proportion and the impelling torque, for a given load current, is directly proportional to the impressed pressure. Therefore, the speed of the meter armature varies directly with the watts supplied to the measured circuit.

Many Thomson wattmeters have a constant by which the dial reading must be multiplied to obtain the correct reading. To calibrate the instrument, first determine how many revolutions of the disc are necessary to record one watt hour on

the dial. If each revolution records one watt hour and the constant of the instrument is 2, each revolution of the disc should represent two watt hours of energy supplied to the circuit. To calibrate the instrument it is only necessary to measure the power supplied to the circuit for a certain length of time, and to count the number of revolutions of the disc.

Data. Make connections as shown in Figure 90A. Keep the load pressure constant and take a series of observations, varying the load from zero to 50 percent beyond the normal full load current of the meter. One observation should be made at the lowest current at which the armature will revolve uniformly. Also observe the load current which will start the armature. Take the time required for ten revolutions of the disc in each case, using a stop watch.

Calculate. The constant of the meter for each load. Calculate the percent error, at each load, in using the maker's constant instead of the constant as determined experimentally.

Curves. Plot a curve showing the constant for various loads, using load as abscissas. Plot a curve showing the percent error, for various loads, if the maker's constant is used.

No. 91. TESTS OF FUSES.

References. C. P. Matthews, *Transactions A. I. E. E.*, Vol. 10, 1893, p. 251; D. C. Jackson and R. J. Ochsner, *Transactions A. I. E. E.*, Vol. 11, 1894, p. 430; W. E. Harrington, *Transactions A. I. E. E.*, Vol. 12, 1895, p. 226; W. M. Stine, H. E. Gaytes and C. E. Freeman, *Transactions A. I. E. E.*, Vol. 12, 1895, p. 546; Joseph Sachs, *Transactions A. I. E. E.*, Vol. 17, 1900, p. 131; Crocker, Vol. 2, p. 387; Underwriters' Rules; Abbott, p. 299; Sheldon, p. 10; Jackson's "Electricity and Magnetism," p. 398; Slingo and Brooker, p. 725; Parham and Shedd, p. 518; Trade Bulletins.

Object. To study the action of fuses under various conditions of operation.

Theory and Method. It is not the intention here to consider the many varieties of fuses which are now on the market, but rather to study the general effect of some of the factors which enter into the practical operation of the fuse. This may best be done by experimenting with fuse wire, and supplementing this with tests on fuse links and other forms of fuses.

The action of a fuse depends upon a rise in its temperature due to the current. A rise in temperature occurs when the heat energy supplied to the fuse in a given time is greater than the heat energy conducted and radiated from the fuse in the same interval.

Since the rise in temperature to the point of fusion is an integrated effect, the blowing of a fuse is not instantaneous. With given conditions as to conduction and radiation, a fuse will blow

more quickly as the fusing current is increased. The relation between fusing current and time is shown in Figure 91A. For the portion of the curve between *A* and *B*, a considerable change in the fusing current makes but a small difference in the time which it takes for the fuse to act, while between *B* and *C* a

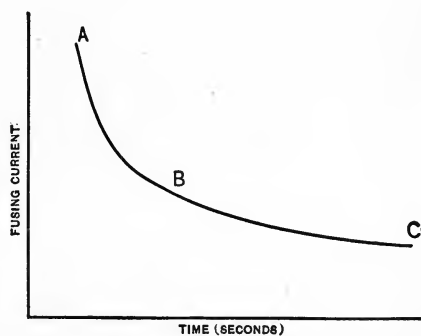

Fig. 91A. Relation of Fusing Current to Time of Fusing.

slight difference in the fusing current makes a considerable difference in time. The curve becomes practically horizontal at the point *C*, and the ordinate at this point is the lowest current which will cause the fuse to blow.

Instead of being an objection, this time element is generally an advantage, as the object of the fuse is to protect wiring or apparatus, and currents which are only momentarily excessive are not generally dangerous. When they are prolonged suffi-

ciently to cause heating in the protected circuit, the fuse acts and opens the circuit before damage is done. In some instances it is desirable to open the circuit more nearly instantaneously. The fuse should then be replaced by some other form of circuit interrupter in which the time element is reduced to a minimum.

Fuses are generally rated at about 80 percent of the lowest fusing current; that is, about 80 percent of the current at the point *C* in Figure 91A. This is in accordance with the requirements of the Rules of the National Board of Fire Underwriters. A fuse is expected to carry a current equal to its rating for an indefinite time, but it should blow in a few seconds if the current is increased to 25 percent above normal; for excessive currents, it should blow in a much shorter time.

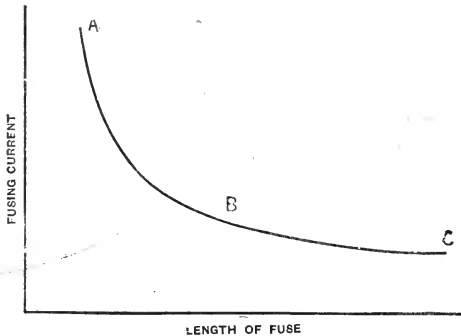

Fig. 91B. Relation of Fusing Current to Length of Fuse.

The effect of conduction is shown by the relation between length of fuse and fusing current, contacts and radiating effects being constant. This relation is represented in Figure 91B. For lengths between *A* and *B*, the fusing current rises rapidly for the shorter fuses, due to the heat being more readily conducted back to the terminals; whereas, as the fuse is lengthened, the heat from the central portion is not thus dissipated, and a lower fusing current results. After a certain length is reached (point *B*, Figure 91B) the fusing current is practically constant for increasing lengths. Fuses should always be rated for lengths corre-

sponding to the portion, *BC*, of the curve. The shorter lengths give unreliable values of fusing current, depending largely on the size and shape of the fuse block terminal.

Fixed conditions as to length of fuse, size and shape of terminals, and protection from air currents materially improve the uniformity of results obtained and consequently the reliability of the fuse.

The first two conditions are met by the ordinary fuse link, and the third one by using a covered fuse block. The Edison plug cut-out meets all three conditions.

Another type is the "inclosed" fuse, in which the fuse is placed in some oxidizing material which fills more or less of the inclosing tube. On melting, the fuse is changed to a non-conducting oxide and the arc is suppressed. In some forms a vent is provided and the arc blown out by the expanding gases, while in others the fuse is closely surrounded and a choking action results.

The "inclosed" fuse has the additional advantage that a fuse closely surrounded with solid material has an increased capacity for heat. It thus requires a little longer to reach the fusing point and momentarily excess currents, which produce no excessive thermal effects, do not cause the fuse to blow.

Data. Using a given size of fuse wire, and the same fuse block, make tests as follows:

1. With a given length between terminals, pass through the fuse a current equal to about three-fourths of its rated capacity and continue this until the maximum temperature is reached. Repeat the operation at a slightly increased current. Continue the operation until the fuse blows.
2. Make tests similar to test (1) for various lengths of the same fuse.
3. Make tests similar to tests (1) and (2), using various sizes of fuse wire.
4. Using a given size and length of fuse wire, apply the rated current for three minutes. Then raise the current immediately

to the desired value and observe the time elapsing before the fuse blows. Make similar tests for various other fusing currents.

5. Make tests similar to (4) for various sizes of fuse wire.

Caution. It may be found advisable to use different fuse blocks for various sizes of fuse wire, but the same fuse block should be used for all the tests on any one size.

Suggestions. Fuse links, fuse plugs, and other special forms of fuses have a given length and, hence, tests (1), (2), and (3) are not applicable. Tests (4) and (5) may be made, however, and other tests may suggest themselves to the experimenter.

If "inclosed" fuses are tested, investigate thoroughly the manner in which they are built up. If any riveted or soldered joints are present, measure their resistances by the fall of potential method, using a milli-voltmeter.

Curves. Plot curves showing the variation of fusing current with length of fuse. Plot curves showing the time required for the fuse to blow with a given fusing current. Use fusing current as ordinates in both cases.

No. 92. TESTS OF DIRECT CURRENT CIRCUIT BREAKERS.

References. Crocker, Vol. 1, p. 412; Jackson's "Alternating Currents," p. 135; Abbott, p. 120; Crocker, Vol. 2, p. 389; Jackson's "Electricity and Magnetism," p. 398; Parham and Shedd, p. 518.

Object. To study the construction and action of circuit breakers.

Discussion. A circuit breaker is an automatic switch which may be adjusted to open the circuit in which it is placed at predetermined values of current, pressure, or watts in the circuit. The most common form is the one which interrupts its circuit at a definite value of current, and it is used in place of a

fuse. The circuit breaker has an advantage here, in that it may readily and quickly be closed on "going out." There is no long time element in its action, as in the case of a simple fuse, and this is of great value on circuits subject to violent short-circuits.

A circuit breaker of this type consists essentially of a switch held closed against a spring by means of a trigger which is operated by a blow from the plunger of a solenoid connected in series with the load. The mechanism is usually adjustable over a range of from 75 to 150 percent of its rating, and the adjustment is generally effected by means of a small spring or weight attached to the plunger of the solenoid.

Circuit breakers are generally connected to lines having loads of considerable self-inductance and an interruption of such a circuit is always accompanied by destructive arcing unless preventive measures are taken. To this end the circuit breaker is often provided with auxiliary carbon contacts. When the catch is released, the main switch jaws are opened but the circuit remains closed through the carbon contacts for some time thereafter, and the energy of self-induction is given time to die down before a complete rupture occurs.

Another form of circuit breaker is provided with a magnetic blow out. By this arrangement, the break occurs in a strong magnetic field and the interaction of this field and the current blows out the arc.

Circuit breakers of the above class are almost universally used in installations involving compound generators. The electric railway is an example of this class of installation. Circuit breakers are placed in the power house to protect the individual machines and the feeders, and are installed on the cars to protect the motors.

Aside from the above class, there are underload circuit breakers, which open at a predetermined minimum of current; potential circuit breakers, which operate at a definite voltage, or at no voltage on the line; reverse current circuit breakers, used in connection with series wound boosters, to prevent the latter from run-

ning in a reversed direction should they be accidentally overpowered and become motors; and circuit breakers with reverse current relays, used in connection with alternating currents, which operate when power comes in over a line in a direction not intended. Any of these types may be provided with a timing device which can be set so that the circuit is not opened until a definite interval after the emergency has occurred. The time element circuit breaker is used extensively in connection with large transmission systems. A bad short circuit on a comparatively unimportant branch might throw a large number of circuit breakers on the system. To avoid this, the time element is made least in these circuits and is increased in the breakers that are nearer the generating station. As an example, a single consumer might have a circuit breaker that operated practically instantaneously, the substation, a breaker that opened after a lapse of one second, and the central station, one that acted after a period of two seconds.

Data. Using a circuit breaker of the overload current type, calibrate it over its entire range of adjustment, using an ammeter to indicate the operating current. Set the circuit breaker for definite currents, as 60, 70, 80, etc., as indicated by its scale.

Having made an adjustment, note in a general way the time between the closing of the switch controlling the load and the opening of the circuit breaker. Make analogous tests on at least one other type of circuit breaker.

Curve. Plot a calibration curve from the above data.

Explain. The operation of the circuit breakers tested, using sketches of the working parts.

No. 93. STUDY OF CONSTANT PRESSURE ARC LAMPS.

References. Crocker, Vol. 2, p. 336; Slings and Brooker, p. 600; Jackson's "Electricity and Magnetism," p. 273; Trade Bulletins.

Object. To obtain a knowledge of the general principles of arc lamp mechanisms and to experimentally study the action of one or more lamps designed to operate on a constant pressure circuit.

Theory and Method. A complete study of an arc lamp would involve investigations concerning the arc itself, tests of arc carbons, etc. Such investigations belong properly to research work and photometry and are beyond the scope of the present experiment.

When direct current arc lamps are operated upon a constant pressure circuit, it is almost invariably a 110 volt or a 220 volt circuit used for incandescent lighting.

The open arc requires a pressure of about 45 volts and two such lamps are operated in series on a 110 volt circuit, a resistance being placed in series with them. This resistance is not only necessary to take care of the excess pressure and prevent short circuits, but also to produce good regulation, as the resistance of the arc varies inversely with the current. Inclosed lamps are now commonly used upon constant pressure circuits and are designed to be placed directly across the 110 or 220 volt mains, a small regulating resistance being placed in series with each lamp. The current taken by constant pressure open arcs is generally about 12 amperes. Inclosed arcs take from 2 to 6 amperes on constant pressure circuits, depending upon the wattage and terminal pressure.

Arc lamps are generally rated commercially according to current, terminal pressure, and watts supplied, and not as to candle power. The lamp mechanism has to perform the following general functions:

1. To strike the arc; first bringing the carbons together if separated.
2. To bring the carbons together as they are consumed.
3. To maintain the power consumption at the arc constant.
4. When the current is cut off, to leave the lamp in condition to be placed in operation again.

Data. Examine one or more types of direct current constant pressure lamps, both open and inclosed arc, and make diagrams of the windings and connections. Operate the lamps at normal terminal pressure, and take readings of the current and also the pressure at the arc. Vary the terminal pressure from 25 percent below normal to 25 percent above normal and take a series of readings of current, terminal pressure, and pressure at the arc. Note the action of the arc and that of the lamp mechanism throughout the experiment.

Explain. The action of the mechanism of each lamp tested. Show by an example how a resistance in series will aid the regulation of an arc lamp operated on a constant pressure circuit.

No. 94. STUDY OF CONSTANT CURRENT ARC LAMPS.

References. Crocker, Vol. 2, p. 336; Slingo and Brooker, p. 600; Jackson's "Electricity and Magnetism," p. 273; Trade Bulletins.

Object. To obtain a knowledge of the general principles of arc lamp mechanisms and to experimentally study the action of one or more lamps designed to operate on a constant current circuit.

Theory and Method. The direct constant current system is used for street arc lighting. Open arcs, taking 50 volts per lamp with the current constant at 6.6 or 9.6 amperes, have been largely used. The tendency at present is to use 6 ampere inclosed arcs supplied either from direct or alternating circuits, the pressure being about 75 volts at the lamp terminals and the power supplied about 450 watts.

The general characteristics of the arc and mechanisms employed are similar to those of constant pressure lamps. Some features of the mechanism are different because of the difference in the two systems. A short-circuiting mechanism is always pro-

vided, which cuts the lamp out of circuit if it does not operate properly. This is necessary in order to insure the proper working of the remaining lamps of the circuit. In double carbon open arc lamps, a change-over mechanism brings the second pair of carbons into action when the first pair has burned away.

Data. Examine several types of direct constant current arc lamps, both open and inclosed, and make diagrams of the windings and connections. Run the lamp on a constant current circuit and study the action of the mechanism. Test the regulation of the lamp by taking a series of readings of terminal pressure, current, and volts at the arc. In testing an open arc lamp these readings should be taken at intervals of 10 or 15 seconds over a period of 5 minutes or more. In the test of an inclosed arc, the readings may be taken at less frequent intervals and over a larger period of time. Note the action of the arc and that of the lamp mechanism throughout the experiment. If practicable, vary the current from 25 percent below normal to 25 percent above normal and take a series of readings of current, terminal pressure, and pressure at the arc.

Curves. Plot readings of terminal pressure, current, and pressure at the arc, using time as abscissas.

Explain. The action of the mechanism of each lamp tested.

No. 95. TEST OF A TRACTIVE ELECTRO-MAGNET.

References. E. R. Carichoff, *Elec. World*, Vol. 23, 1894, pp. 113 and 212; C. T. Hutchinson, *Elec. World*, Vol. 23, 1894, p. 242; W. E. Goldsborough, *Elec. World and Eng.*, Vol. 36, 1900, p. 125; E. B. Clark, *Am. Elec.*, Vol. 12, 1900, p. 558; Lamar Lyndon, *Elec. World and Eng.*, Vol. 36, 1900, p. 422; Thompson's "Lectures," p. 98.

Object. To investigate the characteristics of tractive electro-magnets.

Theory and Method. Tractive electro-magnets are used in so many ways that no attempt will be made to enumerate the applications nor the forms best suited for any specific duty.

Suppose the armature of an electro-magnet is at a distance from the poles and that a current is supplied to the exciting coil. The number of lines of force set up may be calculated by the laws of the magnetic circuit, but the degree of accuracy depends largely on the form of this circuit. Suppose that the magnetic circuit is of such a form that the number of lines of force entering the armature from one pole of the magnet is evenly distributed and that the density is, say \mathfrak{B}_1 and that the number leaving the armature for the other pole of the magnet is also evenly distributed and of density \mathfrak{B}_2 . Let the areas of magnetization of this armature be A_1 and A_2 . Then the forces of attraction, in dynes, F_1 and F_2 , will be:

$$F_1 = \frac{\mathfrak{B}_1^2 A_1}{8\pi}, \quad F_2 = \frac{\mathfrak{B}_2^2 A_2}{8\pi}.$$

If the densities \mathfrak{B}_1 and \mathfrak{B}_2 are not constant over the surfaces,

$$F_1 = \int \frac{\mathfrak{B}_1^2 dA_1}{8\pi}, \quad F_2 = \int \frac{\mathfrak{B}_2^2 dA_2}{8\pi}.$$

If F_1 and F_2 are parallel and in the same direction, the total attraction will be their arithmetical sum; if not, it will be their vector sum.

As the armature moves toward the magnet the number of lines of force increases and the resultant attraction increases. This is greatest when the armature has reached the limit of its travel. As the number of lines of force increases a counter pressure is set up in the exciting coil and the current decreases. After the armature reaches the limit of its travel, there will no longer be a change going on in the induction, due to a change in reluctance, and the current will rise to its normal value,

$$I = \frac{E}{R},$$

along the curve of a logarithmic spiral; and the flux will also rise to its maximum value.

If the excitation be left on, and the armature be pulled away, the decrease in flux will set up a pressure in the direction of the excitation and produce a momentary increase in current.

The total work done upon the armature while it is being attracted is equal to the mean pull multiplied by the distance of travel, and is represented by the equation

$$W = F_m d,$$

where F_m is the mean pull, and d the distance.

F_m may not be the arithmetical mean.

Unless restrained, the armature will move with an accelerating velocity and some of this work will be transformed into kinetic energy which will be dissipated at the instant of impact, in the form of heat. In this case,

$$F_m d = Fd + \frac{Mv^2}{2},$$

where F is the initial pull, M the mass of the armature and v the velocity just before it is stopped.

If the armature be pulled away to the original distance, work $F_m d$ must be done against the magnet. This is dissipated in the iron of the magnet core and in the armature, in the form of hysteresis and eddy currents, and in the exciting circuit in the form of an induced current.

Where the magnet is used merely to lift a dead weight, the useful work, for a given excitation, is equal to the initial pull into the distance, Fd . It has been shown by Carichoff that, neglecting magnetic leakage, this work is a maximum when the ratio of the rate of change of the flux in iron to the rate of change of the magnetizing force producing it, is equal to the permeance of the air gap. Another way of expressing this condition is to say that the tangent to the magnetization curve at the point at which the iron is being worked, should be parallel to the magnetization curve of the air gap drawn to the same scale; or,

$$\frac{d\phi}{d\mathcal{F}} = \frac{\phi}{\mathcal{F}_a}$$

where ϕ is the flux, \mathcal{F} the magneto-motive force necessary to produce it in the iron alone, and \mathcal{F}_a the magneto-motive force necessary to produce it in the air alone.

If the magnet is used, say, to oscillate a pendulum, the useful work will be $F_m d$.

If used to actuate a magnetic hammer, the attraction being in the direction of the blow, the useful work will be,

$$\frac{Mv^2}{2}.$$

In either of the two latter cases, the useful work will be a maximum, for a given excitation, when the armature is placed

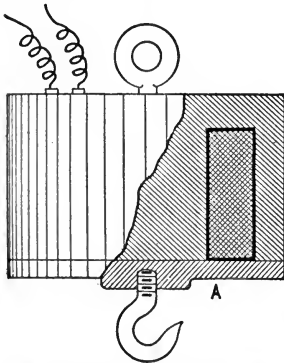

Fig. 95A. Shop Form of Portative Magnet.

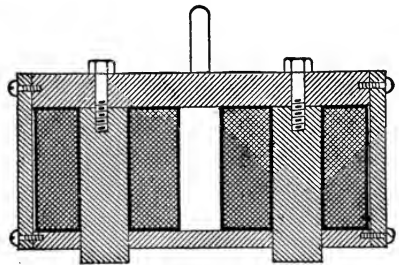

Fig. 95B. Rolling Mill Form of Portative Magnet (end view).

at the greatest initial distance from the magnet at which its friction of rest will be overcome.

Figure 95A shows a form of lifting, or portative magnet, often used in shops. This magnet is suspended from a crane and is used for lifting iron instead of the usual chain and hook. In testing the lifting power of such a magnet, it may be provided with an armature *A* which should be regarded as a part of the load. Figures 95B and 95C illustrate a form of portative magnet often used for lifting large plates in rolling mills. The poles in this form are arranged so that adjacent poles are unlike. The side

and bottom protective plates are of brass. This form is said to possess an advantage in that a large flexible plate is less likely to peel off as it is lifted.

Data. Using various excitations, test the lifting power of a portative magnet by adding load to the armature until it is released. The armature should be blocked so that it will not fall far. Take readings of exciting current, voltage across the excit-

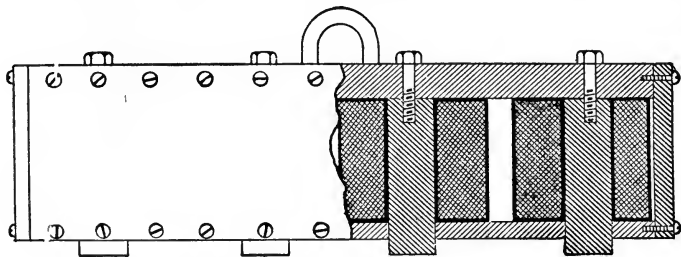

Fig. 95C. Rolling Mill Form of Portative Magnet (side view).

ing coil and releasing weight, including the weight of the armature. Weigh the magnet and obtain the number of turns on the exciting coil.

Test a magnet, designed for lifting its armature through a distance, for the armature position for maximum work; *i. e.*, placing the armature at fixed distances, determine the maximum weight, including the weight on the armature, that the magnet will lift. Do this for a number of different excitations. Take readings of exciting current, volts, total weight lifted and of air gap. Weigh the magnet alone and obtain the number of turns on the exciting coil.

Calculate. In the first magnet, the maximum number of pounds lifted per watt of excitation and also the maximum number of pounds lifted per pound of magnet, for each excitation.

Calculate, in the second magnet, the maximum work in foot pounds, based on initial pull, for each position and for each excitation. Calculate the watts for each maximum lift.

Curves. For the first magnet, plot curves of maximum load, watts, watts per pound of load and load per pound of magnet, using exciting current as abscissas.

For the second magnet, plot curves of work, watts, watts per pound of load and load per pound of magnet for each excitation, using lengths of air gap as abscissas. Using exciting current as abscissas, plot curves of maximum work, minimum watts per foot pound of work and minimum pounds of magnet per foot pound of work.

Suggestion. The most accurate means possible should be used for measuring the air gap. In interpreting the results of any of the above tests, it should be remembered that temperature may limit the operation of the magnet to a lower working efficiency than a short test would indicate.

Questions. Two armatures are provided for an electro-magnet. They are of the same size and shape. One is of cast steel and one of cast iron. On which will the greater pull be exerted, the air gap and the exciting current being the same?

Would you expect the difference to be great in a well designed magnet?

No. 96. TEST OF A STORAGE CELL.

References. Lyndon, p. 177; Treadwell, pp. 109 and 221; Crocker, Vol. I, p. 364; W. W. Griscom, *Transactions A. I. E. E.*, Vol. II, 1894, p. 302.

Object. To test the efficiency of a storage cell and to study its general action under conditions of charging and discharging.

Theory and Method. Storage cells are so directly related to dynamo machinery in commercial applications that some general tests of them are advisable in connection with a dynamo laboratory course. A complete study of their theory and operation falls within the province of electro-chemistry.

Lead cells employing oxides or chlorides have been most generally used, although other types, such as the iron-nickel element,

have been introduced. In a lead cell, the total e. m. f. is about 2 volts, varying from 1.8 volts to 2.4 volts, depending upon the type of cell and the conditions of charge, etc. The ampere-hour capacity depends upon the actual area of lead surface in electrical contact with the active material. The active material is the spongy lead in the negative and lead peroxide in the positive when fully charged, and when discharged it is the above materials changed into the "reversible" lead sulphate.

In general, the rating is such that normal full load current will completely charge the cell in 8 hours, starting with the cell in a discharged condition; and the rated maximum current is that which will completely charge the cell in 5 hours under similar conditions. The relations hold for both charging and discharging currents, although they are greatly exceeded in some of the more recent cells which have been designed for special service.

If a new cell is tested, care should be taken that the electrolyte has the correct specific gravity and a high degree of purity. Sulphuric acid with a specific gravity of about 1.2 is most generally used. In preparing the electrolyte, the acid should be poured into the water and not the water into the acid. A new cell should be charged and discharged several times before an efficiency test is made.

There are two general tests which should be applied to storage cells; the efficiency test, by means of charge and discharge runs; and a capacity test, to determine the proper rating of the cell.

In making an efficiency test, the principal data to be obtained are the impressed pressure, current, and time; both for charge and discharge. Other desirable data are the open circuit e. m. f. and the specific gravity of the electrolyte, taken at frequent intervals during charge and discharge.

The e. m. f. of the cell gradually rises as it becomes charged; varying from about 1.8 volts when discharged to about 2.4 volts when fully charged. The specific gravity also increases with the charge, varying from about 1.18 at discharge to about 1.23 when the cell is fully charged.

The e. m. f. falls off gradually until the cell is discharged down to the lowest desirable point, when the pressure is about 1.8 volts. If the discharge is continued beyond this point the pressure falls off rapidly.

The impressed pressure is the e. m. f. of the cell plus the internal IR drop when charging; while on discharging it is equal to the e.m.f. of the cell minus the internal resistance drop.

The ratio

$$\frac{\text{ampere-hours discharge}}{\text{ampere-hours charge}}$$

is the ampere-hour efficiency and is generally termed the "current" efficiency of the cell.

The energy efficiency must show the relation between the energy delivered by, and the energy supplied to, the cell. This is shown by the formula

$$\eta = \frac{\text{watt-hours discharge}}{\text{watt-hours charge}},$$

and is sometimes called the "watt" efficiency of the cell.

A test of the capacity or proper rating of a cell depends upon the conditions under which it is to operate. For given conditions, the proper rating of a cell would be indicated by the point beyond which it would not pay to continue charging. If both charging and discharging currents are given, the proper rating is determined by making a series of efficiency tests covering different periods of time of charge. If such data are not given, the tests should cover various charging and discharging currents as well. These tests of capacity should take into consideration any tendency toward buckling, sulphating or disintegration.

Data. Select one or more cells which have been in use for some time. If such are not at hand, set up the new cells according to the manufacturer's specifications, and charge and discharge them several times before making the efficiency tests.

Charge the cells at constant current, taking readings of terminal pressure, current, and specific gravity at half hour intervals. Discharge the cells under similar conditions. If no specified rate of charge and discharge is given, adjust the charging current so that the charge will be complete in 8 hours. The discharge current should be the same as the charging current unless otherwise specified. The charge should be begun at an open circuit voltage of about 1.8 and a specific gravity of about 1.18 and continued until the cell voltage is about 2.4. The cells should be discharged to the original open circuit pressure. Note should be made of the action of the cell in general.

Calculate. The "current" and "watt" efficiencies of the cells.

Curves. Plot curves showing the variation of terminal pressures, current, and specific gravity of the cells with charge and discharge, using time as abscissas.



APPENDIX A.

SHOP TESTS.

In the commercial testing of direct current dynamo machinery, the following points should be considered:

1. Mechanical strength.
2. Temperature.
3. Commutation.
4. Regulation.
5. Efficiency.

Mechanical Strength. Dynamo design is now so well understood that but little trouble is experienced by the failure of a machine as a mechanical structure. Numerous accidents occur, however, due to defective parts or to faulty assembling of these parts. The fact that a design is mechanically correct does not speak for its execution and too much stress cannot be laid on the testing and inspection of a machine, mechanically. Many serious accidents follow from imperfections so slight as to escape attention or to seem trivial. A thorough scrutiny is therefore imperative. Familiarity with the particular make of machine under test is a great help, but close observation and the application of "common sense" often find defects that experience alone may overlook.

No rules will be laid down for the entire mechanical inspection, further than those stated in other parts of these instructions. In general, it should be seen that bolts and nuts are tight, that no parts are assembled in a manner likely to work loose or to rattle, that the alignment is good, that such moving parts as brush holders and brush holder rigs turn freely and that leads, especially those of shunt motor fields, be protected from injury. Special attention should be given to vibration during operation, as this is a source of endless trouble. If the machine have rotating

parts of high peripheral velocity, a test above speed should be made. A motor field circuit may be accidentally opened, or the governor of a prime mover may refuse to act at a critical moment, and the machine should be able to stand acceleration while the attendant is opening a switch or spinning a valve to its seat. In cases where a "runaway" is at all probable, a machine should successfully withstand an increase in speed of from fifty to seventy-five percent.

Humming of the armature and screeching of the brushes, while not necessarily injurious, should be regarded as serious defects; customers will not tolerate noise.

Insulation is a mechanical and a chemical rather than an electrical problem. Megohms are of little value in determining the life of insulation and in the present state of the art about the only test of value for a completed machine is the high voltage or "puncture" test.

Temperature. Temperature is the greatest factor in the determination of the life of dynamo machines. Cotton insulation is used almost universally. It is inflammable and its scorching point determines the temperature limit. In the American Institute Standardization Report* this limit is taken at 50° C. above a room temperature of 25° C., because it has been proved by years of experience that this rise is safe. A machine may be operated somewhat above this limit without any immediate injury, but if the excessive temperature is maintained day after day the insulation is liable to fail, due to a gradual carbonization of the cotton, resulting in a general short circuit. Again, excessive temperature causes an undue increase in the losses of molecular friction, *aging*, as it is called.

A purely mechanical effect is the weakening of a structure due to the frequent expansion and contraction of its parts. Intermittent heating and cooling may weaken a commutator, loosen a bolt, or chafe insulation. A hot-box may result from bad alignment, grit, or unsymmetrical magnetic pull.

* Appendix B.

Except scorching of the insulation, all of the above defects may, by proper design and careful execution, be prevented from becoming serious even at a higher temperature than standard. The Institute limit for commutators is fixed at 55° C. rise, largely because of the conduction of heat from the commutator to the armature conductors. The introduction of a cheap, fire-proof insulation would effect a great stride in the weight-efficiency of dynamo machines.

Experiment 65 treats of the temperature test.

Commutation. Commutation is a vital factor in the choice of a dynamo or motor. Without good commutation, the expense of maintenance becomes excessive, for the commutator will require frequent truing and, finally, complete renewal. Brushes will be used up at an alarming rate, and excessive heating goes hand in hand with excessive sparking. Conduction of heat from the commutator may burn out the armature or the latter may be short-circuited by the commutator "spilling over."

In the early history of the dynamo, the laws of commutation were not understood, and the best machine built was one in which sparkless operation could be obtained only by shifting the brushes, to accommodate the load. This sufficed at one time but present practice requires that standard generators operate on loads varying from zero to twenty-five percent overload and standard motors to fifty percent overload, without shifting the brushes.

Experiment 4 gives instructions for the setting of brushes, and Experiment 48, for conducting a sparking test.

Regulation. Good inherent regulation is a refinement of modern engineering. It was made necessary by improvement in receiving devices, such as high efficiency incandescent lamps; by the demand for constant speed motors; and by the centralization of power supply, requiring the operation of large units in parallel.

Poor regulation is always noticed by power consumers, and it is to the interests of manufacturers and station men alike to eliminate sources of public complaint.

Experiments 27, 28, 29, 30, 31, 35, 37, 38, 39, 40, 56, 59, 61, 62, 63, 64, 83, 87, and 88 treat directly of this subject and many of the other experiments are intimately related to it.

Efficiency. Having built a machine that will not fly to pieces, will not burn up, will not destroy its commutator, and that will regulate to suit the exacting conditions of service, the next step is to make it do all these things with the least possible loss of power, consistent with reasonable first cost.

Experiments 66, 67, 68, 72, 73, 74, 75, 76, 77, 87, and 88 deal directly with efficiency, and others are closely related to the subject.

Forms. The following Shop Test form is convenient for use in the testing of generators or motors and for filing away the data of a test in systematic order. It is suitable for a consulting engineer or for a manufacturer; but in the case of the latter, it would be wise to use separate forms for generators and motors and to cut out as many items as the particular system of filing the records will permit. The question of bulk is important where a large number of records are kept in a fire-proof vault, and is a matter often overlooked.

This form includes everything that is necessary in shop testing of standard machines. It embodies the best features that could be found in the similar forms of a dozen manufacturing companies.

The Standardization Report of the American Institute of Electrical Engineers,* covering "Rise of Temperature" and "Over-Load Capacities," should be especially consulted with reference to this form.

* Appendix B.

SHOP TEST (Continued).

Time.	R. P. M.	Volts.	Amperes.	Shunt Volts.	Shunt Amperes.	Series Volts.	Series Amperes.	Temperature.			Brake Pull.	H. P.	
								Air.	Shunt.	Series.			
REGULATION HOT.													
Full Load, Normal Voltage.													
$\frac{3}{4}$ Load.													
$\frac{1}{2}$ Load.													
$\frac{1}{4}$ Load.													
No Load.													
No Load, Normal Voltage.													
OVERLOAD RUN.													

Percent Regulation Hot.....

SHOP TEST (Continued).

SPARKING TEST.

A. BRUSHES NEUTRAL,

- Absolutely Sparkless No Load to.....Amperes, R. H. Rotation.
- Practically Sparkless No Load to.....Amperes, R. H. Rotation.
- Absolutely Sparkless No Load to.....Amperes, L. H. Rotation.
- Practically Sparkless No Load to.....Amperes, L. H. Rotation.

B. BRUSHES AT BEST LEAD....." AT MARK (.....°).

- Absolutely Sparkless No Load to.....Amperes. Rotation.
- Practically Sparkless No Load to.....Amperes. Rotation.

INSULATION TEST.

- Withstood for One Minute.....Volts between Windings and Frame.
- Withstood for One Minute.....Volts between Shunt and Series.
- Withstood for One Minute..... Volts between
- Withstood for One Minute.....Volts between
- Shape of Wave Form.....
- Insulation Resistance.....Megohms between Windings and Frame.
- Insulation Resistance.....Megohms between Shunt and Series.
- Insulation Resistance.....Megohms between.....
- Insulation Resistance.....Megohms between.....

SHOP TEST (Concluded).**MECHANICAL INSPECTION.**

How is End Play?.....
 Is Armature Balanced?.....
 Is Pulley Balanced?.....
 Does Armature Body Run True?.....
 Do Bands Run True?.....
 Is Armature Centered in Frame?.....
 What is Bore?.....
 Does Commutator Run True?.....
 Are Commutator Bolts Tight?.....
 Condition of Commutator at End of Run?.....
 Is Rocker Arm Marked?.....
 Do Bearings Throw Oil?.....
 Do Oil Rings Turn?.....
 Are Oil Rings Noisy?.....
 Do Gauges Leak?.....
 Is Mark at Proper Height?.....
 Condition of Brushes at End of Run?.....
 Can Brushes be Staggered?.....
 Are Brushes Noisy?.....
 Do Brushes Need Lubrication?.....
 Does Machine Hum?.....

CHANGES OR REPAIRS RECOMMENDED.

Tested by.....

Approved by.....

The following order of procedure has been found convenient in carrying out a commercial test.

1. Resistance of windings, cold.
2. Mechanical inspection.
3. Setting of brushes (test by throwing on and off load).
4. Regulation, cold.
5. Heat run, mechanical inspection, drop on spools.
6. Final temperatures.
7. Sparking test, hot (readjusting brushes if necessary).
8. Regulation, hot.
9. Resistance of windings, hot.
10. Insulation resistance.
11. Puncture test.
12. Final mechanical inspection.

In manufacturing establishments, efficiency tests are seldom made on standard machines except when an unusually close guarantee is required. Thorough tests are always made, however, on the first machines of a new size, which it is intended to standardize, and on all special machines on which an efficiency is guaranteed. The purchaser should test all machines for efficiency.

The two following forms are for efficiency tests, one for a stray power test and one for a brake test. If used independently of the general form, they should have similar headings, so that the machine may be identified.

STRAY POWER TEST.

		WATTS.				
		$\frac{1}{4}$ Load.	$\frac{1}{2}$ Load.	$\frac{3}{4}$ Load.	$1\frac{1}{2}$ Load.	$2\frac{1}{2}$ Load.
Brush Drop,	Volts.					
Armature Res,	Ohms.					
Series Coils,	"					
G. S. Shunt,	"					
Connections,	"					
Shunt Coils,	"					
Shunt Rheostat,	"					
.....	"					
.....	"					
Total, I^2R Loss.						

Brush, I^2R Loss.

Armature, I^2R Loss.

Series, "

G. S. Shunt, "

Connections, "

Shunt, "

Rheostat, "

"

"

STRAY POWER TEST (Concluded).

	WATTS.				
	$\frac{1}{2}$ Load.	$\frac{1}{3}$ Load.	$\frac{2}{3}$ Load.	$\frac{1}{2}$ Load.	$\frac{1}{3}$ Load.
Hysteresis Loss.					
Eddy Current Loss.					
Bearing, Friction, and Windage Loss.					
Brush Friction Loss.					
Loss.					
Loss.					
Total Stray Power.					
Total Losses.					
Output.					
Intake.					
Commercial Efficiency (Percent).					

Special Commercial Tests. In factory testing, it is a great economy to shorten the length of a temperature run; for by this means the output of a testing department for a given expenditure of labor and fuel is increased. The American Institute Report* Art. 29, permits a shortening of the time, providing the machine is overloaded in current and voltage so as to accelerate the rate of temperature rise. It requires that the load be reduced to normal and held there until temperatures become constant before taking final readings.

Manufacturers take advantage of this, and many of them have established standard runs called "compromise runs" by means of which great economy is effected. These runs are based on ingenious combinations of overload in field current, armature at rest, and of excessive voltage and current with the armature under load, and are perfectly satisfactory for standard sizes made in quantity. They are not to be recommended for the sizes that are seldom built, nor are they to be recommended as acceptance tests. The regular run is insufficient to detect such weaknesses as require days or perhaps weeks at working temperature to develop and it is perfectly possible for a machine to pass an abbreviated run when it would not be passed on a run made under normal conditions; for example, a hot box might develop on a five hour normal run and not on a half-hour overload run. Inasmuch as factory practice varies considerably no outline will be given for a special run; but it is recommended that where conditions warrant its introduction, a thorough comparison of results with those by the standard method be made for each size and type of machine, before making a change. The special run will naturally vary with the general design of the product.

Special Comments.

The following points gleaned from experience, are inserted, not that they are deemed the most important things to be observed

* Appendix B.

in testing, but because they apply particularly to the shop, and would be likely to be overlooked by the purely technical graduate.

Read thoroughly the matter under the headings "Preliminary" and "Instruments" at the beginning of the book.

Unless *absolutely necessary*, never run a motor separately excited. A circuit breaker cannot be relied upon to take care of a motor if the field excitation fails.

Before starting a motor be sure that the peripheral speed of the pulley is going to be safe; 5,500 feet per minute is the maximum allowable.

Before starting a motor, always see that the shunt field is excited, by trying the magnetism with a piece of iron.

In connecting up a motor use a circuit breaker and an automatic starting-box with field release. Anticipate possible emergencies and decide on the course of action. *Take every reasonable precaution to avoid shutting down the shop or even a part of it* by the throwing of breakers on important feeders.

In case a compound machine is used as a motor for driving a generator under test, cut out the series winding.

Never start a machine under test without first giving it a mechanical inspection. Be sure that rotating parts are clear, and that bolts and nuts are tight; then accelerate slowly, carefully watching for mistakes in the alignment of pulleys and for excessive vibration.

Never start a motor or generator, *no matter how confident you may feel*, without first going over the connections.

Before starting a machine see that the oil rings *dip into and carry oil*. They should begin to turn not later than quarter speed.

It is economical of *power* in most cases to "pump back" when a machine is put on a temperature run. One of the opposition methods, Experiments 73, 74, 75, 76 and 77, may be used. It is not generally economical of space, of time, or of auxiliary test machines to use these methods. This is especially true of small machines.

Look out for leaky bearings before starting, during the run and after the run. If the rings throw oil when the latter is at normal level, the oiling device should be considered defective.

Whenever sanding brushes or commutator, be sure that the oil wells are closed.

In sanding or grinding a commutator, do not hold sandpaper or stone in the hand; use an appropriate holder.

Look for mechanical defects before the run, during the run, and after the run.

Air gaps are conveniently measured with a graduated metal wedge. Two tests are required; one to see if the armature is centered and one to see if the bore is circular. In the first test, a point on the armature should be chosen, and the gap measured at this point for different angular positions. In the second, the armature is allowed to remain stationary and the gap is measured at different points on the circumference. This test should be applied at each end of the armature. There should be a definite shop practice in measuring air gaps; otherwise, it should be stated whether they are measured over band wires or over armature core.

In making "cold" resistance measurements, the temperature of the part measured should be taken by thermometer in addition to the room temperature.

In the measurement of room temperature, care should be taken to observe the Institute instructions. Even then the indication of a single thermometer should not be taken as the room temperature, but its reading should be checked by thermometers placed at different points around the machine. In case of a large machine it may be necessary to average the readings of four or more thermometers.

Great care should be taken in the placing of thermometers on a machine. A shop standard should be established and any variation therefrom recorded by means of an accurate description or by a sketch.

A temperature likely to be neglected is that of the *G. S. Shunt*. This should be taken with the shunt wrapped and placed so as to

imitate as nearly as possible the conditions under which it will be fixed when the machine is installed.

Be sure a machine has reached *maximum temperature* before calling a run off. There is often great temptation on the part of a tester, when rushed, to shorten a run.

After the run is off be sure *maximum readings* of all machine thermometers are recorded. Remember that the last degree or two of rise is slow. Reduce all observed temperature rises to a room temperature of 25° C. before the report is considered complete.

All overload observations should be made with the machine at full load temperature at the start.

If the brushes of a machine glow or spark, particular attention should be paid to inspection of brush span, to symmetry of position of brush studs, and to the thickness of pole tips. If nothing unusual is found, the electrical pressure of each pair of studs should be measured while the brushes on the other studs are off the commutator. This will prove whether or not the armature is electrically centered. In the case of a motor the machine should be driven as a generator for this test. This test is of no use when cross-connected or equalized armature windings are used, but in this case a careful determination of the equalizer connector temperature is of value. Magnetic exploration curves of the air gap flux are also valuable in the detection of the causes of sparking.

After the temperature run the commutator should be carefully inspected. If cut, pitted or blackened, this should be recorded. Any symmetry of distribution of blackened or otherwise defective bars should be investigated and the cause eliminated by a change in the machine. High bars or low bars, hard or soft mica, are serious defects. All commutator bolts should be tried for tightness. Unless the commutator surface has been roughened or blackened by operation under some abnormal condition, it is not advisable to consider turning down in the light of a repair. All commutators should be polished after the final factory test.

After the temperature run the brushes should be examined at the contact surface. Cutting at the toes or heels or pitting are serious defects.

The question of actual leakage coefficient is frequently ignored. When a new machine "falls down" in respect to magnetic flux it is so convenient to attribute the failure to bad iron that the leakage test is not thought of. Not only should thorough tests for leakage coefficients be made on every size of machine, but the difference in leakage of a compound machine when operated under normal conditions and as a shunt machine should be obtained, and a thorough study of the subject made.

All magnetization curves should be taken with the brushes *set neutral*, unless otherwise ordered.

Rated motors should be operated with the brushes set neutral, and, if possible, with a stiff field. The object is to reduce commutation losses.

An armature may hum because it has not been tightly pressed. Humming may also be due to a sharp line of contour, or to a sharp angle in the chamfering, of the pole pieces. This may be stopped by rounding off the corners, or by any method tending to make the flux more nearly uniform in the air gap.

A machine that "falls down" in pressure and has a good margin on sparking may be made to operate perfectly, if the construction permits, by inserting sheet steel plates between the pole pieces and the yoke, thus decreasing the air gap. A more expensive method is to rewind the field. Changing the speed is often permissible.

A machine that sparks may be improved by boring out the frame, by chamfering the poles, by reducing the speed, by changing the kind or the dimensions of the brushes, or by increasing the excitation. Combinations of the above methods are usually used.

The application of equalizer connections to a multiple path armature usually aids commutation.

No change of a permanent or expensive nature should ever be made without first making a thorough test to prove the advisability of the alteration.

In curing any defect in a machine, try the simplest, least expensive expedient first. Do not hack a machine to pieces or add elaborate pieces of workmanship the first thing.

Any machine that requires a change that makes it special has no place in the catalog list of standards.

A chief designer should insist on rating his own machines. Neither salesmen nor manager have any business with the ratings, and no experienced chief will allow interference in this respect.

APPENDIX B.

AMERICAN INSTITUTE OF ELECTRICAL ENGINEERS.

REPORT OF COMMITTEE ON STANDARDIZATION.*

General Plan.

Efficiency. Sections 1 to 24.

I. Commutating Machines,	Sections	7-10
II. Synchronous Machines,	"	11-12
III. Synchronous Commutating Machines,	"	13-16
IV. Rectifying Machines,	"	17-18
V. Stationary Induction Apparatus,	"	19-20
VI. Rotary Induction Apparatus,	"	21-24
VII. Transmission Lines,	"	25

Rise of Temperature. Sections 26-35.

Insulation. Sections 36-49.

Regulation. Sections 50-71.

Variation and Pulsation. Sections 72-74.

Rating. Sections 75-82.

Classification of Voltages and Frequencies. Sections 83-88.

Overload Capacities. Sections 89-92.

Luminous Sources. Sections 93-98.

Appendices.	I. Efficiency.
	II. Apparent Efficiency.
	III. Power Factor and Inductance Factor.
	IV. Notation.
	V. Table of Sparking Distances.

Preliminary Definitions:

A direct current is a unidirectional current.

A continuous current is a steady, or non-pulsating, direct current.

* Adopted at the Nineteenth Annual Convention at Great Barrington, Mass., June 20, 1902. Reprinted from Vol. XIX of the *Transactions*.

An alternating current is a current of equal half-waves in successively opposite directions.

An oscillating current is a current alternating in direction, and of decreasing amplitude.

Electrical Apparatus will be treated under the following heads:

I. Commutating Machines, which comprise a constant magnetic field, a closed-coil armature, and a multi-segmental commutator connected thereto.

Under this head may be classed the following: Continuous-current generators; continuous-current motors; continuous-current boosters; motor-generators; dynamotors; converters and closed-coil arc machines.

A booster is a machine inserted in series in a circuit to change its voltage, and may be driven either by an electric motor, or otherwise. In the former case it is a motor-booster.

A motor-generator is a transforming device consisting of two machines; a motor and a generator, mechanically connected together.

A dynamotor is a transforming device combining both motor and generator acting in one magnetic field, with two armatures, or with an armature having two separate windings.

For converters, see III.

II. Synchronous Machines, which comprise a constant magnetic field, and an armature receiving or delivering alternating currents in synchronism with the motion of the machine; *i. e.*, having a frequency equal to the product of the number of pairs of poles and the speed of the machine in revolutions per second.

III. Synchronous Commutating Machines. These include: (1) Synchronous converters, commonly called "converters"; *i. e.*, converters from alternating to direct, or from direct to alternating current, and (2) double-current generators; *i. e.*, generators producing both direct and alternating currents.

A converter is a machine employing mechanical momentum in changing electric energy from one form into another.

A converter may be either :

a. A direct-current converter, converting from a direct current to a direct current, or

b. A synchronous converter, formerly called a rotary converter, converting from an alternating to a direct current, or vice-versa.

Phase converters are converters from an alternating-current system to an alternating-current system of the same frequency but in different phase.

Frequency converters are converters from an alternating-current system of one frequency to an alternating-current system of another frequency, with or without change in the number of phases.

IV. Rectifying Machines, or Pulsating-Current Generators, which produce a unidirectional current of periodically varying strength.

V. Stationary Induction Apparatus, *i. e.*, stationary apparatus changing electric energy to electric energy through the medium of magnetic energy. These comprise :

a. Transformers, or stationary induction apparatus in which the primary and secondary windings are electrically insulated from each other.

b. Auto-transformers, also called compensators : *i. e.*, stationary induction apparatus in which part of the primary winding is used as a secondary winding ; or conversely.

c. Potential regulators, or stationary induction apparatus having a coil in shunt, and a coil in series with the circuit, so arranged that the ratio of transformation between them is variable at will.

These may be divided into the following types, or combinations thereof :

1. Compensator potential regulators, in which the number of turns of one of the coils is changed.

2. Induction potential-regulators, in which the relative positions of primary and secondary coils is changed.

3. Magneto potential-regulators, in which only the direction of the magnetic flux with respect to the coils is changed.

d. Reactors, or Reactance coils, formerly called choking coils;
i. e., stationary induction apparatus used to produce impedance or phase displacement.

VI. Rotary Induction Apparatus, which consist of primary and secondary windings rotating with respect to each other. They comprise:

- a.* Induction motors.
- b.* Induction generators.
- c.* Frequency converters.
- d.* Rotary phase converters.

Efficiency.

1. The "efficiency" of an apparatus is the ratio of its net power output to its gross power input.*

2. The efficiency of all apparatus, except such as may be intended for intermittent service, should be either measured at, or reduced to, the temperature which the apparatus assumes under continuous operation at full rated load, referred to a room temperature of 25° C.

With apparatus intended for intermittent service, the efficiency should be determined at the temperature assumed under specified conditions.

3. Electric power should be measured at the terminals of the apparatus.

4. In determining the efficiency of alternating-current apparatus, the electric power should be measured when the current is in phase with the e.m.f., unless otherwise specified, except when a definite phase difference is inherent in the apparatus, as in induction motors, induction generators, frequency converters, etc.

5. Mechanical power in machines should be measured at the pulley, gearing, coupling, etc., thus excluding the loss of power

* An exception should be noted in the case of storage batteries or apparatus for storing energy in which the efficiency, unless otherwise qualified, should be understood at the ratio of the energy output to the energy intake in a normal cycle.

in said pulley, gearing or coupling, but including the bearing friction and windage. The magnitude of bearing friction and windage may be considered as independent of the load. The loss of power in the belt and the increase of bearing friction due to belt tension, should be excluded. Where, however, a machine is mounted upon the shaft of a prime mover, in such a manner that it cannot be separated therefrom, the frictional losses in bearings and in windage, which ought, by definition, to be included in determining the efficiency, should be excluded, owing to the practical impossibility of determining them satisfactorily. The brush friction, however, should be included.

Where a machine has auxiliary apparatus, such as an exciter, the power lost in the auxiliary apparatus should not be charged to the machine but to the plant consisting of machine and auxiliary apparatus taken together. The plant efficiency in such cases should be distinguished from the machine efficiency.

6. The efficiency may be determined by measuring all the losses individually, and adding their sum to the output to derive the input, or subtracting their sum from the input to derive the output. All losses should be measured at, or reduced to, the temperature assumed in continuous operation, or in operation under conditions specified. (See Sections 26 to 35.)

In order to consider the application of the foregoing rules to various machines in general use, the latter may be conveniently divided into classes as follows:

I. Commutating Machines.

7. In commutating machines the losses are:

a. Bearing friction and windage. (See Section 5.)

b. Molecular magnetic friction, and eddy currents in iron and copper, also I^2r losses in cross-connections of cross-connected armatures. These losses should be determined with the machine on open circuit, and at a voltage equal to the rated voltage $+ Ir$ in a generator, and $- Ir$ in a motor, where I denotes the current strength and r denotes the internal resistance of the machine.

They should be measured at the correct speed and voltage, since they do not usually vary in any definite proportion to the speed or to the voltage.

c. Armature resistance losses, I^2r' , where I is the current strength in the armature, and r' is the resistance between armature brushes, excluding the resistance of brushes and brush contacts.

d. Commutator brush friction.

e. Commutator brush-contact resistance. It is desirable to point out that with carbon brushes the losses (*d*) and (*e*) are usually considerable in low-voltage machines.

f. Field excitation. With separately excited fields, the loss of power in the resistance of the field coils alone should be considered. With shunt fields or series fields, however, the loss of power in the accompanying rheostat should also be included, the said rheostat being considered as an essential part of the machine, and not as separate auxiliary apparatus.

(*b*) and (*c*) are losses in the armature or "armature losses"; (*d*) and (*e*) "commutator losses"; (*f*) "field losses."

8. The difference between the total losses under load and the sum of the losses above specified, should be considered as "load losses" and are usually trivial in commutating machines of small field distortion. When the field distortion is large, as is shown by the necessity for shifting the brushes between no load and full load, or with variations of load, these load losses may be considerable, and should be taken into account. This applies especially to constant-current arc-light generators. In this case the efficiency may be determined either by input and output measurements, or the load losses may be estimated by the method of Section II.

9. Boosters should be considered and treated like other direct-current machines in regard to losses.

10. In motor-generators, dynamotors or converters, the efficiency is the electric output divided by the electric input.

II. Synchronous Machines.

11. In synchronous machines the output or input should be measured with the current in phase with the terminal e.m.f., except when otherwise expressly specified.

12. The losses in synchronous machines are:

a. Bearing friction and windage; see Section 5.

b. Molecular magnetic friction and eddy currents in iron, copper, and other metallic parts. These losses should be determined at open circuit of the machine at the rated speed and at the rated voltage, $+Ir$ in a synchronous generator, $-Ir$ in a synchronous motor, where I = current in armature, r = armature resistance. It is undesirable to compute these losses from observations made at other speeds or voltages.

These losses may be determined either by driving the machine by a motor, or by running it as a synchronous motor, and adjusting its fields so as to get minimum current input and measuring the input by wattmeter.

In the latter case, with polyphase machines, several wattmeters must be used, arranged so as to measure unbalanced load. The former method is preferable, since the latter is liable to error caused by acceleration and retardation due to a pulsation of frequency, or inherent tendency to surging.

c. Armature-resistance loss, which may be expressed by pI^2r ; where r = resistance of one armature circuit or branch, I = the current in such armature circuit or branch, and p = the number of armature circuits or branches.

d. Load losses as defined in Section 8. While these losses cannot well be determined individually, they may be considerable and, therefore, their joint influence should be determined by observation. This can be done by operating the machine on short circuit and at full-load current, that is, by determining what may be called the "short-circuit core loss." With the low field intensity and great lag of current existing in this case, the load losses are usually greatly exaggerated.

One-third of the short-circuited core loss may, as an approximation, and in the absence of more accurate information, be assumed as the load loss.

e. Collector-ring friction and contact resistance. These are generally negligible, except in machines of extremely low voltage.

f. Field excitation. In separately-excited machines, the I^2r of the field coils proper should be used. In self-exciting machines, however, the loss in the field rheostat should be included. (See Section 7*f.*)

III. Synchronous Commutating Machines.

13. In converters, the power on the alternating-current side is to be measured with the current in phase with the terminal e.m.f., unless otherwise specified.

14. In double-current generators, the efficiency of the machine should be determined as a direct-current generator in accordance with Section 7 and as an alternating-current generator in accordance with Section 12. The two values of efficiency may be different, and should be clearly distinguished.

15. In converters the losses should be determined when driving the machine by a motor. These losses are:

a. Bearing friction and windage. (See Section 5.)

b. Molecular magnetic friction and eddy currents in iron, copper and metallic parts, also I^2r loss, due to cross-current in cross-connected armatures. These losses should be determined at open circuit and at the rated terminal voltage, no allowance being made for the armature resistance since the alternating and the direct currents flow in opposite directions.

c. Armature resistance. The loss in the armature is qI^2r , where I = direct current in armature, r = armature resistance and q , a factor which is equal to 1.47 in single-circuit single-phase, 1.15 in double-circuit single-phase, 0.59 in three-phase, 0.39 in quarter-phase, and 0.27 in six-phase converters.

d. Load losses. The load losses should be determined in the same manner as described in Section 12*d*, with reference to the direct-current side.

e and *f*. Losses in commutator and collector friction and brush contact resistance. (See Sections 7 and 12.)

g. Field excitation. In separately-excited fields, the I^2r loss in the field coils proper should be taken, while in shunt and series fields the rheostat loss should be included, except where fields and rheostats are intentionally modified to produce effects outside of the conversion of electric power, as for producing phase displacement for voltage control. In this case 25 percent of the I^2r loss in the field proper at non-inductive alternating circuit should be added as proper estimated allowance for normal rheostat losses. (See Section 7*f*.)

16. Where two similar synchronous machines are available, their efficiency can be determined by operating one machine as a converter from direct to alternating, and the other as a converter from alternating to direct, connecting the alternating sides together, and measuring the difference between the direct-current input, and the direct-current output. This process may be modified by returning the output of the second machine through two boosters into the first machine and measuring the losses. Another modification is to supply the losses by an alternator between the two machines, using potential regulators.

IV. Rectifying Machines or Pulsating-Current Generators.

17. These include: Open-coil arc machines, constant-current rectifiers, constant-potential rectifiers.

The losses in open-coil arc machines are essentially the same as in Sections 7 to 10 (closed-coil commutating machines). In this case, however, the load losses are usually greater, and the efficiency should be measured by input-and-output test, using wattmeters for measuring the output. In alternating-current rectifiers, the output must be also measured by wattmeter and not by voltmeter and ammeter since owing to the pulsation of current and e.m.f., a considerable discrepancy may exist between watts and volt-amperes, amounting to as much as 10 or 15 percent.

18. In constant-current rectifiers, transforming from constant-potential alternating to constant direct current, by means of constant-current transforming devices and rectifying commutators, the losses in the transformers are to be included in the efficiency, and have to be measured when operating the rectifier, since in this case the losses are generally greater than when feeding an alternating secondary circuit. In constant-current transforming devices, the load losses may be considerable, and, therefore, should not be neglected.

The most satisfactory method of determining the efficiency in rectifiers is to measure electric input and electric output by watt-meter. The input is usually inductive, owing to a considerable phase displacement and to wave distortion. For this reason the apparent efficiency should also be considered, since it is usually much lower than the true efficiency. The power consumed by the synchronous motor or other source driving the rectifier should be included in the electric input.

V. Stationary Induction Apparatus.

19. Since the efficiency of induction apparatus depends upon the wave shape of e.m.f., it should be referred to a sine wave of e.m.f., except where expressly specified otherwise. The efficiency should be measured with non-inductive load, and at rated frequency, except where expressly specified otherwise. The losses are:

a. Molecular magnetic friction and eddy currents measured at open circuit and at rated voltage — I_r , where I = rated current, r = resistance of primary circuit.

b. Resistance losses, the sum of the I^2r in the primary and in the secondary windings of a transformer, or in the two sections of the coil in a compensator or auto-transformer, where I = current in the coil or section of coil. r = resistance.

c. Load losses, *i. e.*, eddy currents in the iron and especially in the copper conductors, caused by the current. They should be measured by short-circuiting the secondary of the transformer and impressing upon the primary an e.m.f. sufficient to send full-

load current through the transformer. The loss in the transformer under these conditions measured by wattmeter gives the load losses + I^2r losses in both primary and secondary coils.

d. Losses due to the methods of cooling, as power consumed by the blower in air-blast transformers, and power consumed by the motor driving pumps in oil or water cooled transformers. Where the same cooling apparatus supplies a number of transformers or is installed to supply future additions, allowance should be made therefor.

20. In potential regulators, the efficiency should be taken at the maximum voltage for which the apparatus is designed, and with non-inductive load, unless otherwise specified.

VI. Rotary Induction Apparatus.

21. Owing to the existence of load losses, and since the magnetic density in the induction motor under load changes in a complex manner, the efficiency should be determined by measuring the electric input by wattmeter, and the mechanical output at the pulley, gear, coupling, etc.

22. The efficiency should be determined at the rated frequency, and the input measured with sine waves of impressed e.m.f.

23. The efficiency may be calculated from the apparent input, the power factor, and the power output. The same applies to induction generators. Since phase displacement is inherent in induction machines, their apparent efficiency is also important.

24. In frequency converters, *i. e.*, apparatus transforming from an alternating system to an alternating system of different frequency, with or without a change in the number of phases, and in phase converters, *i. e.*, apparatus converting from an alternating system, usually single-phase, to another alternating system, usually polyphase, of the same frequency, the efficiency should also be determined by measuring both output and input.

VII. Transmission Lines.

25. The efficiency of transmission lines should be measured with non-inductive load at the receiving end, with the rated re-

ceiving pressure and frequency, also with sinusoidal impressed e.m.f.'s, except where expressly specified otherwise, and with the exclusion of transformers or other apparatus at the ends of the line.

Rise of Temperature.

General Principles.

26. Under regular service conditions, the temperature of electrical machinery should never be allowed to remain at a point at which permanent deterioration of its insulating material takes place.

27. The rise of temperature should be referred to the standard conditions of a room-temperature of 25° C., a barometric pressure of 760 mm. and normal conditions of ventilation; that is, the apparatus under test should neither be exposed to draught nor enclosed, except where expressly specified.

28. If the room temperature during the test differs from 25° C., the observed rise of temperature should be corrected by $\frac{1}{2}$ percent for each degree C. Thus with a room temperature of 35° C., the observed rise of temperature has to be decreased by 5 percent, and with a room temperature of 15° C., the observed rise of temperature has to be increased by 5 percent. The thermometer indicating the room temperature should be screened from thermal radiation emitted by heated bodies, or from draughts of air. When it is impracticable to secure normal conditions of ventilation on account of an adjacent engine, or other sources of heat, the thermometer for measuring the air temperature should be placed so as fairly to indicate the temperature which the machine would have if it were idle, in order that the rise of temperature determined shall be that caused by the operation of the machine.

29. The temperature should be measured after a run of sufficient duration to reach practical constancy. This is usually from six to eighteen hours, according to the size and construction of the apparatus. It is permissible, however, to shorten the time of the test by running a lesser time on an overload in current and

voltage, then reducing the load to normal, and maintaining it thus until the temperature has become constant.

In apparatus intended for intermittent service, as railway motors, starting rheostats, etc., the rise of temperature should be measured after operation under as nearly as possible the conditions of service for which the apparatus is intended, and the conditions of the test should be specified.

In apparatus which by the nature of their service may be exposed to overload, as railway converters, and in very high voltage circuits, a smaller rise of temperature should be specified than in apparatus not liable to overloads or in low voltage apparatus. In apparatus built for conditions of limited space, as railway motors, a higher rise of temperature must be allowed.

30. In electrical conductors, the rise of temperature should be determined by their increase of resistance where practicable. For this purpose the resistance may be measured either by galvanometer test, or by drop-of-potential method. A temperature coefficient of 0.42 percent per degree C., from and at 0° C., may be assumed for copper.* Temperature elevations measured in this way are usually in excess of temperature elevations measured by thermometers.

When thermometers are applied to the free surface of a machine, it is desirable that the bulb of the thermometer should be covered by a pad of definite area. A convenient pad may be formed of cotton waste in a shallow circular box about one and a half inches in diameter, through a slot in the side of which the thermometer bulb is inserted. An unduly large pad over the ther-

* By the formula

$$R_t = R_0 (1 + 0.0042 t) \text{ and } R_{t+\theta} = R_0 [(1 + 0.0042)(t + \theta)]$$

where R_t is the initial resistance at room temperature t° C.

$R_{t+\theta}$ is the final resistance at temperature elevation θ° C.

R_0 is the inferred resistance at 0° C.

These combine into the formula

$$\theta = (238.1 + t) \left(\frac{R_{t+\theta}}{R_t} - 1 \right) \text{ degrees C.}$$

nometer tends to interfere with the natural liberation of heat from the surface to which the thermometer is applied.

31. With apparatus in which the insulating materials have special heat-resisting qualities, a high temperature elevation is permissible.

32. In apparatus intended for service in places of abnormally high temperature, a lower temperature elevation should be specified.

33. It is recommended that the following maximum of values of temperature elevation should not be exceeded:

Commutating machines, rectifying machines and synchronous machines:

Field and armature, by resistance, 50° C.

Commutator and collector rings and brushes, by thermometer, 55° C.

Bearings and other parts of machine, by thermometer, 40° C.

Rotary induction apparatus:

Electric circuits, 50° C., by resistance.

Bearings and other parts of the machine 40° C., by thermometer.

In squirrel-cage or short-circuited armatures, 55° C., by thermometer, may be allowed.

Transformers for continuous service—electric circuits by resistance 50° C., other parts by thermometer, 40° C., under conditions of normal ventilation.

Reactors, induction- and magneto-regulators—electric circuits by resistance 50° C., other parts by thermometer 40° C.

Where a thermometer, applied to a coil or winding, indicates a higher temperature elevation than that shown by resistance measurement, the thermometer indication should be accepted. In using the thermometer, care should be taken so to protect its bulb as to prevent radiation from it, and, at the same time, not to interfere seriously with the normal radiation from the part to which it is applied.

34. In the case of apparatus intended for intermittent service, except railway motors, the temperature elevation which is attained at the end of the period corresponding to the term of full load, should not exceed 50° C., by resistance in electric circuits. In the case of transformers intended for intermittent service, or not operating continuously at full load, but continuously in circuit, as in the ordinary case of lighting transformers, the temperature elevation above the surrounding air-temperature should not exceed 50° C. by resistance in electric circuits and 40° C. by thermometer in other parts, after the period corresponding to the term of full load. In this instance, the test load should not be applied until the transformer has been in circuit for a sufficient time to attain the temperature elevation due to core loss. With transformers for commercial lighting, the duration of the full-load test may be taken as three hours, unless otherwise specified. In the case of railway, crane and elevator motors, the conditions of service are necessarily so varied that no specific period corresponding to the full-load term can be stated.

35. The commercial rating of a railway motor should be the h.p. output giving 75° C. rise of temperature, above a room temperature of 25° C. after one hour's continuous run at 500 volts terminal pressure, on a stand, with the motor covers removed.

For determining the service temperature of a railway motor, the temperature rise should be determined by operating the motor on a straight and level track and under specified conditions:

- (1) As to the load carried in tons per motor.
- (2) The schedule speed in miles per hour.
- (3) The number of stops per mile.
- (4) The duration in seconds of the stops.
- (5) The acceleration to be developed in miles per hour per second.
- (6) The braking retardation to be developed in miles per hour per second.

These specifications should be determined, or agreed upon, as equivalent to the actual service, and the motors to be closed or

open, according to the way in which they are to be operated in service.

The tests should be made in both directions over the same track.

By a "level track" should be understood a track in which the gradient does not exceed one-half percent at any point.

By a "straight track" should be understood a track in which the radius of curvature is nowhere less than the distance travelled by the car in thirty seconds, at the maximum speed reached during the run.

The wind velocity during a test should not exceed ten miles per hour in any direction.

Insulation.

36. The ohmic resistance of the insulation is of secondary importance only, as compared with the dielectric strength, or resistance to rupture by high voltage.

Since the ohmic resistance of the insulation can be very greatly increased by baking, but the dielectric strength is liable to be weakened thereby, it is preferable to specify a high dielectric strength rather than a high insulation resistance. The high-voltage test for dielectric strength should always be applied.

Insulation Resistance.

37. Insulation resistance tests should, if possible, be made at the pressure for which the apparatus is designed.

The insulation resistance of the complete apparatus must be such that the rated voltage of the apparatus will not send more than $1/1,000,000$ of the full load current, at the rated terminal voltage, through the insulation. Where the value found in this way exceeds 1 megohm, 1 megohm is sufficient.

Dielectric Strength.

38. The dielectric strength or resistance to rupture should be determined by a continued application of an alternating e.m.f. for one minute. The source of alternating e.m.f. should be a trans-

former of such size that the charging current of the apparatus as a condenser does not exceed 25 percent of the rated output of the transformer.

39. In alternating-current apparatus, the test should be made at the frequency for which the apparatus is designed.

40. The high-voltage tests should not be applied when the insulation is low, owing to dirt or moisture, and should be applied before the machine is put into commercial service.

The high potential test should be made at the temperature assumed under normal operation, as specified in Paragraph 2 under "Efficiency."

41. It should be pointed out that tests at high-voltages considerably in excess of the normal voltages, to determine whether specifications are fulfilled, are admissible on new machines only.

42. The test for dielectric strength should be made with the completely assembled apparatus and not with its individual parts, and the voltage should be applied as follows:*

(1) Between electric circuits and surrounding conducting material, and

(2) Between adjacent electric circuits, where such exist, as in transformers.

The tests should be made with a sine wave of e.m.f., or where this is not available, at a voltage giving the same striking distance between needle points in air, as a sine wave of the specified e.m.f., except where expressly specified otherwise. As needles, new sewing needles should be used. It is recommended to shunt the apparatus during the test by spark gap of needle points set for a voltage exceeding the required voltage by 10 percent.

A table of approximate sparking distances is given in Appendix V.

43. The following voltages are recommended for apparatus not including transmission lines or switchboards:

* This Section (No. 42), was referred back by the Convention to the Committee with power to amend, and may be subsequently revised.—EDITOR.

Rated Terminal Voltage.		Rated Output.	Testing Voltage.
Not exceeding 400 volts.....		Under 10 k.w.....	1,000 volts.
“	“	10 k.w. and over.....	1,500 “
400 and over, but less than 800 volts..		Under 10 k.w.....	1,500 “
“	“	10 k.w. and over.....	2,000 “
800	“ 1,200 “	Any	3,500 “
1,200	“ 2,500 “	Any	5,000 “
2,500	“ 10,000 “	Any..	Double the normal rated voltages.
10,000	“ 20,000 “	Any..	10,000 volts above normal rated voltages.
20,000	“	Any..	50% above normal rated voltages.

Except that transformers of 5,000 volts or less, directly feeding consumption circuits, should be tested at 10,000 volts.

Synchronous motor fields and fields of converters

started from the alternating current side..... 5,000 volts.

Alternator field circuits should be tested under a breakdown test voltage corresponding to the rated voltage of the exciter, and referred to an output equal to the output of the alternator; *i. e.*, the exciter should be rated for this test as having an output equal to that of the machine it excites.

Condensers should be tested at twice their rated voltage and at their rated frequency.

The values in the table above are effective values, or square roots of mean square, reduced to a sine wave of e.m.f.

44. In testing insulation between different electric circuits, as between primary and secondary of transformers, the testing voltage must be chosen corresponding to the high-voltage circuit.

45. In transformers of 20,000 volts upwards, it should be sufficient to test the transformer by operating it at 50 percent above its rated voltage; if necessary, with sufficiently higher frequency to induce this voltage.

46. The test of the insulation of a transformer, if no testing transformer is available, may be made by connecting one terminal of the high-voltage winding to the core and low-voltage winding, and then repeating the test with the other terminal of the high-

voltage winding so connected. The test of the dielectric resistance between the low voltage winding and the core should be in accordance with the recommendation in Section 43, for similar voltages and capacities.

47. High voltage tests on transformers or other apparatus should be based upon the voltages between the conductors of the circuit to which they are connected.

48. When machines or apparatus are to be operated in series, so as to employ the sum of their separate e.m.f.'s, the voltage should be referred to this sum, except where the frames of the machines are separately insulated both from the ground and from each other.

The insulation between machines and between each machine and ground should be tested, the former referred to the voltage of one machine, and the latter to the total voltage of the series.

49. Underground cables, and line switches, should be tested by the application of an alternating e.m.f. for one minute at twice the voltage at which the cable or switch is to be operated.

Regulation.

50. The term regulation should have the same meaning as the term "inherent regulation," at present frequently used.

51. The regulation of an apparatus intended for the generation of constant potential, constant current, constant speed, etc., is to be measured by the maximum variation of potential, current, speed, etc., occurring within the range from full-load to no-load, under such constant conditions of operation as give the required full-load values, the condition of full-load being considered in all cases as the normal condition of operation.

52. The regulation of an apparatus intended for the generation of a potential, current, speed, etc., varying in a definite manner between full load and no load, is to be measured by the maximum variation of potential, current, speed, etc., from the satisfied condition, under such constant conditions of operation as give the required full-load values.

If the manner in which the variation in potential, current, speed, etc., between full-load and no-load is not specified, it should be assumed to be a simple linear relation, *i. e.*, undergoing uniform variation between full-load and no-load.

The regulation of an apparatus may, therefore, differ according to its qualifications for use. Thus, the regulation of a compound-wound generator specified as a constant-potential generator, will be different from that it possesses when specified as an over-compounded generator.

53. The regulation is given in percentage of the full-load value of potential, current, speed, etc., and the apparatus should be steadily operated during the test under the same conditions as at full load.

54. The regulation of generators is to be determined at constant speed, of alternating apparatus at constant impressed frequency.

55. The regulation of a generator-unit, consisting of a generator united with a prime-mover, should be determined at constant conditions of the prime mover; *i. e.*, constant steam pressure, head, etc. It would include the inherent speed variations of the prime-mover. For this reason the regulation of a generator-unit is to be distinguished from the regulation of either the prime-mover, or of the generator contained in it, when taken separately.

56. In apparatus generating, transforming or transmitting alternating currents, regulation should be understood to refer to non-inductive load, that is to a load in which the current is in phase with the e.m.f. at the output side of the apparatus, except where expressly specified otherwise.

57. In alternating apparatus receiving electric power, regulation should refer to a sine wave of e.m.f., except where expressly specified otherwise.

58. In commutating machines, rectifying machines and synchronous machines, as direct-current generators and motors, alternating-current and polyphase generators, the regulation is to be determined under the following conditions:

- a. At constant excitation in separately excited fields.
- b. With constant resistance in shunt field circuits, and
- c. With constant resistance shunting series fields; *i. e.*, the field adjustment should remain constant, and should be so chosen as to give the required full-load voltage at full-load current.

59. In constant-potential machines, the regulation is the ratio of the maximum difference of terminal voltage from the rated full-load value (occurring within the range from full load to open circuit) to the full-load terminal voltage.

60. In constant-current apparatus, the regulation is the ratio of the maximum difference of current from the rated full-load value (occurring within the range from full-load to short-circuit, or minimum limit of operation), to the full-load current, at constant speed; or, in transformers, etc., at constant impressed voltage and frequency.

61. In constant-power apparatus, the regulation is the ratio of maximum difference of power from the rated full-load value (occurring within the range of operation specified) to the rated power.

62. In over-compounded machines, the regulation is the ratio of the maximum difference in voltage from a straight line connecting the no-load and full-load values of terminal voltage as function of the current, to the full-load terminal voltage.

63. In constant-speed continuous-current motors, the regulation is the ratio of the maximum variation of speed from its full-load value (occurring within the range from full-load to no-load) to the full-load speed.

64. In constant-potential non-inductive transformers, the regulation is the ratio of the rise of secondary terminal voltage from full-load to no-load (at constant primary impressed terminal voltage) to the secondary terminal voltage.

65. In induction motors, the regulation is the ratio of the rise of speed from full-load to no-load (at constant impressed voltage), to the full-load speed.

The regulation of an induction motor is, therefore, not identical with the slip of the motor, which is the ratio of the drop in speed from synchronism, to the synchronous speed.

66. In converters, dynamotors, motor-generators and frequency-converters, the regulation is the ratio of the maximum difference of terminal voltage at the output side from the rated full-load voltage (at constant impressed voltage and at constant frequency), to the full-load voltage on the output side.

67. In transmission lines, feeders, etc., the regulation is the ratio of maximum voltage difference at the receiving end, between no-load and full non-inductive load, to the full-load voltage at the receiving end, with constant voltage impressed upon the sending end.

68. In steam engines, the regulation is the ratio of the maximum variation of speed in passing from full-load to no-load (at constant steam pressure at the throttle) to the full-load speed.

69. In a turbine or other water-motor, the regulation is the ratio of the maximum variation of speed from full-load to no-load (at constant head of water; *i. e.*, at constant difference of level between tail race and head race), to the full-load speed.

70. In alternating-current apparatus, in addition to the non-inductive regulation, the impedance ratio of the apparatus should be specified; *i. e.*, the ratio of the voltage consumed by the total internal impedance of the apparatus at full-load current, to its rated full-load voltage. As far as possible, a sinusoidal current should be used.

71. When in synchronous machines the regulation is computed from the terminal voltage and impedance voltage, the exciting ampere-turns corresponding to terminal voltage plus armature-resistance-drop, and the ampere-turns at short circuit corresponding to the armature-impedance-drop, should be combined vectorially to obtain the resultant ampere-turns, and the corresponding internal e.m.f. should be taken from the saturation curve.*

*This Section (No. 71), was referred back by the Convention to the Committee with power to amend, and may be subsequently revised.

Variation and Pulsation.

72. In prime movers which do not give an absolutely uniform rate of rotation or speed, as in steam engines, the "variation" is the maximum angular displacement in position of the revolving member expressed in degrees, from the position it would occupy with uniform rotation, and with one revolution as 360° ; and the pulsation is the ratio of the maximum change of speed in an engine cycle to the average speed.

73. In alternators or alternating-current circuits in general, the variation is the maximum difference in phase of the generated wave of e.m.f. from a wave of absolutely constant frequency, expressed in degrees, and is due to the variation of the prime mover. The pulsation is the ratio of the maximum change of frequency during an engine cycle to the average frequency.

74. If n = number of poles, the variations of an alternator is $n/2$ times the variation of its prime-mover if direct connected, and $n/2p$ times the variation of the prime-mover if rigidly connected thereto in the velocity ratio p .

Rating.

75. Both electrical and mechanical power should be expressed in kilowatts, except when otherwise specified. Alternating-current apparatus should be rated in kilowatts on the basis of non-inductive conditions; *i. e.*, with the current in phase with the terminal voltage.

76. Thus the electric power generated by an alternating-current apparatus equals its rating only at non-inductive load, that is, when the current is in phase with the terminal voltage.

77. Apparent power should be expressed in kilovolt-amperes as distinguished from real power in kilowatts.

78. If a power-factor other than 100 percent is specified, the rating should be expressed in kilovolt-amperes and power-factor, at full load.

79. The full-load current of an electric generator is that current which with the rated full-load terminal voltage gives the

rated kilowatts, but in alternating-current apparatus only at non-inductive load.

80. Thus, in machines in which the full-load voltage differs from the no-load voltage, the full-load current should refer to the former.

If P = rating of an electric generator and E = full-load terminal voltage, the full load current is:

$I = \frac{P}{E}$ in a continuous-current machine or single-phase alternator.

$I = \frac{P}{E\sqrt{3}}$ in a three-phase alternator.

$I = \frac{P}{2E}$ in a quarter-phase alternator.

81. Constant-current machines, such as series arc-light generators, should be rated in kilowatts based on terminal volts and amperes at full load.

82. The rating of a fuse or circuit breaker should be the current-strength which it will continually carry. In addition thereto, the current strength at which it will open the circuit should be specified.

Classification of Voltages and Frequencies.

83. In direct-current, low-voltage generators, the following average terminal voltages are in general use and are recommended:

125 volts. 250 volts. 550 to 600 volts.

84. In direct-current and alternating-current low-voltage circuits, the following average terminal voltages are in general use and are recommended:

110 volts. 220 volts.

In direct-current power circuits, for railway and other service, 500 volts may be considered as standard.

85. In alternating-current, constant-potential, primary-distribution circuits, an average e.m.f. of 2,200 volts, with step-down

transformers of ratios 1/10 and 1/20, is in general use, and is recommended.

86. In alternating-current, constant-potential, high-pressure circuits, at the receiving end, the following voltages are in general use, and are recommended:

6,000. 10,000. 15,000. 20,000. 30,000. 40,000. 60,000.

87. In alternating-current generators, or generating systems, a range of terminal voltage should be provided from no-load voltage to 10 percent in excess thereof, to cover drop in transmission. If a greater range than ten percent is specified, the generator should be considered as special.

88. In alternating-current circuits, the following approximate frequencies are recommended as desirable:

25 ~

60 ~

120

These frequencies are already in extensive use and it is deemed advisable to adhere to them as closely as possible.

Overload Capacities.

89. All guarantees on heating, regulation, sparking, etc., should apply to the rated load, except where expressly specified otherwise, and in alternating-current apparatus to the current in phase with the terminal e.m.f., except where a phase displacement is inherent in the apparatus.

90. All apparatus should be able to carry the overload specified in Section 92, without self-destruction by heating, sparking, mechanical weakness, etc., and with an increase in temperature elevation not exceeding 15° C., above those specified for full loads, the overload being applied after the apparatus has acquired the temperature corresponding to full-load continuous operation. (See Sections 30 to 34.)

91. Overload guarantees should refer to normal conditions of operation regarding speed, frequency, voltage, etc., and to non-

* The frequency of 120 ~ may be considered as covering the already existing commercial frequencies between 120 ~ and 140 ~.

inductive conditions in alternating apparatus, except where a phase displacement is inherent in the apparatus.

92. The following overload capacities are recommended:

(1) In direct-current generators and alternating-current generators; 25 percent for two hours.

(2) In direct-current motors, induction motors and synchronous motors, not including railway motors and other apparatus intended for intermittent service, 25 percent for two hours, and 50 percent for one minute, for momentary overload capacity.

(3) Synchronous converters. 50 percent for one-half hour.

(4) Transformers. 25 percent for two hours. Except in transformers connected to apparatus for which a different overload is guaranteed, in which case the same guarantees shall apply for the transformers as for the apparatus connected thereto.

(5) Exciters of alternators and other synchronous machines, 10 percent more overload than is required for the excitation of the synchronous machine at its guaranteed overload, and for the same period of time.

(7) All exciters of alternating-current, single-phase or poly-phase generators should be able to give at constant speed, sufficient voltage to excite the alternator, at the rated speed, to the full load terminal voltage, at the rated output in kilovolt-amperes and with 50 percent power factor.

Luminous Sources.

93. It is customary in industrial practice at the present time to rate incandescent lamps upon the basis of their mean horizontal candle-power; but in comparing sources of light in which the relative distribution of luminosity differs considerably, the comparison should be based upon the total quantity of light, or total flux of light emitted by each source.

94. The mean spherical intensity of a luminous source is its total flux of light, expressed in lumens, divided by 4π . If the mean spherical intensity be expressed in British candles, the flux of light will be in British-candle-lumens (B. C. Lumens). If the

mean spherical intensity be expressed in Hefners, the flux of light will be expressed in Hefner-lumens (H. Lumens).

95. The efficiency of a luminous source should be defined as the ratio of the light it emits to the power it consumes. In the case of an incandescent lamp, this ratio might be expressed in B. C. Lumens per watt at lamp terminals.

96. The specific consumption of a lamp should be the reciprocal of its efficiency, or the watts per B. C. Lumen.

97. The consumption per horizontal candlepower of a lamp is the ratio of power consumed at terminals to the mean horizontal candlepower, or watts per mean horizontal candlepower.

98. The Hefner-Alteneck amyl-acetate lamp is, in spite of its unsuitable color, the standard luminous source generally used in accurate photometric measurements. In comparing lamps with this standard, the ratio of the horizontal intensities of the Hefner and British candles may be accepted conventionally as follows: 1 Hefner under Reichsanstalt standard conditions = 0.88 British candle.

Appendix I.

Efficiency of Phase-Displacing Apparatus.

In apparatus producing phase displacement as, for example, synchronous compensators, exciters of induction generators, reactors, condensers, polarization cells, etc., the efficiency should be understood to be the ratio of the volt-ampere activity to the volt-ampere activity plus power loss.

The efficiency may be calculated by determining the losses individually, adding to them the volt-ampere activity, and then dividing the voltampere activity by the sum.

1. In synchronous compensators and exciters of induction generators, the determination of losses is the same as in other synchronous machines under Sections 11 and 12.

2. In reactive coils the losses are molecular friction, eddy losses and I^2r loss. They should be measured by wattmeter. The efficiency of reactive coils should be determined with a sine wave of

impressed e.m.f., except where expressly specified otherwise. In reactive coils, the load losses may be considerable.

3. In condensers, the losses are due to dielectric hysteresis and leakage, and should be determined by wattmeter with a sine wave of e.m.f.

4. In polarization cells, the losses are those due to electric resistivity and a loss in the electrolyte of the nature of chemical hysteresis and are usually very considerable. They depend upon the frequency, voltage and temperature, and should be determined with a sine wave of impressed e.m.f., except where expressly specified otherwise.

Appendix II.

Apparent Efficiency.

In apparatus in which a phase displacement is inherent to their operation, apparent efficiency should be understood as the ratio of net power output to volt-ampere input.

Such apparatus comprise induction motors, reactive synchronous converters, synchronous converters controlling the voltage of an alternating current system, self-exciting synchronous motors, potential regulators and open magnetic circuit transformers, etc.

Since the apparent efficiency of apparatus generating electric power depends upon the power factor of the load, the apparent efficiency, unless otherwise specified, should be referred to a load power-factor of unity.

Appendix III.

Power Factor and Inductance Factor.

The power factor in alternating circuits or apparatus may be defined as the ratio of the electric power, in watts, to volt-amperes.

The inductance factor is to be considered as the ratio of wattless volt-amperes to total volt amperes.

Thus, if p = power factor, q = inductance factor.
then with a sine wave of e.m.f.

$$p^2 + q^2 = 1.$$

The power factor is the

$$\frac{(\text{energy component of current or e.m.f.})}{(\text{total current or e.m.f.})} = \frac{\text{true power}}{\text{volt amperes.}}$$

and the inductance factor is the

$$\frac{(\text{wattless component of current or e.m.f.})}{(\text{total current or e.m.f.})}$$

Since the power-factor of apparatus supplying electric power depends upon the power-factor of the load, the power-factor of the load should be considered as unity, unless otherwise specified.

Appendix IV.

The following notation is recommended:

E, e, voltage, e.m.f., potential difference,

I, i, current,

P, power,

ϕ , magnetic flux,

\mathcal{B} , magnetic density,

R, r, resistance,

x, reactance,

Z, z, impedance,

L, l, inductance,

C, c, capacity,

Y, y, admittance,

b, susceptance,

g, conductance.

Vector quantities when used should be denoted by capital italics.

Appendix V.

TABLE OF SPARKING DISTANCES IN AIR BETWEEN OPPOSED SHARP NEEDLE-POINTS FOR VARIOUS EFFECTIVE SINUSOIDAL VOLTAGES, IN INCHES AND IN CENTIMETERS.

Kilovolts Sq. Root of Mean Square.	Distance.		Kilovolts Sq. Root of Mean Square	Distance.	
	Inches	Cms.		Inches.	Cms.
5	0.225	0.57	60	4.65	11.8
10	0.47	1.19	70	5.85	14.9
15	0.725	1.84	80	7.1	18.0
20	1.0	2.54	90	8.35	21.2
25	1.3	3.3	100	9.6	24.4
30	1.625	4.1	110	10.75	27.3
35	2.0	5.1	120	11.85	30.1
40	2.45	6.2	130	12.95	32.9
45	2.95	7.5	140	13.95	35.4
50	3.55	9.0	150	15.0	38.1

INDEX.

- Action of a booster, experimental illustration of the, 324
- Added turns—compounding of a shunt dynamo by the method of, 167
- Adjustment of brushes of dynamos and motors, 55
- Adjustment of compounding of a dynamo:
By changing the speed, 172
By shunting the series winding, 170
- Air gap:
Determination of depth of—of a dynamo, from its magnetization curve, 144
Magnetic distribution in the—of a dynamo or motor by double pilot brush method, 183
Magnetic distribution in the—of a dynamo or motor by single pilot brush method, 180
- Alternating current instruments, 14
- Alternating current voltmeter, 21
- Ammeter:
Calibration of—by comparison with a standard ammeter, 112
Calibration of—by means of a Kelvin Balance, 122
Calibration of—by the potentiometer method, 127
Calibration of—using a copper voltmeter, 133
- Appendix A, 361
- Appendix B, 381
- Arc dynamo, external characteristic of an, 174
- Arc dynamos, connection and operation of—in series, 314
- Arc lamps:
Study of constant current, 350
Study of constant pressure, 348
- Armature, location of faults in, 326
- Armature, Relation of speed to excitation in a shunt or separately excited motor when the resistance drop in the—circuit is greater than the counter pressure, 336
- Armature characteristic, compounding of a shunt dynamo from its, 166
- Armature characteristic of a shunt dynamo, 165
- Armature reaction, experimental illustration of the operation of a motor whose field is supplied by, 325
- Armatures and fields, measurement of resistance of—by fall of potential method, 47
- Astatic instruments, 32
- Ballistic galvanometer:
Determination of the constant of—by a standard solenoid, 59
Determination of the constant of—by the condenser method, 57
- Ballistic method:
Hysteresis tests of iron by, 91
Magnetic distribution by the, 190
- Blondel opposition method of testing dynamo machines, 300
- Booster, experimental illustration of the action of a, 324
- Brushes, adjustment of, 55
- Calibration:
Of an ammeter by comparison with a standard ammeter, 112
Of an ammeter, by means of a Kelvin balance, 122
Of an ammeter by the potentiometer method, 127
Of an ammeter, using a copper voltmeter, 133
Of a Thomson integrating wattmeter, 338
Of a voltmeter by comparison with a standard voltmeter, 110
Of a voltmeter by means of a Kelvin balance, 125
Of a voltmeter by the potentiometer method, 131
Of a voltmeter using a copper voltmeter, 138
Of instruments, 45

- Cardew voltmeter, 39
- Characteristic:
- Armature—of a shunt dynamo, 165
 - External—of a compound dynamo, 158
 - External—of a differential compound dynamo, 159
 - External—of a separately excited dynamo, 149
 - External—of a series dynamo, 156
 - External—of a shunt dynamo, 152
 - External—of an arc dynamo, 174
- Circuit breakers, tests of direct current, 346
- Classification:
- Of instruments, 15
 - Of voltages and frequencies, 404
- Commercial test:
- Order of, 371
 - Special, 375
- Commutation, 363
- Compounding:
- Adjustment of—of a dynamo by changing the speed, 172
 - Adjustment of—of a dynamo by shunting the series winding, 170
 - A dynamo from its no-load and full-load magnetization curves, 195
 - Of a shunt dynamo by the method of added turns, 167
 - Of a shunt dynamo from its armature characteristic, 166
 - Of a shunt dynamo from its magnetization curve, external characteristic and loss line, 163
- Compound motor, regulation of differential—on a constant pressure circuit, 238
- Condenser method, determination of the constant of a ballistic galvanometer by, 57
- Connection and operation:
- Of arc dynamos in series, 314
 - Of compound dynamos in parallel, 311
 - Of series dynamos in parallel, 308
 - Of shunt dynamos in parallel, 304
 - Of two dynamos on three wire system, 316
- Connections:
- Study of the windings and—of dynamos and motors, 53
 - Switchboard, 4
- Constant:
- Determination of the—of a ballistic galvanometer, by a standard solenoid, 59
 - Determination of the—of a ballistic galvanometer, by the condenser method, 57
- Constant current:
- Study of—arc lamps, 350
- Constant excitation:
- Relation of speed to pressure at the armature terminals of a shunt motor, 208
- Constant pressure:
- Starting of shunt and series motors on—circuits, 106
 - Study of—arc lamps, 348
- Contact, magnetic distribution by the method of instantaneous, 185
- Counter pressure, relation of speed to excitation in a shunt or separately excited motor when the resistance drop in the armature circuit is greater than the, 336
- Cradle dynamometer, efficiency of a dynamo or motor by the, 255
- Current transformers, 42
- Curves: 3
- Plotting of, 4
- D'Arsonval galvanometer type of instruments, 28
- Data, original, 4
- Depth of air gap of a dynamo from its magnetization curve, 144
- Derivation:
- Of the loss line of a series dynamo from its magnetization curve and external characteristic, 162
 - Of the loss line of a shunt dynamo from its magnetization curve and external characteristic, 160
- Determination:
- Experimental—of the number of field turns on a dynamo, 178
 - Of depth of air gap of a dynamo from its magnetization curve, 144
 - Of the constant of a ballistic galvanometer by a standard solenoid, 59
 - Of the constant of a ballistic galvanometer by the condenser method, 57

- Differential compound motor, regulation of a—on a constant pressure circuit, 238
- Direct current circuit breakers, tests of, 346
- Direction of pressure, the effect of reversal of rotation and reversal of excitation on the—of a dynamo, 105
- Dynamo:
- Adjustment of compounding of a—by changing the speed, 172
 - Adjustment of compounding of a—by shunting the series winding, 170
 - Comparison of the direction of rotation as a motor with that of the same machine run as a—the connections remaining the same, 111
 - Compounding a—from its no-load and full-load magnetization curves, 195
 - Determination of depth of air gap of a—from its magnetization curve, 144
 - Experimental determination of the number of field turns on a, 178
 - Magnetic distribution in the air gap of a—or motor: single pilot brush method, 180; double pilot brush method, 183
 - Measurement of insulation resistance of a, 50
 - The effect of reversal of rotation and reversal of excitation on the direction of pressure of a, 105
- Arc:
- External characteristic of an, 174
 - Relation of speed to pressure in an, 204
- Compound:
- External characteristic of a, 158
- Differential compound:
- External characteristic of a, 159
- Separately excited:
- External characteristic of a, 149
 - Relation of speed to pressure in a, 201
- Series:
- Derivation of loss line of a—
—from its magnetization curve and external characteristic, 162
 - External characteristic of a, 156
 - Regulation of a single series motor run from a similar, 239
 - Study of a separately excited motor run by a, 219
 - Study of a shunt motor run by a, 221
- Shunt:
- Armature characteristic of a, 165
 - Compounding of a—by the method of added turns, 167
 - Compounding of a—from its armature characteristic, 166
 - Compounding of a—from its magnetization curve, external characteristic and loss line, 163
 - Derivation of the loss line of a—from its magnetization curve and external characteristic, 160
 - External characteristic of a, 152
 - Magnetization curve of a—at full load current, 194
 - Relation of speed to pressure in a, 202
- Three wire:
- Regulation test of a, 319
- Dynamos:
- Connection and operation of two—
—on a three-wire system, 316
 - Magnetization curves of, 141
- Arc:
- Connection and operation of—
—in series, 314
- Compound:
- Connection and operation of—
—in parallel, 311
- Series:
- Connection and operation of—
—in parallel, 308
- Shunt:
- Connection and operation of—
—in parallel, 304
- Dynamo machines:
- Blondel opposition method of testing, 300

- Hopkinson opposition method of testing, 277
- Hutchinson opposition method of testing, 293
- Kapp opposition method of testing, 283
- Potier opposition method of testing, 287
- Dynamometer, efficiency of a dynamo or motor by the cradle, 255
- Siemens electro, 21
- Dynamotor, efficiency and regulation of a, 332
- Dynamo or motor:
- Efficiency of a—by the cradle dynamometer, 255
 - Efficiency of a—by the stray power method, 258
 - Leakage coefficient of a, 146
 - Magnetic distribution in the air gap of a—double pilot brush method, 183
 - Magnetic distribution in the air gap of a—single pilot brush method, 180
 - Sparking test of a, 196
 - Temperature test of a, 245
- Dynamos and motors:
- Adjustment of brushes of, 55
 - Study of the windings and connections of, 53
- Efficiency, 364; 384, 408
- Apparent, 408
- Efficiency:
- Of a dynamo or motor by the cradle dynamometer, 255
 - Of a dynamo or motor by the stray power method, 258
 - Of a motor by the prony brake method, 252
- Efficiency and regulation:
- Of a dynamotor, 332
 - Of a motor-generator, 329
- Electro-dynamometer type of instruments, 19
- Electrostatic instruments, 34
- Electro-magnet, test of a tractive, 351
- Ewing permeability bridge, magnetization and permeability tests of iron using the, 85
- Excitation:
- Relation of speed to—in a shunt or separately excited motor when the resistance drop in the armature circuit is greater than the counter pressure, 336
 - Relation of speed to—in a shunt motor, 210
 - The effect of reversal of rotation and reversal of—on the direction of pressure of a dynamo, 105
- Experimental determination of the number of field turns on a dynamo, 178
- Experimental illustration of the action of a booster, 324
- Experimental illustration of the operation of a motor whose field is supplied by armature reaction, 325
- External characteristic:
- Compounding of a shunt dynamo from its magnetization curve—and loss line, 163
 - Derivation of the loss line of a series dynamo from its magnetization curve and, 162
 - Derivation of the loss line of a shunt dynamo from its magnetization curve and, 160
 - Of a compound dynamo, 158
 - Of a differential compound dynamo, 159
 - Of a separately excited dynamo, 149
 - Of a series dynamo, 156
 - Of a shunt dynamo, 152
 - Of an arc dynamo, 174
- Fall of potential method, measurement of resistance of armatures and fields by, 47
- Faults in armatures, location of, 326
- Field, experimental illustration of the operation of a motor whose—is supplied by armature reaction, 325
- Fields, measurement of resistances of armatures and—by fall of potential method, 47
- Field turns, experimental determination of the number of—on a dynamo, 178
- Flux, variation of stray power with speed: useful—constant, 269
- Forms:
- Prony brake test, 374
 - Shop test, 365, 366, 367, 368, 369, 370
 - Stray power test, 372, 373
- Frequencies, classification of voltages and, 404

- Full load magnetization curves, compounding a dynamo from its no-load and, 195
- Fuses, tests of, 342
- Galvanometer:
 - Determination of the constant of a ballistic—by the condenser method, 57
 - Determination of the constant of a ballistic—by a standard solenoid, 59
- General electric ground detector, 36
- Hopkinson:
 - Magnetization and permeability tests of iron by the—method, 67
 - Opposition method of testing dynamo machines, 277
- Hot wire instruments, 38
- Hoyt:
 - Ammeters and voltmeters, 19
 - Wattmeter, 22, 26
- Hutchinson opposition method of testing dynamo machines, 293
- Hysteresis tester, hysteresis tests of iron using a, 98
- Hysteresis tests of iron by the ballistic method, 91
- Hysteresis tests of iron using a hysteresis tester, 98
- Inductance factor, power factor and, 409
- Instantaneous contact, magnetic distribution by the method of—185
- Instruments, 13
 - Alternating current, 14
 - Ammeters:
 - Ayrton & Perry, 16; Brush Arc, 16; Edison station, 16; Hoyt, 19; Jewell, 29; Keystone, 29; Olivetti, 39; simple hot wire, 39; Stanley, 39; Stanley, hot wire, 40; Thomson, astatic, 33; Thomson, inclined coil, 19; Westinghouse, 16; Westinghouse station, 16; Weston, direct-current, 29, 31, 32
 - Astatic, 32
 - Balance, Kelvin, 21
 - Balance, Kelvin electrostatic, 34
 - Calibration of, 45
 - Classification of, 15
 - Direct current, Weston, 29
 - Dynamometer, Siemens, 21
 - Electro-dynamometer type, 19
 - Electrostatic:
 - Ground detectors, 35; ground detector, General Electric, 36; multicellular voltmeters, 34; voltmeters, Kelvin, 34, 35; voltmeters, Stanley, 35, 37, 38
 - Hot wire,
 - Cardew, 39; Olivetti, 39; Stanley, 40
 - Indicators:
 - General Electric current and potential, 16
 - Kelvin balance, 21
 - Magnetic vane, 17
 - Mechanism of Weston direct current, 29
 - Multipliers, 42
 - Qualities of good, 13
 - Siemens dynamometer, 21
 - Solenoid and plunger type, 15
 - Transformers, high tension pressure, 43
 - Types of, 15
 - Use of, 41
 - Voltmeters:
 - Ayrton & Perry, 16; Cardew, 39; Edison station, 16; Hoyt, 18; Jewell, 29; Kelvin, 34, 35; Keystone, 29; Olivetti, 39; Stanley, hot wire, 39; Stanley electrostatic, 35, 37, 38; Thomson, astatic, 33; Thomson inclined coil, 19; Westinghouse station, 16; Weston, alternating current, 21, 22, 23, 24; Weston direct current, 29, 30, 31
 - Wattmeters:
 - Hoyt, 21, 26; Thomson, 21, 27, 28; Weston, 21, 25
 - Insulation, 396
 - Insulation resistance, measurement of—of a dynamo, 50
 - Integrating wattmeter, calibration of a Thomson, 338
 - Iron:
 - Hysteresis tests of—by the ballistic method, 91
 - Hysteresis tests of—using a hysteresis tester, 98
 - Magnetization and permeability tests of—using the Ewing permeability bridge, 85

- Magnetization and permeability tests of—by the Hopkinson method, 67
- Magnetization and permeability tests of—by the Rowland method, 62
- Magnetization and permeability tests of—by tractive methods, 72
- Jewell ammeters and voltmeters, 29
- Kapp opposition method of testing dynamo machines, 283
- Kelvin:
- Balance, 21
 - Balance, calibration of a voltmeter by means of a, 125
 - Balance, calibration of an ammeter by means of, 122
 - Electrostatic instruments, 34, 35
- Keystone ammeters and voltmeters, 29
- Lamps:
- Study of constant current arc, 359
 - Study of constant pressure arc, 348
- Leakage coefficient of a dynamo or motor, 146
- Location of faults in armatures, 326
- Loss line:
- Compounding of a shunt dynamo from its magnetization curve, external characteristic and, 163
 - Determination of—of series dynamo from its magnetization curve and external characteristic, 162
 - Derivation of the—of a shunt dynamo from its magnetization curve and external characteristic, 160
- Luminous sources, 406
- Magnetic vane instruments, 17
- Magnetic distribution:
- By ballistic method, 190
 - By the method of instantaneous contact, 185
 - In the air gap of a dynamo or motor: double pilot brush method, 183
 - In the air gap of a dynamo or motor; single pilot brush method, 180
- Magnetization and permeability tests of iron:
- By the Hopkinson method, 67
 - By the Rowland method, 62
 - By tractive methods, 72
 - Using the Ewing permeability bridge, 85
- Magnetization curve:
- Compounding of a shunt dynamo from its—external characteristic and loss line, 163
 - Derivation of loss line of series dynamo from its—and external characteristic, 162
 - Derivation of the loss line of a shunt dynamo from its—and external characteristic, 160
 - Of a shunt dynamo at full load current, 194
- Magnetization curves:
- Compounding a dynamo from its no-load and full-load, 195
 - Of dynamos, 141
- Measurement of insulation resistance of a dynamo, 50
- Measurement of power, rating of a shunt motor for, 274
- Measurement of resistances of armatures and fields by fall of potential method, 47
- Mechanical strength, 361
- Mechanism of (Weston) direct current instruments, 29
- Method of added turns, compounding of a shunt dynamo by the, 167
- Motor:
- Efficiency of a:
 - By the Prony brake method, 252; dynamo or—by the cradle dynamometer, 255; dynamo or—by the stray power method, 258
 - Experimental illustration of the operation of a—whose field is supplied by armature reaction, 325
 - Leakage coefficient of a dynamo or, 146
 - Magnetic distribution in the air gap of a dynamo or—double pilot brush method, 183
 - Magnetic distribution in the air gap of a dynamo or—single pilot brush method, 180
 - Regulation of cumulative compound—on a constant pressure circuit, 236

- Regulation of a differential compound—on a constant pressure circuit, 238
- Sparking test of a dynamo or, 196
- Static torque test of a, 206
- Temperature test of a dynamo or, 245
- Separately excited:
- Operation of a—on a constant current circuit, 226
 - Study of a—run by a series dynamo, 219
- Series:
- Operation of a—on a constant current circuit, 221
 - Operation of a—on a constant pressure circuit, 231
 - Regulation of a single—run from a similar series dynamo, 239
- Shunt:
- Rating of a—for measurement of power, 274; regulation of a—on a constant pressure circuit, 217; relation of speed to excitation in a, 210; relation of speed to pressure at the armature terminals of a—constant excitation, 208; relation of speed to terminal pressure in a, 213; study of a—run by a series dynamo, 221
- Shunt or separately excited:
- Relation of speed to excitation in a—when the resistance drop in the armature circuit is greater than the counter pressure, 336
- Motors:
- Adjustment of brushes of dynamo and, 55
 - Comparison of the direction of rotation as a motor with that of the same machine as a dynamo, the connections remaining the same, reversal of, 111
 - Study of the windings and connections of dynamos and, 53.
- Series:
- Starting of shunt and—on constant pressure circuits, 106
- Shunt:
- Starting of—and series motors on constant pressure circuits, 106
- Motor-generator, efficiency and regulation of a, 329
- Multiplier for voltmeters and wattmeters, 42
- No-load and full-load magnetization curves, compounding a dynamo from its, 195
- Nomenclature, xiii
- Notation, 409
- Number of field turns on a dynamo, experimental determination of the, 178
- Olivetti hot wire instruments, 39
- Operation:
- Connection and—of arc dynamos in series, 314
 - Connection and—of compound dynamos in parallel, 311
 - Connection and—of series dynamos in parallel, 308
 - Connection and—of shunt dynamos in parallel, 304
 - Connection and—of two dynamos on three wire system, 316
 - Experimental illustration of the—of a motor whose field is supplied by armature reaction, 325
 - Of a separately excited motor on a constant current circuit, 226
 - Of a series motor on a constant current circuit, 221
 - Of a series motor on a constant pressure circuit, 231
- Opposition method:
- Blondel—of testing dynamo machines, 300
 - Hopkinson—of testing dynamo machines, 277
 - Hutchinson—of testing dynamo machines, 298
 - Kapp—of testing dynamo machines, 283
 - Potier—of testing dynamo machines, 287
- Order of commercial test, 371
- Original data: 4
- Obtaining of, 5
- Overload capacities, 405
- Permeability bridge, magnetization and permeability tests of iron using the Ewing, 85
- Permeability tests:
- Magnetization and—of iron by the Hopkinson method, 67

- Magnetization and—of iron by the Rowland method, 62
- Magnetization and—of iron by tractive methods, 72
- Magnetization and—of iron using the Ewing permeability bridge, 85
- Pilot brush method:
 - Magnetic distribution in the air gap of a dynamo or motor by the double, 183
 - Magnetic distribution in the air gap of a dynamo or motor by the single, 180
- Potentiometer method:
 - Calibration of an ammeter by the, 127
 - Calibration of a voltmeter by the, 131
- Potier opposition method of testing dynamo machines, 287
- Power factor and inductance factor, 409
- Power:
 - Rating of a shunt motor for measurement of, 274
 - Stray:
 - Separation of the total—into its components, 263; Variation of—with speed; useful flux constant, 269; variation of—with useful flux; speed constant, 271
- Pressure, relation of speed to:
 - At the armature terminals of a shunt dynamo: constant excitation, 208
 - In a separately excited dynamo, 201
 - In a shunt dynamo, 202
 - In an arc dynamo, 204
 - Terminal—in a shunt motor, 213
- Pressure transformers, 42
- Prony brake, efficiency of a motor by the—method, 252
- Prony brake test, form, 374
- Pulsation, variation and, 403
- Qualities of a good instrument, 13
- Rating, 403
- Rating of a shunt motor for measurement of power, 274
- Regulation, 363, 399
- Regulation:
 - Efficiency and—of a dynamotor, 332
 - Efficiency and—of a motor-generator, 329
 - Of a cumulative compound motor on a constant pressure circuit, 236
 - Of a differential compound motor on a constant pressure circuit, 238
 - Of a shunt motor on a constant pressure circuit, 217
 - Of a single series motor run from a similar series dynamo, 239
 - Test of a three-wire dynamo, 319
- Relation of speed:
 - To excitation in a shunt motor, 210
 - To excitation in a shunt or separately excited motor when the resistance drop in the armature circuit is greater than the counter pressure, 336
 - To pressure at the armature terminals of a shunt motor: constant excitation, 208
 - To pressure in a separately excited dynamo, 201
 - To pressure in a shunt dynamo, 202
 - To pressure in an arc dynamo, 204
 - To terminal pressure in a shunt motor, 213
- Report, written, 5
- Resistance drop, relation of speed to excitation in a shunt or separately excited motor when the—in the armature circuit is greater than the counter pressure, 336
- Resistance, measurement of the insulation—of a dynamo, 50
- Resistances of armatures and fields, measurement of—by fall of potential method, 47
- Reversal of motors, comparison of the direction of rotation as a motor with the same machine run as a dynamo, the connections remaining the same, 111
- Reversal, of rotation, effect of—and excitation on the direction of pressure of a dynamo, 105
- Rise of temperature, 362, 392

Rotation:

- Reversal of motors, comparison of the direction of—as a motor with that of the same machine run as a dynamo, the connections remaining the same, 111
- The effect of reversal of—and reversal of excitation on the direction of pressure of a dynamo, 105
- Rowland method, magnetization and permeability tests of iron by, 62
- Series motors, starting of—on constant pressure circuits, 106
- Series winding, adjustment of compounding of a dynamo by shunting the, 170
- Separately excited motor, relation of speed to excitation in a shunt or—when the resistance drop in the armature circuit is greater than the counter pressure, 336
- Separation of the total stray power into its components, 263
- Shop tests, 361
- Shunt motors, starting of—on constant pressure circuits, 106
- Shunt or separately excited motor, relation of speed to excitation in a—when the resistance drop in the armature circuit is greater than the counter pressure, 336
- Shunting the series winding, adjustment of compounding of a dynamo by, 170
- Siemens electro-dynamometer, 21
- Solenoid, standard, determination of the constant of a ballistic galvanometer by a, 59
- Sparking distances, table of, 410
- Sparking test of a dynamo or motor, 196
- Special commercial tests, 375
- Speed:
 - Adjustment of compounding of a dynamo by changing the, 172
 - Relation of:
 - And pressure at the armature terminals of a shunt motor: constant excitation, 208; and pressure in a separately excited dynamo, 201; and pressure in a shunt dynamo, 202; and pressure in an arc dynamo, 204; to excitation in a shunt motor, 210; to excitation in a shunt or separately excited motor when the resistance drop in the armature circuit is greater than the counter pressure, 336; to terminal pressure in a shunt motor, 213
 - Variation of stray power with useful flux—constant, 271
 - Variation of stray power with—useful flux constant, 269
- Standard solenoid, determination of the constant of a ballistic galvanometer by, 59
- Stanley electrostatic voltmeter, 35, 37, 38
- Stanley hot wire ammeters and voltmeters, 39, 40
- Starting of shunt and series motors on constant pressure circuits, 106
- Static torque test of a motor, 206
- Stray power:
 - Separation of the total—into its components, 263
 - Test form, 372, 373
 - Variation of—with speed: useful flux constant, 269
 - Variation of—with useful flux: speed constant, 271
- Stray power method, efficiency of a dynamo or motor by the, 258
- Storage cell, test of a, 356
- Study of:
 - A separately excited motor run by a series dynamo, 219
 - A shunt motor run by a series dynamo, 221
 - Constant current arc lamps, 350
 - Constant pressure arc lamps, 348
 - The windings and connections of dynamos and motors, 53
- Switchboard connections, 4
- Table of sparking distances, 410
- Temperature, 362, 392
- Temperature test of a dynamo or motor, 245
- Terminal pressure, relation of speed to—in a shunt motor, 213
- Test:
 - Regulation—of a three-wire dynamo, 319
 - Sparking—of a dynamo or motor, 196
 - Static torque—of a motor, 206

- Temperature—of a dynamo or motor, 245
 Of a storage cell, 356
 Of a tractive electro-magnet, 351
- Testing, general methods of, 1
- Tests:
- Hysteresis—of iron by the ballistic method, 91
 - Of direct current circuit breakers, 346
 - Of fuses, 342
 - Of iron:
 - Hysteresis—using a hysteresis tester, 98; magnetization and permeability—by the Hopkinson method, 67; magnetization and permeability—by the Rowland method, 62; magnetization and permeability—by tractive methods, 72; magnetization and permeability—using the Ewing permeability bridge, 85
- Testing dynamo machines:
- Blondel opposition method of, 300
 - Hopkinson opposition method of, 277
 - Hutchinson opposition method of, 293
 - Kapp opposition method of, 283
 - Potier opposition method of, 287
- Thomson:
- Astatic instruments, 33
 - Inclined coil instruments, 19
 - Wattmeter, 21, 27, 28
 - Integrating wattmeter, calibration of, 338
- Three-wire dynamo, regulation test of a, 319
- Three-wire system, connection and operation of two dynamos on, 316
- Tractive electromagnet, test of a, 351
- Tractive methods, magnetization and permeability tests of iron by, 72
- Torque, static—test of a motor, 206
- Use of instruments, 41
- Useful flux:
- Variation of stray power with —speed constant, 271
 - Variation of stray power with speed: —constant, 269
- Variation of stray power with:
- Speed: useful flux constant, 269
 - Useful flux: speed constant, 271
- Voltages and frequencies, classification of, 404
- Voltmeter:
- Calibration of a voltmeter, using a copper, 138
 - Calibration of an ammeter, using a copper, 133
- Voltmeter:
- Calibration of a:
 - By comparison with a standard voltmeter, 119; by means of a Kelvin balance, 125; by the potentiometer method, 131; using a copper voltmeter, 138
- Wattmeter, calibration of a Thomson integrating, 338
- Wattmeter:
- Hoyt, 22, 26
 - Thomson, 21, 27, 28
 - Weston, 21, 25
- Weston:
- Alternating current voltmeter, 21, 22, 23, 24
 - Ammeters and voltmeters, 29, 30, 31, 32
 - Wattmeter, 21, 25
- Windings, study of—and connections of dynamos and motors, 53
- Written report:
- Contents of, 5
 - Sample of, 6

THIS BOOK IS DUE ON THE LAST DATE
STAMPED BELOW

AN INITIAL FINE OF 25 CENTS
WILL BE ASSESSED FOR FAILURE TO RETURN
THIS BOOK ON THE DATE DUE. THE PENALTY
WILL INCREASE TO 50 CENTS ON THE FOURTH
DAY AND TO \$1.00 ON THE SEVENTH DAY
OVERDUE.

OCT 5 1932

DEC 7 1940 M.

NOV 23 1932

MAR 8 1941 M

OCT 10 1939

NOV 15 1937

NOV 1 1939

APR 1 1942 E

OCT 3 1940

OCT 24 1940 M

NOV 20 1940

YC 69095

