







IN MEMORIAM



ROBERT HOLMES

R  C  A  
FOR MANY YEARS A TEACHER  
IN THIS COLLEGE     
THIS BOOK IS ONE OF A NUMBER  
FROM THE LIBRARY OF MR HOLMES  
PRESENTED TO THE ONTARIO  
COLLEGE OF ART BY HIS RELATIVES  
JUNE  1930



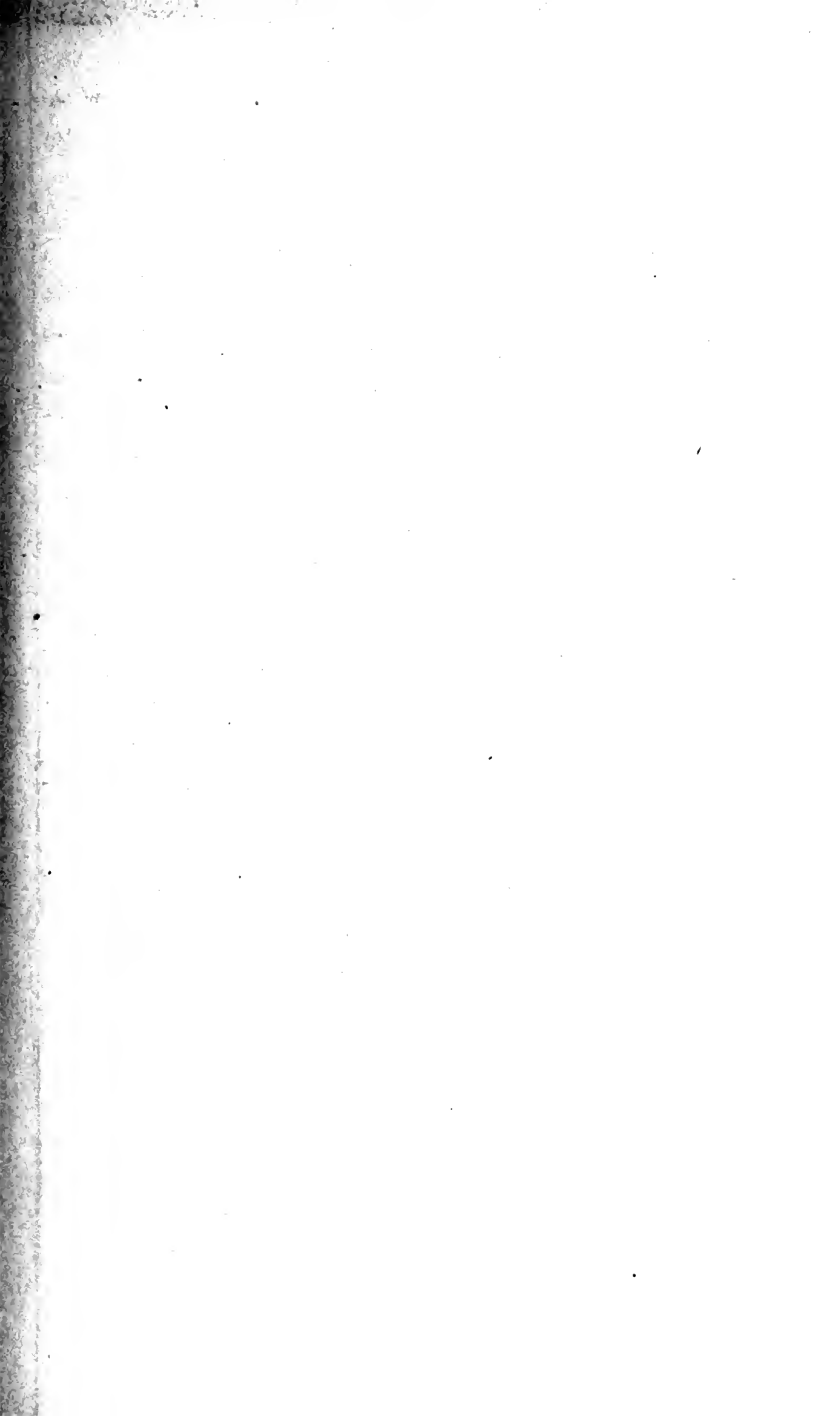



A TEXTBOOK OF BOTANY FOR COLLEGES

ONTARIO COLLEGE OF ART

100 McCAUL ST.

TORONTO 2B, ONTARIO



THE MACMILLAN COMPANY  
NEW YORK • BOSTON • CHICAGO • DALLAS  
ATLANTA • SAN FRANCISCO

MACMILLAN & CO., LIMITED  
LONDON • BOMBAY • CALCUTTA  
MELBOURNE

THE MACMILLAN CO. OF CANADA, LTD.  
TORONTO

# A TEXTBOOK OF BOTANY

FOR COLLEGES

BY

WILLIAM F. GANONG, PH.D.

PROFESSOR OF BOTANY IN SMITH COLLEGE

New York

THE MACMILLAN COMPANY

1927

*All rights reserved*

735

8

COPYRIGHT, 1916 AND 1917,  
BY THE MACMILLAN COMPANY.

---

Set up and electrotyped. Published August, 1917. Reprinted  
October, 1917; May, October, 1918; August, September, 1919;  
January, August, December, 1920; November, 1921; January,  
1923; January, 1924; April, 1926; June, 1927.

Norwood Press  
J. S. Cushing Co. — Berwick & Smith Co  
Norwood, Mass., U.S.A.

## PREFACE

THIS book is written in recognition of the fact that to nearly all college students an introductory course in Botany is part of a general education, and not a preparation for a professional botanical career. The distinction is important because our existent courses are largely adapted, even though unconsciously on our part, to the latter end. The needs in the two cases are not the same, though the difference is less in matter and method than in proportion and emphasis. All students alike need that personal contact with specific realities, and that exercise in verifiable reasoning, which laboratory courses render possible. Knowledge, however, is valuable to the specialist in proportion to its objective importance, but is useful to the general student in accordance with its bearing on the actions and thoughts of mankind. In the one case the demands of the science are paramount and in the other the interests of the student.

This aim to provide for the general rather than the special student will explain certain characteristics of the book,— notably its emphasis upon the larger and more evident phenomena, its attention to the interpretation or “principle” of things, and its full consideration of man’s relations to plants. Indeed, the book may be described as an attempt to present and interpret the humanly important aspects of plant nature in the light of our modern scientific knowledge. For the same reason the book is deliberately conservative, and adopts only such statements and views as have passed the test of wide criticism, and attained to the impersonal, and non-institutional, validity of science.

The book is intended to be used in conjunction with systematic laboratory work, around which is thus to be welded

the general content of the science. Its use is not dependent, however, upon any particular sequence of topics, for the material is presented in the form of semi-independent essays intended to be separately understandable. Obviously there is far more in the book than can be touched in a year in the laboratory, but every topic thus studied should form a leaven of objective understanding for many contiguous subjects. From the abounding wealth of material it has been difficult to select, and it is not supposable that the choice will please everybody, any more than will all the particulars of the treatment. Perhaps, however, the various objections will to some extent counterbalance one another. At all events, I have tried to present systematically and in good proportion the salient and essential matters in our scientific knowledge of plants.

The illustrations are taken from many sources, which are acknowledged with the cuts in all cases except where they are new. It is surely as legitimate to use a good published picture as a good published idea, of course with due credit, and, moreover, its use seems a deserved tribute to its excellence such as its author would desire. Many are taken from the well-known works of Sachs, Goebel, Kerner, Gray, and Strasburger, and are so good that better can hardly be made; and we should not deprive the student of their use, or waste labor in providing inferior new ones, only because the frequency of their appearance has made them wearisome to us. Messrs. Henry Holt and Company have given me full permission to use pictures from Kerner's work, as well as two from Sargent's *Plants and their Uses*, and several from my own book *The Living Plant*, published by them. Also I have used many, by permission, from publications of The Macmillan Company, and especially from one of the greatest of botanical publications, the *Cyclopedia of American Horticulture*, edited by Professor L. H. Bailey, who has graciously granted me the privilege of drawing at will from that work. The Bausch & Lomb Optical Company have



kindly loaned me several cuts from their catalogues illustrating apparatus of my own invention made by them. The new illustrations, comprising about a third of those in the book, have mostly been contributed by my colleagues in the department of Botany at Smith College. Several of the more notable of the figures, especially those in groups, viz., 62, 210, 213, 215, 298, 304, 311, 312, 318, 319, 321, 355, were drawn from nature by Professor Julia W. Snow, while the more elaborate of the anatomical drawings, viz., 85, 162, 163, 164, were drawn, also from nature, by Professor F. Grace Smith. The best of the diagrammatic figures, viz., 81, 169, 182, 191, 222, 225, 226, 227, and 228, are the work of Miss Helen Choate, though the other diagrams are my own. Most of the remainder of the new figures, including several from nature, many from photographs, and a large number adapted from standard sources, are the work of my assistant, Miss Marion T. Pleasants. In many other ways also, these friendly co-workers, with another, Professor Grace Clapp, have rendered invaluable aid, which I hereby gratefully acknowledge.

This work was at first issued in two separate parts, and I have taken advantage of their combination into one volume to remedy some slight defects in the first impression, of which the only ones of importance are corrections of minor errors on pages 100, 108, and 254.

A good many teachers have asked me whether laboratory outlines are planned to accompany this text. It happens that they exist already, for Part II of my book *The Teaching Botanist* (second edition, also published by the Macmillan Company), is devoted to outlines and full practical directions for teaching the topics of a general laboratory course. While not prepared especially to accompany this book, they accord with it so closely as to render needless an additional work.

W. F. GANONG.

NORTHAMPTON, MASS.,  
June 26, 1917.



# CONTENTS

## INTRODUCTION

	PAGE
CHAPTER I. THE SCOPE AND VALUE OF BOTANICAL STUDY . . .	1
CHAPTER II. THE DISTINCTIVE CHARACTERISTICS OF PLANTS . . .	7

## PART I

### THE STRUCTURES AND FUNCTIONS OF PLANTS

CHAPTER III. THE MORPHOLOGY AND PHYSIOLOGY OF LEAVES . . .	15
§ 1. The distinctive characteristics of leaves . . . . .	15
§ 2. The structure of leaves . . . . .	17
§ 3. The synthesis of food by light in leaves . . . . .	19
§ 4. The cellular anatomy of leaves . . . . .	28
§ 5. The characteristics of protoplasm . . . . .	35
§ 6. The water-loss, or transpiration, from plants . . . . .	43
§ 7. The adjustments of green tissues to light . . . . .	52
§ 8. The various forms of foliage leaves . . . . .	58
§ 9. The forms and functions of leaves other than foliage . . . . .	72
§ 10. The nutrition of plants which lack chlorophyll . . . . .	82
§ 11. The autumnal and other coloration of leaves . . . . .	88
§ 12. The economics, and treatment in cultivation, of leaves . . . . .	94
§ 13. The uses of the photosynthetic food . . . . .	97
CHAPTER IV. THE MORPHOLOGY AND PHYSIOLOGY OF STEMS . . . . .	113
§ 1. The distinctive characteristics of stems . . . . .	113
§ 2. The structure of stems and support of the foliage . . . . .	115
§ 3. The cellular anatomy of stems . . . . .	128
§ 4. The development of stems and leaves from buds . . . . .	135
§ 5. The arrangements of leaves on stems . . . . .	139
§ 6. The transfer of water and food through plants . . . . .	144
§ 7. The growth of stems and other plant parts . . . . .	153

	PAGE
§ 8. The respiration of plants . . . . .	162
§ 9. The geotropism of stems . . . . .	174
§ 10. The various forms of foliage-bearing stems . . . . .	179
§ 11. The forms and functions of stems not connected with support of foliage . . . . .	191
§ 12. The monstrosities of stems and leaves . . . . .	196
§ 13. The economics, and treatment in cultivation, of stems . . . . .	205
 <b>CHAPTER V. THE MORPHOLOGY AND PHYSIOLOGY OF ROOTS . . . . .</b>	<b>212</b>
§ 1. The distinctive features of roots . . . . .	212
§ 2. The structure of roots . . . . .	215
§ 3. The cellular anatomy of roots . . . . .	220
§ 4. The absorption of water, and other functions of roots . . . . .	224
§ 5. Osmotic processes in plants . . . . .	232
§ 6. The composition and structure of soils . . . . .	237
§ 7. The self-adjustments of roots to prevailing conditions . . . . .	247
§ 8. The additional, and substitute, functions of roots . . . . .	250
§ 9. The economics, and treatment in cultivation, of roots . . . . .	257
§ 10. Summary of the functions and tissues of plants . . . . .	261
 <b>CHAPTER VI. THE MORPHOLOGY AND PHYSIOLOGY OF FLOWERS . . . . .</b>	<b>267</b>
§ 1. The distinctive features of flowers . . . . .	267
§ 2. The structure of flowers . . . . .	269
§ 3. The accomplishment of fertilization by flowers . . . . .	276
§ 4. The nature and consequences of fertilization . . . . .	279
§ 5. The methods and meaning of cross-pollination . . . . .	286
§ 6. Methods of asexual reproduction . . . . .	298
§ 7. The origin and significance of sex . . . . .	302
§ 8. Heredity, variation, and evolution . . . . .	308
§ 9. The methods used by man in breeding better plants . . . . .	317
§ 10. The morphology of flowers . . . . .	322
§ 11. The morphology and ecology of flower clusters . . . . .	335
§ 12. Special forms, abnormalities, and monstrosities of flowers . . . . .	340
§ 13. The economics, and treatment in cultivation, of flowers . . . . .	343
 <b>CHAPTER VII. THE MORPHOLOGY AND PHYSIOLOGY OF FRUITS . . . . .</b>	<b>345</b>
§ 1. The distinctive characteristics of fruits . . . . .	345
§ 2. The structure and morphology of fruits . . . . .	347
§ 3. The dissemination and dispersal of plants . . . . .	356
§ 4. Special forms and monstrosities of fruits . . . . .	366
§ 5. The nature and cure of plant diseases . . . . .	367
§ 6. The economics and cultivation of fruits . . . . .	370

	PAGE
CHAPTER VIII. THE MORPHOLOGY AND PHYSIOLOGY OF SEEDS . . . . .	372
§ 1. The distinctive characteristics of seeds . . . . .	372
§ 2. The structure, morphology, and functions of seeds . . . . .	373
§ 3. The suspension of vitality, resting period, and duration of life in seeds . . . . .	377
§ 4. The germination of seeds . . . . .	381
§ 5. The economics and cultivation of seeds . . . . .	385
§ 6. The cycle of development from seed to seed . . . . .	386

PART II

THE KINDS AND RELATIONSHIPS OF PLANTS

	PAGE
CHAPTER IX. THE PHYLOGENETIC CLASSIFICATION OF PLANTS . . . . .	391
CHAPTER X. DIVISION 1. THALLOPHYTA: THE THALLUS PLANTS	396
Class 1. Cyanophyceæ: the Blue-Green Algæ . . . . .	399
Class 2. Schizomycetes: the Bacteria . . . . .	402
Class 3. Flagellata: the Flagellates . . . . .	410
Class 4. Myxomycetes: the Slime Molds . . . . .	412
Class 5. Chlorophyceæ: the Green Algæ . . . . .	415
Order 1. Protococcales: the Unicellular Green Algæ . . . . .	416
Order 2. Confervales: the Confervoid Algæ . . . . .	420
Order 3. Conjugales: the Conjugating Algæ . . . . .	424
Order 4. Siphonales: the Tubular Algæ . . . . .	429
Order 5. Charales: the Stoneworts . . . . .	432
Class 6. Phycomycetes: the Algal Fungi . . . . .	434
Order 1. Saprolegniales: the Water Molds . . . . .	435
Order 2. Peronosporales: the Blights . . . . .	436
Order 3. Mucorales: the True Molds . . . . .	437
Class 7. Phæophyceæ: the Brown Algæ . . . . .	439
Order 1. Phæosporales: the Kelps . . . . .	440
Order 2. Fucales: the Rockweeds . . . . .	442
Class 8. Rhodophyceæ: the Red Algæ . . . . .	443
Class 9. Ascomycetes: the Sac Fungi . . . . .	447
Order 1. Discomycetes: the Cup Fungi . . . . .	450
Order 2. Pyrenomycetes: the Black Fungi . . . . .	452
Order 3. Erysipheæ: the Powdery Mildews . . . . .	455
Order 4. Plectascales: the Blue and Green Molds . . . . .	456
Order 5. Exoasci: the Naked-ascus Fungi . . . . .	458
Order 6. Saccharomycetes: the Yeasts . . . . .	458
Order 7. Lichenes: the Lichens . . . . .	459

	PAGE
Class 10. Basidiomycetes : the Basidia Fungi . . . . .	463
Order 1. Ustilaginales : the Smuts . . . . .	464
Order 2. Uredinales : the Rusts . . . . .	465
Order 3. Hymenomycetes : the Toadstool Fungi . . . . .	470
Order 4. Gasteromycetes : the Puffballs . . . . .	474
Fungi Imperfecti . . . . .	476
 CHAPTER XI. DIVISION 2. BRYOPHYTA : THE MOSS PLANTS . . . . .	 478
Class 1. Hepaticæ : the Liverworts . . . . .	479
Order 1. Ricciales . . . . .	480
Order 2. Marchantiales . . . . .	480
Order 3. Jungermanniales . . . . .	482
Order 4. Anthocerotales . . . . .	483
Class 2. Musci : the Mosses . . . . .	484
Order 1. Sphagnales : the Peat Mosses . . . . .	485
Order 2. Bryales : the True Mosses . . . . .	487
 CHAPTER XII. DIVISION 3. PTERIDOPHYTA : THE FERN PLANTS . . . . .	 492
Class 1. Filicineæ : the Ferns . . . . .	494
Order 1. Ophioglossales : the Adder's Tongue Ferns . . . . .	494
Order 2. Filicales : the Ferns Proper . . . . .	495
Order 3. Hydropteridales : the Water Ferns . . . . .	499
Class 2. Equisetineæ : the Horsetails . . . . .	500
Class 3. Lycopodineæ : the Lycopods . . . . .	503
Order 1. Lycopodiales : the Club Mosses . . . . .	503
Order 2. Selaginellales : the Selaginellas . . . . .	505
 CHAPTER XIII. DIVISION 4. SPERMATOPHYTA : THE SEED PLANTS . . . . .	 512
Class 1. Gymnospermæ : the Gymnosperms . . . . .	516
Order 1. Cycadales : the Cycads . . . . .	517
Order 2. Coniferales : the Conifers . . . . .	519
Order 3. Gnetales : the Gnetums . . . . .	524
Class 2. Angiospermæ : the Angiosperms . . . . .	524
Sub-class 1. Monocotyledoneæ : the Monocotyledons . . . . .	527
Series A. The Primitive Monocotyledons . . . . .	529
Orders 1-5. Pandanales to Arales . . . . .	529
Series B. The Differentiated Monocotyledons . . . . .	534
Orders 6-7. Bromeliales to Liliales . . . . .	535
Series C. The Specialized Monocotyledons . . . . .	537
Orders 8-9. Scitaminales and Orchidales . . . . .	537
Sub-class 2. Dicotyledoneæ : the Dicotyledons . . . . .	539
Series A. The Primitive Dicotyledons . . . . .	540
Orders 1-12. Verticillales to Caryophyllales . . . . .	540

# CONTENTS

xiii

	PAGE
Series B. The Differentiated Dicotyledons . . . . .	545
Orders 13-24. Ranales to Umbellales . . . . .	546
Series C. The Specialized Dicotyledons . . . . .	553
Orders 25-32. Ericales to Campanulales . . . . .	553
 <b>CHAPTER XIV. THE ECOLOGICAL CLASSIFICATION OF PLANTS</b> . . . . .	558
1. The Ecological Groups . . . . .	558
2. Plant Habitats and Vegetation Forms . . . . .	559
(1) The Water Habitats and the Hydrophytes . . . . .	561
(2) The Aërial Habitats and the Aërophytes . . . . .	564
A. The Optimum Habitats and the Mesophytes . . . . .	566
B. The Humid-Dry Habitats and the Tropophytes . . . . .	567
C. The Dry Habitats and the Xerophytes . . . . .	569
D. The Undrained Habitats and the Helophytes . . . . .	571
E. The Saline Habitats and the Halophytes . . . . .	573
F. The Acid Soil Habitats and the Oxalophytes . . . . .	573
(3) The Organic Habitats and the Hysterophytes . . . . .	574
A. Habitats of Climbers . . . . .	575
B. Habitats of Epiphytes . . . . .	576
C. Habitats of Half-parasites . . . . .	577
D. Habitats of Parasites and Saprophytes . . . . .	577
E. Habit of Insectivorous Plants . . . . .	578
3. Plant Formations and Associations . . . . .	579
List of the Principal Formations . . . . .	584





# A TEXTBOOK OF BOTANY FOR COLLEGES

## INTRODUCTION

### CHAPTER I

#### THE SCOPE AND VALUE OF BOTANICAL STUDY

THE word BOTANY came originally from the Greek, where it meant simply grass, or herbage, especially that of a pasture. Its meaning, however, has expanded step by step with the progress of knowledge, until now it embraces every kind of scientific inquiry about plants. Thus the scope of the word, as of the science, has indeed become great. In the first place, plants themselves are wonderfully diverse in appearance, structure, and habits, for they comprise not only the familiar trees, shrubs, and herbs, with ferns, mosses, and seaweeds, but also the mushrooms, molds, yeasts, and germs of disease and decay. Furthermore, the number of distinct kinds, or species, is far greater than most people imagine. Of plants having flowers, no less than some 133,000 separate species have already been described and named by botanists, while of the flowerless kinds, which reproduce by spores, some 100,000 species are likewise known, making 233,000 in all. It is believed, however, that a good many others remain to be discovered, probably enough to bring up the number of the flowering kinds to 150,000 and of the flowerless to the same number, making at least 300,000 in all. As to the kinds of facts which botanists are trying to discover concerning this multitude of diversified plants, there are no limitations, because no bounds exist to the intellectual

curiosity of scientific men, nor is there any way of determining in advance which new facts will prove interesting to them or important to mankind.

The study of Botany is pursued for three purposes, — pleasure, progress, and profit. *First*, as to pleasure, its pursuit in any intellectual field is one of the most rational and elevating of human activities. There are those who take as much delight in a close personal acquaintance with plants, or in a clear understanding of their construction and processes, as others find in a knowledge of literature, history, art, or the drama; and the one pursuit is entitled to the same sympathetic approbation as the others. *Second*, as to progress, all experience shows that an individual advances precisely as a race does, — through constant intellectual effort; and for such exercise there exists no more natural field than the scientific investigation of the surrounding world, of which plants comprise the most conspicuous part. *Third*, as to profit, that is clear when one recalls the intimacy of man's dependence upon plants for the very essentials of civilized existence, — for food, shelter, raiment, and medicine, — in conjunction with the fact that they are readily capable of improvement under his hand, as attested by the magnificent flowers, luscious fruits, and nutritious vegetables which he has developed from insignificant wild ancestors. The fact that man can make plants serve still better his material uses would be reason enough, even were there no others, why he should study them thoroughly.

Thus the science of Botany has a scope far too vast, and a body of knowledge much too great, for any one mind to grasp. Therefore it has become subdivided for purposes of exact investigation. From this point of view, all Botany falls into four divisions, and they into subdivisions, as follows.

I. **SYSTEMATIC BOTANY**, the oldest and most fundamental of the divisions, now commonly called **TAXONOMY**, is concerned chiefly with the **CLASSIFICATION** of plants, that is, their arrangement in groups in accordance with their relation-

ships to one another. It includes exact description of the species, and application of scientific names, which are taken from Latin, as the principal language of learning. It has been studied mostly by observation and comparison of the prominent external parts of plants, especially the flowers and fruits; and for the convenience of such study, the plants are preserved in a pressed and dried condition in collections each called an HERBARIUM. For the use of students and other workers with plants, the classification, descriptions, and names of all the plants of a country are embodied synoptically in handbooks, commonly called MANUALS (or, if more elaborate, FLORAS), so arranged as to enable a student to find for himself the correct name of a plant previously unknown to him. An important subdivision of Systematic Botany is PALEOBOTANY, or the study of the plants which existed in past ages, as represented in their petrified, or fossil, remains found in the rocks, — a subject which throws great light upon the evolution of our present plants from their remote and very different ancestors.

II. MORPHOLOGY, second in age of the divisions, is the study of the parts, or structures, of plants, in comparison with one another. It therefore bears much the same relation to the parts of plants that classification bears to plants as a whole; and it is studied by the same methods of observation and comparison. When it leads from the large external to the small internal parts, thus requiring the aid of the microscope, it takes the name ANATOMY, while if it goes deeper yet, into the minute construction of the ultimate smallest parts (called cells), it is termed CYTOLOGY, — the two latter terms together replacing the older term HISTOLOGY. An important phase is EMBRYOLOGY, the study of the stages in development of the individual before its birth or germination, all of its stages collectively constituting its “life-history.”

III. PHYSIOLOGY, third in age of the divisions, is precisely the same study in connection with plants as it is with ani-

mals, including mankind, viz., the study of the organic processes or functions. It is pursued by the exact experimental methods of physics and chemistry, and indeed may be described as the physics and chemistry of plant life. Dealing thus with matters of the most fundamental nature, its discoveries frequently prove not only of the highest scientific interest, but also, as will presently appear, of great economic importance. One of its phases, that which concerns the relations of structure and habit to the conditions under which plants live, has attained to a prominence requiring a name of its own, viz., **ECOLOGY**, — a term which has largely absorbed the older word **PLANT-GEOGRAPHY**, meaning the distribution of plants in light of its causes. Still more recently another phase of physiology has become prominent, viz., **GENETICS**, the experimental study of the facts and methods of heredity.

IV. **ECONOMIC BOTANY**, also known as **PLANT INDUSTRY**, extremely old as an empirical study though very new as a scientific one, is the investigation of plants with reference to their improvement for the uses of mankind. It comprises a number of well-known subdivisions, viz., scientific **AGRICULTURE**, **HORTICULTURE**, and **FORESTRY**, with others less familiar, viz., **BACTERIOLOGY**, the study of disease germs, and other kinds; **PHARMACOLOGY**, dealing with drugs; **PATHOLOGY** (**PHYTOPATHOLOGY**) concerned with the diseases of plants; and **PLANT-BREEDING**, or the systematic attempt to produce new and superior kinds, — a subject closely interlocked with Genetics. Economic Botany is the special field of Agricultural Experiment Stations maintained by civilized governments the world around, including the United States Department of Agriculture and the State Experiment Stations and Agricultural Colleges in this country, excepting that Bacteriology belongs primarily to the Medical Schools. The other three divisions, Systematic Botany, Morphology, and Physiology, are cultivated particularly in the Universities.

These divisions, and subdivisions, of Botany are primarily determined by convenience of study, especially with reference to the methods and instruments employed. Having really no natural boundaries, they intergrade and interlock very closely, on which account the progress of one depends upon progress of the others. Thus, most phases of Economic Botany are so dependent upon Physiology in particular, that the greater Experiment Stations, maintained primarily for economic research, are well-nigh as active in Physiology as are the Universities. This case is typical of the relation which exists everywhere between economically useful and scientifically abstract knowledge. The history of civilization has shown that the greater applications of science to human welfare, as exemplified in electricity, wireless telegraphy, or the control of germ diseases, have arisen not from researches directed to secure useful results, but incidentally as by-products of purely abstract investigations made in the pursuit of knowledge without thought of material returns. All experience shows that knowledge is a unit, of which economically useful knowledge is only an ill-defined and changing part; and the surest way to gain new useful knowledge is first to win new general knowledge, which is possible only through scientific research. For this reason the student who aspires to become a leader in any economic pursuit must first make himself master of its general or abstract knowledge. Such is likewise the reason for the emphasis laid in education as a whole upon subjects having no apparent economic utility.

The facts known about plants being so multitudinous, amounting it must be to millions, and far beyond comprehension by any one person, the student may well ask how it is possible to acquire that general understanding of plants implied in an introductory course, and textbook, of Botany. It is simply thus. The diversity of plants, so extensive and obvious, is really superficial, and rests upon foundations of similarity, which, deep, obscure, and dis-

coverable only by prolonged investigation, are relatively few in number. By utilizing these deep-lying resemblances, it is possible to link together great masses of facts in generalized form, and thus bring the principles of botanical knowledge within the comprehension of one person, who may then pursue in detail any particular phase which his pleasure or business may dictate.

## CHAPTER II

### THE DISTINCTIVE CHARACTERISTICS OF PLANTS

*THE UNIVERSE*, wrote the great Linnæus in the sonorous Latin of the "Systema Naturæ," *comprises everything which can come to our knowledge through the senses. THE STARS are very distant luminous bodies which circle in perpetual motion, and are either FIXED STARS shining by their own light like the Sun . . . or PLANETS deriving their light from the Fixed Stars. . . . THE EARTH is a planetary globe, rotating in twenty-four hours, moving in an orbit around the sun once a year . . . and covered by an immense mantle of NATURAL OBJECTS the exterior of which we try to know. . . . NATURAL OBJECTS . . . are divided into three KINGDOMS OF NATURE, MINERALS, PLANTS, and ANIMALS. . . . PLANTS are organized bodies which live but do not feel (or as we say, are not conscious).*

Such is the place in nature of plants, which the botanist is trying to know.

Of these plants there are many distinct kinds or SPECIES, probably some three hundred thousand, as noted already. Each species, however, consists of thousands, or millions, or perhaps billions, of INDIVIDUAL plants.

Individual plants, of the familiar kinds, are each composed of six primary parts, — LEAVES, STEMS, ROOTS, FLOWERS, FRUITS, and SEEDS. Each part performs a particular primary function to which it is fitted in structure. In the expanded thin green LEAVES food is made for the plant, under action of sunlight, from materials drawn from the air and the soil. The columnar elastic branching STEMS spread and support the leaves in the indispensable sunlight. The slender ROOTS, radiating and ramifying through the soil,

absorb the water and mineral salts needed by the plant, to which they give also a firm anchorage in the ground. The showy and complicated FLOWERS effect fertilization, which is requisite in all sexual reproduction. FRUITS, whether dry like pods, or edible like berries, are concerned with the formation and dissemination of seeds. The compact hard-coated SEEDS, containing each an embryo plant and food supply, separating from the parent plant, and remaining for a time dormant, provide a transportable stage whereby plants are spread. Thus each of the six primary parts performs a definite function in the economy of the plant as a whole, and each part is therefore, from the physiological point of view, an ORGAN. In addition each of these organs performs functions connected with its own individual existence, notably GROWTH, RESPIRATION, and SELF-ADJUSTMENT to the surroundings.

The external form of these primary parts, visible to the unaided eye, is correlated with a definite internal anatomy, revealed by thin sections viewed through magnifying lenses. Thus studied, the parts are found composed of definite and symmetrically arranged differentiations of structure called TISSUES, having each its distinctive position, color, and texture, and each performing a definite part of the organ's function. Thus the veins and green pulp are tissues of the leaf, as are bark, wood, and pith of the stem, though some of the latter are further divisible. These tissues in turn, when viewed by the compound microscope, are found wholly composed of very small structures called CELLS, which appear as compartments separated by firm walls and holding various contents. Of these contents the most important is the PROTOPLASM, a mobile, gelatinous material, the seeming simplicity of which is belied by its many remarkable properties. It is really the protoplasm which performs the functions of the plant, and which builds the cells, and therefore the tissues and organs, suited in structure to the work which is done by the respective parts.



While typical plants all have the same organs, they are not all alike, but differ greatly in habits, aspect, and details of structure. Some are TREES, tall, long-lived, and single-trunked, forming the canopy of forests. Others are SHRUBS, shorter and less lasting, branching from the ground, and forming the typical undergrowth. Others are HERBS, smallest and shortest-lived of all, soft-bodied and mostly green throughout, forming the carpet vegetation of the earth. Then there are plants which grow supported upon others, the CLIMBERS and EPIPHYTES: and the plants of strange aspect found in the deserts: and the WATER-PLANTS, including the seaweeds: and all of the great number of the small and simple PARASITES, which occur everywhere amongst other plants. Some kinds possess organs other than those we have mentioned, such as TENDRILS, PITCHERS, and TUBERS, always associated with special habits; but these parts prove on comparative study to be mostly transformed leaves, stems, or roots, though not all special structures have this origin.

The organs develop in the individual plants in definite predetermined cycles. Every plant normally originates in a fertilized EGG CELL, as does the animal in an egg. The egg cell, lying within the ovule inside the flower, is a microscopic protoplasmic sphere, at first without organs; but in the course of development it forms a stem and a few leaves, in which stage it is an EMBRYO within a seed inside a fruit. When, after dissemination, the seed germinates, the embryo develops a root, and more stem and leaves, becoming a SEEDLING, and with further repetition of those parts, ultimately an ADULT plant. Then it begins reproduction by developing FLOWERS, in which sexual cells, EGG CELLS and SPERM CELLS, are formed and brought together, making new fertilized egg cells, thus closing the cycle, which is repeated in perfect regularity, generation after generation.

Plants are not, however, merely aggregates of parts performing present functions, but include many relics of their

lives in the past. The evidence seems to show beyond question that our present species of plants have descended by gradual evolution from simpler and fewer species which formerly existed, and which in turn were evolved from still simpler and fewer kinds,—back, it is possible, to a single kind which thrived in remotest antiquity. In the course of this evolution, plants have diverged into the many groups, and groups within groups, expressed in our schemes of classification. Thus also various features originally distinctive of one species came to prevail through whole families, and even persist to the present, often having lost completely their original significance. It is the aim of botanists to distinguish between those features which have merely a temporary functional significance and those which are deeply fixed in heredity. They use the former in the interpretation of the phenomena of plant life, and the latter as guides to evolution and classification. Hence botanical study falls most fundamentally into the two phases represented by the two Parts of this book.

While the groups and classification of plants will receive full treatment in Part II, some general knowledge of the more important of such facts is essential to an understanding of Part I. The main groups, with their essential characteristics, are the following.

1. THE FLOWERING PLANTS, the most highly evolved and therefore often called the “higher plants,” comprise the great majority of the trees, shrubs, and herbs constituting the familiar land vegetation. They are distinguished not only by the possession of flowers, which often are extremely inconspicuous, but also, and especially, by their seeds, on which account they are called scientifically SPERMATOPHYTES, that is, “seed plants.” While mostly they dwell on the land with roots in the ground, and make their food in their green leaves, some live in water, and some upon other plants. They are clearly descended from the following

group, which is much older, as shown by fossil remains in the rocks.

2. THE FERNS AND THEIR KIN, called scientifically PTERIDOPHYTES or "Fern plants," comprise not only the familiar true Ferns, but also the less prominent Horsetails and Club Mosses. They have no flowers, but reproduce by small one-celled spores and a definite though not prominent sexual stage. They live chiefly on land, have green leaves, and make their own food. They are mostly undergrowth plants, though some in the tropics become trees. They have evolved (it is likely but not certain) from the following group, and were formerly more prominent than now, having once formed great forests, the earliest of such vegetation.

3. THE MOSSES AND THEIR KIN, called scientifically BRYOPHYTES or "Moss plants," comprise the true Mosses with the Liverworts. They reproduce like the Pteridophytes, by spores and a sexual stage. They have green leaves and make their own food, but they rise little from the ground, on which they grow densely together, thus forming the simplest carpet vegetation of the earth. They are descended from the Algæ, and were probably the first plants to cover the land.

4. THE MOLDS AND THEIR KIN, called scientifically FUNGI, comprise a great number of small or minute plants most of which are found associated with the disease and decay of plants or of animals, e.g., mushrooms, yeasts, molds, rots, rusts, mildews, and bacteria, — popularly known as microbes or germs. They occur in the most diverse situations, but always in contact either with living tissues, upon which they live PARASITICALLY, or else with dead organic substances, upon which they live SAPROPHYTICALLY. They are most diverse in forms, sizes, colors, and other features, in accordance with their particular habits, but never show the green color of the higher plants. They reproduce by minute spores, which are carried everywhere by the winds, thus explaining how those plants can occur in so many

situations. They are undoubtedly descended, as shown by many resemblances in structure, from the Algæ; and so close are their relationships that, from the point of view of classification, the two groups are properly included in one, called THALLOPHYTES, though in practice it is convenient to treat them separately.

5. THE SEAWEEDS AND THEIR KIN, called scientifically ALGÆ, comprise not only the red and brown seaweeds and "sea mosses" (which are green underneath those colors), but likewise many green kinds both of salt and fresh water. They live mostly under water, make their own food in their fronds, have diverse shapes with different habits, and reproduce both by simple spores and sexual stages. They are the simplest and most ancient of the leading groups, and the one from which the others are descended.

Algæ, Fungi, Bryophytes, and Pteridophytes are often called collectively CRYPTOGAMS, because their reproduction was once thought obscure, while the Spermatophytes are called PHANEROGAMS, because their reproduction, through flowers, was considered evident.

It is the primary aim of science to discover, analyze, describe, and classify the elemental facts of nature. It is a secondary aim to explain phenomena with which the facts are connected, though to all except specialists the explanations are hardly inferior in interest to the facts themselves. In this book, while the description of fact always comes first, explanations follow promptly after. The explanations of the phenomena exhibited by living plants fall under four categories. *First*, a great many features, especially those connected with the obvious fitness of form and structure to functions and habits, are best explained, in the opinion of a majority of biologists, as result of a process of gradual ADAPTATION of the modifiable plant to the unmodifiable physical surroundings during the course of evolution. *Second*, other features are clearly survivals, of no other present sig-

nificance, from ancestral forms, as noted already under HEREDITY. *Third*, plants are still in process of evolution, and hence, for causes and by methods still unknown, are constantly developing new features called variations, or better, — MUTATIONS. *Fourth*, the adaptations, the heredity, and the mutations of plants are all more or less affected, and even in some degree directed, by the chemical nature of the materials they are composed of, and the physical forces playing upon them from the world in which they live; and on this account many of their features have a purely incidental, or mechanical, or, as we may designate them collectively, STRUCTURAL significance. Thus the actual plant embodies the resultant of the simultaneous action upon it of adaptational, hereditary, mutational, and structural, with some other minor, factors. It is the task of the botanist to distinguish and separate the various influences which make the plant what it is, for which purpose he needs above all an open mind, a willingness to weigh all forms of evidence, and freedom from the human but unscientific tendency to adopt some single favorite viewpoint and explain all phenomena therefrom. Many matters in science are interpreted differently by equally competent investigators, but discussion and further investigation always bring the truth, for the recognition of which we have only one test, — it is that upon which the great majority of competent investigators, after full and disinterested investigation, agree.

The generalized statements of this chapter are intended to enable the student to approach his study with better understanding. We turn now to the concrete facts and phenomena of plant nature.

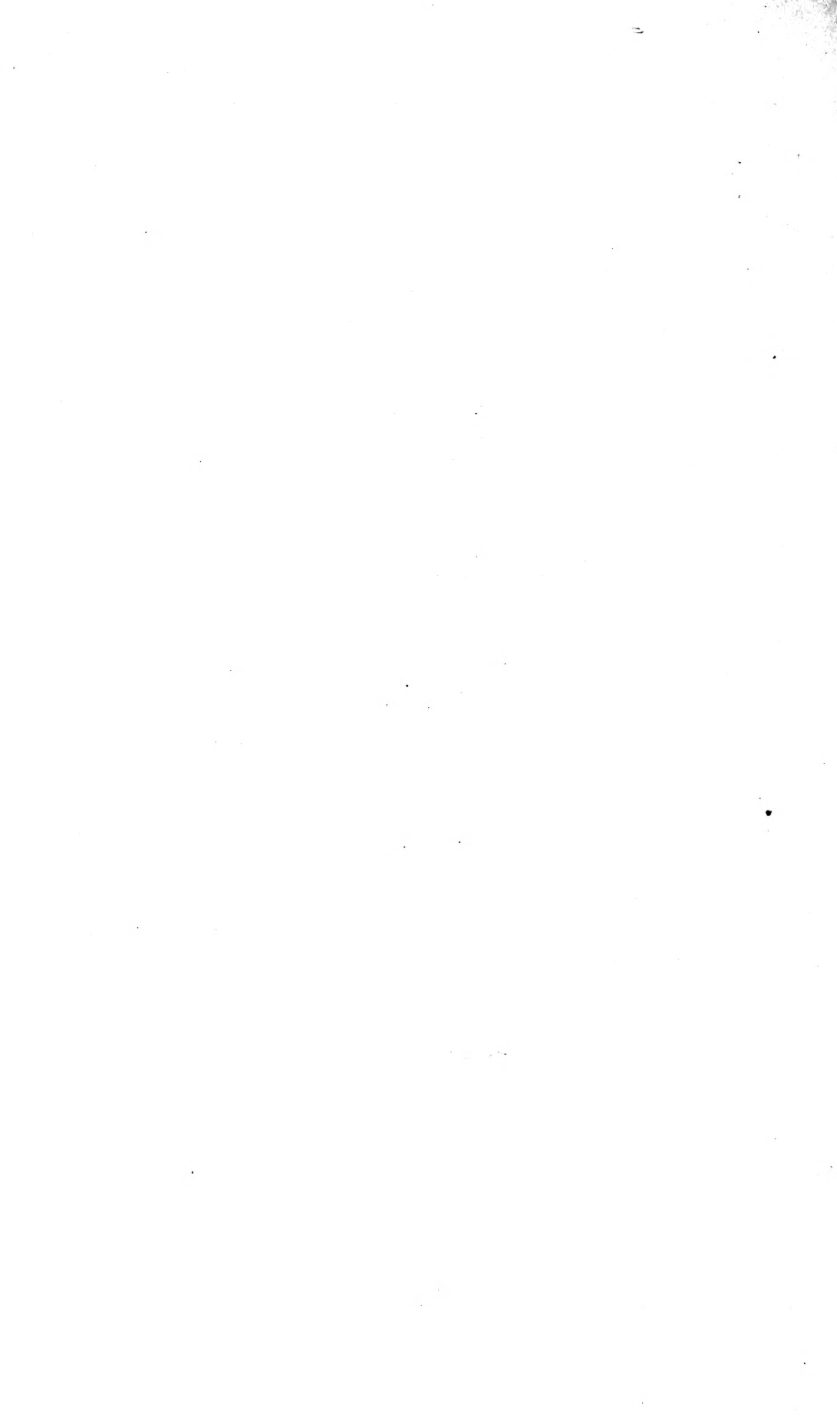

# PART I

## CHAPTER III

### THE MORPHOLOGY AND PHYSIOLOGY OF LEAVES

#### 1. THE DISTINCTIVE CHARACTERISTICS OF LEAVES

LEAVES are the most abundant and conspicuous of plant parts, collectively constituting foliage, the most distinctive part of vegetation. Their essential features consist in their green color, flat form, and growth towards light. Their prominence is explained by their function, which consists in the exposure of green tissue to light, under action of which the plant forms its food out of water and mineral matters drawn from the soil, and a gas received from the air. This function is all the more important because the food thus formed serves not only for plants, but ultimately for all animals as well.

Although uniform in their primary function, foliage leaves show much diversity in various features. In *size*, some are almost microscopic, most are a few square inches in area, and a few are measured in feet. In *shape*, some are nearly circular, others almost needle-form, and others of diverse intermediate gradations. In *color*, while typically green, some are gray, white, yellow, or red; and in autumn they often display a brilliant succession of colors. In *texture*, some are flaccid, as in water plants, others almost leathery, as in evergreen trees, while most are intermediate, with a flexible-elastic consistency. In *duration* of life, they are typically temporary, lasting but one season, and even in evergreens for only a few years; but cases occur in which the leaves persist as long as the long-lived stem. In only one

feature do foliage leaves vary little and that is the *thickness*, or rather the *thinness*, of their green tissue, which is nearly the same no matter what their sizes and shapes.

The thin flat expanse of green tissue, called the **BLADE**, is always the essential, and often the only, part of the leaf. In many kinds, however, the blade is provided with a slender, cylindrical stalk, called the **PETIOLE**, various in length even

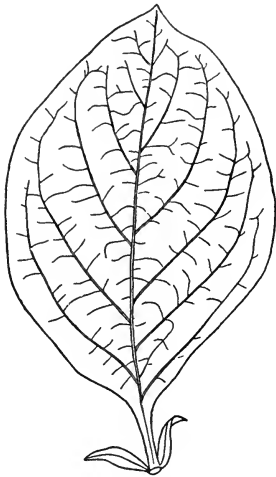

FIG. 1.—A leaf of the Quince, showing blade, petiole, and stipules; reduced. (After Gray's *Structural Botany*.)

up to several feet; and upon it the blade is adjusted to the light, and has free play in the wind. In addition, some kinds possess a pair of small appendages, one on each side of the base of the petiole, called **STIPULES**, which, though usually green like the blade, are very diverse in form. Blade, petiole, and stipules are parts of a complete leaf, of which a typical example is pictured herewith (Fig. 1).

In some kinds of leaves, especially large ones, the blade is not all one piece, but is cleft more or less into divisions, as familiar in Oak or Maple. The same process continued much farther results in the formation of separate **LEAFLETS**, each with a stalk of its own, as in Rose or Strawberry (Fig. 37), while the leaflets also may become themselves subdivided, even more than once, as in some kinds of Ferns. Such leaves are called **COMPOUND**, in distinction from **SIMPLE**, the two being distinguishable by the fact that the leaflets of a compound leaf always stand in one flat plane, while simple leaves are distributed around a stem, at least at their bases. Further, leaflets have no buds in their axils, but leaves, whether simple or compound, always do.

While typical leaves, the kinds designated foliage, are



thin, flat, and green, and perform the function of food formation, other kinds exhibit different features and other functions, as familiar, for instance, in tendrils and pitchers. Likewise there are parts which seem to be leaves but are not, as in case of some flattened stems, and even roots; for leaves, while the principal, are not the only green parts of plants.

## 2. THE STRUCTURE OF LEAVES

Typical, or foliage, leaves, despite their external multiformity, possess an essentially uniform anatomical structure, as shown by comparative observation.

The most conspicuous and important part of the leaf, that in which the food is formed, is the green tissue, called CHLORENCHYMA, which is singularly uniform in thickness, texture, and color throughout the leaf blade. Its distinctive green color is not, however, an integral part of its structure, but a separate and easily removable substance. One has only to place a leaf in a glass dish, cover with alcohol, stand in a warm place, and leave for a time, when the green will come out in a beautiful clear solution, leaving the leaf a uniform white. This soluble green substance is called CHLOROPHYLL, and is one of the most important substances in nature, as will presently appear.

Second in prominence is the system of VEINS, which ramify everywhere throughout the chlorenchyma. They are essentially bundles of tubes which conduct materials into and out of the chlorenchyma. Most commonly they taper and branch from the base of the blade towards the margin, simultaneously producing small veinlets which interlace to a network, as seen very clearly when held up against the light. In other kinds of leaves, such as Grasses, the main veins are uniform in size, and run parallel, or gently curving from base to tip, the veinlets in this case being minute or even wanting; and such leaves are called PARALLEL-VEINED in distinction from the former, or NETTED-VEINED kinds (compare Figs. 1 and 2 with 34). If, further,

some typical leaf, *e.g.* from one of our common trees, be held up against the light and examined with a hand lens, one can see very clearly that the ultimate meshes of

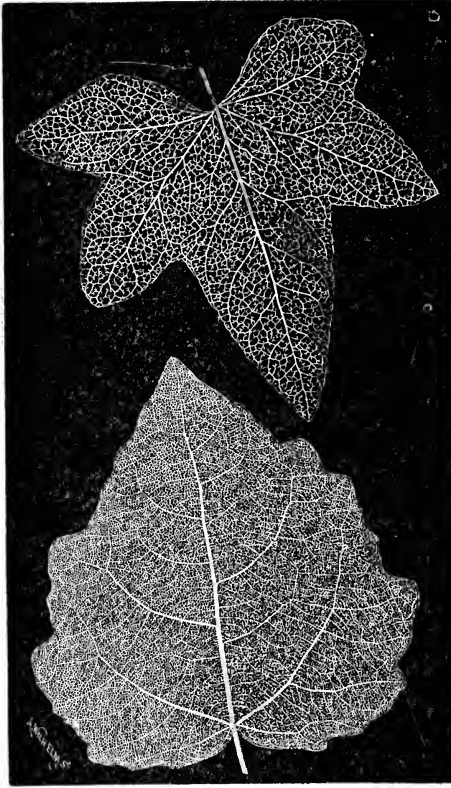

FIG. 2. — The vein systems of English Ivy (above) and Silver Poplar; reduced. (From *The Phantom Bouquet*, by Edward Parrish, 1865.)

The pictures were drawn from specimens "skeletonized" by removal of the chlorenchyma. A magnifying lens should be used to render visible the ultimate veinlets.

the network of veinlets inclose little polygonal areas of pure chlorenchyma, into which often, though not always, extend free tips of the tiniest veinlets (Fig. 2). This ultimate relation of veinlets and chlorenchyma is important, as will later appear. The smallest veinlets are buried within the leaf blade, but the larger ones and the veins which are progressively thicker towards the leaf base, swell gradually out from the blade on its under side until they become many times thicker than the ever uniform chlorenchyma.

Third is the EPI-  
DERMIS, a very thin and transparent

layer by which all leaves are covered, and which often displays a shining surface when viewed obliquely towards the light.

It is practically waterproof, and thus prevents desiccation of the soft leaf tissues when exposed to the sun and dry air. While tightly adherent, as a rule, to the chlorenchyma and veins, it can sometimes be stripped away, if started with a knife, from leaves of the Lily-like kinds, while from some of the Houseleeks (or "Live for ever") it can be loosened by pressure of the fingers, and later blown out, as most children well know. Commonly the epidermis appears perfectly continuous and homogeneous, but in exceptional cases (*e.g.* Wandering Jew), the hand lens will show, especially on the under side of the leaves, tiny slit-like pores inclosed in greener ovals. These slits, called STOMATA, are always present, even though rarely visible to a hand lens. They are real openings, which connect with microscopical AIR PASSAGES extending everywhere through the leaf, and having great functional importance, as will soon appear. Also the epidermis, while typically smooth even to shining, often bears divers sorts of fine hairs or scales, called TRICHOMES, which give to the leaves a grayish, woolly, or sometimes scurfy appearance whereby often the clear green of the underlying chlorenchyma is obscured.

The petioles of leaves, typically cylindrical in form, consist mostly of veins, with little overlying chlorenchyma; but they develop commonly some additional strengthening tissue. The stipules, when present in typical form, have simply the leaf structure in miniature.

### 3. THE SYNTHESIS OF FOOD BY LIGHT IN LEAVES

The prominence of leaves, in conjunction with their comparative uniformity of structure, indicates for them a very fundamental function in plant life. This is well known to consist in the formation of food, which, as one of the most important of all processes in nature, will here be described somewhat fully.

All leaves are found by chemical tests to contain sugar, mostly the kind called grape sugar, which occurs dissolved

in their sap. Under action of sunlight this sugar increases in quantity, but in darkness it lessens, because removed through the veins to the stem. Furthermore, in most leaves, when this sugar increases beyond a certain percentage the surplus becomes automatically transformed into starch, which returns again to grape sugar as the percentage thereof once more falls. Now it happens that starch (unlike sugar) is readily recognizable by a striking and easily applied test, viz., addition of iodine in solution, which turns starch dark blue; and thus we are provided with a convenient means of



FIG. 3.—A light screen for experiments in starch formation by leaves;  $\times \frac{1}{2}$ .

The star is cut from tinfoil attached to glass, and the box excludes light but admits air.

proving the increase of sugar, as manifest in its transformation to starch, under action of light. The experiment is well-nigh classic, and every student should see it. One has only to keep a thin-leaved potted plant for a day or two in the dark (to cause the disappearance of its starch): cover part of a leaf, in a way not to prevent its ordinary functions, with some kind of contrasting light-and-dark screen, such, for example, as shown in our picture (Fig. 3): expose the plant to strong, but not intense, light for two or three hours: place the leaf in warm alcohol until the chlorophyll is removed: and cover the blanched leaf with a solution of iodine. Then a striking result appears, for the parts left in light by the screen all turn dark blue, and the parts which were shaded remain white, or at most a little browned by the iodine (Fig. 4). Thus it is clear that the starch, and there-

fore the sugar, increases in quantity under action of light. Indeed so exactly quantitative is this relation of light to starch-formation that, with certain practical precautions, one may apply a photographic negative to a leaf, and after exposure to light develop a very fair positive "blue-print" of the picture with iodine.

The increase of the grape sugar in light is found by experiment to add weight to the plant. Therefore the sugar must represent not a transformation of material already present, but a new construction out of materials drawn from outside the plant; and all research confirms this conclusion. Further, suitable tests always show that its formation takes place only in light and only in green tissues, which never occur away from the light. Its production indeed is the particular primary function of the chlorenchyma, wherever found, whether in leaves, stems, or other parts,—the leaves being organs adapted to spread chlorenchyma to light. The formation of the sugar being thus a process of synthesis under action of light, is known as PHOTOSYNTHESIS.

What now are the materials from which the grape sugar is constructed?

The chemical formula of grape sugar is  $C_6H_{12}O_6$ , which means of course that its molecule is composed of six atoms of carbon, twelve of hydrogen, and six of oxygen. Now the proportions  $H_{12}O_6$  in this formula recall the familiar  $H_2O$ , suggesting that water may be the source of that part of the sugar, at least of its hydrogen; and



FIG. 4. — A leaf treated with iodine after exposure to light under the screen of Fig. 3;  $\times \frac{1}{2}$ . The black shading represents dark blue in the actual leaf.

this hypothesis is fully confirmed by research. The water is absorbed into the plant from the soil through the roots, conducted through the stem, and distributed through the veins to all parts of the chlorenchyma, from which its immediate evaporation is prevented by the waterproof epidermis. As to the carbon, that is known to come not from the soil (for plants can be grown to perfection

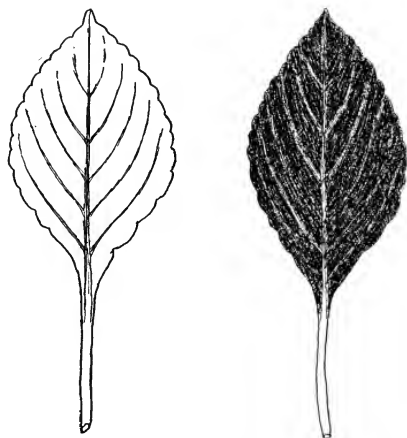

FIG. 5.—Leaves treated with iodine after exposure to light in air lacking and possessing, respectively, the usual carbon dioxide;  $\times \frac{1}{4}$ . The black shading represents dark blue in the actual leaf.

in soils, or even in water, which lack it completely), but from the air, in which it exists in the form of carbon dioxide ( $\text{CO}_2$ ), the heavy poisonous gas which is released by combustion and also by the respiration of animals. It is true, this gas is relatively scarce in the atmosphere, of which it comprises only about .03 per cent (3 parts in 10,000) as compared with about 21 per cent of oxygen, and 79 per cent of nitrogen; but even this small amount suffices

for the photosynthetic needs of plants, as can be proved in various ways. Thus, one has only to keep a thin-leaved plant for a day or two in the dark to free it of starch: remove two similar leaves and place them in water in two glass chambers exactly alike except that from one all carbon dioxide has been removed by a chemical absorbent: expose them thus a few hours to light: blanch them of chlorophyll: and immerse them in iodine, when there follows the result pictured herewith from an actual experiment (Fig. 5). Thus it is clear that a leaf can make starch, and therefore sugar, if the car-

bon dioxide of the atmosphere is available, but otherwise not. Carbon dioxide cannot pass through the walls of the waterproof epidermis (at least not in appreciable quantity), but it enters the leaf through the slit-like openings, the stomata, the function of which is thus explained. From the stomata it moves along the air passages to every part of the chlorenchyma.

The formation of grape sugar from carbon dioxide and water is expressed by the following equation, which exhibits the extremes, though not the intermediate steps, of the process.

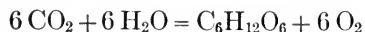

Now this equation implies that in the formation of the sugar, free oxygen is produced in volume precisely equal to that of the carbon dioxide absorbed. This theoretical deduction can readily be tested by experiment, by means of appliances pictured herewith (Figs. 6 and 7); and thus the actual production of oxygen, in the indicated volume, is conclusively proved, and all parts of this *photosynthetic equation* are found exactly true. It expresses concisely and accurately one of the greatest of all natural processes.

The absorption of carbon dioxide and release of oxygen thus shown to occur in the photosynthetic formation of grape sugar in leaves explains the widely known fact that

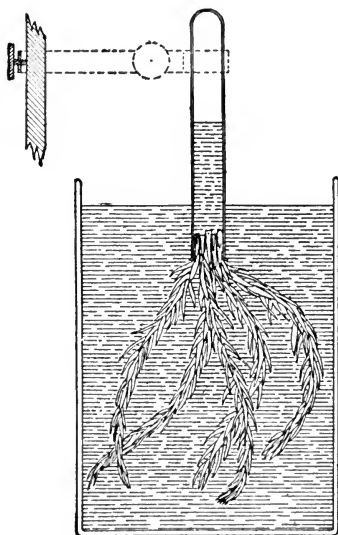

FIG. 6. — A simple arrangement (seen in section) whereby it can be proved that oxygen is released by green tissues in light;  $\times \frac{1}{4}$ .

The gas released by the water plant is caught in the water-filled test-tube supported above, and subsequently tested.

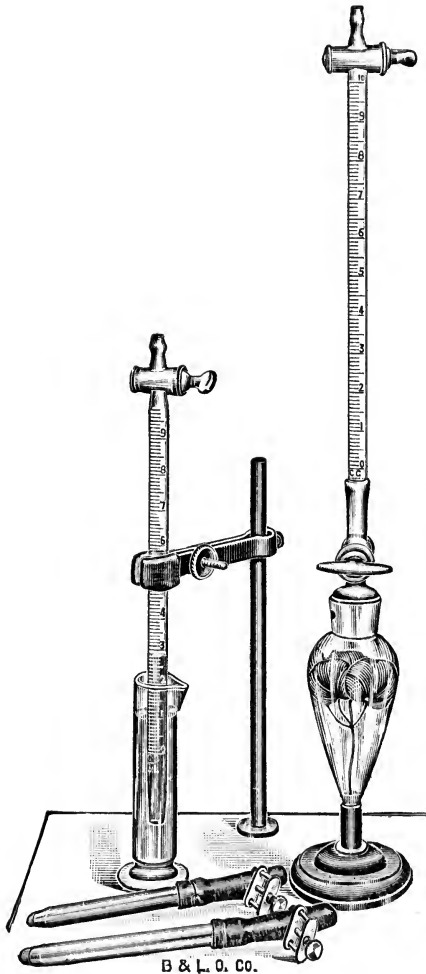

FIG. 7.—A photosynthometer, by which the gas exchange in photosynthesis is quantitatively tested;  $\times \frac{1}{3}$ .

Into the chamber containing the leaves a known quantity of carbon dioxide is admitted through the stop-cock from the graduated tube above. After exposure to light, analysis of the gas in the chamber is made by absorption in the graduated tube by aid of the two reagent tubes shown below on the left. The result can be read directly on the graduated tube, as shown on the left, where the approximate 28% indicates the oxygen present at the close of an experiment in which 10% of carbon dioxide had been added to the tube.

plants (really only green plants in the light) “purify the atmosphere,” that is, remove from it the noxious carbon dioxide released by animals in their respiration (and by all combustion), and replace it by oxygen essential to animal respiration. Thus is a balance maintained between the two kingdoms. The oxygen released in photosynthesis represents merely an incidental by-product of the process.

The amount of sugar made in a given time per unit area of leaf has been determined for a number of plants, and shows, as would be expected, much diversity. The average of these figures, however, expressed in the nearest



round number, gives us a useful conventional expression, or constant, for the process as a whole, even though it has no validity as applied to any particular plant. This CONVENTIONAL CONSTANT for photosynthesis, assuming the usual conditions of light, is 1 gram of grape sugar per square meter of leaf area per hour. This amounts to 10 grams per average working day, or 1500 grams per summer season, for that area. In the process 750 cubic centimeters of carbon dioxide are withdrawn from the atmosphere each hour, and the same volume of pure oxygen returned thereto; and this amounts to 7.5 liters per day, and 1125 liters per season for the same area. These figures are for plants out of doors in summer; for greenhouse plants in winter they approximate to half this amount. It will interest the student to convert these quantities into the more familiar terms of square yards, ounces, and quarts; and it will prove better yet if he see them all actually reproduced before him. Further, for the sake of those to whom statistics appeal, more figures may be added. In a season an average leaf produces enough grape sugar to cover itself with a solid crystalline layer a millimeter thick, which is 40 times thicker than the chlorenchyma which makes it; and in the process it absorbs enough carbon dioxide and releases enough oxygen to form a column of the same area as the leaf 1.125 meters high; and this is all of the carbon dioxide in a column of air 3750 meters or 2.4 miles high. To balance the oxygen absorbed and carbon dioxide released in the respiration of an average man for a year, there is needed 150 square meters of leaf area working through the summer; or in other words, to balance his respiration for a year a man needs all of the oxygen which would be released in a summer by the walls of a cubical room of leaf surface 5 meters on an edge.

We have still to explain why both light and chlorophyll are essential to the photosynthetic formation of grape sugar. Before the elements contained in the carbon dioxide and water can be recombined into sugar, they must first be

separated, in part at least, from their existent unions in those substances. But both carbon dioxide and water are very stable compounds, and therefore their dissociation or separation into their constituent atoms requires the application of much power, the basis of which is energy. This energy is known to be supplied by the sunlight, of which the rôle in photosynthesis is thus explained. Now the energy in the light cannot of itself effect this dissociation (else obviously no carbon dioxide or water vapor could remain in the atmosphere), and accordingly there is also necessary some agency by which the energy in the light can be applied to the actual work of dissociating or splitting the molecules of carbon dioxide and water into their constituent atoms. That agency appears to be the chlorophyll, though it is not yet certain in precisely what way it accomplishes the result. Thus the sun supplies the energy for photosynthesis, and the chlorophyll applies it as power to the actual work. This is why both are essential.

The study of chlorophyll by aid of the spectroscope shows that practically only certain red and the blue rays are absorbed by chlorophyll from the many contained in the white sunlight; but these are known to be the rays effective in photosynthesis. Since those rays are absorbed, they do not come to our eyes from the leaves; but the unabsorbed rays, those useless in photosynthesis, reach our eyes in a mixture which collectively gives the sensation of green. Thus the greenness of vegetation is due to the light rejected by the chlorophyll after removal of the rays useful in photosynthesis.

The photosynthetic formation of grape sugar is often compared with a process of manufacture carried on by man. The leaf is the *factory* constructed for the work: the epidermis forms the external *walls*, giving shelter from weather, while the chlorenchyma cells are the working *rooms*, and the veins, with stomata and air spaces, the passages for access and removal of materials; the sunlight is the

source of *power*, and the chlorophyll the *machinery* by which it is applied to the work: carbon dioxide and water are the *raw materials*, sugar the desired manufactured *product*, and oxygen an incidental *by-product*. The comparison while fanciful in details, is correct in essentials.

Grape sugar is, however, not the only food material formed in the leaves, for they are also the places of construction of PROTEINS. These are substances of the greatest importance in plant life, because they constitute the foundational material of the living protoplasm. They are composed of the elements of the grape sugar, — carbon, hydrogen, and oxygen, — together with nitrogen, sulphur, and phosphorus derived from mineral compounds absorbed from the soil and brought to the leaves with the water. Proteins, though many and diverse, are all constructed from grape sugar by chemical addition of the other constituents, — nitrogen first, and the others later. Unfortunately we know little as yet, despite many researches, as to their exact place of formation in the leaves, whether in the veins or the chlorenchyma. They occur abundantly in the veins, along which they are conducted into the stem. Nor is it certain whether light is essential to their formation, though the evidence seems to show not, in which case the energy needed in their synthesis must be supplied by chemical action. Probably their formation in the leaves is only a functional convenience based on the simultaneous presence there of the basal grape sugar and the needful mineral matters, brought with the water. These proteins, like the grape sugar, move continuously along the veins from the leaves to the stems.

The rôle of the grape sugar thus formed in leaves is very fundamental in plant life. *First*, from it, or from the proteins built upon it, plants build, by minor chemical transformations, their entire structure, and form all of the many organic materials in their bodies, as will later appear in detail in a separate section. *Second*, the energy of the sunlight,

used in forming grape sugar, does not become obliterated in the process, but is simply converted into the latent or potential form. Thus the grape sugar becomes a store of potential energy, which is retained through the later transformations, and which can be released and rendered again active by the process of respiration, as we shall later describe in full. Grape sugar, accordingly, and its derivatives are the source both of the materials and the energy used by plants in their growth and work, or, in other words, are their FOOD. Furthermore, since all animals are dependent upon plants, either directly or indirectly, for their food, the photosynthetic grape sugar is the basal food for all animals also.

This use of the term plant food may seem strange to those who know the common application of the word to the mineral salts taken by plants from the soil. The latter usage, though well sanctioned by custom, especially in connection with agriculture, is physiologically erroneous. Food, in the physiology of both animals and plants, is that material from which the living body is constructed, and energy obtained for its work. It is because the mineral salts of the soil supply only an insignificant fraction of the substance of plants and none at all of their energy that they cannot be considered plant food, while the name belongs properly to grape sugar, which supplies both. The popular usage arose before these matters were understood, but is too firmly fixed to be changed. No confusion can arise if one takes note of the connection in which the word is employed.

#### 4. THE CELLULAR ANATOMY OF LEAVES

The actual process of photosynthetic food-formation is performed in the cells of the leaf, to which we now turn attention. For this study we use the compound microscope, which is the indispensable tool of the biologist, and one of the most powerful and perfect of all the exact instruments which scientific men have invented to extend the range and precision of our limited senses.

When the microscope is turned directly upon a leaf, it shows little, because the tissues as a whole are opaque. But if from a typical leaf a very thin slice or section be cut across from surface to surface, it will show under the microscope the general aspect presented in our picture (Fig. 8). Promi-

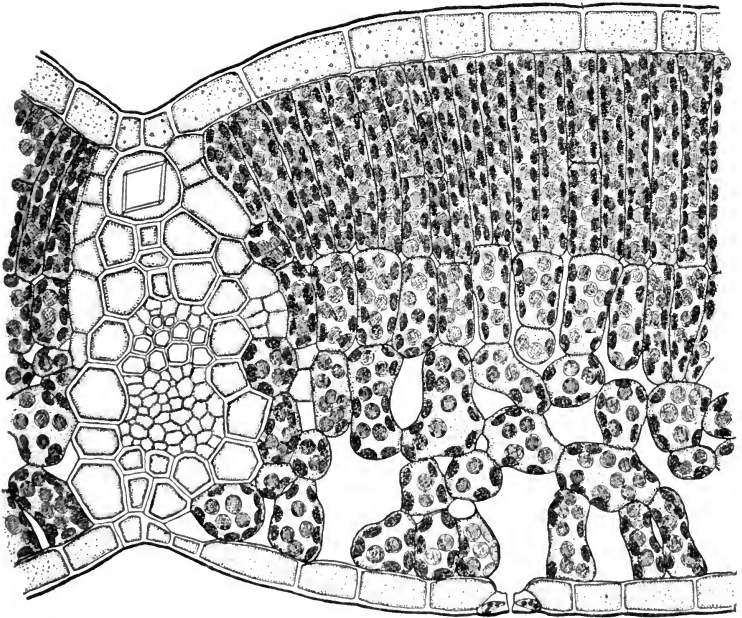

FIG. 8. — A cross section through a typical leaf, that of the European Beech; greatly magnified. The shaded round and oval grains are green in the living leaf. (Drawn, with slight changes, from a wall chart by L. Kny.)

nent in the view are the three tissues of the leaf, — the abundant *chlorenchyma*, distinguished by the presence of chlorophyll (in the shaded discoid grains of our picture): the *veins*, compact and without color (of which a large one shows, on the left): and the transparent *epidermis*, which covers both surfaces. Also amongst the *chlorenchyma* can be seen the various irregular and interconnecting *air-passages*. The cells composing these tissues are individually

visible, — each a compartment inclosed by a wall and containing various contents.

The chlorenchyma cells are inclosed by thin walls, and contain three kinds of contents. Most prominent of all are the chlorophyll grains, or **CHLOROPLASTIDS**, discoid in form, and uniformly dyed by the chlorophyll, which does not occur outside them. These chloroplastids have this great importance, that they are the actual seats of the photosynthetic process. Within the same cells occurs also an inconspicuous, shadowy-grayish, thin-gelatinous material (shown by a sparse dotting in our picture), the **PROTOPLASM**, the living material which builds all the rest. The protoplasm, which contains the chlorophyll grains embedded within it, forms in these cells only a lining to the walls, against which it is held tightly pressed by the **CELL SAP**. This sap is water containing sugar and other substances in solution; and not only does it fill the whole cavity of the cell, but is ordinarily under tense pressure, sufficient not only to hold the lining of protoplasm against the wall, but also to keep the elastic wall itself somewhat stretched. The chlorenchyma cells are variously shaped, — spheroidal, ellipsoidal, ovoid, cylindrical, — as our picture shows. The cylindrical shape prevails towards the upper surface, where the cells occur tightly packed together, forming the so-called **PALISADE** (as distinct from the **SPONGY**) tissue; and thus the greater part of the chlorophyll grains are brought towards the best-lighted surface. This is the reason for the familiar fact that most leaves show a deeper green color on their upper than on their lower faces.

When a vein is cut squarely across, as shown in our picture, its cells appear angular, compact, and colorless. Three kinds of cells appear in each vein. *First*, is an outer or sheath layer forming the **BUNDLE-SHEATH**, large and thick-walled with thin protoplasmic lining. When seen in lengthwise section they are found to be several times longer than wide. They are most developed on the largest veins, thinner on

the smaller, and very thin on the ultimate veinlets; and their function appears to be mainly that of conducting sugar from the leaf into the stem. *Second*, within this sheath, towards the lower side, occur many small, angular, thin-walled cells with protoplasmic linings; which, seen lengthwise, are found greatly elongated and crossed here and there by distinctive perforated plates (Fig. 106), though in the veinlets they are much simpler in structure (Fig. 9). These are the SIEVE-TUBES and associated cells, and their function is principally that of conducting the proteins made in the leaves to the stem.

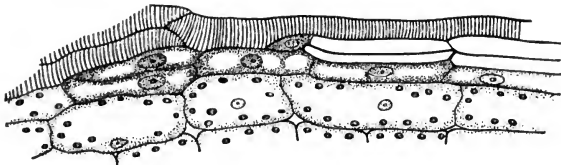

FIG. 9.—A leaf veinlet, in longitudinal section, of *Fuchsia globosa*; greatly magnified. Above are the tracheids, and below are sieve tubes and associated cells, but the sheath cells do not show in the drawing. (From Haberlandt's *Physiological Plant Anatomy*.)

*Third*, just above the sieve-tubes lie a number of somewhat larger, angular, thick-walled cells, lacking a protoplasmic lining; they are found, when seen lengthwise, to run together into tubes, which are distinguished by characteristic spiral and other markings (Fig. 101), though in the veinlets they are only spirally marked elongated cells (Fig. 9). The function of these tubes and cells, called respectively DUCTS and TRACHEIDS, is the conduction of water from the stem to all parts of the leaf. Ducts and sieve-tubes, the former always above and the latter below, in conjunction with the sheath cells, make up the veins, which when large contain many of all three kinds, but when smaller progressively fewer, until finally the ultimate veinlets may consist of no more than the equivalent of a single duct and a sieve-tube.

Although every chlorenchyma cell performs photosyn-

thesis, and therefore must receive water from a duct and transmit its sugar and proteins to bundle-sheath and sieve-tube, many of them, as implied in Fig. 8, stand some distance removed from the nearest veinlet. It is known, however, that chlorenchyma cells can draw water, and likewise pass soluble substances, from one to another, the physical

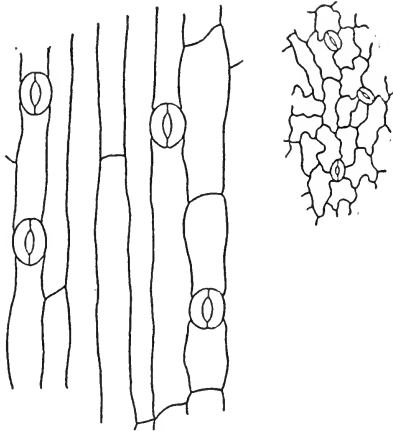

FIG. 10. — Typical epidermal cells, with guard cells, in outline, seen from the surface; magnified to same scale. On the left *Allium*, on the right Sunflower.

methods whereof we shall presently consider. Now the distances through which this method is effective must of course be limited, and while no exact measurements appear to have been made, it seems highly probable that the size of the ultimate areas of chlorenchyma inclosed by the veinlets (as noted on page 18) is correlated with the number of chlorenchyma cells which can thus effectively obtain their water, and remove

their sugar or proteins, through one another.

The cells of the epidermis are rectangular in section, though when viewed from the surface, they are found variously shaped, even to lobed and interlocked (Fig. 10). They contain protoplasm, but ordinarily no chlorophyll (in the higher plants); and their walls, as proved by chemical tests, are infiltrated with a special substance called CUTIN, which renders them waterproof. Especially characteristic of epidermis is the fact that its continuity is unbroken except for the stomata, of which a single example appears in our picture (Fig. 8, also 22). Stomata, however, which provide the entrance and exit for carbon dioxide and oxygen, are by no



means mere gaps in the epidermis, for each is flanked by two special cells called the **GUARD CELLS**, which close and open the stomatal slit in ways, and under conditions, later to be noted.

The picture of our typical leaf (Fig. 8) shows that the stoma opens into a specially large air space. This space is continuous with others, and with passages in a continuous but irregular system which ramifies everywhere through the chlorenchyma, extending even in thin vertical passages (not clear in our figure, though shown by suitable sections) amongst the densely packed cells of the upper, or palisade, chlorenchyma. Thus every cell of the chlorenchyma is reached by the air system, and therefore can receive carbon dioxide from the air; and by the same route the waste product oxygen is returned to the atmosphere. The air system is not constructed of cells, but is **INTER-CELLULAR**, being formed by a splitting and separation of the cell walls in the course of their development.

The leaf of our picture happens to possess a smooth epidermis, but where trichomes are present the epidermal cells can be seen to extend into one-celled, several-celled, or many-celled hairs, scales, or prickles. Sometimes the chlorenchyma also has part, as with many prickles, in which case the structures are called **EMERGENCES**. Some of the cells inside the leaf, as shown by a single example in our picture (Fig. 8), contain crystals, which are excretions, or matters useless to the leaf and thus disposed of; and such single specialized cells are called **IDIUBLASTS**.

The mechanism of the leaf as a photosynthetic organ for the production of food sugar from carbon dioxide and water is sufficiently well known to permit its representation by a diagrammatic plan, as given herewith (Fig. 11). The student should now understand the process so well that with a good section of leaf before him, perhaps aided by our diagram, he can see it proceeding as clearly in imagination as he could with the physical eye were he sufficiently small to wander

at will through the intercellular passages, and view the operations through the crystalline walls of the cells. Thus he would see the water streaming in continuous current through the ducts of the veins to the veinlets, and spreading thence from cell to cell through walls and protoplasm until it saturates every chlorophyll grain. Simultaneously the molecules of carbon dioxide are moving in through the stomata and

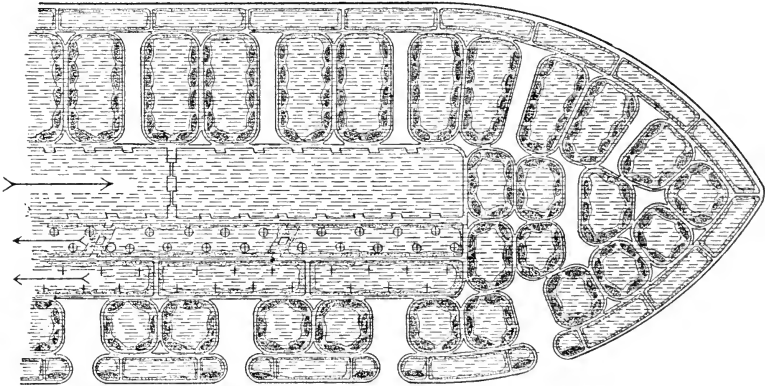

FIG. 11. — Plan of the leaf as a photosynthetic mechanism. The chlorophyll grains (darkest shaded) are embedded in protoplasm (lighter shaded); the water (horizontal lines) is brought by the duct (which lacks protoplasm but has a spirally-thickened wall), and saturates every part of the leaf, sap-cavities, and walls, except the outer walls of the epidermis; the sugar (crosses) and proteins (crossed circles) are removed in the protoplasm-lined sheath and sieve cells; the air-passages ramify to every cell, and open through the stomata to the atmosphere.

along the air passages, then through walls and protoplasm to the same chloroplastids. On these green plastids falls a flood of white sunlight, from which the chlorophyll stops the effective red and blue rays, and turns their vibratory energy against the assembled molecules of carbon dioxide and water, which are thereby dissociated or shattered into their constituent atoms, with an immediate recombination thereof into grape sugar and free oxygen. The molecules of the sugar, dissolved in the omnipresent water, diffuse from cell to cell through protoplasm, walls, and sap to the nearest

veinlet, of which it enters the sheath cells and there passes along the veins to the stem, while the proteins in like manner pass into and along the sieve-tubes. Meantime the molecules of oxygen are moving out of the chloroplastids through protoplasm and wall to the nearest air passages, and along them to the stomata and the external air, passing the entering carbon dioxide en route. The movement of these materials in their paths is of course impelled by definite and adequate forces, and the mechanism is capable of continuous action, which proceeds without break so long as the conditions remain favorable. Meantime something similar, as to the details of which we are ignorant, must be happening in the synthesis of proteins. That is what every green leaf is doing every bright day through the summer.

#### 5. THE CHARACTERISTICS OF PROTOPLASM

All study of physiological processes leads directly to protoplasm, the living part of the organism. It is a perfectly definite material, with distinctive appearance and properties, and it alone, of all the innumerable materials or substances in nature, is alive. In Huxley's famous phrase, protoplasm is the physical basis of life.

Despite its importance, the protoplasm of plant cells has an appearance so inconspicuous as to make it most difficult either to describe or to represent in pictures. Therefore in order to understand it, one must see the material for himself in the laboratory.

In most plant cells, as in those of the leaf lately studied (page 29), the living protoplasm is rendered almost invisible by the thicker and denser walls which inclose it. However, many epidermal hairs have walls so transparent as to show the protoplasm clearly, in which case the microscope reveals an aspect like that of the accompanying picture (Fig. 12). The protoplasm here extends not only as a lining around the walls of the cylindrical cell, but also in irregular threads across the sap cavity. Protoplasm in

this state has an appearance and texture which most observers agree in likening to a jelly, a rather thin and clouded

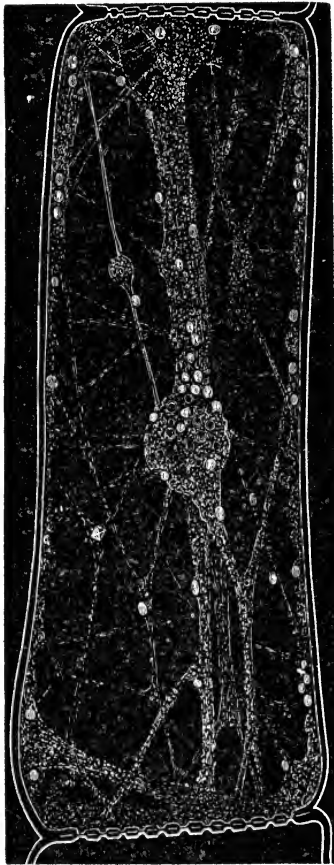

FIG. 12. — The appearance of the protoplasm in a typical hair-cell of a Gourd, as seen projected against a black background; greatly magnified. (Reduced from Sachs, *Lectures on the Physiology of Plants*.)

jelly, which holds various small solid bodies, mostly food grains, in suspension. Scientifically, its constitution is described as *colloidal*. In the oldest cells it often becomes even more thin and watery than here, though hardly ever a true fluid; and the clouded appearance often vanishes, leaving the protoplasm nearly transparent, in which case it is almost completely invisible unless killed and dyed by special stains. In much younger cells, it is more viscous, becoming a gelatinous solid; and in resting seeds and buds, which have given up most of their water, it becomes even as firm in texture as dry gelatine or horn. Since some of the food particles have a yellowish tint, a large mass of such protoplasm has a distinctly yellow color, as seen in the young growing tips of roots, or the central parts of young ovules. There is usually an obvious relation between the condition of the protoplasm in

these respects and the function of the cell.

A characteristic feature of the living protoplasm in plant cells is its **STREAMING**, manifest by a steady movement of the included particles which obviously are carried along passively by currents of the protoplasm itself. In some cells, especially the very large ones of certain *Algae*, the streaming is so active, even up to 10 millimeters per minute, that the protoplasm seems literally to rush across the field of a high-power objective, while in others, and especially in young cells completely filled by the protoplasm, special methods are required for its detection; and all intermediate degrees occur. The streaming is maintained by energy released from food by the protoplasm, and apparently it serves to promote the commingling and transportation of substances throughout the cell.

Thus it is evident that protoplasm possesses no visible mechanical constitution such as might be anticipated in so remarkable a material. But what is its real ultimate constitution or texture, which cannot be as simple as it looks? The exceptional interest of this problem has stimulated the most profound researches, supported by the most refined methods, but as yet without satisfactory result. It was formerly thought, from the appearance of material which had been killed, stained, and sectioned, that the working protoplasm consists of a tangle of flexible fine fibers holding the food granules and various fluids in their meshwork. Later researches, however, seem to show that it has rather the nature of a foam or emulsion, commonly obscure but demonstrable by special methods, in which small globules of various dimensions and different materials are suspended and held apart by thin films of a certain continuous substance; while variously intermingled are food granules, and other small bodies of uncertain significance (Fig. 13). Probably the usual ground structure of most protoplasm is thus **ALVEOLAR**, though it develops fibrous elements on occasion.

Thus the physical structure of protoplasm, in so far as known, gives little clew to the source of its remarkable

powers. Its chemical composition, however, is more illuminating, for research has shown that protoplasm is not a single substance, but a mixture of many, numbering dozens

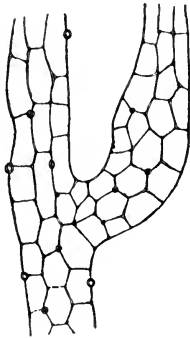

FIG. 13. — Protoplasm from the hair cell of a *Malva*, showing with unusual clearness the alveolar structure; very highly magnified. (Redrawn from Bütschli, *Microscopic Foams and Protoplasm*.)

in even the simplest known organisms (Fig. 14). These substances are various in complexity, from the simplest inorganic salts, through the sugars and other carbohydrates, to the distinctive proteins, which include the most highly elaborate and unstable of natural chemical compounds. The proteins, indeed, seem to represent the essential basis of the protoplasm, the other substances being more or less secondary or incidental. These many substances, some of which would react with one another, obviously cannot exist heterogeneously intermingled within the same solvent, but must occur in some definite organization.

Herein, probably, is to be found the significance of the emulsion or alveolar structure of protoplasm, wherein the different substances are kept apart in their own separate globular compartments by the neutral continuous substance, which permits, however, upon occasion, those regulated interminglings and reactions upon which depend the vital phenomena. At least it seems very clear that most of the physiological powers of protoplasm rest far more upon a chemical than a physical basis.

This consideration of the chemical constitution of protoplasm inevitably raises the question, — is there among its chemical substances some one which is the distinctive living substance and to which all the others are subordinate, or do the vital powers inhere in the organization of the mixture, no one constituent being itself alive? We do not yet know. Both views have their advocates. The former fits best with

the vitalistic conception of organic nature held by some biologists, and the latter with the mechanistic conception held by others.

Protoplasm is unique in possessing simultaneously two sets of properties, physical and physiological. Its physical properties, — color, density, weight, hardness, etc., — are of course simply the aggregate of the properties of its many constituent substances. Its physiological properties are those which are peculiar to itself as the living material. They are manifest most clearly in the physiological processes of plants which they make possible; and we need here but give, for the sake of completeness, and rather for future reference than present learning, the mere roll of their names, viz. automatism, regulation, metabolism, mobility, division, growth, irritability, heredity, variability, morphological plasticity.

All protoplasm originates, and therefore all organisms arise, in only one way, so far as known, and that is by growth and division (or reproduction) of preëxisting protoplasm. SPONTANEOUS GENERATION, or the formation of protoplasm anew out of non-living materials, is not known to occur anywhere in nature; for all supposed cases thereof when investigated by scientific methods have been found to be only apparent and not real, as Pasteur was the first to prove. Thus we can trace back all existent living beings

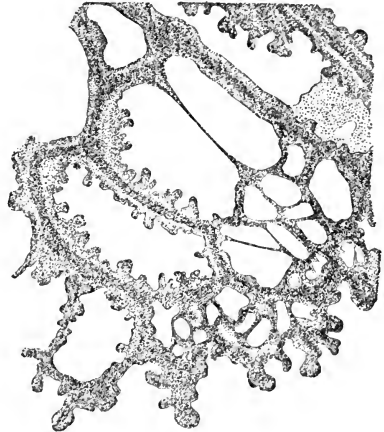

FIG. 14. — Portion of the body (plasmodium) of a Slime-mold;  $\times 225$ . Such organisms, which are naked flat masses of protoplasm often several square inches in area, provide ample material for chemical analysis of the substance. (From Sachs, *Lectures*.)

in an unbroken protoplasmic succession to the very first living organism of the earth. As to the source of the protoplasm of that first being we know nothing, though we have two hypotheses, both of which may be groundless. One relies upon an original case of spontaneous generation, even though perhaps never repeated. The other makes

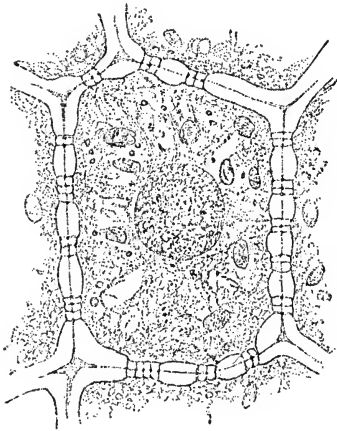

FIG. 15. — A typical example, in Mistletoe, of the continuity of protoplasm by threads through the cell walls. The walls have been made to swell in order to render the threads more clearly visible. (From Strasburger, Jost, Schenck, and Karsten, *Text-book*.)

protoplasm itself an evolution from earlier and simpler substances, suited to the different earlier conditions of the earth, and thus carries it back to an origin contemporaneous and equi-causal with the origin of non-living matter. The former is rather the mechanistic, and the latter the vitalistic view of the subject.

There remains one very important characteristic of protoplasm, and that is its organization within the individual plant or animal. In most organisms the protoplasm is subdivided into the microscopically small masses constituting the cells. This

subdivision, however, is not complete, for suitable methods always show that through the cell walls run protoplasmic threads, which, though extremely fine, suffice to keep the different cells in physiological continuity (Fig. 15); and such threads seem to unite all of the living cells of a plant into one protoplasmic system.

Within each cell the protoplasm shows a definite organization, clearly exhibited in typical form in our Figure 12, and represented in principle in our generalized picture, Figure 16.



Most abundant, though often not most prominent, is the gelatinous-mobile **CYTOPLASM**, which is clearly the working part of the cell, — that which transports materials, builds the wall, produces chemical reactions, and the like. Next in prominence is the **NUCLEUS**, a rounded body of denser but still gelatinous, or colloidal, consistency, lying in the cytoplasm. It seems clearly the control organ of the cell, exerting upon the work of the cytoplasm an influence which guides the building of the organism along the general lines of its heredity. Inside the nucleus is often a smaller **NUCLEOLUS**, which consists of a store of nutritive matter used by the nucleus. Third in prominence in most plant cells come the **PLASTIDS**, embedded in the cytoplasm, also of denser gelatinous consistency, with rounded or discoid forms. They serve as seats of food for-

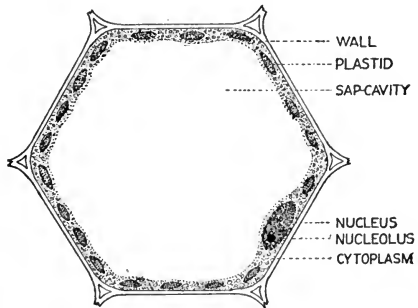

FIG. 16. — A generalized plant cell, showing the constituent parts, in optical section.

formation, the most prominent kind being the chloroplastids. In some cells also, a fourth protoplasmic structure has been newly recognized, viz., the very minute elongated bodies called **CHONDRIOSOMES** or **MITOCHONDRIA**, as to the nature of which, however, we as yet know little.

Such are the protoplasmic parts of the typical plant cell. In addition, most cells possess a firm wall, built by the cytoplasm, and composed of a firm-elastic water-permeable substance called **CELLULOSE**. The wall has the obvious function of a support to the protoplasm, which is far too soft to support itself; and the collective walls of all the cells constitute a firm skeleton for the plant. In young and small cells the protoplasm completely fills the space within the wall, but as they grow older and larger, rifts, filled with sap,

appear in the cytoplasm, and these rifts enlarge and run together until they form a single great central sap-filled cavity; and thus the cytoplasm is left as a thin lining inside the wall, against which it is held tightly pressed by the pressure of the sap. Obviously the arrangement is one which gives a maximal spread of surface with the minimal amount of protoplasm; but spread of much surface is an obvious functional need of an organism which has a mode of nutrition

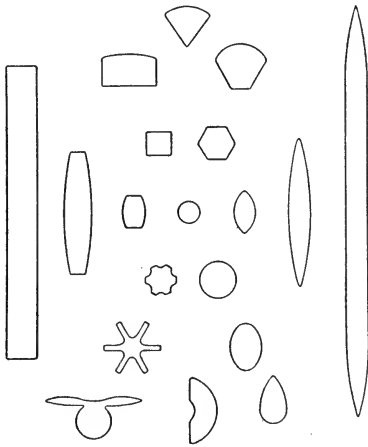

FIG. 17. — Generalized outlines of the principal shapes of cell walls of plants. They are all derivable, by more rapid growth in particular parts of the wall, from the small spherical form in the center. With these shapes occur all degrees of thickening of the walls. (Reduced from Ganong, *The Living Plant*.)

requiring extensive exposure to light, and a wide range in the air and the soil. Within the sap cavity occur also various cell-contents, — food grains, special secretions, crystals, and others, — according to the respective functions of the cells.

The details of cell structure, especially the shape, size, thickness, and composition of the wall and the character of the contents, are most diverse in different tissues, though exhibiting usually an obvious relation to the particular functions of the respective parts (Fig. 17). This relation between structure and function becomes even clearer when the study is extended to animal cells, which also are protoplasmic; for here the cell construction is dominated by the very different habits of animals, which are freely and actively locomotive instead of sedentary and passive. The protoplasm of animals and plants is, however, the same in all essentials, and the organisms are so different only because

of their very different habits, centering especially in their different ways of acquiring their food.

#### 6. THE WATER LOSS, OR TRANSPIRATION, FROM PLANTS,

A special feature of the physiology of leaves, and other green tissues, is the constant loss of water therefrom to the air, — a matter which profoundly influences the forms and distribution of plants. It is called scientifically **TRANSPIRATION**, and the student should not permit the resemblance between this word and respiration to confuse in his mind the two processes, which are wholly unrelated.

The general fact that much water evaporates from plants is well known to all who grow them. The rapid wilting of shoots when cut but not placed in water, is visible evidence thereof. The water which gathers in drops on the glass covers of ferneries, or on windows in which house plants are kept, has mainly this origin, though of course it comes partly from wet soil. The reality of the transpiration from the green parts, as distinct from evaporation from the soil, can be shown very perfectly by the arrangement pictured herewith (Fig. 18); for only the leaves and stem are inside the closed chamber, the pot and soil being excluded by a special glass plate. Within a few minutes some water appears on the glass, at first as a faint vaporous cloud, and later in large drops which run down the sides. Thus we have a perfect demonstration of transpiration, or the removal of water as vapor from leaves and young stems.

The precise amount of transpiration can be determined in several ways, but most accurately by weighing, which requires potted plants. To secure transpiration without evaporation from soil and pot, we use the arrangement shown in our picture (Fig. 19). When a plant thus prepared is weighed at intervals on a good balance, the transpiration is determined exactly, and since the cover may be raised and known quantities of water added at intervals, the experiment may be continued as long as desired. By this method it is found that living green parts in the light never wholly

cease transpiration, though its amount may be insignificant, while it ranges all the way up to above 250 grams per square meter of leaf area per hour. The conventional constant

(page 25) for greenhouse plants is 50 grams per square meter per hour by day, and 10 by night, or 30 night and day together, or 720 grams per 24 hours. This amounts to 108,000 grams per season, which equals a layer of liquid water all over the leaf somewhat more than a decimeter deep; and presumably this figure will prove higher for plants out of doors in the summer. If one can see the 720 grams transpired in 24 hours standing in a measuring glass in the center of a square meter of surface, he will

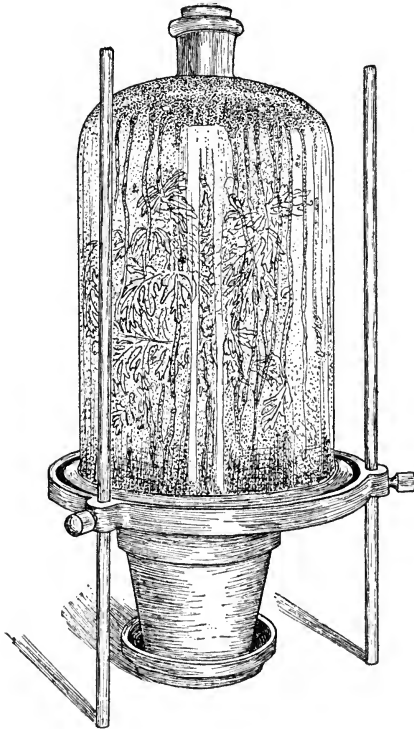

FIG. 18. — A conclusive demonstration of transpiration;  $\times \frac{1}{2}$ . The bell jar was dry when placed over the plant. Its bottom is a plate split and perforated in such a way as to fit closely around the stem of the plant.

realize better the most striking fact about transpiration,—its remarkably large amount. All of this water, it must be remembered, has to be absorbed by the roots from the soil, and lifted through the stem.

Little less surprising than the copiousness of transpiration is the variability in its amount. Much depends upon the character of the plant, for, in general, thick-leaved compact kinds transpire less than thin-leaved open sorts, and hairy less than smooth kinds, and slow-growing less than quick-growing, though occasional surprising exceptions to these rules occur.

But it also varies greatly at different times in the same plant, as shows very clearly when a plant is weighed frequently, or still better, is made to write upon a drum of a transpirograph (Figs. 20, 21) a continuous record of its own transpiration day and night



FIG. 19. — A plant prepared for weight-determinations of the amount of transpiration;  $\times \frac{1}{4}$ .

A thin aluminum shell covers the pot, and the roof is rubber, which may be lifted at will for watering and aërating the soil.

for a week or longer, — the proper arrangements of course being made to insure that all water loss shall take place from the plant alone (as in Fig. 19). If simultaneously, whether by personal observation or by use of recording meteorological instruments, records are taken of the conditions of weather, — temperature, humidity, light, winds, — the reason for the fluctuations in transpiration is found. For thus it becomes clear that the rate of transpiration is increased by light, heat, dryness (of the air), and winds, and is lessened by

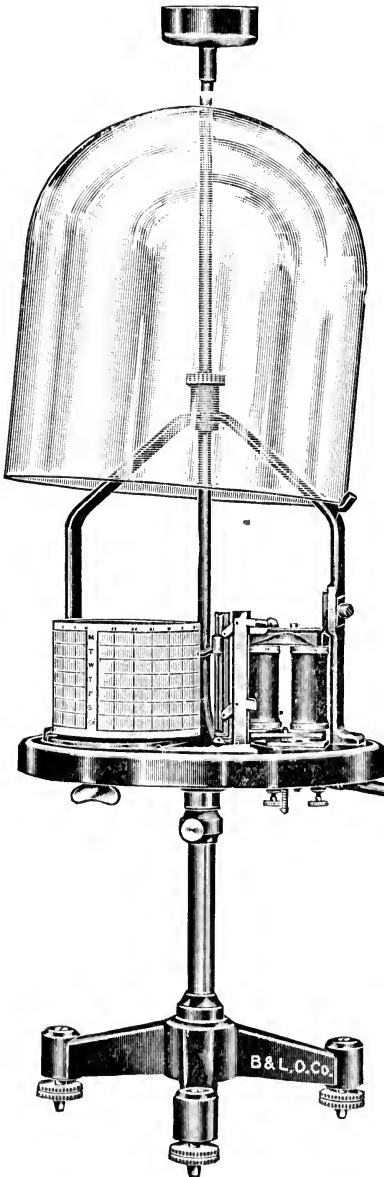

darkness, cold, humidity, and calm. This is assuming an ample supply of water in the soil, under conditions for easy absorption, since otherwise, of course, transpiration is mechanically checked by lack of available water.

Thus it is evident that transpiration is affected by external influences in precisely the same way as evaporation, thereby rais-

FIG. 20.—The Transpirograph;  $\times \frac{1}{2}$ . The plant, prepared as shown by Fig. 19, is adjusted on a balance in such a way that when it has transpired one gram of water, that side of the balance rises and closes an electric circuit. The current acts on the electro-magnet (visible in the picture), which pushes a pen against the revolving time drum (shown by the lines and letters), and simultaneously releases from the vertical tube a spherical gram weight, which runs through the outlet tube on the right and drops into the scale pan. The latter is thus depressed, breaking the circuit, which remains open until another gram of water has been lost. Compare the record in Fig. 21.

Such a precise and continuously self-acting instrument is typical of those which it is the aim of plant physiologists to provide for all of the plant processes.

ing the question as to the relation between the two processes. While closely related, they are not identical, as shown by the modern studies on RELATIVE TRANSPIRATION, that is, the ratio between transpiration and the contemporaneous evaporation, as determined by suitable instruments. In brief, transpiration is evaporation affected considerably by the structure and physiology of the leaf.

The profound effect of external conditions upon transpiration has many important consequences. Thus, a conjunction in high degree of light, heat, dryness, and winds, as happens at times in our gardens, can cause wilting in some plants even when they have ample soil water, because the roots cannot absorb, or the stems conduct, water as fast as transpiration removes it. In such cases a check in the transpiration, by the coming of night or a spraying by the gardener, is promptly fol-

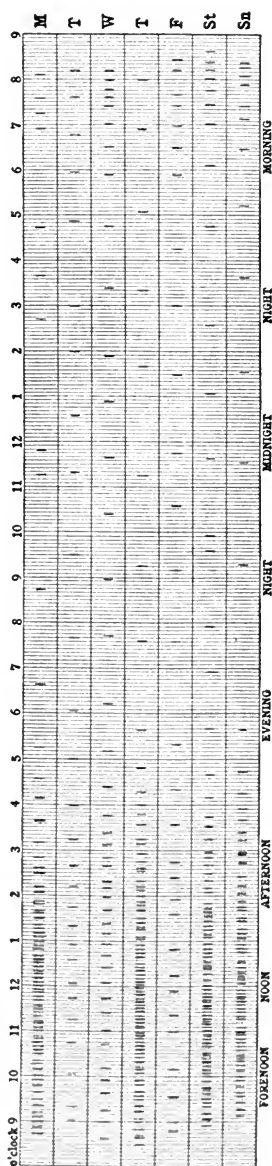

FIG. 21. — A record from the Transpirograph (Fig. 20), showing the transpiration of a *Pelargonium* plant for a week. The vertical lines represent 5-minute intervals, and the short vertical marks are made by the pen whenever a gram of water has been lost by the plant. Note the great difference between the transpiration of day and night, and between different days, of which M, Th, St, Sn, were bright, and T, W, F, were dull.

lowed by a revival of the leaves. It is apparently a similar excess of transpiration over absorption or conduction which, no matter how abundant the root water, limits the kinds of plants we can grow in the dry air of our houses; for house plants, as well known, are not so much those we want as those we can make grow. It is clearly the defective absorption by roots, which absorb slowly at low temperatures, in conjunction with excessive transpiration, which, on bright, dry, windy days in early spring, causes the drying, browning, and death in ornamental evergreens; and likewise a wilting, browning (called wind-burn), and death, in the budding foliage of deciduous plants. The winter-killing of shrubs, as we shall see later, is also largely identical in nature. But the effect of light, heat, dryness, and winds upon transpiration shows most clearly of all in the vegetation of those parts of the earth where such conditions prevail in conspicuous intensity, — the deserts. For there, as well known, and represented in pictures in Part II of this book, the thin-leaved, open types of plants cannot grow at all, and only those sorts can manage to exist which are compact and thick of texture, or have other transpiration-limiting features. The aggregate effect is the peculiar and even somewhat bizarre appearance characteristic of desert vegetation.

What now is the physiological meaning of transpiration, this water-loss which cannot be wholly stopped even though at times it endangers the existence of plants, and greatly restricts their distribution? The cellular anatomy and physiology of leaves give the answer. All chlorenchyma tissues are continually saturated with water, the direct evaporation of which is prevented by the waterproof epidermis. This epidermis is practically impermeable to the carbon dioxide required by the leaves in their food-forming function, and also to the oxygen released in that process; but the access and exit of those gases take place through the stomatal openings. When these stomata are open for such gas passage, however, there is nothing to prevent the water of



the chlorenchyma from evaporating through them, and it does so. The result is transpiration, which is thus primarily not a function in itself, but an incidental accompaniment of the food-forming process. The formation of a given amount of food requires a definite amount of carbon dioxide, and this means so much open stoma, and therefore loss of water, in definite mathematical proportions.

The stomata are slit-like openings which develop by separation of the walls of the young epidermal cells. In so far as the passage of gases is concerned, they might to advantage remain permanently open; but in fact they open and close, with a proportionate effect upon transpiration. The opening and closing in each case is produced by action of two neighboring epidermal cells, specialized as GUARD CELLS (Fig. 22), of which the walls are so

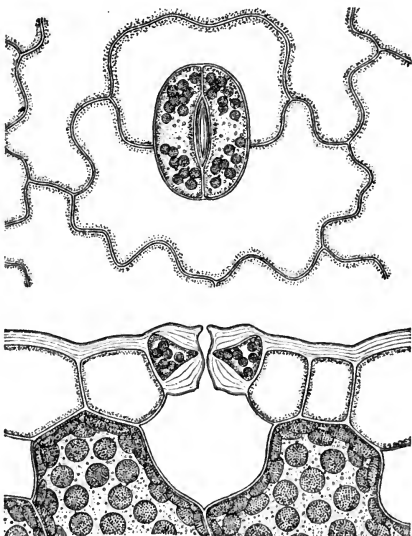

FIG. 22. — A typical stoma, with guard cells, of *Thymus*, seen from the surface, and in cross section. The operation of the guard cells is explained in the text. (After a wall-chart by L. Kny.)

thickened as naturally to spring the cells together, thus closing the stoma; but the absorption of more water into the sap-cavities rounds out the cells and draws them apart, thus opening the stoma to a slit, a spindle form, or even, at an extreme, to an almost circular opening. Thus the mechanism is such that when the cells of the leaf are collectively losing water faster than it is restored from the stem, the guard cells tend automatically to close the stoma, checking proportionally the transpiration, while the access of more water to the

leaf, permitting renewed turgescence of the guard cells, produces a reopening of the stoma. One other important condition, however, influences this result. The guard cells, alone of the epidermal cells, contain chlorophyll, and hence make grape sugar in light; and a solution of grape sugar, as will later be shown, draws water osmotically from neighboring cells, thus increasing the turgescence of the guard cells and opening the stoma. Accordingly, while the stomata tend to close with dryness, so to speak, they also tend to open in light, which is the time when carbon dioxide is needed in the work of the leaf. These two conditions, however, often operate antagonistically, producing irregularities in the action of the guard cells. Thus, while their operation can be viewed as adaptive in general, it is not so in detail. In this respect the stomatal mechanism resembles most other adaptations, which, because so many other factors are simultaneously affecting the part concerned, can never be perfect.

Stomata occur chiefly, and in most plants exclusively, on the under sides of leaves, in which position a stoppage of their openings, and therefore of gas passage, cannot be caused by rain. Against this detriment several adaptations have been described, though often misinterpreted as a supposed need for promoting transpiration. Stomata vary much in size, extent of opening, and number, ranging from 0 all the way up to near 500 per square millimeter. Their conventional constant (page 25) is 100 per square millimeter of surface, and their area when extended the widest possible would open  $\frac{1}{100}$  of the leaf surface (Fig. 23). It is at first puzzling to the observer, as it long was to botanists, how, through so small a total area of opening, a sufficiency of carbon dioxide can enter and so much water vapor escape. The explanation has been found in a very curious physical fact, viz., that the smaller an opening becomes, the more rapid relatively (not absolutely) is the passage of a gas through it by diffusion, while such passage is also more rapid through slit-shaped than through round openings of the same area.

Therefore the capacity of the small stomatal openings for gas passage is far in excess of that implied by their areas. The matter becomes clearer from another point of view when we note that an ordinary stoma when open presents to a molecule of carbon dioxide or water an entrance or exit as great as a passage seven miles wide appears to a man.

While transpiration is thus primarily an incidental accompaniment of photosynthesis, rather than a physiological process in itself, it does have functional value in one respect. Plants need in their leaves, and elsewhere, certain mineral matters which are absorbed from the soil; and these are lifted with the water, and left in the tissues by its evaporation. Indeed, the view has been held in the past that this is the primary functional meaning of transpiration, its copiousness being considered necessary because of the great dilution of the minerals in the soil water. Later evidence, however, shows that little relation exists between the amount of transpiration and the quantity of mineral matters found in the plant. Furthermore, an important rôle has been assigned to transpiration in the dissipation of the excessive energy poured into leaves at times by the strongest summer sun, — an amount sufficiently great to work damage in the leaf were it not for the cooling effect of evaporation; and this advantage must be real, even though incidental rather than adaptive. Thus it seems clear that transpiration is primarily an unavoidable though partially controlled

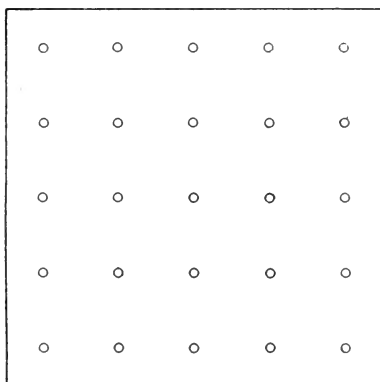

FIG. 23. — Diagram to show the number, and extreme area of opening, of stomata, according to the conventional constant; drawn to scale, 100 times the true length and breadth.

accompaniment of photosynthesis, while secondarily it performs the functions of lifting the minerals into the leaves, and at times of neutralizing excessive solar action upon exposed surfaces.

Connected indirectly with transpiration is GUTTATION, frequent in young herbaceous plants. It occurs at those times when roots are supplying water forcibly and abundantly, but transpiration is checked. The surplus water is then exuded through water pores (which are modified stomata), at the ends of the veins, where it collects in glistening drops, commonly mistaken for dew. The drops can be made to appear by experiment, and are often seen in garden plants on cool mornings after hot nights, or even on warm humid dull days; while often in cool evenings after hot afternoons the water drops run down and wet the foliage, as familiar in Cannas. In some measure related to guttation is the formation of shell-like ice on the stems of certain herbaceous "frost plants" in early winter; for the water freezes as it is forced from cracks in the dying stems.

#### 7. THE ADJUSTMENTS OF GREEN TISSUES TO LIGHT

Food formation is the first function of plants, and takes place only in chlorophyllous tissues under action of light. Accordingly it is natural that plants should exhibit special adjustments of their green tissues to the sun.

Most prominent of such adjustments is the existence of the leaf itself; for the leaf is simply a thin sheet of chlorenchyma provided with accessory veins, air spaces, and epidermis. In any typical foliage leaf, as observation indicates and microscopical measurement confirms, the chlorenchyma is remarkably uniform in thickness throughout all parts of the blade, in which respect it differs greatly from the veins. Furthermore, the chlorenchyma of all foliage leaves, no matter whether small, as in Mosses, or great, as in Palms, is not far from the same thickness. Exact measurements of the cross sections of many common leaves show that in different

kinds the chlorenchyma varies in thickness from .09 to .58 millimeter, with a mean at .179, and hence a conventional constant at .2 millimeter (Fig. 24). This variation, though considerable in itself, is yet wholly insignificant in comparison with the variation in the sizes and forms of leaves, with which indeed it bears no relation. Leaves of evergreen or leathery type which seem specially thick, as in Rubber Plant, have no thicker chlorenchyma, but only a thicker epidermis, while the swollen and succulent leaves of Century Plant or Houseleek really combine the function of storage with that of food formation, and hence fall into another category. What then determines this singularly uniform thickness (or thinness) of all foliage leaves? The spectroscope, the instrument by which light can be analyzed with great precision, shows that the red and blue-violet rays of the sunlight, effective in photosynthesis, are wholly absorbed by a layer of chlorophyll, as dense as that in the chloroplastids, a fraction of a millimeter thick. Accordingly the ordinary chlorenchyma can perform its function only when spread out in layers much less than a millimeter thick. If the chlorophyll is less dense, *i.e.* if there are fewer granules in the tissue, the effective light can go deeper, and the green tissue is thicker though paler, as in young stems. Furthermore, a stronger light can penetrate deeper, and hence effectively illuminate a thicker layer, than a weak light; and it is a fact that the thicker foliage leaves are those which live exposed to the brightest sun, while the thinner kinds occur on shaded undergrowth plants.

Second of the adjustments is the existence of the stem, of which the wide-branching structure carries the leaves aloft and spaces them out in the light; and this, as will later ap-

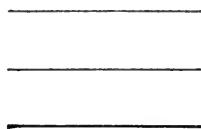

FIG. 24. — The actual thickness of the chlorenchyma of leaves, as seen in cross section.

The upper, one of the thinnest, is *Abutilon*: the lower, one of the thickest, is *Pelargonium*: the intermediate is the average of many kinds.

(The lines were drawn accurately by measurement on a very large scale, and reduced photographically.)

pear, is the primary function of the stem. It is true, not all leaves thus attain full individual exposure to light, and many are shaded more or less by others; but within certain limits this does not matter, for the reason, fully proved by experiment, that a bright diffused light is quite as effective in photosynthesis as direct sunlight, which contains in summer more energy than leaves can utilize.

Third of the adjustments is the presence of chlorophyll in all practicable lighted parts. While leaves are preëminently the chlorophyll-exposing organs, this function is by no means restricted to them, but is shared in lesser degree by young stems, young fruits, and even parts of the flower, though the showy corolla and ripe fruits have other colors suited to their special functions. It looks as though the plant took advantage of all its surfaces not needed in other functions to spread to the light such chlorophyll as it can, even though that be little.

Fourth of the adjustments is the existence in plants of a remarkable property of turning their green parts to the light, no matter from what direction it comes. The fact is familiar in house plants, which turn leaves and stems away from the darker room towards the lighter window to a degree profoundly affecting their forms, while the same power can be proved in many striking ways by simple experiments (Fig. 25). The younger parts of stems bend over until they point towards the light, carrying with them the young leaves, which independently set their blades at right angles to the light. This bending is effected by growth, which becomes more active on the side necessary to swing the stems to the light, and in those parts of petioles necessary to swing the blades across the light. Obviously the light does not effect the bending, for that is accomplished by the plant through its own differential growth; but the growth is made in response to the greater intensity of the light, which therefore acts as the *STIMULUS* to the bending. This process is called *PHOTOTROPISM* (formerly *heliotropism*), and it is typical of

a great many physiologically advantageous adjustments which individual leaves, stems, roots, flowers, and other organs of plants make not only toward light, but towards gravitation, moisture, chemical substances, and other external influences. This very important property of responding thus to external stimuli is called IRRITABILITY (page 39).



FIG. 25. — A Fuchsia grown for a week in a box open only on one side; seen in profile and face view;  $\times \frac{1}{4}$ . Traced from photographs.

Though it often simulates intelligent action, for which it is sometimes mistaken by the beginner in these studies, it has really no direct relation to the consciousness of animals. It does, however, correspond closely with the REFLEX ACTION of animal physiology, each irritable, like each reflex, reaction being perfectly specific and invariable in a given part to a given stimulus. Being thus, in any given case, automatic, these responses are properly describable as SELF-ADJUSTMENTS.

The phototropic response of leaves and stems to light, or of any other parts to a stimulus, involves the coöperation of four factors. *First*, there exists in the plant an hereditary property by virtue whereof the plant makes the responses, which are usually adaptive and evidently acquired in evolution in the same way as other plant-features. *Second*, there

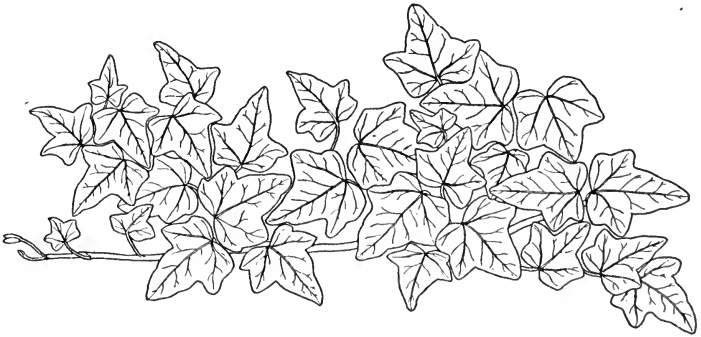

FIG. 26. — A leaf-mosaic in English Ivy. (After Kerner, *Das Pflanzenleben*.)

is some mode of perception of light by the plant, the quantity of light needed being extremely small, only enough, indeed, to make a physical impression upon the sensitive protoplasm. Probably most of the protoplasm of leaf and stem is thus sensitive, though special regions are more so than others, and various adaptations for concentrating light inside specialized perception cells have been described. *Third*, there is some method of transmission of an influence from the perceptive place to a motor mechanism where the actual response is produced. This influence apparently travels, as a rule, through the protoplasm of the cells and the intercellular threads (page 40), although special arrangements, supposed to facilitate its passage, have also been described. *Fourth*, there is a motor mechanism, resting usually upon a differential activity in a growth zone or other growing tissue, though in more active responses, as in the Sensitive Plant and Venus Fly-trap (page 76), a quick-acting hydraulic



mechanism is concerned. It is easy to recognize in the reflex actions of our own bodies the corresponding factors and mechanisms.

Since stems and leaves turn usually towards the stronger light, one may well ask why the vegetation of the northern hemisphere does not all bend towards the south. The reason seems connected with a fact already mentioned, that leaves cannot use all of the energy in full summer sunlight, while a strong diffused light is enough for their needs. Apparently their full power of response is aroused by such diffused light, which comes about equally from all parts of the sky.

Where many leaf blades grow closely together, they tend to move out from under one another's shade, their petioles bending or elongating in ways which effect this result. Thus the blades on a horizontal branch of a tree are commonly brought into one flat plane. The effect is particularly striking in Ivies, where the leaf blades become often so evenly distributed as to suggest the name of LEAF-MOSAIC (Fig. 26).

A familiar light adjustment is involved in the so-called "sleep movements," where the leaflets of compound leaves, as of Clover, Oxalis, Beans, Acacias, Sensitive Plants, droop or close together in darkness and spread widely apart in light (Fig. 27). The response to the light stimulus is plain, but the significance of the movement in the plant's economy is still uncertain. The leaflets of other plants exhibit an analogous movement under very intense light, in which they close together or assume vertical



FIG. 27.—Leaf of a Clover, in "awake" and "asleep" positions. (From Darwin, *Power of Movement in Plants*.)

positions, returning to the horizontal position when the light is less intense; and this movement has been interpreted as protective to the leaf tissues against too intense insolation. A permanent condition of this protective light adjustment, which, at its perfection, involves a setting of the leaf edges

toward the midday sun, produces the "Compass plants," of which there are several kinds in addition to the more famous one of our western prairies. Many other light adjustments are also known in nature, not only in leaves and stems, but also in roots, flowers, and other parts. They include movements towards, from, and variously across the line of incident light. In many cases, a distinct functional advantage to the organism can be clearly perceived, but in others this is not evident, though here the limitations of our knowledge may be at fault.

### 8. THE VARIOUS FORMS OF FOLIAGE LEAVES

Foliage leaves are remarkably diverse in their sizes and shapes, despite their singularly uniform thickness. They all

perform the same function, and their differences correspond for the most part with differences in the habits of the plants which produce them.

The sizes of foliage leaves range all the way from almost microscopic up to that of Palms and Bananas, several square feet in area (Fig. 28). Marshaling sizes against habits we find in general that the largest leaves occur upon plants which have the most abundant water and warmth, and least exposure to bright sun and winds, — in other words, upon plants exposed to relatively least transpiration.



FIG. 28. — The Banana, growing 12 to 15 feet high, and bearing the largest known simple leaves. (From Balfour, *Class-book of Botany*.)

These conditions are best realized in the shelter of tropical forests, and there we find the largest leaves, as all pictures of tropical undergrowth well show (Fig. 29), while the same



FIG. 29. — Primeval tropical forest, in Ceylon. To illustrate the large size of leaves in the undergrowth. (Reduced from Kerner.)

principle holds good in our temperate flora, as the student may recall. At the other extreme, very small leaves occur upon plants which are exposed to the greatest dryness, brightness,

cold, and strong winds, — conditions which make transpiration excessive. These conditions prevail in highest degree in arctic, alpine, and desert regions, and there we find the smallest leaves. In our native flora, the same principle is exemplified in the plants of bogs, which are open cold places, and in the evergreen trees, which have to withstand the rigors



FIG. 30. — A view in Hawaii, showing the contrast between tall-growing compound-leaved and low-growing simple-leaved Palms. (From Bailey, *Cyclopedia of Horticulture*.)

of winter. Under conditions intermediate between the extremes, the leaves are intermediate in size, as our temperate vegetation as a whole well illustrates. Correlatively, leaves which grow exposed to similar general conditions approximate to a similar size, as well shown in our common deciduous trees, where the leaves of Maples, Oaks, Chestnuts, Lindens, Poplars, and others are not far from one size, or at least belong to the same order of magnitude.

Leaves which are morphologically large sometimes become physiologically small by compounding of their blades to separate leaflets (page 16 ; Figs. 32 and 37). The compound-

ing is oftentimes associated with exposure to strong winds, as in Palms, where the compound-leaved forms tower high over the forests, or grow along wind-beaten strands, while the simple-leaved forms are confined perforce to shelter (Fig. 30); and it is probable that the compound leaves of the Tree Ferns (Fig. 31) originated in this way. Compounding,

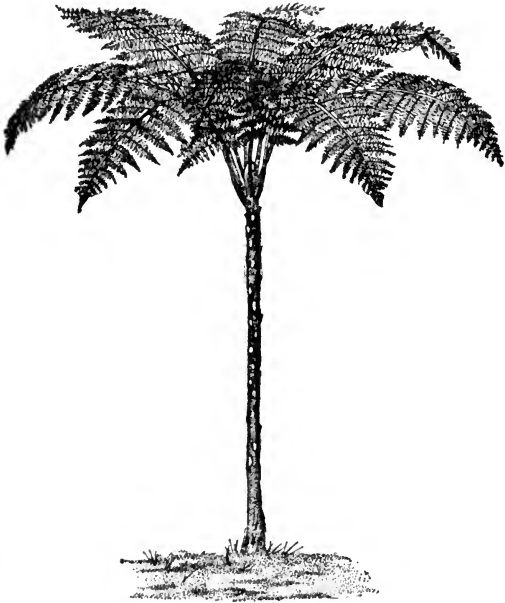

FIG. 31.— *Alsophila oligocarpa*, a tropical Tree Fern, showing the much-compounded leaves. (From Bailey.)

however, has also other associations. Thus, in the Pulse Family, it seems clearly connected with the “sleep,” or drooping at night of the leaves. In submersed water plants, where it is common, the compounding, by its exposure of more surface, facilitates the absorption of the carbon dioxide dissolved in the water (Fig. 32).

While leaf size seems thus largely adaptational, it is sometimes as clearly structural or hereditary. Thus the

small size of the leaves of Mosses, despite their occurrence in protected places, seems structurally determined by the very imperfect water-conducting system of those plants. The compounding, with the consequent small leaflets, of our under-

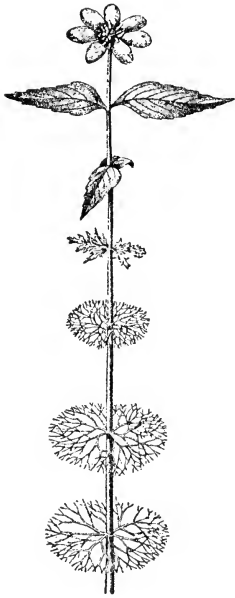

FIG. 32. — *Bidens Beckii*, which grows partly immersed in water and bears simple leaves above, and compound leaves below the surface. (After Goebel, *Biologische Schilderungen*.)

growth Ferns seems probably an hereditary survival from tree-like ancestors. And other minor factors enter into these problems.

In shapes, leaves are equally diverse, seeming to defy classification. Yet comparative study reduces them to modifications and combinations of three primary forms, which are the *orbicular*, *linear*, and *ovate*.

*Orbicular leaves* are well typified by the Garden Nasturtium (Fig. 33), with its nearly circular blade and central-standing vertical petiole from which the veins radiate to the margin, giving off a network of veinlets. In this leaf the blade is unbroken, but in most others a gap or slit runs from margin to petiole, as illustrated by the Pelargonium ("Geranium"), the difference apparently representing a different mode of evolution from ancestral forms which had marginal petioles. Structurally the orbic-

ular form serves best the leaf function, since it combines the most green surface with the least lateral spread, and provides the shortest paths of conduction for water and food through the blade. Orbicular leaves are found oftenest upon low-growing or flat-growing plants, where each blade has room for exposure to light unshaded by its neighbors, as in "stemless" herbs, in creeping vines like Ground Ivy, and in

leaves which float on the water, as with Water-lilies; while climbing Ivies show the same tendency, usually modified, however, by marked angularity of form. The full exposure of the round blades to light is aided by adjustments in the slender petioles, and it is in such plants that leaf-mosaics, mentioned in the preceding section, become the most perfect.

*Linear leaves* are typified by those of the Grasses, with their

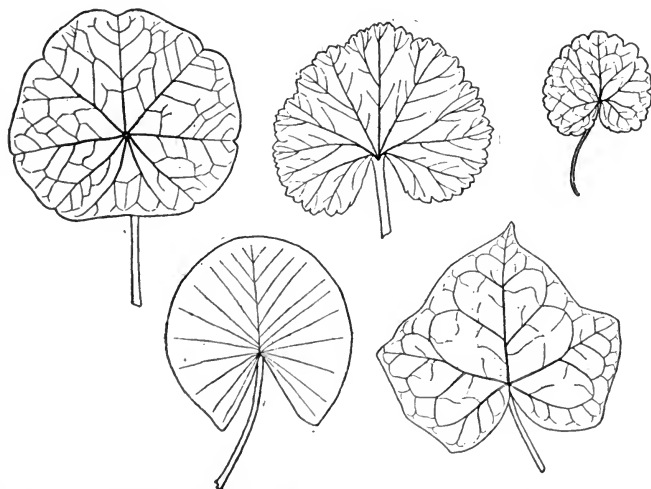

FIG. 33.—Leaves approximating to orbicular shape;  $\times \frac{1}{2}$ . Garden Nasturtium, Yellow Water-lily, Pelargonium, English Ivy, Ground Ivy.

slender elongated blades merging imperceptibly into the petioles, and their approximately equal-sized parallel veins joined by inconspicuous veinlets (Fig. 34). Such leaves occur chiefly in dense growths in the most brightly lighted places, either upright and parallel like the Grasses in meadows or the Cat-tails along lake sides, in dense radiating heads like the Bunch-grasses and Spanish Bayonets (Fig. 35), or else in mats and tufts, as along the branches of our evergreen trees. At first thought it would seem that such leaves, presenting their edges rather than their faces to the sun, must be badly illuminated. Yet their habitual occurrence in the sunniest

places, in conjunction with the daily swing of the sun through the sky, must insure among them a sufficiency of that bright diffused light which, as earlier noted (page 54), is fully as

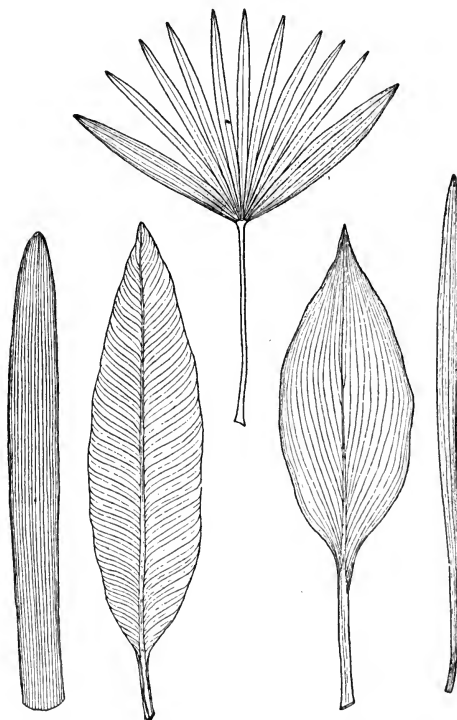

FIG. 34. — Linear and other parallel-veined leaves;  $\times \frac{1}{3}$ . Hyacinth, Banana (small), *Thrinax* (a Fan Palm), *Eucharis*, a Grass.

effective in food formation as direct sunlight. Furthermore, the crowded condition of such leaves tends greatly to restrict transpiration, without equivalent check to the access of carbon dioxide; and such an arrangement has obvious advantage to plants of limited water supply.

*Ovate leaves* are typified by those of Lilac (Fig. 36). The petiole, at the larger end, merges into a strong midrib from which spring side veins, which in turn give rise to a network of veinlets.

This general shape is the commonest in nature, and associated with the commonest condition of leaf existence, viz., that in which the blades, neither spread out in one plane nor densely crowded in full sun, are carried aloft and spaced apart on ascending stems and branches, as occurs in our larger herbs, and especially in shrubs and trees. This mode of life is essentially intermediate between that associated with orbicular



and that with linear leaves, and the ovate shape approximates to orbicular at base and linear at tip. It is therefore quite consistent that when the leaves become more crowded on the branches, as in Chestnut and Beech, the ovate shape tends towards linear, resulting in a spindle form; but when on the contrary the leaves are more fully spread out, the ovate tends towards orbicular, with the great veins coming to radiate from an elongated petiole, as in Redbud. The tendency towards orbicular goes farther in heart-shaped leaves, like Linden and Violet, and ultimately leads back to the true orbicular with central-standing petiole.

Between orbicular, linear, and ovate forms, there occur all gradations, giving a great diversity of forms. Many of these have been named from their resemblance to common objects (*e.g.* lanceolate, spatulate, reniform, peltate); and such designations find constant use in the descriptions of plants contained in floras and manuals.

Closely connected with the shapes of leaves is their **VENATION**. Orbicular and ovate leaves are typically *netted*-

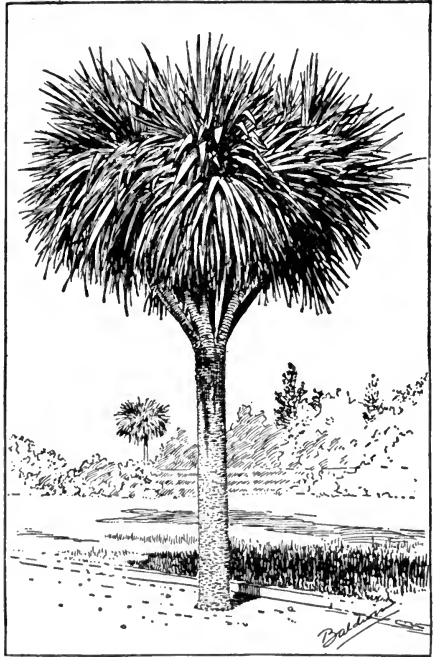

FIG. 35. — *Cordyline australis*, the "Draena Palm," showing radiate heads of linear leaves. (From Bailey, *Cyclopedia*.)

*veined*, that is, have a few prominent veins and many intersecting veinlets (Figs. 2, 33, 36). In the typical ovate forms there is commonly one midrib with a few veins running thence parallel-diagonal to the margin, and such venation is called

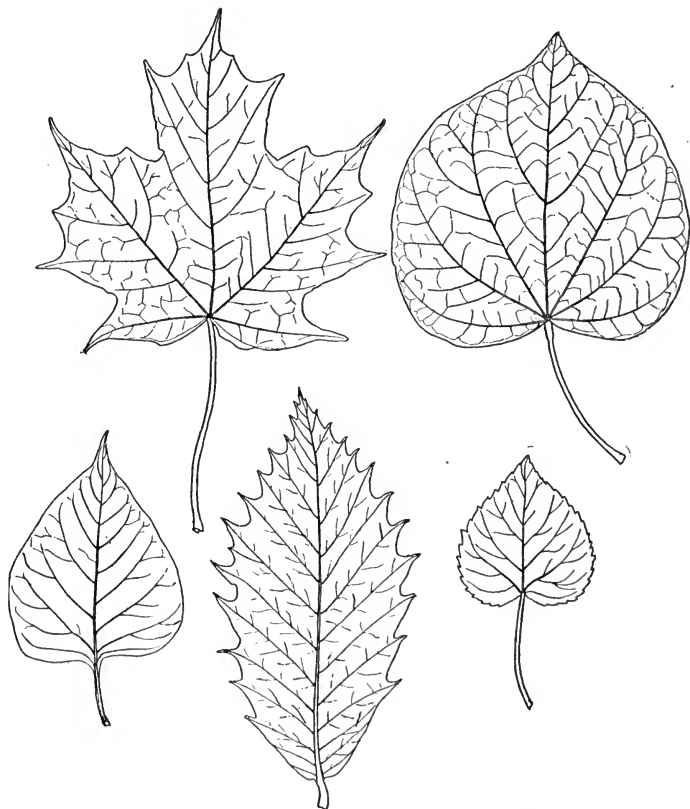

FIG. 36. — Leaves approximating to ovate shape;  $\times \frac{1}{2}$ . Lilac, Maple, Beech, Redbud, Violet.

PINNATE, while in orbicular forms several approximately equal veins radiate from the petiole, and that is called PALMATE. Linear leaves are typically *parallel-veined*, that is, have many approximately equal veins running parallel, with the cross

veinlets almost invisible. In some the veins gradually converge towards tip and base, as in Grasses and many Lilies; in others they run out strictly parallel from a midrib, as in Banana (Fig. 28), while in still others they radiate from

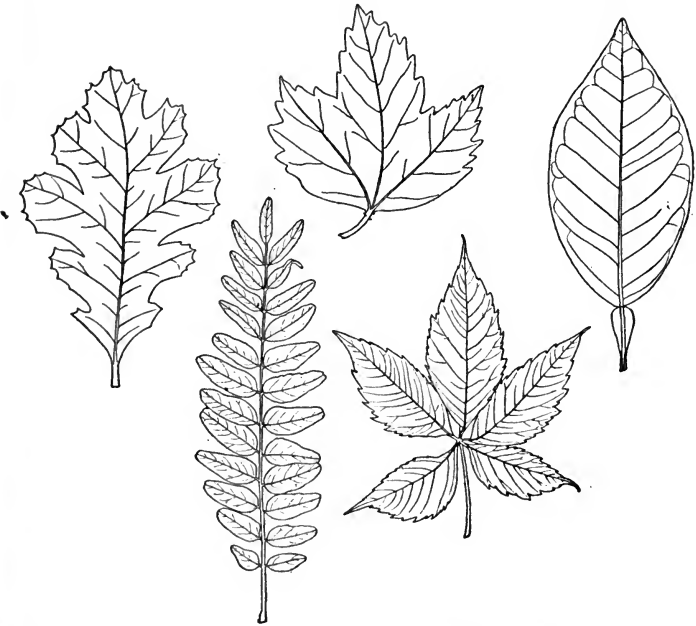

FIG. 37. — Typical lobed and compound leaves;  $\times \frac{1}{2}$ . Oak, Locust, High Bush Cranberry, Virginia Creeper, Orange. The single leaflet of the latter is jointed to the petiole, which in related forms bears two additional leaflets.

the base, producing a fan shape, as in the Fan Palms (Fig. 34). And of course there occur all gradations and combinations.

There is also close connection between the venation, and the *lobing* and *compounding* of leaves. Some kinds become deeply lobed between their main veins, and therefore PINNATELY LOBED, as in Oak (Fig. 37), or PALMATELY LOBED, as in Maple. The significance of this lobing is not yet under-

stood, but it seems connected with a tendency of the chlorenchyma to collect more closely towards the main veins. The lobing carried farther leads to compounding, which therefore is either PINNATE, as in *Acacia*, or PALMATE, as in *Virginia Creeper* (Fig. 37); and often the leaflets are themselves compounded, even more than once, as in some Ferns. Parallel-veined leaves are rarely lobed or compounded, their mode of venation being obviously unfavorable thereto. The number of leaflets in a compound leaf can be very great, or no more than three, as in *Poison Ivy*, or even only one, as in *Orange*.

Leaves differ also in the character of their margins, which in some, *e.g.* *Rubber Plant*, and most parallel-veined kinds,



FIG. 38. — Forms of leaf margins.  
(After Gray.)

are unbroken or ENTIRE, but in others are sharp-toothed or SERRATE, *e.g.* *Rose*, and in others yet otherwise formed (Fig. 38). The differences seem to have no functional significance, but represent structural expressions of the various ways in which the chlo-

renchyma is arranged with respect to the vein endings.

Leaves also display some peculiar forms of tips and bases (Fig. 39). The prolonged slender tip found in some leaves of tropical plants has been claimed to act as a "drip point," effective in removing water from the leaf after rain, thus preventing a long closure of the stomata; but the evidence is not clear. Some leaves have the base of the blade prolonged into ear-shaped (AURICULATE) or pointed forms, occasionally making the leaf arrow-shaped. In some kinds these extensions grow together around the stem, which accordingly seems to pierce the blade (PERFOLIATE), while in others two opposite leaves grow together in similar manner surrounding

the stem (CONNATE-PERFOLIATE). Such features, for the most part, seem to have a structural rather than adaptational origin.

The leaves of plants which grow in places where water is scarce, or hard to absorb exhibit several features obviously

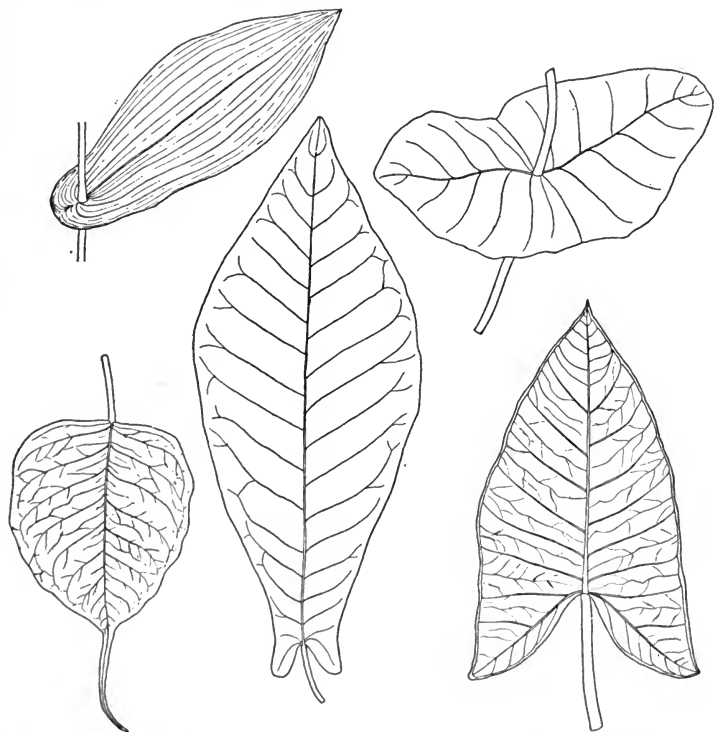

FIG. 39. — Special forms of tip and base in leaves;  $\times \frac{1}{2}$ . *Ficus religiosus*, with "drip" point; perfoliate *Uvularia*; auriculate *Magnolia Fraseri*; connate-perfoliate Honeysuckle; *Caladium*.

related to reduction of transpiration. Such are, — *reduction in size*, already mentioned; *compact or rounded forms*, often storing water, as in Cactus; a very *thick epidermis*, which prevents any loss by direct evaporation; *sunken stomata* with an air chamber outside, or else *inrolled leaves*, with the stomata

in the concavity (Fig. 40), or coverings of hairs or scales (Fig. 41), all of which arrangements tend to delay the

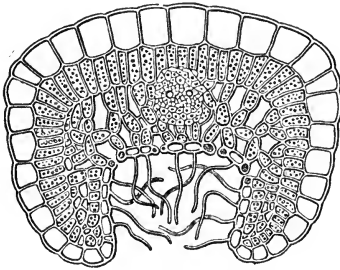

FIG. 40. — Leaf of *Erica*, in cross section;  $\times 280$ . (From Kerner.)

escape of water without materially affecting the entrance of carbon dioxide: and a vertical position of the green tissues, which lessens the evaporative effect of the noonday sun without any effect upon gas absorption. The collective result of these features is to give the characteristic

grayish condensed aspect to the vegetation of dry places.

The trichomes of plants are indeed remarkable in their variety, and often in their beauty when viewed through the

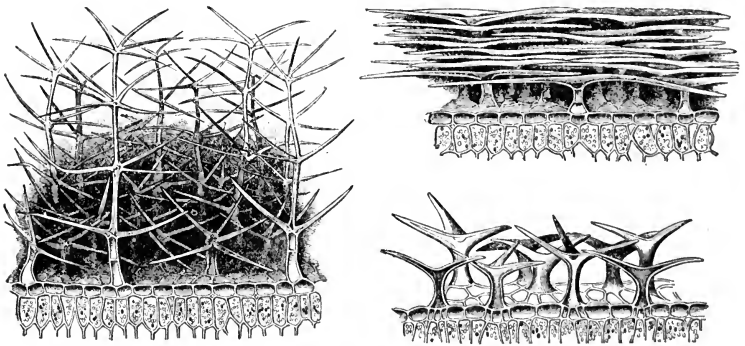

FIG. 41. — Various forms of epidermal hairs and scales (trichomes) found upon leaves; much magnified. (From Kerner.)

microscope. Diverse functions have been ascribed to them, in addition to their part in restricting transpiration, but without convincing evidence. Perhaps they represent a kind of play of growth forces rather than any adaptational development.

A very remarkable form of leaf occurs in the *Welwitschia mirabilis* of Southwest Africa, a plant unique in a great many

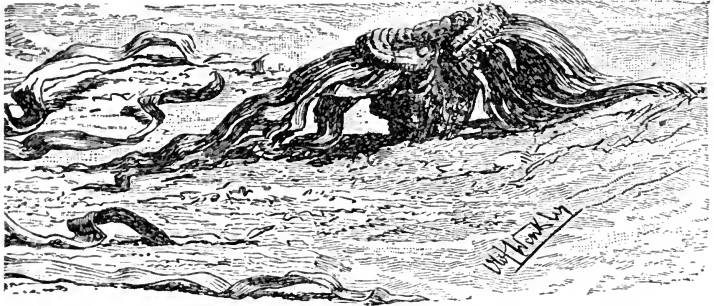

FIG. 42. — *Welwitschia (Tumboa) mirabilis*, growing in the desert of Kalahari, Africa. The woody trunk, though many years old, is but two feet in height. (From Kerner.)

features (Fig. 42). The leaves, only two in number, grow at their bases as they die at their tips throughout the long life of the plant.

Leaves are produced in buds, but produce buds in very few cases. The leaves of some kinds of *Begonia*, however, if cut across the veins, develop buds which grow into normal new plants; and gardeners are accustomed to propagate those *Begonias* in that way. In the well-known Life Plant (*Bryophyllum*), the rather thick fleshy leaves regularly produce buds at the outer ends of the veins (Fig. 43); and these buds develop freely into young plants when the leaves fall on damp soil,

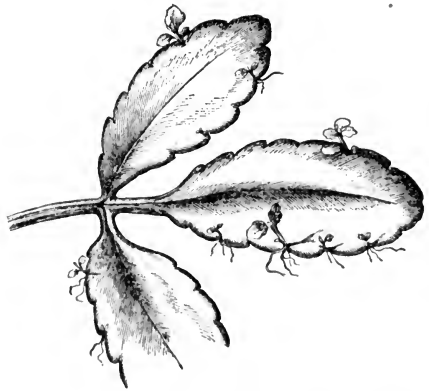

FIG. 43. — The Life Plant (*Bryophyllum calycinum*), developing young plants on the margin of the leaves;  $\times \frac{1}{2}$ . (From Kerner.)

or even when they are pinned up against a wall in the house, as often done for a curiosity. Apparently this leaf is quite genuine and not a stem in disguise, as one tends to infer.

Finally, one often finds foliage leaves which exhibit abnormal features, such as forked, lacinate, crested, or even pitcher-form blades, or eccentric coloration, or other unusual features. When extreme, such cases are popularly called *freaks*, and in science *monstrosities*. It happens that monstrosities in leaves are closely connected with those in stems, and accordingly we can most conveniently discuss them together in a later section.

## 9. THE FORMS AND FUNCTIONS OF LEAVES OTHER THAN FOLIAGE

While formation of food is the primary, and usually the exclusive, function of leaves some kinds perform additional functions, and exhibit corresponding peculiarities of aspect and structure. Further, in some leaves the new

function comes to overshadow the old, and even to replace it. In such case we have a new organ, though one which retains evidence of its morphological origin in its mode of development, and various peculiarities of structure.

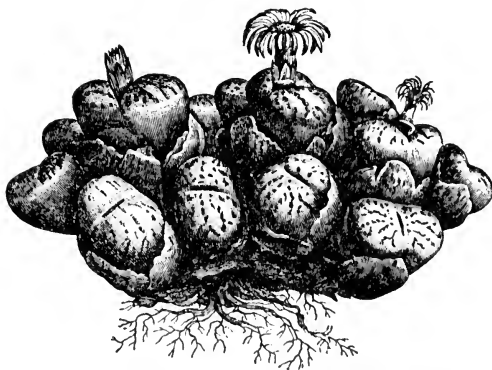

FIG. 44. — *Mesembryanthemum obconellum*, a plant which stores water in the pairs of thickened leaves. (From Goebel.)

The simplest case of an additional function in leaves consists in the *storage* of water or food, the presence of which swells the leaves greatly, as in Century Plant, and Houseleek



(Fig. 44). The chlorophyll, of course, is all near the surface, and wanting in the interior cells of the chlorenchyma, which increase in number and size, and present a translucent aspect if water is stored, but are opaque if much food is present. Sometimes the upper parts of the leaves become true foliage while the bases alone store food, in which case these storage parts, after the foliage has withered away, form collectively a typical BULB, as in Hyacinth (Fig. 45). In related plants the specialization has gone further, making a division between foliage and storage leaves, in which case the latter become exclusively food-storing organs, as in the bulb scales of Lilies (Fig. 46).

Another form of food-storing leaves, serving also in some cases as foliage and in other cases not, are the COTYLEDONS or "seed leaves" of embryo plants, later to be fully described.

In many kinds of plants, some of the leaves deviate in minor features from the typical condition, in which case they are called collectively BRACTS. Commonest of all are the little pale scale-like bracts which stand under each flower in a cluster, where apparently they have no function, but represent foliage leaves in an arrested or rudimentary state of development; for it is a constant structural peculiarity of the higher plants that flowers originate in the AXILS of leaves, that is, in the upper angle between leaf and stem. Likewise little scale-like bracts occur just below the leaf-like branches of *Asparagus* and florists' *Smilax* (page 195). In the Linden the bract is much larger (Fig. 47), and attached thereto is the flower cluster which

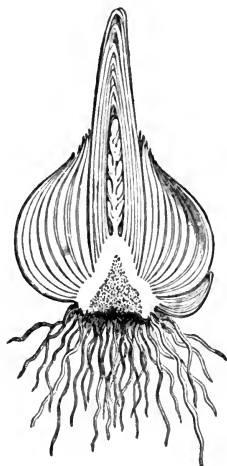

FIG. 45.— A Hyacinth bulb, in section. The outer or storage leaves are the bases of last year's foliage leaves, and will be replaced, as they wither, by the bases of the new leaves surrounding the flower cluster. (From Figurier, *Vegetable World*.)

grows out of its axil; while later this bract serves as a "sail" against which the wind acts in transporting the seeds. Very

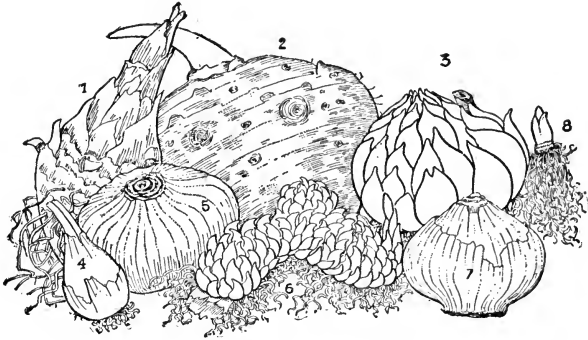

FIG. 46. — Various forms of common "bulbs." Nos. 3, Easter Lily, 4, Jonquil, 6, *Lilium pardalinum*, and 7, Hyacinth, are true bulbs, *i.e.* are composed mainly of storage leaves. Nos. 2, *Colocasia antiquorum*, and 5, *Gladiolus*, are corms, *i.e.* storage stems. No. 1, Tuberose, is a tuber, and 8, Lily of the Valley, a rootstock, called a "pip." (From Bailey.)

striking are the cases where the bracts become highly colored, thus forming the showy part of a "flower," as in Poinsettia,



FIG. 47. — A leaf and the specialized bract in American Linden. (From Bailey.)

the real flowers of which are small and inconspicuous. The sepals and petals of ordinary flowers are also morphologically leaves, as, in a slightly different way, are the stamens and pistils. Colored bracts and petals retain mostly the structure of foliage leaves, excepting that the chlorenchyma now holds other pigments in place of the chlorophyll.

Another striking case of the combination of a new function with the old is found in the pitchers and other leaf traps in which insects are caught and digested. They all retain



FIG. 48. — The Pitcher Plant of Northeastern America, *Sarracenia purpurea*;  $\times \frac{1}{2}$ .

The frontispiece, reduced, of Barton's *Elements of Botany* (2d ed., 1804), the first great American botanical textbook.

their chlorenchyma, and the changes are chiefly in form. Thus our native Pitcher Plant, or *Sarracenia* (Fig. 48), seems to represent a leaf in which the margin has grown up around a central-standing petiole, forming as it were first a saucer, then a cup, and finally a pitcher. In the *Nepenthes*, most

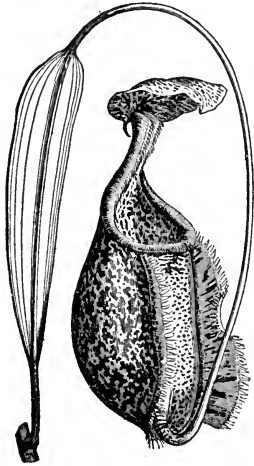

FIG. 49.—*Nepenthes*, an East Indian Pitcher Plant;  $\times \frac{1}{2}$ . The slender stalk between blade and pitcher often serves as a tendril.

(From Le Maout and Decaisne, *Traité Général de Botanique*.)

elaborate of Pitcher Plants (Fig. 49), there occurs a partial division of labor between the pitcher and foliage functions, for a very perfect blade exists in addition to the pitcher. Doubt still exists as to the precise morphology of the parts in this remarkable leaf, though it seems most probable that the pitcher represents a blade transformed as in *Sarracenia*, with the lid a special outgrowth and the seeming blade an expansion of the elongated petiole, which often serves also as a tendril. But we must guard against pushing such homologies too far, because leaves and other parts, while strongly influenced in development by the characteristics of the part from which they have evolved, are by no means limited to the charac-

teristics thereof, but often break loose, as it were, and develop new features upon their own account. In another well-known insect-trapping leaf, that of the Venus Fly-trap (Fig. 50), the morphology is obvious, the petiole becoming expanded much like the blade.

Another function performed by leaves is that of support to climbing plants, in which case they form TENDRILS, which are characteristic organs of most vines. Tendrils are very slender almost thread-like structures, fitted to twine around supports, to which they thus attach their plants. In the

simplest case, the petiole acts as the tendril, making a turn around the support, as in our common wild Clematis (Fig. 51). In other cases, as illustrated by our figures, the tendril is a transformed leaflet or leaflets, or else stipule-like structures, or even the entire blade. The typical tendril moves about through the air until it touches some object; then it bends towards the touched side, and, if the object be of suitable form, continues the process, and makes several turns around it (Fig. 52). Then the intermediate part of the tendril becomes twisted to a double spiral, drawing the plant closer to the support, after which it develops tough

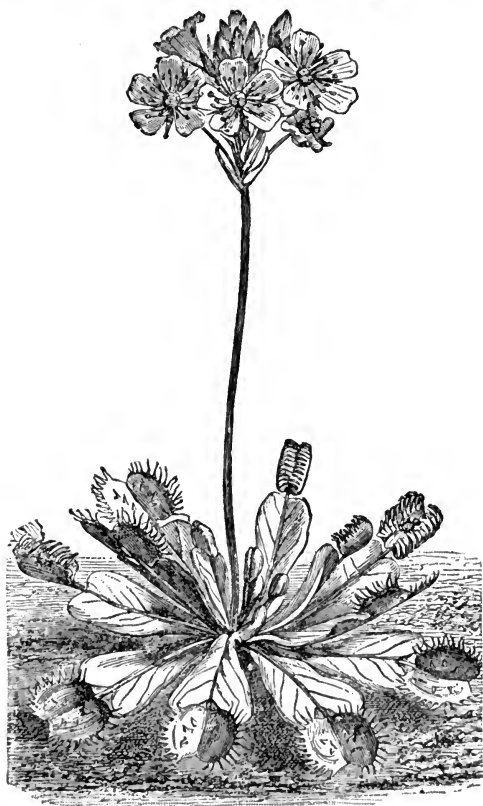

FIG. 50. — Venus Fly-trap, *Dionaea muscipula*, a plant which catches insects by sudden closure of its leaf blades;  $\times \frac{1}{2}$ . (From Figurier.)

fibrous tissues, thus forming a strong but elastic bond between plant and support. In this definite action of tendrils we have another instance of those automatic self-adjustments made possible by the irritability of protoplasm (pages 39, 55), this particular form being called THIGMOTROPISM.

Another special form and function of leaves is represented in the brown BUD SCALES which enwrap the winter buds of our trees. They mostly lack chlorophyll, their cell walls become thick and well cutinized, and often they develop

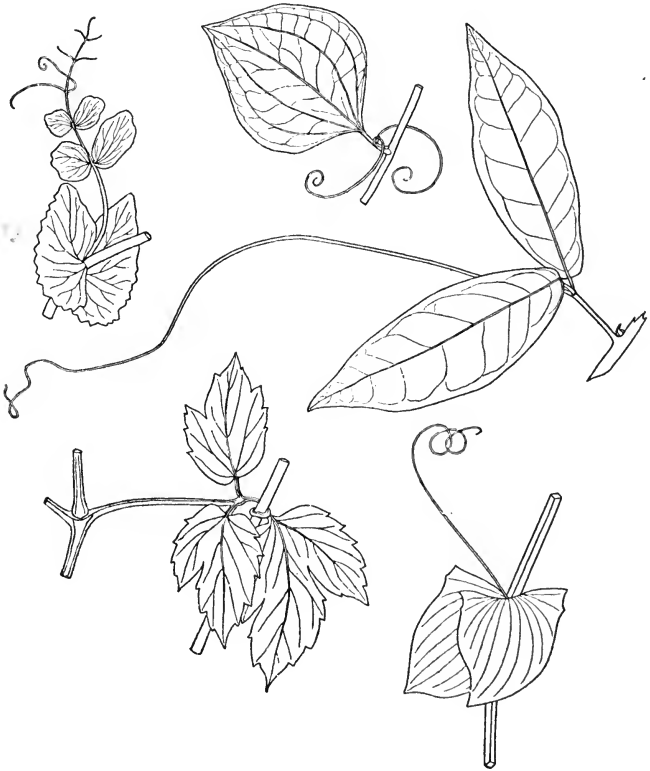

FIG. 51. — Forms of leaf tendrils;  $\times \frac{1}{2}$ . Pea, Smilax, Bignonia, Clematis, *Lathyrus Aphaca*. The apparent leaves of the latter are stipules.

coatings of resin or hairs; and they fall away as the buds unfold. In some kinds each scale is an entire leaf, in others it is a petiole with blade suppressed (Fig. 53), or it may be a stipule, as conspicuous in Tulip tree, where together the pair forms a close-fitting cap (Fig. 57).

Leaves are also often modified to SPINES, especially in plants of dry places. The significance of spines, however, is uncertain; for the older view that they represent a protection against animal enemies seems inadequate, while the newer idea that they result from a structural degeneration of leaves rendered superfluous by changed habit has not won acceptance. In the transformation they lose their chlorophyll and flat form, and become slender, conical, and hard. In some cases each spine represents a single transformed leaf, as is believed true in the Cactuses (Fig. 54); in others they represent the midrib and two lateral ribs of a leaf, as in Barberry (Fig. 55); in *Euphorbias*, when paired, they clearly represent stipules (Fig. 57); while in some tropical climbers the stipular spines are very strong downward-turned hooks which catch firmly upon other vegetation.

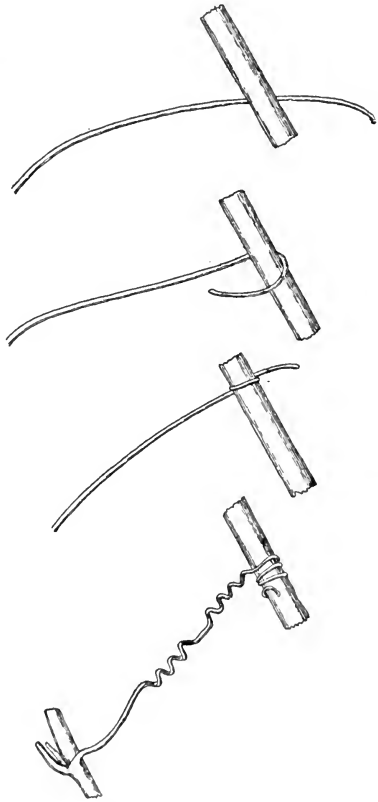

FIG. 52. — Stages in the twining of a tendril, of *Bryonia*;  $\times \frac{1}{4}$ . This is a stem tendril, but the method is the same in leaf tendrils. (Drawn, with slight alterations, from a wall-chart by Errera and Laurent.)

While the blade is the distinctive chlorenchyma-carrying part of the leaf, the foliage function is in some cases assumed by petioles or stipules, the blade being more or less suppressed. Thus, in

the Australian Acacias, the chlorenchyma is all in the petioles (called PHYLLODIA), which are vertically flattened (Fig. 56), while the much compounded blades distinctive of

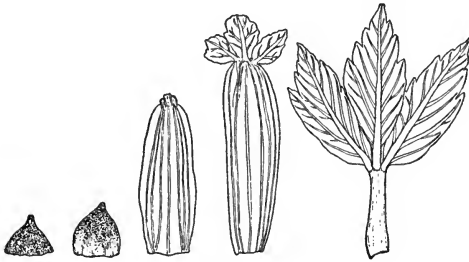

FIG. 53. — Transition from bud scales to leaf, showing the former to be petioles, in Box Elder;  $\times \frac{1}{2}$ .

Acacias are suppressed. In other cases the stipules become enlarged, aiding the blade in its function as in Violets (Fig. 57), reaching to a size and form identical with those of the blades as in Galium, or replacing the foliage altogether as in *Lathyrus Aphaca* (Fig. 51). The causes of these curious substitutions of functions are mostly not known, but they are presumably connected with peculiarities in the past history of the plants. For example, it seems likely that the abandonment of the leaf blade and transfer of the foliage function to the petioles in Acacias represents a mode of adaptation to a climate increasing in dryness. Leaflets, which expose much horizontal surface, are out of place in dry climates, while a single petiole, flattened vertically, is better protected against extreme transpiration (page 70).

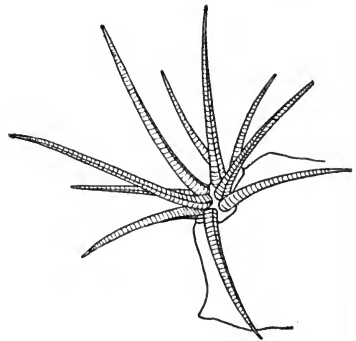

FIG. 54. — A cluster of spines from an *Echinocactus*;  $\times \frac{1}{2}$ . (After Goebel.)

One cannot but notice the diversity of form, and the variety of apparent function, in the stipules. In existent plants they seem to represent no distinctive organ, but



rather a kind of morphological entity easily specialized in diverse directions. Recent investigations have shown that leaves containing stipules receive from the stem three sets of veins, from two of which the stipules are supplied, while leaves lacking stipules receive but one set, or vein. Since the original or primitive leaf of our modern trees was apparently three-lobed, the stipules may represent the two lateral lobes, which became reduced as the middle lobe developed into the leaf blade of our existent plants.

Not all paired structures at the bases of leaves are stipules. In *Pereskia*, a climbing Cactus, the paired hooks whereby the plant clings to a support are the first two spines of an axillary cluster, and in some kinds of *Aristolochia* the leaf-like seeming stipules are simply the first leaf of an

axillary branch. In the Telegraph Plant (Fig. 58), they are leaflets, much smaller than the terminal leaflet; and in this plant they have further the remarkable property, that, for reasons uncertain, they are constantly rising and falling, in short jerky motion suggestive of the arms of the old semaphore telegraph,—whence of course the plant's name.

Typically, leaves are flat plates of tissue, and in their various transformations this plane character is mostly retained. In certain cases, however, the face of the leaf develops an outgrowth of tissues,

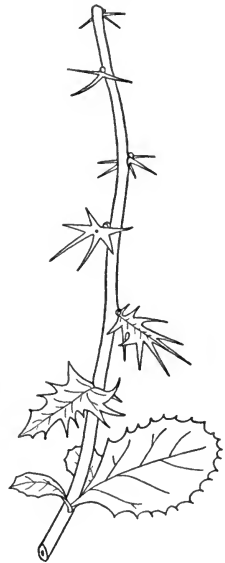

FIG. 55.— Leaf spines of Barberry;  $\times \frac{1}{2}$ . (After Gray.)



FIG. 56.— A phyllode of an Acacia;  $\times \frac{1}{2}$ . Often a few leaflets of the compound leaves appear at the tip.

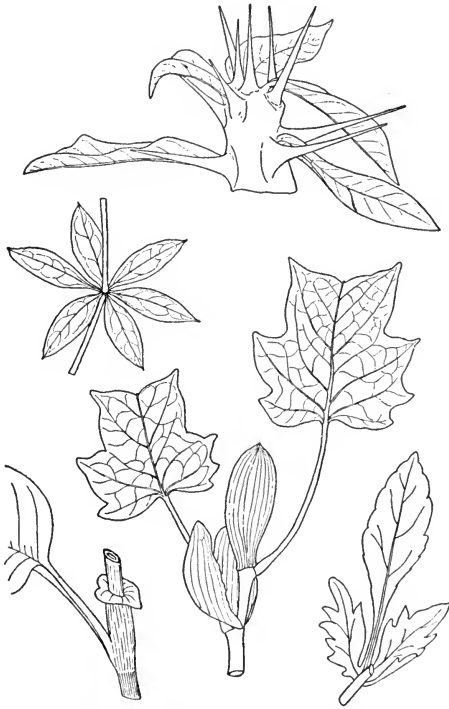

FIG. 57. — Special forms of stipules;  $\times \frac{1}{2}$ . *Euphorbia*, paired spines: *Galium*, with two opposite leaves simulating a 6-leaved whorl: Tulip Tree, bud scales: *Polygonum*, united in a sheath (ochrea) around the stem: Violet, accessory foliage.

a kind of branching of the face of the leaf. Such seems the case in the lid of the *Nepenthes* pitcher earlier mentioned, and in the corona, or crown, of the petals of some flowers, notably the Daffodil (Fig. 230).

Thus we see that the leaf, though having a definite and typical primary function and structure, is yet highly plastic in all of its features, and can be led along many different lines of development. Such morphological plasticity is characteristic of all parts of living beings, and is one of their distinctive

properties (page 39). The tracing of such lines of development is the distinctive province of morphology.

#### 10. THE NUTRITION OF PLANTS WHICH LACK CHLOROPHYLL

While most plants possess chlorophyll and make their own food, there are some which do not. If, now, all plant food is based on grape sugar made in green tissues, how do these chlorophyll-less kinds secure their supply? The

matter is simple; they take it from green plants, or from animals which obtain it from green plants. When they take it from living plants or animals, they are called PARASITES, the one from which it is taken being known as the HOST; and when they take it from dead plants or animals or decaying remains thereof, they are called SAPROPHYTES. The difference between parasites and saprophytes has no particular physiological significance, but is rather a convenience in our description of those plants. The absorbing organs of such plants are called HAUSTORIA.

Among the Flowering Plants, the most familiar parasite is doubtless the Dodder (Fig. 59), a relative



FIG. 58. — The Telegraph Plant, *Desmodium gyrans*;  $\times \frac{1}{2}$ . It is native to tropical Asia, but is grown in greenhouses. (From Figurier.)

of the Morning Glory. Its slender, orange-colored, smooth stem twines around and among various green herbs in the fields; and wherever it touches their stems it sends forth aërial rootlets which penetrate the tissues until they reach the veins (Fig. 59). Here a connection is established with both ducts and sieve tubes, from which the parasite can now draw both water and food. The most familiar flowering saprophyte is doubtless the Indian Pipe or Ghost Plant (Fig. 60), the roots of which are believed to absorb the decaying material of green plants, not, however, directly, but by aid of a Fungus (*Mycorhiza*, page 244). Such parasites and saprophytes, having no chlorophyll, need no leaves, which accordingly are reduced to mere scales; and these persist only as relics of an evolution from chlorophyll-

possessing ancestors. Without leaves, there is small need for stems, which accordingly are also much reduced in many of the flowering parasites. An extreme in these respects is reached in that remarkable flowering parasite, the *Rafflesia* of Java (Fig. 61), where the plant consists

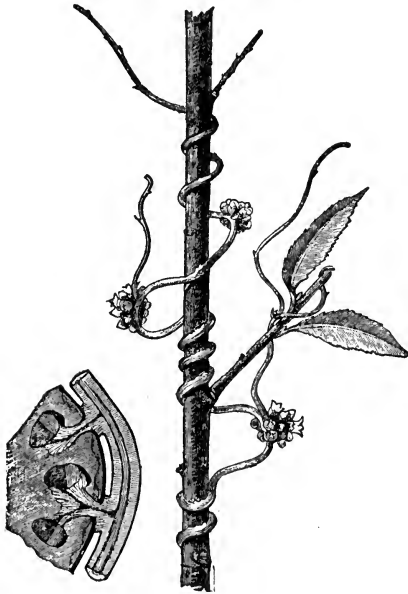

FIG. 59. — The Dodder, *Cuscuta Europea*;  $\times \frac{1}{2}$ . It is here parasitic on Willow, on which it twines. Note the scale-like minute leaves, and the flowers in clusters. On the left is a section showing the connection of the haustorial roots with the veins of the host. (From Strasburger.)

solely of a single gigantic flower (some three feet across and the largest flower known), which, through a very short stem and some haustorial roots, is parasitic upon overground roots of trees.

The Fungi, including the Bacteria, comprise many thousands of species of parasites and saprophytes, which exhibit structures having obvious relation to the conditions under which those plants live. Parasitic Bacteria mostly inhabit the tissues of

living plants or animals, from which they absorb the nutritive juices directly through the walls of their very simple bodies. The true Fungi possess no leaves, stems, or roots, but consist ordinarily of two parts, — *first*, a feeding body called a MYCELIUM (Fig. 62), composed of numerous fine white threads which ramify over and through their hosts, or the decaying materials on which they grow; and *second*, a SPOROPHORE which comes out from the surface, and develops

the minute reproductive spores in the air where the winds can scatter them. Indeed, were it not for the sporophore, often the presence of the hidden mycelium would never be suspected. The familiar mushrooms and molds have this structure.

Parasites, whether flowering plants or fungi, enter and penetrate their hosts by use of digestive ferments, or *enzymes*, put forth by the tips of the entering haustoria. Enzymes are definite chemical substances which have power to digest (*i.e.* convert into soluble forms) the cell walls, starches, and proteins; and these digested materials are absorbed into the roots or mycelium and form food for the parasite. It is precisely the same with saprophytes. The damage done by parasites to their hosts is of three sorts, — *first*, the removal of food, thus tending to starve the host plant; *second*, the excretion of injurious or poisonous substances apparently by-products of the parasite's own metabolism; and *third*, the disturbance of the growth-control mechanism, resulting in the production of various monstrosities.

Parasites and saprophytes are relatively small plants, the majority being microscopic; and they constitute an insignificant



FIG. 60. — The Indian Pipe, or Ghost Plant;  $\times \frac{1}{4}$ . It has no chlorophyll, but is translucent white in color. (From Bailey.)

nificant and inconspicuous part of the earth's vegetation. Thus it is clear that their mode of life is far less successful than that of green plants. There is, however, another group of organisms of similar habit which has been more successful in this respect, and that is the animals. They, too, are parasitic or saprophytic upon plants, but have



FIG. 61. — *Rafflesia Padma*, of Java, parasitic on a root. (From Kerner.)

this advantage, that possessing the power of free locomotion, they are not confined for their food to single hosts, but can take it from many.

It might be supposed that in absence of chlorophyll, the bright colors displayed by some Fungi, notably the brilliant reds and yellows of poisonous toadstools, perhaps have part in a food-making process. No evidence for such function exists, and the significance of those colors is not known.

The student may recall that the Mistletoe, a reputed parasite, possesses chlorophyll. That plant, however, is only a half parasite, for while taking water and minerals from the host it makes its own food in its leaves. There are plants

which are likewise half parasitic upon the roots of other plants, as in case of our wild Purple Gerardia.

Insect-catching plants do not belong among parasites, because they all make their own food. The insectivorous

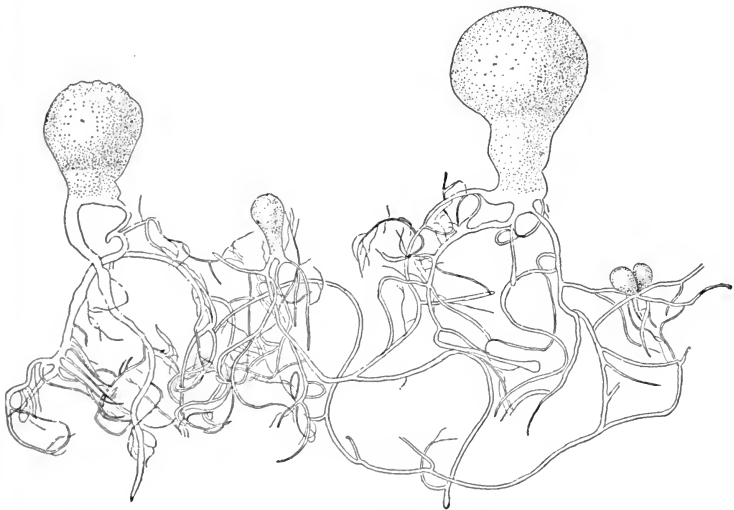

FIG. 62. — The mycelium (threads ramifying in the ground) and sporophores (above the surface) of a small Puff-ball;  $\times 5$ .

habit is connected only with the acquisition of nitrogen compounds, as will later appear.

Finally, there is one other very distinct method of plant nutrition. Certain Bacteria which live in the soil have power to make their own food from carbon dioxide and water entirely without sunlight, the necessary energy for the process being derived from chemical energy set free by the oxidation of substances in the soil. The process is thus naturally designated CHEMOSYNTHESIS in distinction from photosynthesis. While occurring at present, so far as known, in only one group of Bacteria, the method has great interest for the reason that it suggests a way in which plants may have made their food in the far-distant times before chloro-

phyll was developed. The existing chemosynthetic Bacteria, indeed, may represent a survival from that ancient epoch, in which case they are doubtless the most ancient type of organisms now inhabiting the earth.

#### 11. THE AUTUMNAL AND OTHER COLORATION OF LEAVES

The distinctive color of leaves is the chlorophyll green, which most of them exhibit. Other colors, however, occur, especially in "foliage" and "variegated" plants, and in the autumnal foliage.

The most prominent of the non-green colors of living leaves is *red*. It is most intense in cultivated plants, such as Japanese Maples, Copper Beeches, Coleus, Beets, and Red Cabbages. In all cases, however, the color has been greatly intensified under cultivation, from a very moderate quantity in the ancestors of these plants. Little blotches or streaks of red color are indeed very common in wild plants, as intensive observation, centered on this point, soon reveals. The color is due to the presence of a red substance, called descriptively *ERYTHROPHYLL* but chemically *ANTHOCYAN* or *ANTHOCYANIN*, which is dissolved in the sap of the cells. Being thus soluble in water, it is easily removed by hot water from red leaves, which thereby are left green, showing that chlorophyll is present in foliage plants, though masked by the more brilliant and abundant erythrophyll. As to the reason for its presence, that is greatly in doubt. Probably it has no functional utility in itself, but represents simply an incidental product of the complicated metabolism of the plant.

In some cases, however, a functional utility has been claimed for erythrophyll. Thus, a great many plants in our own flora show in the leaves in early spring a blush of red which later disappears. The claim has been made that here the red forms a protective screen to the young developing parts, by absorbing the blue and ultraviolet rays of the sunlight believed to injure unscreened living protoplasm,



much as the photographer's ruby light cuts off the same rays which would spoil his plate in development; and thus is tided over the time prior to the full formation of the chlorophyll, which incidentally acts as a sufficient protection. It has also been supposed that the absorbed light is converted into heat, and used to warm the young parts and thus promote their development. The latter explanation would account for the prevalent red color in the mosses of open bogs, which are notoriously cold places. Various explanations have also been offered for the deep red of the under sides of leaves in some tropical plants, and for the brilliant hues of the toadstools. But the evidence in these cases does not stand our earlier-cited test for scientific truth (page 13), which shows how much we have still to learn about some of the commonest phenomena. The case is quite different, however, with the colors in flowers and fruits, for here the evidence demonstrates functional use, as will later appear. A functional use seems also reasonably clear in the beautiful rose-red Algæ called "sea mosses," where the red screen (here, however, not erythrophyll, but another red pigment) probably aids the underlying chlorophyll in a better utilization of the sunlight as altered by its passage through the sea water.

Second in prominence of the non-green colors of living leaves is *yellow*. Indeed, the normal green color of leaves is not a perfectly pure green, but tends a trifle towards yellow, which, however, is only rarely pronounced in healthy leaves. It occurs occasionally in small blotches and stripes in wild plants, from which it has been much developed under cultivation in some variegated leaves, notably in yellow varieties of *Coleus*. It is more commonly associated with waning vitality of the leaf, whether through old age, or insufficient light, or the action of parasites, or (and above all) the fall of the leaves in autumn. It is due to the presence along with the chlorophyll, of a mixture of yellow pigments, descriptively called XANTHOPHYLL, and composed chiefly

of two chemical substances, CAROTIN and XANTHOPHYLL PROPER, though sometimes additional yellow pigments are present. Carotin and xanthophyll have the property of relatively high stability in light, on which account they show forth in full intensity when the more unstable chlorophyll, which is made only while the leaf is in full health, fades away in the light.

The *white* colors of leaves represent simply the natural color of composition of the leaf structure when all colored pigments are absent. The white is translucent in cells which contain sap, but is silvery in those which are dead and filled with air, as in some variegated Begonias. White areas cannot, of course, form food, and are rare in wild plants; but they have been greatly intensified in cultivation, in the striped and variegated foliage of Begonias, fancy-leaved Caladiums, and Ribbon Grasses. Sometimes the same leaves contain also areas or stripes of red, thus increasing the variegation, as occurs very prominently in the recently-developed Rainbow Corn.

Various colors appear also in leaves as result of the action of parasites, either Fungi or Insects. In some cases the color belongs to the parasite itself, as in the Rust of Wheat leaves, where it resides in the rusty-red spore masses. More commonly it results from damage done to the complicated metabolism of the leaf by the parasite, followed by disappearance of chlorophyll, and consequent exposure of the yellow xanthophyll; or the tissues may be killed altogether, and hence soon display their distinctive decay color, which is brown. Colors due to injury by parasites may usually be recognized by a certain abnormal or unhealthy aspect they give to the leaf, and especially by their wholly irregular or asymmetrical distribution in relation to the leaf structure.

Most striking and interesting, however, of all the non-green leaf colors is the autumnal coloration of foliage, which constitutes one of the major phenomena of nature. Its foundation lies in the fact that with waning vitality, brought

on by old age or the coming of autumn, a leaf makes no more chlorophyll, while that already present fades rapidly away, permitting other colors which are present to show, and likewise some new ones to form under the altered conditions. The rapidity with which chlorophyll can fade in the light is strikingly shown by the simple experiment of exposing a fresh alcoholic solution to strong light in contrast with a control kept in the dark (page 17). In an hour or two the green color is gone, leaving the solution colored *yellow* by the xanthophyll. This experiment shows why leaves turn yellow in autumn, for the fading of the chlorophyll exposes the xanthophyll, always present with chlorophyll but far more resistant to destruction by light. Thus *all* autumn leaves are yellow, though some acquire additional colors. The xanthophyll is easily extracted in a clear solution by simply warming yellow leaves in alcohol; and it is also obtainable by blanching an alcoholic extract from green leaves, as just mentioned. As to the function of this widely present xanthophyll (a mixture of carotin and xanthophyll proper), that is still unknown, though the constancy of the substances indicates some important functional utility. Herein lies another of the problems inviting the future investigator.

Less abundant but more conspicuous than yellow, as an autumn color, is *red*, which is due to the erythrophyll (anthocyanin) already described. Being soluble in the cell sap, it is easily removed, in a clear solution, by heating the red autumn leaves in water. It is indeed worth one's while, for æsthetic as well as educational reasons, to extract the green, yellow, and red pigments in their beautiful clear solutions, and view them side by side in glass cylinders against the light; for these are the three which give almost the entire coloration to all foliage. The erythrophyll originates in autumn leaves very differently from xanthophyll, for it is not previously present, but is made during the fading of the chlorophyll. There is much uncertainty about the details, but it seems reasonably certain that it results in-

identally, as a purely chemical reaction, when certain substances, of which sugar is certainly one, and tannin is probably another, happen to be present, and, under the conditions prevailing in the dying leaf cells, are struck by bright light. It is the fading away of the chlorophyll which admits into the leaf a sufficient intensity of light to produce the chemical reaction. That the light is essential to the process is suggested by the extra brilliance of the colors in specially bright climates and seasons, and is proven by the fact that any leaf which would ordinarily turn red does not do so if closely covered by another, as may be tested by experiment. Thus red in these leaves does not replace yellow, which is also present, but simply outshines it. The reason why some kinds of leaves turn red, and others only yellow, appears to be simply this, that some kinds contain the necessary substances and others do not. It is highly significant in this connection that the leaves which turn most brilliantly red, *e.g.* Maples, Oaks, and Sumachs, are noted either for their abundance of sugar, or of tannin, or of both.

Next in importance of autumn colors is *brown*, which has several origins. In some leaves it is apparently an oxidized product of yellow sap substances called flavone derivatives; in others it results from an oxidation of tannins in cell-walls when exposed to the light and the air, — precisely the same kind of photochemical process which turns wood or bark brown with time. In these cases the color has obviously no functional utility, but represents a purely incidental result of the chemical and physical conditions which prevail in the dying or dead tissues. When the browning takes place not too rapidly, it sometimes combines with the yellow of xanthophyll into a beautiful golden bronze, as in some Oaks, though it may later become so intense as to mask the xanthophyll, which fades slowly, as in Beech. With the brown, as with other colors, the exact shade is often determined by the simultaneous presence of other substances, such as resins, or even by remnants of unfaded

chlorophyll, or by air-spaces, hairs, or other structural features. In a few cases no brown color appears, and by the slow fading of the xanthophyll the tissues are left nearly white, as happens to some extent in our Birches.

All autumnal coloration of foliage rests upon these five colors, either singly or in combinations, modified somewhat by other substances, or by the leaf structure. The student will notice how different they are in their significance to the plant, for while chlorophyll has a well-known and vastly important function, and xanthophyll an unknown but probably important function, erythrophyll and the browns are mere chemical resultants of the physical and chemical conditions prevailing in dying leaves, and white is the natural color of the unaltered leaf structure. In autumn leaves, obviously, none of the colors seem to have any functional utility to the plants, and autumnal coloration as a whole appears to represent simply a gigantic chemical incident, comparable with the blue of the sky and the red of a sunset. Though thus but an incident, it is a happy one for mankind, in whose elevated enjoyment of nature it forms a great factor.

Everybody knows that autumnal coloration is far more brilliant in some climates and some seasons than others, thus showing a marked sensitiveness to external conditions. Something depends on the kinds of plants which constitute the flora, for plants differ in their susceptibility to the color changes. Again, the coloration is notable only in those regions where the transition from summer to autumn is rather abrupt, and the vitality of the leaves is suddenly checked while they are still full of sap; and it is relatively poor in places of gradual transition from summer to autumn where the leaves lose their sap before dying. It is through the abrupt check to the vitality of the leaves that early frosts help the coloring, though they do not cause it, as popularly believed. In fact, any cause which hastens the waning of leaf vitality brings on the coloration more quickly.

Thus with our Maples, the partial splitting away of a branch, an injury to the bark, or infection by disease, will often produce the red coloration in the leaves of the injured branch while the remainder of the tree is still green. Further, a bright climate is essential to the best coloration, partly because bright light produces a quicker and fuller fading of the chlorophyll, and therefore a better exposure of the xanthophyll, and partly because the brilliancy of erythrophyll formation is directly proportional to the brightness of the light. It is because bright days and frost go together that the latter is commonly credited with more than its due in the process. The conditions of the preceding summer, whether dry or wet, play also some minor part, through influence on leaf vitality. In general, other conditions being equal, the brightness of autumn coloration in any given region is proportional to the clearness of its autumn climate, while its brightness in any given season is proportional to the clearness that year. This importance of light explains why the color is more vivid in climates like that of New England, where the autumnal skies are prevailingly bright, than it is in old England, where autumn is a season of moisture and cloud. Finest of all is the coloration in places where the summer ends abruptly, the autumn is bright, and the frosts come early, as occurs in Eastern Canada, where some of us think it is the best in the world.

## 12. THE ECONOMICS, AND TREATMENT IN CULTIVATION, OF LEAVES

All cultivation of plants depends for its success upon conformity to their physiological peculiarities. It is true, gardeners and farmers have not had in the past any scientific knowledge of these matters, but through centuries of experience, consisting in observation and trial and the passing along of the results, they have reached conclusions nearly enough correct for all practical purposes. We consider now the practice of plant cultivation with respect to leaves.

Few kinds of plants are cultivated for their leaves alone, aside from foliage plants, grown in gardens for ornament. Direct utility is confined to a few which happen to store food, as in Cabbage, or which contain some palatable relish, as in Lettuce, Spinach and other "greens," or yield some special product, like Tobacco, or serve as fodder for cattle, as in Grasses. Such uses, however, are insignificant in comparison with the indirect importance of leaves as the source for the food and other useful substances which are formed or stored elsewhere in the plant. For this reason leaves, even though temporary organs of little direct economic value, must all be kept in health and good photosynthetic operation; and thereto is much of our gardening and farming practice devoted.

For best health, leaves need ample but not too much sunlight, all the carbon dioxide they can get, plenty of water, some mineral salts, and air.

In winter, greenhouse plants receive little more than a fourth of the sunlight of summer, and not enough for their needs. Hence house plants must be given the very best light available; and good modern greenhouses are studies in light-efficiency, embodying the best experience and investigation in direction of exposure (preferably south or south-east), pitch of roof, transparency of glass, and slenderness of frame. On the other hand, the full summer sun contains not only more energy than plants can make use of, but often much more than is good for them, particularly if in greenhouses, where they lack the free circulation prevailing outdoors. On this account it is needful, even in spring, to shade such houses by curtains, slats, matting, or paint on the glass. Under light thus tempered greenhouse plants grow quite as well as in full sunlight, while keeping in better general health. Similarly, it has been found that some kinds of crops actually thrive better under some shade, though this is not wholly a matter of light, but also in part of protection from hail and strong winds. Thus it is found

profitable to grow Pineapples under slat shading in Florida and Tobacco under thin cotton tents in Massachusetts; while some recent experiments indicate that several common crops, including Potatoes, Cotton, Lettuce, and Radish likewise do better under some shade. Corn is one plant which seems to thrive best without any shade, though it is to be noted that this plant exposes not the faces but only slanting surfaces of its leaves to the sun.

The carbon dioxide indispensable to food formation comes from the air through the stomata; and therefore the leaf must be kept free from dirt which would clog them. Such a clogging of the stomata, with consequent starvation of the leaves, explains the damage now done to hedges along country roads by the dust thrown by automobiles, and likewise the death of leaves growing near cement factories, from which a very fine dust continually radiates. In minor degree dust is a detriment to house plants, explaining the value of an occasional spraying or washing by rain, and also the following advice contained in a recent almanac, — "Cover your plants kept in the living rooms with a thin cloth when you sweep." Not only dust, but the floating spores of plants, and also the excretions of some insects, close the stomata in greenhouse plants, and necessitate the frequent scrubblings which gardeners must give. Fortunately such damage is minimized by the fact that most leaves have the great majority, or all, of their stomata upon their under surfaces.

Water is needed by leaves for food-formation, to compensate transpiration, to hold the soft tissues tensely spread, and for other purposes; and every gardener and keeper of house plants knows how essential is an ample supply. In some cases, however, no amount of water supplied to the roots will compensate the transpiration from the leaves, because of slow absorption by roots or transmission by stems. Thus are explained several familiar phenomena (page 47), viz. the occasional wilting of garden plants when the soil is not dry, the limitation in the kinds of plants which can be grown in



houses, the disastrous browning, wind-burn, and winter-killing of shrubs. One might think it possible to compensate these difficulties by supplying water directly to leaves; but leaves cannot absorb any appreciable quantity of water, and such benefit as seems to follow spraying is due to the check in transpiration (page 47). The spraying of plants in the sun may even bring damage, because drops of water left on the foliage sometimes act as small burning glasses, which concentrate the sunlight, kill the protoplasm, and brown the foliage in spots.

Transpiration from leaves has another connection with gardening in this way, that seedlings when transplanted continue to lose water; and since the absorbing roots are destroyed, the plants always wilt; hence it is best when practicable to cover them with boxes, etc., to check transpiration until new roots are formed. For exactly this reason gardeners remove much of the foliage of cuttings before placing them in the ground to root.

Leaves also need certain mineral matters for chemical uses, involving the application of fertilizers; and they must have sufficient oxygen, which means fresh air, for their respiration. These matters, however, can be considered more conveniently in later sections.

### 13. THE USES OF THE PHOTOSYNTHETIC FOOD

It has been said more than once in the foregoing pages that the photosynthetic grape sugar made in green leaves in the light is the basal food of plants and animals alike. Here follows the evidence for this statement.

The photosynthetic grape sugar and the associated proteins move continuously from their places of formation in the leaves, and pass along the veins into stems, roots, buds, flowers, fruits, and other parts, every cell of which receives a share thereof. Within the cells a part of the sugar and proteins are chemically transformed into other substances, having definite functions in the plant's economy. These

chemical transformations are collectively designated as the plant's METABOLISM. Functionally, the metabolic changes center chiefly in the provision of materials serving five ends, — the skeleton, reserve foods, living protoplasm, special secretions, and respiration.

1. *THE PLANT SKELETON.* In the great majority of plant cells, a part of the food sugar is used in building the cell walls (page 41), which collectively constitute the plant skeleton. The substance of the walls is primarily CELLULOSE, a transparent, elastic, water-absorbing material, of which the filter paper of laboratories is a good illustration, though cotton and linen are nearly as pure. Chemically its formula is  $(C_6H_{10}O_5)_n$ , which means that its molecule is composed of the combination  $C_6H_{10}O_5$  repeated an unknown number of times. The combination  $C_6H_{10}O_5$  (not known to occur by itself) differs only slightly in proportions from the food sugar ( $C_6H_{12}O_6 - H_2O = C_6H_{10}O_5$ ), and is clearly transformed therefrom. The ease with which cellulose absorbs and transfers water has high physiological importance in the interior of the plant, but would be fatal on the exterior in contact with dry air. In these outer walls, however, a part of the sugar (or cellulose) is converted into new substances called CUTIN and SUBERIN, which are waterproof, and have a faintly brownish color; and the epidermis which enwraps the soft parts of plants, and the cork which encloses their woody stems, have walls of such cutinized or suberized cellulose. Furthermore, this cellulose, while ample in strength for the construction of small plants, is too yielding for the building of large ones, which have to withstand great strains from their weight and the winds. Accordingly, in the trunks of trees and shrubs some of the sugar (or cellulose) is converted into a new substance called LIGNIN, which infiltrates and greatly stiffens the walls without loss of their power to transmit water; and such lignified walls constitute WOOD. The shells of nuts, and some coats of seeds, also owe their hardness to lignification. And other modifications

of the walls occur, including the GELATINATION familiar in the Flax seed, while often the walls are also strongly infiltrated with mineral matters.

The cell walls of a plant collectively form a continuous system, somewhat like the cement walls and floors in our modern buildings. In the compartments (the cells) lives the protoplasm which builds the whole structure. Thus the protoplasm, itself too soft and weak to rise from the ground, can, like man, construct lofty buildings, in the rooms of which it can dwell in the sun.

It happens that the qualities which fit the cell walls for their functions in plants make them also useful to man for many of his needs. Hence he appropriates the elastic cellulose for paper, or, as it occurs in long fibers, for cotton and linen to make clothing. The waterproof cork serves to stopper his bottles. The stiff wood provides a rigid but easily-worked material which he utilizes, as lumber, for his dwellings, and as cabinet woods, for his furniture, while it serves minor uses innumerable.

Man makes one other use of cellulose and its derivatives not represented by any function in the plant, but dependent on an incidental feature of their chemical composition, viz. — they will oxidize, or burn, thus providing him with fuel. This use goes further than appears at first sight, for coal is nothing but the cell walls of plants which throve in swamps of the Carboniferous epoch, and in course of long ages, under pressure and warmth, lost the two gaseous constituents, hydrogen and oxygen, retaining only the solid and oxidizable carbon, which is the substance of coal. A perfect sequence can be traced from the photosynthetic sugar made in the green leaves of the Carboniferous plants, first to cellulose, then in succession, with progressive loss of the gaseous constituents, to lignin, peat, soft coal, and anthracite. The same qualities which make cellulose burn, make it explode, in suitable combinations; and hence it is convertible into high explosives, useful in peace and deadly in war.

2. *THE RESERVE FOODS.* While much of the photosynthetic sugar is used directly as food by the various living cells throughout the plant body, a large quantity is transformed into reserve materials, which accumulate in special parts, to be used later in growth, especially that of the next season. The places of such accumulation are buds, bulbs, tubers, and seeds; and it is to the presence of these accumulated foods that the swollen form of those parts is due. These reserve foods are of three general classes, — carbohydrates, fatty oils, and proteins.

*The Carbohydrates* are minor transformations of grape sugar into substances which retain the food value of the sugar, though with different physical properties. They include the sugars, starches, and hemi-celluloses.

THE SUGARS are of several kinds. The photosynthetic sugar itself is a mixture of two kinds, grape sugar or GLUCOSE (also called DEXTROSE) and fruit sugar or FRUCTOSE, these two being the simplest and most stable of the sugars. They have an identical formula,  $C_6H_{12}O_6$ , and differ only in the arrangement of the atoms within the molecules. Both are present, the former more abundantly, dissolved in the sap of practically all plants. The glucose, with some fructose, accumulates in stems, as in the Sugar Cane, where it constitutes most of the molasses, but the commercial "glucose" is produced by action of acid on starch from Corn. Both occur also in fruits, where, however, the fruit sugar is usually the more abundant; and they form also the sugar of nectar, which is the basis of honey, chief food of many insects. Far better known, however, is Cane sugar, or SUCROSE (SACCHAROSE), which accumulates in Sugar Cane, Beets, and the Sugar Maple. Its formula is  $C_{12}H_{22}O_{11}$ , implying a close relation to glucose and fructose ( $2 C_6H_{12}O_6 - H_2O = C_{12}H_{22}O_{11}$ ), to which it is readily converted back, into a molecule of each, in various ways. And several other sugars, differing little from these, occur also in plants, though none are especially prominent. Grape and fruit sugars can be made artificially in the chemical laboratory.

The sugars are very nutritive substances, and thus constitute reserve food of the highest value to plants. Their qualities, however, make them also good food for animals, which draw freely upon them. Thus, they form the chief food of insects, are an important constituent of the fodder of domestic animals, and give value to the vegetables and fruits used by man, who, however, goes much further in his utilization of them, since he not only systematically cultivates and improves the plants which produce them most abundantly, but also extracts, refines, and stores them for his own more convenient use. Pressing out the sweet sap, he boils away the water, obtains the sugar in crystals, and refines them of impurities, a process much easier for cane than grape sugar, for which reason the former is common on our

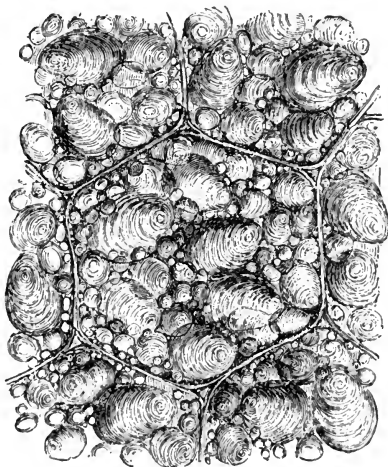

FIG. 62 a.—Starch grains (concentrically striated) in the cells of Potato; highly magnified. (From Figurier.)

tables, while the latter is there unknown. Grape sugar, however, has another economic importance, in that it is the sugar which is fermented to alcohol by the Yeast Plant, though that organism has the power first to convert other sugars to grape sugar. From this source comes our entire store of alcohol, including all of our wines and strong liquors, as we shall note more fully in the section on fermentation.

THE STARCHES, also, originate in transformations of grape sugar. Their formula is the same as that for cellulose ( $C_6H_{10}O_5$ )<sub>n</sub>, with the <sub>n</sub> signifying a different number. They are insoluble in the sap, and exist in the plant as solid grains

(Fig. 62 a), having very characteristic forms and markings, differing with the kind of plant (Fig. 63). Starch is formed from sugar only in the plastids of the cells, either the chloroplastids of the green cells, or the colorless leucoplastids

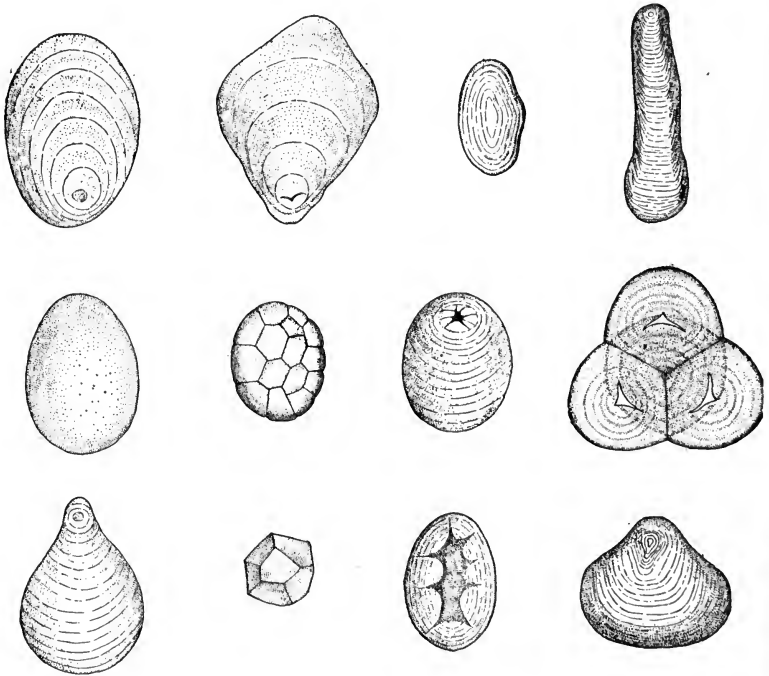

FIG. 63. — Typical grains of various starches; highly magnified. *Upper row*, Potato, Maranta, Pea, Hyacinth; *middle row*, Wheat, Oats, Sago, Smilax; *lower row*, Canna, Corn, Bean, Oxalis.

The characteristic forms and markings of the grains form invaluable identification marks in the recognition of adulterations of foods, etc. (Re-drawn from Ganong, *The Living Plant*.)

of storage cells; and it cannot as yet be made artificially. Starch is particularly abundant in *tubers* (Potato), *tuberous roots* (Sweet Potato), *bulbs* (Lilies and Hyacinths), and especially in large *seeds*, to all of which its presence imparts a dull, white, firm aspect, in marked contrast to the soft trans-

lucency where sugar is the food, as, for example, in Beets. Being insoluble in water and therefore not removable in that form from storage cells, starch must be digested before use, in which process it is converted by the action of enzymes back into grape sugar, the change being marked, as familiar in germinating seeds and growing potatoes, by a transition from the dull white to a soft translucent appearance.

Starch, stored by plants for their own uses, forms likewise the best of food for animals, which take what they need, and like plants digest it by enzymes back to grape sugar, in which form it is transferred for use to all parts of their bodies. It is the principal constituent of the ordinary foods of all herbivorous and graminivorous animals. As for man, starch is by far the most important of all the food substances taken by him from plants. This is sufficiently plain when we recall that all of the grains, which constitute the principal food of the human race, — Wheat, Corn, Rice, Barley, Millet, and others, — consist chiefly of starch.

THE HEMI-CELLULOSES are much less prominent than the sugars and starches. They are modified forms of cellulose, having the same chemical formula, but with the  $n$  indicating a different number. They occur as extra layers of the cellulose walls (Fig. 64), especially in some tropical seeds, which thereby are made heavy and hard, as well illustrated in the Date seed, or still better the Ivory Nut, — a large seed of a Palm, hard enough to serve as imitation of ivory. The hemi-celluloses are easily digested by plants but only in part by animals. They merge over gradually to the *pectins*, or fruit jellies (the ordinary gelatin being an animal product), which are dissolved out by hot water in making preserves, and these again merge over

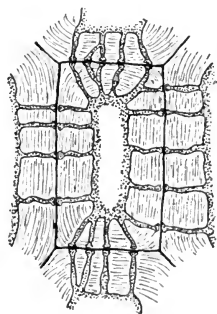

FIG. 64. — Thickened cell walls (striated) in the Ivory Nut. The protoplasm (dotted) extends into pits persistent in the walls.

① See next page for further details

into the *gums*, like gum arabic, all readily digestible by plants and animals.

*The Fatty Oils* come ultimately from grape sugar, through intermediate stages, including fatty acids. They are really mixtures of true fats, which are not volatile, and thus differ from the essential oils, to be considered under secretions. They are found in a few fruits, such as Olive (yielding olive oil), but accumulate in quantity in a good many seeds, from which we obtain Castor oil, Cottonseed oil, Linseed oil, and some others. They occur usually in small round globules among other food substances, giving a characteristic oily luster to sections through such tissues, and, while commonly liquid, they form sometimes a butter-like solid, as in cocoa-butter. They are insoluble in water, and hence not movable through the plant until digested back to the soluble fatty acids. Chemically they are rather diverse in composition (a typical formula, that of tri-olein, being  $C_{57}H_{104}O_6$ ), but are all marked by this peculiarity, — that their proportion of oxygen is very small to that of their carbon and hydrogen.

As with sugars and starches, the fatty oils are also good food for animals. They are a valuable constituent of the seeds eaten by animals, including man, who also extracts and refines them for food and for diverse uses in medicine, arts, and manufactures. Like the animal fats to which they are so closely related, their paucity of oxygen makes necessary a large supply of fresh air for their assimilation; but they yield a great deal of heat, which explains why fats are so craved in cold climates.

*The Proteins* are much more complicated substances, forming the most important, even if not the most abundant, of the reserve foods. While scattered throughout all living cells, they accumulate chiefly in seeds, where they occur mostly as solid grains, either scattered throughout the cells, as in Peas and Beans, or in a special layer just underneath the husk, as in Wheat and other grains (Fig. 65). There are hundreds of kinds of named proteins, grouped under



certain chemical classes, the chief of which are the ALBUMINS, material like white of egg, GLUTELINS, in semi-crystalline grains (Fig. 66), GLOBULINS, familiar in the gluten of flour which gives tenacity to dough, NUCLEO-PROTEINS, the chemical basis of the chromosomes (the most important part of the protoplasm), and a great many others. While ordinarily in solid grains, they are all digestible by enzymes into soluble and diffusible forms called PEP-TONES and PROTEOSES, and thus can be moved through the plant. Chemically they are all very complex, for to the elements of

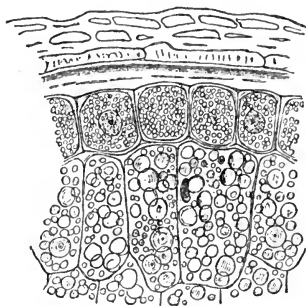

FIG. 65. — Section across a grain of wheat, showing the layer of protein-holding cells under the husk and outside of the starch-holding cells;  $\times 180$ . (From Strasburger.)

grape sugar there are added small amounts of nitrogen, sulphur, and phosphorus, taken with water through the roots; and it is for this reason that nitrates and phosphates in particular are so essential to fertility in a soil. The stages in

their formation are complicated, and only partially known, but it seems clear that first the nitrogen is added chemically to the elements of the sugar, forming amino-compounds or amides (containing C, H, O, N), with which later the other elements are combined. These amides are inconspicuous substances though widely distributed in plants, the most common being Asparagin,  $C_4H_8O_3N_2$ . There is good reason to believe that many of the proteins are built up from a simple combination in

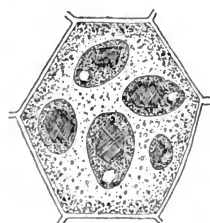

FIG. 66. — A cell from Castor Bean, showing the protein grains, of which the structure is rendered visible by treatment with reagents.

much the same way that we found the starches and cellulose are based on a  $C_6H_{10}O_5$  foundation (page 98). These

proteins, composed of the elements C, H, O, N, S, [P], in diverse, but always complicated, proportions, form the basis of flesh in animals; and it is because the seeds of the Pulse Family (Peas and Beans) contain so much protein that they approach near to meat in their food value.

Like the carbohydrates and fatty oils, but perhaps even more than they, the proteins are good food for animals, which take them in fodder, vegetables, fruits, and grains. To animals, however, they have this special importance, that while muscles, nerve substance, and other essential tissues are composed chiefly of proteins, the higher animals at least have no power to construct them from simpler substances, but must take them ready-made from plants, or from animals which have taken them from plants. It is for its condensed supply of such proteins that meat has such food value, and it is, of course, for their value as protein-accumulators from plants on his behalf that man keeps cattle and other domestic animals which he eats. Unlike the case of the sugars, starches, and fatty oils, however, man does not, because of practical difficulties, extract the plant proteins and refine them for use, though he can do so when he wishes; but he usually takes them with the other food materials which they happen to accompany.

3. *THE LIVING PROTOPLASM.* The living material, the most important in all organic nature, has already been described (page 35). It is chemically a mixture of a great many substances, but its greater and most essential part is composed of proteins. The proteins, indeed, have their great importance as reserve food because they are a step in the formation of living protoplasm. Some of these proteins are very complex (one, for example, has the formula  $C_{720}H_{1134}N_{218}O_{248}S_5$ , and much more complicated kinds are known); and they are consequently unstable and labile, changing into other forms with absorptions or releases of energy which are the foundation of various phenomena of life. But our knowledge of the chemistry of the living

protoplasm is wholly insignificant in comparison with the magnitude and importance of the phenomena it displays.

4. *THE SECRETIONS.* These are numerous and diverse substances having each a special meaning in the plant's economy. Chemically they are as different as well can be. Some are carbohydrates; others are hydrocarbons (containing carbon and hydrogen only); some contain nitrogen like the amides; while still others are obvious transformations from proteins. Some secretions have a perfectly obvious function; others clearly have some function though it is not known; but in many cases the substances seem to represent simply by-products of functional changes, or, like autumn colors, the incidental result of conditions which happen to occur in certain parts. Some of them serve well certain needs of man, who takes them for his purposes, often extracting and refining them to this end. The principal classes of secretions are the following.

*THE ESSENTIAL OILS,* or aromatic oils, best known in Clove oil, Cedar oil, oil of Lavender, and of "Lemon Geranium," and the oil of Orange rind, differ greatly from the fatty oils in being volatile, and hence giving odors. They occur in plants in special cells, or in special collections of cells called glands (Fig. 67). They are the basis of practically all the odors of plants, including the fragrance of flowers, to which they serve to guide insects in connection with cross-pollination, later to be more fully considered. In leaves they have been supposed to give protection, by their acrid taste, against insect enemies, or to have other uses, for all of which the evidence is still insufficient. Chemically they are in part hydrocar-

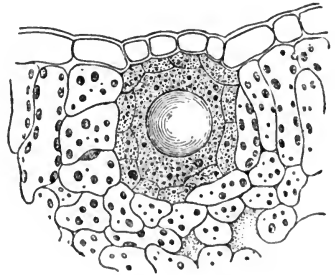

FIG 67. — A gland, in section, containing ethereal oil, in *Dic-tamnus Frazinella*; much magnified. (From Sachs.)

bons, or else contain also some oxygen, being formed without doubt from carbohydrates. Their pleasant odors and tastes are utilized by man in perfumes and essences, though in recent times he has been able to dispense with the plants, and manufacture a great many in his own chemical laboratory. But they will always continue to add charm to our gardens.

Related to the essential oils are some other substances of considerable importance, of which the most important are resins, camphor, and caoutchouc. *Resins*, known to us in balsam, rosin, pitch, and spruce gum, are formed mostly in special passages, and are particularly abundant in the Coniferæ or Pine Family; but we know little as to their significance, whether functional or incidental. Man utilizes their imperviousness to water in various ways. A fossil resin is *amber*. *Camphor* is a gum of a special tree, again of unknown significance, and having well-known uses by man. *Caoutchouc*, the basis of *rubber*, is formed by many plants, usually in their "milk" (or latex), though its meaning to the plant is uncertain; but the uses that man makes of its wonderful tenacity and elasticity need no description.

THE PIGMENTS are the substances which give the bright colors to the various parts of plants. They are very diverse in chemical composition (often including elements additional to those of carbohydrates and proteins), and in significance to the plant. Thus *chlorophyll* (composition  $C_{54}H_{72}O_6N_4Mg$ ) has a function already familiar to the student, while the ever-associated *xanthophyll* (composition  $C_{40}H_{56}O_2$ ) and *carotin* ( $C_{40}H_{56}$ ) have, no doubt, a function, though it is unknown. *Anthocyanin*, called descriptively erythrophyll (composition, in a typical case, the Cranberry,  $C_{21}H_{22}O_{12}$ ) is the basis of the reds, purples, and blues in plants, yielding red with acid cell sap, and blue with alkaline. In flowers these and other pigments help to guide insects, and in fruits other animals, for functional reasons later to be noted; but in other cases they seem to represent

simply incidental by-products of other processes, as in foliage plants (page 88), in autumn leaves, in the heart wood of trees, in the colored saps of roots and stems, and in the highly colored Fungi, though in some of these cases investigators have found suppositional explanations of their presence. These pigments are mostly too unstable in light to serve any useful purpose to man, unless we consider pleasure a utility, for he takes great delight in assembling them in gardens. Some pigments, however, are stable, including a few which lack color in the plant but acquire it on exposure to air (*e.g.* indigo and madder), making them useful dyes. But chemists can now make such dyes artificially, and more cheaply than we can obtain them from plants.

THE ALKALOIDS are best known to us in Morphine (from the Poppy), Nicotine (from Tobacco), Quinine (from a tree bark, Cinchona), Strychnine (from seeds of *Nux vomica*), Cocaine (from the leaves of a shrub, *Erythroxylon Coca*); while Caffein or Thein (from Coffee and Tea), and Theobromine (from the Cacao tree) are related, if not actually in the same class. They occur mostly in special cells or tubes (often in the "milk" system, or latex), but their significance to the plant is very uncertain. Some investigators hold that they are semi-poisonous waste products which the plant thus isolates, while others have thought that their powerful bitter tastes form a protection to the plants against animal foes. Chemically they are composed of C, H, O, N, thus suggesting a derivation through the amides. They are all endowed with active properties, which are the source of their value to man, for, as the list above given will show, they include some of the most efficacious stimulants and powerful poisons which are contained in our *materia medica*. In fact, the principal plant poisons and our most important drugs belong in this class. The *ptomaines*, those well-known poisons resulting from the action of Bacteria in animal tissues, are also alkaloids.

Related to the alkaloids in their active properties are some

of the substances called GLUCOSIDES, a very large and heterogeneous group, probably of diverse significance to the plant, characterized chiefly by the chemical fact that they consist of glucose (grape sugar) in union with another substance. Certain ones give the bitter taste to nut kernels, and to the bark of many trees, and the peppery taste to Nasturtium, Water Cress, and some other plants.

THE ENZYMES are the most important of the plant secretions. They are formed in small quantities but large numbers of kinds in diverse parts of plants, where they are apparently dissolved in the protoplasm. Chemically they are supposed to be proteins, but this is not certain, for, while we know their effects, we hardly yet know the enzymes themselves. This is because of the great difficulty of extracting them in a pure state from the complicated protoplasm. Their importance depends upon the fact that, like the catalyzers of the chemist, they cause chemical changes in various substances (each enzyme but one change in one substance, as a rule), without themselves entering into the reaction; and on this account very small quantities of enzymes can change great quantities of substance. It is apparently by the action of enzymes that the majority of chemical changes in plants are brought about. Thus an enzyme called *diastase* is active in digestion, changing the insoluble starch into soluble sugar both in germinating seeds and animal saliva; another, called *zymase*, secreted by the Yeast Plant, changes sugar into alcohol and carbon dioxide, as will be described under fermentation; *lipase* converts fats to soluble fatty acids; *pepsin* changes insoluble proteins into soluble peptones both in seeds and the animal stomach; and so with many others. No phase of plant chemistry is now of such acute interest and active investigation as that concerned with the enzymes.

Other secretions are the following. The *fruit acids*, malic and citric and others, give the tart taste to fruits, of functional utility in connection with dissemination by animals, and pleasing to man. The *tannins* occur chiefly in the bark of plants,

where their bitter, astringent taste has been supposed to protect the trees against rodents and insects, while a certain antiseptic quality prevents development of parasitic Fungi and hence decay of the bark. It is the oxidation changes in these tannins under weathering which give the dark brown color to old bark. Having incidentally the remarkable property of hardening the gelatine in skins, they are utilized by man for tanning leather, though here again the chemist is providing artificial substitutes. The *plant waxes* occur as the "bloom" upon some fruits and leaves, and at times, as in the Bayberry of the coast, such a wax is abundant enough to be collected and used for candles, as our forefathers found; but the meaning of the wax to the plants is not certain. And other secretions occur, of more special kind and mostly uncertain significance.

Rather common in plants are crystals, frequently, though not always, in cells differing from their neighbors; and they often exhibit marked beauty of form (Fig. 68).

They are composed chiefly of oxalate or carbonate of lime, and represent not secretions but excretions; for they seem to be either useless by-products of functional chemical reactions, or else substances brought into the plant from the soil with the water, and not needed in growth. The

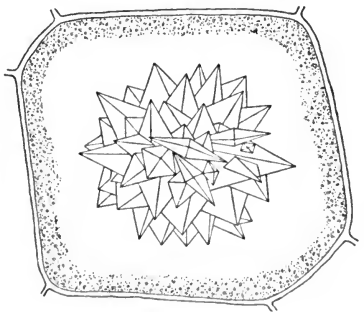

FIG. 68. — Crystals of calcic oxalate, in a cell of *Begonia*; much magnified. (After Kny.)

plant has no continuously-acting excretion system such as the higher animals possess, but instead accumulates waste matters in out-of-the-way cells, often in leaves and bark, the fall of which does incidentally provide an excreting system.

5. *RESPIRATION*. The photosynthetic sugar has one other use, not at all inferior in importance to any yet

mentioned, namely, a considerable quantity is consumed in RESPIRATION, whereby energy is set free for the work of the plant. This important subject will find treatment in the next chapter, along with plant growth where its manifestations are plainest. There, also, will be traced the final fate of all the plant substances after they have served their functions, or played their other respective parts, in the life of the plant.

Thus all of the substances constituting the plant body, — the skeleton, foods, living protoplasm, and secretions, and also the materials from which is derived the energy by which plants do their work, — are built up from the photosynthetic sugar, either by direct transformations thereof, or with certain small additions from a few mineral substances taken by the roots from the soil. Upon these materials made by plants all animals are dependent for their food, both that from which they construct their bodies, and that which yields the energy for their work. Thus the importance of the photosynthetic sugar, of the green leaves, and of the photosynthetic process becomes abundantly clear.



## CHAPTER IV

### THE MORPHOLOGY AND PHYSIOLOGY OF STEMS

#### 1. THE DISTINCTIVE CHARACTERISTICS OF STEMS

STEMS are second only to leaves in prominence and importance as a constituent of vegetation. They are distinguished by their tapering-cylindrical, continuous-branching, radiate-ascendant forms, so constructed as to support and spread the leaves in the light. This is their primary function, although, as with other plant parts, some kinds perform additional and even substitute functions.

Foliage-supporting stems, even when performing the same function, differ greatly in their external features. In *shape*, their differences center in diverse degrees and methods of branching, as will later be noted. In *size*, they range from minute in small herbs, all the way up to the gigantic stature of the famous California Redwoods (*Sequoia gigantea*), over 320 feet tall and nearly 30 feet through, or the Gum trees of Australia (*Eucalyptus amygdalina*), even taller though not so stout. In mere length, however, these stems are much surpassed by the Rattan Palm, which clambers as a vine for more than a thousand feet through the tropical woods. In *texture*, all herbaceous stems, including the new growth on trees, are soft-cellular like the leaves, being softest in water plants, which are supported by their buoyancy in the water. In trees, however, the stems become firm in various degrees through softwood and hardwood, even to "ironwood," as familiar in lignum vitæ. In *color* herbaceous stems are green, from presence of chlorenchyma, which aids the leaves in food formation; but older stems, which develop a thick protective

bark, are brown or gray, as the incidental result of the weathering-decay of the tissues.

Stems differ much in *duration*, according to the habits of the plant. Some are ANNUALS, that is, they start from seed, develop an herbaceous shoot, use their food to make new seeds, and die, all in the same summer. They abound in our flower gardens and include most weeds. Others are BIENNIALS, that is, they start from seed, develop an herbaceous shoot, store food in some underground part, and die to the ground in one summer; then they use this food to form a new shoot which develops seeds and dies completely the second season. They are familiar in our vegetable gardens, in Beets and Carrots. Some are HERBACEOUS PERENNIALS, that is, they act like biennials except that they continue to form a food supply and develop new shoots and new seeds year after year. They include most of the favorites of our flower gardens. Others again are WOODY PERENNIALS, that is, they do not die back to the ground at all, unless accidentally, but persist and become woody, so that each season's new growth is added upon that of the preceding year, thus developing shrubs and trees. Then there are some which, like the annuals, flower and form seed only once in their lives (MONOCARPIC plants), but take many years in preparation. This is the case with the Century plant, which accumulates food for thirty years or more, then blossoms, forms seed profusely, and dies; but the same habit is found in other groups, including even some Palms.

The mode of growth of the woody perennials, whereby each season's growth is added upon the preceding, involves none of the internal limitations of size or age to which animals are subject. Hence trees continue to grow until stopped by causes incident to their very size, such as the difficulty of transferring a sufficient water supply to great heights, and the leverage they come to present to the action of storms, whereby branches are broken, rot Fungi admitted, and decay begun. Trees fortunately constructed in relation to these

conditions can attain to a great size and age. Thus the giant Redwood is known to exceed two thousand years in age, some trees now standing being probably older than the Christian era, while the Dragon Tree of the Canary Islands has been claimed to live even longer. If, however, mere age is in question, there are probably much older plants, for the Sphagnum mosses of peat bogs appear to have had a continuous growth from the inception of the bogs at the close of the glacial period, many thousands of years ago.

Stems, like leaves, perform also special functions, when suitably modified in structure, — forming tendrils, storage organs, and even foliage, as will later appear. It is easily possible, for the most part, to distinguish such stems from leaves, — for stems usually grow from buds in the axils of leaves, while leaves have buds in their axils.

## 2. THE STRUCTURE OF STEMS AND SUPPORT OF THE FOLIAGE

The primary function of stems, and their distinctive contribution to the plant's mode of life, is the support and spread of the foliage. Therewith, however, are involved minor functions, notably conduction of water and food, with growth, respiration, and self-adjustment to prevailing conditions.

Typical foliage-supporting stems are herbaceous when young, but commonly become woody with age.

*Herbaceous stems*, whether true herbs or the herbaceous tips of woody branches, are typically cylindrical and upright, and produce the leaves horizontally all around. At the tip is a

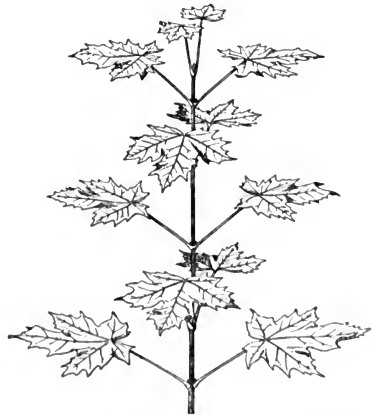

FIG. 69. — A typical leaf-bearing stem, of Norway Maple;  $\times \frac{1}{4}$ . (From Kerner.)

bud developing the leaves, which are there small and close, but which downward are progressively larger and more widely spaced apart (Fig. 69). The leaves stand usually upon slight annular swellings of the stem, sometimes obscure and sometimes well marked, called **NODES**, which are separated by smooth cylindrical leafless **INTERNODES**. In the axil of each leaf occurs a small bud, the foundation of a branch, which later develops and bears leaves precisely in the manner of the main stem.

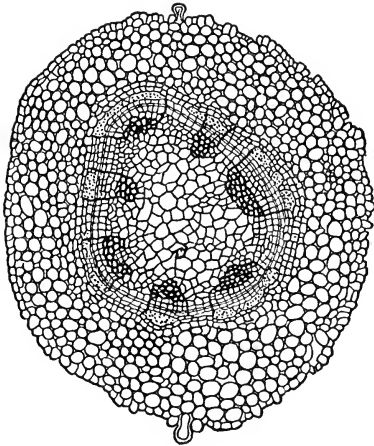

FIG. 70. — The tissues of a typical herbaceous stem, of the Stock, in cross section;  $\times 55$ . The cambium is represented by the heavier double line through the fibro-vascular bundles, which are seven in number. The collenchyma is not marked. (From Scott, *Structural Botany*.)

In their tissues, herbaceous stems are much like the leaves, as to chlorenchyma, epidermis, stomata, trichomes, and peculiarities of color. The veins, however, do not show to the eye, being buried within the cylindrical stem. In cross sections cut close to the bud one sees little more than the general growth tissue, but farther back appears some such aspect as that of our picture (Fig. 70). Beneath the thin

epidermis lies the chlorenchyma, pale green but rather thick, obviously aiding the leaves in food formation. Centerward can be seen the cut ends of the veins, called also **VASCULAR**, or **FIBRO-VASCULAR**, **BUNDLES**, which run lengthwise of the stem, and have the same general structure, and the same function of conduction for water and food, as in the leaves. Commonly they are arranged in a ring, in which case they enclose a **PITH**, of loose open texture, often glistening-white from included air. The pith is especially the storage part of

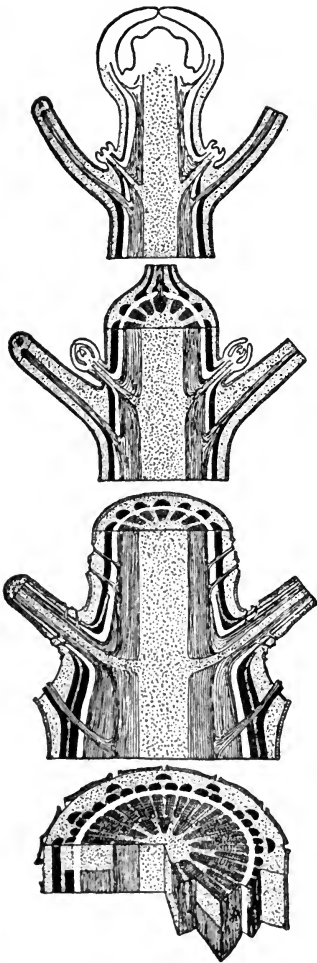

FIG. 71.

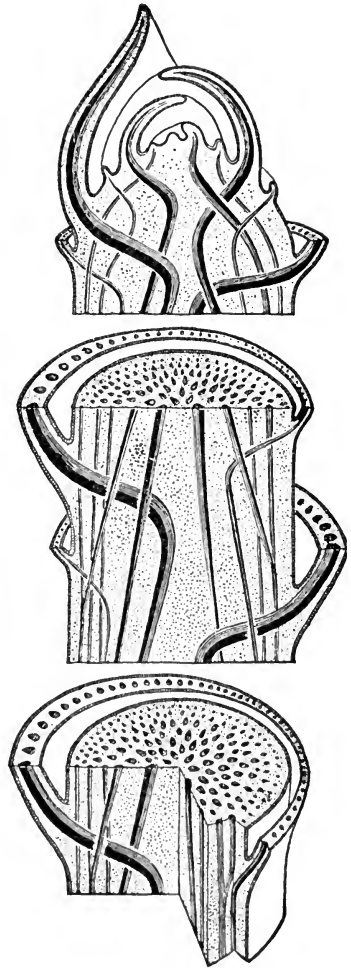

FIG. 72.

FIG. 71.— Generalized sectional drawings, based on the Maple, to show the tissues of a typical stem. Explanation in the text. Secondary growth begins in the lower of the longitudinal sections. The cambium is left white.

FIG. 72.— Companion series to Fig. 71, based on a Palm as the other type of stem.

(From Sargent, *Plants and their Uses*.)

*The whole series - 11 12 13 14 15 16 17 18 19 20 21 22 23 24 25 26 27 28 29 30 31 32 33 34 35 36 37 38 39 40 41 42 43 44 45 46 47 48 49 50 51 52 53 54 55 56 57 58 59 60 61 62 63 64 65 66 67 68 69 70 71 72 73 74 75 76 77 78 79 80 81 82 83 84 85 86 87 88 89 90 91 92 93 94 95 96 97 98 99 100*

young stems, though other tissues share in that function. All of these features are shown with particular clearness in Fig. 71.

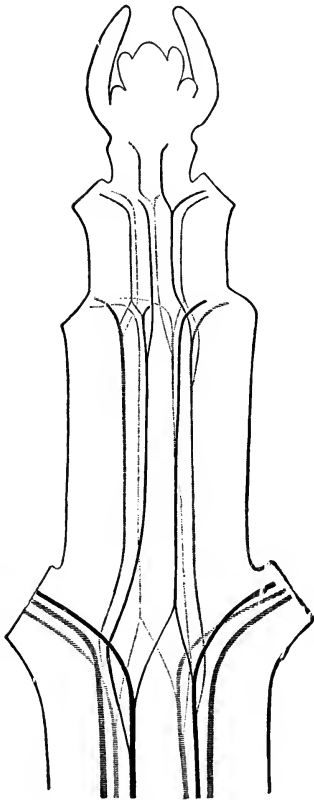

FIG. 73. — The fibro-vascular system, showing its nodal branching, in the young stem of *Clematis viticella*. (After Nägeli, from Strasburger.)

In sections taken well back of the tip, two other tissues appear. One is a mere line extending right through the fibro-vascular bundles, and from one to another (Figs. 70, 71), uniting them into one ring, or (since they run lengthwise) one sheath. This is the important CAMBIUM, or growth tissue, which later builds new tissues on both its outer and inner surfaces. The other is a band of whitish-glistening tissue just beneath the epidermis, called COLLENCHYMA. It has a firm elastic texture, and aids the young stem to support the strains imposed by the presence of the leaves. Its position close to the outside is typical of the strengthening tissues of stems, which are developed upon the principle of the hollow column or tube. This principle is known to engineers as that which provides the greatest resistance to lateral strains with the least expenditure of material, on which account it is used by them in many construc-

tions, — most familiar perhaps in architectural columns and bicycle frames.

The fibro-vascular bundles (or veins) of the stem extend downward all the way to the tips of the roots, and upward

into the buds. Just below the leaves some of the bundles fork, and each sends one branch, called a LEAF TRACE, into a leaf, and the second up the stem, as indicated in the typical example here pictured (Fig. 73), and as can be seen directly in a translucent stem like that of the Balsam. This branching and rejoining of the bundles produces the node, which is thus explained, while thereby the bundles are united into one great cylindrical network or system. In this cylinder the turning of bundles out into the leaves results in gaps just above them; and around these gaps the new developing fibro-vascular cylinders of the axillary buds establish their connection with the main cylinder (Fig. 71).

While in most herbaceous stems the bundles are so arranged as to form a ring when seen in cross section, in others they are scattered irregularly, as illustrated here-with (Fig. 74). In such cases the bundles anastomose in the stems and extend out into the leaves in a manner differing in details, but not in principle, from the methods just described (Fig. 72). Thus the bundles collectively constitute a continuous conducting system for water and food throughout the plant.

The tissues above considered are all formed in the buds, and belong to the PRIMARY GROWTH of the plant. Later the cambium, and other growth layers, add new tissues, which thus belong to the SECONDARY GROWTH.

*Woody stems* develop from an herbaceous condition, through stages easily observed in the twigs of our common

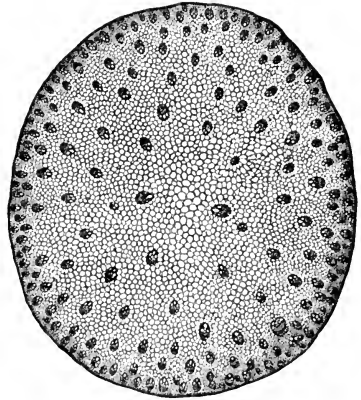

FIG. 74. — Stem of Corn, in cross section;  $\times 5$ . (Drawn from a photomicrograph by Stevens.)

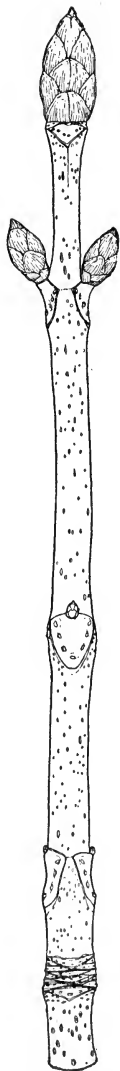

FIG. 75. — Winter twig of Horse Chestnut;  $\times \frac{1}{2}$ .

trees during the first winter (Fig. 75). The leaves are now gone, not to reappear on this part of the stem; but the LEAF-SCARS remain, marked by a lighter colored corky layer, in which can be seen the severed ends of the veins. Each scar of course stands at a node, sometimes plain, but often not, just above which is the now prominent axillary bud, while a larger terminal bud ends the twig. The thin epidermis has been replaced by a layer of gray-brown waterproof cork, scattered over which are the lighter colored warty excrescences called LENTICELS.

The leaf-scars and lenticels need special comment. Leaves fall from trees because of the formation of a special ABSCISS-LAYER of tissue which develops across the base of the leaf in late summer (Fig. 76). Gradually this layer closes the free communication between stem and leaf, though meantime the valuable materials of the leaf are mostly transferred to the stem. Then

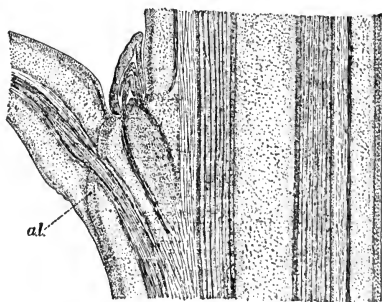

FIG. 76. — Vertical section through a twig and petiole of Poplar, showing the absciss-layer, *a.l.* (From F. Darwin, *Elements of Botany*.)



follows the waning vitality, cessation of chlorophyll formation, appearance of autumn coloration, and finally, by a weakening of the walls of the absciss layer, the fall of the leaf itself, the absciss layer becoming the corky and waterproof leaf-scar. The lenticels are physiologically important structures, for they replace the stomata

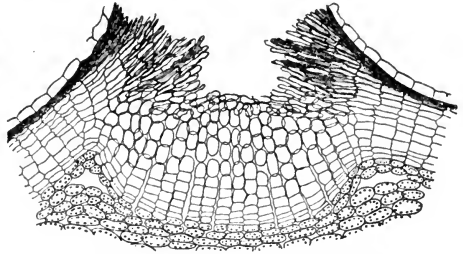

FIG. 77. — A typical lenticel, of *Sambucus nigra*, in section; magnified. (From Haberlandt.)

(which disappear of course with the epidermis), as avenues of gas exchange between the interior of the stems and the external atmosphere. This exchange is no longer needed for photosynthesis, which ceases as cork develops, but is necessary for the respiration of the living tissues within, as will later be shown. The lenticels are places where a loose tissue with inter-cellular spaces is formed instead of the impervious cork; and this tissue by its growth partially closes them in winter and forces them open the next spring (Fig. 77).

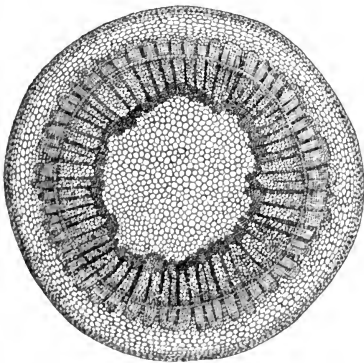

FIG. 78. — A cross section through a winter twig of Tulip Tree;  $\times 10$ . The lighter continuous line is the cambium, and the medullary rays are distinct.

The tissues of these transitional stems show very clearly in cross section (Fig. 78). Their most striking feature is the sharp division between bark and wood at the cambium. The parts of the bundles inside the cambium have grown greatly, and show clearly the characteristic forms and texture, while the

tissue between them is reduced to fine radiating lines, which henceforth are called the MEDULLARY RAYS. These woody parts of the bundles, called XYLEM, contain the ducts, and conduct water through the stems. Inside the cylinder of bundles is the very distinct pith. In the pith is much starch, which is food for the next season's growth, though it occurs also in medullary rays and bark, often in strikingly symmetrical patterns when set forth in blue by the iodine test. Outside of the cambium can be seen, though only

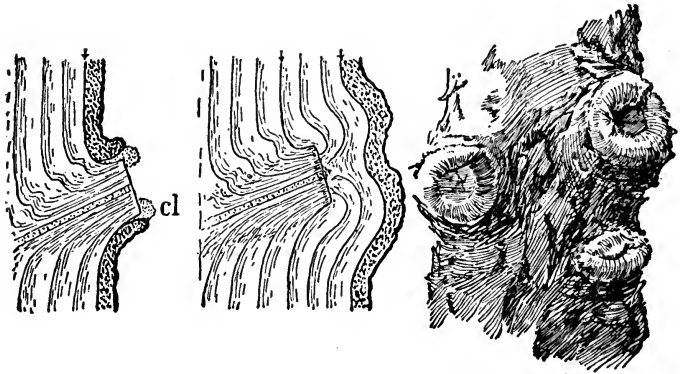

FIG. 79. — Stages in the healing of a pruned stem. *cl* indicates callus, a tissue which precedes the overgrowing bark. (After Curtis, from Duggar, *Plant Physiology*.)

imperfectly by hand lenses, the outer, or PHLOEM, parts of the bundles, which contain the sieve tubes and conduct food through the stem. The remainder of the bark is composed mostly of the former chlorenchyma, now fast losing its chlorophyll, and known henceforth by its morphological name of CORTEX, while the temporary collenchyma and epidermis are being replaced by layers of waterproof cork, made by a cork cambium, and pierced here and there by the lenticels. All of these features can be traced very easily in nearly all twigs.

The tissues of plants have a remarkable power of healing injuries which befall them. Any break in the soft tissues is healed partially within a few hours, and completely within

a few days, by formation of cork layers, often manifest by their brown color. Where an injury includes the wood, as in case of broken branches or the pruning of large trees, the wood itself does not heal, but the neighboring bark, and also the cambium, gradually overgrows it. In time the cambium reestablishes itself over the injury and then continues to make wood as before (Fig. 79). This power of healing injuries has high value for plants, since their epidermis and cork form not only a protection against dryness, but serve also

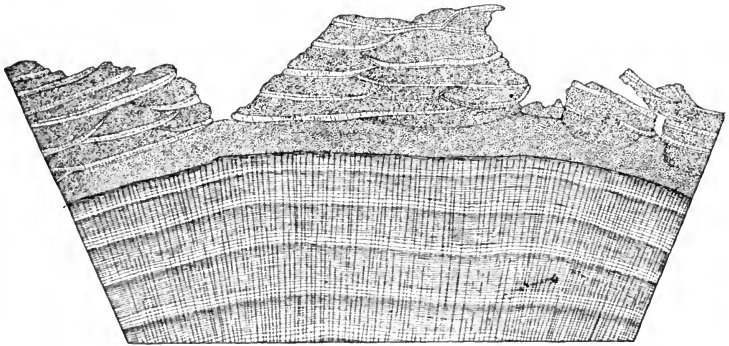

FIG. 80. — Cross section through bark and wood of an old Elm tree, showing abscission of the bark;  $\times \frac{3}{4}$ .

as their first line of defense against the entrance of injurious parasites, which are ever ready to enter any break in the tissues of the stem.

With increasing age several new features appear in woody stems. Sections then show that the outer part of the bark, which is dead, is cut off from the interior living part by layers of cork, which form anew each year, much as the absciss layers form in the bases of leaves (Fig. 80). As in case of leaves, also, the valuable materials in the outer bark are previously removed to the stem. This dead bark becomes vertically cracked by the pressure of the expanding wood within, and the resultant fissures replace the lost lenticels as avenues of gas exchange between the interior of the stem

and the atmosphere. Further, the outer dead bark steadily weathers and falls away, either somewhat evenly as in Beech, or else in great flakes cut off by the cork layers as in Elm, Hickory, Oak, or in remarkably smooth layers as in Birch. The inner living part of the bark consists of soft, continuously growing tissue, together with the phloem parts of the bundles.

In the older stems, both wood and bark are greatly increased in thickness as result of the activity of the cambium, the growth layer of the stem, which continuously forms new wood on its inner and new bark on its outer face. This process goes on indefinitely, making the woody trunk grow steadily in thickness. The bark, however, is simultaneously weathering and peeling away on the outside, and there comes a time when the rate of this weathering just about keeps pace with the additions within, thus holding the bark thenceforth of nearly constant thickness, though in constant renewal. In the wood only a few outer layers forming the **SAP WOOD**, distinguishable by the light color, are alive, while the **HEART WOOD**, usually much darker colored, is all dead; and the heart may even decay and vanish completely, leaving a mere shell of sap-wood, which, however, suffices, on the hollow column principle, to support the tree. The cambium forms the **ANNUAL RINGS**, one each year (Fig. 80). It is easy to see that the appearance of the rings is due simply to the contrast between the loose open texture of the wood formed in spring, when large quantities of water, carrying with it stored food, are needed for the new growth of the herbaceous parts, and the close compact growth of the autumn, when less water, and no such food, are required. It is these annual rings which, when cut lengthwise, give the distinctive, attractive "grain" to cabinet woods. Not only do annual rings appear in the wood, but they also occur in the bark, though here they are difficult to see (compare Fig. 87), because the tissues are soft, and soon crushed, and later cut off by the cork layers. Since they are formed by the cambium, the older layers of bark

are outside, in reverse of the condition in the wood, as shown in principle by our diagram (Fig. 81). The *third* new feature consists in the SECONDARY MEDULLARY RAYS (Fig. 82). They form in the ever-broadening fibro-vascular bundles, which thereby are kept divided to nearly their original width. It is hardly correct, however, to speak

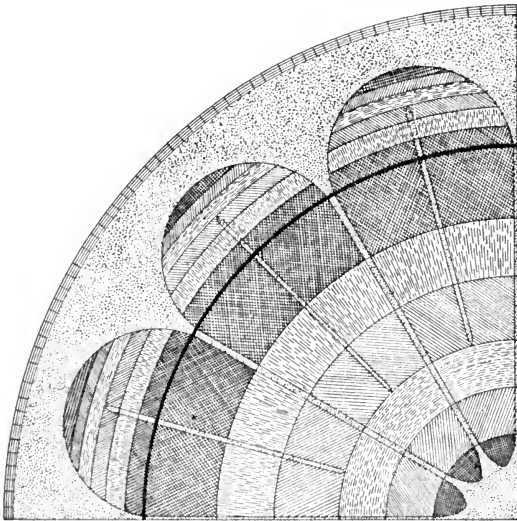

FIG. 81. — Diagram of a cross section of a generalized stem, to illustrate the interrelations of fibro-vascular bundles, pith, medullary rays, both primary and secondary, cambium (black), cortex, and cork. Annual rings in bark and wood of identical age are identically shaded. The extension of the rings across the medullary rays is not shown, though it is usually plain in the wood while obscure or absent in the bark.

any longer of separate fibro-vascular bundles, since their identity has long since been lost in that of the general woody mass and the bark.

The medullary rays are an important, and sometimes a conspicuous feature of the wood. Beginning as plates of tissue between the originally separate bundles, they are later developed and multiplied in number as a persistent part of the wood, in which they serve as avenues of communica-

tion between the inner and outer layers. They do not run far, as a rule, up and down the stem (Fig. 82), no farther than the distance between the successive forkings of the fibrovascular bundles in the original bundle cylinder (page 119). They are more prominent in some woods than others, and are especially striking in Oak, where they form the prominent

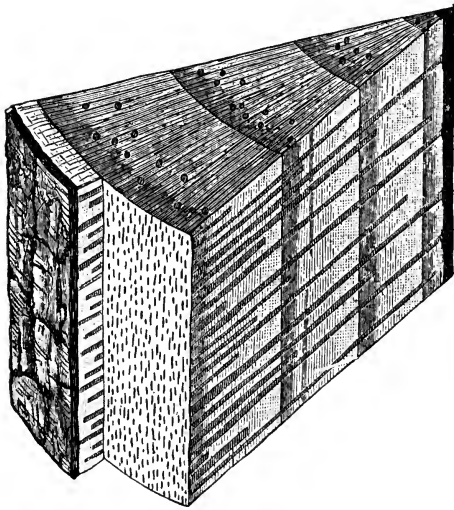

FIG. 82. — A 4-year-old stem of *Pinus sylvestris*, with bark partially removed at the cambium; magnified. It shows clearly the medullary rays, primary and secondary, and the annual rings, containing resin canals. (From Strasburger.)

*f. s. c. 1148*

radial lines so plain on cross sections, and the irregular shining plates for which Oak is "quartered", that is, cut longitudinally in a way to display them. The Oak has also ducts so large as to be clearly visible to the naked eye, — whence its conspicuous grain.

Stems exhibiting clear distinction of bark, wood, and pith, having cambium, annual rings and medullary rays, and increasing indefinitely in thickness by secondary

growth, represent the most highly developed type, which includes all of our common trees and shrubs. Since they grow by additions of layers to the wood, they are called EXOGENOUS. The other prominent type has none of the above-mentioned features, but remains permanently in a primary growth condition with the bundles scattered irregularly throughout the stem (Figs. 72, 74). In the belief, since found erroneous, that such stems grow by addition of new bundles inside of the

older, they were named ENDOGENOUS, and the name remains in use. This type is characteristic of Grasses, Lilies, Palms,

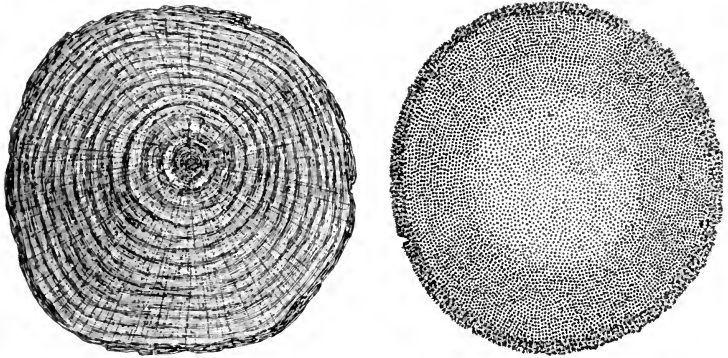

FIG. 83. — Typical exogenous and endogenous stems, in cross section, of Red Pine and a Palm;  $\times \frac{1}{2}$ . (Drawn from photographs.)

and in fact of all plants in the great natural group of the *Monocotyledons*, where it is associated with parallel-veined leaves, and sparse branching.

The contrast between the two types appears very clearly in our picture (Fig. 83). The typical endogenous type does not permit an indefinite increase in diameter, for, after the fibro-vascular bundles first laid down have increased to their full size, the stem no longer enlarges in diameter, but only in height, whereby endogenous plants are rendered extremely slender and graceful, as Palms and Bamboos illustrate. The great heights maintained by such stems with slender diameters



FIG. 84. — The Dragon Tree, *Dracena Draco*, of the Canary Islands, an endogenous plant which grows indefinitely in diameter. (From Balfour.)

rest partly on the yielding elasticity permitted by the long curving courses of their separate fibro-vascular bundles

(Fig. 72), and partly on the perfection to which the hollow-column principle is carried in their construction, as witness the Bamboo. Upon the latter feature they depend far more than do exogenous plants, which find ample support in their massive solid trunks. Some Monocotyledons, however, do exhibit increase in diameter, for the outer layers of their stems develop a cambium-like tissue which continues to form new scattered bundles as long as the plant lives. It is thus that the great Dragon Tree, though endogenous, can attain to so great a diameter and age (Fig. 84). In all endogenous plants, the seeming bark is nothing other than the compact outer tissues, darkened more or less by action of the weather, of which the effects penetrate to some depth.

Striking though the difference appears between the exogenous and endogenous types of stems, they perform the same functions with apparently equal efficiency. The differences between them are therefore not functional, but depend rather upon their relationships within two different and ancient lines of evolutionary descent. Did we not know this fact, we might seek long for a functional explanation of differences the significance of which lies only in heredity.

### 3. THE CELLULAR ANATOMY OF STEMS

From the tissues of stems, which can readily be recognized by aid of a hand lens, we turn naturally to consider the constituent cells, making use of the microscope.

One of the best stems for such study, because of its exceptionally clear definition of the parts, is that of the Dutchman's Pipe (*Aristolochia Sipho*), a common vine. Sections through the terminal bud, or very close thereto, show only the closely packed, squarish, protoplasm-filled cells which one soon learns to associate with the embryonic stage of growth (compare Figs. 92, 162). Such embryonic tissue is always called MERISTEM, whether in buds, growing tips of roots, cambium, or elsewhere. A little behind the bud



FIG. 85. — The cellular anatomy, in corresponding cross and longitudinal sections, of a young stem of *Aristolochia Sipho*, a twining vine;  $\times 50$ .

In the center, the pith; next three fibro-vascular bundles, showing the xylem with ducts, the rectangular nucleate cells of the cambium, and the phloem, marked by sieve-plates and nucleate cells; next the sclerenchyma ring, with the starch sheath just outside; then the cortex, consisting of chlorenchyma and collenchyma; and finally the epidermis.

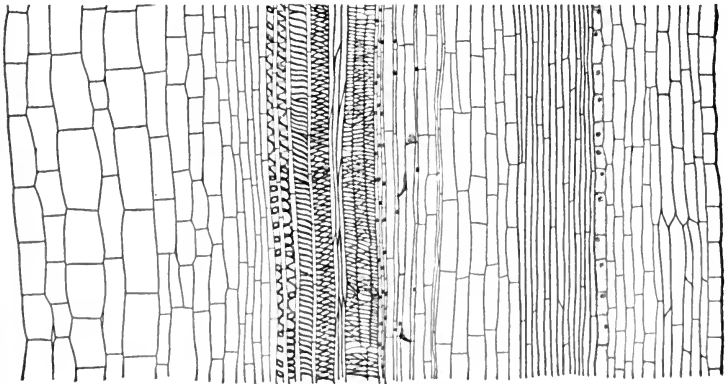
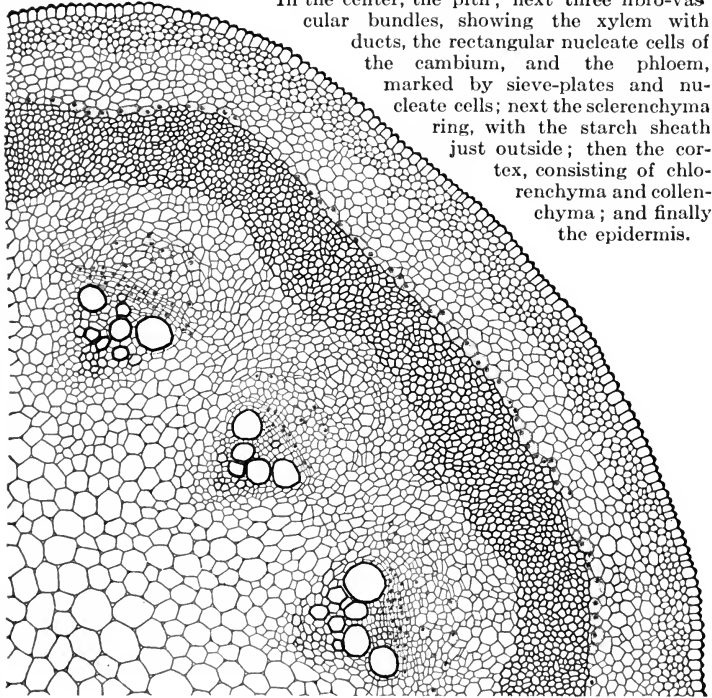

the cells are found well differentiated, as our picture illustrates (Fig. 85). Outside is the single layer of the epidermal cells, with occasional stomata, not essentially different from those in leaves. Just beneath lies the zone of collenchyma cells, of which the thickened angles, elongated forms, and composition from elastic cellulose explain their function as the first strengthening tissue of the flexible and elongating stems. Next comes the chlorenchyma, like that of the leaves, though with scantier chlorophyll. Its innermost layer contains starch, and constitutes the STARCH SHEATH, of which the function is disputed, some investigators assigning it a conducting function for carbohydrates, while others consider it a geotropic-perception sheath, as will later be explained. Next inside comes a very prominent zone of angular, thick-walled, light-colored, greatly elongated empty cells, found by tests to be hard and stiff. These are SCLERENCHYMA cells, the characteristic strengthening cells of plants, found in diverse situations, and here evidently giving special support to the young stems of this vine, which stand out laterally before twining around a support.

Inside the sclerenchyma ring can be seen the fibro-vascular bundles, which here present an unusually distinct structure. Each bundle is ovate in cross section, with the point towards the center, and shows three parts. The XYLEM, or wood, inside of the cambium, contains the large, somewhat angled, thick-walled DUCTS, lacking protoplasm but variously marked by spirals, pits, and the like. They are formed by the union of many cells of which the intermediate walls have been absorbed. Intermingled therewith are smaller cells, partly WOOD FIBERS and partly WOOD PARENCHYMA, having minor functions in connection with the conduction and storage of carbohydrate foods. The characteristics of the xylem are further well illustrated in the diagrammatic figure 86.

The PHLOEM, or bast, is composed of small thin-walled elongated protoplasm-containing cells lying outside of, and

matching, the xylem strands. The larger cells are crossed here and there by the perforated plates which show them to be SIEVE-TUBES; and they are the protein-conducting parts of the bundles, precisely as in leaves (page 31). Intermingled with the sieve-tubes are other slender cells, COMPANION CELLS, which have something to do with the function of the sieve-tubes, and BAST PARENCHYMA cells, in which

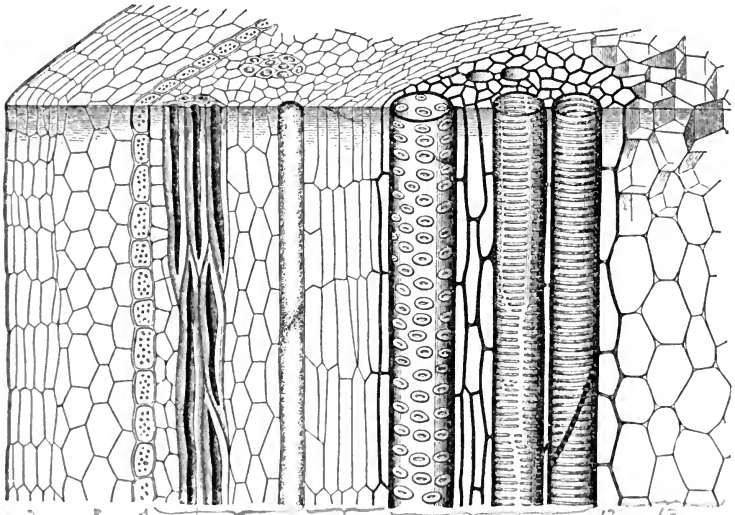

FIG. 86.—Generalized drawing of an exogenous stem, to show the typical anatomy of the cellular elements; highly magnified. From left to right, the cork, the cortical parenchyma, starch sheath, bast fibers, phloem parenchyma, sieve-tube, cambium, ducts with xylem parenchyma, and pith. (From Kerner.)

*See K & O I-447*

carbohydrates are conducted, and which, therefore, along with the wood parenchyma, take the place in stems of the conducting bundle sheath of leaves (page 30). Often the phloem contains in addition very long and thick-walled but flexible fibers, called BAST FIBERS (Fig. 86), which give stiffness to the stem when sclerenchyma is wanting. It is these bast fibers which in the flax plant yield us our linen, and in some trees provide tough strands utilized by savage tribes

- 1 Epidermis
- 2 Cork
- 3 Cortical parenchyma
- 4 Vascular bundle sheath
- 6 Bast parenchyma with companion cells
- 10 Wood parenchyma with fiber vessels
- 12 Pith
- 13 Cambium

for cords, and even a lace-like material serviceable for fabrics.

The *cambium* of the fibro-vascular bundles lies between xylem and phloem. It consists of several rows of compact, rectangular, thin-walled, elongated, protoplasm-filled cells, having the meristematic aspect which is always associated with growth (compare Fig. 92). In older stems, lines of cells in the tissue between the bundles (the beginning of the medullary rays), become converted into cambium, continuous with that in the bundles, and thus the cambium ring is completed around the stem. It then forms a perfectly continuous cylindrical sheath between wood and bark on trunks, branches, and roots, and it merges imperceptibly into the meristem of the buds and root tips, which are thus brought into a single continuous growth system; but it does not occur in leaves. Being a growth tissue, and therefore thin-walled, it is easily torn, which explains why bark is so readily removable from wood, especially in spring when the cambium is most active and tender. Indeed, at this season the cambium can be stripped in long gelatinous sheets from the wood of some trees, notably white pines. In its growth it divides continuously in its own plane, the cells on its inner face becoming new xylem elements, and those on its outer face new phloem elements, while the intermediate cells remain cambium. In this manner it builds also the medullary rays of both wood and bark.

Inside the ring of bundles lie the cells of the pith, exhibiting the large sizes and rounded forms associated with storage, whether of food or water. Among them appear very clearly the intercellular air-spaces, which can likewise be traced in other parts of the stem, although it has not been possible to show them in our small scale drawing (Fig. 85). In reality they are parts of a continuous intercellular aëration system which extends from the pith along the medullary rays and through the outer tissues to the lenticels and the exterior air. In the pith, as in other parts, can frequently be seen

crystals, which have the significance already explained for those of the leaf (page 111).

Woody stems exhibit their cell structure very clearly in sections (Fig. 87). In the bark can be seen the flat, continuous, brownish cells of the cork, made by a special cork-cambium just beneath them. The first cork is usually formed just beneath the epidermis, which it replaces; but later the cork-cambium forms anew each year at some distance from the surface, thus building the layers of cork which cut off the areas of bark (Fig. 80). The wood shows clearly the various cells of the xylem and medullary rays (Fig. 87), as likewise the cellular construction of the annual rings, with the contrast between the loose open cells of the spring wood and the compact growth of the preceding autumn.

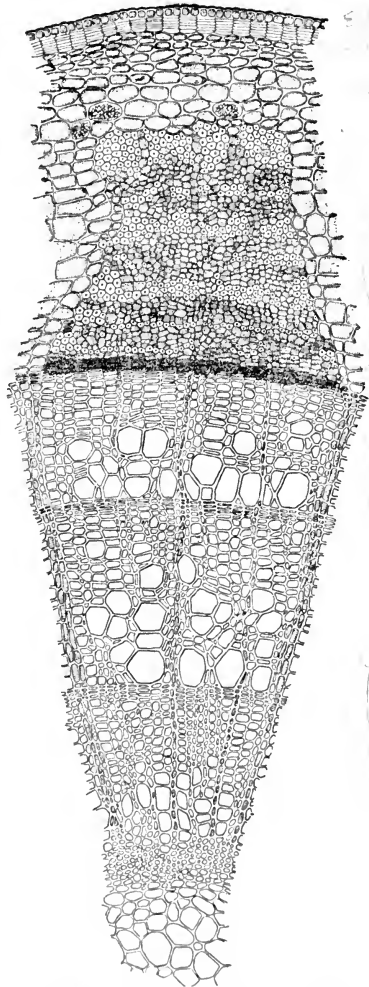

FIG. 87. — A segment, in cross section, of a stem of Linden. From without inward are epidermis (here unusually persistent); cork; cortex (the starch sheath not shown); phloem, consisting of alternating layers of bast fibers (lighter) with sieve and parenchyma elements; cambium; xylem, showing three annual rings, with large ducts, wood cells, and (on the sides) medullary rays; and pith. The view shows one complete fibro-vascular bundle, three years old. (Drawn from a wall-chart by L. Kny.)

Some stems present special cellular features, of which the most striking is the LATEX system. This latex, the milky juice of plants which contains so many diverse substances of uncertain significance (page 108), is found mostly in long, slender, closed tubes branching irregularly through the softer tissues, and even the wood of stems, leaves and other parts (Fig. 88).

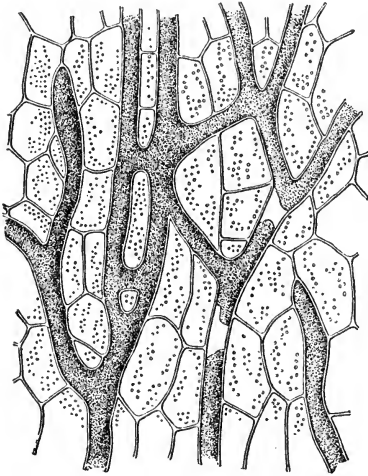

FIG. 88. — The latex system in *Lac-tuca virosa*, in section;  $\times 180$ . (From Kerner.)

The *Aristolochia*, and other stems just mentioned, are all exogenous. The endogenous type presents some, though no great, cellular differences. Thus, as exemplified in the Corn (Fig. 89), the bundles, of course lacking cambium, present each a very distinct strand of thin-walled, regularly-arranged phloem, alongside of which is the strand of xylem, distinguished by very large ducts and commonly a great air passage; while the apparent bundle-sheath encircling the bundle has been found to develop by extension from the xylem. In such stems there is no distinction of pith, medullary rays, and cortex; but all are merged together in one pith-like general ground tissue (Fig. 74).

In the foregoing description of the structure of stems, we have considered only one type of fibro-vascular bundle, — the kind having parallel strands of phloem and xylem. Many other types and sub-types, however, occur, as well as many special forms of arrangement of the bundles within the cylinders and in relation to the leaves. It has recently been found that these morphological features of stems

anatomy are very stable in heredity, thus making them good guides to the evolutionary history and present relationships of plants. This important phase of investigation is now in

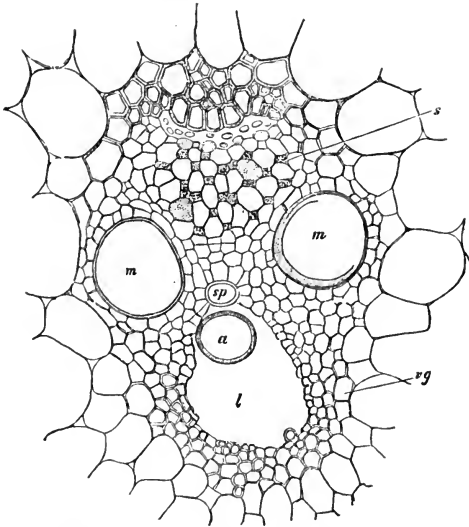

FIG. 89. — A single bundle in Corn (one from those shown in Fig. 74), in cross section;  $\times 130$ . *s* points to the strand of phloem; *m* and *sp* are ducts which, with the intermediate cells, form the xylem; *l* is an air space containing a ring, *a*, from a duct; *vg* indicates the sheath around the bundle. (From Strasburger.)

active and successful development, but is somewhat too special in method for further consideration in an introductory course.

#### 4. THE DEVELOPMENT OF STEMS AND LEAVES FROM BUDS

Stems and leaves originate together in buds, though it is more exact to say that the embryonic condition of a stem with its leaves constitutes a bud.

Most familiar of all are the winter buds of trees, in which the bud proper is enwrapped within corky brown scales, often with accessory linings of hairs or coatings of resin, as

the Horse Chestnut, for instance, well illustrates (Fig. 75). The scales, which are modified leaves of the preceding year's growth, though prominent, are not an essential part of a bud, having only the temporary function of protecting it over winter, after which they fall. The scales are lacking from all summer buds and some winter ones. The really essential feature of a bud is the embryonic stem composed of meristem or active growth tissue, together with the

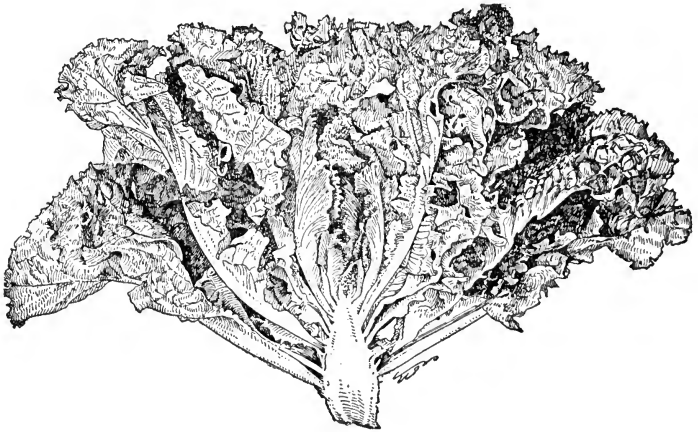

FIG. 90. — A head of Lettuce, in section, illustrative of bud structure;  $\times \frac{1}{2}$ . (From Bailey.)

nascent leaves which grow out laterally therefrom. The lower and older leaves of a bud commonly overlap and cover the upper and younger for a time, but later open out to begin their work; and in herbaceous plants a perfect gradation is often apparent between the nascent leaves in the bud and the full grown leaves of the stem.

Buds are of all sizes, from too small to be seen without the aid of a lens, up to several inches in diameter, as in Palms. A Cabbage or head of Lettuce is essentially a gigantic bud, and offers a particularly favorable illustration of the essentials of bud structure; for a section made lengthwise through its



center shows very clearly the characteristic tapering stem, with the series of leaves in all stages of development (Fig. 90).

Within the buds the leaves are arranged in various ways, either overlapping, or each folded by itself on its midrib, or inrolled from margins or tip. The arrangements are called collectively **VERNATION**, and have importance in descriptive taxonomy.

The most prominent, and commonly the largest, buds are those which are **TERMINAL** on the main stems and branches, and which continue the stem growth. More abundant are the **AXILLARY** buds which develop in the upper angle between leaf and stem, and are nearly as numerous as the leaves themselves, at least in exogenous plants. The functional reason for the usual occurrence of buds in this position is found, no doubt, partly in the nearness to the source of food indispensable for their development, and partly in the favorable structural opportunity to make connection with the main stem in the gap left in the fibro-vascular cylinder above the leaf base (page 119). In a few plants, of which Tatarean Honeysuckle and Red Maple are examples (Fig. 91), more than one bud occurs in each axil, either side by side, or one above another, the extra buds being called **ACCESSORY**. Finally, while in many plants no buds other than terminal or axillary occur, in others they develop in almost any position, especially at some place of injury; and these so-called **ADVENTITIOUS BUDS** produce the branches in irregular positions, as often seen in Willows and some other woody plants. Not all irregular branching, however, results from adventitious buds, for axillary buds often remain latent for years, becom-



FIG. 91. — A twig of Red Maple, showing accessory buds;  $\times \frac{1}{2}$ . (After Gray.)

ing deeply buried under the bark, and yet finally give origin to branches.

Where the terminal bud is notably prominent, as in Horse Chestnut (Fig. 75), the axillary buds are largest just below it, and progressively smaller farther back. Such a terminal bud unfolds its flowers, stem, and foliage very quickly and makes no more growth in length that season, though the upper axillary buds may develop into branches. Such is DEFINITE ANNUAL GROWTH. Where the terminal bud is relatively small, as in Elm, it continues to grow and produce new leaves and axillary buds all summer, and new branching takes place from the lower new buds. Such is INDEFINITE ANNUAL GROWTH.

The occurrence of a bud in the axil of every leaf gives the plant a great surplus, of which few ever develop into branches, though all are capable of so doing. Generally speaking, those nearer the outer ends of the branches, and therefore

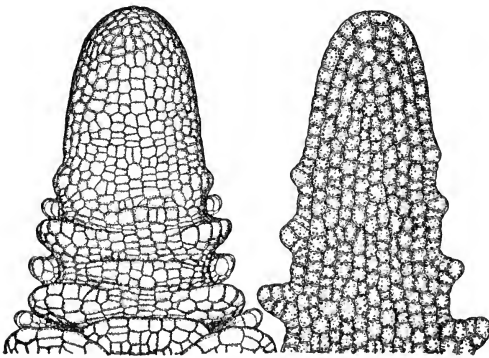

FIG. 92. — A bud, of unusually elongated form, of a water weed, *Elodea canadensis*, in exterior view and section, showing the development of leaves;  $\times 150$ . (After L. Kny.)

nearest the light and free space, are the ones which develop, though if the terminal, or outer axillary, buds become destroyed, whether by frost, insect ravage, or experimental design, the next lower develop in their places. Since all are capable of de-

velopment, it is evident that some factor controls them collectively, either inhibiting the development of some or stimulating that of others, — a subject to which we shall later return under Growth.

The mode of formation of stem and leaves within buds is revealed by longitudinal sections. In an illustrative case (Fig. 92), one can see very clearly the blunt conical end of the stem, composed of small tightly-packed cells in process of formation through new cell-divisions, while backwards the cells are evidently beginning to elongate with the lengthening of the stem. The first visible trace of a leaf is found in the enlargement of a superficial cell, which soon divides; the resultant cells again divide and, including both epidermis and cortex, gradually push out in a flat projection, — the leaf. These leaves enlarge steadily, thus making a perfect gradation from those just appearing to those fully formed. As they develop, the nodes on which they stand, at first close together, are carried apart by lengthening of the internodes, and the tissues gradually pass from the meristematic, or embryonic, to the differentiated or mature condition. In this process, however, the areas of tissue in the axils of the leaves remain meristematic, thus originating the axillary buds.

##### 5. THE ARRANGEMENTS OF LEAVES ON STEMS

Leaves develop upon stems not at haphazard, but in definite mathematical order. This definiteness of arrangement, called scientifically *PHYLLOTAXY*, while sometimes obscure, is often strikingly manifest to the eye.

When two leaves occur at a node, they are always *OPPOSITE* to one another, and each pair stands at right angles to the pairs above and below, thus forming four ranks on a vertical stem, as the *Coleus* of our gardens, and the *Mint* family in general, well

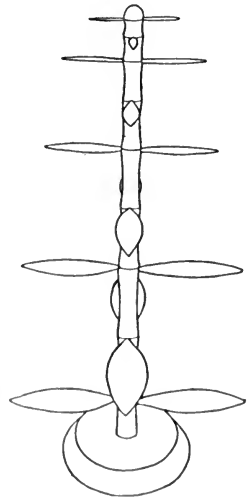

FIG. 93. — The *opposite* arrangement of leaves, as illustrated by a museum model.

illustrate (Fig. 93). When the stem is not vertical, however, the leaf blades swing around phototropically on their

petioles until they face upward, in a sort of mosaic, towards the light (page 57), thus obscuring the opposite arrangement, which, however, can always be seen where the petioles join the stems. It is important to remember that phyllotaxy is a matter of the *place of origin* of leaves upon stems, and has little to do with the positions which the leaf blades ultimately assume. In some kinds of plants, not two, but three, or more, leaves occur at each node, forming a

WHORL, in which case the leaves commonly cover the gaps between those

above and below, as occurs in many plants of the Lily family (Fig. 94). The arrangement is particularly plain in the relation of the petals to the sepals in most flowers. Often, however, it is rendered imperfect by twisting of the stems, variation of number of leaves in the whorls, and other less obvious causes.

When only one leaf occurs at each node, they fall collectively into a spiral, and the leaves are said to be ALTERNATE. In the simplest case the successive leaves stand one-half way around the circumference of the stem from those next above and below, thus

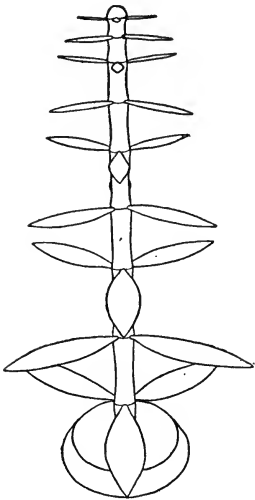

FIG. 94. — The *whorled* arrangement.

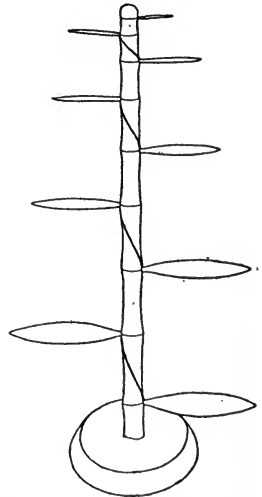

FIG. 95. — The *alternate*,  $\frac{1}{2}$  spiral, arrangement.

forming two vertical ranks and bringing the third leaf over the first (Fig. 95), as well manifest in Corn and other Grasses. In other cases, the leaves stand one-third of the circumference apart, forming an obvious spiral, bringing the leaves into three vertical ranks with a fourth over a first (Fig. 96), as in Sedges, which, correlatively, have triangular stems. The next of the arrangements actually found is that where the leaves stand two-fifths of the circumference apart (Fig. 97), in which case the spiral must turn twice around the stem before a leaf, the sixth, is reached over the first,

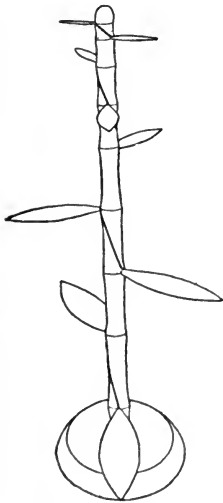

FIG. 97. — The alternate,  $\frac{2}{5}$  spiral, arrangement.

five vertical ranks resulting. This is the commonest of the alternate arrangements. It is very clear in the Apple, and in many common plants,

though at times, in long stems, its regularity is disturbed by some twist of the stem. It underlies the prevalence of the number five in the plan of most flowers, as the one-third and one-half arrangements underlie the numbers three and four in others. The next arrangement is that of three-eighths (Fig. 98), found in the Holly. The next is that of five-thirteenths (Fig. 99), found in the House-leek, which forms the familiar rosettes, while in Pine cones and other such structures, arrangements of eight twenty-firsts, and even thirteen thirty-fourths and twenty-one fifty-fifths have been deter-

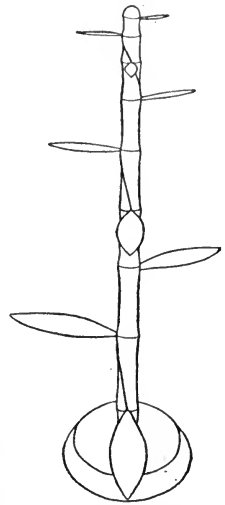
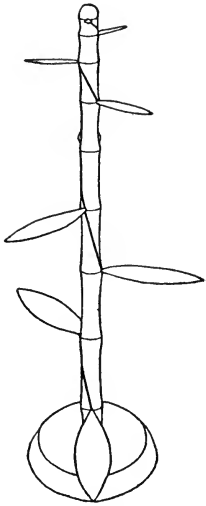

FIG. 96. — The alternate,  $\frac{1}{3}$  spiral, arrangement.

mined, arrangements of eight twenty-firsts, and even thirteen thirty-fourths and twenty-one fifty-fifths have been deter-

mined. These fractions primarily express the angular divergence of the leaves from one another around the stem, but secondarily the numerator shows the number of turns made by the spiral in reaching a leaf directly over any given one, while the denominator expresses the number of leaves in such a complete turn.



It is not only true that these fractions are actually found in phyllotaxy, but also a fact that they are the only ones which ordinarily occur, the exceptions being rare, and following an analogous plan. Furthermore, when a stem having one of these fractional systems becomes twisted, the leaves are always brought into the next system above or below. When, now, the fractions are arranged in sequence, —

FIG. 98. — The alternate,  $\frac{3}{8}$  spiral, arrangement.

- $\frac{1}{2}$     $\frac{1}{3}$     $\frac{2}{5}$     $\frac{3}{8}$     $\frac{5}{13}$     $\frac{8}{21}$     $\frac{13}{34}$     $\frac{21}{55}$

some remarkable relations among them come out, — viz. in all cases after the first and second, the numerators and denominators are each the sum of the two preceding, while each numerator is the same as the denominator next before the preceding. This curiously related series, which as a mathematical abstraction is known from its discoverer as the Fibonacci series, finds actual physical expression not only in phyllotaxy, but also in some other phenomena of nature.

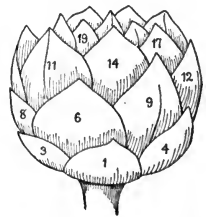

FIG. 99. — Rosette of Houseleek, showing the  $\frac{5}{13}$  arrangement. (After Gray.)

The significance of phyllotaxy has been diversely interpreted. Some botanists have explained it as adaptive, thinking it must give to clusters of leaves the best aggregate exposure to light. But such reasonableness as this theory may

seem to possess in case of the opposite arrangement and the lower fractions of the spirals vanishes in case of the higher systems, which are inappreciably different in so far as leaf exposure is concerned; while, moreover, the ultimate exposure of leaf blades is determined chiefly by their own phototropic movements on their petioles, with little or no regard to the plan of their origin. Later studies, however, seem to show that phyllotaxy originates in the construction of buds,

as an incidental result of the order in which the nascent leaves develop in relation to one another upon the cone of embryonic stem tissue. This order of development, in turn, seems to be connected with conditions of mutual pressure of the forming leaves upon one another in buds of different shapes, this pressure manifesting itself very differently in slender

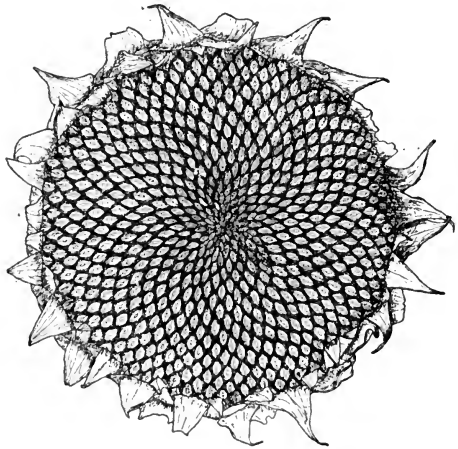

FIG. 100. — A head of Sunflower in seed, showing its symmetry, which is an expression of phyllotaxy. (Drawn from a photograph in the *Report of the New Jersey Experiment Station for 1911.*)

buds, which mostly produce the opposite system and low fractions, as compared with the broad or flat buds, which chiefly produce the higher fractions. Apparently the leaves originate regularly and successively in the lines of least resistance in the differently shaped buds,—and the result is phyllotaxy. Herein we seem to have a particularly clear case of one of those purely structural factors which were earlier mentioned as having a part with adaptation and heredity in determining details of plant form.

Since new buds, which give origin to new branches, are axillary to leaves, the branching of plants should correspond with their phyllotaxy. This, indeed, is true in principle, as shown by young twigs; but as plants grow older the regularity of their branching becomes greatly disturbed by irregular shading and diverse natural accidents. Flowers always originate from axillary buds, and hence clusters of flowers also exhibit the plans of phyllotaxy. This becomes especially striking when flowers are condensed closely together in heads, as in the Composite family; and thus is explained the wonderful phyllotactic symmetry of *Dahlia* flowers, and of the head of a Sunflower in "seed" (Fig. 100). Other structures which show such symmetry strikingly well are cones of various trees, plants of compact growth, like the *Mamillaria* of the Cactus family, and various rosette plants. In all of these cases the primary spiral is difficult to trace because of its condensation; but incidentally there arise a number of secondary and tertiary spirals, and these it is which become so strikingly evident.

## 6. THE TRANSFER OF WATER AND FOOD THROUGH PLANTS

A secondary function of stems is the conduction of water from the roots to the leaves, and of food from the leaves to the roots. We now consider the method of these important processes.

In the lower plants, the Algæ, Fungi, and Bryophytes, composed altogether of parenchyma cells without any, or with only a rudimentary, system of veins, both food and water are passed directly from one cell to another. The process is a slow one, and in land plants prevents any great development of size, as the very low growth of all Bryophytes, or Moss plants, exemplifies. The higher plants, however, both Flowering plants and Ferns, have developed veins, or vascular bundles, which permit the comparatively rapid transfer of both water and food through long spaces of stem, thus rendering possible the growth of those plants to tall trees.



Of the two currents in the fibro-vascular bundles, the water current is by far the more voluminous, because of the great demands of transpiration. Some of the largest trees require each day literally tons of water, which must be raised one, two, or three hundred feet, and in rare cases still higher, into the air. To raise a given amount of water to a given height requires the expenditure of a definite amount of energy, no matter whether done quietly by a tree, noisily by an engine, or laboriously by human effort. It has been calculated that the amount of work done, and energy required, to raise the water used by a large tree during twenty-four hours is approximately the same as that expended by a person in carrying three hundred large pailfuls of water up a ten-foot flight of stairs, — that is, a pailful every two minutes through a ten-hour working day. It is the botanist's problem to explain the source of the energy whereby such great quantities of water can be raised to such heights against gravitation in small tubes which entail a great deal of friction. In other words, what are the forces which impel the rise of the sap in trees?

The water in passing along ordinary stems moves chiefly in the xylem part, especially the ducts, of the fibro-vascular bundles. This can be proven by experiment, for if an herbaceous stem be cut and stood in water dyed with some obvious color, *e.g.* red ink, and then later, as the first traces thereof appear in the younger parts, the stem be sectioned at different heights, the ducts will be found filled with the red fluid, which is also diffusing outward to the neighboring tissues. In a tree the water runs only in the younger xylem, *i.e.* the outer and younger rings of the white SAP WOOD, and the colored HEART WOOD has no part in the process. Thus is explained the fact that many kinds of trees can lose their heart wood by decay without detriment to water conduction, as also the familiar fact that in tapping Maple trees for their sap, it is useless to bore more than an inch or two into the wood.

The water-conducting vessels are of two sorts, — *first*, elongated single cells, called TRACHEIDS, and *second*, tubes, called DUCTS or TRACHEÆ (Fig. 101), which are formed from

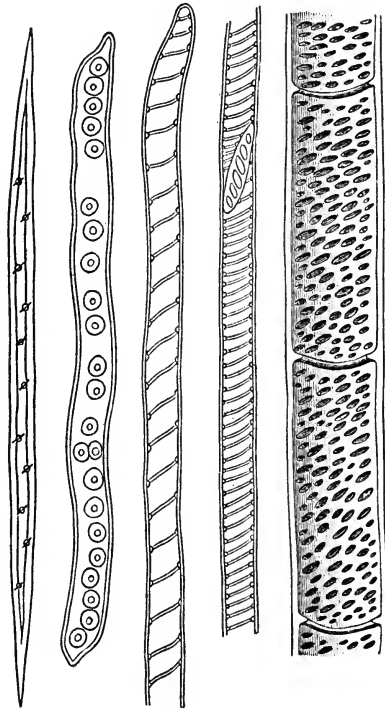

FIG. 101. — Generalized drawings of typical tracheal elements; highly magnified. From left to right, a fiber-tracheid; pitted and spiral tracheids; spiral and pitted ducts, which show end walls and remnants thereof. (From Strasburger.)

many cells of which the intermediate walls have been absorbed. Tracheids occur often intermingled with ducts; they form the ends of the xylem part of the veins in leaves, and they make up wholly the secondary growth of Pines and other coniferous woods (Figs. 102-4). Ducts develop usually from a single row of cylindrical cells by absorption of the intermediate walls; but sometimes many rows of cells are involved, in which case the duct becomes large and visible to the eye, as in Oak and some vines, the single-row type being usually invisible without a lens. Though tubular in structure, ducts are never unlimited in length; many are not more than a few

inches, few exceed a few feet, and the longest, which occur in some vines, are only a few yards in length. In all known cases, however, the ends of ducts and tracheids are in contact with others of like sort, and the intermediate walls are so constructed, with guarded thin areas, as to permit a ready

passage of water moving at the ordinary rate, while resisting any forcible rush of the water along the stem under suddenly developed pressures. Thus the tracheids and ducts form water-conducting systems of unlimited length, even though the length of the individual elements is restricted. These thin areas, however, exist not only at the ends of the ducts,

but throughout their lengths, where sometimes they appear as bordered pits in an otherwise thickened wall, as is very characteristic of the coniferous wood (Fig. 104): or else as the meshes of a reticulation: or as thin parts between spiral or annular thickenings (Fig. 101), — all of which distinctive arrangements represent different ways of combining a thickening of the walls with the

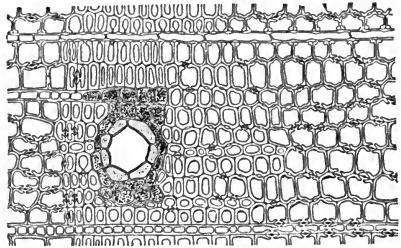

FIG. 102. — Cross section through the wood of Pine; highly magnified.

The cells are mostly tracheids with bordered pits, visible in the walls. Note the medullary rays and the abrupt transition from autumn to spring growth. In the autumn wood is a resin canal. The line in all of the walls is the *middle lamella*, i.e. a plate representing the wall first formed before thickened by additional layers, and somewhat different in chemical and physical composition from the latter. (Reduced from Cavers, *Practical Botany*.)

presence of thin places through which water may move to other ducts or tracheids, or to neighboring tissues. The annular and spiral markings are usually found in ducts or tracheids of the primary growth, in which elongation is still in progress, while other kinds occur in the secondary growth, where elongation has ceased. Both tracheids and ducts, when mature, are without protoplasm, forming non-living tubes. Their mechanism, as a water-conducting system, is shown in our diagrammatic figure 105.

The all-important question as to the forces by which the water is lifted through the ducts has been answered by investigators in several different ways. In earlier times it

was thought that the water ascends by *capillarity*, precisely as oil rises in a wick, or water in a towel; but experiments have proven that water cannot thus rise in wood more than a few feet. Also it has been held that *atmospheric pressure*, by which water is raised in a pump to a height of thirty-two feet, would explain it, the greater height reached in trees

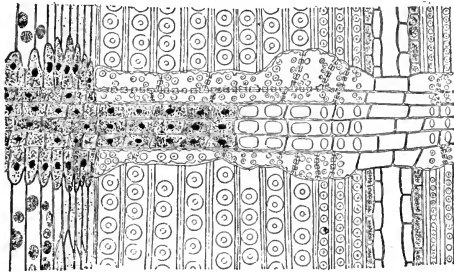

FIG. 103.—Radial section (*i.e.* parallel with a medullary ray) of the Pine of Fig. 102.

A medullary ray runs across the tracheids, with the younger and outer end, containing protoplasm, on the left. Outermost, on the left, are sieve cells showing sieve plates on the walls; next is cambium; then tracheids of the spring wood, showing the characteristic bordered pits; then autumn wood containing a resin canal. Comparison with Fig. 102 will show the construction of a bordered pit, across which extends a thin and flexible plate. (From Cavers.)

being supposed to result from the fact that intermixed air makes the water in the ducts much lighter than without it; but further study has shown that neither are the conditions in the plant suitable for the operation of atmospheric pressure, nor would it suffice in very tall trees. Also it has been argued that the water ascends

in the walls of the xylem by a process of *imbibition*, due to the attraction of wood for water, in precisely the same way that water passes into wood across the grain; but experiments have shown conclusively that the water goes through the cavities, not the walls, of the ducts. Still later it was claimed that living cells, in wood parenchyma or medullary rays, which accompany the ducts, act as a means of *propulsion* of the water upward, each living cell absorbing water from the upper end of one duct and forcing it into the lower end of one higher, somewhat on the analogy of tiny force pumps; but experiments seem to have proven that the water still rises when all living cells are killed by poisons. Finally,

most recently of all, a new and striking explanation has been offered, with much experimental support, to the effect that the water rises by *traction*, *i.e.* is drawn up in long threads, as if solid, by forces acting in the leaves. This matter needs somewhat fuller explanation.

In the next chapter it will be shown that the forces of *osmotic pressure*, operating in the roots, draw water from the soil and give it a start up the stem; also the same forces in the leaves draw water in the same way from the ducts into the leaf cells. Now it is found that the forces thus exerted by the leaf cells are amply powerful to lift the water to the tops of the tallest trees if only the water in the ducts would hold together in threads. The new theory maintains that the water does thus hold together, as if in solid threads, by virtue of its own internal cohesion, a property which is manifest in part in the surface-tension familiar to all students of physics. Everybody knows that a large water-drop hanging free from the *under* side of a glass plate can be lifted with the plate, and it seems clear that the water could be lifted in much larger masses if lengthened out to very thin threads, as it is, of course, in the ducts. The water thus pulled into the leaves by the osmotic power of the leaf cells is removed from those cells by the still greater power of evaporation (transpiration), the energy for which is supplied by the heat of the surroundings. Thus, on this theory, it is really the energy of evaporation which raises the water in tall trees. But while evaporation is the principal, it is not the only source of energy available, for obviously

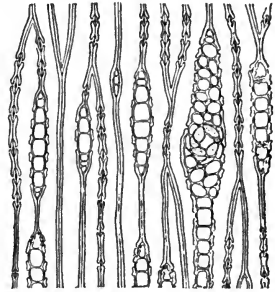

FIG. 104. — Tangential section (*i.e.* at right angles to a medullary ray) of the Pine of Figs. 102-3, but more highly magnified.

The tracheids, with their bordered pits, are plain, as are the cut ends of the medullary rays, of which one contains a resin canal. (From Cavers.)

any power which will draw water into the cells will lift the water-columns in the ducts. This result follows from

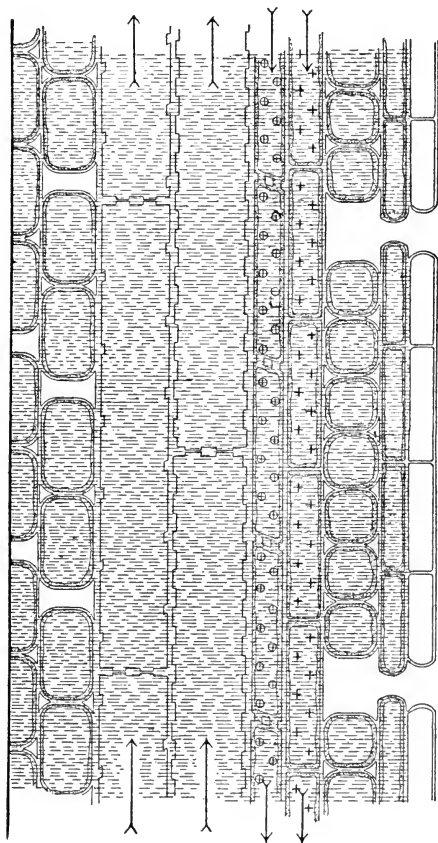

FIG. 105.— Plan of the stem as a conducting mechanism, arranged as in Figs. 11 and 166, with similar signs for protoplasm, water, sugar, and proteins. On the left is the pith, and then, in order, two ducts, a sieve-tube, phloem parenchyma, cortex, and cork with lenticels.

upwards indefinitely, but actually have heights approximately fixed for each kind. Our ordinary deciduous trees,

the cells will lift the water-columns in the ducts. This result follows from various chemical or physical processes in which water is absorbed; and such secretory actions are believed to explain the lifting of the sap in the spring before the leaves are developed. This explanation is not yet universally accepted, many botanists still holding that the living cells along the stem are the chief factor in the process.

It must, of course, be true that the greater the height of a tree, the greater the difficulty of raising a sufficient transpiration supply against the increasing hydrostatic resistance, and the friction within the small ducts. Thus a limit is imposed to the height of trees, which potentially can grow

after reaching their heights, tend to spread out laterally and become flat topped; and the dead branches which occasionally occur above their green summits represent certain ones which were able to exceed the ordinary limit in an especially wet summer, but died in a dryer one. Trees which attain to the greatest heights are apparently such as have particularly favorable structural relations to conduction or transpiration.

It is well known that in spring the sap exudes readily from injuries in many kinds of plants. Thus Grape Vines if pruned too late in the season will "bleed" very copiously, and large drops of sap often fall upon sidewalks from broken twigs or bark of shade trees; and the flow of sap in the Maple in spring is a well known phenomenon. These are evidently cases in which the sap is forced out by osmotic pressure in the roots, complicated, however, by osmotic pressures in the stem, and by expansion and contraction, under varying temperatures, of the air which occurs in the stem. The internal pressure developed by such expansion explains why the flow is greatest on a warm day after a cold night.

The transfer, or more technically, TRANSLOCATION, of food through the plant occurs only in solution in water. In general the food has three paths. *First*, it may pass directly from cell to cell through protoplasm and walls by the power of diffusion, later to be studied. This is the sole method in the lower and simpler plants, and is that by which the food is removed from the chlorenchyma cells of the leaf to the nearest veinlets (page 32). It is also the method by which the food spreads from the ends of the veins to the growing cells in all parts of the plant. *Second*, in woody plants in spring the food stored in the roots or lower part of the stem is transferred into the ducts (along the medullary rays from the bark), where it is rapidly lifted to the growing leaves with the rising water current. This explains the presence of sugar in the sap of Maple and other trees in spring, though later in the season the sap is nothing other than soil water. *Third*,

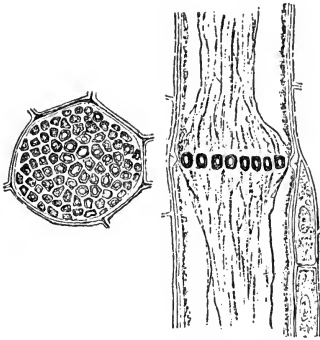

FIG. 106. — The sieve plate, on surface and in section, of a typical sieve-tube of Squash;  $\times 400$ . Note that the protoplasm extends without break through the openings in the plate. (From Strasburger.)

the translocation occurs along special cells and vessels of the veins. Thus the carbohydrates, as already explained (page 31), move along the vein sheath in the leaves, and along parenchyma cells, chiefly of the phloem but partly of the xylem, in older bundles. All such conducting cells are elongated, possess plain walls, and contain protoplasm. The proteins have their clear paths of conduction in the sieve-tubes, of which this is the distinctive function. The sieve-tubes are elongated, thin, and smooth-walled cells, arranged in lines, with their intermediate walls perforated (Fig. 106); and they have always a lining of living protoplasm. Associated with them are certain companion cells, which have seemingly a part, though an unknown one, in their function. So far as known, the proteins move along the sieve-tubes solely by diffusion from the places of greater to places of lesser abundance. The extreme slowness of this method, however, suggests that the living protoplasmic linings of the sieve-tubes may act in some way to force the movement, though there is no evidence thereof.

Thus it is true in general that the movement of water in stems is chiefly in the wood, and the move-

the translocation occurs along special cells and vessels of the veins. Thus the carbohydrates, as already explained (page 31), move along the vein sheath in the leaves, and along parenchyma cells, chiefly of the phloem but partly of the xylem, in older bundles. All such conducting cells are elongated, possess plain walls, and contain protoplasm. The proteins have their clear paths of conduction in the sieve-tubes, of which this is the distinctive function. The sieve-tubes are

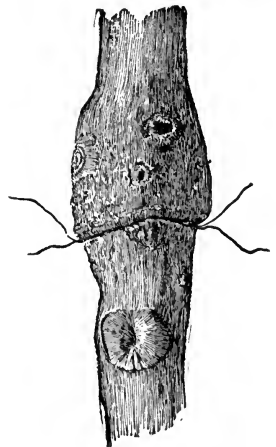

FIG. 107. — The result of constriction by a label wire on a growing shrub. (From Bailey.)



ment of food is in the bark. Accordingly, if the bark be constricted, the passage of food downward from the leaves is stopped, and its accumulation produces a swelling above the constricting object. This happens in botanical gardens where labels are attached by wire, or in shade trees which are strengthened by iron bands placed around them (Figs. 107, 155). The swelling may, however, go so far as to make the bark over-arch the constriction and establish a new connection beyond it, thus burying band or wire completely.

### 7. THE GROWTH OF STEMS AND OTHER PLANT PARTS

It happens that stems exhibit the principal phenomena of plant growth more clearly than any other parts. Accordingly we may best consider that important subject at this place.

The growth of the higher plants differs from that of the higher animals in this, that while animals develop a single set of organs which serve throughout life, plants exhibit a constant and indefinite repetition of a few primary organs, — leaves, stems, roots, flowers, fruits, and seeds. But the general mode of growth of an individual leaf, stem, root, or other part is much the same as that of an animal organ.

The growth of each individual organ or part, whether of animal or plant, exhibits three stages, which often overlap, but commonly are more or less separate. They are, *first*, DEVELOPMENT, or formation in the embryonic state: *second*, ENLARGEMENT, or increase in size, and *third*, MATURATION, or ripening to full functional efficiency. The difference between the stages comes out very clearly in case of the spring vegetation. *First*, as everybody knows, the flowers and leaves which unfold in early spring were all formed or *developed* the preceding season, and existed over winter folded compactly away in buds, in which they can easily be found. The microscope shows that most of the cells of those parts are perfectly formed, though small and filled with food. *Second*, in the early spring the buds, absorbing

water from the stem, swell and open, and the leaves and flowers push forth and rapidly enlarge to their full size, as the familiar Horse Chestnut so strikingly illustrates. The microscope shows that this expansion is chiefly effected by a great increase in the size of the previously-formed cells, of which the large cavities are now empty of food, but tensely filled with water. That this enlargement is really brought about by absorption of water is very well proven by the fact that many such greatly-enlarged parts if thoroughly dried in an oven are found to be no heavier than in the original buds. This is especially clear in embryos, which, often germinating to a size a dozen or more times that which they had in the seed, actually lose dry weight in the process. The functional reason for this rapid spread of a little dry substance upon a great deal of water is plain; the plant mode of life requires a spread of green surface as early as possible. *Third*, the enlargement nearing completion, the parts mature, acquiring the final details of their coloration, thickening, and other features connected with the more effective performance of their functions. In this state they continue until their function is completed, after which they die and vanish through decay.

The *development*, or formation (as distinct from enlargement), of new parts takes place in meristematic cells (Figs. 92, 162), which divide more rapidly in some places and directions than in others. These divisions are apparently effected by the cytoplasm of the cells, which is controlled in the process by the chromosomes of the nuclei, as will appear more fully in connection with reproduction.

We turn now to *enlargement*, the most striking and familiar phase of growth. So rapidly does it proceed in the stems of some plants out of doors in spring that its progress is visible from day to day. It is said that the growth of Bamboo in the tropics is so rapid as to be directly perceptible at times to the unaided eye, reaching often to more than two feet within twenty-four hours. Ordinarily, however, growth proceeds

so slowly as to need the microscope (specially arranged horizontally for the purpose), or else some other magnifying

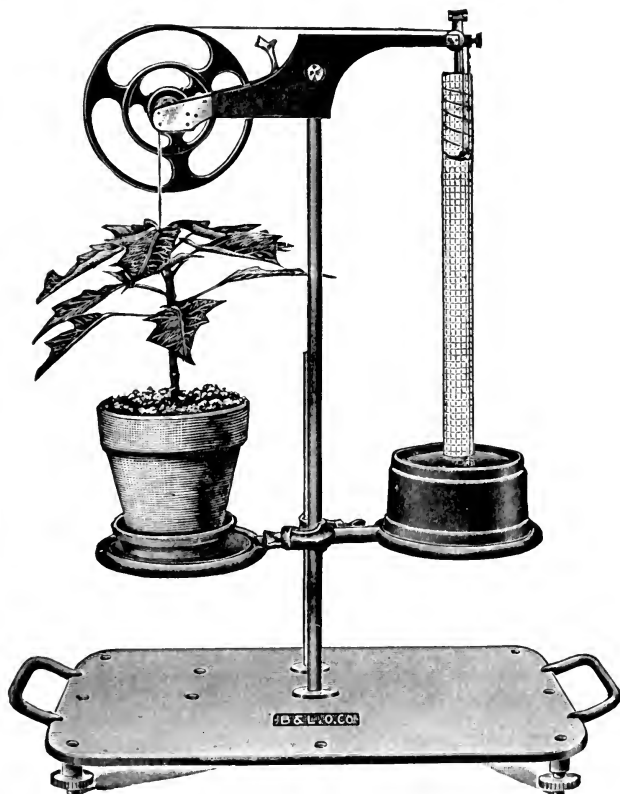

FIG. 108. — An auxograph in operation;  $\times \frac{1}{3}$ .

The thread from the tip of the plant passes over the smaller of two united wheels, and is kept just taut by the weight of the pen, which hangs on the end of the thread passing over the larger wheel. The pen rests against the cylinder, which is turned once an hour by a clockwork in the closed case. The growth spiral marked by the pen is exaggerated in the cut.

device, to make it apparent. A very effective instrument for this purpose, called an AUXOGRAPH (meaning "growth writer"), is shown by our picture (Fig. 108). The arrange-

ment is such that the growth of the plant permits a magnifying wheel to turn, and thereby a pen to fall along a cylinder which revolves once an hour, and upon which, accordingly, the pen marks a spiral line crossing any vertical line once an hour. Thus is obtained, night and day without break, an autographic record of the plant's growth, an example of which, precisely traced, is given herewith (Fig. 109).

As shown by such an instrument, the growth of any individual part, such, for example, as the flower-stalk of some bulbous plant, exhibits always two striking features. *First*, as our record well shows, there are many marked fluctuations in the rate. *Second*, aside from the fluctuations, one can always see that the rate of growth, instead of being uniformly rapid from start to finish, exhibits a slow beginning, a rise up to a culmination where it is most rapid, and then a gradual fall away to cessation as the part approaches maturity. This mode of enlargement, which apparently results incidentally from the way the cells expand, is called the GRAND PERIOD. It is apparently characteristic of the growth of all individual parts, viz. of single internodes of stems, of leaves, flowers, fruits, and really (though not apparently) of roots. In structures composed of many unit parts, however, as in a stem with a number of internodes, the grand periods of the parts often overlap, and thus yield

---

FIG. 109. — The complete record, obtained by the auxograph of Fig. 108, of the growth of a flower stalk of Grape Hyacinth, from its appearance above ground until the completion of blossoming. It is reduced photographically, from the 8-times magnification on the record papers, to the scale of the actual growth. It is also inverted from the record papers and therefore stands in the true position of the growth. Each space on the vertical line marks one hour, and the heavy horizontal lines indicate noon of each day. The lines which run together in the greatly reduced cut are perfectly distinct in the original record.

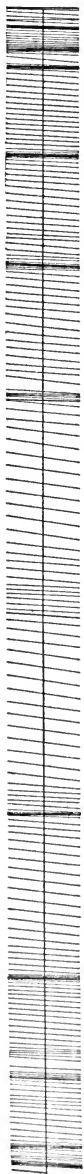

collectively a continuous record. The grand period is most familiarly manifest in the opening out of the spring vegetation, in which, after a slow expansion of the buds, the actual opening takes place very rapidly, and full size is soon reached. In general the spring vegetation opens out on the crests of the grand periods of the parts concerned.

As to the minor fluctuations of the growth records, they are found by experiment to have precisely the meaning which one naturally ascribes to them, viz. they are connected with the weather. If careful comparison be made between rate of growth and the contemporaneous meteorological conditions, the following general results become evident.

1. Higher *temperature* promotes growth, and lower checks it. This fact is of course sufficiently familiar, for everybody knows that plants grow faster in warm weather and slower when cool. The reason thereof is this, — growth involves a number of physical and chemical processes, all of which are directly promoted by heat. However, so far as plants are concerned, there are limits to its favorable action, because above ordinary temperatures heat begins to act injuriously upon the protoplasmic constituents, especially the susceptible proteins, which easily coagulate. Each plant has a *minimum* temperature below which it does not grow at all, an *optimum* temperature at which it grows fastest, and a *maximum* temperature beyond which it ceases to grow. The conventional constants for these cardinal points, for our common plants collectively, are 5° ~~6~~ 30° ~~4~~ 40° C. The matter is illustrated very graphically when plants are grown in a differential thermostat (Fig. 110), in which they can be made to plot their own curve, so to speak, of their growth in relation to temperature. By use of this instrument the three points may be determined for any given plant, and thus it is also shown that in general the points range higher in tropical plants, lower in the arctic kinds, and intermediate in those of temperate regions. Since the

4  
30  
4

cardinal points are ingrained in the protoplasm of particular species, it is clear why tropical plants do not thrive when taken abruptly to the arctics, and vice versa. The points, however, are alterable somewhat with time, as manifest in acclimatization.

2. *Humidity* in the atmosphere (distinct altogether from the water supply at the roots) promotes growth, while dryness checks it. Everybody knows that plants grow best, on the whole, during close, "muggy" days, the kind most uncomfortable to us; and such days are called "growing days" by some farmers. The reason thereof is chiefly this,

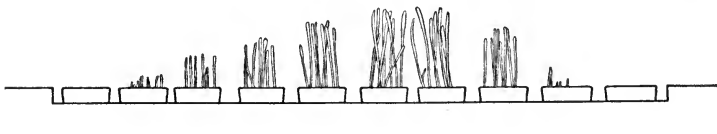

FIG. 110. — Effect of different temperatures upon Oats grown in a differential thermostat, an instrument evenly heated from the right side and cooled from the left;  $\times \frac{1}{12}$ . (Drawn from a photograph.)

that the enlargement of young parts is forced by the internal pressure of water (the *osmotic pressure* explained in the next chapter); this internal pressure is lessened by removal of much water through high transpiration caused by dry air, but is maintained with low transpiration accompanying humidity of the atmosphere. Other things being equal, the growth of vegetation is more rapid in regions of moist climate, and slower in dry ones, as forests and deserts respectively illustrate. The matter, however, is complicated by the matter of water supply to the roots, and other considerations.

3. *Light* affects plants complexly. Indirectly, of course, it is essential to green plants through its relation to food supply. Directly, however, it has no great effect unless very strong, when it tends to check the growth of most plants, which can thrive best under some shade, as we have earlier noted (page 95). The records of auxographs show very

clearly that most plants, when temperature is the same, grow faster at night than in daytime; and this fact is familiar to gardeners. This greater growth at night, however, is chiefly a result of the fall in transpiration which accompanies darkness, but secondarily there seems also involved some release from a direct check imposed upon growth by very bright light. In such a case the light is supposed to act through the unfavorable chemical influence of the blue rays upon the living protoplasm,—an action which, in forms like the Bacteria, where the protoplasm is unshielded by chlorophyll or other coloring matters, makes strong light actually germicidal. But if plants are continuously exposed to too little light, they tend to “draw,” as the gardeners say; that is, they become pale, in obvious partial starvation, and elongate greatly at expense of other growth (Fig. 111). This elongation has been commonly supposed to represent an adaptive

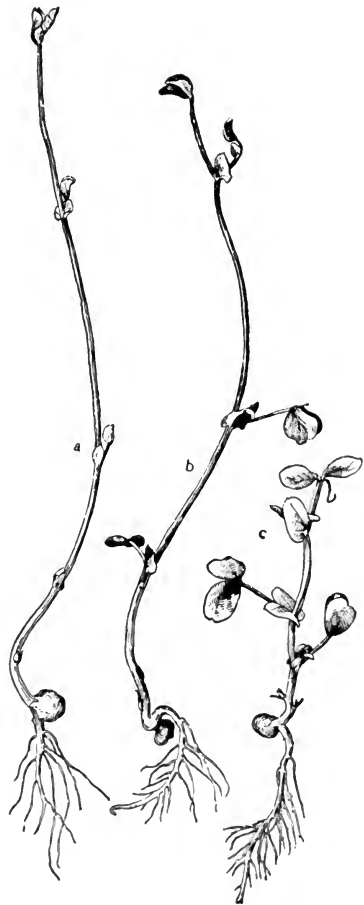

FIG. 111.— Effect of different intensities of light upon the growth of Peas;  $\times \frac{1}{2}$ . *a*, in darkness; *b*, in  $\frac{1}{2}$  light; *c*, in full light. While for a time the growth in darkness is much the greater, the extra bulk is chiefly water, there is loss of dry weight, and the plant ultimately dies of starvation. (From Duggar.)

self-adjustment, tending to raise the green tissues into better light conditions, when the plants happen to start in dark places.

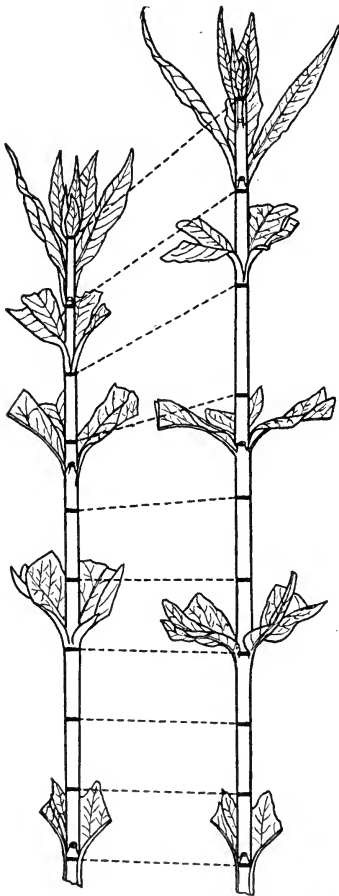

FIG. 112.—The place of elongation in growth of a typical stem of *Lysimachia vulgaris*, as shown by the spread of marks at first evenly spaced;  $\times \frac{1}{2}$ . (Modified from Errera and Laurent.)

4. Many minor conditions likewise affect growth, notably special gases in the atmosphere, peculiar conditions of soil and water, electrical currents, or barometrical pressure. Some of these conditions accelerate growth, while others retard it, though mostly in minor degree, and often in deviously indirect ways.

All growth requires, in addition to warmth and humidity, a supply of water, food, and air. The water, absorbed by the roots, is needed for the swelling of the young parts. The food, whether made in the green leaves or absorbed from some other source, is needed partly as building material for the enlargement of cell walls, and partly as a store of energy for effecting the plant work. The air, more properly the oxygen, is needed to release the energy in the food through the action of respiration, a fundamentally indispensable

process, considered in the following section. As by-



products of respiration, both carbon dioxide and heat are released in growth.

All of the phenomena here described in connection with stems appear also in leaves, roots, and other parts, as shown by use of a suitably modified auxograph, or by the measuring microscope. All parts are found to exhibit the grand period, and the fluctuations in relation to the weather; and the only appreciable differences in their modes of growth are associated with their differences in construction. Stems grow by the progressive elongation of their internodes, which, forming in the bud, go through their grand periods in succession; and thus is produced the familiar appearance which has been compared with the opening out of the joints of a telescope (Fig. 112). The leaves, quite differently, expand pretty evenly throughout their structure (Fig. 113), going each through its grand period, as do flowers and fruits. The roots, on the other hand, grow almost solely near their tips (Fig. 114), their individual cells passing very quickly through the grand period, on which account roots seem as a whole to grow evenly. This

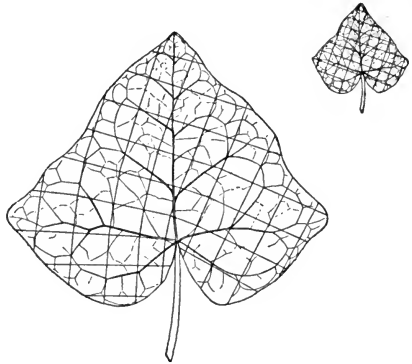

FIG. 113. — The place of expansion in growth of a typical leaf of English Ivy, as shown by the spread of the marks evenly made on the small leaf at the right;  $\times \frac{1}{2}$ .

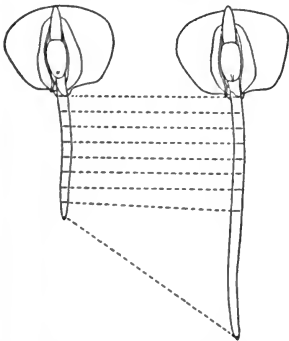

FIG. 114. — The place of elongation in growth of a typical root of Corn, as shown by the spread of evenly spaced marks;  $\times \frac{1}{2}$ .

mode of growth for roots is fully explained by facts in their physiology and structure, as will later be noted.

## 8. THE RESPIRATION OF PLANTS

This process has received frequent mention in the foregoing pages, and in ways which imply much importance. Since its phenomena are more clearly manifest in connection with growth than elsewhere, it may best be considered at this place. Respiration and photosynthesis are without question the two most important of all physiological processes.

A demonstration of typical plant respiration is the following. In the chamber of a *respiroscope* (a "respiration demonstrator"), like that pictured in Figure 115, there is placed a handful of germinating seeds, and the instrument is stood in a warm, darkened place for twenty-four hours; then water is poured down the thistle tube, and the air of the chamber thus forced out goes bubbling up through limewater placed in the cylinder. The limewater speedily turns milky, thus proving by this familiar test that carbon dioxide was present abundantly in the chamber. If the student should ask the natural question whether the carbon dioxide known to be present in air would not account for this result, the answer is given by the other or "control" chamber, the air of which, sent through similar limewater, leaves it quite clear. In fact the quantity of carbon dioxide present in so small a volume of air is insufficient to show any effect by this method. It is therefore evident that carbon dioxide has been produced by the germinating seeds. If, further, a sample of the gas is withdrawn from the chamber containing the seeds and chemically analyzed, as can be done very easily, these additional facts appear. *First*, some of the oxygen originally present in the air has disappeared, and various evidence shows it has been absorbed by the seeds. In starchy seeds, like Oats, the oxygen absorbed and the carbon dioxide produced are approximately equal in volume, though often this RESPIRATORY RATIO is different.

*Second*, not only carbon dioxide but also water is released by the germinating seeds. Thus in the growth of seeds,

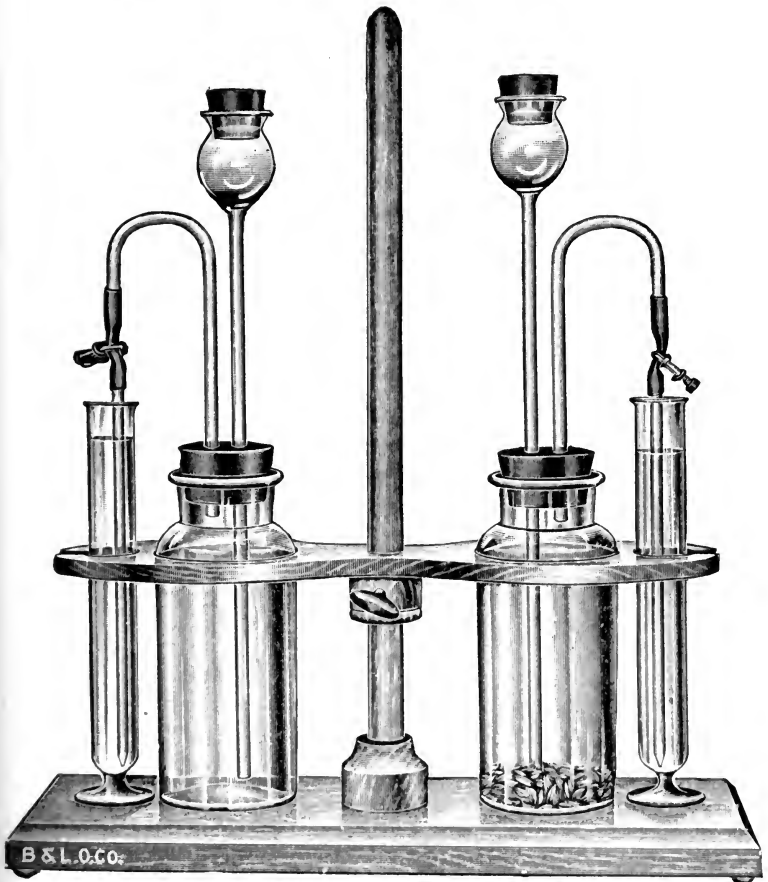

FIG. 115. — A respiroscope;  $\times \frac{1}{3}$ . While the seeds are germinating, the chamber is kept closed by the smaller rubber stopper and clamp, though these are removed in applying the test.

oxygen is absorbed and carbon dioxide and water are released. This, however, is precisely what occurs in the respiration of animals, including mankind. The process in

the seeds is in fact respiration, identical in all essentials with that familiar in animals.

If, now, other plant parts be placed in the respiroscope chamber, — growing bulbs, roots, buds, flowers, fruits, leaves, stems, — in fact any growing plant parts, and if the same tests and analyses as before be applied, then the general result is always the same. It is true, there are cases in which oxygen seems to be absorbed without release of carbon dioxide, and cases in which carbon dioxide seems to be released without absorption of oxygen, with all intermediate gradations. These exceptions, however, from the point of view of respiration, are not real, for in the former case the carbon dioxide is known to be retained and used in formation of special substances, and in the latter the oxygen is taken, not from the air, but from compounds composing the plant tissues themselves. And here is one further point of the first importance, fully proved by respirosopes. Respiration occurs in general not only in tissues which are growing, but in all tissues which are alive. In brief, respiration is found to occur in all living and working parts of plants and animals alike. Its amount depends, as a rule, upon the activity of the parts, being directly proportional thereto.

But what of green leaves, which were earlier shown to perform an opposite process in their photosynthesis, absorbing carbon dioxide and releasing oxygen? If, with green leaves in the chamber, the respiroscope be kept in the light, then indeed no carbon dioxide shows in the test; but if the instrument be kept in the dark, then that gas is yielded abundantly. This does not mean that respiration stops in the light, but only that then it is surpassed by photosynthesis, which for the same area of leaf is, on the average, about twelve times more active than respiration. This fact explains why photosynthesis, even though in progress only a part of the time, can purify the air, despite the unceasing respiration of both plants and animals.

Respiration is little affected by darkness or light. Ac-

cordingly, since photosynthesis is completely dependent on light, there must exist a certain light intensity, at which the photosynthesis and respiration of a leaf exactly balance one another. This must happen twice a day, morning and evening, and perhaps during very dark days. In such case it is probable that the two processes use reciprocally one another's products, and neither of the gases passes into or out of the leaf. It is because photosynthesis stops, while respiration continues, in the dark, that plants are unhealthful in sleeping rooms at night, though in truth the effect is quantitatively small, else one could not camp overnight in the woods.

In respiration the oxygen comes from the air; but the carbon of the carbon dioxide, and the hydrogen of the water come from the food, in which they were incorporated, in the original grape sugar, by photosynthesis. Since respiration thus withdraws solid material from the body, it is always accompanied by loss of weight, and, unless compensated by addition of food, it ends in emaciation and starvation.

Viewing the process now in the large, and centering attention upon the end substances involved, we find that respiration may be expressed in an equation as follows, —

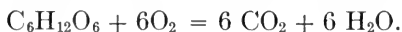

This equation, which may be termed the *respiratory equation*, is the exact reciprocal of the photosynthetic equation (of page 23).

The exchange of gases here described is not, however, the important feature of respiration, but merely an incidental accompaniment thereof. The central fact, and explanation of the great physiological importance of the process is this, — that it releases the energy latent in potential form in the food, — which energy, set free at precisely the points of need, supplies the power which does the work of the plant in its growth and other processes. Respiration is in fact identical in nature with combustion, which, in a steam engine, pro-

duces a union of oxygen with the carbon in coal, whereby, with formation of carbon dioxide, energy is released in the form of heat; and this heat expands the steam which drives the engine and does the work. Both respiration and combustion are essentially energy-releasing processes, acting alike through oxidation of carbon; for it is one of the most fundamental of cosmic facts, that whenever and wherever carbon is allowed to unite chemically with oxygen, energy is set free, and can do work, whether in the cells of a plant, the muscles of a man, or the boiler of an engine. Respiration is in principle nothing but a slow regulated combustion within the bodies of plants and animals under protoplasmic machinery capable of turning its energy into work.

What now is the original source of the energy thus contained in the food? Energy exists in nature in two forms, *kinetic* or active, like heat, light, and electricity, and *potential* or latent, as in wound springs, raised weights, explosives, and unoxidized chemical substances in general. In fact, potential energy exists in all unsatisfied affinities, physical or chemical. When kinetic energy is used to wind springs, lift weights against gravitation, or separate substances from close chemical unions, it goes thereby into the potential form, and thus remains until the spring unwinds, the weight falls, or the chemical unions again take place, during which processes the potential energy again becomes kinetic, and can be used to do work, as clocks, water power mills, and artillery illustrate. The kinetic energy of the sunlight in photosynthesis originally dissociated the carbon dioxide and water into their constituents, thereby passing into potential form. The oxygen was released into the air, but the carbon and hydrogen remained in the food, and thus were transferred throughout the bodies of plants and animals, carrying the store of potential energy, which, on chemical access of oxygen in respiration, again becomes kinetic and does work. The process has an accurate parallel in the case of the storage battery, now familiar in the modern automobile. A charge

of electricity, kinetic energy, is sent into the battery, and there forcibly dissociates certain stable chemical compounds into simpler substances; whilst these substances remain apart the energy is latent, ready to come forth once more in kinetic form (again an electrical current), when, by the closing of a circuit, the substances are allowed to re-combine into the old compounds. Food is nothing other than a storage battery, charged in green leaves by the sun, and discharged in the body by respiration.

Thus it is plain why oxygen is necessary in respiration, and therefore why both plants and animals have need of "air." The parts of plants above ground have an ample supply admitted through stomata and lenticels along the air passages; but the case is different with roots, for often the air is expelled from the soil by the presence of water. This is why wet soils must be drained, — not to remove water, but to introduce air. Where roots live continually in water, as in bogs and swamps, the air supply is usually obtained through large passages extending down through the stems from the leaves; and it is the presence of these ample air passages which gives the soft spongy texture to so many marsh plants.

That respiration is indispensable to all plant processes involving growth and movement can be proven very strikingly by methods which deprive the parts of oxygen, while leaving them otherwise uninjured and ready for work. This is accomplished by use of an instrument called the *anoxyscope* ("without-oxygen demonstrator") shown in our picture (Fig. 116).

The energy released in respiration is mostly applied to various kinds of work involving motion, — the circulation of protoplasm, the enlargement of cell walls, and the like; and on the completion and cessation of motion it is converted into radiant heat. Thus all growing, and even all living, parts are somewhat warmer than their surroundings. A thermometer thrust into the opening flower of a *Calla*

or a Jack-in-the-Pulpit will rise two or three degrees, and in some tropical plants of the same family, two or three times as much; while in any living parts the release of some heat

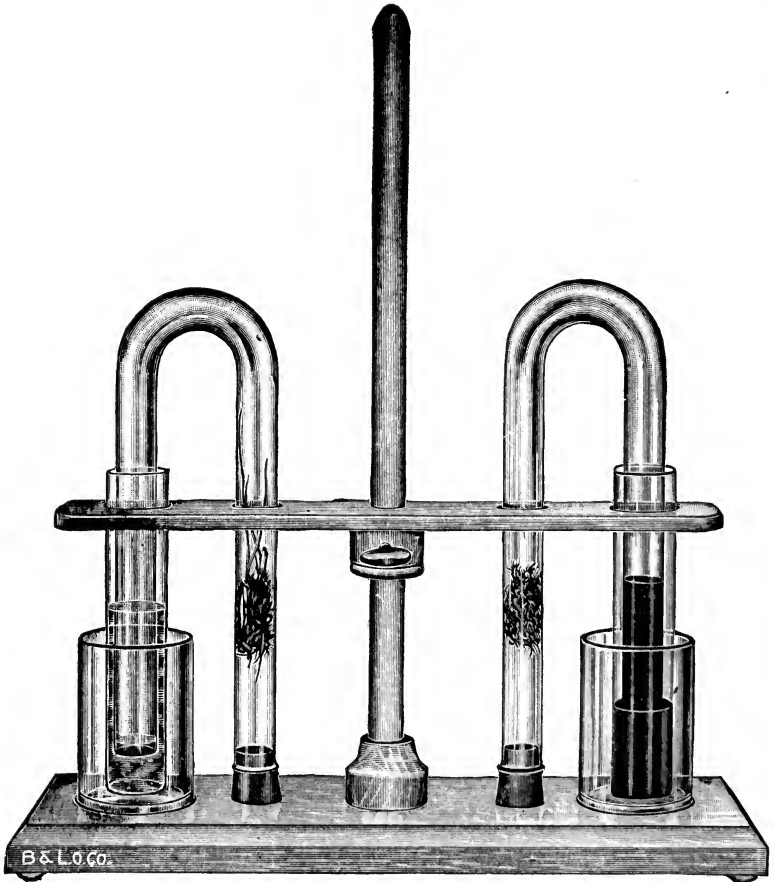

FIG. 116. — An Anoxyscope;  $\times \frac{1}{4}$ . The two tube-chambers are exactly alike except that from the one on the right all oxygen is removed by a chemical absorbent (pyrogallate of potash), which is replaced by pure water in the one on the left. In the case here shown, the soaked oats placed on wet moss in both chambers have grown well in one case but not in the other. The instrument permits many analogous experiments.



may be proven by suitable methods, as explained with our picture (Fig. 117). It is this same respiration heat, intensified and regulated, which yields the "blood heat" of animals.

It will now be worth while to summarize the contrast between photosynthesis and respiration, as is possible in a table.

<i>Photosynthesis</i>	<i>Respiration</i>
Occurs only in green plants	Occurs equally in all plants and animals
Takes place only in the chlorophyll grains	Takes place in all living protoplasm
Proceeds only in light	Proceeds in both light and darkness
Constructs food	Destroys food
Increases weight	Lessens weight
Absorbs carbon dioxide	Releases carbon dioxide
Releases oxygen	Absorbs oxygen
Forms grape sugar from carbon dioxide and water	Reduces grape sugar to carbon dioxide and water
Stores energy	Releases energy

Thus respiration destroys the product of photosynthesis, but in the process develops the driving power for plant and animal life.

There is a form or phase of respiration so important as to demand special treatment, and that is FERMENTATION. If some Yeast (which is a unicellular microscopic plant, to be fully described in Part II of this book), in the form of ordinary compressed Yeast, be placed in a flask with water and sugar, and stood in a warm place, within a few minutes the mixture begins to "work" or ferment, producing many fine bubbles which rise through the liquid and form a froth at the top. If, from this flask a bent outlet tube be led under limewater (Fig. 118), through which the escaping gas can rise, then the limewater will turn very milky, proving the gas to be carbon dioxide. After fermentation has ceased, the

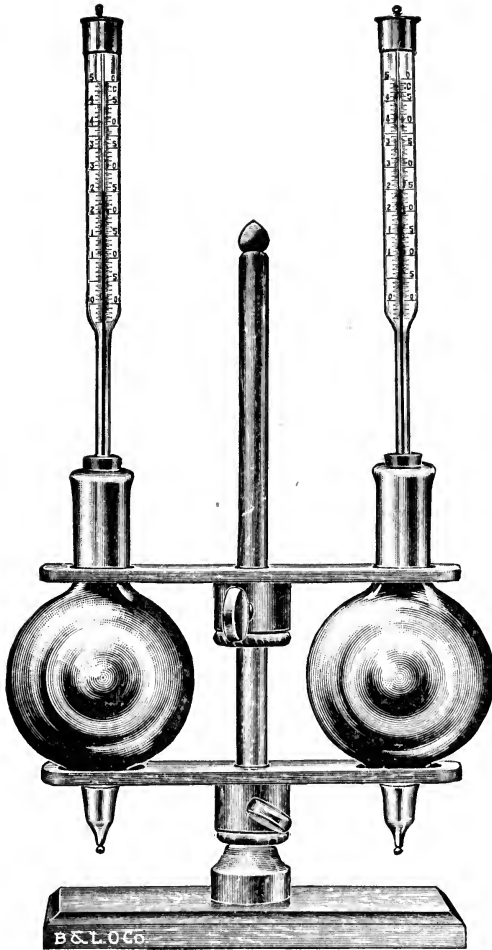

FIG. 117. — A Caloriscopes;  $\times \frac{1}{5}$ . The two Dewar bulbs have double walls with a vacuum between (as familiar in "Thermos" bottles), and hence prevent loss of heat. The respiring tissue to be tested is divided into two parts, and placed in the two flasks, but is immediately killed in one. Thus the delicate thermometers are made to record within a few hours the degree of heat released by the respiration of the living tissues.

liquid in the flask is found to contain a considerable quantity of alcohol, together with small amounts of other substances known to be formed by the activity of the Yeast, which all this time is in vigorous growth and multiplication. If certain mineral salts, essential to the metabolism of the Yeast, are present, the process continues until the sugar is exhausted, or else until the increasing quantities of alcohol inhibit the further growth of the Yeast. Thus, under experimental conditions, the Yeast plant in its growth ferments sugar to carbon dioxide

and alcohol, though it is ultimately overcome by the alcohol it produces. As to the significance of fermentation, all evidence unites to indicate that it represents primarily the Yeast's form of respiration, exaggerated usually by unnatural experimental conditions. Shut away from the air, the Yeast is unable to take oxygen from that source, and has to resort to the supply contained in the grape sugar, into which this plant has the power to convert cane sugar or starch. By action of an enzyme, the sugar is broken up, whereupon its carbon unites with oxygen from the same molecules into carbon dioxide, with the usual release of energy at the moment of union. The remainder of the molecule falls as a natural chemical incident into alcohol, according to the following equation, —



Thus in the formation of the carbon dioxide, a process essential to the Yeast, the alcohol is incidentally and, so to speak, inevitably formed.

That fermentation is fundamentally the Yeast's respiration is attested by many lines of evidence, including the existence of intermediate steps between fermentation and ordinary respiration. Thus Peas, which ordinarily respire in the usual way, can also form carbon dioxide, with incidental production of alcohol, when deprived of all free oxygen; and this power is probably rather widespread, though in limited degree, among plant tissues which have imperfect access to air.

The production of carbon dioxide and alcohol by fermentation renders the process of great importance to man. Thus

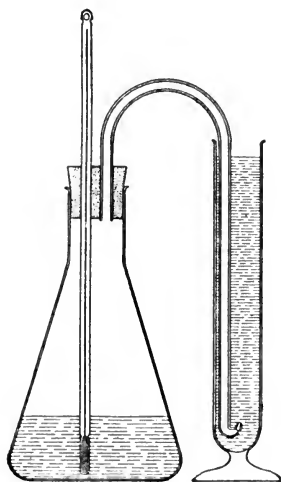

FIG. 118. — Arrangement for demonstration of the release of carbon dioxide in fermentation;  $\times \frac{1}{3}$ . Explanation in text.

we use the carbon dioxide released by Yeast for raising bread, not, it is true, because it is carbon dioxide, but because it is a gas which can be released conveniently all through the dough, from which, along with the alcohol, it is driven out by heat in the baking. Far more extensive is our use of fermentation for production of alcohol. Thus the fermentation of grape juice yields wine, and of germinating barley, beer; and any germinating grains can be fermented in like manner. Fermentation, however, can never yield alcohol stronger than that which inhibits the growth of the Yeast, viz. not over 15 per cent; and for stronger solutions we must resort to *distillation*. This process depends on the fact that the boiling point of alcohol is lower than that of water (78° against 100° C.), on which account it is possible, by suitable regulation of the heat, to cause most of the alcohol to evaporate without much water, the vapor being collected and condensed. In this way are obtained the stronger alcoholic liquors, — whisky, rum, gin, brandy, etc., which consist of approximately 50 per cent alcohol, and 50 per cent water, together with various flavoring and other substances, sometimes naturally occurring in the distillate and sometimes artificially added. The strong alcohol used in medicine and the arts (about 95 per cent) is obtained by repeated distillation, while pure, or absolute, alcohol is secured only by use of chemical methods which remove the last traces of water.

Fermentation is a phase or form of respiration, and a special form of fermentation is DECAY. Everybody now knows that decay is caused principally by the activity of microorganisms, Molds and Bacteria especially. Accordingly we can preserve organic substances indefinitely by any methods which inhibit the action of those organisms, as do heat, poisons, and strong solutions of sugar and salt. When these Molds or Bacteria reach suitable solutions of organic substance, whether in plant tissues or animal bodies, they act precisely as does the Yeast in the solutions of sugar, — viz. deprived of an adequate air supply (some kinds indeed never

use the air, and even are fatally affected by its presence), they break up the molecules of organic substance, and therefrom obtain materials for their respiration and growth, simultaneously forming various by-products. Usually they release carbon dioxide in their respiration or fermentation, but sometimes they form other gases which happen to possess the offensive odors familiarly associated with decay. Some kinds of organisms start the decay, which other kinds continue; and thus in successive steps the most complicated organic substances are reduced gradually back to the carbon dioxide, water, nitrogen, and mineral matters from which they were originally constructed. There is always at each stage some kind of organism ready to utilize any potential energy remaining in the organic substance, until finally all is exhausted. This is the ultimate fate of all organic substance, which, formed photosynthetically in leaves from carbon dioxide and water and mineral salts, is converted back to those substances, either by the respiration of the higher plants and animals themselves, or else by the respiration of the micro-organisms of decay. Thus the carbon dioxide, water, nitrogen, and mineral matters withdrawn from the general circulation of nature and locked up for a time in the substance of plants and animals are all returned in time to their source. But on this withdrawal and return hinge the visible phenomena of life.

The formation of incidental by-products by Molds and Bacteria in their respiration and growth has important practical consequences to other organisms. Thus parasitic Fungi produce such by-products, whereby their host plants are poisoned and damaged, often to complete destruction. The Bacteria associated with disease often produce violently poisonous products, collectively called toxins; and it is these substances, and not any direct injury done by the Bacteria themselves, which cause death from bacterial diseases in man, other animals, and some plants. This fact underlies the methods of combating those diseases by use of antitoxins and the like.

## 9. THE GEOTROPISM OF STEMS

When seeds are germinating, it is always found that no matter in what positions they happen to lie, the sprouting roots grow over to point downwards, while the new stems as regularly grow upwards (Fig. 119). If, while these parts are still young, the germinating embryos are overturned, the roots and stems grow around into their former directions.

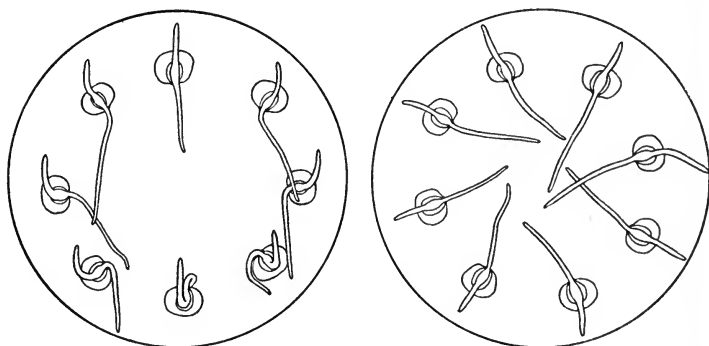

FIG. 119. — Grains of Corn, fastened to vertical corks, with the root ends all pointing centerwards, and there germinated;  $\times \frac{1}{2}$ . The cork on the left was kept fixed in this position, but that on the right was kept revolving, clockwise, on the clinostat (of Fig. 121). Since the roots grow much faster than the shoots, the latter were added to the drawings after the former. Note that on the fixed cork the roots point downward and the shoots upward, while on the revolving cork both roots and shoots continue the general directions in which they happen to start. (Drawn from photographs.)

Later, the side stems and roots as they develop assume positions which are horizontal, or nearly so; and they likewise, if overturned, grow again into those directions. If a young plant in a flower pot be laid on its side, its tip will be found next day to have grown around into the upright position; and if the pot be completely inverted, then a day later the tip will again be found upright, now in exact reverse of its original position in relation to the pot (Fig. 120). These adjustments occur in darkness as well as in light, which shows that they are not phototropic (page 54), though like

phototropism, they are growth movements, as experiment proves. If the plant be kept revolving upon a clinostat, however (Fig. 121), then no such responses can occur, and the parts continue to grow in the directions they happen to have at the start.

Everybody knows how stiffly upright are the Fir trees, and how remarkably horizontal their branches (Fig. 122); and this is as true on the steepest hillsides as on level ground, showing that the upright position is not in any way determined by the slope of the surface from which the trees grow. The facts here cited are typical, and represent a very widespread attribute of the higher plants,—that they grow in such manner as to swing their main roots straight down,

their main stems straight up, and their side roots and stems at definite angles to the up-and-down direction.

The up-and-down, and the horizontal, directions on the earth's surface are determined by a single factor, viz. gravitation, to which, accordingly, plants show remarkable adjustments in their growth,—a property called GEOTROPISM.

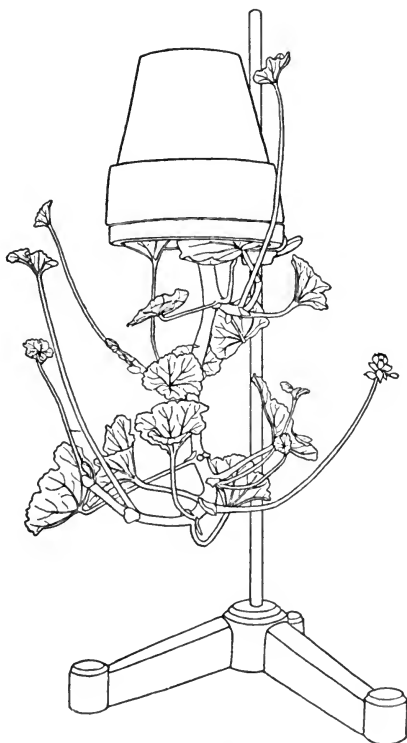

FIG. 120. — A *Pelargonium*, inverted and kept in the dark;  $\times \frac{1}{3}$ . Note that the individual leaf blades have taken positions approximating towards horizontal. (Drawn from a photograph.)

It is clear that plants in growing geotropically are not forced into those positions by the gravitational attraction, for even if the young roots were pulled downward by gravitation, this force could obviously not push the young stem upward, or the side roots and branches out horizontally. In fact, geotropism bears the same relation to gravitation that

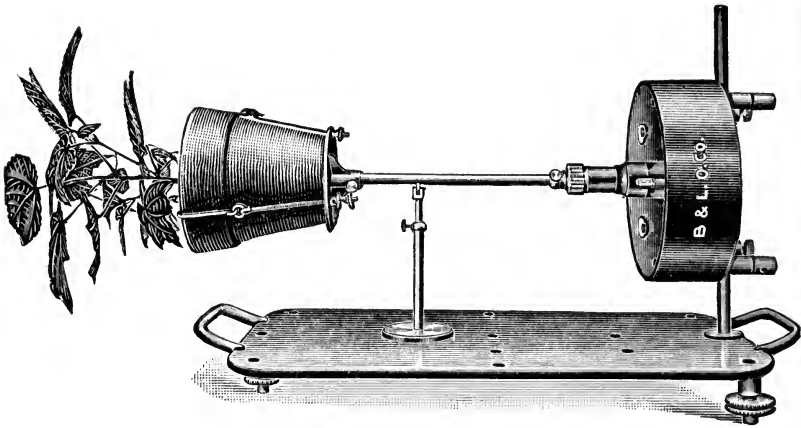

FIG. 121. — A Clinostat;  $\times \frac{1}{2}$ . A powerful clockwork in the case on the right turns the central spindle continuously once in fifteen minutes. It can be used in any position. Thus plant parts can be kept revolving in any desired plane, whereby the action of a stimulus can be made equally all-sided instead of one-sided, — the most convenient method of neutralizing a one-sided stimulation. The instrument is much used in the study of irritability.

phototropism does to light (page 54); just as the light neither pulls the stems towards it, nor pushes the roots away from it, nor forces the leaves across it, but acts simply as a guiding stimulus to the plant's own assumption of those positions, so gravitation neither pulls nor pushes the roots and stems into the positions they take, but acts simply as a guiding stimulus to the plant's own growth. This action of gravitation as a stimulus, and not directly as a force, explains why parts grow as readily and perfectly away from it or across it as towards it.



Seeking a connection between geotropism and the plant's physiology, we can find no direct relation, such as shows so clearly with phototropism in the relation between light and photosynthesis. It is true, under the influence of geotropism the roots are guided down into the soil, and the shoots up into the air, and therefore to the positions essential to their functions; but, as one immediately recalls, those parts would take those positions without any geotropism, — for the shoot would be guided upward by phototropism and the roots downward by hydrotropism (an adjustment to moisture later considered). Geotropism, therefore, produces exactly the same results in shoots and roots as would phototropism and hydrotropism. But there is this difference, that the light and moisture are variable, and often (especially the light) absent altogether at times when the plant is in growth and needing guidance, while gravitation is perfectly constant at all times. It seems wholly probable, therefore, that this invariability of action through all external conditions is a reason why plants employ gravitation as well as light and moisture in guiding the growth of their shoots and roots. Precisely the same principle is illustrated in our human affairs where we regulate our daily actions, our risings, our meal times, and our occupations, by the clock, instead of trusting to the height of the sun, often obscured, or our appetites, often spasmodic. In similar manner the sailor steers by his compass, even when sun or stars are visible.

It must not, however, be inferred that growing towards gravitation or away from it are inseparable from the nature of a main root and main stem respectively. Thus, some main stems have the transverse or horizontal geotropism, as in ground vines. It is for this reason that Ground Pine, our creeping Ferns, and Solomon's Seal, keep their main stems down upon or just under the surface of the ground, instead of sending them upwards. Moreover, the geotropism of parts can change during life, as familiar in cases where a

side branch of Spruce or Fir turns upward, and takes the place of the main stem, on destruction of the main terminal bud. All evidence shows that the geotropism of any part is not in the least inherent in its morphological nature, but is correlated with its habit of life.

Stems and roots are by no means the only geotropic parts. Thus, in the experiment of the inverted potted plant, performed in the dark, not only does the stem grow upward, but most of the leaf blades become horizontal, through independent readjustment upon their own petioles (Fig. 120). Something similar occurs naturally in the undergrowth of woods, where, in the evenly-diffused light, many kinds of leaf blades become strikingly horizontal. Flowers and fruits are often perfectly geotropic, as will later appear in connection with their functions. The lower forms of plants are likewise susceptible to geotropism; and the horizontal growth of the bracket Fungi upon trees, and the upright position of the Mushrooms and Toadstools are thus guided.

While geotropism thus guides the growth of plants in their various parts, its effects of course are intermingled with other irritable responses. Thus, when light acts from one side on a geotropically upright plant, the position which the plant actually takes is a resultant between its tendency to respond both ways; and its roots and other parts are influenced in similar manner. The fact is, the plant tends to guide its growth as a whole, and assume its general form, under the guidance of gravitation, thus establishing a general arrangement of parts, but this ground form is readily modifiable in details by other influences.

It is interesting to note the way in which the plant appears to perceive, so to speak, the direction of action of gravitation. There is much evidence to show that in special cells of root and stem tips, the starch grains, which are relatively hard and heavy, press down by their weight on the sensitive protoplasm, and thus give the sense of direction by which the growth processes are controlled.

## 10. THE VARIOUS FORMS OF FOLIAGE-BEARING STEMS

Stems which perform the same primary function, of support to the foliage, can yet differ greatly in aspect and structure. These differences are connected with different habits.

The simplest form of foliage-bearing stem is found where a vertical, cylindrical, unbranched trunk bears one set of leaves towards its summit, as do most Palms (Fig. 30). Such stems, which may be termed COLUMNAR, characterize crowded vegetation, as in the jungles of the tropics and the meadows of temperate regions. They often attain great heights in proportion to their diameters, in which case they exhibit very perfectly the hollow-column principle of construction (page 118). Thus the Bamboo, practically columnar though it bears small branches, presents an actual hollow column of such great strength as to give it high value for building and other uses in the tropics.

The second form of stem is found where the leaves are spread along slender horizontal branches radiating from a columnar-conical trunk. In such cases the younger and shorter branches are above and the older and longer below, thus producing the very perfect cone-shape displayed in our Fir trees when free to grow without interference (Fig. 122). This form of stem, called botanically EXCURRENT, is associated particularly with the evergreen habit, in which the leaves persist and do some photosynthetic work in the winter. Evergreen trees are especially characteristic of high latitudes and altitudes; and it has been argued that the conical form, with the upper branches progressively covering the lower except near the tips, which readily yield to a weight, renders such trees largely immune against damage by the snow and ice of the climates in which those trees most abound. When such trees are well spaced apart, the cone form is often strikingly perfect from ground to summit; but when crowded together in forests, their lower branches are

overshaded, die, and fall away, after which the old bases become buried as knots by the ever-increasing layers of the wood. Thus in time the cone of foliage comes to stand at



FIG. 122. — *Abies venusta*, a Fir, showing the typical conical form.  
(From Bailey.)

the summit of a branchless columnar trunk which yields our most valuable timber. Such stems do not show the hollow-column principle of construction, except incidentally when the heart wood is removed by decay, for the mode of growth is such as to build a stout solid column.

The third and most highly developed form of stem is found where a swelling dome of foliage is held outspread by a system of stems radiating, tapering, and branching from a relatively short central trunk, as well developed in our common deciduous forest trees, — Oak, Maple, Elm, and others (Fig. 123). Since the trunk thus melts away, as it were, to the twigs, the form is called *DELIQUESCENT*. It permits a great lateral spread as well as high elevation of the foliage, and is the most effective of the forms in the exposure of great numbers of leaves to light; and correspondingly it is the dominant forest type the world over in both temperate and tropical regions. The damage which would be entailed in winter on such widespreading forms by accumulation of snow and ice on the leaves is obviated by the shedding thereof in the autumn. Here, also, a remarkable symmetry of form is developed where space is sufficient, as Maples in old pastures, Elms in meadows, or lawn trees attest (Fig. 124). In such cases the foliage has almost the form of a sphere, or an ellipsoid, or a rounded cone. A crowding in forests, however, produces the same effect as in the excurrent type, excepting that the branches here tend to reach up to a low dome or even flat top, as can be seen very clearly when a deciduous forest is viewed from some mountain. The effect is particularly striking where the dark spires of evergreens break through the rolling plain of the deciduous foliage.



FIG. 123. — Sugar Maple, in a pasture, showing the deliquescent form. (From Bailey.)

Vertical stems are radially symmetrical, or alike all around, both externally and internally. When horizontal or oblique, however, as with branches, they are often excentric, having a greater thickness of wood on the lower side, in obvious adjustment to the support of the branch against the leverage imposed by its increasing length and weight. In such cases,

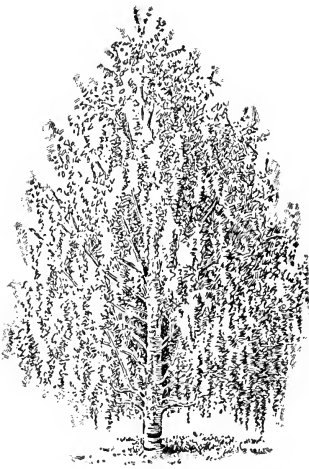

FIG. 124. — The symmetry of a lawn tree, the weeping Birch. (From Bailey.)

also, there is frequently a thickening in the lower angle between branch and stem, on the principle of a bracket, which is present in even greater development at a place of much greater strain, viz. at the angle where a vertical trunk joins spreading roots. Here the bracket often amounts to a buttress, as well shown in old Elms, and even more strikingly in some trees which grow in the tropics. The principle of resistance to strain explains also the form of the main branches in the deliquescent type, for com-

monly they rise almost vertically from the trunk, and turn gradually outward, becoming vertical again at the foliage-bearing tip.

Stems have not only to support the great mass of the foliage and also their own considerable weight, but must likewise resist lateral pressure from winds, which exert great power against the foliage and therefore strong leverage on the stems. Corresponding thereto is the tough-elastic texture of the stems, whereby they are enabled to yield to winds in a manner to shed off their force, as one can see in any great trees in a storm. Where strong winds prevail in one direction during the season of growth, a tree may be held

so much of the time in the leeward position that it acquires a permanent set that way (Fig. 125), though the result is complicated by the greater transpiration, and consequent less growth, on the windward side. The leverage of the winds is felt most at the base of the trunk, which explains the need for the buttresses above mentioned. There is evidence to show that these buttresses, like the brackets and excentric growth of the branches, develop in irritable self-adjustment to the stimulus of the strains there felt, in precisely the same way that leaves and stems turn phototropically to light, or stems hold themselves upright in adjustment to gravitation.

Between stems and branches no structural differences exist, the word "branch," as we use it, being merely an abbreviation for "branches of the stem." For the most part

all of the branches of a given plant are structurally alike, but sometimes they are not. Thus in fruit trees, some branches make extremely little growth in length each year, while their buds form flowers and fruits with the least possible stem; and such branches are the familiar FRUIT-SPURS. Again, some of the branches on a plant may be limited in growth and assume flat forms, as in eladophylla elsewhere described (page 195), the remaining branches having the ordinary form. An even more familiar case of special branches is found in flowers, which are morphologically modified branches including sexual parts. In a few cases, trees form a certain absciss-layer across the bases of some of their young branches, producing the result of a natural pruning.



FIG. 125. — A yellow Birch, exposed to winds from one direction during the growth season. (Drawn from a photograph.)

While the upright self-supporting condition is typical in foliage-supporting stems, modifications thereof occur in connection with special habits. Most prominent are CLIMBERS, which make use of trees, rocks, walls, and other supports to lift their foliage to the light. Being thus supported, they need no great thickness and remain slender, devoting their

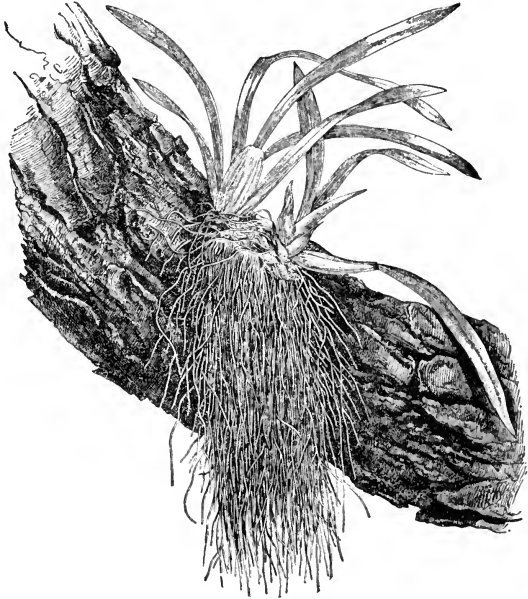

FIG. 126. — A typical epiphytic Orchid, showing aerial roots, and the pseudobulbs, or storage stems, from which spring true leaves. (Reduced from Kerner.)

material to increase in length. Some simply *clamber* over other plants, as in case of the Rattan Palm already mentioned (page 113) or the many great lianas of the tropics, or the Clematis of our woods. Such plants possess hooks (Rattan), twining petioles (Clematis, Fig. 51), or other arrangements preventive of slipping from the supporting vegetation. Others, forming our principal vines, *cling* to a support, either by tendrils, as in Grape and Passion Vine (Fig. 136), or by



adherent disks, as with Virginia Creeper, or by disks on the ends of aërial rootlets as in the Ivies which grow upon buildings (Fig. 180). Others are *twiners*, and wind their very slender stems around the support, as do Morning Glory and Dutchman's-pipe. Some special forms of irritability are concerned in the climbing movements. Thus, vines which climb against walls have the stems negatively phototropic, and thus are kept against the surface to which their roots adhere.

All climbing stems remain slender, forming new wood but slowly, and possess, as a rule, very large ducts.

From the climbing to an epiphytic habit there is every gradation in tropical vegetation. EPI-PHYTES are



FIG. 127. — *Echmea miniata* var. *discolor*, typical of the funnel-form epiphytes. (From Bailey.)

plants which have no connection of their own with the ground, but live supported towards the light upon others, without being parasitic. Very few occur in the flora of temperate regions, aside from a few stray Mosses, Lichens, and other low forms, but most tropical Orchids, some Ferns, and many members of the Pineapple Family, including the "Long Moss" of the South, are typical epiphytes; and they often cover the branches of tropical trees in great variety and profusion (Fig. 126). Their mode of life is peculiar, and many striking adaptations thereto have been described by those who have studied them in the tropics. Their attachment to

the supporting plant is precarious, and they remain compact with very short stems often concealed completely by crowded leaves. Their water supply comes from the rain which wets the bark on which their roots grow ; but a few possess methods of collecting the rain in funnel-shaped cups formed by their



FIG. 128. — An epiphytic Fern, *Platycerium grande*, possessing two kinds of fronds, — ordinary (drooping) and humus-collecting (upright);  $\times \frac{1}{5}$ . (From Goebel.)

leaves (Fig. 127). All epiphytes, indeed, show marked water-conserving features, including thickened epidermis, sunken stomata, storage tissues, and other features associated with plants which must stand frequent dryness (page 69). Their supply of mineral matters is such only as they can derive from the decaying vegetation amongst which they live, and much of it comes from the bark into which they send their roots. Some kinds, however, collect among their leaves the bark, twigs, flowers, etc., which fall from above, while others possess leaves so adjusted to the supporting trunks

as to form half cups in which bark and other materials streaming down with the rain are caught and held, later decaying to a humus from which both water and mineral matters are readily absorbed (Fig. 128). And many other interesting features, some structural and some self-adjustive, are known to accompany the epiphytic habit. From the penetration of dead bark for rain water to a penetration of

living stems for their soil water, the step would seem easy for roots; and thus has probably originated the half-parasitic habit represented in the Mistletoe. Thence it is only a short step further to a connection with the food supply of the host plant, and a completely parasitic habit. It is probable that the parasitism of the flowering plants has mostly originated in this way.

Like climbing stems in many respects are *creeping* or *trailing* stems, such as those of Partridge Berry and Ground

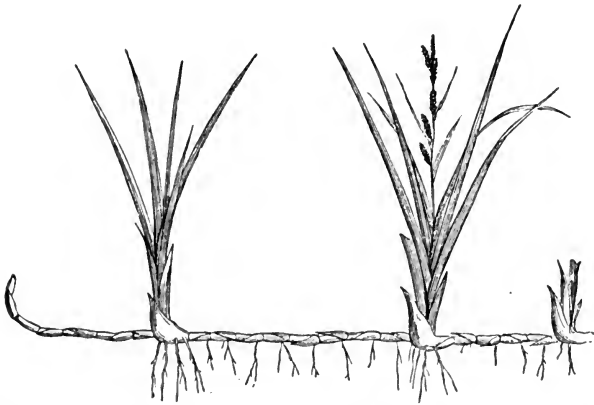

FIG. 129. — The rhizome, or rootstock, with ascending shoots, of a Sedge;  $\times \frac{1}{4}$ . (From Le Maout and Decaisne.)

Pine. Since the ground supports them, they remain slender, and simple in structure. This habit merges over imperceptibly into that where the stems run, not on the surface but just beneath it, as in some Ferns and the Grasses; and remarkable self-adjustive adaptations have been described whereby the stems are kept at a constant depth. This habit is best developed in the Grasses and Sedges, where the slender underground stems branch and interlock so profusely as to form the familiar turf, from which rise short vertical stems bearing the foliage (Fig. 129). When thus underground, the stems lose their green color and acquire the aspect of roots,

whence their botanical name of ROOTSTOCKS; but they are always distinguished by the presence of nodes and rudi-

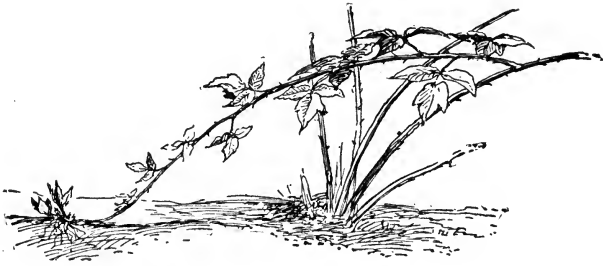

FIG. 130. — Stolon of Black Raspberry. (From Bailey.)

mentary scale-like leaves. Such rootstocks often accumulate food, thus tending towards new organs, which we may best consider in the following section.

There also occur a kind of *traveling stems*. The very slender woody stems of the Brambles bend over and touch



FIG. 131. — *Sempervivum soboliferum*, showing typical offsets. (From Kerner.)

the ground at their tips, where they take root; and thus the plants form dense and ever advancing thickets (Fig. 130).

Some plants develop both upright and reclined stems, the latter, called *STOLONS*, lying close to the ground, as in Hobble-bushes, descriptively named. Short leafy stolons, called *OFFSETS*, are formed by some plants of compact growth like the *Sempervivums*, which thereby spread outward in a continuous growing mat (Fig. 131). Very long and slender stolons, evidently adapted to spreading the plant, are called *RUNNERS*, as familiar in the Strawberry.

The flowering plants are typically land dwellers, but in course of their evolution some kinds have returned to a life in the water, — *e.g.* Water-lilies and a great many of the Waterweeds. The stems of such plants are buoyed up by the water, which thus supplies the support for the foliage, in correspond-

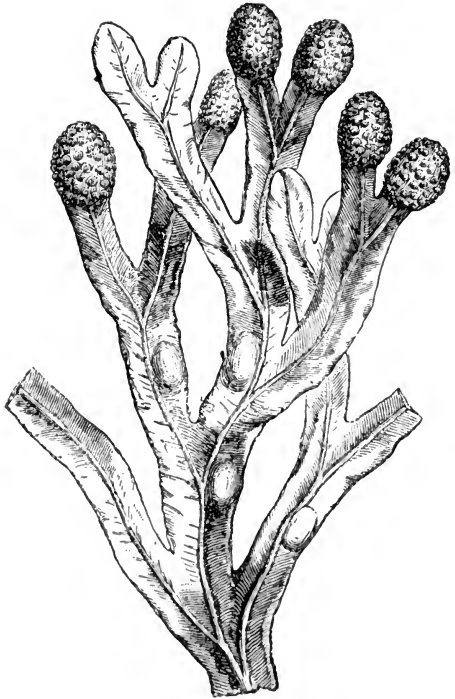

FIG. 132. — *Fucus vesiculosus*, the common brown Rockweed;  $\times \frac{1}{2}$ . (From Figurier.)

ence wherewith the stems are weak and soft, serving rather as cords to retain the leaves than columns to lift them.

Some flowering plants live also in deserts, into which they have been forced in the course of evolution. The scarcity of water entails on such plants great reduction of surface, leading in the most typical cases, like the Cactus, to aban-

© V. S. ... ..

donment of the leaves and the assumption of photosynthesis by the compact, rotund, water-storing, ribbed stems, which possess many structural features connected with restriction of transpiration (Fig. 141). The difference in aspect and structure between forest plants, desert plants, and water plants shows how profoundly plant form is affected by water supply. In accordance, indeed, with this relation to water, most plants fall under three well-recognized groups, the desert plants being called XEROPHYTES, the water plants

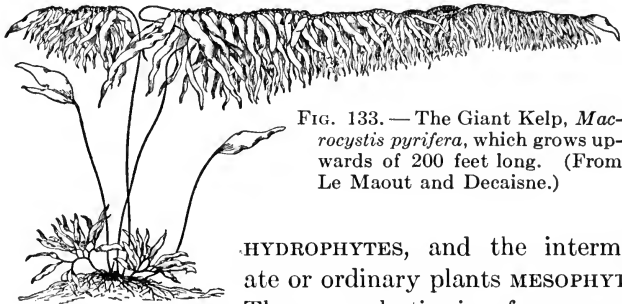

FIG. 133. — The Giant Kelp, *Macrocystis pyrifera*, which grows upwards of 200 feet long. (From Le Maout and Decaisne.)

·HYDROPHYTES, and the intermediate or ordinary plants MESOPHYTES.

The mesophytic is of course the best condition for plant life, and reaches its highest perfection in the rank growths of the tropical forests and jungles, though it is nearly as well attained in the deciduous forests of temperate regions.

The primitive water plants, the Algæ, in their highest development are distinguished by a THALLUS, familiar in the fronds of brown Rockweeds (Fig. 132) and the red Seamounts. The thallus is neither leaf nor stem, but rather a more primitive structure from which leaf and stem have not yet differentiated. Some of the greater Algæ, as for example the giant Kelp of the Pacific (Fig. 133), have developed a distinct leaf and stem structure, though it by no means represents the evolutionary ancestor of the shoot of the higher plants.

The term SHOOT is used in connection with the flowering plants to designate stem and leaves collectively.

## 11. THE FORMS AND FUNCTIONS OF STEMS NOT CONNECTED WITH SUPPORT OF FOLIAGE

As with other plant parts, stems are not limited to the one primary function in adaptation to which they seem clearly to have been evolved, but perform also others, which sometimes replace the original function. Thus are

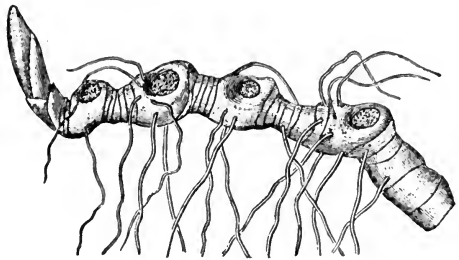

FIG. 134. — Solomon's Seal, *Polygonatum multiflorum*;  $\times \frac{3}{4}$ . Each "seal" marks a fallen shoot, and a year's growth of the rootstock. (From Strasburger.)

produced new organs, with distinctive aspect and structure.

The most frequent additional function of stems is storage of food or water. All woody stems store food over winter, but since ample room therefor exists in the ordinary tissues, — in pith, bark, medullary rays, and parts of the fibro-vascular bundles, — such stems exhibit no external evidence of the storage function. Some stems, however, do show marked swellings resulting from storage of food and water, as especially clear in the pseudobulbs of epiphytic Orchids (Fig. 126). Storage of food is commonest in underground stems or rootstocks, which thereby are given a swollen aspect, as for example in Solomon's Seal (Fig. 134), where a new piece of food-filled stem, producing a new shoot, is made each year. Similar arrangements are found in Iris, Trillium, and others, and reaches an extreme in the corm of Crocus (Fig. 135),



FIG. 135. — A typical corm, composed mostly of stem, of Crocus. (From Figurier.)

where the nearly globular storage stem is commonly mistaken for, and called, a bulb (page 73). All of these stems produce roots, and also give rise to the foliage; but cases occur in which food-storage completely displaces

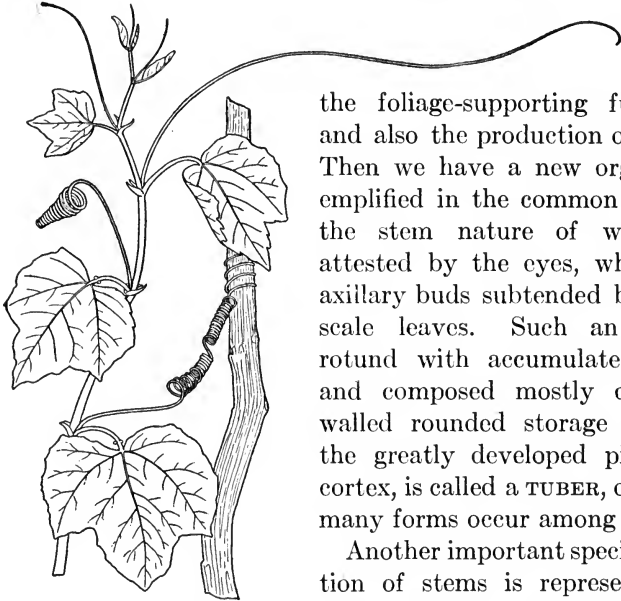

FIG. 136. — Tendrils, from axillary buds, in a Mexican *Passiflora*.

Compare also Fig. 52. The tendrils of Grape Vine and all of the Gourd family (Squash, Wild Cucumber), represent the main stem, the further growth taking place from the axillary bud. (After Gray.)

stem tendrils (Fig. 136), which are more abundant and perfect in form than leaf tendrils, perhaps because support is a more natural function of stems than of leaves.

Stems also become transformed into *spines*, which are sometimes very large, as in Honey Locust (Fig. 137). The

the foliage-supporting function, and also the production of roots. Then we have a new organ, exemplified in the common potato, the stem nature of which is attested by the eyes, which are axillary buds subtended by small scale leaves. Such an organ, rotund with accumulated food, and composed mostly of thin-walled rounded storage cells of the greatly developed pith and cortex, is called a **TUBER**, of which many forms occur among plants.

Another important special function of stems is represented in *tendrils*, which have the same elongated slender forms, movements through the air, thigmotropic twining about a support, and spiral shortening, already described in leaf tendrils (page 77). Passion Vine, Wild Cucumber, and Grape Vines have



single spine of the Cactus-like Euphorbias is a stem, really the persistent and hardened flower-bearing branch. As in case of leaves, however, the significance of these spines is uncertain (page 79).

Support of the flowers, which mostly stand out in the light, is another of the special functions of stems. Flower stalks are usually slender-cylindrical, nodeless, and leafless, though sometimes they bear bracts (page 73). An elongated stem ending in a single flower or small cluster, especially if starting directly

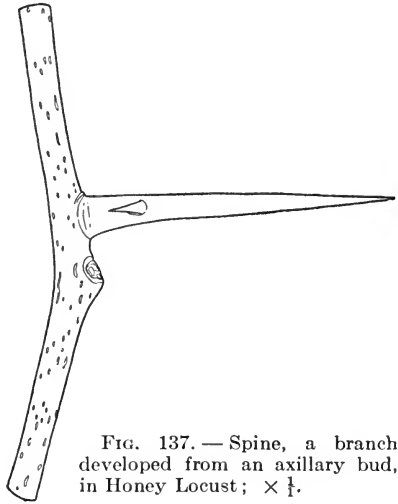

FIG. 137. — Spine, a branch developed from an axillary bud, in Honey Locust;  $\times \frac{1}{2}$ .

from the ground, as with Adder's-tongue or Violets, is called a **SCAPE**; a flower stalk from the axil of a leaf is called a

**PEDUNCLE**, and in clusters each separate stalk is a **PEDICEL**. A typical flower stalk consists really of one internode, bearing at its top several nodes merged together in one enlarged **RECEPTACLE** which supports the floral parts (page 271).



FIG. 138. — *Rubus australis*, a shrub in which the foliage function is assumed by the stems and petioles; much reduced. (From Wiesner.)

The most striking of the new functions assumed by stems is found in the replacement of leaves as foliage. In the simplest

case the stem acquires more chlorophyll, shown by a deeper green color, thus supplementing better the work of the

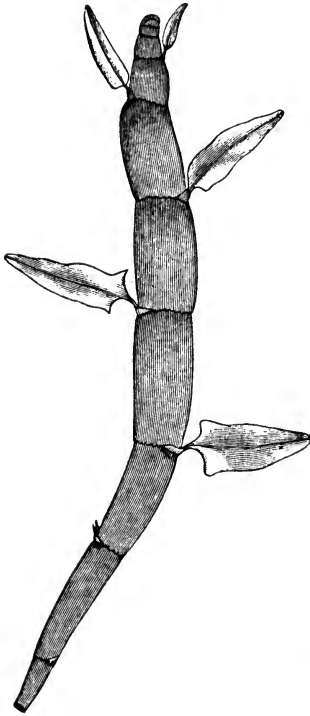

FIG. 139.—*Muehlenbeckia platyclada*;  $\times \frac{1}{2}$ . (From Goebel.)

nodes and the persistent small leaves. Still more striking are the cases in which flattened stems, in this case branches, become limited in growth, and assume characteristic

leaf shapes, to such a degree that their stem nature would hardly be suspected at all, were it not that they grow from

leaves; but in others the leaves are reduced in size almost to disappearance, leaving the foliage function wholly to the slender-cylindrical stems and petioles. In others the stems become flattened, thin, and green like the leaves, as in the familiar greenhouse plant *Muehlenbeckia* (Fig. 139), the stem nature of which, despite its deep green color, is proven by the prominent



FIG. 140.—Leaf-like cladophylla (branches) of Butcher's-Broom, *Ruscus Hypoglossum*, in the axils of bracts, and bearing leaves and flowers;  $\times \frac{1}{2}$ . (After Kerner.)

the axils of small scales which are morphologically leaves, as exemplified in the familiar "Smilax" of the florists. The Butcher's-Broom of Europe is similar in general, but has this further interesting feature, that on the face of the CLADOPHYLL (as such leaf-like branches are called), occurs a small though genuine leaf, bearing in its axil a flower cluster (Fig. 140). The apparent leaves of the common "Asparagus Fern" likewise are branches, of which several occur in the axil of each scale-like leaf. In cladophylla the stems have become foliage without other function.

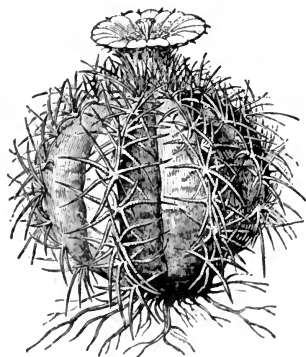

FIG. 141. — *Echinocactus*, a typical globular ribbed Cactus. (Originally after Engelmann.)



FIG. 142. — *Rhipsalis Houlletii*;  $\times \frac{1}{2}$ . The seeming leaves are flattened stems, morphologically equivalent to a form like the *Echinocactus* of Fig. 141, with the ribs reduced to 2 and flattened. (From Rümpler, *Die Sukkulenten*.)

The functions of foliage and storage are combined in the succulent stems of Cactus and other plants of dry places. Such stems, which store principally water absorbed during the rainy season, become swollen to cylindrical, or even almost globular forms, while the entire leafless surface bears ample chlorenchyma, with stomata through the thick epidermis (Fig. 141). Many of these plants possess vertical

ribs, which have the effect of increasing the spread of green surface without a proportional increase of transpiration, which, of course, is the ever-present danger to plants of dry places (page 69). These ribs vary much in number, from many to few, and even in some cases to two, when the structure approximates closely in appearance and function to a single leaf (Fig. 142). Thus is presented still another example of the attainment of the same functional end by a different morphological route.

The explanation of such remarkable morphological-physiological overturnings as are presented by the cladophylla is probably to be found, as with similar anomalies in leaves, in a devious course of evolution through conditions and habits very different from those now distinctive of these plants.

## 12. THE MONSTROSITIES OF STEMS AND LEAVES

It often happens that individual parts of plants grow so differently from their usual method as to attract attention and be designated "freaks." Scientifically such cases are called **ABNORMALITIES**, or if extreme, **MONSTROSITIES**. Aside from their interest as curious things needing explanation, they are scientifically important for the light they throw upon the methods of plant development.

First, it must be noted that not all peculiar growths are properly monstrosities, for many result from purely mechanical causes. Thus, when a stem is encircled by a rigid ring (*e.g.* supporting iron band or wire attachment of a label), it becomes thereby constricted in its further growth, and swells greatly above the obstruction, because of the accumulation of food stopped in its downward passage through the bark (Fig. 107). Precisely this cause produces great spiral ridges on trunks gripped by twining vines. Again, different parts of the same plant often become grown or grafted together, because crushed or rubbed against one another when young. In this way twin fruits are sometimes

produced, though others are true monstrosities resulting from partial fission of one. Oranges sometimes exhibit a segment very different in color and texture of skin from the rest; but these are a special incident of grafting, as elsewhere explained (page 211). Strawberries which remain hard, shrunken, and green on one side are merely individuals which did not receive enough fertilizing pollen (page 279). And other peculiarities of like sort, more or less obvious in origin, occur in various plant parts.

Of true stem monstrosities perhaps the most common are FASCIATIONS. These are cases in which the usually cylindrical stem with its single terminal bud becomes a flattened stem with several imperfectly separated terminal buds, as occurs at times in *Asparagus* (Fig. 143), *Hyacinths*, and other herbs, and in *Forsythia* and *Barberry* among shrubs. A striking example, seemingly in a fruit, but really in a stem, occurs in the *Pineapple* figured herewith (Fig. 144). Fasciations are much more common in cultivated than in wild plants, and sometimes can be propagated; as, for instance in the *Crested* (*i.e.* a fasciated) *Cactus* (Fig. 145), while a crested form of *Celosia* gives us the *Cockscomb* of our gardens, and a related condition in leaves produces the feathered fronds of the *Pearson Fern*, — a new variety of the plain *Boston Fern*. Fasciations are evidently caused by a partial fission of one meristematic growth center into several. In some cases the result follows an injury by insects, but in such cases it cannot be propagated; in others it seems clearly due to internal causes of still unknown nature, affecting the

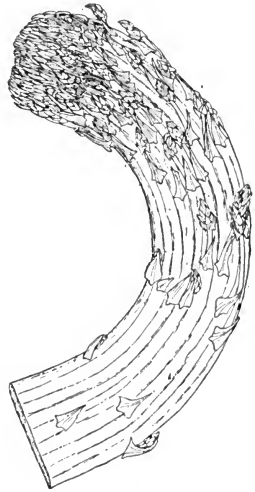

FIG. 143. — Fasciated shoot of *Asparagus*, which is normally cylindrical;  $\times \frac{1}{2}$ . (Drawn from a photograph.)

meristematic tissues or the reproductive cells, and these are the kinds which it is possible to propagate, and thus preserve

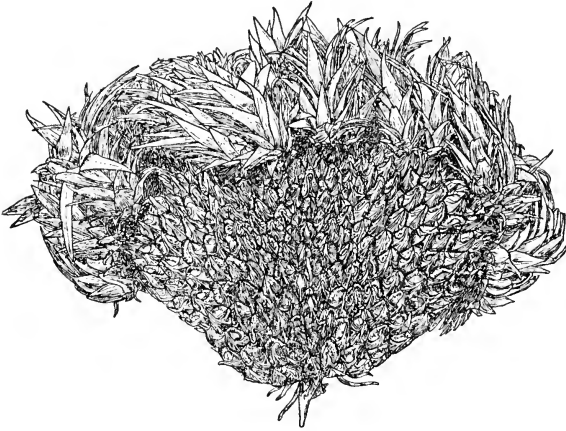

FIG. 144.—  
A Pineapple, fasciated to an unusual degree. It is flattened in the plane that is visible;  $\times \frac{1}{4}$ . The Pineapple is mostly stem covered with coalescent small ovaries and bracts. (Drawn from a photograph.)

in our gardens. The first step towards a fasciation would be a bifurcation, sometimes seen in the fronds of Ferns, and in some double fruits, *i.e.* in Orange (Fig. 146).

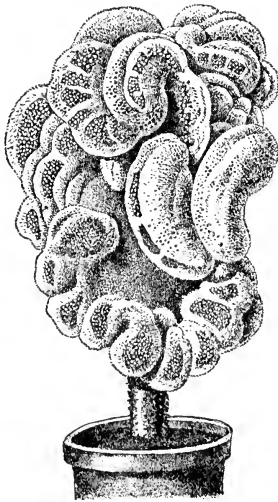

FIG. 145.— Greatly fasciated, or crested, Echinocactus. (From Rümpler.)

Closely related to fasciations are cases of *unregulated bud development*, most familiar in the Bird's-eye Maple. The eyes are knots, that is, buried branches, developed from a mass of adventitious buds which start on the side of a trunk of a Maple, presumably as a result of some injury (page 137), and in their growth about keep pace with the expansion of the trunk. Another prominent case is found in "Witches' brooms" (Fig. 147), those dense masses of slender twigs found on the upper branches of

Spruces and some other trees. Here, instead of the usual development of a few buds with inhibition of others, many or all of the buds on the branches affected develop equally, and more or less independently of the others. It is known that this condition is produced by the presence of a parasite, the obvious effect of which is to paralyze the mechanism of growth correlation by which the buds are ordinarily controlled.

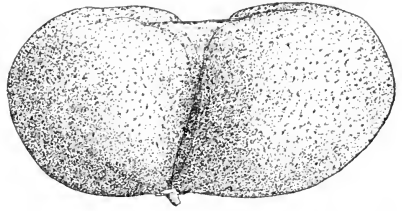

FIG. 146. — A twin-fruit, of Mandarin Orange;  $\times \frac{1}{2}$ . (Drawn from a photograph.)

Closely analogous to these cases in buds is the *unregulated growth of tissues*. Thus, the large burls or gnarls which ap-

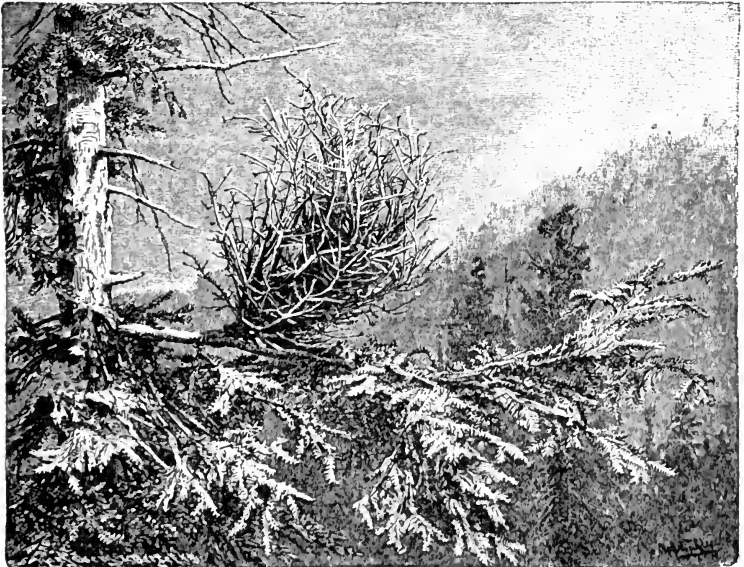

FIG. 147. — A typical Witches' Broom, caused by an *Æcidium*, a Fungus, on a branch of Fir. (From Kerner.)

pear on old Elms, especially near the bases of the lower great branches, are composed of complexly contorted and twisted masses of wood, often beautifully grained when sectioned and polished. They are formed by areas of cambium, which, instead of keeping their places and parts in the regular fibro-vascular cylinder, proceed to grow profusely, and thus are thrown out into irregular folds. A less extreme case is found in Curly Birch, and in some other irregularly grained hardwoods highly valued in fancy carpentry. In

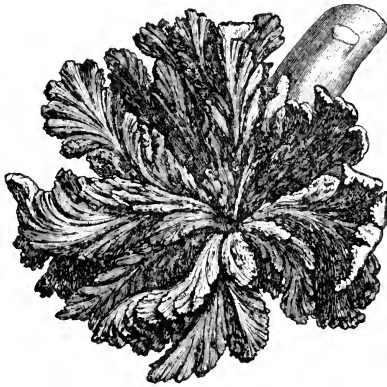

FIG. 148. — A Wooden Flower, or Wooden Rose, on a leguminous plant;  $\times \frac{1}{4}$ . The parasite which induced it was a flowering plant, *Phoradendron*. (From Engler and Prantl, *Pflanzenfamilien*.)

some cases such growths are apparently started by injurious strains, which would explain their frequency at the bases of great branches; and very likely they represent areas in which the growth-control mechanism has been ruptured by the strain. It is interesting to note that a close analogy exists between these burls and the troublesome tumors which form in the human body, for the latter also are formless growths re-

sulting from continued operation of the growth energy of the tissues after the control stimuli have been inhibited, usually as result of some strain or other accident. Other burls, however, with various kinds of knotty growths, are started by presence of parasites, which also inhibit the usual control, presumably by chemical action. Of this nature is the remarkable "wooden flower," sold to tourists in tropical America (Fig. 148). It is nothing but a stem in which a parasite has inhibited the growth control over a limited area, leaving that part free to grow as it happens.



Related to these peculiarities of tissue development are the **TORSIONS**, or close twistings sometimes found in plant tissues, either stems or fruits. They are often prominent on trees standing in burnt woods, or on fence rails, where the layers of wood form closely wound spirals.

Rather striking, and not uncommon, are **PROLIFERATIONS**, well illustrated in the cases where a leafy shoot projects from the tip of the fruit in Pear or Strawberry (Fig. 149). In Roses the stem occasionally grows up through the center of a flower and produces another, thus making a "two storied" flower (Fig. 150), while two-storied fruits, of similar origin, occur occasionally in Apples. An incomplete case is represented in the Navel Orange, where the stem grows up between the segments of the fruit, and bears a smaller orange, not, it is true, on the top, but within the top of the main one. This case is also of interest as showing that such monstrosities can be propagated, for all Navel Oranges are reproduced by grafting. Stems, and therefore the stalks of flowers and fruits, can potentially elongate indefinitely, and some special inhibitory influence must ordinarily check their growth in flowers and fruits. It is apparently the occasional failure, presumably by some accident, of this inhibitory stimulus, which results in proliferations.

Among the commoner monstrosities are **SUBSTITUTIONS** of one part or feature for another. Most people know that green Roses occur; and a variety is grown in Botanical Gardens on which the flowers are well-nigh as green as the leaves. Formerly such cases were considered "reversions," the petals being supposed to have returned to the state of green leaves from which they were evolved. They seem rather, however, to result from a substitution of chlorophyll



FIG. 149. — Proliferous Pear. (From Balfour.)

for the usual color substance, of which the formation is inhibited by some accident.

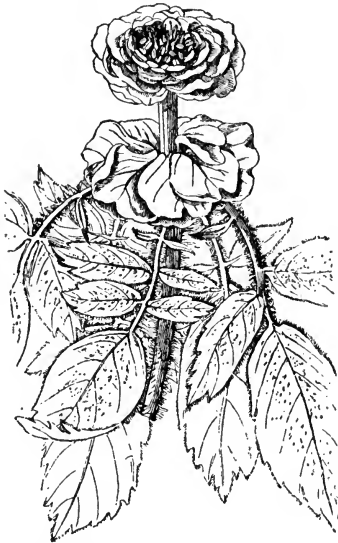

FIG. 150. — Proliferous Rose.  
(From Masters, *Vegetable Teratology*.)

We sometimes find the opposite phenomenon, where the floral color is thrown into leaves, as happens with some Tulips, in which the uppermost leaf of the flower-stalk takes the color of the flower. Genuine reversions no doubt do occur; and perhaps we have a case in the occasional appearance of leaves upon the smooth sides of Apples and Cucumbers, this part of the fruit being morphologically stem. Sometimes Potatoes appear above ground in the axils of the leaves, evidently because food material destined for the underground tubers becomes diverted into axillary buds.

There can be little doubt that with increasing knowledge we shall learn to control such substitutions, and various other stimuli which produce special growths upon plants. Thus the horticulture of the future will surely include some practice whereby palatable and nutritious growths, on the analogy of aerial tubers and galls, will be produced at will upon the leaves or stems of plants.

Several forms of monstrosities are distinctive of leaves. Rather common is the formation of a cornucopia-like pitcher, instead of a flat blade, as happens in Pelargoniums, Cabbage, and others (Fig. 151). Here the bases of the leaf blade seem to unite or graft together over the petiole at an early stage, and remain united during the subsequent growth. The case has an interest in showing one way in which pitchers

may have originated in the Pitcher Plants (page 76). Also distinctive of leaves is a peculiar monstrosity called *PHYLLOMANIA*, propagated in a green-house variety of *Begonia*, where the stem or petioles produce a great number of very minute, but otherwise well-formed blades (Fig. 152). Here the form-factors which shape the blade, whatever they are, evidently have spread all over the plant. An extremely fine division of the leaf blade, closely following the veins, sometimes occurs, and can be propagated: and such is the origin of the "lacinate" or finely cut leaves of some cultivated trees and shrubs.

Not properly monstrosities, though usually associated and intergradient therewith, are *GALLS*. Typical examples occur in the bright red round swellings on Oak leaves, which, when opened, are found to contain the larva of an insect (Fig. 153). A common form upon stems is the familiar globular swelling of the stem in Golden Rods. They are formed by the plant tissues after an insect has laid an egg therein, though we do not yet know the precise nature of the stimulation which controls their development. The growing insect feeds upon the leaf tissue, then makes its way out and escapes. The advantage of the arrangement to the insect is plain, but its meaning to the plant is still problematical. Hundreds or thousands of such galls are known, constant in form for the same kind of insect on the same kind of plant. Some are large, some small, some rough or hairy, some smooth, some on leaves and some on stems, and

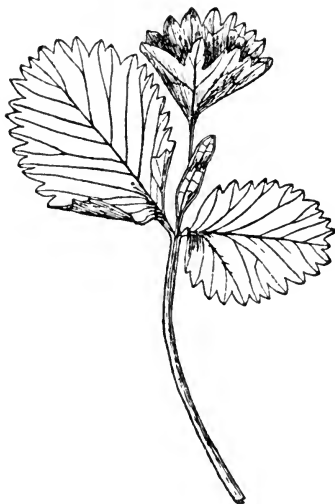

FIG. 151. — Abnormal leaf of a *Potentilla*.

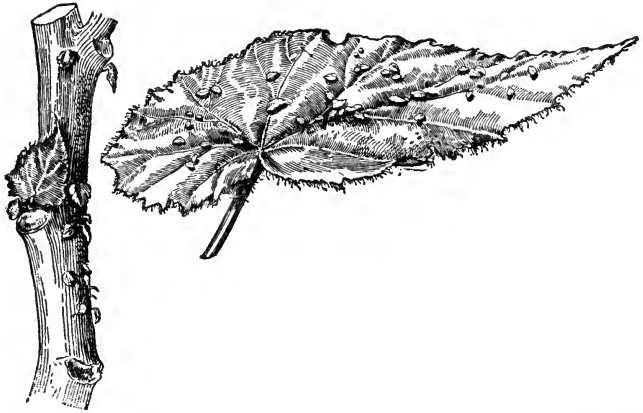

FIG. 152. — *Begonia phyllomaniaca*, which produces many small leaves over leaf and stem. (From Bailey.)

some involve both, as in case of the Willow Roses, — those rose-like masses of shortened leaves often seen on the ends of Willow stems.



FIG. 153. — Typical galls, with the Insects, of Oak; slightly reduced. On the left a leafy "Oak-apple," and on the right the insect in cocoon and adult stages. In the center, an Oak gall, and on the right, lower, the same cut open, showing the larva of the insect. (From Thomé, *Text-book of Botany*.)

A very close relation exists between monstrosities, and those extreme variations called in horticulture SPORTS.

In fact a sport, the foundation of some of our most valuable varieties of cultivated plants, as typified, for example, by the Navel Orange, is probably nothing other than a monstrosity which has originated from internal and not external causes, and which can be propagated.

Monstrosities occur, of course, in the other plant parts, notably flowers and fruits, and along with our description thereof we shall consider still further their causes.

### 13. THE ECONOMICS, AND TREATMENT IN CULTIVATION, OF STEMS

As with other plant parts, stems possess structures and contain substances suited to their functions and habits. These materials, however, happen to meet certain needs of man, who accordingly appropriates them for his purposes.

The size, composition, and tough grain of the great trunks built by trees for support of their foliage fit them admirably for innumerable domestic and manufacturing utilities. Nature has supplied lumber and cabinet woods in great abundance and variety, but not so great as man's increasing needs; and he is driven perforce to conserve, augment, and improve the supply through scientific forestry.

Likewise from stems he obtains material for paper, not now as in old times from consolidated strips of herbaceous pith (*papyrus*), but from cellulose fibers (rag or linen papers), and from the lignified elements of the xylem. These he separates by grinding, or else by use of chemicals which dissolve the middle lamellæ (page 147), and then felts them together to a pulp which is compressed between rollers to the familiar thin sheets. Also he uses tough bast fibers for threads, notably in case of Flax, which he weaves to cloth, giving linen, though cotton has a very different origin, as will later appear. Both bast fibers and sclerenchyma strands

are utilized as hemp, or other cordage. Likewise the bark-cork has uses dependent on its waterproof qualities.

From the stores laid down by plants in their stems man derives many foods, either directly through some vegetables or indirectly through fodder plants. Most of his sugar comes from the main stems of the Sugar Cane, and a little from Maple, and some starch from Sago Palm, while special storage stems, like potatoes, yield him specially rich harvest. And likewise from stems he draws drugs, dyestuffs, tanning substances, resins, rubber, and almost innumerable other materials, having in the plant distinctive meanings which involve properties happening to serve some human purpose.

Man's command over the resources of Nature rests not alone upon his direct appropriation and use of materials which plants happen to offer, but also upon his power to multiply their quantity and improve their quality by cultivation. That part of cultivation which consists in conformity to the plant's physiological peculiarities (page 94) is comparatively simple with stems, involving no special horticultural or agricultural practice, doubtless because of the relatively simple and mechanical part taken by stems in the plant's economy. But the other phase of cultivation, viz. improvement, which always depends on the *utilization of potentialities* which the construction or composition of the plant happens to offer, has some important applications in stems, especially in connection with pruning and grafting.

PRUNING consists in the removal of some parts of a plant for the benefit of the remainder. Its very possibility depends on two leading facts. *First*, branches are practically all repetitions of one another, and hence are not interdependent; and accordingly any particular ones may be removed without damage to the rest. *Second*, any injuries made in living tissues of plants not only heal quickly, but the bark gradually overgrows and permanently covers large areas of dead tissues, as already described (page 122, Fig. 79).

If pruning is done in winter or early spring, the injuries heal largely before the first rush of the valuable sap.

There are four principal uses of pruning. *First*, parts affected with disease which might spread to sound parts can be removed. *Second*, some desired shape can be given ornamental or fruit trees by removing growth in undesired directions. This practice merges over imperceptibly into the clipping of plants forcibly to desired shapes, as practiced with hedges or with evergreen plants in the *TOPIARY* work of formal gardens. *Third*, more space and light can be insured to a few branches, in place of a mediocre exposure to many, thus promoting the development of fine individual flowers or fruits. Trees and shrubs not only form many more buds than ever develop, but develop many more branches than is good for them all. By a form of pruning, viz. disbudding, it is possible to develop the wonderful great exhibition types of *Chrysanthemum*.

The *fourth* use of pruning is the most important of all, especially in orchards, — viz. to produce more formation of fruit and less of leaf and stem. The possibility of gaining this end by pruning depends on the fact that in plants (as also in animals) a certain reciprocal balance exists between the reproductive and the vegetative parts, such that any check to either promotes the other, — and the fruit, of course, is a part of the plant's reproductive mechanism. In a state of nature, all woody plants form only enough reproductive parts for their needs, and, as a phase of their competition with one another for light and space, throw the remainder of their energy into growth of stem and leaf. The human fruit-grower, however, does not so much wish his trees to become big as to bear plenty of fruit; and by pruning away much stem and leaf, he can turn the plant's energy into more copious formation of fruit. Thus the cultivated Grape Vines, left to themselves, produce long leafy canes bearing few clusters of Grapes; but when thoroughly pruned, they produce little cane but many fine clusters. Of course

such pruning must be done with discretion, for in the last analysis the production of fruit depends upon the work of leaves and stems; but the aim of the pruner is that optimum balance at which only enough food is sent to stem and leaves to insure moderate growth for the next season, while all of the remainder goes into fruit. Naturally the best pruning requires judgment, skill, and technique, which are acquired only by a combination of natural aptitude with long and interested practice.

There are other minor uses of pruning for special purposes, of which an example is the root-pruning said to underlie the production of the remarkable dwarf trees of the Japanese. By the consequent restriction of water and mineral matters, the entire development of the plant is restrained without other alteration of its characteristics.

Even more important than pruning in the utilization of the natural potentialities of stems is GRAFTING, or, as the entire art comprehensively is now often called, GRAFTAGE. It consists essentially in this;— a piece of stem, called a CION, or SCION, of some valuable variety of plant is inserted into the stem of another, which is usually a less valuable but more hardy kind, called the STOCK, in such manner that the cambium tissues can unite. In these cases cion and stock grow together as one organism, which through life, no matter how large the plant becomes, retains below the union the hardy roots and other characters of the one, and above the union the special good qualities of the other. The possibility of grafting depends upon the capacity of the cambium of related plants thus to unite; and its value depends upon the permanent retention of the characters of the cion substantially unaltered.

In practice only closely-related kinds can be grafted together, presumably because of chemical incompatibility in the protoplasm of more distant relatives. Further, only exogenous kinds will unite, because the joining of the cambium is the central feature of the process; and much of the



technique of grafting centers in making good contacts of cion and stock, and in holding the parts together until their permanent union is effected (Fig. 154). Grafting is mostly done in very early spring, when the tissues are resting, but are soon to become active. Later, as the tissues awaken, they knit together, the wound heals over, and thereafter they grow as one plant, without need of further attention, except that for a time care must be taken to remove any shoots which spring up from the stock, for these, with their greater vigor, may draw all sap from the cion and cause it to perish. Ideally the process is simplest when cion and stock are the same diameter; but very small twigs can readily be grafted upon very large stumps. Naturally an elaborate technique and great special knowledge appertain to the subject.

Grafting is practiced for three principal reasons:

*First*, and most important, it permits both the preservation and the multiplication of valuable kinds of plants which appear as BUD SPORTS, but which neither transmit their good qualities through seed, nor strike root from cuttings, and hence, except for grafting, would be lost. Bud sports, which are related to monstrosities (page 205), are individual branches which show in their development some striking difference from others on the same plant. Most of our best varieties of Apples, Pears, Oranges, and other fruits, have originated in this way, and are perpetuated only by grafting. Indeed,

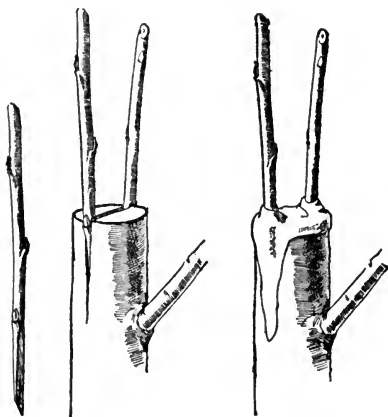

FIG. 154. — Illustration of the method of grafting. On the left a cion of apple, prepared; next, two cions inserted in a stock; on the right, the waxing of the tissues to prevent desiccation and entrance of Fungi. (From Bailey.)

grafting may be defined from this point of view as a process of fitting a set of ready-made roots upon kinds of plants unable to make any of their own.

*Second*, grafting can be used to produce certain desirable changes in minor qualities of the cion, though no essential features can thus be altered. An earlier or later time of blossoming or fruiting of a tree, a better adjustment to a particular soil or climate, advantageous dwarfing or enlarging, resistance to root parasites, even in some small degree an improvement in color or size may be wrought in the cion by grafting on a suitable stock. All such features, however, seem to depend upon the sap, which of course is supplied by the roots of the stock. The more essential characters are seated in the protoplasm, and remain unaltered by grafting, since the protoplasm, unlike the sap, does not pass from stock to cion, but remains separate in the two.

*Third*, curious effects in plant form are obtainable by grafting, as when a dozen or more varieties of Cherries are made to grow on one tree, or bizarre constructions are produced by the grafting upon one stock of many forms of Cacti, which happen to graft extraordinarily well.

The older books upon horticulture frequently mention GRAFT-HYBRIDS, of which the most famous is *Cytisus Adami*, produced by grafting between yellow-flowered and purple-flowered shrubs, and itself preserved by grafting. It shows diverse comminglings of yellow and purple in the flowers, but not an intermediate color. In a true hybrid, produced by the crossing through fertilization of two parents of different races or species, the color is that of one parent or the other, or else has an intermediate shade, but is never a mosaic of the two colors, as in this plant. However, modern research has shown that *Cytisus Adami* is no hybrid at all, but a mixture of the tissues of the two parents, such a combination being now called a CHIMÆRA. It has been found possible to produce these chimæras artificially by so manipulating the grafting that a part of a bud of the cion unites

with a part of a bud of the stock, in which case the resultant bud has the tissues of the two parents intermingled in diverse ways. Such chimæras, accidentally produced, are not uncommon in Oranges, or even in Apples, which sometimes have one segment of skin differing sharply in color or texture from the remainder.

An important economic aspect of stem structure is involved in the new practice of *tree surgery*. In order to preserve valuable trees, it is now customary not only to prune away branches seriously affected by disease, but also to clean out cavities thus caused, and fill them with cement, in imitation of the methods successfully practiced by dentists with teeth. Experience, however, is hardly justifying earlier expectations, for such cement-filled cavities, though seemingly at first satisfactory, often decay next the cement, which shrinks slightly in setting and allows sap to exude and Fungi to enter. Besides, the rigidity of the cement fits badly with the elasticity of trees which must sway in the wind, while its weight in some positions is a serious strain upon thin cylinders of wood. A promising, though rather expensive substitute, is a filling of wooden blocks set in an elastic, antiseptic material like tar. In other details tree surgery has made real progress, *e.g.* in the supporting of weak branches by chains and bolts, the former of which permit a free motion in the tree, while the latter prevents that choking of the bark which follows the use of encircling bands (Fig. 155). The subject is still in the developmental stage, on which account it offers a tempting field to incompetent practitioners, and even impostors, against which type of "tree-surgeons" the owner of trees must be upon guard.

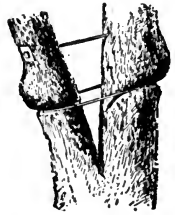

FIG. 155. — A good and a bad way to strengthen a weak crotch of a tree. Better yet, in many cases, is the use of a chain between two bolts instead of the single long bolt. (From Bailey.)

## CHAPTER V

### THE MORPHOLOGY AND PHYSIOLOGY OF ROOTS

#### 1. THE DISTINCTIVE FEATURES OF ROOTS

ROOTS are typically underground parts which spread through the soil and absorb therefrom the water and mineral matters needed by plants, while simultaneously providing a firm anchorage for the stems which rise in the air. Thus roots have a distinctive primary with a prominent secondary function. Though diverse in forms, and occasionally performing additional or substitute functions, they are less multiform in these features than leaves or stems, no doubt because of the more homogeneous environment under which they dwell.

Typical soil roots extend from the base of the stem, and continuously radiate, branch, and taper down to a fibrous size. Taking all angles from vertical to horizontal, they form collectively a mass suggestive of some shoots, but inverted (Fig. 156). Unlike shoots, however, they are rarely symmetrical, because mechanical irregularities in the ground, and self-adjustments to the uneven distribution of water, air, and mineral salts, greatly alter their shapes, making actual root systems extremely irregular. The radiate form, so distinctive of soil roots, enables them to reach a large volume of soil, while also providing the best anchorage against the all-sided strains to which stems are exposed; but there also occur cases in which a single main root continues the stem vertically downward, the lateral roots being very much smaller. Such a TAP ROOT (Fig. 157) is rare in trees but common in herbs, as familiar in Dandelion and others,

where often it is used for storage of food. That the mass of roots keeps towards the surface, especially in the largest plants, is due in part to the need for aëration, and in part to the increasing hardness of the soil with greater depth.

In *size*, roots bear close relations to shoots, for it is clear that the shoot takes the lead, so to speak, in determining the form and habits of the plant, and secondarily produces a corresponding quantity of roots. No matter what the size at the trunk, all roots end in the delicate white tips devoted to absorption and growth; and in correlation with this uniform function, performed under comparatively uniform conditions, the tips of typical soil roots are not far from one size.

In *texture*, roots vary from woody-hard in trees (the wood, indeed, of roots being often harder and more compact than that of the stems) down to the softness of meristem in growing tips. The fibrous parts are tenaciously tough,

—a quality which is evidently connected with the fact that the anchorage function of the roots falls largely on the fibers.

In *color*, roots are white at their growing tips, that being the natural color of meristematic tissue. Farther back they are brown, from the development of protective cork; and in older parts they are very dark from the action of the

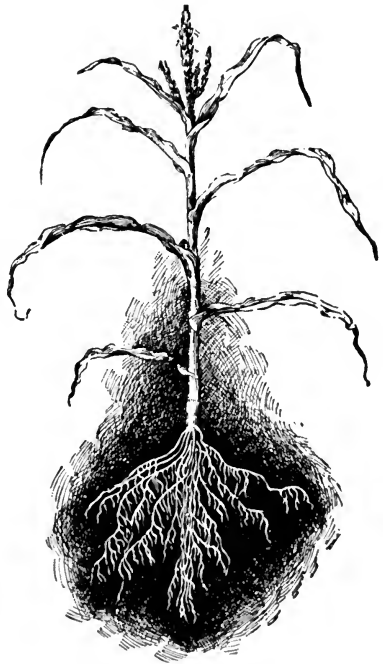

FIG. 156. — A typical root system, of Corn. (From Bailey.)

soil on the bark. Sometimes, when exposed to the light, young roots will turn red, apparently through formation of erythrophyll, which may have any of the meanings already explained for that substance (page 88).

In *duration*, roots conform to the plants which produce them, being annual, biennial, or perennial, and either herbaceous or woody.

Unlike shoots, however, roots drop no parts, for the growing tips develop without break into the older and thicker, and finally the woody parts.

Roots are produced from stems, most commonly and typically from the lower end of the first stem formed by the embryo plant; but sometimes they develop

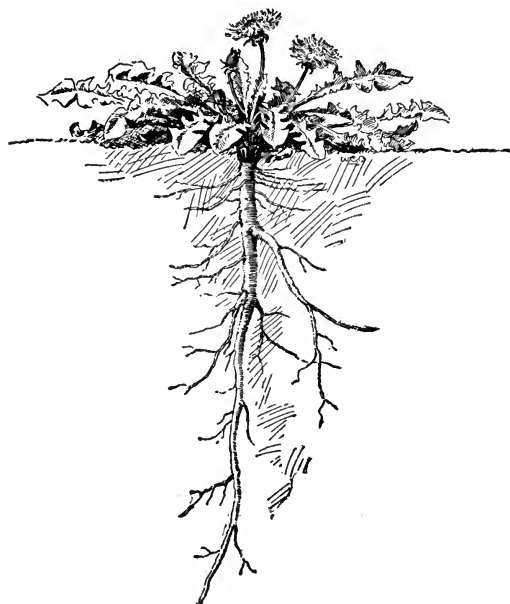

FIG. 157. — A typical tap root, of Dandelion.  
(From Bailey.)

from other parts, particularly from the nodes where these happen to touch the ground. Further, many kinds of plants, like the common "Geraniums," which do not naturally produce roots from their stems, can be made to do so from slips or cuttings, though this is impossible with most kinds. Sometimes, though rarely, roots produce stems, as in Locusts and Apple trees, which send up SUCKERS from their roots at a distance from the trunks.

True soil roots are found only in the Flowering Plants and Ferns. The lower land plants (the Bryophytes, or Moss plants) have substitutes in large hair-like RHIZOIDS. The Algæ need no roots, since they absorb through their whole bodies, though the Rockweeds have attachment organs, somewhat like roots in aspect. In the Fungi no roots occur, although their slender absorbing mycelial threads (page 84) possess certain characteristics of root hairs.

While soil roots are primarily organs of absorption and anchorage, they also perform other functions, becoming storage organs, spines, climbing organs, and even foliage, as will presently be noted.

## 2. THE STRUCTURE OF ROOTS

The principal features of root structure can be seen very well in the root system of some garden herb or house plant carefully lifted and washed free of adherent soil. Observation of such material shows that the entire root system of a plant is continuous, without any trace of such nodes as occur in the stem. Each part is typically cylindrical, though often forced by the soil to other shapes. The branching is very irregular, in marked contrast to the phyllotactic symmetry of the shoot, but answering to the composition of the soil; but in some seedlings the first side roots appear in vertical rows corresponding to the fibrovascular bundles which enter the roots from the stem, — *e.g.* in Bean seedlings four such rows occur. All new branches of roots originate deep in the tissues, in contact with the fibrovascular bundles, whence they make their way out through the overlying tissues, partly by the solvent action of diges-

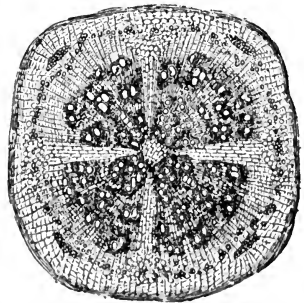

FIG. 158. — Cross section of the fibrous part of a young root of a Bean, *Phaseolus multiflorus*. (From Sachs.)

tive enzymes, and partly by mechanical rupture, as a later picture illustrates (Fig. 164). This method of origin contrasts greatly with that of leaves, which arise as surface swellings in the bud, while the origin of branches is intermediate in

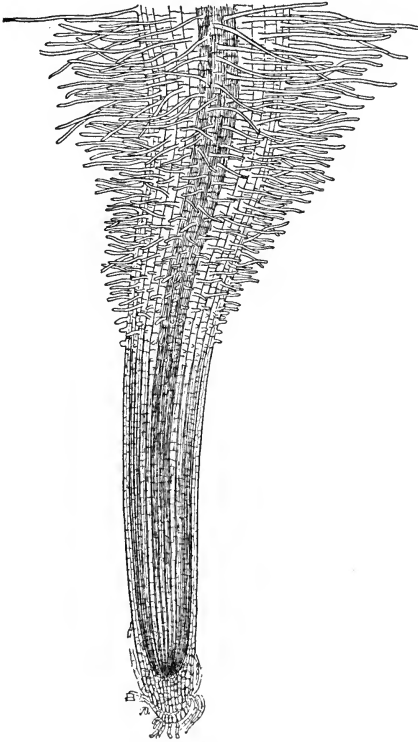

FIG. 159. — A typical root tip, of Radish; magnified.

nature. The vein, or fibro-vascular, system of roots is in perfect continuity with the systems in stems and leaves. The separate fibro-vascular bundles of young roots, clearly visible in sections by aid of a hand lens, differ little from those of the stem, although the fibro-vascular system of roots as a whole is more strongly condensed towards the center, often obliterating the pith (Fig. 158). Thus, while stems approximate, as we have seen (page 118), to the hollow-column principle of construction, roots are built rather on the plan of cords or cables. The difference

is obviously correlated with the different kinds of strains the two parts have to bear; for, while stems are exposed to great lateral strains from the winds (and, on the non-vertical parts, from their weight), against which the hollow column is most effective, the roots are exposed only to pulling strains, in resistance to which the solid cable is best.



The most highly developed roots, those of our exogenous trees, show three distinct though intergradient parts,—viz. the slender white tips, the elongated fibers, and the thick woody parts.

The *tips*, best seen in material grown for the purpose in moist air or moss, show really four parts (Fig. 159). *First*,

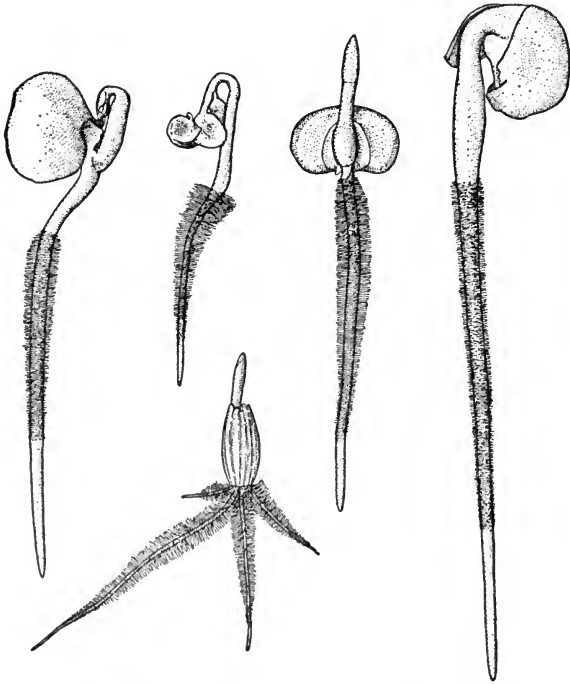

FIG. 160. — The root-hair zones and growth zones in some common roots;  $\times \frac{1}{2}$ . From the left, Pea, Radish, Corn, Lupine, and, below, Oats. The seeds were germinated in moss behind sloping glass plates.

the actual end of the root consists of a **ROOT CAP**, formed from behind by the very delicate growth tissue, to which it acts as a protection in the advance of the root through the soil. *Second*, just behind the root cap lies a yellowish spot, which marks the **GROWING POINT**, the place

of formation of all new cells by which the root increases in length, the color being that of the abundant living protoplasm showing through the transparent walls. *Third*, just behind the growing point lies a short smooth zone, which, though little prominent, has yet this great importance, that it is the **GROWTH ZONE**, or place of enlargement to full size

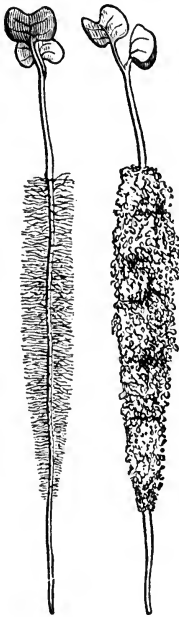

FIG. 161. — Radish seedlings grown in moist air and in soil. (From Sachs.)

of the new cells formed in the growing point. The growth of the root in length is wholly confined to this zone (though new cells cause an increase in diameter farther back), in great contrast to the conditions in stems, where the growth occurs through several expanding internodes (Figs. 112, 114). *Fourth*, just behind the growth zone comes another, differing greatly in length in different plants and under different conditions, the **ROOT HAIR ZONE** (Fig. 160). The **ROOT HAIRS** thereon show remarkably well, especially through a lens, in roots germinated from seeds in moist air, though they have no such regularity of shape in the soil (Figs. 161-2). In the former material the hairs radiate very evenly outward, forming collectively a sort of nimbus along the root; and they are obviously forming anew in front, going each through its grand period, and dying behind. Thus the zone moves along as a whole just behind the advancing tip. The function of the hairs is well known; they provide the great surface

necessary for the absorption of the water when it is scant in the soil. They pass this water through the cortex to the ducts, which extend all the way from this zone to the leaves. We can now see a reason why the entire growth of the root in length takes place in advance of this zone, for any growth behind the hairs would obviously tear them

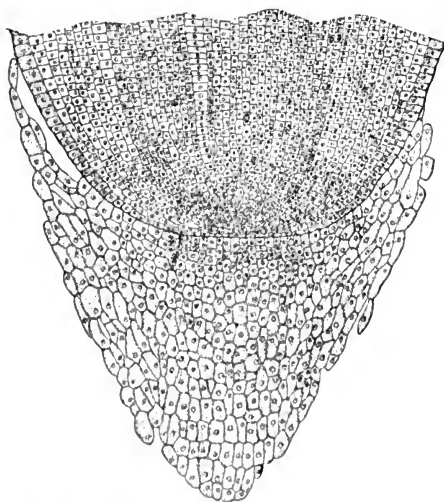
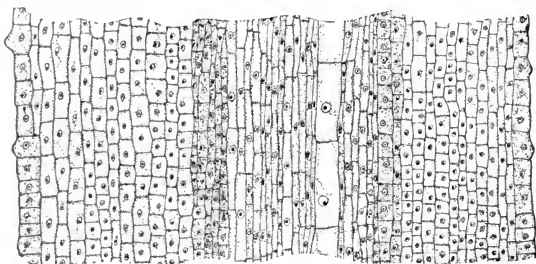
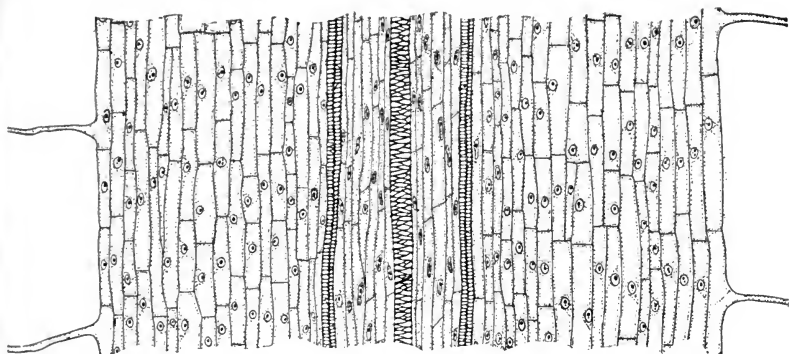

FIG. 162. — Longitudinal sections through a root of Corn, at the growing point, growth zone, and hair zone; highly magnified.

The scale of the drawing is not large enough to permit the representation of all of the details mentioned in the text.

from the root. In cross sections one can see the fibro-vascular bundles lying so closely towards the center as greatly to restrict the area of the pith, or even to obliterate it altogether, though there is always a relatively thick cortex (Fig. 163).

The tips of the soil roots of different plants are far more uniform in size, and especially in diameter, than are the leaves and young stems,—of course because of the more uniform environment presented by the soil. Exact measurements show that in ordinary plants, the roots at the growth zone vary in diameter from .3 to 1.07 mm. with a mean at .67 mm., while the side roots vary from .19 to .79 with a mean at .53, giving a conventional constant of .6 mm. for the diameter of root tips in general. This size bears without doubt a relation to the conditions of water absorption by the roots, analogous to the relation of leaf-thickness to light (page 33), though the precise factors have not yet been determined.

Backwards the young white tips merge gradually into the familiar brown, fibrous roots. Cross sections thereof show the formation of a corky bark, the beginning of a secondary growth in thickness of the bundles (in exogenous kinds), and a general aspect of toughening of the tissues; for this is the part of the root which seems to take much of the strain of the anchorage function.

In herbaceous plants, as a rule, the roots remain fibrous, but in shrubs and trees they grow continuously in thickness by the activity of the cambium, quite after the manner of the stem. Thus they develop a distinct bark and wood, with annual rings, medullary rays, and other features already familiar in stems. Indeed, except for their underground position, such roots are practically stems.

### 3. THE CELLULAR ANATOMY OF ROOTS

As with other plant organs, the cellular anatomy of roots is linked so closely with their functions that the two reciprocally throw light upon one another.

A very thin section cut longitudinally through the tip of an ordinary root, *e.g.* of Corn, presents under the microscope the aspect here pictured (Fig. 162). Close to the conical end stands out the *growing point*, distinguished by its many small, densely-packed cells, which are squarish in section, thin-walled, and filled with the all-important protoplasm. This is the place of cell-formation for the entire tip of the root, the new cells being made by division from a small central group, after which they absorb nourishment and enlarge to the original size. In front these new cells are constantly forming the *root cap*, becoming larger and empty near the outside, where they are continuously abraded away by the forcible passage of the root through the soil. Backwards, in the *growth zone*, the cells hold the regular ranking in which they are formed, but grow rapidly larger, especially in length, while keeping their thin walls, to which the protoplasm comes soon to form only a lining. Each individual cell, in fact, immediately after its formation, goes through a *grand period* of enlargement (page 156), soon reaching its maximum size; and this explains how the growth zone follows so closely behind the growing point. Here also can be seen the beginning of the cellular differentiation of the fibro-vascular bundles, while the intercellular aëration system also is plain, though it does not appear in our drawing. Backward the growth zone merges imperceptibly into the *hair zone*. The hairs originate as slight swellings from the outer walls, and grow rapidly longer until they attain the familiar tube form. In this zone appear also the striking fine spirals of the ducts, of which the mode of formation is clearly apparent in good sections. The end walls in a long line of superposed cylindrical cells break down, under action of digestive enzymes, while simultaneously the spirals begin to appear as local thickenings of the walls.

These sections show further that the outermost layer of cells of the root possesses no breaks or openings of any

description, the walls being everywhere continuous. This absence of stomata is perfectly explained by the habits of roots, which have no chlorophyll and need no cutinized epidermis. The oxygen used in the respiration of the roots passes in solution directly through these walls, which are uncutinized.

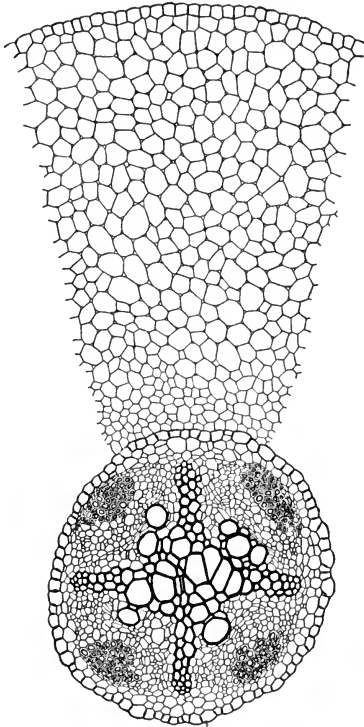

FIG. 163. — Cross section of a root of a Bean, *Vicia Faba*, just behind the hair zone;  $\times 80$ .

The four strands of xylem meet in the center, obliterating the pith, while the strands of phloem stand separately between the arms of the cross thus formed. Between xylem and phloem can be seen the developing cambium, which presently begins to form new xylem inside of the phloem, thus originating bundles of the ordinary stem type. Surrounding the fibro-vascular system is the endodermis, and outside thereof the very wide cortex. (Fibro-vascular system after L. Kuy, the remainder drawn from nature.)

Cross sections bring out several additional features (Fig. 163). Here can be seen more distinctly the innermost layer of the thick cortex, called the ENDODERMIS (Fig. 163), the exact morphological equivalent of the starch sheath of stems (page 130). In the roots, however, the walls of this layer are partially cutinized, especially on the radial parts, for reasons not yet understood. Also there appears a notable difference in the arrangement of the young fibro-vascular bundles as compared with the stem. The xylem, recognizable by the very large size of the ducts, and the phloem, distinguished by the smaller angular form of the sieve tubes, do not

stand in-and-out from one another but alternately, or in different radii. This arrangement, found in all roots, has been viewed as adaptive, in removing the phloem out of the path of transfer of the water from root hairs to ducts; and support is given this supposition by the fact that immediately behind the hair zone the arrangement is abandoned, for the new xylem and phloem made by the developing cambium stand in-and-out from one another as in stems. The method by which the cambium makes the transition from the one arrangement to the other is easily understood by aid of the figure. Endogenous roots do not, of course, form a cambium, but have separated closed bundles as in their stems.

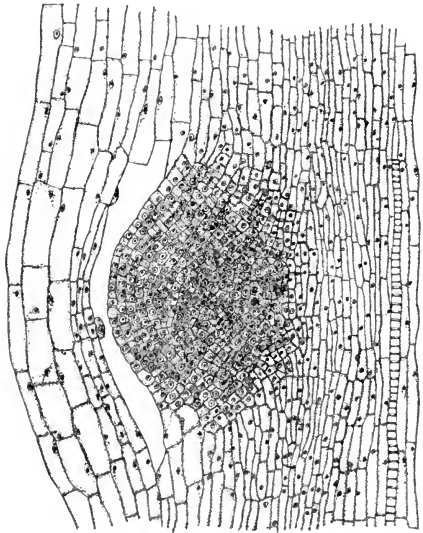

FIG. 164. — Longitudinal section of a root of Corn, showing the origin of a side root; highly magnified.

Just behind the hair zone the cambium begins the secondary increase in thickness, by addition of xylem from its inner and phloem from its outer face, precisely as with stems. Farther back along the root, one can see here and there in cross sections the mode of formation of the new side roots, which come from the fibro-vascular bundles, and make their way to the surface, as already described (Fig. 164).

In the thick woody parts of the roots of shrubs and trees the cellular anatomy is nowise essentially different from

stems. Indeed, except for the relics of their early root anatomy deeply buried within their tissues, and their somewhat greater compactness of texture, such roots are stems, both structurally and physiologically, despite their underground position.

#### 4. THE ABSORPTION OF WATER, AND OTHER FUNCTIONS OF ROOTS

Typical roots perform one primary function, viz. absorption of water and mineral matters; one secondary function,

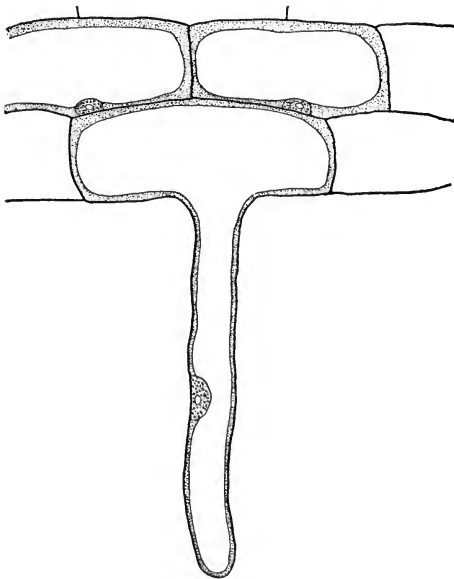

FIG. 165. — Typical root hair, and cortical cells, in a longitudinal section of Radish. (After a wall diagram by Frank and Tschirch.)

viz. anchorage for the stem; and one or two minor functions supplementary to these.

Water is the most necessary of all the materials absorbed by plants, in which it is used for six purposes. *First*, it forms an essential constituent of the photosynthetic food (page 21). *Second*, it constitutes a large proportion of the composition of plants, amounting (as shown by comparative weighings

of fresh and dried material) to more than 90 per cent in most herbaceous parts. *Third*, it holds the soft parts tensely spread by high sap pressure within the cells. *Fourth*, it is a necessary solvent for the many chemical reactions in



progress in plants, such reactions rarely occurring except in solution. *Fifth*, it provides a medium of transport, in form of solution, for substances through the plant. *Sixth*, it is needed to compensate the incessant loss by transpiration. These are the reasons why plants must have plenty of water.

The water used by ordinary plants is wholly absorbed through their roots, and none is taken through leaves or stems. Further, the actual absorption is known to take place in the young parts of roots, and mainly through the root hairs. The hairs are thus effective, not through any special power denied to other cells of the young root, but simply through the great surface they spread. It is because these hairs, tightly adherent to the soil, are mostly torn away when roots are lifted from the soil, that plants commonly wilt on transplanting, and recover only after

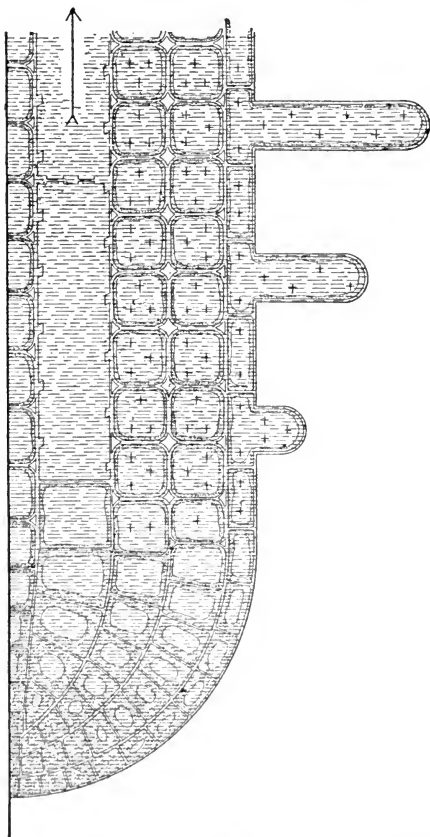

FIG. 166.—A plan of a root as an absorbing mechanism, arranged as in Figs. 11 and 105, with similar signs for water, protoplasm, and sugar. At the tip the growing point; at the left, pith; a duct; two rows of cortex; the root hairs. Note that hairs and cortex contain protoplasm and sugar, but the duct contains neither.

new tips and hairs have again made connection with the water supply.

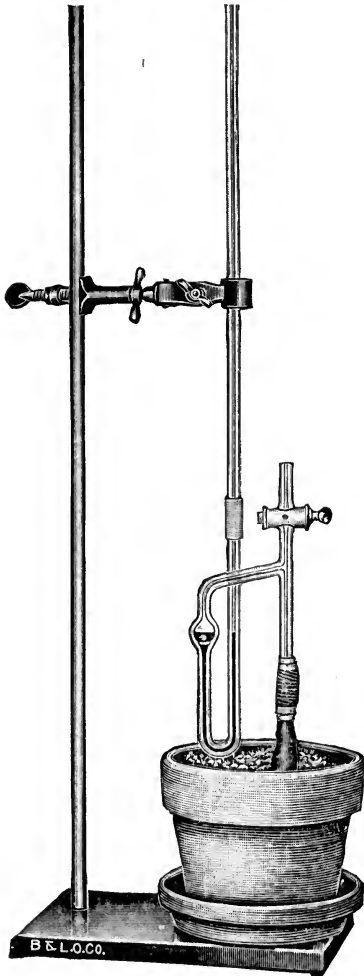

FIG. 167. — A pressure gauge attached to a root for the measurement of sap-pressure;  $\times \frac{1}{5}$ .

The rise of the mercury in the long tube above the level in the reservoir bulb gives the sap-pressure in "atmospheres."

Each root hair is a cell, possessing a cellulose wall lined by living protoplasm (Fig. 165) and a sap containing various substances, especially sugar, in solution. The hairs are in close contact with particles of soil, and bathed in the surrounding water (Fig. 169). In the root they are in contact with the cortical cells, which likewise have cellulose walls, protoplasmic linings, and sugar-containing sap; and the cortical cells in turn are in contact with the ducts which have no protoplasmic linings. A typical example of this absorbing system is shown by an earlier picture (Fig. 159), while its mechanical construction is illustrated by our diagrammatic Figure 166.

The water in the ducts, while sometimes containing sugar and the like, is ordinarily nothing other than soil water, with some mineral matters in solution. Furthermore, this water is forced into the ducts by

the cortical cells under considerable pressure, as manifest to the eye when a suitable pressure-gauge is attached to the cut stump of an active plant (Fig. 167). Thus tested, potted plants will often show a root pressure, *i.e.* a pressure of water in the ducts, sufficient to raise water over thirty feet, while some trees show two or three times as much. This pressure is not enough to raise water to the tops of the tallest trees, but it does give the sap a good start up the stem, after which it is lifted to the leaves by the forces we have earlier considered (page 147). This root pressure, however, is the source of the "bleeding" of broken or pruned stems in the spring, and also of guttation.

What then is the nature of the power by which the root hairs absorb water and give it so forcible a push up the stem? Evidently the water absorbed by the hairs and passed through the cortical cells must pass through walls and protoplasm, which are membranes, and through the cell solutions, which, for simplicity, we can consider as solutions of sugar, their most prominent constituent. Such absorption is known in physics under the name *OSMOSIS*, and so important a part does osmosis play, not only in absorption of water, but also in other physiological phenomena, that the student should not fail to make its acquaintance through experiment. Any simple device in which a membrane, *e.g.* a piece of parchment, separates a sugar solution from water, will serve the purpose; but a specially convenient arrangement is represented in the *OSMOSCOPE* shown in Figure 168. When a solution (molasses is a very convenient solution of sugar) is placed in the parchment tube, which then is immersed in water, the solution will rise in the vertical tube at a distinctly visible rate. If instead of water a solution weaker than that in the parchment tube be used, the result is the same, though the rise is slower. If the water be placed inside and the solution outside, there is no rise, but the tube soon empties, shrinks, and collapses. These phenomena are typical, and the osmotic process may be generalized

thus, — whenever a solution and water, or two solutions of different strengths, are separated by a membrane which they can wet, there is always a movement from the weaker to the stronger at a rate proportional to the difference in strength.

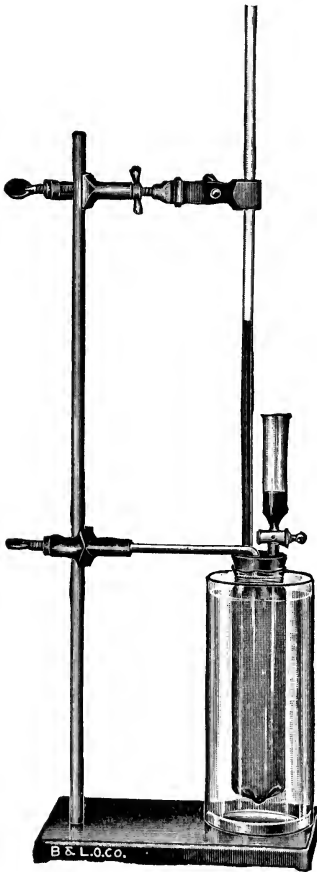

FIG. 168. — An osmoscope, for the demonstration of osmosis;  $\times \frac{1}{3}$ .

The larger jar contains water, the tube inside is parchment paper, and the dark liquid is molasses. When this liquid has risen to the top of the open tube, it can be dropped back to level by opening the stopcock of the reservoir-funnel.

In the foregoing experiment, though the solution rises in the tube, some also escapes into the water, as shown by its color when molasses is used. From the root hairs, however, no sugar escapes to the soil. When we seek a structural reason for this difference, we find that the root hair possesses a protoplasmic lining, which has no counterpart in the tube. It is, however, entirely possible to make up from certain common chemicals, and supply to the parchment tube, a lining which in this respect acts like the protoplasm, viz. it permits water to enter, but no sugar to pass out; and such "artificial cells" are often constructed in botanical laboratories. Thus we see that membranes exist which permit both water and sugar to pass (PERMEABLE membranes), while others permit only water to pass (SEMI-PERMEABLE membranes). This

difference is vastly important in both plant and animal physiology.

It is perfectly clear that the water passes osmotically into the root hair cells, and thence to the cortical cells, which have solutions as strong as the hairs, or stronger. In small simple plants, especially the Moss plants, the water moves thus from cell to cell, throughout the plant. But where ducts are present, as in all of the Flowering Plants and Ferns, the water passes from the innermost cortical cells into those ducts, and does so as pure water, and not as a sugar solution. Why does water *leave* the cortical cells, when it *enters* the similarly constructed hair cells? In a physical machine it would not do so; the cortical cells would absorb water from the ducts, instead of giving it out to them, precisely as in case of the hairs and the soil. Herein we face a still unsolved problem of plant physiology. Several methods are imaginable, though none have been proven; but there is little doubt that the explanation will be found in some simple chemical or physical change controlled by the living protoplasm. Presumably the method is dependent on the relatively great thickness of the cortex in all absorbing roots; and it may prove that each cortical cell contributes a little towards breaking the osmotic hold on the water, the coöperation of many being therefore essential.

In the experiment described a few pages earlier the solution was free to rise. What happens when the tube is closed? In this case pressure always develops, first stretching, and then bursting the cup, unless very strong; and if a suitable gauge be attached, the pressure can be measured. The results are surprising, for with cells specially built for great strength, and the use of strong sugar solutions, osmotic pressures have actually been measured in excess of 24 atmospheres, that is, 360 pounds to the square inch, which is more than the pressure in most steam boilers; and we know that greater pressures occur. In cells of the higher plants the

pressures are much lower than this, usually not more than 10 to 20 atmospheres, though in the lower plants, especially some Molds and Bacteria, there is reason to believe that the pressures rise often far above the 24 atmospheres just mentioned.

Such striking and important phenomena as osmotic absorption and pressure demand explanation, which, however, cannot yet be given with certainty. A close quantitative relation exists between osmotic pressure and gas pressure, on which account some investigators have considered them identical, holding that a substance in solution is virtually in the state of a compressed gas, and exerts a gaseous pressure. Others, however, maintain that nothing more is involved than the adhesive affinity of the sugar, or other dissolved substance, for the water, — the substance confined within the membrane drawing and holding the water which can pass the membrane freely. The most probable explanation makes it a result of the checked diffusive power of the dissolved substance, which cannot escape through the membrane, though the water can enter. As to the passage of water, and (in case of some membranes) dissolved substances, through membranes which seem perfectly solid, that clearly occurs between the ultimate structural units of the membrane, whether molecules or other units. But the subject is too recondite for further discussion at this place.

The mineral matters needed by plants are compounds which contain the following seven elements, — viz. *nitrogen* (which plants cannot absorb from its uncombined state in the air, and therefore must obtain from compounds in the soil); *sulphur* and *phosphorus*, integral constituents of proteins, and therefore of living protoplasm; *potassium*, needed for incidental processes in connection with the formation of carbohydrates; *calcium*, a neutralizer of injurious substances; *magnesium*, an integral constituent of chlorophyll, with *iron*, incidentally necessary in some way to the formation thereof. These elements all occur in mineral

salts dissolved in the soil water with which they are absorbed into the plant. Though other mineral matters are also absorbed, only those which contain these elements are invariably essential; and if we add the three elements, *carbon*, *hydrogen*, and *oxygen*, we have a list of ten elements, indispensable to the life of the higher plants.

Not all of the mineral salts dissolved in the soil water are absorbed equally by plants, or in the same proportions by different plants; but in how far this seeming "selective power" of roots is merely incidental to their physical and chemical constitution, and in how far it acts adaptively to the needs of the plant, is still uncertain. Probably, as in most such phenomena, something of both is involved.

Such is the method of the primary function of roots, that of absorption. The second function, anchorage of the plant in the ground, is chiefly mechanical and comparatively simple. Against the lateral strains upon stems from the action of winds, a suitable resistance is provided in the radiating disposition of the roots, with their tough cord, or cable, type of construction. There is good reason to suppose that roots subjected to the greatest strains may become thicker and tougher in adaptive self-adjustment thereto, in the very same way that our own muscles grow stronger through exercise.

In addition to the two functions which roots perform as their peculiar contribution to the economy of the plant as a whole, they have also certain others essential to their own individual well-being,—notably respiration and growth. Respiration in roots has precisely the same method and meaning as in other parts of the plant (page 165). Roots, accordingly, require air, and this need has a dominating influence upon many features of their habits and structure. In plants which live in bogs, marshes, swamps, and other places of standing water, the air is usually transferred to the roots from the leaves along the intercellular air system, which in such cases is specially developed. By ordinary

roots, however, air is absorbed from the supply contained in the porous soil. Roots have no stomata, or other openings in their equivalent for an epidermis; but the air in the soil becomes dissolved in the water, and goes in solution through the saturated walls into the cells of the root, from which it passes to the air spaces, where it re-collects in the gaseous form and thus reaches other parts of the root. The carbon dioxide produced in respiration diffuses out to the soil by exactly the reverse process. It is because of self-adjustment to a more abundant air supply (aërotropism) that most of the roots of great plants do not commonly penetrate far into the ground, but keep close to the surface. This is also the reason why trees commonly die when their roots are deeply buried, as sometimes happens in grading around new buildings.

Protection of roots against desiccation, the ever present danger to leaves and stems, is effected incidentally by their position within the damp ground. Thus it is possible for the young tips to dispense with a cutinized epidermis, which would be inconsistent with their absorptive function. The older roots develop a bark, but it is thin as compared with that of the stems.

### 5. OSMOTIC PROCESSES IN PLANTS

The absorption of water by roots is only one of several important plant processes in which osmosis has part. It is important to recall that osmosis is a physical process, though living protoplasm may regulate the conditions of its operation: that it occurs wherever in Nature two solutions of different strengths are separated by a membrane they can wet: that in such case there is always a movement from the weaker to the stronger solution: that the movement involves both solvent and dissolved substance in case of permeable membranes, but the solvent only in the semi-permeable kind: that the stronger solution will swell and rise if free, but when confined will develop pressure which can become very great. Also its rate is directly proportional to temperature.



The most striking utilization of osmotic pressure by plants consists in the maintenance of the form and rigidity in leaves, young stems, flowers, and other soft herbaceous parts. So small is the percentage of solid matter in such tissues (not over 10 per cent, with 90 per cent of water), and so thin and flexible the cell walls, that they cannot alone sustain their own weight, as shown by their collapse in wilting. These herbaceous parts are held tensely stretched and outspread in their characteristic forms by the osmotic pressure of their sugar-containing sap inside the thin-walled cells, the needful water being supplied from the ducts. That herbaceous tissues owe their stiffness to osmotic turgescence may be proven conclusively by the simple experiment of immersing them in a solution having a greater osmotic strength than the sap, in which case of course an osmotic movement out of the cells will take place. The result is always a collapse of the tissues even more striking than wilting produces. It is true the experiment works badly with leaves and stems, because the waterproof epidermis almost prevents osmotic movement; but the effect is perfect in parts without epidermis, such as strips cut from Potatoes or Beets. These become soft and flexible after only a few minutes' immersion in strong sugar or salt solution, although comparison strips are rendered stiffer and harder than ever by immersion in pure water. Not only do such tissues become flaccid by wilting or immersion in strong solutions, but they also shrink in area, thus proving that the tense cells are held actually stretched by the osmotic pressure within them. The stiffness which pressure of water can give is familiar also in fire-hose.

Equally important is the rôle of osmotic pressure in growth, for it supplies the mechanical power whereby the newly formed cells expand in size, often against much resistance of the overlying tissues. The young cells osmotically absorb water, and the resultant pressure stretches the wall, in which new cellulose is continuously laid down by the proto-

plasm until the cell is full-grown. By use of the same power roots force and enlarge for themselves passages through hard soil, even prying aside stones in the process; and by the same power they disrupt masonry and lift curbstones in streets. So essential is osmotic pressure to growth, and hence so indispensable is adequate water to growing plants, that any marked scarcity of water, or rapid removal thereof from the plant, always checks its growth. This is why the growth rate of a plant always falls, other things being equal, when transpiration becomes active, and vice versa: why plants tend to grow faster at night than in daytime: and why growth usually is checked with the sunrise.

The question must now occur to the student, whether osmotic pressure can ever become so great as to strain if not burst the plant cells. This does in fact sometimes happen. Thus some fruits, notably Plums, in warm moist weather occasionally burst, from this cause, on the trees. In Tomato plants, watery blisters are sometimes formed osmotically, producing a kind of "physiological disease" called Oedema. Most kinds of pollen (the small yellow grains producing the male cells in flowers), when placed in water, swell and burst, of course to their destruction. This result would be caused by the rain were it not that in most flowers the pollen is well protected therefrom by its position, or other arrangements, as will later be noted (page 295). A case of protective adjustment against excessive osmotic pressure seems involved in the starch formation in leaves. In green leaves in the light, as the student will recall, the appearance of starch is always preceded by the formation of sugar, the starch being formed only after a certain concentration of the sugar has been reached. The starch, however, is always re-converted to grape sugar when the concentration again falls, and thus is translocated into the stem. Now this seemingly useless formation of starch finds an explanation in the fact that while grape sugar exerts osmotic pressure, starch exerts none. The conditions are all consistent with the supposition that

as the concentration of the photosynthetically-formed sugar approaches a quantity which might exert injurious action on the cell, the surplus is converted automatically into starch. The insoluble proteins found abundantly in sieve-tubes have presumably a like explanation, as has the cane sugar found in some leaves intermingled with grape sugar, for cane sugar, weight for weight, exerts only about half the osmotic pressure of grape sugar. In this latter fact, indeed, is probably found the reason why cane sugar is so much more common a storage form than grape sugar, as Sugar Cane, the Maple tree, and Sugar Beets illustrate. The fact that such changes, easily effected by plants, can produce so great a difference in osmotic properties may help to explain how the water is released from the cortical cells of the roots (page 229).

A striking and important feature of osmotic phenomena in plants is this, — that the living protoplasm lining the cells can act either as a permeable membrane, permitting both water and dissolved substances to pass, or as a semi-permeable membrane, permitting only water to pass, or can act at one time as one kind and at another as the other. These various movements, complicated by the nature of the many chemical substances present, and by special phenomena of diffusion, solution, imbibition, and like molecular processes, explain, on a purely physical basis, many of the most important phenomena in plant physiology.

Aside from the living plant, many osmotic phenomena in plant tissues are familiar in our daily experience. When shrunken currants or raisins are immersed in water, especially if heated in cooking, they swell tensely, — for there is sugar in their cells. Berries cooked with little sugar swell and burst (though expanding air confined in the tissues also plays a part); but cooked with much sugar, as in preserving, they collapse. Dry sugar placed on fresh strawberries soon becomes a sirup, while the berries soften and shrink. The osmotic explanations are all obvious. We place cucumbers and celery in cold water to crisp them, that is to make their

soft cells more tense and explosive; but warm water is not used because it tends to fill the air spaces and thus deaden the explosions. Sugar and salt are effective preservatives of fruits and meats, though not in themselves deadly to the living organisms (germs) which cause decay; and the fact that those substances must be used in great strength suggests the explanation, that they inhibit the activity of the germs by osmotically robbing them of water. Beans or rice are cooked more quickly and perfectly if not salted until nearly done, and indeed if placed in water too strongly salted at the start may refuse to swell at all. The sensation of thirst which follows the eating of much sugar or salt has apparently this basis, that those substances withdraw water from the stomach, thus causing the thirst sensation. The student will be able to cite other examples of osmotic phenomena in daily experience.

Closely connected with osmosis, of which it is part, is DIFFUSION. When the molecules of a substance are removed beyond the range of one another's cohesive attraction, as in a gas or a solution, they acquire an active back-and-forth motion from the kinetic energy of the heat waves reaching them from the surroundings. Thereby they strike and rebound from one another, and hence are worked outward, exerting pressure if confined, but spreading indefinitely if not. Accordingly *by diffusion any substance as a gas or a solution always tends to work away from places of greater to places of lesser concentration, and away from a place where it is being produced, and towards a place where it is being absorbed, each substance diffusing in general as though it alone were concerned.* Familiar phenomena of gaseous diffusion occur in the spread of odors through a house, of floral fragrance through gardens, and of smoke through the air; while solution diffusion is illustrated by the spread of ink or sugar through water. This is the way that carbon dioxide, in photosynthesis, passes from the great reservoir of that gas, the atmosphere, through the stomata and along the air-

passages to the places of use in the chlorenchyma; and the way in which the oxygen as released passes outward along the same passages and stomata. It is also the method by which sugar and proteins made in chlorenchyma cells pass from cell to cell until the veins are reached, and then along sieve tubes and sheath cells to places of storage or use in stems or roots. It is probably also the ultimate source of osmotic pressure, which is diffusion pressure (page 230). No matter, however, what the details may be, the energy of diffusion is in all cases the same, — heat from surroundings.

Two other physical processes important in plant physiology must here receive mention. Cell walls, if of cellulose or lignified but not if cutinized, absorb water forcibly by **IMBIBITION**, which rests fundamentally upon adhesive affinity between wall and water. A familiar manifestation occurs in the warping of boards, which occurs as result of access of water from one side, or its removal from one side by heat. Likewise certain dry cell walls can absorb water as vapor from the air, even producing forcible swelling and movements of the structures concerned; and such **HYGROSCOPIC** phenomena occur in connection with the dissemination of seeds, and elsewhere, as will later be noted. The other process is **CAPILLARITY**, that power by which water rises or sinks in small passages according to whether it wets them or not, the energy being furnished by forces of tension within the liquid itself. Capillarity, however, plays but minor part in the physiology of most plants, though it has an indirect importance through its influence on the movements of water through soils.

## 6. THE COMPOSITION AND STRUCTURE OF SOILS

Roots have most intimate connections with soils, which must therefore be considered in connection with root physiology. Besides, soils have high interest on their own account, and because of their importance in agriculture.

Soils are far more complex than they look, having no less

than six primary constituents, viz. pulverized rock, water, air, humus, dissolved substances, and micro-organisms. These are by no means intermingled without order, but have relations to one another which result incidentally in a kind of crude structure.

**PULVERIZED ROCK.** This constitutes the great bulk, fully 90 per cent, of ordinary soils. It is derived from the solid crust of the earth either by chemical *decay* of the rock or else by mechanical *attrition*. Attrition occurs by force of moving ice, as in glaciers (which have ground the surfaces of most northern countries), or else of running water, as in rivers, which forever are grinding the boulders in their beds to fine silt. Thus we find every gradation, from great boulders down through gravel and sand to silt and the finest clay. Under the microscope any soil presents the aspect of rough-angular fragments of rock, variously colored, and more or less crystalline. The weight and mutual pressure of these rock particles provide the resistance needful in the anchorage function of roots, while their irregularity in size and shape, forbidding a tight packing together, insures the open irregular spaces through which water and air can circulate in the soil. These features are well shown in our generalized drawing (Fig. 169).

**WATER.** This comes second in abundance though first in importance of the soil constituents. It furnishes the entire supply to ordinary plants, which can take none through their leaves or stems. It comes into the soil either direct from the rain or else by way of capillary movement up from lower levels. It is sometimes so plentiful as to saturate a soil, that is, fill its spaces completely, as occurs temporarily in all soils after drenching rains and permanently in bogs and swamps. Such a standing, or **HYDROSTATIC**, condition of the water is not beneficial to ordinary plants, because, while supplying far more than they need, it displaces the air essential to the respiration of the roots. As this too plentiful water drains or dries away, however, the larger spaces be-

come emptied, and refill with air, though the water still lingers in the smaller passages and angles in the CAPILLARY condition. Such a soil is moist, and its combination of water and air provides the very best conditions for roots, though one that is nowhere constantly found. It is the condition represented in our drawing (Fig. 169). As the

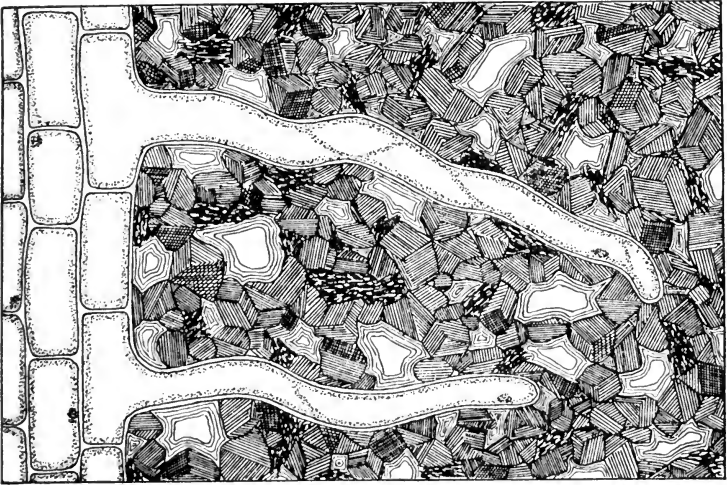

FIG. 169. — A generalized drawing of a section, highly magnified, through a good soil and a portion of a root with root hairs.

The soil particles are cross-lined, the water is concentrically-lined, the humus is black, and the air spaces, in the soil, are left white.

water is further removed, by evaporation and root absorption, some moisture continues to cling tenaciously in thin films around the particles of soil, from which it is removed with greater and greater difficulty the thinner the films become. Upon these HYGROSCOPIC films plants must depend for their supply during much of the time; and it is apparently for absorption from them that the root hairs, flattened tightly against the soil particles, are especially fitted (Fig. 170).

The hygroscopic water films have an important relation with the soil particles. Not only do the films cling very

closely to the particles, but they are themselves, through internal cohesion and surface tension, tenaciously strong; and thus they are brought into a state comparable with stretched rubber. On the other hand, the water molecules are extremely mobile within the films, as if they were the best ball bearings. From this combined tenacity and mobility of the films, it results that when water is with-



FIG. 170. — A root hair in the soil, showing its intimate contact with soil particles;  $\times 240$  (about). (After Strasburger.)

drawn from any part of the soil, whether by root hairs or by evaporation, the films directly affected draw upon the others with which they are connected, and these upon others, so that the draft is thus made over a considerable distance. Hence a plant is not dependent for its water supply upon the soil with which its roots are in actual contact, but can draw from a far wider area. This explains why a house plant dries out the soil of the pot uniformly; how Cactus and other desert plants draw from great areas, growing well spaced apart; and why deep homogeneous soils, like those of the prairies, supply water so evenly to crops. Furthermore, since the water films have in general the same thickness regardless of the size of the soil particles, a fine soil can retain more water than a coarse one, which is why clay holds more water than sand.

**AIR.** This forms the third in abundance of the constituents of ordinary soils, and is the source of the indispensable oxygen for the respiration of most roots. It fills the irregular spaces not occupied by water between the rock particles (Fig. 169) and is ordinarily continuous with the atmosphere above ground. In places of permanent hydrostatic water, like swamps, the air is excluded, and only such plants can there live as have large air passages to the roots from the leaves, or are able to absorb dissolved oxygen directly into their submerged bodies



from the water. It is in order to introduce air into such soils that we drain them preparatory to growing crops.

When air stands long in a soil, it loses part of its oxygen and accumulates carbon dioxide from root respiration. Accordingly it is better for plants that this vitiated air should be expelled at intervals, and replaced by a fresh supply. Such a result accompanies soaking rains; and the keeper of house plants does well to imitate the method by giving the plants an occasional thorough soaking, and allowing them to dry out in large part between times. Such treatment is much better than a frequent addition of small amounts, for the latter method does not effect renewal of air.

**HUMUS.** This comes fourth in abundance of ordinary soil constituents. It comprises the dark-colored vegetable matter, mostly the remains of decaying roots, which to the eye of an expert is so characteristic a mark of a good soil. A mixture of humus with sand and clay constitutes **LOAM**, the best of garden soils. The proportion of humus in soils varies greatly, from almost none through an optimum amount (represented in our picture (Fig. 169), to a very great deal, as in **MUCK**, which owes its black color thereto. Bogs consist almost wholly of a kind of humus, called **PEAT**, which only partially decays, and therefore accumulates. The value of humus in a soil, from the plant point of view, is four-fold. It lightens, or opens, a soil, thus increasing its aëration capacity; it helps to retain moisture, being very absorbent; it adds substances, by its decay, to the soil solution, some beneficial and some harmful, though our knowledge of these matters is scanty as yet; and most important of all, it supports numerous micro-organisms, which play a first rôle in soil fertility.

**DISSOLVED SUBSTANCES.** In the soil water occur many dissolved substances, and therefore it becomes a **SOIL SOLUTION**. Though profoundly important to plant life, the actual quantity of such substances present is relatively small, even the richest soil possessing only a small fraction of 1 per cent al-

together. Most important are the mineral salts necessary in the nutrition of plants, and therefore commonly, though not quite correctly, called "plant foods" (page 28). They consist in compounds of *nitrogen*, *sulphur*, *phosphorus*, *magnesium*, *iron*, *potassium*, and *calcium*, having the uses in the plant already described (page 230). They come into the soil solution chiefly through chemical disintegration of the rocks which contain them, but to some extent through action of living organisms, as will be further described a page or two later. These natural sources of supply are sufficient in case of wild plants, which, by decay, return their substance to the ground; but under cultivation, where great quantities of mineral matters are annually removed with the crops, some are apt to run short and must be replaced artificially, which is accomplished through fertilizers. The mineral salts which usually first become scarce are compounds containing nitrogen, phosphorus, and potash; and since all three are abundant in barnyard manures, we can see the agricultural value thereof. Nitrates, phosphates, and potash salts, obtained from other sources, are also used commonly as fertilizers. Such, at least, is the older and, among farmers, still prevalent belief as to the rôle of fertilizers in the fertility of land. But of late some leading investigators have advocated a different view, based on the claim that the soil solution supplies all of the mineral salts which plants ordinarily need, even on much-cropped land, the fertilizers finding their use chiefly in the neutralization of other unfavorable conditions in the soil.

The functional use of the different mineral salts to plants is inferred from various lines of evidence, but chiefly from the results of WATER CULTURE (Fig. 171). Many herbaceous plants can be grown from seed to maturity with the roots in water, their well-developed aëration systems providing sufficient oxygen to their roots. By using pure (distilled) water as a basis, it is possible to supply to a plant all of the necessary mineral salts except some given one, in which case the

peculiarities of the resultant plant give a clew to the rôle of that substance.

In addition to the mineral matters the soil solution contains small amounts of diverse organic substances, partly beneficial to plants and partly injurious. They are mostly set free by the decay of humus, which was originally living tissue containing proteins, carbohydrates, and other classes of substances; but some appear to be formed as excretions of living roots. It was an old belief, long abandoned but now revived with new evidence, that roots excrete substances injurious to themselves, though commonly harmless to other kinds; that the accumulation of such substances tends to poison a soil for the plants which produce them; and that soils rendered barren by long use of one crop are not exhausted of necessary mineral salts, as commonly supposed, but are poisoned by the accumulation of these excretions. But these matters are still in debate, and their decision must await further evidence.



FIG. 171. — Typical illustration of the methods and results of water culture;  $\times \frac{1}{10}$ .

The plants are Buckwheat. To distilled water in the middle jar were added all of the mineral salts needed by the plant; to that on the left, all except potassium; to that on the right, all except iron. In the latter case the upper, less shaded, leaves are white, not green, in the plant. (Originally from works of Pfeffer.)

**MICRO-ORGANISMS.** Last in prominence, though not in

importance, of the soil constituents are certain minute living organisms, viz. *Fungi*, *Bacteria*, and *Protozoa*.

*Fungi*, of certain small kinds, develop in contact with the tips of the roots of many plants, particularly such as live in much humus, weaving around them a close cover of mycelial threads, which replace the root hairs (Fig. 172). This

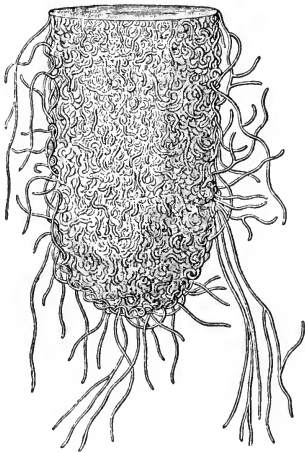

FIG. 172.—Typical Mycorrhiza, on the root of European Beech;  $\times 120$ .

The entire root tip, back to beyond the hair zone, is completely and closely covered by a felted mass of mycelial threads, which extend also into the soil. (After Frank and Tschirch.)

MYCORRHIZA, as it is named, absorbs water and mineral matters which it transmits to the roots; and there is some reason to believe that it also absorbs soluble organic matters set free in decay of the humus but useful again to the plants. The association seems clearly beneficial both to fungus and flowering plant; and accordingly we have here one of the cases where two different organisms derive benefit from their association, a condition called SYMBIOSIS. Some kinds of soil *Fungi* seem also to have the same powers as *Bacteria*, next described, in relation to soil nitrogen.

*Bacteria*, already known to the student as the smallest and simplest of living organisms, are abundant and of many kinds in all soils; but the most important are those which effect NITRIFICATION and NITROGEN FIXATION. Nitrogen, a constituent of the protoplasm, is one of the substances most indispensable to plants; but although it composes four fifths of the atmosphere, the higher plants are unable to take it from that source, and have to rely upon compounds absorbed in solution through the roots. The presence of mineral salts containing combined nitrogen is therefore one

of the most important, perhaps the most important, factor underlying soil fertility. Moreover, the supply needs constant renewal to compensate for loss by drainage and removal from the land with the crops. Now it happens that some kinds of soil Bacteria have the power to change certain nitrogenous substances, notably ammonia, common in soils but not usable by the higher plants, into other nitrogenous substances, notably nitrates, readily usable by those plants; and such *nitrification* of soils, while it only transforms, and does not add nitrogen compounds, is yet an important element in soil fertility. Further, there are other kinds of soil Bacteria which possess the power to take free nitrogen from the air and incorporate it into compounds in their own bodies; and such *nitrogen fixation*, on decay of their bodies, adds nitrogen to the soil, and is the chief

source of supply in soils of that indispensable substance. Both kinds of Bacteria live in the humus, or at least are dependent thereon for most of their food, in which fact lies the principal reason for the association of humus with good soils.

The nitrogen compounds formed by these Bacteria become ultimately dissolved in the soil solution, whence they are absorbed by the roots of higher plants. In a few families,

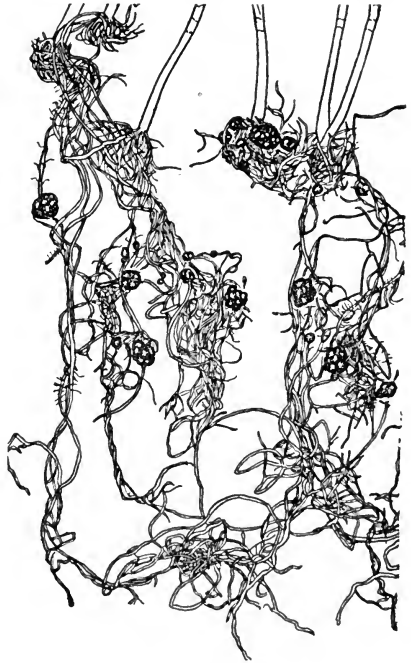

FIG. 173.— Typical root nodules (or tubercles), on roots of Lupine;  $\times \frac{1}{3}$ . (Drawn from a photograph.)

however, and conspicuously the Pulse family, the relation is more direct, for the nitrogen-fixing Bacteria live in the tissues, in the nodules so familiar on the roots of Beans and Peas (Fig. 173), to which the compounds are thus supplied with minimal loss. There is obvious connection between this economical arrangement and the fact that the seeds of Leguminosæ are richest of all plant products in nitrogenous substances, particularly proteins, thus coming nearest to meat in food value.

The importance of nitrogen-fixing Bacteria in soil fertility has of course suggested the attempt to enrich poor soils by adding the suitable Bacteria thereto. Many attempts have been made to this end, but while successful as laboratory experiments, they have not as yet achieved importance in practice.

To complete the subject of nitrogen acquisition by the higher plants, we should note that such has been held to explain the insectivorous habits of the pitcher plants and others which trap insects (page 76). The plants which capture insects digest the bodies thereof, and absorb into their own tissues the resultant substances, which of course are particularly rich in nitrogenous materials. In general, the insectivorous plants are found in places where the nitrifying Bacteria of soils are unlikely to be found, — our *Sarracenias* and *Sundews* in bogs, the *Venus Fly-trap* in sand, and the *Nepenthes* on the trunks of trees.

*Protozoa* are minute one-celled animals, typified by the creeping *Amœba*. They abound in rich soils, the fertility of which they are now claimed to influence. It is found that any methods of treatment, by heat or poisons, which kill these *Protozoa* but not the Bacteria, produce increased fertility; and since it is likely the *Protozoa* feed upon Bacteria, the inference is drawn that the destruction of the former permits increase in numbers of the latter, with proportionally better nitrification and nitrogen-fixation. Here again, however, we must await further evidence.

## 7. THE SELF-ADJUSTMENTS OF ROOTS TO PREVAILING CONDITIONS

Roots possess in remarkable degree that property of individual adjustment to the peculiarities of their immediate surroundings, such as was earlier described in the phototropism of leaves and the geotropism of stems.

Geotropism, indeed, is no less characteristic of roots than of stems. The first root which issues from the germinating seed always grows over to point directly downward, no matter in what position the seed happens to lie (Fig. 119). It is described as positively geotropic, or PROGEOTROPIC, the main stem being negatively geotropic, or APOGEOTROPIC. The secondary or side roots possess transverse geotropism, growing out horizontally, or nearly so, and are described as DIAGEOTROPIC. The tertiary roots, however, those which grow from the side roots, are hardly geotropic at all, and therefore respond more freely to the other influences next to be mentioned. The adaptive explanation of such geotropic growth is obvious, for thus the main root is brought in the quickest way to the water supply, essential to the further growth of the young plant; the side roots are spread at angles which take them into the widest area of soil, while giving them angles advantageous to their anchorage function; and the tertiary roots are left free to wander wheresoever the materials needed by the plant are most abundant.

Especially characteristic of roots is their HYDROTROPISM, or sensitive adjustment to moisture in the soil. Roots not only grow towards soil moisture, but branch and grow more profusely in moist than in dry places. A practical exemplification thereof is found in the filling of drain pipes by tree roots (Fig. 174). The adaptive explanation of hydrotropism is sufficiently clear; since the primary function of roots is the absorption of water, they need to find the most abundant supply. The actual operation seems to be this, — the tip of the root is sensitive to differences in

the quantities of moisture coming from different directions; it transmits a suitable influence to the growth zone; this zone swings the tip over towards the moister side until the

stimulus is even all around; then the root continues its growth in that direction. It is important to note that leaves and stems, neither of which absorb any water, are not in the least hydrotropic.

A third self-adjustment of roots takes them towards air, — AËROTROPISM. Other things being equal, roots grow towards the places in the soil where air is most plentiful. At first sight it would seem that hydrotropism and aërotropism must neutralize one another, since in general much water in the soil means little air, and vice versa. In fact, however, a complete saturation of the soil gives more water than plants can make use of, just as we have found that full summer sunlight gives more light than can be used by leaves (page 56); and it is towards the optimum combination of water and air, best for root life, that roots are guided by their aërotropism, when their hydrotropism is satisfied. It is because this optimum combination of water

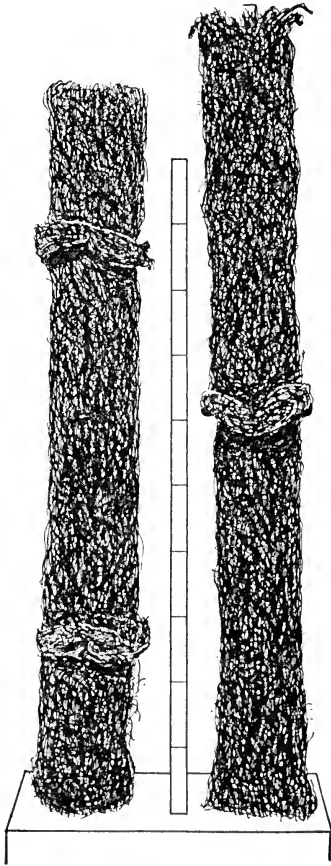

FIG. 174. — Masses of roots, of a Willow, which filled drain pipes. The rod between them is a meter stick, cross-marked in decimeters. The apparent cross folds mark the collars where the tiles were joined. (Drawn from a photograph.)



and air, with mineral matters, occurs commonly in drain pipes that roots are prone to enter and fill them. The adaptive explanation of aërotropism is of course very plain; it is found in the need that all roots have for air (*i.e.* oxygen), indispensable to their respiration, which underlies all of their growth and work.

Aërotropism is really but one phase of CHEMOTROPISM, or self-adjustment to particular chemical substances, of which several forms are known. Thus, some roots grow towards a greater supply of the mineral substances they specially absorb, though their behavior in this respect is not always consistent, nor is it well understood. They show also several minor "tropisms," of which TRAUMATROPISM, or a turning away from injurious contacts or substances, is best known.

All of these tropisms are typical cases of irritability, the equivalent of reflex action in animals (pages 55, 176). The response is not forced by the moisture, air, etc., but simply guided thereby, the work of turning being done by the plant. These phenomena in roots are especially interesting because the place of perception of the guiding stimulus is usually the growing point, while the place of response is the growth zone just behind it. Thus we have an arrangement comparable with that in animals, where special sense organs receive the stimuli, and a separate muscular system makes the responses.

In most plants the young main root is so strongly geotropic that it can be deflected only a limited amount from the vertical position by other influences, but the tertiary and later formed roots have so weak a geotropism that they respond to other stimuli very freely. And here must naturally arise this question: What happens in cases where two or more different stimuli act simultaneously upon the same root from different sides? In some few cases the stimuli seem to influence one another's action, but in general the root attempts to respond to them all. The position that is actually taken is then a resultant, depending upon the

directions of the stimuli and the relative sensitiveness of the roots thereto.

The student will be interested to read at this point the fine passage which closes Darwin's book "The Power of Movement in Plants." He should keep in mind, however, the fact that a thread of simile and fancy runs through the paragraph, to the matters of which our modern science now gives a somewhat more mechanistic interpretation.

### 8. THE ADDITIONAL, AND SUBSTITUTE, FUNCTIONS OF ROOTS

While the great majority of roots have the typical forms and functions already described, there are some which perform additional and even substitute functions, with corresponding modifications of structure.

As in case of other plant organs, roots which perform the typical functions yet exhibit marked diversity of form, usually in clear correspondence with different habits. Thus the difference between the tap root and a mass of fibrous roots (page 212) is of this nature. Again, the relative importance of the absorbing and anchorage function varies much, the latter being highly important in great trees, and almost negligible in low herbs, especially such as have underground rootstocks; and corresponding differences in structure are manifest. The only roots of the low-growing Bryophytes are the great root hairs, or RHIZOIDS, effective in absorption, but obviously having little utility, as there is little need, for anchorage. The depths to which typical roots descend vary also, for while those of swamp and bog plants keep near the surface, obviously in relation to air supply, those of some desert plants reach at least to sixty feet, as in the common desert shrub called Mesquite, evidently in adjustment to the water supply. And other differences are revealed by intensive study, — some most reasonably explained as adaptive, others as hereditary, and others as structural or incidental. Yet the diversity presented by

such roots is insignificant in comparison with the corresponding diversity in leaves and stems. The explanation is found no doubt in the fact that the conditions of life underground are much more uniform than conditions of life in the air.

The commonest additional function of roots is *storage*, mostly of food, but partly of water, which occurs in all degrees, from so little as not to affect perceptibly the root shape, up to the production of a rotundly-swollen organ.

The storage is oftenest in tap roots (which perhaps originated in this way), as familiar in Carrots, Beets, and Turnips. In other cases side roots are specialized, as exemplified in Dahlia and Sweet Potato, where they become tuberous (Fig. 175), and would be hard to distinguish from stem tubers, were it not for the absence

of eyes. Anatomically, as functionally, stem and root tubers are closely alike. As with stems, when starch is principally the food the texture is hard and white (*e.g.* Turnip): when sugar, it is softer and translucent (*e.g.* Beet): and when water, as in some desert plants, it is markedly succulent and almost transparent.

Those flowering plants which have returned in their evolution to a life in the water (*e.g.* Water Lilies and Pondweeds) exhibit naturally a marked reduction in the root system. Their roots are smaller in size and usually lack both hairs

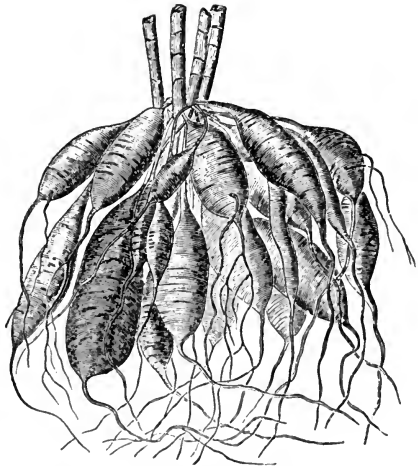

FIG. 175. — Typical tuberous roots, of Dahlia;  $\times \frac{1}{2}$ . (From Strasburger.)

and the cap, though in some the cap is imitated by a pocket-like cover, and the hairs by slender side roots. The reduction leads even to complete disappearance of roots in some immersed Pondweeds, which absorb through their leaf and stem surface, precisely as did their far-distant ancestors, the Algæ. Herein we have a clear case of the widespread

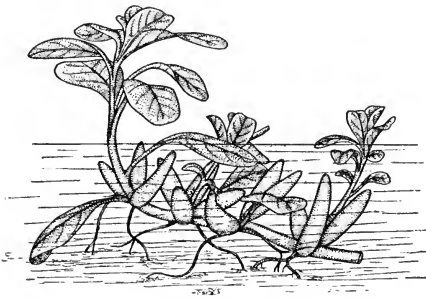

FIG. 176. — *Jussiaea repens*;  $\times \frac{1}{3}$ . The swollen structures are roots, composed chiefly of aërenchyma; when young their tips reach the surface and they become filled with air, which later they supply to the parts under water. (After Goebel.)

tendency for parts rendered useless by a change of habit to disappear gradually, often after lingering long in a rudimentary condition.

There is in some plants another and very different correlation between root structure and water habit. Some common herbs when grown in wet places

develop at the contact of air and water a loose open tissue involving large intercellular spaces (AËRENCHYMA), which seem to transmit air to the under-water parts. In a half-floating water plant called *Jussiaea repens* (Fig. 176), some of the roots develop this tissue immensely, becoming enlarged to conspicuous white spindles which rise vertically to the surface, whence they evidently take air for use of the under-water parts. Thus we have roots with a new substitute function, that of aëration. The Bald Cypress, a prominent tree of the southern swamps, develops from its roots remarkable projections, or "knees," which commonly reach the water surface, and are so constructed as to suggest their use as aërating organs for the roots, though such function has been denied. Other structures of analogous sort are found in Mangroves and elsewhere, as described in works upon water plants.

In a few kinds of plants the roots are AËRIAL, that is, fitted to live in the air, temporarily or permanently; and they exhibit corresponding modifications in structure. The simplest case is illustrated by Corn, where roots grow out on the stem a little above ground and run diagonally to the soil, there acting as props to the stem, as well as organs of absorption. This arrangement is much farther developed in some tropical plants, notably the Screw Pine, or *Pandanus* (Fig. 177), where these roots come to form almost the whole support of the plant, the main stem remaining small. Similar

roots, but more irregularly placed, cause the Mangroves of tropical shores to form their dense thickets. There are tropical plants, belonging mostly to the Fig family, of which the seeds germinate high up in the crotches of trees to which they happen to be carried; thence the growing plants send down aërial roots which, on reaching the ground, thicken to trunks so robust that often they strangle the supporting tree, leaving the strangler a several-trunked tree in its place. Analogous effects occasionally are seen in our



FIG. 177. — *Pandanus*, showing the stilt-like roots. (From Balfour.)

own woods where trees have started on top of moss-covered boulders, excepting that here the boulder does not vanish. By similar aërial roots, put down vertically from horizontal branches and later developed to trunks, a single Banyan tree is enabled to spread to a many-trunked grove covering several acres (Fig. 178). There is no difficulty, of course, in understanding how roots can form trunks, since everywhere behind their young tips all roots are practically stems in their structure (page 220).

The extreme of the aërial habit is attained in some roots which never reach the ground. Thus, in the epiphytic

Orchids (Fig. 126), familiar in all greenhouses, while some of the roots penetrate the crevices of decaying bark and therefrom absorb both water and mineral matters, others hang down free in the air. The latter display a distinctive, swollen, whitish aspect, the thickness being due to the presence of many epidermal layers of loose, empty cells. Into these the water from rain is easily absorbed and thence



FIG. 178. — The Banyan, *Ficus religiosa*, of India.

All degrees of development of the descending aërial roots appear in the view. The tree is a small and very open one. (From Balfour.)

transferred to the fibro-vascular system, though the popular belief that such roots can absorb water as vapor from the air seems unfounded. In some kinds of Orchids the aërial roots, hanging in the light, show traces of chlorophyll, while in a few tropical kinds (Fig. 179) the roots become fully green, flatten to almost leaf-like thinness, and completely assume the photosynthetic function in place of the leaves, which are reduced to mere rudiments. Herein we have indeed a remarkable case of a complete substitute function in roots, and the one we would least expect, — that of *foliage*.

Aërial roots, of other forms, act as supports to climbing plants. Thus the true Ivies (*e.g.* the English Ivy, but not the Boston Ivy) put forth from the shaded sides of

their stems large numbers of short roots, tough in texture and adapted to dryness, which adhere at their tips to stones or other supports (Fig. 180). In some tropical climbers, e.g. species of *Ficus* (Fig. 181), elongated aërial roots grow out

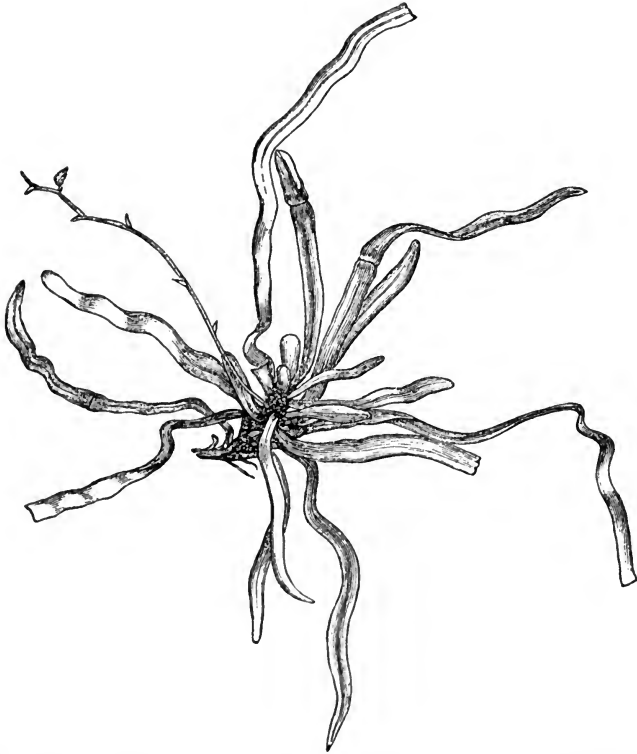

FIG. 179. — *Taniophyllum Zollingeri*, an epiphytic Orchid in which the aërial roots have become flattened and have assumed the function of foliage. A young flower stalk shows towards the left. (From Goebel.)

horizontally, somewhat like tendrils, until they touch a support, around which they turn thigmotropically, thus securing a firm grasp; and it is interesting to note that such roots are able to swing in the horizontal plane by virtue of a marked LATERAL GEOTROPISM. Aërial roots also occur

upon the trunks of Tree Ferns, which they sometimes cover completely with their stiff brown threads, though the significance of their presence is not clear.

A very striking modification of roots is found in the absorbing roots, or HAUSTORIA, of parasites. The common Dodder, for example; a parasitic twiner (Fig. 59), puts out these roots wherever it touches the host plant, and they, by use of digestive enzymes, penetrate the host, and attach themselves to the fibro-vascular bundles, from which they absorb nourishment. The haustorial function is similar in other parasites, including the parasitic Fungi, though here the absorbing structures are mycelial threads, not true roots.

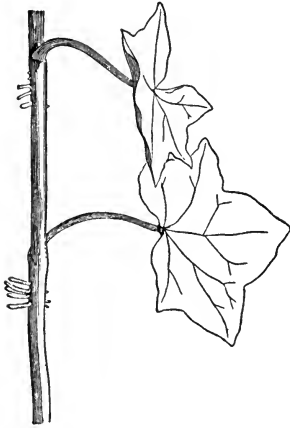

FIG. 180. — English Ivy, showing the aerial roots by which it clings to walls. (From Le Maout and Decaisne.)

Roots are transformed to spines in some Palms, though the significance of these structures is here no plainer than in case of leaves and stems (pages 79, 192). Also, some other, though minor, special functional uses and structural modifications of roots have been described.

Though not matters of function, certain other special matters about roots may conveniently be noted at this place. Thus roots, like some stems, show anomalies of structure often very puzzling, as, for example, the appearance in Beets which simulates annual rings. These rings are due to the fact that the cambium, after forming a certain amount of phloem and xylem, ceases to grow; thereupon a new cambium arises just outside the first cylinder, grows for a time, is itself replaced, and so on, many times. Again, roots can shorten in length, especially in some perennial herbs, which thus are kept below ground despite the yearly growth



of a "crown" at the top. The shortening is effected by a forcible expansion of the shorter cross axes, and hence a contraction of the longer vertical axes, of the cortical cells. An incidental result thereof is the formation, very marked in some tap roots, of cross wrinkles or folds, which are thus explained.

Roots, like leaves and stems, exhibit abnormalities and monstrosities, though in less number and diversity than other parts, again no doubt because of the comparatively uniform conditions of life underground. On the other hand roots are especially subject to an influence from which leaves and stems are comparatively free, viz. the forcible imposition upon them of flattened, contorted, or other peculiar shapes, often amusingly or grotesquely imitative of familiar objects, by the rocks and other impediments among which they grow.

Such growths are often unearthed and displayed as curiosities, or used in "rustic" carpentry.



FIG. 181 — A *Ficus* climbing by aid of aerial roots. (From Kerner.)

## 9. THE ECONOMICS, AND TREATMENT IN CULTIVATION, OF ROOTS

The most important economic uses of roots depend on the stores of food they contain, especially in the case of

biennials and herbaceous perennials, which store their food perforce underground. Beets, Carrots, Turnips, Radishes, and Sweet Potatoes are the most familiar examples. Not all, however, of the farmer's "root crops" are roots, for some are stems, as in potatoes, though this purely morphological distinction has no importance whatever in economics, and very little in physiology.

Because root-absorption is osmotic, and therefore requires a soil solution much weaker than the sap of the root hairs, it injures plants to over-fertilize them; for fertilizers are soluble, and thus increase the strength of the soil solution. But the matter is also complicated by chemical relations, and the stimulation given to growth of soil Fungi and other organisms.

Because roots need air for their respiration, wet or clayey soils must be drained for our crops, often at great trouble and expense. Yet water also is necessary, and must be conserved for dry times. The art of drainage consists in the maintenance of a beneficial balance between water and air throughout the growing season. It is because roots find this balance so excellent in drains, which therefore they tend to fill, that gardeners must take care where they place plants having specially hydrotropic roots (Willows, Poplars, Elms). Where a tree happens to grow on ground which must be graded to a higher level, a wall holding back the soil from the trunk will often permit enough aëration of the larger roots to save the tree, though frequently it does not.

Like other parts, but perhaps more than they, roots need warmth when growing. This is why hot beds are used in the spring, — the heat being developed by the respiration of organisms producing fermentation or decay in the manures which are used. The same value inheres in "bottom heat" supplied through pipes in the soil, sometimes used in forcing greenhouse plants.

Any osmotic process, which root absorption is, proceeds at a rate directly proportional to temperature. Consequently

a low temperature permits only a slow water absorption, which explains the damage often done to trees and shrubs in early spring by warm weather and high winds while the ground is still cold, if not frozen; for the resultant withering, or windburn, and browning is caused by fatal drying through excessive transpiration unsupported by sufficient water supply (compare page 48). Much winter-killing of plants is due to the same cause, *i.e.* a similar exceptional loss of water through lenticels while the ground is still frozen. Thus it becomes a part of good gardening so to place and treat susceptible plants, by selection of sheltered situations or suitable coverings and the like, that they cannot be exposed to high transpiration conditions while the soil is chilled.

The very different powers of plants to strike roots from cuttings or slips has important consequences in gardening. Some, *e.g.* the common house "Geraniums," strike root very easily; others, *e.g.* most ornamental shrubs, do so with some difficulty, and only when aided by special treatments; while still others, *e.g.* our common fruit trees, will not do so at all. The causes of the differences are not fully known, but in general plants of succulent texture, with soft fibro-vascular system and plenty of stored food, strike root most easily. The matter is practically important in two ways, — *first*, plants which strike root from cuttings can thus be propagated rapidly and cheaply, and *second*, special varieties or sports can thus be preserved and multiplied indefinitely. The usual treatment of cuttings conforms perfectly to root physiology. The skilled gardener cuts usually just below a node, because the roots start most readily from nodes; he removes much of the foliage, because too much transpiration would dry out the tissues before the new roots could replace the supply; he puts the cuttings first in sand, because ample air is the first requisite for the vigorous growth of new roots, but when rooted, he transplants them to loam for a better water and mineral supply.

Nurserymen are accustomed to transplant their trees and shrubs two or three times before sale, in order to force root formation near the stem. Thus more young roots are preserved when the plant is lifted for shipment, and it has better chance for recovery when again planted out. This is a reason why nursery-grown trees and shrubs usually survive transplantation so much better than those brought from the woods.

Much farming practice, ancient and modern, finds explanation in root physiology, though there is not agreement on all details. The *addition of fertilizers*, formerly interpreted as a replacement of needful mineral salts removed with the crop (page 242), may perhaps represent another method of neutralizing unfavorable soil conditions introduced by root excretion and decay. The ancient practice of *letting a soil lie fallow* (or idle), for a period, may restore the fertility either by giving time for the diffusion of more mineral salts from lower levels, or through the removal by drainage or oxidation of the injurious substances formed by the roots. The *rotation of crops* may derive its value either from the different demands made by different crops upon the mineral supply of the soil, or from the fact that the organic materials added by roots are usually not injurious to other kinds of plants. There is, however, no question as to the reason for the value of the old practice of *green-manuring*, that is, plowing Clover, and other crops of the Pulse family, into the ground. These plants, with nitrogen-fixing Bacteria in their own roots, are very rich in nitrogen compounds which are thus added to the soil. *Plowing* is primarily of benefit in loosening a soil both for penetration of roots and admission of air. *Sub-soil plowing* carries the air still deeper, while likewise raising more mineral matters to the upper layers. The value of *fall plowing*, leaving the soil exposed for the winter, may possibly lie partly in destruction of the Protozoa which are supposed to destroy the nitrifying Bacteria (page 246). *Cultivating* a soil, in the gardening sense, consists in roughening the surface; it breaks the homogeneity of the

soil, lessens the continuity of the water films (page 240), and hence checks the free movement of soil water to the surface and its loss there by evaporation. The method is important in *dry farming*, of which the first problem is the conservation of soil moisture.

## 10. SUMMARY OF THE FUNCTIONS AND TISSUES OF PLANTS

Having considered separately the principal tissues of plants, it will now be well to summarize them together to show their connections and the systems they form.

The functions of plants are performed by their protoplasm, which is subdivided into cells. When these cells are specialized to a particular function in considerable numbers, we call them collectively a tissue. Organs are enlargements or extensions of the plant body of such shape and position that they bring the tissues devoted to a function into advantageous relation with some external condition crucially affecting that function, — as witness the leaf in its relations to light. Thus organs do not so much perform functions as permit tissues to perform functions in advantageous relation to external conditions essential to their operation.

While some functions are performed almost wholly by the protoplasm inside the cells, others involve great specialization of the shape, thickness, and other features of the cell walls.

With respect to the tissues involved, all functions fall into four classes, as follows :

I. *Functions performed in tissues requiring special positions and constituting morphological systems.*

1. *PROTECTION* against unfavorable external influences, notably dryness of the air and entrance of parasites. The function requires external position, continuity, and a water-proof and "germ-proof" structure. *Tissue*, EPIDERMIS, replaced later by CORK, covering stems and leaves, but merging on young roots to the root hair layer. This physi-

ologically-determined tissue has become fixed as a distinct morphological tissue system, called the DERMAL system (Fig. 182).

2. *PHOTOSYNTHESIS*, or formation of food under action of light. This function requires a superficial position, but protection by the epidermis, and hence comes immediately beneath the latter, which is transparent. *Tissue*, CHLORENCHYMA, which covers young stems, and extends out into flat projections, the leaves; in older stems ceases to be green, merges into bark, develops cork cambium and layers of cork in replacement of the vanishing epidermis, and grows to allow for expansion of the stem; in roots it merges over into the cortical layer. Its innermost layer forms a special STARCH-SHEATH in young stems, or ENDODERMIS in young roots, having perhaps a perceptive function. This tissue has become fixed as a distinct morphological system called the CORTEX (Fig. 182) or CORTICAL SYSTEM.

3. *ABSORPTION* of water, mineral matters, and carbon dioxide. This function requires an external position and freedom from interference of the epidermis. *Tissue*, for water and mineral matters, an external hair-layer on the roots, continuous with the epidermis of stem and leaves, and a thick cortical layer, continuous with the chlorenchyma. The absorption of carbon dioxide by the cortex involves no special tissues, but depends on stomatal breaks in the epidermis, and intercellular air spaces, which are especially large in chlorenchyma.

4. *TRANSPIRATION*, incidental to gas absorption, involves no tissues, but the need for its control explains the presence of the regulating guard cells of the epidermis.

5. *CONDUCTION* of water and food through the plant. It requires a position in contact with the water-absorbing and food-making cortex, and an elongated tubular construction. *Tissues*, XYLEM, comprising DUCTS and associated elements: PHLOEM, comprising SIEVE TUBES and associated elements: in leaves the BUNDLE SHEATH,—the

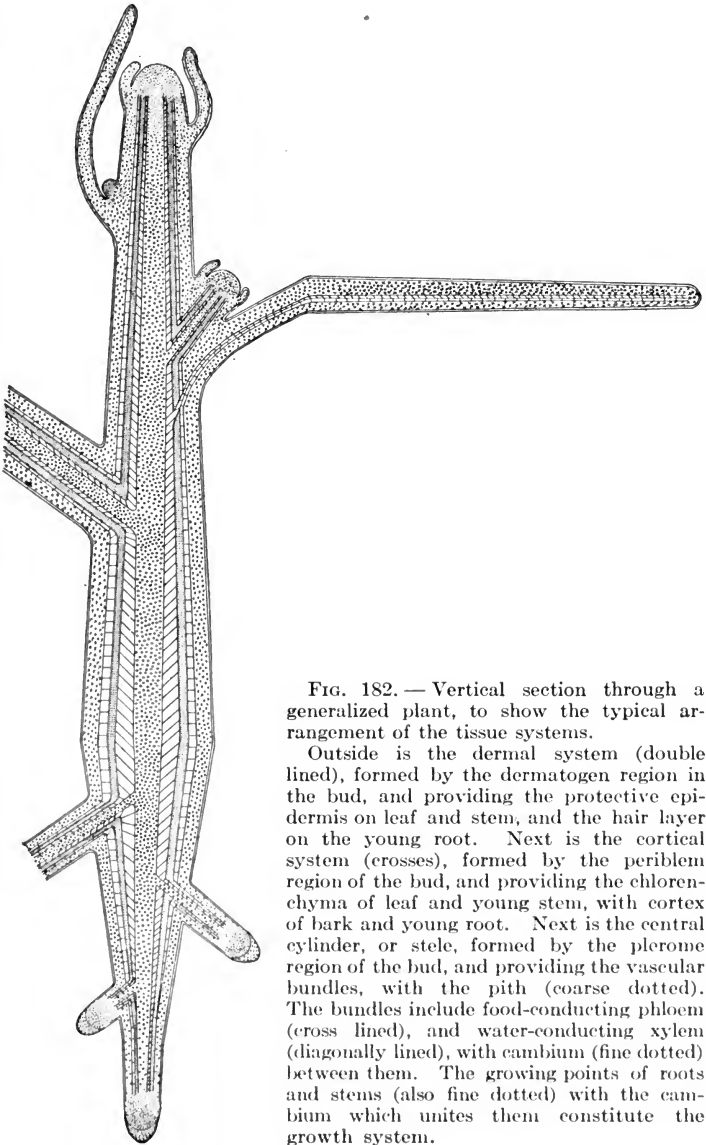

FIG. 182. — Vertical section through a generalized plant, to show the typical arrangement of the tissue systems.

Outside is the dermal system (double lined), formed by the dermatogen region in the bud, and providing the protective epidermis on leaf and stem, and the hair layer on the young root. Next is the cortical system (crosses), formed by the periblem region of the bud, and providing the chlorenchyma of leaf and young stem, with cortex of bark and young root. Next is the central cylinder, or stele, formed by the plerome region of the bud, and providing the vascular bundles, with the pith (coarse dotted). The bundles include food-conducting phloem (cross lined), and water-conducting xylem (diagonally lined), with cambium (fine dotted) between them. The growing points of roots and stems (also fine dotted) with the cambium which unites them constitute the growth system.

three forming VASCULAR BUNDLES. These bundles unite frequently with one another into a cylindrical fibro-vascular system, which, repeated in all plants, has become a distinct morphological system called the CENTRAL CYLINDER, or STELE. This cylinder runs continuously throughout stems and roots, and into the branches (Fig. 182), but not into the leaves, which receive only separate individual bundles therefrom; for leaves consist simply of flattened masses of cortex, with epidermis, into which extend individual bundles from the central cylinder.

6. *GROWTH*, or development of new tissues, primary, secondary, and general. Primary growth requires terminal position, as in buds and growing tips of roots, while secondary growth requires a position among the tissues to be continuously formed, as with cambium, which builds xylem and phloem. *Tissue*, MERISTEM, which is primary in buds and root tips, and secondary in cambium; but meristem itself can arise anew in young tissues, as in case of CORK CAMBIUM, the growth layer of some endogenous stems (page 128), and roots like the Beet (page 257). The growth of tissues is not, however, confined to meristem, but can take place in young tissues by a general cell division, *e.g.* in expanding bark, fruits, etc. Collectively the meristematic tissues form a GROWTH, or MERISTEMATIC SYSTEM, which, in the exogenous type of structure, is continuous throughout the plant (Fig. 182).

Epidermis, cortex, and central cylinder, comprising tissues so fundamentally important in the life of the typical higher plants, have been repeated so long in evolutionary history that they have become fixed as morphological systems which are now regularly laid down in distinct tissue layers by the primary meristem of buds and root tips. Thus the tissue layer from which the epidermis develops is called DERMATOGEN, that of the cortex PERIBLEM, and that of the central cylinder PLEROME. The plerome comprises a cylinder of fundamental or parenchymatous tissue wherein are embedded



certain strands of PROCAMBIUM, which develop cell for cell into the vascular bundles, while the tissue inclosed by them forms the PITH, that between them the MEDULLARY RAYS, and that outside them the PERICYCLE. If the procambium cells all turn into xylem and phloem, we have a closed bundle of the endogenous type, but if some of it turns into cambium, we have open, continuously-growing bundles of the exogenous type. In such cases the cambium usually extends across the medullary rays and forms a continuous cylinder.

II. *Functions performed in tissues requiring special positions but not forming morphological systems.*

7. *REPRODUCTION*, which is asexual or sexual. If *asexual*, the reproductive bodies are usually separable portions of thallus or shoot. If *sexual*, the reproductive bodies, the mother cells, spores, and sexual cells (later to be described), originate in areas of primary meristem persistent on certain branches (flowers). It requires a superficial position for fertilization and dissemination, and hence the reproductive tissues are developed in the cortex.

8. *SUPPORT* of the foliage against strains of weight and winds. It requires, upon well-known mechanical principles, a tough, fibrous construction in a tube-form as near the exterior as practicable; but, to permit movement of air, water, and food in and out through stems and roots, it is necessarily discontinuous, and hence mostly disposed in strands. The needs for this function vary greatly with the habits of plants. *Tissues*, COLLENCHYMA, just beneath epidermis, SCLERENCHYMA in cortex or pericycle, BAST FIBERS in phloem, WOOD FIBERS in xylem, while special strengthening SCLEREIDS occur in some exposed leaves. Because of the frequent presence of fibers with the vascular bundles, especially in herbaceous plants, these bundles are commonly designated fibro-vascular, even if no fibers are present. Collectively these tissues are sometimes described as forming a MECHANICAL SYSTEM, though it has no morphological identity.

III. *Functions performed not in special tissues but in special regions of the tissue systems.*

9. *STORAGE* of food and water. No special position is requisite; hence it occurs in any available regions of pith, cortex, medullary rays, and other parts, which often, by multiplication of the cells, produce swollen tubers, bulbs, etc.

10. *SECRETION* and *EXCRETION*. No special position is requisite, but usually occurs in special cells, as the *IDIOBLASTS*, or collections of cells forming glands, resin passages, etc. The *LATEX* system includes tubes ramifying throughout the other tissues (page 134).

11. *DISSEMINATION*. Involves no special tissues, but modifications, with special outgrowths of hairs, wings, hygroscopic walls, etc., of superficial tissues, epidermis, and cortex, as described in a later section.

IV. *Functions performed in all living cells.*

12. *METABOLISM*, or chemical changes (apart from photosynthesis and respiration) involved in the life processes.

13. *RESPIRATION*, or release of energy by oxidation. Requires usually the access of free oxygen, which is effected by development of an *INTERCELLULAR AIR SYSTEM* (*AËRATION SYSTEM*) ramifying everywhere throughout the plant, and opening to the atmosphere through stomata or lenticels. There occurs in some cases a special development of tissues with large air passages, called *AËRENCHYMA*.

14. *SELF-ADJUSTMENT* to immediate surroundings. Requires perception of the external stimulus, transmission to a motor zone, and a motor response mechanism. For all of these phases special structural features have been described, usually special modifications of tissues, as in case of the starch sheath (page 130).

## CHAPTER VI

### THE MORPHOLOGY AND PHYSIOLOGY OF FLOWERS

#### 1. THE DISTINCTIVE FEATURES OF FLOWERS

So prominent and distinctive a part of the plant is the flower, that to most people the study of flowers and the study of Botany are practically identical. The error of this belief is sufficiently attested by the proportions of the chapters in this book. Functionally the flower is the plant's principal organ of reproduction, being especially devoted to effecting fertilization, the central feature of sexual reproduction. It is in connection with this function that flowers have developed the beautiful colors, attractive fragrance, and striking forms to which they owe their æsthetic charm. There seems indeed no limit to the variety they present in these respects.

In *color*, flowers taken collectively display by far the greatest variegation found anywhere in nature; and somewhere among them could probably be matched any hue of the chromatic scale. Yet some true flowers lack any special color, being green like the foliage, as with Grasses, Birches, and Pines, which plants indeed are not popularly known to have flowers at all. Whatever the bright colors, they have usually this feature in common, that they contrast markedly with the background, being oftenest white or yellow if seen against foliage, blue or red if raised above it, and white if the flowers open at night. Furthermore, showy flowers usually stand out well beyond the foliage, and more than that, so adjust themselves as to face the brightest light. Thus flowers seem especially fitted to attract the eye, as indeed we shall presently find that they are.

Flowers are also distinguished by *odors*, which, however, do not occur in all, perhaps not in the majority, at least so far as our comparatively dull sense can perceive. When present, they are usually pleasing, or fragrant, to us, though a few, like Skunk Cabbage, are positively repulsive. Contrary to a popular belief, fragrant odors and bright colors do not commonly go together, at least not in wild plants; for in general the most fragrance occurs in flowers of which the colors are not especially visible, while odors are unusual in plants of exposed habit, — in meadows, roadsides, or prairies. Thus odors supplement a certain defect of color in making known the presence of flowers.

In *size*, flowers range very widely. The typical size in those which occur separately would perhaps exceed somewhat an inch across; but thence they range down to almost microscopic dimensions, as in certain small floating water weeds, and upward to the truly gigantic proportions of the tropical *Rafflesia*, in which a single flower is more than three feet across (Fig. 61). Everybody knows that some connection exists between flowers and insects, and it is true in general, as we shall presently see, that a relation exists between flower size and insect size. Between flower size and conspicuousness, there also exists a correlation in this way, that while the larger flowers are commonly solitary, the smaller occur massed together into clusters, acquiring thus a collective prominence, the perfection of which is found in the composite heads of the Daisy, Sunflower, and others of their family.

In *shape*, flowers are strikingly multiform. Simplest are those which have no showy parts at all, but only the inconspicuous sexual parts. Of the more familiar kinds, some are regularly concave, like Buttercups and Apple blossoms, with the sexual parts in the center, but thence they range to such elongated forms as the Fuchsia, and, becoming irregular, produce bizarre effects in the Orchids, even to a degree simulative of insects or other unrelated natural ob-

jects. Between these shapes and real insects there exist certain relations presently to be noted.

It is also characteristic of flowers to be fleeting, for commonly they last but a few days, after which they wither and fall. Sometimes indeed they keep fresh but a few hours, and it is only very rarely that their substance is sufficiently firm to persist after drying, though this does occur in the kinds we call "Everlasting." Not the entire flower, however, perishes with the showy structures, for the central parts persist and grow gradually to the fruit which contains the seeds. Indeed, it is the most normal and characteristic feature of the flower that it precedes the fruit. The popular idea that the flower is in some way essential to the production of seed is thus correct.

In case of the flower, as of other plant parts, the popular and the scientific conceptions are by no means coincident. The botanist includes under the term any structures, no matter how minute and obscure, which have part in the production of seed, and excludes from the term any structures, no matter how flower-like, which have no such function. Thus, the so-called "moss flowers" are not botanically flowers at all, and much less are "wooden flowers," "flowers of tan," and some other objects to which the name is fancifully applied.

## 2. THE STRUCTURE OF FLOWERS

Despite their striking external multiformity, flowers are comparatively simple and uniform in their mode of construction.

A typical simple flower, such for example as the Peony (Fig. 183), has six or seven distinct kinds of parts.

Outside is the CALYX, composed of a whorl of five green and leaf-like SEPALS. In the unopened bud they form a close protecting cover to the parts inside them, wherein consists obviously their function. Usually they are somewhat triangular in shape, opening out in a star form, but often

they are rounded (as in the Peony), or else elongated, or otherwise shaped. Typically green like leaves, they sometimes assume both the color and shapes of the next inner parts, the petals, as with Anemone and Four-o'clock. Usually persisting for a time in the opened flower, they sometimes fall off as it opens, as in Poppies. Commonly composed of separate sepals (POLYSEPALOUS), the calyx is often one piece (GAMOSEPALOUS), forming a saucer-, cup-, urn-, or tube-shaped structure, from the summit of which the free sepals

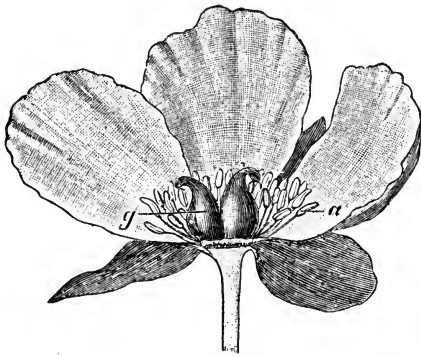

FIG. 183. — A typical flower, of *Paeonia peregrina*;  $\times \frac{1}{2}$ .

Some of the sepals and petals have been removed in order to show clearly the stamens, *a*, and the pistils, *g*. (From Strasburger.)

project. Oftenest five in number, the sepals may be two, three, four, six, or more, in lessening frequency. The student may easily confirm all of these matters for himself, and extend them, in any garden or greenhouse.

Next inside the calyx comes the COROLLA, formed, in the Peony, of a whorl of five brightly-colored PETALS. Collectively they open out in a way to display a disk of color surrounding the sexual parts; and herein, as will later appear, consists their function,—that of showing to insects the position of those parts. The separate petals are here broadest towards their tips, with narrow bases; but from this typical condition there are wide deviations. The bases are extended into greatly elongated stalks, as in Carnation; or their tips are pointed, elongated, cleft, fringed, and variously formed, as the flowers of any greenhouse or garden illustrate; while the most remarkable spurs, hoods, and other structures occur, as in Larkspur and Columbine (Fig. 207).

In fact it would seem as though every shape that fancy can suggest must be embodied in the shapes of the corollas of flowers. In conformity with their fleeting character, they are delicate in texture, showing clearly through a lens or the microscope a leaf-like anatomy of veins and cortical cells, — the latter held tensely expanded by the osmotic pressure within. Typically composed of separate petals (POLYPETALOUS), the corolla is often, like the calyx, one piece (GAMOPETALOUS), forming a saucer-, cup-, urn-, or tube-shaped structure, from the summit of which spread the free petals, as Primrose (Fig. 201), and other garden flowers illustrate. Usually standing directly on the enlarged end of the flower stalk, or RECEPTACLE, the petals often stand on the calyx, as in Garden Nasturtium. As to number, petals vary like the sepals, being usually, though not always, the same number as they. Not infrequently the petals are wanting altogether, in which case the sepals often replace them in color and function. Sometimes the sepals are likewise absent, and in this case the flower is very inconspicuous unless color is supplied by bracts beneath the flower (page 74), as in Poinsettia. As to the variety of colors displayed by corollas, we have spoken already.

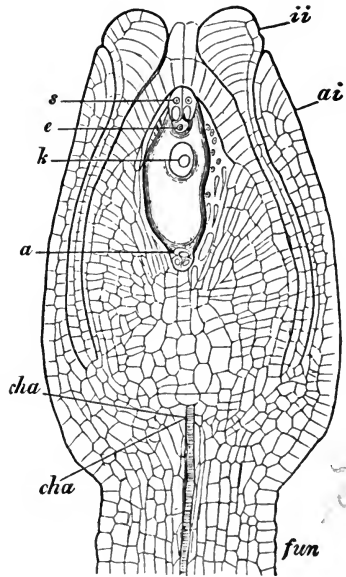

FIG. 184. — A typical simple ovule, of *Polygonum divaricatum*, in section;  $\times 135$ .

*e*, egg cell, in the embryo sac, which lies in a mass of tissue, the nucellus; *fun* is the funiculus or stalk by which the ovule is attached to the ovary; *ai* and *ii* are the integuments, developed from the funiculus, and leaving an open micropyle; *cha*, the chalaza. (From Strasburger.)

Next inside the corolla comes the whorl of STAMENS. Each consists of a slender cylindrical stalk, the FILAMENT, bearing at its tip an enlarged rounded yellow ANTHER. A lens will show that this anther opens by longitudinal slits, allowing the escape of a yellow powder (each grain of which is a cell), called POLLEN. Pollen contains the male sex cells of the plant, which later fertilize the female sex cells in the ovules, as presently to be noted. The filaments are sometimes short, even to disappearance, but again are elongated almost to thread-like, as in Night-blooming Cereus. Often-

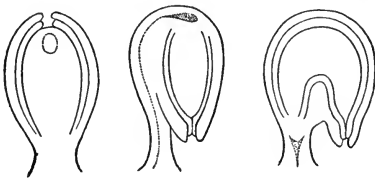

FIG. 185. — Generalized forms of ovules, showing the principal arrangements on the stalks; magnified.

Left, upright, *orthotropous*, form like Fig. 184; middle, inverted on elongated attached stalk (raphe), *anatropous*; right, curved over to inversion, *campylotropous*. (Reduced from Strasburger.)

est cylindrical, they are sometimes flat and even petal-like, as in Water lilies, where it is difficult to say whether the filaments are petal-like or petals bear the anthers. The anthers, typically rounded, are sometimes greatly elongated, or forked, or otherwise remarkably shaped, while

they open in very diverse ways. Usually forming a direct extension of the filament, they are sometimes balanced on the point thereof, as familiar in the larger Lilies. Commonly quite separate from one another (POLYADELPHOUS), they sometimes form one piece at their bases (MONADELPHOUS), as in some of the Pulse family, and Abutilon. While typically they stand directly on the receptacle, they are often on corolla or calyx. Their existence is fleeting like that of the corolla, with which they commonly fall. While often numerous, as in Peony, Buttercup, and Rose, they are commonly limited in number, being typically the same number, or double the number, of the petals, and therefore oftenest five or ten, or else less frequently three or six, or four or eight, though other numbers occur with lesser frequency.



When the same in number with the petals, the stamens usually alternate therewith, though they stand opposite in Primrose (Fig. 201). Flowers also occur without stamens, or rather, to be exact, with the stamens and pistils in separate flowers.

Beyond the stamens, and occupying the center of the flower, come the PISTILS, made up of parts called CARPELS, which, like sepals, petals, and stamens, are morphologically leaves. The Peony here pictured (Fig. 183) shows two pistils composed each of a carpel; and of one carpel each are the many pistils of Buttercup and Strawberry, while Peas and Beans have one pistil composed of one carpel. Most

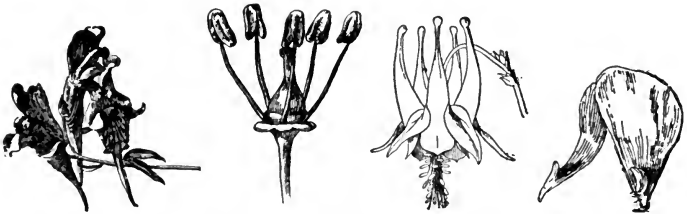

FIG. 186. — Typical forms of nectaries. From the left; spurs of Toad-flax, receptacular swellings of Grape, spurs of Columbine, scales on the petals of Ranunculus. (From Bailey.)

commonly, however, there is one pistil composed of several united carpels. Whether SIMPLE (of single carpels), or COMPOUND (of several carpels united), the pistil has typically a rounded hollow base called the OVARY, tapering upward to a short cylindrical stalk called the STYLE (very short in the Peony), ending in a roughened area called the STIGMA. When the ovary is opened, it is found to contain a number of small rounded whitish bodies called OVULES, within each of which, in a special sac, lies a female sex cell, called the EGG CELL. The functions of the parts of the pistil are plain; the stigma receives the pollen containing the male cells, the style supports the stigma in a position suitable for receiving the pollen, and the ovary protects the delicate

ovules in which the egg cells are fertilized by a method to be fully described in the following section.

The ovules are the most important parts of the pistils. A typical ovule when mature shows the structure represented by Figure 184. Innermost is the relatively large EMBRYO SAC (large enough to be seen by the naked eye in sections of very large ovules), containing much protoplasm which can be recognized by its yellowish-brown color. In the sac lie also several small cells (Fig. 190), amongst which is the one

of greatest importance, usually the largest, the EGG CELL. This egg cell when fertilized grows gradually to an embryo plant within the embryo sac. The embryo sac is imbedded within a rounded mass of tissue called the NUCELLUS, which in turn is inclosed by one or two INTEGUMENTS. These grow up to surround the nucellus from the stalk or FUNICULUS, though they never inclose the nucellus completely; for an opening called the MICROPYLE is always left for the entrance of the pollen tube (Fig. 190). The funiculus is sometimes straight, but oftener is

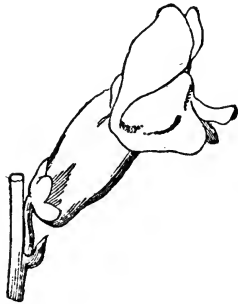

FIG. 187. — The Snapdragon, a typical irregular (bilabiate) flower;  $\times \frac{3}{4}$ . (From Le Maout and Decaisne.)

elongated and grown to the rest of the ovule, the resultant ridge being called the RAPHE. In this way the ovule is swung into positions facilitating the entrance of the pollen tube into the micropyle (Fig. 185). Through the funiculus runs a vein which conveys food into the ovule as far as the meeting place, called the CHALAZA, of nucellus, coats, and funiculus, whence it passes by diffusion to the various parts.

Typically rounded in form, the ovary is often elongated, cylindrically as in Peas, flattened as in Beans, or variously angular. The style is almost wanting in the Peony, but in some flowers is elongated even to thread-like, as conspicuously in the silk of the Corn, while at times it is flat and quite petal-

like, as in *Iris* (Fig. 199). The stigma, while frequently flat, or rounded, is elongated variously, and even branched, sometimes to almost a feather-like degree, as in some trees (Fig. 197). The ovules, while typically few, are sometimes but one to a carpel, though often they are many, as with *Poppies*, in which case they stand in regular masses or rows upon supporting ridges, usually prominent, called **PLACENTÆ**. Unlike the other parts, the pistils are not fleeting but persistent structures, for, after fertilization, the pistils grow normally into fruits, and the ovules into seeds; at least this is true of the ovaries, though commonly the styles and stigmas fall with the petals. While typically the pistil or pistils stand on the receptacle separate from the other parts, frequently the other parts stand upon the ovary, bringing the latter below and outside of the showy part of the flower, as with *Apple* and *Fuchsia*; and in this case the ovary is described as **INFERIOR**, as contrasted with the ordinary **SUPERIOR** condition.

Three other less prominent parts appertain to flowers: the receptacle, nectaries, and bracts.

The **RECEPTACLE** is the tip of the floral stem, usually enlarged to a club-shape where it bears the floral parts, though sometimes it develops specialized forms, as will later be noted in the section on morphology. **NECTARIES** excrete, often in shining drops, the nectar upon which insects feed.

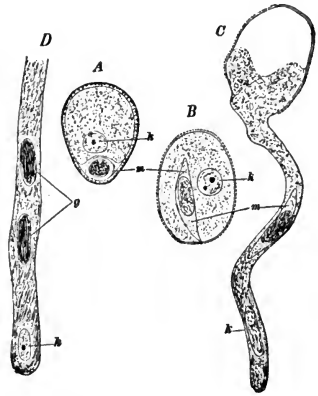

FIG. 188. — The structure of a pollen grain, and germination of the pollen tube, in *Lilium Martagon*;  $\times 200$ .

A, ripe grain with its own vegetative nucleus, *k*, and a generative cell, *m*, which produces the two sperm nuclei; B, the same grain, in another view, about to germinate; C, the germinated grain with its tube, the growth of which is controlled by the nucleus *k*; D, end of the tube, with its two sperm nuclei, formed from the cell *m*, as it nears the egg cell. (From Strasburger.)

Typically they occur at the bases of the petals, either as glandular swellings, or else as shallow cups, as seen so conspicuously in the Crown Imperial, where they hold huge glistening drops; and sometimes they are parts of the receptacle (Fig. 186). Often they are wanting, in which case the nectar is usually secreted from the base of the petals without special glands. BRACTS are leaves belonging to the stem below the flower, but often coöperating in the construction or function of the flower. Sometimes they constitute the conspicuous color-bearing part

(as in *Poinsettia* or *Bougainvillæa*); but again they are merely accessory sepal-like appendages, as in Strawberry, or else they replace the sepals in both form and function, as in Sunflower and others of the Composite family.

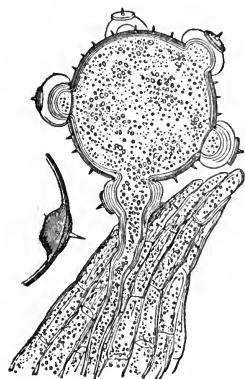

FIG. 189. — A pollen grain germinating on a stigma. (From Sachs.)

Typically a flower is symmetrically radiate in form around a central axis, such kinds being called REGULAR, as with all of those we have thus far mentioned. But many are IRREGULAR, with a special tendency to form a two-lipped structure, as in the Mints and Snapdragon (Fig. 187), while this character attains a very extreme development in the Orchids. Its significance will soon be explained.

Various parts of the flower can be wanting to such a degree that pistils only or stamens only remain, thus forming PISTILLATE and STAMINATE flowers respectively. All that is really essential to a flower is the possession of a stamen or a pistil. A flower which contains both is said to be PERFECT, and one which has also petals and sepals is said to be COMPLETE.

### 3. THE ACCOMPLISHMENT OF FERTILIZATION BY FLOWERS

Everybody knows that flowers are essential to the production of seed, though not everybody knows in what way.

Their function consists in effecting FERTILIZATION, the union of male and female sex cells, without which process seed does not form. The accomplishment of fertilization is the primary function of the flower.

Fertilization in flowers involves three stages, two of them preliminary and subsidiary to the third and crucial one, — viz. pollination, growth of the pollen tube, and fusion of the sex cells.

The pollen grains are developed in the anthers, and develop within themselves the male, or SPERM, cells (Fig. 188). The transport of the ripe pollen from anthers to stigmas, through a space sometimes small but frequently great, is called POLLINATION. It is not effected by any power within the plant, but by some external agency, — mostly by wind in the inconspicuous flowers, and by insects in conspicuous ones.

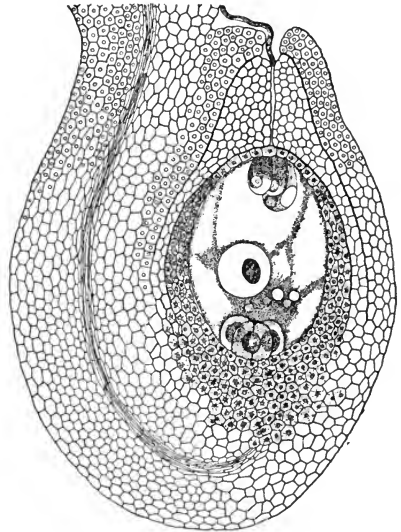

FIG. 190. — A typical ovule, of *Narcissus*, ready for fertilization, in section; much magnified.

Near the upper end of the embryo sac lie three cells, of which the larger is the egg cell. The pollen tube is shown entering the micropyle. (Drawn from a wall chart by Dodel-Port.)

Pollination accomplished, the growth of the pollen tube begins. Into the roughened, sugary-adhesive, epidermless surface of the stigma (Fig. 189) there grows from the pollen grain a slender, delicate, thin-walled tube, in which can be seen the distinctive living protoplasm. This tube, carrying the two sperm nuclei near its tip, grows down through the tissues of the style, dissolving for itself a way by aid of

enzymes and absorbing the digested products for use in its own further growth; and commonly the tube dies and withers behind as the forward part advances. Thus it reaches and enters the ovary, and, taking a direct path, approaches an ovule which it enters by the micropylar

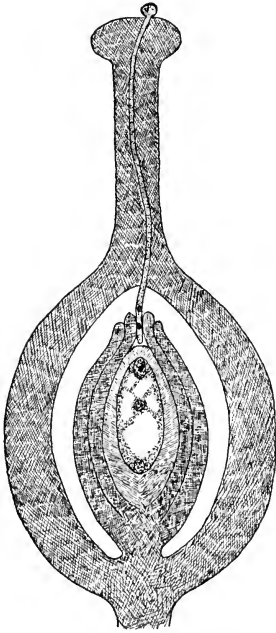

FIG. 191. — A generalized pistil and ovule, in section, showing the mechanism of fertilization described in the text.

opening; thus it reaches the relatively large sac, the embryo sac, which every ovule contains (Fig. 190), and within which, near the micropyle, lies the EGG CELL. This mechanism of fertilization is represented in principle in our generalized picture (Fig. 191). Thus are the sperm cells brought to the immediate vicinity of the egg cells.

The final, and really the essential, stage in this process consists in the fusion of the two sex cells which is thus effected (Fig. 192). One of the two male nuclei (the fate of the other will appear later in connection with the fruit), with probably some surrounding cytoplasm, moves out of the pollen tube into the egg cell, presumably opening the way by action of enzymes. For a time the egg cell exhibits two nuclei; but they move together, touch, and then gradually fuse together into one and fertilization is complete. The result is a cell containing a nucleus derived from the union of two nuclei from different parent cells; and this appears to be the central and essential feature of all fertilization.

After fertilization the sepals, petals, stamens, nectaries, styles, and stigmas, their functions evidently accomplished,

ordinarily wither and fall away, leaving only the ovary on the receptacle. Then this ovary grows into a fruit, the ovule into a seed, and the fertilized egg cell into an embryo plant. In case, however, no fertilization is effected, the parts of the flower usually persist somewhat longer than otherwise, though no fruit, seed, or embryo is formed; but presently all parts, including the ovary, wither and fall. This is the way in which flowers are essential to the production of seed.

4. THE NATURE AND CONSEQUENCES OF FERTILIZATION

Fertilization in flowers, as the preceding section has shown, centers in the fusion of the male and female nuclei within the egg cell; for pollination and the growth of the pollen tube are merely the mechanism for bringing the sex cells together. Fertilization occurs in the reproduction of nearly all plants and animals, and while the mechanisms for bringing the sex cells together are as diverse as possible, the central feature of the fusion, especially of the nuclei, is always the same. Thus this fusion act of fertilization runs as a thread of structural and physiological identity almost throughout the plant and animal kingdoms, binding plants and animals together in this

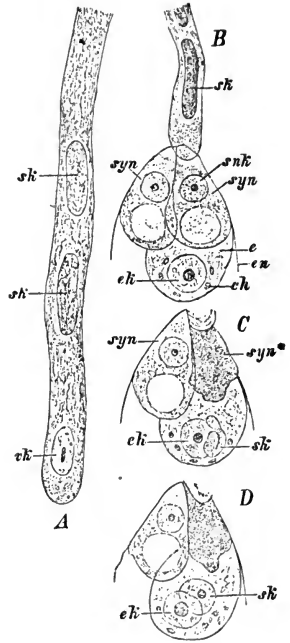

FIG. 192. — The fusion of the sex cells, somewhat generalized from a typical case;  $\times 375$ .

A, the end of the pollen tube (D of Fig. 188), containing two sperm nuclei, *sk*; B, the same tube in contact with an embryo sac, *en*; C, a sperm nucleus, *sk*, has entered the egg cell, the nucleus of which, *ek*, it has approached; D, the sperm nucleus, *sk*, has lost its elongated form and become rounded like the egg nucleus, with which next it fuses completely. (Reduced from Strasburger.)

one fundamental feature, despite their diversity in other respects.

So certain, indeed, is the identity of the sex cells throughout animals and plants that of late some botanists have adopted from zoölogy the terms EGG and SPERMATOZOID, and use them instead of the older terms egg cell and sperm cell. The latter words are retained in this book, because while indicating sufficiently the morphological relations, they are more closely associated with the study of plants. Egg cells and sperm cells are called collectively GERM CELLS.

We examine first the cytological basis of the fusion of the germ cells. The student will recall that the protoplasm in a living cell is differentiated into the cytoplasm, which is clearly the constructing part, the plastids, which have chemical functions, and the nucleus which seems to act as a control center of the work and development of the cell (page 41, Fig. 16). Now as to the nucleus, its essential part is its CHROMATIN, which lies embedded in the gelatinous protoplasm constituting most of its substance. This chromatin is a distinct chemical substance, colorless in the living cell, but possessing a remarkable power to absorb colored stains (whence of course its name); and it ordinarily exists in fine granules strung together in threads which are much intertangled (Fig. 193, 1). This is its usual, or resting, state, but when the cells are about to divide, in reproduction or growth, the chromatin threads disentangle themselves and collect into definite elongated bodies called CHROMOSOMES (Fig. 193, 7). The number thereof is always definite for each kind of plant or animal, though varying widely for different kinds, — all the way, in fact, from two to more than one hundred. Whatever the number, however, there is good reason to believe that they keep their identity even in the resting state, so that the chromosomes which come out of the seeming tangle are identically the same ones which went into it. Now in the fusion of the nuclei of the germ cells, the sperm nucleus passes over its chromosomes to the



egg nucleus, as shown diagrammatically in Fig. 194. It is true, the chromatin is in the resting state at this time, so that the chromosomes cannot be distinguished; but at the

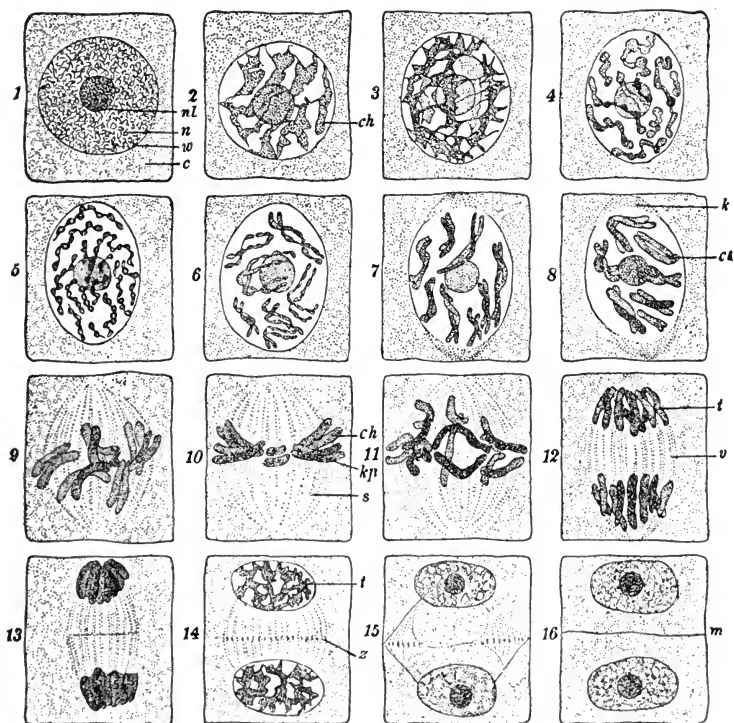

FIG. 193. — Stages in typical cell division in growing tissue, somewhat generalized.

1, Resting cell. 2-5, The chromatin collecting into chromosomes, which become definite in number and outline. 6, Splitting of each chromosome lengthwise into two. 7, 8, The chromosomes growing shorter and thicker. 9, 10, They collect in the equatorial plate of the forming spindle. 11, 12, Separation of the daughter chromosomes. 14, 15, 16, Formation of the new nuclei, return of the chromosomes to the chromatin threads, and formation of a new wall. Thus are produced two new cells from division of the original one. Next these daughter cells grow to the full size of the parent cell, after which they again divide in the same manner. (After Strasburger.)

very first division of the fertilized egg cell its nucleus displays a number of chromosomes precisely equal to that which we know the sperm and egg nuclei possess together, while in some cases it is found possible to identify the two sets. All evidence seems to indicate that this bringing together of the chromosomes (or chromatin) from two parent cells into a single nucleus is the principal (and perhaps only) functional end of fertilization. The accompanying comingling of the cytoplasm appears not to be important, and indeed in some cases seems not to occur, only the nucleus of the sperm cell passing into the egg cell.

Thus we are brought to ask what may be the significance

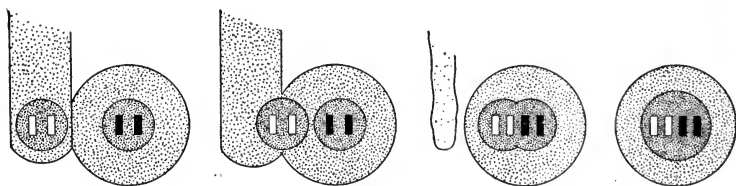

FIG. 194. — Diagram to illustrate the performance of the chromosomes in the fusion of the germ cells.

The two chromosomes from the pollen or male parent are white, and those from the egg cell or female parent are black.

of the chromosomes. Our knowledge of them is still imperfect, but this much seems clear, — that they are the physical basis of heredity, the carriers of the factors which cause the new individual to develop in general like its parents. The chromosomes do not themselves build the cells out of which the organism is constructed, for that is clearly done by the cytoplasm; but in some way, still unknown, the constructive work of the cytoplasm seems guided by the chromosomes, which thus must contain the plans, so to speak, of the new structure. Furthermore, and this is important, the evidence indicates that the set of chromosomes contributed by each nucleus in fertilization is complete, that is, capable of guiding the construction of a complete organism

substantially like that which produced it. Thus the nucleus of the fertilized egg cell contains chromosomes in duplicate, *i.e.* two complete sets, each capable of reproducing an individual.

The subject becomes clearer as we consider the events which follow fertilization. The fertilized egg cell at once proceeds to divide. First the chromatin threads collect themselves into definite chromosomes, equal in number to those contributed by the two nuclei, and indeed, there is little doubt, individually identical therewith. Then each chromosome splits lengthwise very regularly into two (Fig. 193), whereupon, by action of a spindle-shaped mechanism,

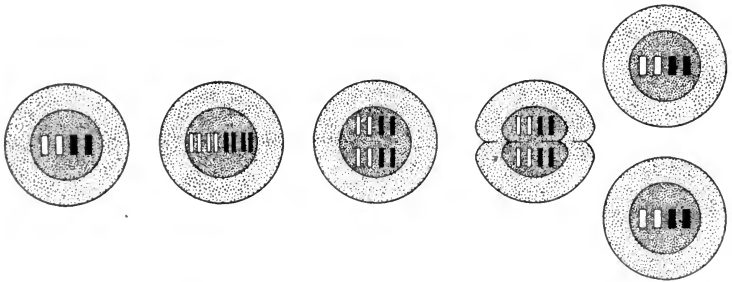

FIG. 195. — Diagram to illustrate the performance of the chromosomes in the division of the fertilized egg cell.

On the left the same egg cell shown in Fig. 194, its chromosomes being derived from the two parents; on the right the two cells resulting from its division.

one of the half chromosomes in every case is drawn to one end of the cell, and the other half to the other, thus dividing every one of the original chromosomes equally between the two ends of the cell. Then a wall forms across the cell between them, and the two sets merge back each to its chromatin tangle. Thereafter these two half-sized cells absorb nourishment and gradually grow to the full original size, the chromatin included. Presently these new cells themselves divide, and the chromosomes which differentiate from the chromatin tangles seem identical with those which went into them, and therefore are the grown-up halves of the

original male and female set (Fig. 195). Then follow other like divisions, always by the same method, though presently proceeding more actively in some places than others, — with the result that first an embryo, then a seedling, and finally an

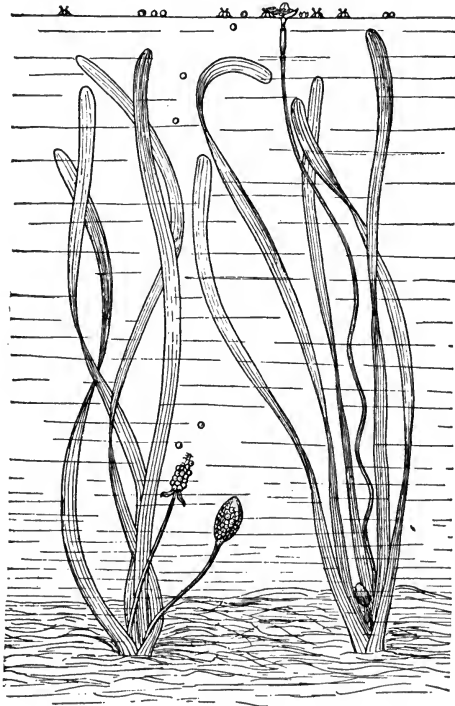

FIG. 196. — The pollination of *Vallisneria spiralis*, a common water plant;  $\times \frac{1}{3}$ . (After Kerner.)

adult plant is produced. When, now, the cells of the adult are examined, their nuclei are found each to contain exactly the same number of chromosomes as did the fertilized egg cell from which the plant has developed; and furthermore it seems reasonably certain that these chromosomes of the adult are the exact individual descendants of those in the fertilized egg cell, and therefore of those contributed by the original parent male and female cells.

This phase of our subject appears clearly in a later diagram (Fig. 219). Thus the adult would have in every cell of its structure chromatin matter, that is, heredity material, derived from both of its parents. This arrangement helps us to understand how an individual can resemble either father or mother in any feature of its structure.

There comes, however, a break in the regularity of this chromosome division. It occurs when the adult plant is forming its own sex cells (pollen and embryo sac). At this time one cell division, called the REDUCTION DIVISION, yields to the new cells only half the number of chromosomes which had prevailed through the body. The functional significance of the reduction is perfectly clear, for if the uniting sex cells contained the full number of chromosomes, obviously the number would double in every generation, to their ultimate enormous multiplication, whereas by the reduction division the number is kept constant. The details of the reduction division are complicated and not wholly understood, but it occurs in such a way as to give each sex cell one complete set of chromosomes instead of the double set which all body cells possess. These chromosomes, however, (and this is a point of great consequence in heredity), do not represent individual chromosomes which occurred in the body cells, but are reconstructed from them in such a way as to include some material from the father set and some from the mother set, in combinations which apparently are due only to chance, and never the same in any two. This matter is illustrated by the diagram of Figure 219, and is apparently identical in every respect in plants and animals.

Thus the principal consequence of fertilization seems to consist in the introduction of complete sets of paternal and maternal heredity-carrying chromosomes into every cell

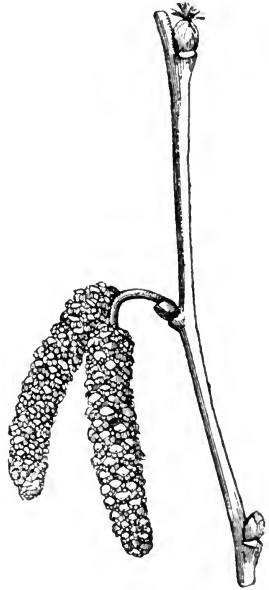

FIG. 197. — Flowers of the Hazel (*Corylus Avellana*);  $\times \frac{1}{2}$ . The staminate flowers hang in two large catkins, and the pistillate flower stands near the top of the stem. (From Balfour.)

throughout the body of each individual, though whether this is the functional aim, or only an incidental result of fertilization, is uncertain.

What now is the significance of fertilization, or, in other words, of sexual reproduction? Fertilization is by no means essential to reproduction, since many kinds of low organisms lack it, while even the higher plants possess many methods of purely vegetative, or asexual, reproduction, as a later section will make clear.

The asexual method is thus not only possible, but it is actually much simpler and easier of accomplishment than the sexual. Why then the overwhelming predominance of the sexual method? Unfortunately we have not yet any certain knowledge upon this point. It has commonly been believed that individuals produced by fertilization are more variable than those produced by asexual methods, and

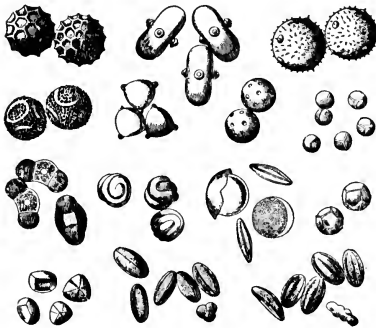

FIG. 198.— Various forms of pollen grains; magnified.

The 3 three-lobed grains in the row on the left are Pine, the two lateral lobes being air-filled bladders. The roughened forms are mostly carried by insects, in the hairy bodies of which the various projections become caught. (Reduced from Kerner.)

that such variability gives advantage in competitive evolution. Yet some investigators hold other views, and the matter is one on which we must await further evidence.

## 5. THE METHODS AND MEANING OF CROSS-POLLINATION

It was said in a preceding section that the transfer of pollen from the anthers to the stigmas of flowers is effected, as a rule, not by action of the plant itself, but by some external agency, notably wind and insects. The matter, however, goes farther than this, for the floral arrangements are such

that the transfer is usually not between anther and stigma within the same flower, but between anthers and stigmas of different flowers,—and oftener than not between different plants, of course of the same species. This CROSS-POLLINATION, as it is called in contrast with CLOSE-POLLINATION within the same flower, is a matter of much botanical consequence.

In the simpler kinds of plants, *e.g.* the low Algæ (page 12), the physiological equivalent of cross-pollination results incidentally from the fact that the free-swimming sexual cells (or GAMETES), usually cast out into the water by many plants of one kind together, intermingle and unite promiscuously. Of course in such cases a union may result between cells from the same plant, as doubtless often occurs, though in higher forms there is reason to believe that chemical attractions and repulsions between the gametes compel crosses between different plants. In the Ferns, and some other plants having free-swimming male cells, a cross is insured through the fact that the sperm and egg cells produced by the same plant are not usually mature at the same time.

Some flowering plants are pollinated on the *water*, notably our submerged pond weeds, eel-grasses, etc. A typical case is the fresh-water eel-grass, *Vallisneria spiralis* (Fig. 196). Growing in masses together, these plants produce pistillate flowers which float by long stalks at the surface,



FIG. 199. — Flower of Iris, cut vertically.

The stamen, somewhat to the right of the center, is under the style; the stigma is the upper side of the small projection from the latter. (From Le Maout and Decaisne.)

and staminate flowers, which become loosened and rise to the surface; here they float about until they touch a stigma of the floating pistil, when fertilization is effected in the usual way. Afterwards the pistil is drawn deep under water, and held there during ripening by the spiral coiling of the stalk. Such water-pollinated flowers are mostly so inconspicuous as not to be popularly recognized as flowers at all. They exhibit, indeed, no other floral characteristics than the possession of the comparatively obscure, even though vastly important, stamens and pistils, although some kinds possess rudimentary petals and sepals as relics of their evolutionary

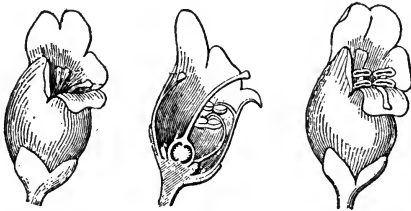

FIG. 200.—Dichogamous flower of *Scrophularia nodosa*;  $\times 2$ .

Left, a flower with ripe stigma but unripe stamens, shown better in the section (middle figure); right, a flower with ripe stamens but withered stigma. (After Warming.)

history. Some water plants, however, notably the Water-lilies, retain their showy flowers pollinated by insects.

In the flowering land plants the simplest agency of pollination is the *wind*. Wind-pollination occurs in most of our trees, *e.g.*

Elms, Birches, Oaks, Pines; in some shrubs, *e.g.* Alders; and in a few herbs,—notably Grasses, including the Corn. A typical case is the Hazel (Fig. 197), in which the long dangling catkins are clusters of staminate flowers, while the pistillate flowers are so few and inconspicuous as to require special search even by the trained eye of the botanist, and would hardly be recognizable at all were it not for the relatively prominent feathery stigmas. When ripe, the pollen, easily shaken from the catkins by a touch, is wafted about on the lightest breezes, so that some of it comes into contact with the stigmas, though of course an overwhelming preponderance is wasted. This case illustrates the typical, though not invariable, features of wind-pollinated flowers,



which are these: *first*, they are inconspicuous, for they lack colored corolla, odor, and nectar, such prominence as they possess being due simply to their abundance, or to the yellow color of their anthers. *Second*, the male blossoms far exceed in number the female, in obvious correlation with the wastefulness of this method. *Third*, the stigmas are large, often branching-feathery, thus spreading a greater net for the drifting pollen. *Fourth*, the flowers are borne in ways to insure free passage of the pollen without inter-

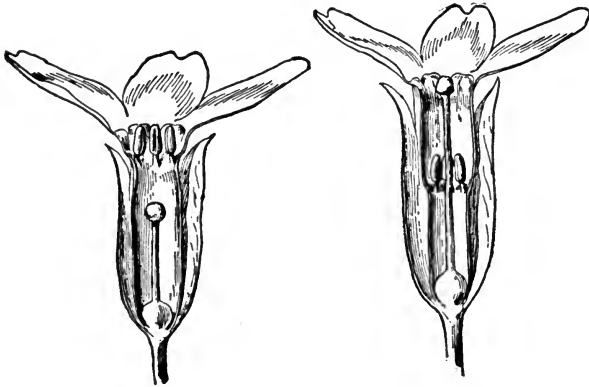

FIG. 201. — Dimorphic flowers of Primrose;  $\times 2$ .

Pollen from the upper stamens will develop on an upper stigma, and from lower stamens on a lower stigma, but not other ways. (From Bailey.)

ference by presence of leaves. Thus the flowers unfold before the foliage in the spring, as with most of our trees, or else they are lifted beyond or above the leaves, as with Pines and Grasses. *Fifth*, the pollen is found, on microscopical examination, to be light in weight and to spread large surface, which is even increased, as in Pines, by extension into large empty bladders (Fig. 198). *Sixth*, the stamens and pistils are commonly borne in separate flowers, often upon different plants, thus preventing close- and insuring cross-pollination. While these characters are typical in wind-pollinated flowers, they are not invariable; for wind-pollinated

nation merges over gradually to insect-pollination, the floral structure being also intermediate, as some Maples and Willows illustrate.

The most prominent of the agencies of cross-pollination, however, are *insects*, to the utilization of which the most typical flowers are fitted. The characteristics of insect-

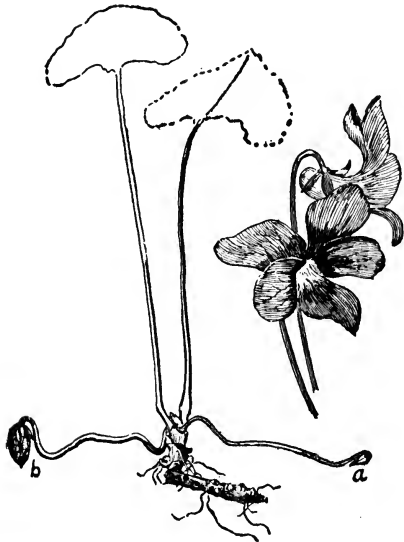

FIG. 202.—The cleistogamous flowers of the common Blue Violet; reduced.

The cleistogamous flowers are on running stalks on the ground. *a* is a small flower, and *b* a pod containing seeds. Ordinary flowers, of natural size, on the right. (From Bailey.)

pollinated flowers are these. *First*, the flower is conspicuous to the eye, through a showy corolla usually colored in contrast to the background and set prominently forth in the light; and often its presence is indicated also by strong odor. *Second*, nectar is commonly present in the base of the flower, and when absent, is replaced by more abundant pollen which some insects particularly desire. *Third*, stamens and pistils are usually present in the same flowers. *Fourth*, the shape of the flower is

such that an insect in probing for nectar leaves some pollen on the stigma, and receives some by contact with the anthers. *Fifth*, the pollen grains are commonly angular, roughened, or adhesive (Fig. 198). Observation, supplemented by experiment, proves that insects visit flowers for the nectar, their usual food: that they are guided in general to the flowers by the bright spots of

contrasting color, although odor is often more potent in this respect ; and that in probing about in their active way for the nectar, their hairy bodies brush pollen upon the stigmas and receive a new supply from the anthers. All of these matters the student can confirm for himself in any garden in summer.

At first sight it would seem that insects must effect close-rather than cross-pollination, but such in fact is not the case. Any one can see that insects in gathering nectar usually visit flower after flower and plant after plant of the same kind as long as

these are plentiful ; and since their bodies possess a large pollen-carrying capacity, it must usually happen that any given stigma, even if

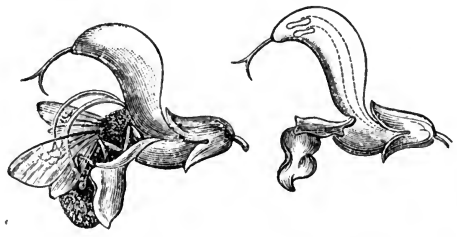

FIG. 203. — Flower of *Salvia pratensis*, pollinated by a Bee ;  $\times \frac{1}{2}$ .

Right, the flower ready for pollination, showing position of stigma and stamens. The stigma is touched by the insect in entering, and later the stamens are brought down on its body by operation of a hinged-lever arrangement. (From Wiesner.)

pollinated from the same flower, becomes also pollinated by other plants from the abundant mixture on the body of the insect. In such cases, as a rule, it is found to be the foreign and not the flower's own pollen which effects the fertilization, the growth of the pollen tubes being more rapid in the former than in the latter case. Flowers, indeed, are known which are entirely sterile to their own pollen. Furthermore, in some plants close-pollination is prevented by mechanical arrangements, as with the *Iris* (Fig. 199), where the stigma is upon a shelf struck by the insect when entering but not when leaving the flower. Still more common are the cases in which the stamens and pistils are not ripe at the same time, as with *Scrophularia*, an arrangement called DICHOGAMY (Fig. 200). And there are plants, of which the Primroses

① *Salvia pratensis*, y. 2035 - 2036

are the most prominent, in which pollen and stigmas are of two reciprocally corresponding kinds, though the two never occur in the same flower, an arrangement called DIMORPHISM (Fig. 201). These and other arrangements bring it to pass that cross-pollination is in fact the rule in showy flowers. It is not, however, invariable, for with many kinds of flowers, especially of the simpler sorts, close-pollination is perfectly

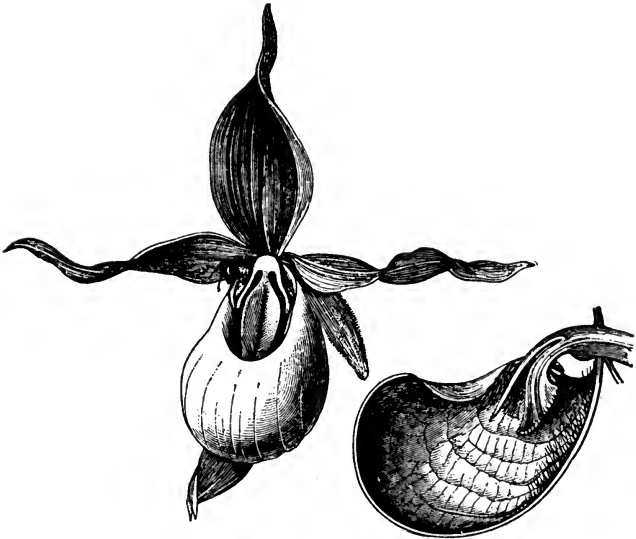

FIG. 204. — *Cypripedium Calceolus*.

The insect can enter only by the front or upper opening, and leave only by a side opening; thus it must pass in succession the stigma and anthers. (From Kerner.)

possible, and is actually self-effected, if no foreign pollen be present. Still further, there exist a few flowers, of which some Violets are examples (Fig. 202), in which self-pollination is not only the rule, but the invariable rule; for the flowers never open and the anthers shed the pollen directly upon the stigmas, an arrangement called CLEISTOGAMY. All such plants, however, possess also showy flowers, cross-pollinated in the usual way.

Not only does the structure of the typical showy flower exhibit remarkable fitness to cross-pollination by insects, but this fitness is carried to degrees which have evoked the wonder and admiration of long generations of loving observers of plants. The simplest condition is found in regular flowers like Buttercups or Apple blossoms, where almost any kind of insect may equally well alight in the shallow basin, and, busily seeking the nectar, effect pollination. This is likewise the case with the Compositæ,—the Dandelions and Daisies and Sunflowers, and that sort. In irregular flowers, such as the Larkspur and Mints (Fig. 203), the arrangements are such that only Bees and like insects can reach the nectar in the elongated spurs or tubes; and those are the principal insects which visit such flowers. In these flowers, as elsewhere, the mechanical arrangements are such that the visiting insect must take a path which insures cross-pollination. In some Orchids, especially the Lady's Slipper (Fig. 204), the insect has to enter the flower

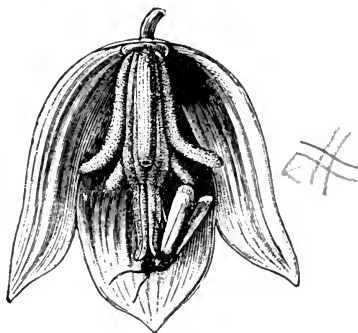

FIG. 205.—A flower of *Yucca Whipplei*, being pollinated by a *Pronuba* moth;  $\times \frac{1}{2}$ .

The insect deliberately collects pollen from one flower, carries it to the stigma of another, and there presses it securely down. It then lays an egg in the ovary of that flower, and its larva feeds on some of the seeds, which would not develop without the pollination. (From Kerner, after work by Trelease.)

by one opening which the stigma guards, and leave by another over which hangs an anther. In Orchids, indeed, the fitting of floral form to insect shape and habit has become wonderfully exact, so that in some cases only a single species of insect can pollinate the flower, the adjustment between the two being carried remarkably into details. These, however, are but few of the great variety of arrangements presented in this relation between flowers and insects, which include even a case of deliberate and purposeful pollination

by the insect (Fig. 205). All of these matters are described in detail in several works devoted to the subject. The student will find that to the original investigators, these remarkable adjustments between flowers and insects seem most reasonably explained as result of a gradual process of adaptation of one to the other during the course of their evolution.

Insect-pollination prevails far more widely than any other method, and moreover is characteristic of the highest kinds of plants. A reason for its superiority over wind-pollination consists obviously in its greater economy and efficiency, for

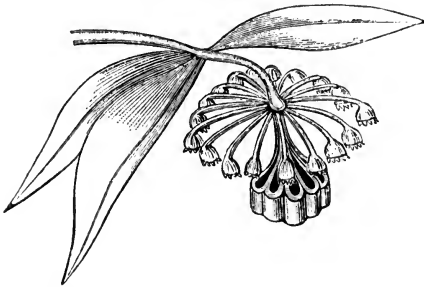

FIG. 206. — *Marcgravia nepenthoides*, pollinated by humming birds; much reduced.

In the pouched nectaries below the flower, there is secreted abundant nectar, in probing for which the hovering birds bring their heads successively against the flowers. (After H. Müller.)

in the one case the pollen is simply cast forth and its access to a stigma left to chance, while in the other the pollen is carried directly from anthers to stigmas. A phase of this economy — making the most, so to speak, of insect visits — explains the presence of stamens and pistils in the same flowers.

While insects are overwhelmingly the most important, they are not the only animal cross-pollinators of flowers. Some kinds of large bright flowers are regularly pollinated by small nectar-eating birds, especially humming-birds (Fig. 206); and others, growing close to the ground, are pollinated by snails, which are attracted by a succulent tissue formed in the spike among the flowers. But insects, from their combination of small size, active habits, and nectar diet, make the most effective cross-pollinators.

As with other plant organs, flowers have not only their primary function, which they perform as their contribution

to the economy of the plant as a whole, but also certain supplementary functions essential to their own nutrition or safety. Thus pollen is commonly liable to injury by water, *i.e.* rain, through osmotic absorption, as earlier shown (page 234); but many flowers are completely inverted, thus

shedding the rain, as in Columbine (Fig. 207), or the petals overarch the stamens, or scales and hairs prevent access of raindrops, or other arrangements occur. Also the nectar is attractive to insects too small, or unadapted by habit, to effect pollination, notably ants, against which there must needs be protection; and a good many corresponding adaptations have been claimed in flowers, — the closed throat of the Snapdragon, which bees can open but ants cannot, the adhesive glands on the calyx of Plumbago, the hairs in the throat of many flowers, and a good many others, for further accounts of



FIG. 207.—The Columbine, *Aquilegia canadensis*, showing the inverted position of the flowers. (From Bailey.)

which the student must turn to the special works. Of course, as with other organs, various hereditary and structural factors also enter into the construction of particular flowers, which therefore can by no means be explained in detail upon the basis of adaptation to insect-pollination alone.

Not only a structural but also a physiological fitness to the accomplishment of pollination occurs in flowers. Thus, most flowers are very strongly *phototropic*, as one can see very easily on any sunny bank or in borders near buildings, and as can be proven very strikingly by experiment (Fig. 208). Thus they are brought, and their faces set, in the most conspicuous positions. Again, many flowers, especially those which present a special alighting position to insects, are very strongly *geotropic* (diageotropic), and thus, no matter what accident may befall the flower stalk, the individual blossoms keep their positions for the visiting insect (Fig. 209). The tubes and coronas of Narcissus and Daffodils are kept thus in their horizontal positions, as can be proven by tying a young flower stalk down horizontally. Again, many flowers do not open before rain, or else close on its approach, and some few flower-clusters turn upside down, seemingly in adaptation against damage to the pollen by water (page 234). The stimuli concerned are not in all cases clear, nor are the weather predictions always accurate, though in this they per-



FIG. 208. — A cluster of Bellflowers, set in one-sided light, showing phototropism of the flowers. (Drawn from a photograph.)

haps succeed as often as our human forecasters with all their exact instruments. Also, various movements of stamens occur, partly effected mechanically, as in Mountain Laurel



(*Kalmia*), partly irritably, as in Barberry, and diversely in some Orchids, though the exact significance of these and other like phenomena is still matter of debate.



FIG. 209. — Clusters of Larkspur, showing the diageotropism of the flowers. The tip of the larger cluster was tied down at an early stage of its development. (Drawn from a photograph.)

There remains one leading question: Why these elaborate arrangements for cross-pollination when close-pollination is

so much simpler, as cleistogamous flowers attest? There is good evidence, based on direct experiments by Darwin, that more and stronger offspring are produced by cross-pollination than by close-, meaning a cross between different plants, for a cross between different flowers on the same plant is little if any better than close-pollination. Thus an advantage must inhere in cross- over close-pollination, which means of course in cross- over close-fertilization, pollination being only a preliminary mechanical step to fertilization. This superiority, in light of the well-known evolutionary principle of the survival of the fittest, amply explains the prevalence of cross-fertilization in plants, and its exclusive use in the higher animals. But why is cross- superior to close-fertilization? As to this, there is still much doubt, but we can gain some light by translating the matter into terms of the chromosome mechanism. Close-fertilization must necessarily give to the offspring two sets of chromosomes identically alike, precisely as in case of asexual reproduction (page 300), while cross-pollination gives to the offspring two sets of chromosomes which differ somewhat. Hence cross-fertilization has the same superiority over close- that close- has over none; or to put the matter in another way, cross-fertilization is apparently necessary in order to realize the full benefits of fertilization. As to the advantages of fertilization over asexual reproduction we have already spoken (page 286). One must regret that such fundamentally important matters cannot as yet be satisfactorily explained, but they cannot. The future, however, will surely yield their interpretation.

#### 6. METHODS OF ASESEXUAL REPRODUCTION

While most reproduction in plants involves fertilization and sex, there is much that is purely asexual. Sexual and asexual methods are by no means mutually exclusive, but commonly exist together in the same plants, either side by side or in a form of alternation.

The only plants which reproduce exclusively by asexual methods, so far as known, are the very simplest Algæ and the Bacteria. Their single-celled bodies divide across into two; the halves grow to full size and fall apart (Fig. 210); and thus we have asexual reproduction by *division*. One might think also that the higher Fungi should be included in the asexual category; but newer studies seem to be showing that these plants possess a form of fertilization.

In addition to *division*, the asexual methods include *specialized vegetative bodies*, *potential vegetative parts*, and *asexual spores*.

1. *Specialized vegetative bodies*. These are mostly of the nature of separable buds, formed on thallus or shoot and later set free, when they grow directly to new plants. Such bodies are found in Algæ and Fungi, especially the Lichens, and reach fuller development in the higher groups. Thus, some Liverworts produce in special cups on the thallus

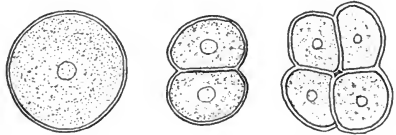

FIG. 210. — Asexual reproduction, by division, of *Pleurococcus*, a green Alga which grows upon tree trunks; much magnified.

The smaller cells thus formed soon grow to full size.

many symmetrical flat bodies called *gemmae* (Fig. 211), which, washed out or blown to some distance, produce there new plants. Some Ferns produce on the margins of their fronds little buds, which sprout and continue their growth when the leaves are dropped. Identically the same feature is found in the Life-plant, or *Bryophyllum* (Fig. 43), which has buds on the margins of its leaves, and thus can produce new plants when the leaves fall on the ground. Essentially the same principle is involved in the formation of little plants at the ends of the runners in the Strawberry, as earlier described (page 189). Some waterweeds form compact winter buds, which separate and float away to start new plants in the spring. The larger Lilies produce in the axils of their

leaves little seed-like bodies (Fig. 212), which really are compact buds though they separate and give rise to new plants.

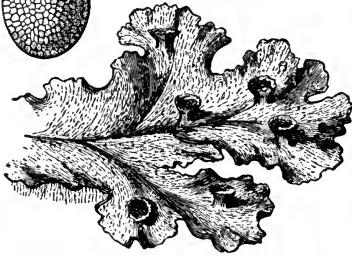
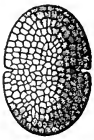

FIG. 211.—The thallus of a Liverwort, *Marchantia*; natural size.

The cups bear small vegetative gemmæ, of which one is shown enlarged. (From Kerner.)

incidentally that function. Thus the brittle twigs of Willows, if blown or drifted to suitable places, take root and grow to new trees. Many kinds of creeping root-stocks, or even roots, will produce new plants when severed, as exemplified by the pertinacious Couch Grass of our gardens. The most important phase of such reproduction, however, is found in the power possessed by many plants to strike root from cuttings placed in the ground, whereby they produce full and perfect plants, even though they never reproduce naturally by this method; and many plants which will not strike root from ordinary cuttings can yet be made to do so by devices well known to skilled gardeners. This potentiality of vegetative reproduction, rarely or never exercised in most of these plants, is rich in consequences for practical gardening.

Similar in nature, albeit very different in appearance, are the little bulblets which so many liliaceous plants produce as outgrowths from their main bulbs. This is a great profit to our gardening, for the possibility of our bulb beds and borders depends upon the existence of these bulblets, which are simply separable buds.

2. *Potential vegetative parts.* Some plant parts not specialized for reproduction can yet serve in-

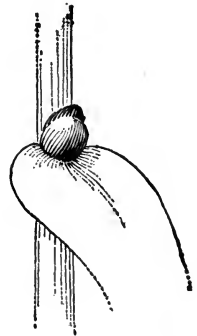

FIG. 212.—A seed-like separable bud on the stem of a Lily. (From Bailey.)

3. *Asexual spores.* A spore is typically a single-celled body which can grow directly into a new plant. Many of the simpler Algæ throw out into the water tiny spores which swim freely about by aid of small cilia, and hence are called ZOÖSPORES (Fig. 213); they resemble closely the gametes later described (page 303), but grow without any fusion into new plants. Higher Algæ also produce such spores, which are thrown off to drift with the currents, as will be described in Part II of this book. Most of the Fungi produce asexual wind-scattered spores, usually in very great number, and minute as the dust, either on the gills, as with Mushrooms, or in special long-stalked spore cases, as in Molds (Fig. 214), or in other equivalent ways. Liverworts and Mosses produce spores in their capsules, and Ferns in the "fruit dots" on the under sides of their fronds, as will later more fully appear. In all of these groups except the Fungi, and even obscurely in them, occurs also a sexual reproduction with fertilization, as already described, while moreover there exists usually, and perhaps always, a marked alternation between the sexual and asexual methods. This latter subject merges into the so-called ALTERNATION OF GENERATIONS, a matter of very great morphological interest, to which we shall return in Part II.

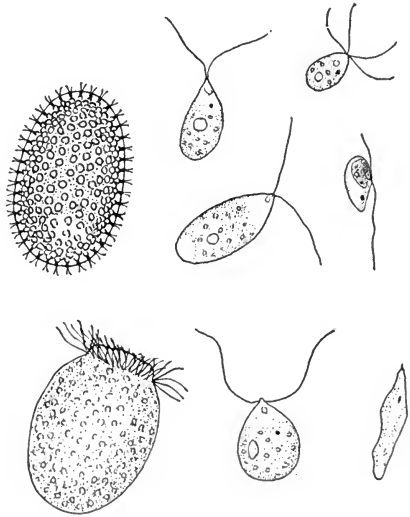

FIG. 213. — Zoöspores, asexual unicellular reproductive bodies, of Algæ; highly magnified.

The forms are typical. All swim by action of the hair-like cilia, — towards the cilia.

A very special and rare form of asexual reproduction is found in PARTHENOGENESIS, *i.e.* the development of an egg cell to a plant without fertilization. This is known in relatively few plants, which include especially the Composite family, though it is frequent in the reproduction of Insects. Closely related thereto are cases of POLYEMBRYONY, in

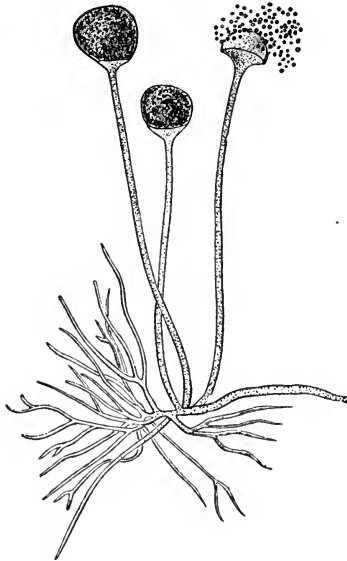

FIG. 214. — The spore cases and spores of a common Mold;  $\times 38$ . (From Strasburger.)

which cells of the embryo sac other than the egg cell develop into apparent embryos, which, however, are really vegetative structures of the nature of branches. Both parthenogenesis and polyembryony are too rare to play any appreciable part in plant reproduction as a whole, and have their chief interest as showing the plasticity of natural processes.

A question must arise at this point as to whether any differences exist between the sexually and asexually produced offspring of the same plant. It seems clear that in general the asexually produced individuals are less variable in their characters than the sexually produced, although there are notable exceptions. At all events it is customary among gardeners to employ asexual propagation when they wish to retain a variety true to some valued character, but to use sexual or seed reproduction when trying for novelties.

## 7. THE ORIGIN AND SIGNIFICANCE OF SEX

In the preceding sections, the two fusing sexual nuclei, the male and the female, have been treated as functionally

alike and contributing the same in kind to the offspring. Such is the conclusion indicated by modern research. If, now, the two sexes thus contribute equally to the constitution of the offspring, where lies the essential difference between them, or, more exactly, why does sex exist at all?

For light upon this question we turn to the sexual methods and structures presented by the different groups of existent plants, from the lowest to the highest. These will be found described in full in Part II of this book, but for our present purposes may be summarized as follows.

I. There are plants of simple kinds, notably Bacteria and some low Algæ, which reproduce solely by division, that is, the single cells constituting the adults simply divide across and grow to full size (Fig. 210), precisely as do meristematic cells already described in the higher plants (page 299). Here is represented a stage of reproduction in which there is neither fertilization nor sex.

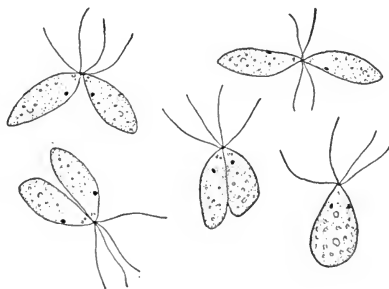

FIG. 215.—Gametes of the simple Alga *Protosiphon*, in process of fusion; highly magnified. On the right a complete "zygote."

II. There are several known Algæ, of grade somewhat higher than those just mentioned, in which the plants are all alike, and produce small reproductive cells called GAMETES, likewise all alike, and provided with swimming appendages. These gametes are thrown out into the water, where, swimming freely about, they come together at haphazard and fuse, uniting their nuclei, quite in the manner of the fertilization of the higher plants (Fig. 215); and from the resulting cell a new plant develops. Here is evidently represented a stage in which fertilization occurs, but without any difference between the sexes.

III. The Rockweeds, the common brown seaweeds so prominent on sea coasts at low tide, and some other Algæ of higher grade than those mentioned under II, produce two kinds of reproductive cells, one relatively large, round, and without swimming appendages, the other small, elongated, and adapted to swim freely (Fig. 216). Both kinds when ripe are thrown into the water, where the large cells float passively about while the small cells swim to them and fuse with them, quite in the manner of fertilization in the higher plants; and this fertilized cell grows into a new plant.

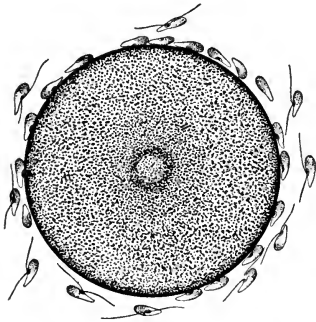

FIG. 216. — An egg cell of Rockweed, surrounded by sperm cells, one of which enters and effects fertilization;  $\times 500$ . (Redrawn from L. Kny.)

We call the larger the EGG CELL, or EGG, and recognize it as female, and the smaller the SPERM CELL or SPERMATOZOID, and recognize it as male; and herein we have a clear case of the existence of sex. Considering, now, the nature of the differences between the two sex cells, it is evident that the egg cell owes its great size to the large supply of food it contains, this food being used in the development of the new plant until it can make its own supply;

and since it is thus large and clumsy, so to speak, its capacity for free locomotion is diminished, and even the attempt is abandoned. The sperm cell, on the other hand, consists of little more than a nucleus, with only enough cytoplasm to construct an efficient swimming apparatus. Here, as in the higher plants, the two nuclei appear to contribute through their chromosomes exactly alike to the offspring, and it seems clear that the difference between the two cells consists in a division of labor with respect to two subsidiary features of reproduction, viz. the bringing of the sex cells together, and the provision of food for the resultant offspring, — one



cell assuming wholly the one function, and the other the other. No differences occur in the plants which produce these cells, excepting in the parts immediately connected with the formation of cells of such different sizes. Thus we have a stage in which there is a clear distinction of sex, but only in the sexual cells themselves, and it arises not from any fundamental matter of difference in contribution to the constitution of the offspring, but in a secondary matter of division of labor in connection with the mechanism of fertilization, and the nutrition of the resultant embryo.

IV. The higher, or Red, Algæ have a complicated reproduction under which we can recognize the essential fact that the egg cell, naked as in the lower kinds, remains permanently attached to the parent plant, upon which it is fertilized by a much smaller floating sperm cell, and from which the resultant growth is supplied with food (Fig. 217). Thus we have a stage, not, it is true, exactly represented in living forms, but presumably once occurring in kinds now extinct, wherein the egg cell remains attached to the parent plant, on which it is fertilized and by which the resultant equivalent of an embryo is supplied with food.

V. The stage just described is the highest attained by the Algæ. In the simplest land plants, the

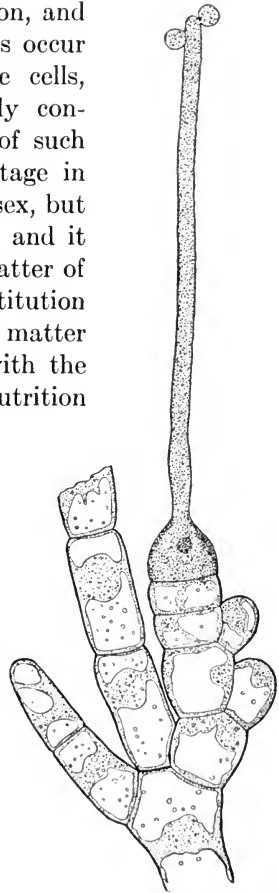

FIG. 217.—The egg cell, attached to a fragment of frond, of *Nemalion multifidum*, a seaweed;  $\times 700$ . Extending from the egg cell is the long-projecting "trichogyne," adapted to receive the small floating sperm cells, of which two are attached. (After L. Kny.)

Bryophytes and Ferns,

the egg cell is no longer naked, but, in obvious correlation with the danger which would attend the exposure of its delicate, succulent substance to dry air, is inclosed within a protective cover, so constructed that when the egg cell is ready for fertilization and the surrounding conditions are favorable, the cover opens, and not only permits, but facilitates, the access of the free-swimming sperm cell, which

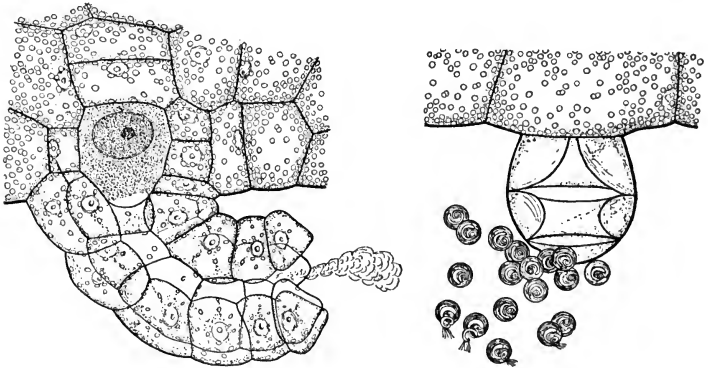

FIG. 218. — Sexual reproduction of a Fern;  $\times 240$ .

The structures occur on the under side of the sexual or prothallus stage, close to the ground. On the left, a section of the prothallus in which the egg cell is buried and covered by the tubular "archegonium." On the right, the free-swimming sperm cells escaping from the "antheridium." When the sex cells are ripe, the access of water causes both structures to open; the archegonium releases into the water a substance (malic acid) very attractive to the sperm cells, which swim towards it, and enter the tube, when the first to reach the egg cell fuses therewith and effects fertilization. (After L. Kny.)

itself develops in a special structure (Fig. 218); and then the developing embryo is supplied with food by the parent plant. Here is evidently represented still another stage in the evolution of sex, in which have been developed, above the earlier differences, special and different *structures*, which protect the sex cells in ways to facilitate the access of the free sperm cell to the fixed egg cell.

VI. The highest development of sex in plants is represented in the construction of the flower, as described in an

earlier section (page 269). Here fertilization is effected, not in water by a free-swimming sperm cell, as in all earlier stages, but in the air by wind- or insect-carried pollen grains from which the pollen tubes carry the sperm cells to the egg cells. In correspondence with the dry and exposed surroundings, the egg cell is deeply buried within the body of the parent plant, — within an embryo sac, inside an ovule, enclosed by an ovary, while the pollen occurs in closed anthers. Now the mode of transport of the pollen, by external agencies, requires that the anthers, with some part of the ovary fitted to receive the pollen, be accessible to wind and insects; and such is the function of stamens and pistils. Accordingly these parts, specially fitted to bring the sex cells together, constitute physiologically the sexual organs of the plant, even though on morphological grounds this designation has been denied them. Here is evidently represented still another stage in the evolution of sex, consisting in the presence of sexual organs, fitted to effect union of the sex cells.

VII. In most plants the stamens and pistils are borne close together in the same flowers, which are said to be PERFECT (OR HERMAPHRODITE). In some cases, however, like Birches and Oaks, they are borne in separate flowers on the same plant, when they are said to be MONŒCIOUS. In any case only the stamens and pistils show structural differences connected with the different sexes of the cells they produce, and the plant itself shows no trace of sex. In a few kinds of plants, however, the staminate and pistillate flowers are borne upon separate plants (are DIŒCIOUS), in which case the plants are somewhat naturally, though not quite correctly, described as male and female. Ordinarily there is no determinable difference, aside from the flowers, between such plants, but occasionally, as in Date Palm, some Willows, and a few others, there is a marked difference in aspect between staminate and pistillate individuals, thus giving a structural basis to the terms male and female as applied to plants. Here, however, is the limit reached by plants in

their sexual differentiation, though the higher animals have gone a little farther, for in them the male and female sex cells are always borne by different individuals, which are distinguished, not only by their very different sexual organs, but also by correlated differences in habits, occupations, dispositions, aspect, stature, and other visible features.

Thus, in summary, there runs throughout all sexual differentiation the one constant thread of the fusion of the two sex cells, which brings together the parental chromosomes in equal contribution to the constitution of the offspring. It is only the mechanisms subsidiary thereto which vary. These mechanisms originate in a way to imply that the sexes were originally alike, and the differences between them arose through a division of labor, at first between the sex cells and later between the individuals which produce them, in connection with two subsidiary features of sexual reproduction, — viz. effecting the union of the sex cells, and nourishing (and later protecting) the embryonic offspring. Even in the highest plants and animals, sex seems to mean no more than this difference, developed to such a degree as to produce structures, organs, and even individuals, fitted to the respective parts taken by the sex cells. It is indeed possible that other factors are also involved in the result, but if so, they are obscure, while these are obvious.

## 8. HEREDITY, VARIATION, AND EVOLUTION

The matters considered in the preceding sections lead naturally to others expressed in the title of this section. They are largely of theoretical, though very fundamental nature. Although in the past largely speculative in treatment they are now the subject of profound experimental researches, the conclusions of which apply equally to plants and animals.

Heredity is the resemblance of an individual to its ancestors. Variation is the difference between an individual and its ancestors. It is easy to see how, granting the chro-

mosome mechanism earlier described, heredity should occur. Indeed, on this basis, offspring should repeat their ancestors exactly, and the scheme leaves no room for variation at all.

The student will note the phrase "like its ancestors," not "like its parents." It is a matter of popular knowledge that family characteristics often skip a generation, or several for that matter; and children thus show features of their grandparents intermingled with those of their parents. Our knowledge of this subject is now firmly grounded, thanks to the labors of Mendel and his many modern successors in experimental biology. As a result it seems clear that the characters or features which make up an individual, and which are built by its cytoplasm under control of its chromosomes, are not indefinite in number and kind, as popularly imagined, but are definite in both respects. In other words, an individual consists of a definite, though great, number of ultimate irresolvable unit characters, of which it forms a kind of mosaic. Furthermore, each such *unit character* is apparently represented in the chromosomes of all of the cells by some kind of *determiner* which controls the construction of that character by the cytoplasm, though whether this determiner be some material carrier, some kind of register, some form of model, some type of enzyme, or some other entity, is not known. Accordingly, the fertilized egg cell, and every body cell formed therefrom, having its two sets of chromosomes, must contain two sets of all the determiners necessary to construct that kind of organism; or in other words every kind of character of an organism is represented in duplicate in every one of its body cells, one determiner being contributed by each parent (see the diagrammatic Fig. 219). Now arises the question: How do these duplicates behave with respect to one another during the development of the cell, and what determines which one is to direct the cytoplasmic construction, and thus determine the character, in any particular case? On this matter Men-

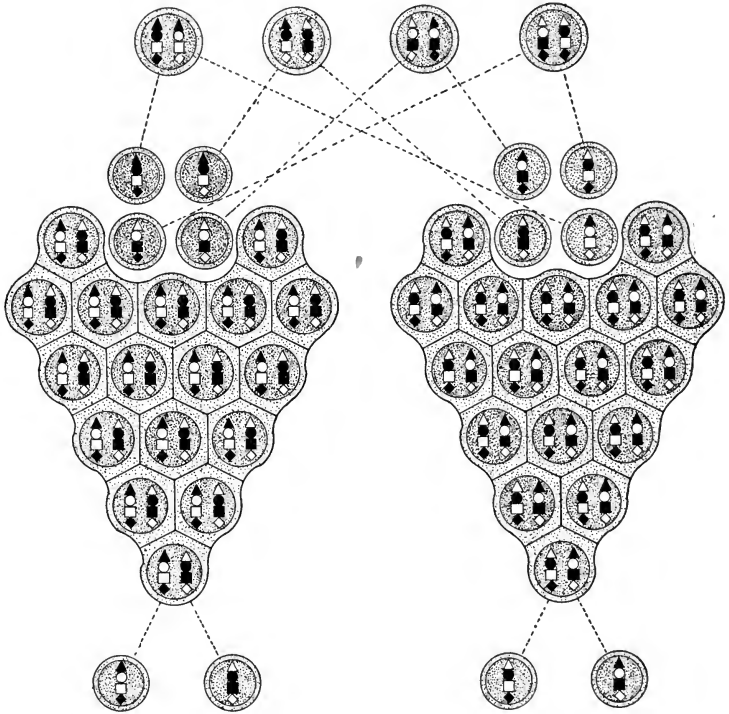

FIG. 219. — A diagram to illustrate the principle of the chromosome mechanism of heredity.

The triangular masses of cells are adult individual plants, or animals, male and female, developed from the parental germ cells shown below, and forming above their own germ cells, which are uniting in pairs into fertilized egg cells. In the nuclei of the individuals are the chromosomes, reduced for simplicity to two, and composed of determiners, reduced for simplicity to four, a black determiner being assumed to be always dominant to a white one. For example, we may take a *triangle* to mean height of stem, black meaning taller and white shorter; *circle*, color of corolla, black darker, white lighter; *square*, shape of leaf, black longer, white rounder; *diamond*, texture of stem, black rougher, white smoother. Thus the two individuals would be taller, longer-leaved, darker-flowered, rougher-stemmed, though having both the capacity to transmit the other qualities, as shown in their germ cells.

Two such individuals as here pictured, being externally alike though differently constituted in their chromosomes, are described in the technical language of genetics as *phenotypically* identical but *genotypically* different; and, having both dominant and recessive determiners, are *heterozygous* for all characters. They can, however, as the diagram shows, produce offspring which contain only the dominant or the recessive determiners for certain characters, that is, are *homozygous* for those characters.

del was the first to obtain exact knowledge, which has been confirmed and greatly extended by others. Using different varieties as parents, he was able to trace the separate characters in their hybrid offspring, and thus he discovered that the rule in such cases is this, — *the matter does not depend upon chance, but one of the two determiners regularly prevails over the other* (is DOMINANT, in his phrase), and shows its influence in the developing cell, while the other is latent (RECESSIVE, in his phrase), and without visible effect. This is the way in which parental characters can lie unseen and latent in the body, thus in our common but erroneous phrase “skipping a generation.”

There is, however, much more in the subject than this. As already explained (page 285), when the adult individual forms its own new sex cells, the number of chromosomes and therefore of determiners, is halved by the reduction division, but in such manner as to give to each new sperm or egg nucleus one complete set. This set is taken partly from the father set and partly from the mother set, the combination apparently being made wholly at random, as manifest by the fact that the different sexual cells of the same individual differ greatly in the make up of their combinations (see Fig. 219). Thus it happens that every sexual or germ cell contains a determiner for each character from its father or its mother, but never from both, a fact called technically “the purity of the germ cells.” It is also true that, for any given character, about as many germ cells carry the father determiner as carry that of the mother. Now if two individuals of the same kind breed together, as imagined in our figure, and if the union of the germ cells is left simply to chance, as seems to be true, then there follows, so far as each single character is concerned, a very remarkable and important result, which can most simply be described by use of our diagram. Thus, if we center our attention upon color of corolla (the circles with black, *dominant*, and white, *recessive*), we find that four and only

four modes of fertilization are possible; a black from a male nucleus may unite with a black from a female, or a black from a male with a white from a female, or a white from a male with a black from a female, or a white from a male with a white from a female. Thus we can have four kinds and only four, of fertilized egg cells, one containing two black determiners, one containing two white determiners, and two containing a black and a white. In other words, theoretically  $\frac{1}{4}$  of all the offspring of this couple will have the black character only, the white being eliminated entirely from their bodies and those of all their offspring if they breed only with their own kind;  $\frac{1}{4}$  likewise will have the white character only, the black being eliminated out of them and their offspring if they breed with their own kind; and two  $\frac{1}{4}$ 's, that is  $\frac{1}{2}$ , of the whole will have the black and white both in their own bodies, and can transmit either to their descendants, although, as black is dominant to white, they will themselves show only the black character, the white being latent or recessive. Thus of all the offspring  $\frac{3}{4}$  will show the dominant black and  $\frac{1}{4}$  the recessive white, though of the  $\frac{3}{4}$ ,  $\frac{2}{4}$  have the white latent. The arrangement is represented for a single character in Fig. 220. This fact was discovered by Mendel in hybrids, but of course is equally true in principle for ordinary offspring from parents of the same variety. It has been found to hold true very widely, even though not universally, in a great many kinds of plants and animals; and it is the central feature of MENDEL'S LAW, now one of the most prominent matters in all Biology.

For the sake of the study of the principle we have reduced our subject to the utmost degree of theoretical simplicity. In fact, however, matters are never so simple, and commonly are vastly complex, in actual life. Thus, the law only holds true as an average of high numbers, its operation being often obscured by chance with small numbers; characters and determiners are not few in number, but many, even to hundreds and thousands; similar forms are



not likely to breed together repeatedly unless compelled by experiment, though the same result is effected in some plants which pollinate themselves; characters are not passed along singly, but commonly a number together in loose aggregations; determiners seem to exert certain influences upon one another directly; and there are yet other complications. Hence in Nature the law is not manifest to observation, though discoverable by experiment; but it operates

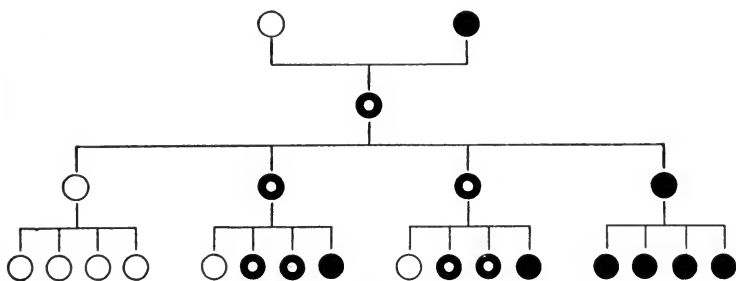

FIG. 220. — Diagram to illustrate Mendel's Law of the segregation of characters in heredity, using a single character of Fig. 219.

If germ cells having the dominant character (black circle) breed with others having the recessive character (white circle), then all of their offspring show only the dominant character but carry the recessive character latent (black circle with white center). If these forms breed together, their offspring will show the distribution of characters represented in the diagram, — one-fourth will be pure dominants and one-fourth pure recessives, while the remainder are dominants carrying the recessive character latent. If those in this generation breed only with their own kind, the result in the next generation is as shown in the diagram; and thus indefinitely.

as a steadily working principle which runs as a kind of guiding thread through all heredity, while coming to view now and then in such phenomena as "skipping a generation," elimination of characters from a race, and other less obvious matters.

Thus, on the basis of our knowledge of the performance of the chromosomes in reproduction, in conjunction with Mendel's law, heredity must rest upon the transmission of determiners which, existing in *each species* in a certain number, are distributed in different combinations in the

*different individuals.* Expressed otherwise, and somewhat fancifully, individuals are simply temporary kaleidoscopic combinations of the various determiners belonging to the species, the act of reproduction, especially the reduction division and subsequent fusion, providing the new turn of the kaleidoscope.

Thus much for heredity, which means the resemblances of individuals to their ancestors. What now of variation, which means the differences? The chromosome mechanism explains heredity well, but not variation. Indeed the mechanism seems to leave no room for variation, since by its operation all individuals are simply combinations of determiners which preëxist. Yet variation is as real a fact as heredity, for organisms do change with time, as proven by comparison of living plants and animals with their fossil ancestors.

The conception of variation, however, needs definition, for some apparent variation is not at all important in evolution. Thus, individuals are often strongly altered in their development by their conditions of life, — insufficient or peculiar food, etc., and also often become altered by self-adjustment to the conditions of their immediate surroundings, as we have noted already under various phases of irritability. But such changes (called **FLUCTUATIONS**) are known not to be hereditary, that is, they affect the cytoplasm but not the determiners in the chromosomes. The variations (called **GENETIC VARIATIONS**, or **MUTATIONS**), which produce hereditary alterations in organisms, must affect the determiners, either by interpolating new ones, or by altering the character or relations of those already present. Yet while such mutational variation undoubtedly exists, we have no knowledge as to how it arises or in what way it affects the determiners. Indeed the origin of variation is the great crucial problem of present-day Biology, though it will be settled, and before long, by the experiments now in progress. It is the watching understandingly for the answer to such deep questions which gives to

the study of science its great charm, and it is the chance to find the answer one's self which gives to scientific investigation its matchless zest.

That the organisms which now exist on the earth are different from those which formerly existed, and that these organisms are fitted to the conditions under which they live, are two facts which have long been known to scientific men, who have explained them in different ways. Thus Linnaeus, and most others of the earlier naturalists, believed that the new kinds were each suddenly created, and in very exact fitness to the surrounding conditions, by an omnipotent Creator. This doctrine is known as SPECIAL CREATION. It did not, however, stand the test of advancing knowledge, for ample evidence seemed to show that existent kinds of organisms have developed out of earlier kinds; and it seemed reasonable to suppose that in course of this development the organisms and their parts became adapted to their environments. This is the meaning of EVOLUTION. All modern research has tended to confirm its correctness.

The fact of evolution is one thing, and the method whereby it has come about is another; and the explanation of its method has been for a half century the foremost problem of philosophical biology. Two great leading solutions have been offered for the problem. Lamarck, a French zoölogist who was active a century ago, argued that the changes which are known to occur in individuals, either directly by action of the environment or by self-adjustment thereto, are transmitted to the next generation and there re-appear; and that thus a character can be intensified generation after generation until a new kind or species results. This is the view of the TRANSMISSION OF ACQUIRED CHARACTERS. Translated into terms of the chromosome mechanism, it would mean that any change in a character of an individual organism, which of course affects the cytoplasm of the cells concerned, can become registered or represented in some way in the determiners in its germ cells. Now of such a result

there is not only no known evidence, but such evidence as we possess seems wholly against its occurrence, with possible rare exceptions which hardly affect the general principle. All evidence seems to show that while alterations in the determiners alter the organism, the reverse is not true.

A second solution, and the most famous, is that of Darwin, who was active in his work somewhat over a half century ago. He argued that a spontaneous variation of all features of organisms is constantly in progress; that only a few of the many varying individuals can survive; that such variations as happen to lie in a direction which fits the organism to its environment will help that organism to survive in competition with those having a less favorable direction; that the offspring of the surviving organism will inherit the variation; that some will vary in even higher degree; and that thus in time the variation can accumulate to a degree which makes its possessor not only a new kind but better adapted than its ancestors to those particular conditions. Thus Nature acts to select certain characters, and the view is known as NATURAL SELECTION. Translated into terms of the chromosome mechanism, this means that the determiners are not stable entities, but exist in a state of unstable equilibrium such that they can produce characters in greater or lesser degree of intensity. As a matter of fact most of the evidence we have accumulated upon this point seems opposed to the idea that the determiners are thus unstable, and many investigators deny them all variability. More recently, however, some apparently incontrovertible evidence has been found which points to an inherent instability of the determiners or unit characters, and their modifiability by selection; and the Darwinian conception of evolution by selection of such variations will probably prove correct in the end.

A modification of Darwin's explanation of the method of evolution is that of De Vries, a Hollander still actively working. He maintains, on the basis of observational and ex-

perimental evidence, that some new kinds or species of organisms originate not slowly and gradually from other kinds, but suddenly,—even so suddenly as in one step from parent to offspring. Such new steps are supposed to be not frequent, but occasional, long periods of stability alternating with short periods of change. Upon forms thus originating natural selection operates to preserve the best fitted kinds. The species which thus originate, called often ELEMENTARY SPECIES, differ really, though only slightly, from those which give rise to them; and several mutational steps are needed to make such markedly different species (LINNÆAN SPECIES), as the older naturalists associated with that word. This view is known as that of MUTATION. Translated into terms of the chromosome mechanism, it means that the determiners, after long periods of transmission in stable form, suddenly alter, apparently not by the interpolation of new ones so much as by spontaneous sudden change in the old. But the evidence on this matter is still in debate.

#### 9. THE METHODS USED BY MAN IN BREEDING BETTER PLANTS

Everybody knows that our most valued varieties of farm and garden plants—our grains, fruits, vegetables, and flowers—do not occur wild, but have been developed by man from inferior wild kinds. Our principal grains, Wheat and Corn, have been so far improved from their wild ancestors that we know only doubtfully what those were. Our best known fruits, Apples, Pears, and Oranges, are incomparably superior to the original kinds in size, flavor, and other qualities we value. Among vegetables, the Cabbage, Cauliflower, Brussels Sprouts, and others, most diverse in aspect, are all known to have been derived in gardens from a very simple little strand plant of western Europe. In flowers, a great many of our garden favorites have been improved from their wild states to a degree which would render the relationship unsuspected were it

not for our historical records. Most remarkable of all, and perhaps the acme of man's developmental accomplishments, is the Chrysanthemum, in which, from two little simple wild plants, smaller than our common field Daisies, have been developed all of the great variety of distinct types, and all of the superb individual specimen plants seen in our horticultural exhibitions, culminating in single plants over sixteen feet across and bearing fifteen hundred blossoms, and in single blooms over twenty inches in diameter. We consider now the methods by which man has achieved these results.

New varieties originate under cultivation, but not as a direct result thereof. High cultivation can supply the conditions for the best development of individual plants or a given crop, but the improvement is not hereditary, and therefore does not yield new kinds, which we acquire in only three ways, — by SELECTION OF VARIATIONS, PRESERVATION OF SPORTS, and HYBRIDIZATION.

1. *Selection of variations.* Both experience and experiment attest that plants of the same variety growing side by side, whether wild or in gardens, present many differences, or variations, from one another; further, that some of these variations are hereditary, though many are not; and still further, that by persistent selection generation after generation of the plants displaying a given variation (*e.g.* size in a grain, red color in a flower), and the use of their seeds in growing the next crop, there results in time a variety in which the given feature is far more prominent and prevalent than in the original form, and moreover comes true to seed. It is true that much of such selection now practiced upon highly developed varieties of plants, whether grains or flowers, appears to consist simply in the assembling together of the plants which already possess the variation in high degree, and is not accompanied by any actual intensification thereof. In other words, selection may effect the *isolation* rather than the *development* of a variety. But an intensifi-

cation of variations must sometime and somehow occur, else we could never have obtained our multiform and multi-chrome Chrysanthemums from their comparatively uniform and simple wild ancestors; and the variation once intensified, by whatever method, could be isolated to a variety by selection. This method of improvement by selection is slow, but is favored by use of great numbers of plants, and by the fact that plants vary more rapidly and extremely under cultivation than in the wild state. In this indirect way, indeed, cultivation does promote the development of new varieties.

2. *The preservation of sports.* Occasionally some one bud on a plant will produce a branch having leaves, flowers, or fruits strikingly different from those on the rest of the plant, such a feature being called a SPORT. If, now, that particular branch be propagated by cuttings or by grafting, the new feature holds true; and thus the plants which contain it can be multiplied indefinitely. The Red, or Copper, Beeches, familiar lawn trees, originated in a single red-leaved branch on an ordinary Green Beech, and have since been propagated and multiplied by grafting. The Navel Orange, which is seedless, and further distinguished by the small accessory Orange within its upper end (page 201), originated in a sport branch upon an ordinary Orange tree, and has been preserved and spread by budding (a form of grafting). Indeed, most highly developed fruits have originated thus; somebody has found them as sports upon more ordinary kinds, and preserved them by grafting. If the sporting branch cannot be propagated by cuttings or by grafting, the sport cannot be preserved at all, for bud sports are not reproduced by their seeds, which produce only the original form. Sometimes, however, SEED SPORTS appear, in which case the sports come true to seed and can thus be propagated, as in case of some fruit trees and a few garden herbs.

The mode and causes of origin of sports are unknown.

They occur in all degrees, from barely perceptible to very striking, from useless to valuable, and from ugly to attractive, — only those which appeal in some way to man's interests being noted and preserved. They are clearly in the nature of extreme variations, which merge over also to monstrosities (page 205); and, whatever the case with bud sports, no distinction is apparent between seed sports and those mutations or hereditary variations upon which selection works.

3. *Hybridization.* When two parents belong to different varieties or species, their offspring are called **HYBRIDS**, and the process of making such crosses is called **HYBRIDIZATION**. Only closely related kinds of plants or of animals can be hybridized, presumably because the process requires a certain degree of chemical similarity in the complicated protoplasm. To make the cross in plants, the pollen from a flower of one parent must of course be transferred to a stigma of a flower of the other parent, which process is usually effected by aid of a fine brush. It is also indispensable to prevent the access to that stigma of any other pollen, including the plant's own. This end is accomplished by removing the anthers before they are ripe and covering the flower completely with a gauze bag which excludes cross-pollinating insects.

Hybrids show four distinctive characteristics important in plant improvement. *First*, hybrids are apt to be larger and finer plants than their parents, although, owing to the operation of Mendelian segregation, this feature is not preserved in the next generation. It may, however, be kept by use of cuttings or grafting. *Second*, entirely new features, not apparent in either parental line, may appear, seemingly not simply as a result of mixing two ancestral strains, but through a kind of sporting induced by the disturbance incident to the wide crossing. *Third*, a given undesirable character may be bred completely out of a race and replaced by a better, on the principle of Mendelian



segregation (page 312), which applies in full force to hybrids, where indeed it was discovered. *Fourth*, two, or more, desirable qualities belonging to different varieties may be brought together and permanently combined in a single variety. Theoretically this is the highest utility of hybridization, and its practice the highest form of plant breeding.

Hybridization is, however, by no means so simple in practice as in principle. It is often very difficult to accomplish mechanically; many plants which one desires to hybridize fail to set seed with one another's pollen; new features are as likely to be useless as desirable; hybrids designed to combine certain good qualities are as likely to combine others which are bad; the reproductive power of hybrids is usually poor; and many other difficulties make hybridization a slow and difficult method of effecting desired improvements in plants. Nevertheless, in the hands of skilled breeders, it is the most important of the three methods of plant improvement, and is actually yielding most valuable results, especially in the breeding of grains.

It was earlier said that cultivation, though it makes better plants and crops, does not produce new varieties. Indirectly, however, it helps to that end; for under cultivation plants vary and sport far more profusely and widely than when wild, — apparently because of their better nutritive conditions, in conjunction with the stimulative effect of new surroundings, and perhaps the removal of old restraints. Further, it is possible, by devices of cultivation, to intensify the rapidity and degree of variation, though not to direct its character; and skilled breeders can thus “break the type,” in their phrase, as a foundation for new varieties. It is also of course true that the greater the number of plants grown, the greater the chance for the appearance of new and desirable variations; and this method of growing plants in vast quantities is one of the “secrets of success” of the best known of present-day plant breeders, Luther Burbank.

By a combination of the methods here described, our cultivated plants have been developed from their wild ancestors. Obviously the process is a kind of evolution, in which man's needs or fancies play the part of the selecting and preserving agency. The methods do not include any way of originating any desired feature; all we can do is to select, preserve, and intensify such features as nature offers.

In earlier times most, or all, of man's improvements in plants were without plan or forethought, his selection being made upon features which pleased him, or seemed profitable, at the moment; and it is only because in general he has continued to be pleased by the same things that our cultivated plants have been brought to their present high development. In modern times, however, much of the improvement is accomplished by expert workers who proceed with deliberate forethought and a definite aim in mind. This is typical *plant breeding*, to which we may confidently look for great triumphs in the future.

## 10. THE MORPHOLOGY OF FLOWERS

Although the flower is physiologically a distinct organ of the plant, having its own primary function of effecting fertilization, its structure shows obvious morphological relation to leaves and stem.

The sepals of flowers are commonly green, and so leaf-like in origin and anatomy as to permit no doubt that they, at least, are morphologically identical with leaves. Besides, the most perfect gradations occur from sepals through bracts to the green leaves of the stem (*e.g. Calycanthus*).<sup>1)</sup> Petals, also, despite their difference in color, have a perfectly leaf-like development and anatomy, with an occasional complete gradation to sepals (*e.g. Cactus flowers*); so that they too are morphologically leaves. As to the stamens, the filaments correspond to leaves in all the morphological test points, including a transition to petals (*e.g. in Water-lilies*),

so that they likewise are leaves, of a linear or needle-like sort. The anther, however, answers to nothing in a leaf, and we hold it in reserve for a moment. In the pistil each carpel has the leaf origin and anatomy, its development being such that it infolds with the upper surface inward (Fig. 221). Where the edges of the infolded leaves grow together, the tissues are enlarged, forming *placentæ* (Fig. 222), upon which stand the *ovules*, while the tips of these leaves become prolonged and modified to styles and stigmas. The ovules, however, do not answer to anything in a leaf, and we reserve them, like the anthers, for the present. The receptacle is very clearly a stem, enlarged at the tip to bear the other floral parts. Sepals, petals, stamens, and carpels all stand in whorls, which, as with whorls of green leaves on the stem, regularly alternate (page 140, and Fig. 94), while other relations of phyllotaxy occur in these parts. Furthermore, as with ordinary leaves and stems, flowers originate in buds, which are either terminal or axillary. Thus the typical simple flower consists morphologically of a branch, of limited, or determinate, growth, containing whorls of modified leaves borne close together at the end of a stem, and surrounding two entirely different kinds of structures, anthers and ovules.

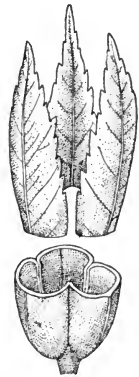

FIG. 221. — Diagrammatic representation of the mode of union of three carpellary leaves into a one-celled ovary. The united edges form the *placentæ*, on which the ovules are borne. (After Gray.)

We turn now to examine the morphological nature of anthers and ovules, which involves the relations of flowers to the reproductive structures of the lower kinds of plants. It happens, unfortunately, that not all of the stages which must have existed in the evolution of the flower are now represented in existent plants; but, as will be shown in detail in Part II of this book, enough of the stages survive

to indicate the general course of that evolution. Thus we can trace the anthers and pollen grains back without any serious break to SPORANGIA (OR SPORE CASES) and SPORES (the kind called microsporangia and microspores) of the highest flowerless plants, each anther being a composite microsporangium and each pollen grain a microspore. We can trace the ovules back in the same way to MEGASPORANGIA and MEGASPORES (Fig. 223), each nucellus being a megasporangium, and the embryo sac a megaspore, while the integuments are a special new outgrowth from the stalk of the sporangium. We can, however, trace these parts still farther back to an origin in a single kind of sporan-

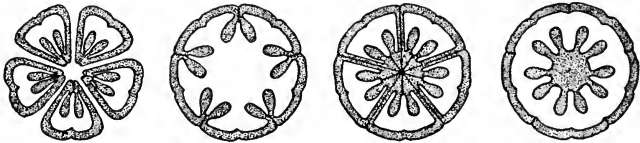

FIG. 222. — Diagrams to illustrate, in cross section, the various ways in which carpels, here five in number, unite to form compound pistils and placentæ.

First, carpels all separate; second, united like Fig. 221, giving *parietal* placentæ; third, infolded to the center, like the first but grown together, giving *central* placentæ; fourth, like the third, but with the partitions wanting, giving *free central* placentæ.

gium and spores, such as we find in the Ferns, where they occur in the brown sori, or "fruit dots," on the backs of the fronds (Fig. 224), and we can even trace them, if we choose, back into the Algæ. Thus we see that pollen grains with the anthers, and embryo sacs with the ovules, are morphologically equivalent to the spores and spore cases of the lower plants, and are therefore far older than the other parts of the flower. Hence a flower consists morphologically of *stem*, *leaves*, and *sporangia* with their *spores*. Or, since the spores are the more important as well as the older parts, we may say that morphologically a flower consists of spores together with stem and leaves specialized to aid in their reproductive function.

This identification of pollen and ovules with the spores of the lower plants at once throws light on two other features of floral structure. *First*, the megasporangia and microsporangia of the flowerless plants occur in close association with, or upon, certain leaves, somewhat modified accordingly, called **SPOROPHYLLS** (Fig. 223); and it seems clear that stamens and pistils are the lineal descendants of the sporophylls. As to petals and sepals, it is not yet certain whether they represent ancient sporophylls which have lost their sporangia, or green leaves independently specialized, though the latter seems most probable. *Second*, the pollen grains and embryo sacs (the ancient spores) are not themselves the sex cells, but develop the sperm cells and egg cells through intermediation of some cell divisions which have no apparent meaning under existent conditions (Figs. 188, 190, and full account in Part II). Now in the lower plants the spores are not sex cells either, but they produce special and often elaborate structures (including the prothallus stage of the Ferns, the thallus of the Liverworts, and the whole body of the Mosses), upon which the sex cells are developed; and it is the reduced prothallus, or equivalent, of the lower plants which persists as the seemingly meaningless cell divisions within the pollen grain and embryo sac. Thus while ovule and embryo sac, with anther and pollen grain, are parts

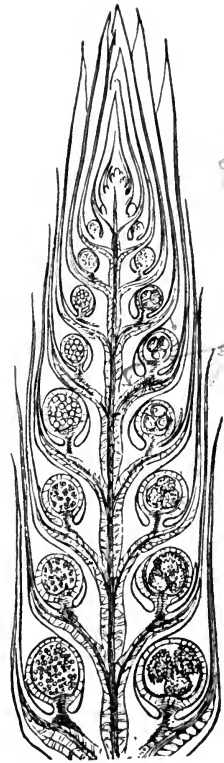

FIG. 223. — The fruiting strobilus of *Selaginella inaequifolia*, a Pteridophyte;  $\times 12$ .

On the left, microsporangia containing several microspores; on the right megasporangia containing four megaspores. The sporangia stand upon sporophylls. (From Sachs.)

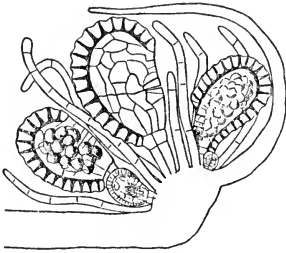

FIG. 224. — Sorus of a fern, in cross section, showing the stalked sporangia containing spores; magnified. From these spores there is an unbroken series to the embryo sacs and pollen grains of flowers. (From F. Darwin.)

of the flower, the prothallial cells of both embryo sac and pollen grain, together with egg cell and sperm cell belong to a new generation.

These morphological matters are certainly complicated and difficult at first to grasp in detail. They can be made clearer, however, by aid of a table or diagram which will exhibit their relations in light of their evolutionary origin, and of the connections of the reproductive with

the nutritive parts; and such a diagram is presented on the opposite page.

We have now traced the flower back to its morphological

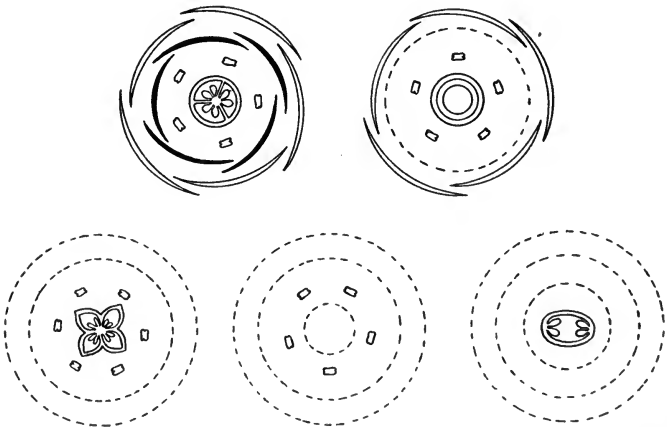

FIG. 225. — Plans, or diagrams, of typical flowers, to illustrate presence and absence of the whorls.

They represent cross sections supposed to be made through the widest parts of sepals, petals, stamens, and pistil. Above, the first is a *complete* flower (*Staphylea*), and the second is *apetalous* (Beet). Below, the first is *asepalous* and *apetalous* (*Saururus*), the next is *staminate* only (Willow), and the last is *pistillate* only (Willow).

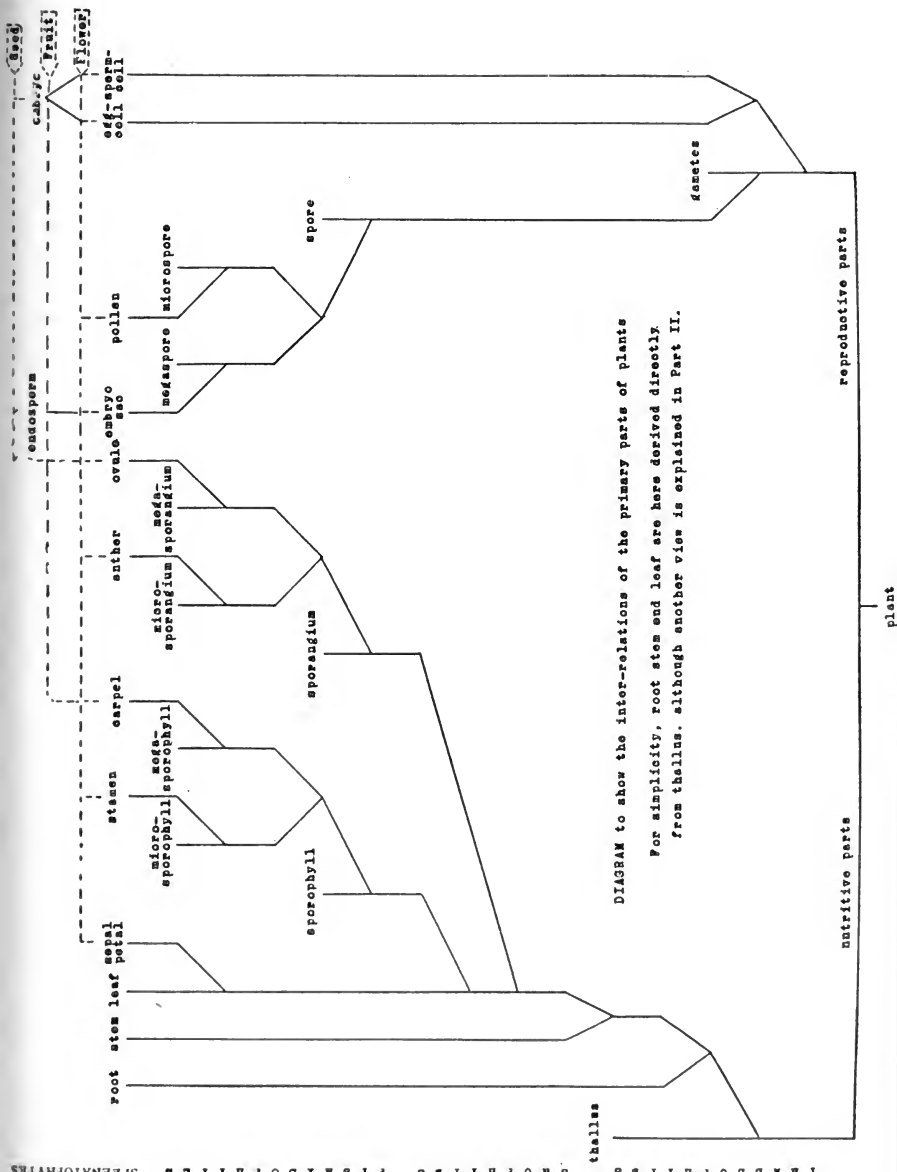

DIAGRAM to show the inter-relations of the primary parts of plants

For simplicity, root stem end leaf are here derived directly from thallus, although another view is explained in Part II.

foundation, but have still to trace it upward through a remarkable morphological elaboration.

Typically the flower has sepals, petals, stamens, and carpels (Fig. 225), but these may be absent in various degrees, making the flowers *apetalous*, *asepalous*, *pistillate*, or *staminate*, all of which terms are self-explanatory.

Typically all of the whorls have the same number of parts, as in the phyllotaxy of leaf whorls on the stem (page 140, Fig. 94). That number is oftenest five (Fig. 226), no doubt because of the predominance of the  $\frac{2}{5}$  system of phyllotaxy (page 141); next most often it is three, connected with the  $\frac{1}{3}$  system; while less often it is four, presumably connected

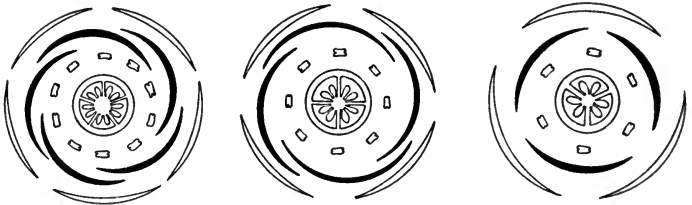

FIG. 226. — Diagrams of typical flowers, to illustrate the principal numerical plans. Constructed as in Fig. 225.

5-plan, Oxalis; 4-plan, Fuchsia; 3-plan, Lily.

with the  $\frac{1}{2}$  system; and these are the only numbers which prevail through flowers. This relation to phyllotaxy, by the way, shows how purely structural and little adaptational is the numerical feature of floral structure. Any of the four whorls may deviate from the number characteristic of the flower. Thus Poppies have but two sepals, Monkshood has but two petals, Orchids have but one or two stamens, and Peas have but one carpel. As to the stamens, they are sometimes fewer, but often are more numerous than the typical number, especially in simple flowers pollinated by many insects, such as Roses and Buttercups. The carpels, on the contrary, rarely exceed the typical number (though they do so in both of the plants last mentioned), but oftener than



not are less than the prevalent number, being commonly three in a 5-part flower, or even only one, as prevails through the great Pulse family (Fig. 227). In general a diminution in number accompanies increasing efficiency in function, and marks a higher grade in evolution. Thus the Composite family (that of the Sunflower and Chrysanthemum), the largest plant family, and the one which stands highest of all in plant evolution, has five sepals (when any), five petals, five stamens, and one carpel.

As the floral leaves, especially the sepals and petals, develop and broaden in the bud, their edges become variously disposed with respect to one another. In some flowers these parts have their edges exactly matching together without any overlapping, as in the sepals of *Fuchsia* (Fig. 226), an arrangement called VALVATE. In others

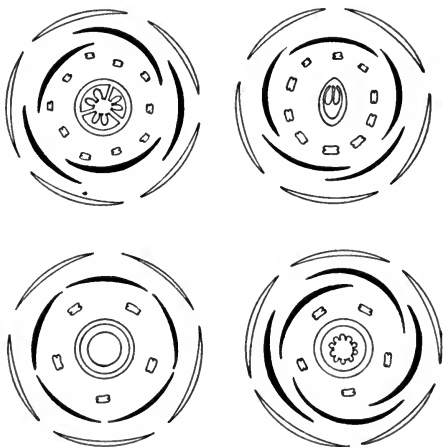

FIG. 227. — Diagrams of typical flowers, to illustrate deviations from numerical symmetry. Constructed as in Figs. 225, 226. Above, *Stellaria* and *Cassia*; below, a Composite (*Helonium*) and Primrose.

the edges regularly overlap spiralwise, as in the petals of *Fuchsia*, an arrangement called CONVOLUTE. Oftenest they overlap in such manner that some parts have both edges under, some both over, and some both ways, an arrangement called IMBRICATE (Primrose in Fig. 227). These arrangements, called collectively ÆSTIVATION, often persist in the open flowers, though sometimes so lightly as to be easily disarranged by a touch or the wind. They are apparently due to a combination of phyllotactic and developmental factors.

Typically, and usually, the floral whorls alternate, as in the case of leaves on the stem (page 140). Most of the exceptions are only apparent, as in the Lily family (Fig. 226), where a whorl of six stamens seems to stand opposite a whorl of six petals or sepals (*e.g.* Lily of the Valley); but in reality whorls of sepals and petals, here alike, and two whorls of stamens regularly alternate. In case of the Primrose, where five stamens stand opposite five petals (Fig. 227), it is likely that another set of five stamens, which would make the alternation perfect, has vanished in the course of evolution. Indeed, two whorls of stamens are more frequent, and perhaps more "typical" than one. The usual lesser number of carpels, of course, destroys the alternation in their case.

Typically the sepals, petals, stamens, and carpels all stand separate and distinct upon the receptacle, precisely as do leaves on the stem; but sometimes each whorl forms a single structure. Thus the calyx, as earlier noted (page 270), is often one structure at base, and even to near its top, while sometimes it forms a tube with only small teeth on its free margin, *e.g.* Phlox. It was formerly supposed that such a calyx is formed by a union of the lower parts of the sepals, the tips alone remaining free, on which account it was called GAMOSEPALOUS (united sepals) in distinction from POLYSEPALOUS applied to the separate condition. This view, however, finds no support in the development of the individual flower, where no such union of parts takes place; for, in fact, the sepals originate and grow separately for a time, and then are lifted by the growth of a continuous ring of leaf-like tissue, which gradually elongates to the tubular part of the calyx. It is possible that in course of their evolution the sepals have become united, as the older view held; but it is equally possible, and much more in accord with the method of their present development, that only the free tips represent the original separate leaves, while the tubular part is a new development, just as we know the

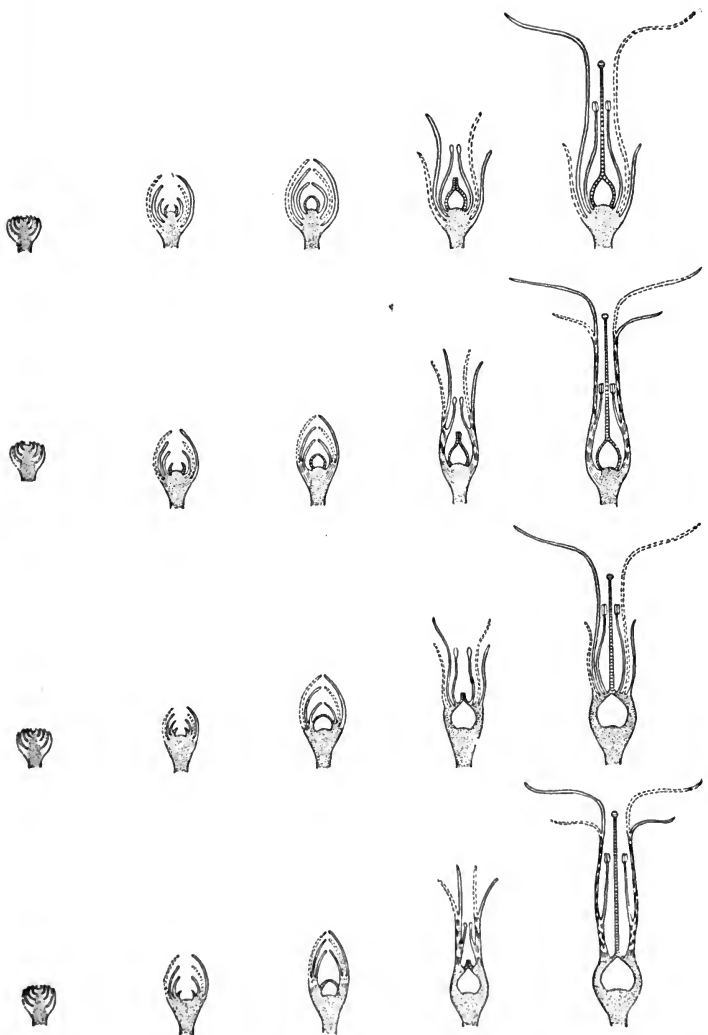

FIG. 228. — Diagrams of typical flowers in vertical section, showing the various relations of calyx, corolla, stamens, and carpels, as interpreted by their development from the buds.

Receptacle is dotted; floral tube is lined lengthwise; carpels are lined crosswise. The parts in broken line do not fall in the median plane in a 3-plan flower.

Upper based on *Scilla*; next on *Hyacinth*; next on *Snowdrop*; lower on *Narcissus*.

external tube, or CORONA, of the Daffodil to be. Precisely the same is true of the gamopetalous corolla, and also of the monadelphous stamens, although in cases where the stamens are united, as in the Compositæ, these anthers do actually grow together although they originate separately. As to the carpels, where two or more unite into a single pistil,

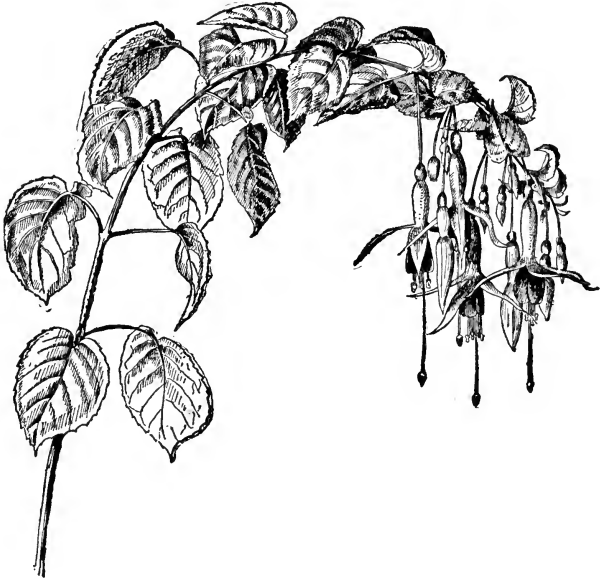

FIG. 229. — *Fuchsia speciosa*, showing the raceme of morphologically specialized flowers, with inferior ovary, and both petals and stamens raised on the calyx tube. (From Bailey.)

the case is quite clear, for they always originate separately in the bud, and later actually grow together as they develop.

The mode of fusion of the carpels determines the place of the placentæ and the number of compartments (unfortunately called cells) in the ovary. Thus in the Pulse family, illustrated by the familiar green Pea, only one carpel is concerned, and it infolds with a single parietal placenta (Fig. 227). When two or more carpels unite to one pistil,

they may grow together in any of the ways shown in Figure 222, producing parietal, central, or free central placentæ, with one or several compartments.

Typically each of the four whorls stands directly on the receptacle independently of the other three; but remarkable interrelations of the whorls also occur in various flowers, as represented diagrammatically in Figure 228. In some cases the calyx and corolla together form one structure, called PERIANTH, upon which stand the stamens, as in the Hyacinth, while various other combinations occur. Formerly such cases were interpreted on the supposition that the different whorls were united, or adnate, to one another from the receptacle upward; but here also the development of the flower favors another interpretation, viz. that the tube which the parts occupy in common has developed in precisely the same way as the tube of the corolla or calyx, — not by a union of originally free parts, but as a new growth intercalated between the free structures and the receptacle. Especially striking is the condition of inferior ovary (page 275), where sepals, petals, and stamens stand upon its top (third flower, Fig. 228). This arrangement was formerly interpreted on the supposition that the calyx (and therefore also the corolla and stamens) was united or adnate to the ovary all the way up from the receptacle below; but here also the



FIG. 230. — The Daffodil, *Narcissus Pseudo-Narcissus*, showing the large corona, an outgrowth from the sepals and petals. (From Bailey.)

development of the flower favors a different interpretation, viz. that the receptacle grows up in cup-shaped form, carrying upon its top the four whorls, of which the carpels come simply to close in the roof of the ovary, as represented in the lower diagrams (Fig. 228). In case of the Apple, the upgrowing receptacle appears to have inclosed the set of carpels, represented by the core. Yet these distinctions of floral



FIG. 231. — Cymes, compound, of the Wild Geranium. (From Bailey.)

parts have in reality no great weight, since as the flower becomes specialized the former sharp distinction between stem and leaves, and even that between receptacle and floral tube, tends to disappear. This consolidation of the parts of the flower goes still farther in cases like Fuchsia, where the floral tube stands upon the ovary, and upon the tube stand sepals, petals, and stamens (Fig. 229); and it reaches perhaps its perfection in the Orchids where even the stamens and pistil form one mass.

Typically the sepals, petals, stamens, and carpels follow the method of leaves in their development, and, like leaves, branch readily in their own plane, but rarely out of it. Yet the floral parts do at times produce special outgrowths from their faces, as in case of some nectaries, the scales in the throats of some Pinks, and the remarkable "crown of thorns" in the Passion flower. Somewhat similar in origin is the corona of the Narcissus, a structure which in the Daffodil (Fig. 230) surpasses in size and prominence even the regular floral tube itself.

In such features as these outgrowths, and in many of the

other facts of progressive consolidation and specialization of parts above described, we see that the flower is by no means closely bound by its former leaf and stem nature, but has acquired in large measure its own morphological independence. It is therefore in effect a morphological member as well as a physiological organ of the plant.

## 11. THE MORPHOLOGY AND ECOLOGY OF FLOWER CLUSTERS

The conspicuousness of flowers, especially of the smaller kinds, is greatly augmented by their aggregation into clusters. There is more, however, in the subject than this, for clusters often exhibit a specific individuality, with distinctive new characters of their own. In wind-pollinated kinds, where showiness has no functional value, the clusters have apparently no more than a structural significance, as a convenience of development.

Each flower originates in a bud, representing morphologically a spore-bearing determinate branch (page 323); and flower buds, like leaf buds, are usually either terminal or axillary. Now every possible gradation is found between a condition in which solitary flowers are scattered along stems in the axils of green leaves and that in which numerous flowers are massed densely together with the leaves reduced to insignificant bracts or wanting altogether. Where the solitary condition ends and a cluster begins is

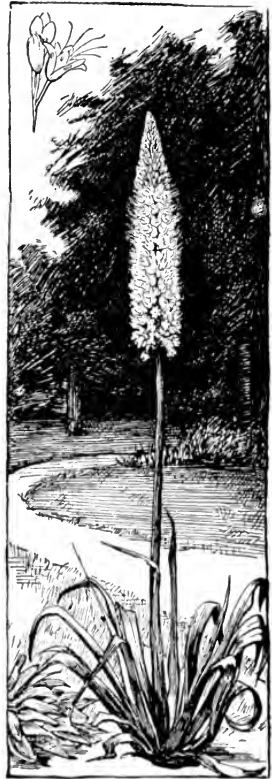

FIG. 232. — *Eremurus himalaicus*, showing a racemose spike of flowers. (From Bailey.)



FIG. 233. — Button Bush, *Cephalanthus occidentalis*, showing the head of flowers. (From Bailey.)

produces a flower in the axil of each reduced leaf, the older blossoms being thus below and the younger above, — and often the lower become fruits while the upper are still buds. Such a cluster, commonest of all kinds, is called a RACEME (Fig. 229). In marked morphological contrast therewith is the CYME (Fig. 231), in which a terminal flower closes the growth of the stem, and the new flowers appear from buds progressively lower down. The two types, called respectively INDETERMINATE and DETERMINATE, correspond exactly with the definite and indefinite annual growth of stems, earlier described (page 138).

largely an arbitrary matter, determined in practice by whether leaves or flowers are more prominent in the mass. In many, perhaps most, cases, however, there is no difficulty in distinguishing a cluster, because it exhibits a sharp transition to the leafy stem; and this distinctness constitutes the first step in the individuality of the cluster.

The simplest clusters are those in which a continuously growing stem



FIG. 234. — Corymb of Cherry. (From Figurier.)



Both racemes and cymes often become compound by the branching of the main flower stalks, and the two types occur intermingled in the more complicated clusters, such as the pyramidal THYRSUS of the Lilac and Horse-chestnut and the much looser PANICLE of the Meadow Rue, and most of the loose-topped Grasses. In the other direction, the clusters become very compact. Thus racemes sometimes have so many flowers on such short stalks as to form collectively a SPIKE (Fig. 232), as familiar in Mullein, while if bracts in a spike are more prominent than petals, as so commonly occurs in wind-pollinated trees, we have a CATKIN, familiar in Birches (Fig. 197) and "pussy willows." If the main stem remains short, bringing the flowers all close together, the cluster is a HEAD, as familiar in Clover and Button Bush (Fig. 233).

The clusters thus far noted are little more than aggregations of similar flowers, but more highly developed kinds show a marked approach to

the aspect of single large flowers. The tendency is first manifest in the production of flat-topped clusters. Thus, if the main stem and the stalks of the lower flowers of a raceme all elongate at about the same rate, there results a flat-topped CORYMB (Fig. 234). When, further, the main stem remains still shorter, or undeveloped, and the flower stalks have all about equal lengths, there results a characteristic UMBEL (Fig. 235), a very common form of cluster, and one which prevails through, and has given name



FIG. 235. — A typical umbel, of *Agapanthus umbellatus*. (From Bailey.)

to, a large family of plants, the Umbelliferae. Both corymbs and umbels also become branched or compounded.

Still more advanced in evolutionary rank are those clusters in which there is found a division of labor with respect to the functions of reproduction and conspicuousness. In some clusters the conspicuousness which shows the flower to insects is given by bracts greatly developed, as with the Calla and Jack-in-the-pulpit, where the single showy bract or SPATHE acts functionally like a corolla, leaving only the function of pollination to the little inconspicuous flowers arranged on a fleshy spike called a SPADIX (Fig. 236). Bracts also form

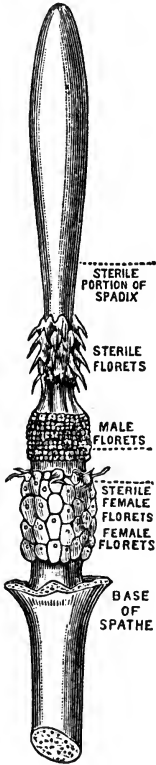

FIG. 236. — The spadix, with flowers, of an Arum; the large showy spathe is removed. (From Cavers.)

the showy parts of the flat-topped clusters of comparatively inconspicuous flowers in Poinsettia and Flowering Dogwood. Still more highly developed are those clusters in which this division of function occurs between the flowers themselves. Thus, in the wild Hydrangea and its relatives, the inner flowers of the flat-topped compound cyme remain inconspicuous, and the showiness of the cluster is due to the petals of the outermost flowers which have developed very greatly (Fig. 237), losing entirely in the process their reproductive parts. It is these outer NEUTRAL flowers which have been developed in cultivation to form the fine great showy pyramidal clusters (thyrsi) of our lawn Hydrangeas. This arrangement reaches its highest development in the family Compositae, where, in forms like the Sunflower, the outer row of the flowers (the so-called RAY FLOWERS) in the dense, flat-topped cluster develop greatly their corollas which make the whole showy parts of the head, but lose their

stamens and often also their pistils in so doing ; while simultaneously all of the interior flowers (the DISK FLOWERS) remain comparatively inconspicuous and devoted entirely to pollination. So far, indeed, does the resemblance to



FIG. 237. — Flower cluster of *Hydrangea Bretschneideri*, a compound corymb with showy neutral flowers.

Lower left ; certain details of the fruit. (From Bailey.)

large single flowers proceed that even a calyx-like structure (called INVOLUCRE) is developed from bracts, these collective features giving the clusters so much the aspect of single flowers that they are popularly thought to be so. The resemblance, indeed, appeals even to insects, which visit and

pollinate the clusters in precisely the same way as they do single flowers. These heads in the *Compositæ* represent the highest evolutionary development of clusters.

## 12. SPECIAL FORMS, ABNORMALITIES, AND MONSTROSITIES OF FLOWERS

Although leaves, stems, and roots often perform functions and have forms very different from those which are primary and typical in those organs, flowers have hardly any additional or substitute functions, doubtless because of their high degree of specialization to their primary function. On the other hand, flowers far surpass all other organs in the abundance of their abnormalities and monstrosities, presumably because their much greater complication of structure allows more opportunity therefor.

Abnormal or monstrous flowers, those which deviate in some unusual or eccentric way from the conditions usual in that kind, are apt to occur in any bed, especially in gardens, — for they are more frequent under cultivation.

The monstrosities occur in all possible parts. Sepals are found, either singly or the whole whorl, entirely leaf-like in size and appearance, even to complete compounding in some *Roses*. Also they occur so petal-like in color and form as to resemble a seemingly two-storied flower, as in “Hose in hose” *Primroses*. Petals act in many strange ways, even turning leaf-green in some monstrous *Roses*. They are especially prone to multiply much in number, giving us double flowers, of which a great many kinds can be propagated, and occur in our gardens. Stamens are sometimes completely petal-like; sometimes bear ovules in their anthers instead of pollen; sometimes are completely replaced by carpels. Carpels often fail to unite their edges, thus leaving the ovary open; and they become in various degrees leaf-like. Sometimes the ovary contains anthers with pollen instead of ovules, and sometimes the ovules are replaced by tiny green leaves. The receptacle also acts diversely, its most

frequent abnormality consisting in a continued growth right up through the center of the flower, above which it produces a second flower, or else a leafy branch, as already described in connection with stems (page 201). Sometimes two or more of these abnormalities are combined in a single flower, in which case we have a genuine, and often an extreme, monstrosity (Fig. 150). One or more of the whorls may be absent though normally present, or present when normally wanting; and any or all may become altered in color, multiplied in number, or converted entirely into a bunch of green leaves. Regular flowers become diversely irregular, and irregular kinds perfectly regular. Also flowers, especially their pistils, become malformed to galls under insect stimulation (page 203). It is surprising how many and diverse are the abnormalities which appear when one's attention is directed to these matters, and how many are described and pictured in the special works devoted to the subject. Of the latter the most famous and instructive is the classic "Vegetable Teratology" by Masters, which the student will do well to examine.

Not only structural, but physiological abnormalities occur, as for example in cases where the "resting-period" (page 378) is wanting, and the flower opens in autumn instead of the next spring, as happens with exceptional Strawberry blossoms and flowers of shrubs. Of course such flowers are destroyed by frost without chance to form seed. Sometimes the abnormality, especially in extreme monstrosities, occurs only in a single flower, in which case it is usually not hereditary and cannot be propagated, just as with fluctuating variations (page 314). But sometimes all of the flowers on one branch or one plant exhibit the feature, in which case it can usually be propagated like a sport, which indeed it really is, — both bud sports and seed sports of this kind occurring. Hence we have in our collections the permanent strain of the "Hose in hose" Primrose; in our greenhouses we have a green Rose propagated as a curiosity; and in

our gardens we have double flowers in an extreme abundance, the doubling in some cases being due to the transformation of stamens to petals, and in others to a multiplication of petals. Thus it is plain that no line can be drawn between variations and abnormalities, sports and monstrosities.

We should now note somewhat more fully the causes of monstrosities, as to which we have little exact knowledge, though some good circumstantial clues. It was once believed that they are mostly reversions to a simpler ancestral condition, but further knowledge has shown that they are usually reversions to a simpler structural condition. They are chiefly due to disturbance in the growth control mechanism. The development of any organism and its parts depends upon three sets of factors: *First*, there is the supply of matter and energy contributed by the metabolism of the plant, and as these are supplied to every living cell, all parts have thus the power and the impulse to grow without dependence upon the others. *Second*, there is the guidance of the development of the particular parts, exercised in some way by the chromosomes through the cytoplasm, and partly determined by heredity and partly by responses to external stimuli. *Third*, there is correlation between the different parts of the plant such that the power and impulse of each part to grow far more than it does is kept in restraint and subordinate to the development of the organism as a whole, as witness the case of buds, sometimes forty times more numerous than are permitted normally to develop (page 138). As to the mechanism of this correlation we have as yet no idea, though it is clear that the physical path of its operation lies through the protoplasm which is continuous from cell to cell. Now monstrosities can often be traced to a failure in operation of some one of these sets of factors, but they seem oftenest to result from a failure in the third, caused by mechanical damage to the path of conduction (as in case of burls, page 200) or by chemical paralysis through action of parasites (Witches'-brooms, page 198). When the

control mechanism becomes inoperative while the growth energy is still forcing forward the growth of the part, then the part seems to be controlled by whatever structural condition happens to be strongest at the moment.

### 13. ECONOMICS, AND TREATMENT IN CULTIVATION, OF FLOWERS

Flowers, unlike the five other primary plant parts, have few economic uses, aside from the beauty they give to our gardens. That, however, is surely a utility of civilization, and besides it maintains great business interests in seed firms and nurseries which supply ornamental flowers, trees, and shrubs. In a few cases perfumes are extracted from flowers, which also supply the nectar elaborated by bees into honey. But otherwise their direct uses are insignificant.

Turning to the cultivation of flowers, we find some features of gardening practice dependent on their physiology.

Since showy flowers are cross-pollinated by insects, those who grow seeds or fruits for market find it well to keep Bees, best of cross-pollinators, in their gardens, or even their greenhouses, where crops of Tomatoes or Cucumbers are forced for early market. It is true the pollination can be effected artificially by use of fine brushes, as often done for special purposes; but Bees are more economical. In another way this relation of insects to flowers affects practical interests, for if the blossoming time of our fruit trees, Apples, Pears, and others, falls cold and wet, the insects are not active and pollination is only partial, which is one cause of poor fruit years.

The reciprocal balance, already described (page 207), between vegetation and reproduction, makes it possible for gardeners to promote flowering by checking the stem and leaf growth, either through withholding fertilizers, by root pruning, or by other devices known in the business. Pruning, in orchards, has chiefly this use, as earlier noted (page 207). These methods, however, have strict limitations, and are

effective only in skilled hands. Theoretically the best results would be attained when a plant has been stimulated to vigorous vegetative growth until a large reserve of food has accumulated, and then is checked in its stem and leaf growth.

Flowers are prone to wilt when cut, even if placed immediately in water, because they now lack the root pressure which helped their supply. Moreover, their evaporation current through the cut ducts draws into the latter various micro-organisms which here find such congenial conditions for growth that they fill the passages and stop the water. The devices for preserving the freshness of flowers are adjusted to neutralize these conditions. Thus, everybody knows that flowers keep best in cool, moist, shaded places, — because evaporation is there checked; and florists keep their Roses before sale in refrigerators for this reason. On the other hand, a frequent changing of the water, clipping away the lower and often discolored ends of the stems, the addition of a little salt, dipping the cut ends for a moment in hot water, charring the ends in a flame, — all of them devices recommended by different people for preserving particular kinds of flowers, — have in one way or another the effect of antagonizing the organic growths in the ducts, thus keeping the passages open. It is said that white flowers last longer after cutting than colored kinds, which perhaps is connected with the fact that they absorb less sunlight than colored kinds, and hence suffer less evaporation from their tissues. Florists have still another device, useful in some cases, depending on the fact that since petals usually fall immediately after fertilization, flowers last longer if that is not effected. Fertilization can be prevented by removing the anthers from all flowers as soon as they open. This is commonly practiced with large Lilies.



## CHAPTER VII

### THE MORPHOLOGY AND PHYSIOLOGY OF FRUITS

#### 1. THE DISTINCTIVE CHARACTERISTICS OF FRUITS

THE WORD FRUIT has far wider significance in scientific than in popular language, for to the botanist it includes any structure which has part in the development of seeds, no matter whether edible or not, or what the aspect it presents.

Most fruits are the ripened ovaries of flowers, from which all other parts (excepting of course the receptacle) have fallen away, though occasionally some of the other floral parts persist, and become incorporated with the ripening ovary. There are fruits, however, which have no connection with ovaries, as in berries of Yews and cones of Pines, though in such cases other structures replace the ovaries in function.

The ovary, as a rule, withers and falls with the other parts of the flower unless pollination occurs; but after pollination the ovary develops to a fruit, the ovule to a seed, and the fertilized egg cell to an embryo. Thus pollination acts as the stimulus to fruit formation, the arrangement being obviously advantageous in preventing the waste of good food material upon fruit and seed if no embryo is formed to be protected and disseminated, — and no embryo is formed without fertilization.

Fruits display well-nigh as great a diversity in their visible features as do the other plant organs. They fall rather naturally, however, into two great classes, — dry fruits, like pods, and fleshy or edible fruits, like berries.

In *size*, fruits are almost microscopic in some very small plants, and vary thence upward to the great double Coco-

nut, a foot or two in diameter, and weighing some thirty pounds. The largest fleshy fruit is probably the Jack fruit or Durian of the tropics, often mentioned by travelers.

In *shape*, fruits are diverse as possible, though tending to rounded forms like the ovaries from which they are developed. Sometimes they answer very closely to the shape and aspect of a single seed, to such a degree as to be commonly mistaken therefor.

In *texture*, the difference between dry and fleshy fruits becomes very manifest. In dry fruits the walls of the ovary are parchment-like or woody, as in most pods, or even almost ivory hard, as in some nuts and fruit pits, while in fleshy fruits the ovary walls become soft, pulpy, nutritious, and palatable, as we, and other animals, know very well.

In *color*, the two classes are likewise contrasted. The dry fruits are mostly brown or gray, like bark, indicating that their color has no bearing on their function, and is simply that which happens to be natural to ripening woody tissues. The fleshy fruits, on the other hand, are mostly bright colored, — red, yellow, purple, and sometimes white, — in marked contrast to their respective backgrounds. Such colors we naturally assume to indicate a functional connection with a seeing eye, — an assumption which proves to be true, as a later section will indicate.

The fruits, of botanical terminology, include some structures which are popularly rated as vegetables, notably Cucumbers, Pumpkins, and Squashes. These, however, are forms of fleshy fruits, as their whole structure attests.

Fruits produce seeds in diverse numbers from one to many hundreds. Dry fruits which contain several seeds open or *dehisce* to allow their escape, but fleshy fruits, no matter how many their seeds, remain closed, the seeds being released in other ways which we shall presently consider.

As in case of other organs, popular terminology is somewhat uncritical. Thus the "fruit-dots" of Ferns have no

connection with fruits; "Cedar apples" are only a Fungus product; and the "fructification" of Fungi refers only to their spore masses.

## 2. THE STRUCTURE AND MORPHOLOGY OF FRUITS

The structure and morphology of fruits are largely determined in the ovaries from which they originate, — fruits being primarily ovaries further developed and specialized. The particular features of the fruit have usually an obvious connection with the method of dissemination of the seeds, — the accomplishment of such dissemination being commonly a function of the fruit.

The structural features of the ovaries — walls, partitions, number of compartments and placentæ — can usually be recognized clearly, and in the same relative connections, in the fruits, while the DEHISCENCE, or opening through which the seeds escape, likewise follows as a rule some morphological lines of the ovary. Deviations in these features, however, often occur, and can usually be traced to a connection with the method of dissemination.

The fruit structure is clearest in dry fruits. Thus a typical fruit of the simplest sort is represented in the pod of Columbine (Fig. 238), which is developed from an ovary of one carpel, bearing one row of seeds; these are arranged along a parietal placenta, formed where the edges of the carpellary leaf unite, and the pod in dehiscence simply dis-unites those edges. In the Green Pea, however, of precisely the same construction, the pod dehisces both by disuniting the edges and also forming a new split along the back or midrib of the carpellary leaf. Pods originating in two or more carpels like



FIG. 238. — Pods of Columbine. (From Bailey.)

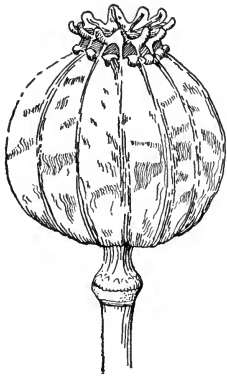

FIG. 239.—Pod of a Poppy;  $\times \frac{1}{4}$ .

It stands at the summit of a long stiff stalk.

wise usually dehisce by disuniting the joined edges, though sometimes they split also down the carpellary midribs. Frequently, however, the dehiscence follows no morphological line in the ovary, but occurs in new and independent positions connected with a particular method of dissemination. Thus, in the capsules of Poppies new openings arise around the tops of the fruits and in Purslane the capsule splits right across without any regard to morphological lines (Fig. 239); in some of the Mustard family the carpels mostly split away as valves from the placentæ, which persist for a time as a framework (Fig. 240); and other arrangements also occur, some of which prevail throughout families in ways to show that large structural and hereditary factors enter along with adaptation into the construction of fruits. On the basis of their aggregate structural features, the dry fruits are classified and named as FOLLICLES, LEGUMES, SILICLES, etc., these distinctions having importance in connection with the taxonomy of plants.

The only dry fruits which do not dehisce at all are those which contain but a single seed, as typified by the little AKENES of the Strawberry and Buttercup, commonly supposed to be seeds (Fig. 241). They are in fact functionally seeds, both in

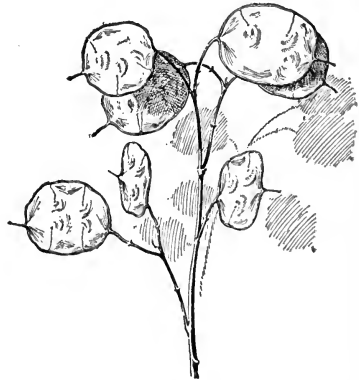

FIG. 240.—Honesty, *Lunaria annua*, in which the persistent partitions of the pods form shining plates;  $\times \frac{1}{2}$ . (From Bailey.)

dissemination and germination, the ovary wall serving simply as an additional pit-like coat. A very important form of single-seeded indehiscent fruit is the grain (Fig. 242), distinguished particularly by the fact that seed coat and ovary wall are grown completely together, thus making the structure so seed-like that only the botanist knows its true morphological nature. As its name implies, this fruit is characteristic of the grains, — Corn, Wheat, Oats, etc. Nuts also are commonly one-seeded, though here we meet with morphological complications, both as to the original number of the ovules and the nature of the shell.

While in general the construction of the fruit answers closely to that of the ovary, some exceptions occur, indicating that the fruit has a certain morphological independence of its own. The development of new dehiscence lines is one instance thereof. The number of compartments, or cells, is usually the same in ovary and fruit, but sometimes partitions disappear, or new ones develop; while we find also such changes as the formation of four little nutlets (prevailing throughout the Mint family) from a two-celled ovary. Not infrequently a several-celled ovary produces a one-celled and one-seeded fruit, as in most of our common nuts (Fig. 243), in which an occasional development of a second seed gives us the philipena variety.

In many cases other parts of the flower persist and are incorporated with the ovary into the fruit, contributing to its functional effectiveness. Thus the style, usually deciduous with the petals and stamens, persists in Clematis, where it forms the very conspicuous plume (Fig. 244). In the Composite family, the



FIG. 241. — The seed-like fruits (akenes) of Buttercup, one in section;  $\times 5$ . (From Bailey.)

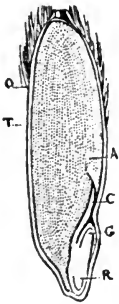

FIG. 242. — A grain, Oat, in vertical section, showing the embryo, *R*, *G*, endosperm, *A*, and the united seed and ovary coat, *T*;  $\times 4$ . (From Le Maout and Decaisne.)

so-called pappus, a structure on the ovary usually interpreted as morphologically calyx, persists as hooks, plumes, and other analogous structures (Fig. 256). Furthermore, wholly

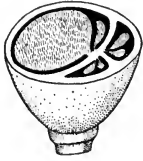

FIG. 243. — Ripening ovary of Buckeye, showing development of one of the six ovules. (After Gray.)

new structures also develop from the ovary wall, usually in obvious adaptation to dissemination. Thus many small weeds develop hooks or adhesive glands, making their "seeds" cling tight to the clothing of the stroller in autumn fields. Very prominent are the flat wings which develop on the Maple (Fig. 245), the Elm, and the Ash.

Fleshy fruits also exhibit, though less clearly, the signs of their origin from ovaries. They possess two features not found in dry fruits, — viz. bright and contrasting colors, and seeds which are usually protected in some way against injury by digestion when eaten; for, as will appear in the following section, fleshy fruits are eaten and their seeds thus disseminated by animals. The simplest fleshy fruit is the BERRY, in which the wall of the ovary, whether carpels or receptacular cup, develops into the pulp, while the seeds have stony coats, as well exemplified in the Grape, and also in Cranberry and Blueberry. Closely related is the stone fruit, or DRUPE, wherein the outer layers of the ovary wall ripen to the soft pulp, while the inner layers form the hard stone, which constitutes the most effective protection to the seed, as so typically illustrated in the Cherry, the Plum, or the Peach (Fig. 246). The fruits just mentioned, by the way, show on one side a depressed line which indicates the original joining of the edges of the



FIG. 244. — Fruit of Clematis. (From Bailey.)

single carpel from which each fruit is developed. In the fleshy fruits of the Apple and Pear type, the receptacle grows up and incloses the carpels (the core), forming a type called the POME, the receptacular nature of which is further attested by the obvious remnants of persistent sepals. In some of the largest GOURD fruits, like the Pumpkin and Squash, the outer wall is hard and only the inner part becomes edible, while in the related Watermelon it is chiefly the placenta which form the pulp, as is likewise true in Tomato and Cucumber. As to the method of protection of the seeds in large fruits like the Apple, Watermelon, and Orange, that will presently be mentioned.

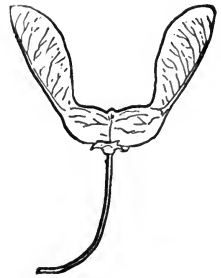

FIG. 245. — Fruit of Maple. (From Bailey.)

In the fruits just described the pulp results from the specialized ripening of *carpel*, or receptacular *ovarian wall*, or *placenta*; but it may develop from other parts also. Thus in the Strawberry the edible part of the fruit is wholly the *receptacle*, which bears the many seed-like akene fruits. In the Wintergreen berry the pulp is largely *calyx*; in the Yew berries it is an extra *seed coat* (for Yews have no ovaries), called an ARIL. In the Orange, which is a kind of huge berry with a separable skin, the pulp is constituted from *hair-like structures* developed from the inner walls of the carpels.

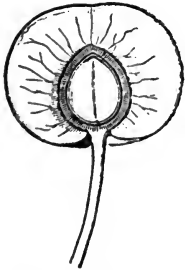

FIG. 246. — Drupe of Cherry. The stone is cross-lined. (From Figurier.)

In considering the various morphological origins of the pulp one cannot but ask why one plant forms it in one way and another so differently. As to this we have little exact knowledge; but circumstantial evidence indicates that here, as elsewhere, evolution moves along lines of least resistance, the pulp in any given case being made from

that part which was already most nearly pulp-like in its structure.

The fleshy fruits thus far described are all SIMPLE, that is, composed of a single pistil; but AGGREGATE and MULTIPLE fruits also occur. Thus, while in Strawberry the pulp is the receptacle on which stand the many dry akenes, in the nearly related Raspberry the receptacle forms no part of the fruit, which is made up of the many separate aggregate carpels ripened to little drupes; while in Blackberry both drupelets and receptacle are included. Further, instead of a single flower a cluster may form a single large MULTIPLE FRUIT. This is the case in the Mulberry (Fig. 247), in which the pulp is chiefly calyx, and also in the Pineapple, where not only the ovaries, but also the bracts and main stem of a large cluster of flowers ripen to the single coalescent fruit mass. A different form of

multiple fruit is that of the Fig, where the flowers are arranged inside a hollowed receptacle (Fig. 248). Somewhat in the nature of a multiple fruit also is the CONE (Fig. 249) of Pines, Spruces, and that family. This form of fruit belongs to the Gymnosperms, or naked-seeded plants, which have no ovaries but usually bear their seeds on the bases of overlapping scales which collectively make up the cones.

The particular feature of pollination which acts as the stimulus to fruit formation is known. The pollen tube, as it reaches the embryo sac (page 278), contains normally two sperm nuclei, of which one always fertilizes the egg cell.

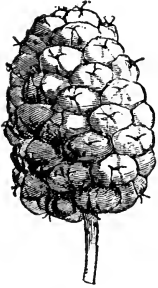

FIG. 247. — The Mulberry, made up chiefly of the ripened calyxes of a cluster of flowers;  $\times \frac{1}{2}$ . (From Figurier.)

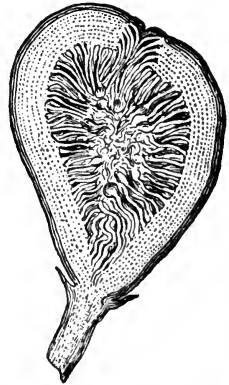

FIG. 248. — A Fig fruit. (From Bailey.)



The other also enters the embryo sac, and moves towards its center, where it fuses with the principal nucleus of the embryo sac itself (Fig. 250). This fusion nucleus, with surrounding protoplasm, soon divides and forms the beginning of the endosperm or food substance later used by the developing embryo. Thus this so called "double fertilization" acts as the stimulus to endosperm formation, and endosperm formation seems clearly to act as the stimulus to seed and fruit formation. Incidentally this double fertilization involves another important consequence, in that the endosperm, like the embryo plant, contains chromosomes from the pollen parent, of which it can thus show some characteristics. A conspicuous case thereof is found in Corn, where red grains, the result of a red endosperm showing through the grain coats, appear on white ears after pollination by a red variety. This phenomenon, called *XENIA*, was very puzzling until its real nature was discovered.

While ordinarily a fruit does not form, or "set" in the gardener's phrase, unless fertilization has occurred and an embryo is formed, cases are known in which the fruit develops without the presence of embryos in the seeds, a condition called *PARTHENOCARPY*. In most such instances pollination is essential, as indeed would be expected from the rôle of double fertilization; but in a few cases, notably some Figs, even pollination is not essential, and fruit formation follows on flower formation without any known special stimulus.

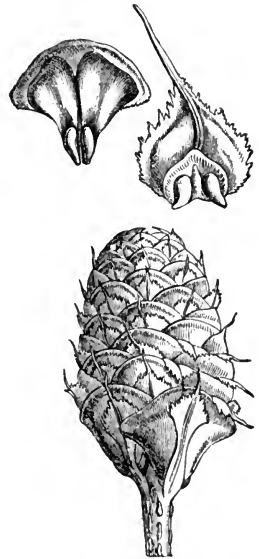

FIG. 249. — A typical cone, of Fir (*Abies pectinata*); reduced.

Above, on right, a scale with ovules; on left the seeds, with part of the scale separating with them to form "wings." (From Sachs.)

The development of ovaries into fruits involves often a great increase in size, as notable in the gourds. Herein is involved not simply an enlargement of cells already present in the ovary, but abundant new cell formation from the

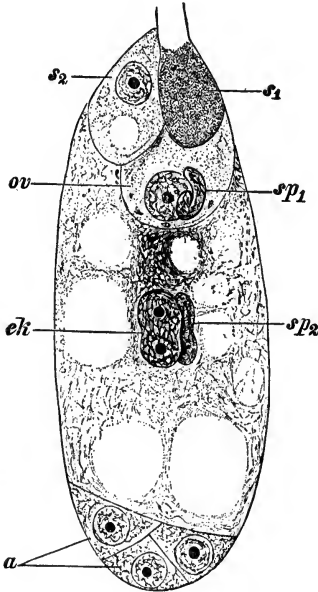

FIG. 250. — Double fertilization in the embryo sac of *Lilium Martagon*, generalized.

One of the two sperm nuclei,  $sp_1$ , is shown in contact with the nucleus of the egg cell,  $ov$ ; the other sperm nucleus,  $sp_2$ , is in contact with the embryo sac nucleus,  $ek$ . The cells  $s_1$  and  $s_2$ , called synergidæ, and the three marked  $a$ , called antipodal cells, represent an inheritance of the thallus of lower plants. (After Strasburger.)

sac, forms the new embryo. This so-called INITIAL CELL divides, as shown in our figure, and divides again until there is formed a multicellular globular structure. Then growth becomes more active at special points, there forming

parenchymatous, but not specially meristematic, tissue,—a method identical with that by which the bark of trees and the chlorenchyma of leaves are enlarged.

While the ovary is developing to the fruit, the ovule is developing to the seed. The coats of the ovule harden, with some changes, to the seed coats; the micropyle becomes sealed with corky tissue; the formation of the endosperm tissue is completed; and (most important of all) the fertilized egg cell develops into the embryo plant.

The development of the embryo from the fertilized egg cell may best be traced in a typical case, illustrated in Figure 251. First the egg cell divides, and then the resultant cells divide, for a time in a line, forming a SUSPENSOR, the end cell of which, thus brought well out into the embryo

the "seed-leaves" or COTYLEDONS and the HYPOCOTYL, as shown in our figure. At this stage the embryo consists mostly of meristematic tissue, though an epidermis is well formed, and the fibro-vascular system begins to appear, while

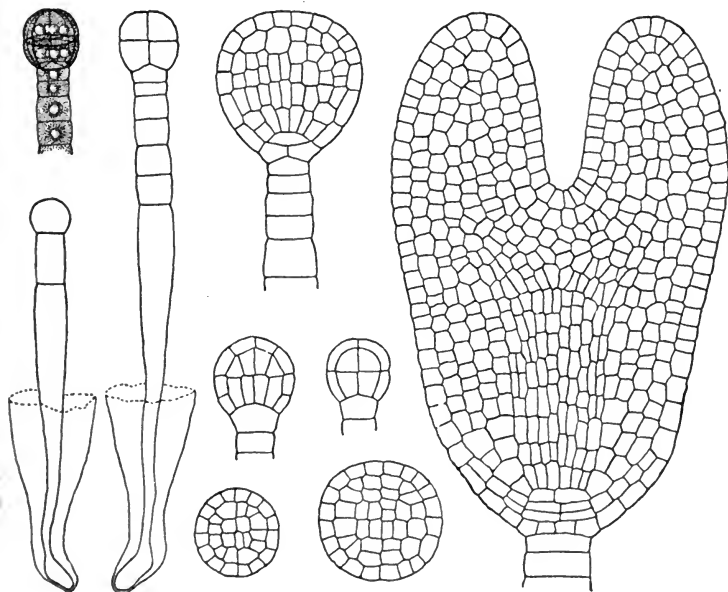

FIG. 251. — Stages in the development of a typical embryo, of Rape (*Brassica Napus*);  $\times 250$ .

The embryo sac, in part, is shown on the left; the egg cell was at its lower end, and has grown into the suspensor, with the initial cell at the top. Above, left, the 8-celled stage of the embryo, with suspensor, shown with protoplasmic contents. Below, middle, are cross sections of the globular stages of the embryo. Right, a nearly formed embryo, with two cotyledons, the suspensor not yet absorbed. (After L. Kny.)

the foundation for a root develops next the suspensor. Meantime the endosperm is developing until it surrounds the growing embryo, the suspensor becoming absorbed; and the two together finally fill the embryo sac. This is the state of the embryo in some seeds (page 374) when ready for germination, but in other kinds the embryo con-

tinues to grow and (by action of digestive enzymes) absorbs the endosperm, and even the nucellus, so that finally it comes to fill completely the seed coats and contains all of the seed food within itself. The shape of the embryo is correlated with that of the embryo sac, being short and straight in some, variously elongated and curved or bent in others, often to extreme degree. Whatever the shape, however, it follows from the mode of development of the embryo that the root end of the hypocotyl lies next to the micropyle.

### 3. THE DISSEMINATION AND DISPERSAL OF PLANTS

Many features in fruits show obvious connection with the dissemination of seeds, though fruits are by no means thus completely explained. Properly, DISSEMINATION means simply the scattering of seeds from the parent plant, but the term is often employed more broadly, even to an equivalence with DISPERSAL, which means the spread of plants over the earth's surface. Many parts besides fruits are here concerned, so that we may best consider the subject as a unit.

That plants which have in themselves no power of free locomotion such as animals possess can yet spread very widely and quickly is shown by the familiar case of weeds, which, introduced into a new territory, often overrun it before man becomes aware of the danger. A striking present-day instance is familiar in the deadly Chestnut disease, a Fungus with wind-carried spores, which, introduced from Asia into eastern America about ten years since, has already spread through several states. Animals could hardly spread faster.

The physiological necessity for some method of dissemination is amply obvious, for if all spores or seeds produced by a plant were to germinate where formed, or on the ground directly beneath, the resultant congestion would prevent normal development of any of the plants. Green plants need room to spread their foliage to the sun, and parasites

need new host plants; so that plants, in a manner like animals, must spread in search of food. Accordingly, dissemination is not a mere incident of plant life, but a necessary function.

The general methods of plant dissemination and dispersal fall under some six heads as follows:

1. *Independent locomotion.* While none of the familiar land plants have any such power, it is frequent in the lower Algæ. Thus, as will appear more fully in Part II of this book, some of the simplest kinds work their way over the bottom of ponds by aid of protoplasmic threads, while others jerk their bodies along by sudden vibrations. More familiar and typical, however, are the ZOÖSPORES possessed by many Algæ (page 301, Fig. 213), which can swim by action of vibratory cilia in a manner so animal-like as to have originated their name. The Slime Molds, or Myxomycetes (page 38, Fig. 14), living out of the water but in damp places, can creep over wet surfaces in a manner identical in aspect and method with that of the animal Amœba.

2. *Extension through growth.* As described in earlier sections (pages 187-9), many plants send off stems along the surface of the ground or beneath it, in the forms called stolons, offsets, runners, and rootstocks, which take root at their tips and there form new plants, after which the old connection with the parent often withers away. The Strawberry offers a familiar and typical example of this mode of spread; the suckers which spring from the ground in the vicinity of fruit trees, often from old roots, are other examples; but it reaches perfection in the Grasses, especially the familiar Couch Grass of the gardens. Of course all such plants have likewise a dissemination by their seeds, their spread by growth-extension being additional and often incidental. In fact all gradations in this method are found from cases clearly incidental or accidental up to those which seem clearly adaptational, in which fact is probably embodied a leading principle of evolution, viz. that

adaptational features frequently, perhaps mostly, arise by the development of features originally incidental.

3. *Waftage by winds.* This is the commonest of the methods of dissemination, and the most efficient for wide dispersal. Fruits and seeds often develop a large spread of surface in proportion to bulk, thus giving a hold to the wind which wafts the seeds to a distance. Often this feature is a "wing," a thin flat plate developed from the ovary, as in Maple or Elm (Fig. 252), or from the seed-coat, as in Bignonia (Fig. 253), or from part of a cone scale, as in Pine (Fig. 249), or from a bract, as in Linden (Fig. 47). That the plants here mentioned are all trees is not mere coincidence but typical of the fact that winged fruits or seeds are almost



FIG. 252. — Fruit of American Elm, containing one seed; enlarged. (From Bailey.)

confined to trees or high-climbing shrubs, while the same is true of kinds having very flat pods, as in Locusts. On the other hand, the fruits and seeds of herbs and low-growing shrubs more often have hairs or plumes, either in great profusion, as in Cotton (Fig. 254), or in terminal tufts, as in Milkweed (Fig. 255), or in parachute-like arrangements, as in Dandelion (Fig. 256); or in yet other ways. Such structures give a hold to the wind, which permits not simply a lateral transport of the seeds before they reach the ground, as occurs and suffices in the case of trees, but a lifting action whereby even light breezes raise the seeds to a height whence winds may carry them far. It is notable that plants of this kind, as witness the Dandelion, are among the most widespread and abundant of plants. The plumes are of diverse morphological origins, being special outgrowths from *seed coat*



FIG. 253. — Seed of *Bignonia alba-lutea*. Reduced. (From F. Darwin.)

(Cotton), *ovary* (Willow), *calyx* (Compositæ), *persistent style* (Clematis), and aborted *flower stalks* (Smoke Bush). Here also, it is likely, the general principle of modification along lines of least resistance explains the particular cases.

Another mode of wind dissemination is found in the "tumbleweeds." In these the flower cluster, as in some members of the Parsley Family, or else the entire plant, as in Russian Thistle, becomes detached, incurls the branches, and thus is rolled over open ground, scattering the seeds as it travels. Such plants are especially characteristic of open plains country. The Rose of Jericho, of the Scriptures (Fig. 257), is said to have this habit, thus giving a concrete meaning to the scriptural phrase "blown like stubble before the wind."

It is also the wind which scatters, though indirectly, the small, rounded, smooth seeds formed in so many kinds of pods upon long stalks, such as the Poppy (Fig. 239); for such seeds seem to be shaken forcibly from the pods when struck by strong gusts in autumn and winter. It has been claimed that the pods have such form and angles of exit as to guide the seeds well away from the plant.

Finally (in so far as we can take space to discuss this phase of our subject), the wind effects dissemination of very minute spores or seeds without any special arrangements. The method rests on the fact that as a body decreases in size, its bulk diminishes far faster



FIG. 254. — Seed of Cotton, with the important long hairs;  $\times \frac{1}{2}$ . (From Figurier.)

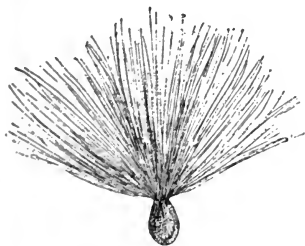

FIG. 255. — Seed of Milkweed;  $\times \frac{1}{2}$ .

than its surface, on which account very minute bodies present so much surface in proportion to their weight that the lightest breezes can waft them into the air and carry them indefinitely. This is why dust floats in the air, and with the dust float the very minute spores of innumerable plants, of Ferns, Mosses, and many kinds of Fungi, — Mushrooms, Molds, Mildews, Blights, and the resting spores of Yeasts and Bacteria; and thus is explained the remarkable spread of those ubiquitous organisms. The seeds of some tropical Orchids are small enough to be spread by this method, especially as their surface is enlarged by presence of small bladders.

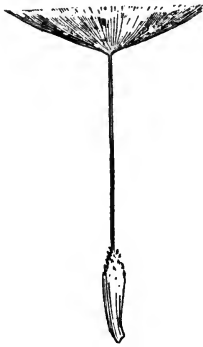

FIG. 256. — Fruit of Dandelion, containing one seed;  $\times 2$ . (From Le Maout and De-caisne.)

Dissemination is the basis of dispersal, in which the wind is the most effective agent. Thus small plumed seeds as well as spores, which can be lifted by light breezes, are carried over vast territories by great gales, even from island to island, and continent to continent.

4. *Flotation by water.* The currents of rivers and oceans are of course important agencies of dissemination and dispersal. This result is often incidental, as when twigs of Willows, or even small plants washed out in time of flood, are carried down stream and left to take root on some emerging bank. Many fruits or seeds ordinarily scattered by wind float also on water, and thus are carried by rivers, which transport likewise the separable winter buds of many Water weeds. There are striking cases in which seeds, themselves heavier than water, possess arrangements whereby they are kept buoyed up



FIG. 257. — The Rose of Jericho (*Hierochuntica Anastatica*);  $\times \frac{1}{2}$ . (From Bailey.)



on its surface. Thus the White Water Lily seed has a loose, air-holding extra coat (Fig. 258) and some Sedges have loose-textured carpels, which form efficient floats. Some seeds have flat, corky expansions, as in Iris, while others float by virtue of the unwettable surface they possess. The Nelumbium (the Lotus of ancient literature and art) has a broad, buoyant receptacle (Fig. 259), out of which the seeds are said to be dropped from time to time in its decay. Very striking is the case of the Coconut (Fig. 260), in which the ovary develops to a great air-holding husk composed of material specially resistant to salt water, although it is now claimed that this plant has been carried by man rather than by drift of ocean currents all around the tropical seas. Ocean currents, indeed, contest with winds for the first place among agencies of plant dispersal.

5. *Carriage by animals.* Very important as agents of dissemination, and even of dispersal, are animals, which are effective in two different ways.

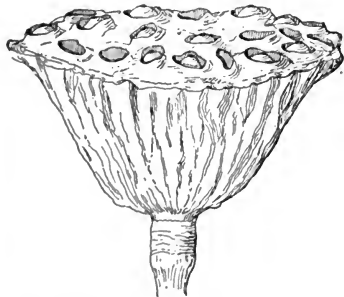

FIG. 259. — Floating receptacle of Lotus (*Nelumbium*);  $\times \frac{1}{2}$ .

have diverse morphological origins; they are developed bracts of the flower head in Burdock (Fig. 261), and outgrowths from the ovary wall in Cocklebur (Fig. 262).



FIG. 258. — Seed of Water Lily, with air-holding coat (aril). (After Gray.)

*First*, many fruits or seeds possess structural arrangements by virtue whereof they are held attached to the bodies of animals, and are finally dropped far from their places of formation. Especially common are hooks, which become entangled in wool or fur, where they often remain until the hair is shed. Such hooks

Sometimes they are gigantic in size, as in the *Martynia* of the western plains (Fig. 263). Everybody knows how abundantly the weed seeds cling to our clothes after walks in the fields in the autumn; and they cling mostly by hooks.

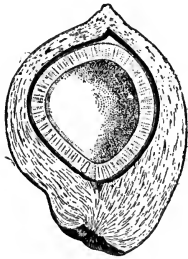

FIG. 260. — The Coconut, in section; reduced.

It shows the air-holding husk, the hard shell (black), endosperm or "meat" (cross-lined), and central cavity containing sap, or "milk." Below in the endosperm can be seen the small embryo, which lies just under, and comes out in germination through one of the "eyes." (From Le Maout and Decaisne.)

The same result follows from the presence of adhesive coverings to fruits or seeds, as especially common in epiphytes or parasites, for instance, the Mistletoe. In these cases the sticky seeds adhere firmly to the feet of perching birds until brushed off by contact with rough parts of some tree, the adhesiveness then serving to attach the seeds to the tree upon which they must grow. Adhesive seeds occur also in some water plants, which thus become attached to the feet or feathers of wide-ranging water birds, many of which travel so widely as to render those plants cosmopolitan. Thus birds come next after winds and ocean cur-

rents as agents of plant dispersal.

*Second*, fleshy fruits, with their edible, palatable pulp and their bright, contrasting colors, are easily found and eaten by animals, through the bodies of which the seeds, variously protected against injury from digestive juices, pass uninjured, and thus are dropped far from their places of origin. This seems very clearly the functional significance of edible colored fruits in nature, all lines of evidence converging upon this explanation. In this way the smaller forms of fleshy fruits, especially the diverse forms of berries and the smaller drupes, are scattered



FIG. 261. — Head of Burdock fruits;  $\times \frac{1}{2}$ . (From Kerner.)

chiefly by birds, which are the most important disseminators of seeds by this method. The larger fruits, Apples, Oranges, Gourds, and multiple fruits, are eaten in part by birds and in part by mammals.

The pulp has very diverse morphological origins, as earlier noted (page 351), and the protective coats to the seed are either the seed coat or else a pit formed from ovary wall (page 350). The claim

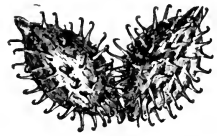

FIG. 262. — Fruits of Cocklebur;  $\times \frac{1}{2}$ . (From Kerner.)

has been made that the seeds of the largest fruits (those too large to be swallowed whole) mostly find their protection in the slipperiness of the coats, which prevents their being actually swallowed at all, though they are carried some way with the fruit.

Some seeds have bright colors without pulp, as in *Abrus* beans, and those of the common *Magnolia*; and such are said to be swallowed by birds, which perhaps mistake them for something edible, or else simply desire their bright attractiveness, as trout take the sportsman's fly. Some seeds and fruits which bear striking resemblances to insects

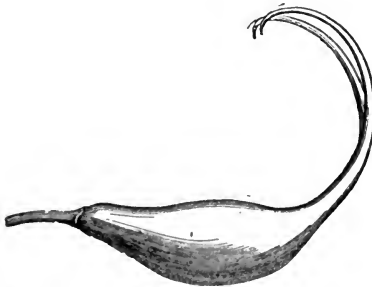

FIG. 263. — Seed pod of *Martynia lutea*;  $\times \frac{1}{2}$ . (From Le Maout and Decaisne.)

are supposed by some observers to secure dissemination on that account, though this is not certain. Recently it has been claimed that the many small seeds provided with CARUNCLES, *i.e.* little rounded projections filled with nutritive food substances (Fig. 270), are very effectively disseminated by ants, which carry off the nutritive bodies, and incidentally the seed therewith. Also snails and even fishes have been claimed to carry seeds.

The greatest results in the dissemination and dispersal of

plants are accomplished by man himself, who carries plants deliberately all around the world for his own purposes, and also spreads them accidentally through his commerce and travel. Much of his deliberate dispersal has effect only so long as his watchful care persists, for without it the most of his carefully grown crops would soon be exterminated by the return of the native vegetation.

6. *Projection by spring-release.* In the dissemination of plants by aid of winds, water currents, and animals, the



FIG. 264. — Seed pods of a Violet, forcibly projecting the seeds. (From Kerner.)

fruits and seeds are wholly passive, and the results are secured by the presence of structures which make the dissemination an inevitable result of the natural and ordinary operations of those agencies. There is, however, one way in which plants effect an active dissemination by forces developed within themselves, — namely, in the hurling of seeds through the

air by the action of suddenly released spring mechanisms. Thus in Violets (Fig. 264), the pod so ripens that the carpels press harder and harder upon the smooth seeds held in an angle between them, until suddenly the pressure overcomes the friction and the seeds are shot to a distance, much as one may shoot a smooth bean from between the pressed fingers. Again, in the Vetches, bands of tissue in the pod so ripen under tension as to bring such a strain on the sutures of dehiscence that they suddenly rupture and shoot the seeds forth in every direction (Fig. 265).

The Witch Hazel hurls forth its seeds in similar manner, as does the Acanthus, the Castor Bean, and the West Indian "Sand box," which bursts with a noise described as like a pistol shot. In some fruits it is the ripening not of dry, but of osmotically turgescient tissues, which produces the explosive result, as in case of the Impatiens, called also descriptively "Touch-me-not," and the so-called "Squirting Cucumber" of the Levant (Fig. 266).

Many accessory adaptations in fruits, connected more or less directly with dissemination, have been described by various observers, although not always accepted as genuine by others. The Kenilworth Ivy and the Chinese Primrose both grow in their native homes upon steep rocky hill-sides or cliffs; both have phototropic flowers, but their seed pods turn away from light, thus bringing the seeds into clefts of the rocks, whereby the plants are kept at the same elevations.



FIG. 266. — The Squirting Cucumber (*Ecbalium Elaterium*).



FIG. 265. — A pod of *Lathyrus vernus*, bursting and throwing its seeds. (From Kerner.)

Dandelions and other plants hold their flower buds close to the ground until their flowers are ripe, then raise them until after pollination, then draw them down once more until the fruits are ripe, and then

raise the plumose fruits well up into the winds; and water plants have analogous ways of drawing their pollinated flowers under water, and later releasing the ripened fruit or seeds (page 288). Several minor parts in connection with dissemination have been ascribed to hygroscopic tissues, with their power of strong movement (page 237), including the sudden release of elastically set tissues, certain creeping movements of fruits along the ground, and others, most of them probably only incidental.

Nowhere among plants, excepting in connection with cross-pollination, appear so many features of structure which have been interpreted as adaptations. Our sketch of the subject does it little justice, but is all that our space permits. The student can find ample additional detail in the books especially devoted to this subject.

#### 4. SPECIAL FORMS AND MONSTROSITIES OF FRUITS

Fruits, like flowers, but unlike leaves, stems, and roots, seem not to perform functions other than the one which is primary and typical to them; and conversely there seem to be no special organs of plants which can be traced to a morphological origin in a transformed fruit. But of abnormalities and monstrosities, fruits show a good many, mostly having connection with similar features in flowers. They have largely been treated, however, in earlier sections, and need only be reviewed at this place.

Mechanically caused effects, simulating monstrosities, are found in Strawberries or Raspberries, where one side of the fruit remains hard and green as result of a failure of complete pollination (page 197); and an Apple or an Orange displaying a clean-cut segment of different skin is a *chimara*, resulting from grafting (page 211). Some twin fruits are also a product of natural grafting when very young, soft-tissued, and tightly pressed together (page 196), though some twin fruits, as in Partridge Berry, are perfectly normal and usual.

Among genuine monstrosities, twin fruits, which are rather common, result from a partial fission of one (Fig. 146 and page 198). A genuine fasciation, producing several distinct lobes, occurs, in highly cultivated Strawberries, and also in Pineapples, as earlier pictured (page 198). Two-storied fruits also occur as result of proliferation (page 202), though sometimes a leafy branch occurs in place of the second fruit; and the Navel Orange is an imperfect case. Apples and Cucumbers occasionally produce bracts on their sides (page 202). Sometimes the carpels do not all unite in the pistil, but some remain separate, as is said to occur rather often in Oranges. Ears of Corn sometimes have tassels of male blossoms on their upper ends, and sometimes branch at the base. And other monstrosities less common are met with of which some can be propagated.

#### 5. THE NATURE AND CURE OF PLANT DISEASES

Plants are subject to many diseases, which appear perhaps in fruits more prominently than elsewhere.

Plant diseases, which are studied very thoroughly in agricultural institutions under the name of PHYTOPATHOLOGY, or simply PATHOLOGY (page 4), fall into three general categories, — those caused by parasitic Fungi, those of purely physiological origin, and those of which the nature is still unknown.

*Parasitic Fungi*, including Bacteria, cause the great majority of the worst plant diseases, notably Rusts, Blights, Smuts, Mildews, Wilts, Rots, Cankers, Crown Galls, Black Knots, Scabs, Spot and Blotch diseases, and other special diseased growths, the description of which will be found in Part II of this book. The very small spores by which these Fungi reproduce are carried everywhere by winds, and when thus brought to a suitable host plant they germinate, and the haustorial threads enter the plant body either through the stomata, the water pores, or some injury of the surface, or even at times, though rarely, directly through the epi-

dermis. Then the feeding threads, or mycelia, branch everywhere throughout the tissues of the host, which they penetrate by aid of enzymes secreted by their tips; while the walls and protoplasm and foods thus digested are absorbed and used in the further growth of the mycelium. Sometimes the Fungus takes no great toll and the host continues to live; but often the damage proceeds even to the death of the host. It is not solely, often indeed not principally, by the robbery of food that the parasite works the injury, but by poisonous substances, by-products of its metabolism, released in the tissues of the host. Thus parasitic Bacteria release into the bodies of animals, including man, the poisonous toxins which are the real cause of death from bacterial diseases (page 173); and in analogous manner parasitic Fungi cause damage and death to large areas of tissues, with resultant formation of brown or black spots, which often spread until the host's nutrition falls below the necessary minimum, and it dies. In addition, Fungi also cause a kind of paralysis of the growth-control mechanism of their hosts, resulting in the formation of many kinds of monstrosities (page 199), especially diseased woody growths. In some cases the Fungus attacks parts which are not vital, such as the heart wood of trees; but others attack the most essential parts, as in case of the Chestnut disease, where the Fungus destroys the living cambium. In any case the Fungus sooner or later sends out to the surface of the host its spore-producing structure, from which the ripe spores are wafted by the wind, this "fructification," as it is sometimes called, being often the only part of the parasite visible on the outside of the host.

*Physiological disturbances* include SUN SCALDS, where the sensitive tissues are injured by too much sunlight; OEDEMA, an osmotic disease (page 234); CHLOROSIS, or failure of chlorophyll to develop, producing unhealthy mottled leaves; and a number of others. One might almost include death from old age in this category, although plants differ much from animals in this relation (page 114).



*Unknown causes*, apparently not parasites or any known kind of physiological disturbance, produce the important diseases known as Peach Yellows, the Mosaic Disease of Tobacco, the Curly Top of Sugar Beets, and others, these names sufficiently describing the characteristic symptoms. Perhaps a wholly new type of disease-cause awaits discovery.

It is not usual to include insect ravages among plant diseases, but rather to reckon them in a category of pests, although their effects come often very close to those of the true diseases, and they are combated by much the same methods. Insects do damage in three principal ways: *first*, they eat the leaves of plants of which the food-making power is thus damaged. *Second*, they bore into and feed upon fruits or other parts, which thereby are rendered repulsive even if not extensively injured. *Third*, they lay their eggs in plant tissues under conditions which promote the formation of galls, already described (page 203). Insects are chiefly combated by poisons, either in sprays, as against the Elm Beetle, or else in gas, as in the fumigation of greenhouses, or of fruit trees under specially made tents.

The great number, variety, and ubiquity of plant diseases, together with the excessive loss they entail every year upon agricultural and horticultural interests, have long stimulated their practical study, with a resultant development of elaborate methods for combating them. In the past these methods have mostly centered in the effort to find a substance fatal to the parasite and not to the host, and such is the principle of spraying plants with solutions like the well-known Bordeaux mixture. Another method, of which the importance has more recently become manifest, consists in determining and applying to plants the conditions requisite for keeping them in fullest vigor, for the condition of balance between parasite and host is often such that a healthy individual can resist while a weakened one cannot. This principle becomes clear in connection with the ventilation

of greenhouses or storehouses for fruits or root crops. Fungi as a rule, in correspondence with their small size and parasitic mode of life within tissues, can stand bad air much better than the higher plants, which are far larger, and physiologically adjusted to more space and air. Accordingly, bad ventilation always gives to Fungi an advantage over their hosts, which explains why plants rot more freely in unventilated than ventilated places.

In our own times an attack has been made on the disease problem along a very different line, viz. the effort to breed immune varieties. The variability of plants is manifest in susceptibility to a given disease as in other features, some individuals of a kind being very susceptible and others much less so. By a systematic selection of the latter individuals it is found possible to breed immune races. Though the problem is by no means so simple in practice as in principle, marked success has already attended the method, of which we are sure to hear more in the future.

## 6. ECONOMICS, AND CULTIVATION, OF FRUITS

The economic uses of fruits, apart from their seeds, which will be considered later by themselves, center almost wholly in the food value of the edible kinds, especially berries, pomes, and gourds. It is notable, however, that fruits as food are rather luxuries than necessities, having a relatively slight food value though great palatability. This combination, of course, comports perfectly with their function of seed dissemination by agency of animals, where the function does not require that animals shall be nourished, but only attracted. The dry kinds of fruits have hardly any uses to man, the opium derived from young Poppy pods being perhaps the most prominent economic product.

As to the cultivation of fruits, the physiological and structural methods concerned have mostly been covered incidentally in the earlier sections. Such are the *pollination* of flowers by insects to insure fruit setting; *pruning* to divert

plant energy from superfluous vegetation to optimum fruit formation; *grafting* to preserve and multiply a desirable new variety or sport; *spraying* and other like methods, including the use of poisonous gases, to combat parasitic fungi and insects; *plant breeding* for the development of better or immune new kinds; and *ventilation*, of greenhouses or storehouses, to aid the larger plants and fruits in resisting disease Fungi. Fine fruits are commonly wrapped individually for transport, chiefly to prevent the breaking of the skin, which not only injures their appearance, but breaks their first line of defense against Fungi.

## CHAPTER VIII

### THE MORPHOLOGY AND PHYSIOLOGY OF SEEDS

#### 1. THE DISTINCTIVE CHARACTERISTICS OF SEEDS

SEEDS form the transportation stage by which plants, otherwise sedentary, are spread outward from their places of origin. They are relatively small parts, which separate of themselves from the parent plants, are so constructed that they may be kept long alive and carried afar, and then when planted, produce individuals like those which produced them. Living under diverse conditions, and transported by various agencies, they differ much in their various external features.

In *size*, seeds vary from almost dust fine in some tropical Orchids (much smaller than the scriptural mustard seed), all the way up to the Coconuts, the mean or average size lying, however, much nearer the former than the latter dimensions.

In *shape*, seeds are most diverse, from approximately globular to elongated, variously angled, and extremely flat, the particular shape being apparently connected in some cases with the method of dissemination, in others with the shape of the embryo, and in others with less evident factors. Often the shape is complicated by the development of special outgrowths, — plumes, hooks, etc., — having connection, as in case of fruits, with dissemination.

In *color*, seeds are sometimes bright, chiefly red or yellow, as are some fruits, and in other cases are mottled, sometimes in ways which simulate the markings of insects; and all of these features may have connection with dissemination

(page 356). Far more common, however, are the simple brown and gray colors such as all ripening tissues assume, as a purely chemical incident, where no functional reason for special color exists. This is the case with all wind- and water-disseminated seeds, and those thrown by spring mechanisms.

In *texture*, seeds are almost invariably hard, sometimes extremely so, as in the Ivory Palm. The hardness results from three causes: the almost complete absence of water from the tissues, the very thick coats, and the frequent large proportion of cellulose food. They soften very greatly, however, in germination.

Many seeds are difficult to distinguish externally from small fruits, especially when the latter are one-seeded. The difference is purely morphological, consisting in the presence of the ripened ovary as a kind of additional coat; but functionally such one-seeded fruits are identical with true seeds.

As with other plant organs, there are various structures, popularly thought to be seeds which are not, such as the little black, hard-walled bulblets in the axils of Lily leaves (Fig. 212). There is no such thing as "Fern seed," the misnamed "fruit dots" on the under sides of fern fronds containing only spores, a very different kind of structure. Spores have no embryo, that is, no ready-formed young plant, which all true seeds contain. Indeed the possession of an embryo is by far the most distinctive mark of a seed.

## 2. THE STRUCTURE, MORPHOLOGY, AND FUNCTIONS OF SEEDS

Despite a wide variety in their external features, seeds possess in common certain primary parts, three and sometimes four in number, which of course are those essential in their function.

*First* in importance is the EMBRYO, which is simply a formed but unborn plant, with its development held for a

time in suspension. It has always a small unjointed stem, the **HYPOCOTYL**, which bears at one end the foundation for a root, at the other the foundation for a bud, and close

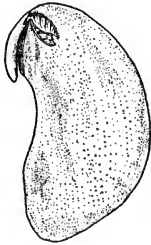

FIG. 267. — Embryo of Lima Bean, as it appears without the seed coat, and on removal of one cotyledon;  $\times \frac{1}{2}$ . The largest part is cotyledon.

to the latter one or more "seed leaves," or **COTYLEDONS** (Figs. 267-9). These cotyledons, which vary from leaf-thin to hemispherically thick, are oftenest two, less frequently one, and sometimes several, as prevails in the Pine family. While the cotyledons are commonly viewed as morphologically leaves, modified by their peculiar position and functions, there is doubt as to whether they really originated as leaves, or are the descendants of special organs by which embryos originally absorbed food direct from the parent plants. The bud between the cotyledons is mostly undeveloped in the seed, but in some large, well-developed embryos, it produces visible leaves, in which case it is called the **PLUMULE** (Fig. 267).

Second in importance is the nutritive **FOOD**, which is supplied by the parent plant, and consists chiefly of starch, oils, and proteins, in a dry and concentrated condition. In some kinds this food occurs in a special tissue, called **ENDOSPERM**, surrounding the embryo, which therefore lies embedded within it (the so-called **ALBUMINOUS** seeds, Fig. 270); but in others the food is contained inside the embryo itself, mostly in the cotyledons which are then conspicuously enlarged; and the embryo now completely fills the space within the seed coats (**EX-ALBUMINOUS** seeds, Fig. 271). The endosperm originates in the embryo sac simultaneously with the embryo

(page 354), and the two develop step by step together until they fill the embryo sac, and even (through the absorption



FIG. 268. — Embryo of Morning Glory, with one cotyledon removed;  $\times 2$ . There is no plumule.

of the nucellus by the endosperm) all of the space within the seed coats. Such are the albuminous seeds, in the germination of which the embryo absorbs the endosperm through its cotyledons. In the ex-albuminous seeds, however, this absorption of the endosperm occurs before germination, and this is the meaning of the difference between the two kinds. It is in correlation with this further stage of development that ex-albuminous seeds have so often a plumule, while albuminous kinds have only the undeveloped foundation of a bud.

*Third* of the parts are the SEED COATS. Oftenest there is but one, which is thick, hard, and woody, and has the obvious function of protecting the embryo against injury during the period of dissemination. Sometimes there is also an inner

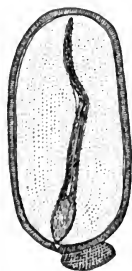

FIG. 270. — Albuminous seed, of Castor Bean, in section;  $\times 2$ . The embryo lies embedded in endosperm; below is a caruncle.

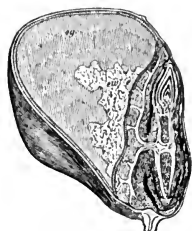

FIG. 269. — Grain of Corn, in longitudinal section;  $\times 3$ .

At the right is the embryo, showing plumule, primary root, and hypocotyl. In the latter can be seen the fibro-vascular system extending into the large SCUTELLUM, which forms a haustorial organ for absorbing the endosperm,—*ew* (looser texture) and *eg* (more compact texture). It is doubtful whether the cotyledon is represented by the scutellum, by the sheath leaf of the plumule, or by both together. (From Sachs.)

coat, then usually membranaceous, and less often an additional outer coat, called an ARIL, which is generally loose

from the others and has obvious connection with dissemination, as in cases earlier mentioned, *i.e.* the Yew berries (page 351) and the Water-lily seeds (page 361). There is some structural connection, not yet fully understood, between these arils and the little insignificant and seemingly functionless swelling

called the STROPHIOLE, occurring near the hilum in some seeds, and the much larger CARUNCLE (Fig. 270), an

appendage which contains nutritive substances apparently having a functional meaning in connection with dissemination (page 356).

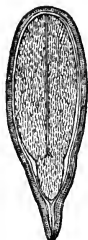

FIG. 271. — Ex-albuminous seed, of Apple;  $\times 4$ .

The embryo, showing clearly the cotyledons and hypocotyl, fills completely the space inside the seed coats.

Seeds show many structural relations with the ovules from which they develop, precisely as do fruits with their ovaries, though it must not be inferred that all such features in seeds and fruits are simple persistences of ovule or ovary characters. It is equally possible that some have originated in seeds or fruits and worked back in evolution into ovules and ovaries.

Every seed shows on its coat a tiny pit, sometimes differently colored, which is the persistent though now sealed MICROPYLE, or opening through which the pollen tube entered the ovule (page 278). This of course has no connection with the much larger scar, called the HILUM, left where the seed breaks away from its stalk (Fig. 272). Where ovules are turned over on their elongated stalks, which are grown to the coats (page 272), the arrangement persists, in the seeds, which show a marked ridge, or *raphe*. The position of the chalaza of the ovule often is manifest in a marked *chalazal angle* in the seed.

Appendages, when present, whether hairs, plumes, hooks, or others, are direct outgrowths from the seed coat, and have obvious function in connection with dissemination, as already discussed (page 356). Outgrowths of the same kind occur often on ovaries which contain on'y a single seed, in which case one can tell only by dissection whether an ovary wall is present or not.



FIG. 272. — Seed of a pansy;  $\times 5$ .

Below and facing to the left is the hilum; at the point (invisible) is the micropyle; along the side on the left is the raphe; and at the top is the chalazal angle.



Seeds apparently present no transformations into structures of other function, and few abnormalities or monstrosities. The principal peculiarity of this kind consists in POLYEMBRYONY (page 302), or the production of more than one embryo to a seed. The additional embryos have diverse morphological origins, resulting oftenest from a budding of nucellus cells into the embryo sac the structure taking very perfectly the embryo form; but they grow also from other cells inside the embryo sacs, and from other embryo sacs contained in the same nucellus. The embryos themselves often show a monstrosity in POLYCOTYLEDONY, the production of cotyledons in more than the normal number.

### 3. THE SUSPENSION OF VITALITY, RESTING PERIOD, AND DURATION OF LIFE IN SEEDS

The primary seed function of serving as the disseminative stage of the plant involves a number of physiological features, of which the more prominent are indicated in the foregoing title.

The value, or necessity, of a SUSPENSION OF VITALITY during dissemination is quite obvious, since the embryo plant while in transit, and hence for considerable periods of time, is perforce exposed to great dryness, intense light, destructive chemicals, etc.; and these conditions are inconsistent with that continuous interchange of oxygen, water, and food essential to the ordinary life of plants. As to the actual physical method by which the suspension of vitality is insured in seeds, that seems to rest primarily upon *dryness*, the greater part of the water being allowed to escape without replacement during the ripening of the seed. Since water is the indispensable solvent for chemical, and the vehicle for physical, operations underlying growth and other processes, its gradual withdrawal slows the processes down, apparently evenly and without injury, until finally a point is reached at which they are barely in action, — precisely as engines may be slowed, by withholding of power,

to a scarcely perceptible motion. Indeed, so slow are the life processes in ordinary dry seeds that, as tested by the most important and typical process of them all, viz. respiration, they are not actually demonstrable by even the very refined methods of research which have been applied to the problem. Accordingly some investigators have maintained that the processes are actually suspended, as an engine may be stopped, all ready to start again when suitable conditions are supplied. But the collective evidence, indirect as well as direct, seems rather to indicate that the processes never stop completely so long as the seed remains capable of germination.

The extent to which the conditions of life in seeds differ from those of ordinary active life is attested by the extremes of temperature they can endure without injury. Thus well-dried seeds can be kept some time above the boiling point of water ( $100^{\circ}$  C.) without damage, though active embryos would be killed very quickly by an exposure to only  $60^{\circ}$  C. Again, seeds have been kept for days surrounded by liquid air, at a temperature of  $-194^{\circ}$  C., and then have germinated freely, though active embryos would perish at  $0^{\circ}$  C. And seeds can endure some other untoward agencies in like manner. It is the same with the thick-walled resting spores of Fungi and Bacteria.

The RESTING PERIOD, also called DELAYED GERMINATION, of seeds, is less familiar, but equally important. Some seeds of wild plants will germinate as soon as mature, if given favorable conditions of moisture and warmth; most kinds, however, first remain quiescent for days, weeks, months, or even years. Essentially the same phenomenon appears in the buds of trees and shrubs, for if twigs are brought into the warm greenhouse and placed in water, most buds will not start at all before February, though later, under precisely the same treatment, they will open and display their flowers to perfection. Bulbs and tubers (*e.g.* potatoes) act in a similar manner. It is true that some individual flower

buds, like some individual seeds, will start in the fall; but such cases are clearly abnormalities or variations, due to failure of the control mechanism to operate (page 342); and the result is always fatal. It is thus evident that the resting period is not simply an incident of seed and bud life, but is obligatory, so to speak, under natural conditions, though it can be shortened artificially in a good many cases. The functional value, or necessity, of the resting period is obvious, since it tends to prevent the germination of seeds and opening of buds in warm times of late autumn or winter, when subsequent freezing must inevitably kill the new growth. As to the physical basis of the resting period (the method by which it is enforced on the seed), that seems to be diverse. In some cases it is known to depend upon the embryo, consisting in a slow "after-ripening," *i.e.* formation of enzymes, acids, or other essential substances; but in other cases it has been proven to depend upon the character of the seed coats, which are so constructed as to prevent the admission of oxygen or of water, both indispensable to germination, — the inhibition continuing until the coats are ruptured by decay. It is of course a necessary corollary of this explanation that in such cases germination will be prompt if the seed coats are artificially broken; and such is found by experiment to be true and has long been known to nurserymen and gardeners. Thus, they break Peach pits with a hammer, open Canna seeds with a file, and bruise or break the coats of others in diverse ways, thereby greatly hastening the germination of those kinds.

While the seeds of most plants have a resting period, cultivated plants seem mostly to lack it. Thus, we grow Corn, Beans, Peas, and other crop plants in our laboratories in autumn from seeds of that summer. This peculiarity, indeed, sometimes brings loss to the farmer, since in exceptionally warm wet autumns, grain is apt to germinate in the ear in the standing crop, to its very great damage. The resting period has presumably been lost from cultivated

plants through its complete disuse during the many centuries of their cultivation by man, who has attended to the safety of the crop himself and directed his selection to quite other qualities.

The DURATION OF LIFE, or VIABILITY, in seeds is most various. Every one who works with a garden knows that some kinds keep good for only one season, while others last two or three; and methods exist for testing the viability in cases of doubt. There are kinds which must germinate the summer they are formed, or not at all; and this is true of Elm, Willow, and Poplar, — trees which form their seed early in spring. Most kinds, however, wild as well as cultivated, if kept dry and cool, remain viable for one, or two, perhaps three years, though beyond that period the number of kinds which survive steadily wanes with advancing years. Tests made on seeds taken from dated museum or herbarium collections have shown indubitable germination in seeds eighty-seven years old, with a possible case over one hundred and twenty years. It is interesting to note, by the way, that these extreme longevities occur in seeds possessing thick hard coats. As to the reported germination of seeds taken from the wrapping of mummies, or from ancient tombs, hundreds or thousands of years old, it is not confirmed by the exact methods of science, while on the other hand there is ample evidence that seeds are often introduced fraudulently into such places.

What then actually ends the viability of such seeds? If they can live so long in the inert state, why not indefinitely? The very fact, by the way, that all die, and mostly within a few years, is presumptive evidence for the view that the life processes are not in suspension, but only slowed down. The death of the seed comes gradually, and without any visible external sign, in most cases at least; and it clearly is not due to exhaustion of food or like kind of cause. Here, however, our knowledge ends. Possibly the loss of water can proceed to a fatal degree; perhaps the accumulation of waste

products of the slow metabolism within the tightly-sealed seed coats poisons the embryo; and it may be that the slow coagulation of the proteins destroys the essential constitution of the protoplasm. Between these possibilities, and perhaps others, the future will decide.

#### 4. THE GERMINATION OF SEEDS

The seed, its resting period completed, germinates on access of water, air, and warmth. The water it needs to expand its parts; the air is necessary for its respiration, which is very active in all growth; the warmth is required to accelerate the many physical and chemical processes involved. As to light, that has no influence, direct or indirect, in most cases, though special seeds are known which will not germinate in light, and others which will not germinate without it, doubtless for reasons incidental to some peculiarity of their metabolism.

In germination we can distinguish some seven stages. *First*, most seeds, though not all, swell greatly throughout, often to more than double their dry size, by absorption of water, which enters partly by imbibition and partly by osmosis. As these words imply, the absorption is forcible, and thus seeds can lift considerable weights in the ground or break strong containers under experiment.

*Second*, the seed coats are broken, no matter how thick and strong, by the pressure from within. In some the rupture is irregular; in others, it follows definite lines corresponding with angles or depressions of the coats. Some very striking special arrangements to this end are known (Fig. 273).

*Third*, the digestion of the food substances begins. The insoluble starches, oils, and proteins are converted by enzymes into soluble sugars, fatty acids, and peptones, as manifest to the eye in the change from opacity to translucency, and a softening of the seed. Then the digested food, absorbed by the cotyledons in albuminous seeds, though

already within them in ex-albuminous kinds, is ready for translocation, and use in the growing parts of the embryo.

*Fourth*, the end of the hypocotyl of the embryo, lying next the micropyle, now pushes forth, and as soon as clear of the seed coats, grows geotropically over to point downward, developing meantime the root at its tip. This root is a new growth, and not a transformation of the hypocotyl, as students are prone to suppose. Then, if the seed, as is

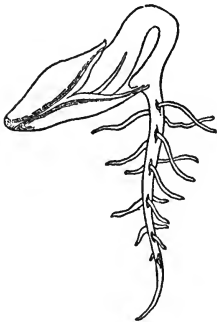

FIG. 273. — Germinating seed of Pumpkin, showing the "peg" or "heel" by the development of which the seed coat is forced open. (From F. Darwin.)

usual with wild plants, lies on the surface of the ground, the root begins to enter the earth. No sooner does the root start into the soil than (from small seeds at least) it sends out a radiating ring or collar of root hairs which take firm hold on the rock particles. Thus is provided a resistance, without which further growth might rather lift the seed from the ground than force the root into the soil. In some other seeds, such as Flax, such resistance is provided by a mucilaginous coat which gums it, so to speak, to the ground. Practically all embryos, as the first act of their development, thus secure access to the water supply

which is indispensable to their further development.

*Fifth*, on the basis of the anchorage secured by the penetration of the root into the earth, the hypocotyl now begins to make such growth movements, too complex for easy description but readily shown in our pictures (Fig. 274), as cause the withdrawal of the cotyledons from the seed coats, and their subsequent elevation, when they open out to the light. In cases, however, like Peas and some Beans, where the cotyledons are apparently too thick to serve later as effective foliage leaves, they remain in the ground, while the plumule issues from between them, and grows geotropically upward.

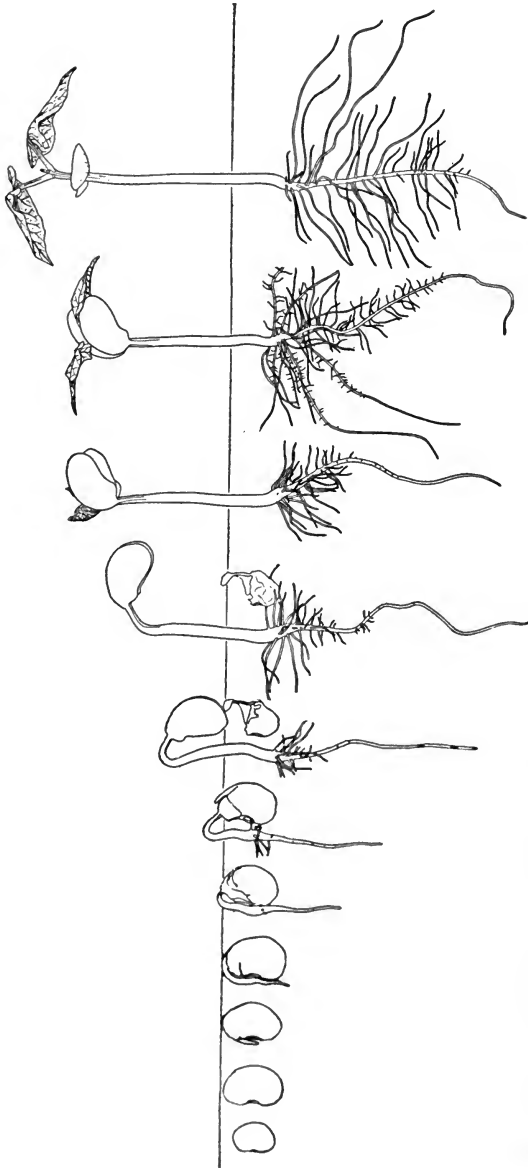

FIG. 274. — Successive stages in the germination of the Lima Bean, from the seed to the fully germinated embryo ;  $\times 4$ .

*Sixth*, the parts which rise in the light, especially the cotyledons and plumule, as they issue from the seed coats, begin to turn green, and, by the time they are spread open at the top of the young stem, have their full quota of chlorophyll, in obvious preparation for the manufacture of new food.

*Seventh*, the enlargement of hypocotyl, cotyledons, and plumule proceeds by absorption of water until all of the cells laid down in the embryo are fully expanded, at which time, with the root firmly fixed in the ground, the young stem is erect with the cotyledons fully green and expanded. Germination is now complete, and the germinated embryo is ready to continue development, with formation of new parts, into a seedling. It is true, the formation of new leaves and buds does not always await the completion of the expansion of embryonic parts, but in principle at least there is this distinction between germination and the subsequent growth of the seedling.

If a fully germinated embryo be compared point by point with one from a resting seed, as may best be done with some of the compact succulent kinds like Cactus, the following differences appear. *First*, except for the root and the chlorophyll, the germinated embryo possesses nothing really new. *Second*, it has become many times larger, even to twenty or thirty times. *Third*, again excepting the root, it has usually few new cells, the enlargement having consisted chiefly in the increase in size of those already developed. *Fourth*, the cells are now all apparently empty (except for water) instead of densely packed with solid food, thus explaining the watery translucency of the germinated embryo as contrasted with the white opacity of its ungerminated condition. *Fifth*, its dry weight, determined by comparative weighings of oven-dried material, is actually less, showing that the far greater bulk consists chiefly of water. Thus it is clear that germination consists primarily in the great expansion through water absorption of the



close-packed cells of the original embryo, the food being used partly in the formation of the root and partly in the enlargement of cell walls. Evidently the functional point of the process is found in the great spread of green surface thus quickly achieved by the use of a relatively small amount of solid material. The value of the spread of surface in this case is obvious, for the young plant has to begin as early as possible the acquisition of its own photosynthetic food supply.

### 5. THE ECONOMICS AND CULTIVATION OF SEEDS

Among all of the parts of plants, seeds stand preëminent in direct utility to man. This of course is because they include the grains, Corn, Wheat, Rice, Barley, Rye, and some others, together with the leguminous crops, Beans, Peas, Millet, which collectively make up the greater part of the food supply of mankind. These seeds contain rich stores of starches, oils, and proteins, originally laid down by plants for the use of their embryos, and now taken for his needs by man, who has been able through long centuries of cultivation and breeding to greatly increase their yield both in quantity and quality. Of a different kind is one other great economic use of seeds, viz., the fibrous hairs developed by the Cotton seed as its disseminative mechanism (by wind) yield the cotton of commerce (Fig. 254).

The grains, as earlier noted (page 349), are fruits as well as seeds, the seed coat and ovary wall being grown together into one structure which constitutes the husk. The husks are removed in milling white flour, but retained in graham flour, which is the more nutritious because it includes the layer of protein-storing cells which form the outermost part of the food in the grain (Fig. 65).

The agricultural and horticultural treatment of seeds appears to offer nothing peculiar, the various principles of cultivation and breeding being the same as with other parts. There is, however, one economic matter peculiar to seeds, in connection with their viability. Since nothing in the

aspect of a seed tells whether it is still alive or not, or what percentage of a given quantity is alive, the purchaser of seeds is at the mercy of a dealer unless he can himself make test of viability. For such tests various methods have been devised, the most simple and direct of which is that of placing a given number in folds of blotting paper kept wet, dark, and well aërated, and noting the percentage which germinates.

#### 6. THE CYCLE OF DEVELOPMENT FROM SEED TO SEED

Having studied the six primary parts of plants with respect to their structures and functions, it remains to consider their successive appearance in that cycle of development through which every individual passes. It is possible to break the cycle for study at any desired point, but in practice we may best start with the germinating seed. The facts having already been considered in detail, we can best review the subject in a way to bring out its general principles.

The seed contains a well-formed embryo plant, provided with stem, rudiments of root and bud, and cotyledonary leaves, all enwrapped with a store of food substance inside protective coats. In germination the seed absorbs water, swells, and bursts the coats; the stem pushes forth its lower end, which grows over geotropically downward and enters the ground. Meantime its tip is developing a root, which, on contact with the soil, puts forth many root hairs, whereby it absorbs osmotically a sufficiency of water. No sooner is the root secure in the ground than the stem makes growth bendings which first withdraw the cotyledons from the seed coats, and then lift them geotropically upward until they open out to the light on the tip of the vertically straightened stem. Meantime the whole plant is swelling rapidly in size through absorption of water, and turning green over stem and leaves by formation of the chlorophyll so essential to its future welfare. Thus the fully GERMINATED EMBRYO now stands rooted in the ground and erect in the sun, to which it spreads a large surface of chlorophyll. In

this process all of the food supplied by the parent plant has been used; and thenceforth the new plant must depend entirely upon its own physiological powers, for the exercise of which, however, it is now fully prepared.

The successive stages in the developmental cycle of plants, while distinct in principle, largely overlap in practice, so that even before the completion of germination, the young plant has commenced the activities of its next, or seedling, stage. With the spread of its chlorophyll in light, it begins to acquire a new food supply of its own, which forms a basis for further development. The root now begins to send out branches, diageotropically guided either horizontally or at definite angles from the vertical main root, though these directions of growth are soon disarranged by obstructions in the soil. Meantime the plumule bud, between the cotyledons, is continuing its development, forming in symmetrical order new leaves, which, at first small and tightly appressed to the stem, later gradually open out until they present their full faces to the sun. Simultaneously there is continuous increase in size, and the formation of suitable firm supporting and other needed tissues. Thus is attained the stage of the SEEDLING.

Gradually the seedling passes into a stage which in case of trees is called the SAPLING. In the roots new branches spring from the secondary roots, not at definite places or angles, but guided hydrotropically and chemotropically towards the moistest and richest parts of the soil, where they develop more profusely, thus making the root system as asymmetrical as the soil is irregular in texture. Meantime, while the leaves are still in the embryonic stage, new buds develop in their axils, and later, after those leaves have passed their maturity and fallen, grow out into branches which bear new leaves in precisely the same manner as does the main stem. These branches, guided diageotropically, grow out at definite angles with the vertical main trunk, and, possessing also the same symmetrical phyllotactic ar-

rangement as the leaves, tend to build stem-and-leaf structures very symmetrical in plan. Meantime also the special tissues which give strength and meet other needs are continuing to develop in places required by stress or other demand.

In this stage appears the striking seasonal cycle imposed on all plants outside of the tropics by the extreme alternation between summer and winter. The *summer* alone has the warmth to permit full vital activity in plants, and accordingly is the season of green vegetation, accumulation of food, and development of new parts. In the *autumn* preparation is made for the winter, and accordingly that is the season when fruits are ripened, buds are enwrapped in their scales, leaves are cut off and dropped, and tissues are partially dried; while the attractive colors of fruits and the varied hues of dying leaves make it a time of bright color in vegetation. The *winter* is the season of enforced dormance, when the dried tissues of plants, approaching the conditions in seeds, remain almost inactive within their nearly sealed wrappings, which display no colors other than their incidental grays or browns. The *spring* is the season of unfolding, when the ready-formed parts, amply supplied with stored food, absorb copious water, enlarge, burst their wrappings, and push forth green leaves to make new food, and bright flowers to effect fertilization; and all vegetation wears the soft colors of the new-forming tissues. This is the four-part seasonal cycle through which our perennial plants pass every year as long as they live.

The next stage of the developmental cycle is the **ADULT**. It is not distinguished from the sapling by attainment of any fixed size, for plants (unlike animals) continue to grow, by formation of new parts, as long as they live. Nor is it marked by any change in the mode of formation of roots, buds, or leaves, which continue to be made in the same general way. It is true, a gradual loss of the youthful symmetry accompanies advancing age in trees and shrubs, partly because of the interference of the over-plentiful

branches with one another, partly because of accidents, and partly because of phototropic and other self-adjustments. The real mark of adult age is the beginning of sexual reproduction. After the young plant has attained a considerable growth, presumably accumulating food in reserve, some of the axillary buds, precisely alike in position and mode of formation to those which have been producing leafy branches, begin to produce flowers,—that is, specialized determinate branches containing reproductive spores which develop the sexual cells. As to the nature of the stimulus which leads the plant thus suddenly to convert certain of its branch buds into flower buds, or more exactly, to develop reproductive spores with the correlated floral structures, we have as yet no exact knowledge, although the influence of various external factors is clearly apparent. Having once begun to produce the flowers, the plant continues to make them, just as it makes leaves, branches, and roots, as long as it lives. The central parts of these flowers are pollen grains and embryo sacs, which in turn develop the two kinds of sex cells.

The next stage in the cycle includes fertilization. The floral parts are essentially organs functionally fitted to effect union of the sex cells, — and a union usually between two different parental strains. By utilization of the motive power of winds, insects, etc., the pollen containing the sperm cell is transported from its place of formation to the vicinity of the deeply-buried egg cell, after which the growth of a pollen tube brings egg cell and sperm cell together into a single FERTILIZED EGG CELL.

The next stage is that of the development of the fertilized egg cell into an embryo. The single cell, lying in the embryo sac, begins at once to divide and to grow, then divides again and grows farther, and thus, under guidance of influences partly hereditary and partly environmental, it gradually assumes the form of the many-celled embryo, with its stem and cotyledons. Meantime the endosperm or food substance is forming around the embryo, and the hard

seed coats are developing around both. Thus is reached the stage of the fully formed EMBRYO within the seed.

The final stage is that of dissemination, performed by the SEED. A considerable time often elapsing either before transport or during that process, with simultaneous exposure to extreme conditions, the seed goes into a resting condition with all of its processes reduced to a minimum, and with provision against premature germination. Then, separating from the parent plant, it becomes transported by wind, animals, or other locomotive agency, acting upon suitably developed mechanisms, to a distance sufficient to permit the free development of its plant without interference with the parent. Having attained a suitable place, its resting period ended, and water, air, and warmth supplied, the seed germinates. But with germination the cycle is closed. If the term cycle seem inappropriate, since the return is not to the same seed, then the simile of the spiral, winding back to the same starting line, may better express the process.

PART II  
THE KINDS AND RELATIONSHIPS OF  
PLANTS

CHAPTER IX

THE PHYLOGENETIC CLASSIFICATION OF PLANTS

THE study of any science presents both analytic and synthetic aspects. By *analysis* we resolve single structures and processes back as nearly as possible to their ultimate elements. The methods are often elaborate and technical, but are those by which most new knowledge is won. To this phase of Botany, Part I of this book was devoted. By *synthesis*, the data supplied by analysis are assembled, correlated, classified, and welded together into a systematic body of knowledge, the continuous development of which is the logical end of all scientific study. To a synopsis, necessarily brief, of this phase of Botany, Part II of this book is devoted. To most people it forms the more interesting phase of the science, dealing as it does with the kinds, habits, uses, classification, names, and other features of plants, which distinguish them as living beings and the companions of man on the earth.

The first requisite of systematized knowledge is classification. When accurately studied, plants are found to exhibit resemblances to one another in various degrees, such that they fall naturally into groups, and groups within groups, expressible in systems of classification. Of these systems there are two, closely interlocked but distinct in character,

one based on descent and called *phylogenetic*, and the other based upon habit and called *ecological*.

Phylogenetic classification (the classification par excellence of natural history), expresses the relationships of plants as determined by their evolution or descent from ancestors in common (page 10). It corresponds precisely to blood relationships among men, as expressed in our genealogies, which show who are brothers, who cousins, and who more distantly related. In plants the relationships, of course, show best in those characters which are most constant in heredity; and these are mostly such, in the higher plants at least, as are connected with the reproductive parts, — whence the emphasis upon flowers and fruits. Thus studied, the Plant Kingdom falls into four primary Divisions, — the Thallophytes, Bryophytes, Pteridophytes, and Spermatophytes, which form the subjects of the four following chapters of this book. These Divisions in turn fall into smaller groups called Classes, and they into smaller called Orders, and they into smaller called Families, and they into smaller called Genera, and they into Species, of which some 233,000 are known (page 1). Species are those aggregates of individuals which we recognize as belonging to the same kind, and com- prisable under one name. It is true, in some cases they fall into varieties or races, but such are exceptional and their existence does not alter the fact that species are the units in phylogenetic classification.

The phylogenetic groups are named scientifically, in Latin, upon a somewhat definite plan, though with exceptions due to historical causes. Thus, every species is given a binomial name, composed of the name of its genus, always a noun in the nominative case, in combination with a word associated with that particular species, usually an adjective in agree- ment with the noun. Thus *Quercus alba* is the botanical name of the White Oak, *Quercus* being the name of the genus, and *alba* applied to the species. We have precisely the same usage in English, though in reverse order, when we say White



Oak, and Red Maple, Oak and Maple being generic names in English, as are *Quercus* and *Acer* in Latin. Families are named usually from some prominent genus, commonly with the termination *-aceæ*; thus *Rosaceæ* is the Rose Family. Orders are named usually from some prominent Family, commonly with the termination *-ales*; thus *Rosales* is the order which includes the Rose Family along with a good many others. The Classes are named usually from some prominent group, commonly with the termination *-ineæ*; thus *Filicineæ* is the Class containing the Ferns. The Divisions are named with the termination *-phyta*.

If classification is to plants the same as genealogy to men, we should be able to construct for plant relationships a table or tree of descent. This can indeed be done in a general way, though with much uncertainty as to details because of our scant knowledge at many places. Such a tree, constructed in accordance with the data contained in the four following chapters, is presented herewith (Fig. 275). Details of classification are expressed in form convenient for use in books called Manuals (page 3), while the plants of a country collectively, considered from this point of view, are called its Flora, — a word often extended to books descriptive thereof.

Plants are related to one another not by single characters but by aggregates of many, more or less linked together and various in prominence. Usually, however, it happens that some one of the correlated features stands out so prominently that we can use it conveniently as an index to the aggregation; and this is the meaning of distinctions between groups based apparently on single features. Thus the classification of the *Algæ* into Green, Brown, and Red does not mean that *Algæ* are classified by color; but it happens that color in those plants is usually a safe, and certainly a convenient, index to the structural features which separate them. The method, however, has its dangers and drawbacks, because sometimes all of the other characters may be present without

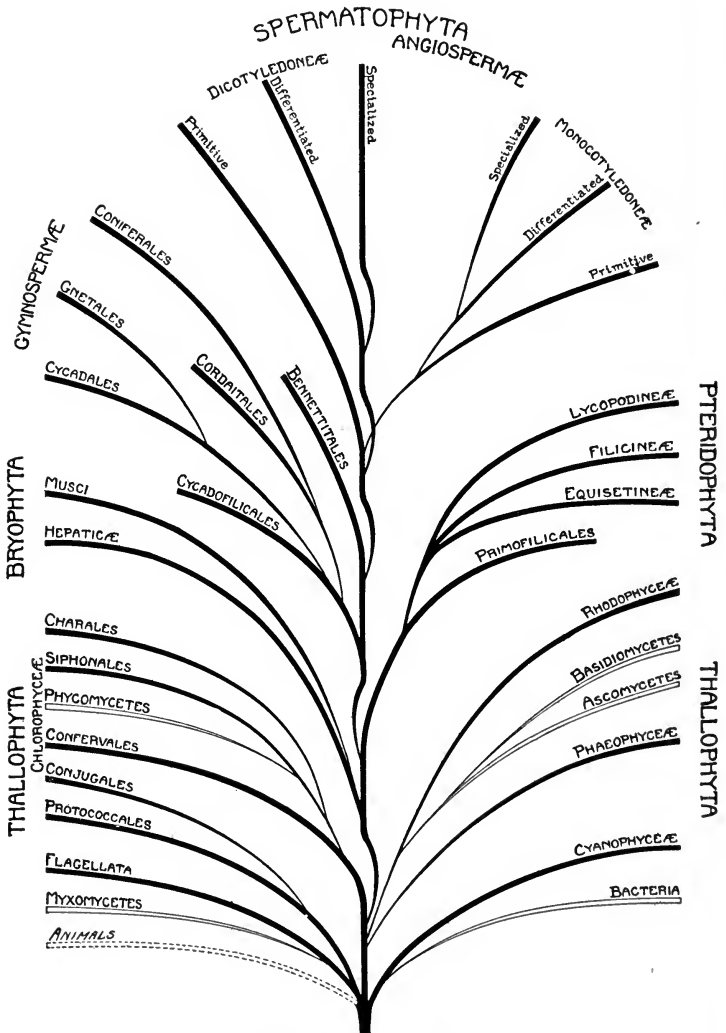

FIG. 275. — A Phylogenetic Tree, showing the relationships of the principal plant groups.

the color, or some members of one group may even adopt the color of another. Hence all such single-feature categories must be used in the knowledge of the ever-present possibility of exceptions.

The classification of plants is interlocked among the lower forms with that of animals. The higher plants and animals are, of course, perfectly distinct, their differences, in the last analysis, centering in their different methods of acquiring their food. Plants are typically organisms, or the descendants of organisms, able to synthesize their own food from inorganic materials by aid of sunlight applied through chlorophyll, this method permitting a sedentary habit, a continuous cellulose and lignified skeleton, and a sensitivity confined to reflex action (page 55). Animals are typically organisms unable to synthesize inorganic materials into food, which accordingly they take from other organisms, by methods involving active locomotion, a muscular system with jointed skeleton, special sense organs, and ultimately, in higher forms, the development of consciousness. Among the lower forms in both kingdoms, however, these and all other distinctions fail, for there are groups which include both undoubted plants and undoubted animals, as in case of the Flagellates (page 410), while other groups consist of organisms which unite in themselves both plant and animal characteristics, as in case of the Myxomycetes (page 412). The explanation, however, is obvious, and attested by many lines of evidence, — the two kingdoms have been evolved from the same ultimate ancestors, of which the groups and organisms above mentioned are the surviving representatives.

Such in brief is phylogenetic classification, which underlies the four following chapters. The second system, ecological classification, which deals with the vegetation of the earth as distinct from its flora, will be considered in the final chapter.

## CHAPTER X

### DIVISION I. THALLOPHYTA: THE THALLUS PLANTS

THIS Division of the Plant Kingdom comprises the lower and simpler, which are also the more ancient and primitive, kinds of plants. They are either Algæ (the seaweeds and their kin), making their own food photosynthetically, or else Fungi (the molds and their kin), taking their food parasitically or saprophytically from other organisms. Some 80,000 species are known, and the group thus comprises one third of all existent kinds of plants.

The plant body in Thallophytes has most diverse forms, being spherical, filamentous, filmy, or frondose; but it never exhibits that differentiation into absorbing root, food-forming leaves, and supporting stems, so distinctive of the higher groups. In size they range from microscopical, in the unicellular kinds, up to gigantic, in some of the coastal seaweeds, the Algæ in general averaging much larger than the Fungi. The Algæ contain chlorophyll, with the associated carotin and xanthophyll (pages 89-90), and often additional pigments. These are usually in CHROMATOPHORES, which are few, or even one, in lower forms, but are small and many (the chloroplasts) in the higher kinds. The Fungi lack them, and take their food in organic form through haustoria or feeding mycelia, as already fully explained (page 82).

The reproduction in Thallophytes is also diverse, being vegetative in various ways, or by fission, or by asexual spores, or by sexual methods, which also involve spores.

Spores, indeed, are the characteristic reproductive bodies of Thallophytes, though they are not confined to that group, but are shared with Bryophytes and Pteridophytes, and can even be traced morphologically in Spermatophytes. A spore is typically a one-celled body capable of growth to a new plant. The purely asexual spores are either ciliate or flagellate, free-swimming, ZOÖSPORES (SWARM SPORES), as developed from vegetative cells of many Algæ and some Fungi (Fig. 213), or else they are smooth round bodies formed in sporangia whence they are scattered by wind, as in Molds (Fig. 214), or they are abstricted in the air from naked hyphæ, as in the CONIDIA of many Fungi (Fig. 319), or they are formed in groups of four, as in the TETRASPORES of the Red Algæ (Fig. 311); and other special kinds occur in particular groups of Algæ and Fungi. Other spores, while themselves asexual, are formed in a regular alternation with sexual reproduction, as in case of the CARPOSPORES of the Red Algæ, and the ASCOSPORES and (originally) the BASIDIOSPORES of the higher Fungi. The word "spore" is also applied to the fertilized cells resulting from sexual fertilization, — ZYGOSPORE when the uniting cells are alike, and OÖSPORE when unlike. The term RESTING SPORE has not a morphological but a physiological connotation, describing any spore which by thick wall and suspended vitality can survive a lengthened period unfavorable for active life. The sexual reproduction of Thallophytes is effected through the union of sex cells, or GAMETES (page 303). These are either alike, when they are called ISOGAMETES, and the resultant fertilized cell is a ZYGOSPORE or ZYGOTE, or else they are unlike, HETEROGAMETES, consisting usually of a smaller SPERM CELL and a larger EGG CELL (page 304), the resultant fertilized cell being called an OÖSPORE. In the lower forms zygospires and oöspores grow directly to new plants, but in the higher kinds, both Algæ and Fungi, they develop into new structures, called CYSTOCARPS, ASCOCARPS, etc., and these produce many true spores, as will later be

noted in detail in connection with the alternation of generations thus introduced into the life cycles of these plants. The Thallophytes never produce anything even remotely resembling the flowers and seeds of the higher plants.

The Thallophytes are disseminated in a great variety of ways, but chiefly by water currents in case of the Algæ, and by wind in case of the Fungi. Spores are so small that they float in the air, and penetrate everywhere, with the dust (page 359); and since many of the resting spores can endure dryness and heat for months or years, we can easily understand how the Fungi, including pathogenic kinds, have become the most ubiquitous of organisms.

In their relations to man's economic interests, the Algæ serve only a few minor uses, but the Fungi are extremely prominent, partly on account of the damage wrought by their parasitism upon crops, and partly because of diseases they cause in man and his domestic animals. The subject has already been treated in brief (page 85), and will receive fuller description in the following pages.

Both Algæ and Fungi fall into groups so related as to imply that the Algæ are the more primitive, and the Fungi have been evolved from them through adoption of the parasitic habit, — their chlorophyll, and most of the sexuality of their reproduction, becoming lost in the process. In various groups of Algæ occur saprophytic and parasitic forms, suggesting the origin of new groups of Fungi; and many Fungi still show plainly their connections with groups of Algæ, though others have lost all external traces thereof, — no doubt because of their very ancient origin and long independent evolution. Parasites and Saprophytes collectively are often called HYSTEROPHYTES.

The Thallophytes fall into ten classes, which are as follows, the Fungi being arranged opposite the Algæ from which they are most probably derived. The student will note the distinction between the terminations *-phyceæ*, meaning Algæ, and *-mycetes*, meaning Fungi.

## CLASSES OF ALGÆ

- CLASS 1. CYANOPHYCEÆ:  
BLUE-GREEN ALGÆ.  
CLASS 3. FLAGELLATA:  
FLAGELLATES.  
CLASS 5. CHLOROPHYCEÆ:  
GREEN ALGÆ.  
CLASS 7. PHÆOPHYCEÆ:  
BROWN ALGÆ.  
CLASS 8. RHODOPHYCEÆ:  
RED ALGÆ.

## CLASSES OF FUNGI

- CLASS 2. SCHIZOMYCETES:  
BACTERIA.  
CLASS 4. MYXOMYCETES:  
SLIME MOLDS.  
CLASS 6. PHYCOMYCETES:  
ALGAL FUNGI.  
CLASS 9. ASCOMYCETES:  
SAC FUNGI.  
CLASS 10. BASIDIOMYCETES:  
BASIDIA FUNGI.

CLASS 1. CYANOPHYCEÆ: THE BLUE-GREEN ALGÆ  
(Myxophyceæ, Schizophyceæ: the Fission Algæ)

These are the simplest of all known plants which form their own food. They show to the eye as the dark bluish-green scums, felts, slimy layers, or gelatinous lumps which occur in sluggish streams, on damp shaded rocks or earth, on logs of old wharves, or wherever organic matter is present in solution. The masses are colonies of microscopic individuals held together by a copious gelatinous secretion from their walls. Some 1200 species are known, very widely distributed over the earth, some living in the water, either attached or floating, some on the land, and some indifferently in either.

Typical forms are pictured in Fig. 276. *Glæocapsa* lives on wet rocks. It consists of a single round simple cell, which reproduces only by division (page 299), though the gelatinous walls of the resultant cells keep them together for a time in loose aggregation. *Oscillatoria* lives submerged in shallow waters, especially such as contain organic matter. Its cells are coin-shaped, and divide in their own planes; and since they remain attached, they form cylindrical filaments. Although a filament is thus only an aggregation of similar cells, it yet acts physiologically as a unit, for it executes oscillatory movements (whence the name) which effect a limited locomotion. *Nostoc* grows both in water

and on wet earth. Its filaments show differentiation between the cells, some of which are empty and of unknown function, called HETEROCYSTS, while others acquire thicker walls and become resistant resting spores, in which state

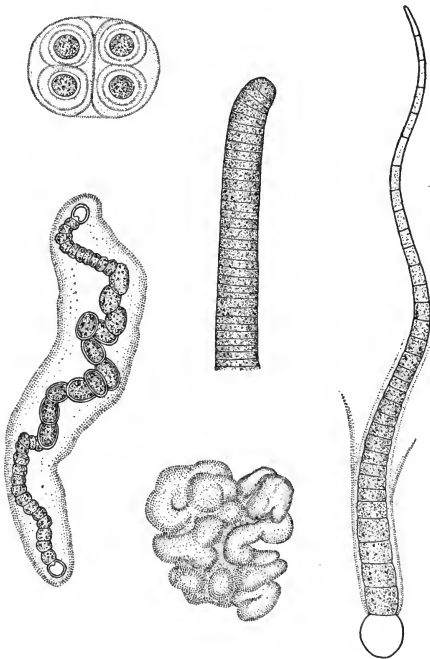

FIG. 276. — Cyanophyceae, typical forms.

Above, left, *Gleocapsa* sp., and below, *Nostoc paludosum*; center, *Oscillatoria principis*; right, *Rivularia bullata*; all  $\times 500$ . Below in center is a colony of *Rivularia*, natural size. (The first from nature, others after Engler and Prantl.)

they are disseminated. These Nostoc filaments are themselves often aggregated together into rounded masses as large as walnuts; and in Europe these are called "fallen stars," from the glistening appearance of their gelatinous envelopes when freshly swollen after a rain. *Rivularia* is a water form showing a structural differentiation of the filament as a whole, for a heterocyst occurs always at one end, while towards the other the cells taper regularly downward in size. These plants also form gelatinous masses, somewhat more specialized in form than in Nostoc, as shown in the figure. Other forms of colonies also occur, some branching, some crudely net-like, and so forth.

In all Cyanophyceae the cells are of the simplest character, showing no clear differentiation of nucleus or chromatophores from the cytoplasm. Their characteristic blue-

and on wet earth. Its filaments show differentiation between the cells, some of which are empty and of unknown function, called HETEROCYSTS, while others acquire thicker walls and become resistant resting spores, in which state they are disseminated. These Nostoc filaments are themselves often aggregated together into rounded masses as large as walnuts; and in Europe these are called "fallen stars," from the glistening appearance of their gelatinous envelopes when freshly swollen after a rain. *Rivularia* is a water form showing a structural differentiation of the filament as a whole, for a heterocyst occurs always at one end, while towards the other the cells taper regularly downward in size. These plants also form gelatinous masses, somewhat more specialized in form than in Nostoc, as shown in the figure. Other forms of colonies also occur, some branching, some crudely net-like, and so forth.



green color, sometimes almost green-black in mass, is due to a special pigment (PHYCOCYANIN), present with the chlorophyll, with which, presumably, it is some way associated in photosynthesis. Occasionally they exhibit other pigments also, especially a red, of which the function is equally obscure. The secretion of gelatinous matter by their walls provides the plants with a firm attachment to the substratum, and also has the advantage of checking excessive desiccation, while permitting rapid re-absorption of water. Thus they are enabled to exist in far dryer and more exposed situations than their naked cells alone could endure, which explains their ability to grow as land plants even in somewhat dry places. They reproduce exclusively by division, without any trace of fertilization or sex, and the filamentous forms are very prone to fragmentation. They spread by movements of water and perhaps wind, without any evident adaptations, aside from the formation of resistant resting cells.

A notable feature of these plants as a whole is their preference for sluggish murky waters, especially such as carry organic matters. They can also endure warm waters, to such a degree indeed that a number of kinds live in hot springs at temperatures above 90° C., — a much greater heat than any other organisms can endure. Some kinds also live as ENDOPHYTES in cavities of larger plants (page 500), and others are associated with Fungi to form Lichens (page 461).

The Cyanophyceæ have no economic importance aside from the fact that some common kinds occasionally impart offensive odor to water supplies, though they are now readily controlled by the regulated use of copper salts. One of this group, *Trichodesmium*, forms an additional reddish pigment and floats as colonies in salt water, thus giving the name to the Red Sea. Other dark green forms which float in fresh water are called in Europe "Water Blooms."

Ecologically the Cyanophyceæ are chiefly hydrophytes, though many can live on the land. Phylogenetically, their

extreme simplicity of cellular structure makes them clearly the simplest of existent independent plants, on which account we must place them at the base of the phylogenetic tree (Fig. 275). This fact, in conjunction with their ability to stand heated and murky waters, implies that they probably represent a survival of forms which were dominant at an early epoch of the earth's history when the temperature was higher and chemical action more vigorous than now. It is possible, indeed, that their blue constituent, phycocyanin, is a survival of a functional precursor of chlorophyll.

## CLASS 2. SCHIZOMYCETES: THE BACTERIA

These are best known through the "germs" or "microbes" associated with deadly diseases, though they also include a multitude of harmless and some economically useful forms, — in all about 1400 species. They are the simplest known organisms, consisting typically each of a single cell, of which the protoplasm is hardly at all differentiated. They are also the smallest known organisms, some spherical kinds being only .0005 millimeter ( $\frac{1}{20000}$  inch) in diameter, which is about the wave length of green light, and hence near the resolving power of the microscope, while still smaller and even ultramicroscopic kinds are known to exist. Despite their apparent structural simplicity and their minuteness, however (possibly, indeed, in consequence of those features), they possess diverse and remarkable physiological powers.

The plant body consists typically of a single cell, which may have any one of a number of shapes, as illustrated in Figure 278. These shapes, indeed, form the basis of the nomenclature of the Bacteria, the spherical kinds being called *coccus* forms, the rod-like, *bacillus* forms, and the spiral, *spirillum* forms, while there are others less common. Many possess fine cilia, or else terminal flagella, the movements of which effect a limited locomotion. No nuclei are visible, though chromatin is present in scattered granules, nor

do the walls ordinarily contain cellulose. They possess no chlorophyll but are almost exclusively parasitic or saprophytic, living thus in a great diversity of situations, — in the bodies of animals and plants, in the soil, in the waters, fresh and salt, and even in the air. They digest their food outside their bodies by action of enzymes which they secrete; and the resultant products are absorbed through the general surface, through which also is taken the oxygen used in their respiration. The conditions of their life bring it often to pass that they cannot respire in the ordinary way, by use of free oxygen (AËROBIC respiration), but must use the oxygen contained in chemical compounds (ANAËROBIC respiration), as occurs conspicuously also in Yeast (page 173). Some anaërobic Bacteria, indeed, are actually injured or killed by contact with free oxygen. In organisms so minute the absorbing surface is so great in proportion to the bulk of the living protoplasm that a far higher respiratory and other chemical activity is possible than in larger plants; and thus in some part is explained their remarkable powers. They secrete gelatinous material very copiously from their simple membranous walls. Their reproduction is wholly by fission, each cell dividing across its middle, and often so rapidly that two divisions occur in an hour; and millions of individuals may arise from one in a single day. Nothing resembling fertilization or sex has been found.

In some kinds the new cells separate immediately after division; in others they remain attached in more or less fragile filaments; and very commonly they become embedded in a copious gelatinous matrix secreted by their walls, whereby they grow into distinctly visible colonies (Fig. 277). The same species, indeed, may appear in one or the other of these states according to the external conditions. In this gelatinous, or so-called ZOËGLËA state, many colonies possess characteristic forms and colors, whereby the species may be identified. This feature is the basis of one of the most important methods of technical Bacteriology, viz. —

the cultivation of such colonies artificially upon nutrient gelatine as an aid to the identification of the species.

Bacteria are spread in diverse ways, partly by free locomotion, partly by movements of the animals with which they are associated, partly by water currents, and partly by winds. This latter method becomes possible through the

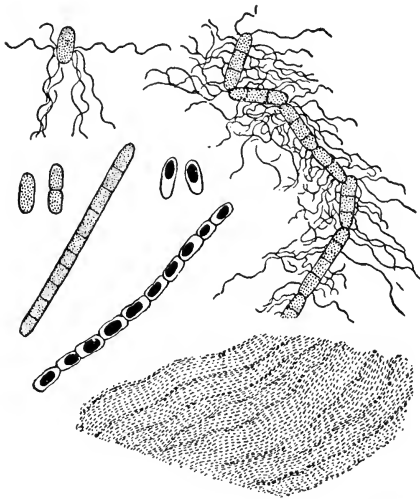

FIG. 277.—The Hay Bacillus, *Bacillus subtilis*, in diverse states.

The ciliate forms are motile, and the smooth are non-motile, while the spores are shown black; all  $\times 1500$ . Below is the zoöglöea;  $\times 250$ . (From Fischer.)

formation from the protoplasm in single cells, when conditions of life become unfavorable, of very thick-walled resting spores (Fig. 277), so resistant that in some cases they can withstand boiling water for hours, and so persistent in vitality as to remain alive for months or years. With these characteristics, and a minuteness such that the spores float with the dust in the air (page 360), it is little wonder that Bacteria penetrate into all kinds of situations. In case of some parasitic kinds the spores are released for dissemination only on the death of the host; and it is possible that the production of the poisons which produce the host's death has this adaptive significance.

The Bacteria have most intimate and important relations with man's economic interests, from which point of view we may group them as follows:

*Decay Bacteria.* These are typical saprophytes, and the cause of nearly all organic decay. Thus the Hay Bacillus

(Fig. 277) appears always in hay which has been boiled and left standing, the resting spores being resistant to boiling water; it is the principal agent in the subsequent decay, or rotting, of the hay. The chief of the putrefactive Bacteria is *Bacillus vulgaris* (Fig. 278), which produces decay in meat with release of very offensive gases; and this form, likewise, is able to exist in a variety of forms under diverse conditions. The poisonous ptomaines, found at times in imperfectly preserved foods, are a product of decay Bacteria. Certain definite forms, notably *Spirochæte dentium*, are associated with the decay of the teeth. And many others occur, in all kinds of substances. The decay of complex materials, like flesh, involves several kinds of Bacteria, one kind reducing the substance to simpler and less highly energized materials, others reducing these to still simpler, and so on, until in successive stages even the most complicated materials become reduced back to the original carbon dioxide, water, nitrogen, and mineral substances from which they were originally formed. Such action is obviously beneficial in organic nature as a whole, since it prevents a continuous accumulation of the remains of plants and animals, and restores their substance to the general circulation for renewed use. Conversely, when the activity of decay Bacteria is checked, organic substances do accumulate, as illustrated by the growth of peat bogs, which contain bactericidal substances. Our methods of preserving fruits and meat depend upon inhibition of bacterial activity.

*Fermentation Bacteria.* These produce several forms of fermentation, though not the alcoholic kind, which is effected mainly by Yeasts (page 169). The fermentation Bacteria oxidize various substances to organic acids, thus producing a souring. *Bacterium aceti* (Fig. 278) produces acetic acid from alcohol, thereby converting fermented cider to vinegar. Another produces the lactic acid which makes milk sour. Another produces butyric acid in butter, turning it rancid. Others produce in like manner special flavors and odors

in ripening cheeses, while yet others are concerned in the ripening of stored tobacco. In all these cases the changes are preventable by conditions which inhibit the activity of the Bacteria, — a low temperature being one.

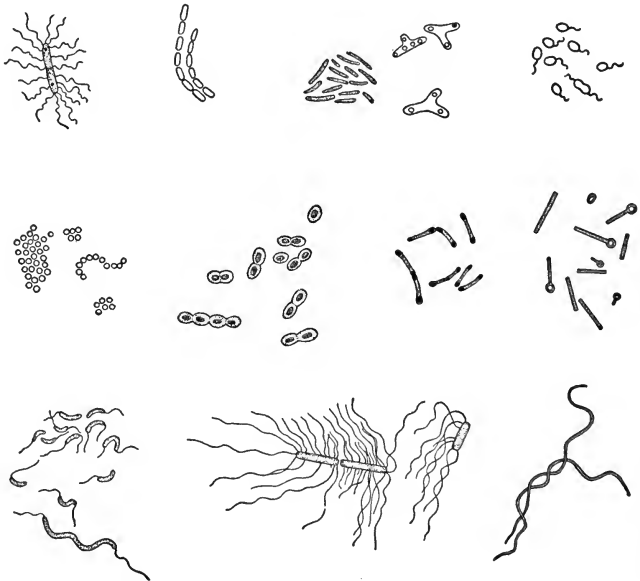

FIG. 278. — Typical and important economic forms of Bacteria; all magnified 1000.

Upper row, *Bacillus vulgaris*, putrefactive, in proteins (meat); *Bacterium aceti*, fermentative, alcohol to vinegar; *Bacillus radicolica*, nitrogen-fixing, in tubercles of Leguminosæ, shown in active condition, and as swollen and distorted to bacteroids; *Pseudomonas europæa*, nitrifying, in soil.

Second row, pathogenic forms; *Coccus* forms, of pus; *Pneumococcus*, of pneumonia; *Bacillus*, of diphtheria; *Bacillus*, of tetanus (lockjaw), with spores.

Third row, also pathogenic; *Spirillum*, of cholera; *Bacillus*, of typhoid; *Spirochæte*, of relapsing fever. (Drawn from various sources, the pathogenic forms from microphotographs by Muir and Ritchie.)

*Disease Bacteria.* These cause most of the worst diseases in animals including man. They are typically parasites, living in the tissues or blood of their hosts, where they produce injury and death. They have diverse forms, often recognizably characteristic (Fig. 278). They produce their

disastrous results partly by direct destruction of tissues (*e.g.* in tuberculosis), but in far greater degree by the development, as by-products of their own metabolism, of substances, called TOXINS, which are poisonous to the host. Prominent among the diseases thus caused are Diphtheria, Lockjaw, Typhoid Fever, and Cholera, and there are several others. Plants, too, are subject to bacterial diseases, exemplified by Rots and Blights in cabbage, potato, and pears, and by the Crown Gall, accompanied by tumor-like swellings, in some common herbaceous plants. On the other hand, not all deadly diseases are bacterial, for a few, notably Yellow Fever and Malaria, are caused by animal parasites transferred by mosquitoes; while Infantile Paralysis is probably caused by another minute animal germ. Furthermore, some diseases are due to physiological disturbance, or to other still unknown causes (pages 368-9).

The ravages of bacterial diseases have naturally stimulated the exhaustive study of these organisms themselves, and encouraged the invention of methods for prevention and cure. So elaborate, indeed, has become this technique that the subject is now a special science, called *Bacteriology*. Preventive methods are based mainly upon quarantine and sterilization, while curative methods rest chiefly on the principle of neutralizing the toxins the Bacteria form. The animal body has a wonderful power of forming substances, called ANTITOXINS, which render the toxins harmless; and if, in bacterial disease, the antitoxins are made by the body as fast as toxins by the Bacteria, the disease is assuaged and the patient recovers. These antitoxins once made, sometimes long persist, thus rendering the patient immune to that disease. Furthermore, it is possible to transfer the antitoxins from the bodies of patients, including other animals which have had the disease, to a patient afflicted therewith; and this is the principle of the method of combating diphtheria by antitoxins obtained from horses which have purposely been inoculated with the disease. It is also

possible to cause the formation of the antitoxins in advance, so to speak, by giving the patient an allied but less harmful disease; and such is the principle of vaccination against smallpox.

*Nitrogen-conserving Bacteria* live in the soil, and produce effects immensely important in agriculture (page 244). Some kinds take the ammonia abundantly set free by decay Bacteria, and effect its transformation to nitrates, most important of all fertilizers. Others do more, for they absorb free nitrogen from the air, and fix it in compounds utilizable by the higher plants, which are not able to use the free gas; and these are the forms which are colonized in the familiar tubercles of the Leguminosæ (page 245). For the most part these Bacteria are saprophytic, depending for their food upon the humus in the soil, but a few are independent forms, able to construct their own food from carbon dioxide and water, using the energy of chemical oxidations instead of the power of sunlight (page 87). Such a *chemosynthetic* mode of food formation suggests a method by which organisms may have existed before chlorophyll was developed.

Other kinds of Bacteria are prominent in various ways. One species contains a purple coloring matter, which seems to enable its possessors to make food photosynthetically. Others develop much heat through intense respiration, and this is the way fermenting manures become warmed, and can be utilized in hotbeds. Another kind is phosphorescent, while others set free the mixture of gases which originates the "will-o'-the-wisp." The gelatinous colonies of another kind become blood red on milk or bread, and formed the basis of the "bleeding host" of the Middle Ages. Others can decompose compounds of sulphur or of iron. Then it must not be forgotten that hundreds of kinds produce no prominent observable effects, but, from man's point of view, are harmless and obscure, as in case of the several dozens which live in the alimentary canal. No matter what the



consequences to man or other organisms, the significance of their actions is always the same to the Bacteria themselves. When they break up the chemically complex organic substances on which they live, and draw therefrom the materials they need in their own growth and respiration, the remnants of those substances fall naturally, according to chemical affinities, into diverse materials, which, together with the excretions of the Bacteria themselves, happen to have properties injurious or beneficial, offensive or agreeable, to other organisms, including mankind. The details depend partly upon the Bacteria, and partly on the nature of the substances concerned.

Ecologically the Bacteria are typical parasites and saprophytes. Phylogenetically, their simplicity of structure, reproduction only by division, formation of gelatinous colonies, and ability to withstand extreme conditions, relate them very obviously to the Cyanophyceæ, of which they seem to represent a specialized offshoot. On the other hand, the Bacteria are simpler than the Cyanophyceæ in some features which appear primitive rather than degenerative, notably, the retention of physiological individuality in the individual cells rather than the colony, and the chemosynthetic habit of some of their members. These facts suggest that the Bacteria may have preceded the Cyanophyceæ in time, developing from chemosynthetic forms which lived prior to the development of phycocyanin or chlorophyll.

While the Bacteria proper exhibit colonial development



FIG. 279. — *Chondromyces crocatus*, a typical form of Myxobacteriaceæ;  $\times 50$ . The structure is a colony, in which the very minute individual Bacteria are embedded in gelatinous material. They form spores in the terminal heads or cysts. (From Thaxter.)

only in low degree, there is one special small group, called *Myxobacteriaceæ*, probably developed from Bacteria, in which the colony is somewhat highly developed, as illustrated in the typical form herewith pictured (Fig. 279).

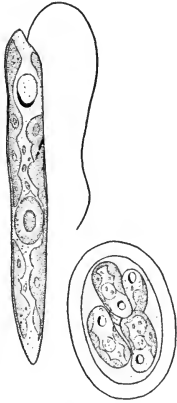

FIG. 280. — *Euglena gracilis*;  $\times$  600.

Above is an adult individual, showing the very thin wall, the nucleus with nucleolus, the cytoplasm, the elongated chloroplasts, the crescent-shaped red pigment spot (black), and, just above the latter, the contractile vacuole. The form pictured is usual, but like most Flagellates *Euglena* readily changes its shape and that of its interior parts. Below is shown the germination of a resting spore. (After Zumbstein.)

### CLASS 3. FLAGELLATA: THE FLAGELLATES

These are minute free-swimming organisms of fresh water, oftenest seen when material from ponds is under the microscope. Over 300 species are known.

A typical form is *Euglena gracilis*, represented in Figure 280. The slender-elongated unicellular body, free swimming by aid of the terminal long flagellum, contains nucleus, large chloroplasts, a vacuole which is contractile, and a red pigment spot (or "eye-spot") which is sensitive to light, toward which the *Euglena* ordinarily swims. It reproduces by longitudinal fission, but no sexual reproduction is yet known. In autumn it forms a thick-walled resting spore which lasts over winter and germinates in the spring, each spore (in this case) producing four new plants. While *Euglena* is ordinarily independent, making its own food photosynthetically, it can also exist in organic solutions as a saprophyte, under which condition it loses its chlorophyll. The case is of interest as showing how readily the saprophytic may originate from the independent habit.

While Flagellates are typically unicellular, they often form gelatinous colonies, which are either globular and free floating, or attached and variously branched. Sometimes the

forms are elaborate and ornate, and many of the free kinds exhibit elongated projections of diverse sorts. Many of them change their forms readily in the manner of the animal *Amœba*. One of the floating colonies, *Uroglena*, rises to economic importance because of the disagreeable oily odor and taste which it imparts to water supplies when the plants are killed and broken against the walls of the pipes.

A distinctive feature of the Flagellates is the obvious relationship between them and the simple animals. Not only do they possess distinctly animal characteristics in their active locomotion, amœboid movements, contractile vacuoles, and red pigment spots (the possession of chlorophyll and the formation of thick-walled resting spores being their plant characteristics), but they also exhibit perfect gradations to the ciliate Infusoria, which are unquestioned animals. They represent a group, indeed, which is neither plant nor animal, but intermediate, forming a bridge, as it were, between the two kingdoms.

Ecologically the Flagellates are mostly free-swimming micro-hydrophytes. Phylogenetically they are low in the scale of evolution, and their obvious rela-

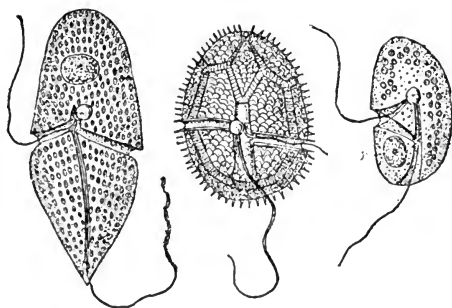

FIG. 281.—Typical forms of the *Peridinea*;  $\times$  about 500.

The presence of two cilia in grooves at right angles is characteristic. (From Van Tieghem.)

tion to animals suggests that they are a survival from an ancient group which gave origin to the Green Algae in one direction and to the Protozoa, which are animals, in the other (Fig. 275). Their relations to the Cyanophyceae are entirely uncertain.

Allied to the Flagellates, probably as a specialized offshoot, is the interesting group of the *Peridineæ* or *Dinoflagellata*, of which some 150 species exist, mostly free floating in the sea. Typical forms are pictured herewith (Fig. 281). They are unicellular, possess large brownish-yellow chromatophores, and exhibit remarkable forms, with walls composed often of beautifully sculptured cellulose plates, suggestive of the Desmids and Diatoms later to be considered. Some are luminous when disturbed, and help produce the well-known phosphorescence of the sea. The very highest forms have a simple sexual reproduction.

#### CLASS 4. MYXOMYCETES: THE SLIME-MOLDS, OR SLIME-FUNGI

(Mycetozoa: Fungus-animals)

These are the slimy, filmy, mold-like masses, of visible, and often considerable, size, which live in damp shaded places, and creep over rotting wood, decaying leaves, humus soil, etc. Later they become converted into spore cases which are often elaborate and beautiful. Over 400 species are known.

The ordinary plant body, called the PLASMODIUM, is a mass of protoplasm, much like white of egg in consistency, lacking walls but containing many nuclei. In some species it is compact in form and a few millimeters in diameter; in others it is a loose open network, as pictured herewith from a typical example (Fig. 282, compare also page 39); in yet others it forms an irregular film or sheet several inches across. The lack of walls and the relatively great size of these plasmodia render them favorite subjects for investigations upon the characteristics of protoplasm. In color they are typically white or yellowish, but are also pink, violet, and other tints, though they never display the green of chlorophyll. Ordinarily the plasmodium lives upon some damp organic substratum upon which it feeds saprophytically, often ingesting, like an animal, solid pieces of substance from which it later digests the nutritive materials. Commonly it ex-

hibits active streaming and other movements, whereby it creeps over the substratum like an animal, *e.g.* the Amœba. It becomes quiescent in times of dryness, and renews its activity during humid intervals. Ordinarily it keeps away from light, and hence lurks in crevices, or under damp objects. But when about to produce spores, the plasmodium moves out from the shelter, rises to the summit of the object beneath which it formerly lay, and there proceeds to convert its entire substance into sporangia, one or a cluster, containing asexual spores. The sporangia, easily visible to the naked eye, have usually a supporting stalk, a firm wall, and an interior lacy-delicate framework, called the CAPILLITIUM (Fig. 283). This capillitium, by its swelling and hygroscopic movements, pushes out the spores, which are then removed by the wind. It differs greatly in form in the different species, and often, like the sporangium wall, is brilliantly colored. Thus the sporangia exhibit a diversity and beauty of which the plasmodia contain little suggestion. In the formation of the spores occur certain nuclear fusions which suggest fertilization, the lowest traces thereof known among plants.

The spores possess thick cellulose walls, and are true resting spores. After dissemination, they germinate in water and form unicellular free-swimming swarm spores, which recall the Flagellates. They swim about freely for a time, living saprophytically; then they come to rest and form amœba-like bodies, which multiply by fission. Ultimately they creep together in groups, and these into larger groups, until



FIG. 282.—Plasmodium of a Myxomycete;  $\times \frac{3}{4}$ .  
The flower pot stood in a damp shaded pit. (Drawn from a photograph.)

they form a new plasmodium. Morphologically, therefore, the plasmodium is a kind of colony, in which the individuality of the original members has become completely merged. The plasmodia reproduce also in other minor ways, notably from separable hard fragments, or SCLEROTIA, which, on access of water, produce new plasmodia. The most striking of

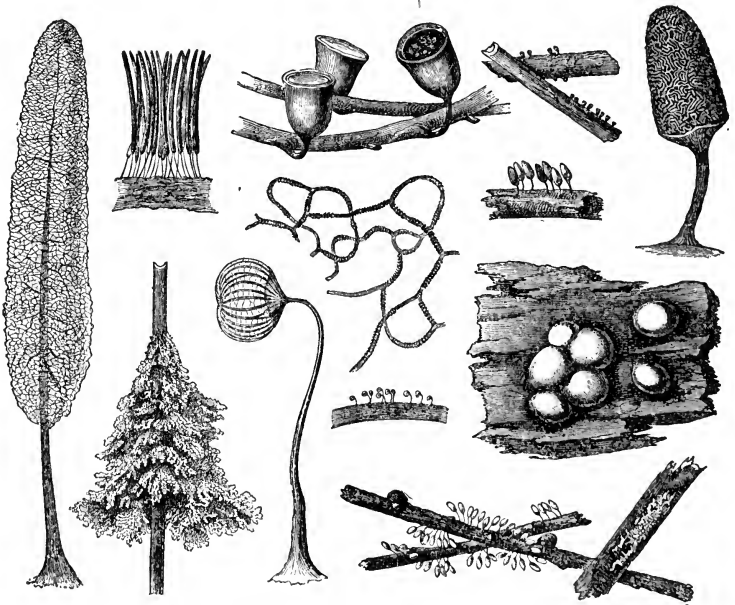

FIG. 283.—Sporangia and capillitia of various Myxomycetes; the smaller are somewhat less than natural size. (From Kerner.)

all the Myxomycetes, in regard at least to its plasmodium, is *Æthaliium septicum*. Its favorite home is old tan bark (whence its name "flowers of tan"), and its yellowish slimy plasmodium often reaches a foot in diameter, though the spore formation is inconspicuous. Mostly the group has no particular economic relations to man's interests, but one parasitic form produces the damaging "club root" of cabbage.

The Myxomycetes exhibit relations to animals so close that some biologists have placed them in that group, and this position is expressed in one of their names (Mycetozoa: "the Fungus-animals"). The free locomotion of their amœboid plasmodia, and the ingestion of solid food, are animal characteristics, but their elaborate sporangia and cellulose-walled spores are wholly plant-like.

Ecologically the Myxomycetes are free-moving saprophytes. Phylogenetically, they show closest affinities with the Flagellates, of which they perhaps represent a highly specialized and peculiar colonial development; and thus we tentatively rank them (Fig. 275). It is not impossible, however, that the colonial habit is primitive, the subdivision into unicellular members being subsequent.

#### CLASS 5. CHLOROPHYCEÆ: THE GREEN ALGÆ

These comprise the Algæ of bright or grass green color, both microscopic and large. They live mostly in fresh water, or in damp shaded places on the land, though a few are marine. Some 9000 species are known, but none are economically important.

The Green Algæ are most diverse in size, form, and habit, as will appear under the different orders. Those of fresh water, especially, present a variety and beauty which, in conjunction with their ease of collection, has made them always very favorite subjects of study by those who are moved by the genuine spirit of the naturalist. All in common possess well-differentiated cells containing bright green chloroplasts wherein they synthesize their food. Their reproduction is likewise diverse, but most of them possess small free-swimming asexual zoöspores which produce new individuals directly. Usually, also, they possess sexual gametes. These are sometimes alike (ISOGAMOUS), and smaller than the zoöspores which they superficially resemble; and on conjugation they produce zygospores. In higher forms the gametes are unlike (HETEROGAMOUS) and ulti-

mately become differentiated into egg cells and sperm cells, which are formed in structures called respectively OÖGONIA and ANTHERIDIA. On fertilization, oöspores, which are usually resting spores, are formed. These Algæ spread partly by their own locomotive powers, and partly by diverse incidents of water movement, without special adaptations. They comprise five orders, —

ORDER 1. *PROTOCOCCALES: THE UNICELLULAR GREEN ALGÆ.*

ORDER 2. *CONFERVALES: THE CONFEROID ALGÆ.*

ORDER 3. *CONJUGALES: THE CONJUGATE ALGÆ.*

ORDER 4. *SIPHONALES: THE TUBULAR ALGÆ.*

ORDER 5. *CHARALES: THE STONEWORTS.*

ORDER 1. *PROTOCOCCALES: THE UNICELLULAR GREEN ALGÆ.* These are mostly microscopic forms dwelling in fresh water or on land. Some are free-swimming by cilia or flagella in the same animal-like manner as the Flagellates, while others drift passively with the currents or remain fixed by their gelatinous walls to rocks, not only in water, but in damp shaded places on the land.

A typical motile form is *Chlamydomonas*, common in fresh water (Fig. 284). The single cell contains a large cup-shaped chloroplast, in which is a protein body, the PYRENOID, commonly surrounded by starch grains, with the formation of which it has something to do. A nucleus, red pigment spot, and contractile vacuoles are also present, while locomotion is effected by large terminal cilia, — the whole arrangement recalling the Flagellates. It reproduces by longitudinal fission and by formation of zoöspores, which are miniatures of the parent and have only to enlarge. This resemblance between the zoöspores of Algæ and the adult Flagellates holds true throughout the group. Other cells produce gametes which conjugate in pairs to form resting zygospores, whence later grow new plants. In certain species a bright red pigment, of unknown function, produces a striking appearance in mass; and plants of this group (*Chlamydomonas nivalis*), readily carried by the wind, produce the "red snow"



described by arctic and alpine travelers. Other kinds sometimes reproduce in such numbers as to form greenish clouds in clear fresh water. Here also belongs *Protosiphon* (page 303).

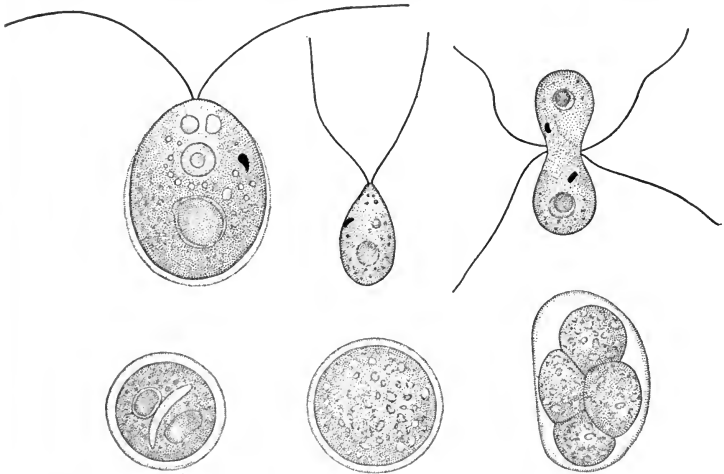

FIG. 284.—*Chlamydomonas Reinhardi*; showing sexual reproduction;  $\times 750$ .

Above, left, adult individual; next, one of the isogametes; right, two gametes in conjugation. The black spot is the red eye spot. Below, young zygospore, the gametes not fully fused; next, ripe zygospore; right, germination of the zygospore into four new individuals. (After Goroschankin.)

The most prominent and familiar of the non-motile kinds is *Pleurococcus*, which forms the bright green coating, often resembling remnants of green paint, on old shaded tree trunks, stones, flowerpots, and earth. The plant body is a single spherical cell (Fig. 285) with a large chromatophore. It reproduces, so far as known, only by fission, the new cells remaining for a time irregularly in contact with the older, to which, as to the substratum, they are bound by the

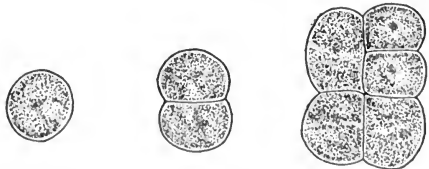

FIG. 285.—*Pleurococcus vulgaris*, from a tree trunk, showing division;  $\times 1000$ .

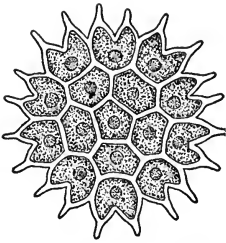

FIG. 286.—*Pediastrum* species;  $\times 300$ .

(Drawn from a micro-  
photograph by Haeckel.)

usual gelatinous material. This material prevents too great desiccation, and also permits rapid absorption of water when available; and thus this plant can live in markedly dry places. In general structure and mode of reproduction it resembles *Glæocapsa* (Fig. 276), but shows higher evolutionary grade in its distinctly differentiated chromatophore and nucleus, while related kinds produce motile swarm spores and gametes. Numerous other forms nearly as simple occur, some of which are symbiotic in habit. Several of the species enter into the composition of Lichens (page 461), and one small form (*Chlorella vulgaris*) lives in the tissues of some lower animals, especially fresh-water Sponges and the Hydra, to which it imparts the green color.

While typically unicellular and separate, some members of this order form colonies containing many individuals. Certain ones lack cilia, and merely drift with the current, as in case of the beautiful *Pediastrum* (Fig. 286). Much larger is the remarkable Water-net or *Hydrodictyon* (Fig. 287), of which the cylindrical colonies, comprising thousands of cells and sometimes attaining a length of a meter, float freely in quiet ponds, with one end buoyed up to the surface by bubbles of oxygen caught in the interior. The net originates within a parent cell by the formation of great numbers of zoöspores, which arrange themselves

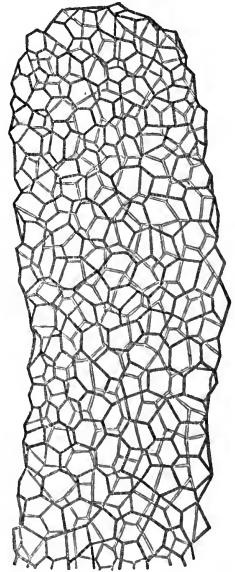

FIG. 287.—The Water-net, *Hydrodictyon ulriculosum*;  $\times \frac{1}{2}$ . (After Kerner.)

against the wall in regular order, grow together at points of contact, and then elongate between those points. When set free by decay of the wall, the cells of the nets, and therefore the nets themselves, increase immensely in size. These plants reproduce sexually by conjugation of gametes formed in great numbers by special cells. The zygospores rest for a time, then produce small nets, from the cells of which large ones later develop.

The motile colonial forms, of which there are several, reach their perfection in the beautiful *Volvox* (Fig. 288). In this remarkable plant, the cells, each retaining its two cilia, form a hollow gelatinous sphere, composed often of thousands of individuals, and as large as a pin head. In this condition it can be seen rolling slowly through the water in clear ponds, or occasionally in tanks in greenhouses. The microscope shows that the individuals are connected by protoplasmic threads extending through the gelatinous matrix. This arrangement is not found lower among plants, but prevails in the higher kinds (page 40), on which

account the *Volvox* might be considered a multicellular individual, rather than a colony. At first the cells are all alike, but later some enlarge and enter the cavity, where they form new colonies which are ultimately set free by

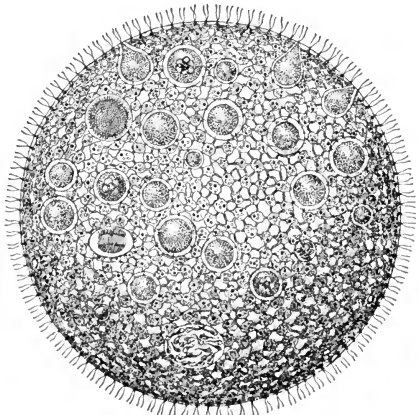

FIG. 288.—*Volvox Globator*;  $\times 125$ .

The smaller irregular cells are the vegetative individuals, each with two cilia; the larger round or pear-shaped cells are egg cells in various stages of development; and three other large cells contain sperm cells in their radiate, parallel, and free stages, the latter just prior to their escape into the cavity of the colony. (After a wall chart by Dodel-Port.)

decay of the parent. Other cells enlarge and produce egg cells or sperm cells, and fertilization occurs inside the cavity. Thus are produced rough-walled resting oöspores, which later germinate to new plants.

Ecologically the Protopoccales are typical micro-hydrophytes, either swimming, drifting, or adherent; and the latter can also exist on the land. Phylogenetically, they are very closely and obviously related to the Flagellates, from which they seem clearly derived, — the non-motile forms being developed from the motile by loss of the cilia.

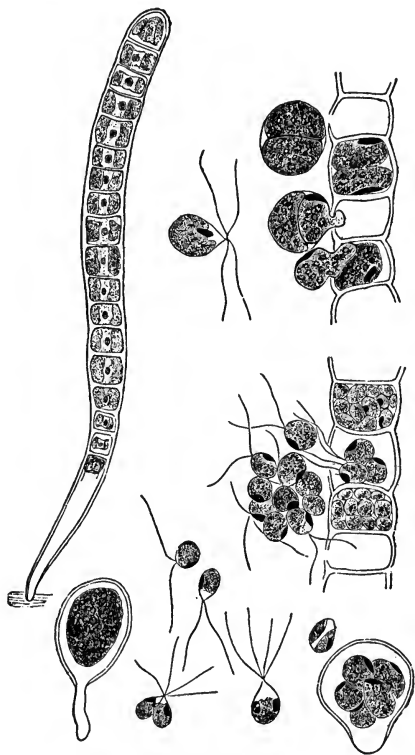

FIG. 289. — *Ulothrix zonata*.

Left, young filament,  $\times 300$ . Right, above, part of a filament showing escaping zoöspores, and below, another part showing escaping gametes, with stages in conjugation, and zygospores; lower, left, zygospore in later stage, and right, after division into zoöspores; all  $\times 482$ . (After Dodel-Port, from Strasburger.)

**ORDER 2. CONFERVALES: THE CONFEROID ALGÆ.** These are the largest and most familiar of the Green Algæ, including the hair-like and moss-like kinds of fresh water, and filmy forms of the sea coasts. Some 750 species are known,

but none have economic importance.

Typical of the simpler forms is the common *Ulothrix* (Fig. 289), which is one of the kinds forming dense, pilose,

bright green growths on the stones of sluggish streams, ponds, troughs, and fountains. The plant body is a filament, 2 or 3 centimeters long, attached by a colorless basal cell; the other cells, all alike, contain each an encircling chloroplastid. Asexual reproduction is effected through zoöspores, which are small and four-ciliate, and formed several together in any cell. After swimming about for a time they come to rest and produce new filaments. Some cells produce gametes, which look much like the zoöspores but are smaller and two-ciliate; they conjugate in pairs, and the resultant resting zygosporangia germinate to several zoöspores which grow to new filaments. This formation of zoöspores instead of a new plant directly, an arrangement already described in *Chlamydomonas* (page 417), has apparently the advantage of developing several plants from one act of fertilization, and anticipates an analogous method prevalent in higher plants. Certain species of *Ulothrix* produce not only zoöspores and gametes, but also intermediate bodies which



FIG. 290. — *Cladophora* species;  $\times \frac{1}{2}$ . (From Oltmanns, *Morphologie und Biologie der Algen.*)

can germinate to new filaments either with or without conjugation; and this fact supplies a certain confirmation of a conclusion probable upon other grounds, that gametes originated from zoöspores in which the first fusion was accidental.

While in *Ulothrix* the filament is short and unbranched, in *Cladophora* it is long and profusely branched, whereby are formed those long, waving, bright green, hair-like masses which, attached by one end to the bottom, wave back and forth in slow-moving streams (Fig. 290). In the Sea Lettuce (Fig. 291), an Alga common near low-tide mark on our sea coasts, the plant body is a filmy, crinkled, bright green thallus.

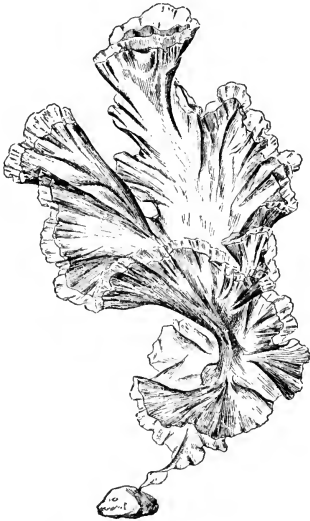

FIG. 291. — *Ulva Lactuca (latis-sima)*, the Sea Lettuce;  $\times \frac{2}{3}$ .

The frond is colored bright green, and is only two cell layers thick. (After Thuret from Oltmanns.)

*Conferva*, another slender form of fresh water, has zoöspores with cilia of unequal length, and is now placed, with other forms displaying the same peculiarity, in a separate class called *Heterocontæ*. Some of this group are epiphytic land plants in the tropics.

A marked advance in the mechanism of reproduction occurs in *Ædogonium*, a form much like *Ulothrix* in aspect and habit. Here the zoöspore, which is provided with a crown of cilia, is very large (Fig. 292), for it is composed of the undivided protoplasm of a cell. In sexual reproduction, certain cells of the filament enlarge and become each an OÖGONIUM, the contents forming a single huge egg cell.

The sperm cells, formed in smaller cells of a filament, resemble the zoöspores in miniature. In fertilization, one of them enters the oögonium through a special opening, and unites with the egg cell, the accompanying phenomena being identical with those of fertilization in the higher plants; and thus is produced a thick-walled resting spore which ultimately germinates to zoöspores, as in case of *Ulothrix*. In some species both kinds of sex cells arise on the same

plants, but in others upon different ones, in which case we may speak of male and female plants. Furthermore, in some species the male plants, here very small, actually develop upon the oögonia of the female plants (Fig. 292), and release their sperm cells in close contiguity to the openings into the egg cells.

A more elaborate development of the plant body is found in the gracefully branched *Chatophoraceæ*. The culmination of the reproductive mechanism occurs in *Coleochate*, a group of small disk-shaped forms which grow attached to water plants (Fig. 293). Reproduction occurs through zoöspores, but also sexually with formation of an oöspore as in *Edogonium*. Two interesting new features, however, appear. First, an enveloping case of cells develops around the oöspore from the subjacent tissue, — an arrangement which becomes frequent in higher Algæ. Second, the oöspore, a resting spore, produces not a new plant directly, but a structure of several cells, each of which gives rise to a zoöspore; and these grow to new plants. Thus we have a new structural stage introduced between fertilization and the formation of new plants, an arrangement anticipated in *Ulothrix*, and itself anticipatory of the regular alternation of generations in higher plants. For this and other reasons, some authorities hold that *Coleochate* stands very close to the ancestral Algæ from which the first land plants were evolved.



FIG. 292. — *Edogonium*, sexual reproduction;  $\times 300$ .

Above, *E. nodulosum*; portion of a filament showing a ripe oögonium, with opening entered by the sperm cell; below the oögonium are the small antheridial cells, from each of which escape two sperm cells, shown just to the right. Above is a zoöspore. (After Bergen and Davis.)

Below, *E. ciliatum*; an oögonium, with attached male plant, from the antheridium of which a sperm cell has passed into the egg cell. (After Pringsheim.)

Ecologically the Confervales are typical sedentary filamentous hydrophytes. Phylogenetically the lower forms seem clearly related to Protococcales, and were no doubt evolved therefrom. The higher kinds presumably gave

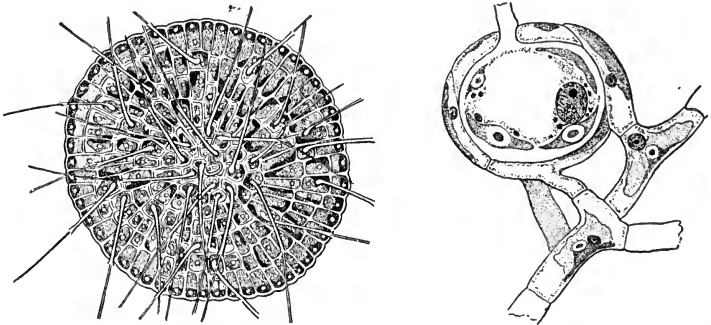

FIG. 293. — *Coleochaete scutata*.

Left, a plant, disk-shaped, seen from above,  $\times 50$ ; right, an oospore in germination, showing formation of the enveloping case,  $\times 500$ . (From Oltmanns.)

origin to the Bryophytes as shown in our phylogenetic tree (Fig. 275).

**ORDER 3. CONJUGALES (ZYGOPHYCEÆ): THE CONJUGATING ALGÆ.** These are unicellular or filamentous floating forms, mostly microscopic but often conspicuous in mass. They are notable for the remarkably diverse and symmetrical elaboration of the chloroplasts and walls, on which account they are beautiful and ever-favorite objects of study with the microscope. Though diverse in certain of their characteristics, to such a degree that not all authorities include them in one class, they are brought into one group by their principal method of sexual reproduction, viz., the conjugation of the contents of two cells to form a zygospore, from which later arises a single new plant. The process obviously represents a very simple, perhaps a simplified, form of sexual reproduction. They comprise three groups, (1) the filamentous *Zygnemaceæ* or Pond Scums, (2) the elaborate unicellular Desmids, and (3) the equally elaborate Diatoms.



*Zygnemaceæ: the Pond Scums.* These are very slender filamentous plants, which are sometimes attached on the bottoms of shallow ponds, but ordinarily float felted together in great numbers on the surface, where the bright green masses are buoyed up by bubbles of gas, which is mostly oxygen set free in their photosynthesis. They are characteristically slippery to the touch because of a gelatinous secretion of the walls. The commonest form is *Spirogyra* (Fig. 294). Its filaments consist of similar, cylindrical, smooth-walled cells which exhibit a remarkable specialization in their contents; for the bright green chromatophores form elaborate crenated spiral bands, beaded, as it were, here and there with pyrenoids.

*Zygnema*, another genus, possesses not a spiral, but two star-shaped chromatophores. The cells multiply in the filaments by cross division. Especially distinctive is the sexual reproduction. In a typical case (Fig. 294), the

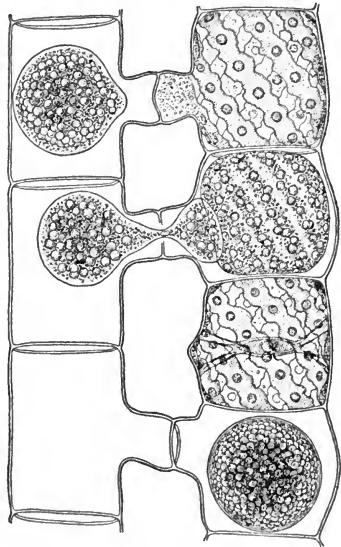

FIG. 294. — *Spirogyra* species;  $\times 300$ .

The cells of the filament on the left show successive stages in conjugation with the filament on the right, which has one cell in the vegetative condition, and one with a fully formed zygospore. (From a wall chart by L. Kny.)

walls of cells in neighboring filaments grow out towards one another in tubular projections; where they meet, an opening is formed, through which the protoplasm of one cell passes by amœboid movement into the other; then the two protoplasts fuse together, and develop a thick cellulose wall, producing a resting zygospore which is later set free by decay of the filament. In some

forms the contents of both cells move into the projections, and conjugate midway between the filaments; and in other kinds two adjoining cells of the same filament conjugate. These conjugation tubes reappear in higher Algæ, and are common in the Fungi; and they anticipate the pollen tube of the flowering plants. The Pond Scums spread by various incidents of water movement, without special adaptations, aside from formation of resting spores. Some 300 species are known, but none have economic importance.

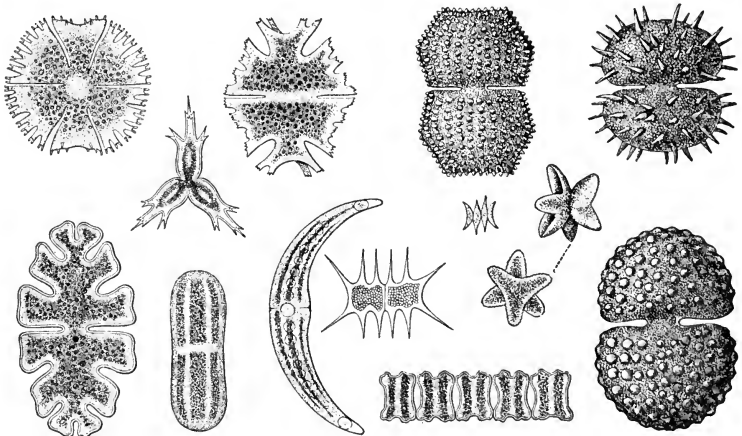

FIG. 295. — Desmids, of various forms;  $\times 200$ . (From Kerner.)

*Desmidiaceæ: the Desmids.* These are chiefly unicellular floating plants of fresh water, notable for their beautifully symmetrical, diversely shaped, and highly sculptured cellulose walls (Fig. 295). They live mostly around the margins and bottoms of ponds, sometimes attached by the abundant jelly secreted from their walls; and they are familiar in all material drawn from such sources for examination by the microscope. A characteristic feature is their duplicate symmetry, for the cell consists of two similar halves, related like an object and its mirror image, spreading from a mid-zone, usually constricted, in which lies

the nucleus. Their large green chromatophores are often compound and elaborate. They reproduce chiefly by division, the two halves separating at the constriction and each regenerating the missing part. The sexual reproduction occurs solely by conjugation. In course thereof, two cells come together and surround themselves with a gelatinous envelope, within which they leave their firm walls, move together, and fuse, forming thick-walled resting zygospores which are often themselves elaborately decorated. They

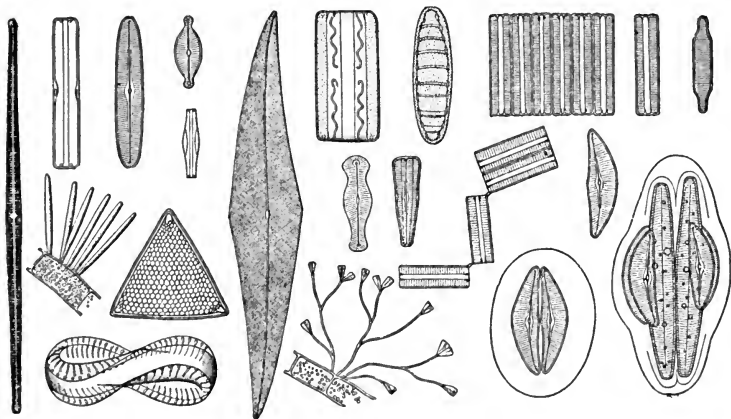

FIG. 296. — Diatoms, of various forms;  $\times 50-300$ .

The pairs, of identical length, represent in each instance the face and profile views of the same individual. (From Kerner.)

have power of limited locomotion, by aid of projecting threads worked against the ground, but are spread chiefly by incidental movements of the water. Some 1000 species are known, but none have economic importance, unless their beauty be rated as a utility.

*Diatomaceæ* (*Bacillariaceæ*): *the Diatoms*. These differ in some features from the Desmids, but resemble them in method of sexual reproduction, in unicellular construction, and in the variety and symmetry of form and sculpturing of the walls, which reach a degree to place the Diatoms among

the most diversified and beautiful of all objects in nature (Fig. 296). Their markings are partly raised ribs or tubercles, and partly sunken pits, slits, or pores. Unlike the Desmids, their cellulose walls are densely infiltrated with silica, which reproduces and holds the form of the wall so perfectly that these beautiful flint skeletons persist and accumulate long after the living substance is decayed, or after the plants are burnt. Many small lakes are filled nearly to the water level with a "mud," which is composed chiefly of living Diatoms near the top, of their partially decayed remains lower down, and of pure white empty shells at the bottom; and from such ponds, and from fossil deposits in like ponds of old time, is taken the "diatomaceous earth," "infusorial earth" or "fossil flour," which forms the basis of most polishing powders, and has other minor uses in the arts. The plant body, while typically a single cell, is sometimes a colony in form of a filament, or even a symmetrical frond, the individuals being embedded in a gelatinous material they secrete. The cell contains chromatophores, from one to many, usually simple in form, and brownish yellow in color on account of admixture of other pigments with the chlorophyll. They reproduce asexually by division, usually lengthwise of the cell. The usual direct fission is of course prevented by the siliceous framework of the wall, but a remarkable compensating feature is found in the method of its construction. It consists of two box-shaped parts, of which one overlaps the other just as the cover slips over a paper box (Fig. 297). The enlarging protoplasm pushes apart the valves, divides lengthwise, and each half develops a new valve on its naked side. Since, however, this new valve is necessarily formed with its edges inside the older, each successive division reduces the size of the cell; but when this reduction has reached a certain degree, the protoplast sheds both valves, and, either with or without conjugation, becomes a special body called an AUXOSPORE, which grows to the full original size before

it again forms the valves characteristic of its kind. Sexual reproduction occurs through conjugation of two protoplasts, and formation of zygospores, with various differences in details in the various kinds, although in a very few cases ciliated zoöspores occur, suggestive of the Flagellates. They spread in small part by free locomotion through aid of protoplasmic threads working against the ground, but chiefly are drifted with movements of the water. At times they form in the ocean great clouds, sometimes with distinctive tinges of color; and in such state they serve as food for various fishes. A large number of species is known, probably 6000, with others which are fossil; but they have no direct economic utility aside from the uses above mentioned, and a certain limited employment as test objects for microscopic lenses, to which purpose they are fitted by the extreme fineness and regularity of their markings.

Ecologically the Conjugales are chiefly drifting micro-hydrophytes. Phylogenetically, the Zygnemaceæ are obviously related to the Protococcales, of which they seem

merely a specialized branch (Fig. 275). The Desmids in turn are clearly related to the Zygnemaceæ, the lower forms of both being very much alike. The position of the Diatoms is less certain, for no connecting links with other groups exist; but their mode of reproduction suggests an origin from the Desmids, as a very ancient offshoot.

*ORDER 4. SIPHONALES: THE TUBULAR ALGÆ.* These are mostly marine forms of warm seas, but include some felt-like or vesicular kinds which grow on the mud of shoal ponds

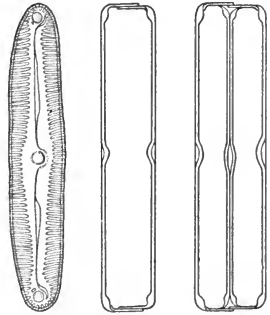

FIG. 297. — A typical Diatom, *Navicula viridis*, much magnified.

Left, a face view; next, profile in optical section, showing arrangement of the two valves of the wall; and, right, the mode of division of the cell. (Adapted from Pfitzer.)

or on wet, shaded ground. They have all in common the notable feature that the plant body, no matter how large and elaborate, consists of a single tubular compartment lined by protoplasm containing numerous nuclei and chloroplasts. Such a structure, morphologically equivalent to a multicellular individual in which the cross walls do not form, but physiologically acting as a single multinucleate cell, is called a CÆNOCYTE. As in all such huge cells, protoplasmic streaming

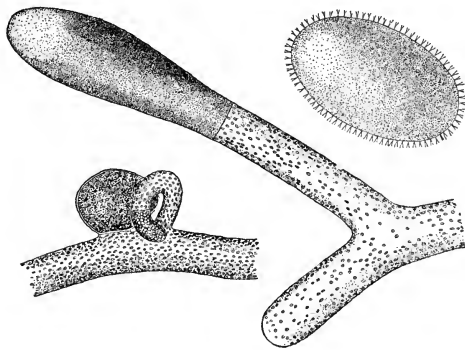

FIG. 298. — *Vaucheria sessilis*.

Center, cænocytic filament, with cell forming a zoospore; and the zoospore, above. Below, an oogonium and antheridium on a filament: all  $\times 150$ .

is active and evident (page 37). Some 300 species are known, none, however, having economic utility.

A common and typical form is the Green Felt or *Vaucheria* (Fig. 298), of which the branching, green, tubular filaments, sometimes attached by colorless holdfasts, interlace to a coarse

felt on the bottom of shallow waters, or on wet ground. It occurs also on shaded, neglected soil or flower pots in greenhouses, whence is commonly drawn the material for laboratory studies. It reproduces asexually by zoöspores, which are multiciliate and multinucleate, and so large as to be visible to the naked eye; for each one is formed from the entire contents of the end of a filament cut off by a cross wall. After swimming about for a time, they come to rest and form new filaments. The sexual reproduction presents features not found in lower forms. A short branch grows out laterally, a cross wall cuts off its contents, and the resultant cell develops into a swollen oogonium containing a single egg cell,

all of the nuclei except one having passed meantime into the main filament. Close alongside, and in some kinds from the same stalk, is formed a smaller tubular branch from which is cut off a terminal antheridium, wherein are developed numerous ciliate sperm cells. The one of these which first gains entrance to the oögonium, through a special opening which appears, fertilizes the egg cell, wherefrom there develops a thick-walled resting oöspore, which later germinates to a new filament. These oögonia and antheridia are of special interest as the first structures met in the ascending scale which are devoted specially to the formation and fusion of the sexual cells; for in all lower forms the cells which produce the reproductive bodies are only transformed vegetative cells. Another common form is *Botrydium* (Fig. 299), which grows in masses upon wet, clayey

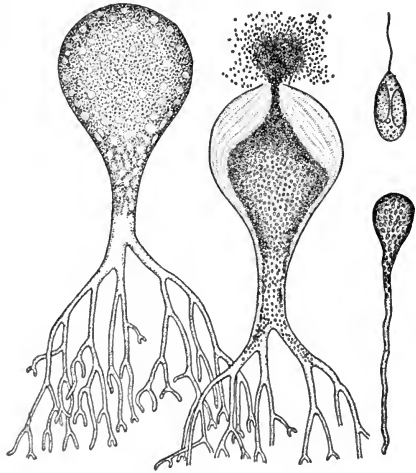

FIG. 299. — *Botrydium granulatum*.

Left, an adult individual; next, individual producing and expelling zoöspores; next, below, young plant germinating from a zoöspore; all  $\times 25$ . Above, right, a zoöspore, with two chloroplasts;  $\times 500$ . (After L. Kny.)

earth, especially when drying from a flooded condition. The single plants, each about the size of a pin head, are balloon shaped, the lower part being differentiated into colorless rhizoids which enter the earth and there absorb water and mineral salts for the green part in the light; and herein is anticipated the physiological differentiation into root and shoot prevailing in the higher plants. It reproduces asexually by zoöspores, which are formed in great numbers, and also sexually by conjugation of small biciliate isogametes.

The marine forms include *Caulerpa* (Fig. 300), which exhibits a differentiation into apparent stems, rhizoids, and leaves; these structures, however, are very different morphologically from their analogues in the higher plants. The protoplasm in these huge cœnocytes shows very active streaming movements, the most active known (viz. about 10 mm. per minute, as against 3–5 in *Chara*); and so large are the tubular compartments that they would apparently

suffer collapse were it not for the system of cross beams which many of them possess. Others have beautiful feathery fronds (*Bryopsis*), and some kinds exhibit striking umbrella-like shapes (*Acetabularia*). The latter, and some others, are heavily incrustated with lime.

Ecologically the Siphonales are mostly marine hydrophytes, though the few of fresh water live also on land. Phylogenetically

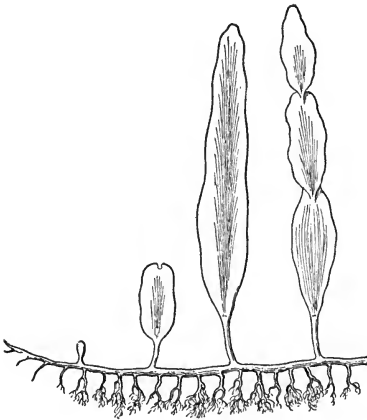

FIG. 300. — *Caulerpa prolifera*;  $\times \frac{1}{2}$ .  
(From Oltmanns.)

they seem clearly related to Confervales, from which they differ chiefly in absence of cross septa, and of which they are no doubt an offshoot, specialized in the reproductive mechanism.

**ORDER 5. CHARALES: THE STONEWORKS.** These are slender-jointed, whorled-branching, green growths, a foot or more long, rising from the bottoms of ponds, often over considerable areas. Some kinds are incrustated with lime and are brittle and rough, whence their common name. They occur only in fresh water, and include some 160 species, none of which have economic uses.



The plant body is more complex than in any other Green Algæ (Fig. 301), involving a system of long, unicellular internodes alternating with short nodes, all developing from a simple kind of growing point. At the nodes are borne whorls of determinate, unicellular branches, together with ordinary elongating branches and the sexual structures, while colorless rhizoids form the attachment to the bottom. The huge cells when young have each a single nucleus, which breaks into several as growth progresses, while many small chloroplasts are arranged with pavement-like regularity around the wall. In such great cells, sometimes three inches long, the streaming of the protoplasm is strikingly apparent, on which account these plants, especially the more delicate *Nitella*, are

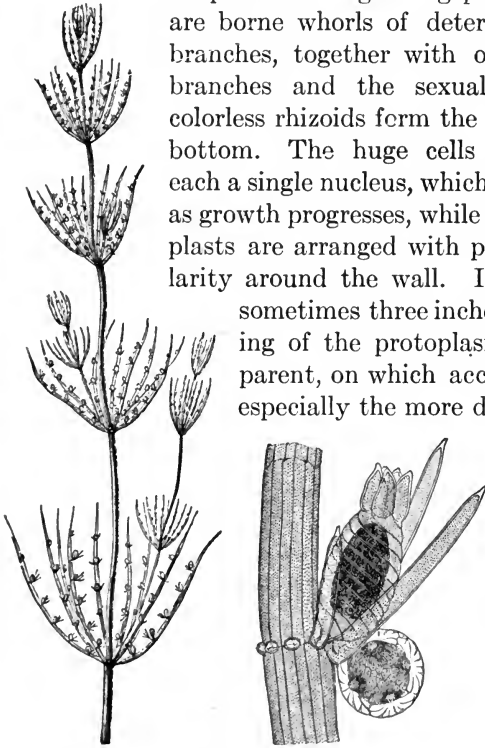

FIG. 301. — *Chara fragilis*.

Left, end of a shoot, natural size; right, portion of shoot, with oögonium and antheridium;  $\times 25$ . (From Strasburger and Sachs.)

favorite subjects for studies upon protoplasm in laboratories. Some kinds reproduce vegetatively by tuber-like basal outgrowths, but no forms of zoöspores occur. The sexual reproduction, however, is remarkably elaborate. At the

nodes occur oögonia containing each a huge egg cell, conspicuously visible to the naked eye because of its orange-red color. The oögonium is wrapped by an envelope composed of spirally wound cells developed from the subjacent tissues. At the same nodes occur remarkably complicated antheridia,

which produce numerous highly specialized sperm-cells. In fertilization, a sperm cell reaches the egg cell through a gap which opens in the spiral envelope, and the resulting oöspore is a resting spore. It remains surrounded by the inner walls of the lime-incrusted spiral envelope of which the outer parts degenerate; and thus is formed a stony, spirally-marked, nut-like shell. The two prominent genera are *Chara*, which comprises the coarser kinds, distinguished by presence of a sheath of cells around the long axial cell of the stem, and *Nitella*, which is more slender, lacking the sheath. They spread only through incidental movements of the water, without special adaptations.

Ecologically the Charales are typical sedentary hydrophytes. They really represent, like *Hydrodictyon*, greatly overgrown micro-hydrophytes. Phylogenetically their position is very uncertain, since no connecting links with other groups exist. They seem to come nearest to the Siphonales, of which they perhaps represent a very ancient, and now highly specialized, offshoot.

#### CLASS 6. PHYCOMYCETES: THE ALGAL FUNGI

This is one of the five large groups of Fungi (page 399), and it belongs in this place because of its obvious relationship to the Green Algæ, especially the Siphonales, of which it is clearly an hysterophytic offshoot. It includes the most familiar of the bread molds, the Water Molds which surround the bodies of floating insects and small fish, and the Downy Mildews of leaves. They are partly saprophytic and partly parasitic; and some are the cause of typical and destructive plant diseases.

The plant body consists of a colorless mycelium of profusely branching cœnocytic hyphæ, which ramify and penetrate everywhere over and through the substratum or host, from which food is absorbed in the characteristic manner (page 83). As in Siphonales, these hyphæ show often marked protoplasmic streaming. They reproduce in part by asexual

spores, either free-swimming or wind-carried, according to habit, and in part sexually by methods almost identical with those in Green Algæ. They fall into three principal orders as follows:

ORDER 1. *SAPROLEGNIALES*: THE WATER MOLDS.

ORDER 2. *PERONOSPORALES*: THE BLIGHTS OR DOWNY MILDEWS.

ORDER 3. *MUCORALES*: THE TRUE MOLDS OR BLACK MOLDS.

ORDER 1. *SAPROLEGNIALES* (OÖMYCETES IN PART): THE WATER MOLDS. These live on the floating bodies of dead

insects, tadpoles, and small fish, where they appear as a woolly wrapping of white hyphæ, while they also attack small living fish, through the gills, often causing great losses in fish hatcheries. In the common and typical *Saprolegnia* (Fig. 302), the plant body suggests a mass of colorless *Vaucheria* threads, composed of multinucleate cœnocytes, sending haustoria into the substratum or host.

Asexual reproduction occurs through biciliate zoöspores formed in elongated sporangia. In sexual re-

production (when present, as it often is not), lateral oögonia are formed in which are usually several egg cells; tubular antheridia grow towards and into contact with these oögonia, into which they send tubes carrying each a sperm nucleus to an egg cell, a method curiously anticipatory of that used in the fertilization of the egg cell by the sperm nucleus in the pollen tube of the higher plants. The resultant oöspores acquire

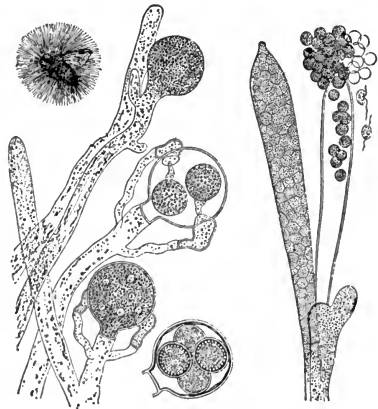

FIG. 302. — *Saprolegnia* species. As it appears ordinarily on a dead insect in water, natural size, and portions,  $\times 200$ .

Left, the cœnocytic hyphæ bearing oögonia, with fertilization of the egg cells, in various stages; and right, formation of zoöspores. (Chiefly from Kerner.)

thick walls and become resting spores which later produce new mycelia. They spread by their zoöspores, or are carried by water currents and movements of their hosts, without any special adaptations of their own. Some 55 species are known.

*ORDER 2. PERONOSPORALES: THE BLIGHTS, OR DOWNY MILDEWS.* These are parasites which live in the tissues of the higher plants, and there produce some of the most serious plant diseases. About 100 species are known.

An important and typical form is the Blister Blight or White Rust (Fig. 303), which attacks members of the

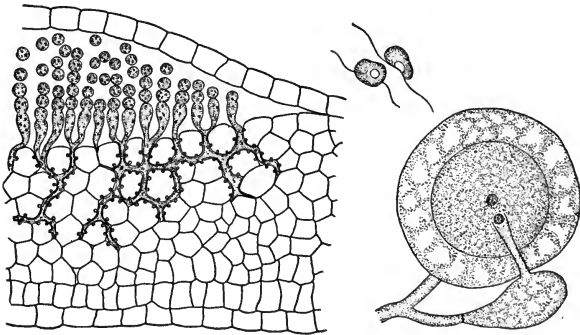

FIG. 303. — *Albugo candida*.

Left, cross-section of a leaf, showing mycelium, with conidia forming in the blister;  $\times 60$ . Next, swarm spores;  $\times 400$ . Right, oogonium containing one egg cell in process of fertilization through a tube from an antheridium;  $\times 400$ . (After Bergen and Davis, *Principles of Botany*, and other data.)

*Cruciferae* or Mustard family. Its mycelium runs everywhere through the intercellular spaces of the host, and sends short haustoria into the living cells themselves, in which are produced those typical toxic effects which cause damage and death (page 85). Asexual reproduction occurs through formation of many conidia (spores) on the ends of hyphal branches collected just under the epidermis. Thus is produced a white blister, from which, when it bursts, the spores are scattered by wind. These germinate in wet weather on the surface of leaves of suitable kind to which

they are carried, and form zoöspores, which move over the wet surface, come to rest, send hyphæ through stomata, and thus start the disease anew. The sexual reproduction takes place deep in the tissues, where a sperm nucleus from an antheridium unites with an egg nucleus. There results a resting oöspore which is ultimately set free by decay of the tissues, and germinates in the spring to zoöspores which infest young growing plants of the suitable kinds.

Belonging to this group is the Potato Blight or Rot (*Phytophthora infestans*) which destroys potato tops, and hibernates in the tubers. It sends its conidia, on long-stalked branching sporophores, out through the stomata, whence they are disseminated by wind; and as they germinate to zoöspores on other wet leaves the disease spreads rapidly in warm, wet, windy weather. Sexual reproduction has not yet been found in this parasite. The Grape Blight, or "False Mildew" (*Plasmopara*), of which the branching sporophores form downy spots on grape leaves, does very great damage in some places unless held in check by Bordeaux mixture, of which the copper salts are effective fungicides. The Damping-off Fungus (*Pythium* species), which causes rapid wilting of young seedlings in greenhouses when kept too damp and unventilated, is also of this group, as are the Onion Mold and some other plant parasites.

*ORDER 3. MUCORALES (ZYGOMYCETES): THE TRUE MOLDS OR BLACK MOLDS.* These comprise the familiar black-headed Molds which appear upon damp bread, and also upon preserves and various decaying and refuse organic matters, though blue and green Molds belong to other groups. So ubiquitous are they, that one can at any time obtain a laboratory supply from damp bread kept a few days under a shaded bell jar. The plant body is a cœnocytic mycelium, of which the white or glistening hyphæ branch so profusely over the substratum as to present often a woolly or cobwebby appearance. They form many small dark-colored

spores in round sporangia raised on tall, vertical stalks, whence they are strewn by the wind; and it is these dark-colored sporangia which form the distinctive black spots of the bread mold (Fig. 304). The sexual reproduction, which occurs rarely, is zygosporic. Short, blunt branches

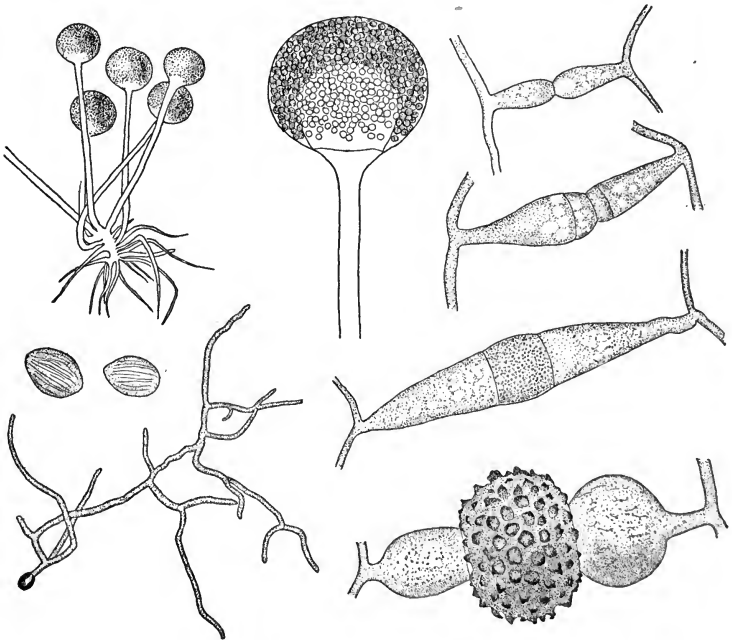

FIG. 304. — The Bread Mold, *Rhizopus nigricans*.

Upper left, mycelium and sporangia;  $\times 30$ ; next a sporangium in section,  $\times 160$ . Right, series of stages in the development of a zygospore,  $\times 160$ . Left, mycelium germinating,  $\times 160$ , and spores,  $\times 650$ .

develop towards one another from adjacent hyphæ, come together end to end, and unite; the contents of their tips, cut off by cross walls, merge into thick-walled resting spores which later germinate to new mycelia. In some Molds it has been found that not any mycelium will thus unite with any other, but only certain ones with certain others, in ways to imply the existence of a physiological differentiation

of sex, invisible structurally. A common form is the *Pilobolus* or Squirting Fungus (Fig. 305), which hurls its sporangia towards the light, and exhibits other phenomena, which make it of interest in physiological laboratories. To this group belong also some forms which attack living insects (*Entomorphales*), familiar in *Empusa muscorum* which kills the common House Fly; and it is the white sporangia shot from the hyphæ of the fungus which one can often see as a circle or halo around dead flies on window panes. Various members of this group exhibit stages in the degeneration of the sexual apparatus, thus illustrating well a principle, amply manifest in other groups, that the parasitic habit is usually accompanied by a disuse and ultimate disappearance of ordinary sexual reproduction. About 180 species are known.

Ecologically the Phycomycetes are thus typical hystero-phytes, partly hydrophytic and partly aërophytic. Phylogenetically their reproduction, both oösporic and zygosporic, relates them clearly to the Green Algæ, while the structure of their bodies brings most of them close to the Siphonales (Fig. 275).

#### CLASS 7. PHÆOPHYCÆ: THE BROWN ALGÆ

These are the largest and most prominent of Algæ, including as they do the Rock Weeds, which cover all stony sea beaches between the tide marks, and the gigantic half-floating Kelps, which live just below. Their color is brown, or golden brown, from the presence of a special pigment, called FUCOXANTHIN, which occurs in their plastids with the chloro-

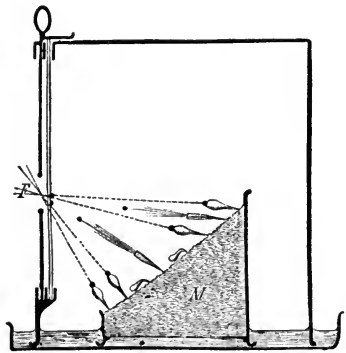

FIG. 305. — *Pilobolus crystallinus*, grown in a moist chamber darkened except for a lateral window. The sporophores both bend, and project their sporangia, phototropically towards the light. (From Strasburger.)

phyll, but of which the function is uncertain. Their bodies are mostly leathery-tough and elastic, in correlation with their exposure to the force of great breakers, and they are strongly attached to rocks by firm holdfasts which suggest roots in their aspect, but are quite different in nature. These holdfasts are connected with the leaf-like fronds by stalks, often of great length; and many of the prominent kinds possess floats, in the form of gas-holding bladders, which raise the fronds towards or upon the surface. Unlike all lower forms, which are filmy, or finely divided in correlation with the conditions of gas absorption from the water (page 562), they possess somewhat massive fronds and stalks often many cell layers thick; and they even exhibit some differentiation of tissues, — cortical, storage, and conducting, — suggestive of cellular differentiation in the higher plants. Their considerable thickness seems clearly connected with the effective aëration permitted their fronds by the daily exposure directly to the air, either by the fall of the water around them, or their flotation at low tide on the surface. They do not admit air into intercellular spaces, but the needful gases diffuse from cell to cell from the constantly renewed supply at the surface; and perhaps the distinctive brown pigment has connection with this function. Somewhat over 1000 species are known, of which a few have minor economic uses as fertilizers or sources of certain chemicals. They include two orders:

ORDER 1. *PHÆOSPORALES*: THE KELPS AND KIN.

ORDER 2. *FUCALES*: THE ROCKWEEDS.

ORDER 1. *PHÆOSPORALES* (*LAMINARIALES*): THE KELPS AND KIN. These are the largest of Algæ, and include indeed some of the longest of plants. The "Devil's Aprons" (*Laminaria* species), of the Atlantic coast, growing just below low tide mark and often cast upon the beaches, have leathery fronds, 20 or 30 feet long and one or two broad, with several feet of cylindrical stalk (Fig. 306). The largest



forms occur in high northern seas, probably because cold waters dissolve more gases than warm. On the Pacific coast occurs *Nereocystis*, with its very long stalk, single great float, and several broad blades, while *Postelsia*, the Sea Palm, has a stiff stem, a foot high, with a crown of fronds (Fig. 307). The great *Macrocystis* of South Pacific waters has a float at the base of each blade of the frond (Fig. 133), and becomes 200 or more feet in length. They all reproduce by the conjugation of small ciliate gametes (long mistaken for zoöspores and thus recorded in most books), which are formed in special cells developed in irregular patches on the surfaces of the fronds; and the resulting zygospores grow directly to new plants like the parents.

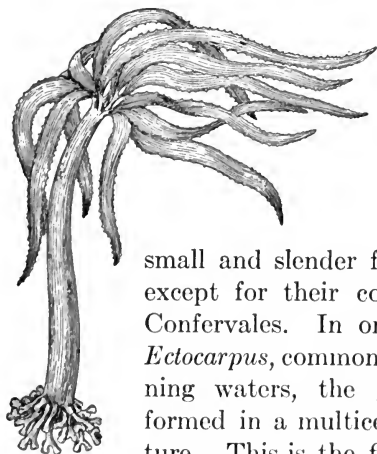

FIG. 307.  
— *Postelsia*  
*palmae*  
*formis*;  $\times \frac{1}{2}$ .  
(From *Pos-*  
*telsia*.)

While the great Kelps are the principal members of this order, there also occur some

small and slender forms which, except for their color, suggest Confervales. In one of these, *Ectocarpus*, common in clear running waters, the gametes are formed in a multicellular structure. This is the first instance

thereof in the ascending scale, and another anticipation of conditions prevailing in the higher plants. "Anticipation" of course has nothing to do with morphological origin,



FIG. 306.—*Lamnaria*  
*saccharina*;  
 $\times \frac{1}{100}$ .

On the upper segment can be seen the elongated patch of cells which produce the gametes. (From Oltmanns.)

ORDER 2. *FUCALES*: THE ROCKWEEDS OR BLADDER WRACKS. These are the common seaweeds of rocky shores, which they cover densely in vast quantities. The plant body (Fig. 132, 308) is a branching elastic thallus, approximately a foot long, buoyed up by bladders holding air and oxygen gas. The reproduction is wholly sexual. In the commonest of the Rockweeds, *Fucus vesiculosus* (Fig. 308), the tips of the

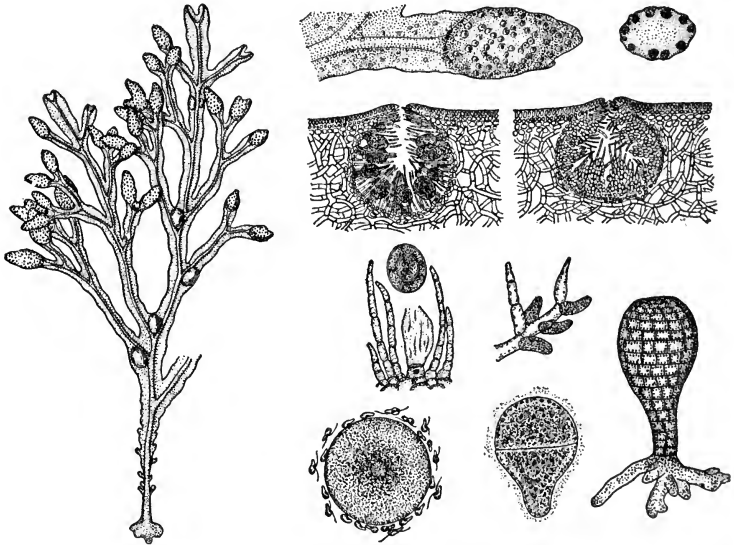

FIG. 308. — The life history of *Fucus vesiculosus*, a typical Brown Alga. Left, a plant;  $\times 4$ . Above, swollen tip showing conceptacles, and cross section;  $\times 2$ . Second line, cross sections of conceptacles showing oogonia and antheridia;  $\times 20$ . Third line, opened oogonium, and antheridia;  $\times 50$ . Lower line, egg cell surrounded by sperm cells,  $\times 200$ , germinating oospore,  $\times 200$ , and young plant,  $\times 25$ . (In part after Thuret, in part from nature.)

fronds are enlarged and covered with small swellings, under which are the hollow CONCEPTACLES. These when sectioned are found lined with oogonia and antheridia, — on separate fronds in this species, but in the same conceptacles in some others. Each oogonium contains 8 egg cells, which, set free en masse, soon separate and pass singly outside the frond,

where they are fertilized, usually on the rising tide, by the small laterally biciliate sperm cells set free from the antheridia. So great is the contrast in size between egg cell and sperm cell in *Fucus* that this plant is commonly cited as representative of one of the theoretical stages in the evolution of sex (page 304).

In this order belongs also the *Sargassum*, the floating brown seaweed of the Sargasso Sea, which, originally attached, now floats freely and increases by vegetative multiplication. This plant is further noteworthy for the remarkable specialization of its thallus into seeming leaf and stem (Fig. 309), with axillary stalks carrying floats and reproductive bodies; but the arrangement bears no morphological relation to that familiar in the higher plants.



FIG. 309. — *Sargassum vulgare*;  $\times \frac{1}{2}$ . (From Sachs.)

Ecologically the Phæophyceæ are hydrophytes which for a time can endure exposure to air, perhaps to their profit. Phylogenetically they are a specialized group independent of all other kinds in their higher forms, but in their lower showing marked affinities with the Flagellates and lower Chlorophyceæ (Fig. 275). Though they have attained a higher specialization than the Green Algæ, they have not, unlike the latter, given rise to any higher forms.

#### CLASS 8. RHODOPHYCEÆ: THE RED ALGÆ

These comprise the majority of the Algæ of the sea, especially in tropical waters. Most typical are the kinds called Sea Mosses, noted for their great beauty of color, from rose red to violet or purple, and for the extreme grace of their elaborately fringed or divided fronds. They are mostly

of moderate size, from near microscopic to a yard in length, perhaps oftenest about the size of the hand. They live almost wholly below low water mark, and extend to greater depths than any other Algæ, — down indeed as far as light can reach, viz. some 200 feet in clear waters. A few occur



FIG. 310. — *Rhodomela subfusca*, var. *gracilis*, a typical Red Alga;  $\times \frac{3}{4}$ . (From Hervey's *Sea Mosses*.)

in fresh water; but such kinds are small, and tend towards a greenish color. Some 3000 species are known, of which a few have limited economic uses.

The plant body consists typically of a flat, thin, flexible thallus, cut to divisions which are often filamentous (Fig. 310), such characters being usual in wholly submerged water plants (page 562). In this group, as in the Brown Algæ, the thallus is sometimes differentiated into parts strongly simulative of the leaf, stem, and root of the

higher plants, though of quite different morphology. The cells of the fronds usually lie in definite lines, suggesting an origin from amalgamated filaments; and the continuity of the protoplasm from cell to cell is often evident, even more clearly than in the higher plants (page 40). The walls form much gelatinous material, often in quantity and quality sufficient to give these plants value as food, as in case of the Irish Moss, from which a blanc-mange is made, the Dulse, a favorite raw comestible of children in seaport towns, and the Agar-Agar,

much eaten in Japan, and invaluable in bacteriology as a culture basis for Bacteria. The distinctive rose-red color is given by a special pigment, called PHYCOËRYTHRIN, present in the chromatophores with the chlorophyll. It appears to aid in photosynthesis, though the method is not wholly clear. Perhaps it works through its fluorescence, by which rays of light otherwise unavailable are brought within reach of the chlorophyll, — all possible rays being valuable where so many are lost through absorption by the water. Some kinds have the power, in common with other Algæ (*Charales*, *Acetabularia*), to store up lime in their walls; and thereby they add irregular stony growths to the rocks upon which they grow. Such is the nature of the pink “nullipores” found at extreme low tides on our own coasts and often mistaken for coral, while in the tropics they actually contribute largely to the construction of the real coral reefs. They reproduce asexually by non-motile drifting spores, especially a characteristic kind formed in groups of four and called TETRASPORES (Fig. 311). No motile reproductive bodies of any kind are found in the group. Their sexual reproduction, however, is elaborately specialized, as noted below.

The Rhodophyceæ include three or four orders, of which a single one, the *Florideæ*, is so much the larger and more important as to become almost synonymous with the class. One of the commonest and simplest in reproduction of the *Florideæ* is *Nemalion*, a small, branching, filamentous, purplish form which grows in patches on rocks among the Rockweeds. Its only known method of reproduction is that partially represented in Figure 217. The combined egg cell (CARPOGONIUM) and trichogyne there shown is called a PROCARP; after fertilization, effected by the small, round, non-motile sperm cell (SPERMATIUM), the trichogyne withers and the egg cell grows into a compact, branched structure producing asexual spores on the branches, — the entire mass being called a CYSTOCARP. The spores grow each to a new plant. A practically similar method of reproduction occurs in

*Batrachospermum*, of clear running waters. The formation of the multispore cystocarp instead of a new plant directly has no doubt the advantage that many new plants are secured from one act of fertilization, as in the analogous

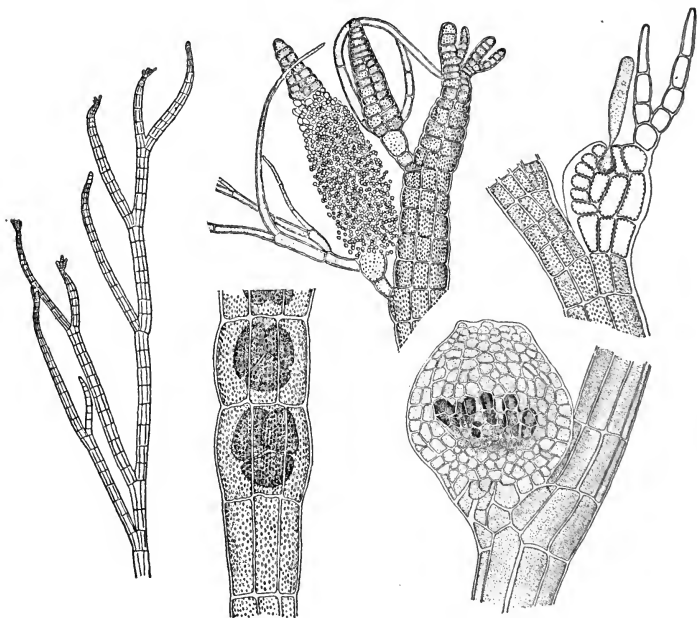

FIG. 311. — *Polysiphonia violacea*.

Left, part of a typical plant;  $\times 60$ . Next, portion of a tetrasporic plant, showing tetraspores;  $\times 150$ . Next, portion of antheridial plant, showing unripe antheridium, and one emitting the sperm cells;  $\times 200$ . Next, above, portion of procarpal plant, showing (shaded) procarp with trichogyne, and the supporting cells;  $\times 500$ . Below, a ripe cystocarp;  $\times 80$ .

cases of *Ulothrix* and *Coleochaete*; but in *Nemalion* is involved also another physiological feature (the reduction division) which will later be considered. It is enough to note here that these plants present a regular alternation between sexual and asexual stages or generations, and exhibit another anticipation of the arrangement which becomes very prominent in the higher plants.

The majority of Red Algæ show a remarkable specialization of the cystocarp formation. Thus in *Polysiphonia*, a small dark, purple form common on our coasts among the Rockweeds (Fig. 311), three kinds of plants are produced, vegetatively similar but developing respectively tetraspores, antheridia, and procarps. In course of development the cells of the procarp form curious unions with contiguous cells, though apparently these unions are purely of nutritive nature; and the cystocarp does not remain naked as in *Nemalion*, but becomes inclosed in a flask-shaped cover developed from the subjacent tissues, as anticipated in *Coleochæte* (page 423). Moreover, in this form, a regular alternation occurs between the sexual and the tetrasporic plants, providing a case in which the two generations are vegetatively alike (Fig. 361).

There are many genera of beautiful forms of Red Algæ, some of which possess names, — *Dasya*, *Ceramium*, *Calithamnion*, *Rhodomela*, *Delesseria*, as graceful in their way as the plants in theirs. These in fact are the beautiful "Sea Mosses" which are favorite objects of collection by visitors to southern sea shores.

Ecologically the Rhodophyceæ are typical divided thalloid hydrophytes. Phylogenetically they represent a highly specialized branch of the Algæ, rather divergent in the higher forms, but derived no doubt from some of the Green Algæ, probably not far from the *Coleochæte* group. They represent the very highest development in the Algæ, but gave origin to nothing higher, unless possibly to some of the higher Fungi (page 455).

#### CLASS 9. ASCOMYCETES: THE SAC FUNGI

(Part of Eumycetes)

The groups of Fungi earlier described, — Bacteria, Myxomycetes, and Phycomycetes, — bear close and obvious relations to groups of Algæ, of which they seem clearly to represent hysterozytic offshoots. There remain two greater

groups, Ascomycetes and Basidiomycetes, which are frequently treated together as Eumycetes or "true Fungi," though this name is often made also to include the Phycomycetes. The relations of these groups to other Thallophytes are obscure, some authorities deriving them from the Red Algæ, and others from the Phycomycetes. Since they are mostly saprophytes or parasites upon land plants, they probably represent the descendants of Fungi which accompanied the earliest plants from the water to the land in their evolution from the Algæ. Thus these Fungi have had time for a long evolution upon their own account.

The Ascomycetes and Basidiomycetes together comprise some 50,000 to 60,000 species of Mildews, Mushrooms, Lichens, Rusts, Smuts, and other conspicuous and important forms, of which many are the cause of destructive plant diseases. Vegetatively the two groups are much alike, the plant body being commonly differentiated into two very distinct parts. First there is the feeding *mycelium*, which, while sometimes compact and thallus-like, or even dense and hard (SCLEROTIUM), is commonly wide ranging and loose branching in thin threads (Fig. 328), which penetrate the tissues of a host, or else dead organic matter, including humus, from which they draw their food in the usual manner (page 85). Second, there are the *sporophores*, typically stalked structures (as in the Mushroom), which carry the spores out into the air where the winds reach and scatter them. These structures are composed of compacted or intertwined threads, sometimes dense and hard. It is in the reproduction that the distinction exists between the two groups, for in the Ascomycetes the characteristic structure is an ASCUS or sac, containing typically eight spores. Numbers of these asci develop together in an ASCOCARP, which is either open cup-shaped (APOTHECIUM), or else flask- or globular-shaped (PERITHECIUM). This ascocarp typically forms like the cystocarp of the Red Algæ, — viz. as result of the fertilization of an ASCOGONIUM (the procarp) through a tri-



chogyne by a sperm cell. While this arrangement occurs in some of the group, it is suppressed in others, in all degrees down to the formation of the asci without any external trace of fertilization or sexual structures. In the Basidiomycetes the distinctive structure is a **BASIDIUM**, or enlarged end of a hypha, on which are developed naked spores, typically four in number. These basidia are usually collected in large parallel groups which form without any external evidence of fertilization or sexual structures, though probably they are homologous with the asci and were originally formed like them.

Although external structures and processes connected with sexual reproduction are absent from many Ascomycetes and most Basidiomycetes, there do occur within their cells certain fusions of nuclei, and other processes, strongly suggesting a form of sexuality; and it may yet prove that practically all of the Fungi do possess a sexual reproduction, physiologically like that of other plants, though morphologically very different.

The homology of the methods of sexual reproduction in some of the Ascomycetes with those in Red Algæ suggests that these Fungi also should exhibit an alternation of generations. This in fact is found to be true, and the ordinary mycelium in the Ascomycetes and Basidiomycetes represents the sexual generation, while the ascocarp, and its equivalents in the various Fungi, represent the asexual generation.

Some 19,000 species of Ascomycetes are known. They are divided into several orders, the relationships of which are somewhat doubtful, though in practice we may conveniently treat them as follows:

- ORDER 1. *DISCOMYCETES: THE CUP FUNGI.*
- ORDER 2. *PYRENOAMYCETES: THE BLACK FUNGI.*
- ORDER 3. *ERYSIPHÆ: THE POWDERY MILDEWS.*
- ORDER 4. *PLECTASCALES: THE BLUE AND GREEN MOLDS.*
- ORDER 5. *EXOASCI: THE NAKED-ASCUS FUNGI.*
- ORDER 6. *SACCHAROMYCETES: THE YEASTS.*
- ORDER 7. *LICHENES: THE LICHENS.*

**ORDER 1. DISCOMYCETES: THE CUP FUNGI.** These are mostly saprophytes, which have an extensive, loose mycelium in decaying wood, leaf mold, or rich humus, and bear on the surface of the

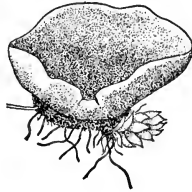
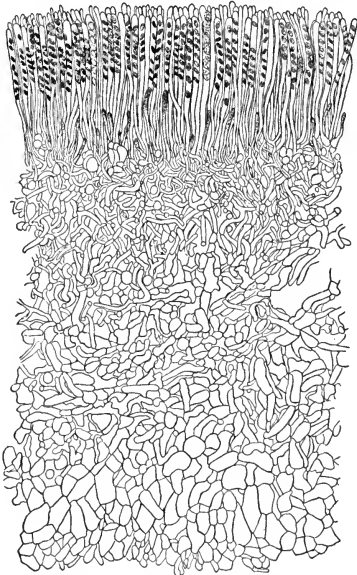

ground a characteristic cup-shaped, and often brightly colored, apothecium, which may reach to three inches in diameter. Some 3000 species are known, though none have direct economic importance.

FIG. 312. — *Peziza aurantiaca* (?). Right, a complete cup, with the mycelium entangling a shoot of moss;  $\times 2$ . Left, vertical section of hymenium, showing asci with ascospores, and intermingled paraphyses, merging below into the "tissue" composed of intertwined mycelial threads;  $\times 200$ .

A typical form is a *Peziza* frequent in forests (Fig. 312). The mycelium is invisible in the ground, but the bright scarlet cup, 2 or 3 inches across, is conspicuous on the surface. The bottom of this cup is composed of a **HYMENIUM**, that is, of a "tissue" of closely-packed, parallel, sterile, hyphal threads,

amongst which occur the asci containing each eight spores. The ripe ascospores are expelled by rupture of the ascus and swelling of its contents; and they are disseminated by wind. In this genus the apothecium, which is an ascocarp, forms without any known fertilization, but in the related *Pyronema*, it develops as result of the regular fertilization of an ascogonium through a trichogyne by a sperm-cell (Fig. 313), in the way already described as typical, and apparently in strict homology with the method in *Nemalion* and other Red Algæ.

A well-known member of this group, sometimes placed in a separate order, is the Morel (Fig. 314), one of the edible Fungi. Its mycelium ramifies in rich ground, and its huge, conical fructification, suggesting the mushrooms (which belong to the Basidiomycetes), bears a compound mass of irregular contiguous apothecia, the bottoms of which are lined with hymenium containing asci and ascospores as in other Discomycetes.

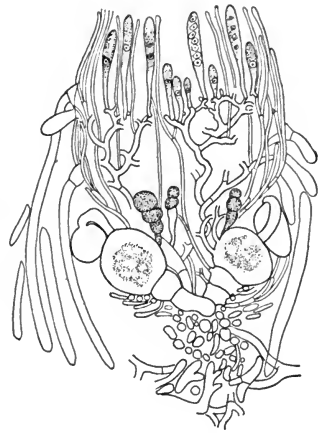

FIG. 313. — A young ascocarp, semi-diagrammatic, in vertical section, of *Pyronema confluans*; much magnified. The largest cells are oögonia, with stout trichogynes, at the ends of which are the rounded antheridia developed from other hyphæ. Fertilization has been accomplished, and from the oöspores are growing new hyphæ which are developing the asci, while the paraphyses are here formed by the subjacent mycelium. (After Harper.)

Another group of ascomycetous edible Fungi, also commonly treated as a separate order, includes the *Tuberaceæ*,

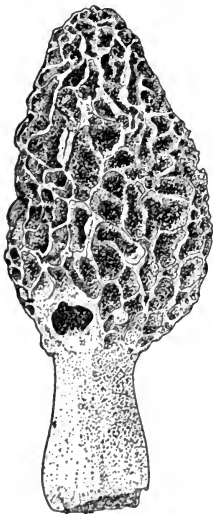

FIG. 314. — *Morchella esculenta*;  $\times \frac{1}{2}$ . (Drawn from a photograph by Knight and Step.)

or Truffles, highly valued in Europe. The loose underground mycelium occurs commonly in association with certain trees, of which it is believed to constitute the mycorrhiza (page 244). Furthermore, and this is a distinctive feature of the Truffles, the ascocarp, a tuber-like body which is closed except for a small exit, also occurs wholly underground, the ascospores being released by decay of the wall. Since they are underground they cannot be found by

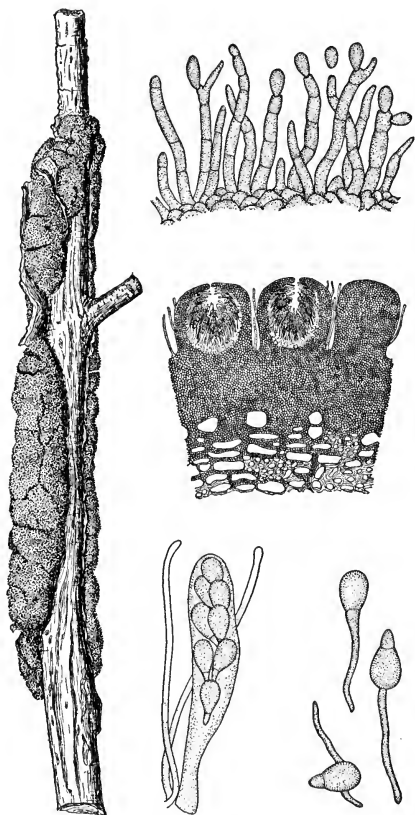

FIG. 315. — The Black Knot, *Plowrightia morbosa*.

Left, appearance of the Fungus on a branch of Cherry, natural size. Right, above, the superficial conidiophores, abstricting conidia;  $\times 400$ . Next, cross section through twig and sclerotium, and longitudinal section through perithecia;  $\times 25$ . Below, an ascus, and (right), germinating ascospores;  $\times 300$ . (In part from nature, and in part after Longyear.)

any visible sign, but they are collected by aid of pigs or dogs which detect them by their aromatic smell.

**ORDER 2. PYRENOMYCETES: THE BLACK FUNGI.** These are parasites and saprophytes of diverse forms and manner of growth, but characterized chiefly by a compact, superficial mycelium which has a blackened aspect suggestive of charring by fire, — whence both the Latin and English names (the former meaning “burnt fungi”). The fructification is usually a perithecium. Some 11,000 species are known, of which many produce destructive plant diseases.

One of the most prominent of the group is the Black Knot (Fig. 315), familiar in the black swellings so abundant on the branches of Cherry and Plum trees, to which it does much damage. The parasitic mycelium ramifies at first in the bark, but later breaks through to the surface, where,

inclosing some bark tissue, it forms the black, compact, rounded, swollen masses (sclerotium), which everybody knows. From the surface rise short stalks wherefrom conidia (spores) are abstracted and carried by the wind to infect other trees. In autumn small papilla-like perithecia,

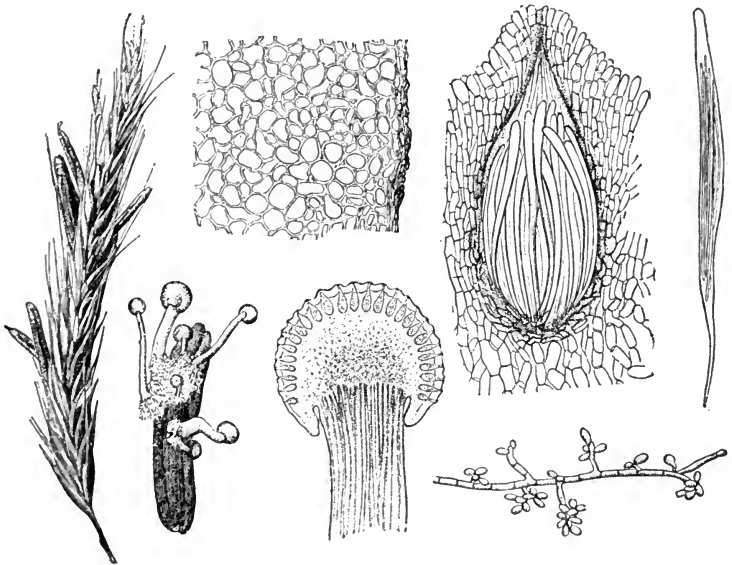

FIG. 316. — The Ergot Fungus, *Claviceps purpurea*.

Left, ear of Rye, with projecting sclerotia, natural size. Next, above, section through a sclerotium, showing the compact pseudo-parenchymatous mycelium,  $\times 250$ ; below, sclerotium, with fructifications,  $\times 3$ , and one of the latter in section, showing perithecia,  $\times 20$ . Next, a perithecium, showing asci,  $\times 200$ , and a single ascus, with the filamentous ascospores,  $\times 350$ . Below, the hypha, which develops from an ascospore on the grain, bearing conidia. (From Strasburger.)

containing 8-spored asci, form also on the surface, and in the spring the spores escape and are disseminated by wind. Another prominent form is the Ergot of Rye and other grasses (Fig. 316). The ascospores, in early summer, infect the ovaries of rye flowers, causing them to swell; and the mycelium later develops conidia from short stalks on the surface of the grain. At the same time the mycelium

secretes a sweet liquid, honey dew, which attracts insects, by whose movements the spores are transferred to other Rye flowers; and herein we have perhaps the first case in the ascending scale where insects are utilized by plants. Ultimately the mycelium absorbs all of the contents of the ovary, which it fills with its own compact, dark purple mycelium, or sclerotium. This dark purple, sclerotized ovary, which projects from among the uninjured grains in the head of Rye, is used in medicine, under the name of *ergot*, on account of its astringent power of contracting muscles. These sclerotized grains fall to the ground and live over winter. In spring they develop stalked, globular, rose-colored heads, in which are buried many perithecia. Therein are produced the ascospores, which are carried by the wind to other developing Rye plants.

To this group belongs also the very destructive Chestnut disease (*Endothia parasitica*), introduced a few years ago from eastern Asia, and now working sad havoc among American Chestnut trees. The spores are carried by wind, and incidentally by birds and insects. Reaching the bark of a Chestnut, they develop mycelia which penetrate to the phloem and cambium, and encircle the stem; and this is soon killed. Later the dead bark becomes warty, with yellowish-brown pustules developing through the lenticels; in these are formed great numbers of summer spores, which are extruded in twisted threads, and infect other trees. In autumn, the same pustules develop buried perithecia with ascospores (winter spores), also wind-carried. These germinate the next spring, when the old mycelium also renews its growth, and continues to destroy the tree downward. No method has been found for killing the deeply buried mycelium or checking the formation of the multitudinous spores; and only the total destruction of the infested trees avails to end the disease.

To this order belongs *Cordyceps* (Fig. 317), parasitic on the bodies of underground insects. The mycelium con-

sumes, and itself replaces, all of the organic matter within the chitinous skin. Later it carries to the surface of the ground a club-shaped fructification, containing perithecia with ascospores. The stalk grows to a length sufficient to attain the surface, and often that is considerable.

Another small group of Ascomycetes parasitic upon insects, especially water beetles, is the *Laboulbeniales*. They are notable for the clear definition of their sexual reproduction, which bears striking resemblance to that of Red Algæ. Thus they tend to show a direct connection between that group and the Ascomycetes.



FIG. 317. — *Cordyceps militaris*; natural size. The swellings on the stalked sporophores are the perithecia. (After Errera and Laurent.)

### ORDER 3. ERYSHIPHEÆ: THE MILDEWS.

These are familiar on leaves of Lilacs, Alders, Roses, and others, where they appear as delicate, white, superficial growths, mold-like or cobweb-like. In autumn they develop minute black perithecia amidst the white mycelium, justifying the name of "powdery mildews" sometimes applied to distinguish them from the "downy mildews" which are Phycomycetes, earlier studied (page 436). Some 100 species are known, of which a number are mildly injurious parasites.

A typical form, *Microsphaera Alni*, occurs on the Alder. A loose mycelium on the surface of the leaf sends haustorial hyphæ into the epidermal cells, and therefrom absorbs nourishment. Up from the surface it sends conidiophores, from which abundant spores are abstracted and carried by the wind. In sexual reproduction ascogonia and antheridia develop from neighboring hyphæ and fuse; and as result of this fertilization there is formed a peculiar, globular, hard, black perithecium, visible to the eye as a black spot amid the white mycelium on the leaf (Fig. 318). From these

perithecia extend long, hyphal branches ending in hooks of characteristic forms: and the different species are marked by a striking variety in details of the ends of these branches. The perithecia remain in place until the leaves fall, after

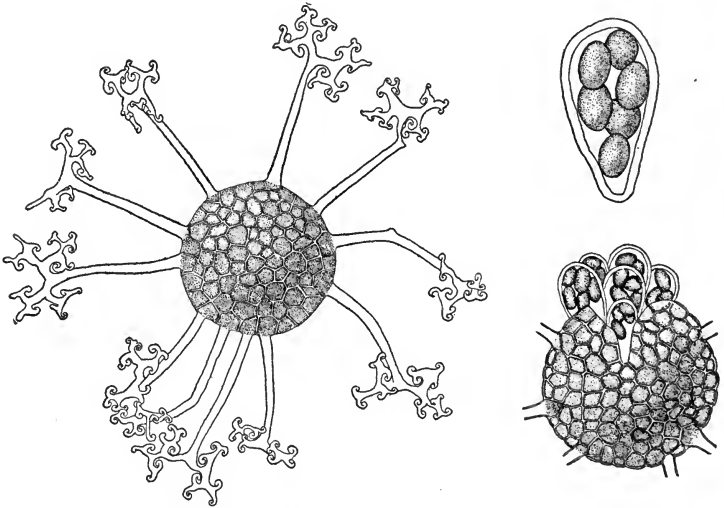

FIG. 318. — *Microsphaera Alni*.

Left, a perithecium, with the characteristic appendages, and right, a perithecium releasing the asci;  $\times 200$ . Above, an ascus, with ascospores;  $\times 400$ .

which, in the next spring, the ascospores are released by the decay of the hard inclosing walls.

ORDER 4. PLECTASCALES: THE BLUE AND GREEN MOLDS.

These plants are well described by their common name, for while superficially they resemble the true, or Black, Molds already considered under Zygomycetes (page 437), they produce bluish or greenish, instead of blackish, spore masses. They occur among the Black Molds, but extend more widely than they, to almost all kinds of damp organic bodies, — including cheese, leather, wall paper, and nearly anything that will “mold” in dampness. Some 250 species are known, all saprophytes of minor economic importance.



A common and typical form is the Green (bluish green) Mold (Fig. 319) which sends its slender mycelium over and through the substratum, and puts up tall conidiophores

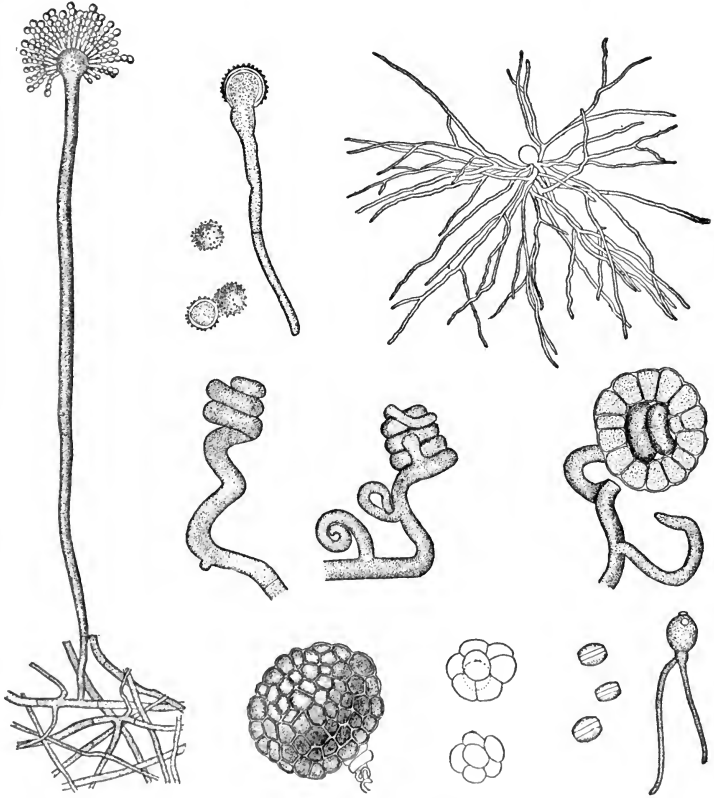

FIG. 319. — *Aspergillus (Eurotium) herbariorum*.

Left, sporophore developing conidia,  $\times 200$ . Upper line, conidia (asexual spores), one germinating,  $\times 625$ ; and young mycelium,  $\times 150$ . Middle line, ascogonium, and stages in development of the perithecium, the second showing antheridia,  $\times 625$ . Lower line, perithecium,  $\times 150$ ; two asci and ascospores, and germinating ascospore,  $\times 625$ .

which produce radiating lines of conidia, disseminated by winds. In sexual reproduction two short hyphal filaments come together and intertwine spirally, with presumably a

sexual fusion. There results a rounded perithecium, in which 8-spored asci are scattered amongst hyphal filaments, the spores being later set free by decay of the wall. The Blue Mold (*Penicillium glaucum*) occurs abundantly upon bread intermixed with Black Mold, and in other situations; and it has a certain utility in its power to give, through by-products of its own growth, the peculiar flavor to Roquefort cheese.

**ORDER 5. EXOASCI: THE NAKED-ASCUS FUNGI.** These are small and simple parasites, 80 in number, which cause deformities in plants. Thus, *Exoascus deformans* produces the curl of Peach leaves; another causes abortion of pits, and bladdery swelling in plums (Fig. 320); and others (*Taphrina*) induce small growths of Witches' Brooms (page 198) on some deciduous shrubs. Their mycelium develops perennially in the epidermis of the host, and forms on the surface many 8-spored asci, which appear as gray, powdery films. This is the only mode of reproduction in the group, and no sexual structures whatever are known. Thus these plants are among the simplest, and presumably most degenerate, of all Ascomycetes.

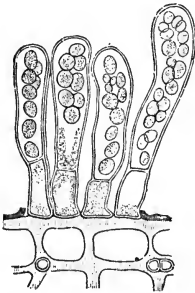

FIG. 320. — *Taphrina Pruni*, on a plum;  $\times 400$ .

The mycelium shows in cross section in the epidermis. The ascospores abstrict conidia. (After Sadebeck, from Strasburger.)

**ORDER 6. SACCHAROMYCETES: THE YEASTS.** These are microscopic simple plants, well known through their connection with the raising of bread and the production of alcohol by fermentation, as already fully explained (page 169). Only some 50 species are known, but they have great economic importance.

In typical Yeasts (Fig. 321), the plant body consists of a single ovoid, colorless cell, possessing cytoplasm, nucleus, and sap cavity within a thin wall. In nature they live sapro-

phytically in the sweet juices of plants, especially such as ooze from over-ripe fruits. These they absorb into the cell, and use the sugar as material for both growth and anaërobic respiration, the incidental products being carbon dioxide, alcohol, and some minor substances (page 170). They reproduce asexually by the budding of new cells from the old ones, new and old remaining attached for a time in irregular, fragile chains. When the food supply approaches exhaustion the contents of some cells segregate into four spores which develop thick walls

and go into the resting condition. In this state they float with the dust in the air, and reach other fruits. Thus the wine yeasts are carried into the vats where grapes are crushed, and produce the fermentation which underlies the making of wine. It happens that Yeasts are easily susceptible to cultivation by

man, who uses them for various purposes, including the making of beer and the production of alcohol used in the arts; and some of the kinds thus propagated are not now known in the wild state.

At first sight the Yeasts seem little related to Ascomycetes, but good reason exists for the view that the cell which forms four spores is an ascus, even though its structure is so simplified. In a few kinds its formation is preceded by a conjugation of two cells, while in some allied forms a simple mycelium develops.

*ORDER 7. LICHENS: THE LICHENS.* These are among the most prominent of all Fungi, for they comprise the

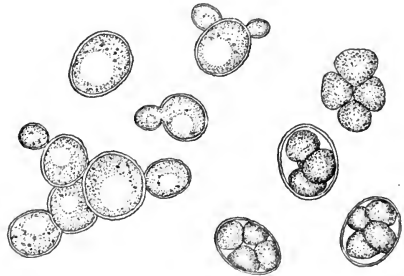

FIG. 321. — The bread Yeast, *Saccharomyces cerevisiae*.

Left, the ordinary vegetative state, in process of budding;  $\times 625$ . Right, the formation of spores;  $\times 825$ .

familiar grayish, or bright colored (other than bright green) incrusting growths on old trees, fences, and rocks. They differ from all other Fungi in the fact that they incorporate Algae in their bodies; and the resultant symbiotic structure has a much more compact, definitely shaped, and even thallus-like construction than has the mycelium of other Fungi. While several are Basidiomycetes nearly all are Ascomycetes,

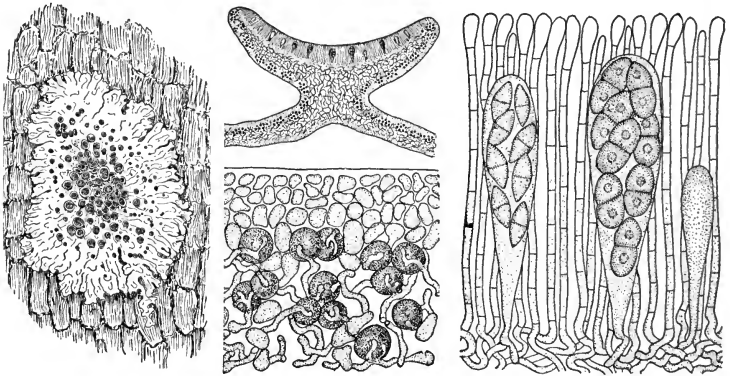

FIG. 322. — The Tree Lichen, *Physcia stellaris*, a foliose form.

Left, plant on a tree trunk; natural size. Center, above, vertical section through apothecium and thallus;  $\times 15$ . Below, vertical section into thallus, showing hyphae of Fungus in relation to the Alga (*Pleurococcus*);  $\times 200$ . Right, section through hymenium of the apothecium, showing asci, each with 2-celled ascospores, developing among paraphyses;  $\times 200$ . (Based on figures by Bergen and Davis, in part from nature.)

though belonging to different orders. While thus a somewhat diversified group phylogenetically, they have prominent characteristics in common, on which account it is convenient to consider them together. Some 4000 species are known, of which a few have minor economic uses.

A typical form is the common Tree Lichen, which grows as a grayish radiate incrustation on the bark of old trees (Fig. 322). On the thallus occur many little cups like the apothecia of the Discomycetes, with which, indeed, this form really belongs. The thallus-mycelium is composed of felted hyphae, which are compact towards the surface, but

looser within; and it sends rhizoidal threads among the inequalities of the substratum, to which it thus adheres. In the thallus can be seen the masses of Green Alga, around and against which the hyphæ form a close mesh. The reproduction in this form occurs chiefly through the ascospores, formed in asci among paraphyses in the hymenium of the apothecial cup, the entire arrangement being the same as already described for the Discomycetes (page 450). The Alga reproduces by division, keeping pace with the growth of the mycelium.

Among typical Lichens are the closely clinging or CRUSTOSE forms, often brightly colored, which occur upon rocks, including boulders, in old pastures. Other kinds are more leaf-like or FOLIOSE (Fig. 322), some of them, indeed suggesting Liverworts (Bryophytes). Others branch freely, almost like small shrubs, and are called FRUTICOSE, as in case of the Reindeer Lichen and the Long Moss of northern woods; while some are gelatinous or filamentous. The color in the Tree Lichen is gray, but in some others the Algæ show through, making them greenish. Others contain pigments which give them bright orange or red hues, as in case of some kinds common on rocks in pastures. They are mostly slow-growing and long-lived. The mycelium of the Fungus, slightly gelatinous in its texture, has high power of resistance to loss of water, with great capacity to absorb it when offered. This feature, in conjunction with the presence of photosynthetic Alga cells in the thallus, permits the Lichens to grow in more barren and exposed places than any other plants, even to bare rocks in alpine and arctic regions, and in deserts.

The Algæ in the Tree Lichen are Protococcales, and such Green Algæ are the commonest in Lichens; but Blue-green Algæ are frequent, and a few from other groups are known to occur. All are kinds which exist by themselves outside of the Fungus, though, almost without exception, the Fungus is unable to exist without the Alga. This fact

suggests the nature of the relation between the two, viz., the Fungus is parasitic upon the Alga, though the parasitism must be of a very mild sort, since the Alga suffers little if any injury therefrom. Indeed, it is possible that the Fungus is simply saprophytic upon the photosynthate the Alga produces. The Algæ, for their part, derive a certain minor benefit from the association, because the translucent thallus covers and protects them from desiccation and excessive

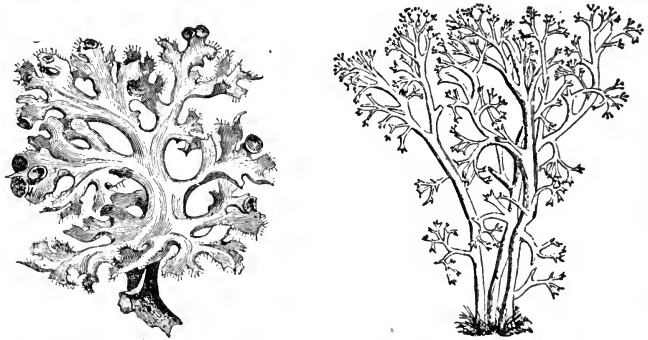

FIG. 323.—Fruticose Lichens, *Cetraria islandica*,  $\times \frac{1}{2}$  (left), and *Cladonia rangiferina*,  $\times \frac{1}{2}$ . (From Figurier, and Warming.)

insolation, thus permitting them to grow in much drier and more exposed places than they could otherwise endure. The relation between the two has been compared with that of master to slave, and on that account is sometimes called HELOTISM. It is of course because the Fungus does no serious damage to the Alga that they are enabled to grow perennially together.

The reproduction of the Tree Lichen, through ascospores formed in an apothecium as in Discomycetes, is typical of most Lichens, but some have perithecia. While fertilization precedes the formation of the ascocarp in many species, in others it does not, the sexual mechanism being more or less eliminated. In addition, many kinds reproduce vegetatively, either by portions of the thallus incidentally separated, or else from regularly-formed SOREDIA, *i.e.* rounded

masses of combined mycelium and Algæ, scattered by the wind. The ascospores are also carried by the wind, and germinate on reaching suitable situations; but the mycelium is unable to continue its growth unless it comes into contact with the suitable kinds of Algæ.

A very prominent Lichen is the so-called Reindeer Moss, a fruticose form bearing its apothecia as brown spots at the ends of the branches (Fig. 323). It abounds on northern plains, where it constitutes the favorite food of Reindeer and Caribou. The "Long Moss," which droops from the dead branches of northern evergreen trees, is a fruticose Lichen, though the superficially similar Long Moss, or Spanish Moss, of the southern trees is a flowering plant (page 535). A foliose form, the Iceland Moss (*Cetraria islandica*) is sometimes used as food by natives of northern countries. Many of the Lichens produce peculiar organic acids, which by suitable treatment can be converted into bright pigments useful in dyeing; and the litmus of laboratories is one of these.

Ecologically the Lichens are xerophytes, often living as epiphytes. Since they lead all other plants in advance upon barren places, their remains help to form a soil permitting the advance of Mosses and other forms. Phylogenetically, they are a composite group, brought into one for convenience, as already noted (page 460).

#### CLASS 10. BASIDIOMYCETES: THE BASIDIA FUNGI

(Part of Eumycetes)

These are the highest of the Fungi, and they include the most destructive of crop parasites, the Smuts and Rusts, together with the saprophytic Mushrooms, widely known because edible. They differ from the Ascomycetes in a pre-vaillingly greater size and prominence of the spore-producing bodies (as witness the Mushrooms and Puffballs), but chiefly in the absence of any externally visible sexual processes. The reproduction is effected mainly by the naked wind-carried

basidiospores, formed on basidia, which are specialized ends of hyphæ arranged more or less definitely in a hymenium. As noted already (page 449), the basidium is probably the morphological equivalent of the ascus (an everted ascus), and was formed originally after a fertilization which is now lost. The Basidiomycetes include more species than the Ascomycetes, — over 18,000. There is little doubt that they have been evolved from the Ascomycetes, though at a very remote period.

The Basidiomycetes include some four principal orders as follows :

ORDER 1. *USTILAGINALES: THE SMUTS.*

ORDER 2. *UREDINALES: THE RUSTS.*

ORDER 3. *HYMENOMYCETES: THE TOADSTOOL FUNGI.*

ORDER 4. *GASTEROMYCETES: THE PUFFBALLS.*

ORDER 1. *USTILAGINALES: THE SMUTS.* These are parasites causing destructive diseases chiefly in members of the Grass family, and especially in the cultivated cereals, the grains of which they fill with a powdery black mass of spores, — whence their name. Some 2200 species are known.

A common and destructive form is the Corn Smut (Fig. 324). When the spores reach a young Corn plant, they form mycelia which penetrate limited areas of any part of the plant, but develop especially in the stamens or the ovaries, which become greatly swollen. Inside these parts, the mycelium abstracts great numbers of thick-walled, dark colored resting spores, the "brand spores," which are the smut. These spores are disseminated by wind, rest over winter in the ground, and in spring germinate to a short mycelium (PROMYCELIUM) which lives saprophytically in organic material, for which reason the presence of manure greatly promotes the development of the disease. The cells of this mycelium give rise by budding to spores which are morphologically basidiospores despite their indefinite number; and moreover they increase still more by budding, much after the manner of the Yeasts. They infect Corn seed placed



in the ground, or young seedlings, and later produce again the mycelium and brand spores, as already described. This Smut also infests Oats and Wheat, doing them great damage.

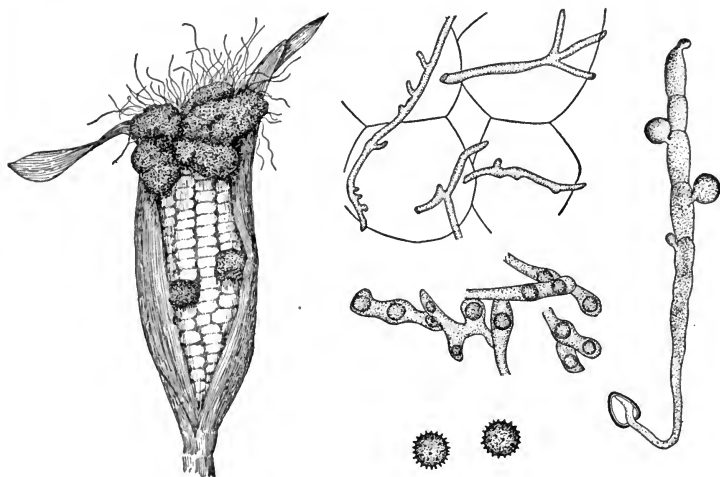

FIG. 324. — The life cycle of the Corn Smut (*Ustilago Zeæ*).

Left, ear of Corn containing characteristic smutted grains;  $\times \frac{1}{4}$ . Middle, above, the mycelium in cells of the Corn plant;  $\times 250$ . Below, tips of hyphæ in the grain forming the brand spores, and ripe spores;  $\times 250$ . Right, a spore germinated to the promycelium, which is developing sporidia, — the spores which infect new plants;  $\times 200$ . (First and last after Curtis, others after Knowles.)

Another species produces the so-called Stink Brand or Stinking Smut of Wheat, which smells like rotting fish.

Thus the life history of the Smuts includes two stages, — one parasitic on a host, and one saprophytic on the ground.

**ORDER 2. UREDINALES: THE RUSTS.** These are mostly internal parasites, especially of the Grass family, and are visible externally only in the spore masses, of which the dull red color gives the name to the group. They produce several kinds of spores, and are notable for their alternating stages upon different hosts, in a more complicated life cycle than is known in any other plants. Some 2000 species occur, including several of the most destructive plant parasites.

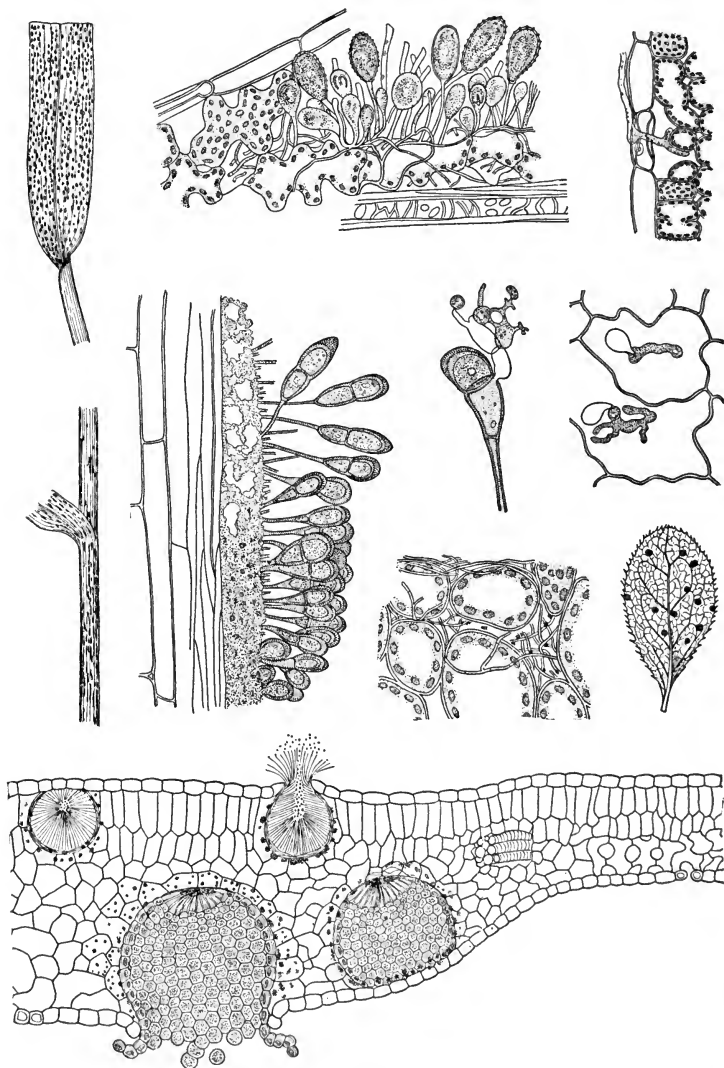

FIG. 325. — The life cycle of the Wheat Rust (*Puccinia graminis*).

Left, above, wheat leaf with rust, *i.e.* masses of uredospores;  $\times \frac{1}{2}$ . Next, a group of uredospores;  $\times 200$ . Next, mycelium from uredospore entering a wheat leaf through a stoma;  $\times 200$ . Middle, left, wheat stem

The most prominent, and a typical, member of the order is the Wheat Rust, which does great damage in wet seasons. Its complicated life history is shown in the accompanying Figure 325. The mycelium ramifies through the tissues of Wheat plants, which it greatly weakens, while here and there it breaks through to the surface and produces elongated clusters of one-celled, rough-walled, reddish uredospores which constitute the characteristic "rust." These uredospores, or summer spores, are disseminated by wind, and germinate immediately upon new Wheat plants, thus rapidly spreading the disease. Towards autumn, as the plants are maturing, other elongated, darker colored clusters appear, containing thick-walled, two-celled spores, called TELEUTOSPORES, or TELIOSPORES, which are winter spores, and rest in the ground over winter. In spring a teleutospore germinates in the ground to a 4-celled promycelium, each cell producing a SPORIDIUM or spring spore, — morphologically a basidiospore. Now comes a very striking feature of the life history of this Rust, for the sporidium will not infect a Wheat plant, but only a very different one, — the Barberry. The spores germinate on the epidermis, which they penetrate, and form in the leaf a copious mycelium. Later this mycelium produces in the Barberry leaf two kinds of structures, viz., smaller, flask-shaped SPERMAGONIA, containing non-functional SPERMATIA, usually on the upper surface, and on the lower surface, larger cluster cups, or ÆCIDIA, producing great numbers of æcidiospores. Spermagonia and æcidia are supposed to represent the remnants of a sexual apparatus, as in Ascomycetes, but functionless. The æcidiospores are disseminated by wind, and on reaching other Wheat plants,

showing masses of teleutospores;  $\times \frac{1}{2}$ . Next, a cluster of teleutospores;  $\times 200$ . Next, above, teleutospore germinating to promycelium bearing sporidia,  $\times 300$ ; and sporidia germinating on epidermis of Barberry leaf;  $\times 500$ . Below, chlorenchyma of interior of Barberry leaf infected by mycelium,  $\times 300$ ; and Barberry leaf, under side, showing æcidia;  $\times \frac{1}{2}$ . Lowermost, a cross section of Barberry leaf, showing on under surface the æcidia shedding æcidiospores, and on the upper surface, the spermagonia;  $\times 200$ . (Chiefly after Marshal Ward, in part from Carleton, and from nature.)

produce a mycelium which develops uredospores and teleutospores, as already described. Thus this plant includes in its life history three stages, two hosts, and four kinds of spores aside from the spermatia (or PYCNOSPORES).

While such is the life cycle of the Wheat Rust in localities where the Barberry occurs, that host may be omitted in case Winter Wheat is grown, for uredospores can hibernate in the young plants over winter, and re-infect the fields in the spring. Furthermore, varieties of this *Puccinia* appear to have been evolved with an æcidial host other than Barberry. The parasite is a particularly difficult one to combat, and cannot be destroyed by any known method which will not ruin the host plants. The greatest hope for its suppression lies through the breeding of immune varieties.

To this order belongs also the White Pine Blister Rust (*Cronartium ribicola*), recently introduced from Europe, and now threatening to rival the Chestnut disease in destructiveness. The two hosts are the Currant or Gooseberry and

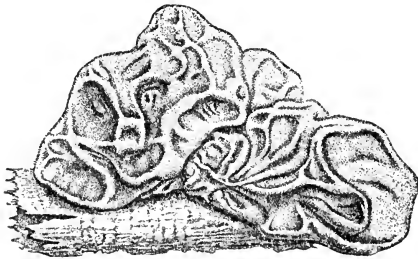

FIG. 326. — *Tremella mesenterica*;  $\times \frac{3}{4}$ .

The body is gelatinous, and the basidia form on the surface. (After Tulasne, from Bennett and Murray, *Cryptogamic Botany*.)

the White Pine, and, contrary to the case with *Puccinia*, the æcidial stage, on the Pine, is much the more destructive. For a year or more after infection the Pine shows no external sign, but then the mycelium destroys the cambium and inner bark, and therefore

kills the branch. On the bark now appear white blisters which break open and expose the yellowish æcidial spore masses. These æcidiospores do not infect Pines, but only Currant or Gooseberry leaves, in which the mycelium develops, and produces, on the under side, powdery yellowish clusters of uredospores. These are disseminated by the wind,

and infect only other leaves of those plants; but later in the season appear hair-like structures on which are developed many teleutospores. These, also disseminated by the wind, infect not Currants but White Pines, in which they produce the effects already described. This alternation of hosts seems invariable, and offers, through destruction of the Currant and Gooseberry bushes, the only known method of combating the disease.

Another member of this group (*Gymnosporangium*), having its æcidial stage on Hawthorns and Apples, causes the

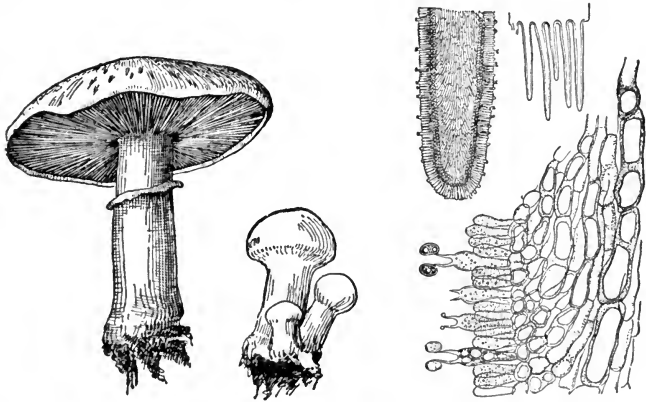

FIG. 327. — The common edible Mushroom, *Agaricus campestris*;  $\times \frac{1}{2}$ .

On the right, a section across several gills,  $\times 2$ ; a section across one gill,  $\times 10$ ; and a portion of one gill showing mycelium, hymenium, and basidia, with basidiospores,  $\times 25$ . (From Bailey, and Sachs.)

swollen gall-like growths called Cedar Apples on Red Cedar, while other members of the same group produce the largest Witches' Brooms (often called "Hurrah's Nests" in this country) upon Spruces and Firs, as earlier described (page 198; Fig. 147). And there are many other striking kinds, some having but one host, well known to experts in the subject.

The Uredinales are connected with the Hymenomycetes by intermediate forms, commonly treated as separate orders, of which the Ear Fungi (*Auriculales*), and certain Gelatinous Fungi (*Tremellales*, Fig. 326), are most prominent.

*ORDER 3. HYMENOMYCETES: THE TOADSTOOL FUNGI.* These are the Fungi par excellence to most people. They are chiefly saprophytic, having a slender-branching wide-ranging mycelium invisible in the ground or in dead tree trunks, and a prominent, typically umbrella-shaped sporophore (toadstool) on the surface. On the under side of the sporophore, and hence under protection from rain, falling débris, etc., occurs a hymenium (whence the name of the

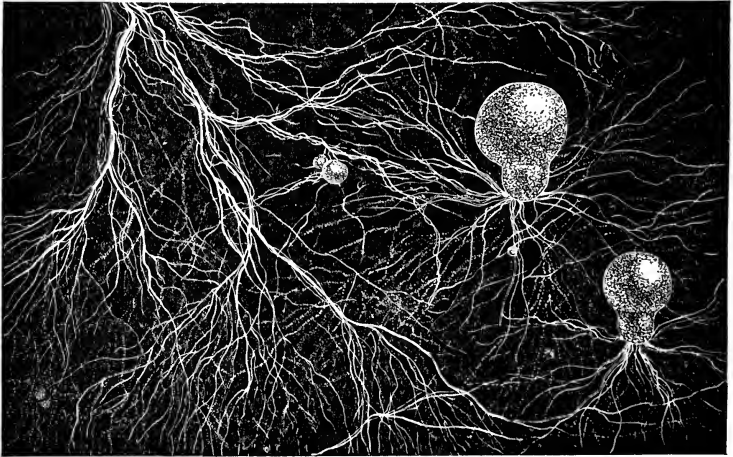

FIG. 328.— Typical mycelium of the Agaricineæ (*Amanita vernus*), showing its fine structure, and origin of the sporophores.

(Adapted from W. Hamilton Gibson, *Our Edible . . . Mushrooms.*)

order), containing basidia which produce the wind-carried basidiospores. The tissues of this sporophore, as of all Fungi, consist only of hyphal threads, which in this case are so compactly parallel or intertwined as to simulate the parenchyma of higher plants. Ordinarily soft in texture and sometimes collapsing in a deliquescent-gelatinous mass after shedding the spores, they are often persistent and hard as wood. Rarely other spores, especially conidia, are formed, but for the most part the basidiospores are the only reproductive bodies. No less than 10,000 species are

known, including all of the edible Fungi excepting a few Ascomycetes and Gasteromycetes; and many are violently poisonous. A few are parasitic and cause decay in living trees.

The Hymenomycetes fall into sub-groups according to their method of spreading the hymenium. Largest and most important are the *Agaricineæ*, the Agarics or Gill Fungi, of which the common Field Mushroom, now exten-

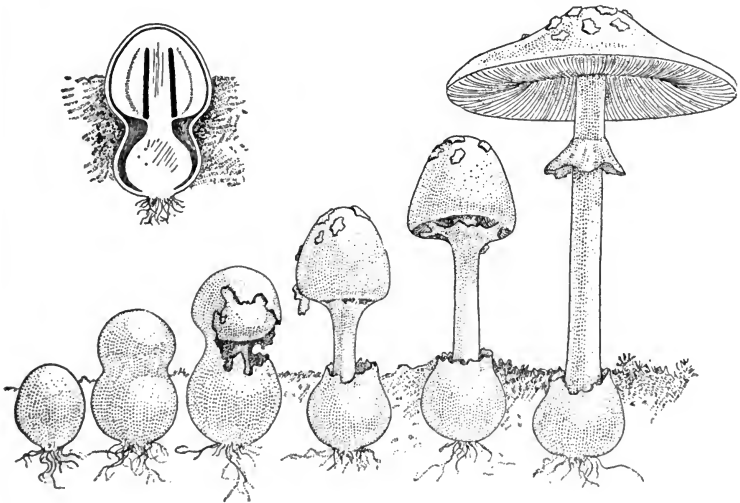

FIG. 329. — Development of the sporophore of *Amanita vernus*, partly diagrammatic;  $\times \frac{1}{2}$ . (After W. Hamilton Gibson.)

sively cultivated for market, is a typical member (Fig. 327). The mycelium, called "spawn" by the growers, ranges widely in rich humus in fine, white, cobweb-like growths (Fig. 328). Upon it, in places, develop compact rounded masses of hyphal threads, within which the sporophores are gradually differentiated. Later they break forth, and, as shown for an allied form in Figure 329, the stalk or stipe grows apogeotropically upwards, lifting the unfolding cap or PILEUS. The original wrapping persists in part as the VOLVA at the base,

or as flecks on the pileus, while a membrane which occurs between the edge of the pileus and the stalk persists as the ruptured VELUM. On the under side of the pileus develop the GILLS, *i.e.* regularly radiating plates of hyphal tissue completely clothed with the hymenium containing the basidia

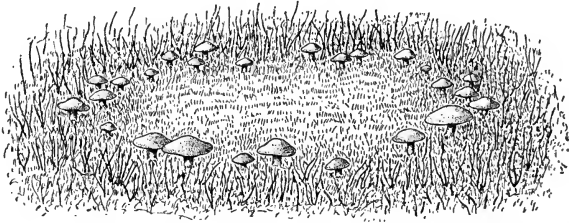

FIG. 330. — A Fairy Ring. (Adapted from Bonnier, *Le Monde Végétal*.)

(Fig. 327). On this account the basidiospores fall from the Mushrooms in radiating lines, as can be demonstrated prettily by placing a ripe pileus with the gills downward on dark paper.

While many of the *Agaricineæ* are edible (certainly over one hundred species in the United States), others are very poisonous, as in case of the common Deadly *Amanita*, which has a conspicuous bright orange-red pileus flecked with white specks (Fig. 329). No guides exist, except knowledge and experience, for telling the edible from the poisonous species, and many distressing accidents have followed amateur attempts to distinguish them. The poisonous, like the edible, quality seems a mere incident of the metabolism of the plants, and without adaptive significance; and the same appears true as to



FIG. 331. — *Hydnum repandum*; reduced. (From Strasburger.)



their colors, which are remarkably diverse, and often bright and even beautiful.

In many of this group, the mycelium is perennial, and, developing in humus, spreads radiately outward, probably away from its own excretions. Thus the sporophores of one year form a ring, which enlarges each season; and such is the origin of the well-known Fairy Rings (Fig. 330). A member of this order produces in wood the material which makes it phosphorescent in the dark. Another (*Rozites gongylophora*) is actually cultivated as a food plant by certain tropical ants. In the galleries of their nests, they grow the mycelium on leaves collected for the purpose, and feed upon enlarged protoplasmic bodies formed in great numbers at the ends of the hyphæ. These bodies are of wholly



FIG. 332. — *Boletus subtomentosus*;  $\times \frac{1}{2}$ . (From Bailey.)

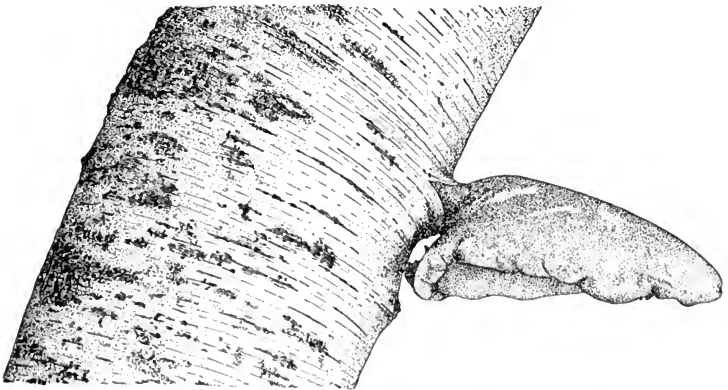

FIG. 333. — A Bracket Fungus, *Polyporus betulinus*, on a Birch;  $\times \frac{1}{2}$ . (Drawn from a photograph.)

vegetative nature, and in order to cause their continuous production, the ants regularly destroy the sporophores.

While the hymenium covers radiating gills in the forms just considered, it clothes spinose projections in the Tooth Fungi (*Hydnum* species), some of which have umbrella-shaped sporophores (Fig. 331), though in others they are flat incrustations.

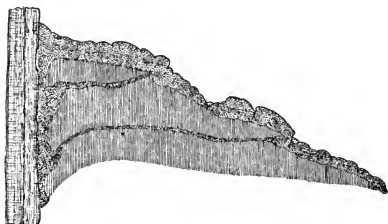

FIG. 334. — Sporophore of *Fomes ap-planatus*, and supporting trunk, in vertical section;  $\times \frac{1}{4}$ .

Of the 3 annual layers of hymenium, the lowest is the youngest. (After Buller, *Researches on Fungi*.)

Again, the hymenium forms a lining to tubes opening by pores, in the large group of Pore Fungi. These also have in some cases the umbrella-form sporophores, and are either edible or poisonous (*Boletus*, Fig. 332); but much more commonly (*Polyporus* species) they constitute the Bracket Fungi or Shelf Fungi of trees. Here the mycelium ramifies through the wood, which it gradually destroys, thus making the tree hollow, while the sporophore has the form of a bracket (Fig. 333), familiar on dying trees. These brackets are diageotropically horizontal, and often are perennial, forming each year a new layer of hymenium which covers the older (Fig. 334).

Belonging also to Hymenomycetes are the Coral Fungi (*Clavaria*, Fig. 335), of which the branching sporophores are tipped by red or yellow hymenium. Another form (*Exobasidium*) infests the ovaries of the Heath family, causing them to swell in a manner simulating galls (page 203).

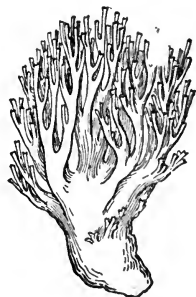

FIG. 335. — *Clavaria aurea*;  $\times \frac{1}{2}$ . (From Bailey.)

ORDER 4. GASTEROMYCETES: THE PUFFBALLS AND KIN. These, the highest of all Fungi, are in habit much like the Hymenomycetes, but their sporophores, usually approx-

inating towards globular form, remain closed until the spores are all ripe. They include some 700 species, and are of slight economic importance.

The best known and most typical members of the order are the Puffballs (Fig. 336; also 62). The subterranean saprophytic mycelium produces at the surface round masses of hyphæ, which gradually differentiate into a thin brown parchment-like wall (PERIDIUM), and an interior, chambered, soft mass of intermingled hyphæ and basidia (GLEBA), producing copious basidiospores. In ripening, the spores become dry, loose, and dark colored, and gradually escape through apical openings, from which they may be made to puff by sudden pressure. Some of the kinds break loose from the mycelium, and are rolled by the wind over the ground, thus scattering the spores. One kind attains a diameter of a foot and a half, and most of them are edible.

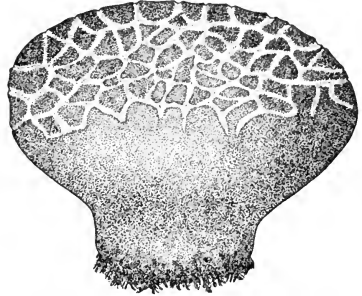

FIG. 336. — *Lycoperdon cyathiforme*;  $\times \frac{1}{2}$ . (After Peck.)



FIG. 337. — *Geaster tenuipes*;  $\times \frac{1}{2}$ . (From Le Maout and Decaisne.)

Closely related are the remarkable Earthstars (*Geaster* species), which are practically Puffballs in which the wall is double. The outer layer splits into regular segments (Fig. 337), free above, but attached below. These segments are hygroscopic, and curl backward and downward in wet weather, often so strongly as to lift and break the structure from the mycelium; and then the wind rolls it over the ground, scattering its spores. Some of these Earthstars contain a capillitium, in form and function strikingly like that of some Myxomycetes (page 413-4).

Less prominent but equally interesting are the Bird's Nest Fungi (*Nidularia*). In these the different hymenium-lined chambers of the gleba separate from one another and develop each its own envelope, in such manner that the opened fructification suggests a nest with several eggs.



FIG. 338. —  
*Phallus impu-*  
*dicus*;  $\times \frac{1}{2}$ .  
(From Stras-  
burger.)

Finally, we have the Carrion Fungi, or Stink Horns, best known in the common *Phallus impudicus* (Fig. 338). These remarkable sporophores differ from those of other Gasteromycetes in the fact that when ripe the gleba, which is conical in shape, breaks out from the peridium, and is pushed upward on the end of an elongated stalk. This gleba is fleshy and foul smelling, but thereby is attractive to carrion insects, which on their visits help to disseminate the spores.

Some of the Basidiomycetes, like Ascomycetes, form mycorrhiza with higher plants (page 244), presumably to mutual benefit.

#### FUNGI IMPERFECTI

To complete our synopsis of the Fungi, we must note the existence and nature of the great group, containing not less than some 16,000 to 17,000 kinds, included under this name. It is not a natural, but an artificial, assemblage, constituted for convenience to contain Fungi of which only fragments of the life history are known. Usually only conidia with associated mycelium have been found, and while in some cases this may represent the entire organism, in others there must exist additional stages which when discovered will transfer these plants to some one or the other of the recognized groups, probably to Ascomycetes for the most part.

With the Fungi, as with so many other phases of botanical

science, abundant and alluring problems still await the coming investigator.

Ecologically the Ascomycetes and Basidiomycetes are all hysterozytes, parasitic or saprophytic upon land plants almost entirely. Phylogenetically, their relationships have already been indicated (pages 448 and 464), and are shown, as they seem most probable, in Figure 275.

## CHAPTER XI

### DIVISION 2. BRYOPHYTA: THE MOSS PLANTS

THESE are the simplest of the land plants. They include the true Mosses, the low, dense, tufted, ground plants known to everybody, together with the less familiar Liverworts, which lie close to the ground, and are found in somewhat moister places. Over 16,000 species are known, mostly Mosses, but few have any economic use.

All Bryophytes are very low-growing, none rising more than a few inches from the ground. The plant body is typically leafy and upright in Mosses, but creeping and thallose in Liverworts. They have no roots, but send into the soil large hairs, called RHIZOIDS, which perform the root functions. Practically all of them synthesize their own food by aid of chlorophyll, one genus alone of Mosses being saprophytic and none parasitic. Their tissues develop from definite growing cells, as in higher plants, and are differentiated into epidermis with stomata, chlorenchyma with intercellular spaces, and elongated conducting cells, though no true ducts or sieve-tubes occur. This lack of a vascular system is without doubt the reason why they do not grow taller, their height being limited presumably by the distance through which water can be raised by diffusion from cell to cell in sufficient abundance for their needs. The intercellular air system, first developed in this group, permits aëration of deep-lying tissues, and hence more massive growth than is possible in water plants proper (page 562).

Reproduction occurs partly through diverse vegetative means, and partly through regularly alternating sexual and asexual methods. In the sexual reproduction, an egg cell formed in an elongated flask-shaped ARCHEGONIUM (char-

acteristic of this group and the Pteridophytes), is fertilized by a free-swimming sperm cell formed in an elongated many-celled ANTHERIDIUM. Thus the fertilization requires water (in this case rain or dew) as in the Algæ, from which the method is a survival. The fertilized egg cell grows at once into a more or less elaborate SPOROGENIUM or spore capsule, containing numerous asexual spores, which are disseminated by wind; and these spores develop into new plants. It is perfectly clear that the Moss or Liverwort plant represents the sexual generation, or GAMETOPHYTE, while the spore capsule with its appurtenances represents the asexual generation, or SPOROPHYTE. With these Bryophytes this alternation of generations, of which anticipations occurred in the Algæ and Fungi (pages 423, 446, 449), becomes firmly fixed, and it persists thenceforth throughout the higher plants. Moreover, this alternation bears in these plants a very definite relation to the reduction division of the chromosomes (page 285), for the number of chromosomes is always reduced in the divisions concerned in the development of spores, which are regularly formed in groups of four. The reduced number persists through all of the cells of the gametophyte, and is doubled with fertilization, after which the full number occurs in all of the cells of the sporophyte until the formation of the spores. It seems reasonably clear that the alternation of generations had originally the significance of a method of securing the development of several individuals from one act of fertilization. Later it became involved in alternation between fertilization and the reduction division, and thus it persists in the higher plants.

The Bryophytes fall into two distinct classes as follows :

CLASS 1. HEPATICÆ : THE LIVERWORTS.

CLASS 2. MUSCI : THE MOSSES.

#### CLASS 1. HEPATICÆ : THE LIVERWORTS

These are typically thallose land plants growing flat on the ground in moist places, though some float on water, or

even live submerged. They represent without doubt the transitional group between water plants and land plants, though the gap is wide between them and any known Algae. Some 4000 species are known, divided into four orders.

ORDER 1. *RICCIALES*: THE *RICCIAS* AND *KIN.*

ORDER 2. *MARCHANTIALES*: THE *MARCHANTIAS* AND *KIN.*

ORDER 3. *JUNGERMANNIALES*: THE *LEAFY LIVERWORTS.*

ORDER 4. *ANTHOCEROTALES*: THE *ANTHOCEROS* AND *KIN.*

ORDER 1. *RICCIALES*: THE *RICCIAS* AND *KIN.* These have a true thallus, suggestive of Algae, but possessing intercellular spaces like the

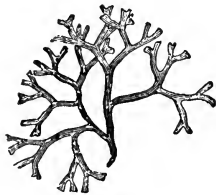

FIG. 339. — *Riccia fluitans*, natural size. Left, submerged form; right, land form. (After Goebel, from Strasburger.)

higher plants. They grow upon wet ground, but some forms are floating and can live submerged according to circumstances (Fig. 339). The archegonia and antheridia are

sunken in a groove along the middle line of the upper surface, and the fertilized egg cell grows into a simple, spherical, unstalked sporogonium, containing many spores.

ORDER 2. *MARCHANTIALES*: THE *MARCHANTIAS* AND *KIN.* These include the best-known Liverworts, of which the very common *Marchantia polymorpha*, abundant in the woods of north temperate regions, and therefore much studied in botanical laboratories, may be taken as representative (Fig. 340). The lobed and somewhat liver-shaped thallus was formerly supposed, in accord with the "doctrine of signatures," to have this form as an indication of sovereign virtues in the cure of diseases of the liver, — whence its class name. It creeps on the ground, to which it is attached by absorbing rhizoids. Its tissue is chiefly a colorless storage parenchyma overlaid by rhombic air chambers, which open through the epidermis by chimney-form, non-



closing stomata. In these chambers is the chlorenchyma, in loosely-arranged lines of cells,—an arrangement unusual in Liverworts, and one of several features in which *Marchantia* is peculiarly specialized. The thalli are dioecious,

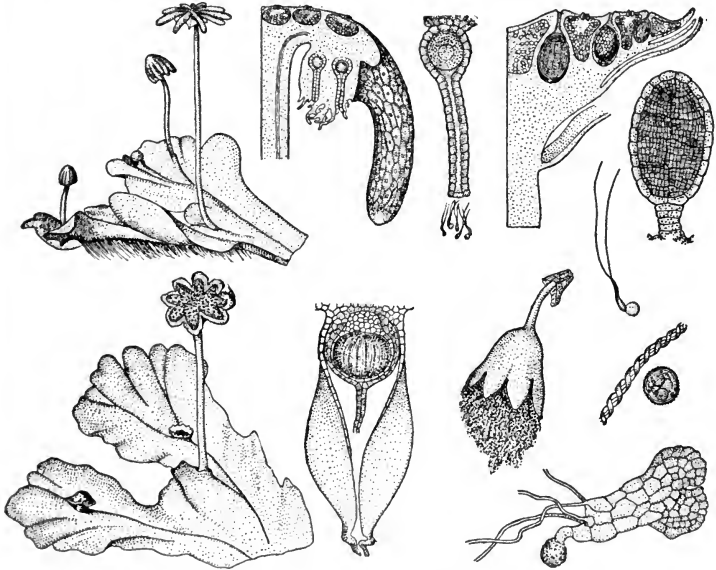

FIG. 340. — The life cycle of *Marchantia polymorpha*.

Left, thalli with archegonial and antheridial receptacles, and (on lower) gemmæ cups;  $\times \frac{1}{2}$ . Upper line, receptacles in median vertical section, showing archegonia and antheridia, and the characteristic air chambers,  $\times 5$ , and also an archegonium, with sperm cells, and an antheridium, in section,  $\times 20$ . Lower line, ripening sporogonium,  $\times 45$ , ripe sporangium emitting spores intermingled with elaters,  $\times 10$ , a spore and portion of an elater,  $\times 300$ , and a spore germinating to a thallus,  $\times 120$ . (Adapted from L. Kny.)

and the archegonia and antheridia are borne upon umbrella-shaped RECEPTACLES, which are upgrowths of the thallus midrib; and thus is explained the presence of bundles of rhizoids in unclosed tubes in the stalks of the receptacles. The antheridia, containing great numbers of regularly-arranged sperm mother cells, are borne in pits on the upper surface of the male receptacles, while the archegonia lie on

the under side (morphologically the upper) of the female receptacles. The fertilization requires water, *e.g.* heavy rain, and when conditions are favorable, the archegonia eject diffusible substances attractive to the sperm cells, which enter the neck, — the first to reach the egg cell effecting fertilization. The fertilized egg cell grows at once to a somewhat elaborate sporogonium, comprising a wall, a chamber containing many spores intermingled with hygroscopic ELATERS, and ultimately an elongated stalk, at the base of which persist the membranous remnants of the archegonium. This sporogonium represents clearly the

sporophyte, just as the thallus is the gametophyte. When ripe, the spore capsule bursts open, and the hygroscopic movements of the elaters force out the spores, which are disseminated by the wind, and on germination produce new thalli. In the *Marchantia* occurs also a well-developed vegetative reproduction by gemmæ, as earlier described (Fig. 211). The mode of growth of the perennial thallus incidentally effects the same end, for the death of the older parts results in separation of the lobes.

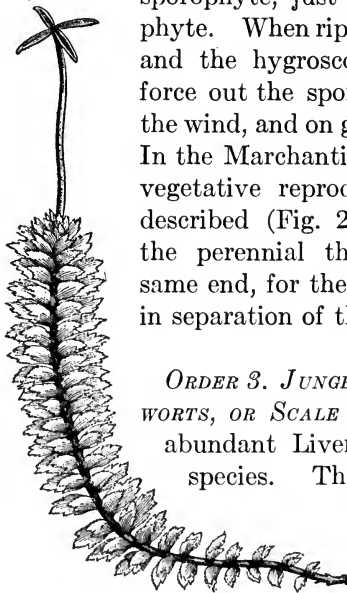

FIG. 341. — A leafy Liverwort, *Gottschea appendiculata*, with opened sporogonium; somewhat reduced. (From Le Maout and Decaisne.)

**ORDER 3. JUNGERMANNIALES: THE LEAFY LIVERWORTS, OR SCALE MOSSES.** These are the most abundant Liverworts, numbering some 3000 species. They are mostly tropical, and

grow not only on the ground, but also epiphytically on the trunks and even the leaves of trees; and very pretty forms occur in our own woods, mostly among the true Mosses on old fallen logs. While some are

thallose, as in the preceding order, they are usually, and characteristically, differentiated into slender, creeping stems bear-

ing two horizontal ranks of very delicate leaves (Fig. 341). These are scale-like, one cell-layer thick, without midrib, and very pleasing to see under the microscope. In some epiphytic forms the lower lobes of these leaves are developed to water-holding sacs; and many kinds have also

a third row of smaller leaves along the under side of the stem. The antheridia occur among the leaves on side branches, but the archegonia mostly terminate the main shoots. The sporogonium develops an elongated stalk and opens by four valves. Vegetative reproduction also occurs through various special bodies.

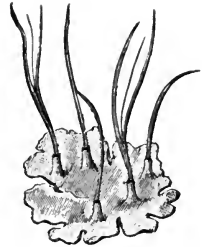

FIG. 342.—*Anthoceros laevis*, natural size.

The walls of the vertical sporogonium split in two valves from the columella, releasing the spores. (From Strasburger.)

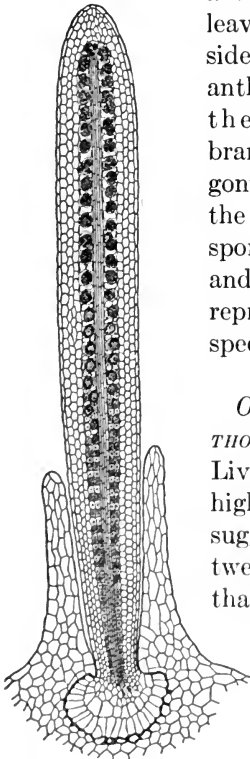

FIG. 343.—The sporogonium of *Anthoceros*, in median vertical section, diagrammatic, and greatly magnified. The spores are shaded.

**ORDER 4. ANTHOCEROTALES: THE ANTHOCEROS AND KIN.** These inconspicuous Liverworts form a small order, but are highly interesting because their structure suggests a possible mode of transition between Bryophytes and Pteridophytes. The thallus is simple, and rests on the ground like a *Riccia* (Fig. 342); but the archegonia and antheridia are sunken in the upper surface. The striking feature is the sporogonium (Fig. 343), which differs from that of other Liverworts in several respects. It has a very slender elongated form, and grows continuously from the base; the spores are borne not

in one large chamber but in many smaller ones separated by sterile cells; and the surface tissue is chlorenchyma which contains intercellular spaces and is covered with an epidermis containing stomata and guard cells like those of the higher plants, — this being the first appearance of such stomata. Thus this sporogonium, like the thallus, can synthesize its own food, though it is dependent on the thallus for the supply of water and mineral salts. Evidently the development of a root would make it a complete plant, and in this case the two generations, the gametophyte (thallus) and sporophyte (sporogonium) would be entirely independent of one another vegetatively. This is precisely what happens in some Pteridophytes, as will later appear.

#### CLASS 2. MUSCI: THE MOSSES

These are well known to everybody, even sufficiently to make “mossy” a word of familiar significance. They are distinguished by the dense growth of their usually vertical, slender stems, which bear spirally-arranged, very thin, small green leaves, with long-stalked spore capsules rising above the stems. These leaves and stems do not correspond morphologically to the thallus or the leafy stem of Liverworts, but are rather special upgrowths from the actual thallus, which consists of a system of creeping, branching, felted, green filaments called the PROTONEMA. They occur in diverse situations, from hydrophytic to xerophytic, but generally in drier places than the Liverworts. They reproduce vegetatively in various ways, and sexually like the Liverworts, but with more elaborate sporogonia. The archegonia and antheridia are borne at the upper ends of the stems, sometimes on the same but commonly on different plants; and often they are surrounded by compactly arranged and even somewhat colored leaves having an aspect which has suggested the erroneous name “moss flowers.” The sporogonium, on a slender SETA, or stalk, is a somewhat

elaborate and highly specialized structure provided with chlorenchyma. Some 12,000 species are known, but only the Peat Mosses have any economic uses. The name is wrongly extended in some cases to plants which are not Mosses, as *e.g.* Sea Mosses, Long Moss, Spanish Moss, Reindeer Moss, etc. They fall into two principal orders, viz:

ORDER 1. SPHAGNALES: THE PEAT MOSSES.

ORDER 2. BRYALES: THE TRUE MOSSES.

ORDER 1. SPHAGNALES: THE PEAT MOSSES. These are very soft-spongy Mosses occurring only where ground water is plentiful; and oftenest they form close mats or tussocks in wet woods, or else fill shallow ponds. They belong all to one genus, *Sphagnum*, having about 250 species, mostly in temperate and arctic regions. Their very slender stems (Fig. 344), part creeping and part upright, grow indefinitely at the tips, often branching, and thus may attain great length and age (page 115). The leaves, one cell layer thick, consist of alternate rows of chlorenchyma and larger, empty, perforated cells, which absorb and hold water by capillarity (Fig. 345); and as the stems are clothed with similar cells there results a very unusual power of holding water, which is one of the chief characteristics of these mosses. In exposed places they are mostly red in color, but are bright green in shade. The antheridia occur singly in the axils of the leaves on special short branches, while the archegonia terminate the upper branches, where they are



FIG. 344. — *Sphagnum cymbifolium*;  $\times \frac{1}{2}$   
(From Kerner.)

replaced after fertilization by the long-stalked rounded spore capsules. These stalks, while apparently identical with those of true Mosses, have a very different morphological origin, for they are developed by the gametophyte. The spores are disseminated by wind, and germinate in wet places to a small thallus-like protonema, on which the new leafy *Sphagnum* originates from a bud.

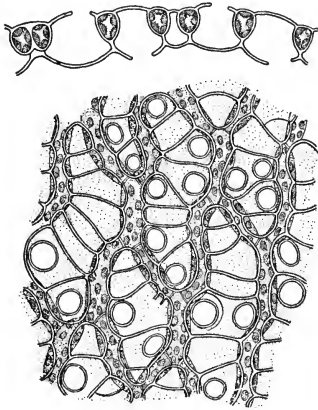

FIG. 345. — Leaf of *Sphagnum*;  
× 600.

Above, cross section, showing the smaller chlorenchyma and larger water cells, the latter with capillary openings. Below, surface view. (Adapted from Sachs.)

The Peat Mosses develop especially well in shallow sheltered ponds. From the shores they grow outward in a mat, which at first floats, but later becomes compacted and sunken by the continuous upward growth of the Mosses and other plants which associate themselves therewith. The poor drainage in such places permits accumulation of organic acids which check the activity of decay-causing Molds and Bacteria; and thus the dead

remains of the Mosses, with roots and rootstocks of associated plants, accumulate until the basin is filled and the pond disappears. This is the way in which the peat bogs, so characteristic of high northern regions, are formed; and after the same general manner, but with different plants, the coal beds were formed in the swamps of the Carboniferous era. More than this, the Peat Mosses, by virtue of their great power of water absorption, can actually grow a dozen feet or more above the original level of the pond, thus forming remarkable raised bogs. These are treeless, and bear only small shrubs and other low-growing plants.

The compacted peat from the lower levels of the bogs forms a valuable fuel, much used in Ireland especially. The looser moss of the upper layers, and especially of the raised bogs, makes valuable litter in stables, is much used by florists in packing plants, and is utilized, because of its antiseptic and absorptive properties, as a dressing in surgery. The antiseptic property of the bogs causes also the preservation of animal bodies, and thus the remains of men and other animals, which become buried in them, remain often long intact. In this way, also, the bones of extinct animals, like the Mastodon and Great Irish Elk, have been preserved to our own time.

*ORDER 2. BRYALES: THE TRUE MOSSES.* These are the Mosses par excellence, distinctive of much drier places than the Peat Mosses. Their densely-crowded, small, leafy stems, bearing the characteristic stalked spore capsules at their tips (Fig. 346), rise from creeping protonemata and send down stout rhizoids, this arrangement enabling them to advance over the ground much as do the Grasses, in solid phalanx. They occur in mat-like or tussock-like masses not only on the ground, but on fallen tree trunks, and even on standing trees, where they become true epiphytes; and they are also familiar on old fences, and roofs of old houses. They are by no means confined to genial climates, but extend over open barren ground and moors, especially in arctic and alpine places, where they follow close after the Lichens in their occupancy of places too inhospitable for other life. In such forms the typical intense green is often overlaid by other bright colors. Thus they are the typical carpet plants of the drier places of the earth as the Liverworts are of the moister; and our existent forms are presumably the relics of an original green carpet which covered the uplands of the world before any larger vegetation had been evolved in those situations. They have no economic uses.

The typical life cycle in true Mosses is illustrated in Figure 346. On the upright leafy stems, which are the gametophytes, are borne the sporogonia, which are the sporophytes. The latter consist of spore capsules at the summit of tall

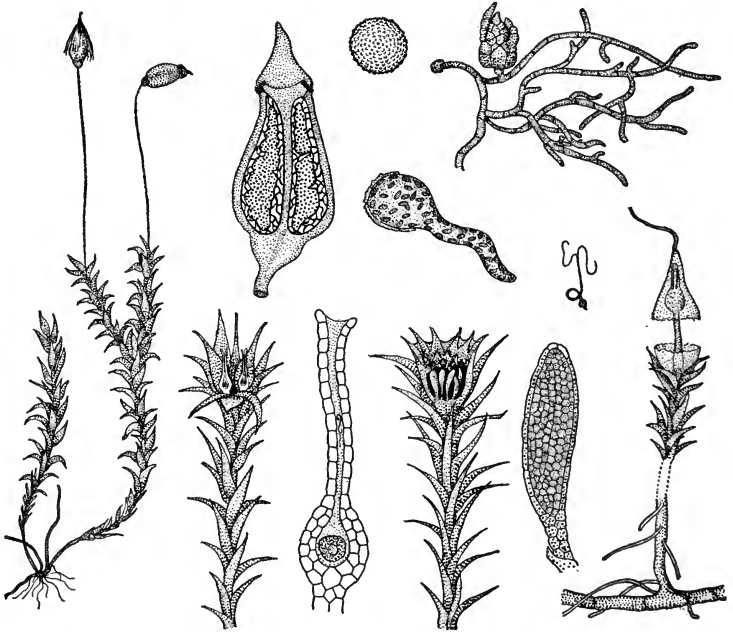

FIG. 346. — The life cycle of a Moss, mostly *Polytrichum*.

Left, the plant;  $\times \frac{1}{2}$ . Next, above, the capsule, in vertical median section,  $\times 6$ , with spore and germinating spore,  $\times 300$ , and a spore germinated to a protonema bearing a bud from which develops the familiar leafy plant,  $\times 75$ . Below, archegonial shoot,  $\times 2$ ; with archegonium in section,  $\times 16$ , antheridial shoot,  $\times 2$ , with antheridium,  $\times 16$ , and single sperm cell,  $\times 600$ . Last, developing sporogonium, showing origin of calyptra from enlarged archegonium. (After Dodel-Port, and other sources.)

slender SETÆ; and they are usually capped by the CALYPTRA, a loose conical cover which is a relic of the archegonium. The spore capsule in the true Mosses is a highly specialized structure. At its base is a swelling, the APOPHYSIS; at its tip is a cap, the OPERCULUM, which falls off at maturity, released



from a special ring, the ANNULUS; beneath the operculum is the PERISTOME, which is a circle, sometimes two, of diversely marked slender teeth; the spore case proper is a chamber which surrounds a central COLUMELLA, while outside of the chamber occurs always some chlorenchyma. When the spores are ripe, the operculum is forced off by the swelling of the annulus, leaving the capsule open except as guarded by the peristome; and the movements of the strongly hygroscopic teeth thereof both permit and aid the ejection of the spores. All these features of the spore capsule, and especially of its peristome, show remarkable diversity in details of construction and ornamentation in the different species (Fig. 347), providing indeed another instance of apparent specialization far beyond bounds of utility. The spores are disseminated by wind, and on reaching a suitable place, germinate into a branching, filamentous, green protonema. On this appear buds, whence grow the vertical stems, while new rhizoids enter the ground from their bases. At the tips of these stems, sometimes on the same but often on different ones, appear elongated archegonia and antheridia. In the antheridia are produced many two-ciliate spiral free-swimming sperm cells, which probably reach the vicinity of the archegonia in splashing water drops. The opening archegonium puts forth substances attractive to the sperm cells, of which the first to enter the neck effects fertilization of the egg cell. From this oöspore develops the new sporogonium.

As a whole the Mosses are rather uniform in habit. A few species live in water (*Fontinalis* species), and are cor-

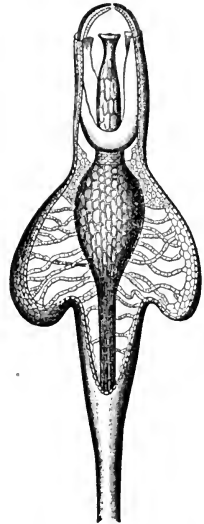

FIG. 347. — Spore capsule of the Moss, *Splachnum vasculosum*, illustrating extreme structural specialization;  $\times 65$ . (From Kerner.)

respondingly modified, while at the opposite extreme, those in very dry, cold, mountainous regions form dense, compact, radiate tussocks. A European form, living in caves, has a very remarkable protonema, which has been much studied from a physiological point of view (Fig. 348).

Ecologically the Bryophytes represent the typical carpet vegetation of the land, — the Liverworts in the moister and the Mosses in the drier places; and both become also epiphytes. Phylogenetically they are the lowest of true land

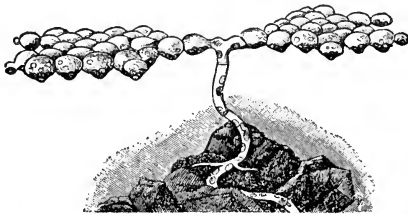

FIG. 348.— The protonema of *Schistostega osmundacea*, a cave-dwelling moss;  $\times 200$ .

The cells are so shaped as to concentrate the feeble light upon chloroplasts in the depression at the bottom of each cell. (From Strasburger.)

plants, and no doubt represent a survival of the first land forms which evolved from the Algæ. Presumably they were never taller than now, their lack of a vascular system being prohibitive of such growth. It is probable, however, that in a period of geological history prior to the

development of any other land vegetation, the surface of the earth was covered with a dense green carpet of Liverworts and Mosses, which became in large part displaced by the later development of Pteridophytes and Spermatophytes. As to the group of Algæ from which they arose, there is much uncertainty, since connecting links are missing. In some features of their reproduction the Bryophytes show resemblance to the Brown Algæ, though much other evidence implies descent from the higher Green Algæ. Probably Brown Algæ and Bryophytes originated close together among the higher Green Algæ, somewhere near *Coleochæte*, as suggested in our phylogenetic tree (Fig. 275). Indeed, a transition is not difficult to suppose from the submerged disc-form thallus of *Coleochæte* (page 424), to the floating, and later land-dwelling, thallus of simple Liverworts like *Riccia*;

and a transition can also be imagined, though here with more difficulty, in the reproductive structures. Of the two classes, the Liverworts are obviously nearer the Algae, and the Mosses are presumably an ancient offshoot from them.

## CHAPTER XII

### DIVISION 3. PTERIDOPHYTA: THE FERN PLANTS

THESE are the highest of the CRYPTOGAMS, a name which was long since applied to the three divisions of plants producing free spores, because their sexual reproduction was believed to be hidden or obscure in contrast with that of the PHANEROGAMS (the Flowering Plants or Spermatophytes), where it seemed obvious. Though not wholly accurate in fact, the word is retained for its convenience. Pteridophytes are often called also VASCULAR CRYPTOGAMS, because they alone of Cryptogams possess a vascular system. This, however, they share with the next division, the Spermatophytes, with which they are sometimes combined as VASCULAR PLANTS. The Pteridophytes and Bryophytes together are often called ARCHEGONIATÆ, because they possess in common, and exclusively, the distinctive archegonium.

At first sight the Pteridophytes present a very heterogeneous aspect, for they include with the familiar Ferns the wholly dissimilar little floating Water Ferns, the rush-like Horsetails, and the Club Mosses, which suggest true Mosses but are coarser and creeping. Although the plant bodies are so different, the reproduction shows features which unite them all into one group.

The Pteridophytes possess in common five important features which mark them off from the Bryophytes. *First*, their well-developed vascular system, containing true ducts and sieve-tubes, has enabled them to grow greatly in height, even to forming trees in tropical forests, while the Bryophytes, now as probably in the past, reach hardly a foot above ground. Not only the vascular system, but the other tis-

sues in the Pteridophytes, reach a degree of differentiation far in advance of the Bryophytes, even rivaling if not equaling the Spermatophytes. *Second*, they have developed the shoot, and especially the leaves, in very high degree, as manifest in the beautiful great fronds of the Ferns. *Third*, they possess true roots, substantially like those of Spermatophytes, and a great advance over the bryophytic rhizoids. The main root, however, soon ceases to grow, and is replaced by numerous adventitious rootlets. *Fourth*, while their alternation of generations is morphologically identical with that in Bryophytes, the relative prominence of the generations is reversed, for the conspicuous green plant is now the sporophyte, while the gametophyte is reduced to a much smaller, and often insignificant, thalloid structure called the PROTHALLUS. The chromosome numbers, however, keep their former relations, and the reduction division still occurs in the formation of the spores. Thus the half number prevails through the gametophyte, with a doubling at fertilization, and the full number occurs in all the cells of the sporophyte. *Fifth*, the Pteridophytes in their higher forms possess not a single kind of spore as in all lower groups (HOMOSPORY), but two kinds (HETEROSPORY), differing in size and in the fact that one kind produces male, and the other female, prothallia, or sexual plants. This arrangement is carried farther in the next group, the Spermatophytes, where the smaller male-producing spores become the pollen grains, and the larger female-producing spores become the embryo sacs of the ovules. The spore-cases are called SPORANGIA, and occur commonly in clusters, which are often large and prominent.

The reproduction in the Pteridophytes is essentially like that of Bryophytes, even to the point that the sperm cells are free-swimming, and require water for fertilization. This fact makes it necessary that the sexual stage be kept where such fertilization is possible, viz., close to ground which is occasionally wet; and this factor greatly limits the distri-

bution of Pteridophytes, because it prevents their extensive occurrence in very dry places.

The living Pteridophytes number some 4500 species, and many more are known in the fossil state. Few have any economic importance. They fall into three classes.

CLASS 1. FILICINEÆ: THE FERNS.

CLASS 2. EQUISETINEÆ: THE HORSETAILS.

CLASS 3. LYCOPODINEÆ: THE CLUB MOSSES.

### CLASS 1. FILICINEÆ: THE FERNS

These include the Ferns par excellence of our own woods, with the more abundant and larger kinds, which are even true trees, in the tropics, where also occur some very delicate and filmy forms. Here belong also some small "Water Ferns," very different in aspect. The class contains three principal orders.



FIG. 349. — The Adder's Tongue Fern, *Ophioglossum vulgatum*;  $\times \frac{2}{3}$ . (From Bennett and Murray.)

ORDER 1. OPHIOGLOSSALES: THE ADDER'S TONGUE FERNS.

ORDER 2. FILICALES: THE FERNS PROPER

ORDER 3. HYDROPTERIDALES: THE WATER FERNS.

ORDER 1. OPHIOGLOSSALES: THE ADDER'S TONGUE FERNS. This small order is chiefly important because of the primitive character of its members. It includes the Adder's Tongue (not to be confounded with the liliaceous plant of that name) and the Moonwort of our own flora (Fig. 349). Upon the stalks of single leaves rising from underground root-stocks are developed close spikes of thick-walled (EUSPORANGIATE) sporangia, which contrast markedly with the thin-walled type (LEPTOSPORANGIATE) of the true Ferns.

In this they closely resemble early fossil kinds. Their prothallia live underground, are saprophytic, and are penetrated by a mycorrhizal Fungus (Fig. 350).

Closely allied are the *Marattiales*, another small order of large tropical ferns having short, tuberous stems. While frondose like the Tree Ferns, the sporangia on those fronds are of the thick-walled, primitive, eusporangiate type, though the prothallus is green, resembles a Liverwort, and has the antheridia and archeogonia on the under side.



FIG. 350. — The subterranean prothallus of *Ophioglossum vulgatum*;  $\times 10$ .

The larger dark structures are antheridia, the smaller (just visible each as four small cells) are the necks of archeogonia. A young sporophyte projects to the left. The black threads are mycorrhizal hyphæ. (After Bruchmann.)

#### ORDER 2. FILICALES: THE FERNS PROPER.

These are familiar enough in their frondose stage, but not in the stages of their very interesting life history, which may best be understood from a typical example (Fig. 351).

The ordinary Fern plant of our woods has a creeping, perennial, often underground stem, from which rise annually, usually in a rosette, the familiar fronds. On the under sides of the fronds occur many brown spots, the SORI, which are clusters of spore cases, SPORANGIA, often partially covered by a membranous INDUSIUM. The stalk of each sporangium is prolonged into a thick-walled incomplete ring, the ANNULUS, which, when mature, suddenly straightens hygroscopically, ruptures the thin side walls, and throws out the spores. These spores, which have roughened brown walls, are disseminated by wind, and germinate upon damp, shaded ground. Here they produce not the familiar Fern plant but a PROTHALLUS, which recalls the homologous thallus of a Liverwort.

The prothallus is a dainty structure, mostly one cell layer thick. It synthesizes its own food, sends rhizoids into the ground,

and is green, and thus is an independent plant. On its under surface it bears archegonia, which are flask-shaped bodies containing each an egg cell, much like those of Bryophytes but shorter and partly sunken in the prothallus; while the antheridia are compact structures developed

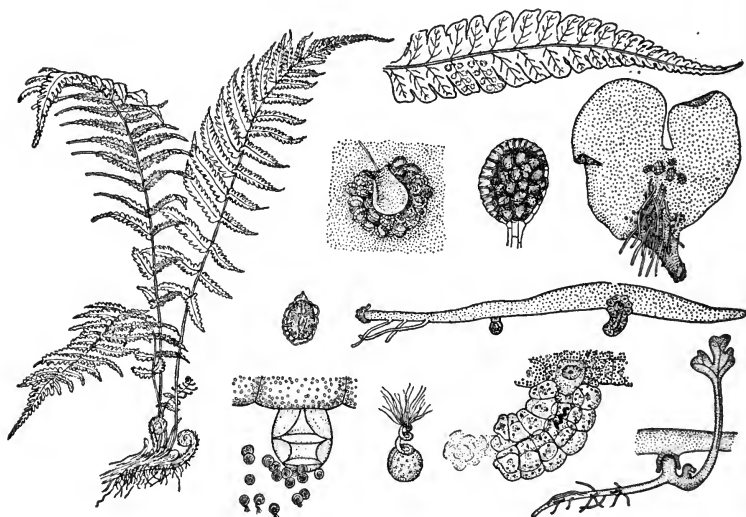

FIG. 351. — The life cycle of a Fern, chiefly *Aspidium* species.

Left, the plant;  $\times \frac{1}{16}$ . Right, above, a pinna showing sori;  $\times \frac{1}{2}$ . Second line, a sorus, showing indusium and sporangia,  $\times 10$ ; a sporangium,  $\times 50$ , with a single spore (below, left),  $\times 100$ . Next a prothallus, seen from below, showing the spore, rhizoids, archegonia and antheridia,  $\times 3$ , with a median section below,  $\times 6$ . Lower line, antheridium expelling sperm cells,  $\times 120$ , and a single sperm cell, with still-attached lining of mother cell,  $\times 300$ ; ripe open archegonium, with sperm cell in neck,  $\times 120$ ; and young Fern developing from fertilized egg-cell. (In part from nature, and in part after L. Kny.)

on the surface. In these are formed the sperm cells, which are spiral and multi-ciliate, and carry for a time the sac-like lining of their mother cell. On access of water the antheridia swell and expel the sperm cells, while the archegonia exude a substance, *i.e.* malic acid, very attractive to them. Accordingly, they swim into the open neck of the



archegonium, and one of them fertilizes the egg cell, as already described (page 306). In most cases, antheridia and archegonia are not ripe at the same time on a prothallus, thus insuring a cross-fertilization between different prothallia (page 287). The fertilized egg cell divides into four parts, which in the formation of the embryo develop respectively the first root, leaf, and stem, with an absorbing foot, which remains in the prothallus and absorbs all available nourishment therefrom until withered. The young root establishes connection with the ground, the leaf rises and begins to form new food, and soon the young plant is growing thriftily into the familiar frondose Fern.

In this, as in other Ferns, the tissues are very highly differentiated, being well-nigh identical, structurally and functionally, with those in the highest plants. The fibro-vascular bundles are usually of a concentric type, in which the phloem surrounds the xylem; and often they have remarkably specialized shapes as seen in cross-section (Fig. 352). Commonly the epidermis contains chlorophyll, a feature associated with their life in the shade. Often they bear many chaffy or hairy growths, a form of trichomes (page 19); and small adventitious, even aërial roots, are readily produced.

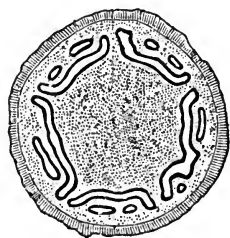

FIG. 352. — The fibro-vascular bundles of a Fern (*Cyathea* species) in cross-section;  $\times \frac{1}{2}$ . (From LeMaout and Decaisne.)

The identity of the two generations in the Fern is clear, for the prothallus is a typical gametophyte and the frondose plant the sporophyte. Here, however, is involved a specially interesting feature in the evolution of the alternation of generations, viz. both generations spread green tissue to light and have their own connection with the soil, being thus independent plants as concerns their nutrition. The Ferns are the only group in which this is true, for below them the sporophyte is dependent more or less upon the gametophyte.

and above them, as will presently appear, the gametophyte is dependent upon the sporophyte. In this respect the Ferns are a pivotal group.

While the life cycle here described is usual in the Ferns, various deviations occur. Thus sometimes a sporophyte buds out from the tissue of the prothallus, fertilization being omitted, a condition called APOGAMY; and prothallia sometimes bud out from the leaves of the sporophyte, producing APOSPORY. Also, in some kinds little bulblets appear on the fronds, and develop young plants, even (in *Asplenium bulbiferum*), while still in place. Commonly the sori are spaced apart in regular order on the under sides of the fronds, but in some species they are confined to segments which are wholly devoted to their formation. In others they are confined to fertile fronds, likewise wholly devoted to them, the ordinary fronds being sterile, as in the common Sensitive Fern (*Onoclea sensibilis*). The sori themselves are very diversely shaped, — round, kidney-shaped, elongated, and even in lines under the overturned edge of the leaf, as in the Maidenhair and the common Brake. The fronds are in some kinds entire, in others once compound, in others several times compounded, often in forms of great grace, as our Maidenhair and Tree Ferns especially illustrate. It is, indeed, in the form of their fronds and the arrangement of their sori that the true Ferns find that play of variation which in some form or other is exhibited by all highly specialized groups of plants.

While most Ferns are terrestrial some are epiphytic, as *Platynerium* (page 186), and Filmy Ferns (*Hymenophyllaceæ*), remarkable for the delicacy of their very thin leaves. There are climbing (twining) Ferns and a Walking Fern, which advances by rooting at the tip of its elongated leaves, on the principle of the traveling stems already described (page 188). Most striking of all are the Tree Ferns (Fig. 31), which grow to forty feet in height, with great crowns of frondose foliage, and rough trunks clothed with

small adventitious dried aërial roots. These plants are survivals of a type common in the first forests of the earth.

*ORDER 3. HYDROPTERIDALES: THE WATER FERNS.* These include a few small aquatic plants, not in the least fern-

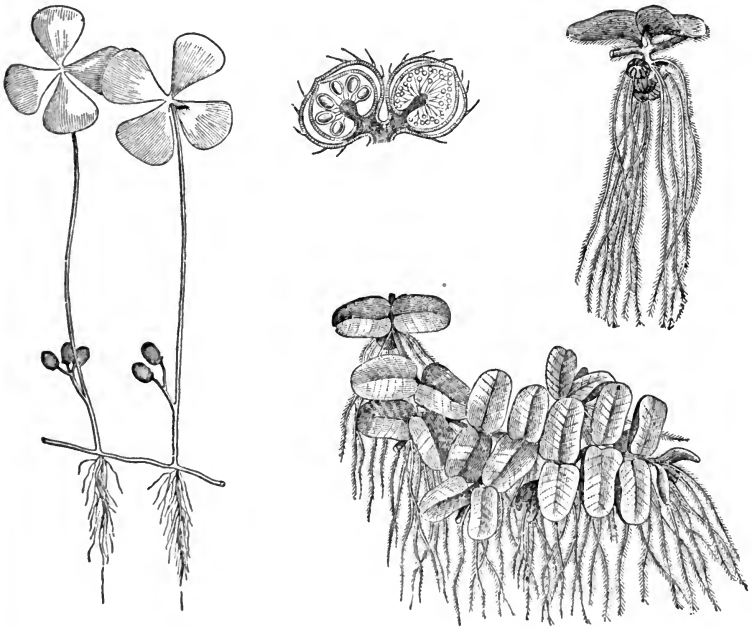

Fig. 353. — Water Ferns.

Left, Clover-leaf Fern, *Marsilia quadrifida*, somewhat reduced. Above, middle, sporocarps of the latter, showing megasporangia and microsporangia,  $\times 4$ . Below, *Salvinia natans*,  $\times \frac{2}{3}$ ; and above, right, one node of the latter, showing the sporocarps. (From Kerner.)

like in aspect, but bound to that group by many features of their reproduction. They are further distinguished by their highly developed heterospory.

The commonest of the group is the Clover-leaf Fern (Fig. 353) which grows in shallow ponds. From a creeping rootstock rise slender shoots bearing at their tops two bilobed, opposite leaves simulating four leaflets, while near the

base are the rounded sporocarps. These contain two kinds of sporangia with two kinds of spores. The megaspores develop a small prothallus bearing one archegonium, and the microspores a small prothallus having antheridia with large, spiral, free-swimming sperm cells. After fertilization the embryo develops by aid of food stored in the megaspore, an arrangement which approaches very close to that found in the seeds of the higher plants. Another common form is *Salvinia*, which is small and floating (Fig. 353). At each internode occur three leaves, of which two are floating and entire, while one is submerged and cut to many fine, hairy, root-like, pendent divisions, among which occur the sporocarps. These contain two kinds of sporangia and spores, whereof the development is like *Marsilia* in principle though not in detail. Another allied form is *Azolla*, with much smaller floating leaves, in lobes of which are hollows occupied regularly by filaments of *Anabaena*. Herein we have an example of an ENDOPHYTE (page 401), though its relation to the economy of the *Azolla* is uncertain.

## CLASS 2. Equisetineæ: THE HORSETAILS, OR SCOURING RUSHES

These plants are in part rush-like, and in part slender, excurrent, and bushy, as expressed in their English name. They grow along water margins, but also in sandy ground, being among the first plants to spring up along railway embankments. Those of temperate regions are never more than a few feet high, but a tropical kind, leaning on other vegetation, reaches forty feet. They number only 25 species, all in one genus *Equisetum*, and their economic uses are minor. Of fossil forms a great many are known, of which some grew to great trees, especially in the Carboniferous Period; and our existent herbaceous kinds are their degenerate descendants.

The sporophyte consists of creeping, perennial rootstocks from which rise slender, erect, hollow, fine-fluted stems, on

which the leaves are reduced merely to sheathing scales. The cones of sporangia are always terminal. In some

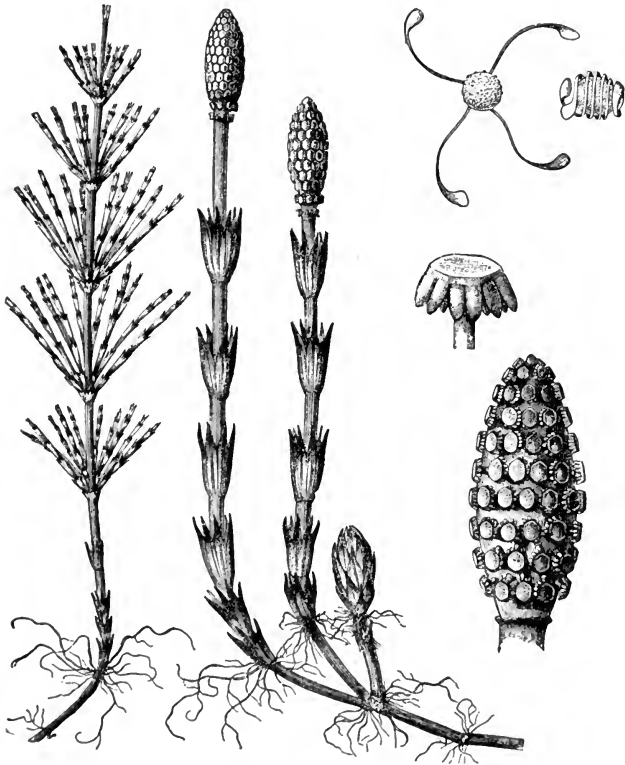

FIG. 354. — *Equisetum arvense*.

Left, a sterile, green, shoot; next two fertile, uncolored, shoots;  $\times \frac{1}{2}$ . Right, below, a strobilus, showing shield-shaped sporophylls, with sporangia,  $\times 2$ ; above, one of the latter,  $\times 6$ ; uppermost, spores, with elaters coiled and uncoiled,  $\times 20$ . (From Kerner.)

species the rush-like stems are green, columnar, and unbranched, but in others the cone-bearing stem is without chlorophyll, while a separate shoot is green and usually branched in whorls in a way to suggest the name Horsetails (Fig. 354). The tissues are rather remarkably differen-

tiated, the vascular bundles being much like those of endogenous stems (page 135), while there are separate strengthening strands. Commonly the epidermis contains much silica, — enough to permit the use of the stems for polishing or scouring purposes, whence one of their names. The spores, all of one kind, occur regularly in sporangia, which lie on the under side of peltate sporophylls of such form that they fit together in ovate cones or strobili. The spores bear each

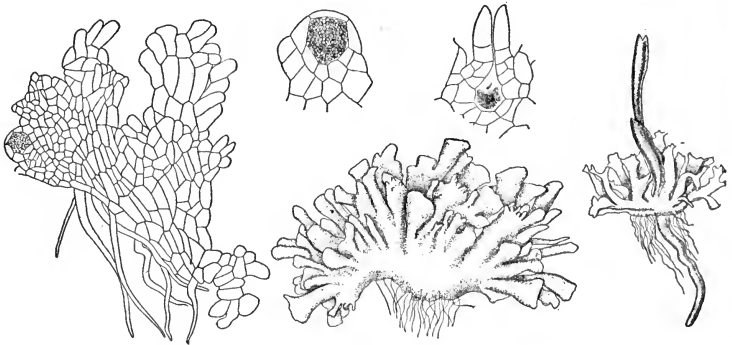

FIG. 355. — The prothallia of *Equisetum arvense*.

Left, male prothallus, showing antheridium,  $\times 35$ , and, next, an antheridium,  $\times 80$ . Below, female prothallus,  $\times 10$ , and above, an archegonium,  $\times 80$ . Right, young sporophyte,  $\times 6$ .

four slender hygroscopic arms or elaters, which help to lift them from the sporangia, and keep them hooked together in groups as they are disseminated by the wind. This attachment to one another involves physiological advantage, since the prothallia produced by the spores are dioecious; and fertilization, by the free-swimming sperm cells, is therefore facilitated by their contiguity. These prothallia (Fig. 355), somewhat resemble Liverworts, and bear the antheridia at the tips, and archegonia near the bases, of the lobes. After fertilization the egg cell grows to a new plant, much as in Ferns. While all living forms are homosporous, many of the fossil kinds show well developed heterospory.

CLASS 3. LYCOPODINEÆ: THE LYCOPODS, OR CLUB  
MOSSES

These are most familiar in the Ground Pine and its relatives, which are trailing plants resembling coarse Mosses, frequent in our own woods, and in the Selaginellas, which are ornamental fern-like plants much grown in conservatories. They are nearly all perennial trailing evergreens with small leaves, and commonly possess terminal erect clusters of sporophylls which often are club-shaped, originating the name. They number some 700 species, of which few have any economic importance. Though now all creeping forms, the group formerly included great trees. They comprise two orders, —

ORDER 1. LYCOPODIALES: THE CLUB MOSSES PROPER.

ORDER 2. SELAGINELLALES: THE SELAGINELLAS.

ORDER 1. LYCOPODIALES: THE CLUB MOSSES PROPER.  
Typical forms of this order are well shown in our Figure 356. They are mostly terrestrial creepers, but some are

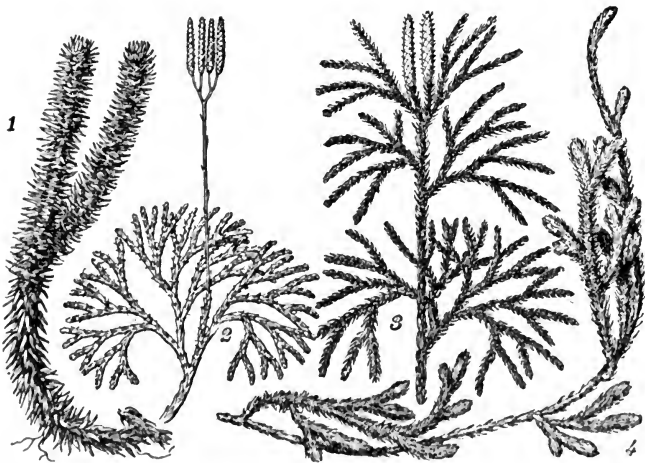

FIG. 356. — Species of *Lycopodium*.

1. *L. lucidulum*; 2. *L. complanatum*; 3. *L. obscurum*; 4. *L. clavatum*, (lacking strobili); all about  $\frac{1}{2}$ . (After Knobel, from Bailey.)

epiphytic. They branch freely, not from axillary buds but by fission of the terminal bud, *i.e.* by **DICHOTOMY**. The tissues are well differentiated, but the fibro-vascular system is primitive in type, for it consists really of one large central bundle in which the xylem is completely surrounded by phloem in the young stage, though they become intermingled when older (Fig. 357). From such a bundle, by fragmentation, so to speak, has probably arisen the system prevailing in

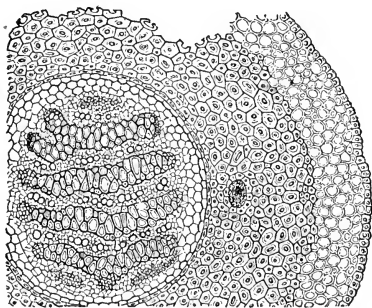

FIG. 357. — The stem of *Lycopodium complanatum*, in cross section;  $\times 75$ .

The stele, or central cylinder, contains several masses of xylem, with intermediate phloem; these are branches from one mass of xylem surrounded by phloem in the young stem. (From Sachs.)

the higher plants, which possess a ring of bundles, each with phloem outside of the xylem. The simple sporangia, producing only one kind of spores, occur singly on the leaves, just above the base on the upper side; and accordingly such leaves are typical sporophylls. There are species in which every leaf of the plant is a sporophyll, and such cases are of interest as showing a possible mode of transition from a

sporogonium like that of *Anthoceros* (page 483), to the sporophyte of the higher plants; for one has only to imagine that the green tissue around the spore chambers in *Anthoceros* (Fig. 343), grows out into leaves, carrying the separate spore chambers part way with them, to have a condition like that in *Lycopodium*. In other species, the lower leaves are sterile, becoming typical foliage leaves, while the sporophylls become collected together into clusters, called **STROBILI**, sometimes with no abrupt transition to the leaves, but again in definite, compact, stalked, and often club-shaped, clusters. This is the highest condition these plants attain. The sporangia open by slits and shed the spores which are dis-



seminated by wind. These spores are very light and happen to be also very inflammable, on which account they have been used somewhat in fireworks, under the name "vegetable sulphur." They germinate to prothallia which are remarkably diverse in the different species, some being green, and others partially so (Fig. 358). Others are completely buried in the ground, tuberous, symbiotic with mycorrhizal fungus, much as in case of *Ophioglossum* (page 495). Archegonia and antheridia are sunken in the prothallus, and the free-swimming sperm cells are biciliate, as in Liverworts. The fertilized egg cell germinates to an embryo having a suspensor as in the Spermatophytes, and remains buried in the prothallus until well developed, — other features which bring these plants very close to the Spermatophytes.

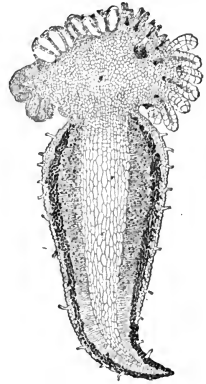

FIG. 358.—Prothallus of *Lycopodium complanatum*, in optical section;  $\times 10$ .

The lower portion is tuberous and subterranean, and the upper is above ground. In the latter can be seen archegonia, antheridia, and an embryo. (After Bruchmann.)

**ORDER 2. SELAGINELLALES: THE SELAGINELLAS OR LITTLE CLUB MOSSES.** These resemble in general the Lycopodiales, but are more delicate and graceful. They abound most in the tropical regions. Their leaves occur usually in horizontal ranks, suggesting the Leafy Liverworts, for which our native species might readily be mistaken. Many of the species possess a unique structural feature in the RHIZOPHORES, which are leafless stem-like structures springing from the under sides of the stems, and developing roots when they enter the ground. While most of the species are terrestrial, some are partly climbing or epiphytic. An interesting form, rather familiar because often sold by itinerant vendors, is the Resurrection Plant (*Selaginella lepidophylla*), a rosette form which closes to a compact ball when dried, and opens

out flat when watered, — presumably in the functional class of the Tumbleweeds (page 359).

Of special interest is the reproduction in *Selaginella* (Fig. 359), for its form of heterospory brings it very close to the

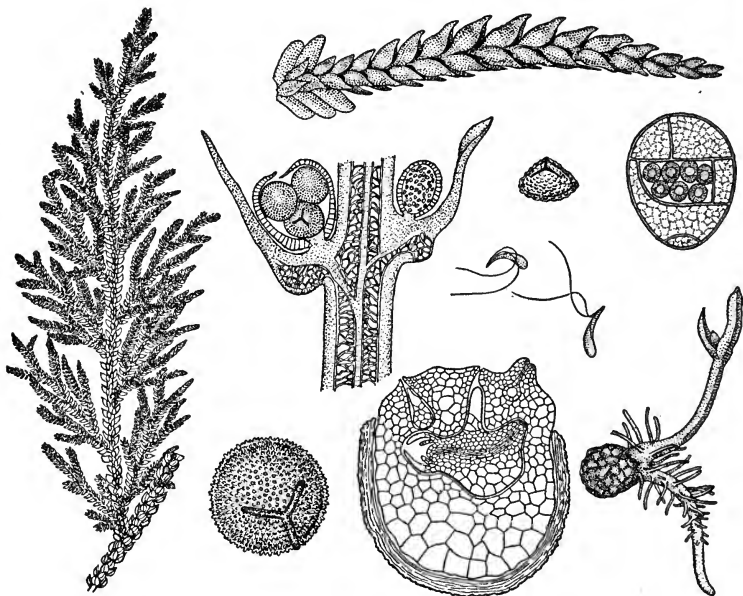

FIG. 359. — The life cycle of *Selaginella*, the stages from various species. Left, a branch from a typical plant;  $\times \frac{1}{2}$ . Next, above, a strobilus;  $\times 5$ . Second line, part of a strobilus in median longitudinal section, showing megasporangium with megaspores on left, and microsporangium with microspores on right;  $\times 25$ . Next a microspore,  $\times 250$ , and a germinated microspore, in section, the single prothallial cell being below,  $\times 500$ , and two sperm cells,  $\times 500$ . Lower line, a megaspore,  $\times 75$ , and a germinated megaspore, with archegonia and a fully formed embryo embedded in the prothallus,  $\times 150$ . Finally, a young plant developing from the embryo,  $\times 40$ . (In part after Dodel Port.)

Seed plants. The sporophylls are collected in terminal strobili (Fig. 223), and bear in their axils two kinds of sporangia, containing two kinds of spores. Both kinds are formed in fours, in correlation with the reduction division of the chromosomes. They begin to germinate while still

in the sporangia. The microspores develop a prothallus of only one cell, the remainder of their contents forming a large antheridium containing the sperm-cells, which are free swimming and biciliate. The megaspore forms a multicellular prothallus mostly inside the spore, though it breaks the coat and grows somewhat outward, producing the archegonia on the exposed part. After fertilization, which in some kinds occurs while the spores are still on the plants, the egg cell grows to an embryo which has a suspensor and remains for some time buried in the prothallus, as in case of the Seed plants. In germination the foot, one of the four primal subdivisions of the embryo as in Ferns (page 497), often remains in the prothallus after the root and shoot have issued, much as do the cotyledons in some Seed plants. Indeed it is possible that this haustorial foot, and not the first leaves, is the morphological prototype of the cotyledons.

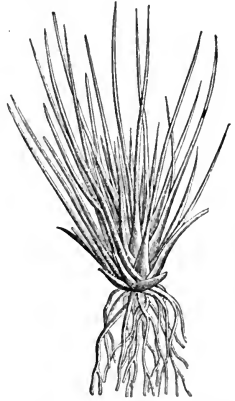

FIG. 360. — *Isoetes lacustris*;  $\times \frac{3}{4}$ . (From Kerner.)

Related to the Lycopods in their mode of reproduction, though very different vegetatively, is *Isoetes*, the Quillwort (Fig. 360), which grows in marshes and shoal ponds. The plants are tufted, with awl-shaped leaves, at the bases of which are borne the heterosporous sporangia.

The homologies of these parts are all perfectly clear. The Selaginella plant is the sporophyte, but there are two gametophytes, male and female, which are not independent plants as in the true Ferns, but dependent for their nutrition upon food supplied by the sporophyte. This condition continues also in the Spermatophytes, and stands in great contrast to that in forms below the Ferns, where the gametophyte is the prominent vegetative plant, and the sporophyte is dependent for nutrition upon it.

## EXPLANATION

Gametophytes on left, sporophytes on right, all in median section. Shading shows place of photosynthesis. Circles are reproductive cells: heavy, sexual; and light, asexual. Signs | and # mean single and double number of chromosomes. Lines with arrows: solid mean fusion of sex cells, and dotted mean closing of life cycle. Dotted structures are the other generation.

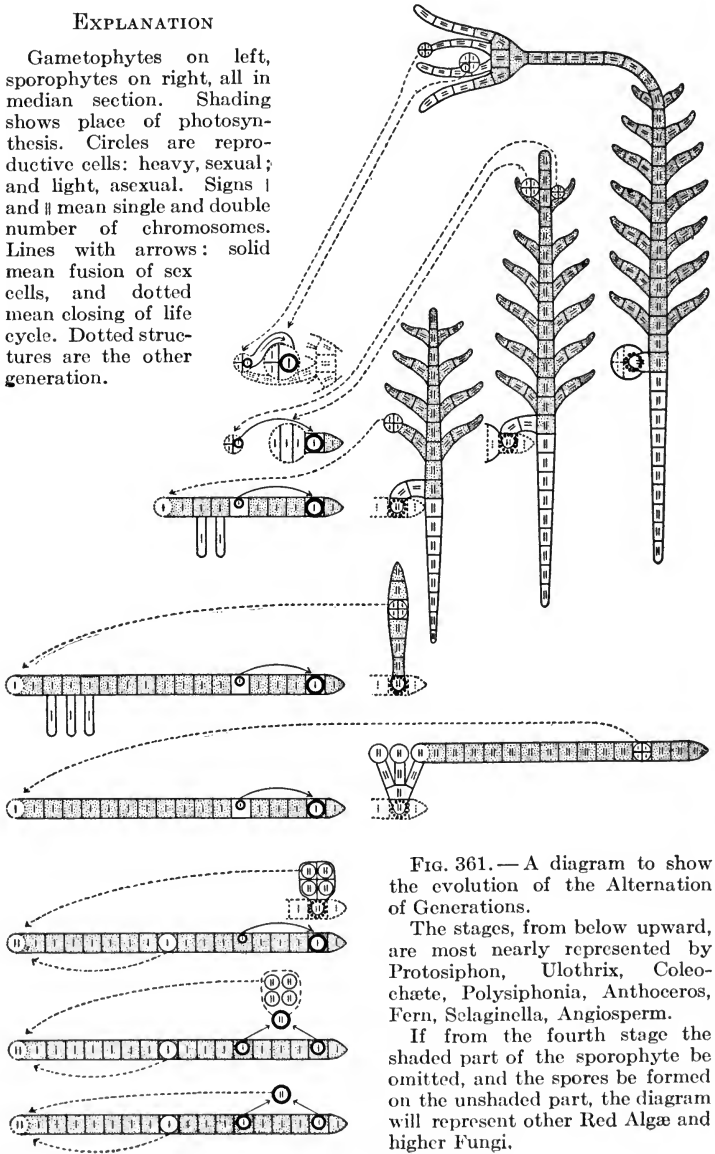

FIG. 361.—A diagram to show the evolution of the Alternation of Generations.

The stages, from below upward, are most nearly represented by Protosiphon, Ulothrix, Coleochæte, Polysiphonia, Anthoceros, Fern, Selaginella, Angiosperm.

Fern from the fourth stage the shaded part of the sporophyte be omitted, and the spores be formed on the unshaded part, the diagram will represent other Red Algæ and higher Fungi.

The subject of the alternation of generations is one of the most interesting in plant morphology. It has been mentioned often in the preceding pages, and may now be summarized to advantage in a diagram (Fig. 361). It should be noted, however, that not all investigators take the view of its origin accepted in this book, for some maintain that the sexual and asexual generations were originally not different but alike in structure, as *Polysiphonia* suggests, the differences being supposed to have developed subsequently. This is termed the HOMOLOGOUS theory of alternation, as contrasted with the ANTITHETIC theory now generally accepted.

Viewing the Pteridophytes as a whole, it is a striking fact that the living forms are insignificant in number and size as compared with those which flourished in past geological ages, notably in the Carboniferous Period. Then there were many great Tree Ferns, of the eusporangiate type, and giant arborescent Horsetails, especially of the kinds called *Calamites*, and stately tree Lycopods, of the genera *Lepidodendron* and *Sigillaria* (Fig. 362). Of these and many more, the remains are found finely preserved as fossils in the rocks, while they make up the chief part of the material of the coal beds. These beds were formed in great swamps of lush vegetation which was preserved from decay by the presence of organic acids, precisely as in case of the peat bogs still forming in northern regions (page 486). If one asks why the Carboniferous Period in particular was the time of such active coal formation, the answer is probably this, that previously there was no great amount of large woody swamp vegetation. The Bryophytes, probable predecessors of the Pteridophytes, were only carpet plants, unable to rise above the ground; and hence they were unable to utilize the greater abundance of carbon dioxide then prevailing in the atmosphere. The Pteridophytes, however, with their vascular system, were able to form great forests, which rapidly fixed the abundant carbon dioxide as carbon in their tissues, setting free the oxygen; and the process continued until the

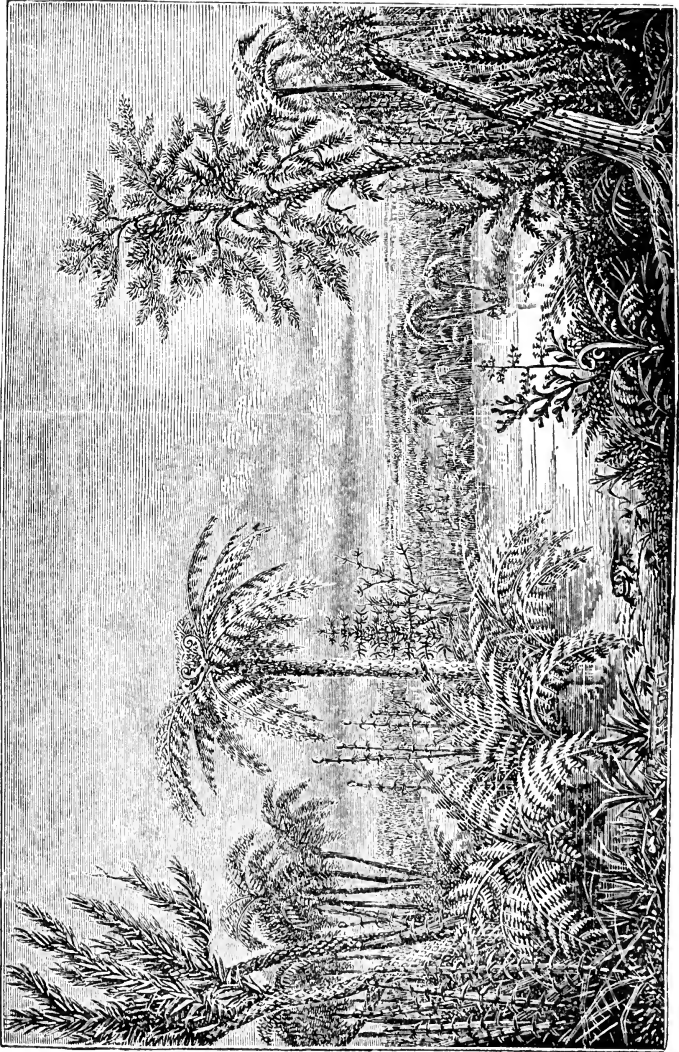

FIG. 362. — Vegetation of the Carboniferous Period, chiefly Pteridophytic, as reconstructed from fossils by Dana.

carbon dioxide was reduced to a point where new growth and decay nearly balance, as at present. The steps in the conversion of plant tissue to coal are well known, and have already been indicated in brief (page 99).

Ecologically, the Pteridophytes are typically terrestrial plants, mostly mesophytes, though some are water plants, some are epiphytes, and a few are xerophytes. While undoubtedly they formed the first forest vegetation of the earth, they have been largely superseded by the more highly developed Spermatophytes, and manage to linger only in the undergrowth of tropical forests or as creeping forms in our own woods. Phylogenetically their relations are somewhat uncertain. No one of the three classes seems to have been derived from any of the others, but all three must have had independent but contiguous origins from lower forms. It is not likely that they came directly from the Bryophytes, though this view was long held, but apparently Bryophytes and Pteridophytes came anciently from one stock, which evolved from the higher Green Algæ (Fig. 275).

## CHAPTER XIII

### DIVISION 4. SPERMATOPHYTA: THE SEED PLANTS

(Phanerogamia: the Phanerogams or Flowering Plants)

THESE are the highest plants, and include the great majority of the familiar trees, shrubs, and herbs which constitute the present vegetation of the earth. They are distinguished from the lower divisions by three special features, all of which have been expressed in names given to the group, viz. by the seed, the flower, and the pollen tube. They comprise some 133,000 species, making over half of the known total of 233,000; and they include the great majority of the plants useful to man.

The structure of these plants was treated so fully in Part I of this book as to need here only brief mention. The plant body is segregated into *leaf*, *stem*, and *root*, devoted to the photosynthetic formation of food, with *flower*, *fruit*, and *seed*, concerned with reproduction and dissemination. The tissues include the waterproof *epidermis* with guarded *stomata*, the *bark* with *lenticels*, the photosynthesizing *chlorenchyma*, the strengthening strands of *sclerenchyma*, the conducting bundles of vascular *phloem* and *xylem*, the growth tissue of *meristem* including *cambium*, the storage *parenchyma*, and the intercellular *air system*. All of this structure is primarily fitted to a terrestrial life, and the Spermatophytes constitute the characteristic and dominant terrestrial plants. They are, however, more than this, for their relatively high differentiation of structure permits more ready adaptation to special situations, whereby they are enabled to compete with the other groups in their own habitats. Thus they have almost wholly displaced the Pterido-



phytes as forest plants, are competing with the Bryophytes as carpet plants, are intruding among the Algæ as water plants, and are even entering the domain of the Fungi as parasites.

Reproduction in Spermatophytes occurs to some extent through various minor vegetative methods, but the principal form is sexual, which is universally present. The method thereof has already been explained (pages 269-79). The *egg cell* lies in an embryo sac which forms in a *nucellus* inclosed by *integuments* except for a *micropyle*. This *ovule* is commonly but not always inclosed in an *ovary* provided with *style* and *stigma*, and surrounded by showy or protective parts. The sperm cell is formed in the *pollen grain* which develops in the *anther* of the *stamen*, and is transferred to the vicinity of the ovule not by any power of locomotion of its own but by action of wind, insects, etc. From the pollen grain develops a haustorial tube which grows through all intervening tissues to the egg cell, to which it brings a sperm nucleus. The fertilized egg cell grows to an *embryo* plant which is nourished from *endosperm* developed within the embryo sac; and this embryo, with its food and the thickened ovular coats, separates from the ovary and plant as the *seed*. This seed is the dissemination stage of the plant, and as such is a resting body which can long endure dryness and other unfavorable conditions; and in this state it is carried afar by winds, water currents, or various animals according to the structural features it presents. Later, under favorable conditions, it germinates, and produces a new plant, which develops new egg cells and sperm cells in its turn.

The homologies of the parts in Spermatophytes and Pteridophytes are perfectly clear (Fig. 361). The familiar conspicuous plant is in both the *sporophyte*. The spores, in Spermatophytes as in Selaginella, are of two kinds. The *megaspores*, which remain permanently attached to the parent plant, are the embryo sacs, in the early stage with a

single nucleus. They are normally one to a megasporangium, which is the nucellus, the coats being a new growth apparently not represented in Pteridophytes unless by the indusium in Ferns. Although but one megaspore develops, four are usually formed, as in *Selaginella*, in connection with the reduction division, but three are aborted. The *microspores* are the pollen grains, in the early stage with a single nucleus. They also are formed in tetrads in microsporangia, which make the anthers. The *sporophylls* are the carpels and stamens, which are megasporophylls and microsporophylls respectively (page 327), though it is still uncertain whether petals and sepals represent sterilized sporophylls or specialized foliage leaves. The gametophytes, advancing a stage beyond *Selaginella*, develop wholly inside the spores, in great contrast to the true Ferns, where the gametophyte grows out from the spore, turns green, and becomes the independent prothallus. The gametophyte produced by the megaspore is represented by the organized contents of the embryo sac, appearing ultimately as the food substance or endosperm, which is therefore the prothallus, while the archegonium, no longer necessary in this situation, becomes rudimentary and finally disappears, leaving the egg cell only. The gametophyte produced by the microspore is represented by the organized contents of the pollen grain after the internal cell divisions, which in some forms produce rudimentary prothallial cells (Fig. 366), and always two sperm nuclei which are carried by the pollen tube to the embryo sac.

Thus the gametophytes in Spermatophytes are reduced very greatly from their former high estate as an independent generation in the true Ferns, and as the main plant in all groups below them, while the sporophytes, originally the dependent spore cases in lower forms, have become stately green plants (Fig. 361). This remarkable overturn in the relative importance of the two generations appears to have resulted from the fact that the vertical position of

the sporophyte, acquired originally by the first land plants in adaptation to the need for lifting the spores into the air for their dissemination by the wind, offered an opportunity for the development of lateral food-forming members, and hence for an indefinite increase in height, which was not possible to the creeping habit of the original gametophytes. It is possible, however, that the presence of the double number of chromosomes in the cells of the sporophyte may have had influence in promoting its greater development.

In many respects the Spermatophytes exhibit no great advance over the Pteridophytes. In differentiation of the plant body and of the tissue systems, the improvement is only minor, presumably because those parts had already attained in the Pteridophytes the fullest functional efficiency of which they are capable. In reproduction, also, the advance is slight except in one particular, which, however, has proven profoundly important, viz. the transfer of the sperm cell from its place of formation to the egg cell is no longer accomplished by free locomotion in water, but by a combination of wind or animal dissemination with growth of a pollen tube. This method has rendered the fertilization of the Spermatophytes independent of the presence of standing water which the Pteridophytes require for the locomotion of their free-swimming sperm cells. It is for this reason that the Fern plants must keep a prothallus on ground that is occasionally wet, a fact which greatly limits the range of the Pteridophytes. Freed from this need by the pollen tube, the Spermatophytes have been able to extend over much drier country than the Pteridophytes. Moreover, they have been able to keep the prothallus on the sporophyte, and even within the spore itself, where, greatly reduced, it still has part in the formation of egg cell and sperm cell, and acts as a store of nourishment for the embryo plant.

Ecologically the Spermatophytes are typical terrestrial plants, mostly of the kind called mesophytes (page 190); but they have also diverged in their evolution into nearly

all situations where plants can grow at all. Phylogenetically they are without doubt descendants of the Pteridophytes, as will be noted further below.

The Spermatophytes fall into two Classes, sharply distinguished in several characters, —

CLASS 1. GYMNASPERMÆ: THE GYMNASPERMS.

CLASS 2. ANGIOSPERMÆ: THE ANGIOSPERMS.

CLASS 1. GYMNASPERMÆ: THE GYMNASPERMS

These are familiar in the Pines, Firs, Spruces, Cedars, and other evergreen and cone-bearing trees, though the group includes some with different characteristics. All have in common, however, the feature that the seeds are naked, that is, not inclosed by sporophylls (carpels) as in the Angiosperms. Though of great evolutionary interest, the class is not large, for it includes only some 500 living species. Among them are included the most valuable of our timber trees, and others which supply many minor needs of man. A great many fossil species are known, and clearly the group is declining in importance.

The plant body exhibits the typical differentiation into leaf, stem, and root, usually modified in adaptation to dry situations in which most of these plants occur. Their growth is exogenous, as in some ancient Pteridophytes. The flowers are of the simplest character, lacking anything like calyx or corolla, and are usually collected into unisexual clusters most conspicuous in the cones. They are pollinated and disseminated almost wholly by wind. The megaspores (embryo sacs) become completely filled with the prothallus (endosperm), in which are buried the archegonia. These are reduced to some short neck cells, and a little-differentiated layer around the large egg cell. The embryo develops on an elongated suspensor, and has usually several cotyledons (polycotyledonous).

Ecologically the Gymnosperms are all terrestrial plants, living in somewhat drier situations, upon the whole, than

the Angiosperms. Phylogenetically they are closely related to the Pteridophytes. While nearest to Selaginellas among living forms, especially as to their reproduction, the evidence of palæontology shows that our Gymnosperms are descended from ancient Fern-like forms through the intermediate group of extinct plants called Pteridosperms ("seed ferns") or Cycadofilicales. Apparently our existent Gymnosperms are a survival of those which, the first to develop the pollen tube, were able to occupy drier situations upon the earth than were possible to the true Pteridophytes, with their need for keeping a prothallus upon wet ground. Thus we can imagine a time when the forests of the earth consisted of Pteridophytes in the moister places, with Gymnosperms in those which were drier, though now both groups have been largely displaced in both situations by the Angiosperms.

The Gymnosperms include three leading Orders, —

ORDER 1. *CYCADALES: THE CYCADS.*

ORDER 2. *CONIFERALES: THE CONIFERS.*

ORDER 3. *GNETALES: THE GNETUMS AND KIN.*

ORDER 1. *CYCADALES: THE CYCADS.* These are woody plants of warm regions, mostly with slow-growing unbranched trunks bearing a crown of very stiff pinnately-compound leaves. Some 80 species are known.

The most familiar form is *Cycas revoluta*, or Sago Palm (Fig. 363), from eastern Asia, grown in large conservatories partly for ornament and partly for its leaves, which are much used in funeral decorations. Its rough columnar trunk reaches some



FIG. 363. — *Cycas revoluta*,  $\times \frac{1}{25}$ : as commonly seen in our greenhouses. (From Bailey.)

40 feet in height, and its crown of pinnate leaves recalls its relation to the tree ferns. The plants are diœcious. On the female plant the terminal bud produces from time

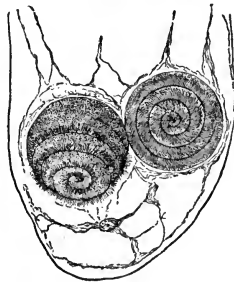
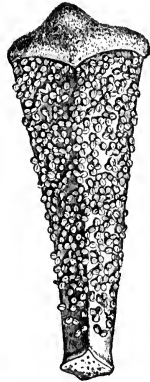

FIG. 364. — Sporophylls and sperm cells in Cycads.

Left, megasporophyll, with ovules, of *Cycas revoluta*;  $\times \frac{1}{2}$ . Right, above, microsporophyll of *Cycas circinalis*, with microsporangia (anthers) on under surface. Below, sperm cells of *Cycas revoluta*;  $\times 70$ . (From Kerner, Richard, and Hirase and Ikeno.)

to time a zone of hairy brown sporophylls, on the margins whereof are huge orange-colored ovules (Fig. 364), which grow to large size even without fertilization. The male plants produce great terminal cones, over a foot long, of closely set sporophylls which bear many anthers (microsporangia) on the lower surface. In this and allied forms, the pollen is carried by wind to the ovules, where the micropyle, and an open pollen chamber between micropyle and nucellus, are filled with a liquid secreted by the tissues. The partial evaporation of this liquid

draws the pollen grain into the chamber, where it develops the tubes and effects fertilization, at its leisure, so to speak, since several months intervene between pollination and the actual fertilization. In this chamber is developed

draws the pollen grain into the chamber, where it develops the tubes and effects fertilization, at its leisure, so to speak, since several months intervene between pollination and the actual fertilization. In this chamber is developed

a short pollen tube, by opening of which are set free two very large multiciliate sperm cells. These swim freely in the liquid of the pollen chamber and the now open end of nucellus and embryo sac, pass down between the neck cells of the archegonia, and fertilize the large egg cells. This persistence of the free-swimming sperm cells in the Spermatophytes, where it is confined to the Cycads and to *Ginkgo* (mentioned below), is a very striking fact, of great interest in connection with plant evolution.

Other forms of Cycads bear the ovules in cones, as in *Zamia*, common in Florida, and typical of the many with short, tuberous, rough stems. Great numbers of fossil Cycads are known, especially in the Jurassic Period, and our existent forms are a decadent remnant of an extensive ancient Cycad flora. Their

characters link them very perfectly with the extinct *Cycadofilicales*, a group intermediate between Cycads and Ferns, and thence with the ancient Ferns (Fig. 275).

Related to the Cycads, but commonly placed in a separate order, is the *Ginkgo*, or Maiden Hair Tree of Japan, often grown in America. It is diœcious, and has free-swimming sperm cells, but the solitary ovules ripen to fleshy drupe-like fruits (Fig. 365).

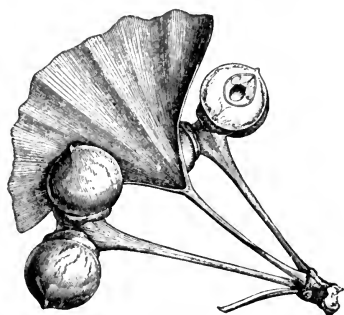

FIG. 365. — *Ginkgo biloba*;  $\times \frac{2}{3}$ . Leaf and unripe fruits, one sectioned. (From Kerner.)

**ORDER 2. CONIFERALES: THE CONIFERS.** These are the most abundant and familiar of existent Gymnosperms, for they include the Pine (*Pinus*), Fir (*Abies*), Spruce (*Picea*), Hemlock (*Tsuga*), Arbor Vitæ (*Thuja*), Cedar (*Chamaecyparis*), Cypress (*Cupressus*), Redwood (*Sequoia*), and Larch (*Larix*), having cones, with Juniper (*Juniperus*) and Yew

(*Taxus*) having berries, and some others, diversely constituted, in foreign parts. Some 350 species are known, living mostly in cold temperate or mountainous regions, where often they form great forests, the source of our most valuable timber trees.

The prevailing form is excurrent, with branches overlapping in a cone shape, giving a form specially fitted to the snows they have to endure (page 179; Fig. 122). The leaves are mostly evergreen (the Larch being a notable exception), linear, or scale-like in form (pages 63-4), and xerophytic in structure; and thereby those plants are fitted to endure the dryness of winter, when they are unable to absorb water from the cold or frozen soil (pages 258-9). The xerophytic character thus determined enables them to live in other dry places, notably ridges and hills where they largely prevail, though many (*e.g.* *Arbor Vitæ*) can also stand plenty of water, and even thrive in swamps. Some of them, notably Pines and Larches, produce two kinds of branches, the ordinary long kinds, and others so short that the leaves are brought together in rosettes or clusters familiar in the fascicles of five in the White Pine. The wood is composed almost wholly from tracheids (page 146), to which fact is due that uniformity of grain which gives them their value as workable timber, and also as wood pulp for the making of paper. Many kinds produce much resin, which waterproofs their buds, keeps water from lodging among their leaves, and resists entrance of Fungi when their soft wood becomes broken.

The reproduction in Conifers is wholly sexual. In typical cases (Fig. 366), the staminate flowers, which form compact cones at the base of the season's growth, are composed of sporophylls, each of which bears on the under side two microsporangia (the anther), containing many microspores (pollen grains). These microspores, which often are provided with air sacs, making them easily carried by the wind, germinate internally and produce one or two prothallial



cells and two sperm cells, which later pass into the growing pollen tube. The ovulate flowers, on either the same or a different plant, are the familiar cones, formed of spirally arranged, ovuliferous scales specialized in construction. Each scale is double, with a subtending and an axillary

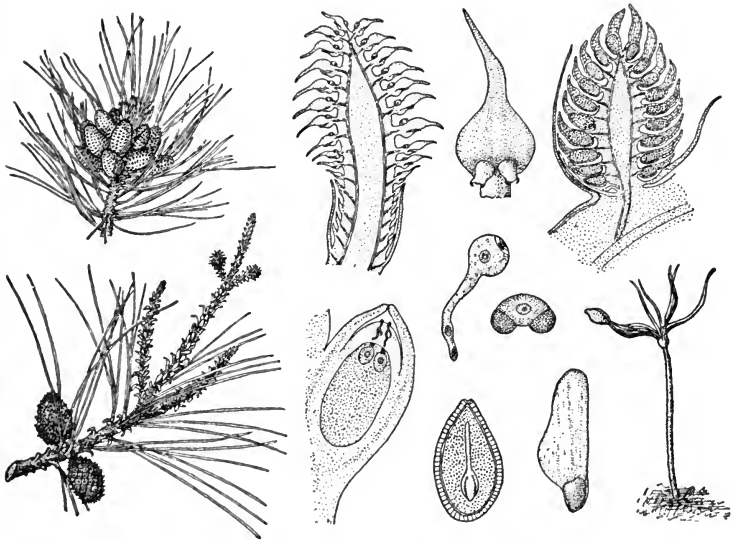

FIG. 366. — The life cycle of a Pine, chiefly *Pinus rigida*.

Left, branches with clusters of staminate flowers, and cones, the latter of the season, and one year old;  $\times \frac{1}{3}$ . Next, above, young cone in longitudinal section, showing the double scales and ovules,  $\times 3$ ; scale from above, showing the two ovules,  $\times 15$ ; staminate cone in longitudinal section, showing stamens,  $\times 2$ . Lower line, ovule in section, somewhat diagrammatic, showing embryo sac and archegonia, with germinating pollen tubes,  $\times 120$ ; pollen grain, and germinating pollen,  $\times 100$ ; ripe seed in section, showing embryo,  $\times 2$ , and seed with wing,  $\times \frac{1}{2}$ . Finally, young seedling. (In part after Strasburger, but chiefly from nature.)

part, the latter bearing the two megasporangia or ovules, which lie near its base with the micropyles downward and the integuments flaring open. There is doubt, by the way, as to the morphology of these inner scales, and two principal views have been advocated with evidence in favor of each. The outer scale may be the sporophyll, and the inner a

specialized placental or supporting growth for the ovules, in which case the cone is a many-carpelled single flower; or the outer may be simply a subtending bract and the inner composed of two sporophylls, joined edge to edge, and derived from an otherwise suppressed axillary bud, in which case the cone is morphologically a cluster. The megaspore

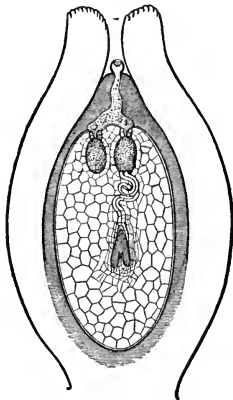

FIG. 367. — Ovule of a Gymnosperm in longitudinal optical section, diagrammatic.

The coats, nucellus (shaded), embryo sac, endosperm, embryo on a suspensor, archegonia, with distinct neck cells, and pollen grain and tube, are all obvious. (From Sachs.)

germinates internally and becomes filled with prothallus (endosperm), in which occur the egg cells. Above and around each egg cell occur certain cells which are the rudiment of an archegonium. When ready for pollination, the young cone is upright, with the scales apart; the pollen, brought by the wind, slips down the scales to the ovules, which have secreted water drops in the gaping micropyles. These drops later dry up, thereby drawing the pollen into the micropyle near the nucellus. The grains germinate slowly, and the tube carrying the sperm cell to the egg cell does not effect fertilization until the following spring, the cones taking two seasons to mature. When pollination is accomplished, the scales of the cone close together, and the cone itself turns over to hang downward, thus to remain until the seeds are ripe. The fertilized egg cell divides on the side away from the micropyle into four tiers of cells (Fig. 367); one of the intermediate tiers then elongates in the endosperm, which is digested by enzymes as they grow. This is the suspensor, which develops the embryo proper at its end. The embryo when grown is polycotyledonous, and lies in the midst of the endosperm, which is absorbed by the cotyledons in germination. Ultimately the cone opens, and

the seeds, each provided with a wing formed by part of the ovuliferous scale, are disseminated by wind.

While in most Coniferæ the ovules occur in cones, in Juniper and Yew they do not. In the former, two or three naked ovules at the end of a small branch become nearly inclosed by their subtending bracts, which develop into a kind of dry berry. In the Yew (Fig. 368), the single terminal ovule becomes nearly surrounded by a pulpy red aril, or extra seed coat, attractive to birds, by which the seeds are disseminated.

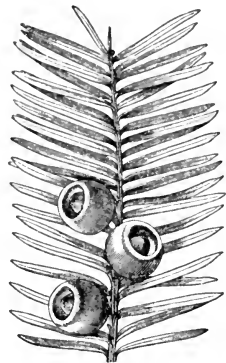

FIG. 368. — The Yew, *Taxus baccata*;  $\times \frac{2}{3}$ . (From Kerner.)

The Cedar of Lebanon (Fig. 369) is a famous tree of this



FIG. 369. — The Cedar of Lebanon. (From Balfour.)

group, as is the *Sequoia* or Redwood of California, which is the largest if not the tallest of trees (page 113). In the Southern Hemisphere, the *Araucaria* takes the place of Pines and Spruces, and is known to us in the Norfolk Island Pine grown in greenhouses. *Taxodium*, the Bald Cypress, is a well-known swamp tree of the southeastern United States, and noted for the remarkable knees which have puzzled ecologists (page 252).

Ecologically the Coniferæ are all terrestrial plants, with a partly xerophytic habit. Phylogenetically they have an ancient lineage of their own, without any direct relations to the Cycads; for apparently they are derived from the extinct group of Cordaitales, which early diverged from the Cycadofilicales (Fig. 275).

**ORDER 3. GNETALES: THE GNETUMS AND KIN.** A small group, only some 50 species, but interesting because including the most highly specialized of the Gymnosperms. Here belongs the remarkable *Welwitschia*, or *Tumboa*, of

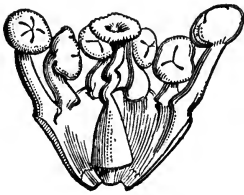

FIG. 370. — *Welwitschia mirabilis*, showing abortive stamens, and the pistil-like covering of the seed. (From Le Maout and Decaisne.)

Southwest Africa (Fig. 42), *Ephedra*, mostly leafless shrubs of dry regions somewhat resembling much-branched Equisetums, and *Gnetum*, which includes tropical trees and vines. Their wood has ducts in the secondary growth as in Angiosperms, and, what is more remarkable, they possess a sort of ovary surrounding each ovule, — composed, however, not of sporophylls, but of a special integument which is prolonged into a flaring tube simulating the ovary, style, and stigma of the Angiosperms (Fig. 370), though there is probably not the least relationship between these groups. The flowers of Gnetaceæ, alone among Gymnosperms, are apparently pollinated by insects. The group has certain relations with Cycads, ultimately through the Cycadofilicales.

## CLASS 2. ANGIOSPERMÆ: THE ANGIOSPERMS

These comprise the plants with true flowers in the popular sense, and thus embrace the great majority of the familiar and favorite kinds. Some 133,000 or more species are known, which is more than half of the total number; and they include most of the kinds which are useful, especially as food.

While possessing the distinctive spermatophytic characters in common with the Gymnosperms, they differ from that group in some features (Fig. 371). In the plant body and the tissues the differences are not great, except that the Angiosperms include ducts in their secondary as well as primary wood, while one great division is endogenous in growth.

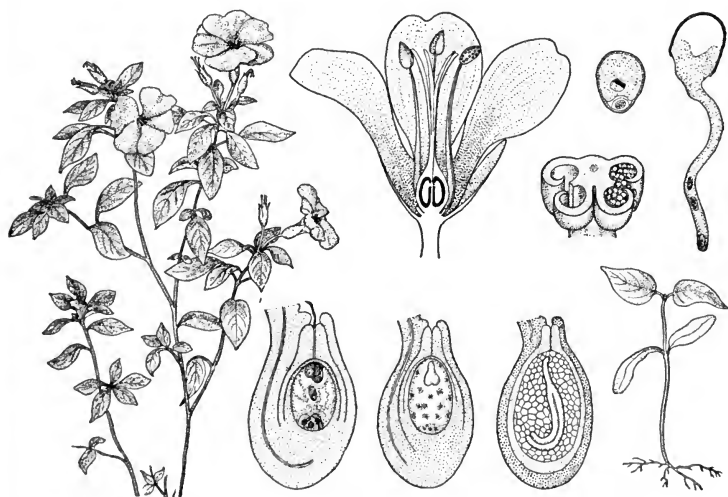

FIG. 371. — The life cycle of an Angiosperm, from various plants. Left, a shoot of Flax (*Linum* species), with flowers,  $\times \frac{1}{3}$ , and, next, a flower sectioned vertically,  $\times \frac{1}{4}$ . Right, an anther, cut across, showing four microsporangia with microspores (pollen grains),  $\times 6$ ; and a pollen grain ungerminated, showing vegetative and generative nuclei, and germinated, showing nuclei in the tube,  $\times 110$ . Below, in longitudinal sections, an ovule, showing prothallial contents of the embryo sac,  $\times 20$ ; a young seed, showing young embryo and developing endosperm (prothallus),  $\times 10$ ; and a ripe seed, with embryo embedded in endosperm,  $\times 5$ . Last, a seedling,  $\times \frac{1}{2}$ .

More considerable differences occur in connection with the reproductive parts. *First*, the ovules (megasporangia) become inclosed by carpellary leaves (megasporophylls), so developed as to form ovary, style, and stigma. *Second*, the embryo sacs (megaspores), germinate only partially before fertilization, forming instead of the complete prothallus, as in Gymnosperms and lower forms, only the egg cell, two

synergidæ, three antipodal cells and the fusion nucleus (Figs. 190, 250). If fertilization occurs, the stimulus given by the union of the second sperm nucleus with the fusion nucleus (page 353), causes a resumption of the formation of prothallus or endosperm, which, with the developing embryo, fills the sac, — this arrangement representing apparently an adaptation of economy which prevents the waste of endosperm if no embryo is formed. *Third*, the pollen grain (microspore) germinates more simply than in Gymnosperms, omitting the prothallial cells (Fig. 188). *Fourth*, the embryo possesses normally one or two cotyledons instead of several. *Fifth*, the Angiosperms have utilized, both for pollination and dissemination, other agencies in addition to the wind, upon which the Gymnosperms almost wholly rely. In contiguity with the stamens and pistils, they have developed nectaries, of which the position is clearly shown by bright and contrasting leaves (petals); and the structural arrangements are such that insects and small birds thus induced to visit the flowers transfer the pollen. Further, in correlation with a fuller utilization of these visits, the monœcious and diœcious arrangements of the Gymnosperms are largely abandoned in favor of the aggregation of stamens and pistils into the same flowers (*hermaphrodite*), while various arrangements, structural and physiological (pages 286–294), prevent self-pollination and ensure the advantageous cross-pollination. Dissemination also is effected largely by the aid of animals, in fitness whereto various structural features appear, — hooks which catch in the fur, edible fruits with protected seeds which are eaten, and other arrangements (pages 356–66). These features are especially connected with fruits, of which the development begins in the flower, wherein are produced profound structural changes, such as enlarged receptacles, inferior ovaries, and the like. Not all, however, of the multi-form morphological modifications of flowers and fruits are to be associated with pollination and dissemination, for many are undoubtedly purely structural and mutational (pages 12–13).

Ecologically the Angiosperms are typical terrestrial mesophytes, though extending into many other situations. They are at present the dominating and expanding group, still in active evolution. Phylogenetically their relations with the Gymnosperms have been variously explained in the past, but the present evidence seems rather clearly to demonstrate their origin from an extinct group called *Bennettitales* which in turn was a branch of the *Cycadofilicales* (Fig. 275). Thus no direct connection would exist between the present Gymnosperms and Angiosperms, though they are related through a not too distant ancestry.

The Angiosperms fall into two sharply-marked sub-classes, as follows :

SUB-CLASS 1. MONOCOTYLEDONEÆ: THE MONOCOTYLEDONS OR ENDOGENS.

SUB-CLASS 2. DICOTYLEDONEÆ: THE DICOTYLEDONS, OR EXOGENS.

SUB-CLASS 1. MONOCOTYLEDONEÆ: THE MONOCOTYLEDONS, OR ENDOGENS.

These are distinguished from the Dicotyledons by the presence of one cotyledon instead of two in the embryo, by a usually parallel instead of netted venation of the leaves, by prevalence of the number 3 instead of 4 or 5 in the whorls of the flower, and by endogenous instead of exogenous structure of the stem (page 127). The fibro-vascular bundles are separate, closed (without cambium), and scattered in a general ground tissue. They include about 24,000 of the 133,000 known Angiosperms, and are most abundant towards the tropics.

As a whole they are inclined to herbaceous texture, only a few tropical kinds, especially Palms, becoming woody and forming real trees. They prefer humid situations, and hence prevail in damp forests and meadows, while many have taken to life in the water as true hydrophytes; but others live also in dry places, even in deserts. The closed

type of bundle seems unfavorable to branching, which is infrequent as compared with Dicotyledons; but its absence is compensated by the great size of the leaves. The perfection of this arrangement is reached in the Palms, with their tall unbranched trunks bearing at the summit a crown of gracefully compounded fronds (page 60). For a similar reason the simple leaves are usually parallel-veined and entire, instead of variously emarginate as in Dicotyledons. Owing to lack of cambium the Monocotyledons cannot increase indefinitely in diameter, except in those kinds which have developed a sort of cortical cambium which grows steadily outward and lays down new bundles (page 128). Commonly the leaves have sheathing bases, which often conceal the stem. Large primary roots are wanting, their place being taken by many small secondary ones. The flowers, sometimes inconspicuous but commonly showy, have typically 3 carpels, 6 stamens, 3 sepals, and 3 petals, the two latter whorls being usually shaped and colored alike, and hence included under the one name of *perianth*. They are mostly pollinated by insects, and in fitness thereto some of the forms exhibit the most remarkable adaptations found in the plant kingdom. Besides, they possess, like the Dicotyledons, remarkable specializations of structure which seem to run far beyond any possible utility to the plant. The fruits also are greatly varied in structure, though they are mostly adapted to dissemination by various animals. The comparative infrequency of wind pollination and dissemination in this group is of course correlated with their usual occurrence in sheltered situations.

Ecologically the Monocotyledons are mostly terrestrial mesophytes, with preference for warm moist places. Phylogenetically their origin is obscure, though the evidence suggests derivation from the Dicotyledons, next to be considered; and some investigators derive them from the group Ranales (page 546). On this view they represent an early offshoot developed in adaptation to the aquatic condi-



tions of marshes, swamps, etc., which were formerly far more prominent and prevalent than now. In any case their evolution has long been independent of that of the Dicotyledons despite the remarkable parallelism they exhibit with that group in their floral characteristics.

When we attempt to subdivide the large groups of Monocotyledons and Dicotyledons, we find that both present a series of orders progressively ascending from obviously primitive through well differentiated to highly specialized, without any marked breaks between them. This feature shows chiefly in the flowers, for the vegetative parts and the tissues already possess such high functional efficiency in even the lowest kinds as to leave apparently no room for adaptational improvement, while the conditions of their life, especially competition for space, light, etc., forbid any such fantastic specialization of vegetative parts as the flowers seem free to exhibit. Accordingly we divide the Monocotyledons somewhat arbitrarily into three series, as follows:—

*SERIES A. THE PRIMITIVE MONOCOTYLEDONS.*

*SERIES B. THE DIFFERENTIATED MONOCOTYLEDONS.*

*SERIES C. THE SPECIALIZED MONOCOTYLEDONS.*

*SERIES A. THE PRIMITIVE MONOCOTYLEDONS.*

These have very simple and inconspicuous flowers, either without perianth, or with parts indefinite in number and spirally arranged; but they are massed into usually bisexual clusters, with commonly a large bract or spathe to each cluster. They are largely pollinated and disseminated by wind, though animals are utilized by the higher kinds. They include some four principal orders.

*ORDER 1. PANDANALES: SCREW PINES AND CAT-TAILS.*  
About 100 species of shrubs and herbs best known in the Pandanus, or Screw Pines. These are shrubs of tropical regions, cultivated in greenhouses (Fig. 177), diœcious, with spikes of very simple naked flowers, spiral ranks of sword-

like leaves, and stilt roots. Here belong also the Cat-tails (*Typhaceæ*) of our marshes, with erect sword-shaped leaves

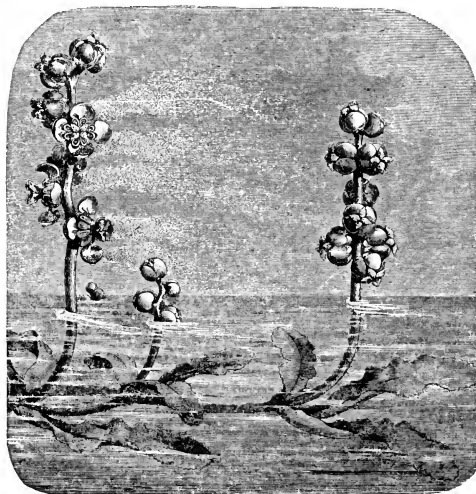

FIG. 372. — *Potamogeton crispus*;  $\times \frac{1}{3}$ .  
(From Kerner.)

and superposed spikes of staminate and pistillate flowers, of which the slender ovaries with accompanying hairs form the familiar "tails."

ORDER 2. NAIDALES (HELOBIE): WATERWEEDS. About 100 species, nearly all small herbs growing in wet places, or submerged in the

manner of true hydrophytes. The simple flowers are chiefly pollinated by wind or water movements, and the seeds are disseminated by water currents. They include the Pondweeds (*Potamogeton*, Fig. 372) most common of the larger waterweeds of fresh waters, the Eel-grasses, *Zostera* and *Vallisneria* (Fig. 196), with the Water Plantain (*Alisma*), and Arrow-head (*Sagittaria*) of stream margins.

ORDER 3. GRAMINALES (GLUMIFLORE): GRASSES AND SEDGES. About 8000 species in a sharply defined group, of uncertain

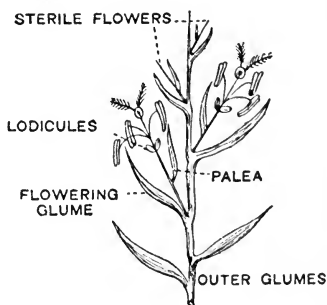

FIG. 373. — A diagram showing the construction of the highly-specialized Grass flower. (From Cavers.)

relationship. The flowers are mostly bisexual, and arranged in spikes or panicles, often rendered conspicuous by their feathery stigmas, abundant stamens, and position above the leaves, as any meadow illustrates. Each flower is provided with green bracts (GLUMES, Fig. 373),

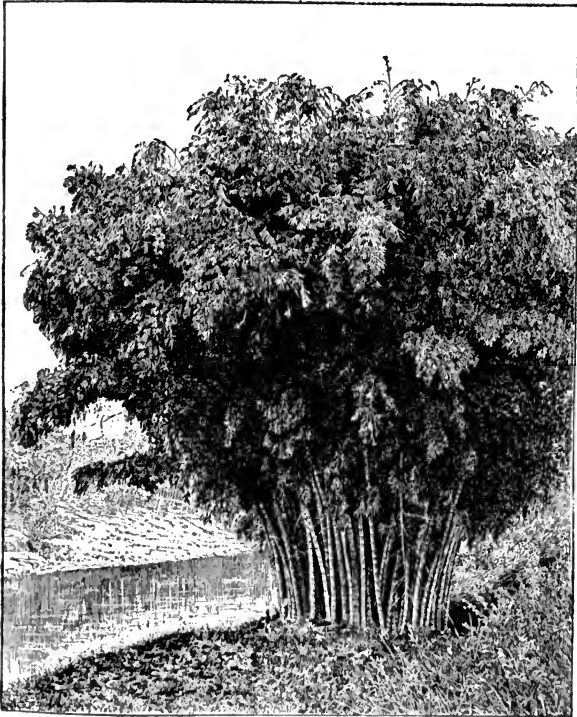

FIG. 374. — The Giant Bamboo, *Gigantochloa ater*, in a Botanic Garden in Ceylon. (From Bailey.)

instead of the single spathe to a cluster, and the fruit is the characteristic grain (page 349). Very distinctive are the interlacing rootstocks producing annual shoots (Fig. 129), thus forming a turf which competes with the Mosses as carpet plants. The Grass family (*Gramineæ*) includes some 5000 species, chiefly mesophytic but widely distributed

from wet marshes to dry plains. While mostly low growing, some reach to tree size, as in the Bamboo of the tropics (Fig. 374). They are the most valuable of all plants to man, for they include the principal fodder of his domestic animals



FIG. 375. — *Papyrus antiquorum*;  $\times \frac{1}{25}$ .  
(From Bailey.)

and most of his own important food plants, — Corn (Maize), Wheat, Rice, Oats, Barley, Rye, Millet and other grains, while Sugar Cane is also a grass. The Sedges (*Cyperaceæ*), some 3000 species, are distinguished from Grasses by triangular instead of round stems, and by more simple flowers. They prefer wetter places than the Grasses, but include only a few economic forms, of which the Papyrus (Fig. 375), source of the paper of the ancients, is perhaps best known.

ORDER 4. PALMALES  
(PRINCIPES): THE  
PALMS. Some 1000 species including the most graceful and stately of

tropical trees. They have columnar stems crowned by great fronds (Fig. 30). The rather small flowers occur in long spikes, simple or branching, inclosed when young by a single huge spathe. Some are pollinated by wind, and others by in-

sects. The fruits are often drupaceous and sometimes edible. They are very prominent in tropical vegetation, and the smaller forms, notably *Kentia* or *Howea*, are grown for decoration in houses. Some are highly useful, such as the Coconut and Date Palm, while others furnish minor products (Ivory nuts, Rattan, Fig. 376, etc.), including many of great utility in the tropics. Closely related is a small order including the *Carludovica* (Fig. 377), which yields the fiber for Panama hats.

ORDER 5. ARALES (SPATHIFLOREÆ): THE AROIDS AND KIN. Some 1000 species of diversified herbaceous plants. Most important are the Aroids (Araceæ), best known to us in the Jack-in-the-Pulpit of our

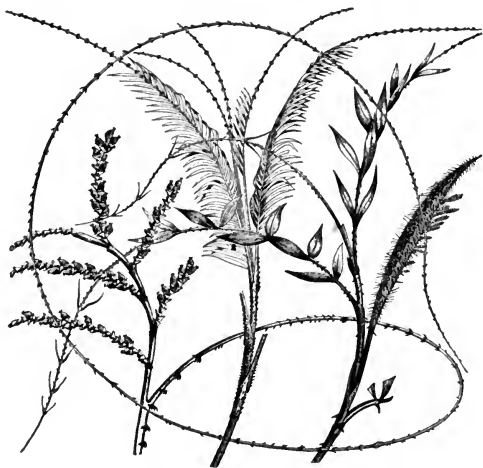

FIG. 376.—Tips of Rattan Palms, greatly reduced. Their very slender stems clamber over other vegetation by aid of the hooks on the leaves. (From Kerner.)

woods and Calla of our greenhouses. They abound most in the tropics, where they form huge undergrowth or climbing herbs, often distinguished by the great netted-veined leaves and clasping roots. The simple flowers are densely crowded on a fleshy spadix (Fig. 236), partially wrapped by a large and often brilliantly colored spathe. They are pollinated by insects; and the seeds, usually in colored berries, are disseminated by animals. They represent the highest development of the primitive flower cluster. Various members of the order have minor



FIG. 377. — *Carludovica palmata*;  $\times \frac{1}{10}$ .  
(From Le Maout and Decaisne.)

uses in food or medicine, some are poisonous, and a few are cultivated for their attractive flower clusters, notably *Calla* and *Anthurium* (Flamingo Flower), or for their luxuriant foliage as in case of *Monstera* (Fig. 378).

In this order belong the Duckweeds (*Lemnaceæ*), very tiny floating plants consisting of a rounded leaf-like shoot bearing the

simplest of flowers, and a pendent root (Fig. 379). One of these, *Wolffia*, is the smallest known flowering plant, being in all not so large as a medium pin head.

**SERIES B. THE DIFFERENTIATED MONOCOTYLEDONS.**

In these the cluster is subordinate to the individual flower, which becomes large, showy, and regular, with the floral parts in whorls, definite in number, *i.e.* usually 3 carpels, 6 stamens (two whorls),



FIG. 378. — *Monstera deliciosa*;  $\times \frac{1}{5}$ .  
The characteristic spadices are visible.  
The plant is native to Mexico. (From Le Maout and Decaisne.)

6 perianth parts (two whorls). They are pollinated by insects, and disseminated mostly through edible fruits by animals. They include two principal orders.

**ORDER 6. BROMELIALES (FARINOSÆ):**  
**THE BROMELIADS AND KIN.** Some 2000 species, largely tropical, best known in the Pineapple Family (*Bromeliaceæ*), which are largely epiphytes of the rosette form (Fig. 127), having close clusters of bright flowers with colored bracts. Here belongs the Pineapple with its multiple fruit, though the plant is terrestrial, and also the southern Long Moss or Spanish Moss, a remarkable lichen-like epiphyte; and many bright-flowered forms are grown in conservatories.

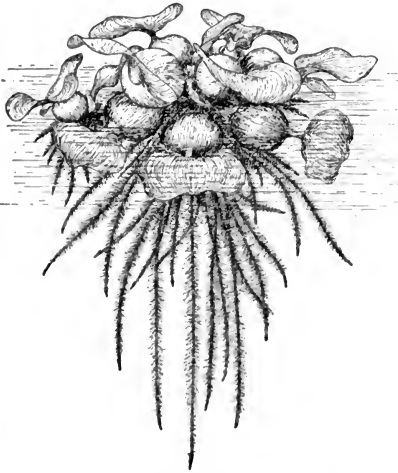

FIG. 380. — The Water Hyacinth, *Eichornia crassipes*;  $\times \frac{1}{4}$ .  
 The expanded petioles serve as floats.

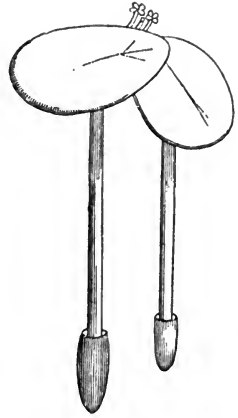

FIG. 379. — *Lemna minor*;  $\times 20$ . (From Le Maout and Decaisne.)

In this order belong also the Wandering Jew, or Spiderwort, of gardens, the common Pickerel Weed of our streamsides, and the floating Water Hyacinth of the south (Fig. 380), grown in botanical gardens.

**ORDER 7. LILIALES**  
**(LILIFLORE): THE**  
**LILIES AND KIN.** Some 5000 species, mostly herbs with large and beautiful,

regular flowers. Many are bulbous perennials, that is, they send up annual shoots from underground, perennial bulbs (page 73). The Lily Family proper (*Liliaceæ*), of

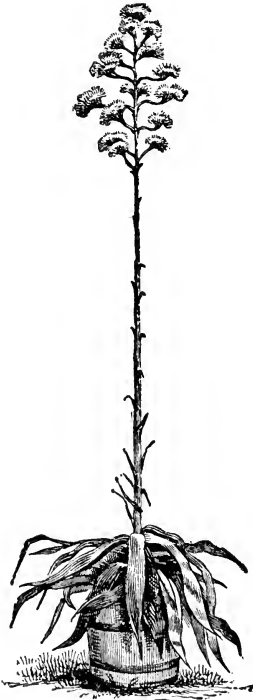

FIG. 381. — A Century Plant, *Agave americana*, in bloom;  $\times \frac{1}{30}$ .

The leaves have collapsed through loss of their stored food to the developing flower cluster. The plant flowers but once, and then dies. (From Bailey.)

some 2000 species, includes many of the favorites of our gardens, — Lilies, Tulips, Hyacinths, Trillium, Scilla, Lily of the Valley, Solomon's Seal, Adder's Tongue, with Onion and many more. In another division of Liliaceæ occur Asparagus (Asparagus Fern of florists) and Ruscus (Fig. 140); in another the Aloe, very like Century Plant, the Yucca or Spanish Bayonet, Cordyline (Fig. 35), and the great *Dracæna* or Dragon Tree (Fig. 84), for these are the Monocotyledons which can grow indefinitely in diameter, even to massive trees (page 128).

In the same order belongs the Amaryllis Family (*Amaryllidaceæ*) differing from Liliaceæ in the inferior ovary, and also including many garden favorites, — Amaryllis, Narcissus with Jonquil and Daffodil, Snowdrop, Tuberose, and some glorious greenhouse kinds. Here also is *Agave*, the monocarpic Century Plant (page 114, Fig. 381). Allied is the Iris Family (*Iridaceæ*), differing from Amaryllidaceæ in having only three stamens, and including

Iris or Fleur-de-lis in its many beautiful forms, Crocus, Freesia, and Gladiolus. In the same order are also the Rushes (*Juncaceæ*), the familiar slender-columnar, water-side herbs with flowers like small green Lilies. Many members



of the order have minor uses as food or medicine, the most important being the Yam, so valuable in the tropics for its huge, tuberous, edible roots. Related is the remarkable *Testudinaria* (Fig. 382).

*SERIES C. THE SPECIALIZED MONOCOTYLEDONS.*

In these the flowers, while retaining their conspicuousness, become remarkably specialized by the development of floral tubes, inferior ovaries, reduction of number in some whorls, and irregularity of parts. Some of these features are obviously adaptive to the visits of certain kinds of cross-pollinating insects, or to the development of certain forms of fruits in connection with dissemination by aid of animals; but others have no traceable connection with function and suggest rather some principle of diversity as such, of which we gain glimpses in many other places in the plant kingdom. They include two orders of special importance.

*ORDER 8. SCITAMINALES: THE BANANAS AND KIN.*  
About 1200 species, mostly tropical undergrowth giant herbs,

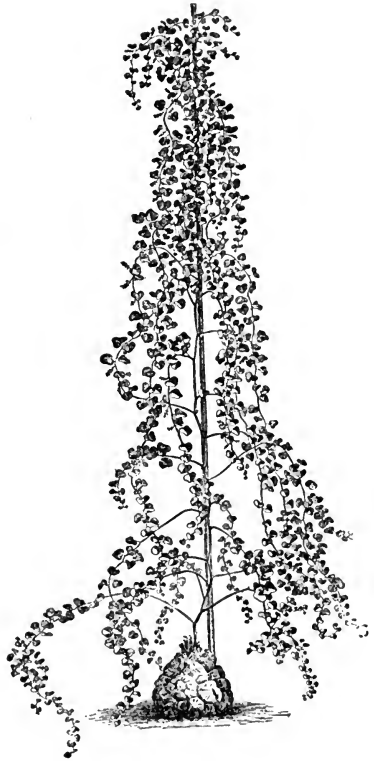

FIG. 382. — *Testudinaria elephantipes*;  $\times \frac{1}{10}$ .

It grows in South Africa. In the wet season, it spreads a leafy shoot, which dies down to the condensed stem for the dry season. (From Le Maout and Decaisne.)

of which the great petioles make up the apparent stem (Fig. 28). The flowers are usually in huge clusters, large, showy, and zygomorphic (*i.e.* irregular in a way to facilitate the visits of insects, page 276, 293). Most prominent is the Banana (*Musa sapientum*), the chief food plant of the

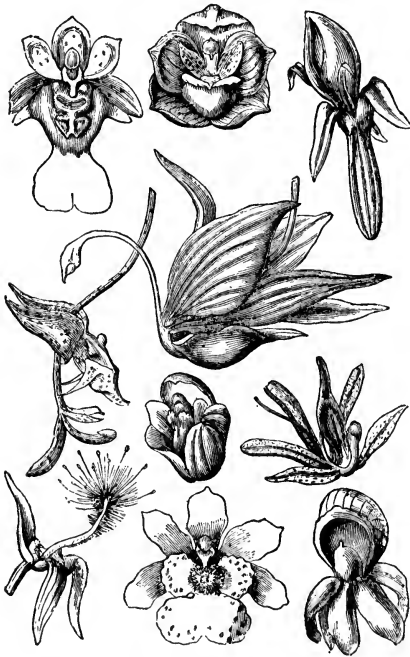

FIG. 383. — Orchid flowers, showing their specialization of form. (From Figurier.)

tropics, which has been propagated for ages by man from its vegetative shoots, and, like the Pineapple under similar circumstances, has lost its power to produce good seeds. Another Banana (*Musa textilis*) yields the Manila Hemp of commerce, obtained from the sclerenchyma fibers in its petioles. Here belong also the Traveler's Tree of the tropics, with its great fan-form head, and the Bird of Paradise Flower, grown in our greenhouses. Closely related are the Canna or Indian Shot of gardens, and the Marantas, of which

one yields Arrowroot. An allied family (*Zingiberaceæ*), has the aromatic rhizomes which yield Ginger.

*ORDER 9. ORCHIDALES (MICROSPERMÆ): THE ORCHIDS.* With these plants we associate justly the most elaborate and beautiful of all flowers. They include some 7000 species, chiefly perennial herbs of warm regions, especially tropical epiphytes of distinctive habit (Fig. 126). The flowers are

specialized in the extreme, having inferior ovary, 1 or 2 stamens consolidated with the style near the stigma, zygomorphic perianth, and other elaborations of detail which have a meaning, or at least a degree of specialization, far beyond explanation through utility alone (Fig. 383). Many are wonderfully adapted to the visits of particular insects, even to single species. The seeds are mostly so minute that they float with the dust in the air, and thus achieve wide dispersal. Hardly any economic forms occur in the order, aside from *Vanilla*, which is now supplanted by the synthetic substance. They yield, however, the most treasured plants of our exotic greenhouses, and are the special favorites of wealthy lovers of plants. Some kinds, *Cattleya*, *Lælia*, *Dendrobium*, *Oncidium*, may be bought from florists, while *Cypripedium*, *Orchis*, *Arethusa*, *Pogonia*, *Habenaria*, *Calopogon*, *Calypso*, are rare and exquisite forms of our own flora.

#### SUB-CLASS 2. DICOTYLEDONEÆ: THE DICOTYLEDONS, OR EXOGENS

These include most of the Angiosperms, — some 108,000 out of the 133,000 species of that group — with the highest, largest, and dominant families. They differ from the Monocotyledons in that the embryo has two cotyledons instead of one, the leaves are almost invariably netted-veined, the stem is exogenous with clear distinction of bark, wood, and pith and with indefinite growth by aid of a cambium, the root system is mostly derived, as in Gymnosperms, from a branching primary root, and the flowers have typically five parts to a whorl, with sometimes four and very rarely three, — the petals and sepals being usually unlike. The fruits are diverse, and adapted to various modes of dissemination. While the lower forms are both pollinated and disseminated by wind, the higher make use of insects and other animals in both functions, often displaying notable adaptations to that end. Further, as in Monocotyledons, both flowers and fruits exhibit in the higher forms a structural specialization

apparently much in excess of any demands of utility, and hence requiring some other than an adaptive explanation.

Ecologically the Dicotyledons are the dominant terrestrial mesophytes, though in general they occupy somewhat drier and cooler situations than the Monocotyledons. They comprise trees, shrubs, and herbs, in somewhat equivalent proportions. By virtue of their superior and more plastic organization, they have sent representatives into nearly all situations where plants can grow at all, and in those places are steadily displacing the older groups. It is notable that while the lower forms are largely trees, the higher are mostly herbs; and the resultant implication that the Angiospermous trees preceded the herbs in evolution is sustained by other evidence. Their relations to the lower forms, especially the Gymnosperms, have already been noted (page 527), and to the Monocotyledons they apparently stand as the parent stock (page 528).

The orders of the Dicotyledons, like the Monocotyledons, form an ascending series with numerous side branches but no marked breaks. Accordingly we can best subdivide them, somewhat arbitrarily, into the three series:

*SERIES A. THE PRIMITIVE DICOTYLEDONS.*

*SERIES B. THE DIFFERENTIATED DICOTYLEDONS.*

*SERIES C. THE SPECIALIZED DICOTYLEDONS.*

*SERIES A. THE PRIMITIVE DICOTYLEDONS.*

(Archichlamydeæ; Apetalæ.)

These have the flowers in clusters, commonly bisexual, with no petals or sepals, or only primitive ones, of indefinite number and spirally arranged. They are largely pollinated and disseminated by wind, though in some of the higher forms animals are utilized. They include some twelve principal orders.

*ORDER 1. VERTICILLALES: THE CASUARINAS.* Only some 20 species, of Australasian branching trees and shrubs,

Equisetum-like in aspect, with very simple flowers in heads or spikes. They are interesting because of their primitive characteristics. The ovules contain many embryo-sacs (megaspores) instead of the usual single one. The fertilization is CHALAZOGAMIC, *i.e.* the pollen tube enters haustorially by the chalaza instead of through the micropyle, — a peculiarity found in others of the simpler families.

ORDER 2. *PIPERALES: THE PEPPERS AND KIN.* Over 1000 species, mostly tropical, of small shrubs with simple naked flowers in loose spikes. A tendency to scattering of the fibro-vascular bundles suggests relation to Monocotyledons. Some fruits yield a sharp-tasting oil, the basis of the pepper of commerce. Here belongs the *Saururus*, or Lizard's Tail, of our own wet fields.

ORDER 3. *SALICALES: THE WILLOWS AND POPLARS.* About 160 species of soft-wooded trees and shrubs of temperate and arctic regions, preferring wet places, especially riversides. They become creeping in the Arctic regions. They are dioecious, and bear close woolly catkins of naked flowers which possess nectaries and are pollinated by insects despite lack of a perianth; and they produce hair-covered short-lived seeds widely carried by winds. They have limited uses in basket-making, etc.

ORDER 4. *MYRICALES: THE SWEET GALES AND KIN.* About 35 species of shrubs, growing in barren places, with clusters of simple, unisexual, wind-pollinated flowers; most familiar in the Bayberry of the coast (page 111), and the "Sweet Fern" of barren uplands.

ORDER 5. *JUGLANDALES: THE WALNUTS AND HICKORIES.* About 35 species of large and valuable timber and nut trees of temperate regions. They have long drooping catkins of male blossoms, and small groups of pistillate flowers, typically wind pollinated. The fruits are large nuts containing the familiar crinkled embryos.

ORDER 6. FAGALES: THE BIRCHES, ALDERS, AND HAZELS, WITH THE BEECHES, OAKS, AND CHESTNUTS. About 700 species of important timber and nut trees of north temperate regions, including the most valuable hardwood timbers, as

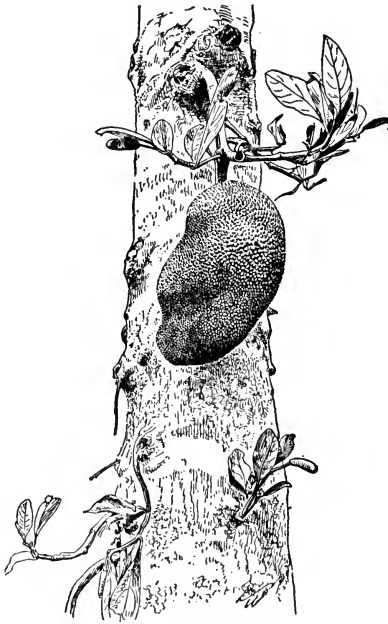

FIG. 384. — The Jack Fruit, *Artocarpus integrifolia*;  $\times \frac{1}{10}$ . (From Bailey.)

the Coniferæ include the principal softwoods. They have characteristic drooping staminate catkins, with solitary or few-clustered pistillate flowers (Fig. 197). Some have winged fruits which are wind carried; but others produce large nuts inclosed more or less by bracts, such being the character of the Chestnut and the Acorn.

ORDER 7. URTICALES: THE ELMS, MULBERRIES, FIGS, HEMPS, AND NETTLES. About 1500 species of apparently heterogeneous, but really interrelated trees, shrubs, and herbs, having clusters of simple

separated flowers, pollinated in part by wind and in part by insects, with fruits of various forms partly disseminated by wind and partly by animals. The Elms, having early wind-pollinated flowers, are noted shade trees of remarkable grace; the Mulberries, with multiple fleshy fruits (Fig. 247), are best known as providing food, in their leaves, for silkworms. Closely related are the valuable Bread Fruits and Jack Fruits of the tropics (Fig. 384). The Figs yield the familiar fruits, which are ripened, hollowed receptacles with the ovaries inside (Fig. 248), a

transitional form being the *Dorstenia* or open fig, grown in greenhouses. Here belong also the Banyan (Fig. 178), and the familiar Rubber Plant grown in houses. The latter is one of several plants which yield the invaluable rubber from their milky juice (page 108). Members of this family form the prominent "strangling figs" of the Tropics (Fig. 385). Here also belongs the familiar Hop vine, the Hemp — a tall herb producing a tough fiber, now largely superseded by Manila hemp (page 538), and the Nettles, with their stinging hairs and excellent fine fibers.

ORDER 8. *SANTALALES*:  
*THE SANDALWOODS AND*  
*MISTLETOES.* About 1000  
 species, chiefly tropical, of  
 shrubby plants, with rather  
 simple flowers, but interest-  
 ing because including a  
 great many parasites. The  
 Sandalwoods, known for  
 their aromatic wood, are  
 half-parasitic on roots in the  
 ground in the same manner  
 as are Mistletoes on trees,

viz., they have chlorophyll and form their own food, taking only water and mineral salts from the host (page 86; Fig. 386). Many, however, notably in the family *Loranthaceæ*, become complete colorless parasites, exhibiting striking adaptations to their special modes of life (Fig. 387). A form of our own woods (*Arceuthobium*), produces a form of Witches' Broom, much like those developed by Fungi (page 198).

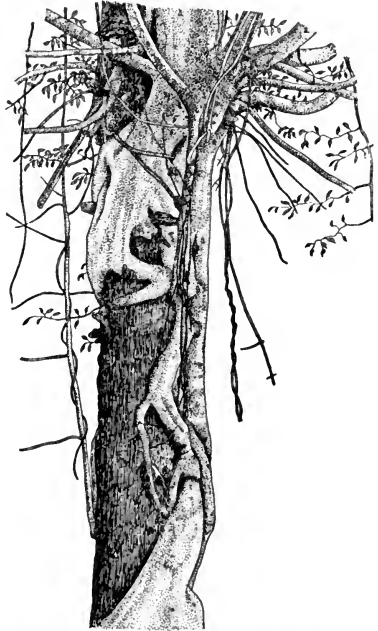

FIG. 385. — A Strangling Fig, *Ficus ligustrina*, in process of development on a Palmetto; greatly reduced. (After Trelease.)

ORDER 9. ARISTOLOCHIALES: THE BIRTHWORTS AND KIN.

About 200 species of herbs and vines, with apetalous flowers elaborately specialized as to the calyx, which has remarkable tubular-flaring forms (Fig. 388), and moreover is often dark-colored and ill-smelling in fitness to pollination by carrion

insects. The common Wild Ginger (*Asarum*), and the Dutchman's Pipe, a porch vine, are familiar representatives. A number have minor medicinal uses, and some had formerly high repute, in ways expressed by their name. Here belongs *Rafflesia*, the gigantic-flowered parasite earlier described (Fig. 61).



FIG. 386. — The Mistletoe, *Viscum album*; reduced.

A branch, with berries; a seedling on a branch, the bark removed; and an older seedling, the branch in section. (From Warming.)

ORDER 10. POLYGONALES: THE KNOTWEEDS AND KIN.

About 700 species, mostly herbs of northern temperate regions, distinguished by their soft bodies, swollen nodes, sheathing stipules, and simple flowers in clusters. Some contain acids in leaves or stem, as in Sorrel and Rhubarb, while the large starchy seeds give value to

Buckwheat, an important cereal crop. Here belong several dooryard weeds, and some aquatics with pretty pink flowers and floating leaves.

ORDER 11. CHENOPODIALES: THE GOOSEFOOTS AND KIN.

About 1800 species of rather heterogeneous herbs. They include some ugly dooryard weeds with wind-pollinated flowers, the Pokeweed with purple berries, the Samphire, a succulent red annual of salt shores (Fig. 389), the Amaranth



and Cockscomb of gardens with their highly colored clusters of flowers with bracts, the Four-o'-Clock, with calyx specialized like an attractive corolla, the Mesembryanthemum, a leaf succulent (Fig. 44), with sepals cut to simulate the rays of an Aster, and the Beet, a good vegetable.

**ORDER 12. CARYOPHYLLALES**  
(*CENTROSPERMÆ*): *THE PINKS AND KIN.* Some 1500 species, chiefly herbs of temperate regions, having flowers clearly related, especially as to ovaries and seeds, with the preceding orders, but fully differentiated into showy corolla and large calyx, each of five parts, thus giving a transition to the differentiated insect-pollinated series which follows. Here come some of our garden favorites, the Carnation and Pinks, with Sweet William and Lychnis, and also some garden weeds, Chickweed and Corn Cockle.



FIG. 387. — A fruit of *Myzodendron brachystachyum*;  $\times \frac{3}{4}$ . The feathery appendages aid in dissemination by wind, and twine thigmotropically around the branch with which they come into contact. (From Warming.)

Some forms exhibit a compact polster growth in alpine and arctic regions (Fig. 390). Closely related is the Purslane.

*SERIES B. THE DIFFERENTIATED DICOTYLEDONS.*

(Polypetalæ or Dialypetalæ.)

In these orders the cluster becomes subordinate to the individual flower, which has attained a definite differentiation into four whorls, typically of five members each, with usually a marked con-



FIG. 388. — The flower of *Aristolochia labiosa*;  $\times \frac{1}{2}$ . (From Kerner.)

trast between showy corolla and green calyx. The flowers are pollinated mostly by insects, and dissemination is effected in various ways by animals. Herein are included some eleven important orders.

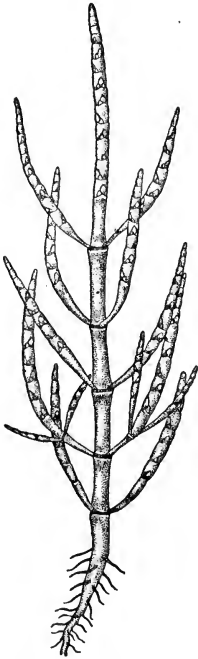

FIG. 389. — The Samphire, *Salicornia herbacea*;  $\times \frac{1}{2}$ . (After Schimper.)

**ORDER 13. RANALES: THE BUTTERCUPS AND KIN.** About 3000 species of trees, shrubs, and herbs, much diversified, but bound together by connecting forms, and having in common separate sepals, petals and stamens, and usually carpels, the two latter often numerous. They include many ornamental and some useful forms, notably the Buttercup family (*Ranunculaceæ*), with Anemone, Clematis, Larkspur, Columbine, Peony: the Water Lilies (*Nymphæaceæ*), most beautiful and fragrant of water plants, including the Lotus of the ancients and the great *Victoria regia* of the Amazon (Fig. 391): the Magnolias, trees and shrubs noted for their large flowers, and including the Tulip tree, valuable for timber (white-wood): the Barberries: the true Laurels (*Lauraceæ*), many aromatic, including Sassafras, Cinnamon, Camphor and our

native Spice Bush, with the Laurel or Sweet Bay, used in formal gardening: and the Nutmeg, from a tropical tree.

**ORDER 14. PAPAVERALES (RHEADALES): THE POPPIES, MUSTARDS, AND KIN.** About 2200 species, almost wholly herbs, differing from Ranales chiefly in united carpels, with a limited number of stamens. They include many showy and useful plants. In the Poppy family (*Papaveraceæ*) are the favorite garden annuals, the Bloodroot, the California Poppy, and *Papaver somniferum* which yields opium. The

Fumitory family includes the typical flower of old-fashioned gardens, the Bleeding Heart. The huge Mustard family, with its precise cruciform flowers, includes a few ornamental plants, *i.e.* Wallflower, Sweet Alyssum, Rocket, Stock, and some which are useful as food, as Cabbage, Radish, Mustard, Water Cress. Here also belongs the Rose of Jericho (Fig. 257), and closely related are the Capers and the Mignonette.

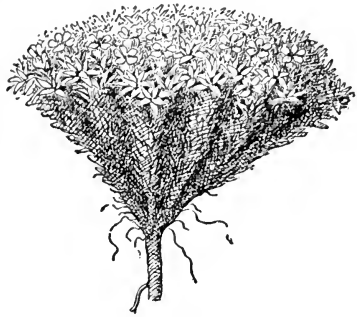

FIG. 390. — *Silene* species; natural size.

A polster form from the Alps. (From Bonnier.)

**ORDER 15. SARRACENIALES:**  
**THE PITCHER PLANTS.** A very interesting group, comprising three families and some

150 species of plants which are insectivorous, this habit being apparently connected with acquisition of nitrogen which makes good a deficiency in the environment (page 246). Most prominent are the *Sarracenias*, familiar in our common form (Fig. 48), and the *Nepenthes* of the East Indies, grown

often as exotics in green-houses (Fig. 49). The Sundew (*Drosera*, Fig. 392), and Venus Fly Trap (*Dionaea*, Fig. 50), and *Aldrovanda*, a water form, have no pitchers, but catch

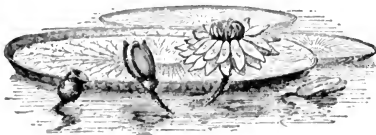

FIG. 391. — *Victoria Regia*;  $\times \frac{1}{10}$ . (From Balfour.)

insects in other ways. All insectivorous plants except three genera (*Cephalotus*, *Utricularia*, and *Pinguicula*) belong to this family.

**ORDER 16. ROSALES: THE ROSE FAMILY AND KIN.** A very large, diversified, and important order, of some 10,000 species, of trees, shrubs, and herbs, including many of our most prom-

inent economic and ornamental plants. The showy flowers recall those of Ranunculaceæ, but have the stamens and

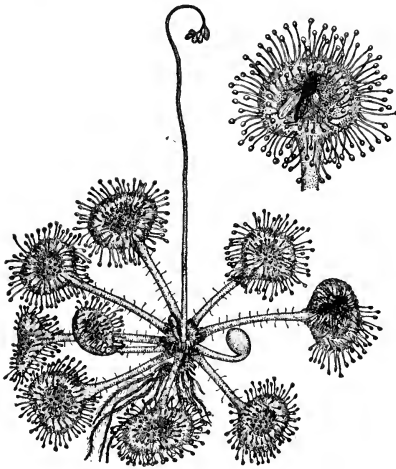

FIG. 392. — *Drosera rotundifolia*; natural size.

Above, right, a leaf;  $\times 2$ . (After Errera and Laurent.)

petals on a calyx tube, while the ovaries are often inferior, ripening to large edible fruits. Prominent members are the Orpines, (*Crassulaceæ*), mostly fleshy plants, familiar in Stonecrop, Live-forever, and Bryophyllum (Fig. 43): the Saxifrages (*Saxifragaceæ*), including the Hydrangea (Fig. 237), "Syringa," Deutzia, the Currants and Gooseberries (*Ribes*): *Cephalotus*, a rare insectivorous plant: *Podostemonaceæ*, with some remarkable water

plants (Fig. 393): the Witch Hazels: the Plane Trees, with Buttonwood: the Rose Family (*Rosaceæ*), of 1500 species, including Rose, Apple, Quince, Pear, Cherry, Plum, Peach, Raspberry, Strawberry, the ornamental Shadbush, Hawthorn, Bridal Wreath, and others familiar in gardens. In this order belong also the Leguminosæ, the second largest of plant families, with some 7000 species, distinguished mostly by irregular papilionaceous flowers (Fig. 394) with the characteristic one-carpel



FIG. 393. — *Oenone latifolia*;  $\times \frac{1}{2}$ . This plant grows in swiftly running fresh water, whence its resemblance to some Algæ. (From Goebel.)

legume, including Peas, Beans, Clover, Cytisus, Judas Tree, Locusts, Laburnum, Vetch, Wistaria, with the many Acacias, and the Sensitive Plant.

**ORDER 17. GERANIALES: THE GERANIUMS AND KIN.** Another large and diversified assemblage, some 8000 species, of trees, shrubs and herbs, forming a continuous series from kinds related to Rosales, up to kinds which are highly specialized. They include the Geraniums, Pelargoniums, Oxalis, and Garden Nasturtium (*Tropæolum*); the Flax, yielding the cortical fibers from which

linen is made, and Linseed oil; the Oranges, Lemons, and Grape Fruits; while here belong the plants producing Cocaine, and also Mahogany. Most specialized are the *Euphorbiaceae*, of which the apparent single blossoms are really clusters with colored bracts surrounding reduced staminate and pistillate flowers (Fig. 395). Some of the Euphorbias live in deserts and resemble Cacti, from which

they differ in possessing a milky juice, and in the fact that their spines are either paired (stipules) or single (axillary flower branch) instead of a cluster. They include also the highly ornamental Poinsettia, the Castor Bean, and some others of medicinal value, with a few rubber-producing plants.

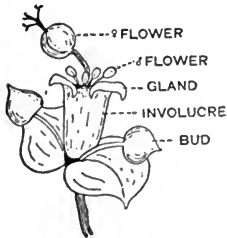

FIG. 395.—A typical compound flower of a *Euphorbia*, showing the parts. (From Cavers.)

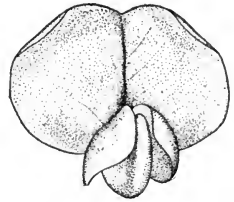

FIG. 394.—Flower of Locust;  $\times 2$ .

In the characteristic papilionaceous corolla, one of the petals is upright (the standard), two are lateral (the wings), and two are united below (the keel) enclosing the stamens and pistil. (After Gray.)

**ORDER 18. SAPINDALES: THE MAPLES AND KIN.** About 2500 species, chiefly shrubs and trees, obviously related to

Geraniales. They include the Box, Mango, Crowberries (low creeping heather-like plants of barren hills), the Hollies, Poison Ivy and Sumach, Smokebush, and climbing Bitter-

sweet. Most prominent are the Maples, very valuable trees, most of which have returned to wind pollination and dissemination, though the allied Horse Chestnut and Buckeye keep the showy flowers. Allied is the Balsam family, including the familiar garden herbs, with the wild Touch-me-not.

*ORDER 19. RHAMNALES: THE BUCKTHORNS AND GRAPES.* About 1000 species of trees and climbing shrubs. The Buckthorn family is not prominent, but in the *Vitaceæ* are included the Grapes (*Vitis*), with their reduced but insect-pollinated flowers, and their familiar fine valuable fruits. Here also belong the Virginia Creeper, and Japanese Ivy.

*ORDER 20. MALVALES: THE MALLOWES AND KIN.* About 2100 species of herbs, shrubs, and tropical trees, related to Sapindales. Here belong the Lindens, or Basswoods, valuable trees: the true Mallows, with showy flowers, familiar in Hollyhock and Marsh Mallow, and the Cotton Plant (*Gossypium herbaceum*), of which the seeds yield the invaluable fibers (Fig. 254) and a valuable oil. With this group belongs also *Theobroma Cacao*, the small tree which yields Cocoa and Chocolate.

*ORDER 21. PARIETALES.* About 3000 species, mostly tropical, of trees and shrubs, related to Rosales in many features, but distinguished by the parietal placentæ, whence their name. They are known to us chiefly through the Tea (*Thea*) and the Camellia, which are closely related, the Violets, the Passion Vines (*Passiflora*), and the Begonias, cultivated for the diversity of their foliage. Here also belong the *Papaya*, a well-known sub-tropical fruit, and the Tamarisk, a graceful garden shrub.

*ORDER 22. OPUNTIALES: THE CACTI.* A homogeneous group, some 1200 species, of well-known desert succulents (Fig. 396) almost wholly American, though a few now run wild in Europe. They have large and beautiful flowers, with inferior ovary and many parts. They show a com-

plete gradation of forms from mesophytic vines (*Pereskia*) to extreme xerophytes (globular *Echinocactus*, Fig. 141), while some return with a different morphology to a semi-mesophytic condition (*Phyllocactus*, *Epiphyllum* and *Rhipsalis*, Fig. 142). Their characteristic spines are metamorphosed leaves. The Prickly Pear, a weed in the sub-tropics, and the Night Blooming Cereus, are the most familiar.

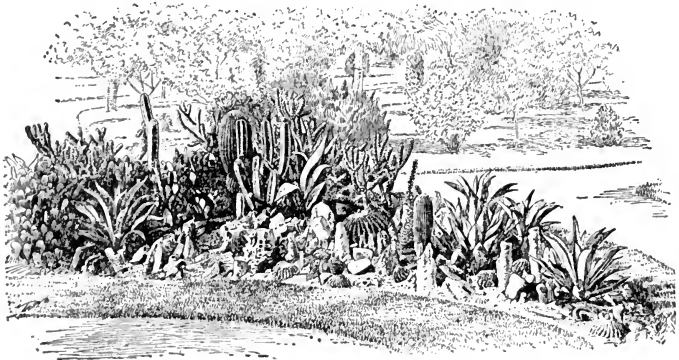

FIG. 396.—A collection of Cacti, recognizable by their condensed rounded forms, with other succulent plants, in a garden. (From Bailey.)

**ORDER 23. MYRTALES: THE MYRTLES AND KIN.** About 7500 species, mostly tropical, of trees, shrubs, and herbs, having in common an inferior ovary and many stamens, suggestive of Rosales. They include the true *Myrtaceæ*, a large and important tropical and sub-tropical family, in which are the Eucalyptus, or Gum Trees (especially developed in Australia, and including the tallest of known plants, page 113), and the Guava. Here also belong the Daphne, a sweet shrub of our greenhouses, the Pomegranate, and the Brazil Nut. The Evening Primrose Family (*Onagraceæ*) includes the Fuchsia and the *Ænothera*, one species of which, *Æ. Lamarckiana*, is now famous through the studies of De Vries on mutation. Here also belongs a family of hydrophytes, including the Water Milfoils (*Myriophyllum*), of which the Parrot's Feather is one. The Mangroves

(Fig. 397), which form a fringe to the growing land in tropical salt waters, belong also to this order.

*ORDER 24. UMBELLALES: THE UMBELLIFERS AND KIN.*  
Some 2000 species, mostly herbs, distinguished in general

by the specialized inferior ovaries of the many small flowers. To the *Araliaceæ* belong the Ginseng, a medicinal plant, the English Ivy, and some spiny garden shrubs (*Aralia*). In the *Umbelliferaæ*, or Parsley Family, with their characteristic simple or compound umbels of small flowers (Fig. 398), are some food plants (Carrot), and many which are medicinal and poisonous, including the classic Poison Hemlock, for which our Hemlock



FIG. 397. — A thicket of Mangroves (*Rhizophora mangle*) bordering salt water.

The characteristic aerial roots are prominent; and on the branches are the "viviparous" embryos, *i.e.* they put forth their long hypocotyls while still in the fruits. (From Kerner.)

tree was named on account of a fancied resemblance in the foliage. Here belong also the Dogwoods (*Cornaceæ*)



with their flowers rendered ornamental by large white bracts, and the Pigeon Berry of the woods.

*SERIES C. THE SPECIALIZED DICOTYLEDONS.*

(*Metachlamydeæ*; *Sympetalæ*; *Gamopetalæ*.)

In these orders, the flowers, while retaining their showiness, become remarkably specialized by the development of floral tubes and inferior ovaries, with reduction in number in some whorls. Herein we find a remarkable parallelism with Monocotyledons, although, in marked contrast with the latter, the Dicotyledons show comparatively little irregularity, even in the highest kinds. Here also, while part of the features stand obviously related to insect pollination, or to special methods of dissemination, others have apparently no relation to utility, but show rather an aspect of specialization for diversity's sake. They include eight principal orders.



FIG. 398. — *Heracleum* species, showing the formal compound umbel;  $\times \frac{1}{4}$ . (From Baillon.)

*ORDER 25. ERICALES: THE HEATHS AND KIN.* About 1800 species, mostly shrubs, prevailingly evergreen, with sympetalous corolla bearing the stamens which are often specialized in peculiar forms. They include the Heathers and Heaths, with Azaleas and Rhododendrons, our Mayflower (*Epigaea repens*), and our Laurels (*Kalmia*), the

Cranberry, Blueberry, and Bearberry. Here also are included two families having special ecological interest, viz. the saprophytic Indian Pipe, or Ghost Plant (Fig. 60), and the Pyxie, or Flowering Moss, which has adopted the moss habit.

*ORDER 26. PRIMULALES: THE PRIMROSES AND KIN.* Some 1100 species, many tropical, with prominent flowers distinguished by the position of the five stamens opposite the lobes of the corolla (Fig. 201). They include all of our true Primroses (not Evening Primroses), with Cyclamen, and the Leadwort of greenhouses.

*ORDER 27. EBENALES: THE EBONY AND KIN.* Some 1000 species, mostly tropical, of trees and shrubs, noted for their hard and valuable woods, typified by Ebony. The Persimmon also belongs here, and our garden Silver Bell.

*ORDER 28. GENTIANALES (CONTORTÆ): THE GENTIANS AND KIN.* Some 4400 species of widely-spread trees, shrubs, and herbs. Here belongs the important Olive family, with its flowers on the unusual plan of four, including such important plants as the Olive, Ash, Fringe Tree, Golden Bell, Jessamine, Privet, and Lilac. Related is the tree which produces the poison strychnine. Here belong, of course, the Gentians, and also the Dogbanes, with Oleander and Periwinkle. Related are the Milkweeds, with their milky juice, their very remarkable diversity of form and habit, and the high specialization of their flowers in connection with pollination.

*ORDER 29. TUBIFLORÆ: THE TUBULAR-FLOWERED FAMILIES.* A great assemblage, some 13,500 species, of trees, shrubs, and herbs, having in common an elongated corolla tube bearing the stamens, the ovary being superior in some, inferior in others. They include the Morning Glory family (*Convolvulaceæ*), with Morning Glory, Sweet Potato, and the parasitic Dodder (Fig. 59); the Phloxes; the Borage

family (*Boraginaceæ*), including Heliotrope and Forget-me-not; the Verbenas; the very important Mint family (*Labiataæ*), with the characteristic square stems and bilabiate flowers (Fig. 203), including many medicinal and other garden plants, — notably Mint, Peppermint, Sage, Thyme, Lavender, Rosemary, with Hyssop, Ground Ivy, Bergamot, and others; the important Nightshade family (*Solanaceæ*),

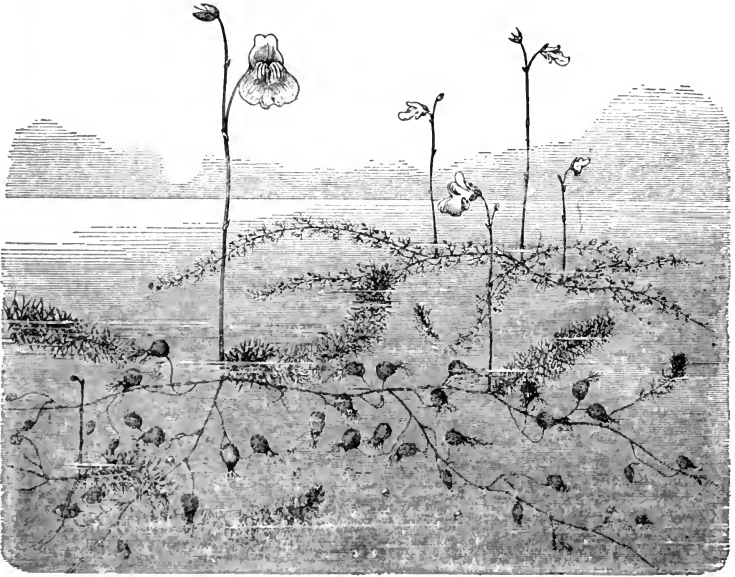

FIG. 399. — The Bladderwort, *Utricularia Grafiana*, and (behind) *U. minor*;  $\times \frac{1}{2}$ . (From Kerner.)

with poisonous, useful, and ornamental plants, notably Tobacco, Tomato, Egg Plant, Potato, Jerusalem Cherry, Schizanthus, Petunia, and more; the important Figwort family (*Scrophulariaceæ*), including Snapdragon, Calceolaria, Foxglove, Gerardia, Kenilworth Ivy, and others; the Acanthus family, including the classical Acanthus and tropical forms of greenhouses; the Bignonia family, mostly climbers, *e.g.* the Trumpet Creepers. Here belong also

Martynia, and Gloxinia, with the Bladderworts (Fig. 399), a family of insectivorous aquatic plants, including the insectivorous Butterwort (*Pinguicula*).

**ORDER 30. PLANTAGINALES: THE PLANTAINS.** Some 200 species of herbs typified by the common dooryard Plantain, of which the inconspicuous flowers show relations to the Mints.

**ORDER 31. RUBIALES: THE MADDERS AND KIN.** About 5300 species, mostly tropical, of trees, shrubs, and herbs, with flowers often on the plan of four. Most important is the Madder family (*Rubiaceæ*), including Coffee, Cinchona, which yields quinine, our Bluets or Quaker Ladies, Button Bush, and Partridge Berry. The Honeysuckle family (*Caprifoliaceæ*), includes all of the true Honeysuckles, Snowberry, Snowball Bush, Weigela, the sweet Twin Flower (*Linnæa*), and High Bush Cranberry; here belong also Valerian and the Teasel.

**ORDER 32. CAMPANULALES: THE COMPOSITES AND KIN.** A large group, over 13,000 species, almost entirely herbs, with flowers highly specialized as to consolidation of parts. They include three prominent families. The Gourd family (*Cucurbitaceæ*), noted for the huge fruits developed from inferior ovaries, includes Squash, Pumpkin, Cucumber, various Melons, and Ecballium (Fig. 266). The Bell-flowers (*Campanulaceæ*), are garden forms, familiar in Blue Bells, or Canterbury Bells, while with them belong the irregular Lobelias, including our beautiful Cardinal Flower. But by far the most important family is that of the *Compositæ*, which is the largest of all plant families, having about 12,000 species. Its most notable feature is the characteristic composite head (Fig. 400) within which the flowers are commonly differentiated more or less perfectly into showy and reproductive members. Moreover an entire flower is devoted to the pollination, and an entire disseminative ap-

paratus to the dissemination of a single seed. It is certainly a curious fact that this highest of the plant groups has returned to the arrangement in which the individual flower is subordinate to the cluster, and has returned also to wind dissemination. They are practically all herbs,

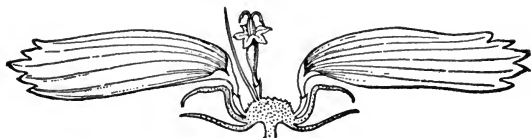

FIG. 400. — Section through a flower head of *Coreopsis*, exhibiting the showy marginal flowers, which are sterile, and one of the inconspicuous disc flowers which is fully fertile. Next the latter is its subtending bract, and other bracts appear below. (From Bailey.)

very widely distributed. They include a great many economically important forms, — Lettuce, Jerusalem Artichoke, and many plants cultivated for ornament; Chrysanthemum, Aster, Marigold, Daisy, Cineraria, Cosmos, Dahlia, Sunflower, Golden Glow, Goldenrod, with Dandelion, Marguerite, and many of our weeds. This family represents clearly the present acme of plant evolution.

## CHAPTER XIV

### THE ECOLOGICAL CLASSIFICATION OF PLANTS

#### 1. THE ECOLOGICAL GROUPS

IN the four preceding chapters the plants of the earth were considered phylogenetically, that is, according to their relationships; but incidentally they were also described ecologically, that is, according to their fitness to their surroundings. Of this fitness the most important phase concerns their habits, viz. the way they live in the places they do. Now plants which have habits in common constitute *ecological groups*, and these ecological, or habit, groups collectively make up the orderly *vegetation* of the earth, precisely as the phylogenetic groups make up its flora (page 392). Thus plants are also classifiable ecologically, as we have now to consider.

The comparative study of plants shows that no necessary connection exists between relationship and habit. Relationship is a matter of heredity, which mostly shows best in connection with the reproductive parts of plants (page 392), but habit concerns chiefly the vegetative organs, — leaves, stems, and roots. Some of the habit, or ecological, groups have already been mentioned, — *e.g.* *Xerophytes*, *Hydrophytes*, and *Mesophytes* on page 190, with *Climbers* and *Epiphytes* on pages 184–5. Such groupings correspond with those of men into trade unions, professional associations, etc., all the members of which possess in common such characteristics and interests as have essential connection with their mutual occupation, though none may be blood relatives at all. It is true, in large measure the phylogenetic and ecological groups are coincident, especially among the lower forms, just as members of the same family among men, particularly of primitive races, tend to follow the same occupation.

Among higher forms, however, this is less the case, again as among men of civilized races, where members of the same family often scatter into the most diverse occupations, following each the opportunity indicated by his own tastes or talents. Thus the phylogenetic and the ecological groups, while partly coincident, are largely different.

## 2. PLANT HABITATS AND VEGETATION FORMS

The surface of the earth presents a variety of situations in which plants can live. Such situations are called HABITATS. Observation shows that each habitat is occupied by certain forms of vegetation which are better fitted than other kinds to the conditions there prevailing. These are called VEGETATION FORMS, or GROWTH FORMS (though they were better called HABIT FORMS), and they constitute the dominant vegetation of that habitat. Thus the condensed, thick-epidermed stem succulents, familiar in the Cacti, are a dominant vegetation form of some deserts, while at the opposite extreme the diffuse, thin-tissued Waterweeds are a dominant form of quiet waters. Thus these vegetation forms constitute the units of the ecological classification of the vegetation of the earth, just as species are the units of the phylogenetic classification of its flora (page 392). Vegetation forms and species, however, are not coincident, because all species possess features, — hereditary, structural, or mutational (pages 12–13), not connected with their fitness to the habitat, and therefore not a part of their vegetation form. Moreover, several or many species, and from widely separated families, can belong to the same vegetation form. Thus the Waterweeds, above mentioned, contain members of several families; and there are species of Euphorbia, living in deserts, which are so like some Cacti that only a botanist can tell them apart, though the families Cactaceæ and Euphorbiaceæ are widely separated phylogenetically. Vegetation forms, accordingly, are far less numerous than species, and their actual number depends upon the extent to which we

refine our analysis of habitats. The essential feature of a vegetation form consists in the *method* by which the plants are fitted by form and structure to perform their principal functions under the physical conditions which determine the habitat, — *e.g.* excessive dryness in deserts, and defective aëration in water. The main condition of the habitat being met by a common method, a diversity in other features does not matter, precisely as the members of a trades union, or professional association, all in equally good standing, may differ in looks, height, speech, dress, and any other features unconnected with the main object of the union.

We shall now consider some of the principal vegetation forms of the earth in relation to the habitats they occupy. The nomenclature of vegetation forms is still chaotic. In principle, they should be so named as to express the structural method by which they interlock with the salient condition of the habitat; but in practice they are named very diversely.

Plant habitats are necessarily limited to those places on the earth which provide the conditions and substances indispensable to plant life. The primal necessities are six, — *viz.* *warmth, water, light, carbon dioxide, oxygen,* and certain *mineral salts*. Where any one is wanting, plants cannot exist, as in polar ice or rainless deserts. Where all are present, however, it is not in uniformity, but great diversity, of proportions and combinations. It is this diversity which determines the differences between habitats.

The plant habitats of the world, despite their intergradations, are amenable to detailed classification. Most fundamentally they divide according to whether (1) they offer only the raw materials for the formation of food, in which case they constitute the **INORGANIC HABITATS**, and are occupied by independent green plants, called **AUTOPHYTES**, or (2) they offer ready-formed organic food, in which case they constitute the **ORGANIC HABITATS**, and are occupied by parasites and saprophytes, collectively called **HYSTERO-**



PHYTES. The inorganic habitats fall in turn into two principal subdivisions, — (a) those under water, occupied by forms called HYDROPHYTES (understood as autophytic), and (b) those upon land, or more properly, in the air, occupied by forms which, reviving an old word, obsolete in its former somewhat different sense, we may call AËROPHYTES (also understood as autophytic). We may most conveniently treat our subject under three divisions, as follows :

- (1.) *THE WATER HABITATS, AND THE VEGETATION FORMS CALLED HYDROPHYTES.*
- (2.) *THE AËRIAL HABITATS, AND THE VEGETATION FORMS CALLED AËROPHYTES.*
- (3.) *THE ORGANIC HABITATS, AND THE VEGETATION FORMS CALLED HYSTEROPHYTES.*

- (1.) *THE WATER HABITATS, AND THE VEGETATION FORMS CALLED HYDROPHYTES.*

In the true water habitats the plants are wholly submerged, for the floating and partly submerged kinds, which we often include among hydrophytes, are really aërophytes with roots in water, as will later appear.

The physical conditions of the submerged habitats, to which the structure of hydrophytes must conform, are well known. The carbon dioxide, oxygen, and mineral salts accessible to the plants are such as occur in solution in the water, and thus are equally in contact with all parts of the plant body, which, free from danger of desiccation, needs no waterproof epidermis. Correspondingly, water plants absorb their needed gases and mineral salts anywhere over the body, and do not possess the differentiation into absorbing root and leafy shoot so characteristic of land plants; and for the same reason they lack differentiation into conducting, storage, and other special tissues. Again, gases diffuse so slowly in water as compared with air, that interior tissues cannot be adequately aërated through passages from the surfaces, — as effected so easily in land plants. Corre-

spondingly, hydrophytes lack an air system, but instead expose most of their cells at the general surface, thus producing those unicellular, filamentous, filmy, or finely cut forms so distinctive of water plants, which are massive only where special aëration occurs through tidal or wave action. This great spread of surface in water plants facilitates also the absorption of light, which, weakened by its passage through water, can penetrate even less deeply into the chlorenchyma of water, than of land, plants (page 53). Finally, plant substance is so slightly heavier than water as to need little extra aid (some gas in the tissues, or even oil in the cells), to render it automatically buoyant. Correspondingly, water plants lack those self-supporting firm tissues essential in land plants, and are therefore soft bodied and collapsible when brought into the air. This lack of lignification permits the ready transformation of the cellulose walls into the gelatinous or mucilaginous material which is so abundant in the tissues of water plants, and utilized by them in different ways.

Thus the conditions of their habitat explain the distinguishing characteristics of hydrophytes, — viz. why they are so little differentiated as to organs and tissues, spread so much surface in their thin or slender bodies, and have such softness of texture.

The hydrophytes, while ecologically homogeneous, include members from diverse phylogenetic groups. They are chiefly Algæ, which is the typical and primitive hydrophytic group, but others are land forms which in course of their evolution have taken to life in the water. Thus Bryophytes, Pteridophytes, and even Spermatophytes (represented in the Pondweeds and Eelgrasses) have become wholly submerged hydrophytes, with all of the hydrophytic characteristics, though they also retain flowers, leaves, stems, roots, and even the air system, from their former habitats.

The principal vegetation forms among hydrophytes are the following, as characterized by their salient features.

The limitations of this book do not permit consideration of details, which often include remarkable adjustments in minutiae, not only of structure, but also of physiology.

**FREE-SWIMMING MICRO-HYDROPHYTES**; unicellular, ovoid, thin and smooth walled, actively locomotive with cilia or flagella; typified by some Flagellates (Fig. 280), *Chlamydomonas* (Fig. 284), and by zoöspores, gametes, and spermatozoids of Algæ. Allied are colonial forms of *Volvox* (Fig. 288). **DRIFTING MICRO-HYDROPHYTES**; unicellular, globular or radiate, often thick-walled, carried in suspension by currents; typified by *Peridineæ* (Fig. 281), Desmids and some Diatoms (Figs. 295-6), and by non-motile spores of Algæ and Fungi. Allied are some filamentous forms, and non-motile colonies, like *Pediastrum* (Fig. 286), and *Hydrodictyon* (Fig. 287) which is simply an overgrown form. Allied are the Water Blooms (page 401), including the familiar floating felts of *Spirogyra* (page 425). **DRIFTING SEA-WEEDS**; chiefly brown Rockweeds, originally attached but now drifted by ocean currents, vegetatively reproducing; typified by *Sargassum* (Fig. 309), which fills the Sargasso Sea. **ADHERENT MICRO-HYDROPHYTES**; unicellular, gelatinous-walled, and thus adherent to one another and the substratum; typified by many *Cyanophyceæ* (Fig. 276), and *Pleurococcus* (Fig. 285). Since these gelatinous walls progressively resist increasing loss of water, and also absorb it eagerly when offered, these forms can survive when exposed to air, and can even occupy dry situations, thus becoming aërophytic and even xerophytic. Allied are the forms of the tubular Algæ, e.g. *Vaucheria* (Fig. 298) and *Botrydium* (Fig. 299). **SEDENTARY FILAR-HYDROPHYTES**; filamentous, attached by holdfasts, and rising buoyantly towards the light, often social, in pilose masses; typified by *Ulothrix* (Fig. 289) and other Confervoid Algæ, and by colonial Desmids and Diatoms. The *Characeæ* (Fig. 301) and the marine *Siphonales* are overgrown forms. **FRONDOSE SEAWEEDS**; thalloid, but thin or finely cut, attached by holdfasts, and rising

buoyantly towards light; typified by Sea Lettuce (Fig. 291), and especially by the "Sea Moss" Red Algæ (Fig. 310). SEDENTARY WATERWEEDS; Spermatophytes, with true leaves and stems, attached by true roots, but slender-elongate, thin or cut like Algæ, rising buoyantly towards the light, several feet long in quiet places, with flowers pollinated above, on, or under the surface; typified by the Pondweeds (Fig. 372), Eelgrasses (Fig. 196), Bladderworts (Fig. 399), and others. INTERTIDAL ROCKWEEDS; thalloid, divided, attached by firm holdfasts, and tough-elastic, yielding to wave action, and relatively massive; typified by the Rockweeds of the coast (Figs. 132, 308). Allied is the form of the Kelps, with fronds floating at times, buoyed on long stalks (Figs. 133, 306-7).

(2.) *THE AËRIAL HABITATS, AND THEIR VEGETATION FORMS, CALLED AËROPHYTES.*

The fundamental distinction between water and land habitats consists in the fact that water plants absorb their carbon dioxide and oxygen from solution in the water, while land plants absorb them direct from the air. The conditions of absorption of water and mineral salts, and the relations to light, are substantially the same in both. Hence the contrast between water and land habitats is not between water and land (*i.e.* soil), but between water and air; and therefore we call land plants not *geophytes*, but *aërophytes* (page 561).

The physical conditions to which the structure of aërophytes must conform, are well known. On land the primal necessities of plant life do not exist intercommingled, as in water, but from the point of view of plant life occur in two strata, viz., the light and carbon dioxide in the atmosphere above, and the water and mineral salts in the soil below, oxygen being present in both strata where the soil is well aërated. Correspondingly, aërophytes are differentiated into two primary parts, green shoot and absorbing root,

while the conditions of light absorption by chlorenchyma (pages 52-3), explain the further differentiation of the shoot into thin leaves and supporting stem. Again, the usual, and often extreme, scarcity of moisture in the air exposes the aërial parts of plants to desiccation; and correspondingly such parts are enwrapped with waterproof coverings of epidermis and cork. The waterproof covering, however, is practically impervious to carbon dioxide and oxygen; and correspondingly we find epidermis and cork pierced by openings, — the stomata and lenticels, through which those gases pass readily. Openings which permit passage of carbon dioxide and oxygen, however, permit also passage of water vapor, and hence loss from the plant (transpiration), with danger of desiccation of the tissues. Correspondingly we find stomata and lenticels guarded by movable cells or special tissue growth, which automatically diminish those openings as the tissues dry out. The method, however, has limitations, and in places where dryness prevails is supplemented by reduction in size of the plant, verticality of the tissues, thickness of epidermis, and other xerophytic features (page 69-70), which produce a profound effect upon form and aspect. Again, the rapidity of diffusion of carbon dioxide and oxygen in air permits their effective transfer along slender passages; and, correspondingly, aërophytes possess systems of continuous intercellular passages, opening through stomata and lenticels, whereby deep-lying tissues are effectively aërated, and massive growth becomes possible. Finally, unlike the water, the air affords practically no buoyant support to plants, which must withstand great and increasing strains as they grow in size. Correspondingly, while plants of low stature and sheltered habitat are herbaceous and soft-bodied, those which grow tall or exposed develop firm woody tissue arranged upon mechanically effective systems.

These conditions of the land habitats explain the distinctive features of aërophytes, — their differentiation into chloro-

phyllous leaves, supporting stems, and absorbing roots; the inclosure of their shoots in waterproof epidermis and cork, pierced by regulable stomata and lenticels; their alteration in form, size, and aspect, with dryness of habitat; their penetration by intercellular passages; and their attainment to massive size and firm structure.

The aërial habitats fall into subdivisions determined by the relative proportions of the six primal necessities; and these, with the distinctive vegetation forms, are the following:—

- A. *THE OPTIMUM HABITATS, AND THE VEGETATION FORMS CALLED MESOPHYTES.*
  - B. *THE ALTERNATING HUMID-DRY HABITATS, AND THE VEGETATION FORMS CALLED TROPOPHYTES.*
  - C. *THE DRY HABITATS, AND THE VEGETATION FORMS CALLED XEROPHYTES.*
  - D. *THE UNDRAINED HABITATS, AND THE VEGETATION FORMS CALLED HELOPHYTES.*
  - E. *THE SALINE HABITATS, AND THE VEGETATION FORMS CALLED HALOPHYTES.*
  - F. *THE ACID SOIL HABITATS, AND THE VEGETATION FORMS CALLED OXALOPHYTES.*
- A. *THE OPTIMUM HABITATS, AND THE VEGETATION FORMS CALLED MESOPHYTES.*

These are the habitats characterized by constant warmth, ample rainfall, and a well-aërated soil rich in mineral salts; and in all such places, light, carbon dioxide, and oxygen are sufficient for plant needs. These conditions, which are the very best for plant life, are realized only within the tropics in places of ample rainfall; and here, in the so-called tropical rain forests, is attained the greatest luxuriance and diversity of plant life. The vegetation forms, which, of course, are all perennially green, are called *mesophytes* (*i.e.* intermediate plants, or normal plants), and the principal are the following. For simplicity, the word *mesophytes* is not repeated, though understood in the names of the forms, *e.g.* the first would read in full “deliquescent tree mesophytes,” or “deliquescent arborescent mesophytes.”

DELIQUESCENT TREES; the greatest of all vegetation, a dome of foliage supported on branches radiating from a single trunk (page 181), which is wide rooted in aerated soil; typified by the greater trees of the tropical forests, and by the summer condition of our own deciduous forest trees, Maples, Oaks, Elms, Beeches, etc. (Fig. 123). COLUMNAR TREES; upright, unbranched, columnar trunk, with a great crown of pinnately compound fronds usually lifted above all surrounding vegetation; typified by the Palms (Fig. 30); in the Tree Ferns (Fig. 31), and the greater Cycads (page 517) the form survives, though now as undergrowth. DWARF COLUMNAR TREES; like the preceding but short stemmed with fan-shaped leaves; typified by Dwarf Palms (Figs. 30, 34, 377). GIANT HERBS; of rapid soft growth to great size in sheltered situations; typified by the Banana (Figs. 28-29) and many great Aroids. GIANT GRASSES; typified by Bamboo (Fig. 374). STILT SHRUBS; the shoot raised above ground upon prop or stilt roots, typified by *Pandanus* (Fig. 177).

B. THE ALTERNATING HUMID-DRY HABITATS, AND THE  
VEGETATION FORMS CALLED TROPOPHYTES.

In some habitats, otherwise optimum, water is scant or unavailable during much of the year, and thus the plants, mesophytic for part of the time, are perforce xerophytic for the remainder. This condition obtains in some dry parts of the earth, but is most familiar in our own temperate climate, where the plants find plenty of water in summer, but not in winter, because roots absorb badly from cold soils, and not at all from those that are frozen. Thus our winter soils are *physiologically* even though not *physically* dry, and our plants in winter are exposed to desert conditions. Correspondingly, the typical temperate vegetation, while spreading ample thin foliage in summer, largely sheds the leaves, and protects itself against desiccation, for the winter. Thus are produced vegetation forms which are alternately

mesophytic and xerophytic, — the condition called **TROPOPHYTIC**, — and the following are the principal ones.

**DECIDUOUS TREES**; mostly deliquescent, as with mesophytes, but dropping the foliage, thus eliminating its excessive transpiration in winter, when the stems are enwrapped within corky waterproof coverings; typified by our common forest trees, Maples, Elms, Oaks, etc. **DECIDUOUS SHRUBS**; of form like the trees, but branching from the ground without trunks, and living as undergrowth or in places where trees are prohibited; typified by our Dogwoods, Viburnums, etc. In alpine and arctic regions, trees become reduced to shrub-size, and shrubs to trailing forms. **ANNUAL HERBS**; erect leafy stems with fibrous roots, completing the cycle of growth from seed to seed in the summer, and lasting over winter as the resting seed only (page 114); typified by many weeds, and garden favorites. **HERBACEOUS PERENNIALS**; like annuals in the overground parts, but storing food through the winter in underground rootstocks and tubers (page 114); typified by Solomon's Seal (Fig. 134) and many undergrowth herbs of the woods. Biennials are similar in principle. Allied is the form of our Ferns, of which the creeping rootstocks produce annual fronds. In general the creeping condition indicates degeneracy from former upright state, — in this case from tree forms. **TURF-FORMING GRASSES**; perennial horizontal interlacing rootstocks sending up annual shoots which die to the ground in winter; typified by our meadow grasses (page 187), which take possession of all places where trees and shrubs are prohibited. **BULBOUS PERENNIALS**; underground food-storing bulbs, inclosing leaves and flowers which push to the surface and complete flowering, fruiting, and food formation in comparatively short time; typified by Adder's Tongue, and many bulbous plants of gardens (page 73). This form is well suited to dry climates with considerable moist seasons, as in the Levant, where it abounds. **TUBEROUS CLIMBERS**; xerophytic rotund stem succulents, sending up temporary leafy shoots in



the moist season; typified by *Testudinaria* (Fig. 382), and other forms in South Africa.

C. *THE DRY HABITATS, AND THE VEGETATION FORMS CALLED XEROPHYTES.*

These are the habitats in which, optimum in other respects, both air and soil are dry for the greater part of the year. To some extent tropophytic vegetation is found in such places, but characteristic vegetation forms also occur which keep in the vegetative state (evergreen) throughout the long dry season. Such true xerophytes are further distinguished by the permanent possession of transpiration-reducing features, including close set leaves, thickened epidermis, reduced size, verticality of tissues, and associated characteristics (pages 69-70). These features, while useless during the moist season, are then no detriment; and these plants are accustomed to make most of their growth at that time. Xerophytic evergreens occur among the deciduous tropophytes in our temperate region forests, really as immigrants from the north, where they form great forests. The advantage of the evergreen habit in such cases consists in the longer season of activity, including even mild parts of the winter, thus permitted. The principal xerophytic vegetation forms are the following.

EVERGREEN EXCURRENT TREES; cone-shaped, with horizontal branches and linear leaves, fitted to dryness and snow-fall (pages 63-4, 179), but able to endure for a time mesophytic conditions; typified by the Pines, Spruces, and Firs (Fig. 122). Their xerophytism, primarily fitted to the physiological dryness of winter, enables them to occupy physically dry situations, like mountain slopes and gravel ridges. EVERGREEN EXCURRENT SHRUBS; in principle like the foregoing, but living in places where conditions prohibit trees. EVERGREEN BROADLEAF SHRUBS; deliquescent, but with leathery, thick-epidermed leaves; in forests, typified by Mountain Laurel and Rhododendron. In regions of pre-

vailing, but not desert dryness, like the Levant, forms like Butcher's Broom (Fig. 140) are common. EVERGREEN GROUND PLANTS; on the same principle as the preceding; typified by Wintergreen. Allied are evergreen trailers like Periwinkle, Ground Pine, and the evergreen Ferns. CARPET MOSSES; with dense-tufted, upright, low stems from creeping protonemata (page 487), forming dense turf; occurring also as epiphytes, and on barren plains. Allied is the form of the Carpet Liverworts. CRUSTACEOUS LICHENS; the associations of Fungi and Algæ, able to resist desiccation but to absorb water quickly when available (page 461); fitted to cling to bare surfaces, and hence extending into barren situations, including tree trunks and bare rocks. BUNCH GRASSES; forming compact radiating heads on dry plains (page 63). SAGE BRUSH SHRUBS; deliquescent, but with persistent vertical leaves which revive at moist times, as in the Sage Brush of our deserts. Allied are the leafless shrubs of dry climates (Fig. 138). RESURRECTION PLANTS; rosette-form, curling inward to a ball when dry, but expanding flat with moisture; typified by *Selaginella lepidophylla* (page 505) and the Rose of Jericho (Fig. 257). SPINY SHRUBS; more or less green on the stems and the great spines; found commonly on deserts in Asia and Australia. ROSETTE LEAF SUCCULENTS; with compact, rotund leaves storing water and food, as in the African *Mesembryanthemum* (Fig. 44). ROSETTE PERENNIALS; stemless, with leaves brought to a compact whorl on the ground; typified by the rock-dwelling *Sempervivum* (Fig. 131) and by many evergreen herbs. RADIATE LEAF SUCCULENTS; a head of stout, stiff-pointed leaves, swollen towards the base and storing water and food, as in Century Plant, Aloe, and *Eremurus* (Fig. 232). TUFT TREES; radiate heads of long, stiff, linear leaves in a crown on a columnar trunk; typified by *Cordyline* (Fig. 35) and *Yucca*, common on American deserts. STEM SUCCULENTS; stems short and thick, often rotund, filled with water and food, thick-epidermed, bearing the

chlorenchyma in vertical ribs instead of leaves, which are wanting; typified by Cacti and some Euphorbias. This is the extreme xerophytic type.

D. *THE UNDRAINED HABITATS, AND THE VEGETATION  
FORMS CALLED HELOPHYTES.*

In the habitats where water stands constantly, viz. in swamps, bogs, marshes, and along river and lake margins, the relatively massive roots and rootstocks of Spermatophytes can obtain from solution in water only a small part of the oxygen needed in their respiration, especially as the supply is renewed slowly where its diffusion is impeded by presence of the soil. Hence the oxygen for the under-water parts must be supplied from other sources. To some extent it may be derived from anaërobic or "intracellular" respiration (page 171), but chiefly it is conducted from the atmosphere through the aërial parts. Correspondingly, plants which grow in such places possess greatly enlarged air passages in stems or petioles, whereby is explained the soft-spongy texture of true marsh and bog plants. Superficially these plants, especially if floating, are often confounded with hydrophytes; but in fact these marsh plants or helophytes are true aërophytes, since they take their supply of carbon dioxide and oxygen, even for their immersed parts, through intercellular spaces from the atmosphere. Every gradation exists between soil saturated with water and standing water without soil, but physiologically they are practically identical. The principal helophytic vegetation forms are the following.

SWAMP FLAGS; vertical sword-shaped leaves rising from submerged rootstocks aërated through passages from the leaves; typified by Cat-tails, true Flags (*Acorus*), Iris, with Saw Grass of the Florida Everglades, and many of tropical marshes. MARSH REEDS; vertical, slender, cylindrical shoots from submerged rootstocks, aërated through specially spongy pith; typified by Bulrushes, some Sedges, and Horsetails.

Allied is the form of Papyrus (Fig. 375). Such reeds can live in deeper water than any other except the floating helophytes. WATER GRASSES; like the last physiologically, but more leafy; typified by Wild Rice. WATERSIDE HERBS; long-petioled leaves from underwater roots or rootstocks; typified by Pickerel Weed, Water Plantain, Arrowhead, and by Calla in its native home. DIMORPHIC-LEAVED HERBS; air-fitted leaves above water, and water-fitted beneath the surface, on the same stem; typified by *Bidens Beckii* (Fig. 32), some species of *Ranunculus*, and *Cabomba*. AËRENCHYMOUS HERBS; possessing special organs of aëration as in *Jussiaea* (Fig. 176). FLOATING LEAF AQUATICS; typified by the White and Yellow Water Lilies; large, rounded leaves, unwettable on the upper surface, are connected with the submerged rootstocks by elongated flexible petioles, adjusted to the depth of water, and specially fitted for conduction of air through the large passages. Water Poppy, some Knot-weeds, and Water Shield belong here. Related is the form of our Wild Calla, and the Buck Bean in which the shoots are afloat. FREE-FLOATING AQUATICS; either a thallus, as in floating Liverworts (*Riccia*, page 480), or a pel-tate shoot, as in *Lemna* (Fig. 379), or floating leaves, as in *Salvinia* and *Azolla* (Fig. 353), or a rosette, as in Water Hyacinth (Fig. 380). In all cases the upper surface is unwettable, and the roots hang below as a counterweight which prevents overturning. FLOATING BOG MOSSES; typified by the Peat Mosses (*Sphagnum* species, page 485), which grow out over water as mats, and later grow up on the peat which they form.

No prominent helophytic trees or shrubs have been developed, unless the Bald Cypress of southern swamps, with its aërating knees (page 252) is here included. The swamps and flat bogs of temperate regions are occupied mostly by evergreen conifers, or by heath shrubs, though the mode of aëration of their roots, aside from their nearness to the surface, is somewhat uncertain. These forms seem to

occur in such places because swamp and bog waters are both cold and acid, — conditions which only xerophytes can endure. The typical waterside shrubs are Alder and Willows; these are deliquescent forms with soft wood and many fine roots, which they form easily above ground, especially in running water.

*E. THE SALINE HABITATS, AND THE VEGETATION FORMS CALLED HALOPHYTES.*

On the sea-coast the soil contains salt, from little to the three per cent of pure sea water; and even more occurs at salt springs or in other special places. Its presence renders osmotic absorption by roots more difficult, while in quantity it injures the tissues, from which it cannot be excluded. Correspondingly, the plants which grow in such places exhibit xerophytic features, preventive of much transpiration, and hence absorption. The vegetation of seashores and salt marshes includes many xerophytic grasses, annual herbs, etc., and the following principal halophytes.

ANNUAL SUCCULENTS; typified by the common Samphire or Saltwort of our coasts, a stem succulent with rudimentary leaves and wind-pollinated flowers (Fig. 389). Allied are leaf succulents like *Buda*, *Suaeda*, etc. MANGROVES, familiar on tropical strands (Fig. 397); large, deliquescent, broad-leaved, with xerophytic tissues, organs of root aëration, vivipary of the seeds, and other notable adaptations to their difficult habitat.

*F. THE ACID SOIL HABITATS, AND THE VEGETATION FORMS CALLED OXALOPHYTES.*

These are places in which organic acids accumulate in the soil, because drainage is defective; for bacteria, which destroy the acids, are inhibited by poor aëration or low temperature. This condition obtains in bogs, heaths, and cold moors. The acids render absorption of water somewhat more difficult osmotically, and also are disadvantageous in the tissues of

the plants, from which they cannot be wholly excluded. Correspondingly the plants which grow in such places exhibit xerophytic adaptations against large loss of water and hence much absorption. While many of the plants of bogs, heaths, and moors are xerophytic forms of ordinary shrubs and herbs, two distinctive oxalophytic vegetation forms occur.

HEATH SHRUBS; low, dense-growing, more or less evergreen, well protected against transpiration, as illustrated in *Rhodora*, *Ledum*, *Cassandra*, *Kalmia*, and others of that ilk, which grow not only on bogs, but along the shores of deadwater streams. HEATHER SHRUBS; low or creeping, evergreen with scale leaves, typified by Heather, Crowberry, and others of dry, barren, exposed moors, where often the peaty soil is but a few inches deep. Allied is the form of the Blueberry, Huckleberry, etc.

Other inorganic habitats are recognized in exact studies, though for the most part they possess no distinctive vegetation forms. Thus, sand dunes and beaches, dry habitats, bear a vegetation of xerophytic grasses, herbs, shrubs, and trees, but no peculiar forms. Exposed rocks and cliffs, subject to desiccation, have likewise no peculiar forms, unless the rosette perennials, or the Lichens, should here be placed. Finally, arctic and alpine tracts beyond the tree line, characterized by coldness, have meadows of moss-like herbs, trees which are condensed towards the ground, shrubs which are creeping, and one characteristic vegetation form. TUSSOCK PLANTS, dense, radiating, perennial, hemispherical heads resting on the ground, either Mosses, Grasses, or other flowering plants; typified by some Pinks (Fig. 390) and especially by the remarkable Vegetable Sheep (*Raoullia*) of New Zealand.

### 3. THE ORGANIC HABITATS, AND THE VEGETATION FORMS WHICH INCLUDE HYSTEROPHYTES.

Here we may include all habitats created by the existence of organisms, whether serving as a source of food, or simply

as mechanical support. Both habitats and vegetation forms merge off gradually from those already described, beginning with the simpler autophytic mesophytic climbers, and passing through all gradations to extreme parasites. They include plants from all of the four great divisions, Thallophytes to Spermatophytes. Accordingly we recognize, —

- A. *THE HABITATS OCCUPIED BY CLIMBERS, OR LIANES.*
- B. *THE HABITATS OCCUPIED BY EPIPHYTES.*
- C. *THE HABITATS OCCUPIED BY HALF-PARASITES.*
- D. *THE HABITATS OCCUPIED BY PARASITES AND SAPROPHYTES.*
- E. *THE HABIT OF THE INSECTIVOROUS PLANTS.*

A. *THE HABITATS OCCUPIED BY CLIMBERS, OR LIANES.*

The erect self-supporting trunks built by trees for the spread of their own foliage, offer opportunity to other plants to achieve the elevation of their foliage without themselves providing stout stems; and correspondingly we have the existence of many forms of slender-stemmed climbers or lianes, which are specially abundant in tropical forests. Their stems are largely composed of great ducts, and they possess always some definite method whereby they are enabled to cling to their support. The principal vegetation forms are the following.

CLAMBERING VINES; very slender, often branched, clinging haphazard to large vegetation by aid of retrorse hooks, etc., as in Rattan Palm (Fig. 376), a form very common in the tropics. Such are our Bedstraws (*Galium*) in miniature, and our Clematis, though with hooks replaced by sensitive petioles (Fig. 51). TWINING VINES; these turn spirally around the support, as in Morning Glory, Climbing Bittersweet, and many tropical lianes, the latter often choking the support plant. CLINGING VINES; with thigmotropically sensitive tendrils, as in Grape Vines, and Passion Vines (Fig. 136). Allied are the tropical forms with horizontal climbing roots (Fig. 181), including climbing Aroids. ADHERENT VINES; with clinging disks at the tips of aerial

roots, as in English Ivy (Fig. 180), or at the ends of modified tendrils, as in Boston Ivy.

*B. THE HABITATS OCCUPIED BY EPIPHYTES.*

The horizontal branches of trees, which spread their own foliage so well to the light, offer opportunity for a spread of foliage by other plants also. Correspondingly there occur many small plants which grow on the branches and trunks of trees far above the ground, especially in tropical forests; and such are the typical epiphytes. The epiphytic is the logical development of the climbing habit. The situation involves difficulties, — viz. the seeds must reach the branches and germinate there, the plant must hold securely to the slender perch, the roots must acquire the needed mineral salts and water without contact with the ground. The epiphytes, however, show ample fitness to all of these conditions in adaptations which are often remarkable. The seeds are carried chiefly by birds; the plants are firmly anchored by roots insinuated into the crevices of the bark; mineral salts are obtained from a humus resulting from decaying bark, leaves, etc., collected by the plant; water is derived from the rainfall, absorbed and stored in various ways, though the limitations and inconstancy of such sources have evolved xerophytic adaptations which conserve it.

The epiphytes include members of all the great divisions of plants — Algæ, Fungi, Liverworts, Mosses, Ferns, and various Spermatophytes. Also epiphytes occur in the water upon hydrophytes, as do parasites. The principal vegetation forms are the following.

ORCHIDACEOUS EPIPHYTES; with storing pseudobulbs, and hanging aërial roots fitted to absorb rainfall (page 254; Fig. 126). TANK EPIPHYTES; funnel-form rosettes of leaves, forming a cup which holds water, as in *Æchmea* (Fig. 127). Water reservoirs of other forms are also frequent. NEST EPIPHYTES; with certain leaves so arranged as to catch



falling leaves and bark as a store of humus, as in some Ferns, notably *Platycerium* (Fig. 128), and in another way the Bird's Nest Fern (*Asplenium Nidus*). PENDENT EPIPHYTES; as in *Tillandsia usneoides*, the Long Moss, and some Lichens; often absorbing water through stem and leaves under capillary scales. STRANGLING EPIPHYTES; frequent in tropical forests; the seed lodges in the crotch of a tree, on which the plant develops epiphytically, but it sends to the ground aerial roots which then develop as stems, often crushing to death the supporting tree (Fig. 385).

A form of epiphyte is the ENDOPHYTE, represented by the colonies of *Anabaena* always present in cavities of *Azolla* (page 500), or of certain leafy Liverworts. The significance of the habit is not clear, nor have any special vegetation forms been developed.

#### C. THE HABITATS OCCUPIED BY HALF-PARASITES.

The difficulty experienced by epiphytes in obtaining water and mineral salts, renders natural the use of the supply in the tissues of the stems on which those plants are supported. Thus originates the habit of the green half-parasites, of which the principal form is the following.

EPIPHYTIC GREEN HALF-PARASITES; typified by the Mistletoe, which is an epiphyte sending haustorial roots into the fibro-vascular bundles of the host plant, whence it draws the water and mineral salts used in the photosynthetic formation of its own food (page 86; Fig. 386). Other forms have a similar habitat on roots in the ground (page 543).

#### D. THE HABITATS OCCUPIED BY PARASITES AND SAPROPHYTES, I.E., HYSTEROPHYTES.

Autophytic plants are able to form organic food not only sufficient for their own use, but in large surplus. Upon this fact rests the existence of animal life, and of plant parasites and saprophytes. These hysterothytes include some Spermatophytes, which have been developed from epiphytes

through half-parasites; these are really epiphytes sending haustorial roots into the hosts, and absorbing organic food instead of water and mineral salts only. The transition is illustrated within the order Santalales (page 543). Most of the hysterothytes, however, are Fungi, fully described in the preceding pages. No essential physiological differences exist between saprophytes and parasites, which moreover are alike in their forms, and hence may be treated together. The principal vegetation forms are the following.

**EPIPHYTIC PARASITES**; Spermatophytes, really epiphytes without chlorophyll, and hence with reduced leaves and stems, sending haustorial roots into the tissues of the host, whence they draw organic food; typified by the remarkable *Rafflesia* (Fig. 61), and by many members of the Loranthaceæ (Fig. 543). Allied is the form of the Dodder (Fig. 59). **TOADSTOOL HYSTEROPHYTES**; a wide-ranging, fine-branching mycelium in host or substratum, producing a large sporophore exposed to the winds (Fig. 328), as typified by the Toadstools, Bracket Fungi, etc., both parasites and saprophytes, of the Ascomycetes or Basidiomycetes. **HETERECIOUS PARASITES**; having stages with parasitic mycelium on more than one host, bearing distinctive spore bodies on the surface of each; typified by Smuts, Rusts, and other Fungi. **HYDROPHYTIC PARASITES**, living in water upon insects, with limited mycelium, typified by *Saprolegnia* (Fig. 302). **ENDOPHYTIC HYSTEROPHYTES**; typified by many Bacteria and Yeasts, living in solutions, with spores set free by the desiccation or decay of the substratum. **FREE-MOVING SAPROPHYTES**; typified by the Myxomycetes, with motile plasmodium. **MYCORHIZA**; symbiotic association of a fungus mycelium with the root tips of the higher plants (page 244, Fig. 172).

#### *E. THE PECULIAR HABIT OF THE INSECTIVOROUS PLANTS.*

A peculiar form of parasitism is found in the insectivorous habit. Certain plants are known to catch insects, digest the bodies, and absorb the products, thus supplementing

their supply of combined nitrogen, which is usually scanty in places where those plants occur (page 246). The method by which the insects are taken determines the vegetation forms as follows.

PITCHER PLANTS; typified by *Nepenthes* (Fig. 49) and *Sarracenia* (Fig. 48) with true pitchers containing secreted water and digestive enzymes, often with remarkable adaptations for attracting and holding the insects. Allied is the form of the Bladderwort (Fig. 399). LEAF TRAPS, typified by the Venus Fly-trap (Fig. 50), with hinged leaf closing suddenly on contact. ADHESIVE TRAPS; typified by Sundew (Fig. 392), with viscid glands; leaf incurling and digesting the insect. Allied is the form of the *Pinguicula* or Butterwort, the leaves provided beneath with wax to which insects adhere.

In some measure allied is the association between ants and plants called MYRMECOPHILY. The former belief that the constant presence of ants on certain tropical trees is symbiotic, the trees providing the insects with residence and food, and receiving in return protection against leaf-cutting ants, seems now doubtful. But there is no question as to the cultivation of Mushrooms by ants in Brazil (page 473).

### 3. PLANT FORMATIONS AND ASSOCIATIONS

The vegetation of the earth, considered comprehensively, is presented to the eye in areas and zones having each its characteristic aspect and distinctive place as a feature of the landscape. Usually also a connection is obvious between these areas and zones and the physical features of the country, that is, the principal habitats. Such areas or zones of vegetation are called PLANT FORMATIONS, and a formation is the totality of vegetation in any given habitat. Their reality and prominence are attested by our common nomenclature, which recognizes *woods* (of different kinds), *marshes*, *bogs*, *prairies*, etc. These words, by long usage, have come to involve something of the idea of both the vegetation and the habitat. It is because of this close correlation between vege-

tation and geography that this phase of ecology is often called ECOLOGICAL PLANT GEOGRAPHY.

When a plant formation is examined more closely, it is found composed, of course, from vegetation forms. Rarely, however, if ever, does a formation consist of one form, but usually there are several, and oftentimes many, complexly but definitely interrelated. What now are the factors which determine the presence of the respective vegetation forms in particular formations? In the first place, while mere accident plays some part in special instances, in the long run the natural methods of dissemination of plants are so effective that all the kinds in a given region are able to migrate, and are constantly sifting by their seeds, to all parts of it, though they only develop in those places to which they are fitted. Thus the forms in a formation represent those which are *retained* from the entire drifting flora. *Second*, any given habitat is naturally preëmpted and held by the largest vegetation form of the country which happens to be best fitted to it. Such a form is called *dominant*, and chiefly determines the character of the formation. Theoretically we would expect a single dominant form in each habitat, as often occurs, *e.g.* in pine forests, maple groves, etc. Commonly, however, two or even more forms share the dominance, as when Maples and Birches grow intermingled in our New England forests, or, more strikingly, when deciduous and evergreen trees grow intermingled, as so often in our woods. In such case it is still uncertain whether this shared dominance is a result of practically identical relations to habitat, the two forms thus standing in a state of balanced contention, or whether in some one of several conceivable ways they are *complementary* to one another, one using what the other does not need. Shared dominance is more common towards the tropics, and single dominance towards the poles. Vegetation forms which share dominance are often called COMMENSALS (table-mates), and are *like* or *unlike*, as the case may be. *Third*, to the dominant forms some others may be

symbiotically linked by bonds of mutual benefit, as in case of mycorrhiza with some trees. Possibly some forms may destroy the root excretions of the dominants, to mutual advantage; and other bonds of such nature are conceivably more prevalent than we yet know. Such forms are SYMBIONTS. *Fourth*, the spacing apart of the dominant forms sufficiently for the spread of their own foliage, usually leaves interspaces available for smaller forms which can fit the conditions there present. Thus in a forest the dominant trees build a canopy of foliage upheld on the ends of lofty radiate branches. Beneath there is room for tall shrubs, which utilize light that filters through the canopy; and, in like manner, below the shrubs is room for tall herbs, and below them for a ground layer of low herbs, creepers, Mosses, Liverworts, and perhaps Algæ. Thus we have forms which are simply interpolated in the interspaces left by the dominant kinds, or are INTERPOLANTS. *Fifth*, the presence of the independent plants in the formation offers a field for exploitation by dependent plants, — climbers, epiphytes, half-parasites and parasites, while saprophytes profit by their decaying remains; and these DEPENDENTS differ with the character of the dominant and interpolated forms. *Sixth*, special forms may be present as VISITANTS, by chance or accident, as with rare members of the flora. Thus any formation consists of a framework of dominant vegetation forms determined by the habitat, with which others are present as symbionts, as interpolants, as dependents, or as visitants. A formation is thus somewhat of an organism, though of loose aggregation.

The more intensive study of any formation shows that, while homogeneous in general, it differs in details of constitution in different parts. Thus, in our mixed forest formations the deciduous trees are more abundant in some places and the evergreens in others; and the undergrowth differs correspondingly, for each kind is accompanied by somewhat different associates. Such groups, comprising

the totality of associates which tend to go with a given dominant form, are called ASSOCIATIONS, or sometimes SOCIETIES, though this latter word has often been used for formations and associations without distinction. Thus an association is the particular assemblage of vegetation forms which accompany a given dominant or combination of dominants. Defined in another way, an association is the aggregation of forms which live together on the same area of ground. In case a formation has but one dominant vegetation form, it has ordinarily only a single association, but where two or more dominant forms occur, there will be different associations. Other groups, subordinate to the associations, have been recognized by investigators, just as varieties are recognized among species, but the matter is recondite and little understood. In these minor groups, those features of species which are not connected with their vegetation forms come also into play, complicating the combinations.

In the description of associations, it is easy and convenient to designate the species which are represented in the vegetation forms, and in this way the connection is made between the vegetation and the flora. Indeed, associations are often named scientifically by using the stem of the name of the dominant form with the termination *-etum*, e.g. *Pinetum*, *Quercetum*, etc., which terms should now be self-explanatory to the student. No scientific system for naming the formations has yet come into use.

The relations of these groups may be summarized by saying that the species of a country tend to collect in the habitats which their vegetation forms happen most nearly to fit; the vegetation forms tend to collect into associations according to the most natural manner of interlocking around the dominant forms of a habitat; the associations tend to collect, according to the similar habits of their dominants, into formations; the formations are linked in areas and zones with the habitats; and collectively the formations make up the vegetation of a country.

In the study of the constituents of the vegetation of a country, it is customary to make records partly by photography, and partly on maps, showing by suitable signs the areal and zonal distribution. Particularly effective, however, are diagrammatic TRANSECTS, or optical sections across vegetation and habitats, whereby may be shown vividly both the leading features of the vegetation form, and also the association of the different forms.

It is a familiar fact that while the principal formation in some countries is forest, in others it is prairie, or desert, etc., though minor formations may be similar in all. It is well known that climate, *i.e.* temperature and rainfall, determine the nature of these greater formations, which therefore are often called CLIMATIC FORMATIONS. The minor ones, however, marsh, swamp, etc., are determined rather by local soil conditions, and are called EDAPHIC. The distinction has its chief importance in this fact, that while the climate of a country, and therefore the nature of its principal formation, alters very slowly, the soil conditions, and therefore the edaphic formations, are in much more rapid change. The change, however, is in a definite direction, because, for geological reasons, the physical conditions are tending to reduce a country to a base level, *i.e.* hills are being leveled, lakes filled, etc. Accordingly the formations are likewise approximating always towards one kind, which is the leading formation permitted by the climate. Thus the vegetation of each country is all tending towards a uniform *climatic climax formation*. In New England this is a mixed forest, further south a deciduous forest, farther north an evergreen forest, while in the west, it is prairie, plains, or desert.

Since formations are made up of vegetation forms, which depend upon fitness to habitats, it ought to be true that widely separated countries which have similar conditions of climate and soil should have similar vegetation forms and formations, even though the floras are entirely different. This is actually true, as shown by the fact that the vegetation

of countries as far apart and different in flora as New England and New Zealand, or the tropics of Brazil and Borneo, are substantially alike, the same formations being found in both. Indeed, to general view, and as shown in the best photographs, the vegetation of these contrasted regions is indistinguishable, though nearer examination shows them to be made up of very different species.

The limitations of this book forbid description of even the principal plant formations of the world, and permit only the following list. The interested student who would follow the subject farther should turn to the fine books of Schimper and of Warming.

*THE FOREST FORMATIONS.* The **TROPICAL RAIN FOREST**, composed wholly of mesophytes, is the most highly developed, and exhibits the most luxuriant vegetation of the world. The always-green canopy, formed by the several great dominant trees, is pierced here and there by columnar palms, while beneath is an undergrowth of tall shrubs and tree ferns, a lower growth of giant herbs, and a ground layer of creepers, Moss plants and Algæ; and rampant in all the interstices are climbers, epiphytes, parasites, and saprophytes. The **DECIDUOUS FOREST** of warm temperate regions, composed chiefly of tropophytes, has a canopy of deciduous foliage, with undergrowth of tall shrubs, a lower growth of tall herbs, and a ground layer of carpet herbs, Algæ, and Moss plants. Climbers occur, but few true epiphytes, aside from xerophytic Mosses, Lichens, and adherent Algæ, because they cannot endure the long dry period of winter. The **MIXED FOREST** of cool temperate regions, composed of tropophytes intermingled with evergreen xerophytes, has a canopy of deciduous foliage pierced by the taller cone-shaped spires of the excurrent evergreens, while the undergrowth likewise consists of deciduous and evergreen shrubs and herbs. The **EVERGREEN FOREST**, of more northern regions and of mountains, composed chiefly of xerophytic excurrent evergreens, forms often great growths of one dominant, — Pine, Spruce, Fir, with



suitable undergrowth and ground plants. A DWARF FOREST, composed mostly of dwarfed evergreen trees ("Elfin Trees"), merging down to creeping Willows, etc., gives the transition from true forest to open plains beyond the tree line in high northern regions and on mountains, where it forms often almost impenetrable growths ("pucker brush," "Krummholz," etc.).

*THE SHRUB FORMATIONS.* These are found where conditions forbid trees, as locally in exposed places in different parts of the world; and often they bear appropriate local names, e.g. *garigue* and *maqui* in Europe, *thickets* in England, *chaparral* in western America, though this form approaches a desert formation.

*THE GRASSLAND FORMATIONS.* These occur where the climate would permit trees and shrubs, but local conditions prohibit them. They are composed of Grasses and Sedges, with associated plants of conformable habit. Such are our own MEADOWS, where we artificially prevent growth of trees. The PRAIRIES are Grass Formations from which trees and shrubs have long been excluded, perhaps by the periodical fires. In mountainous districts often occur open grassy PARKS, while everybody has heard of the ALPINE MEADOWS found above the tree lines on mountains, and composed of a turf of low-growing perennial herbs having very beautiful flowers.

*THE PLAINS* form a transition from grass lands to deserts, as illustrated in our own western plains, with scattered bunch grasses. The STEPPES of Asia are allied, as are the SAVANNAHS of Africa, and the PAMPAS of South America.

*THE DESERT FORMATIONS.* These are "open" formations, with spaces of bare soil between the plants, which include the extreme xerophytes of North America. The Desert Formation has associations of succulent Cacti, and of Sage Brush. The deserts of Asia, Africa, and Australia have, of course, their own associations.

*THE HEATH FORMATIONS.* These include the BOG FORMATIONS, both flat bogs, with a vegetation much like swamps, and raised bogs, with a very sparse heath vegetation. Northward they merge to MUSKEAG and ultimately to Arctic TUNDRA. THE HEATH FORMATION occurs on thin organic soil, and consists chiefly of Heather, and other dwarf Ericaceous plants. Moor formations are the same.

*THE SALINE FORMATIONS.* These include the SALT MARSH FORMATION, MANGROVE SWAMP FORMATION, the open COAST FORMATIONS, and those of interior saline basins.

*THE ROCK FORMATIONS,* those of cliffs and stony plains.

*SAND AND GRAVEL FORMATIONS,* those of sand dunes and exposed beaches.

*FORMATIONS OF WASTE AND CULTIVATED GROUND* are also sometimes recognized.

*THE AQUATIC FORMATIONS.* These include SWAMP, MARSH, and WATERSIDE FORMATIONS, with their characteristic associations. In the water occur two, the BENTHOS (Formation), including the vegetation attached to the bottom, and the PLANKTON (Formation), the free-swimming and drifting forms, whether fresh water or marine.

The chief value of this conception of plant formations and associations consists in the power it gives to understand causatively the vegetation of a country, and also to describe it vividly. From a study first of the flora, and then of the vegetation groups, with illustration by photography, diagrammatic maps and transects, it is possible to prepare the most expressive descriptions of the plants of any country, and moreover in a way to make comparison possible with the plants of other countries. Few such studies have yet been made, and herein lies not the least of the opportunities for scientific service open to the interested student, especially to one so fortunate as to possess the instinct of the field naturalist.

## INDEX

Figures in heavy type indicate pages on which illustrations occur.

- Abnormalities, 196.  
 Abrus, 363.  
 Absciss-layer, **120**.  
 Absorption, 262; affected by temperature, 258; by roots, 224.  
*Acetabularia*, 432.  
 Acid Soil Habitats, 573.  
 Adaptation, 12.  
 Adder's Tongue, 494.  
 Adherent Vines, 575.  
 Adhesive, seeds, 362; Traps, 579.  
*Echmea*, **185**, 576.  
*Æcidia*, 466.  
*Æcidium*, **199**.  
 Aëration system, 132, 266.  
 Aërenchyma, 252, 266.  
 Aërenchymous Herbs, 572.  
 Aërial, Habitats, **564**; roots, 254, 256.  
 Aërobic, 403.  
 Aërophytes, 564; characteristics, 565.  
 Aërotropism, 232, 248.  
 Aëstivation, 329.  
*Æthalum*, 414.  
 After-ripening, 379.  
 Agar-agar, 444.  
*Agaricinae*, 471.  
*Agaricus campestris*, **469**.  
*Agave americana*, **536**.  
 Age, of Trees, 114.  
 Agriculture, 4.  
 Air, in soils, 240; passages, 19, 29; system, 33.  
 Akene, 348, **349**.  
*Albugo candida*, **436**.  
 Alcohol, 459; production, 172; source, 101.  
*Aldrovanda*, 547.  
 Algæ, 12; classes of, 399; Red, 305; relationship to Fungi, 398.  
 Algal Fungi, 434.  
 Alkaloids, 109.  
 Alpine Meadows, 585.  
 Alternating Habitats, 567.  
 Alternation of generations, 301, 446, 479, 507, 509; diagram, **508**.  
*Amanita vernus*, **470**, **471**.  
*Amaryllidaceæ*, 536.  
*Anabæna*, 500, 577.  
 Anaërobic, 403.  
 Anatomy, 3, 8.  
 Anchorage by roots, 231.  
*Angiospermae*, described, 524; life cycle, **525**.  
 Animals, classification of, 395; nutrition, 86; seed carriage, 361.  
 Annual, 114; Herbs, 568; rings, 124; Succulents, 573.  
 Annulus, 489, 495.  
 Anoxyscope, 167, **168**.  
 Anther, 272.  
 Antheridium, 306, 416, 479.  
*Anthoceros*, 483, 504; *lavis*, **483**; sporogonium, **483**.  
*Anthocerotales*, described, 483.  
 Anthocyanin, 88; composition, 108.  
*Anthurium*, 534.  
 Antitoxin, 173, 407.  
 Ants, cultivating Fungi, 473; in dissemination, 363.  
*Apetalæ*, 540.  
 Apogamy, 498.  
 Apogocotrophic, 247.  
 Apophysis, 488.  
 Apospory, 498.  
 Apothecium, 448.  
 Aquatic Formations, 586.  
*Aquilegia*, **295**.  
*Arales*, described, 533.  
*Araliaceæ*, 552.  
*Araucaria*, 523.  
*Arceuthobium*, 543.  
*Archegoniate*, 492.  
 Archegonium, 306, 478.  
*Archichlamydeæ*, 540.  
 Arctic Willows, 541.

- Aril, 351, 375.  
*Aristolochia*, anatomy, **129**; *labiosa*, **545**.  
*Aristolochiales*, described, 544.  
 Aroids, 533, 575.  
*Artocarpus*, **542**.  
*Asarum*, 544.  
 Ascocarp, 397, 448.  
 Ascogonium, 448.  
*Ascomycetes*, described, 447.  
 Ascospores, 397.  
 Asexual spores, 301.  
 Asexual *vs.* sexual propagation, 302.  
 Asparagus, fasciated, **197**.  
*Aspergillus herbariorum*, **457**.  
*Aspidium*, **496**.  
*Asplenium bulbiferum*, 498.  
 Associations, 582.  
*Auricales*, 469.  
 Automatism, 39.  
 Autophytes, 560.  
 Autumn coloration, 88; effect of external conditions, 93.  
 Auxograph, **155**, 156; record, **156**.  
 Auxospore, 428.  
*Azolla*, 500.  
  
*Bacillariaceæ*, 427.  
*Bacillus radicolica*, **406**; *subtilis*, **404**; *vulgaris*, 405, **406**.  
 Bacteria, 84, 244, 368; description, 402; forms, 402; nitrifying, 244; nutrition, 84; in soils, 244.  
 Baeteriology, 4, 407.  
*Bacterium aceti*, 405, **406**.  
 Bald Cypress, 252, 523, 572.  
 Bamboo, 127, 179, **531**.  
 Banana, **58**, 537, 538.  
 Banyan, 253, **254**, 543.  
 Bark, abscission, **123**.  
 Basidia Fungi, 463.  
*Basidiomycetes*, **463**.  
 Basidiospores, 397.  
 Basidium, 449, 464.  
 Bast, 130; fibers, 131, 265; parenchyma, 131.  
*Batrachospermum*, 445.  
 Bayberry, 111.  
 Beet rings, 256.  
*Begonia phyllomaniaca*, **204**.  
*Bennettiales*, 527.  
 Benthos Formation, 586.  
 Berry, 350.  
*Bidens Beckii*, **62**, 572.  
  
 Biennials, 114.  
 Bignonia seed, **358**.  
 Bird of Paradise Flower, 538.  
 Bird's-eye Maple, 198.  
 Bird's Nest Fungi, 476.  
 Birds, as cross-pollinators, 294; in dissemination, 363.  
 Birthwort, 544.  
 Black, Fungi, 452; Knots, 367, **452**; Molds, 437.  
 Bladders, of Algæ, 440.  
 Bladderwort, **555**, 556, 564, 579.  
 Bladder Wracks, 442.  
 Bleeding, 151, 227.  
 Bleeding host, 408.  
 Blights, 367, 436.  
 Blister Blight, 436.  
 Blotch diseases, 367.  
 Blue Molds, 456, 458.  
 Blue-green Algæ, description, 399.  
 Bog, Formations, 586; Mosses, 572.  
*Boletus*, 474; *subtomentosus*, **473**.  
*Boraginaceæ*, 555.  
 Bordeaux mixture, 369.  
 Botany, definition, 1; study, 2; subdivisions, 2.  
*Botrydium*, 563; *granulatum*, **431**.  
 Bracket, Fungus, **473**, 474; on stems, 182.  
 Bract, 73, 271, 276; colored, 74; of Linden, 74; in Poinsettia, 74.  
 Brand spores, 464.  
 Bread, Fruits, 542; Mold, **438**.  
 Broadleaf Shrubs, 569.  
*Bromeliales*, described, 535.  
 Brown Algæ, 439.  
*Bryales*, described, 487.  
*Bryophyllum*, **71**, 299, 548.  
*Bryophyta*, described, 478.  
 Bryophytes, 11; low growth of, 144.  
*Bryopsis*, 432.  
 Buckwheat, 544.  
 Bud, accessory, **137**; adventitious, 137; anatomy, **138**; axillary, 137; defined, 135; on leaves, 71; of Lettuce, **136**; of Palm, 136; scales, 78, **80**; separable, **300**; sizes, 136; sport, 209; terminal, 137; unregulated development, 198; winter, 135.  
 Bulb, **73**, 300; forms, **74**.  
 Bulblet, 373.  
 Bulbous Perennials, 568.  
 Bulrushes, 571.

- Bunch Grasses, 570.  
 Bundle-sheath, 30.  
 Burbank, 321.  
 Burdock head, **362**.  
 Burls, 199, 200.  
 Burnt Fungi, 452.  
 Butcher's Broom, **194**, 570.  
 Button Bush, **336**.  
  
 Cactus, 189, 550, **551**.  
 Caffein, 109.  
*Calamites*, 509.  
 California Poppy, 546.  
*Callithamnion*, 447.  
 Caloriscopes, **170**.  
 Calyptra, 488.  
 Calyx, 269, 351.  
 Cambium, 118; described, 132;  
   growth from, 124.  
*Campanulales*, described, 556.  
 Camphor, 108.  
 Cankers, 367.  
 Caoutchouc, 108.  
 Capillarity, 148, 237.  
 Capillitium, 413, **414**, 475.  
*Caprifoliaceæ*, 556.  
 Carbohydrates, 100; value, 100.  
 Carbon dioxide, absorption by plants,  
   22.  
 Carboniferous Period, 500, 509, **510**.  
*Carludovica palmata*, 533, **534**.  
 Carotin, 90; composition, 108.  
 Carpel, 273, 351.  
 Carpet Liverworts, 570; Mosses, 570.  
 Carpogonium, 445.  
 Carpospores, 397.  
 Carrion Fungi, **476**.  
 Caruncle, 363, 375.  
*Caryophyllales*, described, 545.  
 Castor Bean, **375**, 549.  
 Casuarinas, 540.  
 Cat-Tails, 529.  
*Caulerpa prolifera*, **432**.  
 Cedar, apples, 347; of Lebanon, **523**.  
 Cell, contents, 42; definition, 8;  
   division, **281**, **283**; initial, 355;  
   sap, 30; shapes, **42**; structure,  
   **41**; wall, thickened, **103**.  
 Cellulose, 41; composition, 98; uses,  
   99.  
 Cement, in trees, 211.  
 Central cylinder, 264.  
*Centrospermæ*, 545.  
 Century Plant, 114, **536**, 570.  
  
*Cephalanthus*, **336**.  
*Cephalotus*, 548.  
*Ceramium*, 447.  
*Cetraria islandica*, **462**.  
*Chaetophoraceæ*, 423.  
 Chalaza, 274.  
 Chalazal angle, 376.  
 Chalazogamic, 541.  
 Chaparral, 585.  
*Chara*, 434; *fragilis*, **433**.  
*Charales*, described, 432.  
 Chemosynthesis, 87, 408.  
 Chemotropism, 249.  
*Chenopodiales*, described, 544.  
 Chestnut disease, 356, 454.  
 Chimæra, 210, 366.  
*Chlamydomonas*, 416, **417**.  
*Chlorella*, 418.  
 Chlorenchyma, 17, 29, 262; areas,  
   32; thickness, **53**.  
*Chlorophyceæ*, described, 415.  
 Chlorophyll, 17, 108, 386; composi-  
   tion, 108; function, 25; spread,  
   387.  
 Chloroplastids, 30.  
 Chlorosis, 368.  
 Chondriosomes, 41.  
*Chondromyces crocatus*, **409**.  
 Chromatin, 280.  
 Chromatophores, 396.  
 Chromosome, mechanism of heredity,  
   **310**; numbers, 493.  
 Chromosomes, 280; diagram, **282**;  
   significance, 282.  
 Chrysanthemum, 318, 557.  
 Cion, 208.  
*Cladonia rangiferina*, **462**.  
*Cladophora*, **421**.  
 Cladophylla, **194**, 196.  
 Clambering stems, 184; vines, 575.  
 Classes, 392, 393.  
 Classification, 2, 10; ecological, 392;  
   nature, 391, 393; phylogenetic,  
   391, 392; of plants and animals,  
   395.  
*Clavaria aurea*, 474.  
*Claviceps purpurea*, **453**.  
 Cleistogamous flowers, **290**.  
 Cleistogamy, 292.  
 Clematis fruit, **350**.  
 Climatic Formations, 583.  
 Climax Formation, 583.  
 Climbers, 9, 184, 575.  
 Clinging Vines, 575.

- Clinostat, 174, **176**.  
 Close-pollination, 287.  
 Club, Mosses, 503; root, 414.  
 Cluster, 268; of flowers, 335.  
 Coal beds, formation, 99, 486, 509.  
 Coast Formations, 586.  
 Cocaine, 109.  
*Coccus*, **406**.  
 Cocklebur fruit, **363**.  
 Coconut, 345, 361, **362**, 372, 533.  
 Cœnocyte, 430.  
*Coleochæte*, 423, 446, 490; *scutata*, **424**.  
 Collenchyma, 118, 265.  
 Colors of leaves, 88, 89, 90, 92.  
 Columbine, **295**; pods, **347**.  
 Columella, 489.  
 Columnar Trees, 567.  
 Commensals, 580.  
 Companion cell, 131.  
 Compass plants, 58.  
*Compositæ*, 556; head, **557**.  
 Conceptacles, 442.  
 Conduction, 262; of carbohydrates, 152; of proteins, 152.  
 Cone, 352, **353**.  
*Conferva*, 422.  
*Confervales*, described, 420.  
 Conidia, 397.  
*Coniferales*, described, 519.  
*Conjugales*, described, 424.  
 Conjugating Algæ, 424.  
 Conjugation tubes, 426, 435.  
 Constriction of stems, **152**.  
*Contortæ*, 554.  
 Conventional constant, 25.  
 Convolute, 329.  
*Convolvulacæ*, 554.  
 Copper Beech, 319.  
 Cordage, 206.  
*Cordyceps*, 454; *militaris*, **455**.  
*Cordyline*, **65**, 570.  
*Coreopsis* head, **557**.  
 Cork, 133, 261; cambium, 264; uses, 99.  
 Corm, 191.  
*Cornacæ*, 552.  
 Corn bundle, **135**; stem, **119**.  
 Corn Smut, 464; life cycle, **465**.  
 Corolla, 270.  
 Corona, 82, 332, **333**.  
 Cortex, of roots, 220.  
 Cortical system, 262.  
 Corymb, **336**, 337, **339**.  
 Cotton, 205; plant, 550; seed, **359**.  
 Cotyledons, 73, 355, 374.  
*Crassulacæ*, 548.  
 Crested forms, 197.  
*Cronartium ribicola*, 468.  
 Cross fertilization, 298.  
 Cross-pollination, 286, 287; meaning, 298.  
 Crown Gall, 367, 407.  
 Cryptogams, 12, 492.  
 Crystals, 33; in plants, **111**.  
*Cucurbitacæ*, 556.  
 Cultivated Ground Formations, 586.  
 Cup Fungi, 450.  
 Curly Birch, 200.  
 Curly Top, 369.  
*Cuscuta*, **84**.  
 Cutin, 32, 98.  
 Cuttings, 259.  
*Cyanophyceæ*, 563; description, 399.  
*Cyathea*, stem, **497**.  
*Cycadales*, described, 517.  
*Cycadofilicales*, 517, 519, 527.  
 Cycads, 517.  
*Cycas revoluta*, **517**, **518**.  
 Cyme, **334**.  
*Cyperacæ*, 532.  
*Cypripedium*, **292**.  
 Cystocarp, 397, 445, 447.  
*Cytisus Adami*, 210.  
 Cytology, 3.  
 Cytoplasm, 41.  
 Daffodil, **333**.  
 Damping-off Fungus, 437.  
 Dandelion fruit, **360**.  
 Darwin, 316.  
*Dasya*, 447.  
 Date Palm, 533.  
 Deadly Amanita, 472.  
 Decay, Bacteria, 404; nature, 172.  
 Deciduous, Trees, 568; Shrubs, 568; Forest, 584.  
 Dehiscence, 346, 347.  
*Delesseria*, 447.  
 Deliquescent Trees, 567.  
 Dependents, 581.  
 Dermal system, 262.  
 Dermatogen, 264.  
 Desert, 383; Formations, 585; vegetation, 48.  
 Desmids, **426**, 563.  
*Desmodium gyrans*, 83.  
 Determiner, 309.

- Development, 153, 154; cycle, 9, 386.  
 Devil's Aprons, 440.  
 De Vries, 316.  
 Dextrose, 100.  
 Diageotropic, 247.  
*Dialypetalæ*, 545.  
*Diatomaceæ*, described, 427.  
 Diatomaceous earth, 428.  
 Diatoms, **427**, 563; valves, 428, **429**.  
 Dichogamous flower, **288**.  
 Dichogamy, 291.  
 Dichotomy, 504.  
*Dicotyledoneæ*, described, 539; differentiated, 545; primitive, 540; specialized, 553.  
 Differential thermostat, 157.  
 Diffusion, 236; described, 236.  
 Dimorphic flowers, **289**.  
 Dimorphic-leaved Herbs, 572.  
 Dimorphism, 292.  
*Dinoflagellata*, 412.  
 Diœcious plants, 307.  
*Dionæa*, **77**.  
 Disbudding, 207.  
*Discomycetes*, described, 450.  
 Disease Bacteria, 406.  
 Diseases of plants, nature, 367.  
 Dispersal, 356.  
 Dissemination, 266, 356.  
 Distillation, 172.  
 Division, 39, **299**.  
 Divisions of plants, 392, 393.  
 Doctrine of Signatures, 480.  
 Dodder, 83, **84**, 256, 554, 578.  
 Dominant, 311; Forms, 559; vegetation, 580.  
*Dorstenia*, 543.  
 Double fertilization, **354**.  
 Downy Mildews, 436.  
*Dracæna*, **65**, 536.  
 Dragon tree, 115, **127**, 128, 536.  
 Drainage, 167.  
 Drifting Seaweeds, 563.  
 Drip point, 68, **69**.  
*Drosera*, 547; *rotundifolia*, **548**.  
 Drupe, 350, **351**.  
 Dry, farming, 261; Habitats, 569.  
 Duckweed, 534.  
 Duct, 31, 122, 130, **146**, 262; length, 146.  
 Dulse, 444.  
 Durian, 346.  
 Dust, on plants, 96.  
 Dwarf Forest, 585.  
 Ear Fungi, 469.  
*Ebenales*, described, 554.  
 Ebony, 554.  
*Ecbalium Elaterium*, **365**.  
 Echinocactus, **195**.  
 Ecological, Classification, 558; groups, 558; Plant Geography, 580.  
 Ecology, 4.  
 Economic botany, 4.  
*Ectocarpus*, 441.  
 Edaphic, 583.  
 Edible Fungi, 471, 472.  
 Eelgrass, 530, 564.  
 Egg, 280.  
 Egg cell, 9, 273, 274, 278, 304; fertilized, 389, 397; of *Fucus*, **304**; of *Nemalion*, **305**.  
*Eichornia crassipes*, **535**.  
 Elaters, 482, 502.  
 Elementary species, 317.  
 Elements, essential to plants, 230.  
 Elm fruit, **358**.  
 Embryo, 9, 373, **374**; development, **355**; germinated, 384, 386; plant, 386; sac, 274.  
 Embryology, 3.  
 Emergences, 33.  
*Empusa muscorum*, 439.  
 Endodermis, 222, 262.  
 Endogenous, 127; growth, 128.  
 Endogens, 527.  
 Endophytes, 401, 500, 577.  
 Endophytic Hysterophytes, 578.  
 Endosperm, 374.  
*Endothia parasitica*, 454.  
 Energy, kinetic, 166; potential, 166.  
 Enlargement, 153; described, 154.  
*Entomorphales*, 439.  
 Enzyme, 85; description, 110.  
*Ephedra*, 524.  
 Epidermis, 18, 29, 261; cells, **32**.  
 Epiphyte, 9, 185, 576; funnel form, **185**.  
 Epiphytic, Fern, **186**; Orchid, **184**; Parasites, 578.  
*Equisetinea*, described, 500.  
*Equisetum*, 500; *arvense*, **501**; prothallia, **502**.  
*Eremurus*, **335**, 570.  
 Ergot Fungus, **453**, 454.  
*Erica* leaf, **70**.  
*Ericales*, described, 553.

- Erysipheæ*, described, 455.  
 Erythrophyll, 88; formation, 91;  
 functions, 88.  
 Essences, 108.  
 Essential oils, 107.  
 Eucalyptus, 113.  
*Euglena gracilis*, 410.  
*Eumyces*, 447, 448, 463.  
*Euphorbia*, flower, 549.  
*Euphorbiaceæ*, 549.  
*Eurotium*, 457.  
 Eusporangiate, 494.  
 Evergreen, Forest, 584; Shrubs,  
 569; Trees, 569.  
 Evolution, 13, 308, 315, 395.  
 Excretion, 266.  
 Excurrent, 179; Trees, 569.  
*Exoasci*, described, 458.  
*Exobasidium*, 474.  
 Exogenous, 126.  
 Exogens, 539.  
 Extension through growth, 357.  
 Eye-spot, 410.
- Fagales*, described, 542.  
 Fairy Ring, 472.  
 Fall plowing, 260.  
 Fallen Stars, 400.  
 Fallow, 260.  
 False Mildew, 437.  
 Families, 392, 393.  
*Farinosæ*, 535.  
 Fasciated, Asparagus, 197; Echino-  
 cactus, 198; Pineapple, 198.  
 Fasciation, 197, 367.  
 Fatty oil, 104; as food, 104; kinds,  
 104.  
 Fermentation, 169; Bacteria, 405;  
 demonstration, 171; equation, 171.  
 Fern, 494; fibrovascular bundles,  
 497; Filmy, 498; life cycle, 496;  
 plants, 11, 492; reproduction,  
 306; seed, 373.  
 Fertilization, 277, 279, 413; double,  
 354; significance, 286.  
 Fertilizers, rôle, 242; use, 260.  
 Fibonacci series, 142.  
 Fibro-vascular, bundles, 116, 118,  
 133, 135; system, 118.  
*Ficus ligustrina*, 543.  
 Field Mushroom, 471.  
 Fig, 352.  
 Filament, 272.  
 Filar-hydrophytes, 563,
- Filicales*, described, 495.  
*Filicineæ*, described, 494.  
 Films, of water, 239.  
 Fir tree, 180.  
 Fission Algæ, 399.  
*Flagellata*, described, 410.  
 Flax, 525, 549.  
 Fleshy fruits, dissemination, 362.  
 Flora, 3, 393.  
 Floral diagrams, horizontal, 326, 328,  
 329; numerical plans, 328; verti-  
 cal, 331; the whorls, 326.  
*Floridæ*, 445.  
 Flower, cleistogamous, 290; colors,  
 267; complete, 276; dichogamous,  
 288; dimorphic, 289, 292; dura-  
 tion, 269; disk, 339; economics,  
 343; features, 267; function, 8;  
 geotropism, 297; hermaphrodite,  
 307; insect pollinated, 290; ir-  
 regular, 274, 276, 293; monstrosi-  
 ties, 340; morphology, 183, 322;  
 neutral, 338, 339; odors, 268;  
 perfect, 276, 307; phototropism,  
 296; pistillate, 276, 285; polli-  
 nated by bee, 291; preservation,  
 344; ray, 338; regular, 276;  
 staminate, 276, 285; structure,  
 269; typical, 270; wind-polli-  
 nated, 288.  
 Flowering plants, 10, 512.  
 Fluctuations, 314.  
 Fodder, constituents, 101; plants,  
 206.  
 Foliage, autumnal coloration, 90;  
 support, 265; variegated, 90.  
 Follicle, 348.  
*Fomes applanatus*, 474.  
*Fontinalis*, 489.  
 Food, 28, 374; of animals, 112;  
 reserve, 100; synthesis, 19.  
 Forest Formations, 584.  
 Forestry, 4, 205.  
 Fossil flour, 428.  
 Freaks, 72, 196.  
 Free-moving Saprophytes, 578.  
 Frondose Seaweeds, 563.  
 Frost plant, 52.  
 Fructification, 347.  
 Fructose, 100.  
 Fruit, acids, 110; aggregate, 352;  
 defined, 345; dehiscence, 346;  
 dots, 324, 373; dry, 345; econom-  
 ics, 370; features, 345; formation



- stimulus, 352; fleshy, 345; function, 8; monstrosities, 366; morphology, 347; multiple, **352**; relation to ovary, 345; simple, 352; spurs, 183; twin, 196, **199**; two-storied, 367.
- Fucales*, described, 442.
- Fuchsia*, **332**.
- Fucoxanthin, 439.
- Fucus*, **189**; life cycle, **442**; sex cells, **304**; *vesiculosus*, **442**.
- Fumitory family, 547.
- Fungi, 11, 84; classes of, 399; colors, 86; damage by, 368; Imperfecti, 476; nutrition, 84; parasitic, 367; relationship to Algæ, 398; in soils, 244.
- Fungus-animals, 412.
- Fusion nucleus, 353.
- Fusion of germ cells, 280.
- Galls, described, 203; typical, **204**.
- Gamete, 287, **303**, 397; origin, 421.
- Gametophyte, 484, 497.
- Gamopetalæ*, 553.
- Gamopetalous, 271.
- Gamosepalous, 270, 330.
- Garigue, 585.
- Gasteromycetes*, described, 474.
- Geaster*, **475**.
- Gelatination, 99.
- Gelatinous, Fungi, 469; secretion, 401.
- Gemmæ, **300**.
- Genealogies, 392.
- Genera, 392.
- Generation, skipping a, 311.
- Generations, alternation of, 507, **508**, 509.
- Genetic variations, 314.
- Genetics, 4.
- Genotypically, 310.
- Gentianales*, described, 554.
- Geophytes, 564.
- Geotropism, 174, 175, 296, **297**; function of, 177; lateral, 255; of Mushrooms, 178; of roots, **174**; of stems, **175**.
- Geraniales*, described, 549.
- Gerardia, Purple, 87.
- Germ cell, 280; fusion, 280; purity of, 311.
- Germination, 381; delayed, 378; of Lima Bean, **383**; movements, 382; of mummy seeds, 380; of pollen, **275**; stages, 381.
- Germes, 402.
- Ghost Plant, **85**.
- Giant, Grasses, 567; Herbs, 567; Kelp, **190**.
- Gigantochloa ater*, **531**.
- Gill Fungi, 471.
- Ginkgo biloba*, **519**.
- Gland, ethereal oil, **107**.
- Gleba, 475.
- Globulin, 105.
- Glaucapsa*, 399, **400**, 418.
- Glucose, 100.
- Glucoside, 110.
- Glumes, 531.
- Glumifloræ*, 530.
- Glutelin, 105.
- Gnarls, 199.
- Gnetales*, described, 524.
- Gnetum*, 523, 524.
- Goebel, Schilderungen, 62.
- Gottschea appendiculata*, **482**.
- Gourd, 351.
- Graft-hybrids, 210.
- Graftage, 208.
- Grafting, 208, **209**, 371; results, 210.
- Graham flour, 385.
- Grain, 317, 385; Corn, **375**; importance, 385; structure, **349**.
- Grains, 532.
- Graminales*, described, 530.
- Grand period, 156, 157; described, 156.
- Grape Blight, 437.
- Grape sugar, formula, 21; rôle in plant, 27.
- Grasses, 530; flower, diagram, **530**.
- Grassland Formations, 585.
- Gravel Formations, 586.
- Gravitation, effects on plants, 175.
- Green, Algæ, described, 415; Felt, 430; Molds, 456.
- Green-manuring, 260.
- Greenness of vegetation, 26.
- Ground Plants, 570.
- Growth, 39, 264; definite annual, 138; described, 153; control mechanism, 342; effect of humidity on, 158; effect of light on, 158, **159**; effect of temperature on, 157, **158**; of general tissue, 354; grand period in roots, 221; indefinite annual, 138; of leaves,

- 161**; primary, 119; of roots, **161**; secondary, 119; of stems, **160**.  
 Growth Forms, 559.  
 Guard cells, 33, **49**, 50, 262; operation of, 49.  
 Gum, 104.  
 Gum tree, 113, 551.  
 Guttation, 52.  
 Gymnosperm, 352.  
*Gymnospermæ*, described, 516.  
*Gymnosporangium*, 469.
- Habitats, 559.  
 Habit Forms, 559.  
 Hair-like structures, 351.  
 Hairs, **70**.  
 Half parasite, 87, 577.  
 Halophytes, 573.  
 Haustorium, 83, 256.  
 Head, **336**, 337.  
 Healing of injuries, **122**, 123, 206.  
 Health in plants, 369.  
 Heart wood, 124, 145.  
 Heat of respiration, 168.  
 Heath, Formations, 586; Shrubs, 574.  
 Heather Shrubs, 574.  
 Heaths, 553.  
 Heliotropism, 54.  
*Helobia*, 530.  
 Helophytes, 571.  
 Helotism, 462.  
 Hemi-cellulose, 103.  
 Hemlock, 552.  
*Hepaticæ*, described, 479.  
*Heracleum*, **553**.  
 Herb, 9.  
 Herbaceous Perennials, 568.  
 Herbarium, 3.  
 Heredity, 10, 13, 39, 128, 285, 308; defined, 308, 314; diagram, **310**.  
 Hermaphrodite, 526.  
*Heterocontæ*, 422.  
 Heterocysts, 400.  
 Heterocœious Parasites, 578.  
 Heterogametes, 397.  
 Heterogamous, 415.  
 Heterosporous, 493.  
 Heterozygous, 310.  
 Hilum, 376.  
 Histology, 3.  
 Holdfasts, of Algæ, 440.  
 Hollow column, 180.  
 Homospory, 493.
- Homozygous, 310.  
 Honesty, **348**.  
 Hooks, 361.  
 Horse Chestnut, twig, **120**, 550.  
 Horsetails, 500, 501.  
 Horticulture, 4.  
 Host, 83.  
 Hotbeds, 258.  
 Houseleek, **142**.  
 House plants, 48, 241.  
 Humid-Dry Habitats, 567.  
 Humus, described, 241, 243.  
 Hurrahs' Nests, 469.  
 Hybrid, 320.  
 Hybridization, 318; method, 320.  
*Hydnum*, 474; *repandum*, **472**.  
*Hydrangea*, **339**.  
*Hydrodictyon*, **418**, 434, 563.  
 Hydrophyte, 190, 561.  
 Hydrophytic Parasites, 578.  
*Hydropteridales*, described, 499.  
 Hydrotropism, 177; described, 247.  
 Hygroscopic phenomena, 237; tissues, 366.  
 Hymenium, 450, 464.  
*Hymenomyces*, described, 470.  
*Hymenophyllaceæ*, 498.  
 Hypocotyl, 355, 374.  
 Hysterophytes, 398, 561, 574, 577.
- Iceland Moss, 463.  
 Idioblasts, 33.  
 Imbibition, 148, 237.  
 Imbricate, 329.  
 Immunity, 370, 407.  
 Improvement of plants, 2.  
 Indian Pipe, 83, **85**, 554.  
 Indusium, 495.  
 Infantile paralysis, 407.  
 Infusoria, 411.  
 Infusorial earth, 428.  
 Inhibitory influence, 202.  
 Initial cell, 355.  
 Injuries, healing, **122**.  
 Inorganic Habitats, 560.  
 Insectivorous Plants, 87, 578.  
 Insect-pollinated flowers, 290.  
 Insects as cross-pollinators, 290.  
 Integuments, 274.  
 Intercellular air system, 33, 266.  
 Internode, 116.  
 Interpolants, 581.  
 Intertidal Rockweeds, 564.  
 Involucre, 339.

- Iodine test, 20.  
*Iridaceæ*, 536.  
 Iris flower, **287**.  
 Irish Moss, 444.  
 Iron Bacteria, 408.  
 Ironwood, 113.  
 Irritability, 39, 55.  
*Isoëtes lacustris*, **507**.  
 Isogamete, 397.  
 Isogamous, 415.  
 Ivory, Nut, 533; Palm, 373.
- Jack fruit, 346, **542**.  
*Juglandales*, described, 541.  
*Juncaceæ*, 536.  
*Jungermanniales*, described, 482.  
*Jussiaea*, **252**, 572.
- Kelps, 440.  
 Kinds of plants, 391.  
 Knees, 252.  
 Knotweeds, 544.  
 Knowledge, useful, 5.  
 Krummholz, 585.
- Labiatae*, 555.  
*Laboulbeniales*, 455.  
 Lacinate, 203.  
 Lamarek, 315.  
*Laminaria saccharina*, **441**.  
*Laminariales*, 440.  
 Latex, 108, 109; system, **134**; system, described, 134.  
*Lathyrus Aphaca*, **78**, 80; *vernus*, pod, **365**.  
*Lauraceæ*, 546.  
 Leaf, anatomy, 28, **29**; Aquatics, 572; arrangements, 139; auriculate, 68, **69**; axil of, 73; of *Bidens Beckii*, **62**; characteristics, 15; compound, 16, **67**; connate-perfoliate, **69**; economics, 94; entire, 68; as a factory, 26; functions, 7, 72; linear, 63, **63**; lobed, **67**; margins, **68**; morphological plasticity, 82; mosaic, **56**; netted-veined, 17, 66; orbicular, 62, **63**; ovate, 64, **66**; palmately compound, 68; parallel-veined, 17, 66; perfoliate, 68, **69**; pinnately compound, 68; pitched, 202, **203**; plan, **34**; scars, 120; serrate, 68; shapes, 62, 68; simple, **16**; storage function, 72; structure, 17; Succulents, 570; tendrils, 76, **78**; thickness, 16; trace, 119; Traps, 579; typical, **16**; venation, **18**.  
 Leaflet, 16.  
 Leafy Liverwort, **482**, 505.  
 Leaves, arrangements, 139; alternate, **140**, **141**, **142**; opposite, **139**; variegated, 89; whorled, **140**.  
 Legume, 348.  
*Leguminosæ*, 548; vs. Bacteria, 246; tubercles of, 408.  
*Lemna*, 572; *minor*, **535**.  
*Lemnaceæ*, 534.  
 Lenticel, 120, **121**; described, 121.  
*Lepidodendron*, 509.  
 Leptosporangiate, 494.  
 Lettuce bud, **136**.  
 Lianes, 575.  
 Lichen, 459, 570; Crustaceous, 461; Foliose, 461, **462**; Fructicose, 461, **462**; Reindeer, 461, 463.  
*Lichenes*, described, 459.  
 Life cycle, Angiosperm, **525**; Corn Smut, **465**; Fern, **496**; *Fucus*, **442**; *Marchantia*, **481**; Moss, **488**; Pine, **521**; *Selaginella*, **506**; Wheat Rust, **467**.  
 Life history, 3.  
 Life Plant, **71**.  
 Light, adjustment, 52; leaves adjusted, **57**; rôle in plant, 26; screen, **20**.  
 Lignin, 98.  
*Liliaceæ*, 536.  
*Liliales*, described, 535.  
 Linden, bract, **74**; bundles, **133**, 550.  
 Linen, 205.  
*Linnæa*, 556.  
 Linnæan species, 317.  
 Linnæus, 7, 315.  
*Linum*, **525**.  
 Lipase, 110.  
 Little Club Mosses, 505.  
 Liverworts, 11, 479.  
 Loam, 241.  
 Locomotion, 357.  
 Locust, flower, **549**.  
 Long Moss, 185, 463, 535, 577.  
*Loranthaceæ*, 543.  
 Lotus, receptacle, **361**.  
 Lumber, 205.  
*Lycopodon cyathiforme*, **475**.

- Lycopodiales*, described, 503.  
*Lycopodineæ*, described, 503.  
*Lycopodium*, **503**; prothallus, **505**;  
 stem, **504**.  
 Lycopods, 503.
- Macrocystis*, **190**, 441.  
 Madders, 556.  
 Maidenhair, 498.  
 Malaria, 407.  
*Malvales*, described, 550.  
 Mangrove, 253, 551, **552**, 573;  
 Swamp Formation, 586.  
 Manila Hemp, 538.  
 Manual, 3, 393.  
 Maple fruit, **351**.  
 Maqui, 585.  
 Maranta, 538.  
*Marattiales*, 495.  
*Marcgravia*, **294**.  
*Marchantia*, **300**, 480; life cycle, **481**;  
*polymorpha*, **481**.  
*Marchantiales*, described, 480.  
 Marsh, Formation, 586; Reeds, 571.  
*Marsilia quadrifida*, **499**.  
*Martynia*, 362, **363**.  
 Maturation, 153.  
 Mayflower, 553.  
 Meadows, 585.  
 Mechanical, effects, 196; system, 265.  
 Mechanistic conceptions, 39, 40.  
 Medullary ray, 122, 125, 265;  
 secondary, 125.  
 Megasporangium, 324.  
 Megaspore, 324.  
 Mendel's Law, 399, 312, **313**.  
 Meristem, 128, 264.  
*Mesembryanthemum*, **72**, 545, 570.  
 Mesophyte, 190, 566.  
 Metabolism, 39, 98, 266.  
*Metachlamydeæ*, 553.  
 Microbes, 402.  
 Micro-hydrophytes, 563.  
 Microorganisms, 243.  
 Micropyle, 376.  
*Microspora*, 538.  
*Microsphaera Alni*, 455, 456.  
 Microsporangium, **325**.  
 Middle lamella, **147**.  
 Mildews, 367, 436, 455.  
 Milkweed seed, **359**.  
 Milky juice, 134.  
 Mineral salts, 230, 242; use, 28.  
 Mistletoe, 86, 187, 362, 543, **544**, 577.
- Mitochondria, 41.  
 Mixed Forest, 584.  
 Mobility, 39.  
 Molds, 11; true, 437.  
 Monadelphous, 272.  
 Monocarpic plants, 114.  
*Monocotyledoneæ*, described, 527.  
 Monocotyledons, 127; differentiated  
 534; primitive, 529; specialized,  
 537.  
 Monœcious plants, 307.  
*Monstera deliciosa*, **534**.  
 Monstrosities, 72, 196; cause, 342;  
 of flowers, 340; of stems and  
 leaves, 196.  
*Morchella esculenta*, **451**.  
 Morel, 451.  
 Morphine, 109.  
 Morphological plasticity, 39.  
 Morphology, 3; definition, 82; dia-  
 gram, **327**.  
 Mosaic disease, 369.  
 Moss, life cycle, **488**; Flowers, 269,  
 484; Plants, 11, 478  
 Mosses, true, 484, 487.  
 Muck, 241.  
*Mucorales*, described, 437.  
 Mud lakes, 428.  
*Muehlenbeckia*, 194.  
 Mulberry, **352**, 542.  
 Multiple fruit, **352**, 363.  
*Musci*, described, 484.  
 Mushroom, **469**.  
 Muskeg, 586.  
 Mustard family, 547.  
 Mutation, 13, 314, 317.  
 Mycelium, 84, **87**, 448, **470**.  
*Mycetozoa*, 412, 415.  
 Mychoriza, 83, **244**, 505, 578, 581.  
*Myricales*, described, 541.  
*Myriophyllum*, 551.  
 Myrmecophily, 579.  
*Myrtales*, described, 551.  
*Myxobacteriaceæ*, **409**; described, 410.  
*Myxomyces*, described, 412, 578.  
*Myxophyceæ*, 399.  
*Myzodendron brachystachyum*, **545**.
- Naidales*, described, 530.  
 Naked-ascus Fungi, 458.  
 Natural selection, 316.  
 Navel Orange, 201, 205, 319, 367.  
*Navicula viridis*, **429**.  
 Necessities of Plant Life, 560.

- Nectar, 343.  
 Nectary, 275; forms, **273**.  
*Netumbium*, **361**.  
*Nemalion*, **305**, 445, 446.  
*Nepenthes*, **76**, 246, 547, 579.  
*Nereocystis*, 441.  
 Nicotine, 109.  
*Nidularia*, 476.  
*Nitella*, 433, 434.  
 Nitrates, 242.  
 Nitrogen-conserving Bacteria, 408.  
 Nitrogen fixation, 244.  
 Node, 116.  
 Nodules, **245**.  
 Nomenclature of groups, 392, 393.  
*Nostoc*, 399, **400**.  
 Nucellus, 274.  
 Nucleolus, 41.  
 Nucleo-protein, 105.  
 Nucleus, 41.  
 Nullipores, 445.  
 Nut, 349.  
 Nutrition without chlorophyll, 82.  
*Nymphæaceæ*, 546.
- Oak, 542; quartered, 126.  
 Oats, temperature on growth, **158**.  
 Œdema, 234, 368.  
*Œdogonium*, 422, **423**; *ciliatum*, **423**;  
*nodulosum*, **423**.  
*Œnone latifolia*, **458**.  
*Œnothera Lamarckiana*, 551.  
 Offsets, **188**, 189.  
 Oil, Castor, 104; Cottonseed, 104;  
 Linseed, 104; Olive, 104.  
*Onagraceæ*, 551.  
 Onion Mold, 437.  
*Onoclea sensibilis*, 498.  
 Oögonia, 416.  
*Oömycetes*, 435.  
 Oöspore, 397.  
 Operculum, 488.  
*Ophioglossales*, described, 494.  
*Ophioglossum vulgatum*, **494** pro-  
 thallus, **495**.  
 Opium, 546.  
 Optimum Habitats, 566.  
*Opuntiales*, described, 550.  
 Orchid, **184**; and flowers, **538**; pollina-  
 tion, 293; seeds, 372.  
 Orchidaceous Epiphytes, 576.  
*Orchidales*, described, 438.  
 Orders, 392, 393.  
 Organic Habitats, 560, 574.
- Oscillatoria*, 399, **400**.  
 Osmoscope, 227, **228**.  
 Osmosis, described, 227, 232; ex-  
 planation, 230; phenomena, com-  
 mon, 235; pressure in growth,  
 233; pressures, 229; processes,  
 described, 232; uses in plants,  
 233, 234.  
 Outgrowths from petals, 334.  
 Ovarian wall, 351.  
 Ovary, of Buckeye, **350**; compart-  
 ments, 349; compound, 273;  
 described, 274; inferior, 275;  
 simple, 273; superior, 275; union  
 of carpels, **323**.  
 Ovule, 273, 323; described, 274;  
 forms, **272**; Gymnosperm, **522**;  
 to seed, 354; structure, **271**, **277**.  
 Oxalophytes, 573.  
 Oxygen, release by plants, **23**.
- Paleobotany, 3.  
 Palisade tissue, 30.  
 Palm, **60**, 127, 136, 532.  
*Palmales*, described, 532.  
 Palmate venation, 66.  
 Pampas, 585.  
 Panama hats, 533.  
*Pandanales*, described, 529.  
*Pandanus*, **253**, 567.  
 Panicle, 337.  
 Pansy seed, **376**.  
*Papaveraceæ*, 546.  
*Papaverales*, described, 546.  
*Papaya*, 550.  
 Papilionaceous, 548, **549**.  
*Papyrus*, 572; *antiquorum*, **532**.  
 Parasite, 9, 11, 83; damage, 85.  
 Parasitic Fungi, 367.  
*Parietales*, described, 550.  
 Parks, 585.  
 Parthenocarpy, 354.  
 Parthenogenesis, 302.  
 Pathology, 4, 367.  
 Peach yellows, 369.  
 Pearson Fern, 197.  
 Peat, 241; Bogs, 486; Mosses, 485,  
 572; uses, 487.  
 Pectin, 103.  
*Pediastrum*, **418**, 563.  
 Pedicel, 193.  
 Peduncle, 193.  
 Peg, of Pumpkin, **382**.  
 Pendent Epiphytes, 577.

- Penicillium glaucum*, 458.  
 Pepsin, 110.  
 Peptone, 105.  
 Perennials, 114; herbaceous, 114;  
   woody, 114.  
 Perfumes, 108.  
 Perianth, 333, 528.  
 Periblem, 264.  
 Pericycle, 265.  
*Peridineæ*, 411; described, 412.  
 Peridium, 475.  
 Peristome, 489.  
 Perithecium, 448.  
 Permeable membrane, 228, 235.  
*Peronosporales*, described, 436.  
 Petal, 270; outgrowths, 334.  
 Petiole, 16.  
*Peziza aurantiaca*, 450.  
*Phæophyceæ*, described, 439.  
*Phæosporales*, described, 440.  
*Phallus impudicus*, 476.  
 Phanerogamia, 12, 492, 512.  
 Pharmacology, 4.  
 Phloem, 122, 130, 222, 262.  
 Phosphates, 242.  
 Phosphorescence, 412.  
 Phosphorescent Wood, 473.  
 Photosynthesis, 262; amount, 25;  
   definition, 21; *vs.* respiration, 169.  
 Photosynthetic equation, 23.  
 Photosynthometer, 24.  
 Phototropic response, nature, 56.  
 Phototropism, 54, 296; in Fuchsia,  
   55.  
 Phycoeyanin, 401.  
 Phycoerythrin, 445.  
 Phycomycetes, described, 434.  
 Phyllodia, 80, 81.  
 Phyllomania, 203.  
 Phyllotaxy, 328; described, 139;  
   origin, 143.  
 Phylogenetic tree, 393, 394.  
*Physcia stellaris*, 460.  
 Physiological, disturbances, 368;  
   dryness, 567.  
 Physiology, 3, 5.  
 Phytopathology, 4, 367.  
*Phytophthora infestans*, 437.  
 Pigments, 108.  
*Pilobolus*, 439.  
 Pine Blister Rust, 468.  
 Pine, cross section, 147; life cycle,  
   521; radial section, 143; stem,  
   126; tangential section, 149.  
 Pineapple, fasciated, 198.  
*Pinguicula*, 579.  
 Pinnate venation, 66.  
*Pinus rigida*, 521.  
*Piperales*, described, 541.  
 Pistil, 273; generalized, 278.  
 Pistillate flower, 276, 285.  
 Pitcher Plant, 75, 76, 203, 547, 579.  
 Pitchers, 9, 74.  
 Pith, 116, 132, 265.  
 Placenta, 275, 323, 347, 351; dia-  
   gram, 324.  
 Plains, 585.  
 Plankton Formations, 586.  
 Plant, adult, 9; Associations, 579;  
   breeding, 4, 371; definition, 7;  
   diversity, 5; food, use of term,  
   28; foods, 242; Formations, 579;  
   geography, 4; Habitats, 559; In-  
   dustry, 4; insect catching, 87;  
   primary parts, 7; skeleton, 98;  
   spraying, 97; transplanting, 97.  
*Plantaginales*, described, 556.  
 Plants, classification of, 395; num-  
   bers, 1.  
 Plasmodium, 39, 412, 413, 414.  
*Plasmopara*, 437.  
 Plastid, 41.  
*Platyserium*, 186, 498, 577.  
*Plectascales*, described, 456.  
 Plerome, 264.  
*Pleurococcus*, 299, 417, 563.  
 Plowing, 260.  
*Plowrightia morbosa*, 452.  
 Plume, 358.  
 Plumule, 374.  
*Pneumococcus*, 406.  
*Podostemonaceæ*, 548.  
 Poisonous Fungi, 472.  
 Pollen, 272; germination, 275, 276;  
   grains, 286; injured by water, 295.  
 Pollination, 277, 370.  
 Polster, 547.  
 Polyadelphous, 272.  
 Polycotyledony, 377.  
 Polyembryony, 302, 377.  
*Polygonales*, described, 544.  
*Polypetalæ*, 545.  
 Polypetalous, 271.  
*Polyporus*, 474; *betulinus*, 473.  
 Polysepalous, 270, 330.  
*Polysiphonia*, 447, 509; *violacea*,  
   446.  
*Polytrichum*, 488.

- Pond Scums, 425.  
 Pondweeds, 530, 564.  
 Poppy, **348**.  
 Pore Fungi, 474.  
*Postelsia*, 441; *palmaeformis*, **441**.  
*Potamogeton crispus*, **530**.  
 Potato, Blight, 437; Rot, 437.  
 Powdery mildews, 455.  
 Prairie, 583, 585.  
 Pressure gauge on root, **226**.  
 Primrose, **289**.  
*Primulales*, described, 554.  
*Principes*, 532.  
 Procambium, 265.  
 Procarp, 445.  
 Progeotropic, 247.  
 Projection of seeds, 364.  
 Proliferations, 201, 367.  
 Proliferous Pear, **201**; Rose, **202**.  
 Promycelium, 464.  
 Propulsion of water, 148.  
 Protection, 261; of roots, 232.  
 Protein, 104; composition, 27; as food for man, 106; grains, **105**; kinds, 105; layers, **105**; where made, 27.  
 Proteose, 105.  
 Prothallus, 306, 493, 495.  
*Protococcales*, described, 416.  
 Protonema, 484.  
 Protoplasm, 30; alveolar structure, **38**; appearance, 35, **36**; characteristics, 35; chemical composition, 38; composition, 106; constitution, 37; continuity, **40**, 444; definition, 8; organization, 40; properties, 39; streaming, 37, 430, 432, 434; texture, 36.  
*Protosiphon*, **303**.  
 Protozoa, in soil fertility, 246; in soils, 244.  
 Pruning, 122, 370; uses, 206.  
*Pseudomonas europaea*, **406**.  
*Pteridophyta*, described, 492.  
 Pteridophytes, 11.  
 Pteridosperms, 517.  
 Ptomaines, 109.  
*Puccinia graminis*, **467**.  
 Puffball, **87**, 474, **475**.  
 Pyrenoids, 416, 425.  
*Pyrenomyces*, described, 452.  
*Pyronema*, 450; *confluans*, ascocarp, **451**.  
*Pythium*, 437.  
 Quarantine, 407.  
 Quinine, 109.  
 Raceme, 336; determinate, 336; indeterminate, 336.  
*Rafflesia*, 84, **86**, 268, 544, 578.  
 Rainbow Corn, 90.  
 Raised bogs, 486.  
*Ranales*, described, 546.  
*Ranunculaceæ*, 546.  
*Raoullia*, 574.  
 Raphe, 274, 376.  
 Rattan Palm, 113, 184, **533**, 575.  
 Receptacle, 193, 271, 275, 351, 481.  
 Recessive, 311.  
 Red, Algæ, 443, 564; Sea, 401; snow, 416.  
 Reduction division, 285, 446, 479, 493.  
 Redwood, 113, 115, 523.  
 Reflex action, 55.  
 Regulation, 39.  
 Relationships of plants, 391.  
 Relative transpiration, 47.  
 Reproduction, 265; asexual, 298, **299**, **300**; in Fern, **306**; sexual, 389.  
 Resin, 108.  
 Respiration, 111, 112, 266; amount, 164; described, 162; in roots, 231; vs. combustion, 165.  
 Respiratory ratio, 162; equation, 165.  
 Respiroscope, 162, **163**.  
 Resting period, 341, 377, 378; nature, 379.  
 Resting spore, 397, 404.  
 Resurrection Plant, 505, 570.  
 Reversions, 201.  
*Rhamnales*, described, 550.  
*Rhipsalis*, **195**.  
 Rhizoid, 215, 250, 478.  
 Rhizome, of Sedge, **187**.  
 Rhizophore, 505.  
*Rhizopus nigrans*, **438**.  
*Rhodomela*, 447; *subfusca*, **444**.  
*Rhodophycææ*, described, 443.  
*Rhaadales*, 546.  
*Riccia*, **480**.  
*Ricciales*, described, 480.  
*Rivularia*, **400**.  
 Rock, Formations, 586; pulverized, 238.

- Rockweed, **189**, 304, 442; sex cells, **304**.
- Root, aëration, 258; aërial, 253, 254, **256**, **257**; anatomy, **219**, 220, **222**; anchorage function, 250; cap, 217, 221; crops, 258; cross section, **215**; distinctive features, 212; distorted, 257; in drains, **248**; duration, 214; economics, 257; excretions, 243; as foliage, 254, **255**; function, 7; growing point, 217, 221; growth zone, 218, 221; hair, 218, **224**; hair in soil, **240**; hair zone, **217**, 218, 221; hairs, use, 225; length, 250; longitudinal section, **219**; need for air, 258; of Orchids, **254**; origin, 223; plan of, **225**; pressure, 226; protection of, 232; pruning, 208; selective power, 231; self-adjustments, 247; shortening, 257; special functions, 250; as spines, 256; as storage organs, 251; strains, 216; structure, 215; system, typical, **213**; tip, 213, 217; tip, diameter, 220; tip, of Radish, **216**.
- Rootstock, **187**, 188.
- Roquefort, 458.
- Rosaceæ*, 548.
- Rosales*, described, 547.
- Rose, green, 201, 341; of Jericho, 359, **360**, 570.
- Rosette Perennials, 570, 574.
- Rosette Succulents, 570.
- Rotation of crops, 260.
- Rots, 367.
- Rozites gongylophora*, 473.
- Rubber, 108.
- Rubiales*, described, 556.
- Rubus squarrosus*, **193**.
- Ruscus*, **194**, 536.
- Russian Thistle, 359.
- Rust, 367, 465, 466; of Wheat, 90.
- Sac Fungi, 447.
- Saccharomyces*, **459**; described, 458.
- Saccharose, 100.
- Sage Brush Shrubs, 570.
- Sago Palm, 517.
- Sabicales*, described, 541.
- Sabicornia herbacea*, **546**.
- Saline Formations, 586; Habitats, 573.
- Salt Marsh Formations, 586.
- Salvia pratensis*, **291**.
- Salvinia natans*, **499**, 500.
- Samphire, 544, **546**, 573.
- Sand-box, 365.
- Sand Formations, 586.
- Sandalwood, 543.
- Santalales*, described, 543.
- Sap, rise in trees, 147; theory of ascent, 149; wood, 124, 145.
- Sapindales*, described, 549.
- Sapling, 387.
- Saprolignia*, **435**, 578.
- Saproligniales*, described, 435.
- Saprophyte, 11, 83.
- Sargassum*, 563; *vulgare*, **443**.
- Sarracenia*, **75**, 76, 246, 579.
- Sarraceniales*, described, 547.
- Savannahs, 585.
- Saw Grass, 571.
- Saxifragaceæ*, 548.
- Scabs, 367.
- Scale Mosses, 482.
- Scape, 193.
- Schistostega osmundacea*, **490**.
- Schizomycetes*, description, 402.
- Schizophyceæ*, 399.
- Science, aim, 12; applications, 5.
- Scion, 208.
- Scitaminales*, described, 537.
- Sclereids, 265.
- Sclerenchyma, 130, 265.
- Sclerotium, 414, 448, 453.
- Scouring Rushes, 500.
- Screw Pines, 529.
- Scrophulariaceæ*, 555.
- Sea, Lettuce, **422**; Mosses, 443, 447; Palm, 441.
- Seasonal cycle, 388.
- Seaweeds, 12.
- Secretion, 266.
- Secretions, 107.
- Sedentary Waterweeds, 564.
- Sedges, 530.
- Seed, 390; albuminous, 374, **375**; characteristics, 372; coat, 351, 375; condition of life, 378; duration of life, 377, 380; economics, 385; ex-albuminous, 374, **376**; function, 8; plants, 10, 512; projection, 364; structure, 373.
- Seedling, 9, 387; of Radish, **218**.
- Selaginella*, 325, 505; *lepidophylla*, 505, 570; life cycle, **506**.



- Selaginellales*, described, 505.  
 Selection of variations, 318.  
 Self-adjustments, 55, 266.  
 Semi-permeable membrane, 228, 235.  
*Sempervivum*, **188**.  
 Sepals, 269.  
*Sequoia*, 113, 523.  
 Seta, 484, 488.  
 Sex, cells, fusion, 278, **279**; established, 304; origin, 302; origin, summary, 308; in plants, 307; stages in development, 303.  
 Sexual organs, 307.  
 Shade, growth under, 95.  
 Shelf Fungi, 474.  
 Shoot, 190.  
 Shrub Formations, 585.  
 Shrubs, 9.  
 Side roots, origin, **223**.  
 Sieve, plate, **152**; tube, 31, 131, **152**, 262.  
*Sigillaria*, 509.  
*Silene*, **547**.  
 Silicles, 348.  
*Siphonales*, 563; described, 429.  
 Skeleton of plants, 98.  
 Skunk Cabbage, 268.  
 Sleep movements, **57**, 61.  
 Slime-fungi, 412.  
 Slime-mold, **39**, 357, 412.  
 Slips, 259.  
 Smuts, 367, 464.  
 Snapdragon, **274**.  
 Societies, 582.  
 Soil, composition, 237; cultivation, 260; solution, 241; structure, 238, **239**.  
*Solanaceae*, 555.  
 Solomon's Seal, **191**.  
 Soredia, 462.  
 Sorus, **326**, 495.  
 Spadix, **338**.  
 Spanish Moss, 463, 535.  
 Spathe, 338.  
*Spathiflora*, 533.  
 Spawn, 471.  
 Special creation, 315.  
 Specialization, 489, 498.  
 Species, 7, 392; name, 392.  
 Spectroscope, 53.  
 Sperm, 277; cell, 9, 397; of *Fucus*, **304**; of *Nemalion*, **305**.  
 Spermagonia, 466.  
 Spermatorium, 445, 466.  
*Spermatophyta*, described, 512.  
 Spermatophyte, 10; homologies, 512; reproduction, 512; structure, 512.  
 Spermatozoid, 280, **304**.  
*Sphagnales*, described, 485.  
*Sphagnum*, 115, 572; *cymbifolium*, **485**; leaf, **486**.  
 Spike, **335**, 337.  
 Spines, 192, **193**, 256; Barberry, **81**; Echinocactus, **80**; morphology, 79; significance, 79.  
*Spirillum*, **406**.  
*Spirochete*, **406**; *dentium*, 405.  
*Spirogyra*, **425**.  
*Splachnum vasculosum*, **489**.  
 Spongy tissue, 30.  
 Spontaneous generation, 39, 40.  
 Sporangium, 324, **325**, 397, **414**, 493, 495.  
 Spore, 324, 373; asexual, 301; cases of Mold, **302**; dissemination, 360; in dust, 404.  
 Sporidium, 466.  
 Sporogonium, 479, 483.  
 Sporophore, 84, **87**, 448.  
 Sporophyll, 325.  
 Sporophyte, 484, 497.  
 Sports, 205, 319; preservation, 318, 319; seed, 319.  
 Spot diseases, 367.  
 Spraying, 371.  
 Squirting, Cucumber, **365**; Fungus, **439**.  
 Stamen, 272; irritable, 297.  
 Staminate flowers, 276, **285**.  
 Starch, as food for man, 103; formation under light screen, **21**; formation vs. osmosis, 234; formation in presence of CO<sub>2</sub>, **22**; grains, **101**; grains, typical forms, **102**; kinds, 101; sheath, 130.  
 Stele, 264.  
 Stem, anatomy, 128, **129**, **131**; characteristics, 113; columnar, 179; as conducting mechanism, **150**; creeping, 187; deliquescent, **181**; economics, 205; endogenous, **127**; excurrent, 179, **180**; exogenous, **127**, **131**; function, 7, 53; generalized diagram, **125**; herbaceous, 115; special function, 191; storage, 191; structure, 115; Succulents, 570; symmetry, 181, **182**; tissues, 116; tissues,

- generalized, **117**; tissues, herbaceous stem, **116**; trailing, 187; traveling, 188; typical leaf-bearing, **115**; various forms, 179; woody, 119.
- Steppes, 585.
- Sterilization, 407.
- Stigma, 273.
- Stilt Shrubs, 567.
- Stimulus, 54; perception, 178.
- Stink, Brand, 465; Horns, **476**.
- Stinking Smut, 465.
- Stipule, **16**; morphology, 80; special forms, **82**.
- Stock, 208.
- Stolon, **188**, 189.
- Stoma, 19, **49**, 262; clogging, 96; diagram of number and area of opening, **51**; number, 50; position, 50.
- Stoneworts, 432.
- Storage, 266; battery, 167.
- Strangling, Epiphytes, 577; Fig, **543**.
- Streaming of protoplasm, 37.
- Strobilus, 504.
- Strophiole, 374.
- Strychnine, 109.
- Style, 273.
- Suberin, 98.
- Subsoil plowing, 260.
- Substitutions, 201.
- Sucker, 214.
- Sucrose, 100.
- Sugar, 100; cultivation, 101; kinds, 100; Maple, **181**.
- Sulphur Bacteria, 408.
- Sun scalds, 368.
- Sundew, 246.
- Sunflower head, **143**.
- Suspensor, 354.
- Swamp, Flags, 571; Formations, 586.
- Swarm spores, 397.
- Sweet, Fern, 541; Gales, 541.
- Symbionts, 581.
- Symbiosis, 244.
- Sympetala*, 553.
- Synthesis, 391.
- Systematic botany, 2.
- Tæniophyllum*, **255**.
- Tamarisk, 550.
- Tank Epiphytes, 576.
- Tannin, 110.
- Tap root, 212, **214**, 250.
- Taphrina Pruni*, **458**.
- Taxodium*, 523.
- Taxonomy, 2.
- Taxus baccata*, **523**.
- Telegraph Plant, 81, **83**.
- Teleutospores, 466.
- Teliospore, 466.
- Tendrils, 9, 76, **192**; mode of operation, **79**.
- Testudinaria*, 569; *elephantipes*, **537**.
- Tetraspores, 397, 445.
- Thallophyta*, description, 396.
- Thallophytes, 12.
- Thallus, 190.
- Thea*, 550.
- Thein, 109.
- Theobromine, 109.
- Theobromo Cacao*, 550.
- Thickets, 585.
- Thigmotropism, 77.
- Thyrsus, 337.
- Tissue systems, diagram, **263**.
- Tissues, definition, 8; healing, 122; summary, 261.
- Toadstool Fungi, 470.
- Toadstool Hysterophytes, 578.
- Tooth Fungi, 474.
- Torsions, 201.
- Toxin, 173, 407.
- Trachæe, 146.
- Tracheid, 31, **146**.
- Traction, 149.
- Transects, 583.
- Transfer, of water and food, 144.
- Translocation, of food, 151.
- Transmission of acquired characters, 315.
- Transpiration, 43, 262; amount, 43; constants, 44; demonstration, 43, **44**; effect of external conditions, 47; effects, 96; fluctuations, 45; plant prepared for study, **45**; record, **47**; reduction, 69; rôle, 49; significance, 51.
- Transpirograph, 45, **46**.
- Traumatropism, 249.
- Tree, 9; crotch, supported, **211**; Fern, **61**, 498; height, 150; Lichen, **460**; surgery, 211.
- Tree of descent, 393.
- Tremella mesenterica*, **468**.
- Tremellales*, 469.
- Trichodesmium, 401.
- Trichogyne, **305**, 445.

- Trichomes, 19, **70**.  
Tropical, Rain Forest, 584; undergrowth, **59**.  
Tropophytes, 567.  
Truffles, 451.  
Truth, test for, 13.  
Tuber, 9, 192.  
*Tuberaceæ*, 451.  
Tubercles, **245**.  
Tuberous, Climbers, 568; roots, **251**.  
*Tubifloræ*, described, 554.  
Tubular Algæ, 429.  
Tuft Trees, 570.  
Tulip Tree, cross section, **121**.  
Tumbleweed, 359, 506.  
*Tumboa*, **71**, 524.  
Tumors, 200.  
Tundra, 586.  
Turf-forming Grasses, 568.  
Tussock Plants, 574.  
Twin fruit, 196, **199**, 367.  
Twiners, 185.  
Twining Vines, 575.
- Ulothrix*, 446, 563; *zonata*, **420**.  
*Ulva Lactuca*, **422**.  
Umbel, **337**.  
*Umbellales*, described, 552.  
*Umbelliferae*, 552.  
Umbellifers, 552.  
Undrained Habitats, 571.  
Unit character, 309.  
*Uredinales*, described, 465.  
*Uroglena*, 411.  
*Urticales*, described, 542.  
*Ustilaginales*, described, 464.  
*Ustilago Maydis*, **465**.  
*Utricularia Grafiana*, **555**; *minor*, **555**.
- Vallisneria*, **284**, 287, 530.  
Valvate, 329.  
Variability, 39.  
Variation, 308; defined, 308, 314; selection, 318.  
Varieties, 392.  
Vascular, bundles, 116, 264; plants, 492.  
*Vaucheria*, 563; *sessilis*, **430**.  
Vegetables, 206; *vs.* fruits, 346.  
Vegetation, 558; forms, 559.  
Vegetative, bodies, specialized, 299; parts, potential, 300.  
Veinlet, **31**.  
Veins, 29, 118; of leaf, 17, netted, 17; parallel, 17; use, 144.  
Velum, 472.  
Venation, 65; netted, 65; palmate, 66; parallel, 66; pinnate, 66.  
Ventilation, 369, 371.  
Venus Fly-trap, 76, **77**, 246, 579.  
Vernation, 137.  
*Verticillales*, described, 540.  
Viability, 380; tests, 386.  
*Victoria regia*, 546, **547**.  
Violet, seed pods, **364**.  
*Viscum album*, **544**.  
Visitants, 581.  
*Vitaceæ*, 550.  
Vitalistic conception of nature, 39, 40.  
Vitality, suspension, 377.  
Volva, 471.  
*Volvox*, **419**, 563.
- Walking Fern, 498.  
Walnuts, 541.  
Waste Ground Formations, 586.  
Water, Blooms, 401, 563; capillary, in soils, 239; Ferns, **499**; flotation by, 360; Grasses, 572; Habitats, 561; Hyacinth, **535**, 572; hydrostatic, 238; hygroscopic films, 239; Lilies, 546; Lily seed, **361**; Molds, 435; in seeds, 377; in soils, 238; uses in plants, 224.  
Water culture, **243**; described, 242.  
Water-net, **418**.  
Water plants, 9, 61, 251; characteristics, 562; roots, 252.  
Waterside Formations, 586; Herbs, 572.  
Water-weeds, 530.  
Wax, 111.  
Weeping Birch, **182**.  
*Welwitschia*, **71**, 524; flower, **524**.  
Wheat Rust, 466, **467**; life cycle, **467**.  
White Rust, 436.  
Whorl, 140.  
Wild, Geranium, **334**; Ginger, 544.  
Will-o'-the-wisp, 408.  
Wilting, 48.  
Wilts, 367.  
Wind, effects on trees, **183**; pollinated flowers, characteristics, 288; pollination, 288; waftage, 358.

- Windburn, 48, 97, 259.  
 Wing, 358; on fruits, 350, **351**.  
 Winter-killing, 259.  
 Witches' brooms, 198, **199**, 458, 469, 543.  
*Wolffia*, 534.  
 Wood, 130; fibers, 265; grain, 124; parenchyma, 130.  
 Wooden Flower, **200**.  
  
 Xanthophyll, 89, 90, **91**; composition, 108.  
 Xenia, 353.  
 Xerophyte, 190, 569.  
 Xylem, 122, 130, 222, 262.
- Yam, 537.  
 Yeast, 169, 458, **459**.  
 Yellow fever, 407.  
 Yew, **523**.  
*Yucca*, 570; pollination, **293**.  
  
*Zamia*, 519.  
*Zingiberaceæ*, 538.  
 Zoöglæa, 403, **404**.  
 Zoöspores, **301**, 357, 397.  
*Zygnemaceæ*, 425.  
*Zygomycetes*, 437.  
*Zygophyceæ*, 424.  
 Zygosporos, 397.  
 Zygote, 397.  
 Zymase, 110.

Stom - conduction of water & food see  
fig. 78 & text p. 121, 122

X Maple sap 151

# Respiration - Plants, Animals, Showers

# Odour 268

l "Close" & "Cross" Pollination 289

# "Across" between two flowers on same plant 298

± no better than close-pollination - 2

Sexual reproduction in Liverworts,  
Mosses, Ferns - 30

l Egg cells & sperm cells - collecting specimens 2















Qk GANONG,  
47 WILLIAM F.  
G2 A TEXTBOOK OF  
BOTANY FOR COLLEGES

ONTARIO COLLEGE OF ART  
100 McCAUL ST.  
TORONTO 2B, ONTARIO

$\frac{1}{325}$

Thermometer see Cont. D.

$$F = C \times \frac{9}{5} + 32^{\circ}$$

$$C = \frac{(F - 32) 5}{9}$$

Freezing pt  $F = 32^{\circ}$ ,  $C = 0^{\circ}$

Boiling pt  $F = 212$ ,  $C = 100$

735

8

THE ONTARIO COLLEGE OF ART, (Incorp.)

