

COLUMBIA LIBRARIES OFFSITE
HEALTH SCIENCES STANDARD



HX64086461

QP31 .M62

A text-book of compa

RECAP

QP31

M62

Columbia University
in the City of New York

College of Physicians and Surgeons



From the Library of

Churchill Carmalt, M. D.

Presented by the Externc Club of New York





Digitized by the Internet Archive
in 2010 with funding from
Columbia University Libraries

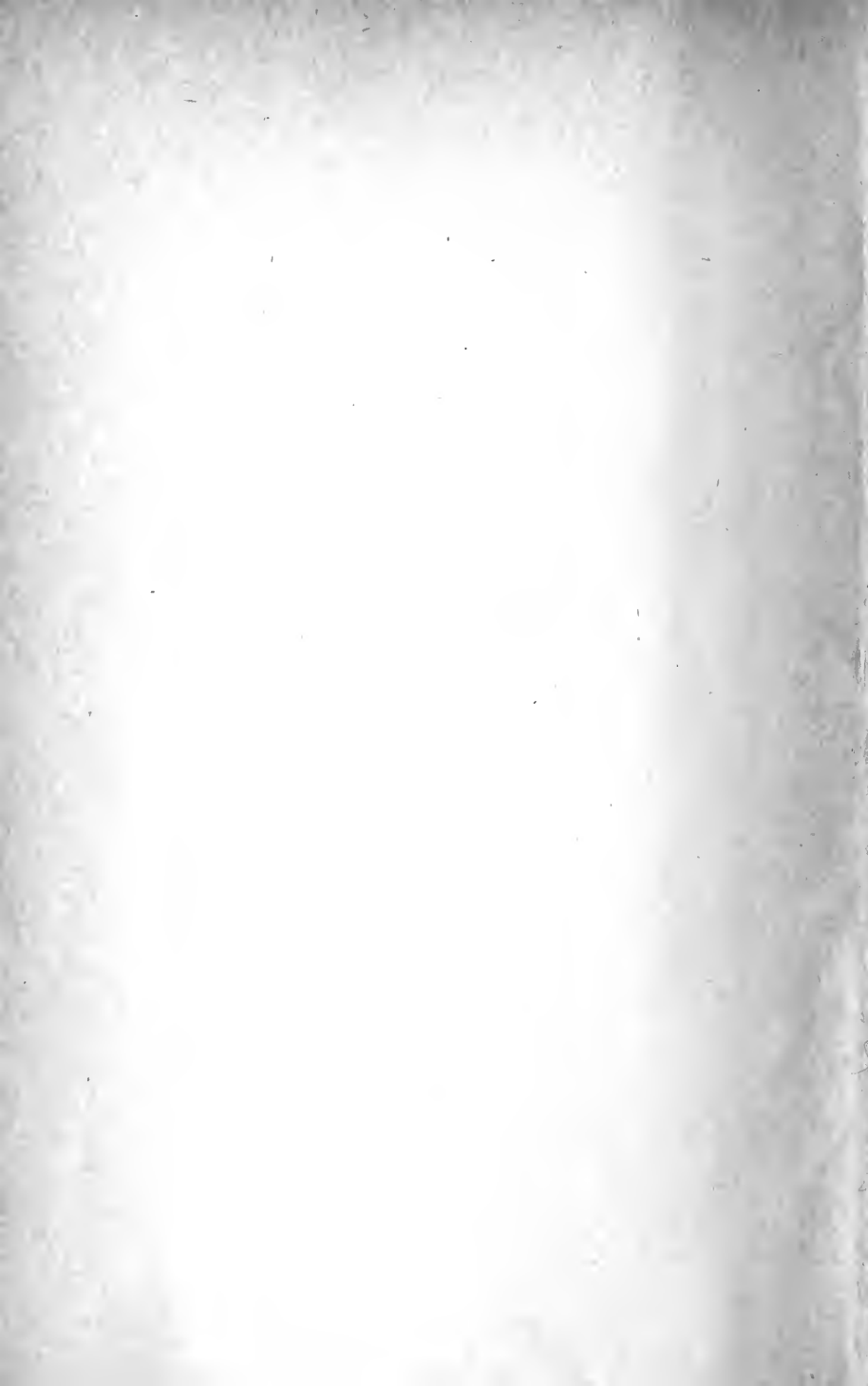

A TEXT-BOOK OF
COMPARATIVE PHYSIOLOGY

FOR STUDENTS AND PRACTITIONERS OF
COMPARATIVE (VETERINARY) MEDICINE

BY

WESLEY MILLS

M. A., M. D., D. V. S.

PROFESSOR OF PHYSIOLOGY IN THE FACULTY OF HUMAN MEDICINE AND THE FACULTY
OF COMPARATIVE MEDICINE AND VETERINARY SCIENCE OF MCGILL
UNIVERSITY, MONTREAL; AUTHOR OF A TEXT-BOOK
OF ANIMAL PHYSIOLOGY, ETC.

WITH 476 ILLUSTRATIONS

NEW YORK
D. APPLETON AND COMPANY
LONDON: CANTON HOUSE, PATERNOSTER SQUARE
1896

COPYRIGHT, 1890,
BY D. APPLETON AND COMPANY

All rights reserved.

P R E F A C E .

SOME years of contact with students of comparative (commonly called veterinary) medicine, and a fair knowledge of the actual needs of the practitioner of this department of the medical art, have convinced me that the time has fully come when the text-books of physiology provided for students of human medicine, and which the former classes have hitherto been compelled to use, should be replaced by works written to meet their special wants and possibilities. In fact, so different from man are most of the animals which the veterinarian is called upon to treat, and therefore to understand, in health as well as in disease, that only the absence of suitable works of a special character can justify the use of those that confessedly treat of man alone.

Unfortunately, till within the past year the English-speaking student of comparative medicine has been without a single work in his own language of the special character required. Within that period two have appeared—the excellent but ponderous *Physiology of the Domestic Animals*, by Prof. Smith, and my own *Text-Book of Animal Physiology*. It has, therefore, occurred to me that a somewhat smaller work than the latter, embodying the same plan, but with greater specialization for the domestic animals, would commend itself to both the students and the practitioners of comparative medicine. In my other work I have endeavored to set before the student a short account of what has been deemed of most importance in general biology; to furnish a full account of reproduction; to apply these two departments throughout the whole of the rest of the work; to bring

before the student enough of comparative physiology in its widest sense to impress him with the importance of recognizing that all medicine like all science is, when at its best, comparative; and to show that the doctrines of evolution must apply to physiology and medicine as well as to morphology.

Comparative medicine is essentially broad. It will not do to measure all the animals the veterinarian is called upon to treat by the equine standard. This has been too much the case in the past for the good even of the horse himself; while others, that fall to the practitioner's care, like the dog, have been much neglected and misunderstood.

There is no more reason, theoretically, why the veterinarian should overlook man than that the practitioner of human medicine should disregard the lessons to be learned from our domestic animals; hence the attempt has been made to exclude references to the human subject from the volume. The student of comparative medicine may learn, by careful observation on himself, to understand much that would otherwise never become realized knowledge; and this conviction has been at the root of a large part of the advice given the student as to how to study throughout the work.

All that relates to reproduction and breeding is, in these days of vast stock interests, of so much practical importance, that on this account alone the fullest treatment of the subject seems justifiable. But, apart from this, it has become clear to me that function as well as form can be much better and more easily grasped when embryology is early considered. This I have tested, with the happiest results, with my own classes. Usually those taking up physiology for the first time are, of course, not expected to master all the details of embryology, but the main outlines prove as helpful as interesting; nevertheless, it is my experience that a considerable number of first-year men are not content to be confined to the merest rudiments of this or any other department of physiology.

That a work written on so new a plan as my Text-Book of Animal Physiology should have met with a reception almost universally favorable, both in Britain and America, in

so short a space of time, encourages me to hope for one equally favorable for this book, which is offered to a profession from which I look for great things in the interests both of man and the lower animals within the next few years. The time has certainly come when medicine must leave the narrow ruts within which it has been confined, and become essentially comparative. To hasten that consummation, so devoutly to be wished, has been the object with which both my earlier and the present work have been written. Unless the student is infused with the broad comparative spirit in the earliest years of his studies, and guided accordingly, there is no sure guarantee of final success in the widest sense.

My publishers again deserve my thanks for the efforts they have made to present this work in their best form.

WESLEY MILLS.

PHYSIOLOGICAL LABORATORY, MCGILL UNIVERSITY,
MONTREAL, CANADA, *August*, 1890.



CONTENTS.

	PAGE
GENERAL BIOLOGY	1
Introduction	1
Tabular statement of the subdivisions of Biology	4
The Cell	5
Animal and vegetable cells	5
Structure of cells	5
Cell-contents	7
The nucleus	8
Tissues	8
Summary	9
Unicellular Organisms (Vegetable)	9
1. Yeast	9
Morphological	9
Chemical	9
Physiological	10
Conclusions	10
2. Protococcus	11
Morphological	12
Physiological	12
Conclusions	12
Unicellular Animals	13
The proteus animalcule	13
Morphological	13
Physiological	13
Conclusions	15
Parasitic Organisms	15
Fungi	15
Mucor mucedo	17
The Bacteria	18
Unicellular Animals with Differentiation of Structure	21
The bell-animalcule	21
Structure	21
Functions	23

	PAGE
Multicellular Organisms	23
The fresh-water polyps	23
The Cell reconsidered	27
The Animal Body—an epitomized account of the functions of a mam- mal	28
Living and Lifeless Matter—General explanation and comparison of their properties	32
Classification of the Animal Kingdom	34
Tabular statement	36
Man's place in the animal kingdom	36
The Law of Periodicity or Rhythm in Nature—Explanations and illustrations	37
The Law of Habit	41
Its foundation	41
Instincts	42
The Origin of the Forms of Life	42
Arguments from :	
Morphology	45
Embryology	45
Mimicry	45
Rudimentary organs	46
Geographical distribution	46
Paleontology	46
Fossil and existing species	46
Progression	47
Domesticated animals	47
Summary	50
REPRODUCTION	51
General	51
The ovum	55
The origin and development of the ovum	57
Changes in the ovum itself	58
The male cell	61
The origin of the spermatozöon	61
Fertilization of the ovum	63
Segmentation and subsequent changes	64
The gastrula	68
The hen's egg	69
The origin of the fowl's egg	70
Embryonic membranes of birds	74
The foetal (embryonic) membranes of mammals	78
The allantoic cavity	80
The placenta	82
The discoidal placenta	83

	PAGE
The metadiscoidal placenta	84
The zonary placenta	89
The diffuse placenta	89
The polycotyledonary placenta	89
Tabulation of placentation	90
Microscopic structure of the placenta	90
Illustrations	91, 92
Evolution	93
Summary	93
THE DEVELOPMENT OF THE EMBRYO ITSELF	95
Germ-layers	98
Origin of the vascular system	102
The growth of the embryo	105
Development of the Vascular System in Vertebrates	108
The later stages of the foetal circulation	109
Development of the Urogenital System	112
The Physiological Aspects of Development	118
Ovulation	120
Oestrus	121
The nutrition of the ovum	123
The foetal circulation	125
Periods of Gestation	127
Parturition	128
Changes in the circulation after birth	129
Coitus	129
ORGANIC EVOLUTION RECONSIDERED	137
THE CHEMICAL CONSTITUTION OF THE ANIMAL BODY	142
Proximate principles	144
General characters of proteids	144
Certain non-crystalline bodies	145
The fats	145
Peculiar fats	146
Carbohydrates	146
Nitrogenous metabolites	147
Non-nitrogenous metabolites	147
PHYSIOLOGICAL RESEARCH AND PHYSIOLOGICAL REASONING	148
THE BLOOD	154
Comparative	154
Corpuscles	155
History of the blood-cells	158
Chemical composition of the blood	160
Composition of serum	161
Composition of the corpuscles	162
The quantity and distribution of the blood	163

	PAGE
The coagulation of the blood	163
Clinical and pathological	167
Summary	169
THE CONTRACTILE TISSUES	171
General	171
Comparative	172
Ciliary movements	173
The irritability of muscle and nerve	175
THE GRAPHIC METHOD AND THE STUDY OF MUSCLE PHYSIOLOGY	176
Chronographs and various kinds of apparatus	176
The apparatus used for the stimulation of muscle	179
A single muscular contraction	185
Tetanic contraction	187
The muscle-tone	189
The changes in a muscle during contraction	189
The elasticity of muscle	189
The electrical phenomena of muscle	191
Chemical changes in muscle	192
Thermal changes in the contracting muscle	195
The physiology of nerve	196
Electrotonus	196
Pathological and clinical	197
Electrical organs	197
Muscular work	198
Circumstances influencing the character of muscular and nervous activity	199
The influence of blood-supply and fatigue	199
Separation of muscle from the central nervous system	201
The influence of temperature	201
Unstriated muscle	202
General	202
Comparative	202
Special considerations	203
Functional variations	204
Summary of the physiology of muscle and nerve	205
THE NERVOUS SYSTEM—GENERAL CONSIDERATIONS	208
Experimental	210
Automatism	211
Conclusions	212
Nervous inhibition	212
THE CIRCULATION OF THE BLOOD	214
General	214
The mammalian heart	215
Circulation in the mammal	219

	PAGE
The action of the mammalian heart	222
The velocity of the blood and blood-pressure	223
General	223
Comparative	224
The circulation under the microscope	224
The characters of the blood-flow	226
Blood-pressure	227
THE HEART	231
The cardiac movements	231
The impulse of the heart	232
Investigation of the heart-beat from within	233
The cardiac sounds	234
Causes of the sounds	235
Endo-cardiac pressures	236
The work of the heart	238
Variations in the cardiac pulsation	239
Comparative	240
The pulse	241
Features of an arterial pulse-tracing	242
Venous pulse	244
Pathological	244
Comparative	244
The beat of the heart and its modifications	248
The nervous system in relation to the heart	249
Influence of the vagus nerve on the heart	253
Conclusions	257
The accelerator nerves of the heart	258
The heart in relation to blood-pressure	260
The influence of the quantity of blood	261
The capillaries	264
Special considerations	265
Pathological	266
Personal observations	566
Comparative	267
Evolution	268
Summary of the physiology of the circulation	269
DIGESTION OF FOOD	274
Foodstuffs, milk, etc.	274
Embryological	280
Comparative	286
Structure, arrangement, and significance of the teeth	286
The digestive juices	297
Saliva and its action	297
Secretion of the different glands	298

	PAGE
Comparative	298
Gastric juice	299
Bile	301
General	301
Pigments	302
Digestive action	303
Comparative	304
Pancreatic secretion	305
Succus entericus	307
Comparative	310
Secretion as a physiological process	311
Secretion of the salivary glands	311
Secretion by the stomach	315
The secretion of bile and pancreatic juice	316
The nature of the act of secretion	318
Self-digestion of the digestive organs	323
Comparative	324
The alimentary canal of the vertebrate	331
The movements of the digestive organs	332
Deglutition	333
Comparative	336
The movements of the stomach	336
Comparative	337
Pathological	337
The intestinal movements	337
Defecation	338
Vomiting	339
Comparative	340
The removal of digestive products from the alimentary canal	341
Lymph and chyle	343
The movements of the lymph—comparative	344
Pathological	352
Fæces	352
Pathological	353
The changes produced in the food in the alimentary canal	354
General	354
Comparative	357
Pathological	359
Special considerations	359
Various	359
Evolution	363
Summary	364
THE RESPIRATORY SYSTEM	366
General	366

	PAGE
Anatomical	367
The entrance and exit of air	370
The muscles of respiration	373
Types of respiration	375
Comparative	375
Personal observation	375
The quantity of air respired	378
The respiratory rhythm	379
General	379
Pathological	379
Respiratory sounds	381
Comparison of the inspired and the expired air	382
Respiration in the blood	383
Hæmoglobin and its derivatives	385
General	385
Blood-spectra	387
Comparative	389
The nitrogen and the carbon dioxide of the blood	389
Foreign gases and respiration	391
Respiration in the tissues	391
The nervous system in relation to respiration	393
The influence of the condition of the blood on respiration	393
The influence of respiration on the circulation	396
General	396
Comparative	398
The respiration and circulation in asphyxia	399
Pathological	401
Peculiar respiratory movements	401
Coughing, laughing, etc.	401
Comparative	402
Special considerations	403
Pathological and clinical	403
Personal observation	404
Evolution	404
Summary of the physiology of respiration	405
PROTECTIVE AND EXCRETORY FUNCTIONS OF THE SKIN	408
General	408
Comparative	408
The excretory function of the skin	411
Normal sweat	411
Pathological	411
Comparative—Respiration by the skin	412
Death from suppression of the functions of the skin	412
The excretion of perspiration	412

	PAGE
Experimental	413
Absorption by the skin	413
Comparative	413
Summary	413
EXCRETION BY THE KIDNEY	415
Anatomical	415
Comparative	415
Urine considered physically and chemically	419
Specific gravity	419
Color	419
Reaction	419
Quantity	419
Composition: Nitrogenous crystalline bodies	420
Non-nitrogenous organic bodies	420
Inorganic salts	420
Abnormal urine	421
Comparative	421
The secretion of urine	421
Theories of secretion	421
Nervous influence	423
Pathological	423
The expulsion of urine	424
General	424
Facts of experiment and of experience	424
Pathological	426
Summary of urine and the functions of the kidneys	426
Comparative	426
THE METABOLISM OF THE BODY	428
General remarks	428
The metabolism of the liver	428
The glycogenic function	429
The uses of glycogen	429
Metabolism of the spleen	429
Histological	430
Chemical	430
The construction of fat	432
General and experimental	432
Histological	433
Changes in the cells of the mammary gland	434
Nature of fat formation	434
Milk and colostrum	435
Pathological	435
Comparative	436
The study of the metabolic processes by other methods	436

	PAGE
Various tabular statements	437
Starvation and its lessons	537
Comparative	438
Diets	439
Feeding experiments	439
General	439
Nitrogenous equilibrium	440
Comparative	441
The effects of gelatine in the diet	441
Fat and carbohydrates	442
Comparative	442
The effects of salts, water, etc., on the diet	443
Pathological	443
Water	443
The energy of the animal body	443
Tabular statements	444
Animal heat	445
General	445
Comparative	445
The regulation of temperature	447
Cold-blooded and warm-blooded animals compared	448
Theories of heat formation and heat regulation	448
Pathological	449
Special considerations	450
Evolution	450
Hibernation	451
Daily variations in temperature in man and other mammals	452
The influence of the nervous system on metabolism (nutrition).	452
Experimental facts	452
Discussion of their significance	455
General considerations, clinical and pathological	456
Summary of metabolism	458
THE SPINAL CORD—GENERAL	461
General	461
Anatomical	461
The reflex functions of the spinal cord	466
General and experimental	466
Evolution and heredity	468
Inhibition of reflexes	469
The spinal cord as a conductor of impulses	469
Anatomical	469
Decussation	471
Pathological	471
Paths of impulses	473

	PAGE
The automatic functions of the spinal cord	475
General	475
Spinal phenomena	476
Special considerations	477
Comparative	477
Evolution	478
Synoptical	479
THE BRAIN	481
General and anatomical	481
Animals deprived of their cerebrum	482
Behavior of various animals and its significance	482
Have the semicircular canals a co-ordinating function?	484
Discussion of the phenomena	484
Forced movements	484
Functions of the cerebral convolutions	485
Comparative	485
Individual differences in brains	489
The connection of one part of the brain with another	491
The cerebral cortex	497
Theories of different observers	498
The circulation in the brain	500
Sleep—hibernation—dreaming	501
Hypnotism, etc.	502
Illustrations of localization	502
Functions of other portions of the brain	504
The corpus striatum and the optic thalamus	504
Corpora quadrigemina	506
The cerebellum	508
Pathological	508
Crura cerebri and pons Varolii	509
Pathological	509
Medulla oblongata	509
Special considerations	510
Embryological	510
Evolution	511
Synoptical	513
GENERAL REMARKS ON THE SENSES	516
Anatomical	516
General principles	516
THE SKIN AS AN ORGAN OF SENSE	520
General	520
Pressure sensations	522
Thermal sensations	522
Tactile sensibility	523

	PAGE
The muscular sense	524
General	524
Pathological	524
Comparative	524
Synoptical	525
VISION	526
Anatomical	527
Embryological	528
Dioptries of vision	531
Accommodation of the eye	532
Alterations in the size of the pupil	533
Phenomena and their explanations	534
Pathological	536
Comparative	536
Optical imperfections of the eye	536
Anomalies of refraction	536
Visual sensations	538
General	538
Affections of the retina	540
The laws of retinal stimulation	541
The visual angle	542
Color-vision	543
Psychological aspects of vision	543
The visual field	543
After-images, etc.	543
Co-ordination of the two eyes in vision	544
The visual axes	544
Ocular movements	544
Estimation of the size and distance of objects	548
Solidity	548
Protective mechanisms of the eye	549
Special considerations	551
Comparative	551
Evolution	552
Pathological	554
Brief synopsis of the physiology of vision	554
HEARING	557
General	557
Anatomical	558
The membrana tympani	558
The auditory ossicles	559
Muscles of the middle ear	561
The Eustachian tube	562
Pathological	563

	PAGE
Auditory impulses	565
Auditory sensations, perceptions, judgments	567
General	567
Auditory judgment	568
Special considerations	568
Comparative	568
Evolution	571
Synopsis of the physiology of hearing	572
THE SENSES OF SMELL AND TASTE	573
Smell	573
Anatomical	573
General	573
Comparative	574
TASTE	575
Anatomical	576
General	576
Experimental	577
Comparative	578
THE CEREBRO-SPINAL SYSTEM OF NERVES	579
1. Spinal nerves	579
General	579
Exception	580
Additional experiments	580
Pathological	580
2. The cranial nerves	580
General	580
The motor-oculi, or third nerve	581
The trochlear, or fourth nerve	582
The abducens, or sixth nerve	282
The facial, or seventh nerve	582
The trigeminus, or fifth nerve	583
The glosso-pharyngeal, or ninth nerve	585
The pneumogastric, or tenth nerve	586
The spinal accessory, or eleventh nerve	587
The hypoglossal, or twelfth nerve	588
Relations of the cerebro-spinal and sympathetic systems	588
Recent views on this subject	588
THE VOICE	592
Physical	592
Anatomical	593
Voice-formation	593
Pathological	598
Comparative	598
Special considerations	600

	PAGE
Evolution	600
Summary	601
CERTAIN TISSUES	602
Connective tissue	603
Elastic tissue	604
Bone	604
Cartilage	604
LOCOMOTION	610
Anatomical	610
Mechanical	610
Standing	610
Walking	611
Running	613
Jumping	614
Hopping	614
Comparative: the gait of quadrupeds	614
The foot of the horse	616
Different gaits: general	621
Walking	623
The amble	624
The trot	624
The gallop	624
Evolution	627



COMPARATIVE PHYSIOLOGY.

GENERAL BIOLOGY.

INTRODUCTION.

BIOLOGY (*βίος*, life ; *λόγος*, a dissertation) is the science which treats of the nature of living things ; and, since the properties of plants and animals can not be explained without some knowledge of their form, this science includes morphology (*μορφή*, form ; *λόγος*, a dissertation) as well as physiology (*φύσις*, nature ; *λόγος*).

Morphology describes the various forms of living things and their parts ; physiology, their action or function.

General biology treats neither of animals nor plants exclusively. Its province is neither zoölogy nor botany ; but it attempts to define what is common to all living things. Its aim is to determine the properties of organic beings as such, rather than to classify or to give an exhaustive account of either animals or plants. Manifestly, before this can be done, living things, both animal and vegetable, must be carefully compared, otherwise it would be impossible to recognize differences and resemblances ; in other words, to ascertain what they have in common.

When only the highest animals and plants are contemplated, the differences between them seem so vast that they appear to have, at first sight, nothing in common but that they are living : between a tree and a dog an infant can discriminate ; but there are microscopic forms of life that thus far defy the most learned to say whether they belong to the animal or the vegetable world. As we descend in the organic series, the lines of distinction grow fainter, till they seem finally to all but disappear.

But let us first inquire : What are the determining characteristics of living things as such ? By what barriers are the animate and inanimate worlds separated ? To decide this, falls within the province of general biology.

Living things grow by interstitial additions of particles of matter derived from without and transformed into their own substance, while inanimate bodies increase in size by superficial additions of matter over which they have no power of decomposition and recomposition so as to make them like themselves. Among lifeless objects, crystals approach nearest to living forms ; but the crystal builds itself up only from material in solution of the same chemical composition as itself.

The chemical constitution of living objects is peculiar. Carbon, hydrogen, oxygen, and nitrogen are combined into a very complex whole or molecule, as protein ; and, when in combination with a large proportion of water, constitute the basis of all life, animal and vegetable, known as protoplasm. Only living things can manufacture this substance, or even protein.

Again, in the very nature of the case, protoplasm is continually wasting by a process of oxidation, and being built up from simpler chemical forms. Carbon dioxide is an invariable product of this waste and oxidation, while the rest of the carbon, the hydrogen, oxygen, and nitrogen are given back to the inorganic kingdom in simpler forms of combination than those in which they exist in living beings. It will thus be evident that, while the flame of life continues to burn, there is constant chemical and physical change. Matter is being continuously taken from the world of things that are without life, transformed into living beings, and then after a brief existence in that form returned to the source from which it was originally derived. It is true, all animals require their food in organized form—that is, they either feed on animal or plant forms ; but the latter derive their nourishment from the soil and the atmosphere, so that the above statement is a scientific truth.

Another highly characteristic property of all living things is to be sought in their periodic changes and very limited duration. Every animal and plant, no matter what its rank in the scale of existence, begins in a simple form, passes through a series of changes of varying degrees of complexity, and finally declines and dies ; which simply means that it rejoins the inanimate kingdom : it passes into another world to which it formerly belonged.

Living things alone give rise to living things ; protoplasm alone can beget protoplasm ; cell begets cell. *Omne animal (anima, life) ex ovo* applies with a wide interpretation to all living forms.

From what has been said it will appear that life is a condition of ceaseless change. Many of the movements of the protoplasm composing the cell-units of which living beings are made are visible under the microscope ; their united effects are open to common observation—as, for example, in the movements of animals giving rise to locomotion we have the joint result of the movements of the protoplasm composing millions of muscle-cells. But, beyond the powers of any microscope that has been or probably ever will be invented, there are molecular movements, ceaseless as the flow of time itself. All the processes which make up the life-history of organisms involve this molecular motion. The ebb and flow of the tide may symbolize the influx and efflux of the things that belong to the inanimate world, into and out of the things that live.

It follows from this essential instability in living forms that life must involve a constant struggle against forces that tend to destroy it ; at best this contest is maintained successfully for but a few years in all the highest grades of being. So long as a certain equilibrium can be maintained, so long may life continue and no longer.

The truths stated above will be illustrated in the simpler forms of plants and animals in the ensuing pages, and will become clearer as each chapter of this work is perused. They form the fundamental laws of general biology, and may be formulated as follows :

1. Living matter or protoplasm is characterized by its chemical composition, being made up of *carbon, hydrogen, oxygen, and nitrogen*, arranged into a very complex molecule.

2. Its universal and constant waste and its repair by interstitial formation of new matter similar to the old.

3. Its power to give rise to new forms similar to the parent ones by a process of division.

4. Its manifestation of periodic changes constituting development, decay, and death.

Though there is little in relation to living beings which may not be appropriately set down under zoölogy or botany, it tends to breadth to have a science of general biology which deals with the properties of things simply as living, irrespective

Biology.
The science of living things; i. e., of matter in the living state.

Morphology.
The science of form, structure, etc.
Essentially statical.

Physiology.
The science of action or function.
Essentially dynamical.

Anatomy.
The science of structure; the term being usually applied to the coarser and more obvious composition of plants or animals.

Histology.
Microscopical anatomy. The ultimate optical analysis of structure by the aid of the microscope; separated from anatomy only as a matter of convenience.

Taxonomy.
The classification of living things, based chiefly on phenomena of structure.

Distribution.
Considers the position of living things in space and time; their distribution over the present face of the earth; and their distribution and succession at former periods, as displayed in fossil remains.

Embryology.
The science of development from the germ; includes many mixed problems pertaining both to morphology and physiology. At present largely morphological.

Physiology.
The special science of the functions of the individual in health and in disease; hence including *Pathology.*

Psychology.
The science of mental phenomena.

Sociology.
The science of social life, i. e., the life of communities, whether of men or of lower animals.

Botany.
The science of vegetable living matter or plants.

Biology.
The science of living things; i. e., of matter in the living state.

Zoölogy.
The science of animal living matter or animals.

very much as to whether they belong to the realm of animals or plants. The relation of the sciences which may be regarded as subdivisions of general biology is well shown in the accompanying table. *

THE CELL. †

All living things, great and small, are composed of cells. Animals may be divided into those consisting of a single cell (*Protozoa*), and those made up of a multitude of cells (*Metazoa*); but in every case the animal begins as a single cell or ovum from which all the other cells, however different finally from one another either in form or function, are derived by processes of growth and division; and, as will be seen later, the whole organism is at one period made up of cells practically alike in structure and behavior. The history of each individual animal or plant is the resultant of the conjoint histories of each of its cells, as that of a nation is, when complete, the story of the total outcome of the lives of the individuals composing it.

It becomes, therefore, highly important that a clear notion of the characters of the cell be obtained at the outset; and this chapter will be devoted to presenting a general account of the cell.

The cell, whether animal or vegetable, in its most complete form consists of a mass of viscid, semifluid, transparent substance (*protoplasm*), a cell wall, and a more or less circular body (*nucleus*) situated generally centrally within; in which, again, is found a similar structure (*nucleolus*).

This description applies to both the vegetable and the animal cell; but the student will find that the greater proportion of animal cells have no cell wall, and that very few vegetable cells are without it. But there is this great difference between the animal and vegetable cell: the former never has a *cellulose* wall, while the latter rarely lacks such a covering. In every case the cell wall, whether in animal or vegetable cells, is of greater consistence than the rest of the cell. This is especially true of the vegetable cell.

It is doubtful whether there are any cells without a nucleus, while not a few, especially when young and most active, pos-

* Taken from the General Biology of Sedgwick and Wilson.

† The illustrations of the sections following will enable the student to form a generalized mental picture of the cell in all its parts.

sess several. The circular form may be regarded as the typical form of both cells and nuclei, and their infinite variety in size and form may be considered as in great part the result of the action of mechanical forces, such as mutual pressure; this is, of course, more especially true of shape. Reduced to its greatest simplicity, then, the cell may be simply a mass of protoplasm with a nucleus.

It seems probable that the numerous researches of recent years and others now in progress will open up a new world of

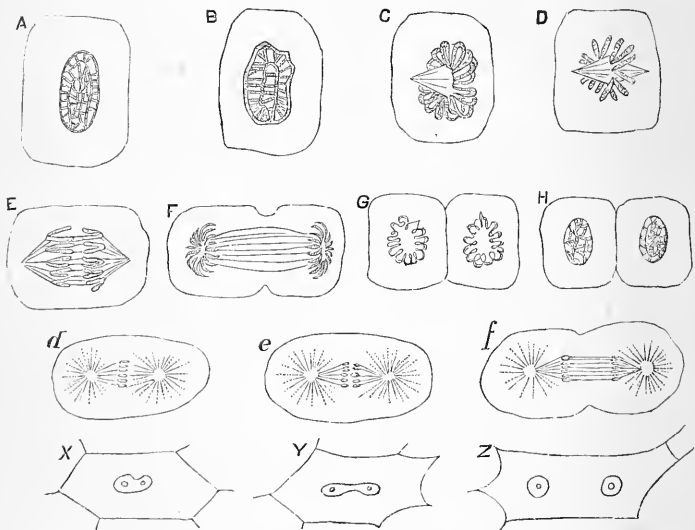

FIG. 1.—NUCLEAR DIVISION. A-H, karyokinesis of a tissue cell. A, nuclear reticulum in its ordinary state. B, preparing for division; the contour is less defined, and the fibers thicker and less intricate. C, wreath-stage; the chromatin is arranged in a complicated looping round the equator of the achromatin spindle. D, monaster-stage; the chromatin now appears as centripetal equatorial V's, each of which should be represented as double. E, a migration of the half of each chromatin loop towards opposite poles of the spindle. F, diaster-stage; the chromatin forms a star, round each pole of a spindle, each aster being connected by strands of achromatin. G, daughter-wreath stage; the newly formed nuclei are passing through their retrogressive development, which is completed in the resting stage, H. *d, f*, karyokinesis of an egg-cell, showing the smaller amount of chromatin than in the tissue-cell. The stages *d, e, f*, correspond to D, E, F, respectively. The polar star at the end of the spindle is composed of protoplasm-granules of the cell itself, and must not be mistaken for the diaster (F). The coarse lines represent the chromatin, the fine lines the achromatin, and the dotted lines cell-granules. (Chiefly modified from Flemming.) X-Z, direct nuclear division in the cells of the embryonic integument of the European scorpion. After Blochmann (*Haddon*).

cell biology which will greatly advance our knowledge, especially in the direction of increased depth and accuracy.

Though many points are still in dispute, it may be safely said that the nucleus plays, in most cells, a rôle of the highest importance; in fact, it seems as though we might regard the nucleus as the directive brain, so to speak, of the individual cell. It frequently happens that the behavior of the body of the cell is foreshadowed by that of the nucleus. Thus frequently, if not always, division of the body of the nucleus precedes that of the cell itself, and is of a most complicated character (*karyokinesis* or *mitosis*). The cell wall is of subordinate importance in the processes of life, though of great value as a mechanical support to the protoplasm of the cell and the aggregations of cells known as tissues. The greater part of a tree may be said to be made up of the thickened walls of the cells, and these are destitute of true vitality, unless of the lowest order; while the really active, growing part of an old and large tree constitutes but a small and limited zone, as may be learned from the plates of a work on modern botany representing sections of the wood.

Animals, too, have their rigid parts, in the adult state especially, resulting from the thickening of a part of the whole of the cell by a deposition usually of salts of lime, as in the case of the bones of animals. But in some cases, as in cartilage, the cell wall or capsule undergoes thickening and consolidation, and several may fuse together, constituting a *matrix*, which is also made up in part, possibly, of a secretion from the cell protoplasm. In the outer parts of the body of animals we have a great abundance of examples of thickening and hardening of cells. Very well-known instances are the indurated patches of skin (*epithelium*) on the palms of the hands and elsewhere.

It will be scarcely necessary to remark that in cells thus altered the mechanical has largely taken the place of the vital in function. This at once harmonizes with and explains what is a matter of common observation, that old animals are less active—have less of life within them, in a word, than the young. Chemically, the cellulose wall of plant-cells consists of carbon, hydrogen, and oxygen, in the same relative proportion as exists in starch, though its properties are very different from those of that substance.

Turning to cell contents, we find them everywhere made up of a clear, viscid substance, containing almost always granules of varying but very minute size, and differing in consistence

not only in different groups of cells, but often in the same cell, so that we can distinguish an outer portion (*ectoplasm*) and an inner more fluid and more granular region (*endoplasm*).

The nucleus is a body with very clearly defined outline (in some cases limited by a membrane), through which an irregular network of fibers extends that stains more deeply than any other part of the whole cell.

Owing to the fact that it is so readily changed by the action of reagents, it is impossible to ascertain the exact chemical composition of living protoplasm; in consequence, we can only infer its chemical structure, etc., from the examination of the dead substance.

In general, it may be said that protoplasm belongs to the class of bodies known as proteids—that is, it consists chemically of carbon, hydrogen, a little sulphur, oxygen, and nitrogen, arranged into a very complex and unstable molecule. This very instability seems to explain at once its adaptability for the manifestation of its nature as living matter, and at the same time the readiness with which it is modified by many circumstances, so that it is possible to understand that life demands an incessant adaptation of internal to external conditions.

It seems highly probable that protoplasm is not a single proteid substance, but a mixture of such; or let us rather say, furnishes these when chemically examined and therefore dead.

Very frequently, indeed generally, protoplasm contains other substances, as salts, fat, starch, chlorophyl, etc.

From the fact that the nucleus stains differently from the cell contents, we may infer a difference between them, physical and especially chemical. It (nucleus) furnishes on analysis *nuclein*, which contains the same elements as protoplasm (with the exception of sulphur) together with phosphorus. Nuclei have great resisting power to ordinary solvents and even the digestive juices.

Inasmuch as all vital phenomena are associated with protoplasm, it has been termed the "physical basis of life" (Huxley).

Tissues.—A collection of cells performing a similar physiological action constitutes a tissue.

Generally the cells are held together either by others with that sole function, or by cement material secreted by themselves. An *organ* may consist of one or several tissues. Thus the stomach consists of muscular, serous, connective, and gland-

ular tissues, besides those constituting its blood-vessels, lymphatics, and nerves. But all of the cells of each tissue have, speaking generally, the same function. The student is referred to works on general anatomy and histology for classifications and descriptions of the tissues. See also page 603.

The statements of this chapter will find illustration in the pages immediately following, after which we shall return to the subject of the cell afresh.

Summary.—The typical cell consists of a wall, protoplasmic contents, and a nucleus. The vegetable cell has a limiting membrane of cellulose. Cells undergo differentiation and may be united into groups forming tissues which serve one or more definite purposes.

The chemical constitution of protoplasm is highly complex and unstable. The nucleus plays a prominent part in the life-history of the cell, and seems to be essential to its perfect development and greatest physiological efficiency.

UNICELLULAR PLANTS.

YEAST (*Torula*, *Saccharomyces Cerevisiae*).

The essential part of the common substance, yeast, may be studied to advantage, as it affords a simple type of a vast group of organisms of profound interest to the student of physiology and medicine. To state, first, the main facts as ascertained by observation and experiment :

Morphological.—The particles of which yeast is composed are cells of a circular or oval form, of an average diameter of about $\frac{1}{3000}$ of an inch.

Each individual *torula* cell consists of a transparent homogeneous covering (*cellulose*) and granular semifluid contents (*protoplasm*). Within the latter there may be a space (*vacuole*) filled with more fluid contents.

The various cells produced by budding may remain united like strings of beads. Collections of masses composed of four or more subdivisions (*ascospores*), which finally separate by rupture of the original cell wall, having thus become themselves independent cells, may be seen more rarely (*endogenous division*).

The yeast-cell is now believed to possess a *nucleus*.

Chemical.—When yeast is burned and the ashes analyzed, they are found to consist chiefly of salts of potassium, calcium, and magnesium.

The elements of which yeast is composed are C, H, O, N, S, P, K, Mg, and Ca; but chiefly the first four.

Physiological.—If a little of the powder obtained by drying yeast at a temperature below blood-heat be added to a solution of sugar, and the latter be kept warm, bubbles of carbon dioxide will be evolved, causing the mixture to become frothy; and the fluid will acquire an alcoholic character (*fermentation*).

If the mixture be raised to the boiling-point, the process described at once ceases.

It may be further noticed that in the fermenting saccharine solution there is a gradual increase of turbidity. All of these changes go on perfectly well in the total absence of sunlight.

Yeast-cells are found to grow and reproduce abundantly in an artificial food solution consisting of a dilute solution of certain salts, together with sugar.

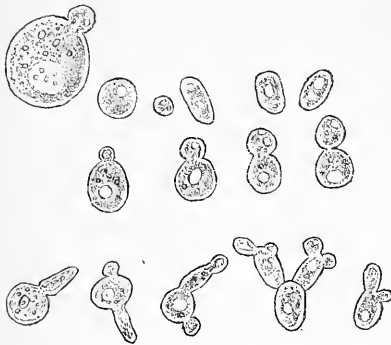

FIG. 2.—Various stages in the development of brewer's yeast, seen, with the exception of the first in the series, with an ordinary high power (Zeiss, D. 4) of the microscope. The first is greatly magnified (Gundlach's $\frac{1}{2}$ immersion lens). The second series of four represents stages in the division of a single cell; and the third series a branching colony. Everywhere the light areas indicate vacuoles.



FIG. 3.—The endogonidia (ascospore) phase of reproduction—i. e., endogenous division.



FIG. 4.—Further development of the forms represented in Fig. 3.

Conclusions.—What are the conclusions which may be legitimately drawn from the above facts?

That the essential part of yeast consists of cells of about the size of mammalian blood-corpuscles, but with a limiting wall of a substance different from the inclosed contents, which latter is composed chiefly of that substance common to all living things—protoplasm; that like other cells they reproduce their

kind, and in this instance by two methods: *gemmation* giving rise to the bead-like aggregations alluded to above; and internal division of the protoplasm (*endogenous division*).

From the circumstances under which growth and reproduction take place, it will be seen that the original protoplasm of the cells may increase its bulk or grow when supplied with suitable food, which is not, as will be learned later, the same in all respects as that on which green plants thrive; and that this may occur in darkness. But it is to be especially noted that the protoplasm resulting from the action of the living cells is wholly different from any of the substances used as food. This power to construct protoplasm from inanimate and unorganized materials, reproduction, and fermentation are all properties characteristic of living organisms alone.

It will be further observed that these changes all take place within narrow limits of temperature; or, to put the matter more generally, that the life-history of this humble organism can only be unfolded under certain well-defined conditions.

PROTOCOCCUS (*Protococcus pluvialis*).

The study of this one-celled plant will afford instructive comparison between the ordinary green plant and the colorless plants or fungi.

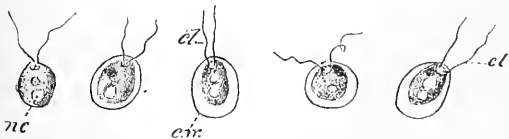
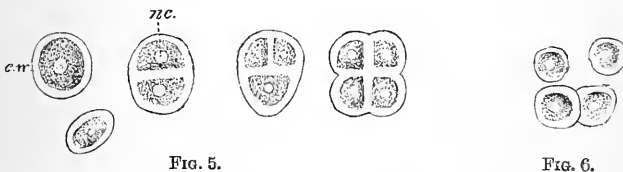

FIG. 7.

FIGS. 5 to 7 represent successive stages observed in the life-history of *Protococci* scraped from the bark of a tree.

FIG. 5.—A group in the dried state, illustrating method of division.

FIG. 6.—One of the above after two days' immersion in water.

FIG. 7.—Various phases in the later motile stage assumed by the above specimens.

The nucleus is denoted by *nc.*; the cell wall by *c.w.*; and the coloring-matter by the dark spot. On the left of Fig. 7 an individual may be seen that is devoid of a cell wall.

Like *Torula* it is selected because of its simple nature, its abundance, and the ease with which it may be obtained, for it abounds in water-barrels, standing pools, drinking-troughs, etc.

Morphological.—Protococcus consists of a structureless wall and viscid granular contents, i. e., of cellulose and protoplasm.

The protoplasm may contain starch and a red or green coloring matter (*chlorophyll*). It probably contains a nucleus. The cell is mostly globular in form.

Physiological.—It reproduces by division of the original cell (*fission*) into similar individuals, and by a process of budding and constriction (*gemmation*) which is much rarer. Under the influence of sunlight it decomposes carbon dioxide (CO_2), fixing the carbon and setting the oxygen free. It can flourish perfectly in rain-water, which contains only carbon dioxide, salts of ammonium, and minute quantities of other soluble salts that may as dust have been blown into it.

There is a motile form of this unicellular plant, and in this stage it moves through the fluid in which it lives by means of extensions of its protoplasm (*cilia*) through the cell wall; or the cell wall may disappear entirely. Finally, the motile form, withdrawing its cilia and clothing itself with a cellulose coat, becomes globular and passes into a quiescent state again. Much of this part of its history is common to lowly animal forms.

Conclusions.—It will be seen that there is much in common in the life-history of *Torula* and *Protococcus*. By virtue of being living protoplasm they transform unorganized material into their own substance; and they grow and reproduce by analogous methods.

But there are sharply defined differences. For the green plant sunlight is essential, in the presence of which its chlorophyll prepares the atmosphere for animals by the removal of carbonic anhydride and the addition of oxygen, while for *Torula* neither this gas nor sunlight is essential.

Moreover, the fungus (*Torula*) demands a higher kind of food, one more nearly related to the pabulum of animals; and is absolutely independent of sunlight, if not actually injured by it; not to mention the remarkable process of fermentation.

UNICELLULAR ANIMALS.

THE PROTEUS ANIMALCULE (*Amœba*).

In order to illustrate animal life in its simpler form we choose the above-named creature, which is nearly as readily obtainable as *Protococcus* and often under the same circumstances.

Morphological.—*Amœba* is a microscopic mass of transparent protoplasm, about the size of the largest of the colorless blood-corpuses of cold-blooded animals, with a clearer, more consistent outer zone (*ectosarc*), (although without any proper cell wall), and a more fluid, granular inner part. A clear space (*contractile vesicle, vacuole*) makes its appearance at intervals in the *ectosarc*, which may disappear somewhat suddenly. This appearance and vanishing have suggested the term pulsating or contracting vesicle. Both a nucleus and nucleolus may be seen in *Amœba*. At varying short periods certain parts of its body (*pseudopodia*) are thrust out and others withdrawn.

Physiological.—*Amœba* can not live on such food as proves adequate for either *Protococcus* or *Torula*, but requires, besides inorganic and unorganized food, also organized matter in the form of a complex organic compound known as *protein*, which contains nitrogen in addition to carbon, hydrogen, and oxygen. In fact, *Amœba* can prey upon both plants and animals, and thus use up as food protoplasm itself. The *pseudopodia* serve the double purpose of organs of locomotion and prehension.

This creature absorbs oxygen and evolves carbon dioxide. Inasmuch as any part of the body may serve for the admission, and possibly the digestion, of food and the ejection of the useless remains, we are not able to define the functions of special parts. *Amœba* exercises, however, some degree of choice as to what it accepts or rejects.

The movements of the *pseudopodia* cease when the temperature of the surrounding medium is raised or lowered beyond a certain point. It can, however, survive in a quiescent form greater depression than elevation of the temperature. Thus, at 35° C., heat-rigor is induced; at 40° to 45° C., death results; but though all movement is arrested at the freezing-point of water, recovery ensues if the temperature be gradually raised. Its form is modified by electric shocks and chemical agents, as well as by variations in the temperature. At the present time it is not possible to define accurately the functions

of the vacuoles found in any of the organisms thus far considered. It is worthy of note that *Amœba* may spontaneously assume a spherical form, secrete a structureless covering, and



FIG. 8.

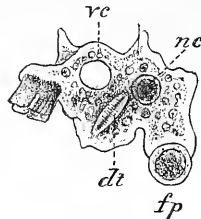

FIG. 9.



FIG. 10.

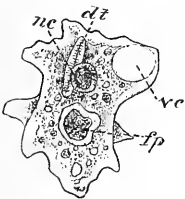

FIG. 11.

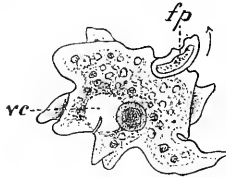

FIG. 12.



FIG. 13.

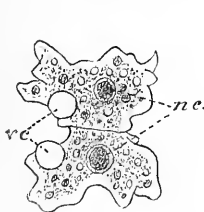

FIG. 14.

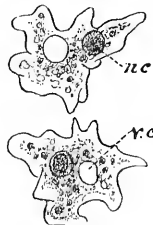

FIG. 15.

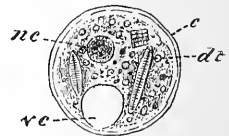

FIG. 16.

FIGS. 8 to 15, represent successive phases in the life-history of an *Amœboid* organism kept under constant observation for three days; Fig. 16 a similar organism encysted, which was a few hours later set free by the disintegration of the cyst. (All the figures are drawn under Zeiss, D. 3.)

FIG. 8.—The locomotor phase; the ectoplasm is seen protruding to form a pseudopodium, into which the endoplasm passes.

FIG. 9.—A stage in the ingestive phase. A vegetable organism, *fp*, is undergoing intussusception.

FIG. 10.—A portion of the creature represented in Fig. 9, after complete ingestion of the food-particle.

FIG. 11, 12.—Successive stages in the assimilative and excretory processes. Fig. 12 represents the organism some twenty hours later than as seen in Fig. 11. The undigested remnants of the ingested organism are represented undergoing ejection (excretion) at *fp*, in Fig. 12.

FIGS. 13, 14, 15, represent successive stages in the reproductive process of the same individual, observed two days later. It will be noticed (Fig. 13) that the nucleus divides first.

In the above figures, *vc*, denotes the contracting vacuole; *nc*, the nucleus; *ps*, pseudopodium; *dt*, diatom; *fp*, food-particle.

remain in this condition for a variable period, reminding us of the similar behavior of *Torula*.

Amœba reproduces by fission, in which the nucleus takes a prominent if not a directive part, as seems likely in regard to all the functions of unicellular organisms.

Conclusions.—It is evident that Amœba is, in much of its behavior, closely related to both colored and colorless one-celled plants. All of the three classes of organisms are composed of protoplasm ; each can construct protoplasm out of that which is very different from it ; each builds up the inanimate inorganic world into itself by virtue of that force which we call vital, but which in its essence we do not understand ; each multiplies by division of itself, and all can only live, move, and have their being under certain definite limitations. But even among forms of life so lowly as those we have been considering, the differences between the animal and vegetable worlds appear. Thus, Amœba never has a cellulose wall, and can not subsist on inorganic food alone. The cellulose wall is not, however, invariably present in plants, though this is generally the case ; and there are animals (Ascidians) with a cellulose investment. Such are very exceptional cases. But the law that animals must have organized material (*protein*) as food is without exception, and forms a broad line of distinction between the animal and vegetable kingdoms.

Amœba will receive further consideration later ; in the mean time, we turn to the study of forms of life in many respects intermediate between plants and animals, and full of practical interest for mankind, on account of their relations to disease, as revealed by recent investigations.

PARASITIC ORGANISMS.

THE FUNGI.

MOLDS (*Penicillium glaucum* and *Mucor mucedo*).

Closely related to *Torula* physiologically, but of more complex structure, are the molds, of which we select for convenient study the common green mold (*Penicillium*), found growing in dark and moist places on bread and similar substances, and the white mold (*Mucor*), which grows readily on manure.

The fungi originate in *spores*, which are essentially like *Torula* in structure, by a process of budding and longitudinal extension, resulting in the formation of transparent branches

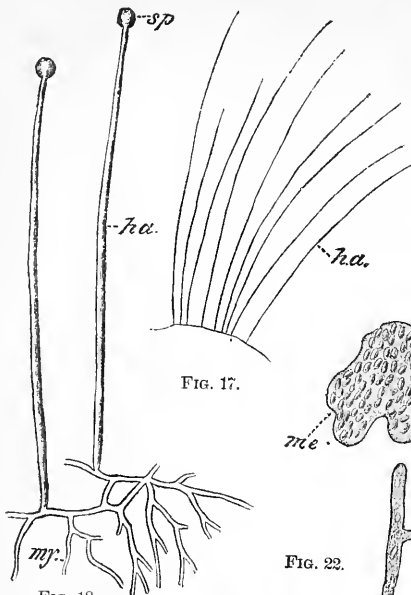

FIG. 17.

FIG. 18.



FIG. 19.

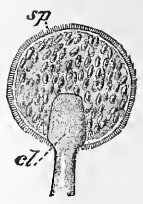

FIG. 20.

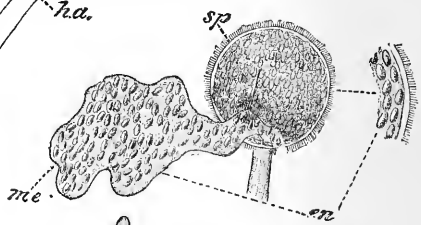

FIG. 21.

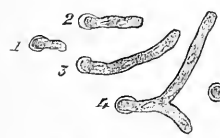

FIG. 22.

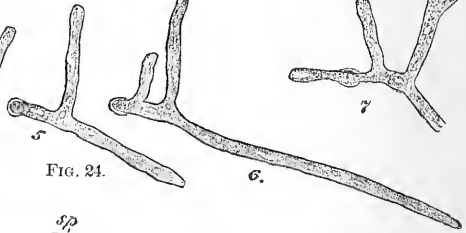

FIG. 23.

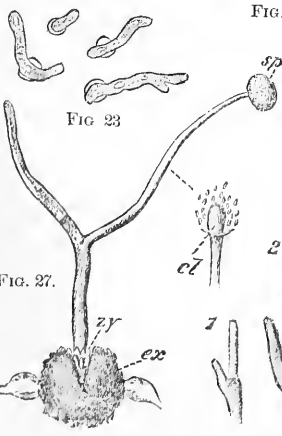

FIG. 24.



FIG. 25.



FIG. 26.

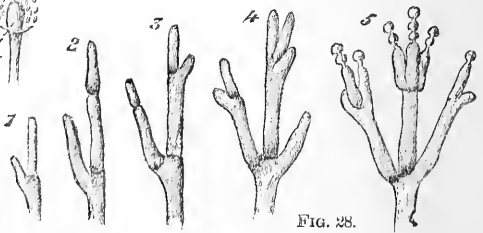

FIG. 27.

FIG. 28.

FIGS. 17 to 28.—In the following figures, *ha*, denotes aerial hyphæ; *sp*, sporangium; *zy*, syngospore; *ex*, exosporium; *my*, mycelium; *mc*, mucilage; *cl*, columella; *en*, endogonia.

FIG. 17.—Spore-bearing hyphæ of *Mucor*, growing from horse-dung.

FIG. 18.—The same, teased out with needles (A, 4).

FIGS. 19, 20, 21.—Successive stages in the development of the sporangium.

FIG. 22.—Isolated spores of *Mucor*.

FIG. 23.—Germinating spores of the same mold.

FIG. 24.—Successive stages in the germination of a single spore.

FIGS. 25, 26, 27.—Successive phases in the conjugative process of *Mucor*.

FIG. 28.—Successive stages observed during ten hours in the growth of a conidiophore of *Penicillium* in an object-glass culture (D, 4).

or tubules, filled with protoplasm and invested by cellulose walls, across which transverse partitions are found at regular intervals, and in which vacuoles are also visible.

The spores, when growing thus in a liquid, gives rise to upward branches (*aërial hyphæ*), and downward branches or rootlets (*submerged hyphæ*). These multitudinous branches interlace in every direction, forming an intricate felt-work, which supports the green powder (spores) which may be so easily shaken off from a growing mold. In certain cases the aerial hyphæ terminate in tufts of branches, which, by transverse division, become split up into spores (*Conidia*), each of which is similar in structure to a yeast-cell.

The green coloring matter of the fungi is not chlorophyl. The *Conidia* germinate under the same conditions as *Torula*.

***Mucor mucedo*.**—The growth and development of this mold may be studied by simply inverting a glass tumbler over some horse-dung on a saucer, into which a very little water has been poured, and keeping the preparation in a warm place.

Very soon whitish filaments, gradually getting stronger, appear, and are finally topped by rounded heads or spore-cases (*Sporangia*). These filaments are the *hyphæ*, similar in structure to those of *Penicillium*. The spore-case is filled with a multitude of oval bodies (*spores*), resulting from the subdivision of the protoplasm, which are finally released by the spore-case becoming thinned to the point of rupture. The development of these spores take place in substantially the same manner as those of *Penicillium*. Sporangia developing spores in this fashion by division of the protoplasm are termed *asci*, and the spores *ascospores*.

So long as nourishment is abundant and the medium of growth fluid, this *asexual* method of reproduction is the only one; but, under other circumstances, a mode of increase, known as *conjugation*, arises. Two adjacent hyphæ enlarge at the extremities into somewhat globular heads, bend over toward each

other, and, meeting, their opposed faces become thinned, and the contents intermingle. The result of this union (*zygospore*) undergoes now certain further changes, the cellulose coat being separated into two—an outer, darker in color (*exosporium*), and an inner colorless one (*endosporium*).

Under favoring circumstances these coats burst, and a branch sprouts forth from which a vertical tube arises that terminates in a sporangium, in which spores arise, as before described. It will be apparent that we have in *Mucor* the exemplification of what is known in biology as "*alternation of generations*"—that is, there is an intermediate generation between the original form and that in which the original is again reached.

Physiologically the molds closely resemble yeast, some of them, as *Mucor*, being capable of exciting a fermentation.

The fungi are of special interest to the medical student, because many forms of cutaneous disease are directly associated with their growth in the epithelium of the skin, as, for example, common ringworm; and their great vitality, and the facility with which their spores are widely dispersed, explain the highly contagious nature of such diseases. The media on which they flourish (feed) indicates their great physiological differences in this particular from the green plants proper. They are closely related in not a few respects to an important class of vegetable organisms, known as bacteria, to be considered forthwith.

THE BACTERIA.

The *bacteria* include numberless varieties of organisms of extreme minuteness, many of them visible only by the help of the most powerful lenses. Their size has been estimated at from $\frac{1}{30000}$ to $\frac{1}{10000}$ of an inch in diameter.

They grow mostly in the longitudinal direction, and reproduce by transverse division, forming spores from which new generations arise.

Some of them have vibratile cilia, while the cause of the movements of others is quite unknown.

As in many other lowly forms of life, there is a quiescent as well as an active stage. In this stage (*zoöglæa form*) they are surrounded by a gelatinous matter, probably secreted by themselves.

Bacteria grow and reproduce in Pasteur's solution, rendering it opaque, as well as in almost all fluids that abound in proteid

matter. That such fluids readily putrefy is owing to the presence of bacteria, the vital action of which suffices to break asun-

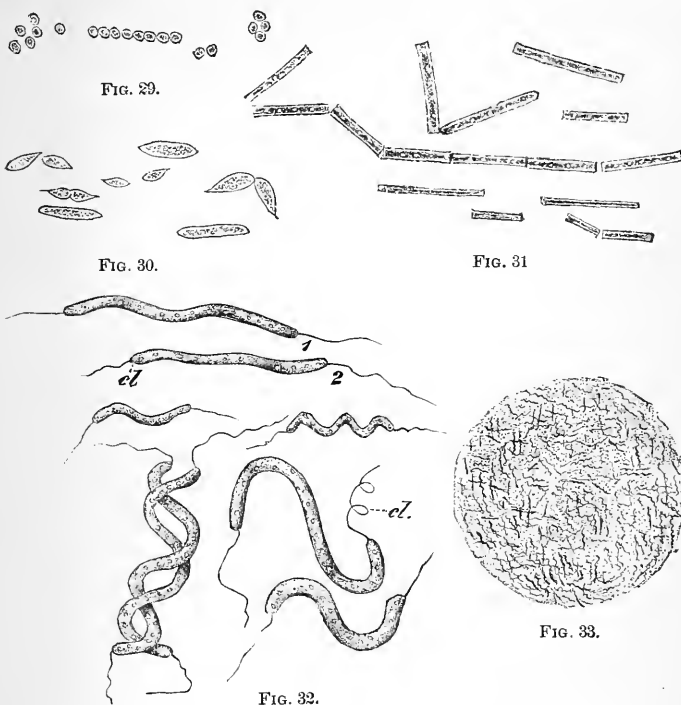

FIG. 29.—Micrococcus, very like a spore, but usually much smaller.

FIG. 30.—Baeterium.

FIG. 31.—Bacillus. The central filament presented this segmented appearance as the result of a process of transverse division occurring during ten minutes' observation.

FIG. 32.—Spirillum; various forms. The first two represent vibrio, which is possibly only a stage of spirillum.

FIG. 33.—A drop of the surface scum, showing a spirillum aggregate in the resting state.

der complex chemical compounds and produce new ones. Some of the bacteria require oxygen, as *Bacillus anthracis*, while others do not, as the organism of putrefaction, *Bacterium termo*.

Bacteria are not so sensitive to slight variations in temperature as most other organisms. They can, many of them, withstand freezing and high temperatures. All bacteria and all germs of bacteria are killed by boiling water, though the spores

are much more resistant than the mature organisms themselves. Some spores can resist a dry heat of 140° C.

The spores, like *Torula* and *Protococcus*, bear drying, without loss of vitality, for considerable periods.

That different groups of bacteria have a somewhat different life-history is evident from the fact that the presence of one checks the other in the same fluid, and that successive swarms of different kinds may flourish where others have ceased to live.

That these organisms are enemies of the constituent cells of the tissues of the highest mammals has now been abundantly demonstrated. That they interfere with the normal working of the organism in a great variety of ways is also clear; and certain it is that the harm they do leads to aberration in cell-life, however that may be manifested. They rob the tissues of their nutriment and oxygen, and poison them by the products of the decompositions they produce. But apart from this, their very presence as foreign agents must hamper and derange the delicate mechanism of cell-life.

These organisms seem to people the air, land, and waters with invisible hosts far more numerous than the forms of life we behold. Fortunately, they are not all dangerous to the higher forms of mammalian life; but that a large proportion of the diseases which afflict both man and the domestic animals are directly caused by the presence of such forms of life, in the sense of being invariably associated with them, is now beyond doubt.

The facts stated above explain why that should be so; why certain maladies should be infectious; how the germs of disease may be transported to a friend wrapped up in the folds of a letter.

Disease thus caused, it must not be forgotten, is an illustration of the struggle for existence and the survival of the fittest. If the cells of an organism are mightier than the bacteria, the latter are overwhelmed; but if the bacteria are too great in numbers or more vigorous, the cells must yield; the battle may waver—now dangerous disease, now improvement—but in the end the strongest in this, as in other instances, prevail.

UNICELLULAR ANIMALS WITH DIFFERENTIATION OF STRUCTURE.

THE BELL-ANIMALCULE (*Vorticella*).

Amœba is an example of a one-celled animal with little perceptible differentiation of structure or corresponding division of physiological labor. This is not, however, the case with all unicellular animals, and we proceed to study one of these with considerable development of both. The Bell-animalcule is found in both fresh and salt water, either single or in groups. It is anchored to some object by a rope-like stalk of clear protoplasm, that has a spiral appearance when contracted; and which, with a certain degree of regularity, shortens and lengthens alternately, suggesting that more definite movement (contraction) of the form of protoplasm known as *muscle*, to be studied later.

The body of the creature is bell-shaped, hence its name; the bell being provided with a thick everted lip (*peristome*), covered with bristle-like extensions of the protoplasm (*cilia*), which are in almost constant rhythmical motion. Covering the mouth of the bell is a lid, attached by a hinge of protoplasm to the body, which may be raised or lowered. A wide, funnel-like depression (*oesophagus*) leads into the softer substance within which it ends blindly. The outer part of the animal (*cuticula*) is denser and more transparent than any other part of the whole creature; next to this is a portion more granular and of intermediate transparency between the external and innermost portions (*cortical layer*). Below the disk is a space (*contractile vesicle*) filled with a thin, clear fluid, which may be seen to enlarge slowly, and then to collapse suddenly. When the *Vorticella* is feeding, these vesicles may contain food-particles, and in the former, apparently, digestion goes on. Such food vacuoles (*vesicles*) may circulate up one side of the body of the animal and down the other. Their exact significance is not known, but it would appear as if digestion went on within them; and possibly the clear fluid with which they are filled may be a special secretion with solvent action on food.

Situated somewhat centrally is a horseshoe-shaped body, with well-defined edges, which stains more readily than the rest of the cell, indicating a different chemical composition; and, from the prominent part it takes in the reproductive and other functions of the creature, it may be considered the nucleus (*endoplast*).

Multiplication of the species is either by *gemmation* or by *fission*. In the first case the nucleus divides and the frag-

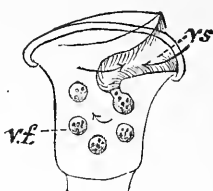
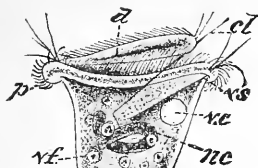

FIG. 36.



FIG. 37.



FIG. 34.



FIG. 38.



FIG. 39.



FIG. 40.

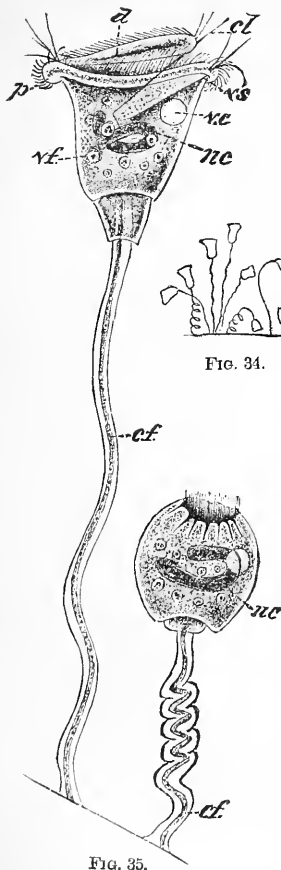

FIG. 35.

FIGS. 34 to 40.—In the figures *d* denotes disk; *p*, peristome; *vc*, contractile vacuole; *vf*, food-vacuole; *vs*, vestibule; *cf*, contractile fiber; *c*, cyst; *nc*, nucleus; *cl*, cilium.

FIG. 34.—A group of vorticellae showing the creature in various positions (A, 3).

FIG. 35.—The same, in the extended and in the retracted state. (Surface views.)

FIG. 36.—Shows food-vacuoles; one in the act of ingestion.

FIG. 37.—A vorticella, in which the process of multiplication by fission is begun.

FIG. 38.—The results of fission; the production of two individuals of unequal size.

FIG. 39.—Illustration of reproduction by conjugation.

FIG. 40.—An encysted vorticella.

ments are transformed into locomotive germs; in the latter the entire animal, including the nucleus, divides longitudinally, each half becoming a similar complete, independent organism. Still another method of reproduction is known. A more or less globular body encircled with a ring of cilia and of relatively small size may sometimes be seen attached to the usual form of Vorticella, with which it finally becomes blended into one mass. This seems to foreshadow the "sexual

conjugation " of higher forms, and is of great biological significance.

Vorticella may pass into an encysted and quiescent stage for an indefinite period and again become active. The history of the Bell-animalcule is substantially that of a vast variety of one-celled organisms known as *Infusoria*, to which Amœba itself belongs. It will be observed that the resemblance of this organism to Amœba is very great; it is, however, introduced here to illustrate an advance in differentiation of structure; and to show how, with the latter, there is usually a physiological advance also, since there is additional functional progress or division of labor; but still the whole of the work is done within one cell. Amœba and Vorticella are both factories in which all of the work is done in one room, but in the latter case the machinery is more complex than in the former; there are correspondingly more processes, and each is performed with greater perfection. Thus, food in the case of the Bell-animalcule is swept into the gullet by the currents set up by the multitudes of vibrating arms around this opening and its immediate neighborhood; the contractile vesicles play a more prominent part; and the waste of undigested food is ejected at a more definite portion of the body, the floor of the œsophagus; while all the movements of the animal are rhythmical to a degree not exemplified in such simple forms as Amœba; not to mention its various resources for multiplication and, therefore, for its perpetuation and permanence as a species. It, too, like all the unicellular organisms we have been considering, is susceptible of very wide distribution, being capable of retaining vitality in the dried state, so that these infusoria may be carried in various directions by winds in the form of microscopic dust.

MULTICELLULAR ORGANISMS.

THE FRESH-WATER POLYPS (*Hydra viridis*; *Hydra fusca*).

The comparison of an animal so simple in structure, though made up of many cells, as the Polyp, with the more complex organizations with which we shall have especially to deal, may be fitly undertaken at this stage. The Polyyps are easily obtainable from ponds in which they are found attached to various kinds of weeds. To the naked eye, they resemble translucent masses of jelly with a greenish or reddish tinge. They range in size from one quarter to one half an inch; are of an elongated

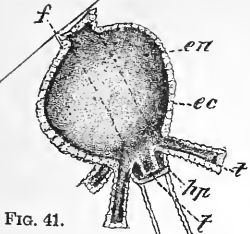

FIG. 41.

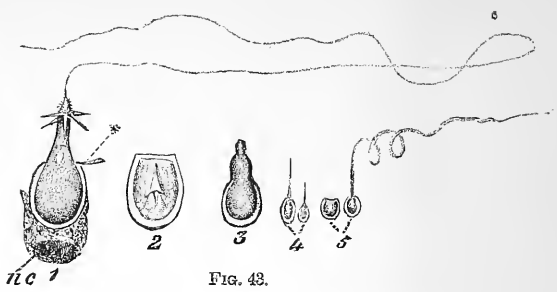

FIG. 43.

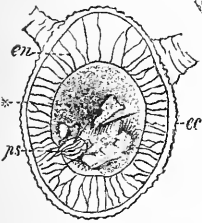

FIG. 42.

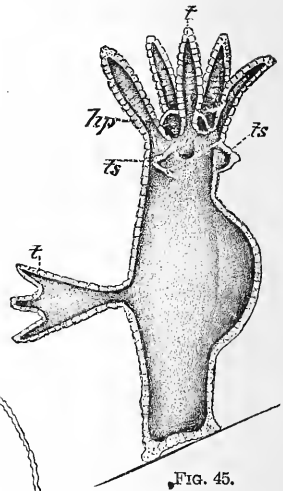

FIG. 45.

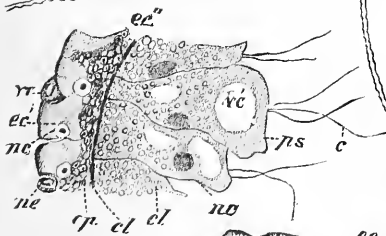

FIG. 44.

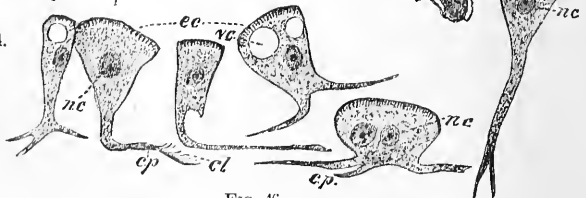

FIG. 46.

FIGS. 41 to 46.—In the figures *ec* denotes ectoderm; *en*, endoderm; *t*, tentacle; *hp*, hypostome; *f*, foot; *ts*, testes; *ov*, ovary; *ps*, pseudopodium; *ec'*, larger ectoderm cells; *nc'*, larger nematocysts before rupture; *cp*, Kleinenberg's fibers; *cl*, supporting lamella; *cl*, chlorophyll-forming bodies; *c*, cilium.

FIG. 41.—The green hydra, at the maximum of contraction and elongation of its body. The creature is represented in the act of seizing a small crustacean (A, 2).

FIG. 42.—Transverse section across the body of a hydra, in the digestive cavity of which a small crustacean is represented.

FIG. 43.—The leading types of thread-cells, after liberation from the body (F, 3). The cells are represented in the active and the resting conditions; in the former all the parts are more distinctly seen in consequence of the necessary eversion.

FIG. 44.—Small portion of a transverse section across the body of a green hydra (D, 3).

FIG. 45.—A large brown hydra bearing at the same time buds produced asexually and sexual organs.

FIG. 46.—Larger cells of the ectoderm isolated. Note the processes of the cells or Kleinenberg's fibers (F, 3).

All the cuts on pages 9 to 24 have been selected from Howes' Atlas of Biology.

cylindrical form; provided at the oral extremity with thread-like tenacles of considerable length, which are slowly moved about in all directions; but they and the entire body may shorten rapidly into a globular mass. They are usually attached at the opposite (aboral) pole to some object, but may float free, or slowly crawl from place to place. It may be observed, under the microscope, that the tenacles now and then embrace some living object, convey it toward an opening (mouth) near their base, from which, from time to time, refuse material is cast out. It may be noticed, too, that a living object within the touch of these tenacles soon loses the power to struggle, which is owing to the peculiar cells (*nettle-cells*, *urticating capsules*, *nematocysts*) with which they are abundantly provided, and which secrete a poisonous fluid that paralyzes prey.

The mouth leads into a simple cavity (*cœlom*) in which digestion proceeds. The green color in *Hydra viridis*, and the red color of *Hydra fusca*, is owing to the presence of *chlorophyll*, the function of which is not known. *Hydra* is structurally a sac, made up of two layers of cells, an outer (*ectoderm*) and an inner (*endoderm*); the tentacles being repetitions of the structure of the main body of the animal, and so hollow and composed of two cell layers. Speaking generally, the outer layer is devoted to obtaining information of the surroundings; the inner to the work of preparing nutriment, and probably, also, discharging waste matters, in which latter assistance is also received from the outer layer. As digestion takes place largely within the cells themselves, or is intracellular, we are reminded of *Vorticella* and still more of *Amœba*. There is in *Hydra* a general advance in development, but not very much individual cell specialization. That of the urticating capsules is one of the best examples of such specialization in this creature.

A Polyp is like a colony of Amœbæ in which some division of labor (function) has taken place ; a sort of biological state in which every individual is nearly equal to his neighbor, but somewhat more advanced than those neighbors not members of the organization.

But in one respect the Polyps show an enormous advance. Ordinarily when nourishment is abundant Hydra multiplies by budding, and when cut into portions each may become a complete individual. However, under other circumstances, near the bases of the tentacles the body wall may protrude into little masses (*tes es*), in which cells of peculiar formation (*spermatozoa*) arise, and are eventually set free and unite with a cell (*ovum*) formed in a similar protrusion of larger size (*ovary*). Here, then, is the first instance in which distinctly sexual reproduction has been met in our studies of the lower forms of life. This is substantially the same process in Hydra as in mammals. But, as both male and female cells are produced by the same individual, the sexes are united (*hermaphroditism*) ; each is at once male and female.

Any one watching the movements of a Polyp, and comparing it with those of a Bell-animalcule, will observe that the former are much less machine-like ; have greater range ; seem to be the result of a more deliberate choice ; are better adapted to the environment, and calculated to achieve higher ends. In the absence of a nervous system it is not easy to explain how one part moves in harmony with another, except by that process which seems to be of such wide application in nature, adaptation from habitual simultaneous effects on a protoplasm capable of responding to stimuli. When one process of an Amœba is touched, it is likely to withdraw all. This we take to be due to influences radiating through molecular movement to other parts ; the same principle of action may be extended to Hydra. The oftener any molecular movement is repeated, the more it tends to become organized into regularity, to become fixed in its mode of action ; and if we are not mistaken this is a fundamental law throughout the entire world of living things, if not of all things animate and inanimate alike. To this law we shall return.

But Hydra is a creature of but very limited specializations ; there are neither organs of circulation, respiration, nor excretion, if we exclude the doubtful case of the thread-cells (*urticating capsules*). The animal breathes by the entire surface of the

body ; nourishment passes from cell to cell, and waste is discharged into the water surrounding the creature from all cells, though probably not quite equally. All parts are not digestive, respiratory, etc., to the same degree, and herein does it differ greatly from *Amœba* or even *Vorticella*, though fuller knowledge will likely modify our views of the latter two and similar organisms in this regard.

THE CELL RECONSIDERED.

Having now studied certain one-celled plants and animals, and some very simple combinations of cells (molds, etc.), it will be profitable to endeavor to generalize the lessons these humble organisms convey ; for, as will be constantly seen in the study of the higher forms of life of which this work proposes to treat principally, the same laws operate as in the lowliest living creatures. The most complex organism is made up of tissues, which are but cells and their products, as houses are made of bricks, mortar, wood, and a few other materials, however large or elaborate.

The student of physiology who proceeds scientifically must endeavor, in investigating the functions of each organ, to learn the exact behavior of each cell as determined by its own inherent tendencies, and modified by the action of neighboring cells. The reason why the function of one organ differs from that of another is that its cells have departed in a special direction from those properties common to all cells, or have become functionally *differentiated*. But such a statement has no meaning unless it be well understood that cells have certain properties in common. This is one of the lessons imparted by the preceding studies which we now review. Briefly stated in language now extensively used in works on biology, the common properties of cells (protoplasm), whether animal or vegetable, whether constituting in themselves entire animals or plants, or forming the elements of tissues, are these : The collective chemical processes associated with the vital activities of cells are termed its *metabolism*. Metabolism is *constructive* when more complex compounds are formed from simple ones, as when the *Protococcus*-cell builds up its protoplasm out of the simple materials, found in rain-water, which makes up its food. Metabolism is *destructive* when the reverse process takes place. The results of this process are eliminated as *excreta*, or useless and harmful products.

Since all the vital activities of cells can only be manifested when supplied with food, it follows that living organisms convert *potential* or possible energy into *kinetic* or actual energy. When lifeless, immobile matter is taken in as food and, as a result, is converted by a process of *assimilation* into the protoplasm of the cell using it, we have an example of potential being converted into actual energy, for one of the properties of all protoplasm is its *contractility*. Assimilation implies, of course, the absorption of what is to be used, with rejection of waste matters.

The movements of protoplasm of whatever kind, when due to a stimulus, are said to indicate *irritability*; while, if independent of any external source of excitation, they are denominated *automatic*.

Among agents that modify the action of all kinds of protoplasm are heat, moisture, electricity, light, and others in great variety, both chemical and mechanical. It can not be too well remembered that living things are what they are, neither by virtue of their own organization alone nor through the action of their environment alone (else would they be in no sense different from inanimate things), but because of the relation of the organization to the surroundings.

Protoplasm, then, is *contractile*, *irritable*, *automatic*, *absorptive*, *secretory* (and *excretory*), *metabolic*, and *reproductive*.

But when it is affirmed that these are the fundamental properties of all protoplasm, the idea is not to be conveyed that cells exhibiting these properties are identical biologically. No two masses of protoplasm can be quite alike, else would there be no distinction in physiological demeanor—no individuality. Every cell, could we but behold its inner molecular mechanism, differs from its neighbor. When this difference reaches a certain degree in one direction, we have a manifest differentiation leading to physiological division of labor, which may now with advantage be treated in the following section.

THE ANIMAL BODY.

An animal, as we have learned, may be made up of a single cell in which each part performs much the same work; or, if there be differences in function, they are ill-defined as compared with those of higher animals. The condition of things in such an animal as *Amœba* may be compared to a civilized community in a very crude social condition. When each individual

tries to perform every office for himself, he is at once carpenter, blacksmith, shoemaker, and much more, with the natural result that he is not efficient in any one direction. A community may be judged in regard to its degree of advancement by the amount of division of labor existing within it. Thus is it with the animal body. We find in such a creature as the fresh-water Hydra, consisting of two layers of cells forming a simple sac, a slight amount of advancement on Amœba. Its external surface no longer serves for inclosure of food, but it has the simplest form of mouth and tentacles. Each of the cells of the internal layer seems to act as a somewhat improved or specialized Amœba, while in those of the outer layer we mark a beginning of those functions which taken collectively give the higher animals information of the surrounding world.

Looking to the existing state of things in the universe, it is plain that an animal to attain to high ends must have powers of rapid locomotion, capacity to perceive what makes for its interest, and ability to utilize means to obtain this when perceived. These considerations demand that an animal high in the scale of being should be provided with limbs sufficiently rigid to support its weight, moved by strong muscles, which must act in harmony. But this implies abundance of nutriment duly prepared and regularly conveyed to the bones and muscles. All this would be useless unless there was a controlling and energizing system capable both of being impressed and originating impressions. Such is found in the nerves and nerve-centers. Again, in order that this mechanism be kept in good running order, the waste of its own metabolism, which chokes and poisons, must be got rid of—hence the need of excretory apparatus. In order that the nervous system may get sufficient information of the world around, the surface of the body must be provided with special message-receiving offices in the form of modified nerve-endings. In short, it is seen that an animal as high in the scale as a mammal must have muscular, osseous (and connective), digestive, circulatory, excretory, and nervous tissues; and to these may be added certain forms of protective tissues, as hair, nails, etc.

Assuming that the student has at least some general knowledge of the structure of these various tissues, we propose to tell in a simple way the whole physiological story in brief.

The blood is the source of all the nourishment of the organism, including its oxygen supply, and is carried to every part of

the body through elastic tubes which, continually branching and becoming gradually smaller, terminate in vessels of hair-like fineness in which the current is very slow—a condition permitting that interchange between the cells surrounding them and the blood which may be compared to a process of barter, the cells taking nutriment and oxygen, and giving (excreting) in return carbonic anhydride. From these minute vessels the blood is conveyed back toward the source whence it came by similar elastic tubes which gradually increase in size and become fewer. The force which directly propels the blood in its onward course is a muscular pump, with both a forcing and suction action, though chiefly the former. The flow of blood is maintained constant owing to the resistance in the smaller tubes on the one hand and the elastic recoil of the larger tubes on the other; while in the returning vessels the column of blood is supported by elastic double gates which so close as to prevent reflux. The oxygen of the blood is carried in disks of microscopic size which give it up in proportion to the needs of the tissues past which they are carried.

But in reality the tissues of the body are not nourished directly by the blood, but by a fluid derived from it and resembling it greatly in most particulars. This fluid bathes the tissue-cells on all sides. It also is taken up by tubes that convey it into the blood after it has passed through little factories (lymphatic glands), in which it undergoes a regeneration. Since the tissues are impoverishing the blood by withdrawal of its constituents, and adding to it what is no longer useful, and is in reality poisonous, it becomes necessary that new material be added to it and the injurious components withdrawn. The former is accomplished by the absorption of the products of food digestion, and the addition of a fresh supply of oxygen derived from without, while the poisonous ingredients that have found their way into the blood are got rid of through processes that may be, in general, compared to those of a sewage system of a very elaborate character. To explain this regeneration of the blood in somewhat more detail, we must first consider the fate of food from the time it enters the mouth till it leaves the tract of the body in which its preparation is carried on.

The food is in the mouth submitted to the action of a series of cutting and grinding organs worked by powerful muscles; mixed with a fluid which changes the starchy part of it into

sugar, and prepares the whole to pass further on its course : when this has been accomplished, the food is grasped and squeezed and pushed along the tube, owing to the action of its own muscular cells, into a sac (stomach), in which it is rolled about and mixed with certain fluids of peculiar chemical composition derived from cells on its inner surface, which transform the proteid part of the food into a form susceptible of ready use (absorption). When this saccular organ has done its share of the work, the food is moved on by the action of the muscles of its walls into a very long portion of the tract in which, in addition to processes carried on in the mouth and stomach, there are others which transform the food into a condition in which it can pass into the blood. Thus, all of the food that is susceptible of changes of the kind described is acted upon somewhere in the long tract devoted to this task. But there is usually a remnant of indigestible material which is finally evacuated. How is the prepared material conveyed into the blood ? In part, directly through the walls of the minutest blood-vessels distributed throughout the length of this tube ; and in part through special vessels with appropriate cells covering them which act as minute porters (*villi*).

The impure blood is carried periodically to an extensive surface, usually much folded, and there exposed in the hair-like tubes referred to before, and thus parts with its excess of carbon dioxide and takes up fresh oxygen. But all the functions described do not go on in a fixed and invariable manner, but are modified somewhat according to circumstances. The forcing-pump of the circulatory system does not always beat equally fast ; the smaller blood-vessels are not always of the same size, but admit more or less blood to an organ according to its needs.

This is all accomplished in obedience to the commands carried from the brain and spinal cord along the nerves. All movements of the limbs and other parts are executed in obedience to its behests ; and in order that these may be in accordance with the best interests of each particular organ and the whole animal, the nervous centers, which may be compared to the chief officers of, say, a telegraph or railway system, are in constant receipt of information by messages carried onward along the nerves. The command issuing is always related to the information arriving.

All those parts commonly known as sense-organs—the eye,

ear, nose, tongue, and the entire surface of the body—are faithful reporters of facts. They put the inner and outer worlds in communication, and without them all higher life at least must cease, for the organism, like a train directed by a conductor that disregards the danger-signals, must work its own destruction. Without going into further details, suffice it to say that the processes of the various cells are subordinated to the general good through the nervous system, and that susceptibility of protoplasm to stimuli of a delicate kind which enables each cell to adapt to its surroundings, including the influence of remote as well as neighboring cells. Without this there could be no marked advance in organisms, no differentiation of a pronounced character, and so none of that physiological division of labor which will be inferred from our brief description of the functions of a mammal. The whole of physiology but illustrates this division of labor.

It is hoped that the above account of the working of the animal body, brief as it is, may serve to show the connection of one part functionally with another, for it is much more important that this should be kept in mind throughout, than that all the details of any one function should be known.

LIVING AND LIFELESS MATTER.

In order to enable the student the better to realize the nature of living matter or protoplasm, and to render clearer the distinction between the forms that belong to the organic and inorganic worlds respectively, we shall make some comparisons in detail which it is hoped may accomplish this object.

A modern watch that keeps correct time must be regarded as a wonderful object, a marvelous triumph of human skill. That it has aroused the awe of savages, and been mistaken for a living being, is not surprising. But, admirable as is the result attained by the mechanism of a watch, it is, after all, composed of but a few metals, etc., chiefly in fact of two, brass and steel; these are, however, made up into a great number of different parts, so adapted to one another as to work in unison and accomplish the desired object of indicating the time of day.

Now, however well constructed the watch may be, there are waste, wear and tear, which will manifest themselves more and more, until finally the machine becomes worthless for the purpose of its construction. If this mechanism possessed the power

of adapting from without foreign matter so as to construct it into steel and brass, and arrange this just when required, it would imitate a living organism ; but this it can not do, nor is its waste chemically different from its component metals ; it does not break up brass and steel into something wholly different. In one particular it does closely resemble living things, in that it gradually deteriorates ; but the degradation of a living cell is the consequence of an actual change in its component parts, commonly a fatty degeneration. The one is a real transformation, the other mere wear.

Had the watch the power to give rise to a new one like itself by any process, especially a process of division of itself into two parts, we should have a parallel with living forms ; but the watch can not even renew its own parts, much less give rise to a second mechanism like itself. Here, then, is a manifest distinction between living and inanimate things.

Suppose, further, that the watch was so constructed that, after the lapse of a certain time, it underwent a change in its inner machinery and perhaps its outer form, so as to be scarcely recognizable as the same ; and that as a result, instead of indicating the hours and minutes of a time-reckoning adapted to the inhabitants of our globe, it indicated time in a wholly different way ; that after a series of such transformations it fell to pieces—took the original form of the metals from which it was constructed—we should then have in this succession of events a parallel with the development, decline, and death of living organisms.

In another particular our illustration of a watch may serve a useful purpose. Suppose a watch to exist, the works of which are so concealed as to be quite inaccessible to our vision, so that all we know of it is that it has a mechanism which when in action we can hear, and the result of which we perceive in the movements of the hands on the face ; we should then be in the exact position in reference to the watch that we now are as regards the molecular movements of protoplasm. On the latter the entire behavior of living matter depends ; yet it is absolutely hidden from us.

We know, too, that variations must be produced in the mechanism of time-pieces by temperature, moisture, and other influences of the environment, resulting in altered action. The same, as will be shown in later chapters, occurs in protoplasm. This, too, is primarily a molecular effect. If the works of

watches were beyond observation, we should not be able to state exactly how the variations observed in different kinds, or even different individuals of the same kind occurred, though these differences might be of the most marked character, such as any one could recognize. Here once more we refer the differences to the mechanism. So is it with living beings : the ultimate molecular mechanism is unknown to us.

Could we but render these molecular movements visible to our eyes, we should have a revelation of far greater scientific importance than that unfolded by the recent researches into those living forms of extreme minuteness that swarm everywhere as dust in a sunbeam, and, as will be learned later, are often the source of deadly disease. Like the movements of the watch, the activities of protoplasm are ceaseless. A watch that will not run is, as such, worthless—it is mere metal—has undergone an immense degradation in the scale of values ; so protoplasm is no longer protoplasm when its peculiar molecular movements cease ; it is at once degraded to the rank of dead matter.

The student may observe that each of the four propositions, embodying the fundamental properties of living matter, stated in the preceding chapter, have been illustrated by the simile of a watch. Such an illustration is necessarily crude, but it helps one to realize the meaning of truths which gather force with each living form studied if regarded aright ; and it is upon the *realization* of truth that mental growth as well as practical efficiency depends.

CLASSIFICATION OF THE ANIMAL KINGDOM.

There are human beings so low in the scale as not to possess such general terms as tree, while they do employ names for different kinds of trees. The use of such a word as "tree" implies generalization, or the abstraction of a set of qualities from the things in which they reside, and making them the basis for the grouping of a multitude of objects by which we are surrounded. Manifestly without such a process knowledge must be very limited, and the world without significance ; while in proportion as generalization may be safely widened, is our progress in the *unification* of knowledge toward which science is tending. But it also follows that without complete knowledge there can be no perfect classification of objects ; hence,

any classification must be regarded but as the temporary creed of science, to be modified with the extension of knowledge. As a matter of fact this has been the history of all zoological and other systems of arrangement. The only purpose of grouping is to simplify and extend knowledge; this being the case, it follows that a method of grouping that accomplishes this has value, though the system may be *artificial* that is based on resemblances which, though real and constant, are associated with differences so numerous and radical that the total amount of likeness between objects thus grouped is often less than the difference. Such a system was that of Linnæus, who classified plants according to the number of stamens, etc., they bore.

Seeing that animals which resemble each other are of common descent from some earlier form, to establish the line of descent is to determine in great part the classification. Much assistance in this direction is derived from embryology, or the history of the development of the individual (*ontogeny*); so that it may be said that the ontogeny indicates, though it does not actually determine, the line of descent (*phylogeny*); and it is owing to the importance of this truth that naturalists have in recent years given so much attention to comparative embryology.

It will be inferred that a *natural* system of classification must be based both on function and structure, though chiefly on the latter, since organs of very different origin may have a similar function; or, to express this otherwise, *homologous* structures may not be *analogous*; and homology gives the better basis for classification. To illustrate, the wing of a bat and a bird are both homologous and analogous; the wing of a butterfly is analogous but not homologous with these; manifestly, to classify bats and birds together would be better than to put birds and insects in the same group, thus leaving other points of relationship out of consideration.

The broadest possible division of the animal kingdom is into groups, including respectively one-celled and many-celled forms—i. e., into *Protozoa* and *Metazoa*. As the wider the grouping the less are differences considered, it follows that the more subdivided the groups the more complete is the information conveyed; thus, to say that a dog is a metazoan is to convey a certain amount of information; that he is a vertebrate, more; that he is a mammal, a good deal more, because each of the latter terms includes the former.

Animal Kingdom.	Invertebrata.	Protozoa (amoeba, vorticella, etc.).
		Cœlenterata (sponges, jelly-fish, polyps, etc.).
	Vertebrata.	Echinodermata (star-fish, sea-urchins, etc.).
		Vermes (worms).
		Arthropods (crabs, insects, spiders, etc.).
		Mollusca (oysters, snails, etc.).
		Molluscoidea (moss-like animals).
		Tunicata (ascidians).
		Pisces (fishes).
		Amphibia (frogs, menobranchus, etc.).
		Reptilia (snakes, turtles, etc.).
		Aves (birds).
		Mammalia (domestic quadrupeds, etc.).

The above classification (of Claus) is, like all such arrangements, but the expression of one out of many methods of viewing the animal kingdom.

For the details of classification and for the grounds of that we have presented, we refer the student to works on zoölogy; but we advise those who are not familiar with this subject, when a technical term is used, to think of that animal belonging to the group in question with the structure of which they are best acquainted.

MAN'S PLACE IN THE ANIMAL KINGDOM.

It is no longer the custom with zoölogists to place man in an entirely separate group by himself; but he is classed with the primates, among which are also grouped the anthropoid apes (gorilla, chimpanzee, orang, and the gibbon), the monkeys of the Old and of the New World, and the lemurs. So great is the structural resemblance of man and the other primates that competent authorities declare that there is more difference between the structure of the most widely separated members of the group than between certain of the anthropoid apes and man.

The points of greatest resemblance between man and the anthropoid apes are the following: The same number of vertebræ; the same general shape of the pelvis; a brain distinguishing them from other mammals; and posture, being bipeds.

The distinctive characters are size, rather than form of the brain, that of man being more than twice as large; a relatively larger cranial base, by which, together with the greater size of the jaws, the face becomes prominent; the earlier closure of the sutures of the cranium, arresting the growth of the brain; more developed canine teeth and difference in the order of eruption of the permanent teeth; the more posterior position of the foramen magnum; the relative length of the limbs to each

other and the rest of the body ; minor differences in the hands and feet, especially the greater freedom and power of apposition of the great-toe.

But the greatest distinction between man and even his closest allies among the apes is to be found in the development to an incomparably higher degree of his intellectual and moral nature, corresponding to the differences in weight and structure of the human brain, and associated with the use of spoken and written language ; so that the experience of previous generations is not only registered in the organism (heredity), but in the readily available form of books, etc.

The greatest structural difference between the races of men are referable to the cranium ; but, since they all interbreed freely, they are to be considered varieties of one species.

THE LAW OF PERIODICITY OR RHYTHM IN NATURE.

The term *rhythm* to most minds suggests music, poetry, or dancing, in all of which it forms an essential part so simple, pronounced, and uncomplicated as to be recognized by all with ease.

The regular division of music into bars, the recurrence of chords of the same notes at certain intervals, of *forte* and *piano*, seem to be demanded by the very nature of the human mind. The same applies to poetry. Even a child that can not understand the language used, or an adult listening to recitations in an unknown tongue, enjoys the flow and recurrences of the sounds. Dancing has in all ages met a want in human organizations, which is partly supplied in quieter moods by the regularity of the steps in walking and similar simple movements.

But as rhythm runs through all the movements of animals, so is it also found in all literature and all art. Infinite variety wearies the mind, hence the fatigue felt by the sight-seer. Recurrence permits of repose, and gratifies an established taste or appetite. The mind delights in what it has once enjoyed, in repetition within limits. Repetition with variety is manifestly a condition of the growth and development of the mind. This seems to apply equally to the body, for every single function of each organism, however simple or complex it may be, exemplifies this law of periodicity. The heart's action is rhythmical (*beats*) ; the blood flows in intermitting gushes from the central pump ; the to-and-fro movements of respiration are so regular

that their cessation would arouse the attention of the least instructed ; food is demanded at regular intervals ; the juices of the digestive tract are poured out, not constantly but periodically ; the movements by which the food is urged along its path are markedly rhythmic ; the chemical processes of the body wax and wane like the fires in a furnace, giving rise to regular augmentations of the temperature of the body at fixed hours of the day, with corresponding periods of greatest bodily activity and the reverse.

This principle finds perfect illustration in the nervous system. The respiratory act of the higher animals is effected through muscular movements dependent on regular waves of excitation reaching them along the nerves from the central cells which regularly discharge their forces along these channels. Were not the movements of the body periodic or rhythmical, instead of that harmony which now prevails, every muscular act would be a convulsion, though even in the movements of the latter there is a highly compounded rhythm, as a noise is made up of a variety of musical notes. The senses are subject to the same law. The eye ceases to see and the ear to hear and the hand to feel if continuously stimulated; and doubtless in all art this law is *unconsciously* recognized. That ceases to be art which fails to provide for the alternate repose and excitation of the senses. The eye will not tolerate continuously one color, the ear the same sound. Why is a breeze on a warm day so refreshing ? The answer is obvious.

Looking to the world of animate nature as a whole, it is noticed that plants have their period of sprouting, flowering, seeding, and decline; animals are born, pass through various stages to maturity, diminish in vigor, and die. These events make epochs in the life-history of each species; the recurrence of which is so constant that the agricultural and other arrangements even of savages are planned accordingly. That the individuals of each animal group have a definite period of duration is another manifestation of the same law.

Superficial observation suffices to furnish facts which show that the same law of periodicity is being constantly exemplified in the world of inanimate things. The regular ebb and flow of the tides; the rise and subsidence of rivers; the storm and the calm; summer and winter; day and night—are all recurrent, none constant.

Events apparently without any regularity, utterly beyond

any law of recurrence, when sufficiently studied are found to fall under the same principle. Thus it took some time to learn that volcanic eruptions occurred with a very fair degree of regularity.

In judging of this and all other rhythmical events it must be borne in mind that the time standard is for an irregularity that seems large, as in the instance just referred to, becomes small when considered in relation to the millions of years of geological time; while in the case of music a trifling irregularity, judged by fractions of a second, can not be tolerated by the musical organization—which is equivalent to saying that the interval of departure from exact regularity seems large.

As most of the rhythms of the universe are compounded of several, it follows that they may seem, until closely studied, very far from regular recurrences. This may be observed in the interference in the regularity of the tides themselves, the daily changes of which are subject to an increase and decrease twice in each month, owing to the influence of the sun and moon being then either coincident or antagonistic.

In the functions of plants and animals, rhythms must become very greatly compounded, doubtless often beyond recognition.

Among the best examples of rhythm in animals are daily sleep and winter sleep, or hibernation; yet, amid sleep, dreams or recurrences of cerebral activity are common—that is, one rhythm (of activity) overlies another (of repose). In like manner many hibernating animals do not remain constantly in their dormant condition throughout the winter months, but have periods of wakefulness; the active life recurs amid the life of functional repose.

To return to the world of inanimate matter, we find that the crust of the earth itself is made of layers or strata the result of periods of elevation and depression, of denudation and deposition, in recurring order.

The same law is illustrated by the facts of the economic and other conditions of the social state of civilized men. Periods of depression alternate with periods of revival in commercial life.

There are periods when many more marriages occur and many more children are born, corresponding with changes in the material conditions which influence men as well as other animals.

Finally, and of special interest to the medical student, are the laws of rhythm in disease. Certain fevers have their regular periods of attack, as intermittent fever; while all diseases have their periods of exacerbation, however invariable the symptoms may seem to be to the ordinary observer or even to the patient himself.

Doubtless the fact that certain hereditary diseases do not appear in the offspring at once, but only at the age at which they were manifested in the parents, is owing to the same cause.

Let us now examine more thoroughly into the real nature of this rhythm which prevades the entire universe.

If a bow be drawn across a violin-string on which some small pieces of paper have been placed, these will be seen to fly off; and if the largest string be experimented upon, it can be observed to be in rapid to-and-fro motion, known as vibration, which motion is perfectly regular, a definite number of movements occurring within a measured period of time; in other words the motion is rhythmical. In strings of the finest size the motion is not visible, but we judge of its existence because of the result, which is in each instance a sound. Sound is to us, however, an affection of the nerve of hearing and the brain, owing to the vibrations of the ear caused by similar vibrations of the violin-strings. The movements of the nerves and nerve-cells are invisible and molecular, and we seem to be justified in regarding *molecular movements as constant and associated with all the properties of matter whether living or dead.*

We see, then, that all things living and lifeless are in constant motion, visible or invisible; there is no such thing in the universe as stable equilibrium. Change, ceaseless change, is written on all things; and, so far as we can judge, these changes, on the whole, tend to higher development. Neither rhythm, however, nor anything else, is perfect. Even the motions of planets are subject to perturbations or irregularities in their periodicity. This subject is plainly boundless in its scope. We have introduced it at this stage to prepare for its study in detail in dealing with each function of the animal body. If we are correct as to the universality of the law of rhythm, its importance in biology deserves fuller recognition than it has yet received in works on physiology; it will, accordingly, be frequently referred to in the future chapters of this book.

THE LAW OF HABIT.

Every one must have observed in himself and others the tendency to fall into set ways of doing certain things, in which will and clear purpose do not come prominently into view. Further observation shows that the lower animals exhibit this tendency, so that, for example, the habits of the horse or the dog may be an amusing reflection of those of the master. Trees are seen to bend permanently in the direction toward which the prevailing winds blow.

The violin that has experienced the vibrations, aroused by some master's hand acquires a potential musical capability not possessed by an instrument equally good originally, but the molecular movements of which never received such an education.

It appears, then, that underlying what we call habit, there is some broad law not confined to living things ; indeed, the law of habit appears to be closely related to the law of rhythm we have already noticed. Certain it is that it is inseparable from all biological phenomena, though most manifest in those organisms provided with a nervous system, and in that system itself. What we usually call habit, however expressed, has its physical correlation in the nervous system. We may refer to it in this connection later: but the subject has relations so numerous and fundamental that it seems eminently proper to introduce it at this early stage, forming as it does one of those cornerstones of the biological building on which the superstructure must rest.

When we seek to come to a final explanation of habit in this case, as in most others, in which the fundamental is involved, we are soon brought against a wall over which we are unable to climb, and through which no light comes to our intellects.

We must simply believe, as the result of observation, that it is a law of matter, in all the forms manifested to us, to assume accustomed modes of behavior, perhaps we may say molecular movement, in obedience to inherent tendencies. But, to recognize this, throws a flood of light on what would be inexplicable, even in a minor degree. We can not explain gravitation in itself ; but, assuming its universality, replaces chaos by order in our speculations on matter.

Turning to living matter, we look for the origin of habit in the apparently universal principle that primary molecular

movement in one direction renders that movement easier afterward, and in proportion to the frequency of repetition ; which is equivalent to saying that functional activity facilitates functional activity. Once accepting this as of universal application in biology, we have an explanation of the origin, the comparative rigidity, and the necessity of habit. There must be a physical basis or correlative of all mental and moral habits, as well as those that may be manifested during sleep, and so purely independent of the will and consciousness. We are brought, in fact, to the habits of cells in considering those organs, and that combination of structures which makes up the complex individual mammal. It is further apparent that if the cell can transmit its nature as altered by its experiences at all, then habits must be hereditary, which is known to be the case.

Instincts seem to be but crystallized habits, the inherited results of ages of functional activity in certain well-defined directions.

To a being with a highly developed moral nature like man, the law of habit is one of great, even fearful significance. We make to-day our to-morrow, and in the present we are deciding the future of others, as our present has been made for us in part by our ancestors. We shall not pursue the subject, which is of boundless extent, further now, but these somewhat general statements will be amplified and applied in future chapters.

THE ORIGIN OF THE FORMS OF LIFE.

It is a matter of common observation that animals originate from like kinds, and plants from forms resembling themselves ; while most carefully conducted experiments have failed to show that living matter can under any circumstances known to us arise from other than living matter.

That in a former condition of the universe such may have been the case has not been disproved, and seems to be the logical outcome of the doctrine of evolution as applied to the universe generally.

By evolution is meant the derivation of more complex and differentiated forms of matter from simpler and more homogeneous ones. When this theory is applied to organized or living forms, it is termed *organic evolution*. There are two views of the origin of life : the one, that each distinct group of plants and animals was independently created ; while by "creation" is

simply meant that they came into being in a manner we know not how, in obedience to the will of a First Cause. The other view is denominated the theory of descent with modification, the theory of transmutation, organic evolution, etc., which teaches that all the various forms of life have been derived from one or a few primordial forms in harmony with the recognized principles of heredity and variability. The most widely known and most favorably received exposition of this theory is that of Charles Darwin, so that his views will be first presented in the form of a hypothetical case. Assume that one of a group of living forms varies from its fellows in some particular, and mating with another that has similarly varied, leaves progeny inheriting this characteristic of the parents, that tends to be still further increased and rendered permanent by successive pairing with forms possessing this variation in shape, color, or whatever it may be. We may suppose that the variations may be numerous, but are always small at the beginning. Since all animals and plants tend to multiply faster than the means of support, a competition for the means of subsistence arises, in which struggle the fittest, as judged by the circumstances, always is the most successful ; and if one must perish outright, it is the less fit. If any variation arises that is unfavorable in this contest, it will render the possessor a weaker competitor : hence it follows that only useful variations are preserved. The struggle for existence is, however, not alone for food, but for anything which may be an advantage to its possessor. One form of the contest is that which results from the rivalry of members of the same sex for the possession of the females ; and as the female chooses the strongest, most beautiful, most active, or the supreme in some respect, it follows that the best leave the greatest number of progeny. This has been termed *sexual selection*.

In determining what forms shall survive, the presence of other plants or animals is quite as important as the abundance of food and the physical conditions, often more so. To illustrate this by an example : Certain kinds of clover are fertilized by the visits of the bumble-bee alone ; the numbers of bees existing at any one place depends on the abundance of the field-mice which destroy the nests of these insects ; the numbers of mice will depend on the abundance of creatures that prey on the mice, as hawks and owls ; these, again, on the creatures that specially destroy them, as foxes, etc. ; and so on, the chain of connections becoming more and more lengthy.

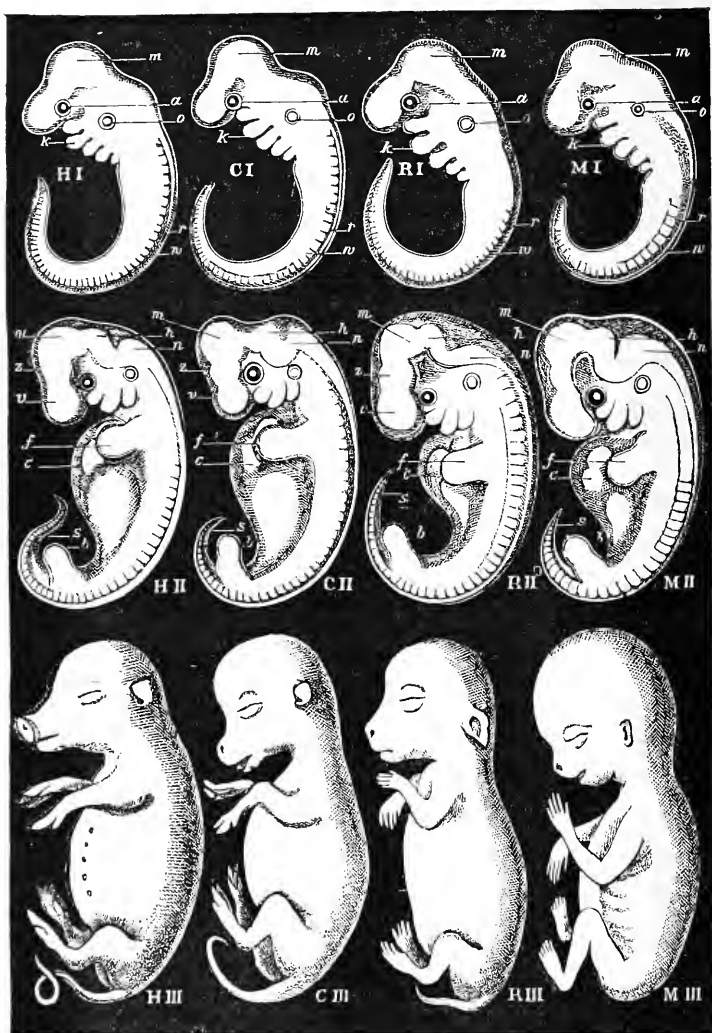

FIG. 47.—Shows the embryos of four mammals in the three corresponding stages : of a hog (H), calf (C), rabbit (R), and a man (M). The conditions of the three different stages of development, which the three cross-rows (I, II, III) represent, are selected to correspond as exactly as possible. The first, or upper cross-row, I, represents a very early stage, with gill-openings, and without limbs. The second (middle) cross-row, II, shows a somewhat later stage, with the first rudiments of limbs, while the gill-openings are yet retained. The third (lowest) cross-row, III, shows a still later stage, with the limbs more developed and the gill-openings

lost. The membranes and appendages of the embryonic body (the amnion, yelk-sac, allantois) are omitted. The whole twelve figures are slightly magnified, the upper ones more than the lower. To facilitate the comparison, they are all reduced to nearly the same size in the cuts. All the embryos are seen from the left side; the head extremity is above, the tail extremity below; the arched back turned to the right. The letters indicate the same parts in all the twelve figures, namely: *c*, fore-brain; *z*, twist-brain; *m*, mid-brain; *h*, hind-brain; *n*, after-brain; *r*, spinal marrow; *e*, nose; *a*, eye; *o*, ear; *k*, gill-arches; *g*, heart; *w*, vertebral column; *f*, fore-limbs; *b*, hind-limbs; *s*, tail. (After Haeckel.)

If a certain proportion of forms varying similarly were separated by any great natural barrier, as a chain of lofty mountains or an intervening body of water of considerable extent, and so prevented from breeding with forms that did not vary, it is clear that there would be greater likelihood of their differences being preserved and augmented up to the point of their greatest usefulness.

We may now inquire whether such has actually been the course of events in nature. The evidence may be arranged under the following heads :

1. **Morphology.**—Briefly, there is much that is common to entire large groups of animals ; so great, indeed, are the resemblances throughout the whole animal kingdom that herein is found the strongest argument of all for the doctrine of descent. To illustrate by a single instance—fishes, reptiles, birds, and mammals possess in common a vertebral column bearing the same relationship to other parts of the animal. It is because of resemblances of this kind, as well as by their differences, that naturalists are enabled to classify animals.

2. **Embryology.**—In the stages through which animals pass in their development from the ovum to the adult, it is to be observed that the closer the resemblance of the mature organism in different groups, the more the embryos resemble one another. Up to a certain stage of development the similarity between groups of animals, widely separated in their post-embryonic life, is marked : thus the embryo of a reptile, a bird, and a mammal have much in common in their earlier stages. The embryo of the mammal passes through stages which represent conditions which are permanent in lower groups of animals, as for example that of the branchial arches, which are represented by the gills in fishes. It may be said that the developmental history of the individual (ontogeny) is a brief recapitulation of the development of the species (phylogeny). Apart from the theory of descent, it does not seem possible to gather the true significance of such facts, which will become plainer after the study of the chapters on reproduction.

3. **Mimicry** may be cited as an instance of useful adaptation.

Thus, certain beetles resemble bees and wasps, which latter are protected by stings. It is believed that such groups of beetles as these arose by a species of selection ; those escaping enemies which chanced to resemble dreaded insects most, so that birds which were accustomed to prey on beetles, yet feared bees, would likewise avoid the mimicking forms.

4. **Rudimentary Organs.**—Organs which were once functional in a more ancient form, but serve no use in the creatures in which they are now found, have reached, it is thought, their rudimentary condition through long periods of comparative disuse, in many generations. Such are the rudimentary muscles of the ears of man, or the undeveloped incisor teeth found in the upper jaw of ruminants.

5. **Geographical Distribution.**—It can not be said that animals and plants are always found in the localities where they are best fitted to flourish. This has been well illustrated within the lifetime of the present generation, for the animals introduced into Australia have many of them so multiplied as to displace the forms native to that country. But, if we assume that migrations of animals and transmutations of species have taken place, this difficulty is in great part removed.

6. **Paleontology.**—The rocks bear record to the former existence of a succession of related forms; and, though all the intermediate links that probably existed have not been found, the apparent discrepancy can be explained by the nature of the circumstances under which fossil forms are preserved ; and the "imperfection of the geological record."

It is only in the sedimentary rocks arising from mud that fossils can be preserved, and those animals alone with hard parts are likely to leave a trace behind them ; while if these sedimentary rocks with their inclosed fossils should, owing to enormous pressure or heat be greatly changed (metamorphosed), all trace of fossils must disappear—so that the earliest forms of life, those that would most naturally, if preserved at all, be found in the most ancient rocks, are wanting, in consequence of the metamorphism which such formations have undergone. Moreover, our knowledge of the animal remains in the earth's crust is as yet very incomplete, though, the more it is explored, the more the evidence gathers force in favor of organic evolution. But it must be remembered that those groups constituting species are in geological time intermediate links.

7. **Fossil and Existing Species.**—If the animals and plants

now peopling the earth were entirely different from those that flourished in the past, the objections to the doctrine of descent would be greatly strengthened; but when it is found that there is in some cases a scarcely broken succession of forms, great force is added to the arguments by which we are led to infer the connection of *all* forms with one another.

To illustrate by a single instance: the existing group of horses, with a single toe to each foot, was preceded in geological

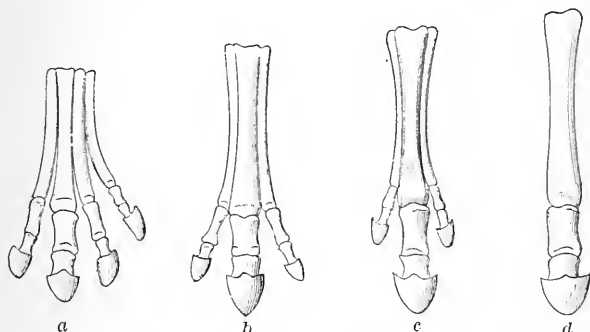

FIG. 48.—Bones of the feet of the different genera of *Equidae* (after Marsh). *a*, foot of *Orohippus* (Eocene); *b*, foot of *Anchitherium* (Lower Miocene); *c*, foot of *Hipparion* (Pliocene); *d*, foot of the recent genus *Equus*.

time in America by forms with a greater number of toes, the latter increasing according to the antiquity of the group. These forms occur in succeeding geological formations. It is impossible to resist the conclusion that they are related genealogically (phylogenetically).

8. **Progression.**—Inasmuch as any form of specialization that would give an animal or plant an advantage in the struggle for existence would be preserved, and as in most cases when the competing forms are numerous such would be the case, it is possible to understand how the organisms that have appeared have tended, on the whole, toward a most pronounced progression in the scale of existence. This is well illustrated in the history of civilization. Barbarous tribes give way before civilized man with the numberless subdivisions of labor he institutes in the social organism. It enables greater numbers to flourish, as the competition is not so keen as if activities could be exercised in a few directions only.

9. **Domesticated Animals.**—Darwin studied our domestic animals long and carefully, and drew many important conclusions

from his researches. He was convinced that they had all been derived from a few wild representatives, in accordance with the principles of natural selection. Breeders have both consciously and unconsciously, formed races of animals from stocks which the new groups have now supplanted; while primitive man had tamed various species which he kept for food and to assist in the chase, or as beasts of burden. It is impossible to believe that all the different races of dogs have originated from distinct wild stocks, for many of them have been formed within recent periods; in fact, it is likely that to the jackal, wolf, and fox, must we look for the wild progenitors of our dogs. Darwin concluded that, as man had only utilized the materials Nature provided in forming his races of domestic animals, he had availed himself of the variations that arose spontaneously, and increased and fixed them by breeding those possessing the same variation together, so the like had occurred without his aid in nature among wild forms.

Evolutionists are divided as to the origin of man himself; some, like Wallace, who are in accord with Darwin as to the

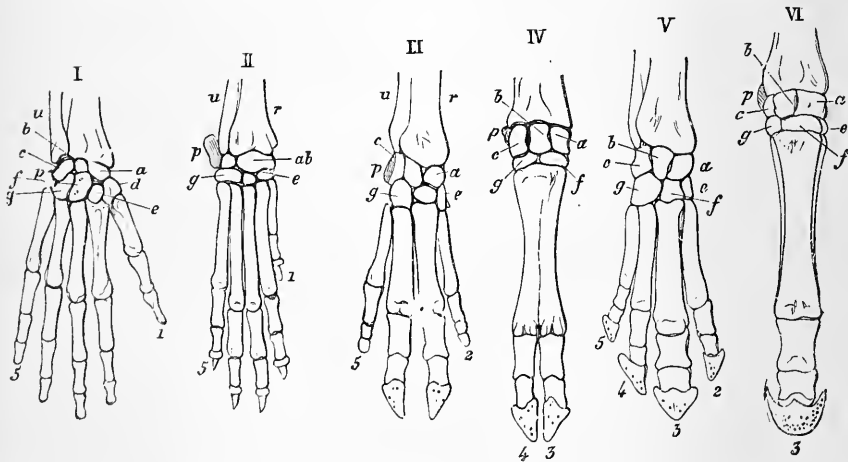

FIG. 49.—Skeleton of hand or fore-foot of six mammals. I, man; II, dog; III, pig; IV, ox; V, tapir; VI, horse. *r*, radius; *u*, ulna; *a*, scaphoid; *b*, semi-lunar; *c*, triquetrum (cuneiform); *d*, trapezium; *e*, trapezoid; *f*, capitatum (unciform process); *g*, hamatum (unciform bone); *p*, pisiform; 1, thumb; 2, digit; 3, middle finger; 4, ring-finger; 5, little finger. (After Gegenbaur.)

origin of living forms in general, believe that the theory of natural selection does not suffice to account for the intellectual

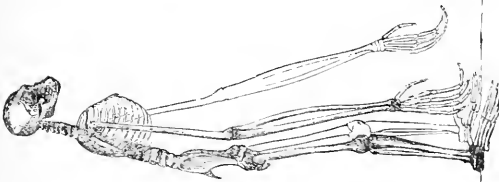

FIG. 50.
Gibbon.

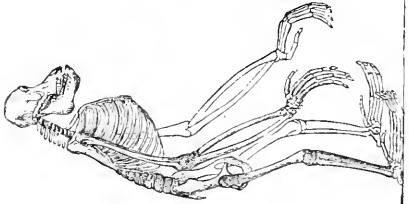

FIG. 51.
Orang-outang.

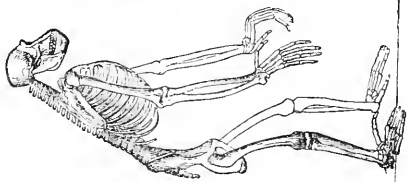

FIG. 52.
Chimpanzee.

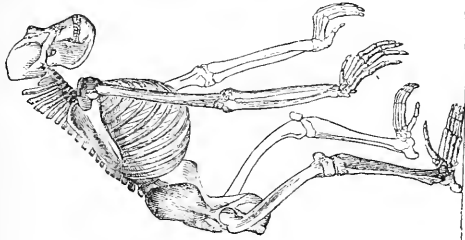

FIG. 53.
Gorilla.

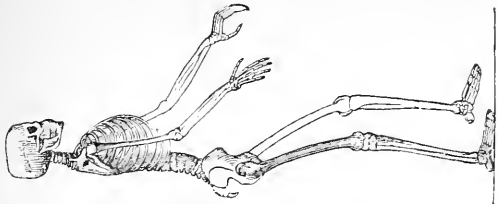

FIG. 54.
Man. (Haeckel.)

and moral nature of man. Wallace believes that man's body has been derived from lower forms, but that his higher nature is the result of some unknown law of accelerated development; while Darwin, and those of his way of thinking, consider that man in his entire nature is but a grand development of powers existing in minor degree in the animals below him in the scale.

Summary.—Every group of animals and plants tends to increase in numbers in a geometrical progression, and must, if unchecked, overrun the earth. Every variety of animals and plants imparts to its offspring a general resemblance to itself, but with minute variations from the original. The variations of offsprings may be in any direction, and by accumulation constitute fixed differences by which a new group is marked off. In the determination of the variations that persist, the law of survival of the fittest operates.

REPRODUCTION.

As has been already noticed, protoplasm, in whatever form, after passing through certain stages in development, undergoes a decline, and finally dies and joins the world of unorganized matter ; so that the permanence of living things demands the constant formation of new individuals. Groups of animals and plants from time to time become extinct; but the lifetime of the species is always long compared with that of the individual. Reproduction by division seems to arise from an exigency of a nutritive kind, best exemplified in the simpler organisms. When the total mass becomes too great to be supported by absorption of pabulum from without by the surface of the body, division of the organism must take place, or death ensues. It appears to be a matter of indifference how this is accomplished, whether by fission, endogenous division, or gemmation, so long as separate portions of protoplasm result, capable of leading an independent existence. The very undifferentiated character of these simple forms prepares us to understand how each fragment may go through the same cycle of changes as the parent form. In such cases, speaking generally, a million individuals tell the same biological story as one ; yet these must exist as individuals, if at all, and not in one great united mass. But in the case of conjugation, which takes place sometimes in the same groups as also multiply by division in its various forms, there is plainly an entirely new aspect of the case presented. We have already shown that no two cells, however much alike they may seem as regards form and the circumstances under which they exist, can have, in the nature of the case, precisely the same history, or be the subjects of exactly the same experiences. We have also pointed out that all these phenomena of cell-life are known to us only as adaptations of internal to external conditions; for, though we may not be always able to trace this connection, the inference is justi-

fiable, because there are no facts known to us that contradict such an assumption, while those that are within our knowledge bear out the generalization. We have already learned that living things are in a state of constant change, as indeed are all things; we have observed a constant relation between certain changes in the environment, or sum total of the surrounding conditions, as, for example, temperature, and the behavior of the protoplasm of plants and animals; so that we must believe that any one form of protoplasm, however like another it may seem to our comparatively imperfect observation, is different in some respects from every other—as different, relatively, as two human beings living in the same community during the whole of their lives; and in many cases as unlike as individuals of very different nationality and history. We are aware that when two such persons meet, provided the unlikeness is not so great as to prevent social intercourse, intercommunication may prove very instructive. Indeed, the latter grows out of the former; our illustration is itself explained by the law we are endeavoring to make plain. It would appear, then, that continuous division of protoplasm without external aid is not possible; but that the vigor necessary for this must in some way be imparted by a particle (cell) of similar, yet not wholly like, protoplasm. This seems to furnish an explanation of the necessity for the conjugation of living forms, and the differentiation of sex. Very frequently conjugation in the lowest animals and plants is followed by long periods when division is the prevailing method of reproduction. It is worthy of note, too, that when living forms conjugate, they both become quiescent for a longer or shorter time. It is as though a period of preparation preceded one of extraordinary activity. We can at present trace only a few of the steps in this rejuvenation of life-stuff. Some of these have been already indicated, which, with others, will now be further studied in this division of our subject, both because reproduction throws so much light on cell-life, and because it is so important for the understanding of the physiological behavior of tissues and organs. It may be said to be quite as important that the ancestral history of the cells of an organism be known as the history of the units composing a community. A, B, and C, can be much better understood if we know something alike of the history of their race, their ancestors, and their own past; so is it with the study of any individual animal, or group of animals or plants. Accordingly,

embryology, or the history of the origin and development of tissues and organs, will occupy a prominent place in the various chapters of this work. The student will, therefore, at the outset be furnished with a general account of the subject, while many details and applications of principles will be left for the chapters that treat of the functions of the various organs of animals. The more knowledge the student possesses of zoölogy the better, while this science will appear in a new light under the study of embryology.

Animals are divisible, according to general structure, into *Protozoa*, or unicellular animals, and *Metazoa*, or multicellular forms—that is, animals composed of cell aggregates, tissues, or organs. Among the latter one form of reproduction appears for the first time in the animal kingdom, and becomes all but universal, though it is not the exclusive method ; for, as seen in *Hydra*, both this form of generation and the more primitive gemmation occur. It is known as sexual multiplication, which usually, though not invariably, involves conjugation of two unlike cells which may arise in the same or different individuals. That these cells, known as the male and female elements, the ovum and the spermatozoön, are not necessarily radically different, is clear from the fact that they may arise in the one individual from the same tissue and be mingled together. These cells, however, like all others, tell a story of continual progressive differentiation corresponding to the advancing evolution of higher from lower forms. Thus *hermaphroditism*, or the coexistence of organs for the production of male and of female cells in the same individual, is confined to invertebrates, among which it is rather the exception than the rule. Moreover, in such hermaphrodite forms the union of cells with greater difference in experiences is provided for by the union of different individuals, so that commonly the male cell of one individual unites with (fertilizes) the female cell of a different individual. It sometimes happens that among the invertebrates the cells produced in the female organs of generation possess the power of division, and continued development wholly independently of the access of any male cell (*parthenogenesis*) ; such, however, is almost never the exclusive method of increase for any group of animals, and is to be regarded as a retention of a more ancient method, or perhaps rather a *reversion* to a past biological condition. No instance of complete parthenogenesis is known among vertebrates, although in birds partial develop-

ment of the egg may take place independently of the influence of the male sex. The best examples of parthenogenesis are to be found among insects and crustaceans.

It is to be remembered that, while the cells which form the tissues of the body of an animal have become *specialized* to discharge one particular function, they have not wholly lost all others ; they do not remain characteristic amœboids, as we may term cells closely resembling *Amœba* in behavior, nor do they wholly forsake their ancestral habits. They all retain the power of reproduction by division, especially when young and most vigorous ; for tissues grow chiefly by the production of new cells rather than the enlargement of already mature ones. Cells wear out and must be replaced, which is effected by the processes already described for *Amœba* and similar forms. Moreover, there is retained in the blood of animals an army of cells, true amœboids, ever ready to hasten to repair tissues lost by injury. These are true remnants of an embryonic condition ; for at one period all the cells of the organism were of this undifferentiated, plastic character. But *the cell (ovum)* from which the individual in its entirety and with all its complexity arises mostly by the union with another cell (*spermatozoön*), must be considered as one that has remained unspecialized and retained, and perhaps increased its reproductive functions. They certainly have become more complex. The germ-cell may be considered unspecialized as regards other functions, but highly specialized in the one direction of exceedingly great capacity for growth and complex division, if we take into account the whole chain of results ; though in considering this it must be borne in mind that after a certain stage of division each individual cell repeats its ancestral history again ; that is to say, it divides and gives rise to cells which progress in turn as well as multiply. From another point of view the ovum is a marvelous storehouse of energy, latent or potential, of course, but under proper conditions liberated in varied and unexpected forms of force. It is a sort of reservoir of biological energy in the most concentrated form, the liberation of which in simpler forms gives rise to that complicated chain of events which is termed by the biologist development, but which may be expressed by the physiologist as the transformation of potential into kinetic energy, or the energy of motion. Viewed chemically, it is the oft-repeated story of the production of forms, of greater stability and simplicity, from more unstable and com-

plex ones, involving throughout the process of oxidation ; for it must ever be kept in mind that life and oxidation are concomitant and inseparable. The further study of reproduction in the concrete will render the meaning and force of many of the above statements clearer.

THE OVUM.

The typical female cell, or ovum, consists of a mass of protoplasm, usually globular in form, containing a nucleus and nucleolus.

The ovum may or may not be invested by a membrane ; the protoplasm of the body of the cell is usually highly granular, and may have stored up within it a varying amount of proteid material (*food-yolk*), which has led to division of ova into classes, according to the manner of distribution of this nutritive reserve. It is either concentrated at one pole (*telolecithal*) ; toward the center (*centrolecithal*) ; or evenly distributed throughout (*alecithal*). During development this material is converted by the agency of the cells of the young organism (*embryo*) into active protoplasm ; in a word, they feed upon and assimilate or build up this food-stuff into their own substance, as *Amœba* does with any proteid material it appropriates.

The nucleus (*germinal vesicle*) is large and well defined, and contains within itself a highly refractive nucleolus (*germinal spot*).

These closely resemble in general the rest of the cell, but stain more deeply and are chemically different in that they contain *nucieine* (*nucleoplasm, chromatin*).

It will be observed that the ovum differs in no essential particular of structure from other cells. Its differences are hidden ones of molecular structure and functional behavior. In ac-

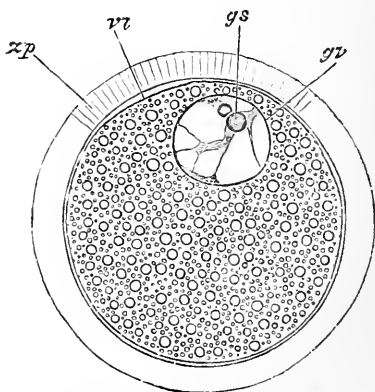

FIG. 55.—Semi-diagrammatic representation of a mammalian ovum (Schäfer). Highly magnified. *zp*, zona pellucida; *vt*, vitellus (yolk); *gv*, germinal vesicle; *gs*, germinal spot.

cordance with the diverse circumstances under which ova mature and develop, certain variations in structure, mostly of the nature of additions, present themselves.

Thus, ova may be naked, or provided with one or more coverings. In vertebrates there are usually two membranes around the protoplasm of the ovum: a delicate covering (*Vitelline membrane*) beneath which there is another, which is sieve-like from numerous perforations (*zona radiata, or z. pellucida*). The egg membrane may be impregnated with lime salts (*shell*). Between the membranes and the yolk there is a fluid albuminous substance secreted by the glands of the oviduct, or by other special glands, which provide proteid nutriment in different physical condition from that of the yolk.

The general naked-eye appearances of the ovum may be learned from the examination of a hen's egg, which is one of

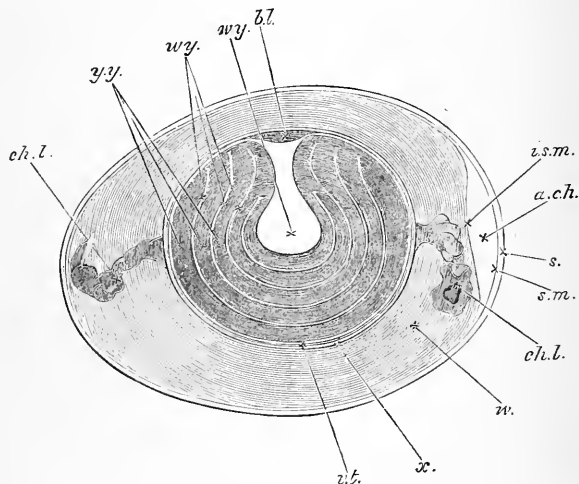

FIG. 56.—Diagrammatic section of an unimpregnated fowl's egg (Foster and Balfour, after Allen Thomson). *bl.* blastoderm or cicatricula; *w. y.* white yolk; *y. y.* yellow yolk; *ch. l.* chalaza; *i. s. m.* inner layer of shell membrane; *s. m.* outer layer of shell membrane; *s.* shell; *a. c. h.* air-space; *w.* the white of the egg; *v. l.* vitelline membrane; *x.* the denser albuminous layer lying next the vitelline membrane.

the most complicated known, inasmuch as it is adapted for development outside of the body of the mother, and must, consequently, be capable of preserving its form and essential vital properties in a medium in which it is liable to undergo loss of water, protected as it now is with shell, etc., but which, at the

same time permits the entrance of oxygen and moisture, and conducts heat, all being essential for the development of the germ within this large food-mass. The shell serves, evidently, chiefly for protection, since the eggs of serpents (snakes, turtles, etc.) are provided only with a very tough membranous covering, this answering every purpose in eggs buried in sand or otherwise protected as theirs usually are. As the hen's egg is that most readily studied and most familiar, it may be well to describe it in somewhat further detail, as illustrated in the above figure, from the examination of which it will be apparent that the yolk itself is made up of a white and yellow portion distributed in alternating zones, and composed of cells of different microscopical appearances. The clear albumen is structureless.

The relative distribution, and the nature of the accessory or non-essential parts of the hen's egg, will be understood when it is remembered that, after leaving its seat of origin, which will be presently described, the ovum passes along a tube (oviduct) by a movement imparted to it by the muscular walls of the latter, similar to that of the gullet during the swallowing of food; that this tube is provided with glands which secrete in turn the albumen, the membrane (outer), the lime salts of the shell, etc. The twisted appearance of the rope-like structures (*chalazæ*) at each end is owing to the spiral rotatory movement the egg has undergone in its descent.

The air-chamber at the larger end is not present from the first, but results from evaporation of the fluids of the albumen and the entrance of atmospheric air after the egg has been laid some time.

THE ORIGIN AND DEVELOPMENT OF THE OVUM.

Between that protrusion of cells which gives rise to the bud which develops directly into the new individual, and that which forms the ovary within which the ovum as a modified cell arises, there is not in *Hydra* much difference at first to be observed.

In the mammal, however, the ovary is a more complex structure, though, relatively to many organs, still simple. It consists, in the main, of connective tissue supplied with vessels and nerves inclosing modifications of that tissue (*Graafian follicles*) within which the ovum is matured. The ovum and the follicles arise from an inversion of epithelial cells, on a portion of the body

cavity (*germinal ridge*), which give rise to the ovum itself, and the other cells surrounding it in the Graafian follicle. At first

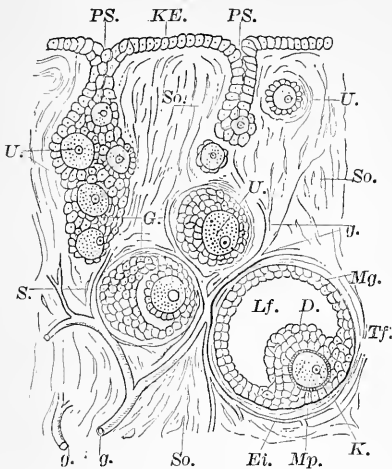

FIG. 57.—Section through portion of the ovary of mammal, illustrating mode of development of the Graafian follicles (Wiedersheim). *D*, discus proligerus; *Ei*, ripe ovum; *G*, follicular cells of germinal epithelium; *g*, blood-vessels; *K*, germinal vesicle (nucleus) and germinal spot (nucleolus); *KE*, germinal epithelium; *Lf*, liquor folliculi; *Mg*, membrana or tunica granulosa, or follicular epithelium; *Mp*, zona pellucida; *PS*, ingrowths from the germinal epithelium, ovarian tubes, by means of which some of the nests retain their connection with the epithelium; *S*, cavity which appears within the Graafian follicle; *So*, stroma of ovary; *Tf*, theca folliculi or capsule; *U*, primitive ova. When an ovum with its surrounding cells has become separated from a nest, it is known as a Graafian follicle.

these inversions form tubules (*egg-tubes*) which latter become broken up into isolated nests of cells, the forerunners of the Graafian follicles.

The Graafian follicle consists externally of a fibrous capsule (*tunica fibrosa*), in close relation to which is a layer of capillary blood-vessels (*tunica vasculosa*), the two together forming the general covering (*tunica propria*) for the more delicate and important cells within. Lining the tunic is a layer of small, somewhat cubical cells (*membrana granulosa*), which at one part invest the ovum several layers deep (*discus proligerus*), while the remainder of the space is filled by a fluid (*liquor folliculi*) probably either secreted by the cells themselves,

or resulting from the disintegration of some of them, or both.

In viewing a section of the ovary taken from a mammal at the breeding-season, ova and Graafian follicles may be seen in all stages of development—those, as a rule, nearest the surface being the least matured. The Graafian follicle appears to pass inward, to undergo growth and development and again retire toward the exterior, where it bursts, freeing the ovum, which is conducted to the site of its future development by appropriate mechanism to be described hereafter.

Changes in the Ovum itself.—The series of transformations that take place in the ovum before and immediately after the

access of the male element is, in the opinion of many biologists, of the highest significance, as indicating the course evolution

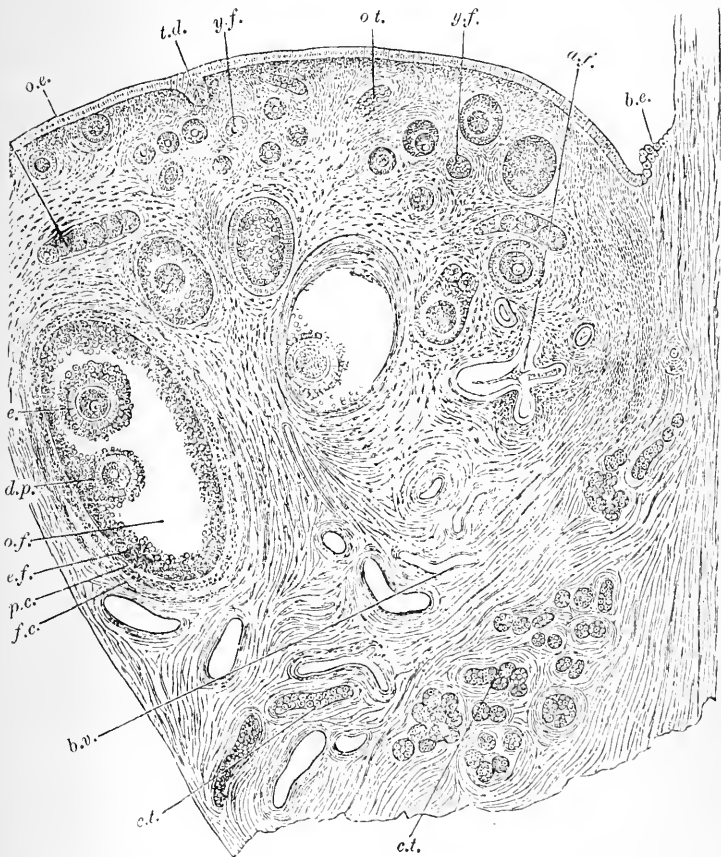

FIG. 58.—Sagittal section of the ovary of an adult bitch (after Waldeyer). *o. e.* ovarian epithelium; *o. t.* ovarian tubes; *y. f.* younger follicles; *o. f.* older follicle; *d. p.* discus proligerus, with the ovum; *e.* epithelium of a second ovum in the same follicle; *f. c.* fibrous coat of the follicle; *p. c.* proper coat of the follicle; *e. f.* epithelium of the follicle (membrana granulosa); *a. f.* collapsed atrophied follicle; *b. v.* blood-vessels; *c. t.* cell-tubes of the parovarium divided longitudinally and transversely; *t. d.* tubular depression of the ovarian epithelium in the tissue of the ovary; *b. e.* beginning of the ovarian epithelium, close to the lower border of the ovary.

has followed in the animal kingdom, as well as instructive in illustrating the behavior of nuclei generally.

The germinal vesicle may acquire powers of slow movement (amoeboid), and the germinal spot disappear : the former passes to one surface (*pole*) of the ovum ; both these structures may undergo that peculiar form of rearrangement (*karyokinesis*) which may occur in the nuclei and nucleoli of other cells prior to division ; in other words, the ovum has features common to it and many other cells in that early stage which precedes the complicated transformations which constitute the future history of the ovum.

A portion of the changed nucleus (*aster*) with some of the protoplasm of the cell accumulates at one surface (*pole*), which is termed the upper pole because it is at this region that the epithelial cells will be ultimately developed, and is separated. This process is repeated. These bodies (*polar cells, polar globules, etc.*),

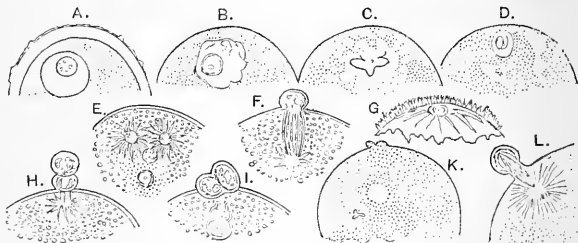

FIG. 59.—Formation of polar cells in a star-fish (*Asterias glacialis*) (from Geddes, A—K after Fol, L after O. Hertwig). A, ripe ovum with eccentric germinal vesicle and spot; B—D, gradual metamorphosis of germinal vesicle and spot, as seen in the living egg, into two asters; E, formation of first polar cells and withdrawal of remaining part of nuclear spindle within the ovum; G, surface view of living ovum in the first polar cell; H, completion of second polar cell; I, a later stage, showing the remaining internal half of the spindle in the form of two clear vesicles; K, ovum with two polar cells and radial striae round female pronucleus, as seen in the living egg (E, F, H, and I from picric acid preparations); L, expulsion of the first polar cell. (Haddon.)

then, are simply expelled ; they take no part in the development of the ovum ; and their extrusion is to be regarded as a preparation for the progress of the cell, whether this event follows or precedes the entrance of the male cell into the ovum. It is worthy of note that the ovum may become amoeboid in the region from which the polar globules are expelled.

The remainder of the nucleus (*female pronucleus*) now passes inward to undergo further changes of undoubted importance, possibly those by virtue of which all the subsequent evolution of the ovum is determined. This brings us to the consideration of another cell destined to play a brief but important rôle on the biological stage.

THE MALE CELL (SPERMATOZOÖN).

This cell, almost without exception, consists of a nucleus (head) and vibratile cilium. However, as indicating that the

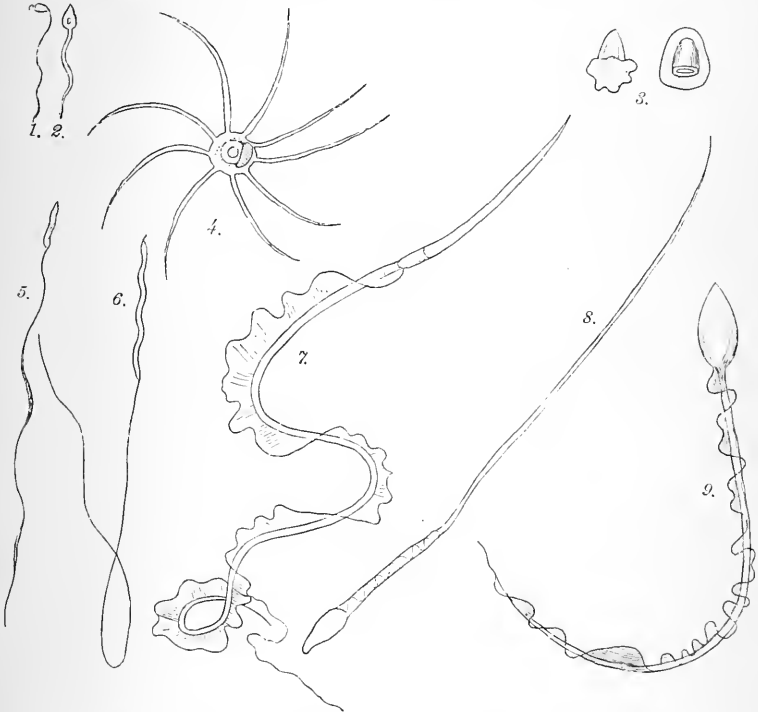

FIG. 60.—Spermatozoa (after Haddon). Not drawn to scale. 1, sponge; 2, hydroid; 3, nematode; 4, cray-fish; 5, snail; 6, electric ray; 7, salamander; 8, horse; 9, man. In many spermatozoa, as in Nos. 7 and 9, an extremely delicate vibratile band is present.

latter is not essential, spermatozoa without such an appendage do occur. The obvious purpose of the cilium is to convey the male cell to the ovum through a fluid medium—either the water in which the ova are discharged in the case of most invertebrates, or through the fluids that overspread the surfaces of the female generative organs.

The Origin of the Spermatozoön.—The structures devoted to the production of male cells (*testes*), when reduced to their essentials, consist of tubules, of great length in mammals, lined

with nucleated epithelial cells, from which, by a series of changes figured above, a general idea of their development may be obtained.

It will be observed that throughout the series the nucleus of the cell is in every case preserved, and finally becomes the head

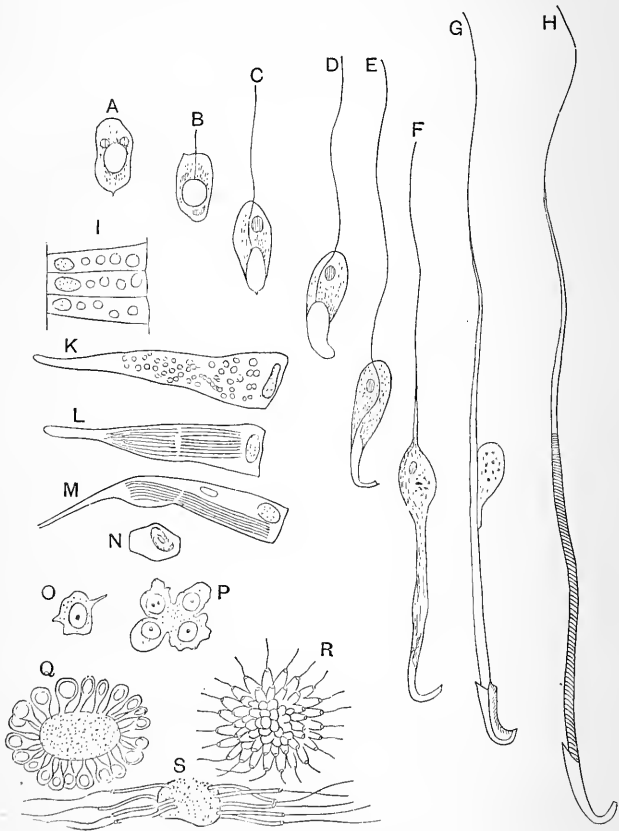

FIG. 61.—Spermatogenesis. A—H, isolated sperm-cells of the rat, showing the development of the spermatozoon and the gradual transformation of the nucleus into the spermatozoon head. In G the seminal granule is being cast off (after H. H. Brown). I—M, sperm-cells of an Elasmobranch. The nucleus of each cell divides into a large number of daughter-nuclei, each one of which is converted into the rod-like head of a spermatozoon. N, transverse section of a ripe cell, showing the bundle of spermatozoa and the passive nucleus (I—N, after Semper). O—S, spermatogenesis in the earth-worm; O, young sperm-cell; P, the same divided into four; Q, spermatosphere with the central sperm-blastophore; R, a later stage; S, nearly mature spermatozoa. (After Blomfield.)

of the male cell. Once more we are led to see the importance of this structure in the life of the cell.

Fertilization of the Ovum.—The spermatozoön, lashing its way along, when it meets the ovum, enters it either through a special minute gateway (*micropyle*), or, if this be not present—as it is not in the ova of all animals—actually penetrates the membranes and substance of the female cell, and continues active till the female pronucleus is reached, when the head enters and the tail is absorbed or blends with the female cell. The nucleus of the male cell prior to union with the nucleus of the

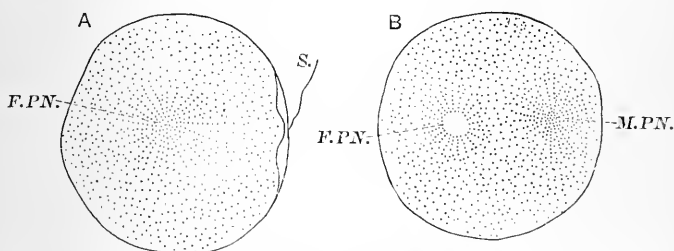

FIG. 62.—Fertilization of ovum of a mollusk (*Elysia viridis*). A. Ovum sending up a protuberance to meet the spermatozoön. B. Approach of male pronucleus to meet the female pronucleus. *F. P.N.*, female pronucleus; *M. P.N.*, male pronucleus. *S.*, spermatozoön.

ovum undergoes changes similar to those that the nucleus of the ovum underwent, and thus becomes fitted for its special functions as a fertilizer; or perhaps it would be more correct to say that these altered masses of nuclear substance mutually fertilize each other, or initiate changes the one in the other which conjointly result in the subsequent stages of the development of the ovum. The altered male nucleus (*male pronucleus*), on reaching the female pronucleus, finds it somewhat amœboid, a condition which may be shared in some degree by the entire ovum. The resulting union gives rise to the new nucleus (*segmentation nucleus*), which is to control the future destinies of the cell; while the cell itself, the fertilized ovum (*oöspERM*), enters upon new and marvelous changes.

In reality this process was foreshadowed in the dim past of the history of living things by the conjugation of infusoria and kindred animal and vegetable forms. When lower forms (unicellular) conjugate they become somewhat amœboid sooner or later, and division of cell contents results. In some cases (septic monads) the resulting cell may burst and give rise to a

shower of animal dust visible only by the highest powers of the microscope, each particle of which proves to be the nucleus from which a future individual arises.

The study of reproduction thus establishes the conception of a unity of method throughout the animal and, it may be added, the vegetable kingdom, for reproduction in plants is in all main points parallel to that process in animals.

But why that costly loss of protoplasm by polar globules? For the present we shall only say that it appears necessary to prevent parthenogenesis; or at least to balance the share which the male and female elements take in the work of producing a new creature. It is to be remembered that both the male and female lose much in the process—blood, nervous energy, etc., in the case of the female, while the male furnishes a thousand-fold more cells than are used. But the period when organisms are best fitted for reproduction is that during which they are also most vigorous, and can best afford the drain on their superfluous energies.

SEGMENTATION AND SUBSEQUENT CHANGES.

After the changes described in the last chapter a new epoch in the biological history of the ovum—now the *oöspERM* (or fertilized egg)—begins. A very distinct nucleus (*segmentation nucleus*) again appears, and the cell assumes a circular outline. The segmentation or division of the ovum into usually fairly equal parts now commences. This process can be best watched in the microscopic transparent ova of aquatic animals which undergo perfect development up to a certain advanced stage in the ordinary water of the ocean, river, lake, etc., in which the adult lives.

Segmentation among invertebrates will be first studied, and for this purpose an ovum in which the changes are of a direct and uncomplicated nature will be chosen.

The following figures and descriptions apply to a mollusk (*Elysia viridis*). We distinguish in ova resting stages and stages of activity. It is not, however, to be supposed that absolute rest ever characterizes any living form, or that nothing is transpiring because all seems quiet in these little biological worlds; for we have already seen reason for believing that life and incessant molecular activity are inseparable. It may be that, in the case of resting ova, changes of a more active char-

acter than usual are going on in their molecular constitution ; but, on the other hand, there may be really a diminution of

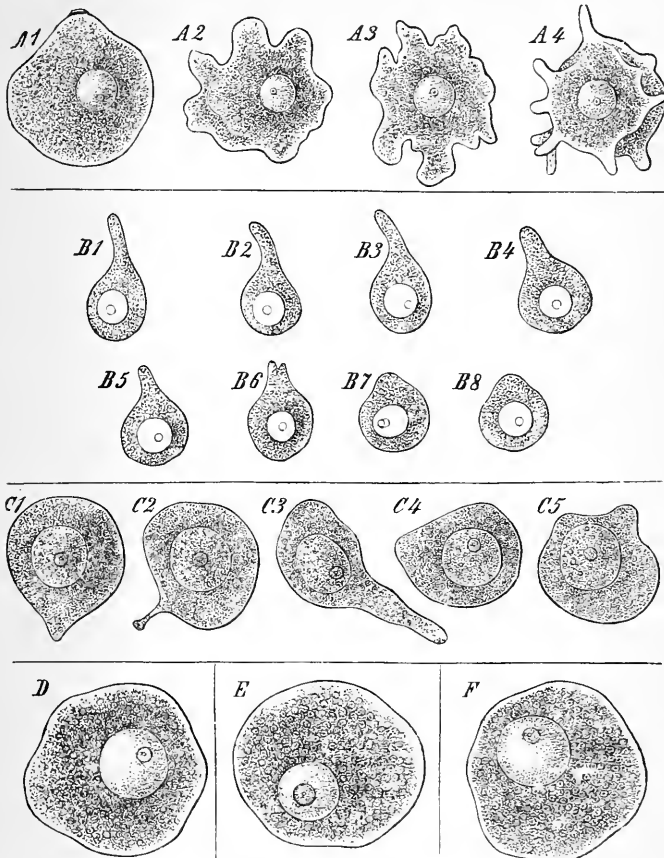

FIG. 63.—Primitive eggs of various animals, performing amoeboid movements (very much enlarged). All primitive eggs are naked cells, capable of change of form. Within the dark, finely granulated protoplasm (egg-yolk) lies a large vesicular kernel (the germ-vesicle), and in the latter is a nucleolus (germ-spot); in the nucleolus a germ-point (nucleolus) is often visible. Fig. A 1—A 4. The primitive egg of a chalk sponge (*Leuculmis echinus*), in four consecutive conditions of motion. Fig. B 1—B 8. The primitive egg of a hermit-crab (*Chontracanthus cornutus*), in eight consecutive conditions of motion (after E. Van Beneden). Fig. C 1—C 5. Primitive egg of a cat in four different conditions of motion (after Pflüger). Fig. D. Primitive egg of a trout. Fig. E. Primitive egg of a hen. Fig. F. Primitive human egg. (Haeckel.)

these activities in correspondence with the law of rhythm. This seems the more probable. The meaning, however, of a "resting

stage" is the obvious one of apparent quiescence—cessation of all kinds of movement. Then ensues rapidly and in succession the following series of transformations: The nucleolus divides, later the nucleus, into two parts. These new nuclei then wander away from each other in opposite directions, and, losing their character as nuclei and nucleoli, are replaced by asters (*polar stars*), which seem to arise in the protoplasm of the body

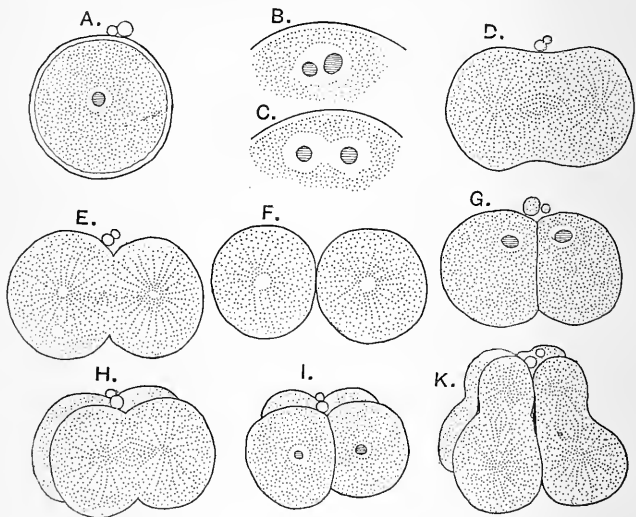
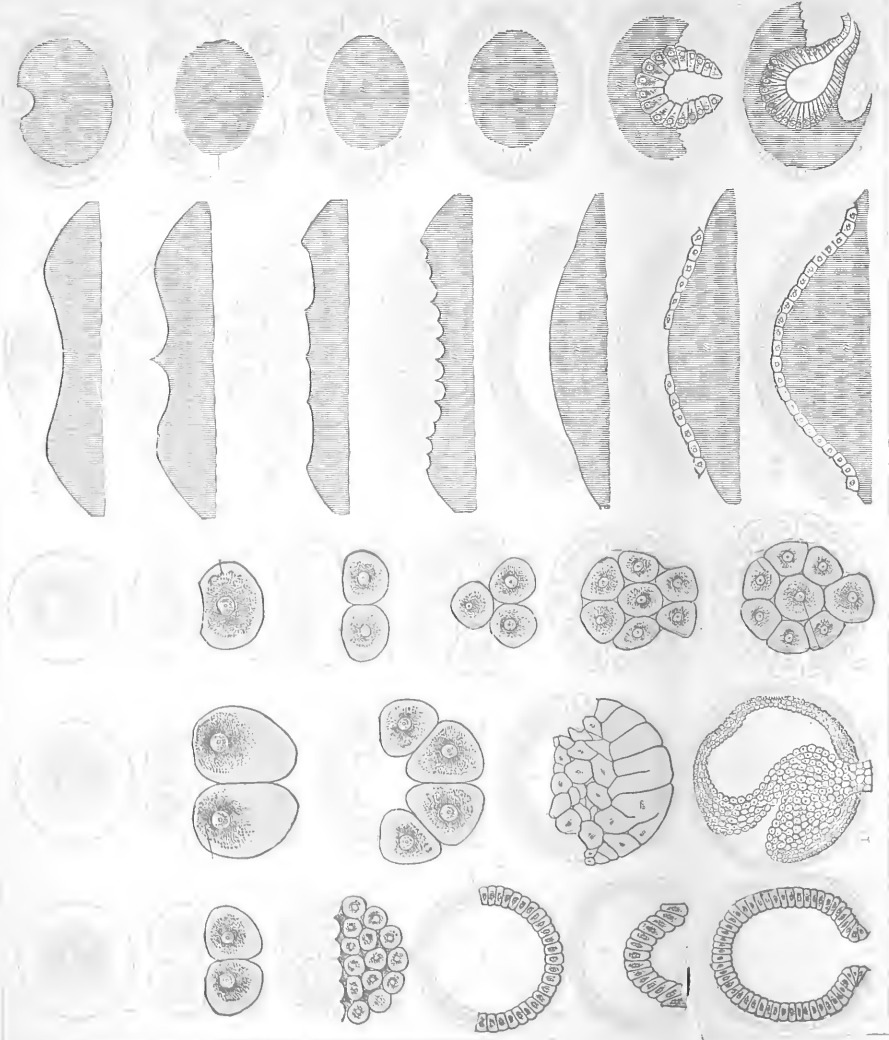

FIG. 64.—Early stages of segmentation of a mollusk, *Elysia viridis* (drawn from the living egg). A, oöspERM in state of rest after the extrusion of the polar cells; B, the nucleolus alone has divided; C, the nucleus is dividing; D, the nucleus, as such, has disappeared, first segmentation furrow appears; E, later stage; F, oöspERM divided into two distinct segmentation spheres, the clear nuclear space in the center of the aster of granules is growing larger; G, resting stage of appressed two spheres; H, I, similar stages in the production of four spheres; K, formation of eight-celled stage. (Haddon.)

of the cell, and which are in close juxtaposition at first, but later separate, the oöspERM becoming amœboid in one region at least. A groove, which gradually deepens, appears on the surface, and finally divides the cell into two halves, which at once become flattened against each other. The nucleus may again be recognized in the center of each polar star, while a new nucleolus also reappears within the nucleus, when again a brief period of rest ensues. In the division and reformation of the nucleus, when most complicated (*karyokinesis*), the changes may be gen-



AMPHIOXUS.

FROG.

MAN.

FISH.

CRAB.

PLATE I. GASTRULATION. (After Haeckel.)

Figs. 1 to 17 represent holoblastic eggs (with total cleavage); Figs. 18 to 30 show microblastic eggs (with partial cleavage). The animal halves are colored gray, the vegetative halves red. The nutritive yolk is shaded vertically. All the figures show vertical meridional sections through the axis of the primitive intestine. In all, the letters indicate the same parts: *c*, the parent-cell (*cyftula*); *f*, cleavage-cells (*segmentata*); *m*, the mulberry-germ (*morula*); *b*, the germ-vesicle (*blastula*); *g*, the cup-germ (*gastrula*); *s*, the cleavage-cavity; *d*, the primitive intestinal cavity; *o*, the primitive mouth; *n*, the nutritive yolk; *i*, the intestinal layer; *e*, the skin-layer.

Figs. 1-6.—Original or primordial egg-cleavage of the lowest vertebrate (*amphioxus*). Fig. 1, parent-cell (*cyftula*); Fig. 2, cleavage-stage with 4 cleavage-cells; Fig. 3, mulberry-germ (*morula*); Fig. 4, germ-vesicle (*blastula*); Fig. 5, the same, in process of inversion (*inversionato*); Fig. 6, bell-gastrula (*archigastrula*).

Figs. 7-11.—Unequal egg-cleavage of an amphibian (frog). Fig. 7, parent-cell (*cyftula*); Fig. 8, cleavage-stage with 4 cleavage-cells; Fig. 9, mulberry-germ (*morula*); Fig. 10, germ-vesicle (*blastula*); Fig. 11, hood-gastrula (*amphigastrula*). Figs. 12-17.—Unequal egg-cleavage of a mammal (man). Fig. 12, parent-cell (*cyftula*); Fig. 13, cleavage-stage with 2 cleavage-cells (*e*, mother-cell of the exoderm; *i*, mother-cell of the endoderm); Fig. 14, cleavage-stage with 4 cleavage-cells; Fig. 15, beginning of the invasion of the germ-vesicle; Fig. 16, further advanced invasion; Fig. 17, hood-gastrula (*amphigastrula*).

Figs. 18-24.—Discoidal egg-cleavage of an osseous fish (*Halella ?* *Cottus ?*). The greater part of the nutritive yolk (*n*) is omitted. (Cf. Figs. 42, 43, pp. 217, 219, Haeckel's "Evolution of Man.") Fig. 18, parent-cell (*cyftula*); Fig. 19, cleavage-stage with 3 cells; Fig. 20, cleavage-stage with 32 cells; Fig. 21, mulberry-germ (*morula*); Fig. 22, germ-vesicle (*blastula*); Fig. 23, the same, in process of inversion; Fig. 24, disc-gastrula (*discogastrula*).

Figs. 25-30.—Superficial egg-cleavage of a crab (*penaeus*). Fig. 25, parent-cell (*cyftula*); Fig. 26, cleavage-stage with 4 cells; Fig. 27, cleavage-stage with 32 cells; Fig. 28, mulberry-germ (*morula*), and at the same time the germ-vesicle (*blastula*); Fig. 29, bladder-gastrula (*peritostolito*); Fig. 30, amphipus-germ; the pharynx-cavity has formed in front of the primitive mouth (*b*), owing to an invagination.

eralized as consisting of division and segregation, followed by aggregation.

The subdivision (*segmentation*) of the cell, after the quiescence referred to, again commences, but in a plane at right angles to the first, from which four spheres result, again to be followed by the resting stage. The process continues in the same way, so that there is a progressive increase in the number

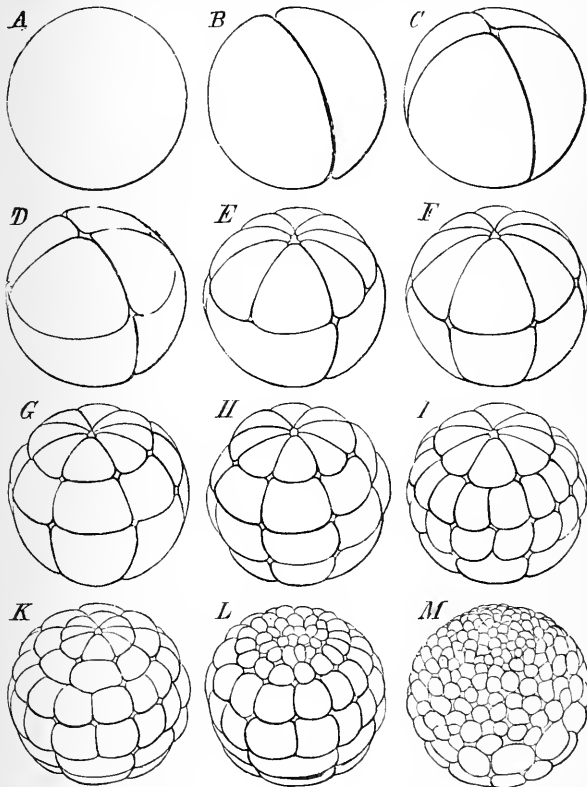

FIG. 65.—The cleavage of a frog's egg (10 times enlarged). *A*, the parent-cell; *B*, the first two cleavage-cells; *C*, 4 cells; *D*, 8 cells (4 animal and 4 vegetative); *E*, 12 cells (8 animal and 4 vegetative); *F*, 16 cells (8 animal and 8 vegetative); *G*, 24 cells (16 animal and 8 vegetative); *H*, 32 cells; *I*, 48 cells; *K*, 64 cells; *L*, 96 cleavage-cells; *M*, 160 cleavage-cells (128 animal and 32 vegetative). (Haeckel.)

of segments, at least up to the point when a large number has been formed. This is rather to be considered as a type of one

form of segmentation than as applicable to all, for even at this early stage differences are to be noted in the mode of segmentation which characterize effectually certain groups of animals; but in all there is segmentation, and that segmentation is rhythmical.

Segmentation results in the formation of a multicellular aggregation which, sooner or later, incloses a central cavity (*segmentation cavity, blastocele*). Usually this cell aggregation (*blastula, blastophere*) is reduced to a single layer of investing cells.

The Gastrula.—Ensuing on the changes just described are

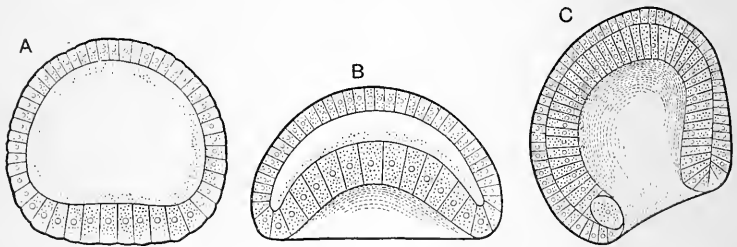

FIG. 66.—Blastula and gastrula of amphioxus (Claus, after Hatschek). A, blastula with flattened lower pole of larger cells; B, commencing invagination; C, gastrulation completed; the blastopore is still widely open, and one of the two hind-pole mesoderm cells is seen at its ventral lip. The cilia of the epiblast cells are not represented.

others, which result in the formation of the gastrula, a form of cell aggregation of great interest from its resemblance to the Hydra and similar forms, which constitute in themselves independent animals that never pass beyond that stage. The blastula becomes flattened at one pole, then depressed, the cells at this region becoming more columnar (*histological differentiation*). This depression (*invagination*) deepens until a cavity is formed (as when a hollow rubber ball is thrust in at one part till it meets the opposite wall), in consequence of which a two-layered embryo results, in which we recognize the primitive mouth (*blastopore*) and digestive cavity (*archenteron*), the outer layer (*ectoderm*) being usually separated from the inner (*endoderm*) by the almost obliterated segmentation cavity. Such a form may be provided with cilia, be very actively locomotive, and bear, consequently, the greatest resemblance to the permanent forms of some aquatic animals.

The changes by which the segmented oöspERM becomes a gastrula are not always so direct and simple as in the above-

described case, but the behavior of the cells of the blastosphere may be hampered by a burden of relatively foreign matter, in the form of food-yelk, in certain instances; so much so is this the case that distinct modes of gastrula formation may be recognized as dependent on the quantity and arrangement of food-yelk. These we shall pass by as being somewhat too complicated for our purpose, and we return to the egg of the bird.

The Hen's Egg.—By far the larger part of the hen's egg is made up of yelk; but just beneath the vitelline membrane a small, circular, whitish body, about four millimetres in diameter, which always floats uppermost in every portion of the egg, may be seen. This disk (*blastoderm, cicatricula*) in the fertilized egg presents an outer white rim (*area opaca*), within which is a transparent zone (*area pellucida*), and most centrally a somewhat elongated structure, which marks off the future being itself (*embryo*). All

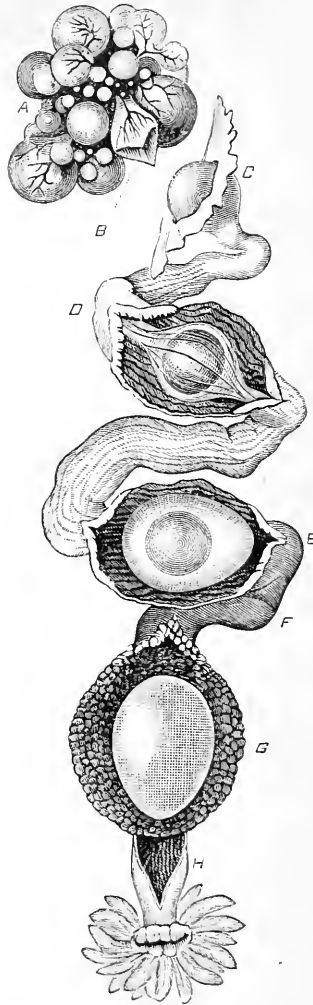

FIG. 67.—Female generative organs of the fowl (after Dalton). *A*, ovary; *B*, Graafian follicle, from which the egg has just been discharged; *C*, yolk, entering upon extremity of oviduct; *D*, *E*, second portion of oviduct, in which the chalaziferous membrane, chalazae, and albumen are formed; *F*, third portion, in which the fibrous shell membranes are produced; *G*, fourth portion laid open, showing the egg completely formed with its calcareous shell; *H*, canal through which the egg is expelled.

these parts together constitute that portion (*blastoderm*) of the fowl's egg which is alone directly concerned in reproduction, all the rest serving for nutrition and protection. The appearance of relative opacity in some of the parts marked off as above is to be explained by thickening in the cell-layers of which they are composed.

The Origin of the Fowl's Egg.—The ovary of a young but mature hen consists of a mass of connective tissue (*stroma*),

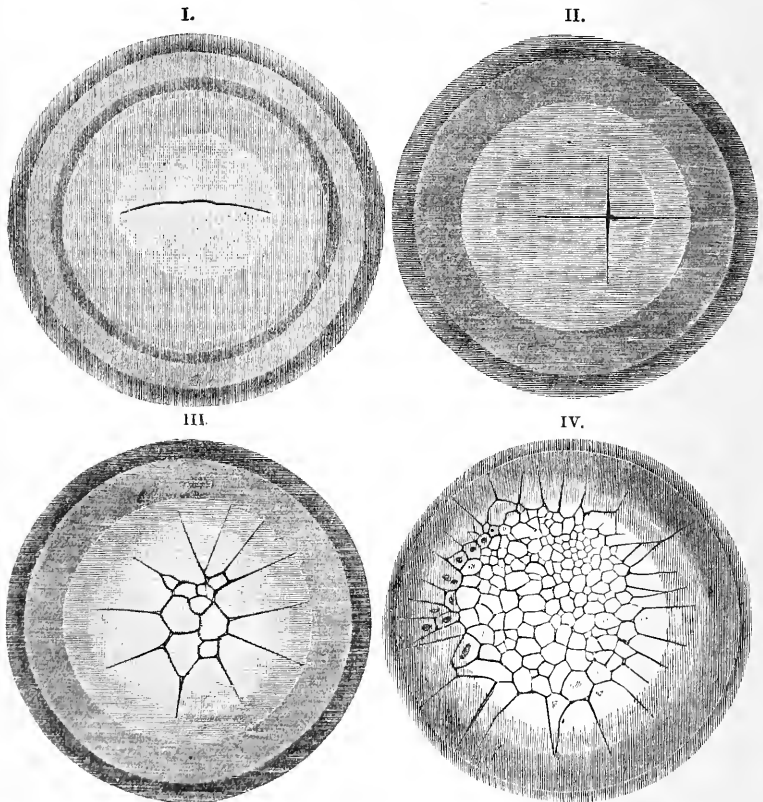

FIG. 68.—Various stages in the segmentation of a fowl's egg (Kölliker).

abundantly supplied with blood-vessels, from which hang the capsules which contain the ova in all stages of development, so that the whole suggests, but for the color, a bunch of grapes in

an early stage. The ovum at first, in this case as in all others, a single cell, becomes complex by addition of other cells (*discus proligerus*, etc.), which go to make up the yelk. All the other parts of the hen's egg are additions made to it, as explained before, in its passage down the oviduct. The original ovum remains as the blastoderm, the segmentation of which may now be described briefly, its character being obvious from an examination of Fig. 68, which represents a surface view of the segmenting fertilized ovum (*oö sperm*).

A segmentation cavity appears early, and is bounded above by a single layer of epiblast cells and below by a single layer of primitive hypoblast cells, which latter is soon composed of several layers, while the segmentation cavity disappears.

The blastoderm of an unincubated but fertilized egg consists of a layer of epiblastic cells, and beneath this a mass of rounded cells, arranged irregularly and lying loosely in the yelk, constituting the primitive hypoblast. After incubation for a couple of hours, these cells become differentiated into a lower layer of flattened cells (*hypoblast*), with mesoblastic cells scattered be-

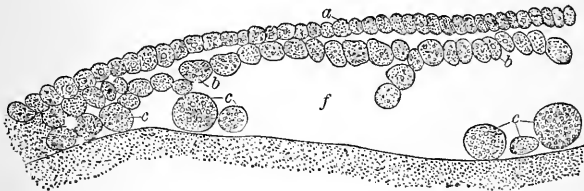

FIG. 69.—Portion of section through an unincubated fowl's oö sperm (after Klein). *a*, epiblast composed of a single layer of columnar cells; *b*, irregularly disposed lower layer cells of the primitive hypoblast; *c*, larger formative cells resting on white yelk; *f*, archenteron. The segmentation cavity lies between *a* and *b*, and is nearly obliterated.

tween the epiblast and hypoblast. It is noteworthy that, in the bird, segmentation will proceed up to a certain stage independently of the advent of the male cell, apparently indicating a tendency to parthenogenesis.

The fowl's ovum then belongs to the class, a portion of which alone segments and develops into the embryo (*meroblastic*), in contradistinction to what happens in the mammalian ovum, the whole of which undergoes division (*holoblastic*); a distinction which is, however, superficial rather than fundamental, for in reality in the fowl's egg the whole of the original ovum does segment. This holoblastic character of the mammalian ovum

and its resemblance to the segmentation of those invertebrate forms previously described may become apparent from an examination of the accompanying figures.

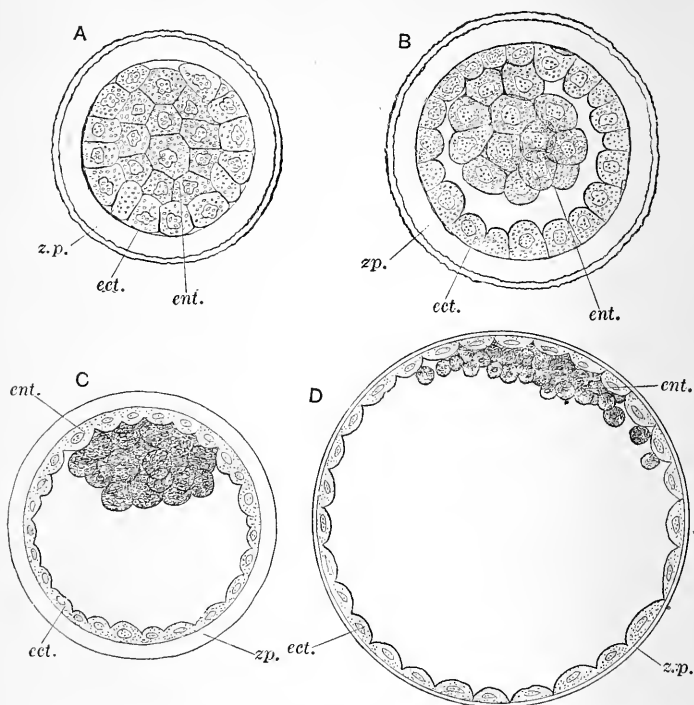

FIG. 70.—Sections of ovum of a rabbit, illustrating formation of the blastodermic vesicle (after E. Van Beneden). A, B, C, D, are ova in successive stages of development. *zp.*, zona pellucida; *ect.*, ectomeres, or outer cells; *ent.*, entomeres, or inner cells.

We shall return to the development of the mammalian ovum later; in the mean time we present the main features of development in the bird.

Remembering that the development of the embryo proper takes place within the pellucid area only, we point out that the area opaca gradually extends over the entire ovum, inclosing the yolk, so that the original disk which lay like a watch-glass on the rest of the ovum, has grown into a sphere. That portion of this area nearest the pellucid zone (*area vasculosa*) develops blood-vessels that derive the food-supplies, which replenish the blood as it is exhausted, from the hypoblast of the area opaca.

The first indications of future structural outlines in the embryo is the formation of the *primitive streak*, an opaque band

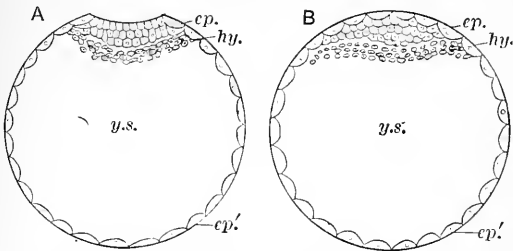

FIG. 71.—Diagrammatic transverse sections through a hypothetical mammal oöspERM (Haddon). A. The yolk of the primitive mammalian oöspERM is now lost. B. Later stage; the non-embryonic epiblast has grown over the embryonic area to form the covering cells; *ep.*, epiblast of embryo; *ep'*, epiblast of yolk-sac; *hy.*, primitive hypoblast; *y. s.*, yolk-sac, or blastodermic vesicle.

in the long diameter of the pellucid area, opaque in consequence of cell accumulation in that region. Very soon a groove (*primitive groove*) extends throughout this band, which gradually occupies a more central position. The relative thickness of the several parts and the arrangement of cells may be gathered from Fig 72. These structures are only temporary, and those that replace them will be described subsequently.

We have thus far spoken of cells as being arranged into epiblast, hypoblast, and mesoblast. The origin of the first two has been sufficiently indicated. The mesoblast forms the intermediate germinal layer, and is derived from the primitive hypoblast, which differentiates into a stratum of flattened cells, situated below the others, and constituting the later

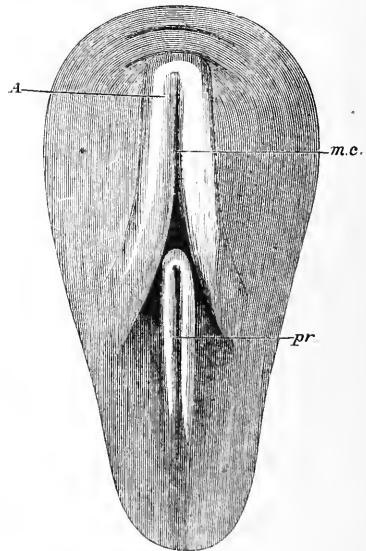

FIG. 72.—Surface view of pellucid area of blastoderm of eighteen hours (Foster and Balfour). *H.*, medullary folds; *mc.*, medullary groove; *pr.*, primitive groove.

hypoblast, and intermediate less closely arranged cells, termed, from their position, mesoblast.

It will be noticed that all future growth of the embryo begins axially, at least in the early stages of its development.

As the subsequent growth and advance of the embryo depend on an abundant and suitable nutritive supply, we must now turn to those arrangements which are temporary and of subordinate importance, but still for the time essential to development.

THE EMBRYONIC MEMBRANES OF BIRDS.

It will be borne in mind throughout that the chief food-supply for the embryo bird is derived from the yelk; and, as would

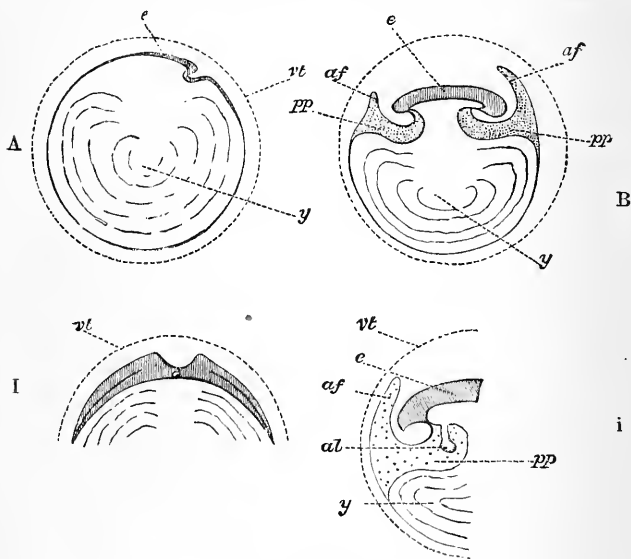

FIG. 73.

FIGS. 73-75.—A series of diagrams intended to facilitate the comprehension of the relations of the membranes to other parts (after Foster and Balfour). A, B, C, D, E, F are vertical sections in the long axis of the embryo at different periods, showing the stages of development of the amnion and of the yelk-sac. I, II, III, IV are transverse sections at about the same stages of development. i, ii, iii, posterior part of longitudinal section, to illustrate three stages in formation of the allantois. *e*, embryo; *y*, yelk; *pp*, pleuroperitoneal cavity; *vt*, vitelline membrane of amniotic fold; *al*, allantois; *a*, amnion; *a'*, alimentary canal.

be expected, the older the embryo the smaller the yelk, or, as it is now called when limited by the embryonic membranes, the

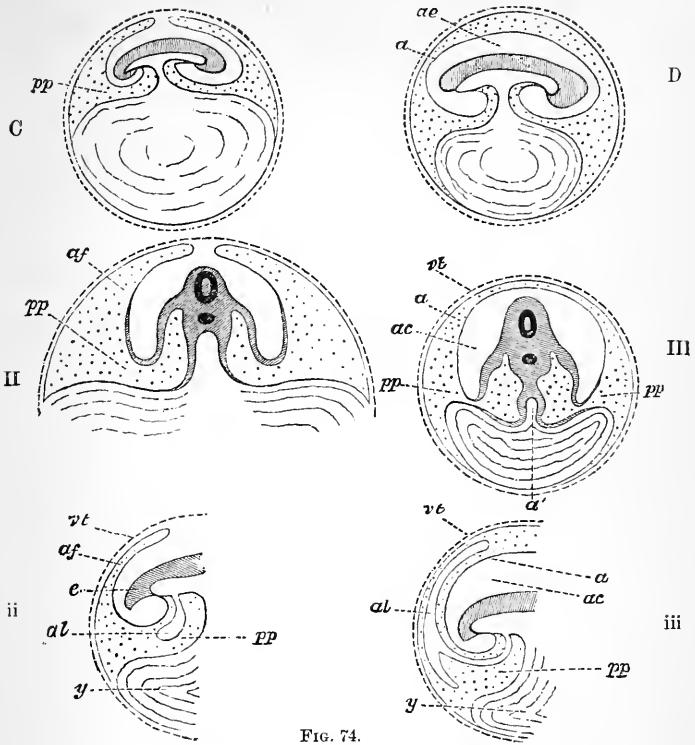

FIG. 74.

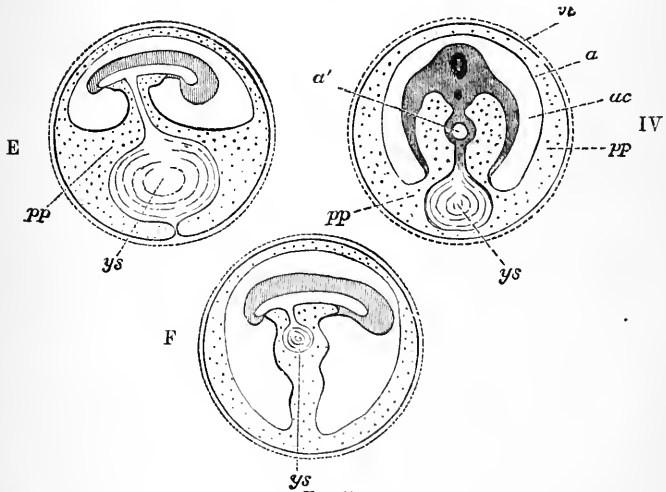

FIG. 75.

yellow-sac (*umbilical vesicle* of the mammalian embryo). The manner in which this takes place will appear upon an inspection of the accompanying figures.

Very early in the history of the embryo two eminences, the head and the tail folds, arise, and, curving over toward each

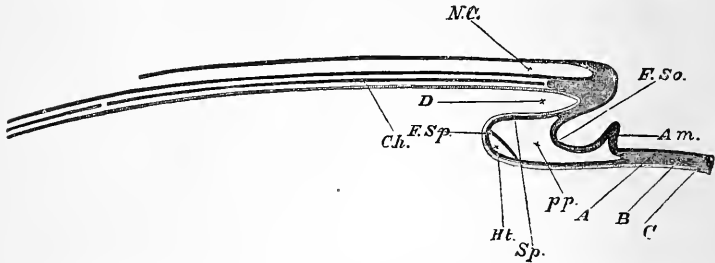

FIG. 76.—Diagrammatic longitudinal section through the axis of an embryo chick (after Foster and Balfour). *N. C.*, Neural canal; *Ch.*, notochord; *Fg*, foregut; *F. So.*, somatopleure; *F. Sp.*, splanchnopleure; *Sp.*, splanchnopleure, forming lower wall of foregut; *Ht.*, heart; *pp.*, pleuroperitoneal cavity; *Am.*, amniotic fold; *E.*, epiblast; *M.*, mesoblast; *H.*, hypoblast.

other, meet after being joined by corresponding lateral folds. Fusion and absorption result at this meeting-point, in the inclosure of one cavity and the blending of two others. These folds constitute the amniotic membranes, the inner of which

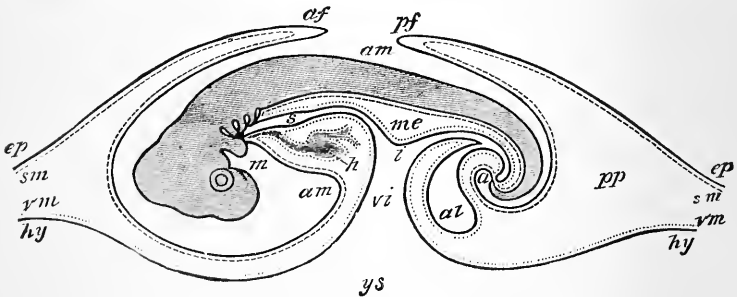

FIG. 77.—Diagrammatic longitudinal section of a chick of the fourth day (after Allen Thomson). *ep.*, epiblast; *hy.*, hypoblast; *sm.*, somatopleure; *vm.*, splanchnopleure; *af.*, *pf.*, folds of the amnion; *pp.*, pleuroperitoneal cavity; *am.*, cavity of the amnion; *al.*, allantois; *a.*, position of the future anus; *h.*, heart; *i.*, intestine; *vi.*, vitelline duct; *ys.*, yolk; *s.*, foregut; *m.*, position of the mouth; *me.*, mesentery.

forms the *true amnion*, the outer the *false amnion* (*serous membrane, subzonal membrane*). Within the amnion proper is the amniotic cavity filled with fluid (*liquor amnii*), while the space between the true and false amniotic folds, which gradually in-

creases in size as the yelk-sac diminishes, forms the *pleuro-peritoneal cavity, body cavity, or cœlom*. The amniotic cavity also extends, so that the embryo is surrounded by it or lies centrally within it. The enlargement of the cœlom and extension of the false amniotic folds lead finally to a similar meeting and fusion like that which occurred in the formation of the true amniotic cavity. The yelk-sac, gradually lessening, is at last withdrawn into the body of the embryo.

Fig. 76 shows how the amniotic head fold arises, from a budding out of the epiblast and mesoblast at a point where the original cell layers of the embryo have separated into two folds, the *somatopleure* or body fold and the *splanchnopleure* or visceral fold, owing to a division or cleavage of the mesoblast toward the long axis of the body. Remembering this, it is always easy to determine by a diagram the composition of any one of the membranes or folds of the embryo, for the components must be epiblast, mesoblast, or hypoblast; thus, the *splanchnopleure* is made up of hypoblast internally and mesoblast externally—a principle of great significance, since, as will be learned later, all the tissues of the body may be classified simply, and at the same time scientifically, according to their embryological origin.

The *allantois* is a structure of much physiological importance. It arises at the same time as the amniotic folds are forming, by a budding or protrusion of the hind-gut into the pleuro-peritoneal cavity, and hence consists of an outgrowth of mesoblast lined by hypoblast.

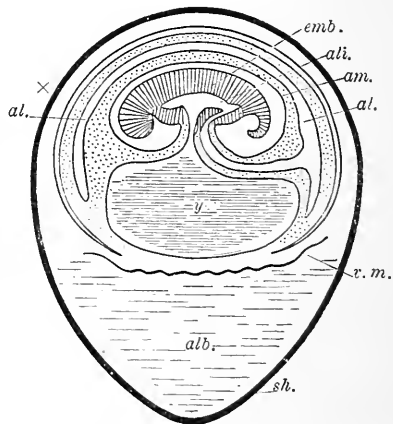

FIG. 78. — Diagrammatic longitudinal section through the egg of a fowl (after Duval). *al.*, cavity of allantois; *alb.*, albumen; *ali.*, mesenteron; *am.*, cavity of amnion; *emb.*, embryo; *sh.*, egg-shell; *r. m.*, vitelline membrane.

THE FŒTAL (EMBRYONIC) MEMBRANES OF MAMMALS.

The differences between the development of the egg membranes of mammals and birds are chiefly such as result from

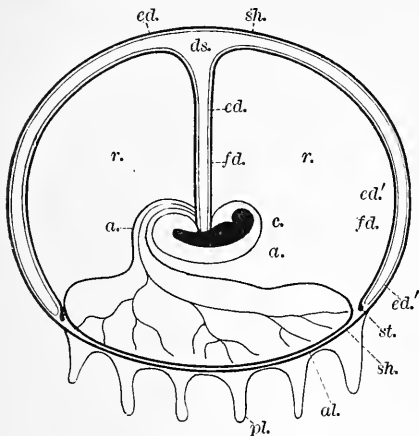

FIG. 79. — Diagrammatic longitudinal section of oöperm of rabbit at an advanced stage of pregnancy (Kölliker, after Bischoff). *a*, amnion; *al*, allantois with its blood-vessels; *e*, embryo; *ds*, yolk-sac; *ed*, *ed'*, *ed''*, hypoblastic epithelium of the yolk-sac and its stalk (umbilical vesicle and cord); *fd*, vascular mesoblastic membrane of the umbilical cord and vesicle; *pl*, placental villi formed by the allantois and subzonal membrane; *r*, space filled with fluid between the amnion, the allantois, and the yolk-sac; *st*, sinus terminalis (marginal vitelline blood-vessel); *u*, urachus, or stalk of the allantois.

the absence in the former of an egg-shell and its membranes, and of yelk and albumen. The mammalian ovum is inclosed by a *zona radiata* (*zona pellucida*) surrounded by another very delicate covering (*vitelline membrane*).

The growth of the *blastodermic vesicle* (yelk-sac) is rapid, and, being filled with fluid, the *zona* is thinned and soon disappears.

The germinal area alone is made up of three layers of cells (Fig. 100), the rest of the upper part of the oöperm being lined with epiblast and hypoblast, while the lower

zone of the yelk-sac consists of epiblast only.

Simple, non-vascular villi, serving to attach the embryo to the uterine walls, usually project from the epiblast of the subzonal membrane. In the rabbit they do not occur everywhere, but only in that region of the epiblast beneath which the mesoblast does not extend, with the exception of a patch which soon appears and demarkates the site of the future placenta. The amnion and allantois are formed in much the same way as has been described for the chick.

At about the same period as these events are transpiring the vascular yelk-sac has become smaller, and the allantois with its abundant supply of blood-vessels is becoming more promi-

ment, and extending between the amnion and subzonal membrane.

The formation of the *chorion* marks an important step in the development of mammals in which it plays an important functional part. It is the result of the fusion of the allantois, which is highly vascular, with the subzonal membrane, the villi of which now become themselves vascular and more complex in other respects.

An interesting resemblance to birds has been observed (by Osborn) in the opossum (Fig. 83). When the allantois is small the blastodermic vesicle (yolk-sac) has vascular villi, which in all probability not only serve the purpose of attaching the embryo to the uterine wall but derive nourishment, not as in

birds, from the albumen of the ovum, but directly in some way from the uterine wall of the mother. It will be remembered that the opossum ranks low in the mammalian scale, so that this resemblance is the more significant from an evolutionary point of view.

The term *chorion* is now restricted to those regions of the subzonal membrane to which either the yolk-sac or the allantois is attached. The former zone has been distinguished as the false chorion and the latter as the true chorion. In the rabbit the false chorion is very large (Fig. 79), and the true (placental) chorion very small in comparison, but the reverse is the case in most mammals. It will be noted that in both birds and mammals the allantois is a nutritive organ. Usually the more prominent and persistent the yolk-sac, the less so

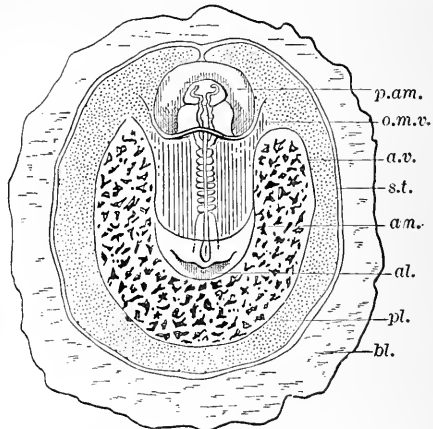

FIG. 80.—Diagrammatic dorsal view of an embryo rabbit with its membranes at the stage of nine somites (Haddon, after Van Beneden and Julin). *al.*, allantois, showing from behind the tail fold of the embryo; *am.*, anterior border of true amnion; *a. v.*, area vasculosa, the outer border of which indicates the farthest extension of the mesoblast; *bl.*, blastoderm, here consisting only of epiblast and hypoblast; *o. m. v.*, omphalo-mesenteric or vitelline veins; *p. am.*, proamnion; *pl.*, non-vascular epiblastic villi of the future placenta; *s. t.*, sinus terminalis.

the allantois, and *vice versa*; they are plainly supplementary organs.

The Allantoic Cavity.—The degree to which the various embryonic membranes fuse together is very variable for different groups of mammals, including our domestic species.

In ruminants, but especially in solipeds, the allantois as it grows spreads itself over the inner surface of the subzonal

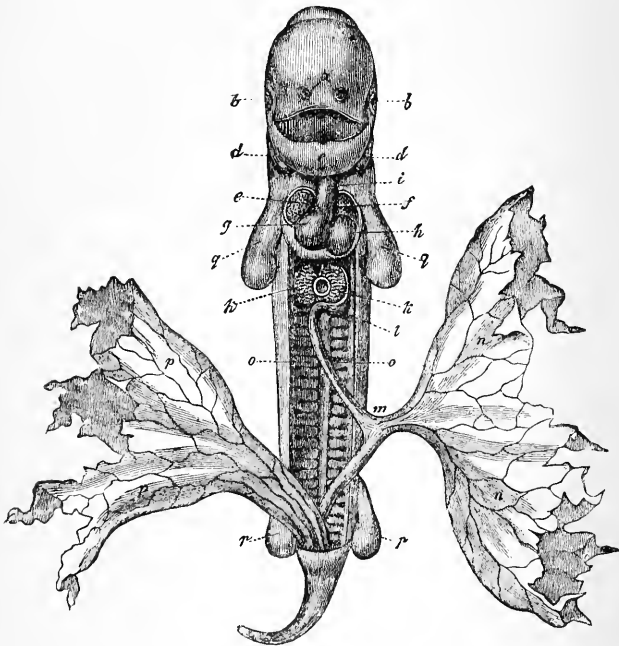

FIG. 81.—Embryo of dog, twenty-five days old, opened on the ventral side. Chest and ventral walls have been removed. *a*, nose-pits; *b*, eyes; *c*, under-jaw (first gill-arch); *d*, second gill-arch; *e*, *f*, *g*, *h*, heart (*e*, right, *f*, left auricle; *g*, right, *h*, left ventricle); *i*, aorta (origin of); *k*, *k*, liver (in the middle between the two lobes is the cut yolk-vein); *l*, stomach; *m*, intestine; *n*, yolk-sac; *o*, primitive kidneys; *p*, allantois; *q*, fore-limbs; *h*, hind-limbs. The crooked embryo has been stretched straight. (Haeckel, after Bischoff.)

membrane, often spoken of as the “chorion,” while it also covers, though capable of easy detachment, the outer surface of the amnion; and thus is formed the allantoic cavity. The portion of the allantois remaining finally within the foetus becomes the bladder, which during embryonic life communicates by its contracted portion (*urachus*) with the general amniotic cavity.

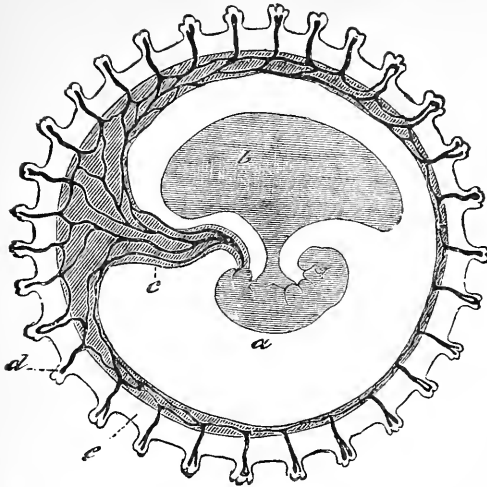

FIG. 82.—Diagram of an embryo showing the relations of the vascular allantois to the villi of the chorion (Cadiat). *e*, embryo lying in the cavity of the amnion; *ys.*, yolk-sac; *al*, allantois; *A.T.*, allantoic vessels dipping into the villi of the chorion; *ch.*, chorion.

In the mare especially these parts can be readily distinguished. From the connection of the portion that ultimately forms the bladder with the main sac, as indicated above, there is ground for regarding the allantoic fluid in the later stages of gestation, at all events, as a sort of urine.

This fluid is at an early period abundant and colorless, later yellowish, and finally brown. Since at one time it contains albumen and sugar, it may serve some purpose in the nutrition of the foetus.

When most suggestive of urine in the latest stages of gestation, it contains

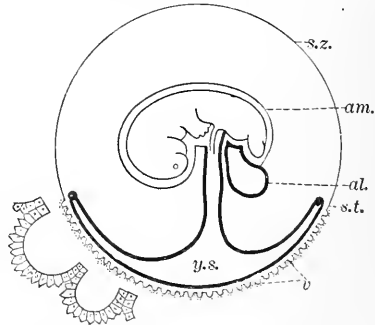

FIG. 83.—Diagram of the fetal membranes of the Virginian opossum (Haddon, after Osborn). Two villi are shown greatly enlarged. The processes of the cells, which have been exaggerated, doubtless correspond to the pseudopodia described by Caldwell. *al.*, allantois; *am.*, amnion; *s.t.*, sinus terminalis; *s.z.*, subzonal membrane; *v.*, villi on the subzonal membrane in the region of the yolk-sac; *ys.*, yolk-sac. The vascular splanchnopleure (hypoblast and mesoblast) is indicated by the black line.

a characteristic body, *allantoin*, related to uric acid, urea, etc.

Certain bodies, being probably inspissated allantoic fluid, have been termed "hippomanes." They may either float free in the fluid or be attached to the allantois by a slender pedicle.

The relation of the parts described above will become clearer after a study of the accompanying cuts and those of preceding pages, in which the allantois is figured.

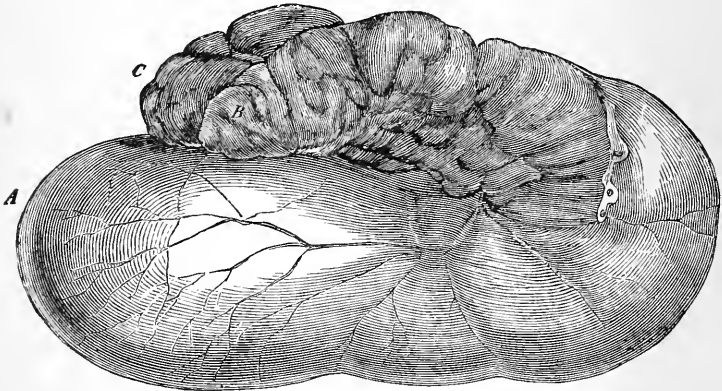

FIG. 84.—Exterior of chorial sac; mare. (Chauveau.) A, body; B. C. cornua.

The Placenta.—This structure, which varies greatly in complexity, may be regarded as the result of the union of structures existing for a longer or shorter period, free and largely independent of each other. With evolution there is differentiation and complication, so that the placenta usually marks the site where structures have met and fused, differentiating a new organ; while corresponding atrophy, obliteration, and fusion take place in other regions.

All placentas are highly vascular, all are villous, all discharge similar functions in providing the embryo with nourishment and eliminating the waste of its cell-life (metabolism). In structural details they are so different that classifications of mammals have been founded upon their resemblances and differences. They will now be briefly described.

In marsupials the yolk-sac is both large and vascular; the allantois small but vascular; the former is said (Owen) to be attached to the subzonal membrane, the latter not; but no villi, and consequently no true chorion, is developed. All mammals

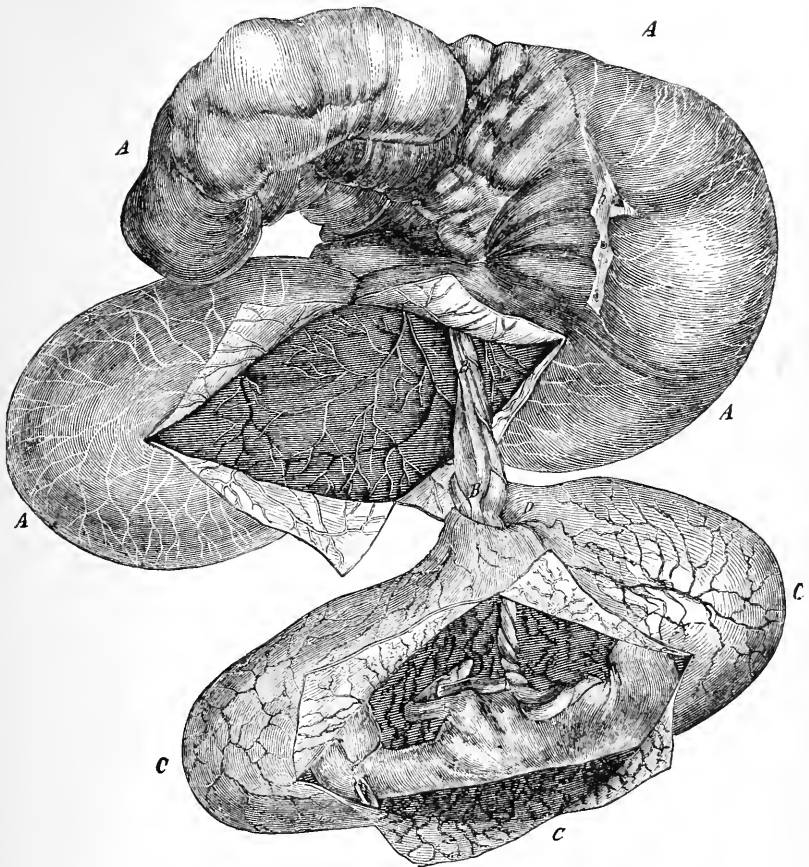

FIG. 85.—Fœtus of mare with its envelopes. (Chauveau.) A, chorion; C, amnion removed from allantoic cavity and opened to expose fetus; D, infundibulum of urachus; B, allantoic portion of umbilical cord.

other than the monotremes and marsupials have a true allantoic placenta.

The Discoidal Placenta.—This form of placenta is that existing in the rodentia, insectivora, and cheiroptera. The condition found in the rabbit is that which has been most studied. The relation of parts is shown in Fig. 79.

The uterus of the rodent is two-horned; so we find in general several embryos in each horn in the pregnant rabbit. They are functionally independent, each having its own set of

membranes. It will be observed from the figure that the true villous chorion is confined to a comparatively small region; there is, however, in addition a false chorion without villi, but highly vascular. This blending of forms of placentation which exist separately in different groups of animals is significant. In the rabbit at a later stage there is considerable intermingling of foetal and maternal parts.

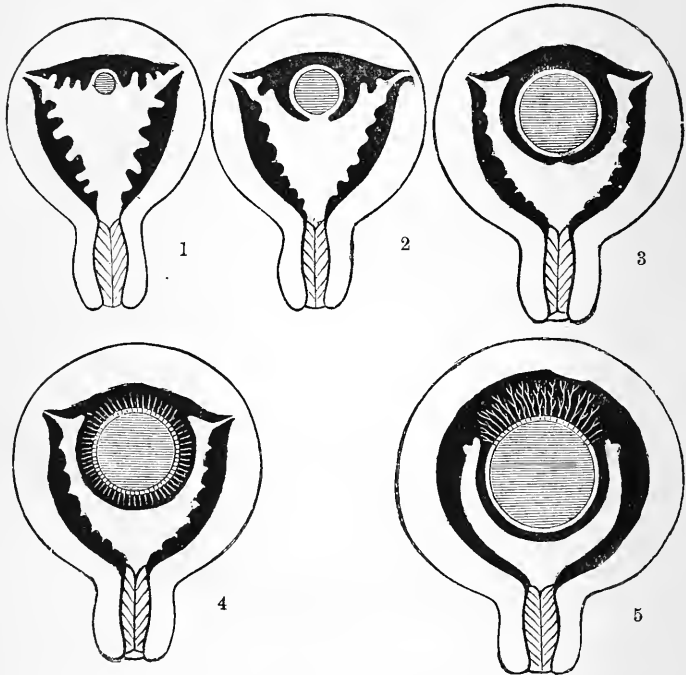

FIG. 86.—Series of diagrams representing the relations of the decidua to the ovum, at different periods, in the human subject. The decidua are dark, the ovum shaded transversely. In 4 and 5 the chorionic vascular processes are figured (after Dalton). 1. Ovum resting on the decidua serotina; 2. Decidua reflexa growing round the ovum; 3. Completion of the decidua around the ovum; 4. Villi, growing out all around the chorion; 5. The villi, specially developed at the site of the future placenta, having atrophied elsewhere.

The Metadiscoidal Placenta.—This type, which, in general naked-eye appearances, greatly resembles the former, is found in man and the apes. The condition of things in man is by no means as well understood as in the lower mammals, especially in the early stages; so that, while the following account is that

usually given in works on embryology, the student may as well understand that our knowledge of human embryology in the very earliest stages is incomplete and partly conjectural. The reason of this is obvious: specimens for examination depending on accidents giving rise to abortion or sudden death, often not reaching the laboratory in a condition permitting of trustworthy inferences.

It is definitely known that the ovum, which is usually fertilized in the oviduct (Fallopian tube), on entering the uterus becomes adherent to its wall and encapsuled. The mucous membrane of the uterus is known to undergo changes, its component parts increasing by cell multiplication, becoming intensely vascular and functionally more active. The general mucous surface shares in this, and is termed the *decidua vera*; but the locality where the ovum lodges is the seat of the greatest manifestation of exalted activity, and is termed the *decidua serotina*; while the part believed to have invested the ovum by

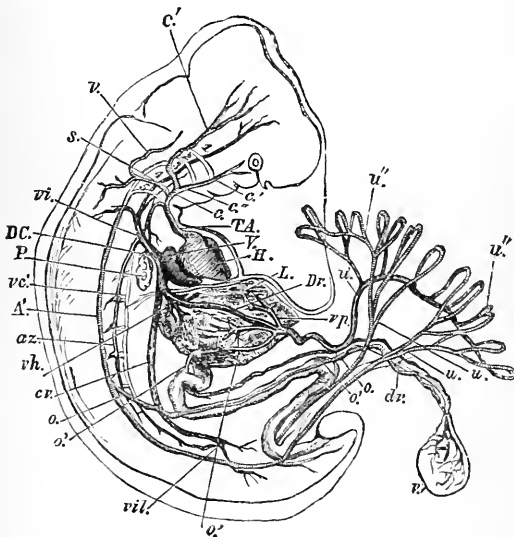

FIG. 87.—Vascular system of the human fetus, represented diagrammatically (Huxley). *H*, heart; *T.A.* aortic trunk; *c*, common carotid artery; *c'*, external carotid artery; *c''*, internal carotid artery; *s*, subclavian artery; *v*, vertebral artery; 1, 2, 3, 4, 5, aortic arches; *A'*, dorsal aorta; *o*, omphalo-mesenteric artery; *dr*, vitelline duct; *o'*, omphalo-mesenteric vein; *v'*, umbilical vesicle; *vp*, portal vein; *L*, liver; *u*, *u*, umbilical arteries; *u''*, *u''*, their endings in the placenta; *u'*, umbilical vein; *Dr*, ductus venosus; *vh*, hepatic vein; *cr*, inferior vena cava; *vil*, iliac veins; *az*, vena azygos; *vc'*, posterior cardinal vein; *DC*, duct of Cuvier; *P*, lung.

fused growths from the junction of the decidua vera and serotina is the *decidua reflexa*.

The decidua serotina and reflexa thus become the outermost of all the coverings of the ovum. These and some other developments are figured below. It is to be remembered, however, that they are highly diagrammatic, and represent a mixture of inferences based, some of them, on actual observation and others on analogy, etc.

The figures will convey some information, though appearances in all such cases must be interpreted cautiously for the reasons already mentioned.

During the first fourteen days villi appear over the whole surface of the ovum; about this fact there is no doubt. At the end of the first month of foetal life, a complete chorion has been formed, owing, it would seem, to the growth of the allantois (its mesoblast only) beneath the whole surface of the subzonal membrane. From the chorionic surface vascular processes clothed with epithelium project like the plush of velvet. The allantois is compressed and devoid of a cavity, but abundantly supplied with blood-vessels by the allantoic arteries and veins, which of course terminate in capillaries in the villi. Compare the whole series of figures.

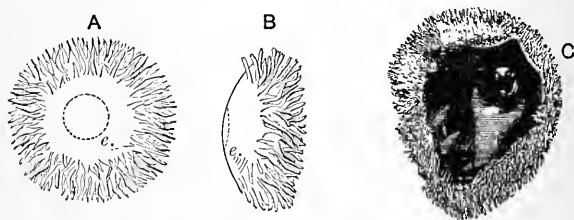

FIG. 88.—Human ova during early stages of development. A and B, front and side view of an ovum supposed to be about thirteen days old; *e*, embryonic area (Quain, after Reichert); C, ovum of four to five weeks, showing the general structure of the ovum before formation of the placenta. Part of the wall of the ovum is removed to show the embryo in position (after Allen Thomson).

At this stage the condition of the chorion suggests the type of the diffuse placenta which is normal for certain groups of animals, as will presently be learned.

The subsequent changes are much better understood, for parts are in general no longer microscopic but of considerable size, and their real structure less readily obscured or obliterated.

The amniotic cavity continues to enlarge by growth of the walls of the amnion and is kept filled with a fluid; the yelk-sac

is now very small ; the decidua reflexa becomes almost non-vascular, and fuses finally with the decidua vera and the chorion, which except at one part has ceased to be villous and vascular ; so that becoming thinner and thinner with the advance of pregnancy, the single membrane, arising practically from

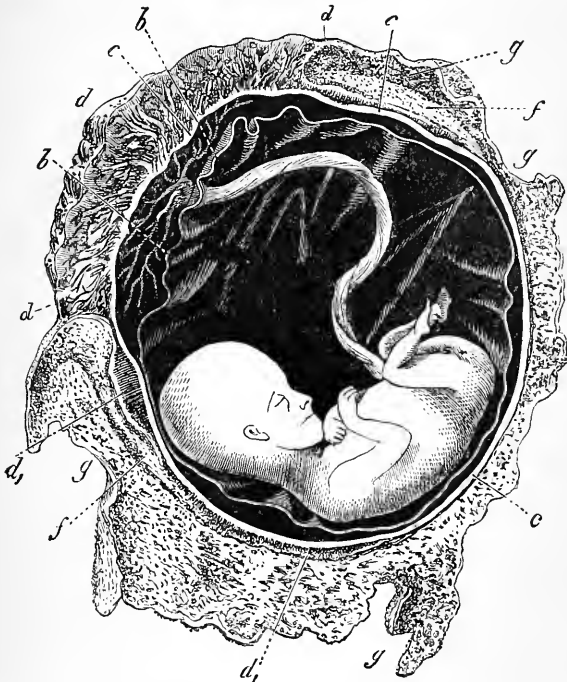

FIG. 89.—Human embryo, twelve weeks old, with its coverings; natural size. The navel-cord passes from the navel to the placenta. *b*, amnion; *c*, chorion; *d*, placenta; *d'*, remains of tufts on the smooth chorion; *f*, decidua reflexa (inner); *g*, decidua vera (outer). (Haeckel after Bernhard Schultze.)

this fusion of several, is of a low type of structure, the result of gradual degeneration, as the rôle they once played was taken up by the other parts.

But of paramount importance is the formation of the *placenta*. The chorion ceases to be vascular except at the spot at which the villi not only remain, but become more vascular and branch into arborescent forms of considerable complexity. It is discoidal in form, made up of a foetal part just described and a maternal part, the decidua serotina, the two becoming blended

so that the removal of one involves that of more or less of the others. The connection of parts is far closer than that described

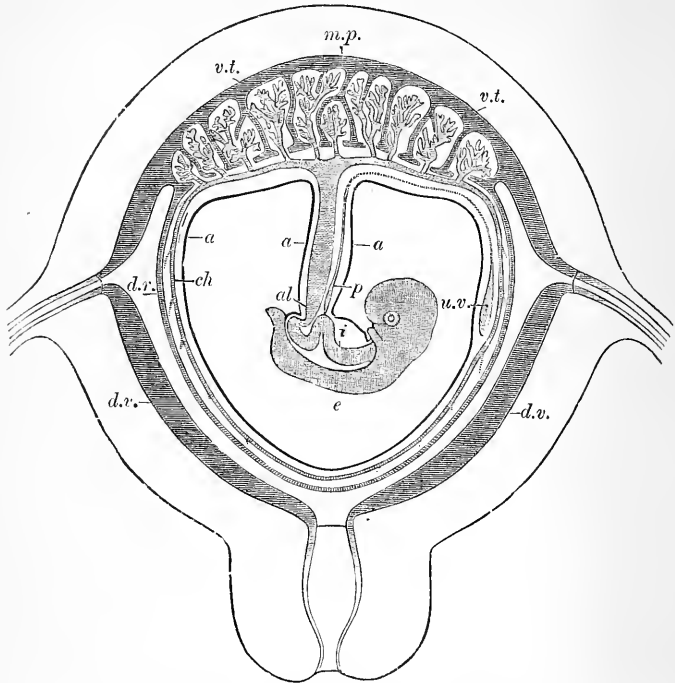

FIG. 90.—Diagram illustrating the decidua, placenta, etc. (after Liégeois). *e*, embryo; *i*, intestine; *p*, pedicle of the umbilical vesicle; *u. v.*, umbilical vesicle; *a*, amnion; *ch*, chorion; *v. t.*, vascular tufts of the chorion, constituting the foetal portion of the placenta; *m. p.*, maternal portion of the placenta; *d. v.*, decidua vera; *d. r.*, decidua reflexa; *al*, allantois.

for the rabbit; and, even with the preparation that Nature makes for the final separation of the placenta from both foetus and mother, this event does not take place without some rupture of vessels and consequent hæmorrhage.

It is difficult to conceive of the great vascularity of the human placenta without an actual examination of this structure itself, which can be done after being cast off to great advantage when floating in water; by which simple method also the thinness and other characteristics of the membranes can be well made out.

The great vessels conveying the foetal blood to and from the

placenta are reduced to three, two arteries and one vein. The villi of the placenta (chorion) are usually said to hang freely in the blood of the large irregular sinuses of the decidua serotina; but this is so unlike what prevails in other groups of animals that we can not refrain from believing that the statement is not wholly true.

The Zonary Placenta.—In this type the placenta is formed along a broad equatorial belt, leaving the poles free. This form of placentation is exemplified in the carnivora, hyrax, the elephant, etc.

In the dog, for example, the yolk-sac is large, vascular, does not fuse with the chorion, and persists throughout. A rudimentary discoid placenta is first formed, as in the rabbit; this gradually spreads over the whole central area, till only the extremes (poles) of the ovum remain free; villi appear, fitting into pits in the uterine surface, the maternal and foetal parts of the placenta becoming highly vascular and closely approximated. The chorionic zone remains wider than the placental. As in man there is at birth a separation of the maternal as well as foetal part of the placenta—i. e., the latter is deciduate; there is also the beginning of a decidua reflexa.

The Diffuse Placenta.—As found in the horse, pig, lemur, etc., the allantois completely incloses the embryo, and it becomes villous in all parts, except a small area at each pole.

The Polycotyledonary Placenta.—This form is that met with in ruminants, in which case the allantois completely covers the surface of the subzonal membrane, the placental villi being gathered into patches (*chorial cotyledons*), which are equivalent to so many independent placentas. The component villi fit into corresponding pits in the uterine wall (*uterine cotyledons*), which is specially thickened at these points. When examined in a fresh condition, under water, they constitute very beautiful objects. The pits referred to above into which the foetal villi fit are, as shown in the figures on page 91, essentially the same in structure as the villi themselves. In the cow the uterine cotyledons are convex; but in the sheep and goat they are raised concave cups in which the openings for the foetal villi may be seen with the naked eye. The differences are not essential ones.

Between the uterine cotyledons and the foetal villi which fit into them a thickish, milky-looking fluid is found, the "uterine milk" elaborated, no doubt, by the cells which line the cotyledonous pits.

The placentation of certain of our domestic animals may be thus expressed in tabular form (Fleming):

Simple placenta.	{	General.	{	Mare.
				Sow.
		Local and circular.	{	Bitch.
				Cat.
Multiple placenta.			{	Cow.
				Sheep.
				Goat.

Comparing the formation, complete development, and atrophy (in some cases) of the various foetal appendages in mammals, one can not but perceive a common plan of structure, with variations in the preponderance of one part over another here and there throughout. In birds these structures are simpler, chiefly because less blended and because of the presence of much food-yolk, albumen, egg-shell, etc., on the one hand, and the absence of a uterine wall, with which in the mammal the membranes are brought into close relationship, on the other; but, as will be shown later, whatever the variations, they are adaptations to meet common needs and subserve common ends.

MICROSCOPIC STRUCTURE OF THE PLACENTA.

This varies somewhat for different forms, though, in that there is a supporting matrix, minute (capillary) blood-vessels, and epithelial coverings in the foetal and maternal surfaces, the several forms agree.

The pig possesses the simplest form of placenta yet known. The villi fit into depressions or crypts in the maternal uterine mucous membrane. The villi, consisting of a core of connective tissue, in which capillaries abound, are covered with a flat epithelium; the maternal crypts correspond, being composed of a similar matrix, lined with epithelium and permeated by capillary vessels, which constitute a plexus or mesh-work. It thus results that two layers of epithelium intervene between the maternal and foetal capillaries.

The arrangement is substantially the same in the diffuse and the cotyledonary placenta.

In the deciduate placenta, naturally, there is greater complication.

In certain forms, as in the fox and cat, the maternal tissue shows a system of trabeculae assuming a meshed form, in which run dilated capillaries. These, which are covered with

a somewhat columnar epithelium, are everywhere in contact with the foetal villi, which are themselves covered with a flat epithelium.

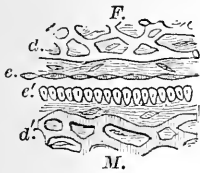

FIG. 91.

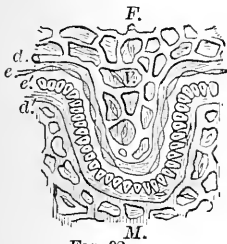

FIG. 92.

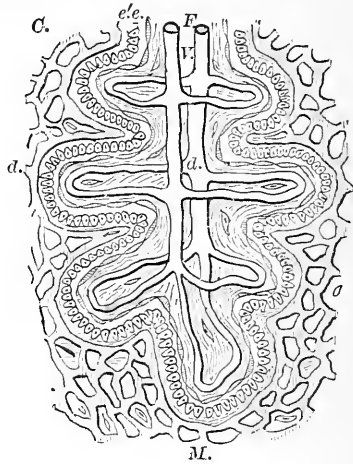

FIG. 93.

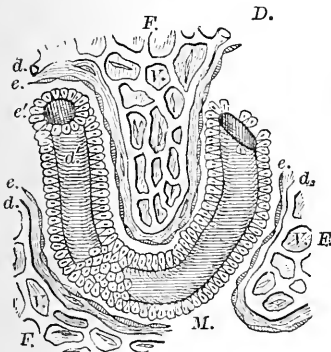

FIG. 94.

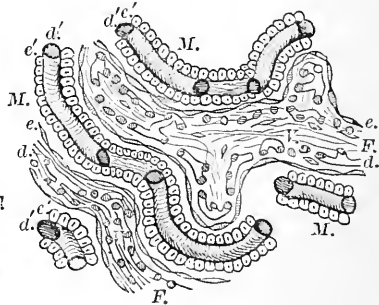

FIG. 95.

FIGS. 91 to 97.—Diagrammatic representation of the minute structure of the placenta (Foster and Balfour, after Turner). *F*, foetal; *M*, maternal placenta; *e*, epithelium of chorion; *e'*, epithelium of maternal placenta; *d*, foetal blood-vessels; *d'*, maternal blood-vessels; *v*, villus.

FIG. 91.—Placenta in most generalized form.

FIG. 92.—Structure of placenta of a pig.

FIG. 93.—Of a cow.

FIG. 94.—Of a fox.

FIG. 95.—Of a cat.

In the case of the sloth, with a more discoidal placenta, the dilatation of capillaries and the modification of epithelium are greater.

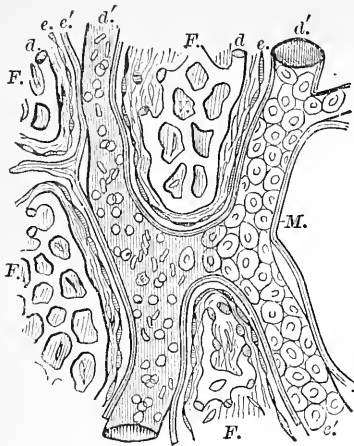

FIG. 96.—Placenta of a sloth. Flat maternal epithelial cells shown in position on right side; on left they are removed and dilated; maternal vessel with its blood-corpuscles exposed.

In the placenta of the apes and of the human subject the most marked departure from simplicity is found. The maternal vessels are said to constitute large intercommunicating sinuses; the villi may hang freely suspended in these sinuses, or be anchored to their walls by strands of tissue. There is believed to be only one layer of epithelial cells between the vessels of mother and foetus in the later stages of pregnancy. This, while closely investing the foetal vessels (capillaries), really belongs to the maternal structures. The signifi-

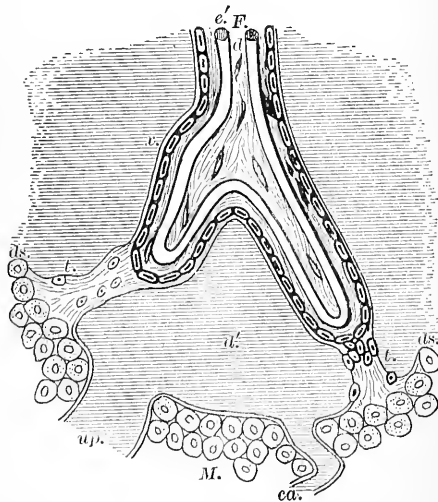

FIG. 97.—Structure of human placenta; *ds*, decidua serotina; *t*, trabeculae of serotina passing to foetal villi; *ca*, curling artery; *up*, utero-placental vein; *a*, prolongation of maternal tissue on exterior of villus, outside cellular layer *e'*, which may represent either endothelium of maternal blood-vessels or delicate connective tissue of the serotina or both; *e'*, maternal cells of the serotina.

cance of this general arrangement will be explained in the chapter on the physiological aspects of the subject.

It remains to inquire into the relation of these forms to one another from a phylogenetic (derivative) point of view, or to trace the evolution of the placenta.

Evolution.—Passing by the lowest mammals, in which the placental relations are as yet imperfectly understood, it seems clear that the simplest condition is found in the rodentia. Thus, in the rabbit, as has been described, both yelk-sac and allantois take a nutritive part; but the latter remains small. In forms above the rodents, the allantois assumes more and more importance, becomes larger, and sooner or later predominates over the yelk-sac.

The discoidal, zonary, cotyledonary, etc., are plainly evolutions from the diffuse, for both differentiation of structure and integration of parts are evident. The human placenta seems to have arisen from the diffuse form; and it will be remembered that it is at one period represented by the chorion with its villi distributed universally.

The resemblance of the embryonic membranes at any early stage in man and other mammals to those of birds certainly suggests an evolution of some kind, though exactly along what lines that has taken place it is difficult to determine with exactness; however, as before remarked, nearly all the complications of the higher forms arise by concentration and fusion, on the one hand, and atrophy and disappearance of parts once functionally active, on the other.

Summary.—The ovum is a typical cell; unspecialized in most directions, but so specialized as to evolve from itself complicated structures of higher character. The segmentation of the ovum is usually preceded by fertilization, or the union of the nuclei of male and female cells, which is again preceded by the extrusion of polar globules. In the early changes of the ovum, including segmentation, periods of rest and activity alternate. The method of segmentation has relation to the quantity and arrangement of the food-yelk. Ova are divisible generally into completely segmenting (holoblastic), and those that undergo segmentation of only a part of their substance (meroblastic): but the processes are fundamentally the same.

Provision is made for the nutrition, etc., of the ovum, when fertilized (oö sperm) by the formation of yelk-sac and allantois; as development proceeds, one becomes more prominent

than the other. The allantois may fuse with adjacent membranes and form at one part a condensed and hypertrophied chorion (placenta), with corresponding atrophy elsewhere. The arrangement of the placenta varies in different groups of animals so constantly as to furnish a basis for classification. Whatever the variations in the structure of the placenta, it is always highly vascular; its parts consist of villi fitting into crypts in the maternal uterine membrane—both the villi and the crypts being provided with capillaries supported by a connective-tissue matrix covered externally by epithelium. The placenta in its different forms would appear to have been evolved from the diffuse type.

The peculiarities of the embryonic membranes in birds are owing to the presence of a large food-yolk, egg-shell, and egg-membranes; but throughout, vertebrates follow in a common line of development, the differences which separate them into smaller and smaller groups appearing later and later. The same may be said of the animal kingdom as a whole. This seems to point clearly to a common origin with gradual divergence of type.

THE DEVELOPMENT OF THE EMBRYO ITSELF.

We now turn to the development of the body of the animal for which the structures we have been describing exist. It is important, however, to remember that the development of parts, though treated separately for the sake of convenience, really goes on together to a certain extent; that new structures do not appear suddenly but gradually; and that the same law applies to the disappearance of organs which are being superseded by others. To represent this completely would require lengthy descriptions and an unlimited number of cuts; but with the above caution it is hoped the student may be able to avoid erroneous conceptions, and form in his own mind that series of pictures which can not be well furnished in at least the space we have to devote to the subject. But, better than any abstract statements or pictorial representations, would be the examination of a setting of eggs day by day during their development under a hen. This is a very simple matter, and, while the making and mounting of sections from hardened specimens is valuable, it may require more time than the student can spare; but it is neither so valuable nor so easily accomplished as what we have indicated; for, while the lack of sections made by the student may be made up in part by the exhibition to him of a set of specimens permanently mounted or even by plates, nothing can, in our opinion, take the place of the examination of eggs as we have suggested. It prepares for the study of the development of the mammal, and exhibits the membranes in a simplicity, freshness, and beauty which impart a knowledge that only such direct contact with nature can supply. To proceed with great simplicity and very little apparatus, one requires but a forceps, a glass dish or two, a couple of watch-glasses, or a broad section-lifter (even a case-knife will answer), some water, containing just enough salt to be tasted, rendered lukewarm (blood-heat).

Holding the egg longitudinally, crack it across the center transversely, gently and carefully pick away the shell and its

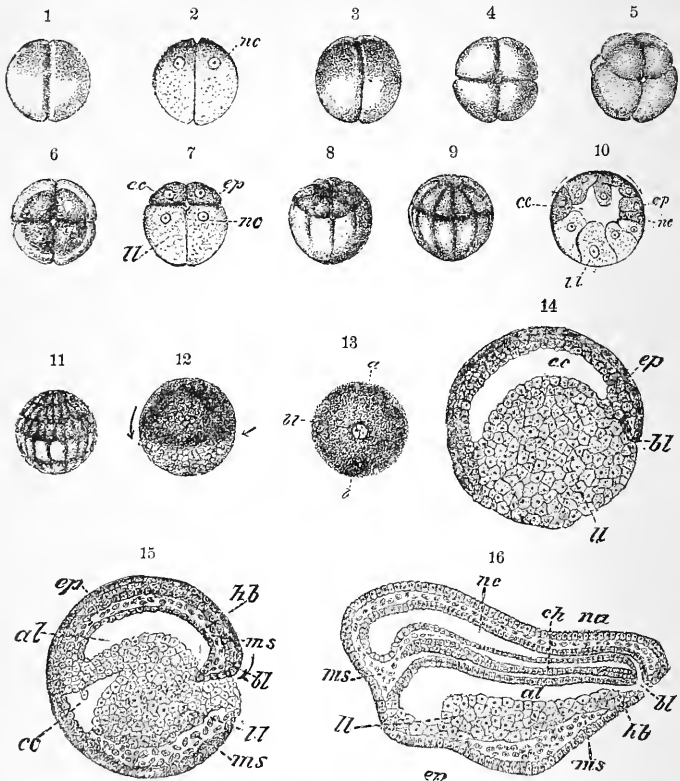

FIG. 98.—Various stages in the development of the frog from the egg (after Howes). 1. The segmenting ovum, showing first cleavage furrow. 2. Section of the above at right angles to the furrow. 3. Same, on appearance of second furrow, viewed slightly from above. 4. The latter seen from beneath. 5. The same, on appearance of first horizontal furrow. 6. The same, seen from above. 7. Longitudinal section of 6. 8 and 9. Two phases in segmentation, on appearance of fourth and fifth furrows. 10. Longitudinal vertical section at a slightly later stage than the above. 11. Later stage. Upper pigmented pole dividing more rapidly than lower. 12. Later phase of 11. 13. Longitudinal vertical section of 12. 14. Segmenting ovum at blastopore stage. 15. Longitudinal vertical section of same. 13 and 15 $\times 10$ (all others $\times 5$). 16. Longitudinal vertical section of embryo at a stage later than 14 (1×10). *nc*, nucleus; *c. c.*, cleavage cavity; *ep*, epiblast; *l. l.*, yolk-bearing lower-layer cells; *bl*, blastopore; *al*, archenteron (mid-gut); *hb*, hypoblast; *ms*, undifferentiated mesoblast; *ch*, notochord; *n. a.*, neural (cerebro-spinal) axis.

membranes, when the blastoderm may be seen floating upward, as it always does. It should be well examined in position,

using a hand lens, though this is not essential to getting a fair knowledge; in fact, if the examination goes no further than the naked-eye appearances of a dozen eggs, selecting one every twenty-four hours during incubation, when opened and the shell and membranes well cleared away, such a knowledge will be supplied as can be obtained from no books or lectures however good. It will be, of course, understood that the student approaches these examinations with some ideas gained from plates and previous reading. The latter will furnish a sort of biological pabulum on which he may feed till he can supply for himself a more natural and therefore more healthful one. While these remarks apply with a certain degree of force to all the departments of physiology, they are of special importance to aid the constructive faculty in building up correct notions of the successive rapid transformations that occur in the development of a bird or mammal.

Fig. 99 shows the embryo of the bird at a very early period, when already, however, some of the main outlines of structure are marked out. Development in the fowl is so rapid that a few days suffice to outline all the principal organs of the body. In the mammal the process is slower, but in the main takes place in the same fashion.

As the result of long and pa-

not essential to getting a fair

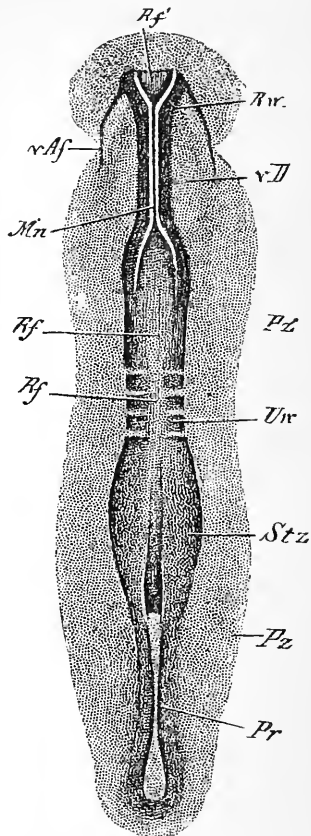

FIG. 99.—Embryo fowl 3 mm. long, of about twenty-four hours, seen from above. 1 × 39. (Haddon, after Kölliker.) *Mn*, union of the medullary folds in the region of the hind-brain; *Pr*, primitive streak; *Pz*, parietal zone; *Rf*, posterior portion of widely open neural groove; *Rf'*, anterior part of neural groove; *Rr*, neural ridge; *Stz*, trunk-zone; *vAf*, anterior amniotic fold; *vD*, anterior umbilical sinus showing through the blastoderm. His divides the embryonic rudiment into a central trunk-zone and a pair of lateral or parietal zones.

tient observation, it is now settled that all the parts of the most complicated organism arise from the three-layered blastoderm previously figured ; every part may be traced back as arising in one or other of these layers of cells—the epiblast, mesoblast, or hypoblast. It frequently happens that an organ is made up of cells derived from more than one layer. Structures may, accordingly, be classified as epiblastic, mesoblastic, or hypoblastic; for, when two strata of cells unite in the formation of any part, one is always of subordinate importance to the other: thus the digestive organs are made up of mesoblast as well as hypoblast, but the latter constitutes the essential secreting cell mechanism. As already indicated, the embryonic membranes are also derived from the same source.

The *epiblast* gives rise to the skin and its appendages (hair, nails, feathers, etc.), the whole of the nervous system, and the chief parts of the organs of special sense.

The *mesoblast* originates the vascular system, the skeleton, all forms of connective tissue including the framework of glands, the muscles, and the epithelial (endothelial) structures covering serous membranes.

The *hypoblast* furnishes the secreting cells of the digestive tract and its appendages—as the liver and pancreas—the lining epithelium of the lungs, and the cells of the secreting mucous membranes of their framework of bronchial tubes.

It is difficult to overrate the importance of these morphological generalizations for the physiologist ; for, once the origin of an organ is known, its function and physiological relations generally may be predicted with considerable certainty. We shall

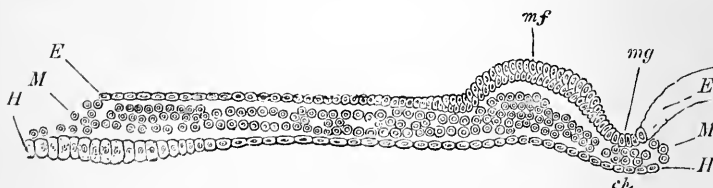

FIG. 100.—Transverse section through the medullary groove and half the blastoderm of a chick of eighteen hours (Foster and Balfour). *E*, epiblast; *M*, mesoblast; *H*, hypoblast; *mf*, medullary fold; *mg*, medullary groove; *ch*, notochord.

endeavor to make this prominent in the future chapters of this work.

Being prepared with these generalizations, we continue our study of the development of the bird's embryo. Before the end

of the first twenty-four hours such an appearance as that represented in Fig. 100 is presented.

The mounds of cells forming the medullary folds are seen coming in contact to form the *medullary (neural) canal*.

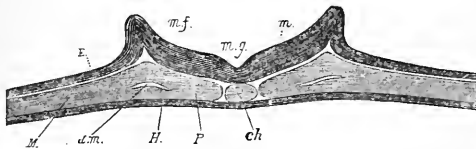

FIG. 101.—Transverse section of embryo chick at end of first day (after Kölliker). *M*, mesoblast; *H*, hypoblast; *m*, medullary plate; *E*, epiblast; *m.g.*, medullary groove; *m.f.*, medullary fold; *ch*, chorda dorsalis; *P*, protovertebral plate; *d.m.*, division of mesoblast.

The *notochord*, marking out the future bony axis of the body, may also be seen during the first day as a well-marked linear extension, just beneath the medullary groove. The cleav-

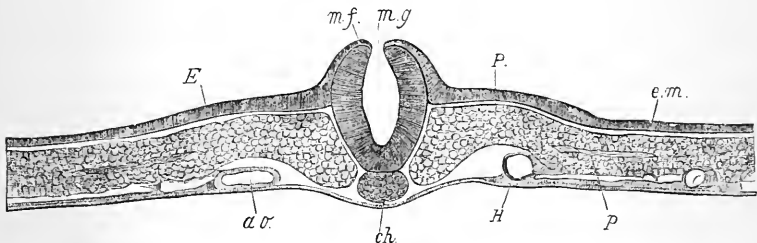

FIG. 102.—Transverse section of chick at end of second day (Kölliker). *E*, epiblast; *H*, hypoblast; *e.m.*, external plate of mesoblast dividing (cleavage of mesoblast); *m.f.*, medullary fold; *m.g.*, medullary groove; *ao*, aorta; *p*, pleuroperitoneal cavity; *P*, protovertebral plate.

age of the mesoblast, resulting in the commencement of the formation of *somatopleure* (body-fold) and the *splanchnopleure* (visceral fold), is also an early and important event. These give rise between them to the *pleuro-peritoneal cavity*. The portions of mesoblast nearest the neural canal form masses (*vertebral plates*) distinct from the thinner outer ones (*lateral plates*). The vertebral plates, when distinctly marked off, as represented in the figure, are termed the *protovertebræ* (*mesoblastic somites*), and represent the future vertebræ and the voluntary muscles of the trunk; the former arising from the inner subdivisions, and the latter from the outer (*muscle-plates*). It will be understood that the protovertebræ are the results of

transverse division of the columns of mesoblast that formed the vertebral plates.

Before the permanent vertebræ are formed, a reunion of the original protovertebræ takes place as one cartilaginous pillar, followed by a new segmentation midway between the original divisions.

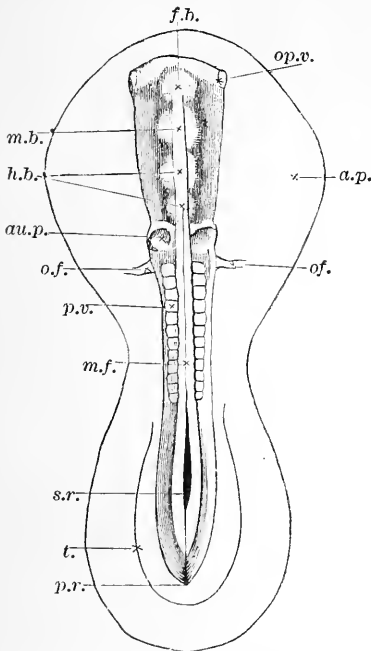

FIG. 103.—Embryo of chick, between thirty and thirty-six hours, viewed from above as an opaque object (Foster and Balfour). *f. b.*, forebrain; *m. b.*, midbrain; *h. b.*, hindbrain; *op. v.*, optic vesicle; *au. p.*, auditory pit; *o. f.*, vitelline vein; *p. v.*, mesoblastic somite; *m. f.*, line of function of medullary folds above; medullary canal; *s. r.*, sinus rhomboidalis; *t.*, tail-fold; *p. r.*, remains of primitive groove; *a. p.*, area pellucida.

It is thus seen that a large number of structures either appear or are clearly outlined during the first day of incubation: the primitive streak, primitive groove, medullary plates and groove, the neural canal, the head-fold, the cleavage of the mesoblast, the protovertebræ, with traces of the amnion and area opaca.

During the *second* day nearly all the remaining important structures of the chick are marked out, while those that arose during the first day have progressed. Thus, the medullary folds close; there is an increase in the number of protovertebræ; the formation of a tubular heart and the great blood-vessels; the appearance of the Wolffian duct; the progress of the head region; the appearance of the

three cerebral vesicles at the anterior extremity of the neural canal; the subdivision of the first cerebral vesicle into the optic vesicles and the beginnings of the cerebrum; the auditory pit arising in the third cerebral vesicle (hind-brain); cranial flexure commences; both head and tail folds become more distinct; the heart is not only formed, but its curvature becomes more marked and rudiments of auricles arise; while outside

the embryo itself the circulation of the yelk-sac is established, the allantois originates, and the amnion makes rapid progress.

It may be noticed that the cerebral vesicles, the optic vesicles, and the auditory pit are all derived from the epiblastic accumulations which occur in the anterior extremity of the embryo; and their early appearance is prophetic of their physiological importance.

The heart, too, so essential for the nutrition of the embryo, by distributing a constant blood-stream, is early formed, and becomes functionally active. It arises beneath the hind-end of the fore-gut, at the point of divergence of the folds of the

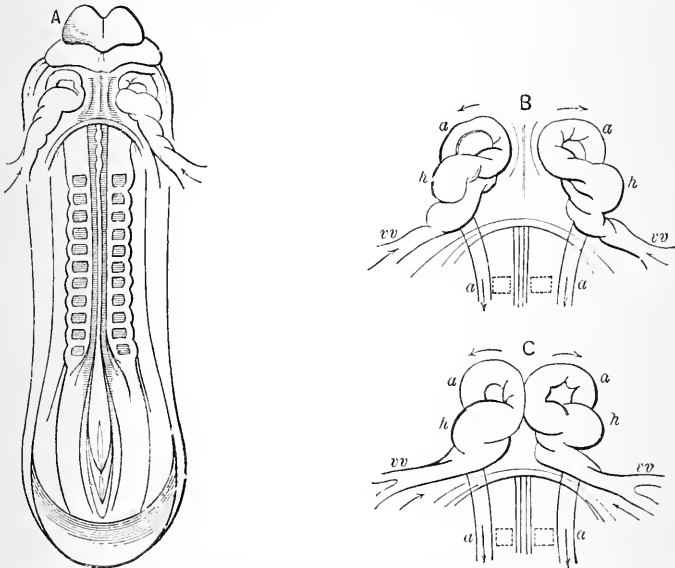

FIG. 104.—Diagram representing under surface of an embryo rabbit of nine days and three hours old, illustrating development of the heart (after Allen Thomson). A, view of the entire embryo; B, an enlarged outline of the heart of A; C, later stage of the development of B; *h h*, ununited heart; *a a*, aortae; *v v*, vitelline veins.

splanchnopleure, and so lies within the pleuro-peritoneal cavity, and is derived from the mesoblast. At the beginning the heart consists of two solid columns ununited in front at first; later, these fuse, in part, so that they have been compared with an inverted Y, in which the heart itself would correspond to the lower stem of the letter (λ) and the great veins (vitelline) to its main limbs. The solid cords of mesoblast become

hollow prior to their coalescence, when the two tubes become one.

The entire blood-vascular system originates in the mesoblast of the area opaca especially; at first appearing in isolated spots

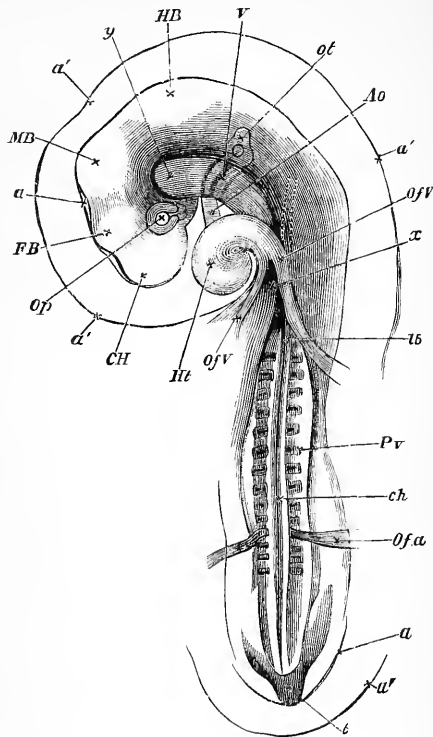

FIG. 105.—Chick on third day, seen from beneath as a transparent object, the head being turned to one side (Foster and Balfour). *a'*, false amnion; *a*, amnion; *CH*, cerebral hemisphere; *FB*, *MB*, *HB*, anterior, middle, and posterior cerebral vesicles; *OP*, optic vesicle; *ot*, auditory vesicle; *OfV*, omphalo-mesenteric veins; *Ht*, heart; *Ao*, bulbus arteriosus; *ch*, notochord; *Of.a*, omphalo-mesenteric arteries; *Pv*, protovertebrae; *α*, point of divergence of the splanchnopleural folds; *y*, termination of the fore-gut, *V*.

which come together as actual vessels are formed. The student who will pursue the plan of examining a series of incubating eggs will be struck with the early rise and rapid progress of the vascular system of the embryo, which takes, when complete, such a form as is represented diagrammatically in Fig. 109.

The blood and the blood-vessels arise simultaneously from

the cells of the mesoblast by outgrowths of nuclear proliferation, and in the case of vessels (Fig. 143) extension of processes, fusion, and excavation.

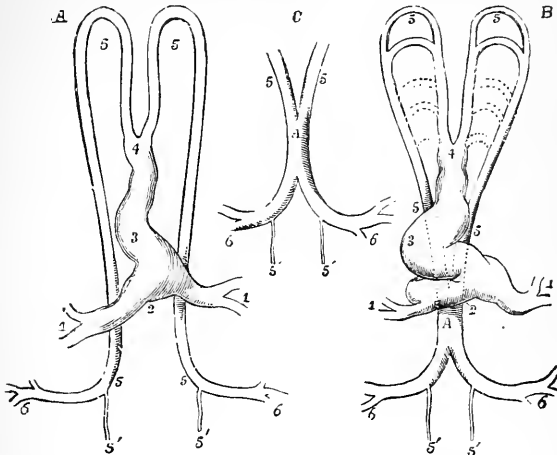

FIG. 106.—Diagram of the heart and principal arteries of the chick (Quain). A represents an earlier and B and C later stages. 1, 1, omphalo-mesenteric veins; 2, auricle; 3, ventricle; 4, aortic bulb; 5, 5, primitive aortæ; 6, 6, omphalo-mesenteric arteries; A, united aortæ.

The *fore-gut* is formed by the union of the folds of the splanchnopleure from before backward, and the hind-gut in a similar manner by fusion from behind forward.

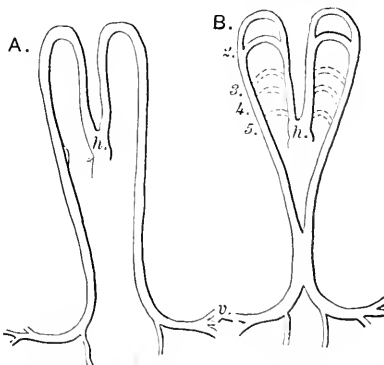

FIG. 107.—Diagrammatic outlines of the early arterial system of the mammalian embryo (after Allen Thomson). A. At a period corresponding to the thirty-sixth or thirty-eighth hour of incubation. B. Later stage, with two pairs of aortic arches. h, bulbus arteriosus of heart; v, vitelline arteries; 1—5, the aortic arches. The dotted lines indicate the position of the future arches.

The excretory system is also foreshadowed at an early period by the Wolffian duct (Fig. 110), a mass of mesoblast cells near which the cleavage of the mesoblast takes place.

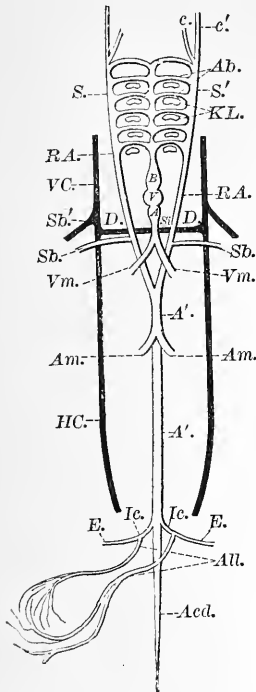

FIG. 108.—Diagram of the embryonic vascular system (Wiedersheim). *A*, atrium; *A'*, *A'*, dorsal aorta; *Ab.*, branchial vessels; *Acd.*, caudal artery; *All.*, allantoic (hypogastric) arteries; *Am.*, vitelline arteries; *B.*, bulbus arteriosus; *c.*, *c'*, external and internal carotids; *D.*, ductus Cuvieri (precaval veins); *E.*, external iliac arteries; *H. C.*, posterior cardinal vein; *Ic.*, common iliac arteries; *K. L.*, gill clefts; *R. A.*, right and left roots of the aorta; *S.*, *S'*, branchial collecting trunks or veins; *Sb.*, subclavian artery; *Sb'*, subclavian vein; *Sv.*, sinus venosus; *V.*, ventricle; *VC.*, anterior cardinal vein; *Vm.*, vitelline veins.

During the latter part of the second day the vascular system, including the heart, makes great progress. The latter, in consequence of excessive growth and the alteration of the relative position of other parts, becomes bent up on itself, so that it presents a curve to the right which represents the venous part, and one to the left, answering to the arterial. The rudiments of the auricles also are to be seen.

The arterial system is represented at this stage by the expanded portion of the heart known as the *bulbus arteriosus*, and two extensions from it, the aortæ, which, uniting above the alimentary canal, form a single posterior or dorsal aorta. From these great arterial vessels the lesser ones arise, and by subdivision constitute that great mesh-work represented diagrammatically in Figs. 108, 109, from which the course of the circulation may be gathered. The beating of the heart commences before the corpuscles have become numerous, and while the tubular system, through which the blood is to be driven, is still very incomplete.

The events of the *third* day are of the nature of the extension of parts already marked out rather than the formation of entirely new ones. The following are the principal changes: The bending of the head-end downward (cranial flexure); the turning of the embryo so that it lies on its left side; the completion of the vitelline circulation; the in-

crease in the curvature of the heart and its complexity of structure by divisions; the appearance of additional aortic arches and of the cardinal veins; the formation of four visceral clefts and five visceral arches; a series of progressive changes in

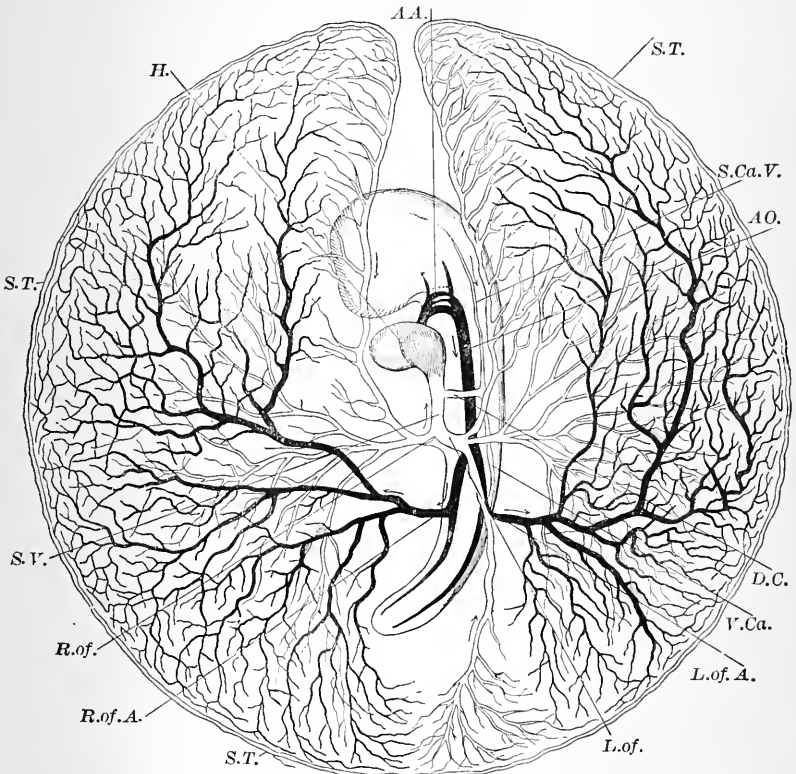

FIG. 109.—Diagram of circulation of yolk-sac at end of third day (Foster and Balfour). Blastoderm seen from below. Arteries made black. *H.*, heart; *A.A.*, second, third, and fourth aortic arches; *A.O.*, dorsal aorta; *L.of.A.*, left vitelline artery; *R.of.A.*, right vitelline artery; *S.T.*, sinus terminalis; *L.of.*, left vitelline vein; *R.of.*, right vitelline vein; *S.V.*, sinus venosus; *D.C.*, ductus Cavieri; *S.Ca.V.*, superior cardinal or jugular vein; *V.Ca.*, inferior cardinal vein.

the organs of the special senses, such as the formation of the lens of the eye and a secondary optic vesicle; the closing in of the optic vesicle; and the formation of the nasal pits. In the region of the future brain, the vesicles of the cerebral hemispheres become distinct; the hind-brain separates into cere-

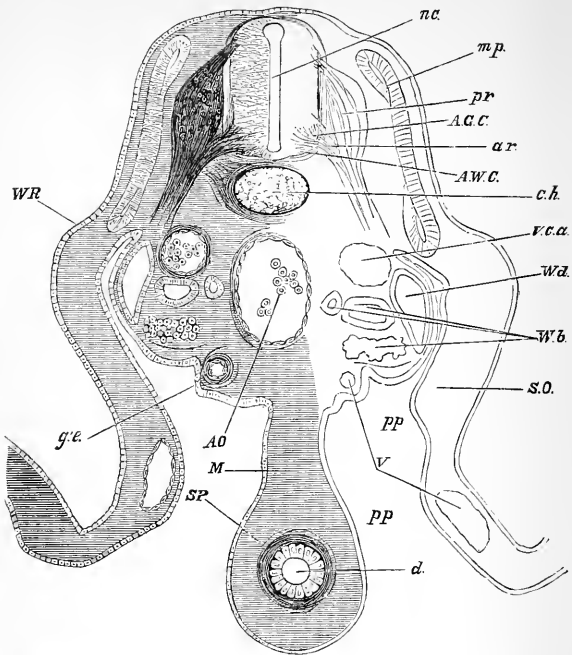

FIG. 110.

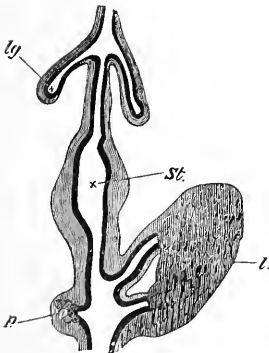

FIG. 111.

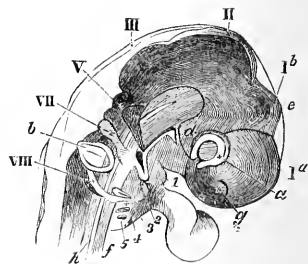

FIG. 112.

FIG. 110.—Transverse section through lumbar region of an embryo at end of fourth day (Foster and Balfour). *n. c.*, neural canal; *pr*, posterior root of spinal nerve with ganglion; *ar*, anterior root; *A. G. C.*, anterior gray column of spinal cord; *A. W. C.*, anterior white column in course of formation; *m. p.*, muscle-plate; *c. h.*, notochord; *WR*, Wolffian ridge; *A. O.*, dorsal aorta; *v. c. a.*, posterior cardinal vein; *W. d.*, Wolffian duct; *W. b.*, Wolffian body, consisting of tubules and Mal-

pighian corpuscles; *g. e.*, germinal epithelium; *d.*, alimentary canal; *M.*, commencing mesentery; *S. O.*, somatopleure; *S.P.*, splanchnopleure; *V.*, blood-vessels; *pp.*, pleuroperitoneal cavity.

FIG. 111.—Diagram of portion of digestive tract of chick on fourth day (after Götte). The black line represents hypoblast; the shaded portion, mesoblast; *lg.*, lung diverticulum, expanding at bases into primary lung vesicle; *st.*, stomach; *l.*, liver; *p.*, pancreas.

FIG. 112.—Head of chick of third day, viewed sidewise as a transparent object (Huxley). *Ia.*, cerebral hemispheres; *Ib.*, vesicle of third ventricle; II, mid-brain; III, hind-brain; *a.*, optic vesicle; *g.*, nasal pit; *b.*, otic vesicle; *d.*, infundibulum; *e.*, pineal body; *h.*, notochord; *V.*, fifth nerve; VII, seventh nerve; VIII, united glossopharyngeal and pneumogastric nerves. 1, 2, 3, 4, 5, the five visceral folds.

bellum and medulla oblongata; the nerves, both cranial and spinal, bud out from the nervous centers. The alimentary canal enlarges, a fore-gut and hind-gut being formed, the former being divided into œsophagus, stomach, and duodenum; the latter into the large intestine and the cloaca. The lungs arise from the alimentary canal in front of the stomach; from similar diverticula from the duodenum, the liver and pancreas originate. Changes in the protovertebræ and muscle-plates continue, while the Wolffian bodies are formed and the Wolffian duct modified.

Up to the third day the embryo lies mouth downward, but now it comes to lie on its left side. See Fig. 105 with the accompanying description, it being borne in mind that the view is from below, so that the right in the cut is the left in the em-

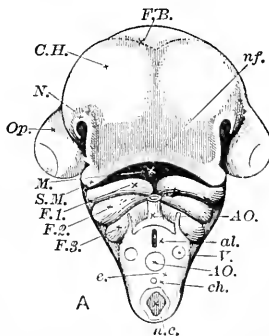

FIG. 113.—Head of chick of fourth day, viewed from below as an opaque object (Foster and Balfour). The neck is cut across between third and fourth visceral folds. *C. H.*, cerebral hemispheres; *F. B.*, vesicle of third ventricle; *Op.*, eyeball; *nf.*, naso-frontal process; *M.*, cavity of mouth; *S. M.*, superior maxillary process of *F. 1*, the first visceral fold (mandibular arch); *F. 2*, *F. 3*, second and third visceral arches; *N.*, nasal pit.

bryo itself. Fig. 110 gives appearances furnished by a vertical transverse section. The relations of the parts of the digestive tract and the mode of origin of the lungs may be learned from Fig. 111.

An examination of the figures and subjoined descriptions must suffice to convey a general notion of the subsequent prog-

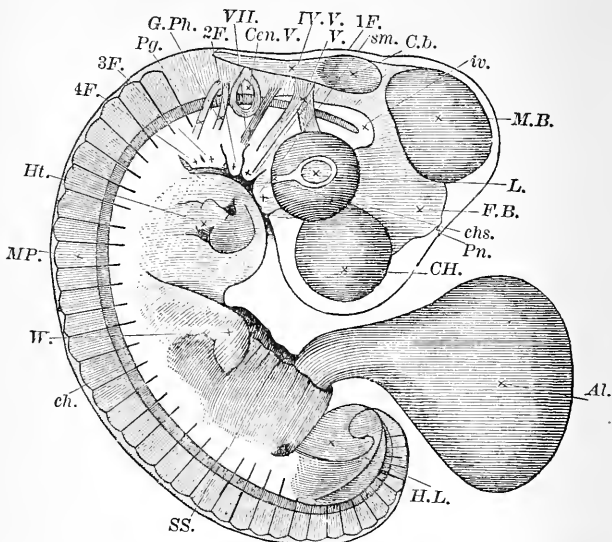

FIG. 114.—Embryo at end of fourth day, seen as a transparent object (Foster and Balfour). *C.H.*, cerebral hemisphere; *F. B.*, fore-brain, or vesicle of third ventricle (thalamencephalon), with pineal gland (*Pn.*) projecting; *M. B.*, mid-brain; *C. b.*, cerebellum; *IV. V.*, fourth ventricle; *L.*, lens; *chs.*, choroid slit; *Cen. V.*, auditory vesicle; *sm.*, superior maxillary process; *1F.*, *2F.*, etc., first, second, etc., visceral folds; *V.*, fifth nerve; *VII.*, seventh nerve; *G. Ph.*, glossopharyngeal nerve; *Pg.*, pneumogastric. The distribution of these nerves is also indicated; *ch.*, notochord; *Ht.*, heart; *MP.*, muscle-plates; *W.*, wing; *H. L.*, hind-limb. The amnion has been removed. *Al.*, allantois protruding from cut end of somatic stalk *SS.*

ress of the embryo. Special points will be considered, either in a separate chapter now, or deferred for treatment in the body of the work from time to time, as they seem to throw light upon the subjects under discussion.

DEVELOPMENT OF THE VASCULAR SYSTEM IN VERTEBRATES.

This subject has been incidentally considered, but it is of such importance morphological, physiological, and pathological, as to deserve special treatment.

In the earliest stages of the circulation of a vertebrate the arterial system is made up of a pair of arteries derived from the single *bulbus arteriosus* of the heart, which, after passing for-

ward, bends round to the dorsal side of the pharynx, each giving off at right angles to the yelk-sac a *vitelline* artery; the aortæ unite dorsally, then again separate and become lost in the posterior end of the embryo. The so-called arches of the aorta are large branches in the anterior end of the embryo derived from the aorta itself.

The venous system corresponding to the above is composed of anterior and posterior pairs of longitudinal (cardinal) veins, the former (jugular, cardinal) uniting with the posterior to form a common trunk (*ductus Cuvieri*) by which the venous blood is returned to the heart. The blood from the posterior part of the yelk-sac is collected by the *vitelline* veins, which terminate in the median *sinus venosus*.

The Later Stages of the Fœtal Circulation.—Corresponding to the number of visceral arches five pairs of aortic arches arise; but they do not exist together, the first two having undergone more or less complete atrophy before the others appear. Figs. 115, 116 convey an idea of how the permanent forms (indicated by darker shading) stand related to the entire system of vessels in different groups of animals. Thus, in birds the right (fourth) aortic arch only remains in connection with the aorta, the left forming the subclavian artery, while the reverse occurs in mammals. The fifth arch (pulmonary) always supplies the lungs.

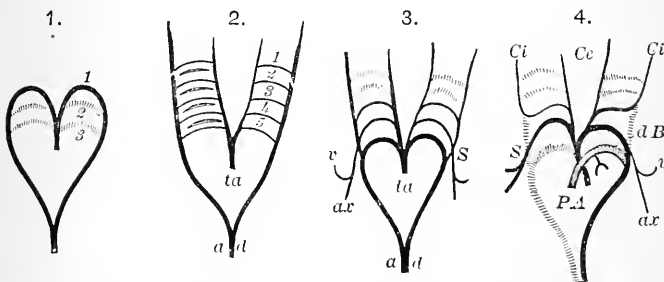

FIG. 115.—Diagrams of the aortic arches of mammal (Landois and Stirling, after Rathke). 1. Arterial trunk with one pair of arches, and an indication where the second and third pairs will develop. 2. Ideal stage of five complete arches; the fourth clefts are shown on the left side. 3. The two anterior pairs of arches have disappeared. 4. Transition to the final stage. *A*, aortic arch; *ad*, dorsal aorta; *ax*, subclavian or axillary artery; *Ce*, external carotid; *Ci*, internal carotid; *dB*, ductus arteriosus Botalli; *P.a*, pulmonary artery; *S*, subclavian artery; *ta*, truncus arteriosus; *v*, vertebral artery.

The arrangement of the principal vessels in the bird, mammal, etc., is represented on page 110. In mammals the two prim-

itive anterior abdominal (*allantoic*) veins develop early and unite in front with the vitelline; but the right allantoic vein and the right vitelline veins soon disappear, while the long common trunk of the allantoic and vitelline veins (*ductus venosus*) passes through the liver, where it is said the ductus venosus gives off and receives branches. The ductus venosus Arantii persists throughout life. (Compare the various figures illustrating the circulation.)

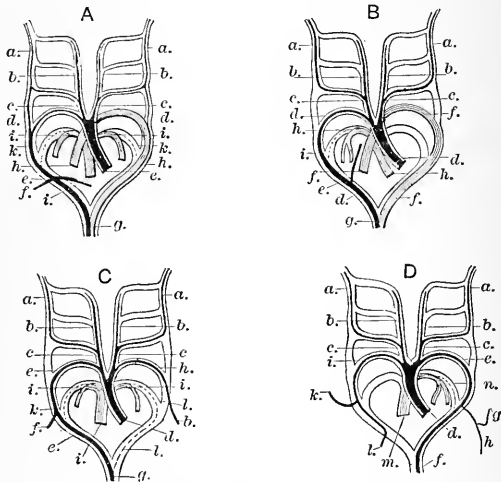

FIG. 116.—Diagram illustrating transformations of aortic arches in a lizard, A; a snake, B; a bird, C; a mammal, D. Seen from below. (Haddon, after Rathke.) *a*, internal carotid; *b*, external carotid; *c*, common carotid. A. *d*, ductus Botalli between the third and fourth arches; *e*, right aortic arch; *f*, subclavian; *g*, dorsal aorta; *h*, left aortic arch; *i*, pulmonary artery; *k*, rudiment of the ductus Botalli between the pulmonary artery and the aortic arches. B. *d*, right aortic arch; *e*, vertebral artery; *f*, left aortic arch; *h*, pulmonary artery; *i*, ductus Botalli of the latter. C. *d*, origin of aorta; *e*, fourth arch of the right side (root of dorsal aorta); *f*, right subclavian; *g*, dorsal aorta; *h*, left subclavian (fourth arch of the left side); *i*, pulmonary artery; *k* and *l*, right and left ductus Botalli of the pulmonary arteries. D. *d*, origin of aorta; *e*, fourth arch of the left side (root of dorsal aorta); *f*, dorsal aorta; *g*, left vertebral artery; *h*, left subclavian; *i*, right subclavian (fourth arch of the right side); *k*, right vertebral artery; *l*, continuation of the right subclavian; *m*, pulmonary artery; *n*, ductus Botalli of the latter (usually termed *ductus arteriosus*).

With the development of the placenta the allantoic circulation renders the vitelline subordinate, the vitelline and the larger mesenteric vein forming the portal. The portal vein at a later period joins one of the *venae advehentes* of the allantoic vein.

At first the vena cava inferior and the ductus venosus enter the heart as a common trunk. The ductus venosus Arantii becomes a small branch of the vena cava.

The allantoic vein is finally represented in its degenerated form as a solid cord (*round ligament*), the entire venous supply of the liver being derived from the portal vein.

The development of the heart has already been traced in the fowl up to a certain point. In the mammal its origin and early progress are similar and its further history may be gathered from the following series of representations.

In the fowl the heart shows the commencement of a division into a right and left half on the third day, and about the fourth week in man, from which fact alone some idea may be gained as to the relative rate of development. The division is effected by the outgrowth of a septum from the ventral wall, which rap-

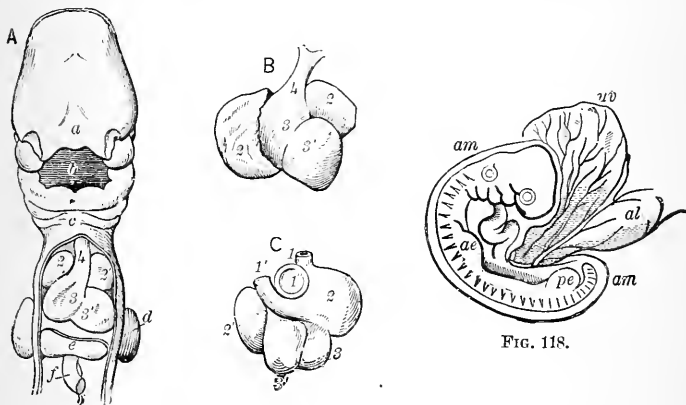

FIG. 117.

FIG. 117.—Development of the heart in the human embryo, from the fourth to the sixth week. A. Embryo of four weeks (Kölliker, after Coste). B, anterior, C, posterior views of the heart of an embryo of six weeks (Kölliker, after Ecker). *a*, upper limit of buccal cavity; *c*, buccal cavity; *b*, lies between the ventral ends of second and third branchial arches; *d*, buds of upper limbs; *e*, liver; *f*, intestine; 1, superior vena cava; 1', left superior vena cava; 1'', opening of inferior vena cava; 2, 2', right and left auricles; 3, 3', right and left ventricles; 4, aortic bulb.

FIG. 118.—Human embryo of about three weeks (Allen Thomson). *uv*, yolk-sac; *al*, allantois; *am*, amnion; *ae*, anterior extremity; *pe*, posterior extremity.

idly reaches the dorsal side, when the double ventricle thus formed communicate by a right and a left auriculo-ventricular opening with the large and as yet undivided auricle. Later an incomplete septum forms similar divisions in the auricle; the aperture (*foramen ovale*) left by the imperfect growth of this wall persisting throughout foetal life.

The Eustachian valve arises on the dorsal wall of the right auricle, between the vena cava inferior and the right and left

venæ cavæ superiores; but in many mammals, among which is man, the left vena cava superior disappears during foetal life.

For the present we may simply say that the histories of the development of the heart, the blood-vessels, and the blood itself are closely related to each other, and to the nature and changes of the various methods in which oxygen is supplied to the blood and tissues, or, in other words, to the development of the respiratory system.

THE DEVELOPMENT OF THE UROGENITAL SYSTEM.

Without knowing the history of the organs, the anatomical relations of parts with uses so unlike as reproduction on the one hand and excretion on the other, can not be comprehended; nor, as will be shortly made clear, the fact that the same part may serve at one time to remove waste matters (urine) and at another the generative elements.

The vertebrate excretory system may be divided into three parts, which result from the differentiation of the primitive kidney which has been effected during the slow and gradual evolution of vertebrate forms:

1. The head-kidney (*pronephros*).
2. The Wolffian body (*mesonephros*).
3. The kidney proper, or *metanephros*.

But in this instance, as in others to some of which allusion has already been made, these three parts are not functional at the same time. The pronephros arises from the anterior part of the segmental duct, pronephric duct, duct of primitive kidney, and archinephric duct, and in the fowl is apparent on the third day; but the pronephros is best developed in the ichthy-

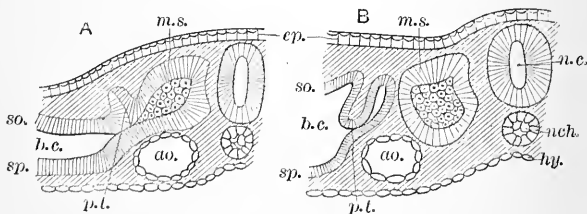

FIG. 119.—Diagrams illustrating development of pronephros in the fowl (Haddon). *ao*, aorta; *b. c.*, body-cavity; *ep.*, epiblast with its epitrichial (flattened) layer; *hy.*, hypoblast; *m. s.*, mesoblastic somite; *n. c.*, neural canal; *nch.*, notochord; *pronephric tubule*; *so.*, somatic, and *sp.*, splanchnic mesoblast.

opsida (fishes and amphibians). A vascular process from the peritoneum (*glomerulus*) projects into a dilated section of the body cavity, which is in part separated from the rest of this cavity (*coelom*). This process, together with the segmental duct, now coiled, and certain short tubes developed from the original duct, make up the pronephros. The segmental duct opens at length into the cloaca.

The *mesonephros* (Wolffian body), though largely developed in all vertebrates during foetal life, is not a persistent excretory organ of adult life.

In the fowl recent investigation has shown that the Wolffian (segmental) tubes originate from outgrowths of the Wolffian

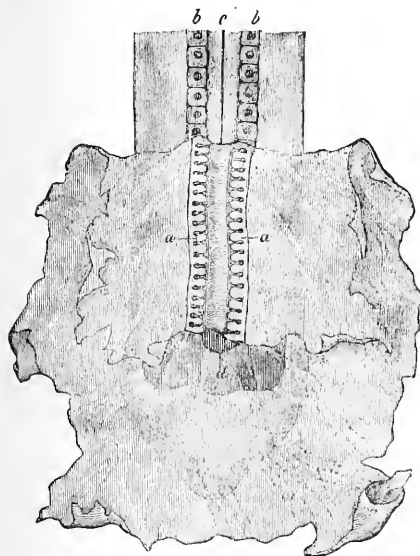

FIG. 120.

FIG. 120.—Rudimentary primitive kidney of embryonic dog. The posterior portion of the body of the embryo is seen from the ventral side, covered by the intestinal layer of the yolk-sac, which has been torn away, and thrown back in front in order to show the primitive kidney ducts with the primitive kidney tubes (*a*). *b*, primitive vertebrae; *c*, dorsal medulla; *d*, passage into the pelvic intestinal cavity. (Haeckel, after Bischoff.)

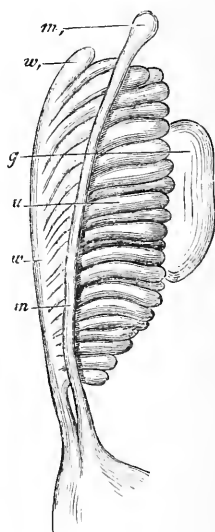

FIG. 121.

FIG. 121.—Primitive kidney of a human embryo. *u*, the urine-tubes of the primitive kidney; *w*, Wolffian duct; *w'*, upper end of the latter (Morgagni's hydatid); *m*, Müllerian duct; *m'*, upper end of the latter (Fallopian's hydatid); *g*, hermaphroditic gland. (After Kobelt.)

duct and also from an intermediate cell-mass, from which latter the Malpighian bodies take rise. The tubes, at first not con-

nected with the duct, finally join it. This organ is continuous with the pronephros; in fact, all three (pronephros, mesonephros, and metanephros) may be regarded as largely continuations one of another.

The *metanephros*, or kidney proper, arises from mesoblast at the posterior part of the Wolffian body. The ureter originates

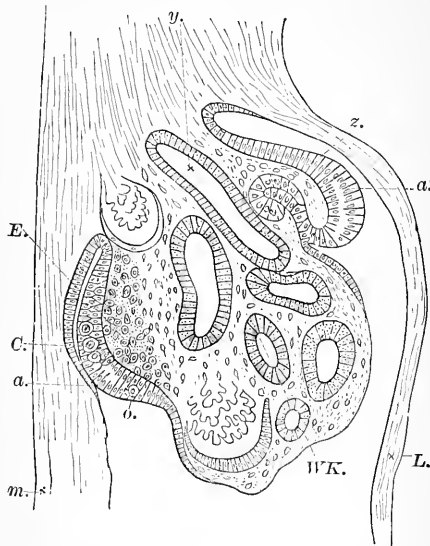

FIG. 122.—Section of the intermediate cell-mass of fourth day (Foster and Balfour, after Waldeyer). 1×160 . *m*, mesentery; *L*, somatopleure; *a'*, portion of the germinal epithelium from the duct of Müller is formed by involution; *a*, thickened portion of the germinal epithelium, in which the primitive ova, *C* and *o*, are lying; *E*, modified mesoblast which will form the stroma of the ovary; *W.K.*, Wolffian body; *y*, Wolffian duct.

first from the hinder portion of the Wolffian duct. In the fowl the kidney tubules bud out from the ureter as rounded elevations. The ureter loses its connection with the Wolffian duct and opens independently into the cloaca.

The following account will apply especially to the higher vertebrates:

The segmental (archinephric) duct is divided horizontally into a dorsal or Wolffian (mesonephric) duct and a ventral or Müllerian duct. The Wolffian duct, as we have seen, develops into both ureter and kidney proper.

To carry the subject somewhat further back, the epithelium

lining the cœlom at one region becomes differentiated into columnar cells (*germinal epithelium*) which by involution into the underlying mesoblast forms a tubule extending from before backward and in close relation with the Wolffian duct, thus forming the Müllerian duct by the process of cleavage and separation referred to previously.

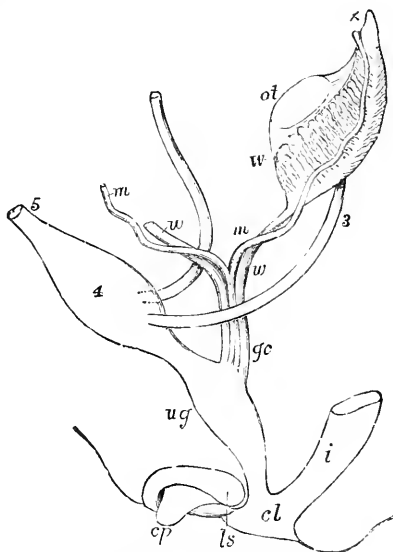

FIG. 123.—Diagrammatic representation of the genital organs of a human embryo previous to sexual distinction (Allen Thomson). *W*, Wolffian body; *gc*, genital cord; *m*, Müllerian duct; *w*, Wolffian duct; *ug*, urogenital sinus; *cp*, clitoris or penis; *i*, intestine; *cl*, cloaca; *ls*, part from which the scrotum or labia majora are developed; *ol*, origin of the ovary or testicle respectively; *x*, part of the Wolffian body developed later into the conii vasculosi; 3, ureter; 4, bladder; 5, urachus.

The future of the Müllerian and Wolffian ducts varies according to the sex of the embryo.

In the male the Wolffian duct persists as the vas deferens; in the female it remains as a rudiment in the region near the ovary (hydatid of Morgagni). In the female the Müllerian duct becomes the oviduct and related parts (uterus and vagina); in the male it atrophies. One, usually the right, also atrophies in female birds. The sinus pocularis of the prostate is the remnant in the male of the fused tubes.

The various forms of the generative apparatus derived from the Müllerian ducts, as determined by different degrees of fu-

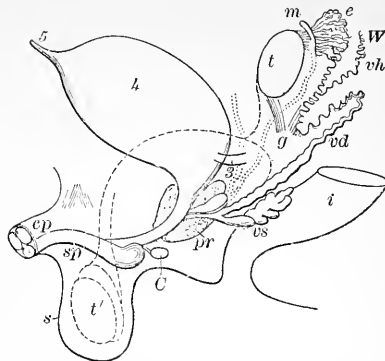

FIG. 124.—Diagram of the mammalian type of male sexual organs (after Quain). Compare with Figs. 123, 125. *C*, Cowper's gland of one side; *cp*, corpora cavernosa penis, cut short; *e*, caput epididymis; *g*, gubernaculum; *l*, rectum; *m*, hydatid of Morgagni, the persistent anterior end of the Müllerian duct, the conjoint posterior ends of which form the uterus masculinus; *pr*, prostate gland; *s*, scrotum; *sp*, corpus spongiosum urethrae; *t*, testis (testicle) in the place of its original formation. The dotted line indicates the direction in which the testis and epididymis change place in their descent from the abdomen into the scrotum; *vd*, vas deferens; *vh*, vas aberrans; *vs*, vascula seminalis; *W*, remnants of Wolffian body (the organ of Giralduc's or paradidymis of Waldeyer); 3, 4, 5, as in Fig. 125.

sion, etc., of parts, may be learned from the accompanying figures.

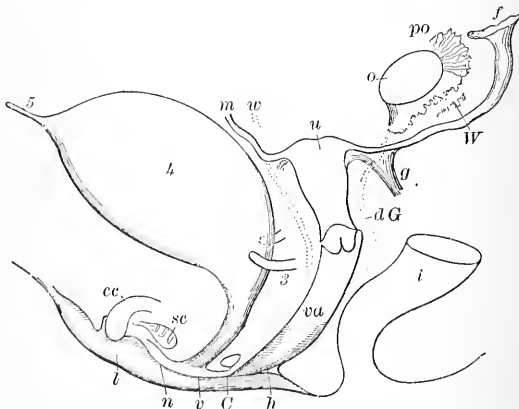

FIG. 125.—Diagram of the mammalian type of female sexual organs (after Quain). The dotted lines in one figure indicate functional organs in the other. *C*, gland of Bartholin (Cowper's gland); *c. c.*, corpus cavernosum clitoridis; *d. G.*, remains of the left Wolffian duct, which may persist as the duct of Gaertner; *f*, abdominal opening of left Fallopian tube; *g*, round ligament (corresponding to the gubernaculum); *h*, hymen; *i*, rectum; *l*, labium; *m*, cut Fallopian tube (oviduct, or Müllerian duct) of the right side; *n*, nymphæ; *o*, left ovary; *po*, parovarium; *sc*, vascular bulb or corpus spongiosum; *u*, uterus; *v*, vulva; *va*, vagina; *W*, scattered remains of Wolffian tubes (paraoöphoron); *m*, cut end of vanished right Wolffian duct; 3, ureter; 4, bladder passing below into the urethra; 5, urachus, or remnant of stalk of allantois.

In both sexes the most posterior portion of the Wolffian duct gives rise to the *metanephros*, or what becomes the permanent kidney and ureter; in the male also to the vas deferens, testicle, vas aberrans, and seminal vesicle.

The ovary has a similar origin to the testicle; the germinal epithelium furnishing the cells, which are transformed into Graafian follicles, ova, etc., and the mesoblast the stroma in which these structures are imbedded.

In the female the parovarium remains as the representative of the atrophied Wolffian body and duct.

The bladder and urachus are both remnants of the formerly extensive allantois. The final forms of the genito-urinary organs arise by differentiation, fusion, and atrophy: thus, the cloaca or common cavity of the genito-urinary ducts is divided

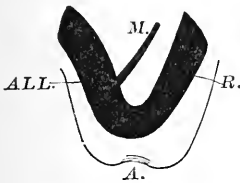

FIG. 126.

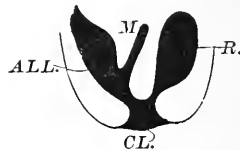

FIG. 127.



FIG. 128.



FIG. 129.

FIGS. 126 to 129.—Diagrams illustrating the evolution of the posterior passages (after Landois and Stirling).

FIG. 126.—Allantois continuous with rectum.

FIG. 127.—Cloaca formed.

FIG. 128.—Early condition in male, before the closure of the folds of the groove on the posterior side of the penis.

FIG. 129.—Early female condition.

A, commencement of proctodæum; ALL, allantois; B, bladder; C, penis; CL, cloaca; M, Müllerian duct; R, rectum; U, urethra; S, vestibule; SU, urogenital sinus; V, vas deferens in Fig. 128, vagina in Fig. 129.

by a septum (the perineum externally) into a genito-urinary and an intestinal (anal) part; the penis in the male and the corresponding clitoris in the female appear in the region of the cloaca, as outgrowths which are followed by extension of folds of integument that become the scrotum in the one sex and the labia in the other.

The urethra arises as a groove in the under surface of the

penis, which becomes a canal. The original opening of the urethra was at the base of the penis.

In certain cases development of these parts is arrested at various stages, from which result abnormalities frequently requiring interference by the surgeon.

The accounts of the previous chapters do not complete the history of development. Certain of the remaining subjects that are of special interest, from a physiological point of view, will be referred to again; and in the mean time we shall consider rather briefly some of the physiological problems of this subject to which scant reference has as yet been made. Though the physiology of reproduction is introduced here, so that ties of natural connection may not be severed, it may very well be omitted by the student who is dealing with embryology for the

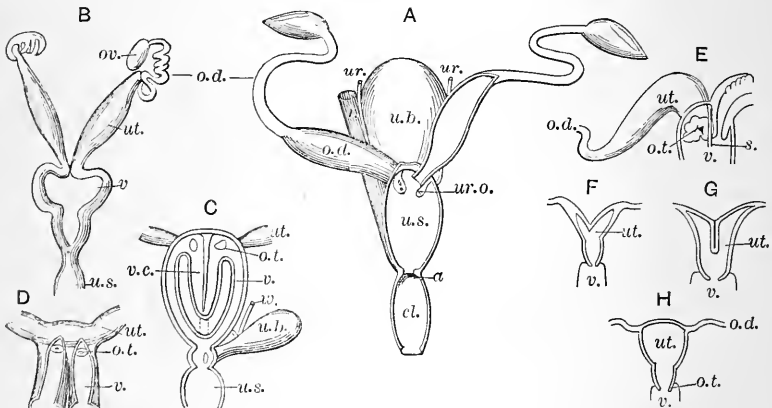

FIG. 130.—Various forms of mammalian uteri. A. *Ornithorhynchus*. B. *Didelphys dorsigera*. C. *Phalangista vulpina*. D. Double uterini and vagina; human anomaly. E. *Lepus cuniculus* (rabbit), uterus duplex. F. Uterus bicornis. G. Uterus bipartitus. H. Uterus simplex (human). *a*, anus; *cl*, cloaca; *o. d.*, oviduct; *o. t.*, os tincae (os uteri); *ov.*, ovary; *v.*, rectum; *s.*, vaginal septum; *u. b.*, urinary bladder; *ur.*, ureter; *ur. o.*, orifice of same; *u. s.*, urogenital sinus; *ut.*, uterus; *v.*, vagina; *v. c.*, vaginal caecum (Haddon).

first time, and in any case should be read again after the other functions of the body have been studied.

THE PHYSIOLOGICAL ASPECTS OF DEVELOPMENT.

According to that law of rhythm which, as we have seen, prevails throughout the world of animated nature, there are periods of growth and progress, of quietude and arrest of devel-

opment ; and in vertebrates one of the most pronounced epochs—in fact, the most marked of all—is that by which the young organism, through a series of rapid stages, attains to sexual maturity.

While the growth and development of the generative organs share to the greatest degree in this progress, other parts of the body and the entire being participate.

So great is the change that it is common to indicate, in the case of the human subject, the developed organism by a new name—the “boy” becomes the “man,” the “girl” the “woman.” Relatively this is by far the most rapid and general of all the transformations the organism undergoes during its extra-uterine life. In this the entire body takes part, but very unequally. The increase in stature is not proportionate to the increase in weight, and the latter is not so great as the change in form. The modifications of the organism are localized and yet affect the whole being. The outlines become more rounded ; the pelvis in females alters in shape ; not only do the generative organs themselves rapidly undergo increased development, but certain related glands (mammæ) participate ; hair appears in certain regions of the body ; the larynx, especially in the male, undergoes enlargement and changes in the relative size of parts, resulting in an alteration of voice (breaking of the voice), etc.—all in conformity with that excess of nutritive energy which marks this biological epoch.

Correlated with these physical changes are others belonging to the intellectual and moral (psychic) nature equally important, and, accordingly, the future being depends largely on the full and unwarped developments of these few years.

Sexual maturity, or the capacity to furnish ripe sexual elements (cells), is from the biological standpoint the most important result of the onset of that period termed, as regards the human species, puberty.

The age at which this epoch is reached varies with race, sex, climate, and the moral influences which envelop the individual. In temperate regions and with European races puberty is reached at from about the thirteenth to the eighteenth year in the female, and rather later in the male, in whom development generally is somewhat slower. Changes analogous to the above occur in all vertebrates. It is at this period that differences of form, voice, disposition, and other physical and psychic characteristics first become pronounced.

As a matter of fact, the pig, sheep, goat, cat, dog, and certain other animals may conceive when less than one year old; and the cow and the mare when under two years.

At such periods these animals are not of course mature and should not be bred.

OVULATION.

In all vertebrates, at periods recurring with great regularity, the generative organs of the female manifest unusual activity. This is characterized by increased vascularity of the ovary and adjacent parts; with other changes dependent on this, and that heightened nerve influence which, in the vertebrate, seems to be inseparable from all important functional changes. Ovulation is the maturation and discharge of ova from the Graafian follicles. The latter, reaching the exterior zone of the ovary, becoming distended and thinned, burst externally and thus free the ovum. The follicles being very vascular at this period, blood escapes, owing to this rupture, into the emptied capsule and clots; and as a result of organization and subsequent degeneration undergoes a certain series of changes dependent on the condition of the ovary and related organs, which varies according as the ovum has been fertilized or not. When fertilization occurs the Graafian follicle undergoes changes of a more marked and lasting character, becoming a *true corpus luteum of pregnancy*.

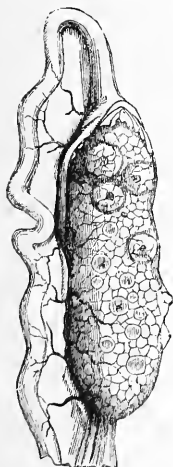

FIG. 131.—Ovary of rabbit at period of oestrus, showing various stages of extrusion of ova. (Chauveau.)

The number of Graafian follicles that mature and the number of ripe ova that escape at about the same period varies, of course, with the species and the individual, and is not always the same in the latter.

In species that usually bear several young at a birth a corresponding number of ova must be ripened and fertilized at about the same time; while the reverse holds for those that usually give birth to but one.

The ovum in the fowl is fertilized in the upper part of the oviduct; in the mammal mostly in this region also, as is shown by the site of the embryos in those groups of animals with a two-horned uterus, and the occasional occurrence of tubal pregnan-

cy in woman. But this is not, in the human subject at least, invariably the site of impregnation. After the ovum has been set free, as above described, it is conveyed into the oviduct (Fallopian tube), though exactly how is still a matter of dispute: some holding that the current produced by the action of the ciliated cells of the Fallopian tube suffices; others that the ovum is grasped by the fimbriated extremity of the tube as part of a co-ordinated act. It is likely, as in so many other instances, that both views are correct but partial; that is to say, both these methods are employed. The columnar ciliated cells, lining the oviduct, act so as to produce a current in the direction of the uterus, thus assisting the ovum in its passage toward its final resting place.

Œstrum.—As a part of the general activity occurring at this time, the uterus manifests certain changes, chiefly in its internal mucous lining, in which thickening and increased vascular-

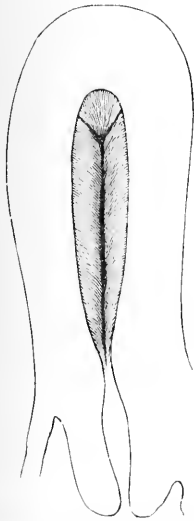

FIG. 132.—Diagram of the human uterus just before menstruation. The shaded portion represents the mucous membrane (Hart and Barbour, after J. Williams).



FIG. 133.—Uterus after menstruation has just ceased. The cavity of the body of the uterus is supposed to have been deprived of mucous membrane (J. Williams).

ity are prominent. A flow of blood from the uterus in the form of a gentle oozing follows; and as the superficial parts of the mucous lining of the uterus undergo softening and fatty degen-

eration, they are thrown off and renewed at these periods (*catamenia, menses*, etc.), provided pregnancy does not take place. In mammals below man, in their natural state, pregnancy does almost invariably take place at such times, hence this exalted activity of the mucous coat of the uterus, in preparation for the reception and nutrition of the ovum, is not often in vain. In the human subject the menses appear monthly; pregnancy may or may not occur, and consequently there may be waste of nature's forces; though there is a certain amount of evidence that menstruation does not wholly represent a loss; but that it is largely of that character among a certain class of women is only too evident. As can be readily understood, the catamenial flow may take place prior to, during, or after the rupture of the egg-capsule.

As the uterus is well supplied with glands, during this period of increased functional activity of its lining membrane, mucus in considerable excess over the usual quantity is discharged; and this phase of activity is continued for a time should pregnancy occur.

All the parts of the generative organs are supplied with muscular tissue, and with nerves as well as blood-vessels, so that it is possible to understand how, by the influence of nerve-centers, the various events of ovulation, menstruation, and those that follow when pregnancy takes place, form a related series, very regular in their succession, though little prominent in the consciousness of the individual animal when normal.

In all animals, without exception, the disturbance of the generative organs during the rutting season (*œstrum*) is accompanied by unusual excitement and special alterations in the temper and disposition, while it may perhaps be said that the whole organism is correspondingly affected.

The frequency of the season of heat or rutting is variable, as also its duration. In most of the domestic animals it lasts but a few days; though in the bitch it may be prolonged for a month.

It is not common for conception to occur in the human subject while the young one is being suckled, and the same remark applies to the domestic animals, though less so, and with considerable variation for different species.

Naturally, the periods of *œstrum* will depend considerably on the occurrence of impregnation and the duration of gestation. It is usual for the mare to be in season in spring and fall,

but, of course, if impregnated in the spring, there will be no autumn œstrum on account of the prolonged period of gestation in this instance; and, similarly, in the case of the cow and other animals.

It is important to recognize that rutting is only the evidence of the maturation of the Graafian follicle within the ovary and of correlated changes.

In a state of nature—i. e., in the case of wild animals—the male experiences a period of sexual excitement corresponding with an increased activity of the sexual organs and at periods answering to the rutting season of the female. In some species the testes descend into the scrotum only at this season. This may be observed in the rabbit. But in our domestic animals, as a class, the male, though capable of copulation at all times, is excited only by the presence of a female in season. It is only at such periods that the approach of the male is permitted by the opposite sex.

THE NUTRITION OF THE OVUM (OÖSPERM).

This will be best understood if it be remembered that the ovum is a cell, undifferentiated in most directions, and thus a sort of amœboid organism. In the fowl it is known that the cells of the primitive germ devour, amœba-like, the yelk-cells, while in the mammalian oviduct the ovum is surrounded by abundance of proteid, which is doubtless utilized in a somewhat similar fashion, as also in the uterus itself, until the embryonic membranes have formed. To speak of the ovum being nourished by diffusion, and especially by osmosis, is an unnecessary assumption, and, as we believe, at variance with fundamental principles; for we doubt much whether any vital process is one of pure osmosis. As soon as the yelk-sac and allantois have been formed, nutriment is derived in great part through the vessel-walls, which, it will be remembered, are differentiated from the cells of the mesoblast, and, it may well be assumed, have not at this early stage entirely lost their amœboid character. The blood-vessels certainly have a respiratory function, and suffice till the more complicated villi are formed. The latter are in the main similar in structure to the villi of the alimentary tract, and are adapted to being surrounded by similar structures of maternal origin. Both the maternal crypts and the foetal villi are, though complementary in shape, all but

identical in minute structure in most instances. In each case the blood-vessels are covered superficially by cells which we can not help thinking are essential in nutrition. The villi are both nutritive and respiratory. It is no more difficult to understand their function than that of the cells of the endoderm of a polyp, or the epithelial coverings of lungs or gills.

Experiment proves that there is a respiratory interchange of gases between the maternal and foetal blood which nowhere mingle physically. The same law holds in the respiration of the foetus as in the mammals. Oxygen passes to the region where there is least of it, and likewise carbonic anhydride. If the mother be asphyxiated so is the foetus, and indeed more rapidly than if its own umbilical vessels be tied, for the maternal blood in the first instance abstracts the oxygen from that of the foetus when the tension of this gas becomes lower in the maternal than in the foetal blood; the usual course of affairs is reversed, and the mother satisfies the oxygen hunger of her own blood and tissues by withdrawing that which she recently supplied to the foetus. It will be seen, then, that the embryo is from the first a parasite. This explains that exhaustion which pregnancy, and especially a series of gestations, entails. True, nature usually for the time meets the demand by an excess of nutritive energy: hence many animals are never so vigorous in appearance as when in this condition; often, however, to be followed by corresponding emaciation and senescence. The full and frequent respirations, the bounding pulse, are succeeded by reverse conditions; action and reaction are alike present in the animate and inanimate worlds. Moreover, it falls to the parent to eliminate not only the waste of its own organism but that of the foetus; and not infrequently in the human subject the overwrought excretory organs, especially the kidneys, fail, entailing disastrous consequences.

The digestive functions of the embryo are naturally inactive, the blood being supplied with all its needful constituents through the placenta by a much shorter process; indeed, the placental nutritive functions, so far as the foetus is concerned, may be compared with the removal of already digested material from the alimentary canal, though of course only in a general way. During foetal life the digestive glands are developing, and at the time of birth all the digestive juices are secreted in an efficient condition, though only relatively so, necessitating a special liquid food (milk) in a form in which

all the constituents of a normal diet are provided, easy of digestion.

Bile, inspissated and mixed with the dead and cast-off epithelium of the alimentary tract, is abundant in the intestine at birth ; but bile is to be regarded perhaps rather in the light of an excretion than as a digestive fluid. The skin and kidneys, though not functionless, are rendered unnecessary in great part by the fact that waste can be and is withdrawn by the placenta, which proves to be a nutritive, respiratory, and excretory organ ; it is in itself a sort of abstract and brief chronicle of the whole physiological story of foetal life.

All the foetal organs, especially the muscles, abound in an animal starch (glycogen), which in some way, not well understood, forms a reserve fund of nutritive energy which is pretty well used up in the earlier months of pregnancy. We may suppose that the amœboid cells—all the undifferentiated cells of the body—feed on it in primitive fashion ; and it will not be forgotten that the older the cells become, the more do they depart from the simpler habits of their earlier, cruder existence ; hence the disappearance of this substance in the later months of foetal life.

In one respect the foetus closely resembles the adult : it draws the pabulum for all its various tissues from blood which itself may, perhaps, be regarded as the first completed tissue. We are, accordingly, led to inquire how this river of life is distributed ; in a word, into the nature of the foetal circulation.

Foetal Circulation.—The blood leaves the placenta by the umbilical vein, reaches the inferior vena cava, either directly (by the *ductus venosus*), or, after first passing to the liver (by the *venæ advehentes*, and returning by the *venæ revehentes*), and proceeds, mingled with the blood returning from the lower extremities, to the right auricle. This blood, though far from being as arterial in character as the blood after birth, is the best that reaches the heart or any part of the organism. After arriving at the right auricle, being dammed back by the Eustachian valve, it avoids the right ventricle, and shoots on into the left auricle, passing thence into the left ventricle, from which it is sent into the aorta, and is then carried by the great trunks of this arch to the head and upper extremities. The blood returning from these parts passes into the right auricle, then to the corresponding ventricle, and thence into the pulmonary artery ; but, finding the branches of this vessel unopened, it takes the line of

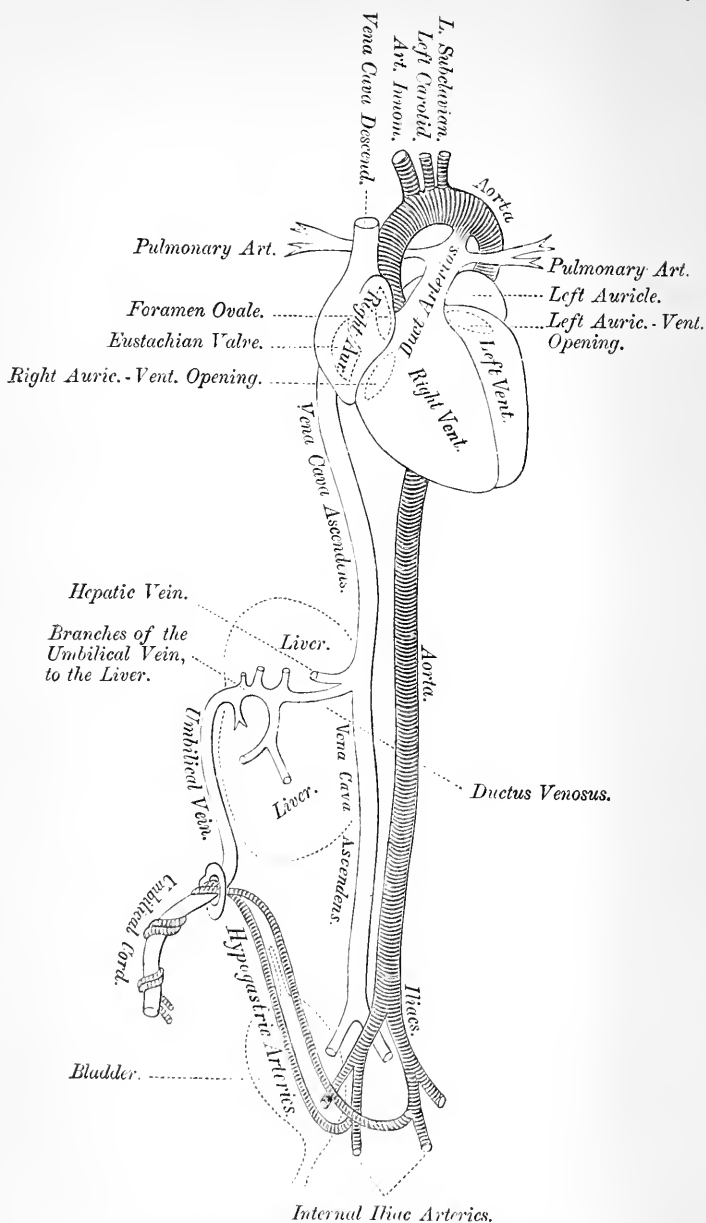

FIG. 131.—Diagram of the fetal circulation (Flint).

least resistance through the *ductus arteriosus* into the aortic arch beyond the point where its great branches emerge. It will be seen that the blood going to the head and upper parts of the body is greatly more valuable as nutritive pabulum than the rest, especially in the quantity of oxygen it contains; that the blood of the foetus, at best, is relatively ill-supplied with its vital essential; and as a result we find the upper (anterior in quadrupeds) parts of the foetus best developed, and a decided resemblance between the mammalian foetus functionally and the adult forms of reptiles and kindred groups of lower vertebrates. But this condition is well enough adapted to the general ends to be attained at this period—the nourishment of structures on the way to a higher path of progress.

As embryonic maturity is being reached, preparation is made for a new form of existence; so it is found that the Eustachian valve is less prominent and the foramen ovale smaller.

PERIODS OF GESTATION.

As a rule, the shorter the period of gestation the more numerous the offspring at a single birth and the greater the number produced within the lifetime of the animal relatively to its duration. Thus, on account of the number of young produced by the rabbit at one birth, the short period of gestation, and the frequency with which impregnation occurs, there is a much larger number of progeny, short as is the animal's life usually, than in the case of the cow, for example, that may bear young for a much longer period.

The following table gives approximately the duration of the period of gestation of some of our domestic animals and their wild allies :

Guinea-pig (cavy).....	3 weeks.
Rabbit, squirrel, rat.....	4 “
Ferret.....	6 “
Cat.....	8 “
Dog, fox.....	9 “
Lion.....	4 months.
Sow.....	4 “
Sheep, goat.....	5 “
Bear.....	7 “
Reindeer.....	8 “
Cow, buffalo.....	10 “

Mare, ass, zebra...	11 months.
Camel.....	12. "
Giraffe	14 "
Elephant.....	22 to 25 "

The period of gestation in the human subject is nine months; in the monkeys and apes somewhat less. The incubation period of certain of our domestic birds and related species is about as follows :

Canary.....	14 days.
Pigeon.....	18 "
Hen.....	21 "
Duck, goose, pea-hen	28 "
Guinea-hen.....	25 "
Turkey.....	28 "

It is interesting to note that the smaller varieties of fowls hatch out sooner than the larger ; and that the period of incubation of all of the above varies with the weather, the steadiness of the incubating bird, the date on which the eggs selected were laid, etc. With very recent eggs, an attentive sitter, and warm weather, the incubation period is shortened.

PARTURITION.

All the efforts that have hitherto been made to determine the exact cause of the result of that series of events which make up parturition have failed. This has probably been owing to an attempt at too simple a solution. The fœtus lies surrounded (protected) by fluid contained in the amniotic sac. For its expulsion there is required, on the one hand, a dilatation of the uterine opening (*os uteri*), and, on the other, an expulsive force. The latter is furnished by the contractions of the uterus itself, aided by the simultaneous action of the abdominal muscles. Throughout the greater part of gestation the uterus experiences somewhat rhythmical contractions, feeble as compared with the final ones which lead to expulsion of the fœtus, but to be regarded as of the same character. With the growth and functional development of other organs, the placenta becomes of less consequence, and a fatty degeneration sets in, most marked at the periphery, usually where it is thinnest and of least use. It does not seem rational to believe that the onset of labor is referable to any one cause, as has been so often taught ; but rather that it is the final issue to a series of processes long ex-

isting and gradually, though at last rapidly, reaching that climax which seems like a vital storm. The law of rhythm affects the nervous system as others, and upon this depends the direction and co-ordination of those many activities which make up parturition. We have seen that throughout the whole of foetal life changes in one part are accompanied by corresponding changes in others ; and in the final chapter of this history it is not to be expected that this connection should be severed, though it is not at present possible to give the evolution of this process with any more than a general approach to probable correctness.

CHANGES IN THE CIRCULATION AFTER BIRTH.

When the new-born mammal takes the first breath, effected by the harmonious action of the respiratory muscles, excited to action by stimuli reaching them from the nerve-center (or centers) which preside over respiration, owing to its being roused into action by the lack of its accustomed supply of oxygen, the hitherto solid lungs are expanded ; the pulmonary vessels are rendered permeable, hence the blood now takes the path of least resistance along them, as it formerly did through the *ductus arteriosus*. The latter, from lack of use, atrophies in most instances. The blood, returning to the left auricle of the heart from the lungs in increased volume, so raises the pressure in this chamber that the stream that formerly flowed through the foramen ovale from the right auricle is opposed by a force equal to its own, if not greater, and hence passes by an easier route into the right ventricle. The fold that tends to close the foramen ovale grows gradually over the latter, so that it usually ceases to exist in a few days after birth.

At birth, ligature of the umbilical cord cuts off the placental circulation ; hence the *ductus venosus* atrophies and becomes a mere ligament.

The placenta, being now a foreign body in the uterus, is expelled, and this organ, by the contractions of its walls, closes the ruptured and gaping vessels, thus providing against hæmorrhage.

COITUS.

In all the higher vertebrates congress of the sexes is essential to bring the male sexual product into contact with the ovum.

Erection of the penis results from the conveyance of an excess of blood to the organ, owing to dilatation of its arteries, and the retention of this blood within its caverns.



FIG. 135.—Section of erectile tissue (Cadiat). *a*, trabeculae of connective tissue, with elastic fibers, and bundles of plain muscular tissue (*c*); *b*, venous spaces (Schäfer).

The structure of the penis is peculiar, and, for the details of the anatomy of both the male and female generative organs, the student is referred to works on this subject; suffice it to say that it consists of erectile tissue, the chief characteristic of which is the opening of the capillaries into cavernous venous spaces (*sinuses*) from which the veinlets arise; with such an arrangement the circulation must be very slow—the inflow being greatly in excess of the outflow—apart altogether from the compressive action of certain muscles connected with the organ. The manner and duration of the act of copulation in the domestic animals varies with the structure of the penis, the animal's nervous excitability, etc. In the stallion the act is of moderate duration, the penis long, and the glans penis highly sensitive.

In the bull the penis is of a different shape. During erection it is believed that the S-shaped curve disappears, and that the extremity of the organ enters the mouth of the uterus itself. Copulation is of very brief duration.

In the dog the penis is of very peculiar formation. Its an-

terior part contains a bone, while there are two erectile portions independent of each other. During copulation the largest (pos-

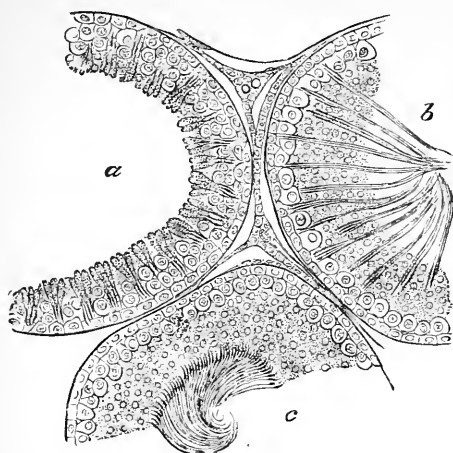

FIG. 136.—Section of parts of three seminiferous tubules of the rat (Schäfer). *a*, with the spermatozoa least advanced in development; *b*, more advanced; *c*, containing fully developed spermatozoa. Between the tubules are seen strands of interstitial cells, with blood-vessels and lymph-spaces.

terior) erectile region is spasmodically (reflexly) grasped by the sphincter cunni of the female, which is the analogue of the bulbo-cavernosus, ischio-cavernosus, and deep transverse muscle of the perinæum, so that the penis can not be withdrawn till the erection subsides, an advantage, considering that the seminal vesicles are wanting in the dog, as well as Cowper's glands. In the cat tribe there is also an incomplete penial bone. The free portion of the organ is provided with rigid papillæ capable of erection during copulation.

As previously explained, the spermatozoa originate in the seminal tubes, from which they find their way to the seminal vesicles or receptacles for semen till required to be discharged. The spermatozoa as they mature are forced on by fresh additions from behind and by the action of the ciliated cells of the epididymis, together with the wave-like (peristaltic) action of the vas deferens. Discharge of semen during coitus is effected by more vigorous peristaltic action of the vas deferens and the seminal vesicles, followed by a similar rhythmical action of the bulbo-cavernosus and ischio-cavernosus muscles, by which the fluid is forcibly ejaculated.

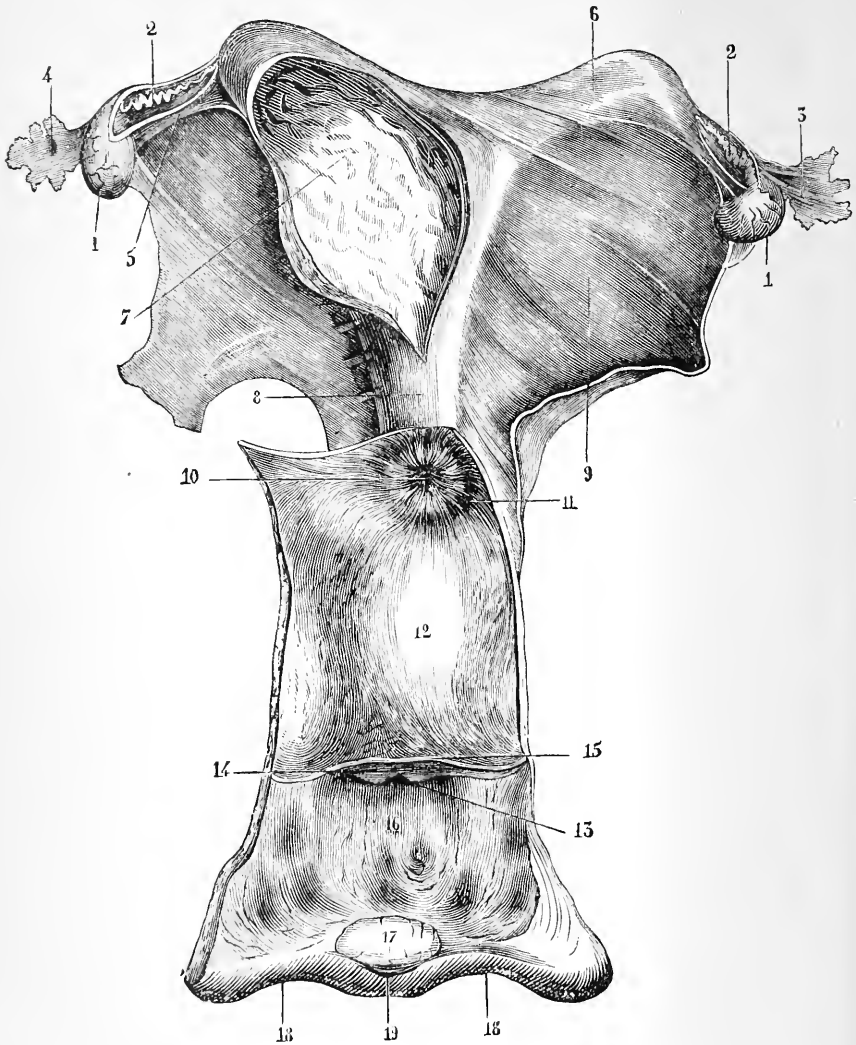

FIG. 137.—Generative organs of the mare, isolated and partly opened (Chanveau). 1, 1, ovaries; 2, 2, Fallopian tubes; 3, pavilion of tube, external face; 4, the same, inner face, showing opening in the middle; 5, ligament of ovary; 6, intact horn of uterus; 7, a horn thrown open; 8, body of uterus, upper face; 9, broad ligament; 10, cervix, with its mucous folds; 11, cul-de-sac of vagina with its folds of mucous membrane; 13, urinary meatus and its valve, 14; 15, mucous fold, a vestige of hymen; 16, interior of vulva; 17, clitoris; 18, 18, labia of vulva; 19, inferior commissure of vulva.

Semen itself, though composed essentially of spermatozoa, is mixed with the secretions of the vas deferens, of the seminal vesicles, of Cowper's glands, and of the prostate. Chemically it is neutral or alkaline in reaction, highly albuminous, and contains nuclein, lecithin, cholesterin, fats, and salts.

The movements of the male cell, owing to the action of the tail (cilium), suffice of themselves to convey them to the oviducts; but there is little doubt that during or after sexual congress there is in the female, even in the human subject, at least

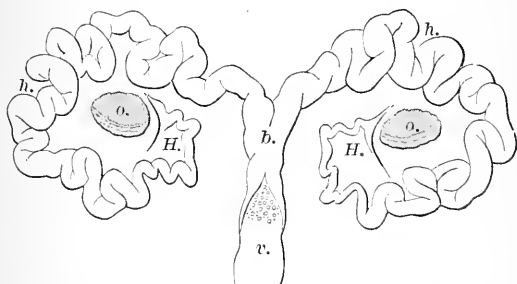

FIG. 138 —Uterus and ovaries of the sow, semi-diagrammatic (after Dalton). *o.*, ovary; *H.*, Fallopian tube; *h.*, horn of the uterus; *b.*, body of the uterus; *v.*, vagina.

in many cases, a retrograde peristalsis of the uterus and oviducts which would tend to overcome the results of the activity of the ciliated cells lining the oviduct. It is known that the male cell can survive in the female organs of generation for several days, a fact not difficult to understand, from the method of nutrition of the female cell (ovum); for we may suppose that both elements are not a little alike, as they are both slightly modified amœboid organisms.

Nervous Mechanism —Incidental reference has been made to the directing influence of the nervous system over the events of reproduction; especially their subordination one to another to bring about the general result. These may now be considered in greater detail.

Most of the processes in which the nervous system takes part are of the nature of reflexes, or the result of the automaticity (independent action) of the nerve-centers, increased by some afferent (ingoin) impressions along a nerve-path. It is not always possible to estimate the exact share each factor takes, which must be highly variable. Certain experiments have assisted in making the matter clear. It has been found

that if, in a female dog, the spinal cord be divided when the animal is still a puppy, menstruation and impregnation may occur. If the same experiment be performed on a male dog, erection of the penis and ejaculation of semen may be caused by stimulation of the penis. As the section of the cord has left the hinder part of the animal's body severed from the brain, the creature is, of course, unconscious of anything happening in all the parts below the section, of whatever nature. If the *nervi erigentes* (from the lower part of the spinal cord) be stimulated, the penis is erected; and if they be cut this act becomes impossible, either reflexly by experiment or otherwise. Seminal emissions, it is well known, may occur during sleep, and may be associated, either as result or cause, with voluptuous dreams. Putting all these facts together, it seems reasonable to conclude that the lower part of the spinal cord contains the nervous machinery requisite to initiate those influences (impulses) which, passing along the nerves to the generative organs, excite and regulate the processes which take place in them. In these, vascular changes, as we have seen, always play a prominent part.

Usually we can recognize some afferent influence, either from the brain (psychical), from the surface—at all events from without that part of the nervous system (center) which functions directly in the various sexual processes. It is common to speak of a number of sexual centers—as the erection center, the ejaculatory center, etc.—but we much doubt whether there is such sharp division of physiological labor as these terms imply, and they are liable to lead to misconception; accordingly, in the present state of our knowledge, we prefer to speak of the sexual center, using even that term in a somewhat broad sense.

The effects of stimulation of the sexual organs are not confined to the parts themselves, but the ingoing impulses set up radiating outgoing ones, which affect widely remote areas of the body, as is evident, especially in the vascular changes; the central current of nerve influence breaks up into many streams as a result of the rapid and extensive rise of the outflowing current, which breaks over ordinary barriers, and takes paths which are not properly its own. Bearing this fact in mind, the chemical composition of semen, so rich in proteid and other material valuable from a nutritive point of view, and considering how the sexual appetites may engross the mind, it is not

difficult to understand that nothing so quickly disorganizes the whole man, physical, mental, and moral, as sexual excesses, whether by the use of the organs in a natural way, or from masturbation.

Nature has protected the lower animals by the strong barrier of instinct, so that habitual sexual excess is with them an impossibility, since the females do not permit of the approaches of the male except during the rutting period, which occurs only at stated, comparatively distant periods in most of the higher mammals. When man keeps his sexual functions in subjection to his higher nature, they likewise tend to advance his whole development.

Summary.—Certain changes, commencing with the ripening of ova, followed by their discharge and conveyance into the uterus, accompanied by simultaneous and subsequent modifications of the uterine mucous membrane, constitute, when pregnancy occurs, an unbroken chain of biological events, though usually described separately for the sake of convenience. When impregnation does not result, there is a retrogression in the uterus (menstruation) and a return to general quiescence in all the reproductive organs.

Parturition is to be regarded as the climax of a variety of rhythmic occurrences which have been gradually gathering head for a long period. The changes which take place in the placenta of a degenerative character fit it for being cast off, and may render this structure to some extent a foreign body before it and the foetus are finally expelled, so that these changes may constitute one of a number of exciting causes of the increased uterine action of parturition. But it is important to regard the whole of the occurrences of pregnancy as a connected series of processes co-ordinated by the central nervous system so as to accomplish one great end, the development of a new individual.

The nutrition of the ovum in its earliest stages is effected by means in harmony with its nature as an amœboid organism; nutrition by the cells of blood-vessels is similar, while that by villi may be compared to what takes place through the agency of similar structures in the alimentary canal of the adult mammal.

The circulation of the foetus puts it on a par physiologically with the lower vertebrates. Before birth there is a gradual though somewhat rapid preparation, resulting in changes which speedily culminate after birth on the establishment of the permanent condition of the circulation of extra-uterine life.

The blood of the foetus (as in the adult) is the great storehouse of nutriment and the common receptacle of all waste products ; these latter are in the main transferred to the mother's blood indirectly in the placenta; in a similar way nutriment is imported from the mother's blood to that of the foetus. The placenta takes the place of digestive, respiratory, and excretory organs.

Coitus is essential to bring the male and female elements together in the higher vertebrates. The erection of the penis is owing to vascular changes taking place in an organ composed of erectile tissue ; ejaculation of semen is the result of the peristaltic action of the various parts of the sexual tract, aided by rhythmical action of certain striped muscles. The spermatozoa, which are unicellular, flagellated (ciliated) cells, make up the essential part of semen ; though the latter is complicated by the addition of the secretions of several glands in connection with the seminal tract. Though competent by their own movements of reaching the ovum in the oviduct, it is probable that the uterus and oviduct experience peristaltic actions in a direction toward the ovary, at least in a number of mammals.

The lower part of the spinal cord is the seat in the higher mammals of a sexual center or collection of cells that receives afferent impulses and sends out efferent impulses to the sexual organs. This, like all the lower centers, is under the control of the higher centers in the brain, so that its action may be either initiated or inhibited by the cerebrum.

ORGANIC EVOLUTION RECONSIDERED.

ADMITTING that the theories of the leading writers on the subject have advanced us on the way to more complete views of the mode of origin of the forms of the organic world, it must still be felt that all theories yet propounded fall short of being entirely satisfactory. It seems to us unfortunate that the subject has not received more attention from physiologists, as without doubt, the final solution must come through that science which deals with the properties rather than the forms of protoplasm ; or, in other words, the fundamental principles underlying organic evolution are physiological. But, in the unraveling of a subject of such extreme complexity, all sciences must probably contribute their quota to make up the truth, as many rays of different colors compounded form white light. As with other theories of the inductive sciences, none can be more than temporary ; there must be constant modification to meet increasing knowledge. Conscious that any views we ourselves advance must sooner or later be modified as all others, even if acceptable now, we venture to lay before the reader the opinions we have formed upon this subject as the result of considerable thought.

All vital phenomena may be regarded as the resultant of the action of external conditions and internal tendencies. Amid the constant change which like involves we recognize two things : the tendency to retain old modes of behavior, and the tendency to modification or variation. Since those impulses originally bestowed on matter when it became living, must, in order to prevail against the forces from without, which tend to destroy it, have considerable potency, the tendency to modification is naturally and necessarily less than to permanence of form and function.

From these principles it follows that when an Amœba or kindred organism divides after a longer or shorter period, it is

not in reality the same in all respects as when its existence began, though we may be quite unable to detect the changes; and when two infusorians conjugate, the one brings to the other protoplasm different in molecular behavior, of necessity, from having had different experiences. We attach great importance to these principles, as they seem to us to lie at the root of the whole matter. What has been said of these lower but independent forms of life applies to the higher. All organisms are made up of cells or aggregations of cells and their products. For the present we may disregard the latter. When a muscle-cell by division gives rise to a new cell, the latter is not identically the same in every particular as the parent cell was originally. It is what its parent has become by virtue of those experiences it has had as a muscle-cell *per se*, and as a member of a populous biological community, of the complexities of which we can scarcely conceive.

Now, as a body at rest may remain so, or may move in a certain direction according to the forces acting upon it exactly counterbalance one another, or produce a resultant effect in the direction in which the body moves, so in the case of heredity, whether a certain quality in the parent appears in the offspring, depends on whether this quality is neutralized, augmented, or otherwise modified by any corresponding quality in the other parent, or by some opposite quality, taken in connection with the direct influence of the environment during development.

This assumption explains among other things why acquired peculiarities (the results of accident, habit, etc.) may or may not be inherited.

These are not usually inherited because, as is to be expected, those forces of the organism which have been gathering head for ages are naturally not easily turned aside. Again, we urge, heredity must be more pronounced than variation.

The ovum and sperm-cell, like all other cells of the body, are microcosms representing the whole to a certain extent in themselves—that is to say, cell A is what it is by reason of what all the other millions of its fellows in the biological republic are; so that it is possible to understand why sexual cells represent, embody, and repeat the whole biological story, though it is not yet possible to indicate exactly how they more than others have this power. This falls under the laws of specialization and the physiological division of labor; but along what paths they have reached this we can not determine.

Strong evidence is furnished for the above views by the history of disease. Scar-tissue, for example, continues to reproduce itself as such ; like produces like, though in this instance the like is in the first instance a departure from the normal. Gout is well known to be a hereditary disease ; not only so, but it arises in the offspring at about the same age as in the parent, which is equivalent to saying that in the rhythmical life of certain cells a period is reached when they display the behavior, physiologically, of their parents. Yet gout is a disease that can be traced to peculiar habits of living and may be eventually escaped by radical changes in this respect—that is to say, the behavior of the cells leading to gout can be induced and can be altered ; gout is hereditary, yet eradicable.

Just as gout may be set up by the formation of certain modes of action of the cells of the body, so may a mode of behavior, in the nervous system, for example, become organized or fixed, become a habit, and so be transmitted to offspring. It will pass to the descendants or not according to the principles already noticed. If so fixed in the individual in which it arises as to predominate over more ancient methods of cell behavior, and not neutralized by the strength of the normal physiological action of the corresponding parts in the other parent, it will reappear. We can never determine whether this is so or not beforehand ; hence the fact that it is impossible, especially in the case of man, whose vital processes are so modified by his psychic life, to predict whether acquired variations shall become hereditary ; hence also the irregularity which characterizes heredity in such cases ; they may reappear in offspring or they may not. In viewing heredity and modification it is impossible to get a true insight into the matter without taking into the account both the original natural tendencies of living matter and the influence of environment. We only know of vital manifestations in *some* environment ; and, so far as our experience goes, life is impossible apart from the reaction of surroundings. With these general principles to guide us, we shall attempt a brief examination of the leading theories of organic evolution.

First of all, Spencer seems to be correct in regarding evolution as universal, and organic evolution but one part of a whole. No one who looks at the facts presented in every field of nature can doubt that struggle (opposition, action and reaction) is universal, and that in the organic world the fittest to a

given environment survives. But Darwin has probably fixed his attention too closely on this principle and attempted to explain too much by it, as well as failed to see that there are other deeper facts underlying it. Variation, which this author scarcely attempted to explain, seems to us to be the natural result of the very conditions under which living things have an existence. Stable equilibrium is an idea incompatible with our fundamental conceptions of life. Altered function implies altered molecular action, which sometimes leads to appreciable structural change. From our conceptions of the nature of living matter, it naturally follows that variation should be greatest, as has been observed, under the greatest alteration in the surroundings.

We are but very imperfectly acquainted as yet with the conditions under which life existed in the earlier epochs of the earth's history. Of late, deep-sea soundings and arctic explorations have brought surprising facts to light, showing that living matter can exist under a greater variety of conditions than was previously supposed. Thus it turns out that light is not an essential for life everywhere. We think these recent revelations of unexpected facts should make us cautious in assuming that life always manifested itself under conditions closely similar to those we know. Variation may at one period have been more sudden and marked than Darwin supposes; and there does seem to be room for such a conception as the "extraordinary births" of Mivart implies; though we would not have it understood that we think Darwin's view of slow modification inadequate to produce a new species, we simply venture to think that he was not justified in insisting so strongly that this was the only method of Nature; or, to put it more justly for the great author of the *Origin of Species*, with the facts that have accumulated since his time he would scarcely be warranted in maintaining so rigidly his conviction that new forms arose almost exclusively by the slow process he has so ably described.

We must allow a great deal to use and effort, doubtless, and they explain the origin of variations up to a certain point, but the solution is only partial. Variations must arise as we have attempted to explain, and use and disuse are only two of the factors amid many. Correlated growth, or the changes in one part induced by changes in another, is a principle which, though recognized by Darwin, Cope, and others, has not, we

think, received the attention it deserves. To the mind of the physiologist, *all* changes must be correlated with others.

In what sense has the line that evolution has taken been predetermined? In the sense that all things in the universe are unstable, are undergoing change, leading to new forms and qualities of such a character that they result in a gradual progress toward what our minds can not but consider higher manifestations of being.

The secondary methods according to which this takes place constitute the laws of nature, and as we learn from the progress of science are very numerous. The unity of nature is a reality toward which our conceptions are constantly leading us. Evolution is a necessity of living matter (indeed, all matter) as we view it.

THE CHEMICAL CONSTITUTION OF THE ANIMAL BODY.

ONE visiting the ruins of a vast and elaborate building, which had been entirely pulled to pieces, would get an amount of information relative to the original structure and uses of the various parts of the edifice largely in proportion to his familiarity with architecture and the various trades which make that art a practical success. The study of the chemistry of the animal body is illustrated by such a case. Any attempt to determine the exact chemical composition of living matter must result in its destruction; and the amount of information conveyed by the examination of the chemical ruins, so to speak, will depend a great deal on the knowledge already possessed of chemical and vital processes.

It is in all probability true that the nature of any vital process is at all events closely bound up with the chemical changes involved; but we must not go too far in this direction. We are not yet prepared to say that life is only the manifestation of certain chemical and physical processes, meaning thereby such chemistry and physics as are known to us; nor are we prepared to go the length of those who regard life as but the equivalent of some other force or forces; as electricity may be considered as the transformed representative of so much heat and *vice versa*. It may be so, but we do not consider that this view is warranted in the present state of our knowledge.

On the other hand, vital phenomena, when our investigations are pushed far enough, always seem to be closely associated with chemical action; hence the importance to the student of physiology of a sound knowledge of chemical principles. We think the most satisfactory method of studying the functions of an organ will be found to be that which takes into consideration the totality of the operations of which it is the seat, together with its structure and chemical composition;

hence we shall treat chemical details in the chapters devoted to special physiology, and here give only such an outline as will bring before the view the chemical composition of the body in its main outlines ; and even many of these will gather a significance, as the study of physiology progresses, that they can not possibly have at the present.

Fewer than one third of the chemical elements enter into the composition of the mammalian body ; in fact, the great bulk of the organism is composed of carbon, hydrogen, nitrogen, and oxygen ; sodium, potassium, magnesium, calcium, sulphur, phosphorus, chlorine, iron, fluorine, silicon, though occurring in very small quantity, seem to be indispensable to the living body ; while certain others are evidently only present as foreign bodies or impurities to be thrown out sooner or later. It need scarcely be said that the elements do not occur as such in the living body, but in combination forming salts, which latter are usually united with albuminous compounds. As previously mentioned, the various parts which make up the entire body of an animal are composed of living matter in very different degrees ; hence we find in such parts as the bones abundance of salts, relative to the proportion of proteid matter ; a condition demanded by that rigidity without which an internal skeleton would be useless, a defect well illustrated by that disease of the bones known as rickets, in which the lime-salts are insufficient. It is manifest that there may be a very great variety of classifications of the compounds found in the animal body according as we regard it from a chemical, physical, or physiological point of view, or combine many aspects in one whole. The latter is, of course, the most correct and profitable method, and as such is impossible at this stage of the student's progress ; we shall simply present him with the following outline, which will be found both simple and comprehensive.*

CHEMICAL CONSTITUTION OF THE BODY.

Such food as supplies energy directly must contain *carbon* compounds.

Living matter or protoplasm always contains *nitrogenous* carbon compounds.

* Taken from the author's Outlines of Lectures on Physiology, W. Drysdale & Co., Montreal.

In consequence, C, H, O, N, are the elements found in greatest abundance in the body.

The elements S and P are associated with the nitrogenous carbon compounds; they also form metallic sulphates and phosphates.

Cl and F form salts with the alkaline metals Na, K, and the earthy metals Ca and Mg.

Fe is found in *hæmoglobin* and its derivatives.

Protoplasm, when submitted to chemical examination, is killed. It is then found to consist of proteids, fats, carbohydrates, salines, and extractives.

It is probable that when living it has a very complex molecule consisting of C, H, O, N, S, and P chiefly.

PROXIMATE PRINCIPLES.

- | | | |
|---------------|------------------------|-------------------------------|
| 1. Organic. | { (a) Nitrogenous. | { Proteids. |
| | | { Certain crystalline bodies. |
| | { (b) Non-nitrogenous. | { Carbohydrates. |
| | | { Fats. |
| 2. Inorganic. | { Mineral salts. | |
| | { Water. | |

SALTS.—In general, the salts of *sodium* are more characteristic of *animal* tissues and those of *potassium* of *vegetable* tissues.

Na Cl is more abundant in the *fluids* of animals; K and phosphates more abundant in the *tissues*.

· *Earthy* salts are most abundant in the harder tissues.

The salts are probably not much, if at all, changed in their passage through the body.

In some cases there is a change from acid to neutral or alkaline.

The salts are essential to preserve the balance of the nutritive processes. Their absence leads to disease, e. g., scurvy.

GENERAL CHARACTERISTICS OF PROTEIDS.

They are the chief constituents of most living tissues, including blood and lymph.

The molecule consists of a great number of atoms (complex constitution), and is formed of the elements C, H, N, O, S, and P.

All proteids are amorphous.

All are non-diffusible, the *peptones* excepted.

They are soluble in strong acids and alkalis, with change of properties or constitution.

In general, they are coagulated by alcohol, ether, and heating.

Coagulated proteids are soluble only in strong acids and alkalies.

Classification and Distinguishing Characters of Proteids.

1. *Native albumins*: Serum albumin ; egg albumin ; soluble in water.

2. *Derived albumins (albuminates)*: Acid and alkali albumin ; casein ; soluble in dilute acids and alkalies, insoluble in water. Not precipitated by boiling.

3. *Globulins*: Globulin (globin) ; paraglobulin † ; myosin ; fibrinogen. Soluble in dilute saline solutions, and precipitated by stronger saline solutions.

4. *Peptones*: Soluble in water; diffusible through animal membranes; not precipitated by acids, alkalies, or heat. Derived from the digestion (peptic, pancreatic) of all proteids.

5. *Fibrin*: Insoluble in water and dilute saline solutions. Soluble, but not readily, in strong saline solutions and in dilute acids and alkalies.

CERTAIN NON-CRYSTALLINE BODIES.

The following bodies are allied to proteids, but are not the equivalents of the latter in the food.

They are all composed of C, H, N, O. Chondrin, gelatin, keratin have, in addition, S.

Chondrin: The organic basis of cartilage. Its solutions set into a firm jelly on cooling.

Gelatin: The organic basis of bone, teeth, tendon, etc. Its solutions set (glue) on cooling.

Elastin: The basis of elastic tissue. Its solutions do not set jelly-like (gelatinize).

Mucin: From the secretion of mucous membranes ; precipitated by acetic acid, and insoluble in excess.

Keratin: Derived from hair, nails, epidermis, horn, feathers. Highly insoluble.

Nuclein: Derived from the nuclei of cells. Not digested by pepsin ; contains P but no S.

THE FATS.

The fats are hydrocarbons ; are less oxidized than the carbohydrates ; are inflammable ; possess latent energy in a high degree.

Chemically, the neutral fats are glycerides or ethers of the

fatty acids, i. e., the acid radicles of the fatty acids of the *oleic* and *acetic* series replace the exchangeable atoms of H in the triatomic alcohol glycerine, e. g. :

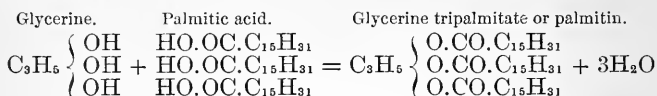

A *soap* is formed by the action of caustic alkalies on fats, e. g. :

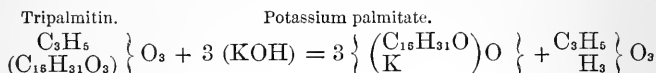

The soap may be decomposed by a strong acid into a fatty acid and a salt, e. g. :

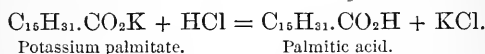

The *fats* are insoluble in water, but soluble in hot alcohol, ether, chloroform, etc.

The *alkaline* soaps are soluble in water.

Most animal fats are mixtures of several kinds in varying proportions ; hence the melting-point for the fat of each species of animal is different.

PECULIAR FATS.

Lecithin, Protagon, Cerebrin :

They consist of C, H, N, O, and the first two of P in addition.

They occur in the *nervous* tissues.

CARBOHYDRATES.

General formula, $\text{C}_m (\text{H}_2\text{O})_n$.

1. THE SUGARS : *Dextrose*, or grape-sugar, $\text{C}_6\text{H}_{12}\text{O}_6$ readily undergoes alcoholic fermentation ; less readily lactic fermentation.

Lactose, milk-sugar, $\text{C}_{12}\text{H}_{22}\text{O}_{11}$; susceptible of the lactic acid fermentation.

Inosit, or muscle-sugar, $\text{C}_6\text{H}_{12}\text{O}_6$; capable of the lactic fermentation.

Maltose, $\text{C}_{12}\text{H}_{22}\text{O}_{11}$, capable of the alcoholic fermentation. The chief sugar of the digestive process.

All the above are much less sweet and soluble than ordinary cane-sugar.

2. THE STARCHES : *Glycogen*, $C_6H_{10}O_5$, convertible into dextrose. Occurs abundantly in many foetal tissues and in the liver, especially of the adult animal.

Dextrin, $C_6H_{10}O_5$, convertible into dextrose. Soluble in water : intermediate between starch and dextrose : a product of digestion.

Pathological : Grape-sugar occurs in the urine in *diabetes mellitus*.

Certain substances formed within the body may be regarded as chiefly waste-products, the result of metabolism or tissue-changes.

They are divisible into nitrogenous metabolites and non-nitrogenous metabolites.

Nitrogenous Metabolites.

1. Urea, uric acid and compounds, kreatinin, xanthin, hypoxanthin (sarkin), hippuric acid, all occurring in urine.

2. Leucin, tyrosin, taurocholic, and glycocholic acids, which occur in the digestive tract.

3. Kreatin, constantly found in muscle, and a few others of less constant occurrence.

The above consists of C, H, N, O. Taurocholic acid contains also S.

The molecule in most instances is complex.

Non-Nitrogenous Metabolites.

These occur in small quantity, and some of them are secreted in an altered form.

They included lactic and sarcolactic acid, oxalic acid, succinic acid, etc.

PHYSIOLOGICAL RESEARCH AND PHYSIOLOGICAL REASONING.

WE propose in this chapter to examine into the methods employed in physiological investigation and teaching, and the character of conclusions arrived at by physiologists as dependent on a certain method of reasoning.

The first step toward a legitimate conclusion in any one of the *inductive* sciences to which physiology belongs is the collection of facts which are to constitute the foundation on which the inference is to be based. If there be any error in these, a correct conclusion can not be drawn by any reliable logical process. On the other hand, facts may abound in thousands and yet the correct conclusion never be reached, because the method of interpretation is faulty, which is equivalent to saying that the process of inference is either incomplete or incorrect. The conclusions of the ancients in regard to nature were usually faulty from errors in both these directions; they neither had the requisite facts, nor did they correctly interpret those with which they were conversant.

Let us first examine into the methods employed by modern physiologists, and determine in how far they are reliable. First, there is the method of *direct* observation, in which no apparatus whatever or only the simplest kind is employed; thus, the student may count his own respirations, feel his own heart-beats, count his pulse, and do a very great deal more that will be pointed out hereafter; or he may examine in like manner another fellow-being or one of the lower animals. This method is simple, easy of application, and is that usually employed by the physician even at the present day, especially in private practice. The value of the results obviously depends on the reliability of the observer in two respects: First, as to the accuracy, extent, and delicacy of his perceptions; and, secondly, on the inferences based on these sense-observations. Much

must depend on practice—that is to say, the education of the senses. The hand may become a most delicate instrument of observation ; the eye may learn to see what it once could not ; the ear to detect and discriminate what is quite beyond the uncultured hearing of the many. But it is one of the most convincing evidences of man's superiority that in every field of observation he has risen above the lower animals, some of which by their unaided senses naturally excel him. So in this science, instruments have opened up mines of facts that must have otherwise remained hidden ; they have, as it were, provided man with additional senses, so much have the natural powers of those he already possessed been sharpened.

But the chief value of the results reached by instruments* consists in the fact that the movements of the living tissues can be *registered* ; i. e., the great characteristic of modern physiology is the extensive employment of the graphic method, which has been most largely developed by the distinguished French experimenter Marey. Usually the movements of the point of lever are impressed on a smoked surface, either of glazed paper or glass, and rendered permanent by a coating of some material applied in solution and drying quickly, as shellac in alcohol. The surface on which the tracing is written may be stationary, though this is rarely the case, as the object is to get a succession of records for comparison ; hence the most used form of writing surface is a cylinder which may be raised or lowered, and which is moved around *regularly* by some sort of clock-work. It follows that the lever point, which is moved by the physiological effect, describes curves of varying complexity. That tracings of this or any other character should be of any value for the purposes of physiology, they must be susceptible of relative measurement both for time and space. This can be accomplished only when there is a known base-line or abscissa from which the lever begins its rise, and a time record which is usually in seconds or portions of a second. The first is easily obtained by simply allowing the lever to write a straight line before the physiological effect proper is recorded. Time intervals are usually indicated by the interruptions of an electric current, or by the vibrations of a tuning-fork, a pen or writer of some kind being in each instance attached to the apparatus so as to record its movements.

* Illustrated in the sections on muscle physiology and others.

As levers, in proportion to their length, exaggerate all the movements imparted to them, a constant process of correction must be carried on in the mind in reading the records of the graphic method, as in interpreting the field of view presented by the microscope.

The student is especially warned to carry on this process, otherwise highly distorted views of the reality will become fixed in his own mind ; and certainly a condition of ignorance is to be preferred to such false knowledge as this may become. But it is likewise apparent that movements that would without such mechanism be quite unrecognized may be rendered visible and utilized for inference. There is another source of possible misconception in the use of the graphic method. The lever is sometimes used to record the movements of a column of fluid (manometer, Fig. 197), as water or mercury, the inertia of which is considerable, so that the record is not that of the lever as affected by the physiological (tissue) movement, but that movement conveyed through a fluid of the kind indicated. Again, all points, however delicate, write with some friction, and the question always arises, In how far is that friction sufficient to be a source of inaccuracy in the record ? When organs are directly connected with levers or apparatus in mechanical relation with them, one must be sure that the natural action of the organ under investigation is in no way modified by this connection.

From these remarks it will be obvious that in the graphic method physiologists possess a means of investigation at once valuable and liable to mislead. Already electricity has been extensively used in the researches of physiologists, and it is to this and the employment of photography that we look in the near future for methods that are less open to the objections we have noticed.

However important the methods of physiology, the results are vastly more so. We next notice, then, the progress from methods and observations to inferences, which we shall endeavor to make clear by certain cases of a hypothetical character. Proceeding from the brain and entering the substance of the heart, there is in vertebrates a nerve known as the *vagus*. Suppose that, on stimulating this nerve by electricity in a rabbit, the heart ceases to beat, what is the legitimate inference ? Apparently that the effect has been due to the action of the nerve on the heart, an action excited by the use of electricity.

This does not, however, according to the principles of a rigid logic, follow. The heart may have ceased beating from some cause wholly unconnected with this experiment, or from the electric current escaping along the nerve and affecting some nervous mechanism within the heart, which is not a part of the vagus nerve ; or it may have been due to the action of the current on the muscular tissue of the heart directly, or in some other way. But suppose that invariably, whenever this experiment is repeated, the one result (arrest of the beat) follows, then it is clear that the vagus nerve is in some way a factor in the causation. Now, if it could be ascertained that certain branches of the nerve were distributed to the heart-muscle directly, and that stimulation of these gave rise to arrest of the cardiac pulsation, then would it be highly probable, though not certain, that there was in the first instance no intermediate mechanism ; while this inference would become still more probable if in hearts totally without any such nervous apparatus whatever, such a result followed on stimulation of the vagus. Suppose, further, that the application of some drug or poison to the heart provided with special nervous elements besides the vagus terminals prevented the effect before noticed on stimulating the vagus, while a like result followed under similar circumstances in those forms of heart unprovided with such nervous structures, there would be additional evidence in favor of the view that the result we are considering was due solely to some action of the vagus nerve ; while, if arrest of the heart followed in the first case but not in the second, and this result were invariable, there would be roused the suspicion that the action of the vagus was not direct, but through the nervous structures within the heart other than vagus endings. And if, again, there were a portion of the rabbit's heart to which there were distributed this intrinsic nervous supply, which on stimulation directly was arrested in its pulsation, it would be still more probable that the effect in the first instance we have considered was due to these structures, and only indirectly to the vagus. But be it observed, in all these cases there is only probability. The conclusions of physiology never rise above probability, though this may be so strong as to be practically equal in value to absolute certainty. Would it be correct, from any or all the experiments we have supposed to have been made, to assert that the vagus was the arresting (inhibitory) nerve of the heart ? All hearts thus far examined have much in common in structure

and function, and in so far is the above generalization probable. Such a statement would, however, be far from that degree of probability which is possible, and should therefore not be accepted till more evidence has been gathered. The mere resemblance in form and general function does not suffice to meet the demands of a critical logic. Such a statement as the above would not necessarily apply to the hearts of all vertebrates or even all rabbits, if the experiments had been conducted on one animal alone, for the result might be owing to a mere idiosyncrasy of the rabbit under observation. The further we depart from the group of animals to which the creature under experiment belongs, the less is the probability that our generalizations for the one class will apply to another. It will, therefore, be seen that wide generalizations can not be made with that amount of certainty which is attainable until experiments shall have become very numerous and widely extended. A really broad and sound physiology can only be constructed when this science has become much more *comparative*—that is, extended to many more groups and sub-groups of animals than at present.

We have incidently alluded throughout the work to the teaching of disease. "Disease" is but a name for disordered function. One viewing a piece of machinery for the first time in improper action might draw conclusions with comparative safety, provided he had a knowledge of the correct action of *similar* machines. Our experience gives us a certain knowledge of the functions of our own bodies. By ordinary observation and by experiment on other animals we get additional data, which, taken with the disordered action resulting from gross or molecular injury (disease), gives a basis for certain conclusions as to the normal functions of the human body or those of lower animals. This information is especially valuable in the case of man, since he can report with a fair degree of reliability, in most diseased conditions, his own sensations.

It is hoped that this brief treatment of the methods and logic of physiology will suffice for the present. Throughout the work they will be illustrated in every chapter, though not always with distinct references to the nature of the intellectual process followed.

Summary.—There are two methods of physiological observation, the direct and the indirect. The first is the simplest, and is valuable in proportion to the accuracy and delicacy and

range of the observer ; the latter implies the use of apparatus, and is more complex, more extended, more delicate, and precise. It is usually employed with the graphic method, which has the advantage of recording and thus preserving movements which correspond with more or less exactness to the movements of tissues or organs. It is valuable, but liable to errors in recording and in interpretation.

The logic of physiology is that of the inductive sciences. It proceeds from the special to the general. The conclusions of physiology never pass beyond extreme probability, which, in some cases, is practically equal to certainty. It is especially important not to make generalizations that are too wide.

THE BLOOD.

It is a matter of common observation that the loss of the whole, or a very large part, of the blood of the body entails death; while an abundant hæmorrhage, or blood-disease in any of its forms, causes great general weakness.

The student of embryology is led to inquire as to the necessity for the very early appearance and the rapid development of the blood-vascular system so prominent in all vertebrates.

An examination of the means of transit of the blood, as already intimated, reveals a complicated system of tubes distributed to every organ and tissue of the body. These facts would lead one to suppose that the blood must have a transcendent importance in the economy, and such, upon the most minute investigation, proves to be the case. The blood has been aptly compared to an internal world for the tissues, answering to the external world for the organism as a whole. This fluid is the great storehouse containing all that the most exacting cell can demand; and, further, is the temporary receptacle of all the waste that the most busy cell requires to discharge. Should such a life-stream cease to flow, the whole vital machinery must stop—death must ensue.

Comparative.—It will prove more scientific and generally satisfactory to regard the blood as a tissue having a fluid and flowing matrix, in which flow cellular elements or corpuscles—a view of the subject that is less startling when it is remembered that the greater part of the protoplasm which makes up the other tissues of the body is of a semifluid consistence. In all animals possessing blood, the matrix is a clear, usually more or less colored fluid. Among invertebrates the color may be pronounced: thus, in cephalopods and some crustaceans it is blue, but in most groups of animals and all vertebrates the matrix is either colorless or more commonly of some slight tinge of yellow. Invertebrates with few exceptions possess

only colorless corpuscles, but all vertebrates have colored cells which invariably outnumber the other variety, and display forms and sizes which are sufficiently constant to be characteristic. In all groups below mammals the colored corpuscles are oval, mostly biconvex, and nucleated during all periods of the animal's existence; in mammals they are circular biconcave disks (except in the camel tribe, the corpuscles of which are oval), and in post-embryonic life without a nucleus; nor do they possess a cell-wall. The red

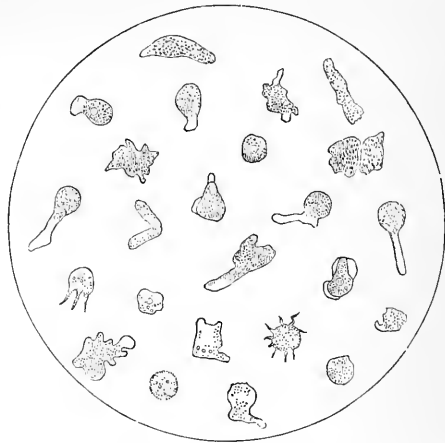

FIG. 139.—Leucocytes of human blood, showing amoeboid movements (Landois). These movements are not normally in the blood-vessels so marked as pictured here, so that the figure represents an extreme case.

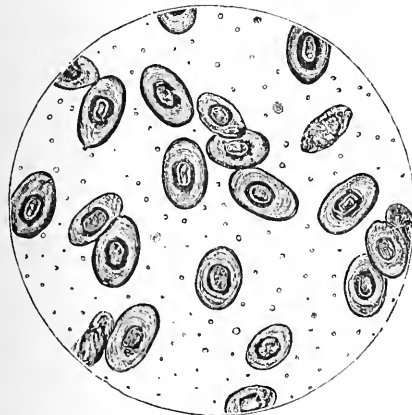

FIG. 140.—Photograph of colored corpuscles of frog. 1×370 . (After Flint.)

cells vary in size in different groups and sub-groups of animals, being smaller the higher the place the animal occupies, as a general rule; thus, they are very large in vertebrates below mammals, in some cases being almost visible to the unaided eye, while in the whole class of mammals they are very minute; their numbers also in this group are vastly greater than in others lower in the scale.

The average size in man is $\frac{1}{32000}$ inch (.0077 mm.) and the number in a cubic millimetre

of the blood about 5,000,000 for the male and 500,000 less for the female, which would furnish about 250,000,000,000 in a pound of blood. It will be understood that averages only are spoken of, as all kinds of variations occur, some of which will be referred to later, and their significance explained. The size of the corpuscles in the domestic animals is variable—a matter of importance when transfusion of blood is under consideration.

Under the microscope the blood of vertebrates is seen to owe its color to the cells chiefly, and, so far as the red goes, almost wholly. Corpuscles when seen singly are never of the deep red, however, of the blood as a whole, but rather a yellowish red, the tinge varying somewhat with the class of animals from which the specimen has been taken.

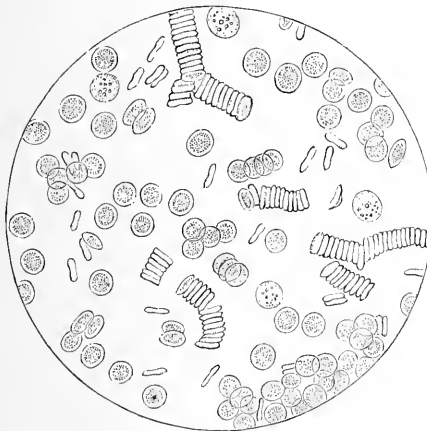

FIG. 141.—Corpuscles from human subject (Funke). A few colorless corpuscles are seen among the colored disks, which are many of them arranged in *rouleaux*.

Certain other *morphological* elements found in mammalian blood deserve brief mention, though their significance is as yet a matter of much dispute.

1. The blood-plates (*plaques, hæmatoblasts, third element*), very small, colorless, biconcave disks, which are deposited in great numbers on any thread or similar foreign body introduced into the circulation, and rapidly break up when blood is shed.

2. On a slide of blood that has been prepared for some little time, aggregations of very minute granules (*elementary granules*) may be seen. These are supposed to represent the disintegrating protoplasm of the corpuscles.

The pale or colorless corpuscles are very few in number in mammals compared with the red, there being on the average only about 1 in 400 to 600, though they become much more numerous after a meal. They are granular in appearance, and possess one or more nuclei, which are not, however, readily

seen in all cases without the use of reagents. They are characterized by greater size, a globular form, the lack of pigment,

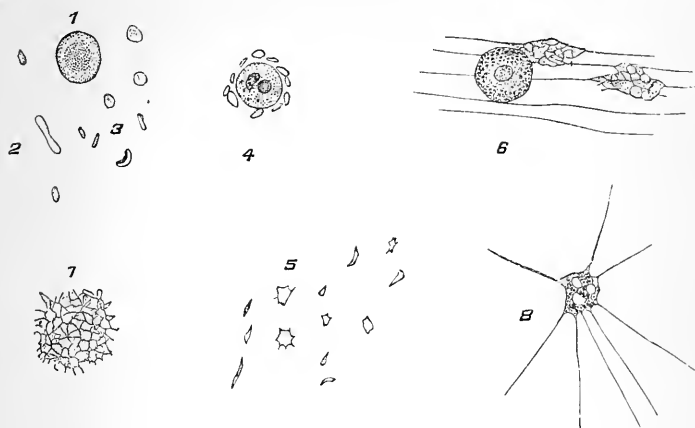

FIG. 142.—Blood-plaques and their derivatives (Landois, after Bizzozero and Laker). 1, red blood-corpuscles on the flat; 2, from the side; 3, unchanged blood-plaques; 4, lymph-corpuscle surrounded with blood-plaques; 5, blood-plaques variously altered; 6, lymph-corpuscle with two masses of fused blood-plaques and threads of fibrin; 7, group of blood-plaques fused or run together; 8, similar small mass of partially dissolved blood-plaques with fibrils of fibrin.

and the tendency to amœboid movements, which latter may be exaggerated in disordered conditions of the blood, or when the blood is withdrawn and observed under artificial conditions. It will be understood that these cells (*leucocytes*) are not confined to the blood, but abound in lymph and other fluids. They are the representatives of the primitive cells of the embryo, as is shown by their tendency (like ova) to throw out processes, develop into higher forms, etc. In behavior they strongly suggest *Amœba* and kindred forms.

We may, then, say that in all invertebrates the blood, when it exists, consists of a plasma (*liquor sanguinis*), in which float the cellular elements which are colorless; and that in vertebrates in addition there are colored cells which are always nucleated at some period of their existence. The colorless cells are globular masses of protoplasm, containing one or more nuclei, and with the general character of amœboid organisms.

THE HISTORY OF THE BLOOD-CELLS.

We have already seen that the blood and the vessels in which it flows have a common origin in the mesoblastic cells of the embryo chick; the same applies to mammals and lower groups. The main facts may be grouped under two headings: 1. Development of the blood-corpuscles during embryonic life. 2. Development of the corpuscles in post-embryonic life. The origin and fate of the corpuscles, especially of the colored variety, have been the subject of much discussion.

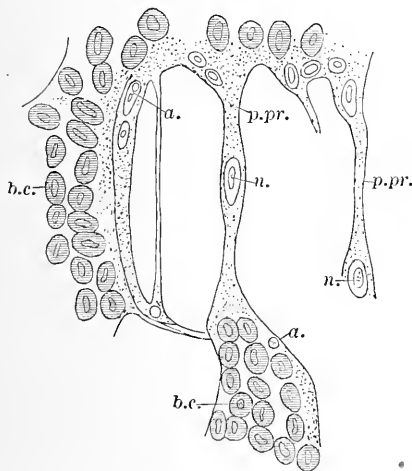

FIG. 143.—Surface view from below of a small portion of posterior end of pellucid area of a chick of thirty-six hours, 1×400 (Foster and Balfour). *b. c.*, blood-corpuscles; *a.*, nuclei, which subsequently become nuclei of cells forming walls of blood-vessels; *p. pr.*, protoplasmic processes, containing nuclei with large nucleoli, *n.*

The best established facts are stated in the summary below, while they are illustrated by the accompanying figures.

The colorless cells of the blood first arise as migrated undifferentiated remnants of the early embryonic cell colonies. That they remain such is seen by their physiological behavior, to be considered a little later. Afterward they are chiefly produced from a peculiar form of connective tissue known as leucocytenic, and which is gathered into organs (lymphatic glands), the

chief function of which is to produce these cells, though this tissue is rather widely distributed in the mammalian body in other forms than these.

Summary.—The student may, with considerable certainty, consider the colorless corpuscle of the blood as the most primitive; the red, derived either from the white or some form of more specialized cell; the nucleated, as the earlier and more youthful form of the colored corpuscle, which may in some groups of vertebrates be replaced by a more specialized (or de-

graded?) non-nucleated form mostly derived directly from the former; that in the first instance the blood-vessels and blood

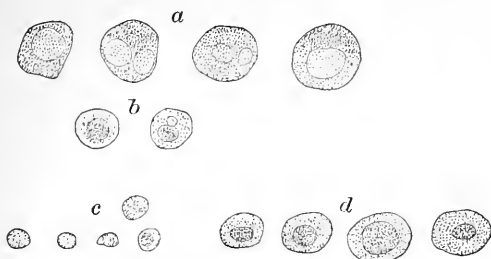

FIG. 144.

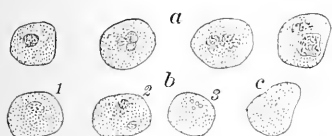

FIG. 145.



FIG. 146.

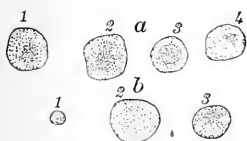

FIG. 147.

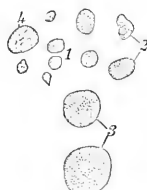

FIG. 148.

FIG. 144.—Cell elements of red marrow. *a*, large granular marrow cells; *b*, smaller, more vesicular cells; *c*, free nuclei, or small lymphoid cells, some of which may be even surrounded with a delicate rim of protoplasm; *d*, nucleated red corpuscles of the bone marrow.

FIG. 145.—Nucleated red cells of marrow, illustrating mode of development into the ordinary non-nucleated red corpuscles. *a*, common forms of the colored nucleated cells of red marrow; *b*, 1, 2, 3, gradual disappearance of the nucleus; *c*, large non-nucleated red corpuscle resembling 2 and 3 of *b* in all respects save in the absence of any trace of nucleus.

FIG. 146.—Nucleated red corpuscles, illustrating the migration of the nucleus from the cell, a process not unfrequently seen in the red marrow.

FIG. 147.—Blood of human embryo of four months. *a*, 1, 2, 3, 4, nucleated red corpuscles. In 4 the same granular disintegrated appearance of the nucleus as is noted in marrow cells. *b*, 1, microcyte; 2, megalocyte; 3, ordinary red corpuscle.

FIG. 148.—From spleen. 1, blood-plaques, colorless and varying a little in size; 2, two microcytes of a deep-red color; 3, two ordinary red corpuscles; 4, a solid, translucent, lymphoid cell or free nucleus. (Figs. 144–148 after Osler.)

arise simultaneously in the mesoblastic embryonic tissue; that such an organ may exist after birth, either normally in some mammals or under unusual functional need; that the red marrow is the chief birthplace of colored cells in adult life; that

the spleen, liver, lymphatic glands, and other tissues of similar structure contribute in a less degree to the development of the red corpuscles; and that the last mentioned organs are the chief producers of the colorless amoeboid blood-cells.

Finally, it is well to remember that Nature's resources in this, as in many other cases, are numerous, and that her mode of procedure is not invariable; and that, if one road to an end is blocked, another is taken.

The Decline and Death of the Blood-Cells.—The blood corpuscles, like other cells, have a limited duration, with the usual chapters in a biological history of rise, maturity, and decay. There is reason to believe that the red cells do not live longer than a few weeks at most. The red cells, in various degrees of disorganization, have been seen within the white cells (*phagocytes*), and the related cells of the spleen, liver, bone-marrow, etc. In fact, these cells, by virtue of retained ancestral (*amoeboid*) qualities, have devoured the weakened, dying red cells. It seems to be a case of survival of the fittest. It is further known that abundance of pigment containing iron is found in both spleen and liver; and there seems to be no good reason for doubting that the various pigments of the secretions of the body (*urine, bile, etc.*) are derived from the universal pigment of the blood. These coloring matters, then, are to be regarded as the excreta in the first instance of cells behaving like amoeboids, and later as the elaborations of certain others in the kidney and elsewhere, the special function of which is to get rid of waste products. The birth-rate and the death-rate of the blood-cells must be in close relation to each other in health; and some of the gravest disturbances arise from decided changes in the normal proportions of the cells (*anæmia, leucocythemia*).

Both the red and white corpuscles show, like all other cells of the organism, alterations corresponding to changes in the surrounding conditions. The blood may be withdrawn and its cells more readily observed than those of most tissues; so that the study of the influence of temperature, feeding of the leucocytes, and the action of reagents in both classes of cells is both of practical importance and theoretic interest, and will well repay the student for the outlay in time and labor, if attention is directed chiefly to the results and the lessons they convey, and not, as too commonly happens, principally to the methods of manipulation.

The Chemical Composition of the Blood.—Blood has a decided

but faint alkaline reaction, owing chiefly to the presence of sodium salts, a saline taste, and a faint odor characteristic of the animal group to which it belongs, owing probably to volatile fatty acids. The specific gravity of human blood varies between 1045 and 1075, with a mean of 1055; the specific gravity of the corpuscles being about 1105 and of the plasma 1027. This difference explains the sinking of the corpuscles in blood withdrawn from the vessels and kept quiet. Much the same difficulties are encountered in attempts at the exact determination of the chemical composition of the blood, as in the case of other living tissues. Plasma alters its physical and its chemical composition, to what extent is not exactly known, when removed from the body.

Composition of Serum.—The fluid remaining after coagulation of the blood can, of course, be examined chemically with considerable thoroughness and confidence.

By far the greater part of serum consists of water; thus, it has been estimated that of 100 parts the following statement will represent fairly well the proportional composition:

Water	90 parts;
Proteids	8 to 9 “
Salines, fats, and extractives (small in quantity and not readily obtained free)	1 to 2 parts.

The *proteids* are made up of two substances which can be distinguished by solubility, temperature at which coagulation occurs, etc., known as *paraglobulin* and *serum-albumen*, and which may exist in equal amount.

It is not possible, of course, to say whether these substances exist as such in the living blood-plasma or not.

The *fats* are very variable in quantity in serum, depending on a corresponding variability in the plasma, in which they would be naturally found in greatest abundance after a meal. They exist as neutral stearin, palmitin, olein, and as soaps.

The principal *extractives* found are urea, creatin and allied bodies, sugar, and lactic acid. Serum in most animals contains more of sodium salts than the corpuscles, while the latter in man and some other mammals contain a preponderating quantity of potassium compounds.

The principal *salts* of serum are sodium chloride, sodium bicarbonate, sodium sulphate and phosphate; in smaller quantity,

also phosphate of calcium and magnesium, with rather more of potassium chloride.

It is highly probable that this proportion also represents moderately well the composition of plasma, which is, of course, from a physiological point of view, the important matter.

The Composition of the Corpuscles.—Taken together, the different forms of blood-cells make up from one third to nearly one half the weight of the blood, and of this the red corpuscles may be considered as constituting nearly the whole.

The colorless cells are known to contain fats and glycogen, which, with salts, we may believe exist in the living cells, and, in addition to the proteids, into which protoplasm resolves itself upon the disorganization that constitutes its dying, lecithin, protagon, and other extractives.

The prominent chemical fact connected with the red corpuscles is their being composed in great part of a peculiar colored proteid compound containing iron.

This will be fully considered later: but, in the mean time we may state that the hæmoglobin is itself infiltrated into the meshes or framework (*stroma*) of the corpuscle, which latter seems to be composed of a member of the globulin class, so well characterized by solubility in weak saline solutions.

The following tabular statement represents the relative proportions in 100 parts of the dried organic matter of the red corpuscles:

Hæmoglobin.....	90·54
Proteids.....	8·67
Lecithin.....	0·54
Cholesterin.....	0·25
	100·00

The quantity of salts is very small, less than one per cent (*inorganic*).

So much for the results of our analyses; but when we consider the part the blood plays in the economy of the body, it must appear that, since the life-work of every cell expresses itself through this fluid, both as to what it removes and what it adds, the blood can not for any two successive moments be of precisely the same composition; yet the departures from a normal standard must be kept within very narrow limits, otherwise derangement or possibly death results. We think that, before we have concluded the study of the various organs of

the body, it will appear to the student, as it does to the writer, that it is highly probable that there are great numbers of compounds in the blood, either of a character unknown as yet to our chemistry, or in such small quantity that they elude detection by our methods; and we may add that we believe the same holds for all the fluids of the body. The complexity of vital processes is great beyond our comprehension.

It must be especially borne in mind that all the pabulum for every cell, however varied its needs, can be derived from the blood alone; or, as we shall show presently, strictly speaking from the lymph, a sort of middle-man between the blood and the tissues.

The Quantity and the Distribution of the Blood.—The relative quantities of blood in different parts of the body have been estimated to be as follows:

Liver.....	one fourth.
Skeletal muscles.....	“ “
Heart, lungs, large arteries, and veins.	“ “
Other structures.....	“ “

The significance of this distribution will appear later.

The Coagulation of the Blood.—When blood is removed from its accustomed channels, it undergoes a marked chemical and physical change, termed clotting or coagulation. In the case of most vertebrates, almost as soon as the blood leaves the vessels it begins to thicken, and gradually acquires a consistence that may be compared to that of jelly, so that it can no longer be poured from the containing vessel. Though some have recognized different stages as distinct, and named them, we think that an unprejudiced observer might fail to see that there were any well-marked appearances occurring invariably at the same moment, or with resting stages in the process, as with the development of ova.

After coagulation has reduced the blood to a condition in which it is no longer diffuent, minute drops of a thin fluid gradually show themselves, exuding from the main mass, faintly colored, but never red, if the vessel in which the clot has formed has been kept quiet so that the red corpuscles have not been disturbed; and later it may be noticed that the main mass is beginning to sink in the center (*cupping*); and in the blood of certain animals, as the horse, which clots slowly, the upper part of the coagulum (*crassamentum*) appears of a lighter color, owing, as microscopic examination shows, to the relative

fewness of red corpuscles. This is the buffy-coat, or, as it occurs in inflammatory conditions of the blood, was termed by older writers, the *crusta phlogistica*. It is to be distinguished from the lighter red of certain parts of a clot, often the result of greater exposure to the air and more complete oxidation in consequence. The white blood-cells, being lighter than the red, are also more abundant in the upper part of the clot (*buffy-coat*). If the coagulation of a drop of blood withdrawn from one's own finger be watched under the microscope, the red corpuscles may be seen to run into heaps, like rows of coins lying against each other (*rouleaux*, Fig. 141), and threads of the greatest fineness are observed to radiate throughout the mass, gradually increasing in number, and, at last, including the whole in a meshwork which slowly contracts. It is the formation of this *fibrin* which is the essential factor in clotting; the inclusion of the blood-cells and the extrusion of the serum naturally resulting from its formation and contraction.

The great mass of every clot consists, however, of corpuscles; the quantity of fibrin, though variable, not amounting to more usually than about .2 per cent in mammals. The formation of the clot does not occupy more than a few minutes (two to seven) in most mammals, including man, but its contraction lasts a very considerable time, so that serum may continue to exude from the clot for hours. It is thus seen that, instead of the plasma and corpuscles of the blood as it exists within the living body, coagulation has resulted in the formation of two new products—serum and fibrin—differing both physically and chemically. These facts may be put in tabular form thus:

Blood as it flows in the vessels.	}	Liquor sanguinis (plasma).	
		Corpuscles.	
Blood after co- agulation.	{	Coagulum	}
		Serum.	Fibrin. Corpuscles.

As fibrin may be seen to arise in the form of threads, under the microscope, in coagulating blood, and since no trace of it in any form has been detected in the plasma, and the process can be accounted for otherwise, it seems unjustifiable to assume that fibrin exists preformed in the blood, or arises in any way prior to actual coagulation.

Fibrin belongs to the class of bodies known as proteids, and can be distinguished from the other subdivisions of this group of substances by certain chemical as well as physical character-

istics. It is insoluble in water and in solutions of sodium chloride; insoluble in hydrochloric acid, though it swells in this menstruum.

It may be whipped out from the freshly shed blood by a bundle of twigs, wires, or other similar arrangement presenting a considerable extent of surface; and when washed free from red blood-cells presents itself as a white, stringy, tough substance, admirably adapted to retain anything entangled in its meshes. If fibrin does not exist in the plasma, or does not arise directly as such in the clot, it must have some antecedents already existing as its immediate factors in the plasma, either before or after it is shed.

The principal theories of coagulation are these : 1. Coagulation results from the action of a fibrin-ferment on fibrinogen and paraglobulin. 2. Coagulation results from the action of a fibrin-ferment on fibrinogen alone. Fibrinogen and paraglobulin (see sections on "The Chemistry of the Animal Body") are proteids originating from the plasma, during clotting in all probability. Fibrin-ferment loses its properties on boiling, and a very small quantity suffices in most cases to induce the result. For these and other reasons this agent has been classed among bodies known as *unorganized ferments*, which are distinguished by the following properties :

They exert their influence only under well-defined circumstances, among which is* a certain narrow range of temperature, about blood-heat being most favorable for their action. They do not seem to enter themselves into the resulting product, but act from without, as it were (catalytic action), hence a very small quantity suffices to effect the result. In all cases they are destroyed by boiling, though they bear exposure for a limited period to a freezing temperature.

From observations, microscopic and other, it has been concluded that the corpuscles play an important part in coagulation by furnishing the fibrin-ferment ; but the greatest diversity of opinion prevails as to which one of the morphological elements of the blood furnishes the ferment, for each one of them has been advocated as the exclusive source of this ferment by different observers.

We do not favor the current theories of the coagulation of the blood. We would explain the whole matter somewhat thus: What the blood is in chemical composition and other properties from moment to moment is the result of the complicated inter-

action of all the various cells and tissues of the body. Any one of these, departing from its normal behavior, at once affects the blood ; but health implies a constant effort toward a certain equilibrium, never actually reached but always being striven after by the whole organism. The blood can no more maintain its vital equilibrium, or exist as a living tissue out of its usual environment, than any other tissue. But the exact circumstances under which it may become disorganized, or die, are legion ; hence, it is not likely that the blood always clots in the same way in all groups of animals, or even in the same group. The *normal* disorganization or death of the tissue results in clotting ; but there may be death without clotting, as when the blood is frozen, in various diseases, etc.

To say that fibrin is formed during coagulation expresses in a crude way a certain fact, or rather the resultant of many facts. To explain : When gunpowder and certain other explosives are decomposed, the result is the production of certain gases. If we knew these gases and their mode of composition but in the vaguest way, we should be in much the same position as we are in regard to the coagulation of the blood.

There is no difficulty in understanding why the blood does not clot in the vessels after death so long as they live, nor why it does coagulate upon foreign bodies introduced into the bloodstream. So long as it exists under the very conditions under which it began its being, there is no reason why the blood should become disorganized (clot). It would be marvelous if it did clot, for then we could not understand how it could ever have been developed as a tissue at all. It is just as reasonable to ask, Why does not a muscle-cell become rigid (clot) in the body during life?

Probably in no field in physiology has so much work been done with so little profit as in the one we are now discussing ; and, as we venture to think, owing to a misconception of the real nature of the problem. We can understand the *practical* importance of determining what circumstances favor coagulation or retard it, both within the vessels and without them ; but from a theoretical point of view the subject has been exalted out of all proportion to its importance.

Coagulation is favored by gentle movement, contact with foreign bodies, a temperature of about 38° to 40° C., addition of a small quantity of water, free access of oxygen, etc.

The process is retarded by a low temperature, addition of abundance of neutral salts, extract of the mouth of the leech, peptone, much water, alkalies, and many other substances. The excess of carbonic anhydride and diminution of oxygen seem to be the cause of the slower coagulation of venous blood, hence the blood long remains fluid in animals asphyxiated. A little reflection suffices to explain the action of most of the factors enumerated. Any cause which hastens the disintegration of the blood-cells must accelerate coagulation; chemical changes underlie the changes in this as in all other cases of vital action. Slowing of the blood-stream to any appreciable extent likewise favors clotting, hence the explanation of the success of the treatment of aneurisms by pressure. It is plain that in all such cases the normal relations between the blood and the tissues are disturbed, and, when this reaches a certain point, death (coagulation) ensues, as with any other tissue.

Clinical and Pathological.—The changes in the blood that characterize certain abnormal states are highly instructive. If blood from an animal be injected into the veins of one of another species, the death of the latter often results, owing to non-adaptation of the blood already in the vessels, and to the tissues of the creature generally. The corpuscles break up—the change of conditions has been too great. Deficiency in the quantity of the blood as a whole (*oligæmia*) causes serious change in the functions of the body; but that a hæmorrhage of considerable extent can be so quickly recovered from speaks much for the recuperative power of the blood-forming tissues. Various kinds of disturbances in these blood-forming organs result in either deficiency or excess of the blood-cells, and in some cases the appearance of unusual forms of corpuscles.

Anæmia may arise from a deficiency either in the numbers or the quality of the red cells; they may be too few, deficient in size, or lacking in the normal quantity of hæmoglobin. In one form (*pernicious anæmia*), which often proves fatal in man a variety of forms in the red blood-cells may appear in the blood-stream; some may be very small, some larger than usual, others nucleated, etc. Again, the white cells may be so multiplied that the blood may bear in extreme cases a resemblance to milk.

In these cases there has been found associated an unusual condition of the bone-marrow, the lymphatic glands, the spleen, and, some have thought, of other parts.

The excessive action of these organs results in the production and discharge into the blood-current of cells that are immature and embryonic in character. This seems to us an example of

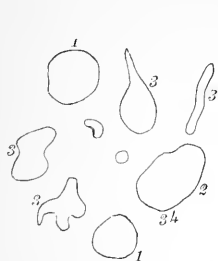

FIG. 149.

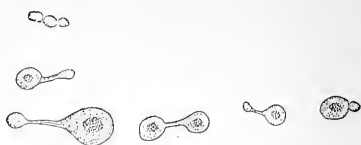

FIG. 150.



FIG. 151.

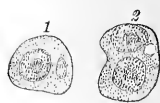

FIG. 152.

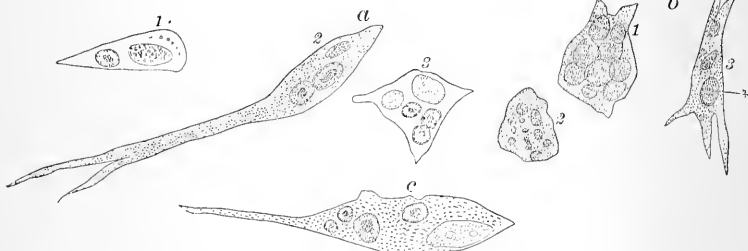

FIG. 153.

FIG. 149.—Outlines of red corpuscles in a case of profound anaemia. 1, 1, normal corpuscles; 2, large red corpuscle—megalocyte; 3, 3, very irregular forms—poikilocytes; 4, very small, deep-red corpuscles—microcytes.

FIG. 150.—Origin of microcytes from red corpuscles by process of budding and fission. Specimen from red marrow.

FIG. 151.—Nucleated red blood-corpuscles from blood in case of leukaemia.

FIG. 152.—Corpuscles containing red blood-corpuscles. 1, from blood of child at term; 2, from blood of a leukaemic patient.

FIG. 153.—*a*, 1, 2, 3, spleen-cells containing red blood-corpuscles. *b*, from marrow; 1, cell containing nine red corpuscles; 2, cell with reddish granular pigment; 3, fusiform cell containing a single red corpuscle. *c*, connective-tissue corpuscle from subcutaneous tissue of young rat, showing the intracellular development of red blood-corpuscles. (Figs. 149-153, after Osler.)

a *reversion* to an earlier condition. It is instructive also in that the facts point to a possible seat of origin of the cells in the adult, and, taken in connection with other facts, we may say, to their normal source. These blood-producing organs, having too much to do in disease, do their work badly—it is incomplete.

Although the evidence, from experiment, to show that the

nervous system in mammals, and especially in man, has an influence over the formation and fate of the blood generally, is scanty, there can be little doubt that such is the case, when we take into account instances that frequently fall under the notice of physicians. Certain forms of anæmia have followed so directly upon emotional shocks, excessive mental work and worry, as to leave no uncertainty of a connection between these and the changes in the blood ; and the former must, of course, have acted chiefly if not solely through the nervous system.

It will thus be apparent that the facts of disease are in harmony with the views we have been enforcing in regard to the blood, which we may now briefly recapitulate.

Summary.—Blood may be regarded as a tissue, with a fluid matrix, in which float cell-contents. Like other tissues, it has its phases of development, including origin, maturity, and death. The colorless cells of the blood may be considered as original undifferentiated embryo cells, which retain their primitive character ; the non-nucleated red cells of the adult are the mature form of nucleated cells that in the first instance are colorless, and arise from a variety of tissues, and which in certain diseases do not mature, but remain, as they originally were at first, nucleated. When the red cells are no longer fitted to discharge their functions, they are in some instances taken up by amœboid organisms (cells) of the spleen, liver, etc.

The chief function of the red corpuscles is to convey oxygen ; of the white, to develop as required into some more differentiated form of tissue, act as porters of food-material, and probably to take up the work of many other kinds of cells when the needs of the economy demand it. The fluid matrix or plasma furnishes the lymph by which the tissues are directly nourished, and serves as a means of transport for the cells of the blood.

The chemical composition of the blood is highly complex, in accordance with the function it discharges as the reservoir whence the varied needs of the tissues are supplied ; and the immediate receptacle (together with the lymph) of the entire waste of the body ; but the greater number of substances exist in very minute quantities. The blood must be maintained of a certain composition, varying only within narrow limits, in order that neither the other tissues nor itself may suffer.

The normal disorganization of the blood results in coagula-

tion, by which a substance, proteid in nature, known as fibrin, is formed, the antecedents of which are probably very variable throughout the animal kingdom, and are likely so even in the same group of animals, under different circumstances ; and a substance abounding in proteids (as does also plasma), known as serum, squeezed from the clot by the contracting fibrin. It represents the altered plasma.

Certain well-known inorganic salts enter into the composition of the blood—both plasma and corpuscles—but the principal constituent of the red corpuscles is a pigmented, ferruginous proteid capable of crystallization, termed hæmoglobin. It is respiratory in function.

THE CONTRACTILE TISSUES.

THAT contractility, which is a fundamental property in some degree of all protoplasm, becoming pronounced and definite, giving rise to movements the character of which can be predicted with certainty once the form of the tissue is known, finds its highest manifestation in muscular tissue.

Very briefly, this tissue is made up of cells which may be either elongated, fusiform, nucleated, finally striated lengthwise,

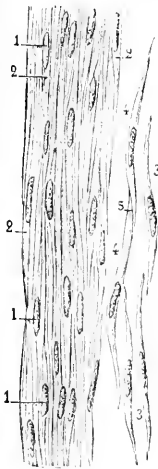

FIG. 154.

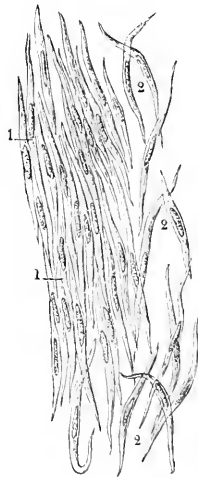

FIG. 155.

FIG. 154.—Muscular fibers from the urinary bladder of the human subject. 1×200 (Sappey.) 1, 1, 1, nuclei; 2, 2, 2, borders of some of the fibers; 3, 3, isolated fibers; 4, 4, two fibers joined together at 5.

FIG. 155.—Muscular fibers from the aorta of the calf. 1×200 . (Sappey.) 1, 1, fibers joined with each other; 2, 2, 2, isolated fibers.

but non-striated transversely, united by a homogeneous cement substance, the whole constituting non-striated or involuntary

muscle ; or, long nucleated fibers transversely striped, covered with an elastic sheath of extreme thinness, bound together into small bundles by a delicate connective tissue, these again into larger ones, till what is commonly known as a "muscle" is formed. This, in the higher vertebrates, ends in tough, inelastic extremities suitable for attachment to the levers it may be required to move (*bones*). Certain of the tissues will be found briefly described in the sections preceding "Locomotion."

Comparative.—The lowest animal forms possess the power of movement, which, as we have seen in *Amœba*, is a result rather of a groping after food ; and takes place in a direction it is impossible to predict, though no doubt regulated by laws definite enough, if our knowledge were equal to the task of defining them.

Those ciliary movements among the infusorians, connected with locomotion and the capture of food, are examples of a protoplasmic rhythm of wonderful beauty and simplicity.

Muscular tissue proper first appears in the *Cœlenterata*, but not as a wholly independent tissue in all cases. In many cœlenterates cells exist, the lower part of which alone forms a delicate muscular fiber, while the superficial portion (*myoblast*), composing the body of the cell, may be ciliated and is not contractile in any special sense. The non-striped muscle-cells are

most abundant among the invertebrates, though found in the viscera and a few other parts of vertebrates. This form is plainly the simpler and more primitive. The voluntary muscles are of the striped variety in articulates and some other invertebrate



FIG. 156.—Myoblasts of a jelly-fish, the *Medusa Aurelia* (Claus).

groups and in all vertebrates ; and there seems to be some relation between the size of the muscle-fiber and the functional power of the tissue—the finer they are and the better supplied with blood, two constant relations, the greater the contractility.

Whether a single smooth muscle-cell, a striped fiber (*cell*), or a collection of the latter (*muscle*) be observed the invariable result of contraction is a change of shape which is perfectly definite, the long diameter of the cell or muscle becoming shorter, and the short diameter longer.

Ciliary Movements.—This subject has been already considered briefly in connection with some of the lower forms of life presented for study.

It is to be noted that there is a gradual replacement of this form of action by that of muscle as we ascend the animal scale; it is, however, retained even in the highest animals in the discharge of functions analogous to those it fulfills in the invertebrates.

Thus, in *Vorticella*, we saw that the ciliary movements of the peristome caused currents that carried in all sorts of particles, including food. In a creature so high in the scale as the frog we find the alimentary tract ciliated; and in man himself a portion of the respiratory tract is provided with ciliated cells concerned with assisting gaseous interchange, a matter of the highest importance to the well-being of the mammal. As before indicated, ciliated cells are found in the female generative organs, where they play a part already explained.

It is a matter of no little significance from an evolutionary point of view, that ciliated cells are more widely distributed in the foetus than in the fully developed animal.

As would be expected the movements of cilia are affected by a variety of circumstances and reagents; thus, they are quickened by bile, acids, alkalis, alcohol, elevation of temperature up to about 40° C., etc.; retarded by cold, carbonic anhydride, ether, chloroform, etc.

In some cases their action may be arrested and re-established by treatment with reagents, or it may recommence without such assistance. All this

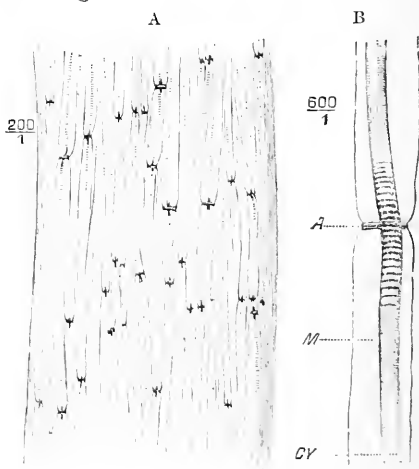

FIG. 157.—Nodes of Ranvier and lines of Fromann (Ranvier). A. Intercostal nerve of the mouse, treated with silver nitrate. B. Nerve-fiber from the sciatic nerve of a full-grown rabbit. A, node of Ranvier; M, medullary substance rendered transparent by the action of glycerin; CV, axis-cylinder presenting the lines of Fromann, which are very distinct near the node. The lines are less marked at a distance from the node.

seems to point to ciliary action as falling under the laws governing the movements of protoplasm in general. It is important to bear in mind that ciliary action may go on in the cells of a tissue completely isolated from the animal to which it belongs, and though influenced, as just explained, by the surroundings, that the movement is essentially automatic, that is, independent of any special stimulus, in which respect it differs a good deal from voluntary muscle, which usually, if not always, contracts only when stimulated.

The lines along which the *evolution* of the contractile tissues has proceeded from the indefinite outflowings and withdrawals

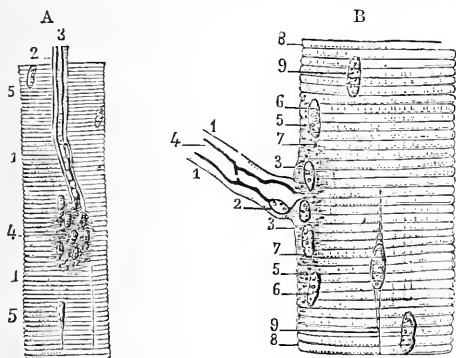

FIG. 158.—Mode of termination of the motor-nerves (Flint, after Rouget). A. Primitive fasciculus of the thyrohyoid muscle of the human subject, and its nerve-tube: 1, 1, primitive muscular fasciculus; 2, nerve-tube; 3, medullary substance of the tube, which is seen extending to the terminal plate, where it disappears; 4, terminal plate situated beneath the sarcolemma—that is to say, between it and the elementary fibrillæ; 5, 5, sarcolemma. B. Primitive fasciculus of the intercostal muscle of the lizard, in which a nerve-tube terminates: 1, 1, sheath of the nerve-tube; 2, nucleus of the sheath; 3, 3, sarcolemma becoming continuous with the sheath; 4, medullary substance of the nerve-tube, ceasing abruptly at the site of the terminal plate; 5, 5, terminal plate; 6, 6, nuclei of the plate; 7, 7, granular substance which forms the principal element of the terminal plate and which is continuous with the axis cylinder; 8, 8, undulations of the sarcolemma reproducing those of the fibrillæ; 9, 9, nuclei of the sarcolemma.

of the substance of Amœba up to the highly specialized movements of a striped muscle-cell are not all clearly marked out; but even the few facts mentioned above suffice to show gradation, intermediate forms. A similar law is involved in the muscular contractility manifested by cells with other functions. The automatic (self-originated, independent largely of a stimulus) rhythm suggestive of ciliary movement, more manifest in the earlier developed

smooth muscle than in the voluntary striped muscle of higher vertebrates, indicating further by the regularity with which certain organs act in which this smooth muscular tissue is predominant, a relationship to ciliary movement something in common as to origin—in a word, an evolution. And if this be borne in mind, we believe many facts will appear in a new

light, and be invested with a breadth of meaning they would not otherwise possess.

The Irritability of Muscle and Nerve.—An animal, as a frog, deprived of its brain, will remain motionless till its tissues have died, unless the animal be in some way stimulated. If a muscle be isolated from the body with the nerve to which it belongs, it will also remain passive ; but, if an electric current be passed into it, if it be pricked, pinched, touched with a hot body or with certain chemical reagents, contraction ensues ; the same happening if the nerve be thus treated instead of the muscle. The changes in the muscle and the nerve will be seen later to have much in common ; the muscle alone, however, *contracts*, undergoes a visible change of form.

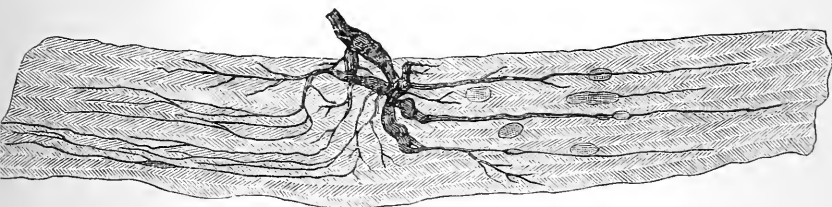

FIG. 159.—Intrafibrillar terminations of the motor nerve in striated muscle, stained with gold chloride (Landois).

Now, the agent causing this is a *stimulus*, and as we have seen, may be mechanical, chemical, thermal, electrical, or nervous. As both nerve and muscle are capable of being functionally affected by a stimulus, they are said to be *irritable* ; and since muscle does not contract without a stimulus, it is said to be *non-automatic*.

Now, since muscle is supplied with nerves, as well as blood-vessels, which end in a peculiar way (*end plates*) beneath the muscle-covering (*sarcolemma*) in the very substance of the protoplasm, it might be that when muscle seemed to be stimulated, as above indicated, the responsive contraction was really due to the excited nerve terminals ; and thus has arisen the question, Is muscle of itself really irritable ?

What has been said as to the origin of muscular tissue points very strongly to an affirmative answer, though it does not follow that a property once possessed in the lower forms of a tissue may not be lost in the higher. From various facts it may be concluded that muscle possesses independent irritability.

THE GRAPHIC METHOD AND THE STUDY OF MUSCLE PHYSIOLOGY.

It is impossible to study the physiology of muscle to the best advantage without the employment of the graphic method; and, on the other hand, no tissue is so well adapted for investigation by the isolated method—i. e., apart from the animal to which it actually belongs—as muscle; hence the convenience of introducing at an early period our study of the physiology of contractile tissue and illustrations of the graphic method, the general principles of which have already been considered.

The descriptions in the text will be brief, and the student is recommended to examine the figures and accompanying explanations with some care.

Chronographs, Revolving Cylinders, etc.—Fig. 160 represents one of the earliest forms of apparatus for the measurement of brief intervals of time, consisting of a simple mechanism for producing the movement of a

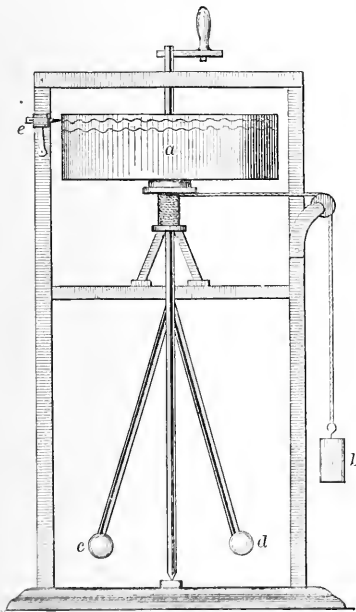

FIG. 160.—Original chronometer, devised by Thomas Young, for measuring minute portions of time (after McKendrick). *a*, cylinder revolving on vertical axis; *b*, weight acting as motive power; *c*, *d*, small balls for regulating the velocity of the cylinder; *e*, marker recording a line on cylinder.

cylinder, which may be covered with smoked paper, or other-

wise prepared to receive impressions made upon it by a point and capable of being raised or lowered, and its movements reg-

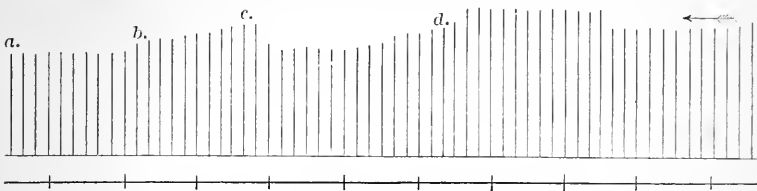

FIG. 161.—Myographic tracing, such as is obtained when the cylinder on which it is written does not revolve during the contraction of the muscle (after McKendrick).

ulated. The cylinder is ruled vertically into a certain number of spaces, so that, if its rate of revolution is known and is constant (very important), the length of time of any event recorded on the sensitive surface may be accurately known. This whole apparatus may be considered a chronograph in a rough form.

But a tuning-fork is the most reliable form of chronograph, provided it can be kept in constant action so long as required ;

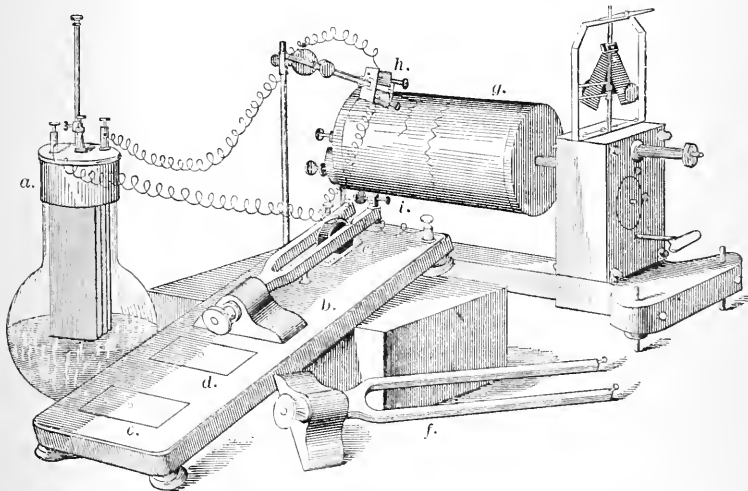

FIG. 162.—Marcy's chronograph as applied to revolving cylinder (after McKendrick). *a*, galvanic element; *b*, wooden stand bearing tuning-fork (two hundred vibrations per second); *c*, electro-magnet between limbs of tuning-fork; *d*, *e*, positions for tuning-forks of one hundred and fifty vibrations per second; *f*, tuning-fork lying loose, which may be applied to *d*; *g*, revolving cylinder; *h*, electric chronograph kept in vibration synchronous with the tuning-fork interrupter. The current working the electro-magnet from *a*, is interrupted at *i*. Foucault's regulator is seen over the clock-work of the cylinder, a little to the right of *g*.

and is provided with a recording apparatus that does not cause enough friction to interfere with its vibrations.

Fig. 162 illustrates one arrangement that answers these conditions fairly well.

The marker, or chronograph, in the more limited sense, is kept in automatic action by the fork interrupting the current from a battery at a certain definite rate answering to its own proper note.

Marey's chronograph, which is represented at *h* above, and in more detail below, in Fig. 163, consists of two electro-magnets armed with keepers, between which is the writer, which

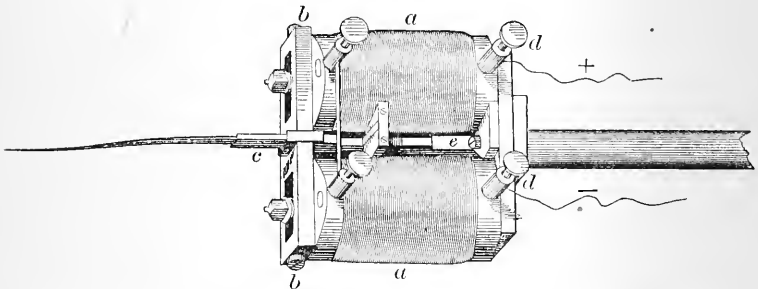

FIG. 163.—Side view of Marey's chronograph (after McKendrick). *a, a*, coils of wire; *b, b*, keepers of electro-magnets; *c*, vibrating style fixed to the steel plate *e*; *d*, binding screws for attachment of wires; + from interrupting tuning-fork; - to the battery.

has a little mass of steel attached to it, the whole working in unison with the tuning-fork, so that an interruption of the current implies a like change of position of the writing-style, which is always kept in contact with the recording surface.

Fig. 173 shows the arrangements for recording a single muscle contraction, and Fig. 174 the character of the tracing obtained.

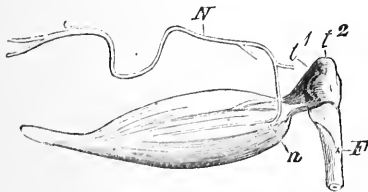

FIG. 164.—Muscle-nerve preparation, showing gastrocnemius muscle, sciatic nerve, and portion of femur of frog, for attachment to a vise (after Rosenthal).

A muscle-nerve preparation, which usually consists of the gastrocnemius of the frog with the sciatic nerve attached, clamped by a portion of the femur cut off with the muscle, is made, on stimulation, to

raise a weighted lever which is attached to a point writing on a cylinder moved by some sort of clock-work. In this case the cylinder is kept stationary during the contraction of the muscle; hence the records appear as straight vertical lines.

For recording movements of great rapidity, so that the intervals between them may be apparent, such an apparatus as is

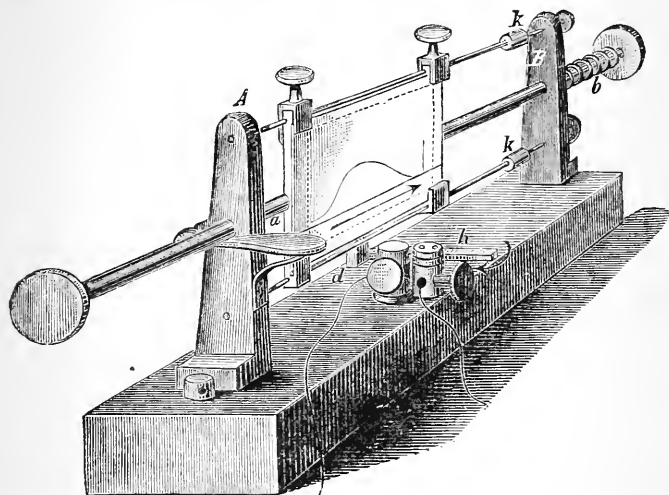

FIG. 165.—Spring myograph of Du Bois-Reymond (after Rosenthal). The arrangements for registering various details are similar to those for pendulum myograph (Fig. 173).

figured here (Fig. 165) answers well, the vibrations of a tuning-fork being written on a blackened glass plate, shot before a chronograph by releasing a spring.

Several records may be made successively by more complicated arrangements, as will be explained by another figure later.

THE APPARATUS USED FOR THE STIMULATION OF MUSCLE.

It is not only important that there should be accurate and delicate methods of recording muscular contractions, but that there be equally exact methods of applying, regulating, and measuring the stimulus that induces the contraction.

Fig. 166 gives a representation of the inductorium of Du Bois-Reymond, by which either a single brief stimulation or a series of such repeated with great regularity and frequency

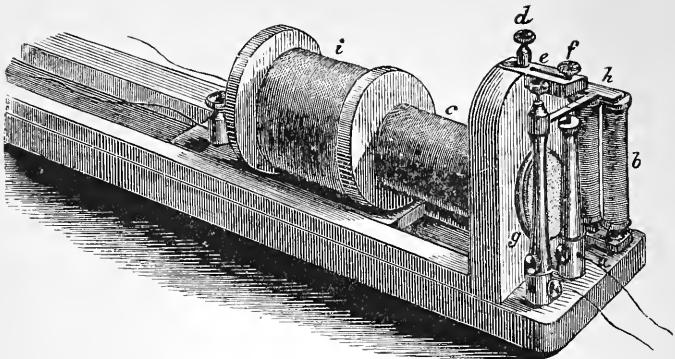

FIG. 166.—Du Bois-Reymond's inductorium (after Rosenthal). *i*, secondary coil; *c*, primary coil; *b*, electro-magnet; *h*, armature of hammer; *f*, small movable screw. The current from battery, ascending metal pillar, passes along hammer, and by connection between primary coil and wires around soft iron of *b*, iron becomes a magnet, hammer is attracted from screw *f*, and current thus broken; but when this occurs, soft iron ceases to be a magnet necessarily, and, hammer springing back, the whole course of events is repeated. This may occur several hundred times in a second. The above may be clearer from diagram, Fig. 167. By sliding secondary coil up and down, strength of induced current can be graduated.

may be effected. The apparatus consists essentially of a primary coil, secondary coil, magnetic interrupter, and a scale

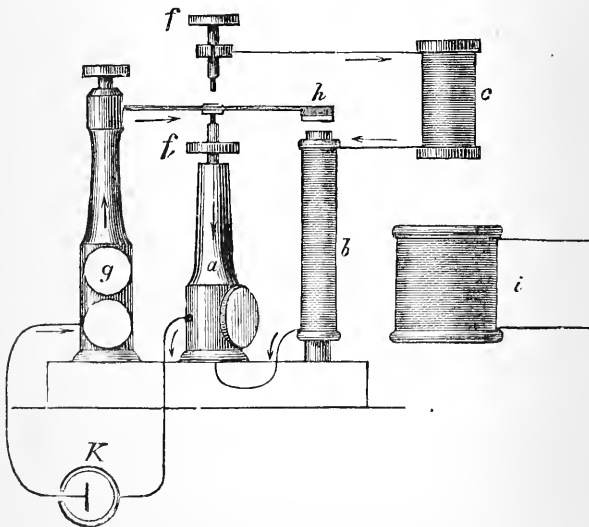

FIG. 167.—Diagrammatic representation of the working of Fig. 166 (after Rosenthal)

to determine the relative strength of the current employed. The instrument is put into action by one or more of the various well-known galvanic cells, of which Daniell's are suitable for most experiments.

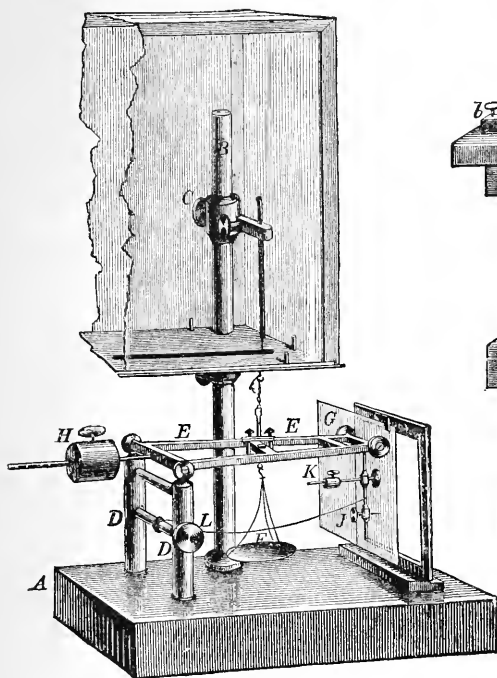

FIG. 168.

FIG. 168.—Pflüger's myograph. The muscle may be fixed to the vise *C* in the moist chamber, the vise connecting with the lever *EE*, the point of which touches the plate of smoked glass *G*. The lever is held in equipoise by *H*. When weights are placed in scale-pan *F*, the lever writes the degree of extension effected (after Rosenthal).

FIG. 169.—Tetanzing key of Du Bois-Reymond (after Rosenthal). Wires may be attached at *b* and *c*. When *d* is down the current is "short-circuited," i. e., does not pass through the wires, but direct from *c* through *d* to *b*, or the reverse, since *b*, *c*, *d* are of metal, and, on account of their greater cross-section, conduct so much more readily than the wires. *a* is an insulating plate of ebonite. This form of key is adapted for attachment to a table, etc.

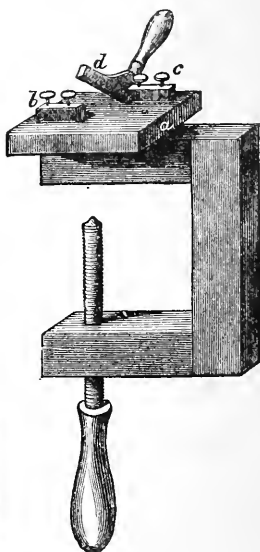

FIG. 169.

The access to, or exclusion of the current from, the inductorium is effected by some of the forms of keys, a specimen of which is illustrated in Fig. 169.

The moist chamber, or some other means of preventing the drying of the preparation, which would soon result in impaired

action, followed by death, is essential. A moist chamber consists essentially of an inclosed cavity, in which is placed some wet blotting-paper, etc., and is usually made with glass sides. The air in such a chamber must remain saturated with moisture.

A good knowledge of the subject of electricity is especially valuable to the student of physiology. But there are a few elementary facts it is absolutely necessary to bear in mind: 1. An induced current exists only at the moment of making or breaking a primary (battery) current. 2. At the moment of making, the induced current is in the opposite direction to that of the primary current, and the reverse at breaking. 3. The strength of the induced current varies with the strength of the primary current. 4. The more removed the secondary coil from the primary the weaker the current (induced) becomes.

The clock-work mechanism and its associated parts, as seen in Fig. 170, on the right, is usually termed a myograph.

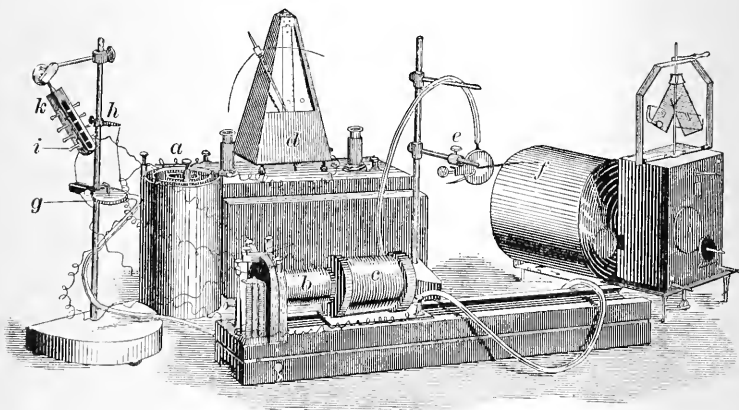

FIG. 170.—Arrangement of apparatus for transmission of muscular movement by tambours (after McKendrick). *a*, galvanic element; *b*, primary coil; *c*, secondary coil of inductorium; *d*, metronome for interrupting primary circuit when induction current is sent to electrodes *k*; *h*, forceps for femur; the muscle, which is not here represented, is attached to the receiving tambour *g*, by which movement is transmitted to recording tambour *e*, which writes on cylinder *f*.

Instead of muscular or other movements being communicated directly to levers, the contact may be through columns of air, which, it will be apparent, must be capable of communicating very slight changes if the apparatus responds readily to the alterations in volume of the inclosed air.

Fig. 171 represents a Marey's tambour, which consists essen-

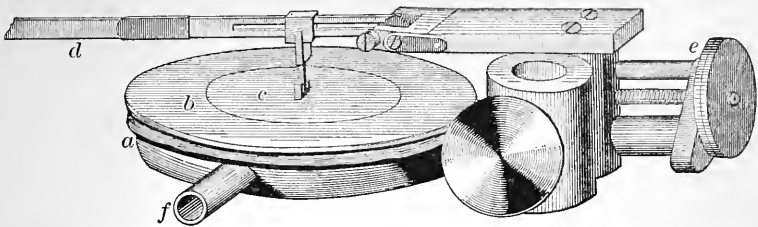

FIG. 171.—Tambour of Marey (after McKendrick). *a*, metallic case; *b*, thin India-rubber membrane; *c*, thin disk of aluminium supporting lever *d*, a small portion of which only is represented; *e*, screw for placing support of lever vertically over *c*; *f*, metallic tube communicating with cavity of tambour for attachment to an India-rubber tube.

tially of a rigid metallic case provided with an elastic top, to which a lever is attached, the whole being brought into communication with a column of air in an elastic tube. The working of such a mechanism will be evident from Figs 170 and 172.

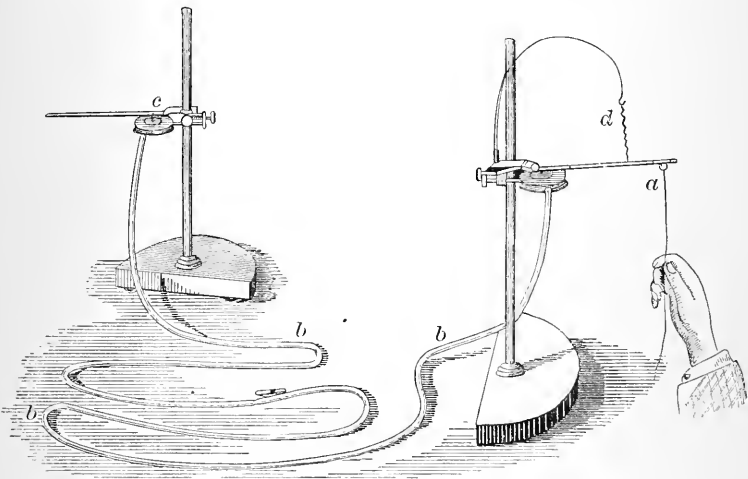

FIG. 172.—Tambours of Marey arranged for transmission of movement (after McKendrick). *a*, receiving tambour; *b*, India-rubber tube; *c*, registering tambour; *d*, spiral of wire, owing to elasticity of which, when tension is removed from *a*, the lever ascends.

The greatest danger in the use of such apparatus is not friction but oscillation, so that it is possible that the original movement may not be expressed alone or simply exaggerated, but also complicated by additions, for which the apparatus itself is responsible.

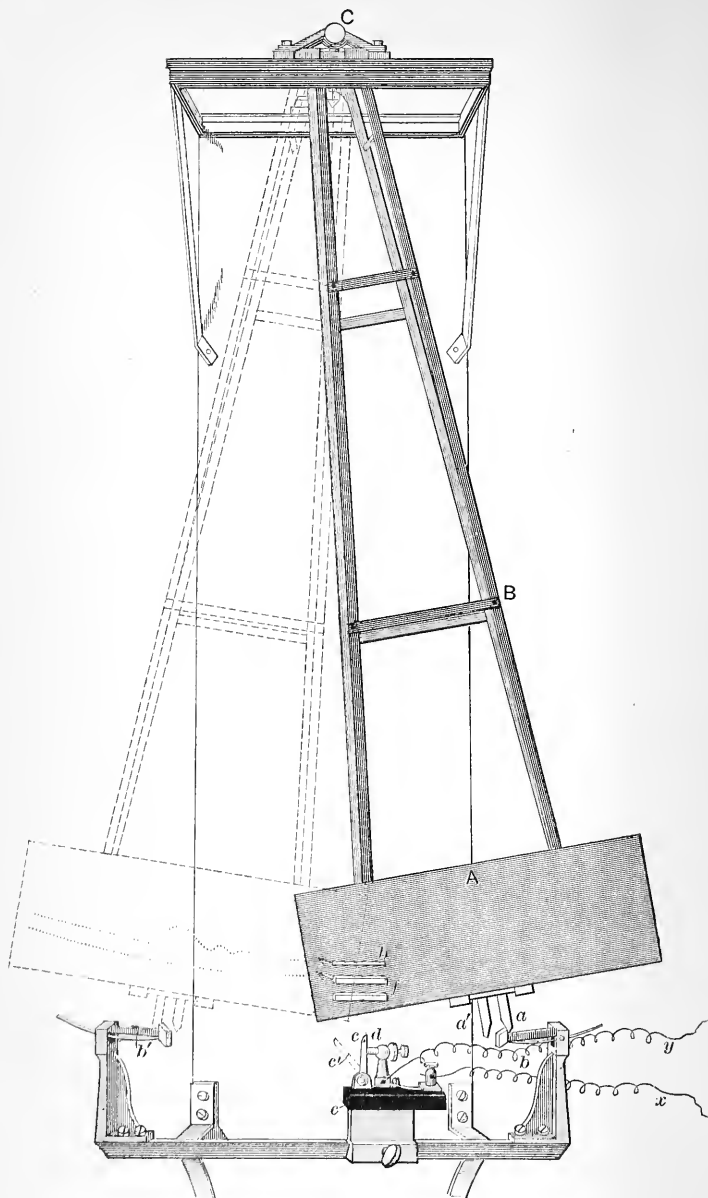

FIG. 173.

FIG. 173.—Diagrammatic representation of the pendulum myograph. The smoked-glass plate, *A*, swings with a pendulum, *B*. Before an experiment is commenced the pendulum is raised up to the right and kept in position by the tooth, *a*, catching on the spring-catch, *b*. On depressing the catch, *b*, the glass plate being set free swings into the new position indicated by the dotted lines, and is held there by the tooth, *a'*, meeting the catch, *b'*. In the course of its swing the tooth, *a*, coming into contact with the projecting steel rod, *c*, knocks it to one side, into the position indicated by the dotted line, *c'*. The rod, *c*, is in electric continuity with the wire, *x*, of the primary coil of an induction machine. In like manner the screw, *d*, is in electric continuity with the wire, *y*, of the same primary coil. The screw, *d*, and the rod, *c*, are provided with platinum points, and both are insulated by means of the ebonite block, *e*. The circuit of the primary coil to which *x* and *y* belong is closed as long as *c* and *d* are in contact. When in its swing the tooth, *a'*, knocks *c* away from *d*, the circuit is immediately broken, and a "breaking" shock is sent through the electrodes connected with the secondary coil of the machine, and so through the nerve. A lever is brought to bear on the glass plate, and when at rest describes an arc of a circle of large radius. The tuning-fork, *f* (ends only seen), serves to mark the time (after Foster).

Apparatus of this kind is not usually employed much for experiments with muscle; such an arrangement is, however, shown in Fig. 170, in which also will be seen a metronome, the pendulum of which, by dipping into cups containing mercury, makes the circuit. Such or a simple clock may be utilized for indicating the longer intervals of time, as seconds.

A SINGLE SIMPLE MUSCULAR CONTRACTION.

Experimental Facts.—The phases in a single twitch or muscular contraction may be studied by means of the pendulum myograph (Fig. 173). It consists of a heavy pendulum, which swings from a position on the right to a corresponding one on the left, where it is secured by a catch. During the swing of the pendulum, which carries a smoked-glass plate (by means of arrangements more minutely described below the figure), a tuning-fork writes its vibrations on the plate, on which is inscribed the marking indicating the exact moment of the breaking of an electric current, which gives rise to a muscle contraction that is also recorded on the plate.

The tracing on analysis presents: 1. The record of a tuning-fork making one hundred and eighty vibrations in a second. 2. The parallel marking of the lever attached to the muscle before it began to rise. 3. A curve, at first rising slowly, and then rapidly to a maximum. 4. A curve of descent similar in character, but somewhat more lengthened.

We may interpret this record somewhat thus: 1. A rise of the lever answering to the shortening of the muscle to which it is attached following upon the momentary induction shock, as the entrance of the current into the nerve, the stimulation of which causes the contraction, may be called. 2. A period before

the contraction begins, which, as shown by the time marking, occupies in this case $\frac{2\frac{1}{8}}{180}$, or about $\frac{1}{77}$ of a second. In the tracing the upward curve indicates that the contraction is at first relatively slow, then more rapid, and again slower, till a brief sta-

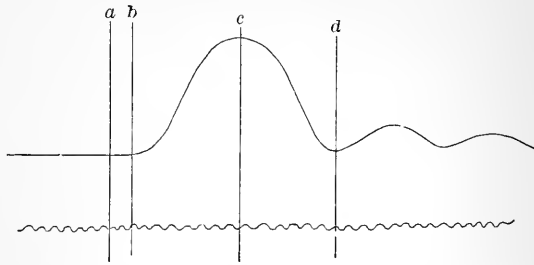

FIG. 174.—Muscle-curve obtained by the pendulum myograph (Foster). Read from left to right. The latent period is indicated by the space between *a* and *b*, the length of which is measured by the waves of a tuning-fork, making one hundred and eighty double vibrations in a second; and in like manner the duration of the other phases of the contraction may be estimated.

tionary period is reached, when the muscle gradually but rapidly returns to its previous condition, passing through the same phases as during contraction proper. In other words, there is a period of rising and of falling energy, or of contraction and relaxation. 4. A period during which invisible changes, as will be explained later, are going on, answering to those in the nerve that cause the molecular commotion in muscle which precedes the visible contraction—the latent period, or the period of latent stimulation.

The facts may be briefly stated as follows : The stimulation of a muscle either directly or through its nerve causes contraction, followed by relaxation, both of which are preceded by a latent period, during which no visible but highly important molecular changes are taking place. The whole change of events is of the briefest duration, and is termed a muscle contraction. The tracing shows that the latent period occupied rather more than $\frac{1}{100}$ second, the period of contraction proper about $\frac{4}{400}$, and of relaxation $\frac{5}{100}$ second, so that the whole is usually begun and ended within $\frac{1}{10}$ second ; yet, as will be learned later, many chemical and electrical phenomena, the concomitants of vital change, are to be observed.

In the case just considered it was assumed that the muscle

was stimulated through its nerve. Precisely the same results would have followed had the muscle been caused to contract by the momentary application of a chemical, thermal, or mechanical stimulus.

If the length of nerve between the point of stimulation and the muscle was considerable, some difference would be observed

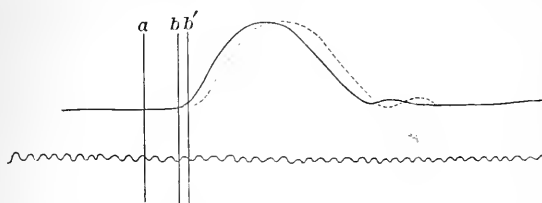

FIG. 175.—Diagrammatic representation of the measurement of velocity of nervous impulse (Foster). Tracing taken by pendulum myograph (Fig. 173). The nerve of same muscle-nerve preparation is stimulated in one case as far as possible from muscle, in the other as near to it as possible. Latent period is ab , ab' , respectively. Difference between ab and ab' indicates, of course, length of time occupied by nervous impulse in traveling along nerve from distant to near point.

in the latent period if in a second case the nerve were stimulated, say, close to the muscle. This is represented in Fig. 175, in which it is seen that the latent period in the latter case is shortened by the distance from b' to b , which must be owing to the time required for those molecular changes which, occurring in a nerve, give rise to a contraction in the muscle to which it belongs: in fact, we have in this method the means of estimating the rate at which these changes pass along the nerve—in other words we have a means of measuring the speed of the propagation of a nervous impulse. The estimated rate is for the frog twenty-eight metres per second, and for man about thirty-three metres. As the latter has been estimated for the nerve, with its muscle in position in the living body, it must be regarded rather as a close approximation than as exact as the other measurements referred to in this chapter.

It will be borne in mind that the numbers given as representing the relative duration of the events vary with the animal, the kind of muscle, and a variety of conditions affecting the same animal.

TETANIC CONTRACTION.

It is well known that a weight may be held by the outstretched arm with apparently perfect steadiness for a few

seconds, but that presently the arm begins to tremble or vibrate, and soon the weight must be dropped. The arm was maintained in its position by the joint contraction of several muscles, the action of which might be described (traced) by a writer attached to the hand and recording on a moving surface. Such a record would indicate roughly what had happened; but the exact nature of a muscular contraction in such a case can best be learned by laying bare a single muscle, say in the thigh of a frog, and arranging the experiment so that a graphic record shall be made.

Using the apparatus previously described (Fig. 173), a series of induction shocks may be sent into the muscle with the result indicated in Figs. 176 and 177, according to the rate of interruption of the current.

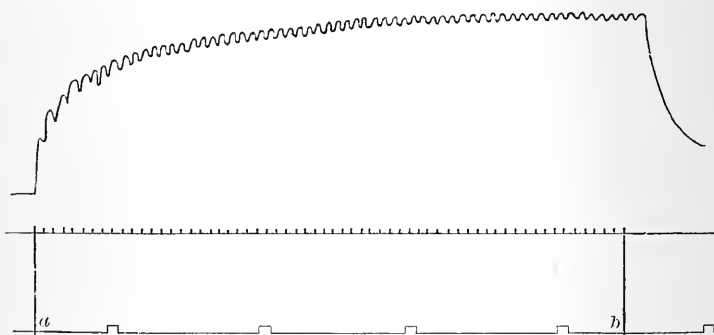

FIG. 176.—Curve of imperfect tetanic contraction (Foster). Uppermost tracing indicates contractions of muscle; intermediate, when the shocks were given; lower, time-markings of intervals of one second. Curve to be read, like others, from left to right, and illustrates at the end a "contraction remainder."

If the stimuli follow each other with a certain rapidity, such a tracing as that represented in Fig. 176 is obtained; and if the rapidity of the stimulation exceeds a fixed rate, the result is that seen in Fig. 177.

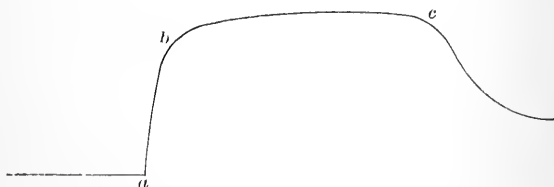

FIG. 177.—Curve of complete tetanic contraction (Foster).

It is possible to see in these tracings a genetic relation, the second figure being evidently derivable from the first, and the third from the second, by the fusion of all the curves into one straight line.

The Muscle Tone.—There are a number of experimental facts from which the conclusion has been drawn that tetanic contraction is accompanied by a muscle tone which is in itself evidence of the nature of the contraction.

We may safely conclude that, at all events, most of the muscular contractions occurring within the living body are tetanic—i. e., the muscle is in a condition of shortening, with only very brief and slight phases of relaxation; and that a comparatively small number of individual contractions suffice for tetanus when caused by the action of the central nervous system; though, as proved by experiments on muscle removed from the body, they may be enormously increased. While a few stimulations per second suffice to cause tetanus, it will also persist though thousands be employed.

THE CHANGES IN A MUSCLE DURING CONTRACTION.

Though the change in form is very great during the contraction of a muscle, the change in bulk is almost inappreciable, amounting to a diminution of not more than about $\frac{1}{1000}$ of the volume. In fact, according to the latest investigator, there is no diminution whatever.

Since the fibers of striped muscle are of very limited length (30 to 40 mm.), it would seem that a contraction originating in one fiber must be capable of initiating a similar action in its neighbor; and, as the ends of the fibers lie in contact, it is easy to understand how the wave of contraction spreads. Normally, the contraction must pass from about the center of the muscle-cell where the nerve terminates in the end-plate.

THE ELASTICITY OF MUSCLE.

In proportion as bodies tend to resume their original form when altered by mechanical force are they elastic, and the extent to which they do this marks the limit of their elasticity.

If a muscle (best one with bundles of fibers of about equal length and parallel arrangement) be stretched by a weight attached to one end, it will, on removal of the extending force,

return to its original length; and if a series of weights which differ by a common increment be applied in succession and the degrees of extensions compared, as may be done by the graphic method, it will be apparent that the increase in the extension does not exactly correspond with increment in the weight, but is proportionally less. With an inorganic body, as a watch-spring, this is not the case.



FIG. 178. — Du Bois-Rey-
mond's apparatus for
the study of elastic ex-
tension in muscle (after
Rosenthal). The gradu-
ated rod attached to
muscle is to be observed
with a lens.

Further, the recoil of the muscle after the removal of the weight is not perfect for all weights; but within certain narrow limits this is the case, i. e., the elasticity of muscle, though slight (for it is easily over-extended), is perfect. When once a muscle is over-extended, so weighted that it can not reach its original length almost at once, it is very slow to recover, which explains the well-known duration of the effects of sprains, no doubt owing to some profound molecular change associated with the stretching.

The tracings below show at a glance the difference between the elasticity of muscle and of ordinary bodies.

It is a curious fact that a muscle during the act of contraction is more extensible than when passive; a disadvantage from a purely physical point of view, but probably a real advantage as tending to obviate sprain by preventing too sudden an application of the extending force.

It will be borne in mind that the limbs are held together as by elastic bands slightly on the stretch, owing to the elasticity of the muscles. Now, as seen in many

tracings of muscular contraction, there is a tendency to imperfect relaxation after contraction—the *contraction remainder* or *elastic after-effect*, which can be overcome by gentle traction. In the living body, the weight of the limbs and the action of the stretched muscles on the side of the limb opposite to that on which the muscles in actual contraction are situated, com-

bine to make the action of the muscle more perfect by overcoming this tendency to imperfect relaxation, which is proba-

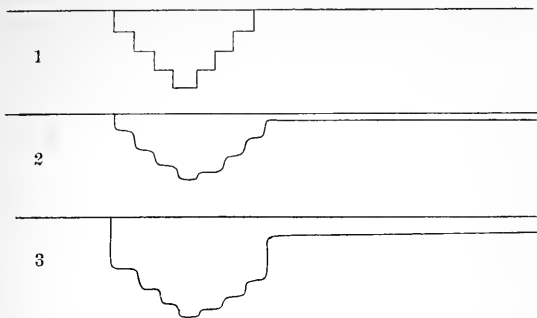

FIG. 179.—Illustrations of the difference in elasticity of inanimate and living matter (after Yeo). 1. Shows graphically behavior of a steel spring under equal increments of weight. 2. A similar tracing obtained from an India-rubber band. 3. The same from a frog's muscle. Note that the extension decreases with equal increments of weight, and that the muscle fails to return to the original position (abscissa) after removal of the weight.

bly less marked, independent of these considerations, in the living body. This elasticity of living muscles, which is completely lost on death, is a fair measure of their state of health or organic perfection. Hence that hard (elastic recoil) feeling of the muscles in young and vigorous persons, especially athletes, in whom muscle is brought to the highest degree of perfection.

This property is then essentially the outcome of vitality, which is in a word the foundation of the differences noted between the elasticity of inorganic and organic bodies. A muscle, the nutrition of which is suffering from whatever cause, whether deficient blood-supply, fatigue, or actual disease, is deficient in elasticity. We wish to emphasize these relations, for we consider it very important to avoid regarding vital phenomena in the light of physics merely, which the employment of the graphic method (and indeed all methods by which we remove living things out of their normal relations) fosters.

Electrical Phenomena of Muscle.—The contraction and probably the resting stage of muscle are attended by the generation of electrical currents, the direction of which is indicated in Fig. 180.

It will be observed that the diagram indicates that between no current and the strongest obtainable there are all shades of

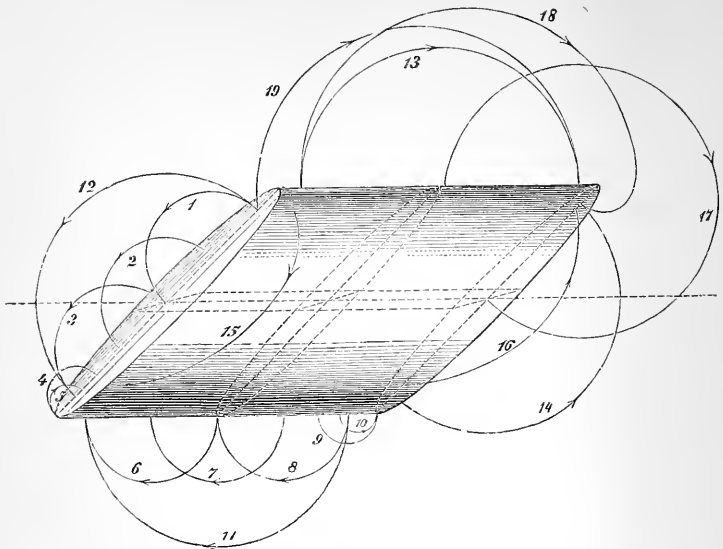

FIG. 180.—Representation of electrical currents in a muscle-rhombus (after Rosenthal).

strength, according to the parts of the muscle connected by the electrodes. The strongest is that resulting when the superficial equator and the transverse center are connected ; and it is found that the nearer these points are approached the stronger the current becomes.

It is important to note that the electric current of muscle, however viewed, is associated with the chemical and all the other molecular changes of which the actual contraction is but the outward and visible sign ; and since the currents have an appreciable duration, wane with the vitality of the tissue, and wholly disappear at death, they must be associated with the fundamental facts of organic life ; for it is to be remembered that electrical currents are not confined to muscle, but have been detected in the developing embryo, and even in vegetable protoplasm. Though the evidence is not yet complete, it seems likely that electrical phenomena may prove to be associated with (we designedly avoid any more definite expression) all vital phenomena.

Chemical Changes in Muscle.—At a variable period after death the muscles become rigid, producing that stiffness (*rigor mortis*) so characteristic of a recent cadaver.

The subject can be studied in some of its aspects to great advantage in an isolated individual muscle.

Three changes in a muscle that has passed into death rigor are constant and pronounced. The living muscle, either alkaline or neutral in reaction, has become decidedly acid; an abundance of carbonic anhydride is suddenly given off; and *myosin*, a specific proteid, has been formed. That these phenomena have some indissoluble connection with each other so far as the first two at least are concerned, while not absolutely certain, seems probable, as will be learned shortly.

It will be borne in mind that muscle-fibers are tubes containing semifluid protoplasm, and that a coagulation of the latter must give rise to general rigor. This protoplasmic substance can be extracted at a low temperature from the muscles of the frog, and, as the temperature rises, coagulates like blood, giving rise to a clot (myosin) and muscle-serum, a fluid not very unlike the serum of blood.

This myosin can also be extracted from dead rigid muscles by ammonium chloride, etc. It resembles the globulins generally, but is less soluble in saline solutions than the globulin of blood (paraglobulin); is less tough than fibrin; has a very low coagulating point (55° to 60° C.); and is somewhat jelly-like in appearance. The clotting of blood and of muscle is thus analogous, myosin answering to fibrin, and there being a serum in each case, both processes marking the permanent disorganization of the tissue. The reaction seems to be due to the formation of a kind of lactic acid, probably sarcolactic; though whether due to excessive production of this acid, on the death of the muscle, which for some reason does not remain free in the living muscle, or whether sarcolactic acid arises as a new product, is uncertain. It is certain that the acid reaction of dead muscle is not owing to carbonic acid, for the reddened litmus does not change color on drying.

That a muscle in action does use up oxygen and give off carbonic anhydride can be definitely proved; though it is equally clear that the life of a muscle is not dependent on a *constant* supply of oxygen as is that of the individual, for a muscle can live, even contract long and vigorously, in an atmosphere free from this gas, as in nitrogen.

From the suddenness of the increase of carbonic anhydride, the onset of death and *rigor mortis* has been compared to an explosion.

After this the muscle becomes greatly changed physically; its elasticity and translucency are lost; there is absence of muscle-currents; it is wholly unirritable, is less extensible—it is, as before stated, firmer—it is dead.

But these fundamental phenomena, the increase of carbonic anhydride and the acid reaction, are observable after prolonged tetanus. It was, therefore—putting all the facts together that we now refer to and others, not forgetting that a muscle is always respiring, inhaling oxygen, and exhaling carbonic anhydride—not unreasonable to conclude that normal tetanus and *rigor mortis* were but exaggerated conditions of a natural state. The coagulation of the muscle protoplasm (*plasma*), giving rise to myosin, was, however, a serious obstacle to the adoption of this view. But it has very recently been urged with great plausibility that an old view is correct, viz., that *rigor mortis* (contracture) is the last act of muscle-life; it is, in fact, a prolonged tetanus or contracture, ending in most cases, though not all, in coagulation of the myosin. This state can be induced and recovered from in favorable cases by cutting off the blood from a part by ligature, and later readmitting it to the starving region. It has been suggested that the products of the muscle-waste, usually washed away by the bloodstream, in such an experiment and after death, collect and act as a stimulant to the muscle, causing it to remain in permanent contraction.

The other constituents of *dead* muscle and their relative properties may be learned from the following table (Von Bibra):

Water.....	744.5
Solids: Myosin, elastic substance, etc., insoluble in water.....	155.4
Soluble proteids.....	19.3
Gelatin.....	20.7
Extractives and salts.....	37.1
Fats.....	23.0
	255.5—255.5
Total.....	1,000

Among the *extractives* of muscle very important is creatin (.2 to .3 per cent), a nitrogenous crystalline body. Certain allied forms, as xanthin, hypoxanthin (sarkin), carnin, taurin, and uric acid, are also found.

Glycogen (animal starch), very abundant in all the tissues,

including the muscles of the embryo, is found in small quantity in the muscles of the adult; and in the heart-muscle a peculiar sugar (*inosit*) is present.

It is, of course, very difficult to say to what extent the bodies known as extractives exist in living muscle, though that glycogen, fats, and certain salts are normally present admits of little doubt.

There is a coloring matter in muscle, more abundant in the red muscles of certain animals than the pale, allied to hæmoglobin, if not identical with that body.

It may be stated as a fact, the exact significance of which is unknown, that during contraction the extractives soluble in water decrease, while those soluble in alcohol increase.

It will, however, be very plain, from what has been stated in this section, that life processes and chemical changes are closely associated, and to realize this is worth much to the student of Nature.

THERMAL CHANGES IN THE CONTRACTING MUSCLE.

Since very marked chemical changes accompany muscular contraction, it might be expected that there would be some modification in temperature, and probably in the direction of elevation. Experiment proves this to be the case.

But why should a muscle when at rest, as may be shown, maintain a certain temperature, unless chemical changes are constantly taking place? As already stated, such is the case, and the rise on passing into tetanus is simply an expression of increased chemical action.

No machine known to us resembles muscle except superficially. The steam-engine changes fuel into heat and mechanical motion, but there the resemblance ends. Muscle changes its food, or fuel, not directly either into heat or motion, but into itself; yet as a machine it is more effective than the steam-engine, for more work and less heat are the outcome of its activity than is the case with the steam-engine.

THE PHYSIOLOGY OF NERVE.

Muscle and nerve are constantly associated functionally, and have so much in common that it becomes desirable to study them together. Much that has been established for muscle

holds equally well for nerve; and the latter, though apparently wholly different in structure at first sight, is really not so. Nerve has its protoplasmic part (axis-cylinder), which is the essential structure, its protective sheaths, and its nuclei (nerve-corpuscles).

As already indicated, a nerve possesses irritability.

It is found that when the constant (polarizing) current is passing from above downward—that is, when the cathode (negative-pole) is on the side toward the muscle—the irritability of the nerve is increased, and the reverse when the opposite conditions prevail.

This altered condition is known as *electrotonus*.

It has been found as the result of many experiments that profound modifications of the irritability of a nerve do take place during the passage of a constant current. These are diagrammatically represented in Fig. 181.

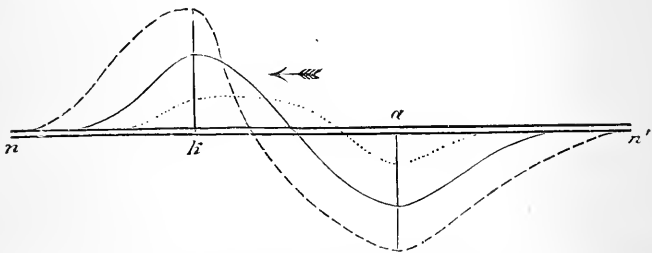

FIG. 181.—Diagrammatic representation of variations in electrotonus according to strength of current employed (after Pflüger). nn' , a section of nerve; a , anode (+ pole); k , cathode (- pole). Curves above the horizontal denote catelectrotonus; below, the opposite.

- Briefly stated, they are these : 1. The nature of the change depends on the direction of the polarizing (constant) current; hence, if the current is descending, there is an increase of irritability (*catelectrotonus*) in the portion of the nerve nearest the muscle, and *vice versa*. 2. The extent of the change of irritability is dependent on the strength of the polarizing current. 3. This change is most marked close to the electrodes, spreads to a considerable extent beyond this point without the electrodes (extra-polar regions), and also exists within the region of contact of the electrodes (intra-polar regions). 4. It follows that there must be a point at which it is not experienced (indifferent point or neutral point).

Now, it is possible to understand why a sudden change in

the current should cause a muscular contraction. An equally sudden alteration, a profound molecular effect, has been caused, and this we must believe essential to the causation of a muscular contraction through the influence of a nerve.

To use an illustration which may serve a good purpose if not taken too literally, it is a well-known experience that one sitting in a room in which a clock is ticking soon fails to notice this regular sound: but should the clock stop suddenly or as suddenly commence to tick very rapidly, the attention is aroused, while a very gradual slowing to cessation or the reverse would have escaped notice. The explanation of such facts takes us down to the very foundations of biology; but just now we wish only to elucidate by our own experience how it is possible to conceive of a muscle being stimulated by the molecular movements of nerve, or rather a change in these.

There are important practical aspects to this question. One may understand why it is that electricity proves so ready a stimulus, and is so valuable a therapeutic agent. It seems, in fact, as will be learned later, to be capable of taking the place to some extent of that constant nerve influence which we believe is being exerted in the higher animals toward the maintenance of the regularity of their cell-life (metabolism).

Pathological and Clinical.—It is believed that in the nerves of a living animal body, the electrotonic condition can be induced as in an isolated piece of nerve. Hence, the value of the constant current in diminishing nerve irritability in neuralgia and allied conditions. Apparatus of great nicety of construction and capable of generating, accurately measuring, and conveniently applying electrical currents of different kinds, now adds to the resources of the practitioner. But we are probably as yet only on the threshold of electro-therapeutics.

Electrical Organs.—Electrical properties can be manifested by a large number of fishes; and the subject is of special theoretical interest. It is now established that the development of electrical organs points to their being specially modified muscles—tissues, in fact, in which the contractile substance has disappeared and the nervous elements become predominant and peculiar. No work is done, but the whole of the chemical energy is represented by electricity. Functionally an electric organ (which usually is some form of cell, on the walls of which nerves are distributed, inclosing a gelatinous substance,

the whole being very suggestive of a galvanic battery) closely resembles a muscle-nerve preparation or its equivalent in the

normal body. The electric organs experience fatigue; have a latent period; their discharge is tetanic (interrupted); is excited by mechanical, thermal, or electrical stimuli; and the effectiveness of the organs is heightened by elevation of temperature, and the reverse by cooling, etc.

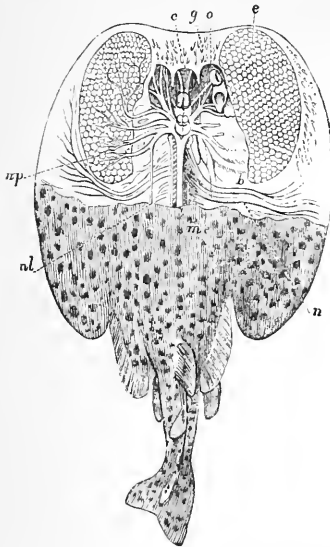

FIG. 182.—The electric-fish torpedo, dissected to show electric apparatus (Huxley). *b*, branchiæ; *c*, brain; *e*, electric organ; *g*, cranium; *me*, spinal cord; *n*, nerves to pectoral fins; *nl*, nervi laterales; *np*, branches of pneumogastric nerves to electric organs; *o*, eye.

MUSCULAR WORK.

If during a given period one of two persons raises a weight through the same height but twice as frequently as the other, it is plain that he does twice the work; from such a case we may deduce the rule for calculating work, viz., to multiply the weight and height together.

The effectiveness of a given muscle must, of course, depend

on the degree to which it shortens, which is from one half to three fifths of its length; and the number of fibers it contains—i. e., upon its length and the area of its cross-section, taking into account in connection with the first factor the arrangement of the fibers; those muscles in which the fibers run longitudinally being capable of the greatest total shortening.

There is, as shown by actual experimental trial, a relation between the work done and the load to be lifted. With double the weight the contraction may be as great as at first, or even greater; but a limit is soon reached beyond which contraction is impossible. This principle may be stated thus: *The contraction is a function of the stimulus*, and is illustrated by the diagram below (Fig. 183).

It has been shown experimentally that the chemical interchanges in a muscle, acting against a considerable resistance,

are increased—i. e., the metabolism and the working tension are related.

These experimental facts harmonize with our experience of a sense of satisfaction and effectiveness in the use of the muscles

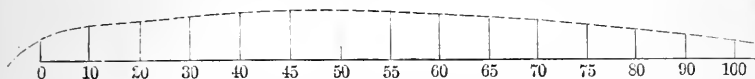

FIG. 183.—Diagram of muscular contractions with same stimulus and increasing weights. The numbers represent grammes (McKendrick).

when weights are held in the hands ; and it must be a matter of practical importance that each person should, in taking systematic exercise, keep to that kind which does not either overweight or underweight the muscles.

CIRCUMSTANCES INFLUENCING THE CHARACTER OF MUSCULAR AND NERVOUS ACTIVITY.

The Influence of Blood-Supply. Fatigue.—Fig. 184 shows at a glance differences in the curves made by a contracting muscle suffering from increasing fatigue.

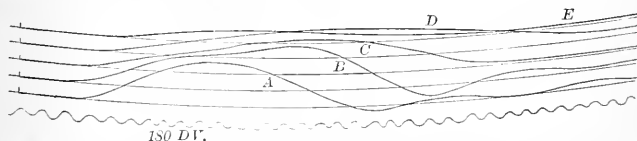

FIG. 184.—Curves of a muscle contraction in different stages of fatigue (after Yeo). *A*, curve when muscle was fresh; *B*, *C*, *D*, *E*, each just after muscle had already contracted two hundred times. The alteration in length of latent period is not well brought out in these tracings.

Suppose that in such a case the blood had been withheld from the muscle, and that it is now admitted, an almost immediate effect is seen in the nature of the contractions ; but even if only saline solution had been sent through the vessels of the muscle, a similar change would have been noticeable. We may fairly conclude that the blood and saline removed something which had been exercising a depressing effect on the vitality of the muscle. In a working muscle, like all living tissues, there are products of vital action (metabolism) that are poisonous. We have already learned that a working muscle generates an excess of carbonic anhydride, and something which gives it an acid reaction ; and that it uses up oxygen as well as other matters derivable from the blood.

Fatigue will occur, it is well known, if the muscles are used for an indefinitely long period, no matter how favorable the blood-supply—another evidence that there is, in all probability, some chemical product, the result of their own activity, depressing them; and this is rendered all the more likely when it is learned that the injection of lactic acid, to take one example, produces effects like ordinary fatigue.

It is also a matter of common experience that exercise, while beneficial to the whole body, the muscles included, as shown by their enlargement under it, becomes injurious when carried to the point of fatigue.

Why the use of the muscles is conducive to their welfare is but a part of a larger question, Why does the use of any tissue improve it?

When the nerve which supplies a muscle is stimulated its blood-vessels dilate, and it has been assumed that the same happens when a muscle contracts normally in the body; and when muscular action is increased there is a corresponding augmentation in the quantity of blood driven through the muscles in a given period, even if there be no actual increase in the caliber of the blood-vessels, for the heart-beat is greatly accelerated.

But repose is as necessary as exercise for the greatest effectiveness of the muscles, as the experience of all, and especially athletes, proves.

That the nervous system plays a great part in the nutrition of muscles is evident from the fact, among countless others, that it is not possible to use the brain to its greatest capacity and the muscles to their fullest at the same time; the individual engaged in physical "training" must forego severe mental application. Nervous energy is required for the muscles, and all questions of blood-supply are, though important, subordinate. But it would be premature to enter into a full discussion of this interesting topic now.

The sense of fatigue experienced after prolonged muscular action is complex, though there can be no doubt that the nerve-centers must be taken into account, since any muscular work that, from being unusual, requires closer attention and a more direct influence of the will, is well known to be more fatiguing. On the other hand, the accumulation of products of fatigue doubtless reports itself through the local nervous mechanism.

Separation of Muscle from the Central Nervous System.—

When the nerve belonging to a muscle is divided, certain histological changes ensue, which may be briefly described as fatty degeneration, followed by absorption; and when regeneration of the nerve-fibers takes place on apposition of the cut ends, a more or less complete restoration of the functions of the nerve follows, but the exact nature of the process of repair is not yet fully agreed upon; it seems, in fact, to vary in different cases as to details, though it is likely that, in instances in which there is a complete return to the normal functionally, the axis-cylinders, at all events, are reproduced.

The degeneration downward is complete; upward, only to the first node of Ranvier.

Immediately after the section the irritability of the nerve is increased, but rapidly disappears, from the center toward the periphery (Ritter-Valli law).

In the mean time the muscle has been suffering. Its irritability at first diminishes, then becomes greater than usual to shocks from the make or break of the constant current; but finally all irritability is lost, and fatty degeneration and disappearance of true muscular structure complete the history. It is theoretically interesting, as well as of practical importance, that degeneration may be delayed by the use of the constant current, the significance of which we have already endeavored to explain.

The Influence of Temperature.—If a decapitated frog be placed in water of the ordinary temperature, and heat be gradually applied, the animal does not move (proving that the spinal cord alone is not conscious), but the muscles, when 43° to 50° C. is reached, contract and become rigid, a condition known as "heat-rigor."

There are some advantages in investigating changes in temperature by the graphic method. Curves from a muscle-nerve preparation show that elevation of temperature shortens the latent period and the curve of contraction. Lowering the temperature has an exactly opposite effect, as might be supposed, and these changes take place in the muscles of both cold-blooded and warm-blooded animals, though more marked in the latter.

The modifications evident to the eye are accompanied by others, chemical in nature, and a comparison of these shows that the rapidity and force of the muscular contraction

run parallel with the rapidity and extent of the chemical changes.

Certain drugs also modify the form of the muscle-curve very greatly, so that it appears that the molecular action which underlies all the phenomena of muscle and nerve (for what has been said of muscle applies also to nerve, if we substitute nervous impulse for contraction) can go on only within those narrow bounds which, one realizes more and more in the study of physiology, are set to the activities of living things.

UNSTRIPED MUSCLE.

This form of muscular tissue is characterized by its long latent period, its slow wave of contraction, and the progress of the contraction being in either a transverse or longitudinal direction, a wave of contraction in one cell being capable of setting up a corresponding wave in adjoining cells even when no nerve-fibers are distributed to them. It is excited, though less readily, by all the kinds of stimuli that act upon striped muscle. In the higher groups of animals this tissue is chiefly confined to the viscera of the chest and abdomen, constituting in the case of some of them the greater part of the whole organ.

The slow but powerful and rhythmical contraction of this form of muscle adapts it well to the part such organs play in the economy. There are variations, however, in the rapidity, force, regularity, and other qualities of the contraction in different parts; thus, it is comparatively rapid in the iris, and extremely powerful and regular in the uterus, serving to produce that prolonged yet intermittent pressure essential under the circumstances (expulsion of the foetus).

Comparative.—Muscular contraction is relatively sluggish and prolonged among the invertebrates, to which, however, the movement of the wings of insects is a marked exception, some of them having been shown by the graphic method to vibrate some hundreds of times in a second.

The slow movements of the snail are proverbial. As a rule, the strength of the muscles of the invertebrates is incomparably greater than that of vertebrates, as witness the powerful grasp of a crab's claw or a beetle's jaws.

These facts are in harmony with the generally slow metabolism of most invertebrates and the lower vertebrates.

The muscles of the tortoise contract tardily but with great power, resist fatigue well, retain their vitality under unfavorable conditions, and after death for a very long period (days).

Without resorting to elaborate experiments, the student may convince himself of the truth of most of the above statements by observing the movements of a water-snail attached to a glass vessel; the note made by the buzzing of an insect, and comparing it with one approaching it in pitch sounded by some instrument of music; the force necessary to withdraw the foot or tail of a tortoise; the peristaltic movements of the intestine and other organs in a freshly killed animal; or the action of a bee, wasp, or wood-boring beetle on the cork of a bottle in which one of them may be inclosed.

SPECIAL CONSIDERATIONS.

In the case of weakly tuberculous animals a sharp tap on the chest will often produce a contraction of the muscles thus stimulated; but, in addition, a local contraction lasting some little time, known as a *wheal* or *idio-muscular* contraction, follows. This phenomenon seems to be the result of a special irritability in such muscles.

Cramp may arise under a great variety of circumstances, but it seems to be in all cases either a complete prolonged tetanus, in which there is unusual muscular shortening in severe cases, at least, or the persistence of a contraction remainder.

The great differences known to exist between individuals of the same species in strength, endurance, fleetness, and other particulars in which the muscles are concerned, raise numerous interesting inquiries. The build of the greyhound or race-horse suggests in itself part of the explanation on mechanical principles, lung capacity, etc. But when it is found that one dog, horse, deer, or man excels another of the same race in swiftness or endurance, and there is nothing in the form to furnish a solution, we are prompted to ask whether the muscles may not contract more energetically, experience a shortening of the latent period or other phase of contraction; or whether they produce less of waste-products or get rid of them more rapidly. The whole subject is extremely complicated, and we may say here that there is some evidence to show that in races of dogs and other animals which surpass their fellows the nerve regulating the heart and lungs (*vagus*) has greater power;

but, leaving this and much more out of the account, it is likely there are individual differences in the functional nature of the muscle. Of equal or more importance is the energizing influence of the nervous system, which probably under great excitement (public boat-races, etc.) acts to produce in man those supermaximal contractions which seem to leave the muscle long the worse of its unusual action. The nerve-centers, it is likely, suffer still more from excessive discharge of nerve-force (as we may speak of it for the present) necessary to originate the muscular work. Hence the importance of training in all animals to minimize the non-effective expenditure, ascertain the capacity possessed, learn the direction in which weaknesses lie; and equally important the much neglected-period of rest before actual contests—if such are to be undertaken at all—so that all the activities of the body may gather head, and thus be prepared to meet the unusual demand upon them.

The law of rhythm in organic nature is beautifully illustrated by the behavior of nerve and especially muscle; at least it is more obvious in the case of muscle, at this stage of our progress.

The regularity with which one phase succeeds another in a single contraction; the essentially rhythmic (vibratory) character of tetanus, fatigue and recovery; the recurrence of increase and decrease in the muscle and nerve currents—in fact, the whole history of muscle is an admirable commentary on the truth of the law of rhythm, into which in further detail space will not permit us to enter.

It is a remarkable fact that the endurance of man, especially civilized man, seems to be greater than that of any other mammal. It may be hazardous to express a dogmatic opinion as to the reason of this, but the influence of the mind over the body is unquestionably greater in man than in any other animal; and, if we are correct in assigning so much importance to the influence of the *nervous* system in maintaining the proper molecular balance which is at the foundation of the highest good of an organism, we certainly think that it is in this direction we must look for the explanation of the above-mentioned fact, and much more that would otherwise be obscure in man's functional life.

Functional Variations.—We have endeavored, in treating this subject of muscle, to point out how the phenomena vary with the animal, the kind of muscle, and the circumstances

under which they are manifested. It may be shown that every one of the qualities which a muscle possesses varies with the temperature, the blood-supply, the duration of its action, the character of the stimulus, and other modifying agents. Not only are there great variations for different groups of animals, but lesser ones for individuals ; though the latter are made more evident indirectly than when tested by the usual laboratory methods ; but they must be taken account of if we would understand animals as they are. Some of these will be referred to later.

If a muscle-cell be regarded in the aspect that we are now emphasizing, its study will tend to impress those fundamental biological laws, the comprehension of which is of more importance than the acquisition of any number of facts, which, however interesting, can, when isolated, profit little.

Summary of the Physiology of Muscle and Nerve.—The movements of a muscle are distinguished from those of other forms of protoplasm by their marked definiteness and limitation.

The contraction of a muscle-fiber (cell) results in an increase in its short transverse diameter, and a diminution of its long diameter, without appreciable change in its total bulk.

Muscle and nerve are not automatic, but are irritable. Though muscle normally receives its stimulus through a nerve, it possesses independent irritability.

Stimuli may be mechanical, chemical, thermal, electrical, and in the case of muscle, nervous ; and to be effective they must be applied suddenly and last for a brief but appreciable time.

Electrical stimulation, especially, is only effective when there is a sudden change in the force or direction of the currents. This applies to both muscle and nerve.

A muscular contraction consists of three phases : the latent period, the period of rising, and the period of falling energy, or of contraction and relaxation.

When the phase of relaxation is minimal and that of contraction approaches continuity, a tetanus results. The contractions of the muscles *in situ* are tetanic, and are accompanied by a low sound, evidence in itself of their vibratory character.

The prolonged contraction of a muscle leads to fatigue ; owing in part, at least, to the accumulation of waste-products within the muscle which depress its energies.

This is a necessary consequence of the fact that all proto-

plasmic activity is accompanied by chemical change, and that some of these processes result in the formation of products which are hurtful and are usually rapidly expelled.

Muscular contraction is accompanied by chemical changes, in which the formation of carbon dioxide, and some substance that causes an acid reaction to take the place of an alkaline or neutral one. Since free oxygen is not required for the act of contraction, but is still used up by a contracting muscle, it may be assumed that the oxygen that plays a part in actual contraction is intra-molecular.

Chemical changes are inseparable from the vital processes of all protoplasm, and the phenomena of muscle show that they are constantly in operation, but exalted during ordinary contraction and that tetanic condition which precedes and may end in coagulation of muscle plasma and the formation of myosin. The latter is a result of the disorganization of muscle, and has points of resemblance to the coagulation of the blood.

The contraction of a muscle and the passage of a nervous impulse are accompanied by electrical changes. Whether currents exist in uninjured muscle and nerve is a matter of controversy. All physiologists agree that they exist in muscle (and nerve) during functional activity.

During the passage of a constant (polarizing) current from a battery through a nerve, it undergoes a change in its irritability and shows a variation in the electro-motive force of the ordinary nerve-current (electrotonus). This fact is of therapeutic importance. The electrical phenomena of nerve are altogether more prominent than the chemical, the reverse of which is true of muscle. The activity of a muscle (and nerve probably) is accompanied by the generation of heat, an exaltation of which takes place during muscular contraction.

Rigor mortis causes an increase in temperature and the chemical interchanges which accompany the other phenomena. A muscle may also become rigid by passing into *rigor caloris*. Living muscle is translucent, alkaline or neutral in reaction, and elastic; dead muscle, opaque, acid in reaction, and devoid of elasticity, but firmer than living muscle, owing to coagulation of the muscle-plasma. Dead nerve undergoes similar changes.

The elasticity of muscle is restricted but perfect within its own limits. It differs from that of inorganic bodies in that the increments of extension are not directly proportional to the

increments of the weight. When overstretched, muscle does not return to its original length (loss of elasticity), hence the serious nature of sprains.

It is important to regard muscular elasticity as an expression of vital properties.

The work done by a muscle is ascertained by multiplying the load lifted by the height; and the capacity of an individual muscle will vary with its length, the arrangement of its fibers, and the area of its cross-section (i. e., the number of fibers).

The work done may be regarded as a function of the resistance (load), as the contraction is also a function of the stimulus. The separation of a muscle from its nerve by section of the latter leads to certain changes, most rapid in the nerve, which show that the two are so related that prolonged independent vitality of the muscle is impossible, and make it highly probable that muscle is *constantly* receiving some beneficial stimulus from nerve, which is exalted and manifest when contraction takes place.

The study of the development of the electrical cells of certain fishes shows that they are greatly modified muscles in which contractility, etc., has been exchanged for a very decided exaltation of electrical properties. It is likely, though not demonstrated, that all forms of protoplasm undergo electrical changes—that these, in fact, like chemical phenomena, are vital constants.

The phases of the contraction of smooth muscular tissue are all of longer duration; the contraction-wave passes in different directions, and may spread into cells devoid of nerves, which we think not unlikely also to be the case, though less so, for all forms of muscle.

The smooth muscle-cell must be regarded as a more primitive, less specialized, form of tissue. Variations in all the phenomena of muscle with the animal and the circumstances are clear and impressive. Finally, muscle illustrates an evolution of structure and function, and the law of rhythm.

THE NERVOUS SYSTEM.—GENERAL CONSIDERATIONS.

SINCE in the higher vertebrates the nervous system is dominant, regulating apparently every process in the organism, it will be well before proceeding further to treat of some of its functions in a general way to a greater extent than we have yet done.

Manifestly, it must be highly important that an animal shall be able to place itself so in relation to its surroundings that it may adapt itself to them. Prominent among these adaptations are certain movements by which food is secured and dangers avoided. The movements having a central origin, a peripheral mechanism of some kind must exist so as to place the centers in connection with the outer world. Passing by the evolution of the nervous system for the present, it is found that in vertebrates generally there is externally a modification of the epithelial covering of the body (*end-organ*) in which a nerve terminates, which latter may be traced to a cell or cells removed from the surface (*center*), and from which in most cases other nerves proceed.

The nervous system, we may remind the student, consists in vertebrates of centers in which nerve-cells abound, united by nerve-fibers and by the most delicate form of connective tissue known, in connection with which there are incased strands of protoplasm or nerves as outgrowths. The main centers are, of course, aggregated in the brain and spinal cord.

It is possible to conceive of the work of a nervous system carried on by a single cell and an afferent and efferent nerve; but inasmuch as such an arrangement would imply that the central cell should act the part of both receiving and originating impulses (except it were a mere conductor, in which case there would be no advantage whatever in the existence of a cell at all), according to the principle of the physiological division

of labor, we might expect that there would be at least two central cells—one to receive and the other to transmit impulses—or at least that there should be some specialization among the central cells; and we shall have good reason later to believe that this has reached a surprising degree in the highest animals.

Moreover, it would be a great advantage if the termination of the ingoing (afferent) nerve should not lie exposed on the surface, but be protected by some form of cell that had also the power to transmit to it the impressions received from without, in a form suitable to the nature of the nerve and the needs of the organism.

So that a complete mechanism in its simplest form would furnish: 1. A peripheral cell or nerve end-organ. 2. An afferent or sensory nerve. 3. Two or more central cells. 4. An efferent nerve, usually connected with—5. A muscle or other form of cell, the action of which may be modified by the outgoing nerve, or, as we should prefer to say, by the central nervous cells through the efferent nerve. The advantages of the principal cells being within and protected are obvious.

When, then, an impression made on the peripheral cell is carried inward, there modified, and results in an outgoing nervous impulse answering to the afferent one, giving rise to a muscular contraction or other effect not confined to the recipient cells, the process is termed *reflex action*.

The great size, the multiplicity of forms, the distinct outline and large nuclei of nerve-cells, suggest the probability that they play a very important part, and such is found to be the case. Indeed, in some sense the rest of the nervous system may be said to exist for them.

Probably nerve-cells do sometimes act as mere conductors of nervous impulses originating elsewhere, but such is their lowest function. Accordingly, it is found that the nature of any reflex action depends most of all on the behavior of the central cells.

It can not be too well borne in mind that nerves are conductors and such only. They *never* originate impulses.

The properties considered in the last chapter are common to all kinds of nerves known; and though we must conceive that there are some differences in the form of impulses, these are to be traced, not to the nerve primarily, but to the organ in which it ends peripherally or to the central cells.

To return to reflex action, it is found that the muscular response to a peripheral irritation varies with the point stimulated, the intensity of the stimulus, etc., but is, above all, determined by the central cells.

Nerve influence may be considered as following lines of least resistance, and there is much evidence to show that an impulse having once taken a certain path, it is easier for it to pass in this direction a second time, so that we have the foundation of the laws of habit and a host of interesting phenomena in this simple principle.

It is found that, in a frog deprived of its brain and suspended by the under jaw, there is no movement unless some stimulus be applied ; but if this be done under suitable conditions, instructive results follow, which we now proceed to indicate briefly. The experiments are of a simple character, which any student may carry out for himself.

Experimental.—Preparing a frog by cutting off the whole of the upper jaw and brain-case after momentary anæsthesia, suspend the animal by the lower jaw and wait till it is perfectly quiet. Add to water in a beaker sulphuric acid till it tastes distinctly but not strongly sour, to be used as a stimulus. 1. Apply a small piece of bibulous paper, moistened with the acid, to the inner part of the thigh of the animal. The leg will be drawn up and the paper probably removed. Remove the paper and cleanse the spot. 2. Apply a similar piece of paper to the middle of the abdomen ; one or both legs will probably be drawn up, and wipe off the offending body. 3. Let the foot of the frog hang in the liquid ; after a few moments it will be withdrawn. 4. Repeat, holding the leg ; probably the other leg will be drawn up. 5. Apply stronger acid to the inside of the right thigh ; the whole frog may be convulsed, or the left leg may be put in action after the right. Even if the stimulating paper be applied near the anus, it will be removed by the hind-legs. 6. Beneath the skin of the back (posterior lymph-sac) inject a few drops of liquor strychniæ of the pharamacopœia ; after a few minutes apply the same sort of stimulus to the thigh as before. The effects follow more quickly and are much more marked—the animal, it may be, passing into a general tetanic spasm.

These experiments may be varied, but suffice to establish the following conclusions : 1. The stimulus is not immediately effective, but requires to act for a certain variable period, de-

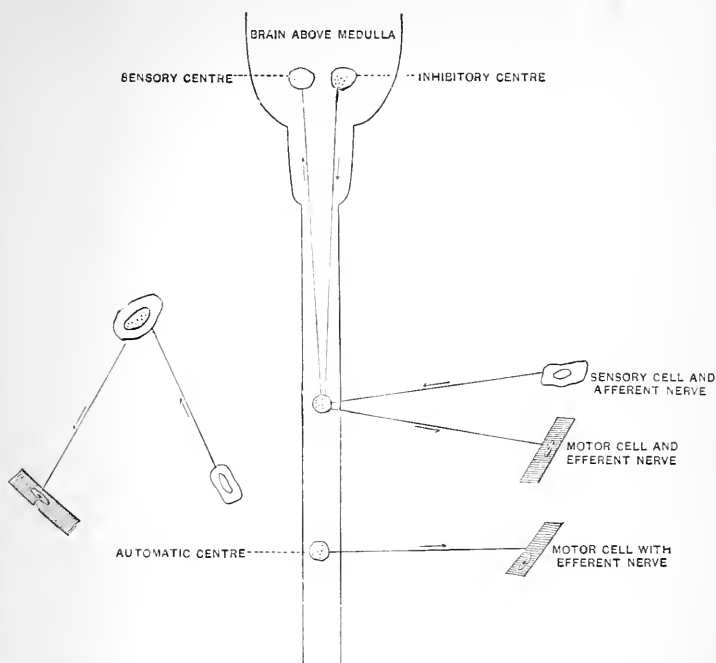

FIG. 187.—Diagram intended to illustrate nervous mechanism of—1, automatism; 2, reflex action; and 3, how nervous impulses in the latter case may pass into the higher parts of brain and become part of consciousness, or be wholly inhibited. A reflex or automatic center may, for the sake of simplicity, be reduced to a single cell, as above on the left.

pending chiefly on the condition of the central nervous system. 2. The movements of the muscles harmonize (are co-ordinated), and tend to accomplish some end—are purposive. If the nerve alone and not the skin be stimulated, there may be a spasm only and not adaptive movement. 3. Nervous impulses, when very abundant, may pass along unaccustomed or less accustomed paths (experiments 4 and 5). This is sometimes spoken of as the radiation of nervous impulses.

The sixth experiment is very important, for it shows that the result varies far more with the condition of the nervous centers (cells) than the stimulus, the part excited, or any other factor.

Automatism.—But, seeing that these central cells have such independence and controlling power, the question arises. Are

these, or are there any such cells, capable of originating impulses in nerves wholly independent of any stimulus from without? In other words, have the nerve-centers any true automatism? Apparently this quality is manifested by unicellular organisms of the rank of *Amœba*. Has it been lost, or has it become a special characteristic developed to a high degree in nerve-cells?

We shall present the facts and the opinions based on them as held by the majority of physiologists, reserving our own criticisms for another occasion: 1. The medulla oblongata is supposed to be the seat of numerous small groups of cells, to a large extent independent of each other, that are constantly sending out nervous impulses which, proceeding to certain sets of muscles, maintain them in rhythmical action. One of the best known of these centers is the respiratory. 2. The posterior lymph hearts of the frog are supplied by nerves (tenth pair), which are connected, of course, with the spinal cord. When these nerves are cut, the hearts for a time cease to beat, but later resume their action. 3. The heart beats after all its nerves are cut, and it is removed from the body, for many hours, in cold-blooded animals. 4. The contractions of the intestine take place in the absence of food, and in an isolated piece of the gut. The intestine, it will be remembered, is abundantly supplied with nerve-elements. 5. In a portion of the ureters, from which it is believed nerve-cells are absent, rhythmical action takes place.

Conclusions.—1. Whether the action of the respiratory and similar centers could continue in the absence of all stimuli can not be considered as determined. 2. That there are regular rhythmical discharges from the spinal nerve-cells along the nerves to the lymph hearts seems also doubtful. 3. Later investigations render the automaticity of the heart more uncertain than ever, so that the result stated above (3) must not be interpreted too rigidly.

Similar doubts hang about the other cases of apparent automatism.

As regards the various comparatively isolated collections of cells known as ganglia, the evidence, so far as it goes, is against their possessing either automatic or reflex action; and new views of their nature will be presented in due course.

Nervous Inhibition.—If the pneumogastric nerve passing from the medulla to the heart of vertebrates be divided and the

lower (peripheral) end stimulated, a decided change in the action of the heart follows, which may be in the direction of weakening or slowing, or positive arrest of its action.

Assuming, for the present, that the cells (center) of the medulla have the power to bring about the same result, it is seen that such nervous influence is preventive or inhibitory of the normal cardiac beat, so that the vagus is termed an inhibitory nerve. Such inhibition plays a very important part in the economy of the higher animals, as will become more and more evident as we proceed. The nature of the influences that produce such remarkable results will be discussed when we treat of the heart.

An illustration will probably serve in the mean time to make the meaning of what has been presented in this chapter more clear and readily grasped.

In the management of railroads a very great variety of complicated results are brought about, owing to system and orderly arrangement, by which the wishes of the chief manager are carried out.

Telegraphing is of necessity extensively employed. Suppose a message to be conveyed from one office to another, this may (1) simply pass through an intermediate office, without special cognizance from the operator in charge; (2) the operator may receive and transmit it unaltered; (3) he may be required to send a message that shall vary from the one he receives in a greater or less degree; or (4) he may arrest the command altogether, owing to the facts which he alone knows and upon which he is empowered always to act according to his best discretion.

In the first instance, we have an analogy with the passage of a nervous impulse through central fibers, or, at all events, unaffected by cells; in the second, the resemblance is to cells acting as conductors merely; in the third, to the usual behavior of the cells in reflex action; and, in the fourth, we have an instance of inhibition. The latter may also be rendered clear by the case of a horse and its rider. The horse is controlled by the rider, who may be compared to the center, through the reins answering to the nerves, though it is not possible for either rider or reins to originate the movements of the animal, except as they may be stimuli, which latter are only effective when there are suitable conditions—when, in fact, the subject is irritable in the physiological sense.

THE CIRCULATION OF THE BLOOD.

EVERY tissue, every cell, requiring constant nourishment, some means must necessarily have been provided for the conveyance of the blood to all parts of the organism. We now enter upon the consideration of the mechanisms by which this is accomplished and the method of their regulation.

Let us consider possible mechanisms, and then inquire into their defects and the extent to which they are found embodied in nature.

That there must be a central pump of some kind is evident. Assume that it is one-chambered, and with an outflow-pipe which is continued to form an inflow-pipe. This might be provided with valves at the openings, by which energy would be saved by the prevention of regurgitation. In such a system things must go from bad to worse, as the tissues, by constantly using up the prepared material of the blood, and adding to it their waste products, would effect their own gradual starvation and poisoning.

It might be conceived, however, that waste at all events was got rid of by the blood being conducted through some eliminating organs; and assume that one such at least is set aside for respiratory work. If the blood in its course anywhere passed through such organs, the end would be attained in some degree; but if the division of labor were considerable, we should suppose that, gaseous interchange being so very important as we have been led to see from the study of the chapters on general biology, and on muscle, organs to accomplish this work might receive the blood in due course and return it to the central pump in a condition eminently fit from a respiratory point of view.

Such, however, would necessarily be associated with a more complicated pump; and, if this were so constructed as to prevent the mixture of blood of different degrees of functional value, higher ends would be attained.

Turning to the channels themselves in which the blood flows, a little consideration will convince one that rigid tubes are wholly unfit for the purpose. Somewhere in the course of the circulation the blood must flow sufficiently slowly, and through vessels thin enough to permit of that interchange between the blood and the tissues, through the medium of the lymph, which is essential from every point of view. The main vessels must have a strength sufficient to resist the force with which the blood is driven into them.

Now, it is possible to conceive of this being accomplished with an intermittent flow ; but manifestly it would be a great advantage, from a nutritive aspect, that the flow and therefore the supply of tissue pabulum be constant. With a pump regularly intermittent in action, provided with valves, elastic tubes having a resistance in them somewhere sufficient to keep them constantly over-distended, and a collection of small vessels with walls of extreme thinness, in which the blood-current is greatly slackened, a steady blood-flow would be maintained, as the student may readily convince himself, by a few experiments of a very simple kind :

1. To show the difference between rigid tubes and elastic ones, let a piece of glass-rod, drawn out at one end to a small diameter, have attached to the other end a Higginson's (two-bulb) syringe, communicating with a vessel containing water. Every time the bulb is squeezed, water flows from the end of the glass rod, but the outflow is perfectly intermittent.

2. On the other hand, with a long elastic tube of India-rubber, ending in a piece of glass rod drawn out to a point as before, if the action of the pump (bulb) be rapid the outflow will be continuous. An apparatus that every practitioner of medicine requires to use answers perhaps still better to illustrate these and other principles of the circulation, such as the pulse, the influence of the force and frequency of the heart-beat on the blood-pressure, etc. We refer to a two-bulb atomizer, the bulb nearer the outflow serving to maintain a constant air-pressure.

We may now examine the most perfect form of heart known, that of the mammal, in order to ascertain how far it and its adjunct tubes answer to *a priori* expectations.

The Mammalian Heart.—In order that the student may gain a correct and thorough knowledge of the anatomy of the heart and the workings of its various parts, we recommend him to pursue some such course as the following :

1. To consult a number of plates, such as are usually furnished in works on anatomy, in order to ascertain in a general way the relations of the heart to other organs, and to the chest wall, as well as to become familiar with its own structure.

2. To supplement this with reading the anatomical descriptions, without too great attention to details at first, but with the object of getting his ideas clear so far as they go.

3. Then, with plates and descriptions before him, to examine several dead specimens of the heart of the sheep, ox, pig, or other mammal, first somewhat generally, then systematically, with the purpose of getting a more exact knowledge of the various structures and their anatomical as well as physiological relations.

We would not have the student confine his attention to any single form of heart, for each shows some one structure better than the others; and the additional advantages of comparison are very great. The heart of the ox, from its size,

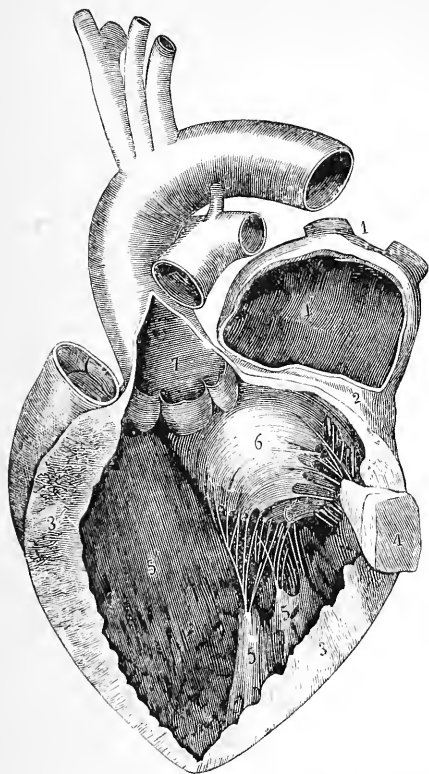

FIG. 186.—The left auricle and ventricle opened and part of their walls removed to show their cavities (Allen Thomson). 1, right pulmonary vein cut short; 1', cavity of left auricle; 3, thick wall of left ventricle; 4, portion of the same with papillary muscle attached; 5, 5', the other papillary muscles; 6, one segment of the mitral valve; 7, in aorta is placed over the semilunar valves.

is excellent for the study of valvular action, and the framework with which the muscles, valves, and vessels are connected; while the heart of the pig (and dog) resemble the human organ more closely than most others that can be obtained.

It will be found very helpful to perform some of the dissections under water, and by the use of this or some other fluid the action of the valves may be learned as it can in no other way. By a little manipulation the heart may be so held that water may be poured into the orifices, prepared by a removal of a portion of the blood-vessels or the auricles, when the valves may be seen closing together, and thus revealing their action in a way which no verbal or pictorial representation can do at all adequately.

A heart thoroughly boiled and allowed to get cold shows, on being pulled somewhat apart, the course, attachment, and other

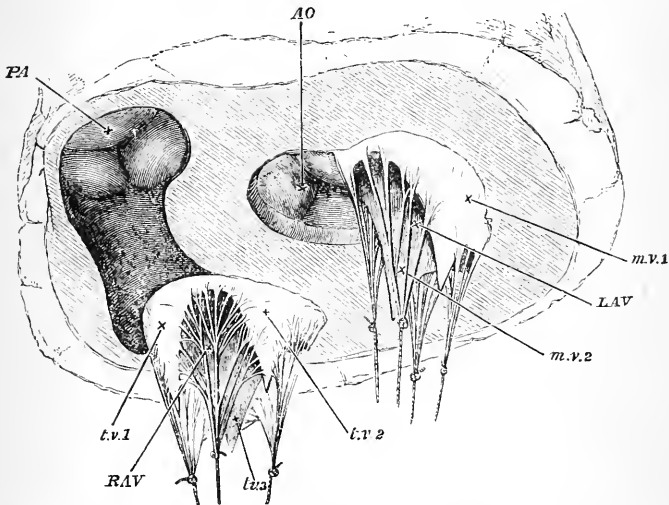

FIG. 187.—View of the orifices of the heart from below, the whole of the ventricles having been cut away (after Huxley). *RAV*, right auriculo-ventricular orifice, surrounded by the three flaps, *t. v. 1*, *t. v. 2*, *t. v. 3*, of the tricuspid valve, which are stretched by weights attached to the *chordae tendinae*. *LAV*, left auriculo-ventricular orifice, etc. *PA*, orifice of the pulmonary artery, the semilunar valves represented as having met and closed together. *AO*, orifice of the aorta.

features of the fibers very well, as also the skeleton of the organ, which may be readily separated.

When this has all been done, the half is not yet accomplished. A visit to an abattoir will now repay amply for the time spent. Animals are there killed and eviscerated so rapidly that an observer may not only gain a good practical acquaintance with the relations of the heart to other parts, but may often see the organ still living and exemplifying that action

peculiar to it as it gradually approaches quiescence and death—a matter of the utmost importance.

If the student will then compare what he has learned of the mammalian heart in this way with the behavior of the heart of a frog, snake, fish, turtle, or other animal that may be killed after brief ether narcosis, without cessation of the heart's action, he will have a broader basis for his cardiac physiology than is usual; and we think we may promise the medical student, who will in this and other ways that may occur to him supplement the usual work on the human cadaver, a pleasure and profit in the study of heart-disease which come in no other way.

With the view of assisting the observation of the student as regards the heart of the mammal, we would call special attention to the following points among others: Its method of suspension, chiefly by its great vessels; the strong fibrous framework for the attachment of valves, vessels, and muscle-fibers; the great complexity of the arrangement of the latter; the various lengths, mode of attachment, and the strength of the

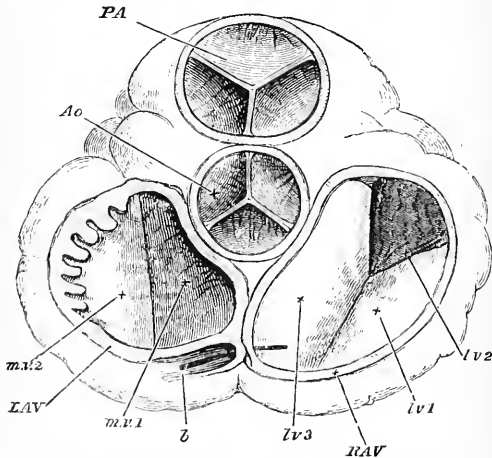

FIG. 188.—Orifices of the heart seen from above, after the auricles and great vessels had been cut away (after Huxley). *PA*, pulmonary artery with its semilunar valves. *Ao*, aorta in a similar condition. *RAV*, right auriculo-ventricular orifice, with *m. v. 1* and *2* flaps of mitral valve; *b*, style passed into coronary vein. On the left part of *LAV* the section of the auricle is carried through the auricular appendage, hence the toothed appearance due to the portions in relief cut across.

inelastic chordæ tendineæ; the papillary muscles, which doubtless act at the moment the valves flap back, thus preventing

the latter being carried too far toward the auricles, the pocketing action of the semilunar valves with their strong margin and meeting nodules (*corpora Arantii*); the relative thickness of auricles and ventricles, and the much greater thickness of the walls of the left than of the right ventricle—differences which are related to the work these parts perform.

The latter may be well seen by making transverse sections of the heart of an animal, especially one that has been bled to death, which specimen also shows how the contraction of the heart obliterates the ventricular cavity.

It will also be well worth while to follow up the course of the coronary arteries, noting especially their point of origin.

The examination of the valves of the smaller hearts of cold-blooded animals is a matter of greater difficulty and is facilitated by dissection under water with the help of a lens or dissecting microscope; but even without these instruments much may be learned, and certainly that the valves are relatively to those of the mammalian heart imperfectly developed, will become very clear.

CIRCULATION OF THE BLOOD IN THE MAMMAL.

It is highly important and quite possible in studying the circulation to form a series of mental pictures of what is transpiring. It will be borne in mind that there is a set of elastic tubes of relatively thick walls, standing open when cut across, dividing into smaller and smaller branches, and finally ending in vessels of more than cobweb fineness, and opening out into others, that become larger and larger and fewer and fewer, till they are gathered up into two of great size which form the right auricle. The larger pipes consist everywhere of elastic tissue proper, muscular tissue (itself elastic), fibrous tissue, and a flat epithelial lining, so smooth that the friction therefrom must be minimal as the blood flows over it.

The return tubes or veins are like the arteries, but so thin that their walls fall together when cut across. They are different from all the other blood-tubes in that they possess valves opening toward the heart throughout their course. The veins are at least twice as numerous as the arteries, and their capacity many times greater. The small vessels or capillaries are so abundant and wide-spread that, as is well known, the smallest

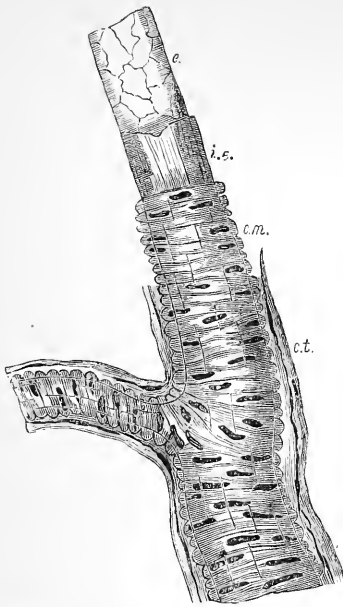

FIG. 189.—Various layers of the walls of a small artery (Landois). *e.*, endothelium; *i. e.*, internal elastic lamina; *c. m.*, circular muscular fibers of the middle coat; *c. t.*, connective tissue of the outer coat, or T. adventitia.

cut anywhere gives rise to a flow of blood, owing to section of some of these tubes, which, it will be remembered, are not visible to the unaided eye. It is estimated that their united area is several hundred (500 to 800) times that of the arteries.

If we suppose the epithelial lining pushed out of a small artery we have, so far as structure alone goes, a good idea of a capillary—i. e., its walls are but one cell thick, and these cells though long are extremely thin, so that it is quite easy to understand how it is that the amœboid corpuscles can, under certain circumstances, push their way through its probably semi-fluid walls.

From what has been said, it will be seen that the whole collection of vascular tubes

may be compared to two inverted funnels or cones with the

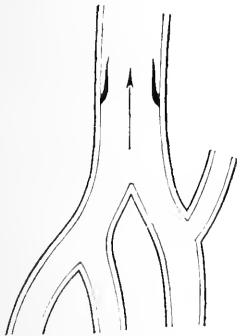

FIG. 190.

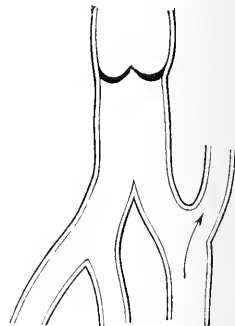

FIG. 191.

FIG. 190.—Vein with valves lying open (Dalton).

FIG. 191.—Vein with valves closed, the blood passing on by a lateral branch below (Dalton).

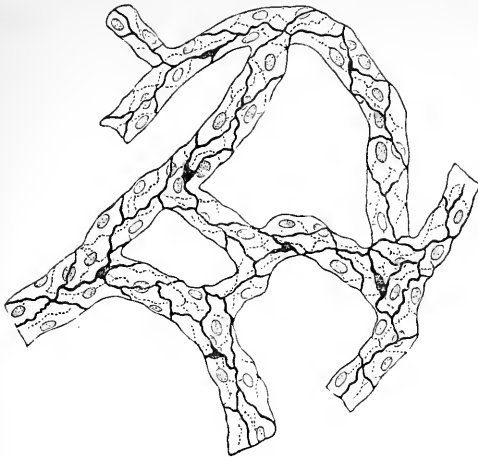

FIG. 192.—Capillary blood-vessels (Landois). The cement substance between the endothelium has been rendered dark by silver nitrate, and the nuclei made prominent by staining.

smaller end toward the heart and the widest portions representing the capillaries.

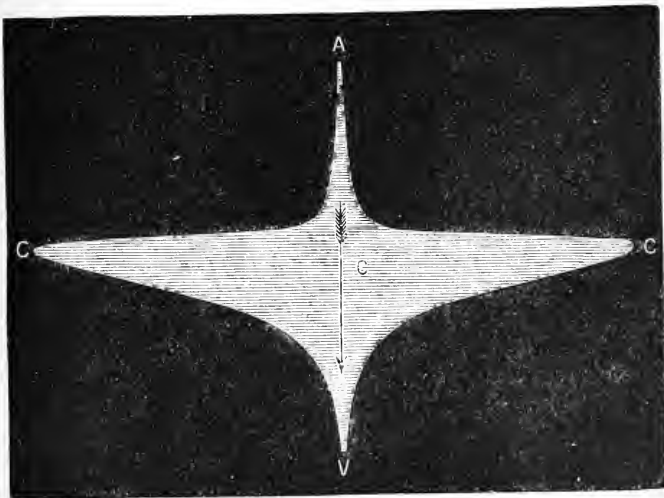

FIG. 193.—Diagram to illustrate the relative proportions of the aggregate sectional area of the different parts of the vascular system (after Yeo). A, aorta; C, capillaries; V, veins.

THE ACTION OF THE MAMMALIAN HEART.

What takes place may be thus very briefly stated : The right auricle contracting squeezes the blood through the auricular-ventricular opening into the right ventricle, never quite

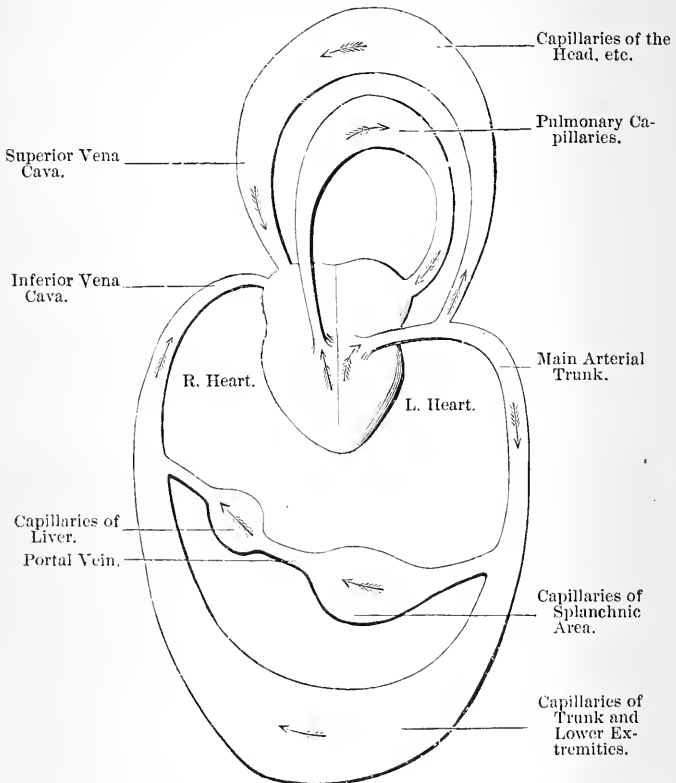

FIG. 194.—Diagram of the circulation. The arrows indicate the course of the blood. Though the pulmonary, the lower and the upper parts of the systemic circulation are represented so as to show the distinctness of each, it will be also apparent that they are not independent. Relative size of different parts of the system is only very generally indicated.

emptying itself probably; immediately after the right ventricle contracts, by which its valves are brought into sudden tension and opposition, thus preventing reflux into the auricle; while the blood within it takes the path of least resistance, and the

only one open to it into the pulmonary artery, and by its branches is conveyed to the capillaries of the lungs, from which it is returned freed from much of its carbonic anhydride and replenished with oxygen, to the left auricle, whence it proceeds in a similar manner into the great arterial main, the aorta, for general distribution throughout the smaller arteries and the capillaries to the most remote as well as the nearest parts, from which it is gathered up and returned laden with many impurities, and robbed of a large proportion of its useful matters, to the right side of the heart.

It will be remembered that corresponding subdivisions of each side of the heart act simultaneously, and that any decided departure from this harmony of rhythm would lead to serious disturbance.

THE VELOCITY OF THE BLOOD AND BLOOD-PRESSURE.

If the relative capacity and arrangement of the various parts of the circulatory system be as has been represented, it follows that we may predict with some confidence, apart from experiment, what the speed of the flow and the vascular tension must be in different parts of the course of the circulation.

We should suppose that, in the nature of the case, the velocity would be greatest in the large arteries, gradually diminish to the capillaries, in which it would be much the slowest and, getting by degrees faster, would reach a speed in the largest veins approaching that of the corresponding arteries.

The methods of determining the velocity of the blood-stream have not entirely surmounted the difficulties, but they do give results in harmony with the above-noted anticipations.

The area of the great aortic trunk being so much less than that of the capillaries, the flow in that vessel we should expect to be very much swifter than in the arterioles or the capillaries. Moreover there must be a great difference in the velocity during cardiac systole and diastole, and according as the beat of the heart is forcible or otherwise. But apart from these more obvious differences, there are variations depending on complex changes in the peripheral circulation, owing to the frequent variations in the diameter of the arterioles in different parts, as well as differences in the resistance offered by the capillaries, the causes of which are but ill understood, though less obscure, we think, than they are often represented to be. Since for the

maintenance of the circulation, the quantity of blood entering and leaving the heart must be equal, in consequence of the sectional area of the great veins that enter the heart being greater than that of the aorta, it follows that the venous flow even at its quickest is necessarily slower than the arterial.

Comparative.—There must be great variations in velocity in different animals, as such measurements as have been made demonstrate. Thus, in the carotid of the horse, the speed of the blood-current is calculated as about 306 mm., in the dog at from 205 to 357 mm. These results can not be considered as more than fair approximations.

Highly important is it to note that the rate of flow in the capillaries of all animals is very slow indeed, not being as much as 1 mm. in a second in the larger mammals. The time occupied by the circulation is also, of course, variable, being as a rule shorter the smaller the animals. As the result of a number of calculations, though by methods that are more or less faulty, the following law may be laid down as meeting approximately the facts so far as warm-blooded animals are concerned.

The circulation is effected by 27 heart-beats ; thus for a man with a pulse of 81, the time occupied in the completion of the course of the blood from and to the heart would be $\frac{81}{27} = 3$; i. e., the circulation is completed three times in one minute, or its period is twenty seconds; and it is to be well borne in mind that by far the greater part of this time is occupied in traversing the capillaries.

THE CIRCULATION UNDER THE MICROSCOPE.

There are few pictures more instructive and impressive than a view of the circulation of the blood under the microscope. It is well to have similar preparations, one under a low power and another under a magnification of 300 to 500 diameters. With the former a view of arterioles, veins, and capillaries may be obtained at once. Many different parts of animals may be used, as the web of the frog's foot, its tongue, lung, or mesentery; the gill or tail of a small fish, tadpole, etc.

The relative size of the vessels ; the speed of the blood flow; the greater velocity of the central part of the stream; the aggregation of colorless corpuscles at the sides of the vessels, and the occasional passage of one through a capillary wall, when the exposure has lasted some time; the crowding of the red cells;

their plasticity; the small size of some of the capillaries, barely allowing the corpuscles to be squeezed through; the changes in the velocity of the current, especially in the capillaries; its possible arrest or retrocession; the velocity in one so much greater than in its neighbor, without very obvious cause—all this and

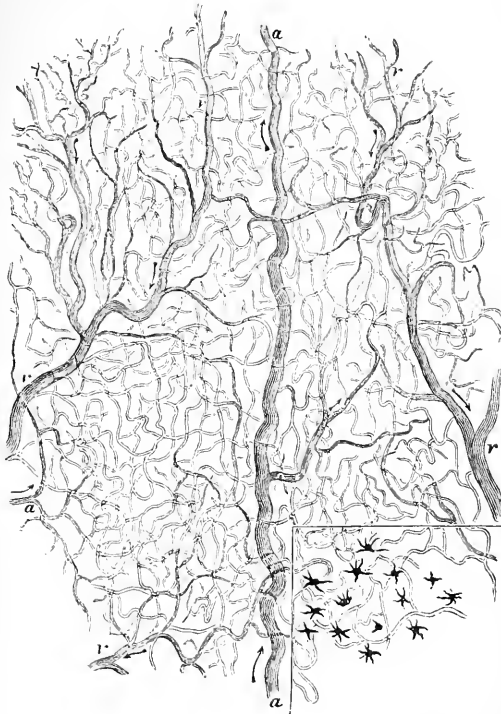

FIG. 195.—Portion of the web of a frog's foot as seen under a low magnifying power, showing the blood-vessels, and in one corner the pigment-spots (after Huxley). *a*, small arteries (arterioles); *v*, small veins. The smaller vessels are the capillaries. The course of the blood is indicated by arrows.

much more forms, as we have said, a remarkable lesson for the thinking student. This, like all microscopic views, especially if motion is represented, has its fallacies. It is to be remembered that the movements are all magnified, or else one is apt to suppose the capillary circulation, extremely rapid, whereas it is like that of the most sluggish part of a stream, and very irregular.

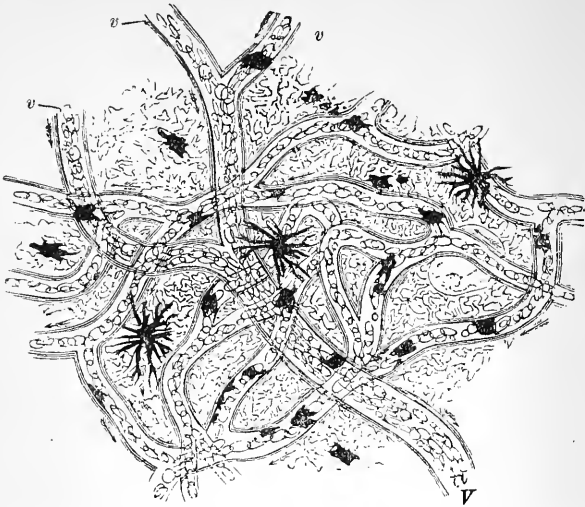

FIG. 196.—Circulation in the web of a frog's foot (Wagner). V, venous trunk composed of the three principal branches (*v. v. v*) covered with a plexus of smaller vessels. The whole is dotted over with pigment masses.

THE CHARACTERS OF THE BLOOD-FLOW.

If an artery be opened, the blood is seen to flow from it in a constant stream, with periodic exaggerations, which, it is found, answer to the heart-beats; in the case of veins and capillaries the flow is also constant, but shows none of the spurting of the arterial stream, nor has the cardiac beat apparently an equal modifying effect upon it.

We have already explained why the flow should be constant, though it would be well to be clearer as to the peripheral resistance. The amount of friction from linings so smooth as those of the blood-vessels can not be considerable. Whence, then, arises that friction which keeps the arterial vessels always distended by its backward influence? The microscopic study of the circulation helps to answer this question. The plasticity of the corpuscles and of the vessel walls themselves must be taken into account, in consequence of which a dragging influence is exerted whenever the corpuscles touch the wall, which must constantly happen with vast numbers of them in the smallest vessels and especially in the capillaries. The arrangement of capillaries into a mesh-work, must also, in

consequence of so many angles, be a source of much friction.

The action of the corpuscles on one another may be compared to a crowd of people hurrying along a narrow passage—the obstruction comes from interaction of a variety of forces, owing to the crowd itself rather than the nature of the thoroughfare. We must set down a great deal to the influence of the corpuscles on one another, as they are carried along according to mechanical principles; but, as we shall see later, other and more subtle factors play a part in the capillary circulation. Owing to the peripheral resistance and the pumping force of the heart, the arteries become distended, so that, during cardiac diastole, their recoil, owing to the closure of the semilunar valves, forces on the blood in a steady stream. It follows, then, that the main force of the heart is spent in distending the arteries, and that the immediate propelling force of the circulation is the elasticity of the arteries in which the heart stores up the energy of its systole for the moment.

BLOOD-PRESSURE.

Keeping in mind our schematic representation of the circulation, we should expect that the blood must exercise a certain pressure everywhere throughout the vascular system; that this blood-pressure would be highest in the heart itself; considerable in the whole arterial system, though gradually diminishing toward the capillaries, in which it would be feeble; lower still in the smaller veins; and at its minimum where the great veins enter the heart. Actual experiments confirm the truth of these views; and, as the subject is one of considerable importance, we shall direct attention to the methods of estimating and recording an animal's blood-pressure.

First of all, the well-known fact that, when an artery is cut, the issuing stream spurts a certain distance, as when a water-main, fed from an elevated reservoir, bursts, or a hydrant is opened, is itself a proof of the existence of blood-pressure, and is a crude measure of the amount of the pressure.

One of the simplest and most impressive ways of demonstrating blood-pressure is to connect the carotid, femoral, or other large artery of an animal by means of a small glass tube (drawn out in a peculiar manner to favor insertion and retention by ligature in the vessel), known as a cannula, by rubber

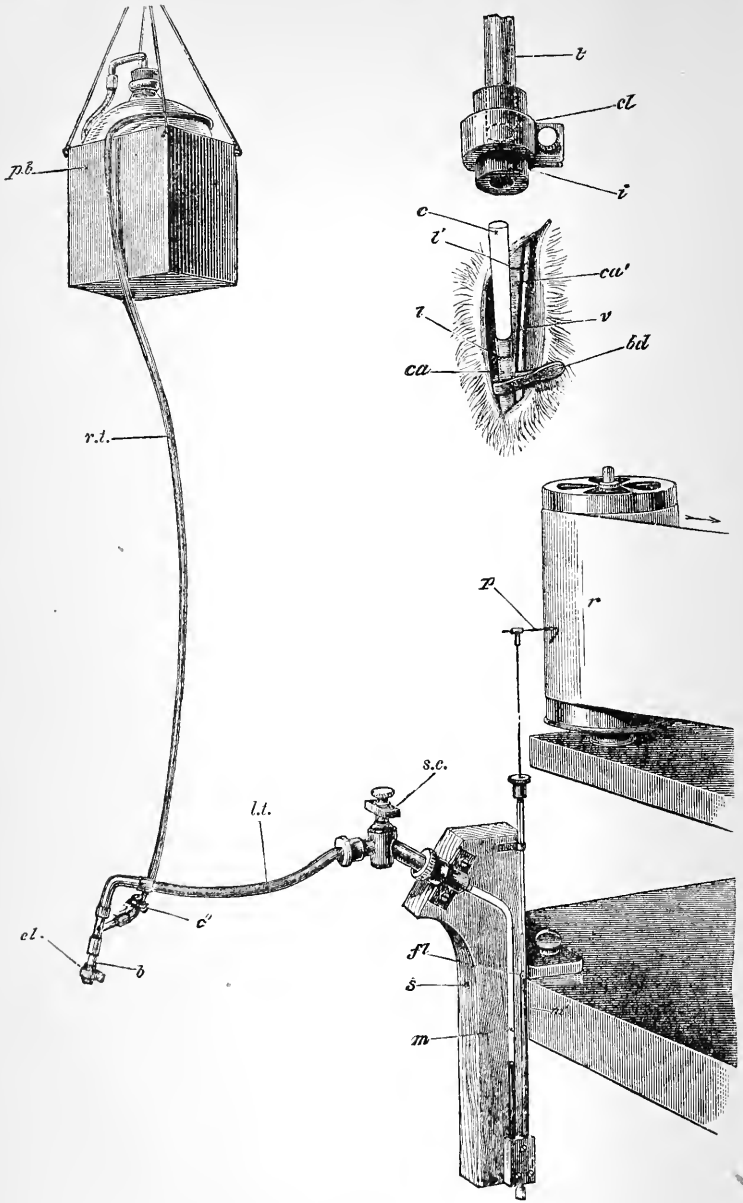

FIG. 197.

FIG. 197.—Apparatus used in making a blood-pressure experiment (after Foster). *p. b.* pressure-bottle, elevated so as to raise the pressure several inches of mercury, as seen in the manometer (*m*) below. It contains a saturated solution of sodium carbonate; *r. t.* rubber tube connecting the *p. b.* with the leaden tube; *l. t.* tube made of lead, so as to be pliable, yet have rigid walls; *s. c.* a stop-cock, the top of which is removable, to allow escape of bubbles of air; *p.* the pen, writing on the roll of paper, *r.* The former floats on the mercury; *m.* the manometer, the shaded portion of the bent tube denoting the mercury, the rest is filled with a fluid unfavorable to the coagulation of the blood, and derived from the pressure-bottle; *ca.* the carotid, in which is placed the cannula, and below the latter a forceps, which may be removed when the blood-pressure is to be actually measured. The registration of the height, variation, etc., of blood-pressure, is best made on a continuous roll of paper, as seen in Fig. 198.

tubing, with a long glass rod of bore approaching that of the artery opened, into which the blood is allowed to flow through the above-mentioned connections, while it is maintained in a vertical position.

To prevent the rapid coagulation of the blood in such experiments, it is customary to fill the cannula and other tubes to a certain extent, at least, with a solution of some salt that tends to retard coagulation, such as sodium carbonate or bicarbonate, magnesium sulphate, etc. If other connections are made in a similar way with smaller arteries and veins, it may be seen that the height of the respective columns representing the blood-pressure, varies in each and in accordance with expectations.

While all the essential facts of blood-pressure and many others may be illustrated by the above simple methods, it is inadequate when exact measurements are to be made or the results to be recorded for permanent preservation; hence apparatus of a somewhat elaborate kind has been devised to accomplish these purposes.

The graphic methods are substantially those already explained in connection with the physiology of muscle; but, since it is often desirable to maintain blood-pressure experiments for a considerable time, instead of a single cylinder, a series so connected as to provide a practically endless roll of paper (Fig. 198) is employed.

When, in the sort of experiments referred to above, the height of the fluid used in the glass tube to prevent coagulation just suffices to prevent outflow from the artery into the connections, we have, of course, in this a measure of the blood-pressure; however, it is convenient in most instances to use mercury, contained in a glass tube bent in the form of a U. for a measure, as shown in the subjoined illustration. It is also desirable, in order to prevent outflow of the blood into the apparatus, to get up a pressure in the U-tube or manometer as

near as may be equal to that of the animal to be employed in the experiment. This may be effected in a variety of ways, one of the most convenient of which is by means of a vessel containing some saturated sodium carbonate or similar solution in connection with the manometer.

It is important that the pressure should express itself as directly and truthfully on the mercury of the manometer as possible, hence the employment of a tube with rigid walls, yet capable of being bent readily in different directions for the sake of convenience.

Mercury, on account of its inertia, is not free from objection; and when very delicate variations in the blood-pressure—

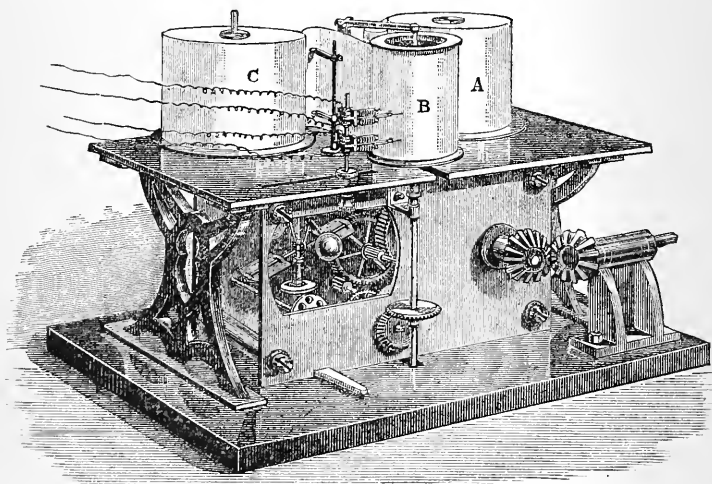

FIG. 198.—Large kymograph, with continuous roll of paper (Foster). The clock-work machinery unrolls the paper from the roll C, carries it smoothly over the cylinder B, and then winds it up into the roll A. Two electro-magnetic markers are seen in position recording intervals of time on the moving roll of paper. A manometer may be fixed in any convenient position.

e. g., feeble pulse-beats—are to be indicated, it fails to express them, in which case other fluids may be employed.

It will be noted that when an ordinary cannula is used, inserted as it is lengthwise into the blood-vessel, the pressure recorded is not that on the side of the vessel into which it is inserted as when a \perp -piece is used, but of the vessel, of which the one in question is a branch. The blood-pressure, in the main arterial trunk, for example, must depend largely on the

force of the heart-beat; consequently it would be expected, and it is actually found, that the pressure varies for different animals, size having, of course, in most instances a relation to the result. It has been estimated that in the carotid of the horse the arterial pressure is 150 to 200 mm. of mercury, of the dog 100 to 175, of the rabbit 50 to 90. Man's blood-pressure is not known, but is probably high, we may suppose not less than 150 to 200 mm.

After the fact that there is a certain considerable blood-pressure, the other most important one to notice is that this blood-pressure is constantly varying during the experiment, and, as we shall give reason to believe, in the normal animal; and to these variations and their causes we shall presently turn our attention.

THE HEART.

The heart, being one of the great centers of life, to speak figuratively, it demands an unusually close study.

THE CARDIAC MOVEMENTS.

There is no special difficulty in ascertaining the outlines of the heart by means of percussion on either the dead or the living subject. Quite otherwise is it with the changes in form which accompany cardiac action. Attempts have been made to ascertain the alterations in position of the heart with respect to other parts, and especially its own alterations in shape during a systole, the chest being unopened, by the use of needles thrust into its substance through the thoracic walls; but the results have proved fallacious. Again, casts have been made of the heart after death, in a condition of moderate extension, prior to *rigor mortis*: and also when contracted by a hardening fluid. These methods, like all others as yet employed, are open to serious objections.

Following the rapidly beating heart of the mammal with the eye produces uncertainty and confusion of mind.

It may be very confidently said that the mode of contraction of the hearts of different groups of vertebrates is variable, though it seems highly probable that the divergences in mammals are slight. The most that can be certainly affirmed of the mammalian heart is, that during contraction of the ventricles

they become more conical; that the long diameter is not appreciably altered; that the antero-posterior diameter is lengthened; and that the left ventricle at least turns on its own axis from left to right. This latter may be distinctly made out by the eye in watching the heart in the opened chest.

THE IMPULSE OF THE HEART.

When one places his hand over the region of the heart in man and other mammals, he experiences a sense of pressure varying with the part touched, and from moment to moment. Instruments constructed to convey this movement to recording

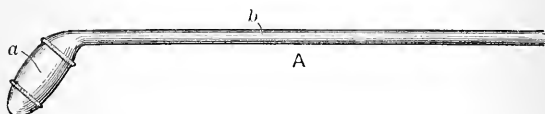

FIG. 199.—Marey's cardiac sound, which may be used to explore the chambers of the heart (after Foster). *a* is made of rubber stretched over a wire framework, with metallic supports above and below; *b* is a long tube.

levers also teach that certain movements of the chest wall correspond with the propagation of the pulse, and therefore to the systole of the heart. It can be recognized, whether the hand or an instrument be used, that all parts of the chest wall over the heart are not equally raised at the one instant. If the beating heart be held in the hand, it will be noticed that during systole there is a sudden hardening. The relation of the apex to the chest wall is variable for different mammals, and with different positions of the body in man.

As a result of the investigation which this subject has received, it may be inferred that the sudden tension of the heart, owing to the ventricle contracting over its fluid contents, causes in those cases in which during diastole the ventricle lies against the chest wall, a sense of pressure beneath the hand, which is usually accompanied by a visible movement upward in some part of the thoracic wall, and downward in adjacent parts.

It will not be forgotten that the heart lies in a pericardial sac, moistened with a small quantity of albuminous fluid; and that by this sac the organ is tethered to the walls of the chest by its mediastinal fastenings; so that in receding from the chest wall the latter may be drawn after it; though this might

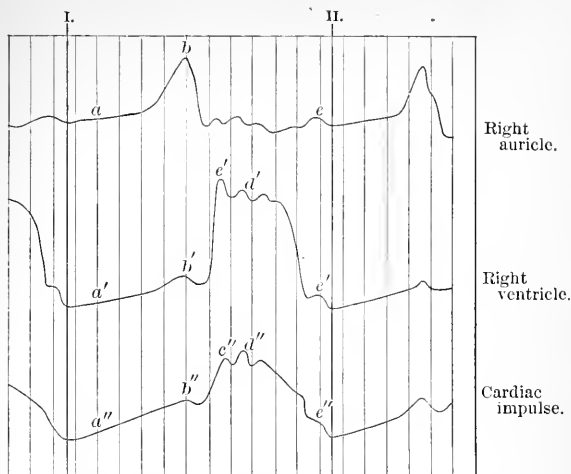

FIG. 200.—Simultaneous tracings from the interior of the right auricle, from the interior of the right ventricle, and of the cardiac impulse in the horse (after Chauveau and Marey). Tracings to be read from left to right, and the references above are in the order from top to bottom. A complete cardiac cycle is included between the thick vertical lines I and II. The thin vertical lines indicate tenths of a second. The gradual rise of pressure within the ventricle (middle tracing) during diastole, the sudden rise with the systole, its maintenance with oscillations for an appreciable time, its sudden fall, etc., are all well shown. There is disagreement as to the exact meaning of the minor curves in the larger ones.

also follow from the intercostal muscles being simply unsupported when the heart recedes.

INVESTIGATION OF THE HEART-BEAT FROM WITHIN.

By the use of apparatus, introduced within the heart of the mammal and reporting those changes susceptible of graphic record, certain tracings have been obtained about the details of which there are uncertainty and disagreement, though they seem to establish the nature of the main features of the cardiac beat clearly enough. An interpretation of such tracings in the light of our general and special knowledge warrants the following statement.

1. Both auricular and ventricular systole are sudden, but the latter is of very much greater duration.

2. While the chest wall feels the ventricular systole, the auriculo-ventricular valves shield the auricle from its shock.

3. During diastole in both chambers the pressure rises gradu-

ally from the inflow of blood; and the auricular contraction produces a brief, decided, though but slight rise of pressure in the ventricles.

4. The onset of the ventricular systole is rapid, its maximum pressure suddenly reached, and its duration considerable.

The relations of these various events, their duration and the corresponding movements of the chest wall, may be learned by a study of the above tracing which the student will find worthy of his close attention.

THE CARDIAC SOUNDS.

Two sounds, differing in pitch, duration, and intensity, may be heard over the heart when the chest is opened and the heart listened to by means of a stethoscope. These sounds may also be heard, and present the same characters when the heart is auscultated through the chest wall; hence the cardiac impulse can take no essential part in their production.

The sounds are thought to be fairly well represented, so far as the human heart is concerned, by the syllables *lub, dup*; the first sound being longer, louder, lower-pitched, and "booming" in quality; the second short, sharp, and high-pitched.

In the exposed heart, the first sound is heard most distinctly over the base of the organ or a little below it; while the second is communicated most distinctly over the roots of the great vessels—that is to say, both sounds are heard best over the auriculo-ventricular and semilunar valves respectively. When the chest wall intervenes between the heart and the ear, it is found that the second sound is usually heard most distinctly over the second costal cartilage on the right; and the first in the fifth costal interspace where the heart's impulse is also often most distinct. In these situations the arch of the aorta in the one case, and the ventricular walls in the other, are close to the situations referred to during the cardiac systole; hence it is inferred that, though the sounds do not originate directly beneath these spots, they are best propagated to the chest wall at these points. Prior to the study of the heart in our domestic animals the student is recommended to investigate the subject on himself by means of a double stethoscope or on another person with or without any instruments.

There are, however, individual differences, owing to a variety of causes, which it is not always possible to explain fully

in each case, but owing doubtless in great part to variations in anatomical relations.

The Causes of the Sounds of the Heart.—There is general agreement in the view that the *second* sound is owing to the closure of the semilunar valves of the aortic and pulmonary vessels; the former, owing to their greater tension in consequence of the higher blood-pressure in the aorta, taking much the larger share in the production of the sound, as may be ascertained by listening over these vessels in the exposed heart. When these valves are hooked back, the second sound disappears, so that there can be no doubt that they bear some important relation to the causation of the sound.

In regard to the *first* sound of the heart the greatest diversity of opinion has prevailed and still continues to exist. The following among other views have been advocated by physiologists:

1. The first sound is caused by the tension and vibration of the auriculo-ventricular valves.
2. The first sound is owing to the contractions of the large mass of muscle composing the ventricles.
3. The sound is directly traceable to eddies in the blood.

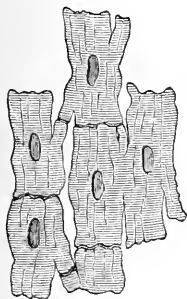

FIG. 201.

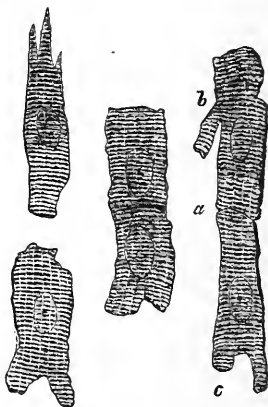

FIG. 202.

FIG. 201.—Microscopic appearance of fibers from the heart. The cross-striae, divisions (branching), and junctures are visible (Landois).

FIG. 202.—Muscular fiber-cells from the heart. (1×425 .) *a*, line of juncture between two cells; *b, c*, branching cells.

But, looking at the whole question broadly, is it not unreasonable to explain the sound resulting from such a complex act

as the contraction of the heart and what it implies in the light of any single factor? That such narrow and exclusive views should have been propagated, even by eminent physiologists, should admonish the student to receive with great caution explanations of the working of complex organs, based on a single experiment, observation, or argument of any kind.

The view we recommend the student to adopt in the light of our present knowledge is, that the first sound is the result of several causative factors, prominent among which are the sudden tension of the auriculo-ventricular valves, and the contraction of the cardiac muscle, not leaving out of the account the possible and probable influence of the blood itself through eddies or otherwise; nor would we ridicule the idea that in some cases, at all events, the sound may be modified in quality and intensity by the shock given to the chest wall during systole.

ENDO-CARDIAC PRESSURES.

Bearing in mind the relative extent of the pulmonary and systemic portions of the circulation, we should suppose that the resistance to be overcome in opening the aortic valves and lifting the column of blood that keeps them pressed together, would be much greater in the left ventricle than in the right; or, in other words, that the intra-ventricular pressure of the left side of the heart would greatly exceed that of the right, and this is confirmed by actual experiment.

That there should be a negative pressure in, say, the left ventricle, follows naturally enough from the fact that not only are the contents of the ventricle expelled with great suddenness, but that its walls remain (see Figs. 200 and 204) pressed together for a considerable portion of the time occupied by the whole systole; so that in relaxation it follows that there must be an empty cavity to fill, or that there must be an aspiratory effect toward the ventricle; hence also one factor in the closure of the semilunar valves.

It thus appears that the heart is not only a force-pump but also to some extent a suction-pump; and, if so, the aspirating effect must express itself on the great veins, lacking valves as they do, at their entrance into the heart; hence, with each diastole the blood would be sucked on into the auricles, a result that is intensified by the respiratory movements of the thorax.

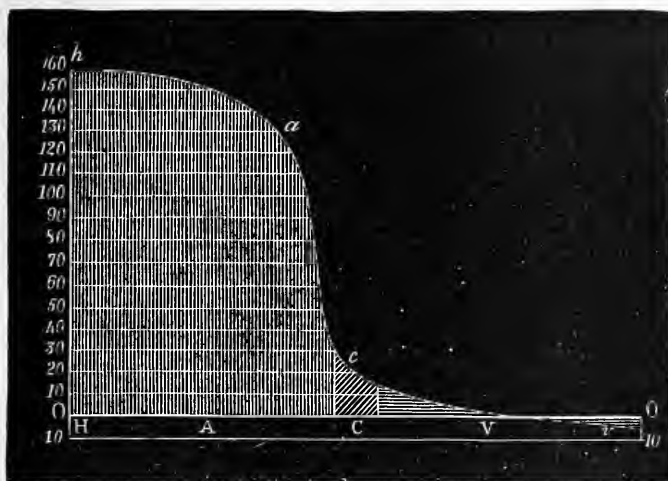

FIG. 203.—Diagram showing the relative height of the blood-pressure in different parts of the vascular system (after Yeo). *h*, heart; *a*, arterioles; *v*, small veins; *A*, arteries; *C*, capillaries; *V*, large veins; *H, V*, representing the zero-line, i. e., atmospheric pressure; the blood-pressure is indicated by the height of the curve. The numbers on the left give the pressure approximately, in mm. of mercury.

Relative Time occupied by the Various Phases of the Cardiac Cycle.—The old and valuable diagram reproduced below is meant to convey through the eye the relations of the main events in a complete beat of the heart or cardiac cycle. The relative length of the sounds; the long period occupied by the pause; the duration of the ventricular systole, which it is to be observed is in excess of that of the first sound, are among the chief facts to be noted.

The tracings of Chauveau and Marey, obtained from the heart of the horse, which has a very slow

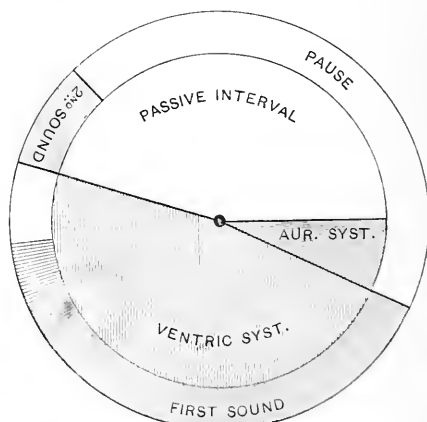

FIG. 204.—Diagram representing the movements and sounds of the heart during a cardiac cycle (after Sharpey).

rhythm, show that of the whole period, the auricular systole occupies $\frac{1}{6}$ or $\frac{2}{10}$ of a second; the ventricular systole, $\frac{2}{6}$ or $\frac{4}{10}$ of a second; and the diastole, $\frac{3}{6}$ or $\frac{6}{10}$ of a second.

With the more rapid beat in man (70 to 80 per minute), the duration of the cardiac cycle may be estimated at about $\frac{6}{10}$ of a second, and the probable proportions for each event are about these: The auricular systole, $\frac{1}{10}$ of a second; the ventricular systole, $\frac{3}{10}$ of a second; and the pause, $\frac{4}{10}$ of a second.

It will be noted that the pause of the heart is equal in duration to the other events put together; and even assuming that there is some expenditure of energy in the return (relaxation) of the heart to its passive form, there still remains a considerable interval for rest, so that this organ, the very type of ceaseless activity, has its periods of complete repose.

THE WORK OF THE HEART.

Since the pressure against which the heart works must, as we shall see, vary from moment to moment, and sometimes very considerably, the work of the heart must also vary within wide limits, even making allowance for large adaptability to the burden to be lifted; for it will be borne in mind that the degree to which the heart empties its chambers is also variable.

If one knew the quantity of blood ejected by the left ventricle, and the rate of the beat, the calculation of the work done would be an easy matter, since the former multiplied by the latter would represent, as in the case of a skeletal muscle, the work of the muscles of the left ventricle; from which the work of the other chambers might be approximately calculated.

The work of the auricles must be slight. The right ventricle, it is estimated, does from one fourth to one third the work of the left.

When we calculate the work done by the heart for certain intervals, as the day, the week, month, year, and especially for a moderate lifetime, and compare this with that of any machine it is within the highest modern skill to construct, the great superiority of the vital pump in endurance and working capacity will be very apparent; not to take into the account at all its wonderful adaptations to the countless vicissitudes of life, without which it would be absolutely useless, even destructive to the organism.

Some of these variations in the working of the heart we may now to advantage consider.

VARIATIONS IN THE CARDIAC PULSATION.

These may be ascertained either by the investigation of the arteries or of the heart, for every considerable alteration in the working of the heart expresses itself also through the arterial system. In speaking of the pulse, the reference is principally to the arteries, but in each case we may equally well think of the heart primarily as acting upon the arteries.

1. The *frequency* of the heart-beat varies, as might be supposed, with a great multitude of conditions, the principal of which are: *age*, being most frequent at birth, gradually slowing to old age, while in feeble old age the heart-beat may, like many other of the functions of the body, approximate the condition at birth, being very frequent, small, feeble, and easily disturbed in its rhythm; *sex*, the cardiac beat being more frequent in females; *posture*, most rapid in the standing position, slower when sitting, and slowest in the recumbent attitude; *season*, more frequent in summer; *period of the day*, more frequent in the afternoon and evening. *Elevation of temperature*, the *inspiratory act*, *emotions*, and *mental activity*, *eating*, *muscular exercise*, etc., render the heart-beats more frequent.

2. *The length of the systole*, though variable, is more constant than that of the diastole.

3. *The force of the pulsation* varies very greatly and exercises an important influence on the blood-pressure and the velocity of the blood-stream. As a rule, when the heart beats rapidly, especially for any considerable length of time, the force of the individual pulsations is diminished.

4. The heart-beat may vary much and in ways it is quite possible to estimate, either directly by the hand placed over the organ on the chest, by the modifications of the cardiac sounds, or by the use of instruments. It is wonderful how much information may be conveyed, without the employment of any instruments, through palpation and auscultation, to one who has long investigated the heart and the arteries with an intelligent, inquiring mind; and we strongly recommend the student to commence personal observations early and to maintain them persistently.

Practitioners recognize the pulse (and heart) as "slow" as distinguished from "infrequent," "slapping," "heaving," "thrilling," "bounding," etc.

Now, if with these terms there arise in the mind corresponding mental pictures of the action of the heart under the circumstances, well; if not, there is a very undesirable blank. How the student may be helped to a knowledge of the actual behavior of the heart under a variety of conditions we shall endeavor to explain later.

Apart from all the above peculiarities, the heart may cease its action at regular intervals, or at intervals which seem to possess no definite relations to each other—that is, the heart may be irregular in its action, which may be made evident either to the hand or the ear.

There are certain deviations from the quicker rhythm which occur with such regularity and are so dependent on events that take place in other parts of the body that they may be considered normal.

Comparative.—We strongly recommend the student to verify all the statements made in these sections by direct observation for himself. Such is invaluable to the practitioner. The following table gives the mean number of cardiac pulsations per minute (after Gamgee):

SPECIES.	Adult.	Youth.	Old age.
Horse.....	36- 40	60- 72	32- 38
Ass and mule.....	46- 50	65- 75	55- 60
Ox	45- 50	60- 70	40- 45
Sheep and goat	70- 80	85- 95	55- 60
Pig.....	70- 80	100-110	55- 60
Dog.....	90-100	110-120	60- 70
Cat.....	120-140	120-140	100-120

The variations with age, for the horse and the ox, are as follows, according to Kreutzer :

<i>Horse.</i>	<i>Ox.</i>
At birth..... 100-120	At birth..... 92-132
When 14 days old..... 80- 96	When 4-5 days old..... 100-120
When 3 months old..... 68- 76	When 14 days old..... 68
When 6 months old..... 64- 72	When 4-6 weeks old..... 64
When 1 year old..... 48- 56	When 6-12 months old.. 56- 68
When 2 years old..... 40- 48	For the young cow..... 46
When 3 years old..... 38- 48	For the four-year-old ox. 40
When 4 years old..... 38- 50	
When aged..... 32- 40	

THE PULSE.

Naturally the intermittent action of the heart gives rise to corresponding phenomena in the elastic tubes into which it may be said to be continued, for it is very desirable to keep in mind the complete continuity of the vascular system.

The following phenomena are easy of observation : When a finger-tip is laid on any artery, an interrupted pressure is felt ; if the vessel be laid bare (or observed in an old man), it may be seen to be moved in its bed forward and upward ; the pressure is less the farther the artery from the heart ; if the vessel be opened, blood flows from it continuously, but in spurts ; if one finger be laid on the carotid and another on a distant vessel, as one of the arteries of the foot, it may be observed (though it is not easy from difficulty in attending to two events happening so very close together) that the beat in the nearer vessel precedes by a slight interval that in the more distant.

Investigating the latter phenomenon with instruments, it is found that an appreciable interval, depending on the distance apart of the points observed, intervenes.

What is the explanation of these facts ?

The student may get at this by a few additional observations that can be easily made.

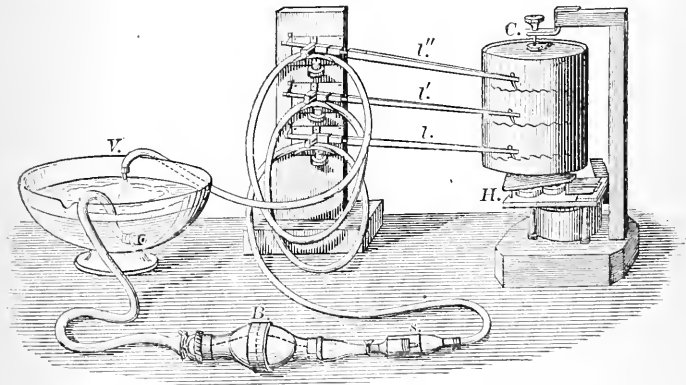

FIG. 205.—Marcy's apparatus for showing the mode in which the pulse is propagated in the arteries. *B.* a rubber pump, with valves to prevent regurgitation. The working of the apparatus will be apparent from the inspection of the figure.

If water be sent through a long elastic tube (so coiled that points near and remote may be felt at the same time) by a bulb

syringe, imitating the heart, and against a resistance made by drawing out a glass tube to a fine point and inserting it into the terminal end of the rubber tube, an intermittent pressure like that occurring in the artery may be observed; and further that it does not occur at precisely the same moment at the two points tested.

Information more exact, though possibly open to error, may be obtained by the use of more elaborate apparatus and the graphic method.

By measurement it has been ascertained that in man the pulse-wave travels at the rate of from five to ten metres per second, being of course very variable in velocity. It would seem that the more rigid the arteries the more rapid the rate, for in children with their more elastic arteries the speed is slower; and the same principle is supposed to explain the higher velocity noticed in the arteries of the lower extremities. But with such a speed as even five metres a second it is evident that with a systole of moderate duration (say $\cdot 3$ second) the most distant arteriole will have been reached by the pulse-wave before that systole is completed.

It is known that the blood-current at its swiftest has no such speed as this, never perhaps exceeding in man half a metre per second, so that the pulse and the blood-current must be two totally distinct things.

When the left ventricle throws its blood into vessels already full to distention, there must be considerable concussion in consequence of the rapid and forcible nature of the cardiac systole, and this gives rise to a wave in the blood which, as it passes along its surface, causes each part of every artery in succession to respond by an elevation above the general level, and it is this which the finger feels when laid upon an artery.

That there is considerable distention of the arterial system with each pulse may be realized in various ways, as by watching and feeling an artery laid bare in its course, or in very thin or very old people, and by noticing the jerking of one leg crossed over the other, by which method in fact the pulse-rate may be ascertained. And that not only the whole body but the entire room in which a person sits is thrown into vibration by the heart's beat, may be learned by the use of a telescope to observe objects in the room, which may thus be seen to be in motion.

Features of an Arterial Pulse-Tracing.—In order to judge of

the nature of arterial tracings, it is important that the circumstances under which they are obtained should be known.

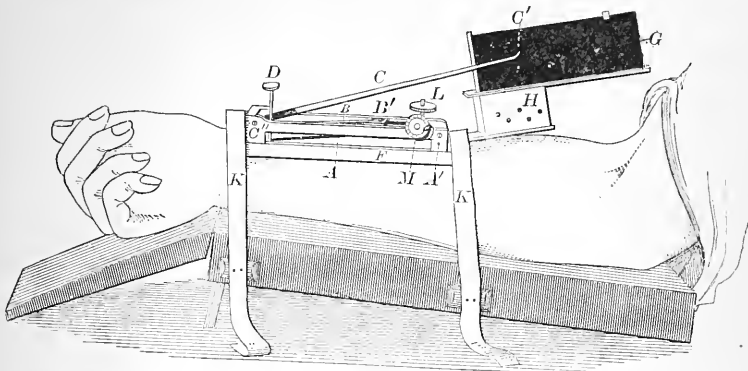

FIG. 206.—Marey's improved sphygmograph arranged for taking a tracing. *A*, steel spring; *B*, first lever; *C*, writing lever; *C'*, its free writing end; *D*, screw for bringing *B* in contact with *C*; *G*, slide with smoked paper; *H*, clock-work; *L*, screw for increasing the pressure; *M*, dial indicating the amount of pressure, *K, K'*, straps for fixing the instrument to the arm, and the latter to the double-inclined plane or support (Byrom Bramwell).

The movements of the vessel wall in most mammals suitable for experiment and in man is so slight that it becomes necessary to exaggerate them in the tracing, hence long levers are used to accomplish this.

The sphygmograph is the usual form of instrument employed for the purpose. It consists, essentially, of a clock-work for moving a smoked surface (mica plate commonly) on which the movements of a lever-tip, answering to those of a button placed on the artery, are recorded.

We shall do well to inquire whether there are any features in common in tracings obtained in various ways, and which have therefore in all probability a real foundation in nature.

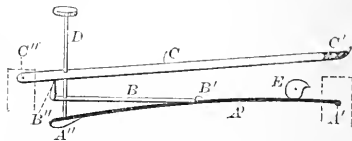

FIG. 207.—Diagrammatic schema showing the essential part of the instrument when in working order. The knife-edge *B''* of the short lever *C* is in contact with the writing-lever *C'*. Every movement of the steel spring at *A''*, communicated by the arteries, will be imparted to the writing-lever (Byrom Bramwell).

An inspection of a large number of pulse-tracings, taken under diverse conditions, seems to show that in all of them there occurs, more or less marked, the following: 1. An upward

curve. 2. A downward curve, rendered irregular by the occurrence of peaks or crests and notches. The first of these are

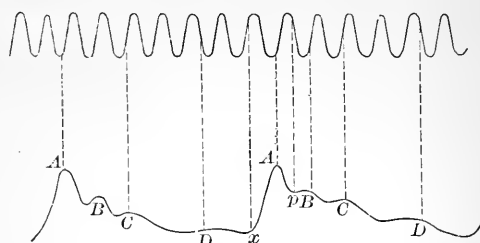

FIG. 208.—Pulse tracing from carotid artery of healthy man (after Moens). *x*, commencement of expansion of artery; *A*, summit of first rise; *C*, dicrotic secondary wave; *B*, predicrotic secondary wave; *p*, notch preceding this; *D*, succeeding secondary wave. Curve above is that made by a tuning-fork with ten double vibrations in a second.

termed the predicrotic notch and crest, and the succeeding ones the dicrotic notch and crest. The latter seem to be the more constant.

Venous Pulse.—Apart from the variations in the caliber of the great veins near the heart, constituting a sort of pulse, though due to variations in intra-cardiac pressure, a venous pulse proper is rare as a normal feature. One of the best-known examples of such occurs in the salivary gland. When, during secretion, the arterioles are greatly dilated, a pulse may be witnessed in the veins into which the capillaries open out, owing to diminution in the resistance which usually is sufficiently great to obliterate the pulse-wave.

Pathological.—In severe cases of heart-disease, owing to cardiac dilatation or other conditions, giving rise to incompetency of the tricuspid valves, there may be with each ventricular systole a back-flow, visible in the veins of the neck.

A venous pulse is a phenomenon, it will be evident, that always demands special investigation. It means that the usual bounds of nature are for some good reason being overstepped.

Comparative.—Before entering on the consideration of phenomena that all are agreed are purely vital, we call attention to the circulation in forms lower than the mammal, in order to give breadth to the student's views and prepare him for the special investigations, which must be referred to in subsequent chapters; and which, owing to the previous narrow limits (researches upon the frog and a few well-known mammals) having at last been overleaped, have opened up entirely new aspects of

cardiac physiology—one might almost say revolutionized the subject.

Owing to the limitations of our space, the references to lower forms must be brief.

We recommend the student, however, to push the subject further, and especially to carry out some of the experiments to which attention will be directed very shortly.

In the lowest organisms (*Infusorians*) represented by *Amœba*, *Vorticella*, etc., there are, of course, no circulatory organs, unless the pulsating vacuoles of some forms mark the crude beginnings of a heart. It will be borne in mind, however, that there is a constant streaming of the protoplasm itself within the organism.

The heart is first represented, as in worms, by a pulsatile tube, which may, as in the earth-worm, extend throughout the greater part of the length of the animal, and has usually dorsal and ventral and transverse connections

The dilatations of the transverse portions in one division (*metamere*) of the animal seem to foreshadow the appearance of auricles.

The pulsation of the dorsal vessel in a large earth-worm is easy of observation.

In amphioxus, which is often instanced as the lowest vertebrate, the blood-vessels, including the portal vein, are pulsatile, while there is no distinct and separate heart.

Although the respiratory system will be treated from the comparative point of view, the student will do well to note now

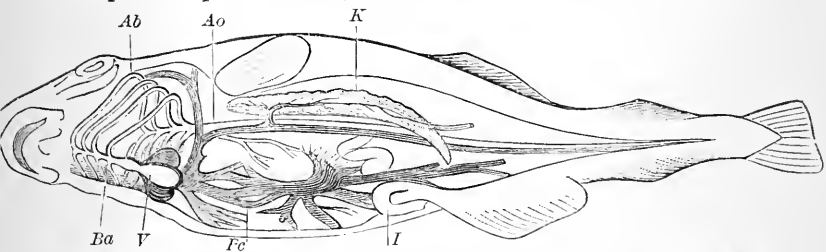

FIG. 209.—Diagram of the circulation of a Teleostean fish (*Clarus*). V, ventricle; Ba, bulbus arteriosus, with the arterial arches which carry the blood to the gills; Ab, arterial arches; Ao, aorta descendens, into which the epibranchial arteries passing out from the gills unite; K, kidneys; I, intestine; Pc, portal circulation.

(in the figures) the close relation between the organs for distributing and aërating the blood.

Passing on to the vertebrates, in the lowest group, the fishes,

the heart consists of two chambers, an auricle and a ventricle, the latter being supplemented by an extension (*bulbus arteriosus*) pulsatile in certain species; and an examination of the

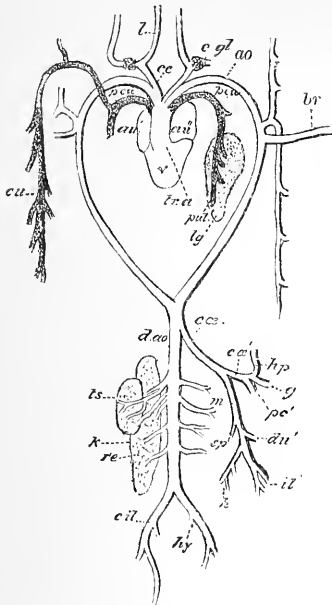

FIG. 210.

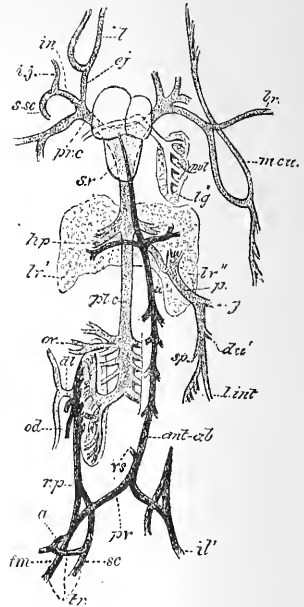

FIG. 211.

FIG. 210.—The arterial trunks and their main branches in the frog (*Rana esculenta*). $1 \times 1\frac{1}{2}$. (Howes.) *l.*, lingual vessel; *c. c.*, common carotid artery; *p. eu.*, pulmonary cutaneous artery; *c. gl.*, carotid gland; *au'*, right auricle; *au''*, left auricle; *v.*, ventricle; *tr. a.*, truncus arteriosus; *pul'*, pulmonary; *lg.*, left lung; *ao.*, left aortic arch; *br.*, brachial; *cu.*, cutaneous; *d. ao.*, dorsal aorta; *cæ.*, cæliaco-mesenteric; *hp.*, hepatic vessels; *g.*, gastric; *pc'*, pancreas; *m.*, mesenteric; *h.*, hæmorrhoidal; *il'*, ileal; *il.*, common iliac; *re.*, renal; *k.*, kidney; *ts.*, spermatic.

FIG. 211.—Venous trunks and their main branches in the frog (*Rana esculenta*). $1 \times 1\frac{1}{2}$. (Howes.) *l.*, lingual vein; *e. j.*, external jugular; *in.*, innominate; *i. j.*, internal jugular; *s. sc.*, subscapular; *pr. c.*, vena cava superior; *s. v.*, sinus venosus; *hp.*, hepatic; *lv'*, right lobe of liver; *lv''*, left lobe of liver; *pl. c.*, vena cava inferior; *ob.*, ovarian; *d. l.*, dorso-lumbar; *od.*, oviducal; *r. p.*, renal-portal; *fm.*, femoral; *sc.*, sciatic; *a.*, femoro-sciatic anastomosis; *pe'*, right pelvic; *vs.*, vesical; *ant. ab.*, anterior abdominal; *a'*, abdominal-portal anastomosis; *il'*, ileal; *sp.*, splenic; *du'*, duodenal; *l. int.*, lieno-intestinal; *g.*, gastric; *p.*, portal; *lg''*, left lung; *pul.*, pulmonary; *m. cu.*, musculo-cutaneous; *br.*, brachial.

course of the circulation will show that the heart is throughout venous, the blood being oxidized in the gills after leaving the former.

Among the amphibians, represented by the frog, there are two auricles separated by an almost complete septum, and one

ventricle characterized by a spongy arrangement of the muscle-fibers of its walls.

In the reptiles the division between the auricles is complete, and there is one ventricle which shows imperfect subdivisions.

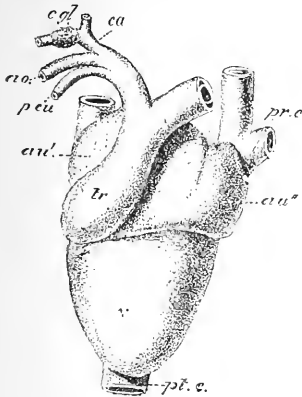

FIG. 212.

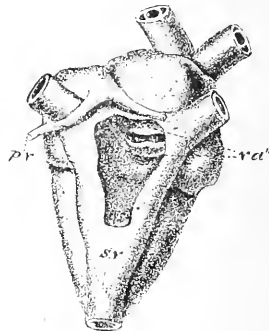

FIG. 213.

FIG. 212.—The frog's heart, seen from the front, the aortic arches of the left side having been removed. (1×4 .) *ca*, carotid; *c. gl.*, carotid gland; *ao*, aorta; *au'*, right auricle; *au''*, left auricle; *pp. c.*, vena cava superior; *pl. c.*, vena cava inferior; *p. cu.*, pulmo-cutaneous trunk; *tr.*, truncus arteriosus; *v.*, ventricle (Howes).

FIG. 213.—The same, seen from behind, the sinus venosus having been opened up to show the sinu-auricular valves. (1×4 .) *p. v.*, pulmonary vein; *s. v.*, sinus venosus; *va''*, sinu-auricular valve. Other lettering as in Fig. 212 (Howes).

In the crocodile, however, the heart consists of four perfectly divided chambers. Of the two aortic arches, one arises together with the pulmonary artery from the right ventricle, and, as it crosses over, the left communicates with it by a small opening, so that, although the arterial and the venous blood are completely separated in the heart, they intermingle outside of this organ.

In birds the circulatory system is substantially the same as in mammals; but in all vertebrate forms below birds the blood distributed to the tissues is imperfectly oxidized or is partially venous.

As a result of the entire vascular arrangements in the frog, etc., the least oxidized blood passes to the lungs, and the most aërated to the head and anterior parts of the animal.

Whatever ground for differences of opinion there may be as to the extent to which the phenomena we have as yet been describing are mechanical in their nature, all are agreed that

such explanations are insufficient when applied to the facts with which we have yet to deal. They, at all events, can be regarded only as the result of vitality.

When one reflects upon the vicissitudes through which an animal must pass daily and hourly, necessitating either that they be met by modified action of the organs of the body or that the destruction of the organism ensue, it becomes clear that the varying nutritive needs of each part must be answered by changes in the circulatory system. These changes may affect any part of the entire arrangement, and it rarely happens, as will appear, that one part is modified without a corresponding one, very frequently of a different kind, taking place in some other. What these various correlated modifications are, and how they are brought about, we shall now attempt to describe, and it will greatly assist in the comprehension of the whole if the student will endeavor to keep a clear mental picture of the parts before his mind throughout, using the figures and verbal descriptions only to assist in the construction of such a mental image. We shall begin with the vital pump—the heart.

THE BEAT OF THE HEART AND ITS MODIFICATIONS.

As has been already noted, the cardiac muscle has features peculiar to itself, and occupies histologically an intermediate place between the plain and the striped muscle-cells, and that the contraction of the heart is also intermediate in character, and is best seen in those forms of the organ which are somewhat tubular and beat slowly. But the contraction, though peristaltic, is more rapid than is usually the case in organs with the smooth form of muscle-fiber.

The heart behaves under a stimulus in a peculiar manner. The effect of a single induction shock depends on the phase of contraction in which the heart happens to be at the moment of its application. Thus at the commencement of a systole there is no visible effect, while beats of unusual character result at other times. But tetanus can not be induced by any form or method of stimulation. The latent period of cardiac muscle is long.

In a heart at rest a single stimulus (as the prick of a needle) usually calls forth but one contraction.

THE NERVOUS SYSTEM IN RELATION TO THE HEART.

The attempts to determine just why the heart beats at all, and especially the share taken by the nervous system, if any direct one, are beset with great difficulty ; though, as we shall attempt to show later, this subject also has been cramped within too narrow limits, and hence regarded in a false light.

Till comparatively recently the frog's heart alone received much attention, if we except those of certain well-known mammals. In the heart of the frog there are ganglion-cells in various parts, especially numerous in the sinus venosus (or expansion of the great veins where they meet the auricles) ; also in the auricles, more especially in the septum (ganglia of Remak), while they are absent from the greater part of the ventricle, though found in the auriculo-ventricular groove (ganglia of Bidder).

Recently it has been found that ganglion-cells occur in the ventricles of warm-blooded animals. In the hearts of the dog, calf, sheep, and pig, which are those lately subjected to investigation, it is found that the nerve-cells do not occur near the apex of the ventricles, but mainly in the middle and basal portions, being most abundant in the anterior and posterior inter-ventricular furrows and in the left ventricle. But there are differences for each group of animals ; thus, these ganglion-cells are most abundant, so far as the mammals as yet investigated are concerned, in the ventricles of the pig, and least so in those of the dog. In the cat they are also scanty. Ganglion-cells occur in the auricles, and are especially abundant near the terminations of the great veins.

It has long been known that the heart of a frog removed from the body will pulsate for hours, especially if fed with serum, blood, or similar fluids ; and that it may be divided in almost any conceivable way, even when teased up into minute particles, and still continue to beat. The apex, however, when separated does not beat. Yet even this quiescent apex may be set pulsating if tied upon the end of a tube, through which it may be fed under pressure.

We may here point out that the whole heart or a part of it may be made to describe its action by the graphic method in various ways, the principles underlying which are either that the heart pulls upon a recording lever (lifts it) ; acts against the fluid of a manometer ; or, inclosed in a vessel containing oil or similar fluid, moves a piston in a cylinder.

It has also long been known that a ligature drawn around the sinus venosus (in the frog) at its junction with the auricles stopped the heart for a certain period, and this experiment (of Stannius) was thought to demonstrate that the heart was arrested because the nervous impulses proceeding to the ganglion-cells along the cardiac nerves or ganglia of this region were cut off by the ligature ; in other words, the heart ceased to beat because the outside machinery on which the action of the inner depended was suddenly disconnected. Other explanations have been offered of this fact.

Within the last few years great light has been thrown upon the whole subject of cardiac physiology in consequence of investigators having studied the hearts of various cold-blooded animals and of several invertebrates. The hearts of the *Chelonians* (tortoises, turtles) have received special attention, and their investigation has been fruitful of results, to the general outcome of which, as well as those accruing from recent comparative studies as a whole, we can alone refer. Since in other parts of the work the limits of space will not always allow us to give the evidence on which conclusions rest, attention is especially called to what here follows, as an example of the methods of physiological research, and the nature of the reasoning employed.

Very briefly the following are some of the main facts :

1. In all cold-blooded animals the order in which the subdivisions of the heart ceases to pulsate when kept under the same conditions is invariable, viz., ventricle, auricles, sinus.

2. The sinus and auricles, when separated by section, ligature, or otherwise, either together or singly, continue to beat, whether amply provided with or surrounded by blood.

3. The ventricle thus separated displays less tendency to beat independent of some stimulus (as feeding under pressure), though a very weak one usually suffices—i. e., its tendency to spontaneous rhythm is less marked than is the case with the other parts of the heart. These remarks apply to the hearts of *Chelonians*—fishes, snakes, and some other cold-blooded animals.

4. In certain fishes (skate, ray, shark) the beat may be reversed by stimulation, as a prick of the ventricle. This is accomplished with more difficulty in other cold-blooded animals, and still more so in the mammal.

5. In certain invertebrates, notably the *Poulpe* (Octopus), a

careful search has revealed no nerve-cells, yet their hearts continue to beat when their nerves are severed, on section of parts of the organ, etc.

6. A strip of the muscle from the ventricle of the tortoise, when placed in a moist chamber and a current of electricity passed through it for some hours, will commence to pulsate and continue to do so after the current has been withdrawn ; and this holds when the strip is wholly free from nerve-cells.

From the above facts certain inferences have been drawn : 1. It has been concluded that the sinus is the originator and director of the movements of the rest of the heart. 2. That this is owing to the ganglia in its walls. While all recognize the importance of the sinus, some physiologists hold to the ganglionic influence as essential to the heart-beat still ; while others, influenced by the facts mentioned above, are disposed to regard them as of very doubtful importance—at all events, as originators of the movements of the heart.

The tendency now seems to be to attach undue importance to the spontaneous contractility of the heart-muscle ; for it by no means follows logically that, because a muscle treated by electricity, when cut off from the usual nerve influence that we believe is being constantly exerted on the heart like other organs, will contract and continue to do so in the absence of the stimulus, it does so normally ; or, because some hearts beat in the absence of nerve-cells, that therefore nerve-cells are of no account in any case. Such views, when pressed to the extreme, lead to as narrow conceptions as those they are intended to replace.

Taking into account the facts mentioned and others we have not space to enumerate, we submit the following as a safe view to entertain of the beat of the heart in the light of our present knowledge :

Recent investigations show clearly that there are great differences in the hearts of animals of diverse groups, so that it is not possible to speak of "the heart" as though our remarks applied equally to this organ in all groups of animals.

It must be admitted that our understanding of the hearts of the cold-blooded animals is greater than of the mammalian heart ; while, so far as exact or experimental knowledge is concerned, the human heart is the least understood of all, though there is evidence of a pathological and clinical kind and subjective experience on which to base conclusions possessing a certain

value; but it is clear to those who have devoted attention to comparative physiology that the more this subject is extended the better prepared we shall be for taking a broad and sound view of the physiology of the human heart and man's other organs.

Whatever may be said of the invertebrates, among which greater simplicity of mechanism doubtless prevails, there can be no doubt that the execution of a cardiac cycle of the heart in all vertebrates, and especially in the higher, is a very complex process from the number of the factors involved, their interaction, and their normal variation with circumstances; and we must therefore be suspicious of any theory of excessive simplicity in this as well as other parts of physiology.

We submit, then, the following as a safe provisional view of the causation of the heart-beat:

1. The factors entering into the causation of the heart-beat of all vertebrates as yet examined are: (a) A tendency to spontaneous contraction of the muscle-cells composing the organ; (b) intra-cardiac blood-pressure; (c) condition of nutrition as determined directly by the nervous supply of the organ and indirectly by the blood.

2. The tendency to spontaneous contraction of muscle-cells is most marked in the oldest parts of the heart (e. g., sinus), ancestrally (phylogenetically) considered.

3. Intra-cardiac pressure exercises an influence in determining the origin of pulsation in probably all hearts, though like other factors its influence varies with the animal group. In the mollusk (and allied forms) and in the fish it seems to be the controlling factor.

4. We must recognize the power one cell has to excite, when in action, neighboring heart-cells to contraction. The ability that one protoplasmic cell-mass has to initiate in others, under certain circumstances, like conditions with its own, is worthy of more serious consideration in health and disease than it has yet received.

5. The influence of the cardiac nerves becomes more pronounced as we ascend the animal scale. Their share in the heart's beat will be considered later.

6. Apparently in all hearts there is a functional connection leading to a regular sequence of beat in the different parts, in which the sinus or its representatives (the terminations of great veins in the heart) always takes the initiative. One part having

contracted, the others must necessarily follow; hence the rapid onset of the ventricular after the auricular contraction in the mammal, and the long wave of contraction that seems to pass evenly over the whole organ in cold-blooded animals.

The basis of all these factors is to be sought finally in the *natural contractility of protoplasm*. A heart in its most developed form still retains, so to speak, the inherited but modified *Amœba* in its every cell.

Whether the intrinsic nerve-cells of the heart take any share *directly* in the cardiac beat must be considered as yet undetermined. Possibly they do modify motor impulses from nerves, while again it may be that they have an influence over nutritive processes only. The subject requires further study, both anatomical and physiological.

INFLUENCE OF THE VAGUS NERVE UPON THE HEART.

The principal facts in this connection may be stated as follows, and apply to all the animals thus far examined :

1. In all cases the action of the heart is modified by stimulation of the medulla oblongata or the vagus nerve.
2. The modification may consist in prompt arrest of the heart, in slowing, in enfeeblement of the beat, or a combination of the two latter effects.
3. After the application of the stimulation there is a latent

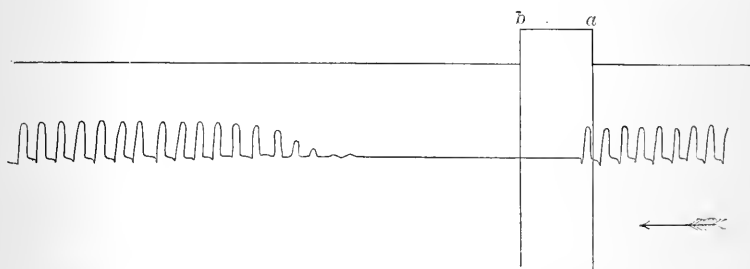

FIG. 214.—Inhibition of frog's heart by stimulation of the vagus nerve. To be read from right to left. The contractions of the ventricle are registered by a simple lever resting on it. The interrupted current was thrown in at *a*. Note that one beat occurred before arrest (latent period), and that when standstill of the heart did take place it lasted for a considerable period (Foster).

period before the effect is manifest, and the latter may outlast the stimulation by a considerable period.

4. In most animals the sinus venosus and auricles are affected before the ventricles, and the vagus may influence these parts when it is powerless over the ventricle.

5. After vagus inhibition, the action of the heart is (almost unexceptionally) different, the precise result being variable, but generally the beat is both accelerated and increased in force. We may say that the working capacity of the heart is temporarily increased.

6. The improvement in the efficiency of the heart is in proportion to its previous working power, and in cases when the

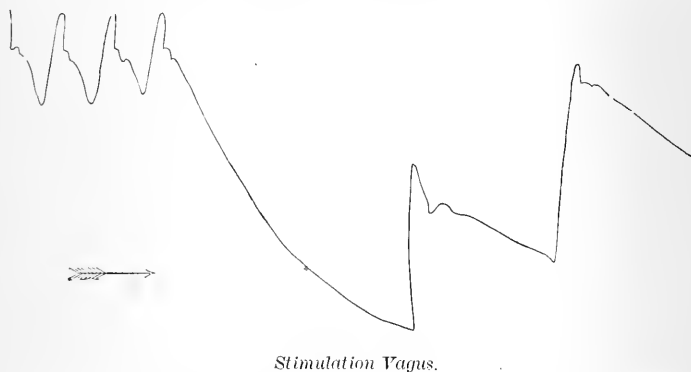

FIG. 215.—Effects of vagus stimulation, illustrated by a form of sphygmographic curve derived from the carotid of a rabbit (Foster).

action is feeble and irregular (abnormal) it might be said to be in proportion to its needs. This is a very important law that deserves to receive a general recognition.

7. Section of both vagi nerves results in histological alterations in the heart's structure, chiefly fatty degeneration, which must, of course, impair its working capacity and expose it to rupture or other accidents under the frequently recurring strains of life.

8. In the cold-blooded animals the heart may be kept at a standstill by vagus stimulation till it dies, a period of hours (one case of six hours reported for the sea-turtle).

9. Certain drugs (as atropine), applied directly to the heart, or injected into the blood, prevent the usual action of the vagus.

10. During vagus arrest the heart substance undergoes a change, resulting in an unusual dilatation of the organ. This may be witnessed whether the heart contains blood or not.

11. The heart may be arrested by direct stimulation, especially of the sinus, and at the points at which the electrodes are applied there is apparently a temporary paralysis. The same alteration in the beat may be noticed as when the main trunk of the vagus is stimulated.

12. The heart may be inhibited through stimulation of various parts of the body, both of the surface and internal organs (reflex inhibition).

13. One vagus being divided, stimulation of its upper end may cause arrest of the heart.

14. Stimulation of a small part of the medulla oblongata will produce the same result, provided one or both vagi be intact.

15. Section of both vagi in some animals (the dog notably) increases the rate of the cardiac beat. The result of section of one pneumogastric nerve is variable. The heart's rhythm is usually to some extent quickened.

16. During vagus inhibition from any cause in mammals and many other animals, the heart responds to a single stimulus, as the prick of a needle, by at least one beat. An observer studying for himself the behavior of the heart in several groups of animals with an open mind, for the purpose of observing all he can rather than proving or disproving some one point, becomes strongly impressed with the variety in unity that runs through cardiac physiology, including the influence of nerve-cells (centers) through nerves; for it will not be forgotten that normally nerves originate nothing, being conductors only, so that when the vagus is stimulated by us we are at the most but imitating in a rough way the work of central nerve-cells. We can only mention a few points to illustrate this.

In the frog a succession of light taps, or a single sharp one ("Klopfversuch" of Goltz), will usually arrest the heart reflexly; though sometimes it is very difficult to accomplish. But in the fish the ease with which the heart may be reflexly inhibited by gentle stimulation of almost any portion of the animal is wonderful. Again, in some animals the vagus arrests the heart for only a brief period, when it breaks away into its usual (but increased) action.

In the fish, menobranchus, and probably other animals, the irritability of some subdivision of the heart is lost during the vagus inhibition—i. e., it does not respond to a mechanical stimulus.

There is usually a certain order in which the heart recommences after inhibition (viz., sinus, auricles, ventricles); but there are variations in this, also, for different animals. It is also a fact that in most of the cold-blooded animals the right

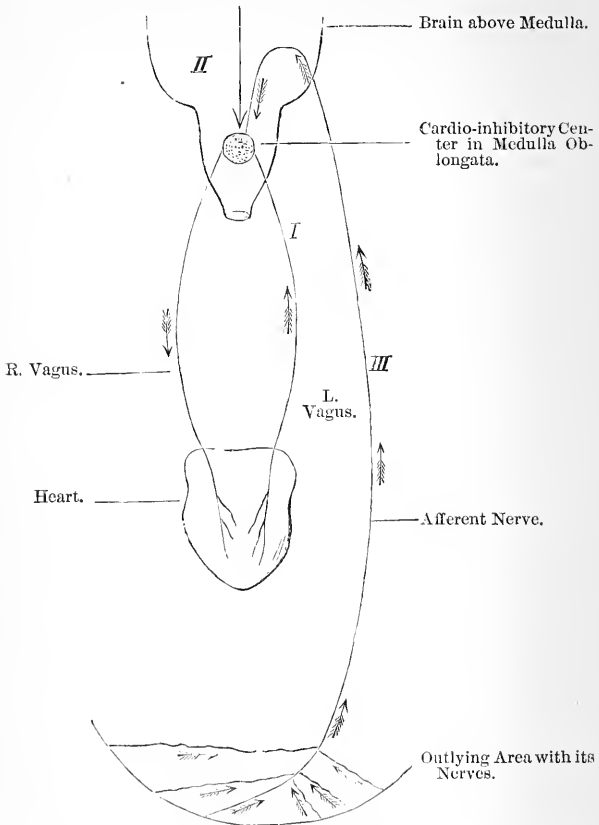

FIG. 216.—Diagram of the inhibitory mechanism of the heart. The arrows indicate in all cases the path the nervous impulses take. I. Path of afferent impulses from the heart itself. II. Path from parts of the brain above (or anterior to) the vaso-motor center. A similar one might, of course, be mapped out along the spinal cord. III. Path from some peripheral region. The downward arrows indicate the course of efferent impulses, which probably usually pass by both vagi.

vagus is more efficient than the left, owing, we think, not to the nerves themselves so much as to their manner of distribution in the heart—the greater portion of the driving part of the

organ, so to speak, being supplied by the right nerve ; for, when even a small part of the heart is arrested, it may be overcome by the action of a larger portion of the same, or a more dominant region (the sinus mostly).

Conclusions.—The inferences from the facts stated in the above paragraphs are these : 1. There is in the medulla a collection of cells (center) which can generate impulses that reach the heart by the vagi nerves and influence its muscular tissue, though whether directly or through the intermediation of nerve-cells in its substance is uncertain. It may possibly be in both ways. 2. This center (cardio-inhibitory) may be influenced reflexly by influences ascending by a variety of nerves from the periphery, including paths in the brain itself, as shown by the influence of emotions or the behavior of the heart. 3. The cardio-inhibitory center is the agent, in part, through which the rhythm of the heart is adapted to the needs of the body. 4. The arrest, on direct stimulation of the heart, is owing to the effect produced on the terminal fibers of the vagi, as shown by the dilatation, etc., corresponding to what takes place when the trunk of the nerve or the center is stimulated. 5. The quickening of the heart, following section of the vagi, seems to show that in some animals the inhibitory center exercises a constant regulative influence over the rhythm of the heart. 6. The irritability and dilatibility of the cardiac tissue may be greatly modified during vagus inhibition. Sometimes this is evident before the rhythm itself is appreciably altered. 7. The heart-muscle has a latent period, like other kinds of muscle ; and cardiac effects, when initiated, last a variable period.

There are many other obvious conclusions, which the student will draw for himself.

But a question arises in regard to the significance of the cardiac arrest under these circumstances, and the altered action that follows. The fact that, when the heart is severed from the central nervous system by section of its nerves, profound changes in the minute structure of its cells ensue, points unmistakably to some nutritive influence that must have operated through the vagi nerves. That stimulation of the vagus restores regularity of rhythm and strengthens the beat of the failing heart, is also very suggestive. That many disorders of the heart are coincident with periods of mental anguish or worry, and that in certain cases of severe mental application

the heart's rhythm has become very slow, also point to influences of a central origin as greatly affecting the life-processes of this organ.

It has been shown that the vagus nerve in some cold-blooded animals, as is probable also in the higher vertebrates, *consists of two sets of fibers—those which are inhibitory proper and those which are not, but belong to the sympathetic system.*

Separate stimulation of the former favors nutritive processes, is preservative ; of the latter, destructive. This has been expressed by saying that the former favors constructive (anabolic) metabolism ; the latter destructive (katabolic) metabolism. It is assumed that all the metabolism of the body may be represented as made up of katabolic following anabolic processes.

Whether such a view of metabolism expresses any more than a sort of general tendency of the chemistry of the body is doubtful. It is a very simple representation of what in all probability is extremely complex ; and if it be implied that throughout the body certain steps are always taken upward in construction to be always afterward followed by certain downward destructive changes, we must reject it as too rigid and artificial a representation of natural processes.

We think, however, that, upon all the evidence, pathological and clinical as well as physiological, the student may believe that the vagus nerve, like the other nerves of the body, according to our own theory, exercises a constant beneficial, guiding—let us say determining—influence over the metabolism of the organ it supplies ; and we here suggest that, if this view were applied to the origin and course of cardiac disease, it would result in a gain to the science and art of medicine.

THE ACCELERATOR (AUGMENTOR) NERVES OF THE HEART.

It has been known for many years that in the dog, cat, rabbit, and some other mammals, there are nerves proceeding from certain of the ganglia of the sympathetic chain high up, stimulation of which lead to an acceleration of the heart-beat. Very recently these nerves have been traced in a number of cold-blooded animals, and the whole subject placed on a broader and sounder basis.

There are variations in the distribution of these nerves for different groups of animals, but it will suffice if we indicate

their course in a general way, without special reference to the variations for each animal group: 1. These nerves emerge from the spinal cord (upper dorsal region), and proceed upward

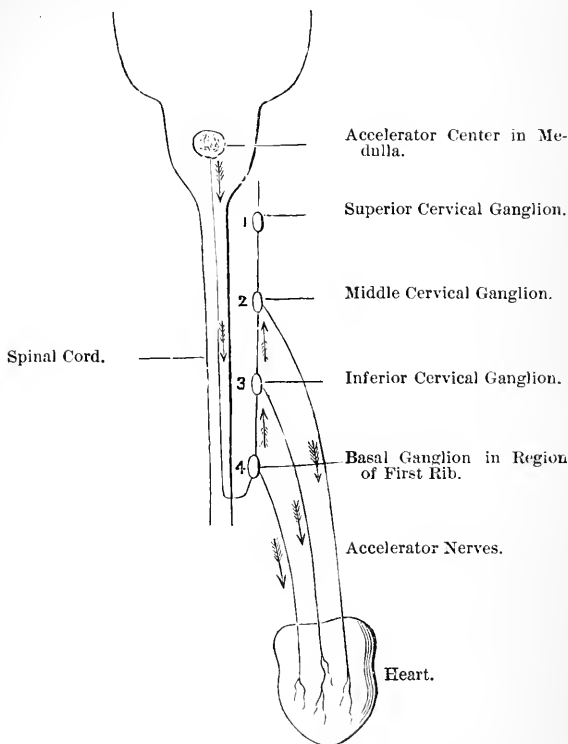

FIG. 217.—Diagram to illustrate the origin, course, etc., of accelerator impulses. It will be understood that this is intended to indicate the general plan, and not precisely what takes place in any one animal. Thus, while the accelerator nerves may arise in this way, it is not meant to be implied that the heart is actually supplied by *three* nerves of such origin in any case. The arrows, as before, indicate the path of the impulses.

before being distributed to the heart. 2. They may leave for their cardiac destination either at (a) the first thoracic (or basal cardiac ganglion, as it might be named in this case), (b) the inferior cervical ganglion, (c) the annulus of Vieussens, or (d) the middle cervical ganglion.

It follows that the heart may be made to do increased work in three ways: First, the relaxation of a normal inhibitory

control through the vagus nerve by the cardio-inhibitory center : second, through the sympathetic (motor) fibers in the vagus itself : and, finally, through fibers with similar action in the sympathetic system, usually so called.

The share taken by these factors is certainly variable in different species of animals, and it is likely that this is true of the same animals on different occasions. It is also conceivable, and indeed probable, that they act together at times, the inhibitory action being diminished and the augmentor influence increased.

THE HEART IN RELATION TO BLOOD-PRESSURE.

It is plain that all the other conditions throughout the circulatory system remaining the same, an increase in either the force or the frequency of the heart-beat must raise the blood-pressure. But, if the pressure were generally raised when the heart beats rapidly, it would fare ill with the aged, the elasticity of their arteries being usually greatly impaired. As a matter of fact any marked rise of pressure that would thus occur is pre-

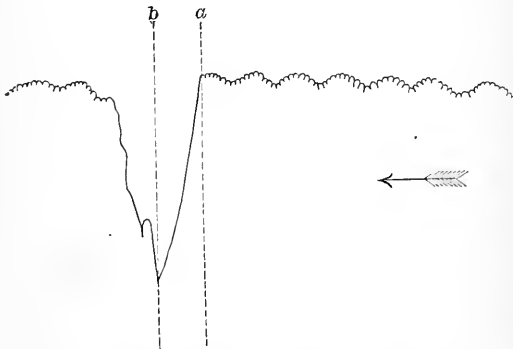

FIG. 218.—Tracing from a rabbit, showing the influence of cardiac inhibition on blood-pressure. The fall in this case was very rapid, owing to sudden cessation of the heart-beat. The relative emptiness of the vessels accounts for the peculiar character of the curve of rising blood-pressure (Foster).

vented as a rule, and in different ways, as will be seen ; but, so far as the heart is concerned, its beat is usually the weaker the more rapid it is, so that the cardiac rhythm and the blood-pressure are in inverse proportion to each other.

By what method is the heart's action tempered to the condi-

tions prevailing at the time in the other parts of the vascular system ?

The matter is complex. *The effect of vagus stimulation* on the blood-pressure is always very marked, as would be supposed.

As seen in the tracing, the beats, when the heart commences its action again tell on the comparatively slack walls of the arteries, distending them greatly, and this may be made evident by the sphygmograph as well as the manometer; indeed, may be evident to the finger, the pulse resembling in some features that following excessive loss of blood,

If the heart has been merely slowed, or its pulsation weakened, the effects will of course be less marked.

The Quantity of Blood.—The blood-pressure may also be augmented, the cardiac frequency remaining the same, by the *quantity* of blood ejected from the ventricles, which again depends on the quantity entering them, a factor determined by the condition of the vessels, and to this we shall presently turn.

In consequence of changes in different parts of the system by way of compensation, results follow in an animal which might not have been anticipated.

Thus, bleeding, unless to a dangerous extreme, does not lower the blood-pressure except temporarily. It is estimated that the body can adapt itself to a loss of as much as 3 per cent of the body-weight.

The adaptation is probably not through absorption chiefly, but through constriction of the vessels by the vaso-motor nerves.

Again, an injection of fluid into the blood does not cause an appreciable rise of blood-pressure, so long as the nervous system is intact; but, if by section of the spinal cord the vaso-motor influences are cut off, then a rise may take place to the extent of 2 to 3 per cent of the body-weight, the extra quantity of fluid seeming to be accommodated in the capillaries and smaller veins. These facts are highly significant in illustrating the adaptive power of the circulatory system (protective in its nature), and are of practical importance in the treatment of disease.

We think the benefit that sometimes follows bleeding has not as yet received an adequate explanation, but we shall not attempt to tackle the problem now. Changes in the circulation depend on variations in the size of the blood-vessels.

It is important in considering this subject to have clear notions of the structure of the blood-vessels. It will be borne in mind that, while muscular elements are perhaps not wholly lacking in any of the arteries, they are most abundant in the smallest, the arterioles, which by their variations in size are best fitted to determine the quantity of blood reaching any organ. It is well known that nerves derived chiefly from the sympathetic system pass to blood-vessels, though their exact mode of termination is obscure. As the result of the section and stimulation of certain nerves the following inferences have been drawn in regard to the nerves supplying blood-vessels.

1. There are *vaso-motor* nerves of two kinds—*vaso-constrictors* and *vaso-dilators*—which may exist in nerve-trunks either separately or mingled. Examples of the former are found in the cervical sympathetic, splanchnic, etc., of the latter in the chorda tympani, nerves of the muscles and *nervi erigentes* (from the first, second, and third sacral nerves), while the sciatic seems to contain both.

2. Impulses are constantly passing from the medullary vaso-motor center along the nerves to the blood-vessels, hence their dilatation after section of the nerves. The nerves are traceable to the spinal cord, and in some part of their course run, as a rule, in the sympathetic system.

3. Impulses pass at intervals to the areas of distribution of vaso-dilators along these nerves, the effect of which is to dilate the vessels through their influence, as in other cases, on the muscular coat.

It is inferred that there are vaso-motor centers in the spinal cord which are usually subordinated to the main center in the medulla, but which in the absence of the control of the chief center in the medulla assume an independent regulating influence.

There is a nerve with variable origin, course, etc., in different mammals, but in the rabbit given off from either the vagus, the superior laryngeal, or by a branch from each, which, running near the sympathetic nerve and the carotid artery, reaches the heart, to which it is distributed. This is known as the *depressor* nerve.

From stimulation of the central end of this nerve results follow which warrant the conclusion that impulses can by it reach the vaso-motor center in the medulla, and interfere with (inhibit) the outflow of efferent, constrictive, or tonic impulses,

which start from the vaso-motor center, descend the cord, and find their way to the organs of a definite region, in consequence of which the muscular coats of the arterioles relax, more blood flows to this area which is very large, and the general blood-pressure is lowered.

Again, if the central end of one of the main nerves—e. g., sciatic—be stimulated, a marked change in the blood-pressure

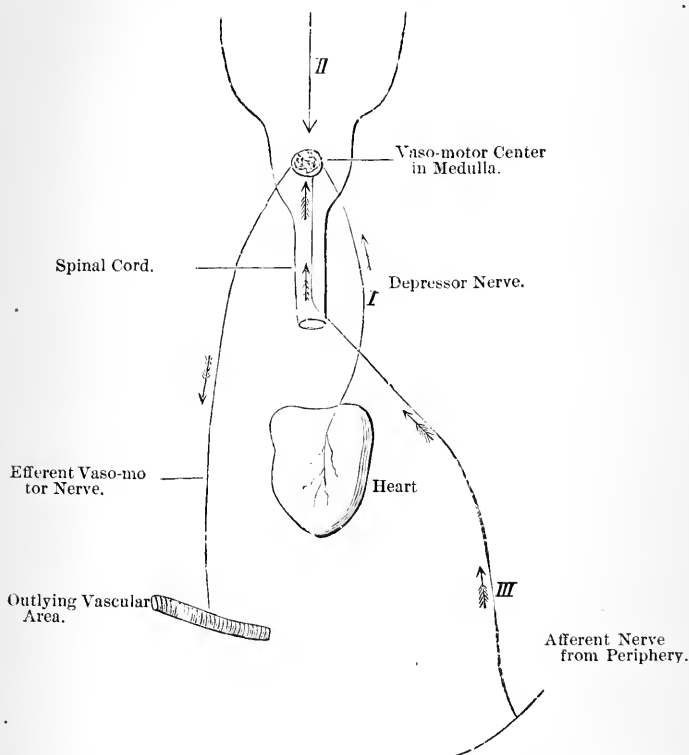

FIG. 219.—Diagram of nervous vaso-motor mechanism. I. Course of afferent impulses from the heart itself along the depressor nerve. II. Course from some other part of the brain. III. Course from some peripheral region along a nerve joining the spinal cord. The efferent impulses are represented as passing to a vascular area, reduced for the sake of simplicity to a single arteriole.

results, but whether in the direction of rise or fall seems to depend upon the condition of the central nervous system, for, with the animal under the influence of chloral, there is a fall; if under urari, a rise.

It is not to be supposed that the change in any of these cases is confined to any one vascular area invariably, but that it is this or that, according to the nerve stimulated, the condi-

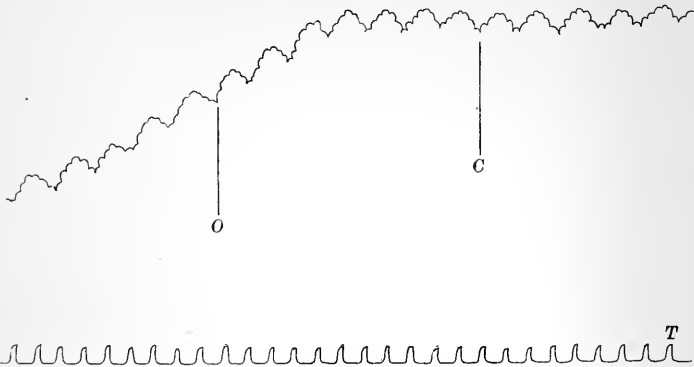

Fig. 220.—Curve of blood-pressure resulting from stimulation of the central end of the depressor nerve. To be read from right to left. *T* indicates the rate at which the recording surface moved, the intervals denoting seconds. At *C* the current was thrown into the nerve, and shut off at *O*. The result appears after a period of latency, and outlasts the stimulus (Foster)

tion of the centers, and a number of other circumstances. Moreover, it is important to bear in mind that with a fall of blood-pressure in one region there may be a corresponding rise in another. With these considerations in mind, it will be apparent that the changes in the vascular system during the course of a single hour are of the most complex and variable character.

The question of the distribution of vaso-motor nerves to veins is one to which a definite answer can not be given.

THE CAPILLARIES.

The cells of which the capillaries are composed have a contractility of their own, and hence the caliber of the capillaries is not determined merely by the arterial pressure or any similar mechanical effect.

Certain abnormal conditions, induced in these vessels by the application of irritants, cause changes in the blood-flow, which can not be explained apart from the vitality of the vessels themselves.

Watched through the microscope under such circumstances,

the blood-corpuscles no longer pursue their usual course in the mid-stream, but seem to be generally distributed and to hug the walls, one result of which is a slowing of the stream, wholly independent of events taking place in other vessels. It is thus seen that in this condition (*stasis*) the capillaries have an independent influence essentially vital. We say independent, for it is still an open question whether nerves are distributed to capillaries or not. That inflammation, in which also the walls undergo such serious changes that white and even red blood-cells may pass through them (*diapedesis*), is not uninfluenced by the nervous system, possibly induced through it in certain cases, if not all, seems more than probable.

But when we consider the lymphatic system new light will, it is hoped, be thrown upon the subject of the nature and the influences which modify the capillaries. One thing will be clear from what has been said, that even normally the capillaries must exert an influence of the nature of a resistance, owing to their peculiar vital properties; and, as we have already intimated such considerations should not be excluded from any conclusions we may draw in regard to tubes that are made up of living cells, whether arteries, veins, or capillaries, though manifestly the applicability to capillaries, with their less modified or more primitive structure, is stronger.

It has now become clear that the circulation may be modified either centrally or peripherally; that a change is never purely local, but is correlated with other changes; that the whole is, in the higher animals, directly under the dominion of the central nervous system; and that it is through this part chiefly that harmony in the vascular as in other systems and with other systems is established. To have adequately grasped this conception is worth more than a knowledge of countless details.

SPECIAL CONSIDERATIONS.

Pathological.—Changes may take place either in the substance of the cardiac muscle, in the valves, or in the blood-vessels, of a nature unfavorable to the welfare of the body. Some of these have been incidentally referred to already.

Hypertrophy, or an increase in the tissue of the heart, is generally dependent on increased resistance, either within or without the heart, in the region of the arterioles or capillaries. Imperfections of the aortic valves may permit of regurgitation

of blood, entailing an extra effort if it is to be expelled in addition to the usual quantity, which again leads to hypertrophy; but this is often succeeded by dilatation of the chambers of the heart one after the other, and a host of evils growing out of this, largely dependent on imperfect venous circulation, and increased venous pressure. And it may be here noticed that arterial and venous pressures are, as a general rule, in inverse proportion to each other.

If the quantity of blood in the ventricle, in consequence of regurgitation, should prove to be greater than it can lift (eject), the heart ceases to beat in diastole; hence some of the sudden deaths from disease of the aortic valves.

As a result of fatty, or other forms of degeneration, the heart may suddenly rupture under strains.

Actual experiment on the arteries of animals recently dead, including men, shows that the elasticity of the arteries of even adult mammals is as perfect as that of the vessels of the child, so that man ranks lower than other animals in this respect.

After a certain period of life the loss of arterial elasticity is considerable and progressive. The arteries may undergo a degeneration from fatty changes or deposit of lime; such vessels are, of course, liable to rupture; hence one of the modes of death among old animals is from paralysis traceable to rupture of vessels in the brain.

These and other changes also cause the heart more work, and may lead to hypertrophy. Even in young animals the strain of a prolonged racing career may entail hypertrophy or some other form of heart-disease.

We mention such facts as these to show the more clearly how important is balance and the power of ready adaptation in all parts of the circulation to the maintenance of a healthy condition of body.

The heart is itself nourished through the coronary arteries; so that morbid alterations in these vessels cause, if not sudden and painful death, at least nutritive changes in the heart-substance, which may lead to a dramatic end or to a slow impairment of cardiac power, etc.

Personal Observation.—The circulation is one of those departments of physiology in which the student may verify much upon his own person. The cardiac impulse, the heart's sounds (with a double stethoscope), the pulse—its nature and changes with circumstances, the venous circulation, and many other

subjects, are all easy of observation, and after a little practice without liability of causing those aberrations due to the attention being drawn to one's self.

The observations need not, of course, be confined to the student's own person ; it is, however, very important that the normal should be known before the observer is introduced to cases of disease. Frequent comparison of the natural and the diseased condition renders physiology, pathology, and clinical medicine much good service. We again urge upon the student to try to form increasingly vivid and correct mental pictures of the circulation under its many changes.

Comparative.—An interesting arrangement of blood-vessels, known as a *rete mirabile*, occurs in every main group of verte-

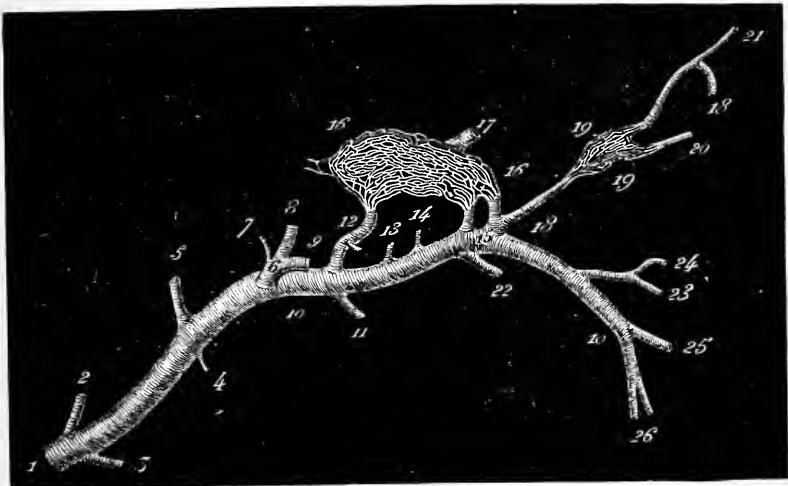

FIG. 221.—*Rete mirabile* of sheep, seen in profile (after Chauveau). The larger *rete* is in connection with the encephalic arteries; the smaller, the ophthalmic. The large artery is the carotid.

brates. An artery breaks up into a great number of vessels of nearly the same size, which terminate, abruptly and without capillaries, in another arterial trunk.

They are found in a variety of situations, as on the carotid and vertebrate arteries of animals that naturally feed from the ground for long periods together, as the ruminants ; in the sloth, that hangs from trees ; in the legs of swans, geese, etc. ; in the horse's foot, in which the arteries break up into many small divisions. It has been suggested that these arrangements

permit of a supply of arterial blood being maintained without congestion of the parts. Very marked tortuosity of vessels, as in the seal, the carotid of which is said to be forty times as long

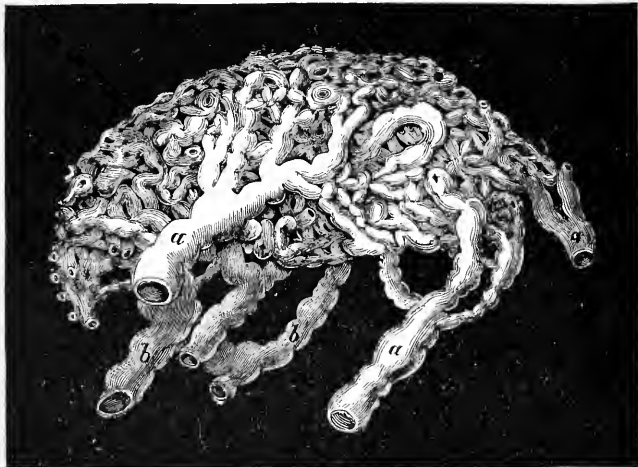

FIG. 222.—Section of a lymphatic *rete mirabile*, from the popliteal space (after Chanveau). *a, a*, afferent vessels. *b, b*, efferent vessels. The whole very strongly suggests a crude form of lymphatic gland.

as the space it traverses, in all probability serves the same purpose.

Evolution.—The comparative sketch we have given of the vascular system will doubtless suggest a gradual evolution. We observe throughout a dependence and resemblance which we think can not be otherwise explained. The similarity of the foetal circulation in the mammal to the permanent circulation of lower groups has much meaning. Even in the highest form of heart the original pulsatile tube is not lost. The great veins still contract in the mammal; the sinus venosus is probably the result of blending and expansion. The later differentiations of the parts of the heart are clearly related to the adaptation to altered surroundings. Such is seen in the foetal heart and circulation, and has probably been the determining cause of the forms which the circulatory organs have assumed.

It is a fact that the part of the heart that survives the longest under adverse conditions is that which bears the stamp of greatest ancestral antiquity. It (the sinus venosus) may not

be less under nervous control, but it certainly is least dependent on the nervous system, and has the greatest automaticity.

The law of rhythm in organic nature finds some of its most evident exemplifications in the circulation. Most of the rhythms are compound, one being blended with or superimposed on another. Even the apparent irregularities of the normal heart are rhythmical, such as the very marked slowing and other changes accompanying expiration, especially in some animals.

We trust we have made it evident that the greatest allowance must be made for the animal group, and some even for the individual, in estimating any one of the factors of the circulation. We know

a good deal at present of cardiac physiology, but we do not know a physiology of "the heart" in the sense in which we understand that term to have been used till recently—i. e., we are not in a position to state the laws that apply to all forms of heart.

Summary of the Physiology of the Circulation.—In the mammal the circulatory apparatus forms a closed system consisting of a central pump or heart, arteries, capillaries, and veins. All the parts of the vascular system are elastic, but this property is most developed in the arteries.

Since the tissue-lymph is prepared from the blood in the capillaries, it may be said that the whole circulatory system exists for these vessels.

As a result of the action of an intermittent pump on elastic



FIG. 223.—Veins of the foot of the horse (after Chauveau).

vessels against peripheral resistance, in consequence of which the arteries are always kept more than full (distended), the flow through the capillaries and veins is constant—a very great advantage, enabling the capillaries to accomplish their work of feeding the ever-hungry tissues. While physical forces play a very prominent part in the circulation of the blood, vital ones must not be ignored. They lie at the foundation of the whole, here as elsewhere, and must be taken into the account in every explanation.

As a consequence of the anatomical, physical, and vital characters of the circulatory system, it follows that the velocity of the blood is greatest in the arteries, least in the capillaries, and intermediate in the veins.

The veins with their valves, their superficial position and thinner walls, make up a set of conditions favoring the onflow of the blood, especially under muscular exercise.

In the mammal the circulatory system, by reason of its connections with the digestive, respiratory, and lymphatic systems, and in a lesser degree with all parts of the body, especially the glandular organs, maintains at once the usefulness and the fitness of the blood.

The arterioles, by virtue of their highly developed muscular coat, are enabled to *regulate* the blood-supply to every part, in obedience to the nervous system.

The blood exercises a certain pressure on the walls of all parts of the vascular system, which is greatest in the heart itself, high in the arteries, lower in the capillaries, and lowest in the veins, in the largest of which it may be less than the atmospheric pressure, or negative. The heart in the mammal consists of four perfectly separated chambers, each upper and each lower pair working synchronously, intermixture of arterial and venous blood being prevented by septa and interference in working by valves. The heart is a force-pump chiefly, but, to some extent, a suction-pump also, though its power as such purely from its own action and independent of the respiratory movements of the chest is slight under ordinary circumstances. In consequence of the lesser resistance in the pulmonary division of the circulation, the blood-pressure within the heart is much less in the right than in the left ventricle—a fact in harmony with and causative of the greater thickness of the walls of the latter; for in the fœtus, in which the conditions are different, this distinction does not hold.

The ventricles usually completely empty themselves of blood and maintain their systolic contraction even after this has been effected. The contraction of the heart, which really begins in the great veins near their junction with the auricles (that do not fully empty themselves), is at once followed up by the auricular and ventricular contraction, the whole constituting one long peristaltic wave. Then follows the cardiac pause, which is of longer duration than the entire systole.

When the heart contracts it hardens, owing to closing on a non-compressible fluid dammed back within its walls by resistance *a fronte*. At the same time the hand placed on the chest-walls over the heart is sensible of the cardiac impulse, owing to what has just been mentioned. The systole of the chambers of the heart gives rise to a first and a second sound, so called, caused by several events combined, in which, however, the tension of the valves must take a prominent share. The work of the heart is dependent on the quantity of blood it ejects and the pressure against which it acts. The pulse is an elevation of the arterial wall, occurring with each heart-beat, in consequence of the passage of a wave over the general blood-stream. There is a distention of the entire arterial system in every direction. The pulse travels with extreme velocity as compared with the blood-current. The heart-beat varies in force, frequency, duration, etc., and with age, sex, posture, and numerous other circumstances.

The whole of the circulatory system is regulated by the central nervous system through nerves. There is in the medulla oblongata a small collection of nerve-cells making up the cardio-inhibitory center. This center, with varying degrees of constancy, depending on the group of animals and the needs of the organism, sends forth impulses (which modify the beat of the heart in force and frequency) through the vagi nerves. There are nerves of the sympathetic system with a center in the cervical spinal cord, and possibly another in the medulla, which are capable of originating either an acceleration of the heart rhythm or an increase of the force of the beat, or both together, known as accelerators or augmentors. In the vertebrates thus far examined the vagus is in reality a vago-sympathetic nerve, containing inhibitory fibers proper, and sympathetic, accelerator, or motor fibers.

The inhibitory fibers can arrest, slow, or weaken the cardiac

beat; the sympathetic accelerate it or augment its force. When both are stimulated together, the inhibitory prevail.

These nerves, as also the accelerators, exercise a profound influence upon the nutrition of the heart, and affect its electrical condition when stimulated, and we may believe when influenced by their own centers.

The inhibitory fibers tend to preserve and restore cardiac energy; the sympathetic, whether in the vagus or as the augmentors, the reverse. The vagus nerve (and probably the depressor) acts as an afferent, cardiac sensory nerve reporting on the intra-cardiac pressure, etc., and so enabling the vaso-motor and cardio-inhibitory centers, which are, it would seem, capable of related and harmonious action to act for the general good.

The arterioles must be conceived as undergoing very frequent changes of caliber. They are governed by the vaso-motor center, situated in the medulla, and possibly certain subordinate centers in the spinal cord, through vaso-motor nerves. These are (*a*) vaso-constrictors, which maintain a constant but variable degree of contraction of the muscle-cells of the vessels; (*b*) vaso-dilators, which are not in constant functional activity; and (*c*) mixed nerves, with both kinds. An inherited tendency to rhythmical contraction throughout the entire vascular system, including the vessels, must be taken into account.

The depressor nerve acts by lessening the tonic contraction of (dilating) the vessels of the splanchnic area especially.

It is important to remember that all the changes of the vascular system, so long as the nervous system is intact—i. e., so long as an animal is normal—are correlated; and that the action of such nerves as the depressor is to be taken rather as an example of how some of these changes are brought about, mere chapters in an incomplete but voluminous history, if we could but write it all. The changes in blood-pressure, by the addition or removal of a considerable quantity of blood, are slight, owing to the sort of adaptation referred to above, effected through the nervous system. Finally, the capillary circulation, when studied microscopically, and especially in disordered conditions, shows clearly that the *vital* properties of these vessels have an important share in determining the character of the circulation in themselves directly and elsewhere indirectly.

The study of the circulation, in other groups shows that below birds the arterial and venous blood undergoes mixture

somewhere, usually in the heart, but that in all the vertebrates the best blood is invariably that which passes to the head and upper regions of the body. The deficiencies in the heart, owing to the imperfections of valves, septa, etc., are in part counteracted in some groups by pressure relations, the blood always flowing in the direction of least resistance, so that the above-mentioned result is achieved.

Capillaries are wanting in most of the invertebrates, the blood flowing from the arteries into spaces (sinuses) in the tissues. It is to be noted that a modified blood (lymph) is also found in the interspaces of the cells of organs. Indeed, the circulatory system of lower forms is in many respects analogous to the lymphatic system of higher ones.

DIGESTION OF FOOD.

THE processes of digestion may be considered as having for their end the preparation of food for entrance into the blood.

This is in part attained when the insoluble parts have been rendered soluble. At this stage it becomes necessary to inquire as to what constitutes *food* or a food.

Inasmuch as animals, unlike plants, derive none of their food from the atmosphere, it is manifest that what they take in by the mouth must contain every chemical element, in some form, that enters into the composition of the body.

But actual experience demonstrates that the food of animals must, if we except certain salts and water, be in organized form—i. e., it must approximate to the condition of the tissues of the body in a large degree. Plants, in fact, are necessary to animals in working up the elements of the earth and air into form suitable for them.

Foodstuffs are divisible into :

I. Organic.

1. Nitrogenous. (a) Albumins; (b) Albuminoids (as gelatin).
2. Non-nitrogenous. (a) Carbohydrates (sugars, starches); (b) Fats.

II. Inorganic.

1. Water.
2. Salts.

Animals may derive the whole of their food from the bodies of other animals (*carnivora*); from vegetable matter exclusively (*herbivora*); or from a mixture of the animal and vegetable, as in the case of the pig, bear, and man himself (*omnivora*).

It has been found by feeding experiments, carried out mostly on dogs, that animals die when they lack any one of the constituents of food, though they live longer on the nitrogenous than any other kind. In some instances, as when fed on gelatin and water, or sugar and water, the animals died almost as

soon as if they had been wholly deprived of food. But it has also been observed that some animals will all but starve rather than eat certain kinds of food, though chemically sufficient. We must thus recognize something more in an animal than merely the mechanical and chemical processes which suffice to accomplish digestion in the laboratory. A food must be not only sufficient from the chemical and physical point of view, but be capable of being acted on by the digestive juices, and of such a nature as to suit the particular animal that eats it.

To illustrate, bones may be masticated and readily digested by a hyena, but not by an ox or by man, though they meet the conditions of a food in containing all the requisite constituents. Further, the food that one man digests readily is scarcely digestible at all by another ; and it is within the experience of every one that a frequent change of diet is absolutely necessary.

Since all mammals, for a considerable period of their existence, feed upon milk exclusively, this must represent a perfect or typical food. It will be worth while to examine the composition of milk. The various substances composing it, and their relative proportions for different animals, may be seen from the following table, which is based on a total of 1,000 parts :

CONSTITUENTS.	Human.	Cow.	Goat.	Ass.
Water.....	889.08	857.05	863.58	910.24
Casein.....	} 39.24	{ 48.28	33.60	} 20.18
Albumin.....				
Butter.....	26.66	43.05	43.57	12.56
Milk-sugar.....	43.64	40.37	40.04	} 57.02
Salts.....	1.38	5.48	6.22	
Total solids....	110.92	142.95	136.42	89.76

The following table, giving the percentage composition of the milk of different animals, may prove instructive.

	Woman.	Cow.	Mare.	Bitch.
Casein.....	2.00	4.00	2.50	10.00
Fats.....	2.75	4.00	2.00	10.00
Salts.....	0.25	0.60	0.50	0.50
Sugar.....	5.00	4.40	5.00	3.50
Total solids.....	10.00	13.00	10.00	24.00
Water.....	90.00	87.00	90.00	76.00

1. The *proteids* of milk are :

(a.) An albumin very like serum-albumin.

(b.) Casein, normally in suspension, in the form of extremely minute particles, which contributes to the opacity of milk.

It can be removed by filtration through porcelain ; and precipitated or coagulated by acids and by rennet, an extract of the mucus membrane of the calf's stomach. After this coagulation, whey, a fluid more or less clear, separates, which contains the salts and sugar of milk and most of the water. Much of the fat is entangled with the casein.

Casein, with some fat, makes up the greater part of cheese.

2. *Fats*.—Milk is an emulsion—i. e., contains fat suspended in a fine state of division. The globules, which vary greatly in size, are surrounded by an envelope of proteid matter. This covering is broken up by churning, allowing the fatty globules to run together and form butter.

Butter consists chiefly of olein, palmitin, and stearin, but contains in smaller quantity a variety of other fats. The rancidity of butter is due to the presence of free fatty acids, especially butyric.

The fat of milk usually rises to the surface as cream when milk is allowed to stand.

3. *Milk-sugar*, which is converted into lactic acid, probably by the agency of some form of micro-organism, thus furnishing acid sufficient to cause the precipitation or coagulation of the casein.

Milk, when fresh, should be neutral or faintly alkaline.

4. *Salts* (and other extractives), consisting of phosphates of calcium, potassium, and magnesium, potassium chloride, with traces of iron and other substances.

It can be readily understood why animals fed on milk rarely suffer from that deficiency of calcium salts in the bones leading to rickets, so common in the ill-fed. It thus appears that milk contains all the constituents requisite for the building up of the healthy mammalian body ; and experiments prove that these exist in proper proportions and in a readily digestible form. The author has found that a large number of animals, into the usual food of which, in the adult form, milk does not enter, like most of our wild mammals, as well as most birds, will not only take milk but soon learn to like it, and thrive well upon it. Since the embryo chick lives upon the egg, it might have been supposed that eggs would form excellent food for

adult animals, and common experience proves this to be the case; while chemical analysis shows that they, like milk, contain all the necessary food constituents. *Meat* (muscle, with fat chiefly) is also, of course, a valuable food, abounding in

Animal Foods.

Explanation of the signs.

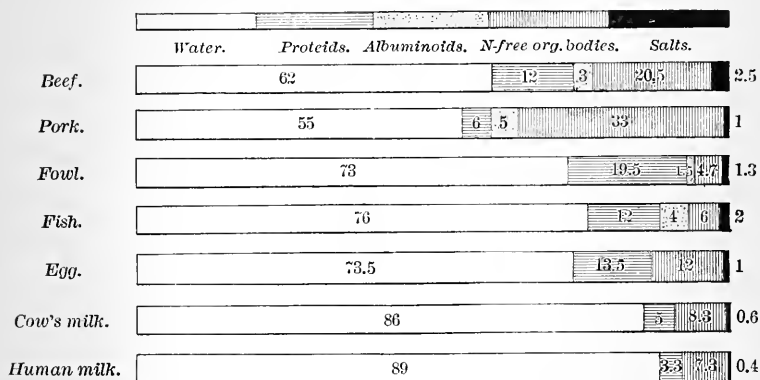

Vegetable Foods.

Explanation of the signs.

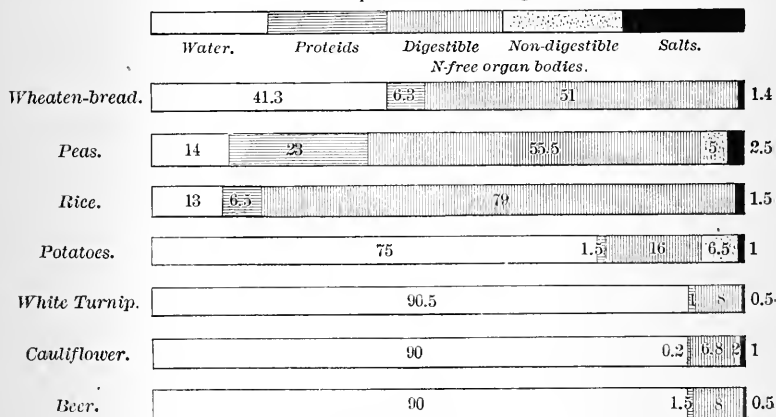

FIG. 234 (Landois).

proteids. *Cereals* contain starch in large proportion, but also a mixture of proteids. *Green vegetables* contain little actual nu-

tritive material, but are useful in furnishing salts and special substances, as certain compounds of sulphur which, in some ill-understood way, act beneficially on the metabolism of the body. They also seem to stimulate the flow of healthy digestive fluids. *Condiments* act chiefly, perhaps, in the latter way. Tea, coffee, etc., contain alkaloids, which it is likely have a conservative effect on tissue waste, but we really know very little as to how it is that they prove so beneficial. Though they are recognized to have a powerful effect on the nervous system as stimulants, nevertheless it would be erroneous to suppose that their action was confined to this alone.

The accompanying diagrams will serve to represent to the eye the relative proportions of the food-essentials in various articles of diet.

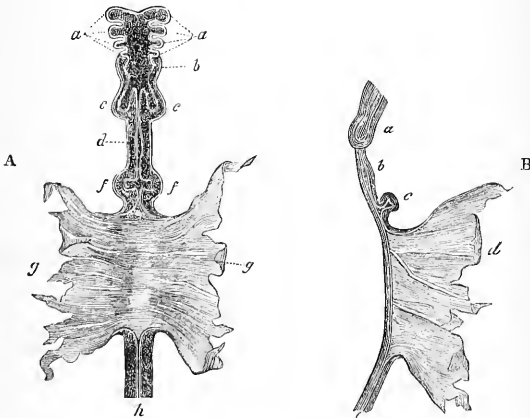

FIG. 225.—Alimentary canal of embryo while the rudimentary mid-gut is still in continuity with yolk-sac (Kölliker, after Bischoff). A. View from before. *a*, pharyngeal plates; *b*, pharynx; *c, e*, diverticula forming the lungs; *d*, stomach; *f*, diverticula of liver; *g*, membrane torn from yolk-sac; *h*, hind gut. B. Longitudinal section. *a*, diverticulum of a lung; *b*, stomach; *c*, liver; *d*, yolk-sac.

It is plain that if, in the digestive tract, foods are changed in solubility and actual chemical constitution, this must have been brought about by chemical agencies. That food is broken up at the very commencement of the alimentary tract is a matter of common observation; and that there should be a gradual movement of the food from one part of the canal to another, where a different fluid is secreted, would be expected. As a matter of fact, mechanical and chemical forces play a

large part in the actual preparation of the food for absorption. Behind these lie, of course, the vital properties of the glands, which prepare the active fluids from the blood, so that a study of digestion naturally divides itself into the consideration of—1. The digestive juices; 2. The secretory processes; and, 3. The muscular and nervous mechanism by which the food is carried from one part of the digestive tract to another, and the waste matter finally expelled.

Embryological.—The alimentary tract, as we have seen, is formed by an infolding of the splanchnopleure, and, according as the growth is more or less marked, does the canal become tortuous or remain somewhat straight. The alimentary tract of a mammal passes through stages of development which correspond with the permanent form of other groups of vertebrates, according to a general law of evolution. Inasmuch as the embryonic gut is formed of mesoblast

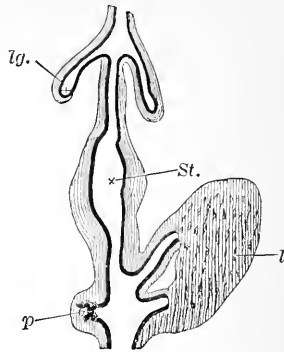

FIG. 226.—Diagram of alimentary canal of chick at fourth day (Foster and Balfour, after Götte). *lg.*, diverticulum of one lung; *St.*, stomach; *l.*, liver; *p.*, pancreas.

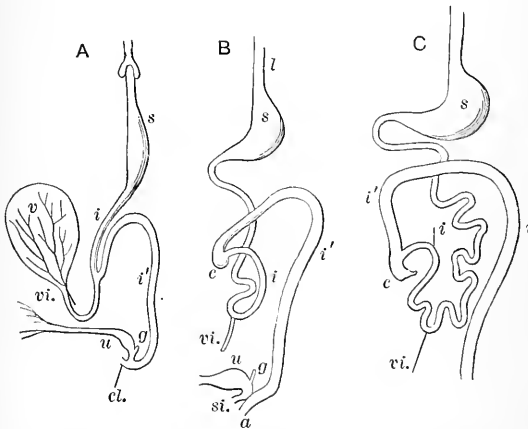

FIG. 227.—Position of various parts of alimentary canal at different stages. A. Embryo of five weeks. B. Of eight weeks. C. Of ten weeks (Allen Thomson). *l.*, pharynx with the lungs; *s.*, stomach; *i.*, small intestine; *i'*, large intestine; *g.*, genital duct; *u.*, bladder; *cl.*, cloaca; *c.*, cæcum; *vi.*, ductus vitello-intestinalis; *si.*, urogenital sinus; *v.*, yolk-sac.

and hypoblast, it is easy to understand why the developed tract should so invariably consist of glandular structures and muscular tissue disposed in a certain regular arrangement. The fact that all the organs that pour digestive juices into the alimentary tract are outgrowths from it serves to explain why there should remain a physiological connection with an anatomical isolation. The general resemblance of the epithelium throughout, even in parts widely separated, also becomes clear, as well as many other points we can not now refer to in detail, to one who realizes the significance of the laws of descent (evolution).

Comparative. — Amœba ingests and digests apparently by every part of its body ; though exact studies have shown that it neither accepts nor retains without considerable power of discrimination ; and it is also possible that some sort of digestive fluid may be secreted from the part of the body with which the food-particles come in contact. It has been shown, too, that there are differences in the digestive capacity of closely allied forms among Infusorians.

The ciliated Infusorians have a permanent mouth, which may also serve as an anus ; or, there may be an anus, though usually less distinct from the rest of the body than the mouth.

Among the Coelenterates *intra-cellular* digestion is found. Certain cells of the endoderm (as in Hydra) take up food-particles Amœba-like, digest them, and thus provide material for other cells as well as themselves, in a form suitable for assimilation. This is a beginning of that differentiation of function which is carried so far among the higher vertebrates. But, as recent investigations have shown, such *intra-cellular* digestion exists to some extent in the alimentary canal of the highest members of the vertebrate group (see page 345).

The means for grasping and triturating food among invertebrates are very complicated and varied, as are also those adapted for sucking the juices of prey. Examples to hand are to be found in the crab, crayfish, spider, grasshopper, beetle, etc., on the one hand, and the butterfly, housefly, leech, etc., on the other.

Before passing on to higher groups, it will be well to bear in mind that the digestive organs are to be regarded as the outcome both of heredity and adaptation to circumstances. We find parts of the intestine, e. g., retained in some animals in whose economy they seem to serve little if any good purpose, as

the vermiform appendix of man. Adaptation has been illustrated in the lifetime of a single individual in a remarkable

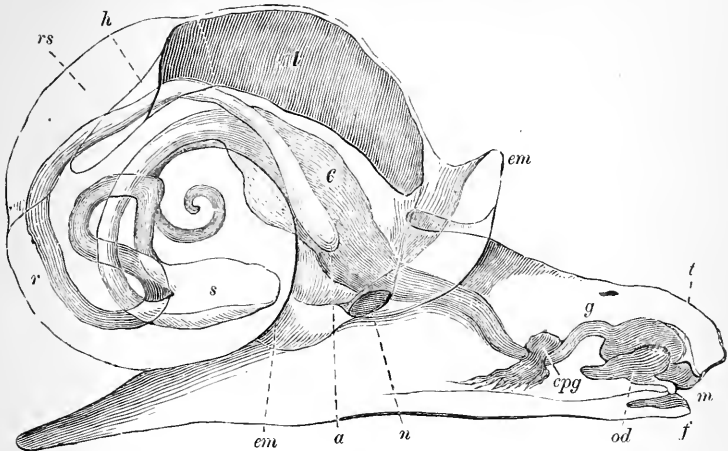

FIG. 228.—Diagram illustrating arrangement of intestine, nervous system, etc., in common snail, *Helix* (after Huxley). *m*, mouth; *t*, tooth; *od*, odontophore; *g*, gullet; *c*, crop; *s*, stomach; *r*, rectum; *a*, anus; *r. s.*, renal sac; *h*, heart; *l*, lung (modified pallial chamber); *n*, its external aperture; *em*, thick edge of mantle united with sides of body; *f*, foot; *cpg*, cerebral, pedal, and parieto-splanchnic ganglia aggregated round gullet.

manner; thus, a seagull, by being fed on grain, has had its stomach, naturally thin and soft-walled, converted into a muscular gizzard.

Since digestion is a process in which the mechanical and chemical are both involved, and the food of animals differs so widely, great variety in the alimentary tract, both anatomical and physiological, must be expected. Vegetable food must usually be eaten in much larger bulk to furnish the needed elements; hence the great length of intestine habitually found in herbivorous animals, associated often with a capacious and chambered stomach, furnishing a larger laboratory in which Nature may carry on her processes. To illustrate, the stomach of the ruminants consists of four parts (*rumen*, *reticulum*, *omasum* or *psalterium*, *abomasum*). The food when cropped is immediately swallowed; so that the paunch (*rumen*) is a mere storehouse in which it is softened, though but little changed otherwise; and it would seem that real gastric digestion is almost confined to the last division, which may be compared

to the simple stomach of the *Carnivora* or of man ; and, before the food reaches this region, it has been thoroughly masticated and mixed with saliva.

The stomach of the horse is small, though the intestine,



FIG. 229.—The viscera of a rabbit as seen upon simply opening the cavities of the thorax and abdomen without any further dissection. *A*, cavity of the thorax, pleural cavity on either side; *B*, diaphragm; *C*, ventricles of the heart; *D*, auricles; *E*, pulmonary artery; *F*, aorta; *G*, lungs collapsed, and occupying only back part of chest; *H*, lateral portions of the ribs; *I*, cartilage at the end of sternum (ensiform cartilage); *K*, portion of the wall of body left between thorax and abdomen; *a*, cut ends of the ribs; *L*, the liver, in this case lying more to the left than to the right of the body; *M*, the stomach, a large part of the greater curvature being shown; *N*, duodenum; *O*, small intestine; *P*, the caecum, so largely developed in this and other herbivorous animals; *Q*, the large intestine. (Huxley.)

especially the large gut is capacious. The stomach is divisible into a cardiac region, of a light color internally, and lined with epithelium, like that of the cesophagus, and a redder

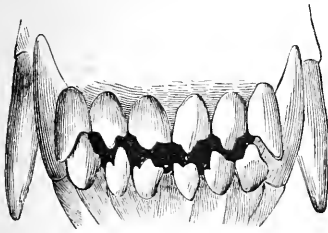

FIG. 231.

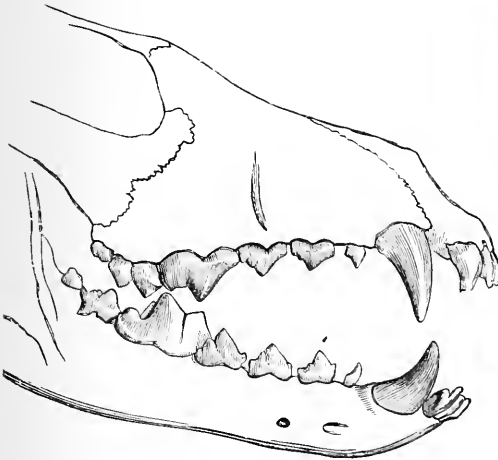

FIG. 230.



FIG. 232.

FIG. 230.—General and lateral view of dog's teeth (after Chauveau).

FIG. 231.—Anterior view of incisors and canine teeth in a year-old dog (Chauveau).

FIG. 232.—Dentition of inferior jaw of horse (after Chauveau).

pyloric area, in which the greater part of the digestive process goes on (Fig. 266).

The mouth parts, even in some of the higher vertebrates, as the *Carnivora*, serve a prehensile rather than a digestive purpose. This is well seen in the dog, that bolts his food; but in this and allied groups of mammals gastric digestion is very active.

The teeth as triturating organs find their highest development in ruminants, the combined side-to-side and forward-and-backward motion of the jaws rendering them very effective.

In *Carnivora* the teeth serve for grasping and tearing, while in the *Insectivora* the tongue, as also in certain birds (woodpeckers), is an important organ for securing food.

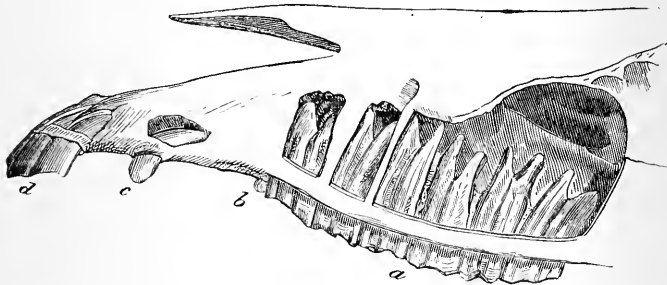

FIG. 233.—Profile of upper teeth of the horse, more especially intended to show the molars, the fangs having been exposed (Chauveau). *a*, molar teeth; *b*, supplementary molar; *c*, tusk; *d*, incisors.

It is to be noted, too, that, while the horse crops grass by biting it off, the ox uses the tongue, as well as the teeth and lips, to secure the mouthful.

Man's teeth are somewhat intermediate in form between the carnivorous and the herbivorous type. Birds lack teeth, but the strong muscular gizzard suffices to grind the food against the small pebbles that are habitually swallowed.

The crop, well developed in granivorous birds, is a dilatation of the œsophagus, serving to store and soften the food.

In the pigeon a glandular epithelium in the crop secretes a

FIG. 234.—General view of digestive apparatus of fowl (after Chauveau). 1, tongue; 2 pharynx; 3, first portion of œsophagus; 4, crop; 5, second portion of œsophagus; 6, succentric ventricle (proventriculus); 7, gizzard; 8, origin of duodenum; 9, first branch of duodenal flexure; 10, second branch of same; 11, origin of floating portion of small intestine; 12, small intestine; 12', terminal portion of this intestine, flanked on each side by the two cæca (regarded as the analogue of colon of mammals); 13, 13, free extremities of cæcums; 14, insertion of these two *cæca-de-sac* into intestinal tube; 15, rectum; 16, cloaca; 17, anus; 18, mesentery; 19, left lobe of liver; 20, right lobe; 21, gall-bladder; 22, insertion of pancreatic and biliary ducts; the two pancreatic ducts are the most anterior, the choledic or hepatic is in the middle, and the cystic duct is posterior; 23, pancreas; 24, diaphragmatic aspect of lung; 25, ovary (in a state of atrophy); 26, oviduct.

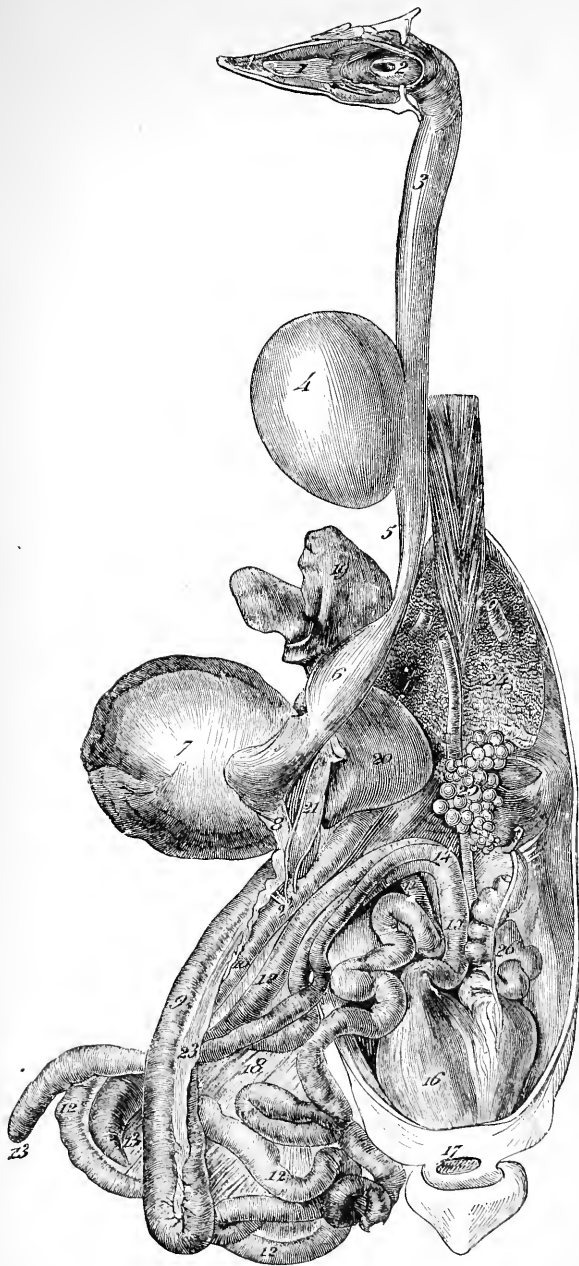

FIG. 234.

milky-looking substance that is regurgitated into the mouth of the young one, which is inserted within that of the parent bird.

The proventriculus—an enlargement just above the gizzard—is relatively to the latter very thin-walled, but provides the true gastric juices.

Certain plants digest proteid matter, like animals; thus the sun-dew (*Drosera*), by the closure of its leaves, captures insects, which are digested and the products absorbed. The digestive fluid consists of a pepsin-containing secretion, together with formic acid.

STRUCTURE, ARRANGEMENT, AND SIGNIFICANCE OF THE TEETH.

In a tooth we recognize a portion imbedded in the jaw (fang, root), a free portion (crown), and a constricted region (neck).

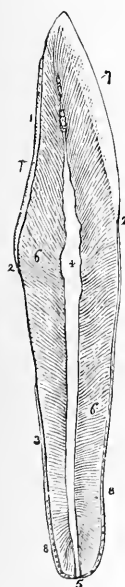

FIG. 235.

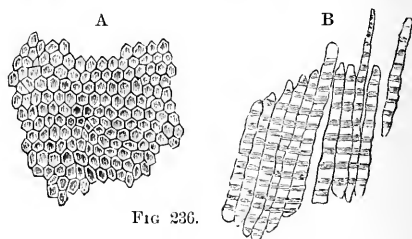

FIG. 236.

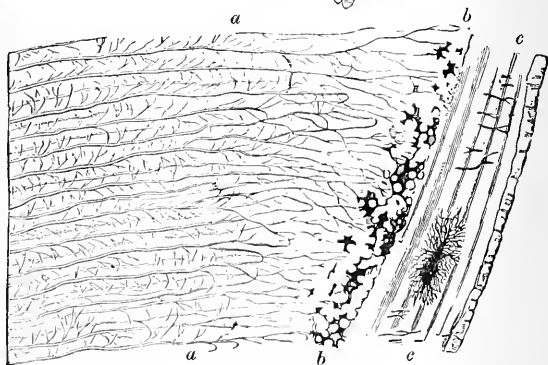

FIG. 237.

FIG. 235.—Magnified section of a canine tooth, showing its intimate structure. 1, crown; 2, 2, neck; 3, fang, or root; 4, cavitas pulpæ; 5, opening by which the vessels and nerves communicate with the pulp; 6, 6, ivory, showing fibrous structure; 7, 7, enamel; 8, 8, cement.

FIG. 236.—A, transverse section of enamel, showing its hexagonal prisms; B, separated prisms (Chauveau).

FIG. 237.—Section through fang of molar tooth (Chauveau). a, a, dentine traversed by its tubuli; b, b, interglobular or nodular layer; c, c, cementum.

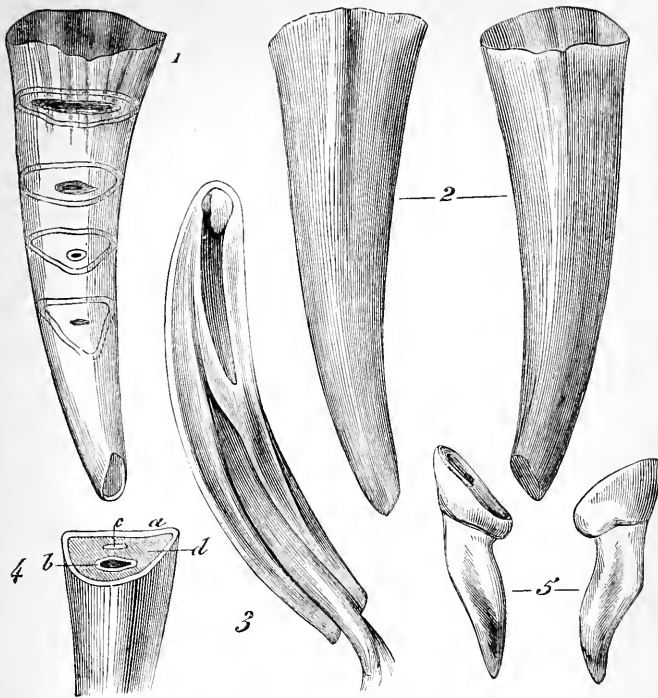

FIG. 238.—Incisor teeth of the horse. Details of structure (Chauveau). 1, a tooth in which is indicated general shape of a permanent incisor and the particular forms successively assumed by dental table in consequence of friction and the continued pushing outward of these teeth; 2, a virgin tooth, anterior and posterior faces; 3, longitudinal section of a virgin tooth, intended to show the internal conformation and structure. Not to complicate the figure, the external cement and that amassed in the infundibulum have not been exhibited; 4, transverse section for the same purpose; *a*, encircling enamel; *b*, central enamel; *c*, dental star; *d*, dentine; 5, deciduous tooth.

A tooth is made up of enamel, dentine or “ivory,” and cement (*crusta petrosa*). The relative distribution of these is shown in Fig. 235.

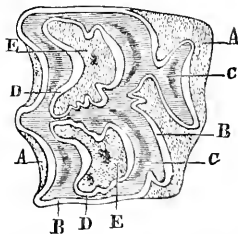

FIG. 239.—Transverse section of a horse's upper molar tooth (Chauveau). A, external cement; B, external enamel; C, dentine; D, internal enamel; E, internal cement.

Enamel is made up of elongated hexagonal prisms set almost vertically in the dentine (Fig. 236).

It is the hardest substance known in the animal body, consisting almost entirely of inorganic material ; and when lost is but indifferently if at all replaced.

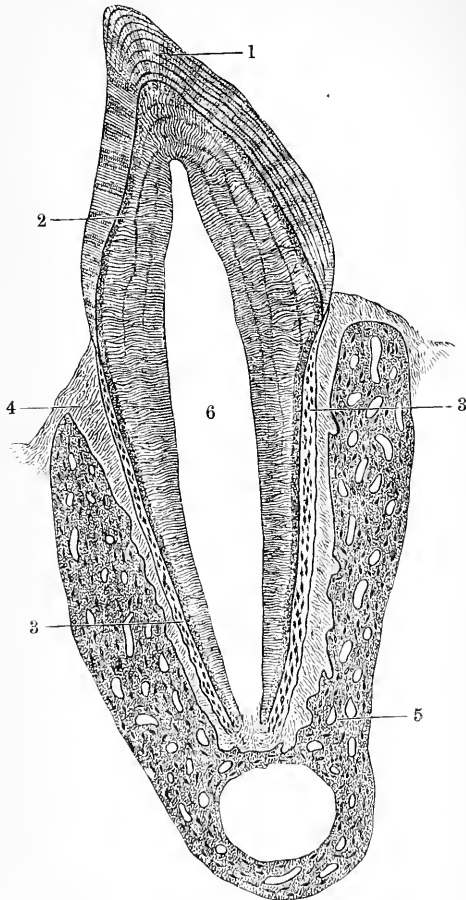

FIG. 240.--Tooth of cat in situ (Waldeyer). 1, enamel; 2, dentine; 3, cement; 4, periosteum of alveolar cavity; 5, bone of jaw; 6, pulp cavity.

Dentine is traversed by the dentine tubules (Fig. 237), which radiate outward from the pulp cavity.

The latter is filled by the tooth-pulp, which consists of a delicate connective tissue supporting blood-vessels and nerves which ramify in it after entering by the openings in the fang of the tooth. From the pulp protoplasmic fibers extend into the dentine tubules.

The crusta petrosa is very similar to bone, but is usually without Haversian canals, and, like bone, is covered with periosteum.

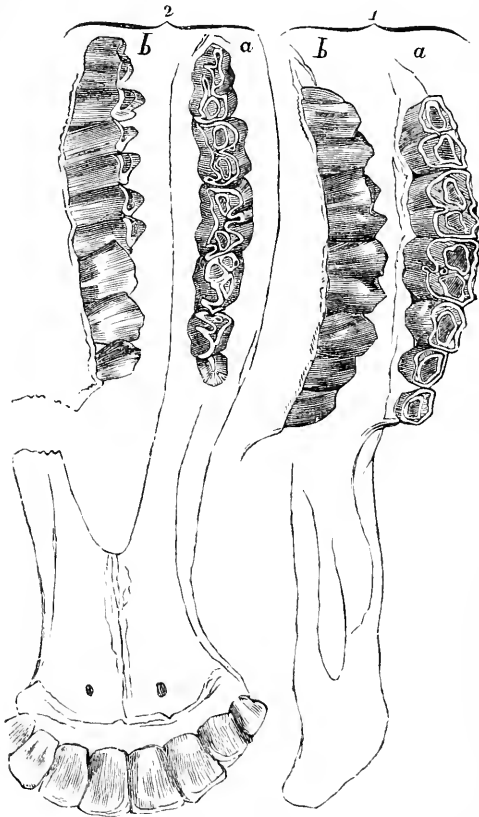

FIG. 241.—The teeth of the ox (Chauveau). 1, upper jaw, with *a*, friction surface, and *b*, external surface; 2, lower jaw, with *a*, dental tables, and *b*, external face.

Teeth are simple and compound. In the former (carnivora) the entire crown is covered with enamel; in the latter, owing

to wear, the other constituents appear on the upper surface of the crown (Figs. 238, 239, 240).

It follows that the former are better adapted for tearing, the latter for grinding, as the different components wear unequally and leave the top of the crown rough, so that the upper and lower jaws of a ruminant are like two millstones, (Fig. 241).

It also follows that in the horse and in ruminants the age may be learned with considerable accuracy from the condition of wear of the teeth and as the incisors are most readily examined they are taken as the chief indicators of the age of the animal.

In nearly all animals are found the deciduous or milk teeth succeeded by the permanent teeth. This arises as a necessity from the growth of the jaw and the need of stronger teeth, either as weapons of defense and attack or in order the more effectually to secure and prepare food. The permanent teeth are also more numerous than the milk teeth.

The dentition of our domestic animals may be expressed thus :

Dog.	Incisors,	$\frac{3-3}{3-3}$;	canines,	$\frac{1-1}{1-1}$;	premolars,	$\frac{4-4}{4-4}$;	molars,	$\frac{2-2}{3-3} = 42$.
Cat.	"	$\frac{3-3}{3-3}$;	"	$\frac{1-1}{1-1}$;	"	$\frac{3-3}{2-2}$;	"	$\frac{1-1}{1-1} = 30$.
Man.	"	$\frac{2-2}{2-2}$;	"	$\frac{1-1}{1-1}$;	"	$\frac{2-2}{2-2}$;	"	$\frac{3-3}{3-3} = 32$.
Pig.	"	$\frac{3-3}{3-3}$;	"	$\frac{1-1}{1-1}$;	"	$\frac{3-3}{3-3}$;	"	$\frac{4-4}{4-4} = 44$.
Ox.	"	$\frac{0-0}{3-3}$;	"	$\frac{0-0}{1-1}$;	"	$\frac{3-3}{3-3}$;	"	$\frac{3-3}{3-3} = 32$.
Horse.	"	$\frac{3-3}{3-3}$;	"	$\frac{1-1}{1-1}$;	"	$\frac{3-3}{3-3}$;	"	$\frac{3-3}{3-3} = 40$.
"	"	$\frac{3-3}{3-3}$;	"	$\frac{0-0}{0-0}$;	"	$\frac{0-0}{0-0}$;	"	$\frac{3-3}{3-3} = 24$.

The latter is the representation of the milk dentition. The mare is without canines ("tushes").

It will be noticed that in the ox incisors and canines do not appear in the upper jaw, though they are represented by embryonic rudiments.

The table above and that on page 296 (after Leyh) give a large amount of information in a small space, and are illustrated by the accompanying figures :

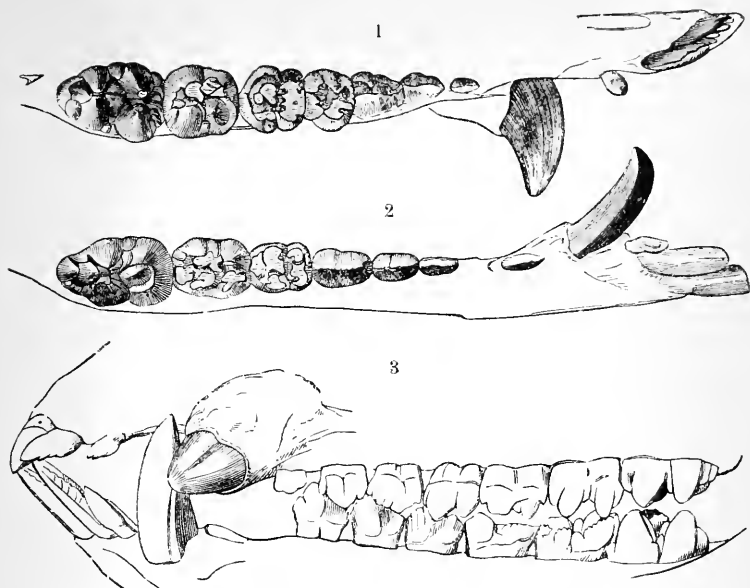

FIG. 242.—The teeth of the pig (Chauveau). 1, upper teeth, table surface; 2, lower teeth, table aspect; 3, lateral view of jaws.

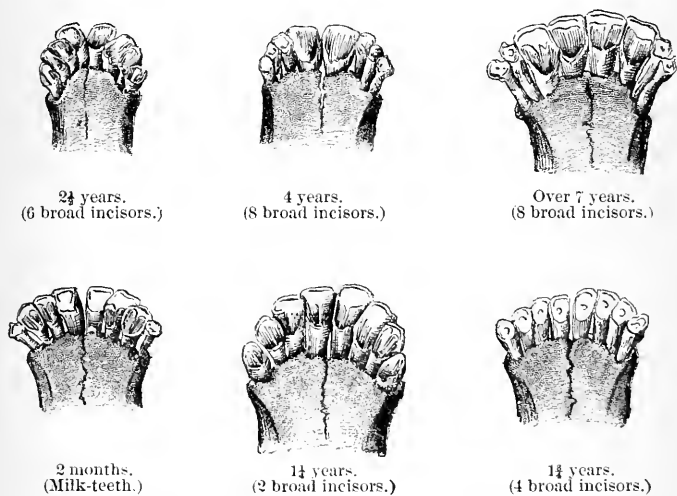
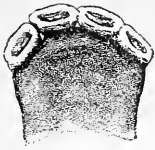

FIG. 243.—Changes in incisor teeth of the sheep (Wilckens).



New-born.



3 months.



6 months.

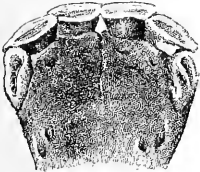

1 year.



2 years.

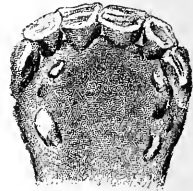

2½ years.

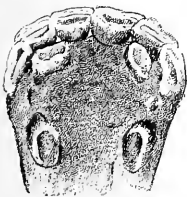

3 years.

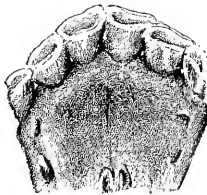

4 years.

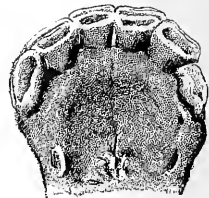

5 years.

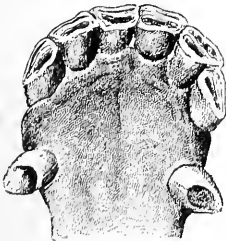

6 years.



7 years.

FIG. 244 (1).—Changes in incisor teeth of horse with age (Wilckens).

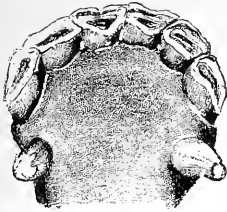

8 years.

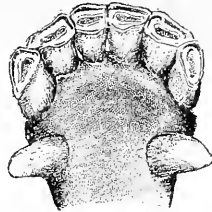

9 years.

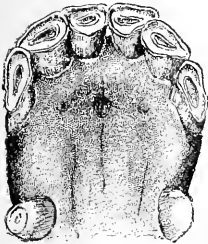

9 years (?).

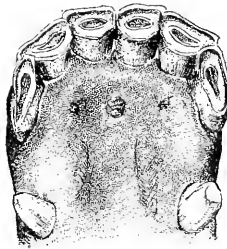

10 years (?).

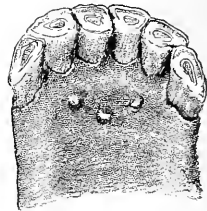

11 years (?).

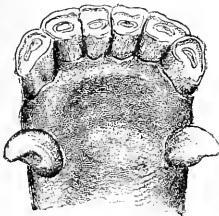

12 years.

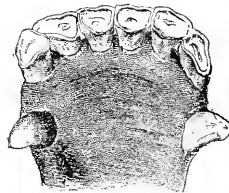

15 years.

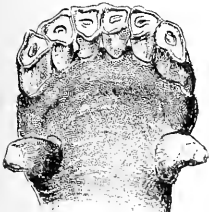

18 years.



24 years.

FIG. 244 (2). Changes in incisor teeth of horse with age (Wilckens).



New-born.



8 days.



4 weeks.



1 year.



2 years.



2½ years.

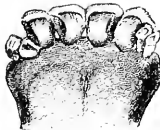

3 years.



3½ years.



4 years.



5 years.

FIG. 245 (1).—Changes in incisor teeth of ox with age (Wilckens).



6 years.

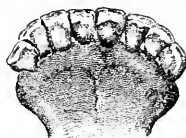

7 years.



8 years.

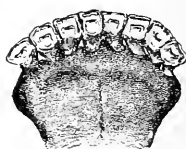

10 years.



12 years.



14 years.



16 years.

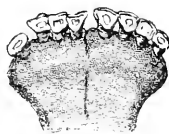

18 years.



20 years.

FIG. 245 (2).—Changes in incisor teeth of ox with age (Wilckens).

TEETH.	HORSE.		RUMINANTS.		PIG.		DOG.	
	Eruption.	Replace-ment.	Eruption.	Replace-ment.	Eruption.	Replace-ment.	Eruption.	Replace-ment.
I. INCISOR TEETH.								
Central	Before, or some d. after birth.	2½ years. Before, or some d. after birth.	3 to 4 months.	2½ to 3 y.	4 to 6 wks.	3 to 4 mos.		
First intermediates	4 to 6 weeks.	3½ years.	"	"	"	"	"	"
Second intermediates	14 days.
Outer	6 to 9 months.	4½ years.	2 to 3 weeks.	4½ years.	Before, or some d. after birth.	6 mos.	"	5 months.
II. CANINE TEETH.								
Canine teeth	6 months.	4 to 5 y.	"	1 year.	"	5 to 6 mos.
III. MOLAR TEETH.								
First	Before, or some d. after birth.	2½ years. Before, or some d. after birth.	Before, or some d. after birth.	2½ years.	3 to 4 mos.		
Second	"	"	"	3½ years.	2 years.	4 to 5 wks.	5 to 6 mos.	"
Third	"	3½ years.	"	"	"	"	"
Fourth	10 to 12 mos.	6 to 9 months.	5 to 6 months.
Fifth	2 to 2½ years.	2½ years.	1 year.	4 to 5 mos.
Sixth	4 to 5 years.	4 to 5 years.	1½ to 2 years.	5 to 6 mos.
Seventh	3 years.	5½ to 6½ m.
NUMBER OF TEETH.								
Males	40	32	44	44	Dog.	42		
Females	36	32	44	44	Cat.	30		

THE DIGESTIVE JUICES.

Saliva.—The saliva as found in the mouth is a mixture of the secretion of three pairs of glands, alkaline in reaction, of a low specific gravity (variable in different groups of animals), with a small percentage of solids consisting of salts and organic bodies (mucin, proteids).

Saliva serves mechanical functions in articulation, in moistening the food, and dissolving out some of its salts. But its principal use in digestion is in reducing starchy matters to a soluble form, as sugar. So far as known, the other constituents of the food are not changed chemically in the mouth.

The Amyolytic Action of the Saliva.—Starch exists in grains surrounded by a *cellulose* covering, which saliva does not digest: hence its action on raw starch is slow.

It is found that if a specimen of boiled starch not too thick be exposed to a small quantity of saliva at the temperature of the body or thereabout (37° to 40° C.), it will speedily undergo certain changes :

1. After a very short time sugar may be detected by Fehling's solution (copper sulphate in an excess of sodium hydrate, the sugar reducing the cupric hydrate to cuprous oxide on boiling).

2. At this early stage starch may still be detected by the blue color it gives with iodine ; but later, instead of a blue, a purple or red may appear, indicating the presence of *dextrin*, which may be regarded as a product intermediate between starch and sugar.

3. The longer the process continues, the more sugar and the less starch or dextrin to be detected ; but, inasmuch as the quantity of sugar at the end of the process does not exactly correspond with the original quantity of starch, even when no starch or dextrin is to be found, it is believed that other bodies are formed. One of these is achroodextrin, which does not give a color reaction with iodine.

The sugars formed are : (a) Dextrose. (b) Maltose, which has less reducing power over solutions of copper salts, a more pronounced rotatory action on light, etc.

It is found that the digestive action of saliva, as in the above-described experiment, will be retarded or arrested if the sugar is allowed to accumulate in large quantity. That digestion in the mouth is substantially the same as that just de-

scribed can be easily shown by holding a solution of starch in the mouth for a few seconds, and then testing it for sugar, when it will be invariably found.

While salivary digestion is not impossible in a neutral medium, it is arrested in an acid one even of no great strength (less than one per cent), and goes on best in a feebly alkaline medium, which is the condition normally in the mouth. Though a temperature about equal to that of the body is best adapted for salivary digestion, it will proceed, we have ourselves found at a higher temperature than digestion by any other of the juices, so far as man is concerned—a fact to be connected, in all probability, with his habit for ages of taking very warm fluids into the mouth.

The active principle of saliva is *ptyalin*, a nitrogenous body which is assumed to exist, for it has never been perfectly isolated. It belongs to the class of unorganized ferments, the properties of which have been already referred to before (page 162).

Characteristics of the Secretion of the Different Glands.—

Parotid saliva in man not a viscid fluid, but clear and limpid, containing very little mucin. Submaxillary saliva in most animals and in man is viscid, while the secretion of the sublingual gland is still more viscid.

Comparative.—Saliva differs greatly in activity in different animals; thus saliva in the dog is almost inert, that of the parotid gland quite so; in the cat it is but little more effective; and in the horse, ox, and sheep, it is known to be of very feeble digestive power.

In man, the Guinea-pig, the rat, the hog, both parotid and submaxillary saliva are active; while in the rabbit the submaxillary saliva, the reverse of the preceding, is almost inactive, and the parotid secretion very powerful.

An aqueous or glycerin extract of the salivary glands has digestive properties. The secretion of the different glands may be collected by passing tubes or cannulas into their ducts.

The saliva, normally neutral or only faintly acid, may become very much so in the intervals of digestion. The rapid decay of the teeth occurring during and after certain diseases seems in certain cases to be referable in part to an abnormal condition of the saliva.

The *tartar* which collects on the teeth consists largely of earthy phosphates.

Gastric Juice.—Gastric juice may be obtained from a fistulous opening into the stomach. Such may be made artificially by an incision over the organ in the middle line, catching it up and stitching it to the edges of the wound, incising and inserting a special form of cannula, which may be closed or opened at will.

Digestion in a few cases of accidental gastric fistulæ has been made the subject of careful study. The most instructive case is that of Alexis St. Martin, a French Canadian, into whose stomach a considerable opening was made by a gunshot-wound.

Gastric juice, in his case and in the lower animals with artificial openings in the stomach, has been obtained by irritating the mucous lining mechanically with a foreign body, as a feather.

The great difficulty in all such cases arises from the impossibility of being certain that such fluid is normal; for the conditions which call forth secretion are certainly such as the stomach never experiences in the ordinary course of events, and we have seen how saliva varies, according as the animal is fasting or feeding, etc.

Bearing in mind, then, that our knowledge is possibly only approximately correct, we may state what is known of the secretions of the stomach.

The gastric secretion is clear, colorless, of low specific gravity (1001 to 1010), the solids being in great part made up of pepsin with a small quantity of mucus, which may become excessive in disordered conditions. There has been a good deal of dispute as to the acid found in the stomach during digestion. It is now generally agreed that during the greater part of the digestive process there is free hydrochloric acid to the extent of about .2 per cent. It is maintained that lactic acid exists normally in the early stages of digestion, and it is conceded that lactic, butyric, acetic, and other acids may be present in certain forms of disordered digestion.

It is also generally acknowledged that in mammals the work of the stomach is limited, so far as actual chemical changes go, to the conversion of the proteid constituents of food into peptone. Fats may be released from their proteid coverings (cells), but neither they nor starches are in the least altered chemically. Some have thought that in the dog there is a slight digestion of fats in the stomach. The solvent power of the gastric juice is

greater than can be accounted for by the presence of the acid it contains merely, and it has a marked antiseptic action.

Digestive processes may be conducted out of the body in a very simple manner, which the student may carry out for himself. To illustrate by the case of gastric digestion: The mucous membrane is to be removed from a pig's stomach after its surface has been washed clean, but not too thoroughly, chopped up fine, and divided into two parts. On one half pour water that shall contain .2 per cent hydrochloric acid (made by adding 4 to 6 cc. commercial acid to 1,000 cc. water). This will extract the pepsin, and may be used as the menstruum in which the substance to be digested is placed. The best is fresh fibrin whipped from blood recently shed.

Since the fluid thus prepared will contain traces of peptone from the digestion of the mucous membrane, it is in some respects better to use a glycerin extract of the same. This is made by adding some of the best glycerin to the chopped up mucous membrane of the stomach of a pig, etc., well dried with bibulous paper, letting the whole stand for eight to ten days, filtering through cotton, and then through coarse filter-paper. It will be nearly colorless, clear, and powerful, a few drops sufficing for the work of digesting a little fibrin when added to some two per cent of hydrochloric acid.

Digestion goes on best at about 40° C., but will proceed in the cold if the tube in which the materials have been placed is frequently shaken. It is best to place the test-tube containing them in a beaker of water kept at about blood-heat. Soon the fibrin begins to swell and also to melt away.

After fifteen to twenty minutes, if a little of the fluid in the tube be removed and filtered, and to the filtrate added carefully to neutralization dilute alkali, a precipitate, insoluble in water but soluble in excess of alkali (or acid), is thrown down. This is in most respects like acid-albumen, but has been called parapeptone. The longer digestion proceeds, the less is there of this and the more of another substance, peptone, so that the former is to be regarded as an intermediate product. Peptone is distinguished from albuminous bodies or proteids by—1. Not being coagulable from its aqueous solutions on boiling. 2. Diffusing more readily through animal membranes. 3. Not being precipitated by a number of reagents that usually act on proteids.

In artificial digestion it is noticeable that much more fibrin

or other proteid matter will be dissolved if it be finely divided and frequently shaken up, so that a greater surface is exposed to the digestive fluid.

The exact nature of the process by which proteid is changed to peptone is not certainly known.

Since starch on the addition of water becomes sugar ($C_6H_{10}O_5 + H_2O = C_6H_{12}O_6$), and since peptones have been formed through the action of dilute acid at a high temperature or by superheated water alone, it is possible that the digestion of both starch and proteids may be a *hydration*; but we do not know that it is such.

As already explained, milk is curdled by an extract of the stomach (rennet); and this can take place in the absence of all acids or anything else that might be suspected except the real cause; there seems to be no doubt that there is a distinct ferment which produces the coagulation of milk which results from the precipitation of its casein.

The activity of the gastric juice, and all extracts of the mucous membrane of the stomach, on proteids, is due to *pepsin*, a nitrogenous body, but not a proteid.

Like other ferments, the conditions under which it is effective are well defined. It will not act in an alkaline medium at all, and if kept long in such it is destroyed. In a neutral medium its power is suspended but not destroyed. Digestion will go on, though less perfectly, in the presence of certain other acids than hydrochloric. As with all digestive ferments, the activity of pepsin is wholly destroyed by boiling.

IN 100 PARTS.	Man.	Ox.	Pig.	DOG.	
				Fresh.	From gall-bladder.
Water	86.3	90.4	88.8	95.3	85.2
Solids	13.7	9.6	11.2	4.7	14.8
Bile salts	7.4	8.0	7.3	3.4	12.6
Lecethin, cholesterin					
Fats, soaps	3.0		2.2	0.5	1.3
Mucin and coloring matter ..	2.2	0.3	0.6	0.2	0.3
Inorganic salts	1.1	1.3	1.1	0.6	0.6

The color of the bile of man is a rich golden yellow. When it contains much mucus, as is the case when it remains long in the gall-bladder, it is ropy, though usually clear. Bile may contain small quantities of iron, manganese, and copper, the

latter two especially being absent from all other fluids of the body. Sodium chloride is the most abundant salt. Bile must be regarded as an excretion as well as a secretion; the pigments, copper, manganese, and perhaps the iron and the cholesterin being of little or no use in the digestive processes, so far as known.

The bile-salts are the essential constituents of bile as a digestive fluid. In man and many other animals, they consist of taurocholate and glycocholate of sodium, and may be obtained in bundles of needle-shaped crystals radiating from a common center. These salts are soluble in water and alcohol, with an alkaline reaction, but insoluble in ether.

Glycocholic acid may be resolved into cholalic (cholic) acid and glycin (glycocol); and taurocholic acid into cholalic acid and taurin. Thus:

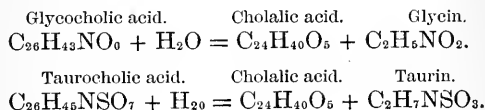

Glycocol (glycin) is amido-acetic acid—



Taurin, amido-isethionic acid,

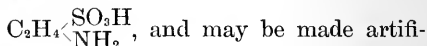

cially from isethionic acid.

It is to be noted that both the bile acids contain nitrogen, but that cholalic acid does not. The decomposition of the bile acids takes place in the alimentary canal, and the glycin and taurin are restored to the blood, and are possibly used afresh in the construction of the bile acids, though this is not definitely known.

Bile-Pigments.—The yellowish-red color of the bile is owing to *Bilirubin* ($\text{C}_{10}\text{H}_{18}\text{N}_2\text{O}_3$), which may be separated either as an amorphous yellow powder or in tablets and prisms. It is soluble in chloroform, insoluble in water, and but partially soluble in alcohol and ether. It makes up a large part of gall-stones, which contain, besides cholesterin, earthy salts in abundance.

It may be oxidized to *Biliverdin* ($\text{C}_{16}\text{H}_{18}\text{N}_2\text{O}_4$), the natural green pigment of the bile of the herbivora. When a drop of

nitric acid, containing nitrous acid, is added to bile, it undergoes a series of color changes in a certain tolerably constant order, becoming green, greenish-blue, blue, violet, a brick red, and finally yellow; though the green is the most characteristic and permanent. Each one of these represents a distinct stage of the oxidation of bilirubin, the green answering to biliverdin. Such is Gmelin's test for bile-pigments, by which they may be detected in urine or other fluids. The absence of proteids in bile is to be noted.

The Digestive Action of Bile.—1. So far as known, its action on proteids is *nil*. When bile is added to the products of an artificial gastric digestion, bile-salts, peptone, pepsin, and para-peptone are precipitated and redissolved by excess. 2. It is slightly solvent of fats, though an emulsion made with bile is very feeble. But it is likely helpful to pancreatic juice, or more efficient itself when the latter is present. With free fatty acids it forms soaps, which themselves help in emulsifying fat. 3. Membranes wet with bile allow fats to pass more readily; hence it is inferred that bile assists in absorption. 4. When bile is not poured out into the alimentary canal the fæces become clay-colored and ill-smelling, foul gases being secreted in abundance, so that it would seem that bile exercises an anti-septic influence. It may limit the quantity of *indol* formed. It is to be understood that these various properties of bile are to be traced almost entirely to its salts; though its alkaline reaction is favorable to digestion in the intestines, apart from its helpfulness in soap-forming, etc. 5. It is thought by some that the bile acts as a stimulant to the intestinal tract, giving rise to peristaltic movements, and also, mechanically, as a lubricant of the fæces. In the opinion of many, an excess of bile naturally poured out causes diarrhœa, and it is well known that bile given by the mouth acts as a purgative. However, we must distinguish between the action of an excess and that of the quantity secreted by a healthy individual. The acid of the stomach has probably no effect allied to that produced by giving acids medicinally, which warns us that too much must not be made out of the argument from bilious diarrhœa. 6. As before intimated, a great part of the bile must be regarded as excrementitious. It looks as though much of the effete hæmoglobin of the blood and of the cholesterin, which represents possibly some of the waste of nervous metabolism, were expelled from the body by the bile. The cholalic acid of the fæces is

derived from the decomposition of the bile acids. Part of their mucus must also be referred to the bile, the quantity originally present in this fluid depending much on the length of its stay in the gall-bladder, which secretes this substance. 7. There is throughout the entire alimentary tract a secretion of mucus which must altogether amount to a large quantity, and it has been suggested that this has other than lubricating or such like functions. It appears that mucus may be resolved into a proteid and an animal gum, which latter, it is maintained, like vegetable gums, assists emulsification of fats. If this be true, and the bile is, as has been asserted, possessed of the power to break up this mucus (mucin), its emulsifying effect in the intestine may indirectly be considerable. Bile certainly seems to intensify the emulsifying power of the pancreatic juice.

There does not seem to be any ferment in bile, unless the power to change starch into sugar, peculiar to this secretion in some animals, is owing to such.

Comparative.—The bile of the carnivora and omnivora is yellowish-red in color; that of herbivora green. The former contains taurocholate salts almost exclusively; in herbivorous animals and man there is a mixture of the salts of both acids, though the glycocholate predominates.

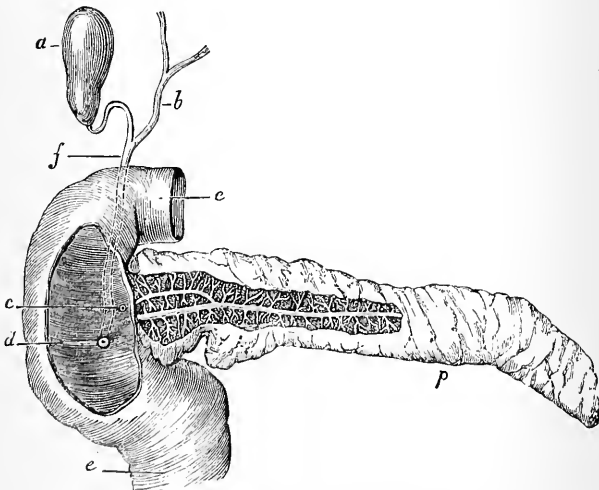

FIG. 246.—Gall-bladder, ductus choledochus and pancreas in man (after Le Bon). *a*, gall-bladder; *b*, hepatic duct; *c*, opening of second duct of pancreas; *d*, opening of main pancreatic duct and bile-duct; *e*, *e*, duodenum; *f*, ductus choledochus; *p*, pancreas.

Pancreatic Juice.—This fluid is found to vary a good deal quantitatively, according as it is obtained from a temporary (freshly made) or permanent fistula—a fact which emphasizes the necessity for caution in drawing conclusions about the digestive juices as obtained by our present methods.

The freshest juice obtainable through a recent fistulous opening in the pancreatic duct is clear, colorless, viscid, alkaline in reaction, and with a very variable quantity of solids (two to ten per cent), less than one per cent being inorganic matter.

Among the organic constituents the principal are albumin, alkali-albumin, peptone, leucin, tyrosin, fats, and soaps in small amount. The alkalinity of the juice is owing chiefly to sodium

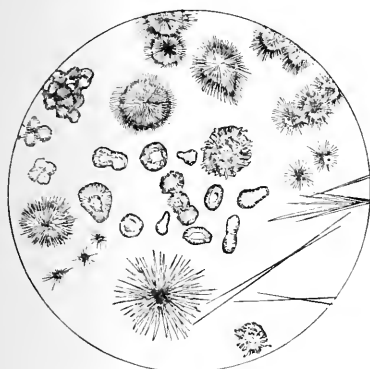

FIG. 247.—Crystals of leucin (Funke).



FIG. 248.—Crystals of tyrosin (Funke).

carbonates, which seem to be associated with some proteid body. There is little doubt that leucin, tyrosin, and peptone arise from digestion of the proteids of the juice by its own action.

Experimental.—If the pancreatic gland be mostly freed from adhering fat, cut up, and washed so as to get rid of blood; then minced as fine as possible, and allowed to stand in one-per cent sodium-carbonate solution at a temperature of 40° C., the following results may be noted: 1. After a variable time the reaction may change to acid, owing to free fatty acid from the decomposition (digestion) of neutral fats. 2. Alkali-albumin, or a body closely resembling it, may be detected and separated by neutralization. 3. *Peptone* may be detected by the

use of a trace of copper sulphate added to a few drops of caustic alkali, which becomes red if this body be present. 4. After a few hours the smell becomes faecal, owing in part to *indol*, which gives a violet color with chlorine-water; while under the microscope the digesting mass may be seen to be swarming with bacteria. 5. When digestion has proceeded for some time, *leucin* and *tyrosin* may be shown to be present, though their satisfactory separation in crystalline form involves somewhat elaborate details. These changes are owing to self-digestion of the gland.

All the properties of this secretion may be demonstrated more satisfactorily by making an aqueous or, better, glycerin extract of the pancreas of an ox, pig, etc., and carrying on artificial digestion, as in the case of a peptic digestion, with fibrin. In the case of the digestion of fat, the emulsifying power of a watery extract of the gland may be shown by shaking up a little melted hog's lard, olive-oil (each quite fresh, so as to show no acid reaction), or soap. Kept under proper conditions, free acid, the result of decomposition of the neutral fats or soap into free acid, etc., may be easily shown. The emulsion, though allowed to stand long, persists, a fact which is availed of to produce more palatable and easily assimilated preparations of cod-liver oil, etc., for medicinal use.

Starch is also converted into sugar with great ease. In short, the digestive juice of the pancreas is the most complex and complete in its action of the whole series. It is amyolytic, proteolytic, and steaptic, and these powers have been attributed to three distinct ferments—*amylopsin*, *tripsin*, and *steapsin*.

Proteid digestion is carried further than by the gastric juice, and the quantity of crystalline nitrogenous products formed is in inverse proportion to the amount of peptone, from which it seems just to infer that part of the original peptone has been converted into these bodies, which are found to be abundant or not in an artificial digestion, according to the length of time it has lasted—the longer it has been under way the more leucin and tyrosin present. Leucin is another compound into which the amido (NH_2) group enters to make amido-caproic acid—one of the fatty series—while tyrosin is a very complex member of the aromatic series of compounds. Thus complicated are the chemical effects of the digestive juices; and it seems highly probable that these are only some of the compounds into which the proteid is broken up. Though putrefactive changes with

formation of *indol*, etc., occur in pancreatic digestion, both within and without the body, they are to be regarded as accidental, for by proper precautions digestion may be carried on

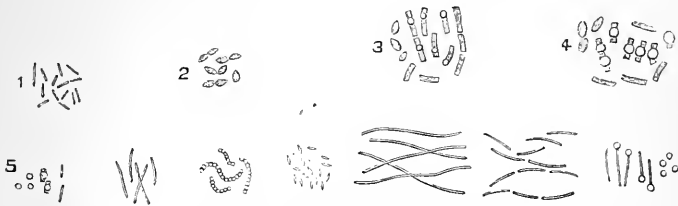

FIG. 249.—Micro-organisms of large intestine (after Landois), 1, bacterium coli commune; 2, bacterium lactis aërogenes; 3, 4, large bacilli of Bienstock, with partial endogenous spore-formation; 5, various stages of development of bacillus which causes fermentation of albumen.

in the laboratory without their occurrence, and they vary in degree with the animal, the individual, the food, and other conditions. It is not, however, to be inferred that micro-organisms serve no useful purpose in the alimentary canal; the subject, in fact, requires further investigation.

Succus Entericus.—The difficulties of collecting the secretions of Lieberkühn's, Brünner's, and other intestinal glands will be at once apparent. But by dividing the intestine in two places, so as to isolate a loop of the gut, joining the sundered

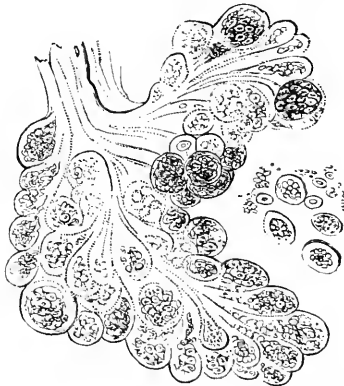

FIG. 250.—Portion of one of Brünner's glands (Chauveau).

ends by ligatures, thus making the continuity of the main gut as complete as before, closing one end of the isolated loop, and

bringing the other to the exterior, as a fistulous opening, the secretions could be collected, food introduced, etc.

But it seems highly improbable that information approximately correct at best, and possibly highly misleading, could

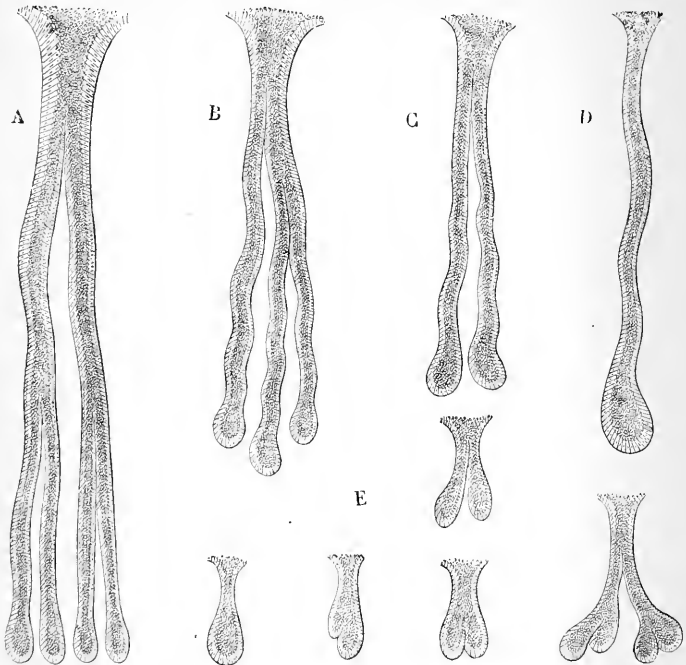

FIG. 251.—Intestinal tubules (follicles of Lieberkühn) 1×100 (Sappey). A, from dog; B, ox; C, sheep; D, pig; E, rabbit.

be obtained in such manner. Moreover, the greatest diversity of opinion prevails as to the facts themselves, so that it seems scarcely worth while to state the contradictory conclusions arrived at.

It is, however, on the face of it, probable that the intestine—even the large intestine—does secrete juices that in herbivora, at all events, play no unimportant part in the digestion of their

FIG. 252.—General view of horse's intestines; animal is placed on its back, and intestinal mass spread out (after Chauveau). A, duodenum as it passes behind great mesenteric artery; B, free portion of small intestine; C, ileocaecal portion; D, caecum; E, F, G, loop formed by large colon; G, pelvic flexure; F, F, point where colic loop is doubled to constitute suprasternal and diaphragmatic flexures.

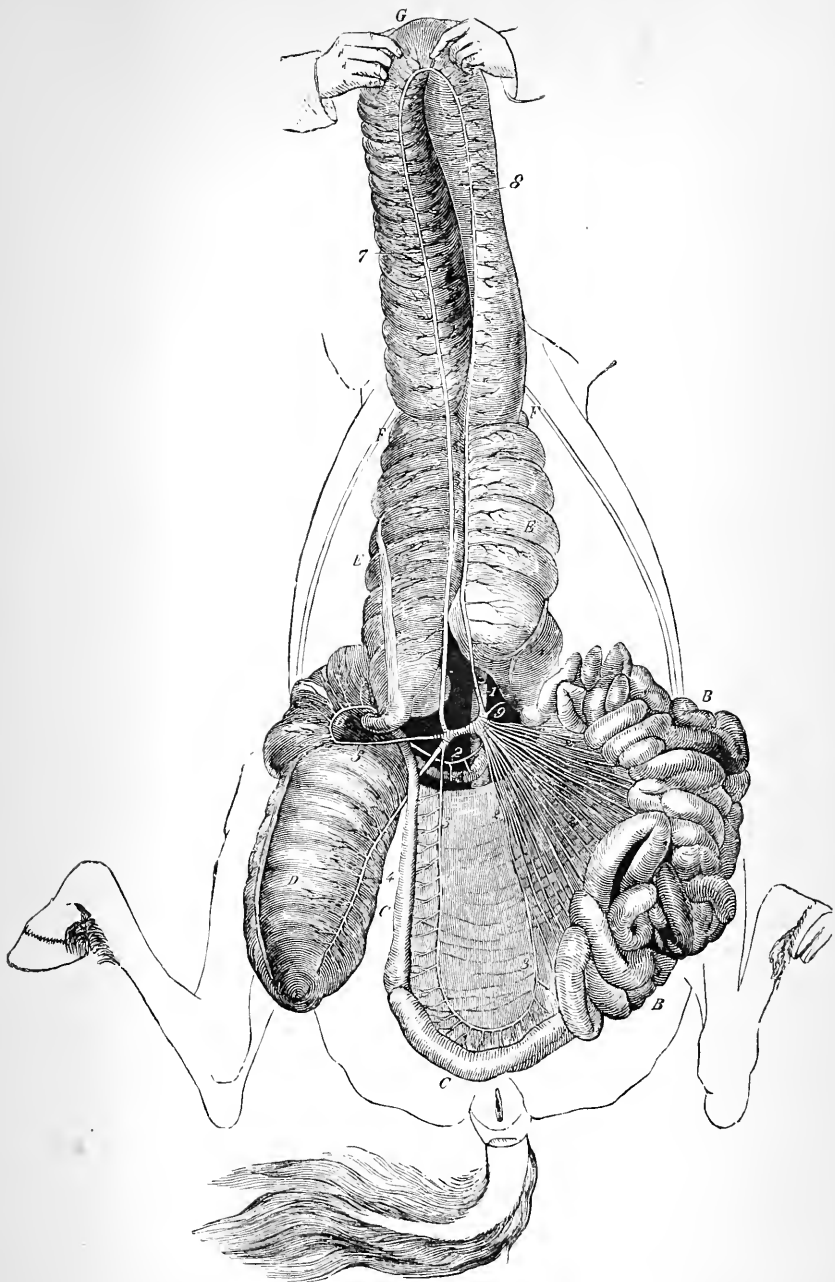

FIG. 252.

bulky food ; and it is also probable, as in so many other instances, that, when the other parts of the digestive tract fail when the usual secretions are not prepared or do not act on the food, glands that normally play a possibly insignificant part may function excessively—we may almost say vicariously—and that such glands must be sought in the small intestine. There are facts in clinical medicine that seem to point strongly in this direction, though the subject has not yet been reduced to scientific form.

Comparative.—Within the last few years the study of vegetable assimilation from the comparative aspect has been fruitful in results which, together with many other facts of vegetable metabolism, show that even plants ranking high in the organic plane are not in many of their functions so different from animals as has been supposed. It has been known for a longer period that certain plants are carnivorous ; but it was somewhat of a surprise to find, as has been done within the past few years, that digestive ferments are widely distributed in the vegetable kingdom and are found in many different parts of plants. What purpose they may serve in the vegetable economy is as yet not well known. At present it would seem as though, from their presence in so many cases in the seed, they might have something to do with changing the cruder forms of nutriment into such as are better adapted for the nourishment of the embryo.

Thus far, then, not only diastase but pepsin, a body with action similar to trypsin, and a rennet ferment, rank among the vegetable ferments best known.

A ferment has been extracted from the stem, leaves, and unripe fruit of *Carica papaya*, found in the East and West Indies and elsewhere, which has a marked proteolytic action.

It is effective in a neutral, most so in an alkaline medium ; and, though its action is suspended in a feeble acid menstruum, it does not appear to be destroyed under such circumstances, as is trypsin. This body is attracting a good deal of attention, and its use has been recently introduced into medical practice.

Very lately also a vegetable rennet has been found in several species of plants. The subject is highly promising and suggestive.

SECRETION AS A PHYSIOLOGICAL PROCESS.

Secretion of the Salivary Glands.—We shall treat this subject at more length because of the light it throws on the nervous phenomena of vital process ; and, since the salivary glands have been studied more thoroughly and successfully than any other, they will receive greater attention.



FIG. 253.



FIG. 254.

FIG. 253.—Lobule of parotid gland, injected with mercury, and magnified 50 diameters.

FIG. 254.—Capillary network around the follicles of the parotid gland.

The main facts, ascertained experimentally and otherwise, are the following :

Assuming that the student is familiar with the general anatomical relations of the salivary glands in some mammal, we would further remind him that the submaxillary gland has a double nervous supply : 1. From the cervical sympathetic by branches passing to the gland along its arteries. 2. From the chorda tympani nerve, which after leaving the facial makes connection with the lingual, whence it proceeds to its destination.

The following facts are of importance as a basis for conclusions: 1. It is a matter of common observation that a flow of saliva may be excited by the smell, taste, sight, or even thought of food. 2. It is also a matter of experience that emotions, as fear, anxiety, etc., may parch the mouth—i. e., arrest the flow of saliva. The excited speaker thus suffers in his early efforts. 3. If a glass tube be placed in the duct of the gland and any substance that naturally causes a flow of saliva be placed on the tongue, saliva may be seen to rise rapidly in the tube. 4. The same may be observed if the lingual nerve, the glossopha-

ryngeal, and many other nerves be stimulated; also if food be introduced into the stomach through a fistula. 5. If the pe-

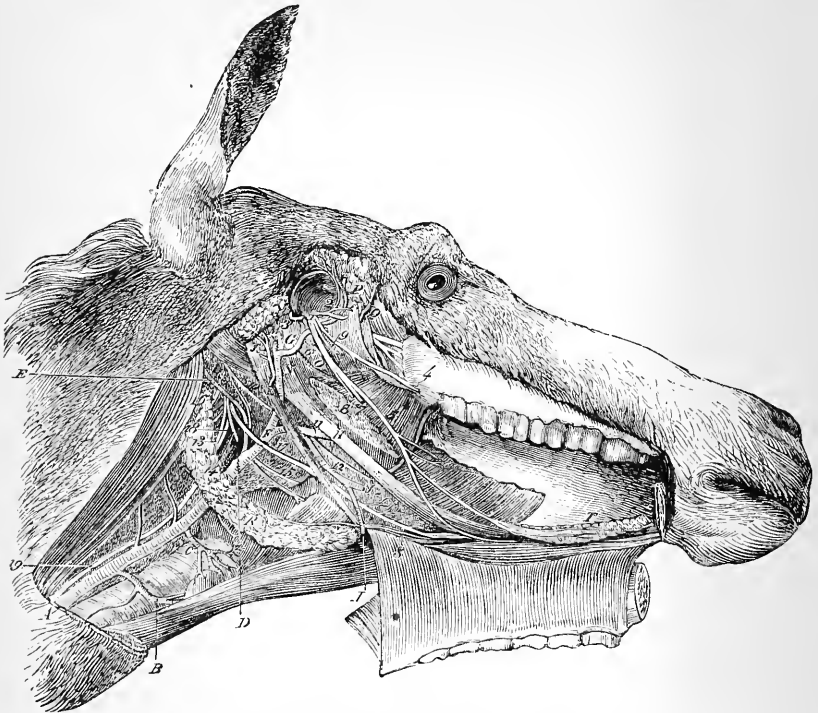

FIG. 255.—Maxillary and sublingual gland (Chauveau). R, maxillary gland; S, Wharton's duct; T, sublingual gland.

ripheral end of the chorda tympani be stimulated, two results follow: (a) There is an abundant flow of saliva, and (b) the arterioles of the gland become dilated: the blood may pass through with such rapidity that the venous blood may be bright red in color and there may be a venous pulse. 7. Stimulation of the medulla oblongata gives rise to a flow of saliva, which is not possible when the nerves of the gland, especially the chorda tympani, are divided; nor can a flow be then excited by any sort of nervous stimulation, excepting that of the terminal branches of the nerves of the gland itself. 8. If the sympathetic nerves of the gland be divided, there is no immediate flow of saliva, though there may be some dilatation of its ves-

sels. 9. Stimulation of the terminal ends of the sympathetic and chorda nerves causes a flow of saliva, differing as to total quantity and the amount of contained solids; but the nerve that produces the more abundant watery secretion, or the reverse, varies with the animal, e. g., in the cat chorda saliva is

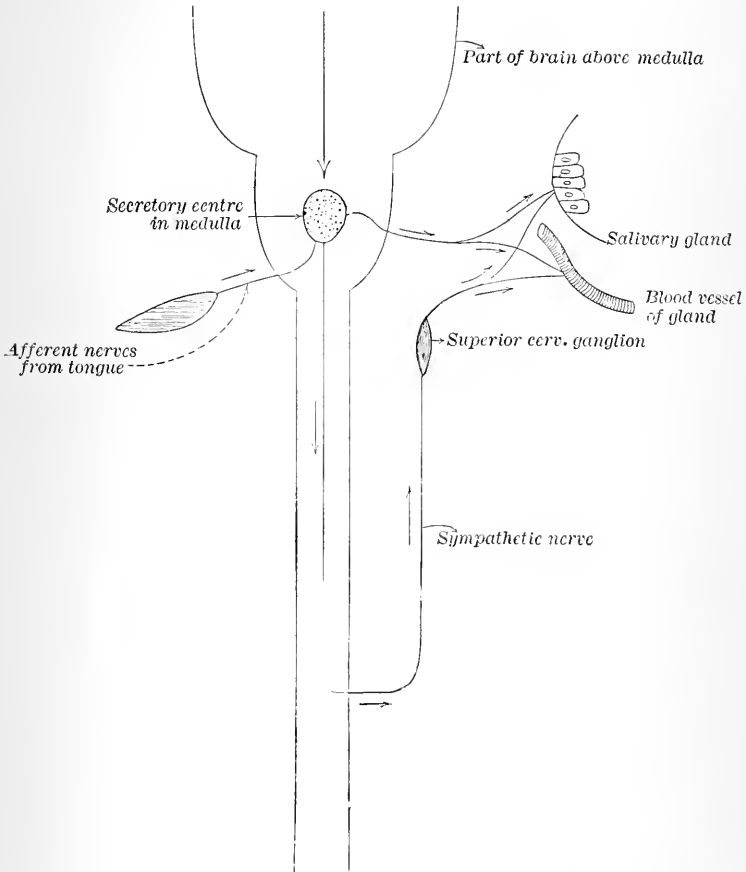

FIG. 256. -Diagram intended to indicate the nervous mechanism of salivary secretion.

more viscid, in the dog less so; though in all animals as yet examined it seems that the secretion as a result of stimulation of the chorda tympani nerve is the most abundant; and in the

case of stimulation of the chorda the vessels of the gland are dilated, while in the case of the sympathetic they are constricted. 10. If atropin be injected into the blood, it is impossible to induce salivary secretion by any form of stimulation, though excitation of the chorda nerve still causes arterial dilatation.

Conclusions.—1. There is a center in the medulla presiding over salivary secretion. 2. The influence of this center is rendered effective through the chorda tympani nerve at all events, if not also by the sympathetic. 3. The chorda tympani nerve contains both secretory and vaso-dilator fibers; the sympathetic secretory and vaso-constrictor fibers. 4. Arterial change is not essential to secretion, though doubtless it usually accompanies it. Secretion may be induced in the glands of an animal after decapitation by stimulation of its chorda tympani nerve, analogous to the secretion of sweat in the foot of a recently dead animal, under stimulation of the sciatic nerve. 5. The character of the saliva secreted varies with the nerve stimulated, so that it seems likely that the nervous centers normally in the intact animal regulate the quality of the saliva through the degree to which one or the other kind of nerves is called into action. 6. Secretion of saliva may be induced reflexly by experiment, and such is probably the normal course of events. 7. The action of the medullary center may be inhibited by the cerebrum (emotions).

Some have located a center in the cerebral cortex (taste center), to which it is assumed impulses first travel from the tongue and which then rouses the proper secreting centers in the medulla into activity. It seems more likely that the cortical center, if there be one, completes the physiological processes by which taste sensations are elaborated.

From the influence of drugs (atropin and its antagonist pilocarpin) it is plain that the gland can be effected through the blood, though whether wholly by direct action on the center, on any local nervous mechanism or directly, on the cells, is as yet undetermined. It is found that pilocarpin can act long after section of the nerves. This does not, however, prove that in the intact animal such is the usual *modus operandi* of this or other drugs, any more than the so-called paralytic secretion after the section of nerves proves that the latter are not concerned in secretion.

We look upon paralytic secretion as the work of the cells

when gone wrong—passed from under the dominion of the nerve-centers. Secretion is a part of the natural life-processes of gland-cells—we may say a series in the long chain of processes which are indispensable for the health of these cells. They must be either secreting cells, or have no place in the natural order of things. It is to be especially noted that the secretion of saliva continues when the pressure in the ducts of the gland is greater than that of the blood in its vessels or even of the carotid; so that it seems possible that over-importance has been attached to blood-pressure in secretory processes generally.

It may, then, be safely assumed that formation of saliva results in consequence of the natural activity of certain cells, the processes of which are correlated and harmonized by the nervous system; their activity being accompanied by an abundant supply of blood. The actual outpouring of saliva depends usually on the establishment of a nervous reflex arc. The other glands have been less carefully studied, but the parotid is known to have a double nervous supply from the cerebrospinal and the sympathetic systems.

It would appear that, as the vaso-motor changes run parallel with the secretory ones, the vaso-motor and the proper secretory centers act in concert, as we have seen holds of the former and the respiratory center. But it is to our own mind very doubtful whether the doctrine of so sharp a demarkation of independent centers, prominently recognized in the physiology of the day, will be that ultimately accepted.

Secretion by the Stomach.—The mucous membrane of St. Martin's stomach was observed (through an accidental fistulous opening) to be pale in the intervals of digestion, but flushed when secreting, which resembled sweating, so far as the flow of the fluid is concerned. When the man was irritated, the gastric membrane became pale, and secretion was lessened or arrested, and it is a common experience that emotions may help, hinder, or even render aberrant the digestive processes.

While the evidence is thus clear that gastric secretion is regulated by the nervous system, the way in which this is accomplished is very obscure. We know little of either the centers or nerves concerned, and what we do know helps but doubtfully to an understanding of the matter, if, indeed, it does not actually confuse and puzzle.

Digestion can proceed in a fashion after section of the nerves

going to the stomach, though this has little force as an argument against nerve influence. We may conclude the subject by stating that, while the influence of the nervous system over gastric secretion is undoubted as a fact, the method is not understood; and the same remark applies to the secreting activity of the liver and pancreas.

The Secretion of Bile and Pancreatic Juice.—When the contents of the stomach have reached the orifice of the discharging bile-duct, a large flow of the biliary secretion takes place, probably as the result of the emptying of the gall-bladder by the contraction of its walls and those of its ducts. This is probably a reflex act, and the augmented flow of bile when digestion is proceeding is also to be traced chiefly to nervous influences reaching the gland, though by what nerves or under the government of what part of the nervous centers is unknown. Very similar statements apply to the secretion of the pancre-

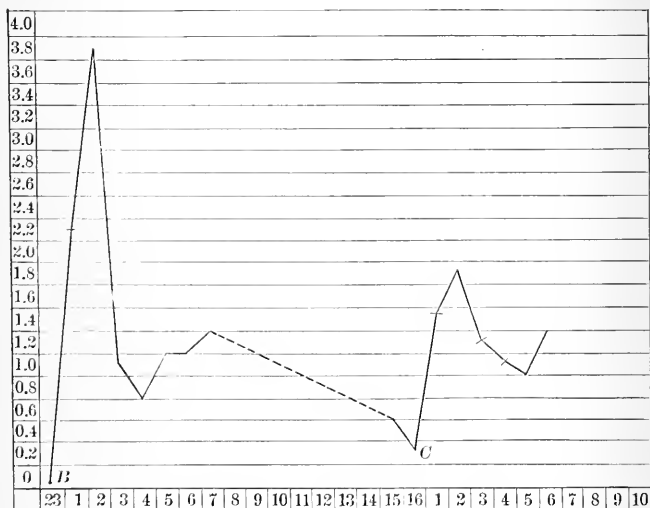

FIG. 257.—Diagram to show influence of food in secretion of pancreatic juice (after N. O. Bernstein). The abscissæ represent hours after taking food; ordinates amount in cubic centigrammes of secretion in ten minutes. Food was taken at B and C. This diagram very nearly also represents the secretion of bile.

atic glands, though this is not constant, as in the case of bile—at all events in most animals.

It is known that after food has been taken there is a sudden

increase in the quantity of bile secreted, followed by a sudden diminution, then a more gradual rise, with a subsequent fall. Almost the same holds for the pancreas.

It seems impossible to explain these facts, especially the first rapid discharge of fluid apart from the direct influence of the nervous system.

Upon the whole, the evidence seems to show that the pressure in the bile-ducts is greater than in the veins that unite to make up the portal system; but there are difficulties in the investigation of such and kindred subjects as regards the liver, owing to its peculiar vascular supply. It will be borne in mind that the liver in mammals consists of a mass of blood-vessels, between the meshes of which are packed innumerable cells, and that around the latter meander the bile capillaries; that the portal vein breaks up into the intralobular, from which capillaries arise, that terminate in the central interlobular veins, which make up the hepatic veinlets or terminate in these vessels. But the structure is complicated by the branches of the hepatic artery, which, as arterioles and capillaries, enters to some extent into the formation of the lobular vessels.

A question of interest, though difficult to answer, is the extent to which the various constituents of bile are manufactured in the liver. Taurin, for example, is present in some of

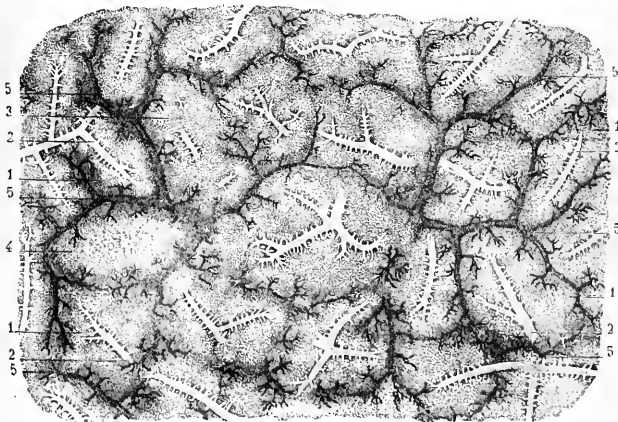

FIG. 258.—Lobules of liver, interlobular vessels, and intralobular veins (Sappey). 1, 1, 1, 1, 3, 4, lobules; 2, 2, 2, 2, intralobular veins injected with white; 5, 5, 5, 5, 5, intralobular vessels filled with a dark injection.

the tissues, but whether this is used in the manufacture of taurocholic acid or whether the latter is made entirely anew, and possibly by a method in which taurin never appears as such, is an open question. It is highly probable that a portion of the bile poured into the intestine is absorbed either as such or after partial decomposition, the products to be used in

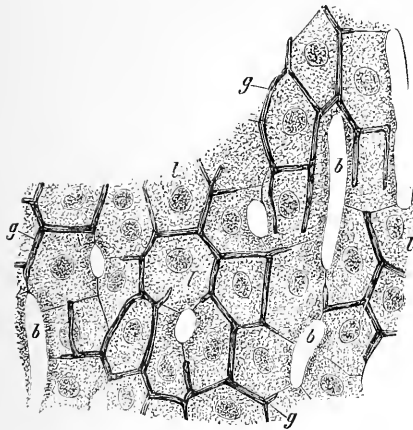

FIG. 259.—Portion of transverse section of hepatic lobule of rabbit magnified 400 diameters (Kölliker). *b, b, b*, capillary blood-vessels; *g, g, g*, capillary bile-ducts; *l, l, l*, liver-cells.

some way in the economy and presumably in the construction of bile by the liver. There are many facts, including some pathological phenomena, that point clearly to the formation of the pigments of bile from hæmoglobin in some of its stages of degeneration.

Pathological.—When the liver fails to act, either from derangement of its cells primarily or owing to obstruction to the outflow of bile leading to reabsorption

by the liver, bile acids and bile pigments appear in the urine or may stain the tissues, indicating their presence in excess in the blood.

This action of one gland (kidneys) for another is highly suggestive, and especially important to bear in mind in medical practice, both in treatment and prognosis. The chances of recovery when only one excreting gland is diseased are much greater evidently than when several are involved. Such facts as we have cited show, moreover, that there are certain common fundamental principles underlying secretion everywhere—a statement which will be soon more fully illustrated.

THE NATURE OF THE ACT OF SECRETION.

We are now about to consider some investigations, more particularly their results, which are of extraordinary interest.

The secreting cells of the salivary, the pancreatic glands,

and the stomach have been studied by a combination of histological and, more strictly, physiological methods, to which we shall now refer. Specimens of these glands, both before and after prolonged secretion, under stimulation of these nerves,

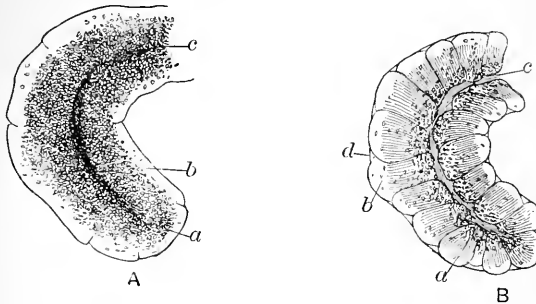

FIG. 260.—Portion of pancreas of rabbit (after Kühne and Lea). A represents gland at rest; B, during secretion.

were hardened, stained, and sections prepared. As was to be expected, the results were not entirely satisfactory under these methods; however, the pancreas of a living rabbit has been viewed with the microscope in its natural condition; and by this plan, especially when supplemented by the more involved and artificial method first referred to, results have been reached which may be ranked among the greatest triumphs of modern physiology.

Some of these we now proceed to state briefly. To begin with the pancreas, it has been shown that, when the gland is not secreting—i. e., not discharging its prepared fluid—or during the so-called resting stage, the appearances are strikingly different from what they are during activity. The cell presents during rest an inner granular zone and an outer clearer zone, which stains more readily, and is relatively small in size. The lumen of the alveolus is almost obliterated, and the individual cells very indistinct. After a period of secreting activity, the lumen is easily perceived, the granules have disappeared in great part, the cells as a whole are smaller, and have a clear appearance throughout. Coincident with the changes in the gland's cells it is to be noticed that more blood passes through it, owing to dilatation of the arterioles.

Again, the course of the changes in the salivary glands, whether of the mucous or serous variety, is very similar. In

the mucous gland in the resting stage the cells are large, and hold much clear matter in the interspaces of the cell network;

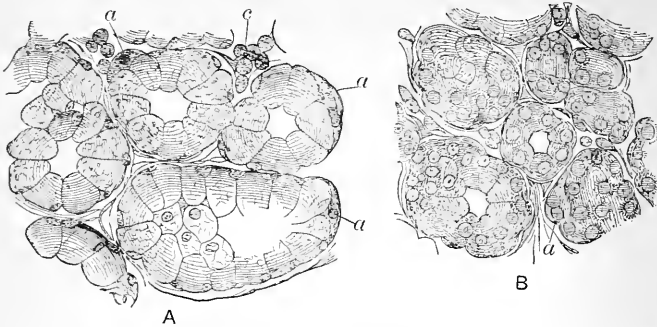

FIG. 261.—Section of mucous gland (after Lavdowsky). In A, gland at rest; in B, after secreting for some time.

and, as this does not stain readily, it can not be ordinary protoplasm. This, when the gland is stimulated through its nerves, disappears, leaving the containing cells smaller. It has become *mucin*, and may itself be called *mucinogen*.

It is to be noted that, as the cells become more protoplasmic, less burdened with the products of their activity, the nucleus becomes more prominent, suggestive of its having a probable directive influence over these manufacturing processes.

Substantially the same chain of events has been established for the serous salivary glands and the stomach, so that we may safely generalize upon these well-established facts.

It seems clear that a series of changes constructive and, from one point of view, destructive, following the former are con-

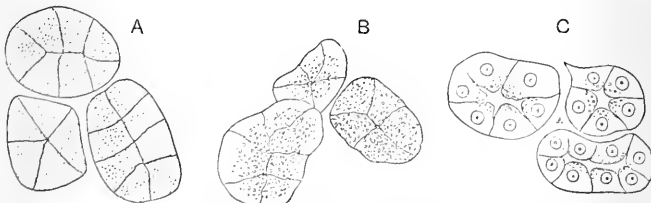

FIG. 262.—Changes in parotid (serous) gland during secretion (after Langley). A, during rest; B, after moderate, C, after prolonged stimulation. Figures partly diagrammatic.

stantly going on in the glands of the digestive organs. Protoplasm under nerve influence constructs a certain substance,

which is an antecedent of the final product, which we term a ferment. It is now customary to speak of these changes as constructive (anabolic) and destructive (katabolic), though we have already pointed out (page 258) that this view is, at best, only one way of looking at the matter, and we doubt if it may not be cramping and misleading.

We must also urge caution in regard to the conception to be associated with the use of the terms "resting" and "active" stage. It is not to be forgotten that strictly in living cells there is no absolute rest—such means death; but, if these terms be understood as denoting but degrees of activity, they need not mislead. It is also more than probable that in certain of the glands, or in some animals, the processes go on simultaneously; the protoplasm being renewed, the *zymogen*, or mother-ferment, being formed, and the latter converted into actual ferment, all at the same time.

The nature of secretion is now tolerably clear as a whole; though it is to be remembered that this account is but general, and that there are many minor differences for each gland and variations that can scarcely be denominated minor for different animals. Evidently no theory of filtration, no process depending solely on blood-pressure, will apply here. And if in this, the best-studied case, mechanical theories of vital processes utterly fail, why attempt to fasten them upon other glands, as the kidneys and the lungs, or, indeed, apply such crude conceptions to the subtle processes of living protoplasm anywhere or in any form?

It is somewhat remarkable that an extract of a perfectly fresh pancreas is not proteolytic; yet the gland yields such an extract when it has stood some hours or been treated with a weak acid. These facts, together with the microscopic appearances, suggested that there is formed a forerunner to the actual ferment—a *zymogen*, or mother-ferment, which at the moment of discharge of the completed secretion is converted into the actual ferment. We might, therefore, speak of a pepsinogen, trypsinogen, etc., and, though there may be a cessation in the series of processes, and no doubt there is in some animals, this may not be the case in all, or in all glands.

Secretion by the Stomach.—The glands of the stomach differ in most animals in the cardiac and pyloric regions. In those of the former zone, both central (columnar) and parietal (ovoid) cells are to be recognized. It was thought that possibly the lat-

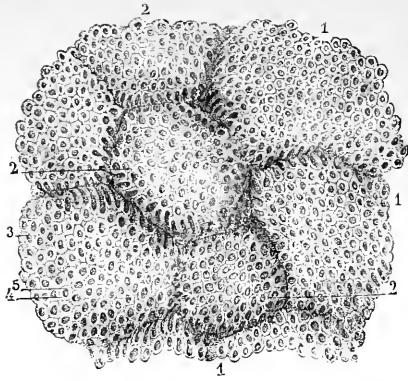

FIG. 263.

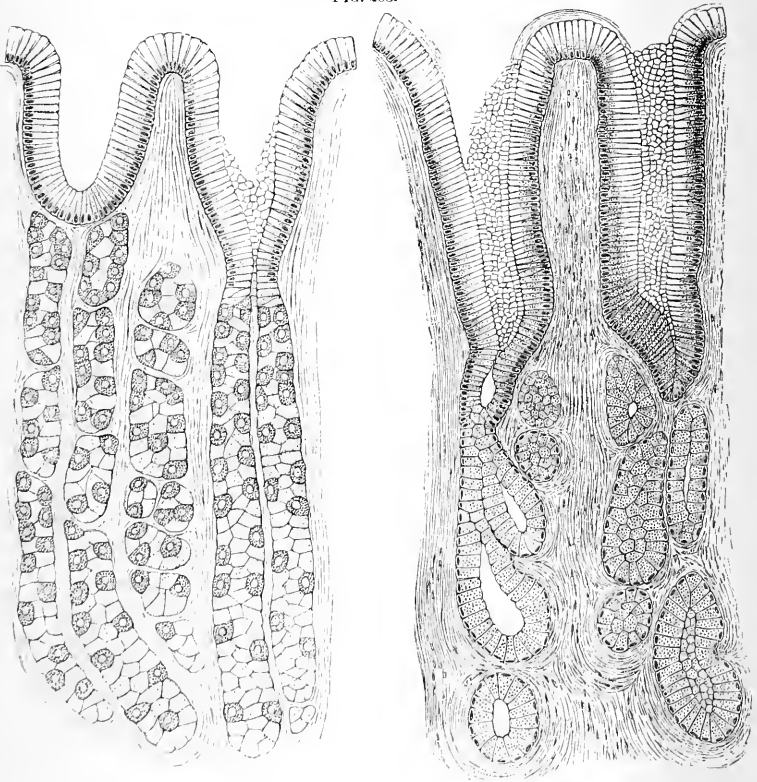

FIG. 264.

FIG. 265.

FIG. 263.—Pits in mucous membrane of stomach in which are openings of tubular glands. 1×30 (Sappey).
 FIG. 264.—Glands of stomach with both central and parietal (ovoid) cells (Heidenhain).
 FIG. 265.—Pyloric glands (Ebstein).

ter were concerned in the secretion of the acid of the stomach, but this is by no means certain. Possibly these, like the demilune cells of the pancreas, may be the progenitors of the central (chief) cells. The latter certainly secrete pepsin, and probably also rennet. Mucus is secreted by the cells lining the neck of glands and covering the mucous membrane intervening between their mouths. The production of hydrochloric acid by any act of secretion is not believed in by all writers, some holding that it is derived from decomposition of sodium chloride, possibly by lactic acid. So simple an origin is not probable, not being in keeping with what we know of chemical processes within the animal body.

Self-Digestion of the Digestive Organs.—It has been found, both in man and other mammals, that when death follows in a healthy subject while gastric digestion is in active progress and the body is kept warm, a part of the stomach itself and often adjacent organs are digested, and the question is constantly being raised, Why does not the stomach digest itself during life? To this it has been answered that the gastric juice is constantly being neutralized by the alkaline blood; and, again, that the very vitality of a tissue gives it the necessary resisting powers, a view contradicted by an experiment which is conclusive. If the legs of a living frog be allowed to hang against the inner walls of the stomach of a mammal when gastric digestion is going on, they will be digested.

The first view (the alkalinity of the blood) would not suffice to explain why the pancreas, the secretion of which acts best in an alkaline medium, should not be digested.

It seems to us there is a good deal of misconception about the facts of the case. Observation on St. Martin shows that the secretion of gastric juice runs parallel with the need of it, as dependent on the introduction of food, its quantity, quality, etc. Now, there can be little doubt that, if the stomach were abundantly bathed when empty with a large quantity of its own acid secretion, it would suffer to some extent at least. But this is never the case; the juice is carried off and mixed with the food. This food is in constant motion and doubtless the inner portions of the cells, which may be regarded as the discharging region (the outer, next the blood capillaries, being the chief manufacturing region of the digestive ferment), are frequently renewed.

Such considerations, though they seem to have been some-

what left out of the case, do not go to the bottom of the matter. Amoeba and kindred organisms do not digest themselves. Some believe that the little pulsatile vacuoles of the Infusorians are a sort of temporary digestive cavities.

But, to one who sees in the light of evolution, it must be clear that a structure could not have been evolved that would be self-destructive.

The difficulty here is that which lies at the very basis of all life. We might ask, Why do living things live, since they are constantly threatened with destruction from within as from without? Why do not the liver, kidney, and other glands that secrete noxious substances, poison themselves? We can not in detail explain these things; but we wish to make it clear that the difficulty as regards the stomach is not peculiar to that gland, and that even from the ordinary point of view it has been exaggerated.

Comparative.—More careful examination of the stomachs of some mammals has revealed the fact that in several animals, in which the stomach appears to be simple, it is in reality compound. There are different grades, however, which may be regarded as transition forms between the true simple stomach and that highly compound form of the organ met with in the ruminants.

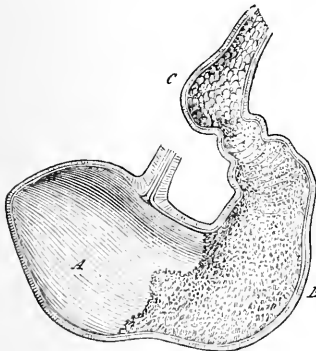

FIG. 266.—Interior of horse's stomach (after Chauveau). *A*, left sac; *B*, right sac; *C*, duodenal dilatation.

It has been shown recently that the stomach of the hog has an œsophageal dilatation; and that the entire organ may be divided into several zones with different kinds of glandular epithelium, etc. These portions

differ in digestive power, in the characteristics of the fluid secreted, and other details beyond those which a superficial examination of this organ would lead one to suspect.

The stomach of the horse represents a more advanced form of compound stomach than that of the hog, which is not evident, however, until its glandular structure is examined closely. The entire left portion of the stomach represents an œsophageal dilatation lined with an epithelium that closely resembles that

of the œsophagus, and with little if any digestive function. It thus appears that the stomach of the horse is in reality smaller, as a true digestive gland, than it seems, so that a great part of the work of digestion must be done in the intestine; though in this animal, if the food be retained as long as it is in the hog, which is not, however, the general opinion as regards the stomach of the horse, salivary digestion may continue for a considerable period after the food has left the mouth. The secretion of mucus by the stomach in herbivora is abundant.

As has been already explained, the stomach of ruminants consists of several compartments which are supplementary to one another, though genuine gastric digestion does not take place except in the fourth stomach.

The first and second stomachs being destitute of other than mucous glands, and lined with a horny epithelium, are to be considered rather as dilatations of the œsophagus. They answer admirably the purpose of storehouses for the bulky food in which the softening process preparatory to mastication goes on.

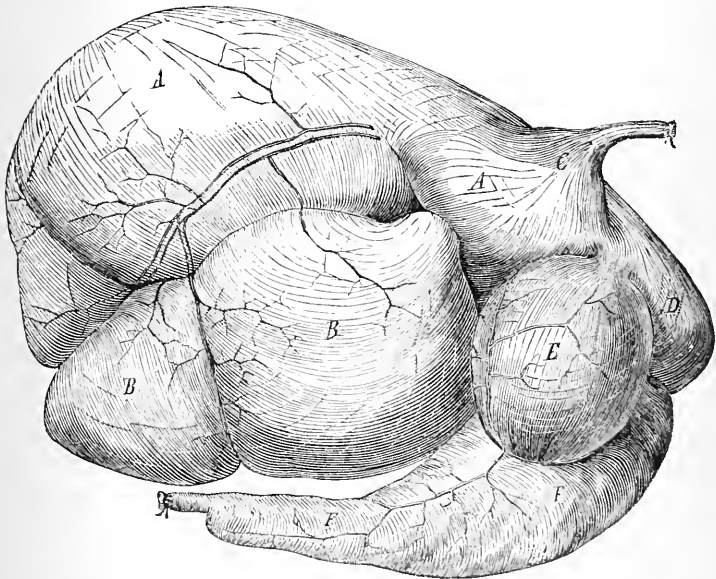

FIG. 267.—Stomach of the ox seen on its right upper face, the abomasum being depressed (Chauveau). A, rumen, left hemisphere; B, rumen, right hemisphere; C, termination of the œsophagus; D, reticulum; E, omasum; F, abomasum.

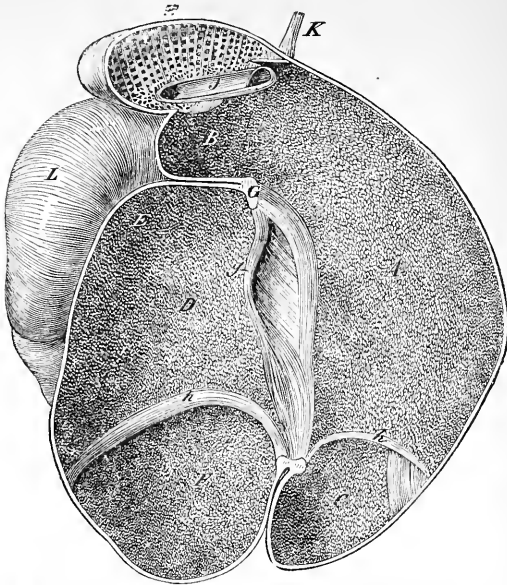

FIG. 268.—Interior of stomach in ruminants; the upper plane of the rumen and reticulum, with the oesophageal furrow (Chauveau). A, left sac of the rumen; B, anterior extremity of that sac turned back on right sac; C, its posterior extremity, or left conical cyst; G, section of anterior pillar of rumen; *g, g*, its two superior branches; H, posterior pillar of same; *h, h, h*, its three inferior branches; I, cells of reticulum; J, oesophageal furrow; K, oesophagus; L, abomasum.

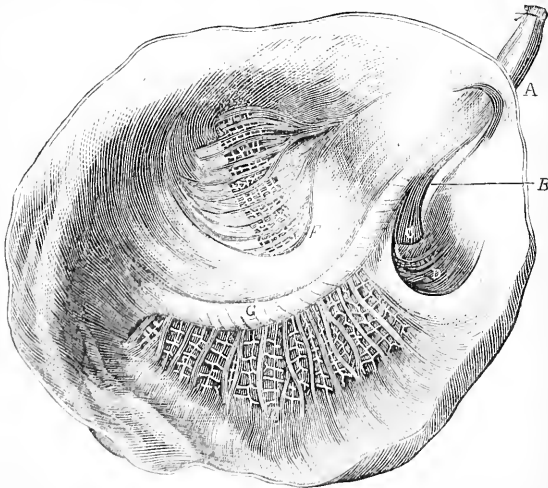

FIG. 269. - Stomach of llama (Colin). A, lower extremity of gullet; B, single pillar of oesophageal canal; C, superior opening of the psalter; D, reticulum; E, right or anterior water-cells; F, inferior water-cells; G, fleshy column separating the two cell groups.

The reticulum, so called from the peculiar arrangement of the mucus membrane, is usually regarded as a receptacle for water more especially; however, this stomach is to be regarded both anatomically and physiologically as a subdivision of the first, or at all events as equivalent to that.

The quantity of food that it can hold in the ox is enormous, (150 to 200 pounds), a condition of things advantageous in an

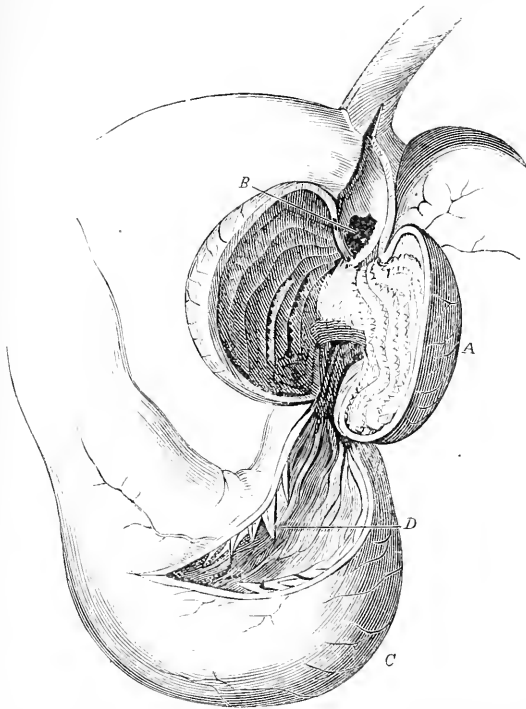

FIG. 270.—Omasum and abomasum of ox cut open (Smith). A, psalterium, with opening between it and the reticulum at B; D, foldings (plicae) of mucous membrane at C, fourth stomach.

animal feeding upon substances so poor in nutritive material in proportion to their bulk and requiring so much mastication to fit them to be acted on by the digestive juices. The reaction of the first two stomachs is alkaline.

In the camel tribe, water cells are arranged in parallel order in the rumen. The edges of these are provided with muscular

fibers constituting sphincters by which their openings inward may be closed. These cells number several hundred, and are capable of containing some quarts of water.

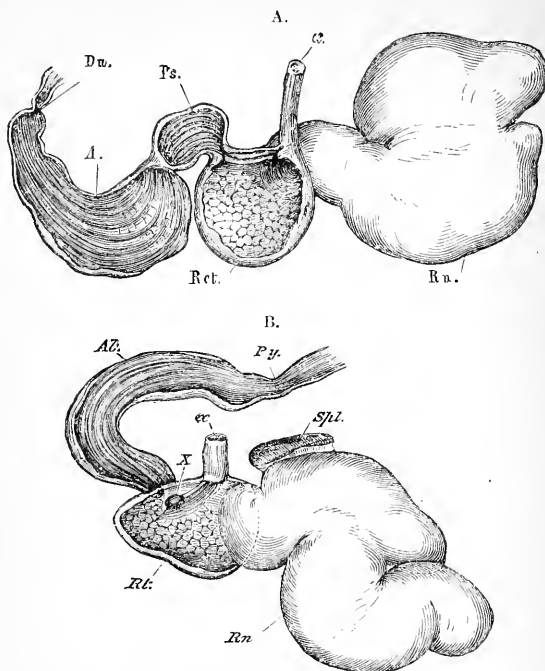

FIG 271.—A. Stomach of sheep. B. Stomach of musk-deer. *æ*, oesophagus; *Rn.*, rumen; *Ret.*, reticulum; *Ps.*, psalterium; *A.*, *Ab.*, abomasum; *Dn.*, duodenum; *Py.*, pylorus (Huxley).

The manyplies is so named from the arrangement of its mucus membrane in folds, a condition, however, not equally well marked in all ruminants.

A structure known as the oesophageal canal, (furrow, groove) communicates with the first three stomachs. During swallowing, its lower portion is raised above the level of the third stomach, so that it is likely that this is a barrier against the entrance of all except liquids or soft foods into the manyplies.

It is difficult to make any positive statement as to what other part it may take in determining the direction of food when entering or leaving the various stomachs. It does not seem to be essential to return of the cud.

The abomasum or rennet resembles other forms of true digestive stomachs in all essential particulars.

While the opening between the first and second stomachs is large enough to allow of free intercommunication, the reverse applies to the entrance into the third stomach.

The rumen is nearly always tolerably well filled with food, a condition of things favorable to its return for remastication.



FIG. 272.—Stomach of horse (after Chauveau). *A*, cardiac extremity of oesophagus; *B*, pyloric ring.

We may conclude that only food in a proper form for the action of the fourth stomach passes to any extent beyond the first two.

After the food has been duly softened and has undergone some fermentative changes in the rumen, leading to the evolution of gases (CO_2 , H_2S) and certain organic acids (acetic, butyric), it is regurgitated by a process that closely resembles vomiting.

In this the diaphragm and the abdominal muscles, as well

as the stomach itself and the gullet, take part. Probably as a result of the descent of the diaphragm and consequent diminution of the intrathoracic pressure, the ascent of the cud is assisted by an aspiratory process. The returning food is prevented from passing into the nasal chambers by co-ordinated movements analogous to those of swallowing. The whole process is reflex in the same sense as is deglutition.

Normally the rumen always contains considerable liquid, a portion of which passes up with the cud, but is in great part returned at once. A ruminant given dry food without water can not return the cud.

In the second mastication the process is in most ruminants unilateral; and as hundreds of cuds are to be chewed, a considerable proportion of the whole day is occupied with rumination. When a single cud is sufficiently masticated it is swallowed,

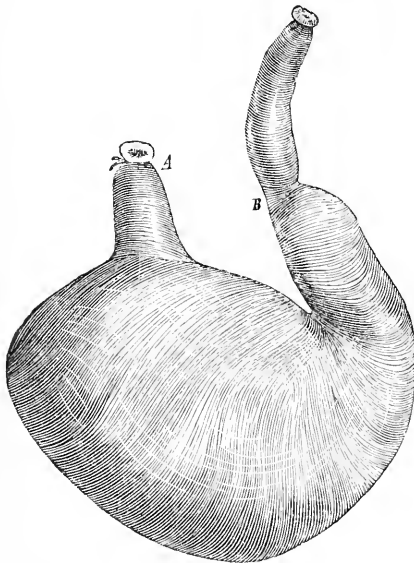

FIG. 273.—Stomach of dog (after Chaveau). A, œsophagus; B, pylorus.

and being finely comminuted passes at once through the small opening between the reticulum and manplies into the third stomach, and thence into the abomasum, though possibly on the way a little may pass into the first two stomachs.

Pathological.—While moderate fullness of the paunch is

favorable to rumination, extreme distention tends to paralysis of the muscular coat of the organ, allowing of the accumulation of the gases of fermentation which may lead, if not artificially relieved, to rupture of the organ.

THE ALIMENTARY CANAL OF THE VERTEBRATE.

Amid all variations in this great group, the alimentary canal has common features, both of structure and function. Throughout the entire tract muscle cells of the unstriped (involuntary) kind, arranged in two layers, constitute the motor mechanism for the transportation of food from one part to another. Outside of these is the serous coat, consisting of fibrous and elastic tissue, and admirably adapted to preserve organs from undue distention, at the same time providing a smooth external covering which lessens the friction of one organ against another in the abdominal cavity ; while folds of such tissue constitute the omentum for supporting the various organs.

Between the muscular and mucous coats of the organs that constitute the alimentary canal there is a submucous coat of loose connective tissue in which ramify blood-vessels, nerves, etc.

It is the mucous coat, however, that is of paramount importance, and for which all other parts may in some sense be considered to exist ; for it is from the glands with which it is supplied that the digestive juices are derived, as well as that mucus which keeps the tract moist and its delicate structures shielded under all circumstances. The amount of surface provided by the mucous membrane is increased by its various foldings (*rugæ, valvule conniventes, etc.*), so generally present, and which also allow of distention ; and if the secreting glands are regarded as minute induplications of this coat, it will be evident that its total area is much greater than at first appears.

While each part has glands with structure peculiar to themselves, it may be noticed that all the essential epithelium has a tendency to assume a somewhat cubical form.

The secreting glands of the stomach and intestines are tubular ; while the salivary glands, the pancreas, and the liver are masses of cells so packed together as to form great colonies of cells with lesser subdivisions (lobules), the whole being bound together by some form of connective tissue, and well supplied with blood-vessels and nerves, thus constituting organs with a

covering (capsule) in structure allied to the serous covering of the stomach and intestines.

Details will be referred to in various parts of the sections devoted to this subject as far as may be necessary to render function clear, but we think these few generalizations may tend to widen the student's field of view, and at the same time lessen his labor and render it more effective.

THE MOVEMENTS OF THE DIGESTIVE ORGANS.

As with other parts of the body, so in the alimentary tract, the slower kind of movement is carried out by plain muscular fibers; and the movements, as a whole, belong to the class known as peristaltic; in fact, it is only at the beginning of the digestive tract that voluntary (striped) muscle is to be found and to a limited extent in the part next to this—i. e., in the cesophagus.

Teeth in the highly organized mammal are remarkable in being to the least degree living structures of any in the entire animal, thus being in marked contrast to other organs. The enamel covering their exposed surfaces is the hardest of all the tissues, and is necessarily of low vitality. We have already alluded to the difference in the teeth of different animals, and their relation to customary food and digestive functions. In fact, it is clear that the teeth and all the parts of the digestive system are correlated to one another. The compound stomach of the ruminants, with its slow digestion of a bulky mass of food which must be softened and thoroughly masticated before the digestive juices can attack it successfully, harmonizes with the powerful jaws, strong muscles of mastication, and grinding teeth; and all these in marked contrast with the teeth of a carnivorous animal with its simple but highly effective stomach. Compare figures in earlier pages.

Mastication in man is of that intermediate character befitting an omnivorous animal. The jaws have a lateral and forward-and-backward movement, as well as a vertical one, though the latter is predominant. The upper jaw is like a fixed millstone, against which the lower jaw works as a nether millstone. The elevation of the jaw is effected by the masseter, temporal, and internal pterygoid muscles; depressed by the mylohyoid and geniohyoid, though principally by the digastric. The jaw is advanced by the external pterygoids; unilateral contraction

of these muscles also produces lateral movement of the inferior maxilla, which is retracted by the more horizontal fibers of the temporal. The movements of mastication are, of course, very pronounced in ruminants.

The cheeks and tongue likewise take part in preparing the food for the work of the stomach, nor must the lips be overlooked even in man. The importance of these parts is well illustrated by the imperfect mastication, etc., when there is paralysis of the muscles of which they are formed. Even when there is loss of sensation only, the work of the mouth is done in a clumsy way, showing the importance of common sensation, as well as the muscular sense.

Nervous Supply.—The muscles of the tongue are governed by the hypoglossal nerve; the other muscles of mastication chiefly by the fifth. The afferent nerves are branches of the fifth and glosso-pharyngeal. It is, of course, important that the food should be rolled about and thoroughly mixed with saliva (insalivation).

Deglutition.—The transportation of the food from the mouth to the stomach involves a series of co-ordinated muscular acts of a complicated character, by which difficulties are overcome with marvelous success.

It will be remembered that the respiratory and digestive tracts are both developed from a common simple tube—a fact which makes the close anatomical relation between these two physiologically distinct systems intelligible; but it also involves difficulties and dangers. It is well known that a small quantity of food or drink entering the windpipe produces a perfect storm of excitement in the respiratory system. The food, therefore, when it reaches the œsophagus, must be kept, on the one hand, from entering the nasal, and on the other, the laryngeal openings. This is accomplished as follows: When the food has been gathered into a bolus on the back of the tongue, the tip of this organ is pressed against the hard palate, by which the mass is prevented from passing forward, and, at the same time, forced back into the pharynx, the soft palate being raised and the edges of the pillars of the fauces made to approach the uvula, which fills up the gap remaining, so that the posterior nares are closed and an inclined plane provided, over which the morsel glides. The after-result is said to depend on the size of the bolus. When considerable, the constrictors of the pharynx seize it and press it on into the gullet; when the mor-

sel is small or liquid is swallowed, it is rapidly propelled onward by the tongue, the œsophagus and pharynx being largely passive at the time, though contracting slowly afterward; at

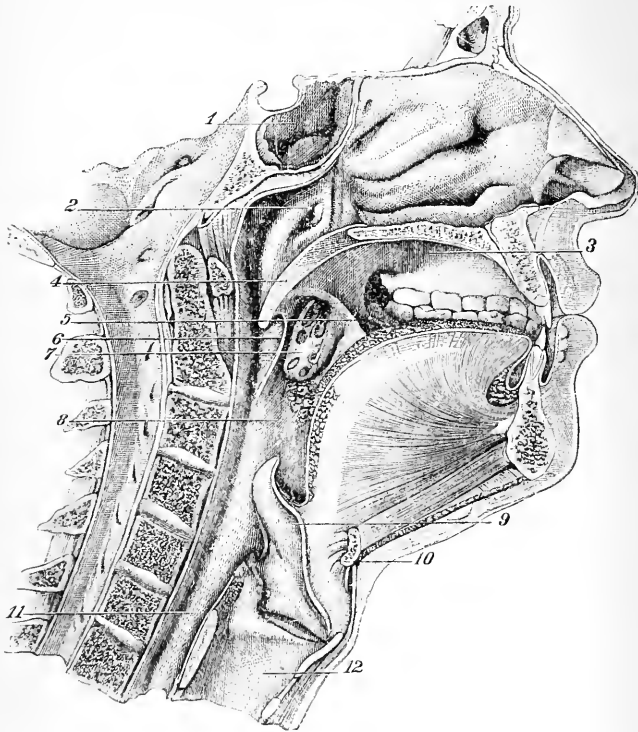

FIG. 274.—Cavities of mouth and pharynx, etc., in man (after Sappey). Section, in median line, of face and superior portion of neck, designed to show the mouth in its relations to the nasal fossæ, pharynx, and larynx: 1, sphenoidal sinuses; 2, internal orifice of Eustachian tube; 3, palatine arch; 4, velum pendulum palati; 5, anterior pillar of soft palate; 6, posterior pillar of soft palate; 7, tonsil; 8, lingual portion of cavity of pharynx; 9, epiglottis; 10, section of hyoid bone; 11, laryngeal portion of cavity of pharynx; 12, cavity of larynx.

the same time the larynx as a whole is raised, the epiglottis pressed down, chiefly by the meeting of the tongue and itself, while its cushion lies over the *rima glottidis*, which is closed or all but closed by the action of the sphincter muscles of the larynx, so that the food passes over and by this avenue of life, not only closed but covered by the glottic lid. The latter is not so essential as might be supposed, for persons in whom it

was absent have been known to swallow fairly well. The ascent of the larynx any one may feel for himself ; and the behavior of the pharynx and larynx, especially the latter, may be viewed by the laryngoscope. The grip of the pharyngeal muscles and the œsophagus may be made clear by attaching a piece of food (meat) to a string and allowing it to be partially swallowed.

The upward movement of food under the action of the constrictors of the pharynx is anticipated by the closure of the passage by the palato-glossi of the anterior pillars of the fauces.

The circular muscular fibers of the gullet are probably the most important in squeezing on the food by a peristaltic movement, passing progressively over the whole tube, though the longitudinal also take part in swallowing, perhaps, by steadying the organ.

Deglutition can take place in an animal so long as the medulla oblongata remains intact ; and the center seems to lie higher than that for respiration, as the latter act is possible when, from slicing away the medulla, the former is not. An-encephalous monsters lacking the cerebrum can swallow, suck, and breathe.

Food placed in the pharynx of animals when unconscious is swallowed, proving that volition is not essential to the act ; but our own consciousness declares that the first stage, or the removal of the food from the mouth to the pharynx, is voluntary.

When we seem to swallow voluntarily there is in reality a stimulus applied to the fauces, in the absence of food and drink, either by the back of the tongue or by a little saliva.

It thus appears that deglutition is an act in the main reflex, though initiated by volition. The afferent nerves concerned are usually the glosso-pharyngeal, some branches of the fifth, and of the vagus. The efferent nerves are those of the numerous muscles concerned.

When food has reached the gullet it is, of course, no longer under the control of the will.

Section of the vagus or stimulation of this nerve modifies the action of the œsophagus, though it is known that contractions may be excited in the excised organ ; but no doubt normally the movements of the gullet arise in response to natural nerve stimulation.

Comparative.—That swallowing is independent of gravity is evident from the fact that long-necked animals (horse, giraffe) can and do usually swallow with the head and neck down, so that the fluid is rolled up an inclined plane. The peristaltic nature of the contractions of the gullet can also be well seen in such animals. In the frog the gullet, as well as the mouth, is lined with ciliated epithelium, so that in a recently killed animal one may watch a slice of moistened cork disappear from the mouth, to be found shortly afterward in the stomach. The rate of the descent is surprising—in fact, the movement is plainly visible to the unaided eye.

The Movements of the Stomach.—The stomach of mammals, including man, is provided with three layers of muscular fibers; 1. External longitudinal, a continuation of those of the œsophagus. 2. Middle circular. 3. Internal oblique. The latter are the least perfect, viewed as an investing coat. The pyloric end of the stomach is best supplied with muscles; where also there is a thick muscular ring or sphincter, as compared with which the cardiac sphincter is weak and ill-developed.

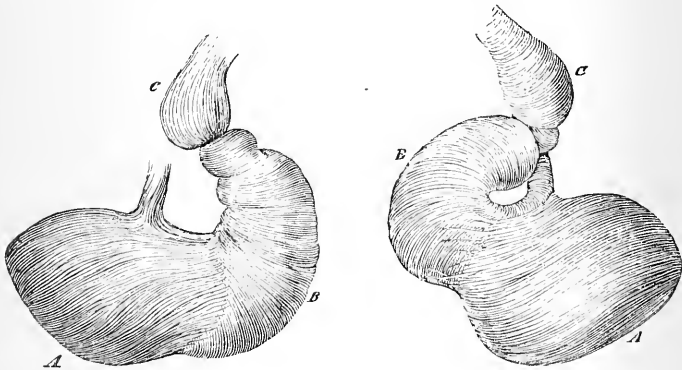

FIG. 275.

FIG. 276.

FIG. 275.—Muscular fibers of the stomach of horse; external and middle layers (Chauveau). A, fibers of external layer enveloping left sac; B, fibers of middle plane in right sac; C, fibers of œsophagus.

FIG. 276.—Deep and muscular layers exposed by removing mucous membrane from an everted stomach (Chauveau). A, deep layer of fibers enveloping left sac; B, fibers of middle plane which alone form the muscular layer of right sac; C, fibers of œsophagus.

The movements of the stomach begin shortly after a meal has been taken, and, as shown by observations on St. Martin, continue for hours, not constantly, but periodically. The effect

of the conjoint action of the different sets of muscular fibers is to move the food from the cardiac toward the pyloric end of the stomach, along the greater curvature and back by the lesser curvature, while there is also, probably, a series of in-and-out currents to and from the center of the food-mass. The quantity of food is constantly being lessened by the removal of digested portions, either by the blood-vessels of the organ or by its passing through the pyloric sphincter. The empty stomach is quiescent and contracted, its mucous membrane being thrown into folds.

The movements of the stomach may be regarded as reflex, the presence of food being an exciting cause, though probably not the only one; and so largely automatic is the central mechanism concerned that but a feeble stimulus suffices to arouse them, especially at the accustomed time.

Of the paths of the impulses, either afferent or efferent, little is known. Certain effects follow section or stimulation of the vagi or splanchnics, but these can not be predicted with certainty, or the exact relation of events indicated.

It is said that the movements of the stomach cease, even when it is full, during sleep, from which it is argued that gastric movements do normally depend on the influence of the nervous system. However, the subject is too obscure at present for further discussion.

Comparative.—Recent investigations on the stomach of the pig indicate that in this animal the contents of the two ends of the stomach may long remain but little mingled; and such is certainly the case in this organ among ruminants.

Pathological.—Distention of the stomach, either from excess of food or gas arising from fermentative changes, or by secretion from the blood, may cause, by upward pressure on the diaphragm, etc., uneasiness from hampered respiration and irregularity of the heart, possibly, also, in part traceable to the physical interference with its movements. After great and prolonged distention there may be weakened digestion for a considerable interval. It seems not improbable that this is to be explained, not alone by the impaired elasticity (vitality) of the muscular tissue, but also by defective secreting power. It is not necessary to impress the lesson such facts convey.

The Intestinal Movements.—The circular fibers play a much more important part than the longitudinal, being, in fact, much more developed. It is also to be remembered that nerves in

the form of plexuses (of Auerbach and Meissner) abound in its walls.

Normally the movement, slowly progressive, with occasional haltings, is from above downward, stopping at the ileo-cæcal valve; the movements of the large gut being apparently mostly independent.

Movements may be excited by external or internal stimulation, and may be regarded as reflex; in which, however, the tendency for the central cells to discharge themselves is so great (automatic) that only a feeble stimulus is required, the normal one being the presence of food.

It is noticeable in a recently killed animal, or in one in the last stages of asphyxia, that the intestines contract vigorously. Whether this is due to the action of blood overcharged with carbonic anhydride and deficient in oxygen on the centers presiding over the movements, on the nerves in the intestinal walls, or on the muscle-cells directly, is not wholly clear, but it is probable that all of these may enter into the result. The vagus nerve, when stimulated, gives rise to movements of the intestines, while the splanchnic seems to have the reverse effect; but the cerebrum itself has an influence over the movements of the gut, as is plain from the diarrhœa traceable to unusual fear or anxiety. There is little to add in regard to the movements of the large intestine. They are, no doubt, of considerable importance in animals in which it is extensive. Normally they begin at the ileo-cæcal valve.

Defecation.—The removal of the waste matter from the alimentary tract is a complicated process, in which both smooth and striped muscle, the spinal cord, and the brain take part.

Defecation may take place during the unconsciousness of sleep or of disease, and so be wholly independent of the will; but, as we all know, this is not usually the case. Against accidental discharge of fæces there is a provision in the sphincter ani, the tone of which is lost when the lower part of the spinal cord is destroyed. We are conscious of being able, by an effort of will, to prevent the relaxation of the sphincter or to increase its holding power, though the latter is probably almost wholly due to the action of extrinsic muscles; at all events any one may convince himself that the latter may be made to take a great part in preventing faecal discharge, though whether the tone of the sphincter can be increased or not by volition it is difficult to say.

What happens during an ordinary act of defecation is about as follows : After a long inspiration the glottis is closed ; the diaphragm, which has descended, remains low, affording, with the obstructed laryngeal outlet, a firm basis of support for the action of the abdominal muscles, which, bearing on the intestine, forces on their contents, which, before the act has been called for, have been lodged mostly in the large intestine ; at the same time the sphincter ani is relaxed and peristaltic movements accompany and in some instances precede the action of the abdominal muscles. The latter may contract vigorously on a full gut without success in the absence of the intestinal peristalsis, as too many cases of obstinate constipation bear witness.

Like deglutition, and unlike vomiting, there is usually both a voluntary and involuntary part to the act.

Though the will, through the cerebrum, can inhibit defecation, it is likely that it does so through the influence of the cerebrum on some center in the cord ; for in a dog, the lumbar cord of which has been divided from the dorsal, the act is, like micturition, erection of the penis, and others which are under the control of the will, still possible, though, of course, performed entirely unconsciously.

Vomiting.—If we consult our own consciousness and observe to the best of our ability, supplementing information thus gained by observations on others and on the lower animals, it will become apparent that vomiting implies a series of co-ordinated movements into which volition does not enter either necessarily or habitually. There is usually a preceding nausea, with a temporary flow of saliva to excess. The act is initiated by a deep inspiration, followed by closure of the glottis. Whether the glottis is closed during or prior to the entrance of air is a matter of disagreement. At all events, the diaphragm descends and remains fixed, the lower ribs being retracted. The abdominal muscles then acting against this support, force out the contents of the stomach, in which they are assisted by the essential relaxation of the cardiac sphincter, the shortening of the cesophagus by its longitudinal fibers, and the extension and straightening of the neck, together with the opening of the mouth.

As the expulsive effort takes place, it is accompanied by an expiratory act which tends to keep the egesta out of the larynx and carry them onward, though it may also contribute to overcome the resistance of the elevated soft palate, which serves to

protect the nasal passages. The stomach and œsophagus are not wholly passive, though the part they take actively in vomiting is variable in different animals.

Retching may be very violent and yet ineffectual when the cardiac sphincter is not fully relaxed. The pyloric outlet is usually closed, though in severe and long-continued vomiting bile is often ejected, which must have reached the stomach through the pylorus.

Comparative.—The ease with which some animals vomit in comparison with others is extraordinary, as in carnivora like our dogs and cats ; a matter of importance to an animal accustomed in the wild state to eat entire carcasses of animals—hair, bones, etc., included.

The readiness with which an animal vomits depends in great part on the conformation and relations of the parts of its digestive tract.

The stomach of the human being during infantile life is less pouched than in the adult, which in part explains the ease with which very young children vomit.

It is well known that the horse vomits rarely and with great difficulty. This has been attributed by different writers to various conditions of a structural kind, such as the length of the gullet ; the manner in which it enters the stomach (centrally) ; the pressure of a tightly closing sphincter at this point ; the valve-like foldings of the mucous membrane at the cardiac opening ; the small size of the stomach and its sheltered position, so that the abdominal muscles can not readily act on it ; the existence of a considerable length of the œsophagus between the stomach and diaphragm which is against dilatation of the orifice by the longitudinal fibers of the gullet ; the open pylorus, permitting of the gastric contents being driven into the intestines rather than upward.

But in the ox these peculiarities do not exist ; in fact, from a mechanical point of view, the structure and relation of parts is favorable, yet this animal seldom vomits, and never with ease. Why does the horse vomit after rupture of the stomach when conditions are less favorable from a mechanical point of view ? There is the greatest difference as to the readiness with which different human beings vomit ; moreover, persons that vomit usually with difficulty may do so very perfectly when sufficiently prepared, as by sea-sickness.

These and many other considerations have led us to conclude

that, while there is a certain amount of force in the various views stated briefly above, they do not go to the root of the matter.

Vomiting is a very complex act, implying numerous muscular and nervous co-ordinations. In the natural wild state the horse can have but rare necessity to vomit (unlike the carnivora), hence these co-ordinations have not been organized by habit and use ; they are foreign to the nature of the animal. After rupture of the stomach in the horse, and in sea-sickness in man, the nervous system is profoundly affected and the unusual happens ; in other words, the necessary muscular and nervous co-ordinations take place. At all events, we are satisfied that it lies with the nervous system chiefly.

Similarly, the habit of regurgitating the food is intelligible in the light of evolution. The fact that mammals are descended from lower forms in which unstriped muscle-cells go to form organs that have a rhythmically contractile function, renders it clear why this function may become, as in ruminants, specialized in certain parts of the digestive tract; why carnivora should vomit readily, and why human subjects should learn to regurgitate food. There is, so to speak, a latent inherited capacity which may be developed into actual function. Apart from this it is difficult to understand such cases at all.

The vomiting center is usually located in the medulla, and is represented as working in concert with the respiratory center. But when we consider that there is usually an increased flow of saliva and other phenomena involving additional central nervous influence, we see reason to believe in co-ordinated action implying the use of parts of the central nervous system not so closely connected anatomically as the respiratory and vomiting centers are assumed to be.

THE REMOVAL OF DIGESTED PRODUCTS FROM THE ALIMENTARY CANAL.

The glands of the stomach are simply secretive, and all absorption from this organ is either by blood-vessels directly or by lymphatics; at least, such is the ordinary view of the subject—whether it is not too narrow a one remains to be seen.

It is important to remember that the intestinal mucous membrane is supplied not only with secreting glands but lymphatic tissue, in the form of the solitary and agminated glands

(Peyer's patches) and thickly studded with villi, giving the small gut that velvety appearance appreciable even by the naked eye.

It will not be forgotten that the capillaries of the digestive organs terminate in the veins of the portal system, and that the blood from these parts is conducted through the liver before it reaches the general circulation.

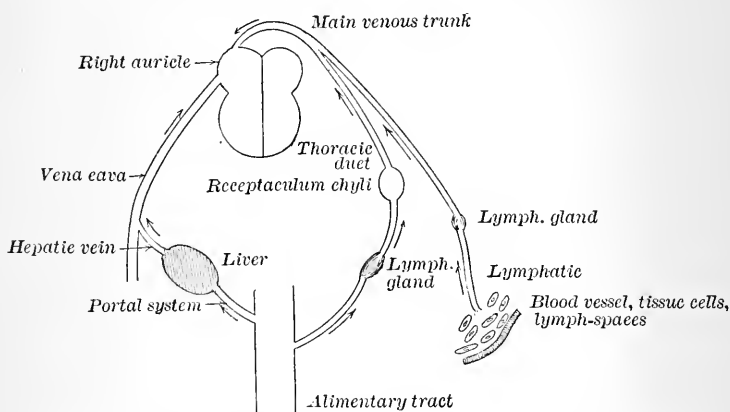

FIG. 277.—Diagram intended to illustrate the general relations of blood and lymph to metabolism (nutrition), and the method by which the portal, lymphatic, and general venous systems are related to the alimentary tract.

The lymphatics of these organs form a part of the general lymphatic system of the body; but the peculiar way in which absorption is effected by villi, and the fact that the lymphatics of the intestine, etc., at one time (fasting) contain ordinary lymph and at another (after meals) the products of digestion, imparts to them a physiological character of their own.

Absorption will be the better understood if we treat now of lymph and chyle and the lymph vascular system, which were purposely postponed till the present; though its connection with the vascular system is as close and important as with the digestive organs.

The lymphatic system, as a whole, more closely resembles the venous than the arterial vessels. We may speak of lymphatic capillaries, which are, in essential points of structure, like the arterial capillaries; while the larger vessels may be compared to veins, though thinner, being provided with valves and having very numerous anastomoses. These lymphatic

capillaries begin in spaces between the tissue-cells, from which they take up the effete lymph. It is interesting to note that there are also perivascular lymphatics, the existence of which again shows how close is the relation between the blood vascular and lymphatic systems, and as we would suppose, and as is actually found to be the case, between the contents of each.

Lymph and Chyle.—If one compares the mesentery in a kitten when fasting with the same part in an animal that was killed some hours after a full meal of milk, it may be seen that the formerly clear lines indicating the course of the lymphatics and ending in glands have in the latter case become whitish (hence their name, *lacteals*), owing to the absorption of the emulsified fat of the milk.

Microscopic examination shows the chyle to contain (when coagulated) fibrin, many



FIG. 278.—Valves of lymphatics (Sappey).

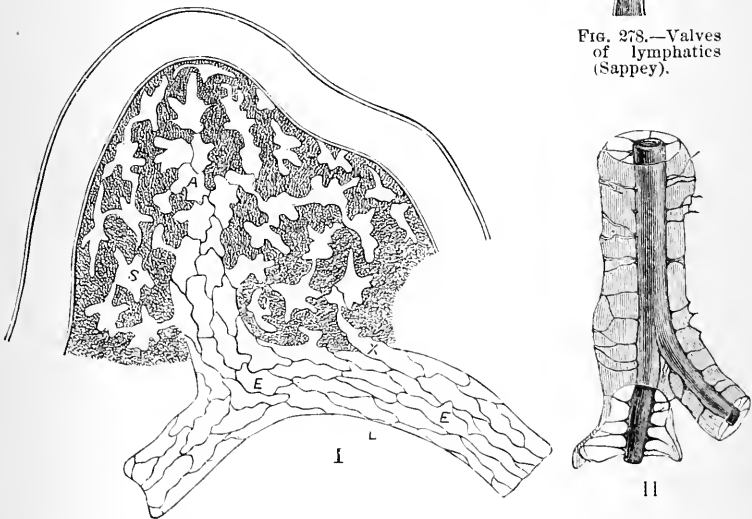

FIG. 279.—Origin of lymphatics (after Landois). I. From central tendon of diaphragm of rabbit (semi-diagrammatic); S, lymph-canals communicating by X with lymphatic vessel L; A, origin of lymphatic by union of lymph-canals; E, E. endothelium. II. Perivascular canal.

leucocytes, a few developing red corpuscles, an abundance of fat in the form both of very minute oil-globules and particles smaller still.

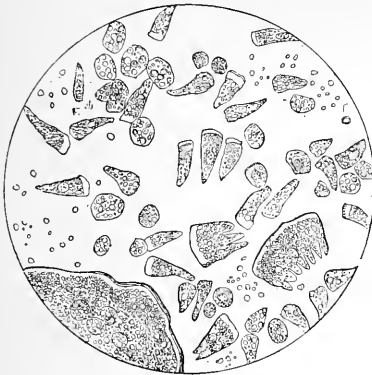

FIG. 280.—Epithelium from duodenum of rabbit, two hours after having been fed with melted butter (Funke).



FIG. 281.—Villi filled with fat, from small intestine of an executed criminal, one hour after death (Funke).

There are also present fatty acids, soaps small in quantity as compared with the neutral fats, also a little cholesterin and lecithin. But chyle varies very widely even in the same animal at different times. To the above must be added proteids (fibrin, serum-albumin, and globulin); extractives (sugar, urea, leucin);

and salts in which sodium chloride is abundant.

The composition of lymph is so similar to that of chyle, and both to blood, that lymph might, though only roughly, be regarded as blood without its red corpuscles, and chyle as lymph with much neutral fat in a very fine state of division.

The Movements of the Lymph — comparative. — In some fishes, some birds, and amphibians, there are lymph hearts.

In the frog there are two

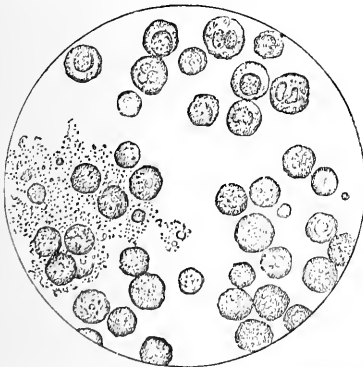

FIG. 282.—Chyle taken from the lacteals and thoracic duct of a criminal executed during digestion (Funke). Shows leucocytes and excessively fine granules of fatty emulsion.

axillary and two *sacral* lymph hearts. The latter are, especially, easily seen, and there is no doubt that they are under the control of the nervous system.

In the mammals no such special helps for the propulsion of lymph exist.

There is little doubt that the blood-pressure is always higher than the lymph-pressure, and when the blood-vessels are dilated the fluid within the perivascular lymph-channels is likely compressed; muscular exercise must act on the lymph-channels as on veins, both being provided with valves, though themselves readily compressible; the inspiratory efforts, especially when forcible, assist in two ways: by the compressing effect of the respiratory muscles, and by the aspirating effect of the negative pressure within the thorax, producing a similar aspirating effect within the great veins, into which the large lymphatic trunks empty. The latter are provided at this point with valves, so that there is no back-flow; and, with the positive pressure within the large lymphatic trunks (thoracic duct, etc.), the physical conditions are favorable to the outflow of lymph or chyle.

Our knowledge of the nature of the passage of the chyle from the intestines into the blood is now clearer than it was till recently, though still incomplete.

The exact structure of a villus is to be carefully considered. If we assume that the muscular cells in its structure have a rhythmically contractile function, the blind terminal portion of the lacteal inclosed within the villus must, after being emptied, act as a suction-pump to some extent; at all events, the conditions as to pressure would be favorable to inflow of any material, especially fluid without the lacteal. The great difficulty hitherto was to understand how the fat found its way through the villus into the blood, for, that most of it passes in this direction there is little doubt.

It is now known that leucocytes (amœboids, phagocytes) migrate from within the villus outward, and may even reach its surface, that they take up (eat) fat-particles from the epithelium of the villus, and, independently themselves, carry them inward, reach the central lacteal and break up, thus releasing the fat. How the fat gets into the covering epithelium is not yet so fully known—possibly by a similar inceptive process; nor is it ascertained what constructive or other chemical processes it may perform; though it is not at all likely that

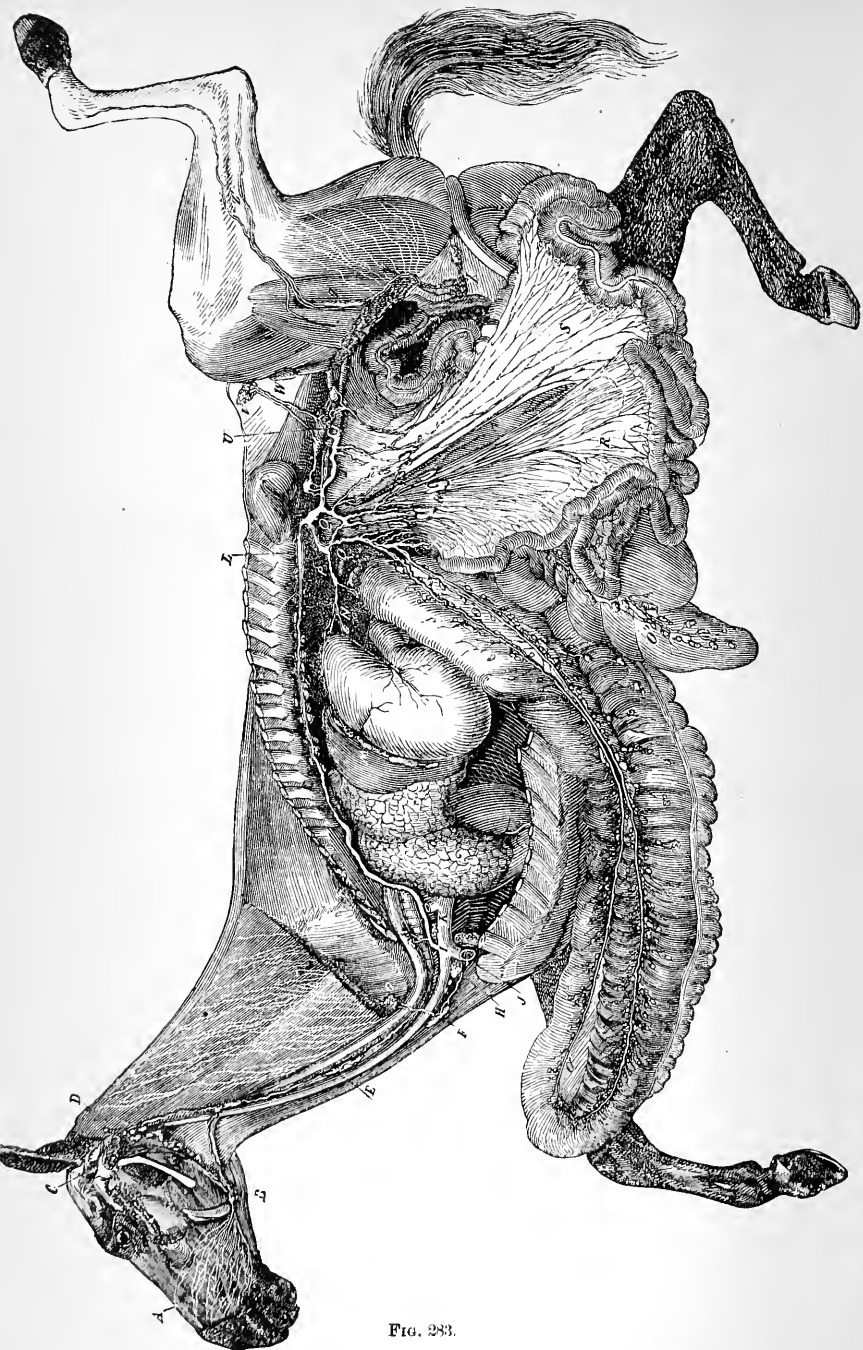

FIG. 233.

FIG. 283.—Lymphatic system of horse (Chauveau). A, facial and nasal plexus whose branches pass to subglossal glands; B, C, parotid lymphatic gland, sending vessels to pharyngeal gland; D, E, large trunks passing toward thorax; F, G, H, glands receiving superficial lymphatics of neck, a portion of those of limbs, and those of pectoral parietes; I, junction of jugulars; J, axillary veins; K, summit of anterior vena cava; L, thoracic duct; M, lymphatics of spleen; N, of stomach; O, of large colon; S, of small colon; R, lacteals of small intestine, all going to form two trunks, P, Q, which open directly into receptaculum chyli; T, trunk which receives branches of sublumbar glands, U, to which vessels of internal iliac glands, V, the receptacles of lymphatics of abdominal parietes, pass; W, precrural glands receiving lymphatics of posterior limb, and which arrive independently in the abdomen; X, superficial inguinal glands into which lymphatics of the mammae, external generative organs, some superficial trunks of posterior limb, etc., pass; Z, deep inguinal glands receiving the superficial lymphatics, Z, of posterior limbs.

the work of the amoeboid cells is confined to the transport of fat alone, but that other matters are also thus removed inward to the lacteal.

When a multitude of facts are taken into account, there

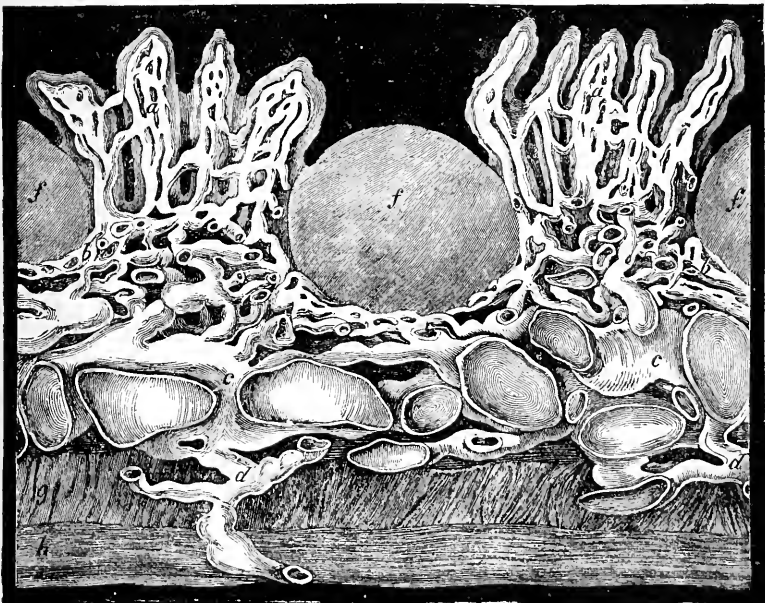

FIG. 284.—Perpendicular section through one of Peyer's patches in the lower part of the ileum of the sheep (Chauveau). *a, a*, lacteal vessels in villi; *b, b*, superficial layer of lacteal vessels; *c, c*, deep layer of lacteals; *d, d*, efferent vessels provided with valves; *f*, Peyer's glands; *g*, circular muscular layer of wall of intestine; *h*, longitudinal layer.

seems little reason to doubt that so important a process as absorption can not fail to be regulated by the nervous centers.

There are two points that are very far from being determined: the one the fate of the products of digestion; the other the exact limit to which digestion is carried. How much—e. g.,

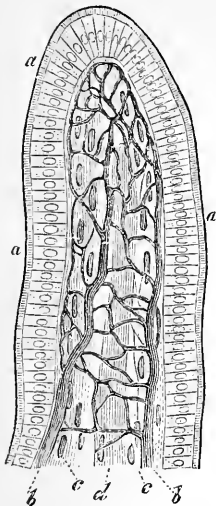

FIG. 285.—Intestinal villus (after Leydig). *a, a, a*, epithelial covering; *b, b*, capillary network; *c, c*, longitudinal muscular fibers; *d*, lacteal.

of proteid matter—does actually undergo conversion into peptone; how much is converted into leucin and tyrosin; or, again, what proportion of the albuminous matters are dealt with as such by the intestine without conversion into peptone at all, either as soluble proteid or in the form of solid particles?

1. It is generally believed that soluble sugars are absorbed, usually after conversion into maltose or glucose, by the capillaries of the stomach and intestine.

2. There is some positive evidence of the presence of fats, soaps, and sugars in unusual amount after a meal in the portal vein, which implies removal from the intestinal contents by the capillaries, though, so far as experiment goes, the fat is chiefly in the form of soaps,

Certain experiments have been made by ligating the pyloric end of the stomach, by introducing a cannula into the

thoracic duct, so as to continually remove its contents, etc. But we are surprised that serious conclusions should have been drawn under such circumstances, seeing that the natural conditions are so altered. What we wish to get at in physiology is the normal function of parts, and not the possible results after our interference. Under such circumstances the phenomena may have a suggestive but certainly can not have a conclusive value.

It is a very striking fact that little peptone (none, according to some observers) can be detected even in the portal blood. True it is, the circulation is rapid and constant, and a small quantity might escape detection, yet a considerable amount be removed from the intestine in the space of a few hours by the capillaries alone. Peptone is not found in the contents of the thoracic duct.

For a considerable period it has been customary to use the

terms osmosis and diffusion in connection with the functions of the alimentary canal, and especially the intestinal tract, as if this thin-walled but complicated organ, or rather collec-

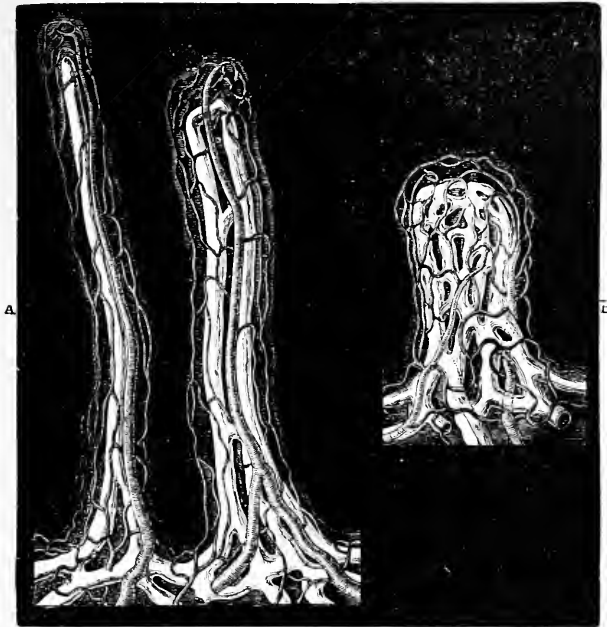

FIG. 286.—A. Villi of man, showing blood-vessels and lacteals; B. Villus of sheep (after Chauveau).

tion of organs, were little more, so far as absorption is concerned, than a moist membrane, leaving the process of the removal of digested food products to be explained almost wholly on physical principles.

From such views we dissent. We believe they are opposed to what we know of living tissue everywhere, and are not supported by the special facts of digestion. When certain foreign bodies (as purgatives) are introduced into the blood or the alimentary canal, that diffusion takes place, according to physical laws, may indicate the manner in which the intestine can act; but even admitting that under such circumstances physical principles actually do explain the whole, which we do not grant, it would by no means follow that such was the natural behavior of this organ in the discharge of its ordinary functions.

When we consider that the blood tends to maintain an equilibrium, it must be evident that the removal of substances from the alimentary canal, unless there is to be excessive activity of

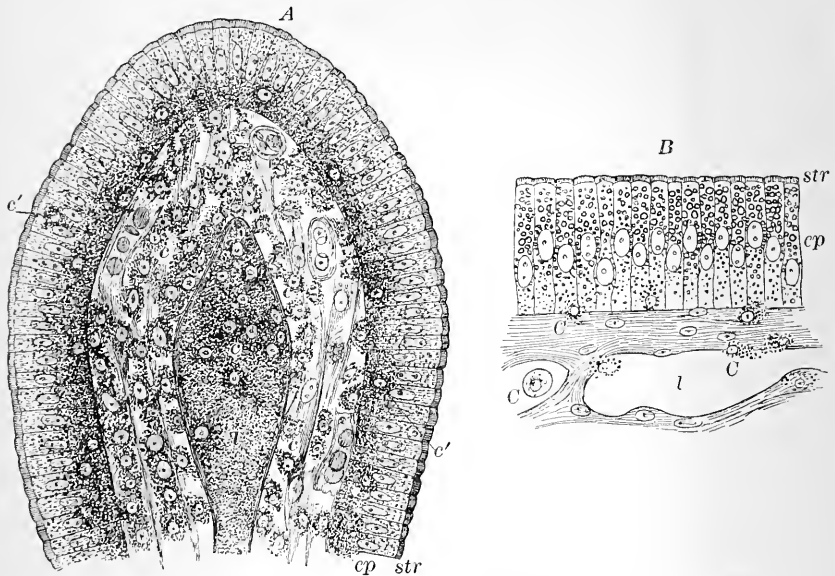

FIG. 287.—A. Section of villus of rat killed during fat absorption (Schäfer). *ep*, epithelium; *str*, striated border; *c*, lymph-cells; *c'*, lymph-cells in epithelium; *l*, central lacteal containing disintegrating corpuscles. B. Mucous membrane of frog's intestine during fat absorption (Schäfer). *ep*, epithelium; *str*, striated border; *C*, lymph-corpuscles; *l*, lacteal.

the excretory organs and waste of energy both by them and the digestive tract, must in some degree depend on the demand for the products of digestion by the tissues. That there is to some extent a corrective action of the excretory organs always going on is no doubt true, and that it may in cases of emergency be great is also true; but that this is minimized in ways too complex for us to follow in every detail is equally true. Digestion waits on appetite, and the latter is an expression of the needs of the tissues. We believe it is literally true that in a healthy organism the rate and character of digestion and of the removal of prepared products are largely dependent on the condition of the tissues of the body.

Why is digestion more perfect in overfed animals after a short fast? The whole matter is very complex, but we think

it is infinitely better to admit ignorance than attempt to explain by principles that do violence to our fundamental conceptions of life processes. To introduce "ferments" to explain so many obscure points in physiology, as the conversion of peptone in the blood, for example, is taking refuge in a way that does no credit to science.

Without denying that endosmosis, etc., may play a part in the vital processes we are considering, we believe a truer view of the whole matter will be ultimately reached. In the mean time we think it best to express our belief that we are ignorant of the real nature of absorption in great part; but we think that, if the alimentary tract were regarded as doing for the digested food (chyle, etc.) some such work as certain other glands do for the blood, we would be on the way to a truer conception of the real nature of the processes.

It would then be possible to understand that proteids, either in the form of soluble or insoluble substances, including peptone, might be taken in hand and converted by a true vital process into the constituents of the blood.

If we were to regard the kidney as manufacturing useful instead of harmful products, the resemblance in behavior would in many points be parallel. We have seen that physical explanations of the functions of the kidney have failed, and that it must be regarded even in those parts that eliminate most water as a genuine secreting mechanism.

We wish to present a somewhat truer conception of the lymph that is separated from the capillaries and bathes the tissues.

We would regard its separation as a true secretion, and not a mere diffusion dependent wholly on blood-pressure. The mere ligature of a vein does not suffice to cause an excess of diffusion, but the vaso-motor nerves have been shown to be concerned. The effusions that result from pathological processes do not correspond with the lymph—that is, the nutrient material—provided by the capillaries for the tissues. These vessels are more than mere carriers; they are secretors—in a sense they are glands. We have seen that in the foetus they function both as respiratory and nutrient organs in the allantois and yolk-sac, and, in our opinion, they never wholly lose this function.

The kind of lymph that bathes a tissue, we believe, depends on its nature and its condition at the time, so that, as we view

tissue-lymph, it is not a mere effusion with which the tissues, for which it is provided, have nothing to do. The differences may be beyond our chemistry to determine, but to assume that all lymph poured out is alike is too crude a conception to meet the facts of the case. Glands, too, it will be remembered, derive their materials, like all other tissues, not directly from the blood, but from the lymph. We believe that the cells of the capillaries, like all others, are influenced by the nervous system, notwithstanding that nerves have not been traced terminating in them.

It is to be borne in mind that the lymph, like the blood, receives tissue waste-products—in fact, it is very important to realize that the lymph is, in the first instance, a sort of better blood—an improved, selected material, so far as any tissue is concerned, which becomes gradually deteriorated.

We have not the space to give all the reasons on which the opinions expressed above are founded; but, if the student has become imbued with the principles that pervade this work thus far, he will be prepared for the attitude we have taken, and sympathize with our departures from the mechanical (physical) physiology.

We think it would be a great gain for physiology if the use of the term “absorption,” as applied to the alimentary tract, were given up altogether, as it is sure to lead to the substitution of the gross conceptions of physical processes instead of the subtle though at present rather indefinite ideas of vital processes. We prefer ignorance to narrow, artificial, and erroneous views.

Pathological.—Under certain circumstances, of which one is obstruction to the venous circulation or the lymphatics, fluid may be poured out or effused into the neighboring tissues or the serous cavities. This is of very variable composition, but always contains enough salts and proteids to remind one of the blood.

Such fluids are often spoken of as “lymph,” though the resemblance to normal tissue-lymph is but of the crudest kind; and the condition of the vessels when it is secreted, if such a term is here appropriate, is not to be compared to the natural separation of the normal lymph—in fact, were this not so, it would be identical with the latter, which it is not. When such effusions take place they are in themselves evidence of altered (and not merely increased) function.

The Fæces.—The fæces may be regarded in at least a three-

fold aspect. They contain undigested and indigestible remnants, the ferments and certain decomposition products of the digestive fluids, and true excretory matters.

In carnivorous and omnivorous animals, including man, the undigested materials are those that have escaped the action of the secretions—such as starch and fats—together with those substances that the digestive juices are powerless to attack, as horny matter, hairs, elastic tissue, etc.

In vegetable feeders a larger proportion of chlorophyl, cellulose, and starch will, of course, be found.

These, naturally, are variable with the individual, the species, and the vigor of the digestive organs at the time.

Besides the above, certain products are to be detected in the fæces plainly traceable to the digestive fluids, and showing that they have undergone chemical decomposition in the alimentary tract, such as cholalic acid, altered coloring-matters like urobilin, derivable probably from bilirubin; also cholesterolin, fatty acids, insoluble soaps (calcium, magnesium), together with ferments, having the properties of pepsin and amylopsin. Mucus is also abundant in the fæces.

We know little of the excretory products proper, as they probably normally exist in small quantity, and it is not impossible that some of the products of the decomposition of the digestive juices may be reabsorbed and worked over or excreted by the kidneys, etc.

There is, however, a recognized non-nitrogenous crystalline body known as *excretin*, which contains sulphur, salts, and pigments, and that may rank perhaps as a true excretion of the intestine.

It is well known that bacteria abound in the alimentary tract, though their number is dependent on a variety of circumstances, including the kind of food and the condition in which it is eaten. These minute organisms feed, of course, and to get their food produce chemical decompositions. *Skatol* and *indol* are possibly thus produced, and give the fæcal odor to the contents of the intestine. But as yet our ignorance of these matters is greater than our knowledge—a remark which applies to the excretory functions of the alimentary tract generally.

Pathological.—The facts revealed by clinical and pathological study leave no doubt in the mind that the intestine at all events may, when other glands, like the kidney, are at fault,

undertake an unusual share of excretory work, probably even to the length of discharging urea.

Obscure as the subject is, and long as it may be before we know exactly what and how matter is thus excreted, we think that it will greatly advance us toward a true conception of the vital processes of the mammalian body if we regard the alimentary tract as a collection of organs with both a secreting and excreting function; that what we have been terming absorption is in the main, at least, essentially secretion or an allied process; and that the parts of this long train of organs are mutually dependent and work in concert, so that when one is lacking in vigor or resting to a greater or less degree, the others make up for its diminished activity; and that the whole must work in harmony with the various excretory organs, as an excretor itself, and in unison with the general state of the economy. We are convinced that even as an excretory mechanism one part may act (vicariously) for another.

Of course, in disease the condition of the fæces is an indication of the state of the digestive organs; thus color, consistence, the presence of food in lumps, the odor, and many other points tell a plain story of work left undone, ill-done, or disordered by influences operating from within or from without the tract. The intelligent physician acts the part of a qualified inspector, surveying the output of a great factory, and drawing conclusions in regard to the kind of work which the operatives have performed.

THE CHANGES PRODUCED IN THE FOOD IN THE ALIMENTARY CANAL.

We have now considered the method of secretion, the secretions themselves, and the movements of the various parts of the digestive tract, so that a brief statement of the results of all this mechanism, as represented by changes in the food, will be appropriate. We shall assume for the present that the effects of the digestive juices are substantially the same in the body as in artificial digestion.

Among mammals food is, in the mouth, comminuted (except in the case of the carnivora, that bolt it almost whole, and the ruminants, that simply swallow it to be regurgitated for fresh and complete mastication), insalivated, and, in most species, chemically changed, but only in so far as starch is concerned.

Deglutition is the result of the co-ordinated action of many muscular mechanisms, and is reflex in nature. The œsophagus secretes mucus, which lubricates its walls, and aids mechanically in the transport of the food from the mouth to the stomach. In the stomach, by the action of the gastric juice, food is further broken up, the proteid covering of fat-cells is digested, and the structure of muscle, etc., disappears. Proteid matters become peptone, and in some animals fat is split up into free fatty acid and glycerin; but the digestion of fat in the stomach is very limited at best and probably does not go on to emulsification or saponification. The digestion of starch con-

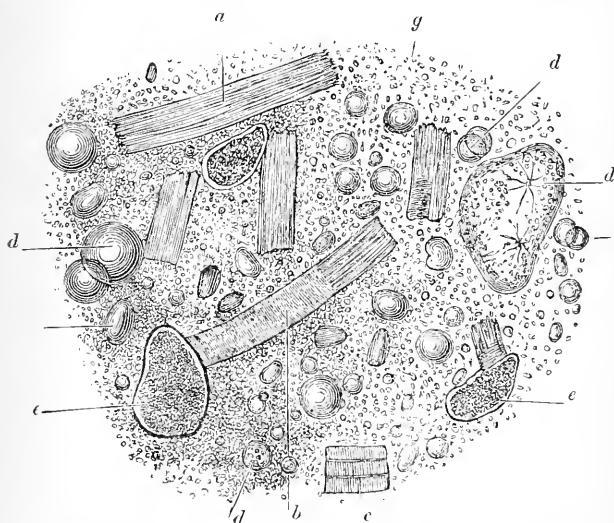

FIG. 288.—Matters taken from pyloric portion of stomach of dog during digestion of mixed food (after Bernard). *a*, disintegrated muscular fibers, striæ having disappeared; *b*, *c*, muscular fibers in which striæ have partly disappeared; *d*, *d*, *d*, globules of fat; *e*, *e*, *e*, starch; *g*, molecular granules.

tinues in the stomach until the reaction of the food-mass becomes acid. This in the hog may not be far from one to two hours, and the amylolytic ferment acts with great rapidity even without the body. The food is moved about to a certain extent, so as to expose every part freely to the mucous membrane and its secretions. It is likely that the sugar resulting from the digestion of starch, the peptones, and, to some extent, the fat formed (if any), is received into the blood from the stomach.

As the partially digested mass (chyme) is passed on into the intestine as a result of the action of the alkaline bile, the parapeptone, pepsin, and bile-salts are deposited. Certain of the constituents of digestion are thus delayed, a portion of the pepsin is probably absorbed, either altered or unaltered, and pepsin is thus got rid of, making the way clear, so to speak, for the action of trypsin. At all events, digestion in one part of the tract is antagonized by digestion in another, but we must also add supplemented.

The fat, which had been but little altered, is emulsified by the joint action of the bile and pancreatic secretion; a portion is saponified, which again helps in emulsification, while an additional part, in form but little changed, is probably dealt with by the absorbents.

Proteid digestion is continued, and, besides peptones, nitrogenous crystalline bodies are formed (leucin and tyrosin), but under what conditions or to what extent is not known; though the quantity is likely very variable, both with the species of animal and the circumstances, such as quantity and quality of food; and it is likely also dependent not a little on the rate of absorption. It seems altogether probable that in those that use an excess of nitrogenous food more of these bodies are formed, and thus give an additional work to the excreting organs, including the liver. But the absence of albumin from healthy fæces points to the complete digestion of proteids in the alimentary canal. Plainly the chief work of intestinal digestion is begun and carried on in the upper part of the tract, where the ducts of the main glands are to be found.

The contents of the intestine swarm with bacteria, though these are probably kept under control, to some extent, by the bile, the functions of which as an antiseptic we have already considered.

The removal of fats by the villi will be shortly considered. The other products of digestion probably find their way into the general circulation by the portal blood, passing through the liver, which organ modifies some of them in ways to be examined later.

The *valvule conniventes* greatly increase the surface of the intestine, and retard the movements of the partially digested mass, both of which are favorable. The peristaltic movements of the small gut serve the obvious purpose of moving on the digesting mass, thus making way for fresh additions of chyme

from the stomach, and carrying on the more elaborated contents to points where they can receive fresh attention, both digestive and absorptive.

Comparative.—In man, the carnivora, and some other groups, it is likely that digestion in the large intestine is slight, the work being mostly completed—at all events, so far as the action of the secretions is concerned—before this division of the tract is reached, though doubtless absorption goes on there also. The muscular strength of this gut is important in the act of defecation.

But the great size of the large intestine in ruminants—in the horse, etc.—together with the bulky character of the food of such animals, points to the existence of possibly extensive processes of which we are ignorant. It is generally believed that food remains but a short time in the stomach of the horse, and that the cæcum is a sort of reservoir in which digestive processes are in progress, and also for water.

Fermentations go on in the intestine, and probably among ruminants they are numerous and essential, though our actual knowledge of the subject is very limited.

The gases found in the stomach are atmospheric air (swallowed) and carbon dioxide, derived from the blood. Those of the intestine are nitrogen, hydrogen, carbonic anhydride, sulphuretted hydrogen, and marsh-gas, the quantity varying considerably with the diet. In herbivora the quantity of CO_2 and CH_4 is large.

Although our knowledge of the actual processes by which food is digested in the domestic animals is meager, there are certain considerations to which it may be well to give prominence at this point.

The whole subject becomes clearer and the way is paved for more exact and comprehensive knowledge if it be borne in mind that the entire alimentary tract has a common embryological origin from the splanchnopleure (Fig. 225, etc.), consisting of outer mesoblast and lining hypoblast, the former giving rise to the muscular and other less essential structures, the latter to the all-important glandular epithelium. But of all regions the alimentary tract has been modified in relation to the development and habits of the animal group. It can not be too well remembered that digestion is highly complex, with one organ and one process supplementary to another.

If mastication is imperfect, as in the carnivora, gastric diges-

tion is unusually active, as is well seen in the dog; if the stomach is capacious the intestine is shorter, also exemplified in this group. The stomach may be small and the small intestines not lengthy, but the large intestine of enormous size, as in the horse.

When the quantity of starchy matters found in the food of the animal is large, provision is made for its digestion in several parts of the alimentary tract. This is seen in the horse and other herbivora. Mastication is fairly complete in these animals, yet a part of the small stomach of the horse is a sort of œsophageal dilatation (Fig. 266) in which amylolytic digestion goes on by the action of the swallowed saliva and possibly by a ferment provided in this region of the organ.

The gastric juice of the horse has been proved capable of digesting starch, possibly because mixed with the swallowed saliva. The stomach of the pig is large, and both proteid and starchy digestion exceedingly active. In the intestines the processes are of brief duration, but very effective.

Digestion in the upper part of the small intestines is, in some animals, as the horse, really a continuation of that in the stomach; or, at all events, the contents of the duodenum and jejunum are usually acid in reaction, so that the digestion peculiar to one region of the tract does not always abruptly end when food has left that part. The readiness with which food passes from the stomach into the intestines is very variable in different animals, and even in the same animal under different circumstances. In the horse the pyloric orifice seems never to be very tightly closed, though in most of our domestic animals the reverse is the case; and with them the quantity of undigested material, as fat, that passes into the small intestine depends on the rate of digestion and absorption in the latter.

In the horse, if water, or even hay, be given after oats a portion of the latter is soon carried on into the intestines, so that the obvious rule for feeding such an animal is to give the water and hay before the oats, or, at least, the water and no hay immediately after the oats.

Digestion in the large intestine is of great importance in the monogastric herbivora, as the horse. The cæcum is of enormous size—about twice that of the stomach—and has communication with the colon by a small opening, so that it furnishes a sort of supplementary reservoir for digestion as well as for water. As the results of experiments, it has been concluded

that food is found in the stomach twelve hours after feeding; in the cæcum after twenty-four hours, with a residue in the jejunum; after forty-eight hours, in the ventral colon, with remains in the cæcum; after seventy-two hours, in the dorsal colon; and after ninety hours in the dorsal colon and rectum.

The cæcum appears to digest large quantities of cellulose, which does not seem to be affected by either the saliva, gastric, or pancreatic juices. The process is ill understood. In herbivora the large intestine takes some very important part—in digestion and absorption—and we would again remind the student that the latter term has been used in a very vague if not unwarrantable sense. It is important for the practitioner to bear in mind that nutrient enemata can be utilized for the general good of the economy when passed into either the large or small intestine.

During the suckling period digestion in all the various groups of animals is probably closely analogous. At this time, in ruminants, the first three divisions of the stomach are but slightly developed.

Pathological.—In subjects of a highly neurotic temperament and unstable nervous system it sometimes happens that immense quantities of gas are belched from an empty stomach or distend the intestines.

It is known that the oxygen swallowed is absorbed into the blood, and the carbonic anhydride found in the stomach derived from that fluid.

It will thus be seen that the alimentary tract has not lost its respiratory functions even in man, and that these may in certain instances be inordinately developed (*reversion*).

SPECIAL CONSIDERATIONS.

It is a matter well recognized by those of much experience in breeding and keeping animals with restricted freedom and under other conditions differing widely from the natural ones—i. e., those under which the animals exist in a wild state—that the nature of the food must vary from that which the untamed ancestors of our domestic animals used. Food may often with advantage be cooked for the tame and confined animal. The digestive and the assimilative powers have varied with other changes in the organism brought about by the new surroundings. So much is this the case, that it is necessary to resort to

common experience and to more exact experiments to ascertain the best methods of feeding animals for fattening, for work, or for breeding. Inferences drawn from the feeding habits of wild animals allied to the tame to be valuable must always, before being applied to the latter, be subjected to correction by the results of experience.

It is now well established by experience that animals kept in confinement must have, in order to escape disease and attain the best results on the whole, a diet which not only imitates that of the corresponding wild forms generally, but even in details, with, it may be, altered proportions or added constituents, in consequence of the difference in the environment. To illustrate: poultry can not be kept healthy confined in a shed without sand, gravel, old mortar, or some similar preparation; and for the best results they must have green food also, as lettuce, cabbage, chopped green clover, grass, etc. They must not be provided with as much food as if they had the exercise afforded by running hither and thither over a large field. We have chosen this case because it is not commonly recognized that our domesticated birds have been so modified that special study must be made of the environment in all cases if they are not to degenerate. The facts in regard to horned cattle, horses, and dogs are perhaps better known.

Cooking greatly alters the chemical composition, the mechanical condition, and, in consequence, the flavor, the digestibility, and the nutritive value of foods. To illustrate: meat in its raw condition would present mechanical difficulties, the digestive fluids permeating it less completely; an obstacle, however, of far greater magnitude in the case of most vegetable foods. By cooking certain chemical compounds are replaced by others, while some may be wholly removed. As a rule, boiling is not a good form of preparing meat, because it withdraws not only salts of importance, but proteids and the extractives—nitrogenous and other. Beef-tea is valuable chiefly because of these extractives, though it also contains a little gelatin, albumin, and fats.

Meat, according to the heat employed, may be so cooked as to retain the greater part of its juices within it or the reverse. With a high temperature (65° to 70° C.) the outside in roasting may be so quickly hardened as to retain the juices.

In feeding dogs it is both physiological and economical to give the animal the broth as well as the meat itself.

It is remarkable in the highest degree that man's appetite, or the instinctive choice of food, has proved wiser than our science. It would be impossible even yet to match, by calculations based on any data we can obtain, a diet for each man equal upon the whole to what his instincts prompt. With the lower mammals we can prescribe with greater success. At the same time chemical and physiological science can lay down general principles based on actual experience, which may serve to correct some artificialities acquired by perseverance in habits that were not based on the true instincts of a sound body and a healthy mental and moral nature; for the influence of the latter can not be safely ignored even in such discussions as the present. These remarks, however, are meant to be suggestive rather than exhaustive.

We may with advantage inquire into the nature of hunger and thirst. These, as we know, are safe guides usually in eating and drinking.

After a long walk on a warm day one feels thirsty, the mouth is usually dry; at all events, moistening the mouth, especially the back of it (pharynx), will of itself partially relieve thirst. But if we remain quiet for a little time the thirst grows less, even if no fluid be taken. The dryness has been relieved by the natural secretions. If, however, fluid be introduced into the blood either directly or through the alimentary canal, the thirst is also relieved speedily. The fact that we know when to stop drinking water shows of itself that there must be local sensations that guide us, for it is not possible to believe that the whole of the fluid taken can at once have entered the blood,

Hunger, like thirst, may be mitigated by injections into the intestines or the blood. It is, therefore, clear that, while in the case of hunger and thirst there is a local expression of a need, a peculiar sensation, more pronounced in certain parts (the fauces in the case of thirst, the stomach in that of hunger), yet these may be appeased from within through the medium of the blood, as well as from without by the contact of food or water, as the case may be.

Up to the present we have assumed that the changes wrought in the food in the alimentary tract were identical with those produced by the digestive ferments as obtained by extracts of the organs naturally producing them. But for many reasons it seems probable that artificial digestion can not be regarded as

parallel with the natural processes except in a very general way. When we take into account the absence of muscular movements, regulated according to no rigid principles, but varying with innumerable circumstances in all probability; the absence of the influence of the nervous system determining the variations in the quantity and composition of the outflow of the secretions; the changes in the rate of so-called absorption, which doubtless influences also the act of the secretion of the juices—by these and a host of other considerations we are led to hesitate before we commit ourselves too unreservedly to the belief that the processes of natural digestion can be exactly imitated in the laboratory.

What is it which enables one animal to digest habitually what may be almost a poison to another? How is it that each one can dispose readily of a food at one time that at another is quite indigestible? To reply that in the one case, the digestive fluids are poured out and in the other not, is to go little below the surface, for one asks the reason of this, if it be a fact, as it no doubt is. When we look further into the peculiarities of digestion, etc., we recognize the influence of race as such, and in the race and the individual that obtrusive though ill-understood fact—the force of *habit*—operative here as elsewhere. And there can be little doubt that the habits of animals, as to food eaten and digestive peculiarities established, become organized, fixed, and transmitted to posterity.

It is probably in this way that, in the course of the evolution of the various groups of animals, they have come to vary so much in their choice of diet and in their digestive processes, did we but know them thoroughly as they are; for to assume that even the digestion of mammals can be summed up in the simple way now prevalent seems to us too broad an assumption. The field is very wide, and as yet but little explored.

The law of rhythm is illustrated, both in health and disease, in striking ways in the digestive tract. An animal long accustomed to eat at a certain hour of the day will experience at that time not only hunger, but other sensations, probably referable to secretion of a certain quantity of the digestive juices and to the movements that usually accompany the presence of food in the alimentary tract. Hence that “colic” so common in horses fed at irregular times and unwisely, after excessive work, etc.

It is well known that defecation at periods fixed, even within a few minutes, has become an established habit with hosts of

people; and the same is to a degree true of dogs, etc., kept in confinement, that are taught cleanly habits, and encouraged therein by regular attention to their needs.

This tendency (rhythm) is important in preserving energy for higher ends, for such is the result of the operation of this law everywhere.

The law of correlation, or mutual dependence, is well illustrated in the series of organs composing the alimentary tract.

The condition of the stomach has its counterpart in the rest of the tract; thus, when St. Martin had a disordered stomach, the epithelium of his tongue showed corresponding changes.

We have already referred to the fact that one part may do extra work to make up for the deficiencies in another.

It is confidently asserted of late that, in the case of persons long unable to take food by the mouth, nutritive substances given by enemata find their way up to the duodenum by anti-peristalsis. Here, then, is an example of an acquired adaptive arrangement under the stress of circumstances.

It can not be too much impressed on the mind that in the complicated body of the mammal the work of any one organ is constantly varying with the changes elsewhere. It is this mutual dependence and adaptation—an old doctrine too much left out of sight in modern physiology—which makes the attempt to *completely* unravel vital processes well-nigh hopeless; though each accumulating true observation gives a better insight into this kaleidoscopic mechanism.

We have not attempted to make any statements as to the quantity of the various secretions discharged. This is large, doubtless, but much is probably reabsorbed, either altered or unaltered, and used over again. In the case of *fistulæ*, the conditions are so unnatural that any conclusions as to the normal quantity from the data they afford must be highly unsatisfactory. Moreover, the quantity must be very variable, according to the law we are now considering. It is well known that dry food provokes a more abundant discharge of saliva, and this is doubtless but one example of many other relations between the character of the food and the quantity of secretion provided.

Evolution.— We have from time to time either distinctly pointed out or hinted at the evolutionary implications of the

facts of this department of physiology. The structure of the digestive organs, plainly indicating a rising scale of complexity with greater and greater differentiation of function, is, beyond question, an evidence of evolution.

The law of natural selection and the law of adaptation, giving rise to new forms, have both operated, we may believe, from what can be observed going on around us and in ourselves. The occurrence of transitional forms, as in the epithelium of the digestive tract of the frog, is also in harmony with the conception of a progressive evolution of structure and function. But the limits of space will not permit of the enumeration of details.

Summary.—A very brief *résumé* of the subject of digestion will probably suffice.

Food is either organic or inorganic and comprises proteids, fats, carbohydrates, salts, and water ; and each of these must enter into the diet of all known animals. They must also be in a form that is digestible. Digestion is the reduction of food to such a form that it may be further dealt with by the alimentary tract prior to being introduced into the blood (absorption). This is effected in different parts of the tract, the various constituents of food being differently modified, according to the secretions there provided, etc. The digestive juices contain essentially ferments which act only under definite conditions of chemical reaction, temperature, etc.

The changes wrought in the food are the following: starches are converted into sugars, proteids into peptones, and fats into fatty acids, soaps, and emulsion ; which alterations are effected by ptyalin and amylopsin, pepsin and trypsin, and bile and pancreatic steapsin, respectively.

Outside the mucous membrane containing the glands are muscular coats, serving to bring about the movements of the food along the digestive tract and to expel the feces, the circular fibers being the more important. These movements and the processes of secretion and so-called absorption are under the control of the nervous system.

The preparation of the digestive secretions involves a series of changes in the epithelial cells concerned, which can be distinctly traced, and take place in response to nervous stimulation.

These we regard as inseparably bound up with the healthy life of the cell. To be natural, it must secrete.

The blood-vessels of the stomach and intestine and the villi of the latter receive the digested food for further elaboration (absorption). The undigested remnant of food and the excretions of the intestine make up the fæces, the latter being expelled by a series of co-ordinated muscular movements essentially reflex in origin.

THE RESPIRATORY SYSTEM.

IN the mammal the breathing organs are lodged in a closed cavity, separated by a muscular partition from that in which the digestive and certain other organs are contained. This thoracic chamber may be said to be reserved for circulatory and respiratory organs which, we again point out, are so related that they really form parts of one system.

The mammal's blood requires so much aëration (ventilation) that the lungs are very large and the respiratory system has become greatly specialized. We no longer find the skin or alimentary canal taking any large share in the process; and the lungs and the mechanisms by which they are made to move the gases with which the blood and tissues are concerned become very complicated.

Our studies of muscle physiology should have made clear the fact that tissue-life implies the constant consumption of oxygen and discharge of carbonic anhydride, and that the processes which give rise to this are going on at a rapid rate; so that the demands of the animal for oxygen constantly may be readily understood if one assumes, what can be shown, though less readily than in the case of muscle, that all the tissues are constantly craving, as it were, for this essential oxygen—well called "vital air."

Respiration may, then, be regarded from a physical and chemical point of view, though in this as in other instances we must be on our guard against regarding physiological processes as ever purely physical or purely chemical. The respiratory process in the mammal, unlike the frog, consists of an active and a (largely) passive phase. The air is not pumped into the lungs, but sucked in. So great is the complexity of the lungs in the mammal, that the frog's lung (which may be readily understood by blowing it up by inserting a small pipe in the glottic opening of the animal and then ligaturing the distended

organ) may be compared to a single infundibulum of the mammalian lung.

Assuming that the student is somewhat conversant with the coarse and fine anatomy of the respiratory organs, we call at-

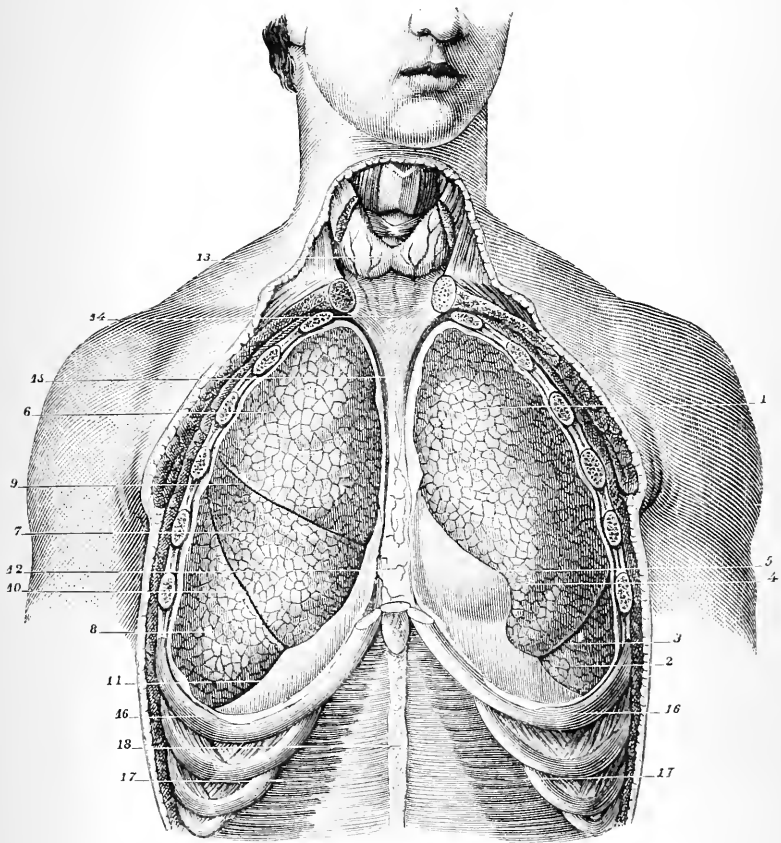

FIG. 289.—Lungs, anterior view (Sappey). 1, upper lobe of left lung; 2, lower lobe; 3, fissure; 4, notch corresponding to apex of heart; 5, pericardium; 6, upper lobe of right lung; 7, middle lobe; 8, lower lobe; 9, fissure; 10, fissure; 11, diaphragm; 12, anterior mediastinum; 13, thyroid gland; 14, middle cervical aponeurosis; 15, process of attachment of mediastinum to pericardium; 16, 16, seventh ribs; 17, 17, transversales muscles; 18, linea alba.

tention to the physiological aspects of some points in their structure. The lungs represent a membranous expansion of

great extent, lined with flattened cells and supporting innumerable capillary blood-vessels. The air is admitted to the com-

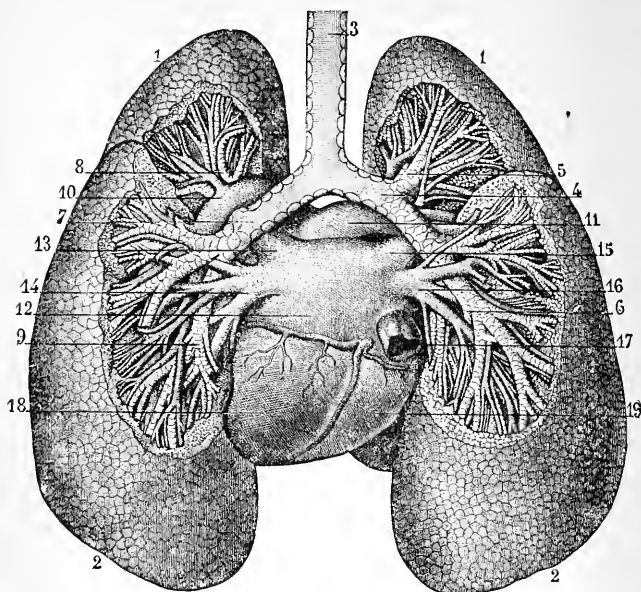

FIG. 290.—Bronchia and lungs, posterior view (Sappey). 1, 1, summit of lungs; 2, 2, base of lungs; 3, trachea; 4, right bronchus; 5, division to upper lobe of lung; 6, division to lower lobe; 7, left bronchus; 8, division to upper lobe; 9, division to lower lobe; 10, left branch of pulmonary artery; 11, right branch; 12, left auricle of heart; 13, left superior pulmonary vein; 14, left inferior pulmonary vein; 15, right superior pulmonary vein; 16, right inferior pulmonary vein; 17, inferior vena cava; 18, left ventricle of heart; 19, right ventricle.

plicated foldings of this membrane by tubes which remain, throughout the greater part of their extent, open, being composed of cartilaginous rings, completed by soft tissues, of which plain muscle-cells form an important part, serving to maintain a tonic resistance against pulmonary and bronchial pressure, as well as serving to aid in the act of coughing, etc., so important in expelling foreign bodies or preventing their ingress.

The bronchial tubes are lined with a mucous membrane, kept moist by the secretions of its glands, and covered with ciliated epithelium, as are also the nasal passages, which, by the outward currents they create, favor diffusion of gases and removal of excess of mucus. The thoracic walls and the lungs

themselves are covered with a tough but thin membrane lined with flattened cells, which secrete a small quantity of fluid that serves to maintain the surrounding parts in a moist con-

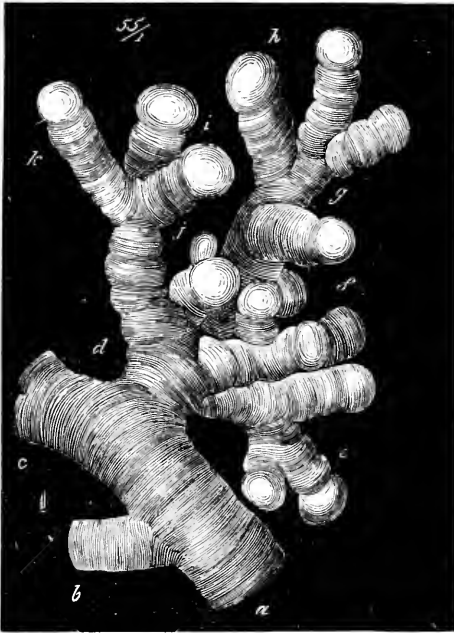

FIG. 291.—Mold of a terminal bronchus and a group of air-cells moderately distended by injection, from the human subject (Robin).

dition, thus lessening friction. The importance of this arrangement is well seen when, in consequence of inflammation of this pleura, it becomes dry, giving rise during each respiratory movement to a friction-sound and a painful sensation. It will not be forgotten that this membrane extends over the diaphragm, and that, in consequence of the lungs completely filling all the space (not occupied by other organs) during every position of the chest-walls, the costal and pulmonary pleural surfaces are in constant contact. By far the greater part of the lung-substance consists of elastic tissue, thus adapting the principal respiratory organs to that amount of distention and recoil to which they are ceaselessly subjected during the entire lifetime of the animal.

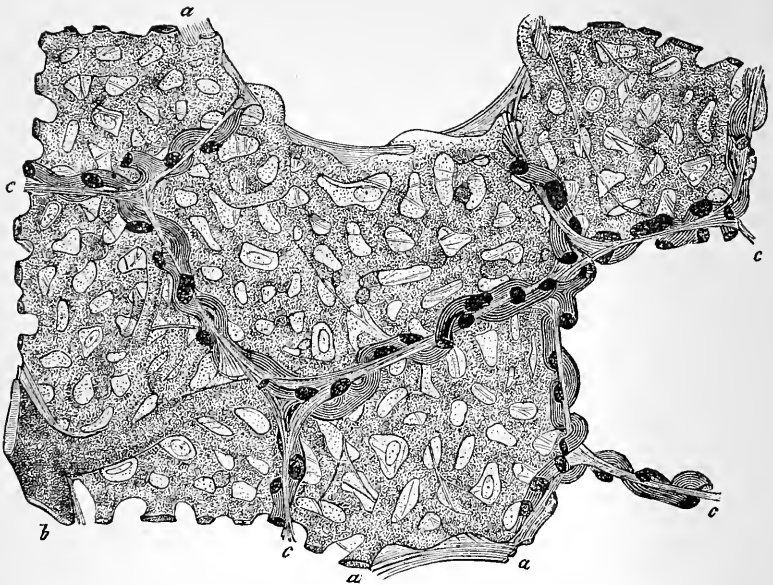

FIG. 292.—Section of the parenchyma of the human lung, injected through the pulmonary artery (Schulze). *a, a, a, c, c, c,* walls of the air-cells; *b,* small arterial branch.

THE ENTRANCE AND EXIT OF AIR.

Since the lungs fill up so completely the thoracic cavity, manifestly any change in the size of the latter must lead to an increase or diminution in the quantity of air they contain. Since the air within the respiratory organs is being constantly robbed of its oxygen, and rendered impure by the addition of carbonic dioxide, the former must be renewed and the latter expelled; and, as mere diffusion takes place too slowly to accomplish this in the mammal, this process is assisted by the nervous system setting certain muscles at work to alter the size of the chest cavity. Because of the ribs being placed obliquely, it follows that their elevation will result in the enlargement of the thoracic cavity in the antero-posterior diameter; and, as the chest, in consequence, gets wider from above downward, also in the transverse diameter; which is moreover assisted by the eversion of the lower borders of the ribs; and, if the convexity of the diaphragm were diminished by its contraction and consequent descent, it would follow that the chest would be increased in

the vertical diameter also. All these events, favorable to the entrance of air, actually take place through agencies we must now consider. The student is recommended to look into the insertion, etc., of the muscles concerned, to which we can only briefly refer. We have made the descriptions and cuts applicable to man, so that it may be easy for the student to verify all essential points on his own person. Respiration in our domestic animals is in the main as in man.

The act of inspiration commences by the fixation of the uppermost ribs, beginning with the first two, by means of the

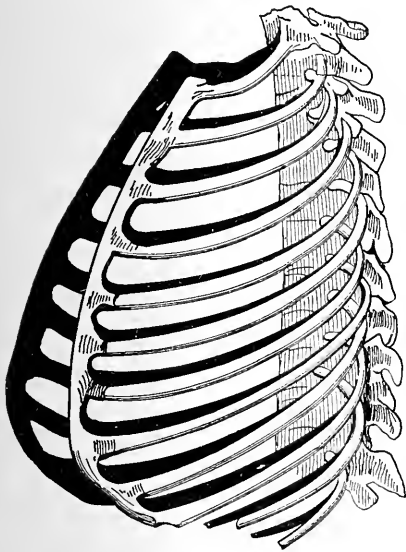

FIG. 293.



FIG. 294.

FIG. 293.—Diagram illustrating elevation of ribs in inspiration (Béclard). The dark lines represent the ribs, sternum, and costal cartilages in inspiration.

FIG. 294.—Diagrammatic representation of action of diaphragm in respiration (Hermann). Vertical section through second rib on right side. The broken and dotted lines show the amount of the descent of the diaphragm in ordinary and in deep inspiration.

scaleni muscles, this act being followed up by the contraction of the external intercostals, leading to the elevation of the other ribs; at the same time, the arch of the diaphragm descends in consequence of the contraction of its various muscular bundles. Under these circumstances, the air from without must rush in, or a vacuum be formed in the thoracic cavity; and, since there

is free access for the air through the glottic opening, the lungs are of necessity expanded. This ingoing air has had to overcome the elastic resistance of the lungs, which amounts to about

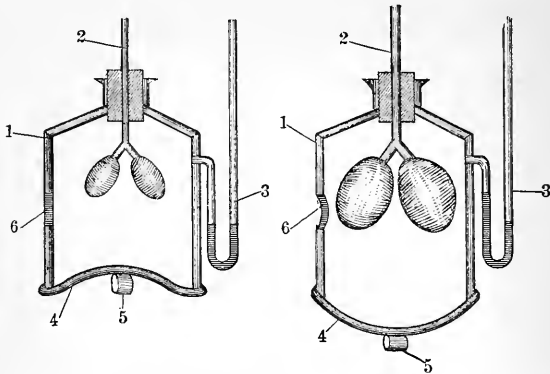

FIG. 295.—Apparatus to illustrate relations of intra-thoracic and external pressures (after Beannis). A glass bell-jar is provided with a light stopper, through which passes a branching glass tube fitted with a pair of elastic bags representing lungs. The bottom of the jar is closed by rubber membrane representing diaphragm. A mercury manometer indicates the difference in pressure within and without the bell-jar. In left-hand figure it will be seen that these pressures are equal; in right (inspiration), the external pressure is considerably greater. At one part (6) an elastic membrane fills a hole in jar, representing an intercostal space.

five millimetres of mercury in man, as ascertained by tying a manometer in the windpipe of a dead subject, and then opening the thorax to equalize the inside and outside pressures, when the lungs at once collapse and the manometer shows a rise of the mercury to the extent indicated above. To this we must add the influence of the tonic contraction of the bronchial muscles before referred to, though this is probably not very great.



FIG. 296.—Dorsal view of four vertebrae and three attached ribs, showing attachment of elevator muscles of ribs and intercostals (after Allen Thomson). 1, long and short elevators; 2, external intercostal; 3, internal intercostal.

That there are variations of intrapulmonary pressure may be ascertained by connecting a manometer with one nostril—the other being closed—or with the windpipe. The mercury shows a negative pressure with each inspiratory, and a positive

with each expiratory act. This may amount to from 30 to 70 millimetres with strong inspiration, and 60 to 100 in forcible expiration.

When inspiration ceases, the elastic recoil of the rib cartilages and the ribs themselves, and of the sternum, the weight of these parts and that of the attached muscles, etc., assists in the return of the chest to its original position, entirely independently of the action of muscles. Moreover, with the descent of the diaphragm the abdominal viscera have been thrust down and compressed together with their included gases; when this muscle relaxes, they naturally exert an upward pressure. Putting these events together, it is not difficult to understand why the air should be squeezed out of the lungs, the elasticity of which latter is, as we have shown, an important factor in itself.

The Muscles of Respiration.—The *diaphragm* may be considered the most important single respiratory muscle, and can of itself maintain respiration. The *scaleni* are important as fixators of the ribs; the *levatores costarum* and *external intercostals*, as normal elevators. The *quadratus lumborum* assists the diaphragm by fixing the last rib. These, with the *serratus posticus superior*, may be regarded as the principal muscles called into action in an *ordinary* inspiration. The muscles used in an ordinary expiratory act are the *internal intercostals*, the *triangularis sterni*, and *serratus posticus inferior*. In forced inspiration the lower ribs are drawn down and retracted, giving support in their fixed position to the diaphragm. The *scaleni*, *pectorales*, *serratus magnus*, *latissimus dorsi*, and others are called into action; but when dyspnoea becomes extreme, as in one with a fit of asthma, nearly all the muscles of the body may be called into play, even the muscles of the face,

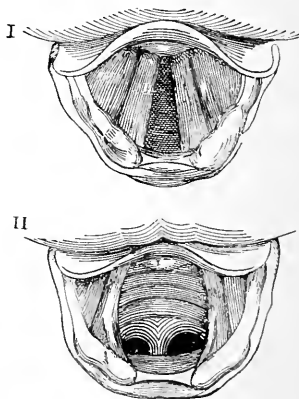

FIG. 297.—Laryngoscopic views of the glottis, etc. (after Quain and Czermak). I. Larynx in quiet breathing. II. During a deep inspiration. In this case the rings of the trachea and commencement of bronchi are visible. Such a condition is persistent in many forms of disease in which respiration is attended with difficulty.

which are not normally active at all or but very slightly in natural breathing.

Facial and laryngeal respiration is best seen in such animals as the rabbit, and it is this condition which is approximated in disordered states in man—in fact, when from any cause inspiration is very labored (asthma, diphtheria, etc.).

In man and most mammals, unlike the frog, the glottic opening is never entirely closed during any part of the respiratory act, though it undergoes a rhythmical change of size,

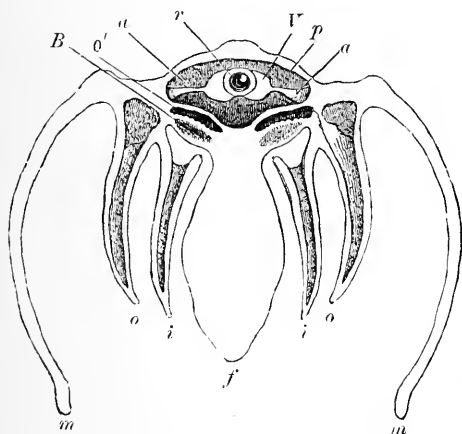

FIG. 298.

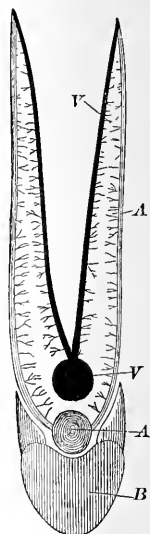

FIG. 299.

FIG. 298.—Vertical transverse section of fresh-water mussel (*Anodon*) through heart (after Huxley). V, ventricle; a, auricles; r, rectum; p, pericardium; i, inner, o, outer gill; o', vestibule of organ of Bojanus; B; f, foot; m, m, mantle lobes.

FIG. 299.—Gill of fish (perch), to illustrate relations of different blood-vessels, etc., concerned in respiration (after Bell). A, branchial artery; B, branchial arch seen in cross-section; V, branchial vein; a, v, branches of artery and vein respectively.

widening during inspiration and narrowing during expiration, in accordance with the action of the muscles attached to the arytenoid cartilages, the action of which may be studied in man by means of the laryngoscope.

The abdominal muscles have a powerful rhythmical action during forced respiration, though whether they function dur-

ing ordinary quiet breathing is undetermined; if at all, probably but slightly. Though the removal of the external intercostals in the dog and some other animals reveals the fact that the internal intercostals contract alternately with the dia-

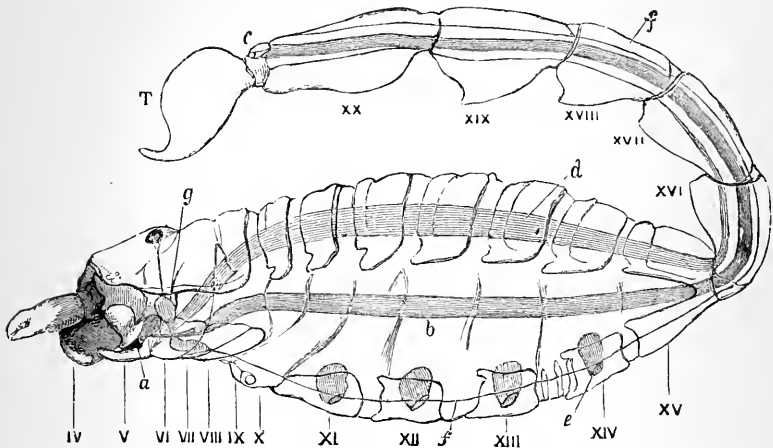

FIG. 300.—Diagram of scorpion, most of the appendages having been removed (after Huxley). *a*, mouth; *b*, alimentary tract; *c*, anus; *d*, heart; *e*, pulmonary sac; *f*, position of ventral ganglionated cord; *g*, cerebral ganglia; *T*, telson. VII—XX, seventh to twentieth somite. IV, V, VI, basal joints of pedipalpi and two following pairs of limbs.

phragm, it must not be regarded as absolutely certain that such is their action when their companion muscles are present, for Nature has more ways than one of accomplishing the same purpose—a fact that seems often to be forgotten in reasoning from experiments. This result, however, carries some weight with it.

Types of Respiration.—There are among mammals two principal types of breathing recognizable—the costal (thoracic) and abdominal—according as the movements of the chest or the abdomen (diaphragm) are the more pronounced.

Personal Observation.—The student would do well at this stage to test the statements we have made in regard to the respiratory movements on the human subject especially. This he can very well do in his own person when stripped to the waist before a mirror. Many of the abnormalities of the forced respiration of disease may be imitated—in fact, this is one of the departments of physiology in which the human aspects may be

examined into by a species of experiment on one's self that is as simple as it is valuable.

Comparative.—It is hoped that the various figures accompanied by descriptions, introduced in this and other chapters, will

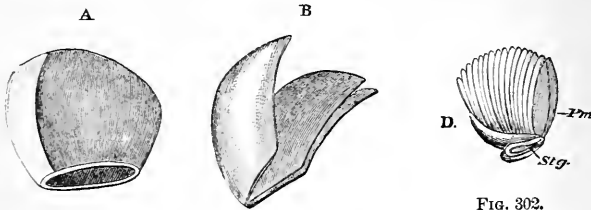

FIG. 301.

FIG. 302.

FIG. 301.—A. Pulmonary sac. B. Respiratory leaflets of *Scorpio occitanus* (after Blanchard).

FIG. 302.—Left pulmonary sac, viewed from dorsal aspect, of a spider (after Dugès). *Pm.* pulmonary lamellæ; *Stg.* stigma, or opening to former.

make the relations of the circulation and respiration in the various classes of animals, whether terrestrial or aquatic, evident

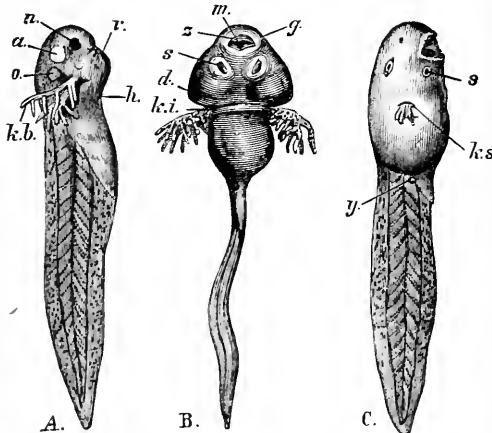

FIG. 303.—A. B. Tadpoles with external branchiæ (after Huxley). *n.* nasal sacs; *a.* eye; *o.* ear; *k. b.* branchiæ; *m.* mouth; *z.* horny jaws; *s.* suckers; *d.* opercular (or gill) fold. C. More advanced frog's larva. *y.* rudiment of hind-limb; *k. s.* single branchial aperture. Owing to figure not having been reversed, this aperture seems to lie on right instead of left side.

without extended treatment of the subject in the text. What we are desirous of impressing is that throughout the entire animal kingdom respiration is essentially the same process: that

finally it resolves itself into tissue-breathing—the appropriation of oxygen and the excretion of carbon dioxide. Since the manner in which oxygen is intro

into the lungs and foul gases expelled from them in some reptiles and amphibians is largely different from the method of respiration in the mammal, we call attention to this process in an animal readily watched—the common frog. This creature, by depressing the floor of the mouth, enlarges his air-space in this region and consequently the air freely enters through the nostrils; whereupon the latter are closed by a sort of valve, the glottis opened and the air forced into the lungs by the elevation of the floor of the mouth. By a series of flank movements the elasticity of the lungs is aided in expelling the air through the now open nostrils. The respiration of the turtle and some other reptiles is somewhat similar. In the case of aquatic animals,

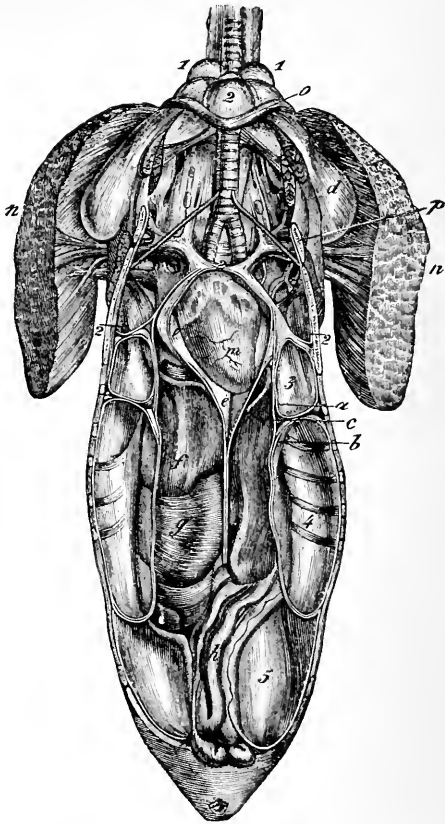

FIG. 304.—General view of air-reservoirs of duck, opened inferiorly, also their relations with principal viscera of trunk (after Sappey). 1, 1, anterior extremity of cervical reservoirs; 2, thoracic reservoir; 3, anterior diaphragmatic reservoir; 4, posterior ditto; 5, abdominal reservoir; *a*, membrane forming anterior diaphragmatic reservoir; *b*, membrane forming posterior ditto; *c*, section of thoraco-abdominal diaphragm; *d*, subpectoral prolongation of thoracic reservoir; *e*, pericardium; *f*, liver; *g*, gizzard; *h*, intestines; *m*, heart; *n, n*, section of great pectoral muscle above its insertion into the humerus; *o*, anterior clavicle; *p*, posterior clavicle of right side cut and turned outward.

both invertebrate and vertebrate, excepting mammals, the blood is freely exposed in the gills to oxygen dissolved in the water as it is to the same gas mixed with nitrogen in terrestrial animals. In the land-snail, land-crab, etc., we have a sort of intermediate condition, the gills being kept moist. It is not to be forgotten, however, that normally the respiratory tract of mammals is never other than slightly moist.

THE QUANTITY OF AIR RESPIRED.

We distinguish between the quantity of air that usually is moved by the thorax and that which may be respired under special effort, which, of course, can never exceed the capacity of the respiratory organs.

Accordingly, we recognize: 1. *Tidal air*, or that which passes in and out of the respiratory passages in ordinary quiet breathing, amounting to about 500 cc., or thirty cubic inches. 2. *Complemental air*, which may be voluntarily inhaled by a forced inspiration in addition to the tidal air, amounting to 1,500 cc., or about 100 cubic inches. 3. *Supplemental (reserve) air*, which may be expelled at the end of a normal respiration—i. e., after the expulsion of the tidal air, and which represents the quantity usually left in the lungs after a normal quiet expiration, amounting to 1,500 cc. 4. *Residual air*, which can not be voluntarily expelled at all, amounting to about 2,000 cc., or 120 cubic inches. Although these quantities have been estimated for man, probably a similar relation (proportion) between them holds for the domestic animals.

The *vital capacity* is estimated by the quantity of air that may be expired after the most forcible inspiration. This will, of course, vary with the age, which determines largely the elasticity of the thorax, together with sex, position, height, and a variety of other circumstances. But, inasmuch as the result may be greatly modified by practice, like the power to expand the chest, the vital capacity is not so valuable an indication as might at first be supposed.

It is important to bear in mind that the tidal air is scarcely more than sufficient to fill the upper air-passages and larger bronchi, so that it requires from five to ten respirations to remove a quantity of air inspired by an ordinary act. Very much must, therefore, depend on diffusion, the quantity of air remaining in the lungs after each breath being the sum of the residual

and reserve air, or about 3,500 cc. (220 cubic inches). Considering the creeping slowness of the capillary circulation, it would not be supposed that the respiratory process in its essential parts should be the rapid one that a greater movement of the air would imply.

THE RESPIRATORY RHYTHM.

In man, and most of our domestic mammals, a definite though somewhat different relation between the cardiac and respiratory movements obtains, there being about three to five heart-beats to one respiration, which would make the rate of breathing in man about sixteen to eighteen per minute. Usually, of course, the largest animals have the slower pulse and respiration; and this is an invariable rule for the varieties of a species, as observable in the canine race, to mention a well-known instance. The horse breathes 9 to 12 times in a minute; the ox 15 to 20; the sheep 13 to 17; and the dog 15 to 20.

The rate of the respiratory movements is to some extent a measure of the rapidity of the oxidative processes in the body, as witness the slow and intermittent breathing of cold-blooded animals as compared with the more rapid respiration of birds and mammals (Fig. 305).

Pathological.—Any condition that lessens the amount of respiratory surface, or diminishes the mobility of the chest-walls, is usually accompanied by accelerated movements, but beneath this is the demand for oxygen, part of the avenues by which this gas usually enters having been closed or obstructed by the disease. So that it is not surprising that, in consequence of the effusion of fluid into the thoracic cavity, leading to the compression of the lung, the opposite one should be called into more frequent use, and even enlarge to meet the demand. These facts show how urgent is the need for constant ventilation of the blood, and at the same time how great is the power of adaptation to meet the emergency.

The difference between the inspiratory and the expiratory rhythm may be gathered by watching the movements of the bared chest, or more accurately from a graphic record. It is usually considered that expiration is only slightly longer than inspiration, and that any marked deviation from this relation should arouse suspicion of disease. Normally the respiratory pause is very slight, so that inspiration seems to follow directly

on expiration; though the latter act reminds us of the prolongation of the ventricular systole after the blood is expelled.

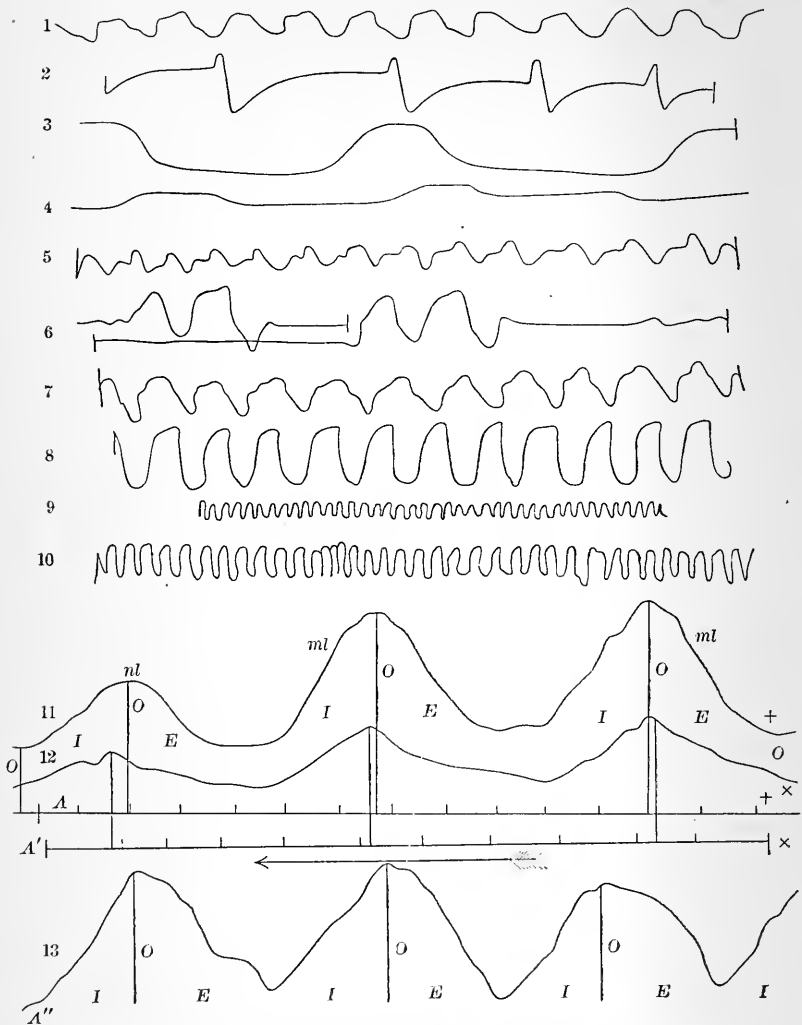

FIG. 305.—Tracings of respiratory movements of individuals belonging to different groups of the animal kingdom (after Thanoffler). Differences in depth, frequency, and especially regularity, are very noticeable. 1, fish; 2, tortoise; 3, adder (in winter); 4, boa-constrictor (in summer); 5, frog; 6, alligator; 7, lizard; 8, canary-bird; 9, adult dog; 10, rabbit; 11, man; 12, dog; 13, horse. Compare these, and note that in *ml* respiration is shallow, and in *ml* deep.

If, in the tracing, the small waves on the upper part of the expiratory curve really represent the effect of the heart-beat, it makes it easier to understand how such might assist in ventilating the blood when the respirations occur only once in a considerable interval and very feebly then, as in hibernating animals or individuals that have fainted; though it must be remembered that diffusion is a ceaseless process in all living vertebrates.



FIG. 306.—Tracings of respiration of horse when at rest and after exercise (after Than-hoffer). *I*, inspiration; *E*, expiration. Spaces between vertical lines indicate time periods of one second each. 1, animal standing at rest; 3, after walk of few minutes; 7 and 8, after trotting; 9, after a brief rest; 11, after trotting and running for some minutes; 17, after resting from last for a short time; 51, tracing at end of experiment.

It is scarcely necessary to point out that the respiratory movements are increased by exercise, emotions, position, season, hour of the day, taking meals, etc.

Respiratory Sounds.—The entrance and exit of air are accompanied by certain sounds, which vary with each part of the

respiratory tract. To these sounds names have been given, but as they are somewhat inconstant in their application, or at least have several synonyms, we pass them by, recommending the student to actually learn the nature of the respiratory murmurs by listening to the normal chest in both man and the lower animals. With the use of a double stethoscope he may practice upon himself, though not so advantageously as in the case of the heart.

The sounds are caused in part by the friction of the air, though they are probably complex, several factors entering into their causation.

COMPARISON OF THE INSPIRED AND EXPIRED AIR.

The changes that take place in the air respired may be briefly stated as follows:

1. Whatever the condition of the inspired air, that expired is about saturated with aqueous vapor—i. e., it contains all that it is capable of holding at the existing temperature.

2. The temperature of the expired air is about that of the blood itself, so that if the air is very cold when breathed, the body loses a great deal of its heat in warming it. The expired air of the nasal passages is slightly warmer than that of the mouth.

3. Experiment shows that the expired air is really diminished in volume to the extent of from one fortieth to one fiftieth of the whole. Since two volumes of carbonic anhydride require for their composition two volumes of oxygen, if the amount of the former gas expired be not equal to the amount of oxygen inspired, some of the latter must have been used to form other combinations. $\frac{\text{CO}_2}{\text{O}}$, amounting to rather less than 1, is called the respiratory coefficient.

4. The difference between inspired and expired air in man may be gathered from the following:

	Oxygen.	Nitrogen.	Carbonic dioxide.
Inspired air.....	20.810	79.150	0.040
Expired air.....	16.033	79.587	4.380

From which the most important conclusions to be drawn are, that the expired air is poorer in oxygen to the extent of 4 to 5 per cent, and richer in carbonic anhydride to somewhat

less than this amount. A similar relationship may be considered to hold for the domestic animals, the quantities varying, of course.

From experiment it has been ascertained that the amount of carbonic dioxide is for the average man 800 grammes (406 litres, equivalent to 218.1 grammes carbon) daily, the oxygen actually used for the same period being 700 grammes. But the variations in such cases are very great, so that these numbers must not be interpreted too rigidly. Experience proves that, while chemists often work in laboratories in which the percentage of carbonic anhydride (from chemical decompositions) reaches 5 per cent, an ordinary room in which the amount of this gas reaches 1 per cent is entirely unfit for occupation. This is not because of the amount of the carbon dioxide present, but of other impurities which seem to be excreted in proportion to the amount of this gas, so that the latter may be taken as a measure of these poisons.

What these are is as yet almost entirely unknown, but that they are poisons is beyond doubt. Small effete particles of once living protoplasm are carried out with the breath, but these other substances are got rid of from the blood by a vital process of secretion (excretion), we must believe; which shows that the lungs to some degree play the part of glands, and that their whole action is not to be explained as if they were merely moistened bladders acting in accordance with ordinary physical laws.

An estimation of the amount of atmospheric air required may be calculated from data already given.

Thus, assuming that a man gives up at each breath 4 per cent of carbon dioxide to the 500 cc. of tidal air he expires, and breathes, say, seventeen times a minute, we get for the amount of air thus charged in one hour to the extent of 1 per cent:

$$500 \times 4 \times 17 \times 60 = 2,040,000 \text{ cc., or } 2,040 \text{ litres.}$$

But if the air is to be contaminated to the extent of only $\frac{1}{10}$ per cent of carbonic anhydride, the amount should equal at least $2,040 \times 10$ hourly. A very much larger quantity would, of course, be required for a horse or an ox.

RESPIRATION IN THE BLOOD.

It may be noticed that arterial blood kept in a confined space grows gradually darker in color, and that the original bright-scarlet hue may be restored by shaking it up with air. When

the blood has passed through the capillaries and reached the veins, the color has changed to a sort of purple, characteristic of venous blood. Putting these two facts together, we are led to suspect that the change has been caused in some way by oxygen. Exact experiments with an appropriate form of blood-pump show that from one hundred volumes of blood, whether arterial or venous, about sixty volumes of gas may be obtained: that this gas consists chiefly of oxygen and carbonic anhydride, but that the proportions of each present depends upon whether the blood is arterial or venous.

The following table will make this clear:

	Oxygen.	Carbonic anhydride.	Nitrogen.
Arterial blood	20	40	1-2
Venous blood	8-12	46	1-2

from 100 volumes of blood at 0° C. and 760 millimetre pressure.

Arterial blood, then, contains 8 to 12 per cent more oxygen and about 6 per cent more carbonic dioxide than venous blood. It is not, of course, true, as is sometimes supposed, that arterial blood is "pure blood" in the sense that it contains no carbonic anhydride, as in reality it always carries a large percentage of this gas.

The Conditions under which the Gases exist in the Blood.—

If a fluid, as water, be exposed to a mixture of gases which it can absorb under pressure, it is found that the amount taken up depends on the quantity of the particular gas present independent of the presence or quantity of the others; thus, if water be exposed to a mixture of oxygen and nitrogen, the quantity of oxygen absorbed will be the same as if no nitrogen were present—i. e., the absorption of a gas varies with the *partial pressure* of that gas in the atmosphere to which it is exposed. But whether blood, deprived of its gases, be thus exposed to oxygen under pressure, or whether the attempt be made to remove this gas from arterial blood, it is found that the above-stated law does not apply.

When blood is placed under the exhaustion-pump, at first very little oxygen is given off; then, when the pressure is considerably reduced, the gas is suddenly liberated in large quantity, and after this comparatively little. A precisely analogous course of events takes place when blood deprived of its oxygen is submitted to this gas under pressure. On the other hand, if these experiments be made with *serum*, absorption follows

according to the law of pressures. Evidently, then, if the oxygen is merely dissolved in the blood, such solution is peculiar, and we shall presently see that this supposition is neither necessary nor reasonable.

HÆMOGLOBIN AND ITS DERIVATIVES.

Hæmoglobin constitutes about $\frac{9}{10}$ of the corpuscles, and, though amorphous in the living blood-cells, may be obtained in crystals, the form of which varies with the animal; indeed, in many animals this substance crystallizes spontaneously on the death of the red cells. It is unique among albuminous compounds in being the only one found in the animal body that is susceptible of crystallization. Its estimated composition is:

Carbon	53·85
Hydrogen	7·32
Nitrogen	16·17
Oxygen.....	21·84
Iron.....	·43
Sulphur	·39

together with 3 to 4 per cent of water of crystallization.

The formula assigned is: $C_{600}H_{960}O_{179}N_{154}FeS_3$. The molecular constitution is not known, and the above formula is merely an approximation, which will, however, serve to convey an idea of the great complexity of this compound. The presence of iron seems to be of great importance. If not the essential respiratory constituent, certainly the administration of this metal in some form proves very valuable when the blood is deficient in hæmoglobin.

This substance can be recognized most certainly by the spectroscope. The appearances vary with the strength of the solution, and, as this test for blood (hæmoglobin) is of much practical importance, it will be necessary to dwell a little upon the subject; though, after a student has once recognized clearly the differences of the spectrum appearances, he has a sort of knowledge that no verbal description can convey. This is easily acquired. One only needs a small, flat-sided bottle and a pocket-spectroscope. Filling the bottle half full of water, and getting the spectroscope so focused that the Fraunhofer lines appear distinctly, blood, blood-stained serum, a solution of hæmoglobin crystals, or the essential substance in any form of dilute

solution, may be added drop by drop till changes in the spectrum in the form of dark bands appear. By gradually increasing

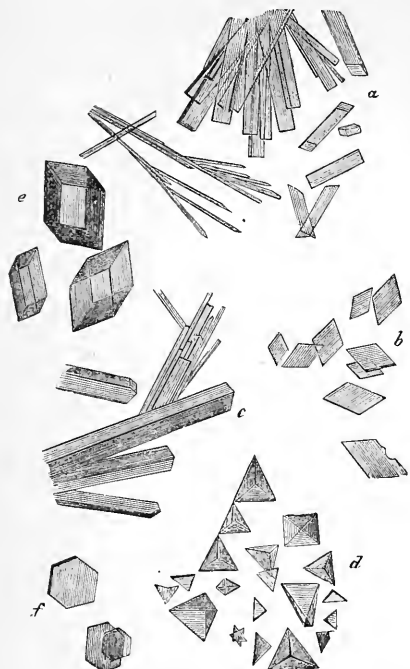

FIG. 307.—Crystallized hæmoglobin (Gantier). *a*, *b*, crystals from venous blood of man; *c*, from blood of cat; *d*, of Guinea-pig; *e*, of marmot; *f*, of squirrel.

the quantity, appearances like those figured below may be observed, though, of course, much will depend on the thickness of the layer of fluid as to the quantity to be added before a particular band comes into view.

When wishing to be precise, we speak of the most highly oxidized form of hæmoglobin as oxy-hæmoglobin (O-H), and the reduced form as hæmoglobin simply, or reduced hæmoglobin(H).

By a comparison of the spectra it will be seen that the bands of oxy-hæmoglobin lie between the *D* and *E* lines; that the left band near *D* is always the most definite in outline and the most pronounced in every respect except breadth; that it is in weak solutions the first to appear, and the last to disappear on reduction; that there are two instances in which there may be a single band from hæmoglobin—in the one case when the solution is very dilute and when it is very concentrated. These need never be mistaken for each other nor for the band of reduced hæmoglobin. The latter is a hazy broad band with comparatively indistinct outlines, and darkest in the middle.

It will be further noticed that in all these instances, apart from the bands, the spectrum is otherwise modified at each end, so that the darker the more centrally placed characteristic bands, the more is the light at the same time cut off at each end of the spectrum.

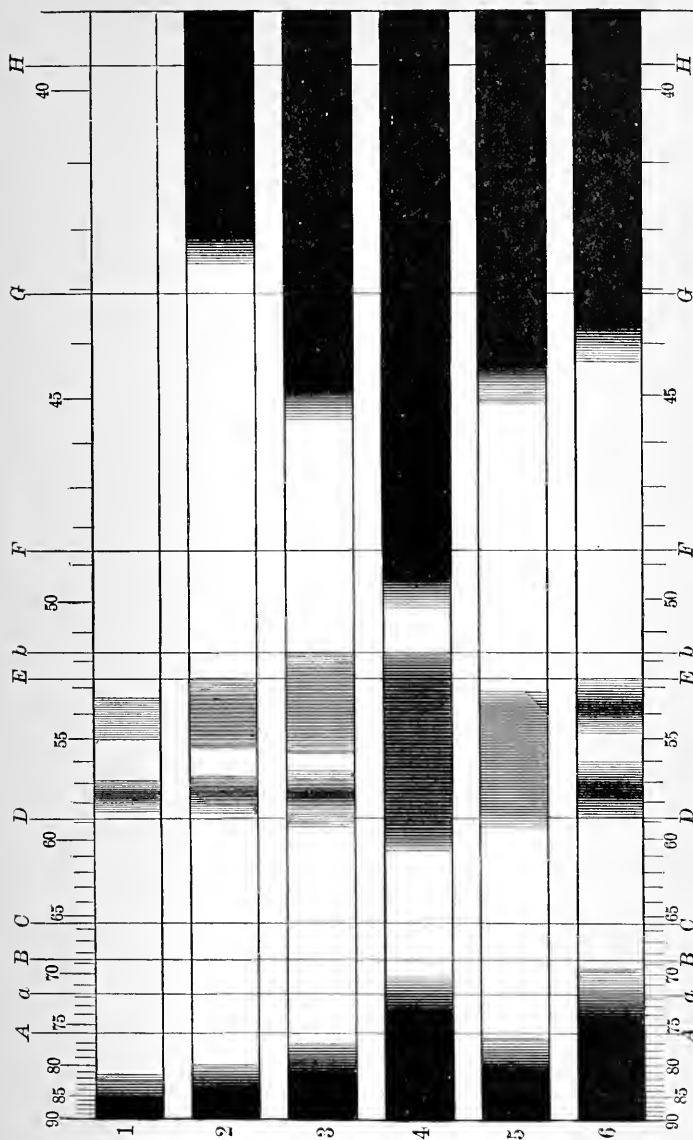

FIG. 308.—The spectra of oxy-haemoglobin in different grades of concentration, of (reduced) haemoglobin, and of carbonic oxide haemoglobin (after Preyer and Gamgee). 1, solution of oxy-haemoglobin containing less than 0.01 per cent; 2, solution of oxy-haemoglobin containing 0.09 per cent; 3, solution of oxy-haemoglobin containing 0.37 per cent; 4, solution of oxy-haemoglobin containing 0.8 per cent; 5, solution of (reduced) haemoglobin containing about 0.2 per cent; 6, solution of carbonic-oxide haemoglobin. In each of the six cases the layer brought before the spectroscope was 1 cm. in thickness. The letters (A, B, C, etc.) indicate Fraunhofer's lines, and the figures, wave-lengths expressed in 100,000th of a millimetre.

If, now, to a specimen showing the two bands of oxy-hæmoglobin distinctly a few drops of ammonium sulphide or other reducing agent be added, a change in the color of the solution will result, and the single hazy band characteristic of hæmoglobin will appear.

It is not to be supposed, however, that venous blood gives this spectrum. Even after asphyxia it will be difficult to see this band, for usually some of the oxy-hæmoglobin remains reduced; but it is worthy of note, as showing that the appearances are normal, that the blood, viewed through thin tissues when actually circulating, whether arterial or venous, gives the spectrum of oxy-hæmoglobin. At the same time there can be no doubt that the changes in color which the blood undergoes in passing through the capillaries is due chiefly to loss of oxygen, as evidenced by the experiments before referred to; and the reason that the two bands are always to be seen in venous blood is simply that enough oxy-hæmoglobin remains to give the two-band spectrum which prevails over that of (reduced) hæmoglobin. We are thus led by many paths to the important conclusion that the red corpuscles are oxygen-carriers, and, though this may not be and probably is not their only function, it is without doubt their principal one. Of their oxygen they are being constantly relieved by the tissues; hence the necessity of a circulation of the blood from a respiratory point of view.

There are other gases that can replace oxygen and form compounds with hæmoglobin; hence we have CO-hæmoglobin and NO-hæmoglobin, which in turn are replaced by oxygen with no little difficulty—a fact which explains why carbonic oxide is so fatal when respired, and, as it is a constituent of illuminating gas, the cause of the death of those inhaling the latter is often not far to seek. Blood may, in fact, be saturated with carbonic oxide by allowing illuminating gas to pass through it, when a change of color to a cherry red may be observed, and which will remain in spite of prolonged shaking up with air or attempts at reduction with the usual reagents. Hæmoglobin may be resolved into a proteid (globin) not well understood, and *hæmatin*. This happens when the blood is boiled (perhaps also in certain cases of lightning-stroke), and when strong acids are added. Hæmatin is soluble in dilute acids and alkalies, and has then characteristic spectra. Alkaline hæmatin may be reduced; and, as the iron can be separated, resulting in a change

of color to brownish red, after which there are no longer any reducing effects, it would seem that the oxygen-carrying power and iron are associated. This iron-free hæmatin is named *hæmatoporphyrin* or *hæmatoin*.

Hæmin is hydrochlorate of hæmatin (Teichmann's crystals), and may be formed by adding glacial acetic acid and common salt to blood, dried blood-clot, etc., and heating to boiling. This is one of the best tests for blood, valuable in medico-legal and other cases.

When oxy-hæmoglobin stands exposed to the air, or when diffused in urine, it changes color and becomes, in fact, another substance—*methæmoglobin*, irreducible by other gases (CO, etc.), and not surrendering its oxygen *in vacuo*, though giving it up to ammonium sulphide, becoming again oxy-hæmoglobin, when shaken up with atmospheric air. Its spectrum differs from that of oxy-hæmoglobin in that it has a band in the red end of the spectrum between the *C* and *D* lines. *Hæmatoidin* is sometimes found in the body as a remnant of old blood-clots. It is probably closely allied to if not identical with the *bilirubin* of bile.

Comparative.—While hæmoglobin is the respiratory agent in all the groups of vertebrates, this is not true of the invertebrates. Red blood-cells have as yet been found in but a few species, though hæmoglobin does exist in the blood plasma of several groups, to one of which the earth-worm and several other annelids belong. It is interesting to note that the respiratory compound in certain families of crustaceans, as the common crab, horseshoe-crab (*limulus*), etc., is blue, and that in this substance copper seems to take the place of iron.

The Nitrogen and the Carbon Dioxide of the Blood.—The little nitrogen which is found in about equal quantity in venous and arterial blood seems to be simply dissolved. The relations of carbonic anhydride are much more complex and obscure. The main facts known are that—1. The quantity of this gas is as great in serum as in blood, or, at all events, the quantity in serum is very large. 2. The greater part may be extracted by an exhaustion-pump; but a small percentage (2 to 5 volumes per cent) does not yield to this method, but is given off when an acid is added to the serum. 3. If the entire blood be subjected to a vacuum, the whole of the CO₂ is given off.

From these facts it has been concluded that the greater part of the CO₂, exists in the plasma, associated probably with sodium

salts, as sodium bicarbonate, but that the corpuscles in some way determine its relations of association and disassociation. Some think a good deal of this gas is actually united with the red corpuscles.

We may now inquire into the more intimate nature of respiration in the blood. From the facts we have stated it is obvious that respiration can not be wholly explained by the Henry-Dalton law of pressures or any other physical law. It is also plain that any explanation which leaves out the principle of pressure must be incomplete.

While there is in oxy-hæmoglobin a certain quantity of oxygen, which is intra-molecular and incapable of removal by reduction of pressure, there is also a portion which is subject to this law, though in a peculiar way; nor is the question of temperature to be excluded, for experiment shows that less oxygen is taken up by blood at a high than at a low temperature.

We have learned that in ordinary respiration, the proportion of carbonic dioxide and oxygen in different parts of the respiratory tract must vary greatly; the air of necessity being much less pure in the alveoli than in the larger bronchi.

It is customary to speak of the oxygen of oxy-hæmoglobin as being in a state of "loose chemical combination." The entire truth seems to lie in neither view, though both are partially correct. The view entertained by some physiologists, to the effect that diffusion explains the whole matter, so far, at least, as carbonic anhydride is concerned, and that the epithelial cells of the lung have no share in the respiratory process, does not seem to be in harmony either with the facts of respiration or with the laws of biology in general. Why not say at once that the facts of respiration show that, here as in other parts of the economy, while physical and chemical laws, *as we know them*, stand related to the vital processes, yet, by reason of being vital processes, we can not explain them according to the theories of either physics or chemistry? Surely this very subject shows that neither chemistry nor physics is at present adequate to explain such processes. It is, of course, of value to know the circumstances of tension, temperature, etc., under which respiration takes place. We, however, maintain that these are conditions only—essential no doubt, but though important, that they do not make up the process of respiration. But, because we do not know the real explanation, let us not exalt a few

facts or theories of chemistry or physics into a solution of a complex problem. Besides, some of the experiments on which the conclusions have been based are questionable, inasmuch as they seem to induce artificial conditions in the animals operated upon; and we have already insisted on the blood being regarded as a living tissue, behaving differently in the body and when isolated from it, so that even in so-called blood-gas experiments there may be sources of fallacy inherent in the nature of the case.

Foreign Gases and Respiration.—These are divided into:

1. *Indifferent gases*, as N, H, CH₄, which though not in themselves injurious, are entirely useless to the economy.

2. *Poisonous gases*, fatal, no matter how abundant the normal respiratory food may be. They are divisible into: (a) those that kill by displacing oxygen, as NO, CO, HCN; (b) *narcotic gases*, as CO₂, N₂O, producing asphyxia when present in large quantities; (c) *reducing gases*, as H₂S, (NH₄)₂S, PH₃, AsH₃, C₂N₂, which rob the hæmoglobin of its oxygen.

There are probably a number of poisonous products, some of them possibly gases, produced by the tissues themselves and eliminated normally by the respiratory tract; and these are doubtless greatly augmented, either in number or quantity, or both, when other excreting organs are disordered.

RESPIRATION IN THE TISSUES.

We first direct attention to certain striking facts:

1. An isolated (frog's) muscle will continue to contract for a considerable period and to exhale carbon dioxide in the total absence of oxygen, as in an atmosphere of hydrogen; though, of course, there is a limit to this, and a muscle to which either no blood flows, or only venous blood, soon shows signs of fatigue. 2. In a frog, in which physiological saline solution has been substituted for blood, the metabolism will continue, carbonic anhydride being exhaled as usual. 3. Substances, which are readily oxidized, when introduced into the blood of a living animal or into that blood when withdrawn undergo but little oxidative change. 4. An entire frog will respire carbonic dioxide for hours in an atmosphere of nitrogen.

Such facts as these seem to teach certain lessons clearly. It is evident, first of all, that the oxidative processes that give rise to carbon dioxide occur chiefly in the *tissues* and not in the

blood; that in the case of muscle the oxygen that is used is first laid by, banked as it were against a time of need, in the form of intra-molecular oxygen, which is again set free in the form of carbon dioxide, but by what series of changes we are quite unable to say. Though our knowledge of the respiratory processes of muscle is greater than for any other tissue, there seems to be no reason to believe that they are essentially different elsewhere. The advantages of this banking of oxygen are, of course, obvious; were it otherwise, the life of every cell must be at the mercy of the slightest interruption of the flow of blood, the entrance of air, etc. Even as it is, the need of a *constant* supply of oxygen in warm-blooded animals is much greater than in cold-blooded creatures, which can long endure almost entire cessation of both respiration and circulation, owing to the comparatively slow rate of speed of the vital machinery.

If one were to rely on mere appearances he might suppose that in the more active condition of certain organs there was less chemical interchange (respiration) between the blood and the tissues than in the resting stage, or, properly speaking, more tranquil stage, for it must be borne in mind that a living cell is never wholly at rest; its molecular changes are ceaseless. It happens, e. g., that when certain glands (salivary) are secreting actively, the blood flowing from them is less venous in appearance than when not functionally active. This is not because less oxygen is used or less abstracted from the blood, but because of the greatly increased speed of the blood-flow, so that the total supply to draw from is so much larger that, though more oxygen is actually used, it is not so much missed, nor do the greater additions of carbon dioxide so rapidly pollute this rapid stream.

It is thus seen that throughout the animal kingdom respiration is fundamentally the same process. It is in every case finally a consumption of oxygen and production of carbonic anhydride by the individual cell, whether that be an *Amœba* or an element of man's brain. These are, however, but the beginning and end of a very complicated biological history of by far the greater part of which nothing is yet known; and it must be admitted that diffusion or any physical explanation carries us but a little way on toward the understanding of it.

THE NERVOUS SYSTEM IN RELATION TO RESPIRATION.

We have considered the muscular movements by which the air is made to enter and leave the lungs in consequence of changes in the diameters of the air-inclosing case, the thorax. It remains to examine into the means by which these muscles were set into harmonious action so as to accomplish the purpose. The nerves supplying the muscles of respiration are derived from the spinal cord, so that they must be under the dominion of central nerve-cells situated either in the cord or the brain. Is the influence that proceeds outward generated within the cells independently of any afferent impulses, or is it dependent on such causes?

A host of facts, experimental and other, show that the central impulses are modified by afferent impulses reaching the center through appropriate nerves. Moreover, drugs seem to act directly on the center through the blood.

The vagus is without doubt *the* afferent respiratory nerve, though how it is affected, whether by the mechanical movement of the lungs, merely, by the condition of the blood as regards its contained gases, or, as seems most likely, by a combination of circumstances into which these enter and are probably the principal, is not demonstrably clear. When others function as afferent nerves, capable of modifying the action of the respiratory center, they are probably influenced by the respiratory condition of the blood, though not necessarily exclusively.

But when all the principal afferent impulses are cut off by division of the nerves reaching the respiratory center directly or indirectly, respiration will still continue, provided the motor nerves and the medulla remain intact.

The center, then, is not mainly at least, a reflex but an automatic one, though its action is modified by afferent impulses reaching it from every quarter.

It has been argued that there are both inspiratory and expiratory centers in the spinal cord, but this can not yet be regarded as established. But, as we have pointed out, on more than one occasion, we must always be on our guard in interpreting the behavior of one part when another is out of gear.

The Influence of the Condition of the Blood in Respiration.—If for any reason the tissues are not receiving a due supply of oxygen, they manifest their disapproval, to speak figuratively,

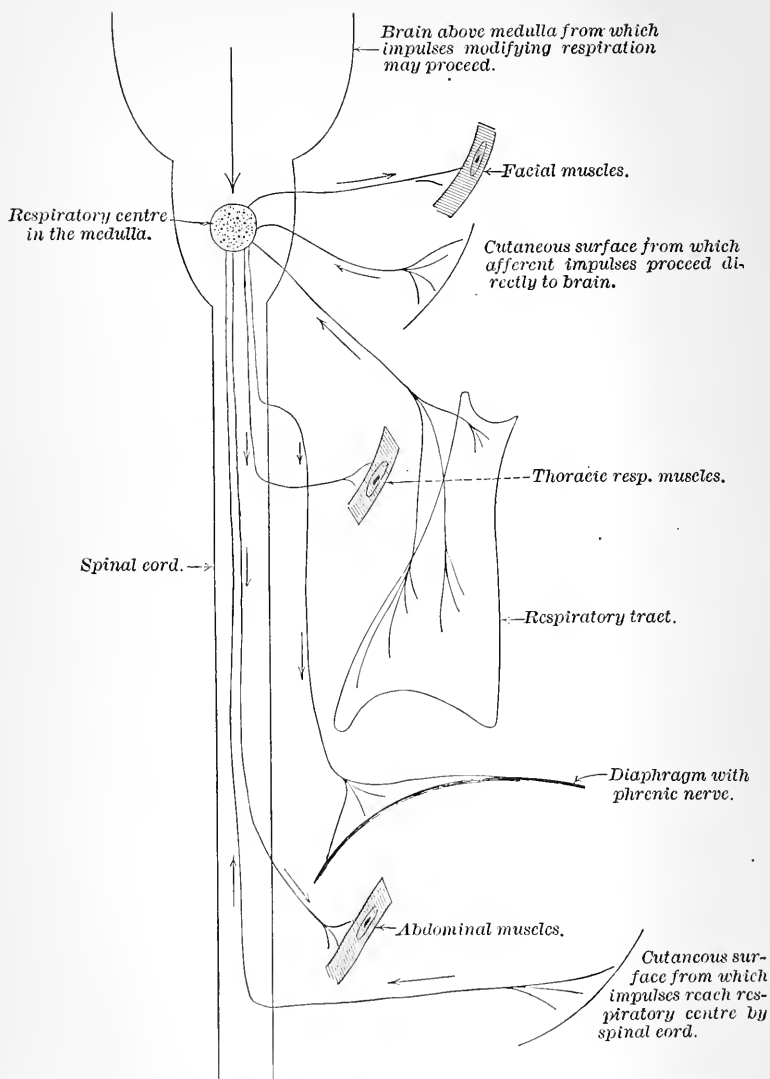

FIG. 309.—Diagram intended to illustrate nervous mechanism of respiration. Arrows indicate course of impulses.

by reports to the responsible center in the medulla, and if the medulla is a sharer in the lack, as it naturally would be, it takes action independently. One of the most obvious instances in which there is oxygen starvation is when there is hindrance to the entrance of air, owing to obstruction in the respiratory tract.

At first the breathing is merely accelerated, with perhaps some increase in the depth of the inspirations (*hyperpnœa*), a stage which is soon succeeded by labored breathing (*dyspnœa*), which, after the medulla has called all the muscles usually employed in respiration into violent action, passes into convulsions, in which every muscle may take part.

In other words, the respiratory impulses not only pass along their usual paths as energetically as possible, but radiate into unusual ones and pass by nerves not commonly thus set into functional activity.

It would be more correct, perhaps, to assume that the various parts of the nervous system are so linked together that excessive activity of one set of connections acts like a stimulus to rouse another set into action, the order in which this happens depending on the law of habit—habit personal and especially ancestral. An opposite condition to that described, known as *apnœa*, may be induced by pumping air into an animal's chest very rapidly by a bellows; or in one's self by a succession of rapid, deep respirations.

After ceasing, the breathing may be entirely interrupted for a brief interval, then commence very quietly, gradually increasing to the normal.

Apnœa has been interpreted in two ways. Some think that it is due to fatigue of the muscles of respiration or the respiratory center; others that the blood has under these circumstances an excess of oxygen, which so influences the respiratory center that it is quieted (inhibited) for a time.

The latter view is that usually adopted; but considering that *apnœa* results from the sobbing of children following a prolonged fit of crying, also in Cheyne-Stokes and other abnormal forms of breathing, and that the blood is normally almost saturated with oxygen, it will be agreed that there is a good deal to be said for the first view, especially that part of it which represents the cessation of breathing as owing to excessive activity and exhaustion of the respiratory center. We find such a calm in asphyxia after the convulsive storm. Perhaps if we regard the respiratory center as double, half being situated on each side

of the middle line; also as made up of an inspiratory and expiratory part; automatic essentially, but greatly modified by afferent impulses, especially those ascending the vagi nerves; while the latter may be considered as containing both inhibitory and augmenting fibers for the center, the whole process will be clearer. Respiration on this view would be self-regulative; the deeper the inspiration, the stronger the inhibitory influence, so the greater the tendency to arrest of inspiration; hence either expiration or apnœa.

Is it, then, the excessive accumulation of carbon dioxide or the deficiency of oxygen that induces dyspnœa? Considering that the former gas acts as a narcotic, and does not induce convulsions, even when it constitutes a large percentage of the atmosphere breathed, and that the need of oxygen for the tissues is constant, it certainly seems most reasonable to conclude that the phenomena of dyspnœa are owing to the lack of oxygen, chiefly at least; though the presence of an excess of carbonic anhydride may take some share in arousing that vigorous effort on the part of the nervous system, to restore the functional equilibrium, so evident under the circumstances.

THE INFLUENCE OF RESPIRATION ON THE CIRCULATION.

An examination of tracings of the intra-thoracic and blood-pressure, taken simultaneously, shows (1) that during inspiration the blood-pressure rises and the intra-thoracic pressure falls; (2) that during expiration the reverse is true; and (3) that the heart-beat is slowed, and has a decided effect on the form of the pulse. But it also appears that the period of highest blood-pressure is just after expiration has begun.

We must now attempt to explain how these changes are brought about. By intra-thoracic pressure is meant the pressure the lungs exert on the costal pleura or any organ within the chest, which must differ from intra-pulmonary pressure and the pressure of the atmosphere, because of the resistance of the lungs by virtue of their own elasticity.

It has been noted that even in death the lungs remain partially distended; and that when the thorax is opened the pulmonary collapse which follows demonstrates that their elasticity amounts to about five millimetres of mercury, which must, of course, represent but a small portion of that elasticity

which may be brought into play when these organs are greatly distended, so that they never press on the costal walls, heart,

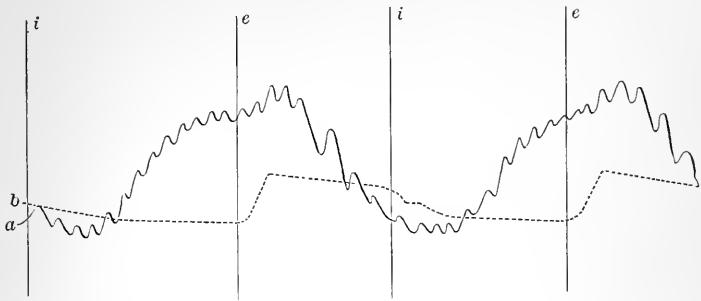

FIG. 310.—Tracings of blood-pressure and intrathoracic pressure in the dog (after Foster). *a*, blood-pressure tracing showing irregularities due to respiration and pulse; *b*, curve of intrathoracic pressure; *i*, beginning of inspiration; *e*, of expiration. Intrathoracic pressure is seen to rise rapidly after inspiration ceases, and then slowly sinks as the expiratory blast continues, to become a rapid fall when inspiration begins.

etc., with a pressure equal to that of the atmosphere. It follows that the deeper the inspiration the greater the difference between the intra-thoracic and the atmospheric pressure. Even in expiration, except when forced, the intra-thoracic pressure remains less, for the same reason.

These conditions must have an influence on the heart and blood-vessels. Bearing in mind that the pressure without is practically constant and always greater than that within the thorax, the conditions are favorable to the flow of blood toward the heart. As in inspiration, the pressure on the great veins and the heart is diminished, and, as these organs are not rigid, they tend to expand within the thorax, thus favoring an onward flow. But the opposite effect would follow as regards the large arteries. Their expansion must tend to withdraw blood. During expiration the conditions are reversed. The effects on the great veins can be observed by laying them bare in the neck of an animal, when it may be seen that during inspiration they become partially collapsed, and refilled during expiration. In consequence of the marked thickness of the coats of the great arteries, the effect of changes in intra-thoracic pressure must be slight. The comparatively thin-walled auricles act somewhat as the veins, and it is likely that the increase of pressure during expiration must favor, so far as it goes, the cardiac systole.

More blood, then, entering the right side of the heart during inspiration, more will be thrown into the systemic circulation, unless it be retained in the lungs, and, unless the effect be counteracted, the arterial pressure will rise, and, as all the conditions are reversed during expiration, we look for and find exactly opposite results. The lungs themselves, however, must be taken into the account. During inspiration room is provided for an increased quantity of blood, the resistance to its flow is lessened, hence more blood reaches the left side of the heart. The *immediate* effect would be, notwithstanding, some diminution in the quantity flowing to the left heart, in consequence of the sudden widening of the pulmonary vessels, the reverse of which would follow during expiration; hence the period of highest intra-thoracic pressure is after the onset of the expiratory act. During inspiration the descent of the diaphragm compressing the abdominal organs is thought to force on blood from the abdominal veins into the thoracic vena cava.

That the respiratory movements do exert in some way a pronounced effect on the circulation the student may demonstrate to himself in the following ways: 1. After a full inspiration, close the glottis and attempt to expire forcibly, keeping the fingers on the radial artery. It may be noticed that the pulse is modified or possibly for a moment disappears. 2. Reverse the experiment by trying to inspire forcibly with closed glottis after a strong expiration, when the pulse will again be found to vary. In the first instance, the heart is comparatively empty and hampered in its action, intra-thoracic pressure being so great as to prevent the entrance of venous blood by compression of the heart and veins, while that already within the organ and returning to it from the lungs soon passes on into the general system, hence the pulseless condition. The explanation is to be reversed for the second case. The heart's beat is modified, probably reflexly, through the cardio-inhibitory center, for the changes in the pulse-rate do not occur when the vagi nerves are cut, at least not to nearly the same extent.

Comparative.—It may be stated that the cardiac phenomena referred to in this section are much more marked in some animals than in others. Very little change may be observed in the pulse-rate in man, while in the dog it is so decided that one observing it for the first time might suppose that such pronounced irregularity of the heart was the result of disease;

though even in this animal there are variations in this respect with the breed, age, etc.

The Respiration and Circulation in Asphyxia.—A most instructive experiment may be arranged thus:

Let an anæsthetized rabbit, cat, or such-like animal, have the carotid of one side connected with a glass tube as before described (pages 228, 229), by which the blood-pressure and its changes may be indicated, and, when the normal respiratory acts have been carefully observed, proceed to notice the effects on the blood-pressure, etc., of pumping air into the chest by a bellows, of hindering the ingress of air to a moderate degree, and of struggling. With a small animal it will be difficult to observe the respiratory effects on the blood-pressure by simply watching the oscillations of the fluid in the glass tube, but this is readily enough made out if more elaborate arrangements be made, so that a graphic tracing may be obtained.

But the main events of asphyxia may be well (perhaps best) studied in this manner:

Let the trachea be occluded (ligatured). At once the blood-pressure will be seen to rise and remain elevated for some time, then gradually fall to zero. These changes are contemporaneous with a series of remarkable manifestations of disturbance in the respiratory system as it at first appears, but in reality due to wide-spread and profound nutritive disturbance. So far as the breathing is concerned, it may be seen to become more rapid, deeper, and labored, in which the expiratory phase becomes more than proportionably marked (dyspnœa); this is followed by the gradual action of other muscles than those usually employed in respiration, until the whole body passes into a terrible convulsion—a muscle-storm in consequence of a nerve-storm. When this has lasted a variable time, but usually about one minute, there follows a period of exhaustion, during which the subject of the experiment is in a motionless condition, interrupted by an occasional respiration, in which inspiration is more pronounced than expiration; and, finally, the animal quietly stretches every limb, the sphincters are relaxed, there may be a discharge of urine or fæces from peristaltic movements of the bladder or intestines, and death ends a striking scene. These events may be classified in three stages, though the first and second especially merge into one another: 1. Stage of dyspnœa. 2. Stage of convulsions. 3. Stage of exhaustion.

It is during the first two stages that the blood-pressure rises, and during the third that it sinks, due in the first instance chiefly to excessive activity of the vaso-motor center, and in the second to its exhaustion and the weakening of the heart-beat.

These violent movements are owing, we repeat, to the action of blood deficient in oxygen on the respiratory center (or centers), leading to inordinate action followed by exhaustion.

The duration of the stages of asphyxia varies with the animal, but rarely exceeds five minutes. In this connection it may be noted that newly born animals (kittens, puppies) bear immersion in water for as much as from thirty to fifty minutes, while an adult dog dies within four or five minutes. This is to be explained by the feeble metabolism of new-born mammals, which so slowly uses up the vital air (oxygen).

If the chest of an animal be opened, though the respiratory muscles contract as usual there is, of course, no ventilation of the lungs which lie collapsed in the chest; and the animal dies about as quickly as if its trachea were occluded. It passes through all the phases of asphyxia as in the former case; but additional information may be gained. The heart is seen to beat at first more quickly and forcibly, later vigorously though slower, and finally both feebly and irregularly, till the ventricles, then the left auricle, and finally the right auricle cease to beat at all or only at long intervals. The terminations of the great veins (representing the *sinus venosus*) beat last of all.

At death the heart and great veins are much distended with blood, the arteries comparatively empty. Even after *rigor mortis* has set in, the right heart is still much engorged.

These phenomena are the result of the operation of several causes. The increasingly venous blood at first stimulates the heart probably directly, in part at least, but later has the contrary effect. The nutrition of the organ suffers from the degraded blood, from which it must needs derive its supplies. The cardio-inhibitory center probably has a large share in the slowing of the heart, if not also in quickening it. Whether the accelerator fibers of the vagus or sympathetic play any part is uncertain. The increase of peripheral resistance caused by the action of the vaso-motor center makes it more difficult for the heart to empty its left side and thus receive the venous blood as it pours on. At the same time the deep inspirations (when the chest is unopened) favor the onflow of venous blood;

and in any case the whole venous system, including the right heart, tends to become engorged from these several causes acting together. The heart gives up the struggle, unable to maintain it, but not so long as it can beat in any part.

The share which the elasticity of the arteries takes in forcing on the blood when the heart ceases, and the contraction of the muscular coat of these vessels, especially the smaller, must not be left out of the account in explaining the phenomena of asphyxia and the *post-mortem* appearances.

Pathological.—The importance of being practically as well as theoretically acquainted with the facts of asphyxia is very great.

The appearance of the heart and venous system gives unequivocal evidence as to the mode of death in any case of asphyxia; and the contrast between the heart of an animal bled to death, or that has died of a lingering disease, and one drowned, hanged, or otherwise asphyxiated, is extreme.

We strongly recommend the student to asphyxiate some small mammal placed under the influence of an anæsthetic, and to note the phenomena, preferably with the chest opened; and to follow up these observations by others after the onset of *rigor mortis*.

PECULIAR RESPIRATORY MOVEMENTS.

Though at first sight these seem so different, and are so as regards acts of expression, yet from the respiratory point of view they resemble each other closely; they are all reflex, and, of course, involuntary. Many of them have a common purpose, either the better to ventilate the lungs, to clear them of foreign bodies, or to prevent their ingress.

Coughing, in which such a purpose is evident, is made up of several expiratory efforts preceded by an inspiratory act. The afferent nerve is usually the vagus or laryngeal, but may be one or more of several others.

The glottis presents characteristic appearances, being closed and then opened suddenly, the mouth being kept open.

Coughing is often induced in attempting to examine the ear with instruments. (Reflex act).

Laughing is very similar to the last, so far as the behavior of the glottis is concerned, though it usually acts more rapidly, of course. Several expirations follow a deep inspiration.

Crying is essentially the same as laughing, but the facial expression is different, and the lachrymal gland functions excessively, though with some persons this occurs during laughter also.

Sobbing is made up of a series of inspirations, in which the glottis is partially closed, followed by a deep expiration.

Yawning involves a deep-drawn, slow inspiration, followed by a more sudden expiration, with a well-known depression of the lower jaw and usually stretching movements.

Sighing is much like the preceding, though the mouth is not opened widely if at all, nor do the stretching movements commonly occur.

Hiccough is produced by a sudden inspiratory effort, though fruitless, inasmuch as the glottis is suddenly closed. It is spoken of as spasm of the diaphragm, and when long continued is very exhaustive.

Sneezing is the result of a powerful and sudden expiratory act following a deep inspiration, the mouth being usually closed by the anterior pillars of the fauces against the outgoing current of air, which then makes its exit through the nose, while the glottis is forcibly opened after sudden closure. It will be noticed that in most of these acts the glottis is momentarily closed, which is never the case in mammals during quiet respiration.

This temporary occlusion of the respiratory passages permits of a higher intrapulmonary pressure, which is very effective in clearing the passages of excess of mucus, etc., when the glottis is suddenly opened. Though the acts described are all involuntary, they may most of them be imitated and thus studied deliberately by the student. It will also appear, considering the many ways in which some if not all of them may be brought about, that if the medullary center is responsible for the initiation of them it must be accessible by numberless paths.

Comparative.—Few of the lower animals cough with the same facility as man, while laughing is all but unknown, crying and sobbing rare, though the whining of dogs is allied to the crying of human beings.

Sneezing seems to be voluntary in some animals, as squirrels, when engaged in toilet operations, etc.

Barking is voluntary, and in mechanism resembles coughing, the vocal cords being, however, more definitely employed, as also in growling.

Bawling, neighing, braying, etc., are made up of long expiratory acts, preceded by one or more inspirations. The vocal cords are also rendered tense.

SPECIAL CONSIDERATIONS.

Pathological and Clinical.—The number of diseases that lessen the amount of available pulmonary tissue, or hamper the movements of the chest, are many, and only the briefest reference can be made to a few of them.

Inflammation of the lungs may render a greater or less portion of one or both lungs solid; inflammation of the *pleura* (pleuritis, pleurisy) by the dryness, pain, etc., may restrict the thoracic movements; *phthisis* may solidify or excavate the lungs, or by pleuritic inflammation glue the costal and pulmonary pleural surfaces together; *bronchitis* may clog the tubes and other air-passages with altered secretions; *emphysema* (distention of air-cells) may destroy elasticity of parts of the lung; *pneuma-thorax* from rupture of the lung-tissue and consequent accumulation of gases in the pleural cavity, or pleurisy with effusion render one lung all but useless from pressure. In all such cases Nature attempts to make up what is lost in amplitude by increase in rapidity of the respiratory movements. It is interesting to note too how the other lung, in diseased conditions, if it remain unaffected, enlarges to compensate for the loss on the opposite side. When the muscles are weak, especially if there be hindrance to the entrance of air while the thoracic movements are marked, there may be bulging inward of the intercostal spaces.

Normally, this would also occur, as the intra-thoracic pressure is less than the atmospheric, were it not for the fact that the intercostal muscles when contracting have a certain resisting power.

The imperfect respiration of animals when dying, permitting the accumulation of carbonic anhydride with its soporific effects, smooths the way leading to the end; so that there may be to the uninitiated the appearance of a suffering which does not exist, consciousness itself being either wholly or partially absent. The dyspnœa of anæmic animals, whether from sudden loss of blood or from imperfect renewal of the hæmoglobin, shows that this substance has a respiratory function; while in forms of cardiac disease with regurgitation, etc., the

blood may be imperfectly oxidized, giving rise to labored respiration.

Personal Observation.—As hinted from time to time during the treatment of this subject, there is a large number of facts the student may verify for himself.

A simple way of proving that CO_2 is exhaled is to breathe (blow) into a vessel containing some clear solution of quicklime (CaO), the turbidity showing that an insoluble salt of lime (CaCO_3) has been formed by the addition of this gas.

The functions of most of the respiratory muscles, the phenomena of dyspnoea, apnoea (by a series of long breaths), partial asphyxia by holding the breath, and many other experiments, simple but *convincing*, will occur to the student who is willing to learn in this way.

The observation of respiration in a dreaming animal (dog) will show how mental occurrences affect the respiratory center in the absence of all the usual outward influences. The respiration of the domestic animals, and of the frog, turtle, snake, and fish, is easily watched if these cold-blooded animals be placed for observation beneath a glass vessel. Their study will teach how manifold are the ways by which the one end is attained. Compare the tracings of Fig. 305.

Evolution.—A study of embryology shows that the respiratory and circulatory systems develop together; that the vascular system functions largely as a respiratory system also in certain stages, and remains such, from a physiological point of view, throughout embryonic life.

The changes that take place in the vascular system—the heart, especially—of the mammal when the lungs have become functionally active at birth, show how one set of organs modifies the other.

When one considers, in addition to these facts, that the digestive as well as the vascular and respiratory organs are represented in one group of structures in a jelly-fish, and that the lungs of the mammal are derived from the same mesoblast as gives rise to the digestive and circulatory organs, many of the relations of these systems in the highest groups of animals become intelligible; but unless there be descent with modification, these facts, clear enough from an evolutionary standpoint, are isolated and out of joint, bound together by no common principle that satisfies a philosophical biology.

It has been found that in hunting-dogs and wild rabbits the

vagus is more efficient than in other races of dogs and in rabbits kept in confinement; and possibly this may in part account for the greater speed and especially the endurance of the former. The very conformation of some animals, as the greyhound, with his deep chest and capacious lungs, indicates an unusual respiratory capacity.

The *law of habit* is well illustrated in the case of divers, who can bear deprivation of air longer than those unaccustomed to such submersion in water. Greater toleration on the part of the respiratory center has probably much to do with the case, though doubtless many other departures from the normal occur, either independently or correlated to the changes in the respiratory center. Some mammals, like the whale, can long remain under water.

Summary of the Physiology of Respiration.—The purpose of respiration in all animals is to furnish oxygen for the tissues and remove the carbonic anhydride they produce, which in all vertebrates is accomplished by the exposure of the blood in capillaries to the atmospheric air, either free or dissolved in water. A membrane lined with cells always intervenes between the capillaries and the air.

The air may be pumped in and out, or sucked in and forced out.

Respiration in the Mammal.—The air enters the lungs, owing to the enlargement of the chest in three directions by the action of certain muscles. It leaves the lungs because of their own elastic recoil and that of the chest-wall chiefly. Inspiration is active, expiration chiefly passive.

The diaphragm is the principal muscle of respiration. In some animals there is a well-marked facial and laryngeal as well as thoracic respiration. Respiration is rhythmical, consisting of inspiration, succeeded without appreciable pause by expiration, the latter being in health of only slightly longer duration. There is also a definite relation between the number of respirations and of heart-beats. According as respiration is normal, hurried, labored, or interrupted, we describe it as *eupnœa*, *hyperpnœa*, *dyspnœa*, and *apnœa*. The intra-thoracic pressure is never equal to the atmospheric—i. e., it is always negative—except in forced expiration; and the lungs are never collapsed so long as the chest is unopened. The expired air differs from that inspired in being of the temperature of the body, saturated with moisture, and containing about 4 to 5 per

cent less oxygen and 4 per cent more carbonic anhydride, besides certain indifferently known bodies, the result of tissue metabolism, excreted by the lungs.

The quantity of air actually moved by a respiratory act, as compared with the total capacity of the respiratory organs, is small ; hence a great part must be played by diffusion. The portion of air that can not be removed from the lungs by any respiratory effort is relatively large.

It is customary to distinguish tidal, complementary, supplementary, and residual air.

The vital capacity is estimated by the quantity of air the respiratory organs can move, and is very variable.

The blood is *the* respiratory tissue, through the mediation of its red cells, by the hæmoglobin they contain. This substance is a ferruginous proteid, capable of crystallization, and assuming under chemical treatment many modifications. When it contains all the oxygen it can retain, it is said to be saturated and is called oxy-hæmoglobin, in which form it exists (with some reduced hæmoglobin) in arterial blood, and to a lesser extent in venous blood, which differs from arterial in the relative proportions of hæmoglobin (reduced) it contains, as viewed from the respiratory standpoint.

Oxy-hæmoglobin does not assume or part with its oxygen, according to the Henry-Dalton law of pressures, nor is this gas in a state of ordinary chemical combination. It is found that the oxygen tension of the blood is lower and that of carbonic anhydride higher than in the air of the alveoli of the lungs, while the same may be said of the tissues and the blood respectively. This has been, however, recently again denied.

Respiration is a vital process, though certain physical conditions (temperature and pressure) must be rigidly maintained in order that the gaseous interchanges shall take place. Respiration is always fundamentally bound up with the metabolism of the tissues themselves. All animal cells, whether they exist as unicellular animals (*Amœba*) or as the components of complex organs, use up oxygen and produce carbonic dioxide. Respiratory organs, usually so called, and the respiratory tissue *par excellence* (the blood) are only supplementary mechanisms to facilitate tissue respiration. Carbonic anhydride exists in blood probably in combination with sodium salts, though the whole matter is very obscure.

Respiration, like all the other functions of the body, is con-

trolled by the central nervous system through nerves. The medulla oblongata is chiefly concerned, and especially one small part of it known as the respiratory center. It is possible, even probable, that there are subordinate centers in the cord, which, under peculiar circumstances, assume importance; but how far they act in concert with the medullary center, or whether they act at all when normal conditions prevail, is an open question.

The vagus is the principal afferent respiratory nerve. The efferent nerves are the phrenics, intercostals, and others supplying the various muscles used in moving the chest-walls, etc.

The respiratory center is automatic, but its action is susceptible of modification through afferent influences taking a variety of paths, the principal of which is along the vagi nerves. The respiratory, vaso-motor, and cardio-inhibitory centers seem to act somewhat in concert.

Blood-pressure is being constantly modified by the respiratory act, rising with inspiration and sinking with expiration. In some animals the heart-beat also varies with these phases of respiration, becoming slow and irregular during expiration. Into the causation of these changes both mechanical and nervous factors enter, and make a very complex mesh, which we can at present but imperfectly unravel. When the access of air to the tissues is prevented, a series of stages of respiratory activity and decline, accompanied by pronounced changes in the vascular system, are passed through, known as asphyxia.

Three stages are distinguishable: one of dyspnoea, one of convulsions, and one of exhaustion—while at the same time there is a rise of blood-pressure during the first two, and a decline during the third, accompanied by marked alterations in the cardiac rhythm.

PROTECTIVE AND EXCRETORY FUNCTIONS OF THE SKIN.

As has been intimated from time to time, thus far, as a result of the metabolism of the tissues, certain products require constant removal from the blood to prevent poisonous effects. These substances are in all probability much more numerous than physiological chemistry has as yet distinctly recognized or, at all events, isolated. Quantitatively considered, the most important are carbonic anhydride, water, urea, and, of less importance, perhaps, certain salts.

In many invertebrates and in all vertebrates several organs take part in this work of elimination of waste products or purification of the blood, one set of which—the respiratory—we have just studied ; and we now continue the consideration of the subject of excretion, this term being reserved for the process of separating harmful products from the blood and discharging them from the body.

We strongly recommend the student to make the study of excretion comparative in the sense of noting how one organ engaged in the process supplements another. A clear understanding of this relation even to details makes the practice of medicine more scientific and practically effective, and gives physiology greater breadth.

The skin has a triple function : it is protective, excretory, sensory, and, we may add, nutritive (absorptive) and respiratory, especially in some groups of animals.

As a sensory organ, the skin will receive attention later.

Protective Function of the Skin.—Comparative.—Among many groups of invertebrates the principal use of the exterior covering of the body is manifestly protection. Among these forms, an internal skeleton being absent, the exo-skeleton is developed externally, and serves not only for protection, but for the attachment of muscles, as seen in crustaceans and in-

sects. But this part of the subject is too large for detailed treatment in such a work as this. Turning to the vertebrates, we see scales, bony plates, feathers, spines, hair, etc., most of them to be regarded as modifications of the epidermis, always useful, and frequently also ornamental.

Primitive man was probably much more hirsute than his modern representative ; and, though the human subject is at present provided with a skin in which protective functions are at their lowest, still the epidermis does serve such a purpose, as all have some time realized when it has been accidentally removed by blistering, etc.

Taking the structure of the skin of man as representing that of mammals generally, certain points claim attention from the physiologist. Its elasticity, the failure of which in old age accounts for wrinkles; its epider-

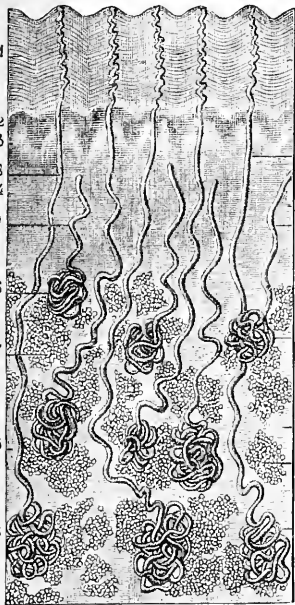

FIG. 311.

FIG. 311.—Sudoriparous glands. 1 x 20. (After Sappey.) 1, 1, epidermis; 2, 2, mucons layer; 3, 3, papillae; 4, 4, derma; 5, 5, subcutaneous areola tisse; 6, 6, 6, 6, sudoriparous glands; 7, 7, adipose vesicles; 8, 8, excretory ducts in derma; 9, 9, excretory ducts divided.

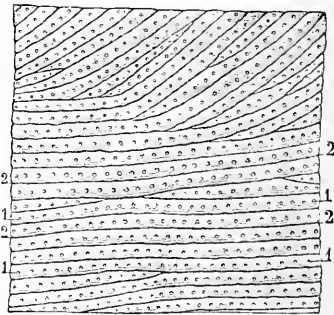

FIG. 312.

FIG. 312.—Portion of skin of palm of hand about one-half an inch (12.7 mm.) square. 1 x 4. (After Sappey.) 1, 1, 1, 1, openings of sudoriferous ducts; 2, 2, 2, 2, grooves between papillae of skin.

mal covering, made up of numerous layers of cells; its coiled and spirally twisted sudoriferous glands, permitting of movements of the skin without harm to these structures; its hair-follicles and associated sebaceous glands, the fatty secretion of which keeps the hair and the skin generally soft and pliable.

The muscles of the skin, which either move it as a whole or erect individual hairs, play an important part in modifying expression, well seen in the whole canine tribe and many others.

There are several modifications of the sebaceous glands that furnish highly odoriferous secretions as in the civet cat, the skunk, the musk-deer, and many lower vertebrates. In some, these are protective (skunk); in others, though they may not be agreeable to the senses of man, they are doubtless attractive to the females of the same tribe, and are to be regarded as important in "sexual selection," being often confined to the males alone.

Ear-wax and the Meibomian secretion are the work of modified sebaceous glands; as also the oil-glands so highly developed in birds, especially aquatic forms, and of which these creatures make great use in preserving their feathers from wetting.

In our domestic animals we may especially notice a cu-

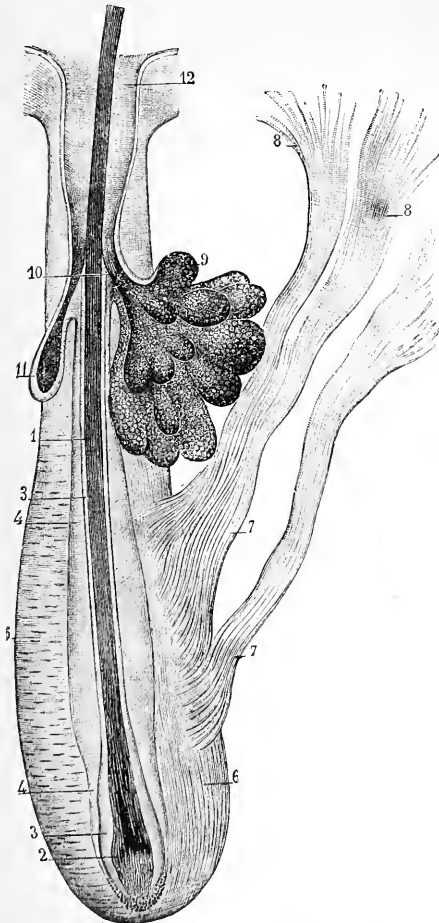

FIG. 313.—Hair and hair-follicle (after Sappey). 1, root of hair; 2, bulb of hair; 3, internal root-sheath; 5, membrane of hair-follicle; 6, external membrane of follicle; 7, 7, muscular bands attached to follicle; 8, 8, extremities of bands passing to skin; 9, compound sebaceous gland, with duct (10) opening into upper third of follicle; 11, simple sebaceous gland; 12, opening of hair-follicle.

taneous gland in the pig, placed at the posterior inner aspect of the knee and of considerable size.

In the sheep, the *interungulate gland* is an inversion of the integument forming an elongated sac, which is supplied with secreting structures analogous to the sebaceous glands. The importance of protective structures of this kind in such situations is obvious.

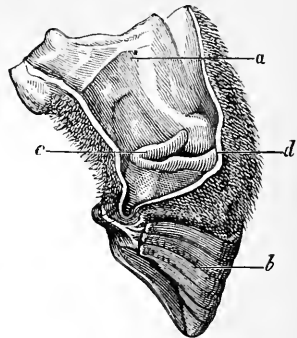

FIG. 314.—Interungulate gland of sheep (Chauveau). *a*, inner aspect of first phalanx; *b*, hoof or claw; *c*, interungulate gland; *d*, orifice of its duct.

THE EXCRETORY FUNCTION OF THE SKIN.

The quantity of matter discharged through the skin is large—greater in man than by the lungs (about as 7 to 11), though the amount is very variable, depending on the degree of activity of other related excreting organs, as the lungs and kidneys, and largely upon the temperature as a physical condition; and so in other animals.

When the watery vapor is carried off, before it can condense, the perspiration is said to be *insensible*; when small droplets become visible, *sensible*. As to whether the one or the other is predominant will, of course, depend on the rapidity of renewal of the air, its humidity, and its temperature. Apart from the temperature, the amount of sweat is influenced by the quality and quantity of food and, especially of drink taken, the amount of exercise, and psychic conditions; not to speak of the effect of drugs, poisons, or disease.

Perspiration in man is a clear fluid, mostly colorless, with a characteristic odor, devoid of morphological elements (except epidermal scales), and alkaline in reaction. It may be acid from the admixture of the secretion of the sebaceous glands.

Its solids (less than 2 per cent) consist of sodium salts, mostly chlorides, cholesterin, neutral fats, and traces of urea. The acids of the sweat belong to the fatty series (acetic, butyric, formic, propionic, caprylic, caproic, etc.).

Pathological.—The sweat may contain blood, proteids, abundance of urea (in cholera), uric acid, oxalates, sugar, lactic acid,

bile, indigo, and other pigments. Many medicines are eliminated in part through the skin.

Respiration by the Skin.—Comparative.—In reptiles and batrachians, with smooth, moist skin, the respiratory functions of this organ are of great importance; hence these animals can live long under water.

It is estimated that in the frog the greater part of the carbonic anhydride of the body-waste is eliminated by the skin. Certainly frogs can live for days immersed in a tank supplied with running water; and it is a significant fact that in this animal the vessel that gives rise to the pulmonary artery supplies also a cutaneous branch.

The respiratory capacity of the skin in man and most mammals is comparatively small under *ordinary* circumstances. The amount of carbonic anhydride thus eliminated in twenty-four hours in man is estimated at not more than 10 grammes. It varies greatly, however, with temperature, exercise, etc.

The skin is highly vascular in mammals, and its importance as a heat regulator is thus very great.

When an animal is varnished over, its temperature rapidly falls, though heat production is in excess. From the fact that life may be prolonged by diminishing loss of heat through wrapping up the animal in cotton-wool, it is inferred that depression of the temperature is, at all events, one of the causes of death. Though the subject is obscure, it is likely that the retention of poisonous products so acts as to derange metabolism, as well as poison directly, which might thus lead to the disorganization of the machinery of life to the point of disruption or death. It is also possible that the reduction of the temperature from dilatation of the cutaneous vessels may be so great that the animal is cooled below that point at which the vital functions can continue.

THE EXCRETION OF PERSPIRATION.

In secretion in the wider sense we find usually certain nervous and vascular effects associated. The vessels supplying the gland are dilated during the most active phase, and at the same time nervous impulses are conveyed to the secreting cells which stimulate them to action. There is a certain proportion of water given off by transpiration; but the sweat, as a whole,

even the major part of the water, is a genuine secretion, the result of the metabolism of the cells.

From experiments it is clear that nervous influences alone, in the absence of any vascular changes, or in the total deprivation of blood, suffice to induce the secretion of perspiration. If the central stump of the divided sciatic be stimulated, sweating of the other limbs follows, showing that perspiration may be a reflex act. It is found that stimulation of the peripheral end of the divided cervical sympathetic leads to sweating on the corresponding side of the face.

Sweating during dyspnoea and from fear, when the cutaneous surfaces are pale, as well as in the dying animal, shows also the independent influence over the sudorific glands of the nervous system. Heat induces sweating by acting both reflexly and directly on the sweat-centers we may suppose. Unilateral sweating is known as a pathological as well as experimental phenomenon. Perspiration may be either increased or diminished in paralyzed limbs, according to circumstances. It is possible that there is a paralytic secretion of sweat as of saliva. The subject is very intricate, and will be referred to again on account of the light it throws on metabolic processes generally.

Absorption by the skin in man and other mammals is, under natural conditions probably very slight, as would be expected when it is borne in mind that the true skin is covered by several layers of cells, the outer of which are hardened.

Ointments may unquestionably be forced in by rubbing; and perhaps absorption may take place when an animal's tissues are starving, and food can not be made available through the usual channels. It is certain that abraded surfaces are a source of danger, from affording a means of entrance for disease-producing substances or for germs.

Comparative.—It is usually stated in works on physiology that the horse sweats profusely, the ox less so; the pig in the snout; and the dog, cat, rabbit, rat, and mouse, either not at all or in the feet (between the toes) only. That a closer observation of these animals will convince any one that the latter statements are not strictly correct, we have no doubt. These animals, it is true, do not perspire *sensibly* to any great extent; but to maintain that their skin has no excretory function is an error.

Summary.—The skin of the mammal has protective, sensory, respiratory, and excretory functions. The respiratory are in-

significant under ordinary circumstances in this group, though well marked in reptiles and especially in batrachians (frog, menobranchus). Sweating is probably dependent on the action of centers situated in the brain and spinal cord, through nerves that run generally in sympathetic tracts during some part of their course. While the function of sweating may go on independently of abundant blood-supply, it is usually associated with increased vascularity.

Sweat contains a very small quantity of solids, is alkaline in reaction when pure, but liable to be acid from the admixture of sebaceous matter that has undergone decomposition. Sebum consists chiefly of olein, palmitin, soaps, cholesterin, and extractives of little known composition. The salty taste of the perspiration is due chiefly to sodium chloride, and its smell to volatile fatty acids; especially is this so of the sweat of certain parts of the body of man and other mammals.

The functional activity of the skin varies with the temperature, moisture, etc., of the air and certain internal conditions; especially is it important to remember that it is one of a series of excretory organs which act in harmony to eliminate the waste of the body, so that when one functions more the other may and usually does function less.

The protective function of the skin and its modified epithelium (hair, horns, nails, feathers, etc.) is in man slight, but very important in many other vertebrates, among which provision against undue loss of temperature is one of the most constantly operative, and enables a vast number of groups of animals to adapt successfully to their varying surroundings.

EXCRETION BY THE KIDNEY.

THE kidney in man and other mammals may be described as a very complex arrangement of tubes lined with many different forms of secreting cells, surrounded by a great meshwork of capillaries, bound together by connective tissue, the quantity

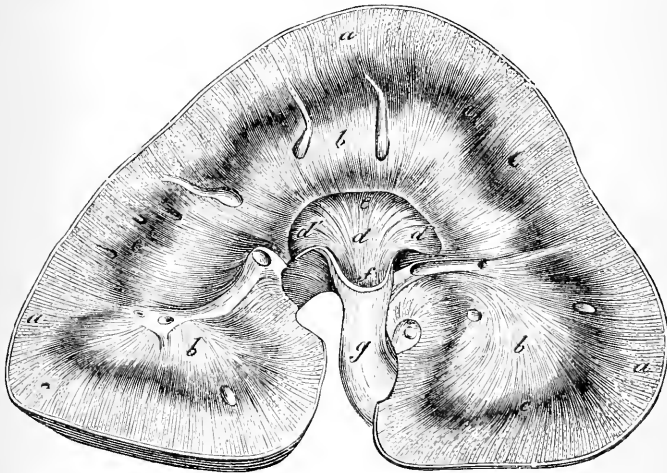

FIG. 315.—Vertical longitudinal section of horse's kidney (Chauveau). *a*, cortical portion; *b*, medullary portion; *c*, peripheral portion of latter; *d*, interior of pelvis; *d'*, *d'*, arms of pelvis; *e*, border of crest; *f*, infundibulum; *g*, ureter.

varying with the animal, and the whole inclosed in a capsule. The organ is well supplied with lymphatics and nerves. Though the tubes are so complex, the kidney may be divided into zones which contain mostly but one kind of tubule.

Among vertebrates, till the reptiles are reached, the kidney is a persistent Wolffian body, hence its more simple form.

In most fishes the kidney is a very elongated organ, though

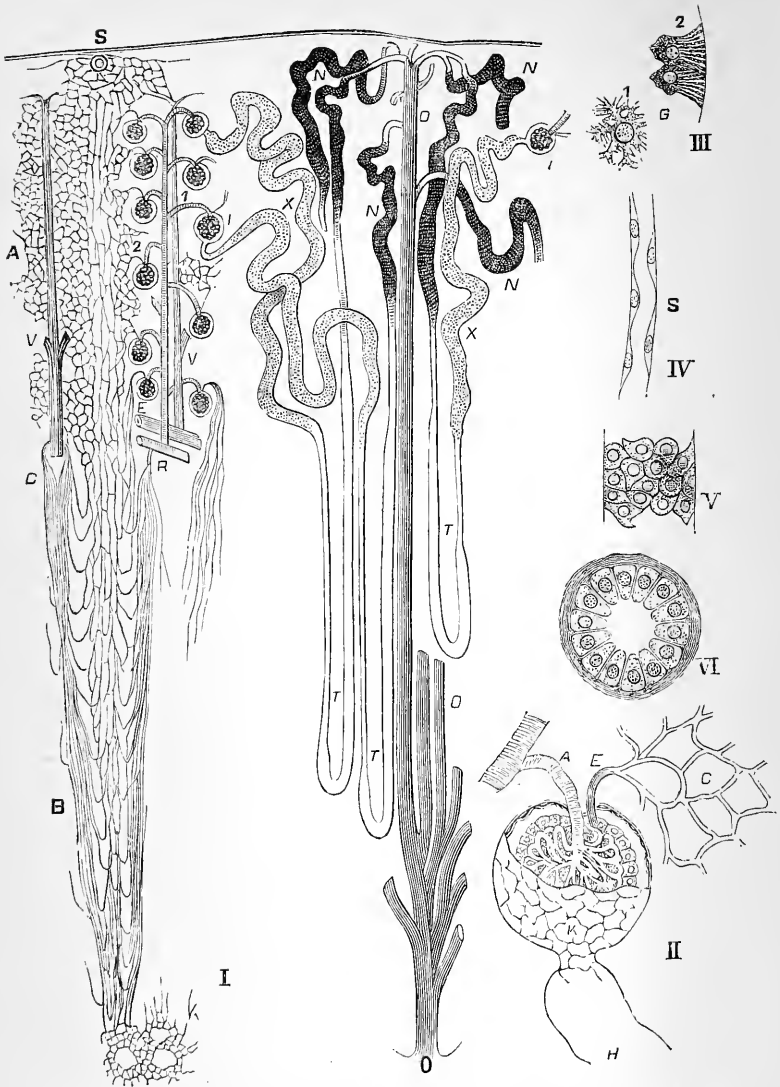

FIG. 316.—Structure of kidney (after Landois). I. Blood-vessels and tubes (semi-diagrammatic). A. Capillaries of cortical substance; B. Capillaries of medullary substance; 1, artery penetrating Malpighian body; 2, vein emerging from a Malpighian body; R, arteriole rectae; C, vena rectae; V, V, interlobular veins; S, stellate veins; I, I, capsules of Müller; X, X, convoluted tubes; T, T, T, tubes of Henle; N, N, N, N, communicating tubes; O, O, straight tubes; O, opening into pelvis of kidney. II. Malpighian body. A, artery; E, vein; C, capillaries; K, epithelium

of capsule; *H*, beginning of convoluted tube. III. Rodded cells from convoluted tube. 1, view from surface; 2, side view (*G*, granular zone). IV. Cells lining tubes of Henle. V. Cells lining communicating tubes. VI. Section of straight tube.

in the lowest it consists of little more than tubules, coiling but slightly, ending by one extremity in a glomerulus and by the

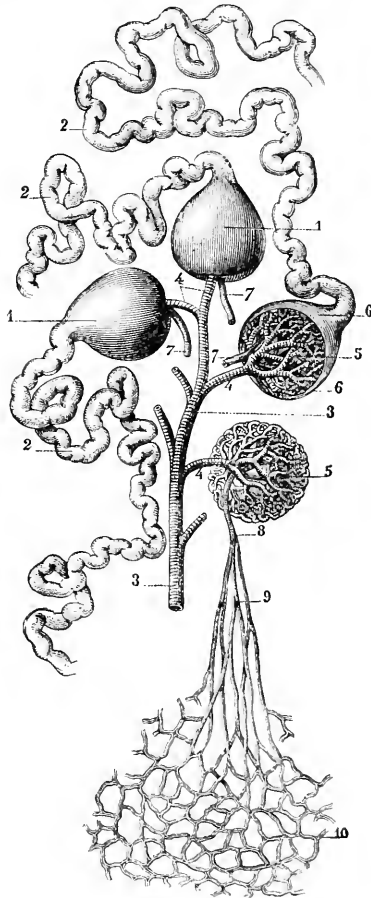

FIG. 317.—Blood-vessels of Malpighian bodies and convoluted tubes of kidney (after Sappey). 1, 1, Malpighian bodies surrounded by capsules; 2, 2, 2, convoluted tubes connected with Malpighian bodies; 3, artery branching to go to Malpighian bodies; 4, 4, 4, branches of artery; 6, 6, Malpighian bodies from which a portion of capsule has been removed; 7, 7, 7, vessels passing out of Malpighian bodies; 8, vessel, branches of which (9) pass to capillary plexus (10).

other opening into a long common efferent tube or duct. The glomerulus is, however, peculiar to the vertebrate kidney. The graded complexity in arrangement, etc., of the tubes is represented well in the figure below. It is a significant fact

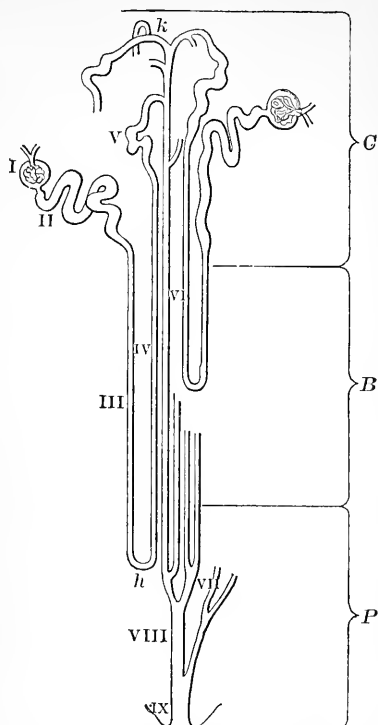

FIG. 318.—Diagrammatic representation of distribution of tubules of kidney (after Huxley). *C*, cortical region; *B*, boundary zone, containing large part of Henle's loops; *P*, papillary zone, in which are the main outflow tubules.

that the kidney of the human subject is lobulated in the embryo, which condition is persistent in some mammals (ruminants, etc.).

As the lungs are the organs employed especially for the elimination of carbonic anhydride, so the kidneys are above all others the excretors of the nitrogenous waste products of the body chiefly in the form of uric acid or urea. Before treating of secretion by the kidney it will be well to examine into the physical and chemical properties of urine with some detail, especially on account of its great importance in the diagnosis of disease.

URINE CONSIDERED PHYSICALLY AND CHEMICALLY.

Urine is naturally a fluid of very variable composition, especially regarded quantitatively—a fact to be borne in mind in considering all statements of the constitution of this fluid.

Specific Gravity.—Urine must needs be heavier than water, on account of the large variety of solids it contains. The average specific gravity of the urine for the twenty-four hours is in man 1015 to 1020; in the horse, 1030 to 1060; in the ox, 1020 to 1030; in the sheep and goat, 1005 to 1015; in the pig, 1010 to 1015; in the dog, 1030 to 1050. It is lowest in the morning and varies greatly with the quantity and kind of food eaten, the activity of the lungs and especially of the skin, etc.

Color.—Some shade of yellow, which is also very variable, being increased in depth either by the presence of an excess of pigment or a diminution of water. In herbivora the urine is turbid, and may darken on exposure to the air.

The reaction of human urine is acid, owing to acid salts, especially acid sodium phosphate (NaH_2PO_4). In the carnivora it is strongly acid; in the herbivora, alkaline. The reaction of urine depends largely though not wholly on the character of the food.

Quantity.—This is, of course, like the specific gravity, highly variable, and frequently they run parallel with each other.

The following tabular statement will prove useful for reference:

Composition of the Urine (Boussingault).

	Horse.*	Cow.†	Pig.‡
Urea.....	31·0	18·5	4·9
Potassium hippurate	4·7	16·5	0·0
Alkaline lactates.....	20·1	17·2	
Potassium bicarbonate	15·5	16·1	10·7
Magnesium carbonate	4·2	4·7	0·9
Calcium carbonate	10·8	0·6	trace.
Potassium sulphate	1·2	3·6	2·0
Sodium chloride	0·7	1·5	1·3
Silica	1·0	trace.	0·1
Phosphates.....	0·0	0·0	1·0
Water and substances undetermined.	910·0	921·3	979·1
Total	1000·0	1000·0	1000·0

* Diet of clover, grass, and oats.

† Diet of hay and potatoes.

‡ Diet of potatoes, cooked.

Nitrogenous Crystalline Bodies.—These are the derivatives of the metabolism of the body, and not in any appreciable degree drawn from the food itself. Besides urea, and of much less importance, occurring in small quantities, are bodies that may be regarded as less oxidized forms of nitrogenous metabolism, such as creatinin, xanthin, hypoxanthin (sarkin), hippuric acid, ammonium oxalurate, and urea, $\text{CO} \left\{ \begin{array}{l} \text{NH}_2 \\ \text{NH}_2 \end{array} \right.$. The latter was first prepared artificially from ammonium cyanate, $\text{CN} \left\{ \begin{array}{l} \text{CN} \\ \text{NH}_4 \end{array} \right. \text{O}$, with which it is isomeric. The quantity of urea is generally in inverse proportion to that of hippuric acid, and varies much with the diet in the herbivora. The richer in proteids the diet, as when oats are fed, the greater the quantity of urea. In the horse this proportion varies with the ordinary diet between 2.5 and 4.0 per cent.

When air has free access to urine for some time in a warm room, the urea becomes ammonium carbonate by hydration, probably owing to the influence of micro-organisms, thus: $\text{CO} (\text{NH}_2)_2 + 2 \text{H}_2\text{O} = (\text{NH}_4)_2 \text{CO}_3$; hence the strong ammoniacal smell of old urine, urinals, etc.

Uric acid ($\text{C}_5\text{H}_4\text{N}_4\text{O}_3$) occurs sparingly (see table), combined with sodium and ammonium chiefly as acid salts.

Non-nitrogenous Organic Bodies.—A series of well-known aromatic bodies occurs in urine, especially in that of the horse, cow, etc. These are phenol, cresol, pyrocatechin, etc., which occur not free, but united with sulphuric acid.

Inorganic Salts.—These are mostly in simple solution, in urine, and not as in some other fluids of the body, united with proteid bodies. The salts are chlorides, phosphates, sulphates, nitrates, and carbonates; the bases being sodium, potassium, calcium, magnesium. The phosphates are to be traced to the food, to the phosphorus of proteids, and to phosphorized fats (lecithin). The sulphates are derived from those of the food and from the sulphur of the proteids of the body. The greater part of the carbonates is supplied directly by the food. In the horse the salts of potassium and calcium (CaCO_3), are abundant; while in the dog magnesium and calcium salts abound as sulphates and phosphates.

Doubtless many bodies appear either regularly or occasionally in urine that have so far escaped detection, which are, like the poisonous exhalations of the lungs, not the less important because unknown to science.

Abnormal Urine.—There is not a substance in the urine that does not vary under disease, while the possible additions actually known are legion. These may be derived either from the blood or from the kidneys and other parts of the urinary tract. The kidneys seem to take upon themselves more readily than any other organ the duty of eliminating foreign matters from the body. But this aspect of the subject is too wide for detailed consideration in this work.

The student of medicine should be thoroughly familiar with the urine in its normal condition before he enters upon the examination of the variations produced by disease. This is not difficult, and much of it may be carried out with but a meager supply of apparatus. For this purpose, however, we recommend some work devoted to the chemical and microscopic study of the urine.

It greatly assists to remember a few points in regard to solubilities. From a physiological point of view, the urine and its variations, as the result of changes in the organism, may be observed with advantage in one's own person—eg., the influence of food and drink, temperature, emotions, etc.

Comparative.—In fishes, reptiles, and birds, uric acid replaces urea, and is very abundant. In these animals most of this substance is white. The urine is passed with the feces.

In certain groups of invertebrates uric acid seems to be a normal excretion.

THE SECRETION OF URINE.

By means of apparatus adapted to register the changes of volume the kidney undergoes, it is found that this organ not only responds to every general change in blood-pressure, but to each heart-beat—that is, its volume varies momentarily. This shows how sensitive it is to variations in blood-pressure.

Theories regarding the secretion of urine may be divided into those that are almost wholly physical, partly physical, and purely secretory: 1. To the first class belongs that of Ludwig, which teaches that very dilute urine is separated from the blood in the glomeruli, and by a process of osmosis and absorption of water by the tubular capillaries is gradually concentrated to the normal. 2. As an example of the second class is that of Bowman, who maintained that the greater part of the water and some of the more soluble and diffusible salts

are separated by the glomeruli but the characteristic constituents of the urine by the epithelium of the renal tubules. 3: As an example of the third is the theory of Heidenhain, who attributed little to blood-pressure in itself, and much, if not the whole, to the secreting activity of the epithelium of the tubules more particularly. This physiologist showed that while liga-

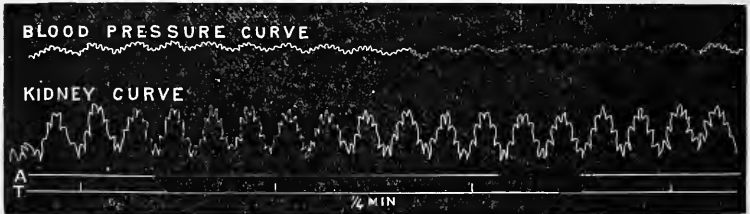

FIG. 319.—Blood-pressure curve and curve of the volume of the kidney; T, time-curve, intervals indicate a quarter of a minute; A, abscissa (Stirling, after Roy).

ture of a vein raised the blood-pressure within a glomerulus, it was not followed by any increase in the quantity of the secretion, but by its actual arrest. He also showed that injection of a colored substance (sodium sulphindigodate) into the blood, after the pressure had been greatly lowered by section of the spinal cord, led to its appearance in the urine; and microscopic examination showed that it had passed through the epithelial cells of the tubules, not of the glomeruli.

It is found, however, that after the removal of a ligature applied to the renal artery the urine is albuminous, showing plainly that the cells have been injured by the operation; hence Heidenhain's experiment described above is not valid against the blood-pressure theory. Moreover, too much must not be inferred from the action of foreign substances under the abnormal conditions of such an experiment. While some physiologists claim that the glomeruli are filtering mechanisms, they explain that filtration is not to be understood in its ordinary laboratory acceptance, but that the glomeruli discriminate as to what they allow to pass, yet they in no way explain how this is done. They make the whole process depend on blood-pressure, and attribute little special action to the flat epithelium of the Malpighian capsules.

Though we can not admit the full force of Heidenhain's experiments as he interprets them, we still believe that his views are most in harmony with the general laws of biology and the

special facts of renal secretion. More recently it has been rendered clear that physical theories of the work of the kidney can not hold, even of the glomeruli, which are shown to be, as we should have expected, true secreting organs. Now, there can be no doubt that blood-pressure is a most important determining condition here as in other secreting processes, in the mammal at all events; but whether of itself or because of the influence it has on the rapidity of blood-flow, it is difficult to determine; or rather whether solely to the latter, for that the constant supply of fresh blood is a regular condition of normal secretion there can be no doubt. Further, it seems probable that blood-pressure has more to do with the secretion of water than any other constituent of urine. But we maintain that it should be called a genuine secretion, and that nothing is gained by using the term "filtration"—on the contrary, that it is misleading, and tends to divert attention from the real though often hidden nature of vital processes. The facts of disease and the evidence of therapeutics, we think, all favor such a view of the work of the kidneys.

Nerves having an influence over the secretion of urine similar to those acting on the digestive glands have not yet been determined. The powerful influence of emotion, especially well seen in the dog, over the secretion of urine shows that there must be nervous channels through which the nerve-centers act on the kidneys; though whether the results are not wholly dependent upon vaso-motor effects may be considered as an open question by many. We think such a view improbable in the highest degree. The most recent investigations would seem to show that the vaso-motor fibers run in the dorsal nerves, especially the eleventh, twelfth, and thirteenth, in the dog, and that of these the vaso-constrictors are the best developed.

Pathological.—When the kidneys are excised, the ureters ligatured, or when the former are so diseased as to be incapable of performing their functions, death is the result, being preceded by marked depression of the brain-centers, passing into coma. Exactly which of the retained products brings about these results is not known. They are likely due to several, and it impresses on the mind the importance of those processes by which the constantly accumulating waste is eliminated.

THE EXPULSION OF URINE.

We now present in concise form certain facts on which to base opinions as to the nature of the processes by which the bladder is emptied.

It will be borne in mind that the secretion of urine is constant, though of course very variable, that the urine is conveyed in minute quantities by rhythmically contractile tubes (ureters) which open into the bladder obliquely; and that the bladder itself is highly muscular, the cells being arranged both circularly and obliquely, with a special accumulation of the circular fibers around the neck of the organ to form the *sphincter vesicæ*.

1. It is found that the pressure which the sphincter of the bladder can withstand in the dead is much less (about one third) than in the living subject.
2. We are conscious of being able to empty the bladder, whether it contains much or little fluid.
3. We are equally conscious of an urgency to evacuation of the vesical contents, according to the fullness of the organ, the quality of the urine, and a variety of other conditions.
4. Emotions may either retard or render micturition urgent.
5. In a dog in which the cord has been divided in the dorsal region some months previously, micturition may be induced reflexly, as by sponging the anus.
6. In the paralyzed there may be retention or dribbling of urine.
7. In cases of urethral obstruction from a calculus, stricture, etc., there may be excessive activity of the muscular tissue of the bladder walls.
8. Evacuation of the bladder may occur in the absence of consciousness (sleep).

The most obvious conclusions from these facts are that—1. The urine finds its way to the bladder partly through muscular (peristaltic) contractions of the ureters, partly through gravity, in man at all events, and partly from the pressure within the tubules of the kidneys themselves.

2. The evacuation of urine *may* take place independently of the will (see 8), and is a reflex (5) act.
3. Micturition may be initiated by the will, which is usually the case, when by the action of the abdominal muscles a little urine is squeezed into the urethra, upon which afferent impulses set up contractions of the bladder by acting on the detrusor center of the cord and at the same time inhibit the center presiding over the sphincter (if such there be), permitting of its relaxation.
4. Emotions seem to interfere with the

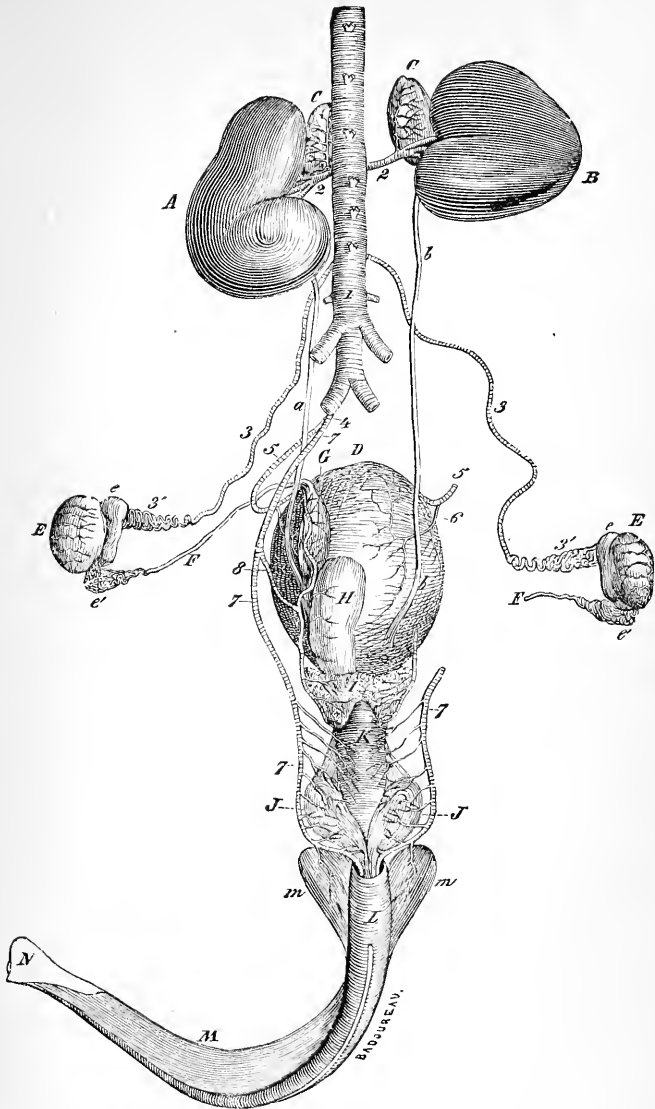

FIG. 320.—Superior and general view of the genito-urinary apparatus in the stallion with the arteries (Chauveau). A, left kidney; B, right kidney; *a, b*, ureters; C, C, suprarenal capsules; D, bladder; E, E, testicles; *e*, head of epididymis; *e'*, tail of epididymis; F, deferent canal; G, pelvic dilatation of deferent canal; H, left seminal vesicle; the right has been removed, along with the deferent canal of

same side, to show insertion of ureters into bladder; I, prostate; J, Cowper's glands; K, membranous or intra-pelvic portion of urethral canal; L, its bulbous portion; M, cavernous body of penis; *m, m*, its roots; N, head of penis; 1, abdominal aorta; 2, 2, arteries (renal) giving off principal capsular artery; 3, spermatic artery; 4, common origin of umbilical and arteries of bulb; 5, umbilical artery; 6, its vesical branch; 7, internal artery of bulb; 8, its vesico-prostatic branch.

ordinary control of the brain-centers over those in the spinal cord. 5. It may be assumed that the normal tone of the sphincter of the bladder is maintained reflexly by the spinal cord. The unwonted muscular contraction associated with an obstruction to the outflow of urine may be in part of nervous origin, but is also, in all probability, owing in some degree to the muscle-cells resuming an independent contractility, due to what we recognize as the principle of reversion. The same is seen in the heart, ureters, and similar structures.

Pathological.—There may be incontinence of urine from paralysis, the cerebral centers being unable to control those in the spinal cord. Dribbling of urine may be due to retention in the first instance, the tone of the sphincter being finally overcome, owing to increase of pressure within the bladder. Overdistention of the bladder may arise in consequence of lack of tone in the muscular walls, though this is rare. *Strangury* is due to excessive action of the walls of the bladder and the sphincter, brought about reflexly, when the organ is unduly irritable, as in inflammation, after the abuse of certain drugs (cantharides), etc.

Comparative.—In man the last drops of urine are expelled by the action of the bulbo-cavernosus muscle and perhaps some others. In the dog and many other animals the regulated and voluntary use of this muscle, marked in a high degree, produces that interrupted flow so characteristic of the micturition of these animals.

Summary.—Urine is in mammals a fluid of variable specific gravity and reaction, yellow in color, and containing certain salts, pigments, and nitrogenous bodies. The chief of the latter is urea.

The kidneys and skin especially supplement one another, and normally great activity of the one implies lessened activity of the other. This is availed of in the treatment of disease.

Both the Malpighian capsules and the renal tubules have a true secretory function, though the larger part of the water of urine is secreted by the former. Blood-pressure is an important

condition of secretion, though it is likely that this is so chiefly because it favors a rapid renewal of the blood circulating through the organ. Whether there are nerves that influence secretion directly, as in the case of the skin, is not determined.

Suppression of the renal functions leads to symptoms in which the nervous system is recognized as suffering to the extent often of coma, ending in death. The urine of most other animals is more concentrated than that of man ; this secretion in carnivora being acid, and in herbivora alkaline in reaction.

THE METABOLISM OF THE BODY.

IN the widest sense the term *metabouism* may be conveniently applied to all the numerous changes of a chemical kind, resulting from the activity of the protoplasm of any tissue or organ. In a more restricted meaning it is confined to changes undergone by the food from the time it enters till it leaves the body, in so far as these are not the result of obvious mechanical causes. The sense in which it is employed in the present chapter will be plain from the context, though usually we shall be concerned with those changes effected in the as yet comparatively unprepared products of digestion, by which they are elevated to a higher rank and brought some steps nearer to the final goal toward which they have been tending from the first. As yet our attempts to trace out these steps have been little better than the fruitless efforts of a lost traveler to find a road, the general direction of which he knows, but the ways by which it is reached only the subject of plausible conjecture. We shall therefore not discuss the subject at length from this point of view.

THE METABOLISM OF THE LIVER.

This organ has two well-recognized functions: 1. The formation of bile. 2. The formation of glycogen. We have already considered the first.

Glycogen may be obtained from the liver of mammals as a whitish amorphous powder, having the chemical composition of starch, and has in fact been termed animal starch.

By appropriate treatment it may be converted into sugar by a process of hydration ($C_6H_{10}O_5 + H_2O = C_6H_{12}O_6$).

The principal facts as to the storage of glycogen in the liver may be briefly stated thus:

1. Glycogen has been found in the liver of a large number

of groups of animals including some invertebrates. 2. Among mammals it is most abundant when the animal feeds largely on carbohydrates. 3. It is found in the liver of the carnivora, and in those of omnivora, when feeding exclusively on flesh. 4. When an animal starves (does not feed), the glycogen gradually disappears. 5. A fat-diet does not give rise to glycogen. 6. During early foetal life glycogen is found in all the tissues, but later it is restricted more and more to the liver, though even in adults it is to be found in various tissues, especially the muscles, from which it is almost never absent.

From the facts the inference is plain that glycogen is formed from carbohydrate materials; or, to be rather more cautious, that the formation of this substance is dependent on the presence of such material in the food.

The Uses of Glycogen.—No positive statement can be made on this subject. It is generally believed to be transformed into sugar.

What is the fate of the transformed glycogen? What becomes of the sugar? We can answer, negatively, that it is not used up in the blood, it is not oxidized there; but by what tissues it is used or how it is made available in the economy is a subject on which we are profoundly ignorant. The presence of so much glycogen in the partially developed tissues of the foetus points to its importance, and suggests its being a crude material which is laid up to be further elaborated, as in vegetables, by the growing protoplasm.

METABOLISM OF THE SPLEEN.

The physiological significance of the peculiar structure of this organ, though not yet fully understood, is much plainer than it was till recently. The student is recommended to look carefully into the histology of the spleen, especially the distribution of its muscular tissue and the peculiarities of its blood-vascular system. It has already been pointed out that there is little doubt that leucocytes are manufactured here even in the adult, possibly also red cells; and that the latter are disintegrated, and the resulting substances worked over, possibly by this organ itself. This view is rendered probable, not only by microscopic study of the organ, but by a chemical examination of the splenic pulp; for a ferruginous proteid, and numerous pigments, of a character such as harmonizes with this conception, are found.

The fact that the spleen-pulp does not agree in composition with either blood or serum; that it abounds in extractives such

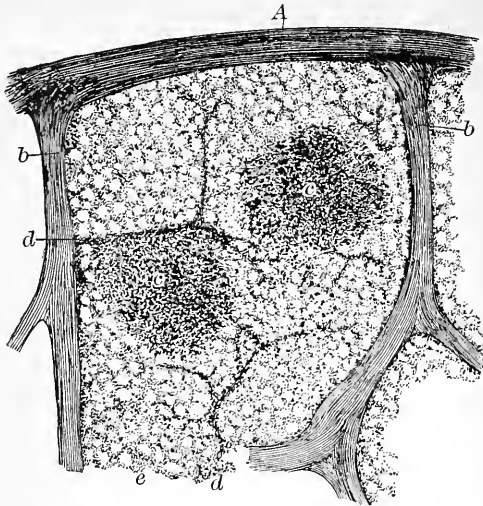

FIG. 321.—Vertical section of a small superficial portion of human spleen, seen with low power (Schäfer). *A*, peritoneal and fibrous covering; *b*, trabeculae; *c*, Malpighian corpuscles, in one of which an artery is seen cut transversely, in the other, longitudinally; *d*, injected arterial twigs; *e*, spleen-pulp.

as lactic, butyric, formic, and acetic acids, together with inosit, xanthin, hypoxanthin, leuciu and uric acid—points to its being

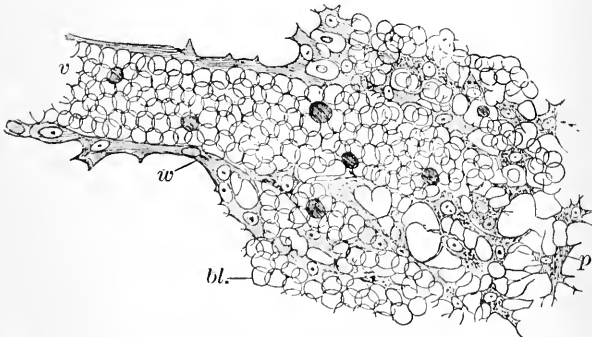

FIG. 322.—Thin section of spleen-pulp, highly magnified, showing mode of origin of a small vein in the interstices of pulp (Schäfer). *v*, vein filled with blood-corpuscles, which are in continuity with others, *bl.*, filling up interstices of retiform tissue of pulp; *w*, wall of vein. The shaded bodies among red corpuscles are pale corpuscles.

the seat of a complex metabolism, though neither the changes themselves nor their purpose are well understood.

Nevertheless, it must be admitted that to recognize this was a great advance upon the view that the spleen had no important function, and that this was shown by the removal of the organ without change in the animal's economy.

But to believe that there are no such changes, and to have clear proof of it, are two different things. As a matter of fact, closer study does show that in some animals there are alterations in the lymphatic glands and bone - marrow, which organs are undoubtedly manufacturers of blood-cells.

These changes are unquestionably compensatory, and that other similar ones corresponding to comparatively unknown functions of the spleen have not as yet been discovered is owing likely to our failures rather than their real absence. We dwell for a moment on this, because it illustrates the danger of the sort of reasoning that has been applied in the case of this and other organs; and it shows the importance of recognizing the force of the general principles of biology, and also the desirability of refraining from drawing conclusions that are too wide for the premises. In every department of physiology it must be more and more recognized that what is true of one group of animals is not necessarily true of another, or even of other individuals, though the differences in the latter case are of course usually less marked. We have referred to this before, and shall do so again, for it is as yet but too little considered.

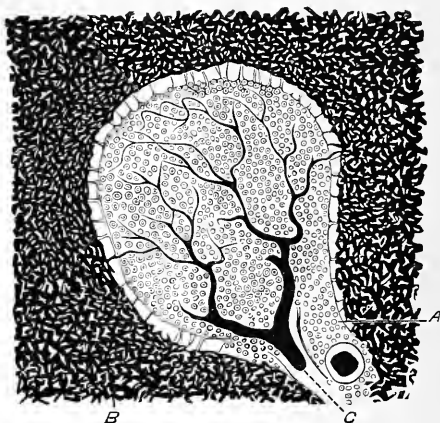

FIG. 323.—Portion of spleen of cat, showing Malpighian (lymphatic) corpuscle (after Cadiat). *A*, artery around which corpuscle is placed; *B*, meshes of spleen-pulp, injected; *C*, artery of corpuscle ramifying in lymphatic tissue. The clear space around corpuscle represents a lymphatic sinus.

THE CONSTRUCTION OF FAT.

It is a well-known fact that, speaking generally, a diet rich in carbohydrates favors fat formation, both in man and other animals; though it is not to be forgotten that many persons seem to be unable to digest such food, or, at all events, to assimilate it so as to form fat to any great extent. Persons given to excessive fat production are as frequently as not sparing users of fat itself.

It is possible in man and probable in ruminants that fermentations may occur in the intestines giving rise to fatty acids which are possibly converted into fats by the cells of the villi or elsewhere. Certain feeding experiments favor the view that carbohydrates may be converted into fat or in some way give rise to an increase in this substance; for it is to be borne in mind that fat may arise from a certain diet in various ways other than its direct transformation into this substance itself.

There are certain facts that make it clear that fat can be formed from proteids: 1. A cow will produce more butter than can be accounted for by the fat in her food alone. 2. A bitch which had been fed on meat produced more fat in her milk than could have been derived directly from her food, and this, when the animal was gaining in weight, which is usually to be traced to the addition of fat; so that the fat of the milk was not, in all probability, derived from that of the dog's body; and, as will be seen presently, can be accounted for without such a supposition. 3. It has been shown by analysis that 472 parts of fat were deposited in the body of a pig for every 100 in its food.

These facts of themselves suffice to show that fat can be formed from proteid, or at least that proteid food can of itself give rise to a metabolism, resulting in fat formation; and the latter is probably the better way to state the case in the present condition of knowledge.

That fat is a real formation, dependent for its composition on the work of living tissues, is clear from the well-known fact that the fat of one animal differs from that of another, and that it preserves its identity, no matter what the food may be, or in what form fat itself may be provided. Certain constituents of the animal's fat may be wholly absent from the fat of its food, yet they appear just the same in the fat produced under such

diet. Even bees can construct their wax from proteid, or use unlike substances, as sealing-wax.

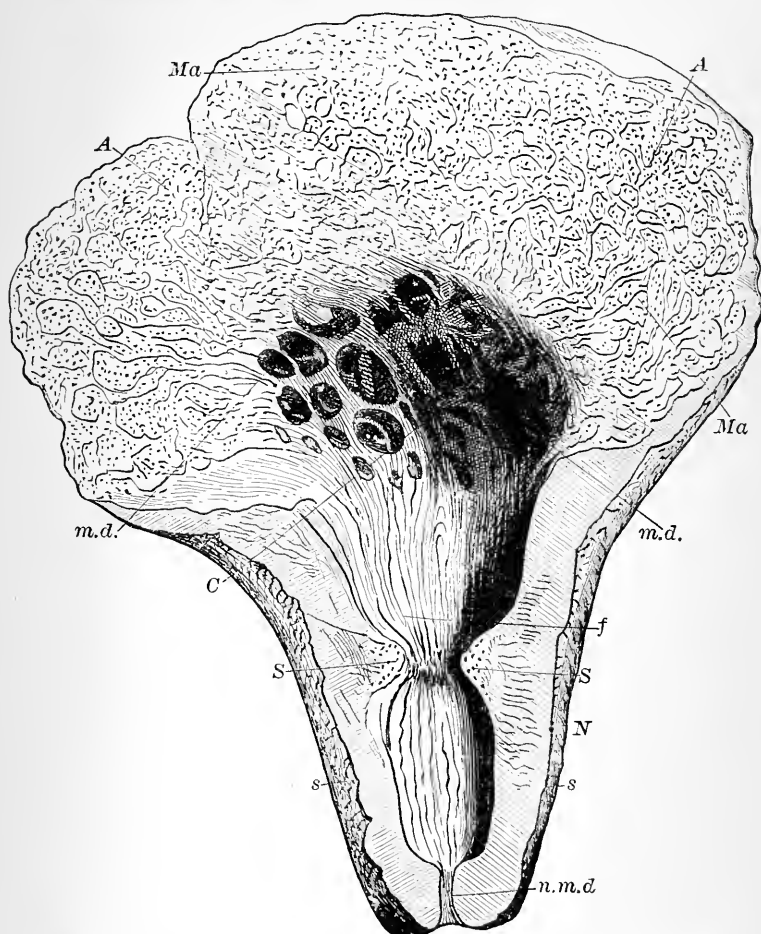

FIG. 324.—Section of mammary gland (udder and nipple) of cow (after Thanoffer). *Ma*, substance of gland; *N* nipple; *A*, acini of gland; *m. d.*, milk-ducts; *C*, milk-cisterns; *f*, folds in wide milk-ducts; *S*, section of sphincter muscle; *s*, external skin; *n. m. d.*, narrow milk-duct in nipple.

But histological examination of forming adipose tissue itself throws much light upon the subject. Fat-cells are those in which the protoplasm has been largely replaced by fat. The

latter is seen to arise in the former as very small globules which run together more and more till they may wholly replace the original protoplasm.

The history of the mammary gland is, perhaps, still more instructive. In this case, the appearance of the cells during lactation and at other periods is entirely different. Fat may be seen to arise within these cells and be extruded, perhaps in the same way as an *Amœba* gets rid of the waste of its food. So far as the animal is concerned, milk is an excretion in a limited sense.

It is, in the nature of the case, impossible to follow with the eye the formation and separation of milk-sugar, casein, etc.

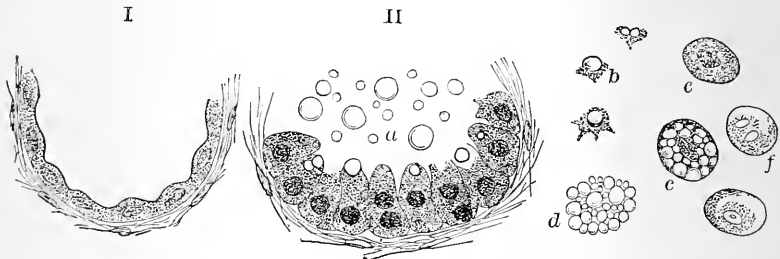

FIG. 325.—I. Acinus from mamma of a bitch when inactive (after Heidenhain). II. During secretion of milk. *a, b*, milk-globules; *c, d, e*, colostrum-corpuscles; *f*, pale cells.

But the whole process is plainly the work of the cells, and in no mechanical sense a mere deposition of fat, etc., from the blood; and the same view applies to the construction of fat by connective (adipose) tissue.

Whether fat, as such, or fatty acid, is dealt with without being built up into the protoplasm of the cell, is not known; but, taking all the facts into the account, and considering the behavior of cells generally, it seems most natural to regard the construction of fat as a sort of secretion or excretion. To suppose that a living cell acts upon material in the blood as a workman in a factory on his raw material, or even as a chemist does in the laboratory, seems to be too crude a conception of vital processes. Until it can be rendered very much clearer than at present, it is not safe to assume that their chemistry is our chemistry, or their methods our methods. It may be so; but let us not, in our desire for simple explanations or undue haste to get some sort of theory that apparently fits into our

own knowledge, assume it gratuitously, in the absence of the clearest proofs, especially when our failures on this supposition are so numerous.

We may say, then, that fat is not merely selected from the blood, but formed in the animal tissues ; that fat formation

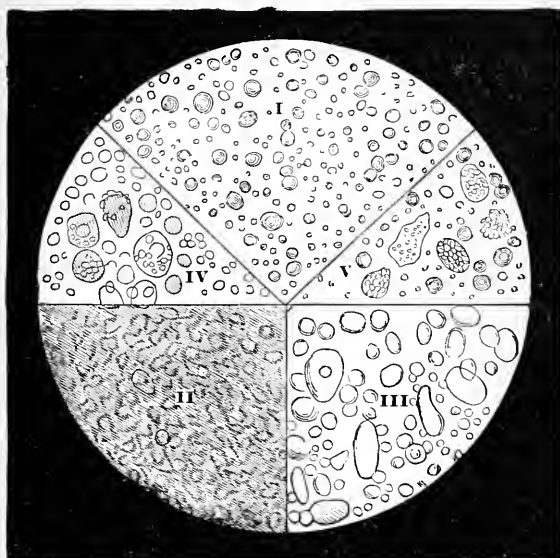

FIG. 326.—Microscopic appearances of—I, milk; II, cream; III, butter; IV, colostrum of mare; V, colostrum of cow (after Thanhoffer).

may take place when the food consists largely of carbohydrates, when it is chiefly proteid, or when proteid and fatty. In other words, fat results from the metabolism of certain cells, which is facilitated by the consumption of carbohydrate and fatty food, but is possible when the food is chiefly nitrogenous. We must, however, recognize differences both of the species and the individual in this respect, as to the extent to which one kind of food or the other most favors fat formation (excretion). The use of the adipose tissue as a packing to prevent undue escape of heat is evident ; but more important purposes are probably served, as will appear from later considerations.

Pathological.—Excessive fat formation, leading to the hampering of respiration, the action of the muscles, and, to a certain extent, many other functions of the body, does not arise in man

usually till after middle life, when the organism has seen its best days. It seems to indicate, if we judge by the frequency of fatty degeneration after disease, that the protoplasm stops short of its best metabolism, and becomes degraded to a lower rank; for certainly adipose tissue does not occupy a high place in the histological scale. Such pathological facts throw a good deal of light upon the general nature of fat excretion, as it would be better to term it, perhaps, and seem to warrant the view that we have presented of the metabolic processes.

Although the nerves governing the secretion of milk have not been traced, there can be no doubt that the nervous system controls this gland also. The influence of the emotions on both the quantity and quality of the milk in the human subject and in lower animals is well known.

Comparative.—While breeders recognize certain foods as tending to fat formation and others to milk production, it is interesting to note that their experience shows that race and individuality, even on the male side, tell. The same conditions being in all respects observed, one breed of cows gives more and better milk than another, and the bull is himself able to transmit this peculiarity; for, when crossed with inferior breeds, he improves the milking qualities of the latter. Individual differences are also well known.

THE STUDY OF THE METABOLIC PROCESSES BY OTHER METHODS.

It will be abundantly evident that our attempts to follow the changes which the food undergoes from the time of its introduction into the blood until it is removed in altered form from the body has not been as yet attended with great success. It is possible to establish relations between the ingesta and the egesta, or the income and output which have a certain value. It is important, however, to remember that, when quantitative estimations have to be made, a small error in the data becomes a large error in the final estimate; one untrue assumption may vitiate completely all the conclusions.

In discussing the subject we shall introduce a number of tables, but it will be remembered that the results obtained by one investigator differ from those obtained by another; and that in all of them there are some deviations from strict ac-

curacy, so that the results must be regarded as only approximately correct. It is, however, we think, better to examine such statistical tables of analyses, etc., than to rely on the mere verbal statement of certain results, as it leaves more room for individual judgment and the assimilation of such ideas as they may suggest outside of the subject in hand.

The subject of diet is a very large one ; but it will be evident on reflection that, before an average diet can be prescribed on any scientific grounds, the composition of the body and the nature of those processes on which nutrition generally depends must be known. . Not a little may be learned by an examination of the behavior of the body in the absence of all diet, when it may be said to feed on itself, one tissue supplying another. All starving animals are in the nature of the case carnivorous.

For the cat an analysis has yielded the following :

Muscle and tendons.....	45·0 per cent.
Bones.....	14·7 “
Skin.....	12·0 “
Mesentery and adipose tissue.....	3·8 “
Liver.....	4·8 “
Blood (escaping at death).....	6·0 “
Other organs and tissues.....	13·7 “

The large proportional weight of the muscles, the similarly large amount of blood they receive, which is striking in the case* of the liver, also suggest that the metabolism of these structures is very active, and we should expect that they would lose greatly during a starvation period. It is a matter of common observation that animals do lose weight and grow thin under such circumstances, which means that they must lose in the muscles and the adipose tissue. Attempts have been made to determine exactly the extent to which the various tissues do suffer during complete abstinence from food, and this may be gathered from the table given below.

It will not be forgotten that about three fourths of the body is made up of water, so that the loss of a large amount of the latter during starvation is to be expected.

In the case of a cat during a starvation period of thirteen days 734 grammes of solids were lost, of which 248 grammes were fat and 118 muscle—i. e., about one half of the total loss was referable to these two tissues alone.

The other tissues lost as follows, estimated as *dry* solids :

Adipose tissues.....	97·0	per cent.
Spleen.....	63·1	“
Liver.....	56·6	“
Muscles....	30·2	“
Blood	17·6	“
Brain and spinal cord.....	0·0	“

It will be observed (*a*) that the loss of the fatty tissue was greatest, nearly all disappearing; (*b*) that the glandular structures were next in order the greatest sufferers; (*c*) that after them come the skeletal muscles.

Now, it has been already seen that these tissues all engage in an active metabolism with the exception of adipose tissue.

The small loss on the part of the heart, which is still less for the nervous system, is especially noteworthy. The loss of adipose tissue is so striking that we must regard it as an especially valuable storehouse of energy, available as required.

When we turn to the urine for information, it is found that in the above case 27 grammes of nitrogen were excreted and almost entirely, of course, in the form of urea; and since the loss of nitrogen from the muscles amounted to 15 grammes, it will appear that more than one half of the nitrogenous excreta is traceable to the metabolism of muscular tissue. It has been customary to account for the urea in two ways: first, as derived from the metabolism of the tissues as such, and continuously throughout the whole starvation period; and, secondly, from a stored surplus of proteid which was assumed to be used up rapidly during the early days of the fasting, and was the *luxus consumption* of certain investigators.

Comparative.—Experiment has shown that the length of time during which different groups of animals can endure complete withdrawal of food is very variable, and this applies to individuals as well as species. That such differences hold for the human subject is well illustrated by the history of the survivors of wrecks. Making great allowances for such deviations from any such results as can be established by a limited number of experiments, it may be stated that the human being succumbs in from twenty-one to twenty-four days; dogs in good condition at the outset in from twenty-eight to thirty days; small mammals and birds in nine days, and frogs in nine months. Very much depends on whether water is allowed or not—life lasting much longer in the former case. The very young and the very old yield sooner than persons of middle

age. It has been estimated that strong adults die when they lose $\frac{1}{10}$ of the body-weight. Well-fed animals lose weight more rapidly at first than afterward.

Diet.—All experiments and observations tend to show that an animal can not remain in health for any considerable period without having in its food proteids, fats, carbohydrates, and salts; indeed, sooner or later deprivation of any one of these will result in death.

Estimates based on many observations have been made of the proportion in which these substances should enter into a normal diet.

For the herbivora from 1 to 8-9 (some claim 1 to $5\frac{1}{2}$) is the estimated ratio of nitrogenous to non-nitrogenous foods; and 2 of the former to 1 of fat.

One conclusion that is obvious from analysis of foods is that, in order to obtain the amount of proteids needed from certain kinds, enormous quantities must be eaten and digested; and as there would be in such cases an excess of carbohydrates, fats, etc., unnecessary work is entailed upon the organism in order to dispose of this; so that to feed a working horse entirely on grass, a dog wholly on porridge, or a man on bread would be very unwise.

FEEDING EXPERIMENTS (Ingesta and Egesta).

If all that enters the body in any form be known, and all that leaves it be equally well known, conclusions may be drawn in regard to the metabolism the food has undergone. The possible sources of fallacy will appear as we proceed.

The ingesta, in the widest sense, include the respired air as well as the food; though from the latter must be subtracted the waste (undigested) matters that appear in the fæces. The ingesta when analyzed include carbon, hydrogen, oxygen, nitrogen, sulphur, phosphorus, water, and salts, their source being the atmosphere and the food-stuffs.

The egesta, the same, and chiefly in the form of carbonic anhydride, of water from the lungs, skin, alimentary canal, and kidneys, of salts and water from the skin and kidneys, and of nitrogen, chiefly as urea almost wholly from the kidneys. Usually in experimental determinations the total quantity of the nitrogen of the urine is estimated. If free nitrogen plays any part in the metabolic processes it is unknown.

A large number of feeding experiments have been made by different investigators, chiefly, though not exclusively, on the lower animals. Some such method as the following has usually been pursued: 1. The food used is carefully weighed and a sample of it analyzed, so that more exact data may be obtained. 2. The amount of oxygen used and carbonic anhydride exhaled, as well as the amount of water given off in any form is estimated. 3. The amount of the nitrogenous excreta is calculated, chiefly from an analysis of the urine, though any loss by hair, etc., is also to be taken into account.

It has been generally assumed that the nitrogen of the excreta represents practically the whole of that element entering the body. This has been denied by some investigators.

The respiratory products have been estimated in various ways. One consists in measuring the quantity of oxygen supplied to the chamber in which the animal under observation is inclosed, and analyzing from time to time samples of the air as it is drawn through the chamber; and on these results the total estimates are based.

It will appear that even errors in calculating the composition of the food—and this is very variable in different samples, e. g., of flesh; or any errors in the analysis of the urine, or in the more difficult task of estimating the respiratory products, may, when multiplying to get the totals, amount to serious departures from accuracy in the end; so that all conclusions in such a complicated case must be drawn with the greatest caution. But it can not be doubted that such investigations have proved of much practical and some scientific value. The labor they entail is enormous.

Nitrogenous Equilibrium.—It is possible to so feed an animal, say a dog, that the total nitrogen of the ingesta and egesta shall be equal; and this may be accomplished without the animal losing or gaining weight appreciably or again while he is gaining. If there be a gain, it can usually be traced to the formation of fat, so that the proteid, we may suppose, has been split up into a part that is constructed into fat and a part which is represented by the urea, the fat being either used up or stored in the body. Moreover, an analysis of a pig that had been fed on a fixed diet, and a comparison made with one of the same litter killed at the commencement of the experiment, showed that of the dry nitrogenous food only about seven per cent in this animal, and four per cent in the sheep had been laid away

as dry proteid. It is perfectly plain, then, that proteid diet does not involve only proteid construction within the body.

Comparative.—The amount of flesh which a dog, being a carnivorous animal, can digest and use for the maintenance of his metabolic processes is enormous; though it has been learned that ill-nourished dogs can not even at the outset of a feeding experiment of this kind maintain the equilibrium of their body weight on a purely flesh diet (fat being excluded). They at once commence to lose weight—i. e., they draw upon their own limited store of fat.

The digestion of herbivora being essentially adapted to a vegetable diet, they can not live at all upon flesh, while a dog can consume for a time without manifest harm $\frac{1}{5}$ to $\frac{1}{6}$ of its body-weight of this food.

Man, when fed exclusively on meat soon shows failure, he being unable to digest enough to supply the needed carbohydrates, etc. But the large amount of urea in the urine of carnivorous animals generally, and the excess found in the urine of man when feeding largely on a flesh diet, show that the proteid metabolism is under such circumstances very active.

It is also a well-known observation that carnivorous animals (dogs) are more active and display to a greater extent their latent ferocity, evidence of their descent from wild carnivorous progenitors, when like them they feed very largely on flesh. The evidence seems to point pretty clearly to the conclusion that a nitrogenous (flesh) diet increases the activity of the vital process of the body, and especially the proteid metabolism.

But in all these considerations it must be borne in mind that the metabolic processes go on in the tissues and not in the blood, and probably not in the lymph. Not that these fluids (tissues) are without their own metabolic processes for and by themselves; but what is meant to be conveyed is that the metabolic processes of the body generally do not take place in the blood.

The Effects of Gelatin in the Diet.—Actual experiment shows that this substance can not take the place of proteid, though it also makes it evident that less of the latter suffices when mixed with a certain proportion of gelatin. It will be borne in mind that ordinary flesh contains, as we find it naturally in the carcass, not only some fat, but a good deal of fibrous tissue, which can be converted by heating into gelatin.

Fats and Carbohydrates.—It is a matter of common observation and of more exact experiment that even a carnivorous animal thrives better on a diet of fat and lean meat than on lean flesh alone. Thus, it has been found that nitrogenous equilibrium was as readily established by a due mixture of fat and lean as upon twice the quantity of lean flesh alone. It is plain, then, that the metabolism is actually slowed by a fatty diet. When an animal is given but little fat, none whatever is laid up, but all the carbon of the fat can be accounted for in the excreta, chiefly as carbonic anhydride. Again, the fatty portion remaining constant, it has been found that increasing the proteid leads not to a storage of the carbon of the proteid excess, but to an increased consumption of this element. It is then possible to understand how excessive consumption of proteids may lead, as seems to be the case, to the disappearance of fat and loss of weight, so that a proteid diet increases not only nitrogenous but non-nitrogenous metabolism. That carbohydrates mixed with a due proportion of the other constituents of a diet do increase fat formation is well established; though there is no equally well-grounded explanation of how this is accomplished. Upon the whole, it seems most likely that fat can be directly formed from carbohydrates, or, at all events, that they directly give rise to fat if they are not converted themselves into that substance.

Comparative.—It is found that there are relations between the food used and the quantity of carbonic dioxide expelled which are instructive. The formula following show the amount of oxygen necessary to convert a starch and a fat into carbonic anhydride and water:

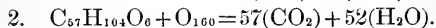
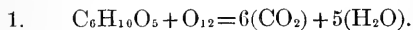

It will be observed that in the first case the oxygen used to oxidize the starch has all reappeared as CO_2 , while in the second only 114 parts out of 160 so reappear. As a matter of fact, more of the oxygen used does in herbivora reappear as CO_2 , and less as water, while the reverse holds for the carnivora, the proportion being, it is estimated, as ninety to sixty per cent. This is to be explained by the character of the food in each instance, for this relation no longer holds during fasting, when the herbivorous animal becomes carnivorous in the sense that it consumes its own tissues.

The Effects of Salts, Water, etc., in the Diet.—When we come to inquire as to the part salts play when introduced into the blood, we soon find that our knowledge is very limited.

Sulphur, and especially phosphorus, seem to have some important use which quite eludes detection. It is important to remember that certain salts are combined with proteids in the body, possibly to a greater extent than we can learn from the mere analysis of dead tissues.

Pathological.—The withdrawal of any of the important salts of the body soon leads to disease, clear evidence in itself of their great importance. This is notably the case in scurvy, in which disease the blood seems to be so disordered and the nutrition of the vessel-walls so altered that the former (even some of the blood-cells) passes through the latter.

Water.—The use of water certainly has a great influence over the metabolic processes of the body. The temporary addition or withdrawal of even a few ounces of water from the regular supply of a dog in the course of a feeding experiment greatly modifies the results obtained for the time. It is well known that increase of water in the diet leads to a corresponding increase in the amount of urea excreted. It is likely that even yet we fail to appreciate fully the great part which water plays in the animal economy.

THE ENERGY OF THE ANIMAL BODY.

As already explained, we distinguish between potential or latent and actual energy. All the energy of the body is to be traced to the influence of the tissues upon the food. Energy may be estimated as mechanical work or as heat, and the one may be converted into the other. All the processes of the organism involve chemical changes, and a large proportion of these are of the nature of oxidations; so that speaking broadly, the oxidations of the animal body are the sources of its energy; and in estimating the quantity of energy, either as heat or work, that a given food-stuff will produce, one must consider whether the oxidative processes are complete or partial; thus, in the case of proteid food, if we suppose that the urea excreted represents the form in which the oxidative processes end or are arrested, we must, in estimating the actual energy of the proteid, subtract the amount of energy that would be produced were the urea itself completely oxidized (burned.)

If the amount of heat that a body will produce in its combustion be known, then by the law of the conversion and equivalence of energy the mechanical equivalent can be estimated in that particular case.

The heat-producing power of different substances can be directly learned by ascertaining the extent to which, when fully burned (to water and carbonic anhydride), they elevate the temperature to a given volume of water; and this can at once be translated into its mechanical equivalent of work, so that we may say that one gramme of dry proteid would give rise to a certain number of gramme-degrees of heat or kilogramme-metres of work. A few figures will now show the relative values of certain food-stuffs:

	Gram.-deg.	Kilomet.
1 gramme proteid	5,103	2,161
1 gramme urea	735	311
Available energy of the proteid	4,368	1,850

The reason of the subtraction has been explained above.

Taking another diet in regard to which the estimates differ somewhat from those given previously, but convenient now as showing how equal weights of substances produce very different amounts of energy, we find that—

	Gram.-deg.	Kilomet.
100 grammes proteid yield	436,800	185,000
100 grammes fat yield	906,900	384,100
240 grammes starch yield	938,880	397,680
Total	2,281,580	966,780

In other words nearly a million kilogramme-metres of energy are available from the above diet for one day, provided it be all oxidized in the body.

Food-stuffs, then, with the oxygen of the air, are the body's sources of energy. What are the forms in which its expenditure appears? We may answer at once heat and mechanical work; for it is assumed that internal movements as those of the viscera, and all the friction of the body, all its molecular motion, all secretive processes, are to be regarded as finally

augmenting the heat of the body. Heat is lost by the skin, lungs, urine, and fæces.

The division of foods into heat-producers and tissue-builders is unjustifiable, as will appear from what has just been stated, as well as from such facts as the production of fat from proteid food, thus showing that the latter is indirectly a producer of carbonic anhydride, assuming that fat is oxidized into that substance.

ANIMAL HEAT.

Though a large part of the heat generated within the body is traceable to oxidations taking place in the tissues, it is better to speak of the heat as being the outcome of all the chemical processes of the organism; and though heat may be rendered latent in certain organs for a time, in the end it must appear. While all the tissues are heat-producers (thermogenic), the extent to which they are such would depend, we should suppose, upon the degree to which they were the seat of metabolic processes; and actual tests establish this fact. Thus, among glands the liver is the greatest heat-producer; hence the blood from this organ is the warmest of the whole body. The muscles also are especially the thermogenic tissue.

The temperature of the blood in the hepatic vein is warmer than that in the portal, a clear evidence that the metabolism of this organ has elevated the temperature of the blood flowing through it.

The temperature of the blood (its own metabolism being slight) is a pretty fair indication of the resultant effect of the production and the loss of heat.

For obvious reasons, the temperature of different parts of the body of man and other animals varies.

The statements of observers in regard to the temperature of various animals and of different parts of the body disagree in a way that would be puzzling, were it not known how difficult it is to procure perfectly accurate thermometers, not to mention individual differences. The axillary temperature is in man about 37° C. (98.6 F.); that of the mouth a little higher, and of the rectum or vagina slightly more elevated. The mean temperature of the blood is placed at 39° C. (102.2 F.).

Comparative.—The temperature of various groups of animals has been stated to be as follows: Hen and pigeon, 42° (107.6 F.); swallow, 44.03° (111.25 F.); dolphin, 35.5° (95.9 F.); mouse, 41.1°

(106 F.); snakes, 10° to 12° (50 to 53·6 F.); but higher in large specimens (python). Cold-blooded animals have a temperature a little higher (less than 1° C. usually) than the surrounding air. During the swarming of bees the hive temperature may rise from 32° to 40° (89·6 to 104 F.). All cold-blooded animals have probably a higher temperature in the breeding-season. In our domestic mammals the normal temperature is not widely different from that of man. In the horse the average is 37·5° to 38° (99·5 to 100·4 F.); in the ass, 38° to 39·5° (100·4 to 103 F.); in the ox, 38° to 38·5° (100·4 to 101·3 F.); in the sheep and pig, 39° to 40° (102·2 to 104 F.); in the cat, 38·5° to 39° (101·3 to 102·2 F.); in the dog, 38·5° (101·3 F.).

Variations in the average temperature are dependent on numerous causes which may affect either the heat production or heat loss : 1. Change of climate has a very slight but real influence, the temperature being elevated a fraction of a degree when an individual travels from the poles toward the equator, and the same may be said of the effect of the temperature of a warm summer day as compared with a cold winter one. The wonder is that, considering the external temperature, the variation is so light. 2. Starvation lowers the temperature, and the ingestion of food raises it slightly, the latter increasing, the former decreasing, the rate of the metabolic processes. 3. Age has its influence, the very young and the very old, in whom metabolism (oxidation) is feeble, having a lower temperature. This especially applies to the newly born, both among mankind and the lower mammals; and, as might be supposed, the temperature falls during sleep, when all the vital activities are diminished. The same remark applies with greater force to the hibernating state of animals. The temperature of man does not vary more than about 1° C. during the twenty-four hours.

It will be inferred, from the facts and figures already cited, that different kinds of food have considerably different capacity for heat production.

It is well known that an animal when working not only feels warmer, but actually produces more heat.

It appears from a multitude of considerations that the body is like a steam-engine, producing heat and doing work ; but it is found that while a very good steam-engine, as a result of the chemical processes going on within it, converts $\frac{1}{3}$ of the potential energy of its supplies into mechanical work, the other $\frac{2}{3}$

appearing as heat, the animal body produces $\frac{1}{5}$ as work and $\frac{4}{5}$ as heat, from its income of food and oxygen.

While it is perfectly clear that it is in the metabolic processes of the body that we must seek for the final cause of the heat produced, it is incumbent on the physiologist to explain the remarkable fact that the mammalian body maintains, under a changing external temperature and other climatic conditions, and with a varying diet, during rest and labor, a temperature varying within, usually, no more than a fraction of a degree centigrade. This we shall now endeavor to explain in part.

The Regulation of Temperature.—It is manifest from the facts adduced that so long as life lasts heat is being of necessity constantly produced. If there were no provision for getting rid of a portion of this heat, it is plain that the body would soon be consumed as effectually as if it were placed in a furnace. We observe, however, that heat is being constantly lost by the breath, by perspiration (insensible), by conduction and radiation from the surface of the body, and periodically by the urine and feces. We have seen that, while heat is being produced in all the tissues and organs of the body, some are especially thermogenic, as the glands and muscles. The skin presents an extensive surface, abundantly supplied with blood-vessels, which when dilated may receive a large quantity of blood, and when contracted may necessitate a much larger internal supply, in the splanchnic region especially. It is a matter of common observation that, when an individual exercises, the skin becomes flushed, and so with the increased production of heat, especially in the muscles (see page 195), there is a provision for unusual escape of the surplus; at the same time sweat breaks out visibly, or if not, the insensible perspiration is generally increased; and this accounts for an additional increment of loss; while the lungs do extra work and exhale an increased quantity of aqueous vapor, so that in these various ways the body is cooled. Manifestly there is some sort of relation between the processes of heat production and heat expenditure. The vaso-motor, secretory, and respiratory functions are modified. We may suppose that the various co-ordinations effected, chiefly at all events through the central nervous system, and not by the direct action of the heat upon local nervous mechanisms, or the tissues themselves directly, are reflexes.

The production of heat, however, seems to be equally under the influence of the nervous system, though we know less about the details of the matter.

A cold-blooded animal differs from a warm-blooded one in that its temperature varies more with the surrounding medium: hence the terms *poikilothermer* and *homoiothermer* for cold-blooded and warm-blooded, would be appropriate.

Such an animal, as a frog or turtle, may have its chemical processes slowed or quickened, almost like those going on in a test-tube or crucible, by altering the temperature. Very different is it, as we have seen, in the normal state of the animal with any mammal. Hence hibernation or an allied state has become a necessary protection for poikilothermers, otherwise they would perish outright, and the groups become extinct in northern latitudes.

It is plain that vaso-motor changes alone can not explain these effects; and, though possibly a part of the rise of temperature, following exposure of the naked body in a cool air, may be accounted for by the increased metabolism of internal organs, accompanying the influx of blood caused by constriction of the cutaneous capillaries, it is probable that in this as in so many other instances the blood and circulation have been credited with too much, and the direct influence of the nervous system on nutrition and heat production overlooked or underestimated. The thermogenic center has not yet been definitely located, though some recent investigations seem to favor a spot in or near the corpus striatum for certain mammals. Some investigators also recognize a cortical heat-center. It has been suggested that we may to advantage speak of a *thermotaxic* (regulative of loss) and a *thermogenic* mechanism (regulative of production), and even a *thermolytic* or discharging mechanism. It has been further suggested that different nerve-fibers may be concerned in the actual work of conveying the different impulses of these respective mechanisms to the tissues; and the whole theory has been framed in accordance with the prevalent conception of metabolism as consisting of anabolism and catabolism, or constructive and destructive processes. But these theories have not yet been confirmed by experiments on animals, though they are, in the opinion of their authors, in harmony with the facts of fever. Certainly, any theory that will imply that vital processes are more under the control of the nervous system than has hitherto been taught, will, we think,

advance physiology, as will shortly appear from our discussion of the influence of the nervous system on the various metabolic processes generally.

The phenomena observable in an animal gradually freezing to death point strongly to the direct influence of the nervous system on the production as well as the regulation of heat. The circulation must of course be largely concerned, but it appears as though the nervous system refused to act when the temperature falls below a certain point. A low temperature favors hibernation, in which we believe the nervous system plays the chief part, though the temperature in itself is not the determining cause, as we have ourselves proved. The fact that the whole metabolism of a hibernating animal is lowered, that with this there is loss of consciousness much more profound than in ordinary sleep, of itself seems to indicate that the nervous system is at the bottom of the whole matter.

Pathological.—It is found that many drugs and poisons lower temperature, acting in a variety of ways. In certain diseases, as cholera, the temperature may sink to 23° C. in extreme cases before death supervenes. When the temperature of the blood is raised 6° to 8° C. (as in sunstroke, etc.), death occurs; and it is well known that prolonged high temperature leads to fatty degeneration of the tissues generally. All the evidence goes to show that in fever both the heat production and the heat expenditure are interfered with; or, at least, if not always, that there may be in certain cases such a double disturbance. In fever excessive consumption of oxygen and production of carbon dioxide occur, the metabolism is quickened, hence its wasting (consuming) effects; the rapid respiration tends to increase the thirst, from the extra amount of aqueous vapor exhaled. The body is actually warmest during the "cold stage" of fever, when the vessels of the skin are constricted and the patient feels cold, because the internal metabolism is heightened; while the "sweating stage" is marked by a natural fall of temperature. The fact that the skin may be dry and pale in fever shows that the thermotaxic nervous mechanism is at fault; but the chemical facts cited above (excess of CO_2 etc.) indicate that the thermogenic mechanism is also deranged.

SPECIAL CONSIDERATIONS.

If the student will now read afresh what has been written under the above heading in relation to the subject of digestion, it will probably appear in a new light. We endeavored to show that, according to that general principle of correlation which holds throughout the entire organism, and in harmony with certain facts, we were bound to believe that digestion and assimilation, or, to speak in other terms, the metabolic processes of the various tissues, in a somewhat restricted sense, were closely related. Beneath the common observation that "digestion waits on appetite" lies the deeper truth that food is not prepared in the alimentary canal (digested) without some relation to the needs of the system generally. In other words, the voice of the tissues elsewhere is heard in the councils of the digestive tract, and is regarded; and this is effected chiefly through the nervous system. Excess in eating may lead to vomiting or diarrhoea—plain ways of getting rid of what can not be digested.

Evolution.—We have already alluded to some of those modifications in the form of the digestive organs that indicate an unexpected plasticity, and impress the fact of the close relation of form and function. The conversion of a sea-gull into a graminivorous bird, with a corresponding alteration in the nature of the form of the stomach (it becoming a gizzard), with doubtless modifications in the digestive processes, when regarded more closely, implies coadaptations of a very varied kind. These are as yet but imperfectly known or understood, and the subject is a wide and inviting field for the physiologist. Darwin and others have indicated, though but imperfectly, some of the changes that are to be regarded in animals as correlations; but in physiology the subject has received but little attention as yet. We have in several parts of this work called attention to it; but the limits of space prevent us doing little more than attempting to widen the student's field of vision by introducing such considerations. The influence of climate on metabolism, an undoubted fact, has many implications.

Any one who keeps a few wild animals in confinement under close observation, and endeavors to ascertain how their natural, self-chosen diet may be varied when confined, will be astonished at the plasticity of their instincts, usually considered as so rigid in regard to feeding. These facts help one

to understand how by the law of habit and heredity each group of animals has come to prefer and flourish best upon a certain diet. But habit itself implies an original deviation some time, in which is involved, again, plasticity of nature and power to adapt as well as to organize. Without this, evolution of function is incomprehensible; but with this principle, and the tendency for what has once been done to be easier of repetition, and, finally, to become organized, a flood of light is thrown upon the subject of diet, digestion, and metabolism generally. On these principles it is possible to understand those race differences, even individual differences, which as facts must be patent to all observers.

The principle of natural selection has clearly played a great part in determining the diet of a species; the surviving immigrants to a new district must be those that can adapt to the local environment best, including the food which the region supplies. The greater capability of resisting hunger and thirst in some individuals of a species implies great differences in the metabolic processes, though these are mostly unknown to us; and the same remark applies to heat and cold.

It seems clear that hibernation is an acquired habit of the whole metabolism, with great changes in the functional condition of the nervous system *recurring periodically*, and, in fact, dependent on these, by which certain large divisions, as the reptiles, amphibians, and certain mammals among vertebrates, are enabled to escape individual death and extinction as groups. We may suppose that, for example, among invertebrates, by a process of natural selection, those survived that could thus adapt themselves to the environment; while, among mammals, hibernation may be considered as a process of reversion, perhaps, for the homiothermer becomes very much a poikilothermer during hibernation, the latter reverting to a condition existing in lower forms, and not wholly unlike that of plants in winter. This can be understood on the principle of the origin of higher from lower forms; otherwise it is difficult to understand why similar states of the metabolism should prevail in groups widely separated in form and function. If all higher groups bear a derivative relation to the lower, what is common in their nature, as we usually find them, as well as the peculiar resemblances of the metabolism of higher to lower forms in sleep, hibernation, etc., can be understood in the light of physiological reversion.

The origin of a homiothermic (warm-blooded) condition

itself is to be sought for in the principle of natural selection. It was open to certain organisms, we may assume, either to adapt to a temperature much below that of their blood, or to hibernate; failing to make either adaptation would result in death; and gradually, no doubt, involving the death of numberless individuals or species, the resisting power attained the marvelous degree that we are constantly witnessing in all homiothermers.

The daily variations of the bodily temperature in homiothermers is a beautiful example of the law of rhythm evident in the metabolism. Hibernation is another such. While these are clear cases, it is without doubt true that, did we but know more of the subject, a host of examples of the operation of this law might be instanced.

We can but touch on these subjects enough to show that they deserve an attention not as yet bestowed on them; and to the thoughtful it will be evident that their influence on practical life might be made very great were they but rightly apprehended.

THE INFLUENCE OF THE NERVOUS SYSTEM ON METABOLISM (NUTRITION).

This subject is of the utmost importance, and has not received the attention hitherto, in works on physiology, to which we believe it is entitled, so that we must discuss it at some length.

We may first mention a number of facts on which to base conclusions: 1. Section of the nerves of bones is said to be followed by a diminution of their constituents, indicating an alteration in their metabolism. 2. Section of the nerves supplying a cock's comb interferes with the growth of that appendage. 3. Section of the spermatic nerves is followed by degeneration of the testicle. 4. After injury to a nerve or its center in the brain or spinal cord, certain affections of the skin may appear in regions corresponding to the distribution of that nerve; thus, *herpes zoster* is an eruption that follows frequently the distribution of the intercostal nerve. 5. When the motor cells of the anterior horn of the spinal cord or certain cells in the pons, medulla, or crus cerebri are disordered, there is a form of muscular atrophy which has been termed "active," inasmuch as the muscle does not waste merely, but

the dwindling is accompanied by proliferation of the muscle nuclei. 6. After neurotomy for navicular disease a form of degeneration of the structures of the foot is not uncommon. 7. After section of both vagi, death results after a period, varying in time, as do also the symptoms with the animal. In some animals pneumonia seems to account for death, since it is found that, if this disease be prevented, life may, at all events, be greatly prolonged. The pneumonia has been attributed to paralysis of the muscles of the larynx, together with loss of sensibility of the larynx, trachea, bronchi, and the lungs, so that the glottis is not closed during deglutition, and the food, finding its way into the lungs, has excited the disease by irritation. The possibility of vaso-motor changes is not to be overlooked. In birds, death may be subsequent to pneumonia or to inanition from paralysis of the oesophagus, food not being swallowed. It is noticed that in these creatures there is fatty (and sometimes other) degeneration of the *heart*, liver, stomach, and muscles. 8. Section of the trigeminus nerve within the skull has led to disease of the corresponding eye. This operation renders the whole eye insensible, so that the presence of offending bodies is not recognized; and it has been both asserted and denied that protection of the eye from these prevents the destructive inflammation. With the loss of sensibility there is also vaso-motor paralysis, the intra-ocular tension is diminished, and the relations of the nutritive lymph to the ocular tissues are altered. But all disturbances of the eye in which there are vaso-motor alterations are not followed by degenerative changes. 9. Degeneration of the salivary glands follows suture of their nerves. 10. After suture of long-divided nerves, indolent ulcers have been known to heal with great rapidity. This last fact especially calls for explanation. It will be observed, when one comes to examine nearly all such instances as those referred to above, that they are complex. Undoubtedly, in such a case as the trigeminus or the vagi, many factors contribute to the destructive issue; but the fact that many symptoms and lesions are concomitants does not, of itself, negative the view that there may be lesions directly dependent on the absence of the functional influence of nerve-fibers. We prefer, however, to discuss the subject on a broader basis, and to found opinions on a wider survey of the facts of physiology.

After a little time (a few hours), when the nerves of the sub-

maxillary gland have been divided, a flow of saliva begins and is continuous till the secreting cells become altered in a way visible by the microscope. Now, we have learned that protoplasm can discharge all its functions in the lowest forms of animals and in plants independently of nerves altogether. What, then, is the explanation of this so-called "paralytic secretion" of saliva? The evidence that the various functions of the body as a whole are discharged as individual acts or series of acts correlated to other functions has been abundantly shown; and, looking at the matter closely, it must seem unreasonable to suppose that this would be the case if there was not a close supervision by the nervous system over even the details of the processes. We should ask that the contrary be proved, rather than that the burden of proof should rest on the other side. Let us assume that such is the case; that the entire behavior of every cell of the body is directly or indirectly controlled by the nervous system in the higher animals, especially mammals, and ask, What facts, if any, are opposed to such a view? We must suppose that a secretory cell is one that has been, in the course of evolution, specialized for this end. Whatever may have been the case with protoplasm in its unspecialized form, it has been shown that gland-cells can secrete independently of blood-supply (page 314, etc.) when the nerves going to the gland are stimulated. Now, if these nerves have learned, in the course of evolution, to secrete, then in order that they shall remain natural (not degenerate) they must of necessity secrete; which means that they must be the subject of a chain of metabolic processes, of which the final link only is the expulsion of formed products. Too much attention was at one time directed to the latter. It was forgotten, or rather perhaps unknown, that the so-called secretion was only the last of a long series of acts of the cell. True, when the cells are left to themselves, when no influences reach them from the stimulating nervous centers, their metabolism does not at once cease. As we view it, they *revert* to an original ancestral state, when they performed their work, lived their peculiar individual life as less specialized forms wholly or partially independent of a nervous system. But such divorced cells fail; they do not produce normal saliva, their molecular condition goes wrong at once, and this is soon followed by departures visible by means of the microscope. But just as secretion is usually accompanied by excess of blood, so most functional conditions, if not all, de-

mand an unusual supply of pabulum. This is, however, no more a cause of the functional condition than food is a cause of a man's working. It may hamper, if not digested and assimilated. It becomes, then, apparent that the essential for metabolism is a vital connection with the dominant nervous system.

It has been objected that the nervous system has a metabolism of its own independent of other regulative influences; but in this objection it seems to be forgotten that the nervous system is itself made up of parts which are related as higher and lower, or at all events which intercommunicate and energize one another. We have learned that one muscle-cell has power to rouse another to activity when an impulse has reached it from a nervous center. Doubtless this phenomenon has many parallels in the body, and explains how remotely a nervous center may exert its power. It enables one to understand to some extent many of those wonderful co-ordinations (obscure in detail) that are constantly taking place in the body. We think the facts as they accumulate will more and more show, as has been already urged, that the influence of blood-pressure on the metabolic (nutritive) processes has been much overestimated. They are not essential but concomitant in the highest animals. Turning to the case of muscle we find that when a skeletal muscle is tetanized the essential chemical and electrical phenomena are to be regarded as changes differing in degree only from those of the so-called resting state. There is more oxygen used, more carbonic anhydride excreted, etc. The change in form seems to be the least important from a physiological point of view. Now, while all this can go on in the absence of blood or even of oxygen, it can not take place without nerve influence or something simulating it. Cut the nerve of a muscle, and it undergoes fatty degeneration, and atrophies. True, this may be deferred, but not indefinitely, by the application of electricity, acting somewhat like a nerve itself, and inducing the approximately normal series of metabolic changes. If, then, the condition when not in contraction (rest) differs from the latter in all the essential metabolic changes in rate or degree only; and if the functional condition or accelerated metabolism is dependent on nerve influence, it seems reasonable to believe that in the resting condition the latter is not withheld.

The recent investigations on the heart make such views as we are urging clearer still. It is known that section of the

vagi leads to degeneration of the cardiac structure. We now know that this nerve contains fibers which have a diverse action on the metabolism of the heart, and that, according as the one or the other set is stimulated, so does the electrical condition vary; and everywhere, so far as known, a difference in electrical conditions seems to be associated with a difference in metabolism, which may be one of degree only, perhaps, in many instances—still a difference. The facts as brought to light by experimental stimulation harmonize with the facts of degeneration of the cardiac tissue on section of the vagi; but this is only clear on the view we are now presenting, that the action of the nervous system is not only universal, but that it is *constant*; that function is not an isolated and independent condition of an organ or tissue, but a part of a long series of metabolic changes. It is true that one or more of such changes may be arrested, just as all of them may go on at a less rate, if this actual outpouring of pancreatic secretion is not constant; but secretion is not summed up in discharge merely; and, on the other hand, it would seem that in some animals the granules of the digestive glands are being renewed while they are being used up, in secreting cells. The processes may be simultaneous or successive. Nor do we wish to imply that the nervous system merely holds in check or in a very general sense co-ordinates processes that go on unoriginated by it. We think the facts warrant the view that they are in the highest mammals either directly (mostly) or indirectly originated by it, that they would not take place in the absence of this constant nervous influence. The facts of common observation, as well as the facts of disease, point in the strongest way to such a conclusion. Every one has observed the influence, on not one but many functions of the animal, we might say the entire metabolism, of depressing or exalting emotions. The failure of appetite and loss of flesh under the influence of grief or worry, tell a plain story. Such broad facts are of infinitely more value in settling such a question as that now discussed than any *single* experiment. The best test of any theory is the extent to which it will explain the whole round of facts. Take another instance of the influence over metabolism of the nervous system.

Every trainer of race-horses knows that he may overwork his beast—i. e., he may use his muscles so much as to disturb the balance of his powers somewhere—very frequently his di-

gestion; but often there seems to be a general break—the whole metabolism of the body seems to be out of gear; and the same applies to our domestic animals. If we assume a constant nervous influence over the metabolic processes, this is comprehensible. The centers can produce only so much of what we may call nervous force, using the term in the sense of directive power; and if this be unduly diverted to the muscles, other parts must suffer.

On this view also the value of rest or change of work becomes clear. The nervous centers are not without some resemblance to a battery; at most, the latter can generate only a definite quantity of electricity, and, if a portion of this be diverted along one conductor, less must remain to pass by any other.

It is of practical importance to recognize that under great excitement unusual discharges from a nerve-center may lead to unwonted functional activity; thus, under the stimulus of the occasion an animal may in a race originate muscular contractions that he could not call forth under other circumstances. Such are always dangerous. We might speak of a reserve or residual-nerve force, the expenditure of which results in serious disability.

It seems that the usually taught views of secretion and nutrition have been partial rather than erroneous in themselves, and it is a question whether it would not be well to substitute some other terms for them, or at least to recognize them more clearly as phases of a universal metabolism. We appear to be warranted in making a wider generalization. To regard processes concerned in building up a tissue as apart from those that are recognized as constituting its function, seems with the knowledge we at present possess, to be illogical and unwise. Whether, in the course of evolution, certain nerves, or, as seems more likely, certain nerve-fibers in the body of nerve-trunks, have become the medium of impulses that are restricted to regulating certain phases of metabolism—as e. g., expulsion of formed products in gland-cells—is not, from a general point of view, improbable, and is a fitting subject for further investigation. But it will be seen that we should regard all nerves as “trophic” in the wider sense. What is most needed, apparently, is a more just estimation of the relative parts played by blood and blood-pressure, and the direct influence of the nervous system on the life-work of the cell.

We must regard the nervous centers as the source of ceaseless impulses that operate upon all parts, originating and controlling the entire metabolism, of which what we term functions are but certain phases, parts of a whole, but essential for the health or normal condition of the tissues. Against such a view we know no facts, either of the healthy or disordered organism.

Summary of Metabolism.—Very briefly and somewhat incompletely, we may sum up the chief results of our present knowledge (and ignorance) as follows:

Glycogen is found in the livers of all vertebrate and some invertebrate animals. The quantity varies with the diet, being greatest with an excess of carbohydrates.

Glycogen may be regarded as stored material to be converted into sugar, as required by the organism; though the exact use of the sugar and the method of its disposal are unknown.

Fat is not stored up in the body as the result of being merely picked out from the blood ready made; but is a genuine product of the metabolism of the tissues, and may be formed from fatty, carbohydrate, or proteid food. This becomes especially clear when the difference in the fat of animals from that on which they feed is considered, as well as the direct results of feeding experiments, and the nature of the secretion of milk.

The liver seems to be engaged in a very varied round of metabolic processes; the manufacture of bile, of glycogen, of urea, and probably of many other substances, some known and others unknown, as chemical individuals. Urea is in great part probably only appropriated by the kidney-cells (Amœbala-like) from the blood in which it is found ready made; though it may be that a part is formed in these cells, either from bodies some steps on the way toward urea, or out of their protoplasm, as fat seems to be by the cells of the mammary gland.

The leucin (and tyrosin?) of the digestive canal sustains some relation to the manufacture of urea by the liver, and possibly by the spleen and other organs; for a proteid diet increases these products, and also the urea excreted. Creatin, one of the products of proteid metabolism, and possibly allied bodies, may be considered as in a certain sense antecedents of urea; uric-acid, however, does not seem to be such, nor is it to be regarded as a body that has some of it escaped complete oxidation, but rather as a result of a distinct departure of the metabolism; and there

are facts which seem to indicate that the uric-acid metabolism is the older, from an evolutionary point of view, and that in mammals, and especially in man, as the results of certain errors there may be a physiological (or pathological) reversion. Hippuric acid, as replacing uric acid in the herbivora, may be regarded in a similar light.

Our knowledge of the metabolism of the spleen, beyond its relations to the formation of blood-cells and their disintegration, is in the suggestive rather than the positive stage. It seems highly probable that this organ plays a very important part, the exact nature of which is as yet unknown.

When an animal starves, it may be considered as feeding on its own tissues, the more active and important utilizing the others. Notwithstanding, organs with a very active metabolism, as the muscles and glands, lose weight to a large extent. The presence of urea to an amount not very greatly below the average in health, shows that there is an active proteid metabolism then as at all times in progress.

General experience and exact experiments prove that, while an animal's diet may be supplied with special regard to fattening, to increase working power, or simply to maintain it in health, as evidenced by breeding capacity, form, etc., in all cases there must be at least a certain minimum quantity of each of the food-stuffs. No one food can be said to be exclusively fattening, heat-forming, or muscle-forming.

A carbohydrate diet tends to production of fat; proteid food to supply muscular energy, but the latter also produces fat, and a diet of proteid mixed with fat or gelatin will serve the purposes of the economy better than one containing a very much larger quantity of proteid alone. Muscular energy, as is to be inferred from the excreta, is not the result of nitrogenous metabolism alone; and in arranging any diet for man or beast the race and the individual must be considered. Animals can not be treated as machines, like engines using similar quantities of fuel; though this holds far more of man than the lower animals—i.e., the results may be predicted from the diet with far more certainty in their case than for man.

Food is related to excreta in a definite way, so that all that enters as food must sooner or later appear as urea, salts, carbonic anhydride, water, etc. These are individually to be regarded as the final links in a long chain of metabolic processes, or rather a series of these. Fats and carbohydrates are repre-

sented finally as carbonic anhydride and water principally, proteids as urea.

Nitrogenous foods may be regarded as accelerating the metabolic processes generally and proteid metabolism in particular, while fats have the reverse effect ; hence fat in the diet renders a less quantity of proteid sufficient. Gelatin seems to act when mixed with proteid food either like an additional quantity of proteid, or possibly like fat, at all events under such circumstances less proteid suffices.

These facts have a bearing not only on health but on economy, in the expenditure for food.

Salts hold a very important place in every diet, though their exact influence is in great part unknown. The heat of the body is the resultant of all the metabolic processes of the organism, especially the oxidative ones. Certain food-stuffs have greater potential capacity for heat formation than others ; but, finally, the result depends on whether the organism can best utilize one or the other.

A certain body temperature, varying only within narrow limits, is maintained, partly by regulation of the supply and partly by the regulation of the loss.

Both these are, in health, under the direction of the nervous system, and both are co-ordinated by the same. Loss is chiefly through the skin and lungs ; gain chiefly through the organs of most active metabolism, as the muscles and glands.

Vaso-motor effects play a great part in the escape of heat.

Animals may be divided into poikilothermers and homoiothermers, or cold-blooded and warm-blooded animals, according as their body heat varies with or is independent of the external changes of temperature. All the facts go to show that in mammals the processes of the body (metabolism) can continue only within a slight range of variations in temperature, though the upward limit is narrower than the downward.

Upon the whole, the evidence justifies the conclusion that the nervous system is concerned in all the metabolic processes of the body in mammals including man, and that, as we descend the scale, the dominion of the nervous system becomes less till we reach a point when protoplasm goes through the whole cycle of its changes by virtue of its own properties uninfluenced by any modification of itself in the form of a nervous system.

THE SPINAL CORD.—GENERAL.

AMONG the higher vertebrates the spinal cord is found to consist of nerve-cells, nerve-fibers, and a delicate connective tissue binding them together ; while these different structures are arranged in definite forms, so that a cross-section anywhere presents a characteristic appearance, the more important ganglionic nerve-cells being internal and forming a large part of the gray matter of the cord. All the various regions of this organ or series of organs are connected with one another, white with white and gray matter, as well as white with gray substance.

While we do not attempt to furnish a complete and detailed account of the anatomy of the cord or other parts of the nervous system, for which the student is referred to works on anatomy, we would remind him that the spinal cord is situated within a bony case with joints permitting of a certain amount of movement, variable in different regions. Inasmuch as the cord itself does not fill its bony covering, but floats in fluid and tethered to the walls by bands of connective tissue, it is well protected from laceration, bruising, or concussion. Like the brain, it has a protective tough outer membrane (*dura mater*) with a closer-fitting inner covering abounding in blood-vessels (*pia mater*).

The white matter of the cord invests the horns of gray matter and is made up of nerve-fibers wanting the outer sheath. Here, as elsewhere, these fibers have only a conducting function; they do not originate nervous impulses. The gray matter, on the other hand, abounds in cells, some of them with many processes, that can originate, modify, and conduct impulses. Certain well-recognized groups of these cells are arranged in columns throughout the cord, as shown in the accompanying figures. The supporting basis for these cells (*neuroglia*) is the most delicate form of connective tissue known.

The cord may be regarded either as an instrument for the

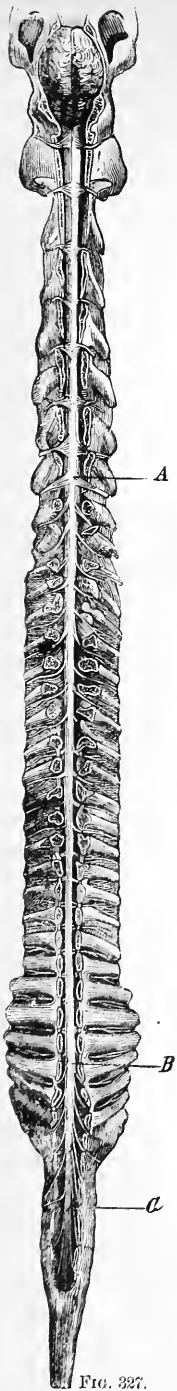

FIG. 327.

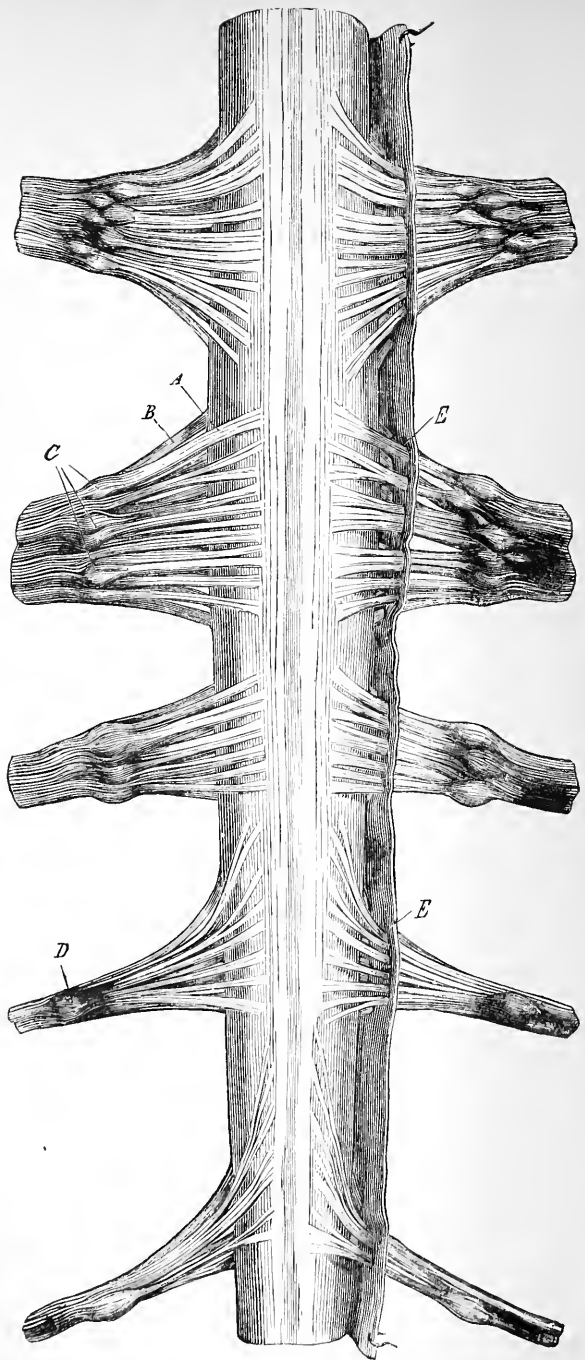

FIG. 328.

FIG. 327.—General view of spinal cord (Chauveau). A, cervical bulb; B, lumbar bulb; C, cauda equina.

FIG. 328.—Segment of spinal cord at the cervical bulb, or brachial plexus, showing its upper face and the roots of the spinal nerves (Chauveau). A, superior roots; B, inferior roots; C, multiple ganglia of superior roots; D, single ganglion on an exceptional pair; E, E, upper roots passing through the envelopes.

reception and generation of impulses independent of the brain; or as a conductor of afferent and efferent impulses destined for the brain or originating in that organ. As a matter of fact, however, it is better to bear in mind that the cord and brain constitute one organ or chain of organs, which, as we have learned from our studies in development, are differentiations of one common track, originating from the epiblast.

While the brain and the cord may act independently to a

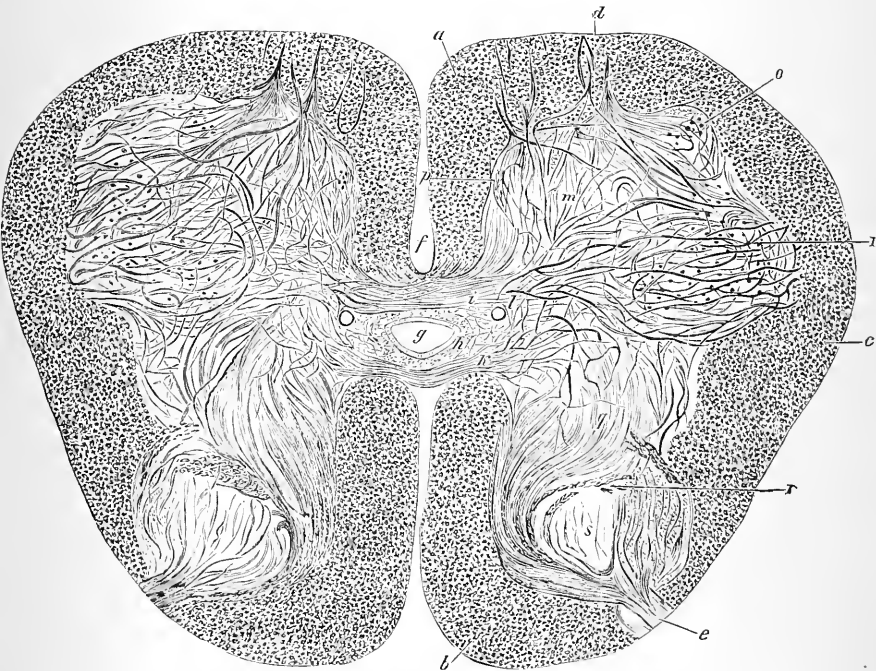

FIG. 329.—Transverse section of spinal cord of child six months old, at middle of lumbar region, showing especially the fibers of gray substance. 1 x 20. (After Gerlach.) *a*, anterior columns; *b*, posterior columns; *c*, lateral columns; *d*, anterior roots; *e*, posterior roots; *f*, anterior white commissure; *g*, central canal lined by epithelial cells; *h*, connective-tissue substance surrounding it; *i*, transverse fibers of gray commissure in front, and *k*, the same behind central canal; *l*, two veins cut across; *m*, anterior cornua; *n*, great lateral cell group of anterior cornua; *o*, lesser anterior cell group (column); *p*, smallest median cell group; *q*, posterior cornua; *r*, ascending fasciculi in posterior cornua; *s*, substantia gelatinosa.



FIG. 330.—Group of cells in connection with anterior roots of spinal nerves, as seen in transverse section of spinal cord of sheep (after Flint and Dean). *A*, emergence of anterior roots from gray matter; *b, b, b*, cells connected both with each other and with fibers of anterior roots.

very large extent, as may be shown by experiment, yet it can not be too well borne in mind that in the actual normal life of an animal such purely independent behavior must be exceedingly rare. We are constantly in danger, in studying a subject, of making in our minds isolations which do not exist in nature. When one accidentally sits upon a sharp object, he

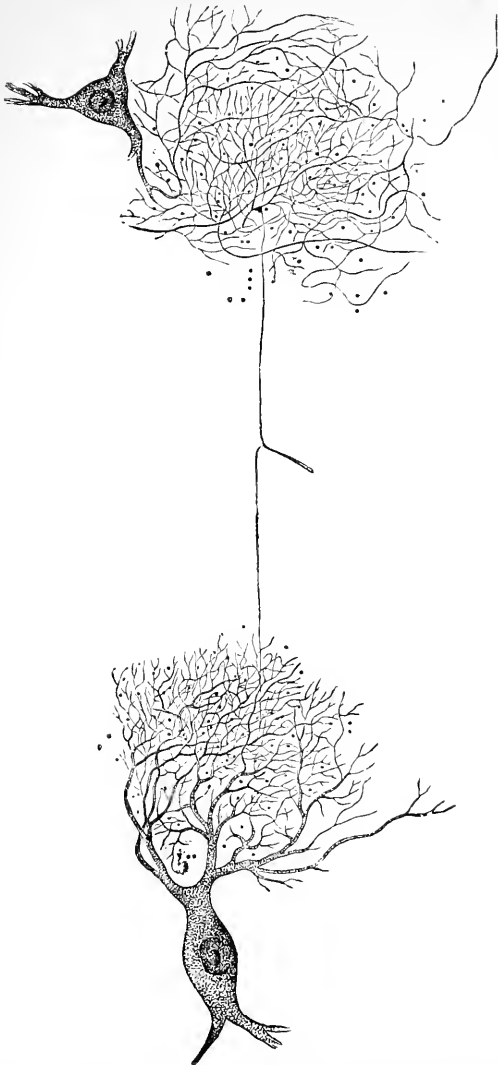

FIG. 331.—Division of a slender nerve-fiber, and communication of its branches with highly ramifying processes of two nerve-cells from spinal cord of ox. 1×150 . (After Gerlach.)

rises suddenly without a special effort of will power; he experiences pain, and has certain thoughts about the object, etc.

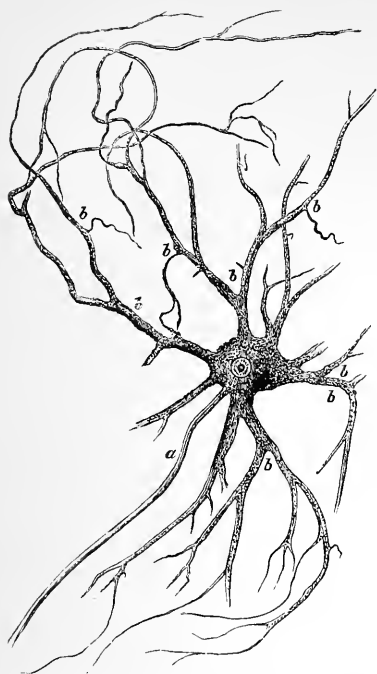

FIG. 332.—Multipolar ganglion cell from anterior gray matter of spinal cord of ox (after Deiters). *a*, axis cylinder process; *b*, branched processes.

Now, in reality this is very complex, though it can be analyzed into its factors. Thus, afferent nerves are concerned, the spinal cord as a reflex center, efferent nerves to the muscles called into action, the cord as a conductor of impulses which result in sensations, emotions, and thoughts referable to the brain; so that if we would grasp the state of affairs it is of importance to so combine the various processes in our mental conception that it shall in our minds form that whole which corresponds with nature, as we have been insisting upon in the last chapter. With this admonition, and assuming a good knowledge of the general and minute anatomy of the spinal cord, we shall proceed to discuss its functions.

THE REFLEX FUNCTIONS OF THE SPINAL CORD.

The following experimental observations may readily be made by the student himself: Let a decapitated frog be suspended freely (from the lower jaw). It hangs motionless and limp at first, but when it recovers from the shock (abolition of function) to the spinal cord produced by the operation, it may be shown that this organ is functional: 1. When a piece of bibulous paper dipped in dilute acid is placed upon the thigh, the leg is drawn up and wipes away the offending body. 2. If the paper be placed on the anus, both legs may be drawn up, either successively or simultaneously. 3. If the leg of one

side be allowed to hang in the dilute acid, it will be withdrawn. 4. If a small piece of blotting-paper dipped in the acid be placed on the thigh, and the leg of that side gently held, the other may be drawn up and remove the object.

It may be noticed that in every case a certain interval of time elapses before the result follows. Upon increasing the strength of the acid very much this interval is shortened, and the number of groups of muscles called into action is increased. Again, the result is not the same in all respects when the nerve of the leg is directly stimulated, as when the skin first receives the impression. Section of the nerves of the parts abolishes these effects; so also does destruction of the spinal cord, or the part of it with which the nerves of the localities stimulated are connected; and more exact experiments show that in the absence of the gray matter the section of the posterior or anterior roots of the nerves also renders such manifestations as we have been describing impossible.

These experiments and others seem to show that an afferent nerve, an efferent nerve, and one or more central cells are necessary for a reflex action; that the latter is only a perfectly co-ordinated one when the skin (end-organs) and not the nerve-trunks are stimulated; that there is a latent period of stimulation, suggesting a central "summation" of impulses necessary for the effect; that the reflex is not due to the mere passage of impulses from an afferent to an efferent nerve through the cord, but implies important processes in the central cells themselves. The latter is made further evident from the fact that (1) strychnia greatly alters reflex action by shortening the latent period and extending the range of muscular action, which, it has been shown, is not due to changes in the nerves themselves. A very slight stimulus suffices in this instance to cause the whole body of a decapitated frog to pass into a tetanic spasm. We must suppose that the processes usually confined to certain groups of central cells have in such a case involved others, or that the "resistance" of the centers of the cord has been diminished, so that many more cells are now involved; hence many more muscles called into action. Normally there is resistance to the passage of an impulse to the opposite side of the cord, as is shown by the fact that when a slight stimulus is applied to the leg of one side the reflex is confined to this member.

It is evident, then, that the reflex resulting is dependent on (1) the location of the stimulus, (2) its intensity and duration.

(3) its character, and (4) the condition of the spinal cord at the time. Occasionally on irritating one fore-limb the opposite hind one answers reflexly. Such is a "crossed reflex," and is the more readily induced in animals the natural gait of which involves the use of one fore-leg and the opposite hind-limb together.

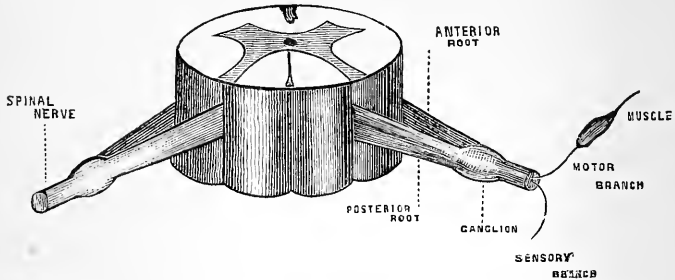

FIG. 333.—Diagram of a spinal segment showing component parts (Ranney).

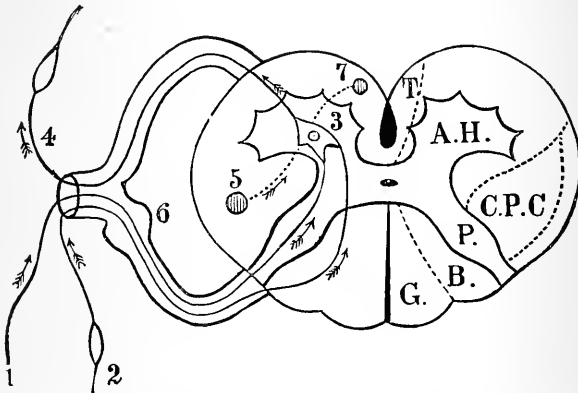

FIG. 334.—Diagrammatic representation to illustrate the reflex arc (Bramwell and Ranney). 1, 2, sensory fibers; 3, motor-cell of anterior horn; 4, motor-fiber connected with 3 and passing out by anterior root to muscle; 5, fiber joining crossed pyramidal tract, C. P. C.; 6, ganglion on root of posterior spinal nerve; 7, fiber joining 3 with Türk's column, T. Fiber 2 is represented as passing through Burdach's column to reach the cell, 3.

Reflexes are often spoken of as purposive, and suggest at first intelligence in the cord; but such phenomena are explained readily enough without such a strained assumption.

Evolution, heredity, and the law of habit, apply here as elsewhere. The relations of an animal to its environment must necessarily call into play certain nervo-muscular mechanisms,

which from the law of habit come to act together when a stimulus is applied. Naturally those that make for the welfare of the animal are such as are most used under the influence of the intelligence of the animal—i. e., of the domination of the higher cerebral centers, so that when the latter are removed it is but natural that the old mechanisms should be still employed. Moreover, the reflex movements are not always beneficial, as when a decapitated snake coils itself around a heated iron under reflex influence, which is readily enough understood if we remember the *habit* of coiling around objects, and what this involves—viz., organized tendencies.

Inhibition of Reflexes.—It can be shown in the case of a frog that still retains its optic lobes and the parts of the brain posterior to them that, when these are stimulated at the same time as the leg, the reflex, if it occurs at all, is greatly delayed.

On the other hand, in the case of dogs, from which a part of the cerebral cortex has been removed, the reflexes are much more prominent than before. Experience teaches us that the acts of defecation, micturition, erection of the penis, and many others, are susceptible of arrest or may be prevented entirely when the usual stimuli are still active, by emotions, etc.

These and numerous other facts tend to show that the higher centers of the brain can control the lower; and it is not to be doubted that pure reflexes during the waking hours of the higher animals, and especially of man, are much less numerous than among the lower vertebrates. The cord is the servant of the brain, and a faithful and obedient one, except in cases of disease, to some forms of which we have already referred.

THE SPINAL CORD AS A CONDUCTOR OF IMPULSES.

It is to be carefully borne in mind now, and when studying the brain, that a conducting path in the nervous centers is not synonymous with conducting fibers. The cells themselves and the neuroglia probably are also conductors. We shall now endeavor to map out, as established by the method of Flechsig, Waller, and others, the main fiber tracts of the spinal cord.

1. *Antero-medial Columns* (columns of Turck).—These probably decussate in the cervical region, where they are most marked, constituting the direct or uncrossed pyramidal tract and disappear in the lower dorsal region.

Secondary degeneration ensues in these tracts upon certain brain lesions, in the motor regions.

2. *Crossed Pyramidal Tracts*.—They pass forward to form part of the anterior pyramids of the medulla after decussation in their lower part. Similarly to the first, degeneration follows in these tracts when there are brain-lesions of the motor area. Hence, both of these constitute descending motor paths.

3. *Anterior Fasciculi* (fundamental or ground bundle).—They possibly connect the gray matter of the cord with that of the medulla.

4. *Anterior Radicular Zones*, in the anterior part of the lateral column.

5. *Mixed Lateral Columns*.—These and the preceding are functionally similar to 3. Neither 3, 4, nor 5 degenerate, on section of the cord, from which it is inferred that they have trophic cells both above and below.

6. *Direct Cerebellar Tracts*.—These bundles, passing by the funiculi graciles or posterior pyramids of the medulla, reach the cerebellum by its inferior peduncles.

These fasciculi enlarge from their site of origin in the lumbar cord upward. After section of the cord they show ascending degeneration, so that it seems probable that their trophic cells are to be referred to the posterior gray cornua of the cord, which they connect in all probability with the cerebellum.

7. *Columns of Burdach* (postero-lateral columns).—This tract is connected with the restiform bodies and reaches the cerebellum by the inferior peduncles. Secondary degenerations do not occur in these fasciculi, so that it seems likely that they connect nerve-cells at different levels in the cord; and

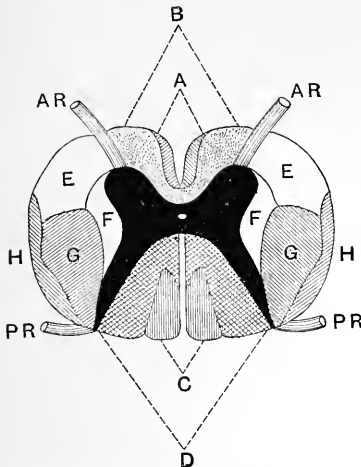

FIG. 335.—Diagrammatic representation of columns and conducting paths in spinal cord in upper dorsal region (after Flint and Landois). AR, AR, anterior roots of spinal nerves; PR, PR, posterior roots; A, columns of Türk (antero-median columns); B, anterior fundamental fasciculus; C, columns of Goll; D, columns of Burdach; E, E, anterior radicular zones; F, F, mixed lateral columns; G, G, crossed pyramidal tracts; H, H, direct cerebellar fibers.

they may also connect the posterior gray cornua with the cerebellum as 6.

Columns of Goll (postero-median columns).—They do not extend beyond the lower dorsal or upper lumbar region; and their fibers pass to the funiculi graciles of the medulla. Ascending degeneration follows section of these columns.

The degenerations referred to above are visible by the microscope, and of the character following section of nerves. It is probable that they are the later stages of a primary molecular derangement in consequence of interference with that continuous functional connection between all parts on which what has been called nutrition, but which we have shown is but a phase of a complex metabolism, depends.

Decussation.—Sections of the cord, when confined to one lateral half, are followed by paralysis on the same side and loss of sensation, confined chiefly to the opposite half of the body below the point of section. The results of experiment, pathological investigation, etc., have rendered it clear that—1. The great majority of the fibers passing between the periphery and the brain decussate somewhere in the centers. 2. Afferent fibers cross almost directly but also to some extent along the whole length of the cord from their point of entrance, the decussation being, however, completed before the medulla is passed. 3. Motor or efferent fibers decussate chiefly in the medulla, though crossing is continued some distance down the cord, such latter fibers being but a small portion of the whole. This fact is best established, perhaps, by noting the results of brain-lesions. With few exceptions, susceptible of explanation, a lesion of one side of the cerebrum is followed by loss of motion of the opposite side of the body. These are all central, well-established truths. It is also now pretty well determined that voluntary motor impulses descend by the pyramidal tracts, both the direct and the crossed. That the posterior columns of the cord are in some way concerned with sensory impulses there is no doubt; but when an attempt is made to decide details, great difficulties are encountered. Experiments on animals are of necessity very unsatisfactory in such a case, from the difficulty experienced in ascertaining their sensations at any time, and especially when disordered.

Pathological.—A good deal of stress has been laid upon the teachings of locomotor ataxia in the human subject. The symptoms of this disease are found associated with lesions of

the posterior columns of the cord. The essential feature is an inability to co-ordinate movements, though muscular power may be unimpaired. But such inco-ordination is not usually the only symptom; and, while the disease seems usually to begin in Burdach's columns, the columns of Goll, the posterior nerve-roots, and even the cells of the posterior cornua, may be involved, so that the subject becomes very complicated. Co-ordination of muscular movements is normally dependent upon certain afferent sensory impulses, themselves very complex. It is to be remembered also that there are numberless connecting links between the two sides of the cord and between its different columns of an anatomical kind, not to mention the possibly numerous physiological (functional) ones.

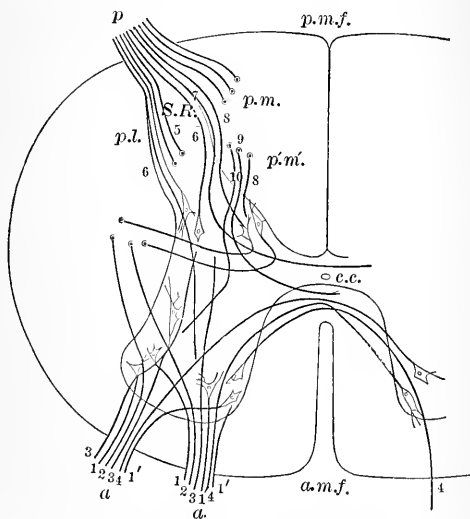

FIG. 336.—Diagram to illustrate probable course taken by fibers of nerve-roots on entering spinal cord (Schäfer).

We have stated above that section of one lateral half of the cord is followed by loss of sensation on the opposite side of the body; but directly the contrary has been maintained by other observers; while still others contend that the effects are not confined to one side, though most pronounced on the side of the section. The same remark applies to motion.

While there is considerable agreement as to the pyramidal tracts of the lateral column, the functions of the rest of these

divisions of the cord are by no means well established. It is possible that vaso-motor, respiratory, and probably other kinds of impulses, pass by portions of the lateral tracts other than the crossed pyramidal. When a lateral half of the cord is divided, the loss of function is not permanent in all instances, but has been recovered from without any regeneration of the divided fibers; and even when a section has been made higher up on the opposite side, partial recovery has again followed; so that it would appear that impulses had pursued a zigzag course in such cases. We do not think that such experiments show that impulses do not usually follow a definite course, but that the resources of nature are great, and that, when one tract is not available, another is taken.

It is plain that impulses do not in any case travel by one and the same nerve-fiber throughout the cord, for the size of this organ does not permit of such a view being entertained; at the same time there is a relation between the size of a cross-section of the cord at any one point and the number of nerves connected with it at that region.

We may attempt to trace the paths of impulses in a cord somewhat as follows: 1. Volitional impulses decussate chiefly

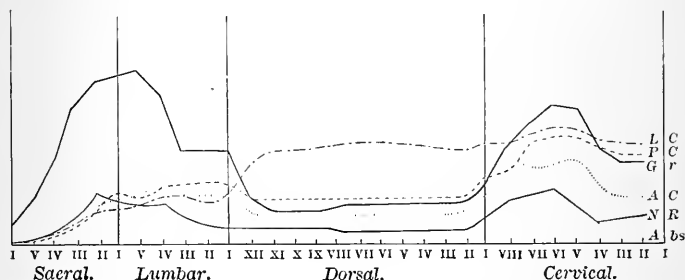

FIG. 337.—Diagram to illustrate relative and absolute extent of (1) gray matter, (2) white columns in successive sectional areas of spinal cord, and (3) sectional areas of several nerve-roots entering cord. *NR*, nerve roots; *AC*, *LC*, *PC*, anterior, lateral, posterior columns; *G*, gray matter (after Schäfer, Ludwig, and Woroschiloff).

in the medulla oblongata, but also, to some extent, throughout the whole length of the spinal cord. They travel in the lateral columns (crossed pyramidal tracts chiefly, if not exclusively), and eventually reach the anterior roots of the nerves through the anterior gray cornua, passing to them, possibly, by the anterior columns. From the cells of the anterior cornua, impulses

travel by the anterior nerve-roots to the motor nerves, by which connection is made with the muscles. 2. Sensory impulses enter the cord from the afferent nerve-fibers by the pos-

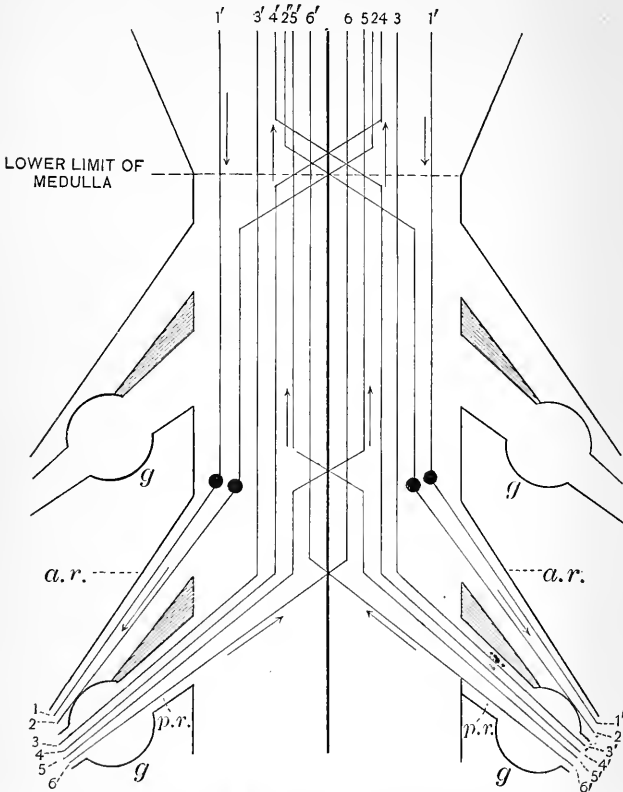

FIG. 338.—Diagram showing course of fibers in spinal cord (after Ranney). 1, 1', direct pyramidal bundles; 2, 2', crossed pyramidal bundles, decussating in medulla; 3, 3', direct cerebellar fibers; 4, 4', fibers related to "muscular sense," decussating in medulla; 5, 5', and 6, 6', fibers relating to the appreciation of touch, pain, and temperature. The motor bundles have a dot upon them to represent the motor cells of the cord (anterior horn). Note that the motor fibers escape from the anterior nerve-root (*a. r.*), and that the sensory bundles enter at the posterior nerve-root (*p. r.*), which has a ganglion (*g*) upon it.

terior nerve-roots, passing probably by the posterior columns to the posterior cornua, thence to the lateral columns, decussation being largely immediate though not completed for some distance up the cord.

It would seem that the lateral columns are the great high-

ways of impulses; though in all instances it is likely that the gray matter of the cord plays an important part in modifying them before they reach their destination. Some observers believe that sensory impulses giving rise to pain travel by the gray matter of the cord almost exclusively. It would be easy to lay out the paths of impulses in a more definite and dogmatic manner; but the evidence does not seem to warrant it, and it is better to avoid making statements that may require serious modification, to say the least, in a few months. The prominent principle to bear in mind seems to be that while there are tracts in the cord of the animals that have been examined and probably of all that have well-formed spinal cords, along which impulses travel more frequently and readily than along others, it is equally true that these paths are not invariable, nor are they precisely the same for all groups of animals. The cord can not be considered independently of the brain; and there can be no doubt that the paths of impulses in the former are related to the constitution, anatomical and physiological, of the latter. It is still a matter of dispute whether the cord is itself irritable to a stimulus. As a whole it is without doubt; as also the white matter by itself. The gray matter is certainly conducting, but whether irritable or not is still doubtful. Why the sensibility of the side of the body on which one lateral half of the cord has been divided should be increased (hyperæsthesia), is also undetermined. Possibly it is due to a temporary disturbance of nutrition, or the removal of certain usual inhibitory influences from above, either in the cord or brain.

THE AUTOMATIC FUNCTIONS OF THE SPINAL CORD.

Reference has been already made to the fact that when portions of a mammal's cerebrum are removed the reflexes of the cord become more pronounced, owing apparently to the removal of influences operating on the cord from higher centers.

When the cord itself is completely divided across, it often happens (in the dog, for example) that there are rhythmic movements of the posterior extremities—i.e., when the animal has recovered from the shock of the operation—that part of the cord now independent of the rest and of the brain seems to manifest an unusual automatism. The question, however, may be raised as to whether this is a purely automatic effect, or the result of reflex action. But, whichever view be entertained,

these phenomena certainly teach the dependence of one part upon another in the normal animal, and should make one cautious in drawing conclusions from any kind of experiment, in regard to the normal functions. As we have often urged in the foregoing chapters, what a part may under certain circumstances manifest, and what its behavior may be as usually placed in its proper relations in the body, are entirely different, or at least may be. When one leg is laid over the other and a sharp blow struck upon the patella tendon, the leg is jerked up in obedience to muscular contraction. It is not a little difficult to determine whether this result is due to direct stimulation of the muscle or to reflex action, the first link in the chain of events necessary to call it forth originating in the tendon; hence the term tendon-reflex. But at present it is safer to speak of it as the "knee-jerk," or the "tendon-phenomenon." It disappears, however, when the spinal cord is destroyed or is diseased, as in locomotor ataxia, or when the nerves of the muscles or the posterior nerve-roots are divided, showing that the integrity of the center, the nerves, and the muscles are all essential. There are normally many such phenomena (reflexes) besides the "knee-jerk."

Another question very difficult to decide is that relating to the usual condition of the muscles of the living animal. It is generally admitted that the muscles of the body are all in a somewhat stretched condition, but it is not so clear whether the skeletal muscles are under a constant tonic influence like those of the blood-vessels. It is certain that, when the nerves going to a set of muscles are cut, when even the posterior roots of the nerves related to the part involved are divided or the spinal cord destroyed, there is an unusual flaccidity of the limb involved. But the natural condition may be, it has been suggested, the result of reflex action. The subject is probably more complex than it has hitherto been considered.

The facts of such a case—those of the tendon-phenomenon and similar ones—would be better understood if the spinal cord, the nerves, and the muscles associated with them, were regarded as parts of a whole so connected in their functions that severance of any one of them leads to disorder of the rest. That the cells of the cord are constantly exercising an influence through the nerves on the muscles, while they in turn do not lead an independent existence, but are as constantly influenced by afferent impulses, and that one of the results is the condi-

tion of the muscles referred to, is, we are convinced, the case. To say that it is either entirely automatic or purely reflex, or that the whole of the facts would be covered even by any combination of these two processes, would probably be unjustifiable. The influence of the centers over the metabolism of parts is both constant and essential to their well-being ; and in such a case as that now considered it may be that a certain degree of tonus is normal to a healthy muscle in its natural surroundings in the body.

There is now considerable evidence in favor of placing certain centers presiding over the lower functions, as micturition, defecation, erection of penis, etc., in the spinal cord of mammals, especially its lower part—which centers, if they be not automatic, are not reflex in the usual sense ; but their consideration is better attempted in connection with the treatment of the physiology of the parts over which they preside.

SPECIAL CONSIDERATIONS.

Comparative.—Among invertebrates there is, of course, no spinal cord, but each segment of the animal is enervated by a special ganglion (or ganglia) with associated nerves. Nevertheless, these are all so connected that there is a co-ordination, though not so pronounced as in the vertebrate, in which the actual structural bonds are infinitely more numerous, and the functional ones still more so. From this result possibilities to the vertebrate unknown to lower forms ; at the same time, independent life and action of parts are necessarily much greater among invertebrates, as evidenced especially by the renewal of the whole animal from a single segment in many groups, as in certain divisions of worms, etc.

It also follows from the same facts that a vertebrated animal must suffer far more from injury, in consequence of this greater dependence of one part on another ; a thousand things may disturb that balance on which its well-being, indeed, its very life hangs. It is noticeable, moreover, that, as animals occupy a higher place in the organic scale, their nervous system becomes more concentrated ; ganglia seem to have been fused together, and that extreme massing seen in the spinal cord and brain of vertebrates is foreshadowed. In the chapters on the brain numerous illustrations of the nervous system in lower forms will be found.

The fact that the brain and cord arise from the same germ layer, and up to a certain point are developed almost precisely alike, is full of significance for physiology as well as morphology. That original deep-lying connection is never lost, though functional differentiation keeps pace with later morphological differentiation. But even among vertebrates the spinal cord shows a complexity gradually increasing with ascent in the organic series. In the lowest of the fishes or vertebrates (*Amphioxus lanceolatus*) the creature possesses a spinal cord only and no brain, so that an opportunity is afforded of witnessing how an animal deports itself in the absence of those directive functions, dependent on the existence of higher cerebral centers. The *Lancelet* spends a great part of its life buried in mud or sand on the bottom of the ocean, and its existence is very similar to that of an invertebrate, though, of course, the dependence of parts on each other is somewhat greater.

Evolution.—According to the general law of habit and inheritance, we should suppose that at birth each group of animals would manifest those reflex and other functions of the cord which were peculiar to its ancestors. Observation and experiment both show that reflexes, etc., are hereditary; that they tend to become more and more so with each generation; and at the same time that habit or exercise is essential for their perfect development. They stand, in fact, in the same relation as instincts, which are closely connected with them. Like the latter, they may be modified by way of increase or diminution and otherwise. To illustrate, it can not be doubted that galloping is the natural gait of horses, as shown by the tendency of even good trotters to “break” or pass into a gallop; but it is equally well known that famous trotters breed trotters. In other words, an acquired gait becomes organized in the nervous system (especially) of the animal, and is transmitted with more and more fixity and certainty with the lapse of time. But all experience goes to show that walking, running, or any of the movements of animals are, when fully formed as habit-reflexes, dependent for their initiation on the will in most but not all instances, and require for their execution certain combinations of sensory and other afferent impulses, and the integrity of a vast complex of nervous connections in the spinal cord.

It is well known that one in a period of absent-mindedness will walk into a building to which he was accustomed to go years before, though not of late, showing plainly that volition

was not momentarily required for the act of walking and all else that is involved in the above behavior. It suggests that certain nervous and muscular connections have been formed, functionally at least. Plainly, then, we should not expect each individual man's spinal cord to be the same, but that the series of mechanisms of which every spinal cord is made up should differ with experience; and if this holds for individuals, how much more must it be true of different groups of animals, the habits of which differ so widely.

All the facts go to show that the cord is made up of nervous mechanisms—if we may so speak—which are naturally associated, both structurally and functionally, with certain nerves and muscles; these, like the paths which impulses take to and from the brain, though usual, are not absolutely fixed, though more so as reflex than conducting paths, while they are constantly liable to be modified in action by the condition of neighboring groups of mechanisms, etc.

We have said less about the gray matter of the cord as a conductor than its importance perhaps deserves. It is believed by many that impulses which give rise to sensations of pain always travel by the gray matter; and there is not a little evidence to show that, when none of the white columns are available, owing to operative procedure, disease, or other disabling cause, the gray matter will conduct impulses that usually proceed by other tracts.

Synoptical.—The spinal cord is composed of large ganglionic nerve-cells, fibers, and connecting neuroglia. Functionally it is a conductor, the seat of certain automatic centers and of reflex mechanisms. Probably in every case the one function is to a certain extent associated with the other—i. e., when the cord acts reflexly it is also a conductor, and the cells concerned are so readily excited to certain discharges of nervous energy that automaticity is suggested, and so in other instances: thus, in the case of automaticity, reflex influence or afferent impulses are with difficulty entirely excluded from consideration.

The great majority of conducting fibers seem to cross either in the cord itself or in the medulla oblongata. The conducting paths that have been shown by pathological and clinical investigation to be best marked out in the spinal cord are those for voluntary motor impulses. So far as the functions of the human organ are concerned, clinical and pathological facts have thrown the greatest amount of direct light on the subject;

but the inferences thus drawn have been modified and supplemented by the results of experiments on certain other mammals.

It is especially important to bear in mind that, while certain conducting paths are usual, they are not invariable: in like manner, reflex impulses may not be confined to usual groups of cells, but may extend widely, and so bring into action a large number of muscles. The resulting reflex in any case is dependent on the character, intensity, and location of the stimulus, and especially on the condition of the central cells involved. In the whole functional life of the cord the influence of higher centers in the organ itself and especially in the brain is to be considered. The cord is rather a group of organs than a single one.

THE BRAIN.

AT the outset we may remark that the whole subject will be studied more profitably if it be borne in mind that—1. The brain is rather a collection of organs, bound together by the closest anatomical and physiological ties than a single one; in consequence of which it is quite impossible to understand the normal function of one part without constantly bearing in mind this relationship. This aspect of the subject has not received the attention it deserves. No one regards the alimentary tract as a single organ; but it is likely that the dependence functionally of one part of the digestive canal upon another is not more intimate than that established in that great collection of organs crowded together and making up the brain. 2. Since the relative size, position, and anatomical connections of the parts that make up the brain are different in different groups of animals, not to speak of the fact that the functions of any part of the brain of an animal, like that of its spinal cord, already alluded to, must depend in great part upon its own and its inherited ancestral experiences, it follows that the greatest caution must be exercised in applying conclusions true of one group of animals to another. 3. It follows from what has been referred to in 1 above, that conclusions based upon the behavior of an animal after section or removal of a part of the brain must be, until at least corrected by other facts, received with some hesitation. 4. It also might be inferred from 1 that it is desirable to study the simpler forms of brain found in the lower vertebrates, in order to prepare for the more elaborate development of the encephalon in the higher mammals and in man. 5. The embryological development of the organ also throws much light upon the whole subject.

The student will see from these remarks that a sound knowledge of the anatomy of the brain and its connections is indispensable for a just appreciation of its physiology; nor must

such knowledge be confined to any single form of the organ. There is only one way by which this can be attained: dissection, with the help of plates and descriptions. The latter alone frequently impart ideas that are quite erroneous, though they serve an especially good purpose in helping to fix the pictures of the natural objects, and in reviving them when they have become dim.

It is neither difficult to obtain nor to dissect the brain of the fish, frog, bird, etc. Valuable material may be saved and the subject approached profitably, if, prior to the dissection of a human brain, a few specimens from some group or groups of the domestic animals be examined. However useful artificial brain preparations may be, they are so far from nature in color, consistence, and many other properties, that, taken alone, they certainly may serve greatly to mislead; and we hope the student will allow us to urge upon him the methods above suggested for getting real lasting knowledge. The figures given below may prove helpful when supplemented as we advise.

The great difference in total size, and in the relative proportion, situation, etc., of parts, will, however, be obvious, from the figures themselves; and as we have already pointed out more than once, the preponderance of the cerebrum in man must ever be borne in mind in the consideration of his entire organization; whether physical, mental, or moral.

ANIMALS DEPRIVED OF THE CEREBRUM.

The cerebrum may be readily removed from a frog, without producing either severe prolonged shock or any considerable hæmorrhage. Such an animal remains motionless, unless when stimulated, though in a somewhat different position from that of a frog, having only its spinal cord. It can, however, crawl, leap, swim, balance itself on an inclined plane, and when leaping avoid obstacles. One looking at such an animal performing these various acts would scarcely suspect that anything was the matter with it, so perfectly executed are its movements. We are forced to conclude, from its remaining quiet, except when aroused by a stimulus, that its volition is lost; but, apart from that, and the fact that it evidently does not see as well as before, it appears to be normal. It has no intelligent directive power over its movements. It remains, therefore, to explain how it is that they are so much more complete, so

much better co-ordinated in the entire animal than when only the spinal cord is left. It seems to be legitimate to infer that the other parts of the brain contain the nervous machinery for this work, which is usually aroused to action by the will, but which an external stimulus may render active. All the connections, structural and functional, are present, except those on which successful volition depends. The frog with the cord only, sinks at once when thrown into water; when gently placed on its back, it may and probably will remain in that position, without an attempt at recovery. There is, in fact, very limited power of co-ordination.

Removal of the cerebral lobes in the bird is more likely to be attended with difficulties, and conclusions must be drawn with greater caution.

But a pigeon may be kept alive after such an operation for months. It can stand, balancing on one leg; recover its position when placed on its side; fly when thrown into the air; it will even preen its feathers, pick up food, and drink water. Its movements are such as we might expect from a stupid, drowsy, or probably intoxicated bird; but it is plainly endowed with vision, though not as good as before. But spontaneous movements are absent, and the pecking at food, etc., must be considered as associate reflexes, and as such are very interesting, in that they show how machine-like, after all, many of the apparently volitional acts of animals really are. In a mammal so great is the shock, etc., resulting from the operative procedure, that the actual functions of the remaining parts of the brain, when the cerebral convolutions are removed, are greatly obscured; nevertheless, little doubt is left on the mind that homologous parts discharge analogous functions. It can walk, run, leap, right itself when placed in an unnatural position, eat when food is placed in its mouth, and avoid obstacles in its path, though not perfectly. Yet it remains motionless unless stimulated; all objects before its eyes impress it alike if at all. The animal evidently has neither volition nor intelligence. Now, if any of the parts between the cerebrum and the medulla be removed the creature shows lessened co-ordinating power; so that the inference that these various parts are essential constituents of a complex mechanism, all the components of which are necessary to the highest forms of muscular co-ordination and probably other functions, is unavoidable.

Since we are dealing with co-ordinated movements, we may

now treat of the functions of a portion of the ear, according to our present classification.

HAVE THE SEMICIRCULAR CANALS A CO-ORDINATING FUNCTION?

Physiologists have as yet been unable to assign to the semicircular canals a function in hearing, and upon certain results, partly of disease but chiefly of experiment, it has been concluded, though somewhat dubiously, that they are concerned with those sensations that conduce to or are essential to maintenance of the sense of equilibrium ; in a word, that they are the organs of that sense in the same way that the eye is the organ of vision.

Until further evidence is forthcoming, we are not inclined to give assent to the existence of any mechanism in the semicircular canals, affording sensory data so *entirely different* from those furnished by other recognized (and unrecognized) sense-organs, that upon them alone, or in a manner entirely their own, arises a consciousness of equilibrium. We are inclined to regard the latter as depending upon the fusion in consciousness of a vast complex of sensations ; and that upon the whole being there represented, or a portion wanting, depends either the preservation of equilibrium, or a partial or entire loss of the same. Nevertheless, it is highly probable that sensory impulses of a very important character, in addition to such as are essential for hearing, may proceed from the semicircular canals, and indeed other parts of the labyrinth of the ear.

FORCED MOVEMENTS.

When certain portions of the brain of the mammal have been injured, movements of a special character result, and, inasmuch as they are not voluntary, in the ordinary sense at least, have been spoken of as forced or compulsory. The movements may be classified according as they are around the long, the vertical or the transverse axis of the body of the animal. Hence there are "circus" movements, when the creature simply turns about in a circle, "rolling" movements, etc. These and others may be toward or from the side of injury. While in some cases there may be a certain amount of muscular weakness in consequence of the injury, which may, in part, account for the

direction of the movements, this is not so in all cases; nor does it, in itself, explain the fact of their being plainly not voluntary in the usual sense.

The parts of the brain, which, when injured, are most liable to be followed by forced movements are the basal ganglia (corpora striata and optic thalami), the crura cerebri, corpora quadrigemina, pons Varolii, and medulla oblongata, and especially if the section be unilateral. We have already seen that several of these parts are concerned in muscular co-ordination; hence the disorderly character of any movements that might now result when any part of this related mechanism is thrown out of gear, so to speak; but, apart from that, we think that the view presented in the previous sections is applicable in this case also, while the forced movements themselves throw light upon the symptoms following injury to the semicircular canals. When that constant afflux of sensory impulses toward the nervous centers is interfered with, as must be the case in such sections as are now referred to, it is plain that the balance in consciousness must be disturbed; confusion results, and it is not surprising that, instead of a passive condition, one marked by disorderly movements should result in an animal, since movement so largely enters into its life-habits. It is important to remember, in this connection, that the great highway of impulses between the cerebral cortex and other parts of the brain and the spinal cord lies in the very parts of the encephalon we are now considering.

FUNCTIONS OF THE CEREBRAL CONVOLUTIONS.

Comparative.—It will conduce to the comprehension of this subject if some reference be now made to the development of the brain in the different groups of the animal kingdom.

Invertebrates not only have no cerebrum, but no brain in the strict sense of the term as applied to the higher mammals. In most forms of this great subdivision of the animal kingdom, the first or head segment is provided with ganglia arranged in the form of a collar around the œsophagus, by means of commissural nerve connections; so that the nervous supply of the head is not widely different from that of the other segments of the body. But as we ascend in the scale among the invertebrates these ganglia become more crowded together, and so resemble the vertebrate brain with its massed ganglia and

numerous connections through nerve-fibers, etc. But in this respect we find great difference among vertebrates. We can recognize, on passing upward from the *Amphioxus*, destitute of a brain proper, to man, all gradations in the form, relative size, multiplicity of connecting ties, etc.

Speaking generally, there is great difference in the weight of the cerebrum, both relative and absolute. In all animals below the primates (man and the apes) the cerebellum is either not at all or but imperfectly covered by the cerebrum; while

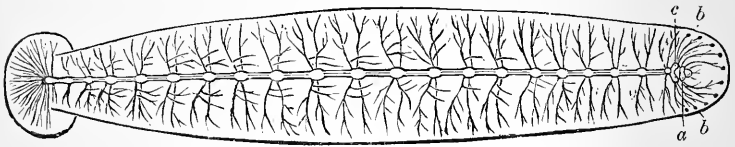

FIG. 339.—Nervous system of medicinal leech (after Owen). *a*, double supra-oesophageal ganglion connected with rudimentary ocelli (*b, b*) by nerves; *c*, double infra-oesophageal ganglionic mass, which is continuous with double ventral cord, having compound ganglia at regular intervals.

in man, so great is the relative size of the latter, that the cerebellum is scarcely visible from above. If we except the elephant, in which the brain may reach the weight of ten pounds, and the whale with its brain of more than five pounds

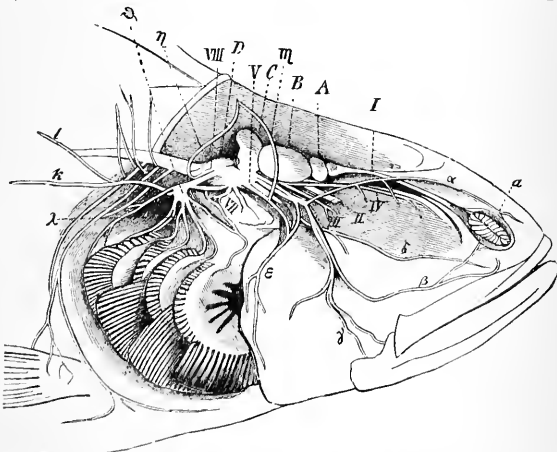

FIG. 340.—Brain and cranial nerves of perch, seen from the side (after Gegenbaur and Cuvier). *A*, cerebral lobe with olfactory ganglion in front; *B*, optic lobe; *C*, cerebellum; *D*, medulla oblongata; *I*—*VIII*, nerves in usual order; *κ*, lateral branch of vagus; *λ*, upper twig of same; *m*, dorsal branch of trigeminus, joined by *n*, dorsal branch of vagus; *α, β, γ*, three branches of trigeminus; *δ, ε*, facial nerve; *λ*, branchial branches of vagus.

in the largest specimens, the brain of man is even absolutely heavier than that of any other animal, which is in great part due to the preponderating development of the cerebrum.

While the cerebral surface is smooth in all the lower vertebrates, and but little convoluted until the higher mammals are reached, the brain of the primates, and especially of man, has its surface enormously increased, owing to its numerous fissures and convolutions, which, in fact, arise from the growth



FIG. 341.—Brain and spinal cord of frog (Bastian). *A*, olfactory lobes; *B*, cerebral lobes; *R*, pineal body; *C, D*, optic lobes; *E*, cerebellum; *H*, spinal cord. The cerebellum is notably small.

of the organ being out of proportion to that of the bony case in which it is contained; and since those cells which go to make up the gray matter and are devoted to the highest functions, are disposed over the surface, the importance of the fact in accounting for the superior intelligence of the primates;

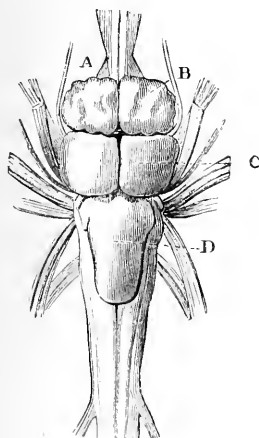

FIG. 342.

FIG. 342.—Brain of the pike, viewed from above (Huxley). *A*, the olfactory nerves or lobes, and beneath them the optic nerves; *B*, the cerebral hemispheres; *C*, the optic lobes; *D*, the cerebellum.

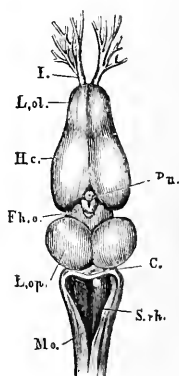

FIG. 343.

FIG. 343.—The brain of edible frog (*Rana esculenta*). 1×4 . (After Huxley.) *L. ol.*, the rhinencephalon, or olfactory lobes, with *I*, the olfactory nerves; *H. c.*, the cerebral hemispheres; *F. h. o.*, the thalamencephalon with the pineal gland, *Pn.*; *L. op.*, optic lobes; *C*, cerebellum; *S. rh.*, the fourth ventricle; *Mo.*, medulla oblongata.

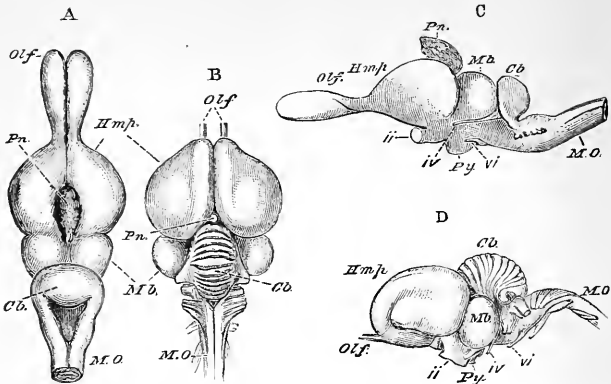

FIG. 344.—A, C, the brain of a lizard (*Psammosaurus Bengalensis*), and B, D, of a bird (*Meleagris gallopavo*, the turkey), drawn as if they were of equal lengths (after Huxley). A, B, viewed from above; C, D, from the left side. *Olf.*, olfactory lobes; *Pn.*, pineal gland; *Hm/h.*, cerebral hemispheres; *Mb.*, optic lobes of the mid-brain; *Cb.*, cerebellum; *M. O.*, medulla oblongata; *ii*, *iv*, *vi*, second fourth, and sixth pairs of cerebral nerves; *Py.*, pituitary body.

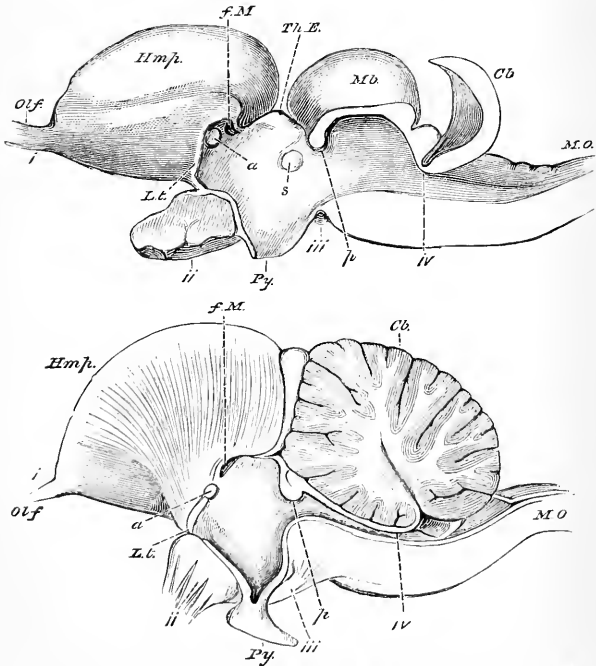

FIG. 345.—Brains of a lizard (*Psammosaurus Bengalensis*) and of a bird (*Meleagris gallopavo*) in longitudinal and vertical section. The upper figure represents the

lizard's brain; the lower, that of the bird (after Huxley and Carus). Letters as in the preceding figure, except *L. t.* *lamina terminalis*, or anterior wall of the third ventricle; *f. M.* foramen of Munro; *a*, anterior commissure; *Th. E.* thalamencephalon; *s*, soft commissure; *p*, posterior commissure; *iv.* indicates the exact point of exit of the fourth pair from that part of the brain which answers to the value of Vieussens.

and especially of man, becomes apparent. Depth of fissuring is, however, of more importance than multiplicity of furrows; and it may be observed that intelligence is not always in proportion to the extent to which the cerebral surface is broken up into fissures and convolutions. The depth of the gray matter is also very variable, and seems to bear an important relation to psychic development. Man's brain, then, is characterized by its great size and complexity; while those parts treated elsewhere, concerned in co-ordination, vision, etc., are well developed, the cerebrum, especially its convolutions as distinguished from its basal ganglia, is, out of all proportion, greater than in any other animal.

The gray matter of the brains of the higher vertebrates is distributed as masses of ganglionic cells internally, and as a fairly uniform layer over its surface. The brain of man weighs about three pounds on the average, that of the male being a few ounces (four to six) heavier than that of the female.

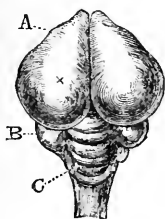

FIG. 346.



FIG. 347.

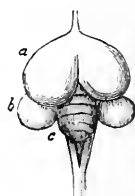

FIG. 348.

FIG. 346.—Brain of pigeon (after Ferrier). *A*, cerebral hemispheres; *B*, optic lobe; *C*, cerebellum, the lateral lobes of which are very small.

FIG. 347.—Brain and spinal cord of chick at sixteen days old; optic lobes, *b*, are still in contact (after Owen and Anderson).

FIG. 348.—Brain and part of spinal cord of chick twenty days old, showing optic lobes widely separated and cerebellum, *c*, largely developed.

The individual and race differences, though considerable, are not comparable in degree to those that distinguish man from even the highest apes, the brain of the latter weighing not more than about one third as much as that of the human subject. While it has been shown that individual men and women, having brains of average or even sub-medium weight, may reach

even distinction in the intellectual world; and though idiots have been known to possess brains abnormally heavy, it is

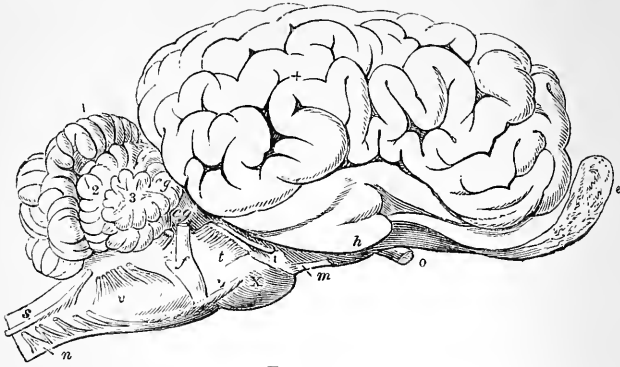

FIG. 349.

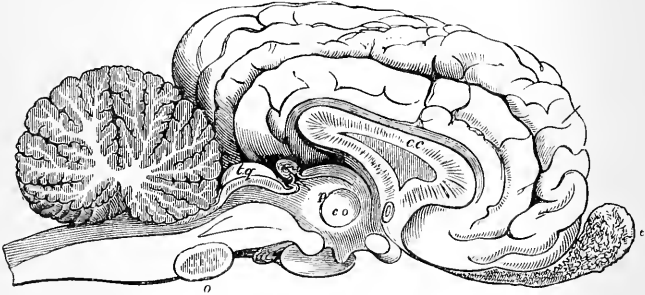

FIG. 350.

FIG. 349.—Outer surface of brain of horse (after Solly and Leuret). *e*, olfactory lobe; *h*, hippocampal lobe (processus pyriformis); 1, 2, 3, lobes of cerebellum; *o*, optic nerve; *m*, motor oculi; *p*, fourth nerve; *t*, fifth nerve; *u*, sixth nerve; *f*, facial; *l*, auditory; *g*, glosso-pharyngeal; *v*, vagus; *s*, spinal accessory; *n*, hypoglossal; *X*, pons Varolii.

FIG. 350.—Longitudinal section through center of brain of horse, presenting view of internal surface (after Solly and Leuret). *c.c.*, corpus callosum; *p*, thalamus; *co*, middle commissure; *t.q.*, corpora quadrigemina, in front of which is the pineal body. The cerebellum has been cut through.

nevertheless true that brain-weight and the higher powers of man bear a close though not invariable relationship. The apparent discrepancies are susceptible of explanation.

Besides the gray matter, with its cells of highest functional value from the standpoint now taken, the brain consists, and in large part, of neuroglia and nerve-fibers, with probably chiefly, and in the case of the fibers solely, a conducting function.

The Connection of one Part of the Brain with another.—
Though it has long been known that the different parts of the

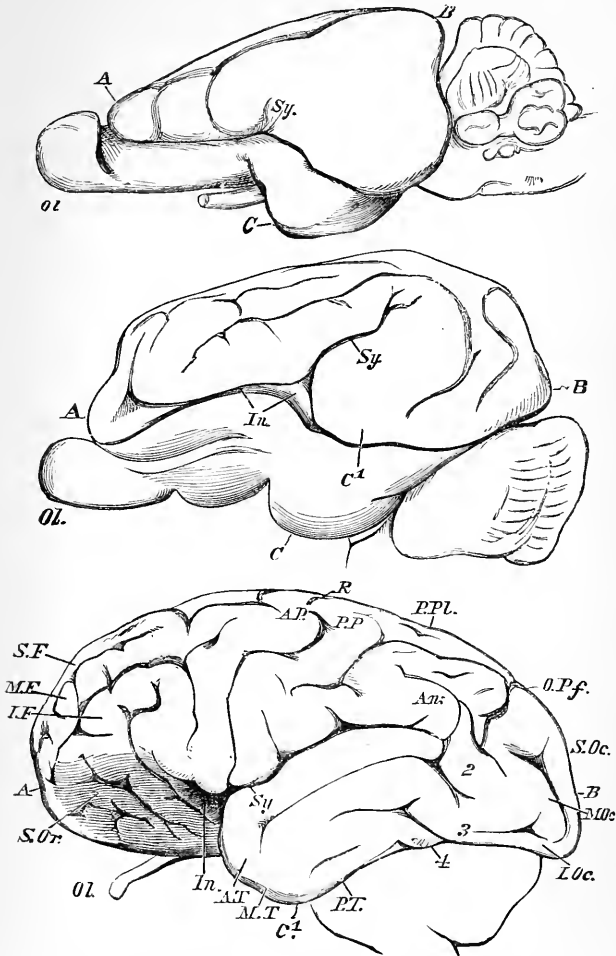

FIG. 351.—Lateral views of the brains of a rabbit, a pig, and a chimpanzee, drawn of nearly the same absolute size (Huxley). The rabbit's brain is at the top; the pig's, in the middle; the chimpanzee's, lowest. OL, olfactory lobe; A, frontal lobe; B, occipital lobe; C, temporal lobe; Sy, the sylvian fissure; In, the insula; S. Or, supra-orbital; S. F., M. F., I. F., superior, middle, and inferior frontal gyri; A. P., antero-parietal; P. P., postero-parietal gyri; R, sulcus of Rolando; P. Pl., postero-parietal lobule; O. Pf., external perpendicular or occipito-temporal sulcus; S. Oc., supra-orbital; S. Oc., M. Oc., I. Oc., the three occipital gyri; An., angular gyrus; 2, 3, 4, annectent gyri; A. T., M. T., P. T., the three temporal, and

brain were connected by bridges of fibers (*commissures*, etc.), the physiological significance of the fact seems to have been largely ignored, and even at the present day is too little con-

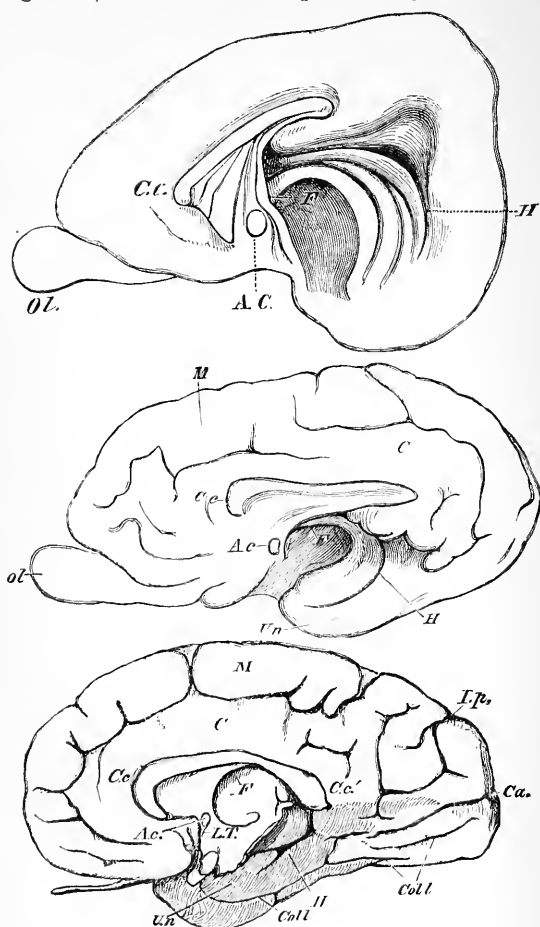

FIG. 352.—Inner views of cerebral hemispheres of the rabbit, pig, and chimpanzee, drawn as before, and placed in the same order (Huxley). *Ol.*, olfactory lobe; *C. c.*, corpus callosum; *A. c.*, anterior commissure; *H.*, hippocampal sulcus; *Un.*, uncinate; *M.*, marginal; *C.*, callosal gyri; *I. P.*, internal perpendicular; *Ca.*, calcarine; *Coll.*, collateral sulci; *F.*, fornix.

sidered. 1. *Cerebral fibers* pass between the convolutions of this part of the brain and the cerebellum; between the former

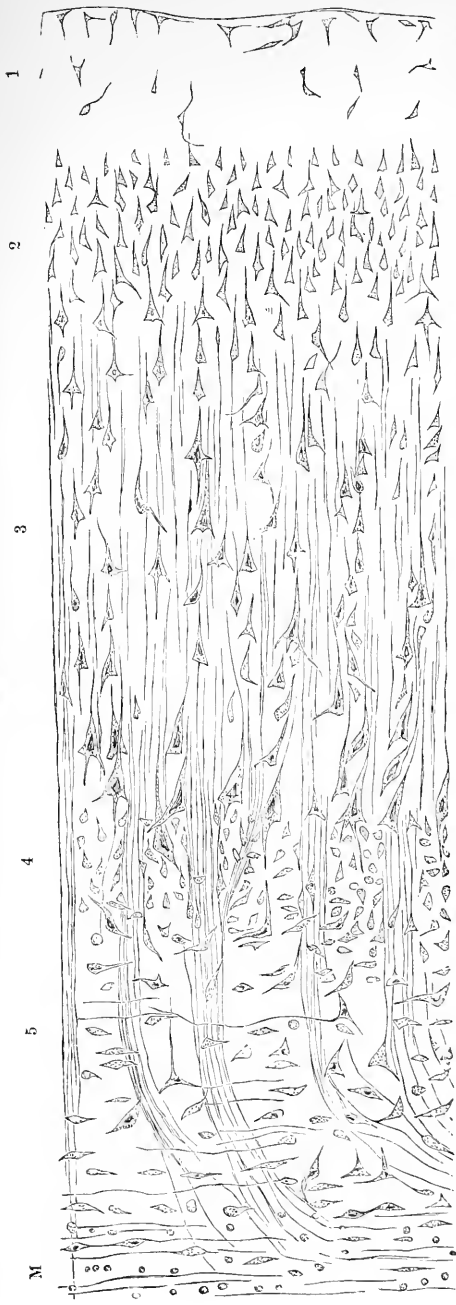

FIG. 353.—Vertical section of third cerebral convolution in man (after Meynert). 1, superficial cells; 2, layer of small pyramidal cells; 3, layer of large pyramidal cells; 4, layer of spindle-shaped cells; 5, layer of small irregular cells; *M*, white substance.

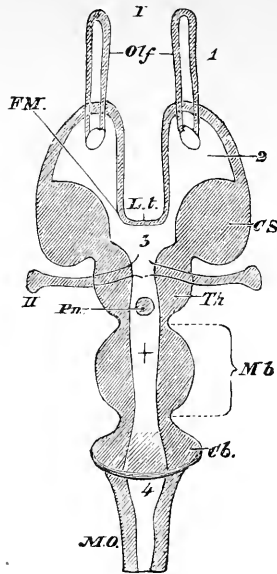

FIG. 354.—Diagrammatic horizontal section of a vertebrate brain (Huxley). The following letters serve for both this figure and the one following. *Mb*, mid-brain. What lies in front of this is the fore-brain, and what lies behind, the hind-brain. *L.t.*, the lamina terminalis; *Olf*, olfactory lobes; *Hmp*, hemispheres; *Th. E.*, thalamencephalon; *Pn*, pineal gland; *Pg*, pituitary body; *FM*, foramen of Munro; *CS*, corpus striatum; *Th*, optic thalamus; *CC*, corpora quadrigemina; *CC*, crura cerebri; *Cb*, cerebellum; *PV*, pons Varolii; *MO*, medulla oblongata; *I*, olfactorii; *II*, of abducentes; *III*, point of exit from brain of motores oculorum; *IV*, of pathetici; *VI*, of abducentes; *V-XII*, origins of the other cerebral nerves. 1, olfactory ventricle; 2, lateral ventricle; 3, third ventricle; 4, fourth ventricle; +, iter a tertio ad quartum ventriculum.

and the main basal ganglia; between the gray matter of the convolutions on the same side, and between the latter and those

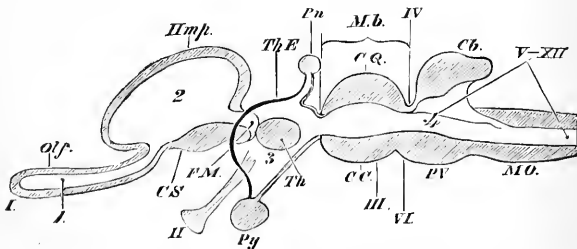

FIG. 355.—A longitudinal and vertical section of a vertebrate brain (Huxley). Letters as above. The lamina terminalis is represented by the strong black line between *FM* and 3.

on the opposite halves; between the gray matter of the cortex and the internal capsule, the corpora striata, optic thalami, pons Varolii, the medulla oblongata, and so to the spinal cord. The course of the latter tracts of fibers have been, especially by the help of pathology, definitely followed. Some of these connections are given in more detail below.

1. *Cerebro-cerebellar fibers.* (a.) From the cortical cells of the anterior cerebral lobe to the pons Varolii, passing through the internal capsule and thence through the lower and outer part of the crus cerebri (*crusta*). (b.) Fibers from the occipital and temporo-sphenoidal lobes, passing by the *crusta*, reach the upper surface of the cerebellum.

2. *Fibers bridging the two sides of the cerebrum.* (a.) By means of the corpus callosum chiefly, passing from the gray matter in the first instance. (b.) From the temporo-sphenoidal lobe on each side through the corpora striata and anterior commissure. (c.) Fibers from the upper part of the crus cerebri (*tegmentum*) to the optic thalamus of each side and onward to the temporo-sphenoidal lobes, forming the posterior commissure.

3. *Fibers connecting different parts of the cerebral convolutions on the same side.* These are exceedingly numerous and belong to such tracts as the "arcuate fibers," passing from one gyrus to another; "collateral fibers," forming distant convolutions; fibers of the fornix between the uncinate gyrus, hippocampus major, and optic thalamus; longitudinal fibers of the corpus callosum; fibers of the *tænia semicircularis*, uncinate fasciculus, etc.

4. *Fibers forming the cerebrum and the spinal cord.* According as they pass downward or upward do they converge or diverge, and the most important seem to pass through the internal capsule; and while the majority do perhaps form some connection either with the corpora striata and optic thalami, some seem to pass directly downward through the internal capsule. It is held by many that the fibers passing through the posterior portion of the internal capsule are derived from the posterior lobe of the cerebrum, and are the paths of sensory impulses upward; while the rest of the internal capsule is made up of fibers from the anterior, and especially the middle portion of the cerebral cortex (motor area), and these fibers are the paths of motor (efferent) impulses.

It now becomes clearer that the brain is constituted a whole

by such connections; and that, apart from the multiplicity of cells with different functions to perform, situated in different

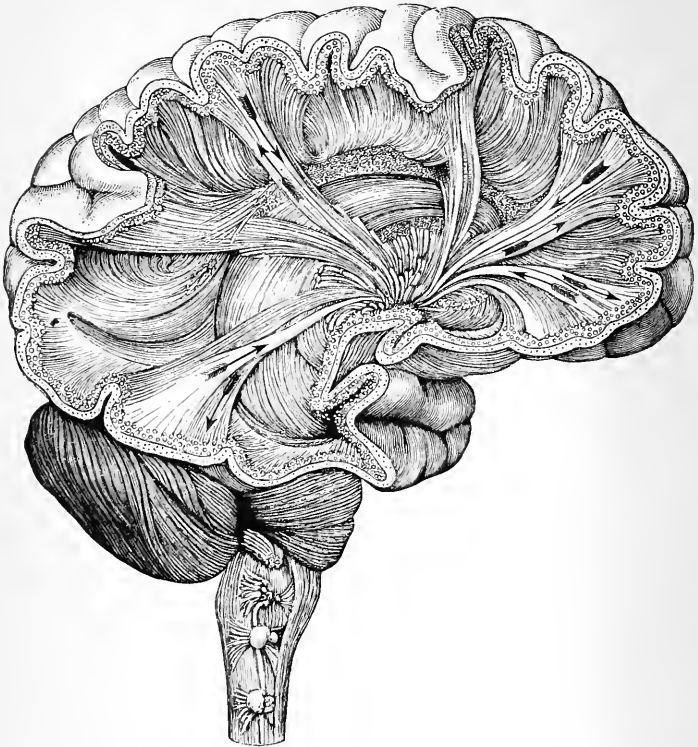

FIG. 356.—Diagrammatic representation of the course of some of the fibers in the cerebrum of man (after Le Bon).

areas, the complexity and at the same time the unity of the encephalon becomes increasingly evident, merely upon anatomical grounds; but we shall find such a view still further strengthened by study of the functions of the various parts. While the tracts enumerated are anatomical and have been clearly traced, there can be little doubt that many others yet remain to be marked out; and that, apart from such collections of fibers, we must recognize functional paths by the neuroglia, and possibly others still. It is not to be forgotten that in the brain, as in the spinal cord, nerve-cells are themselves conductors, and while

there may be certain areas within which the resistance is such that impulses are usually confined to them, it is also true that, as in the cord, there may be a kind of overflow. Adjacent cells, possibly widely separated cells, may become involved. We shall return to this important subject again, however, as, without recognizing such relationships, it seems to us quite impossible to understand the facts as we find them in the working of the body and the mind.

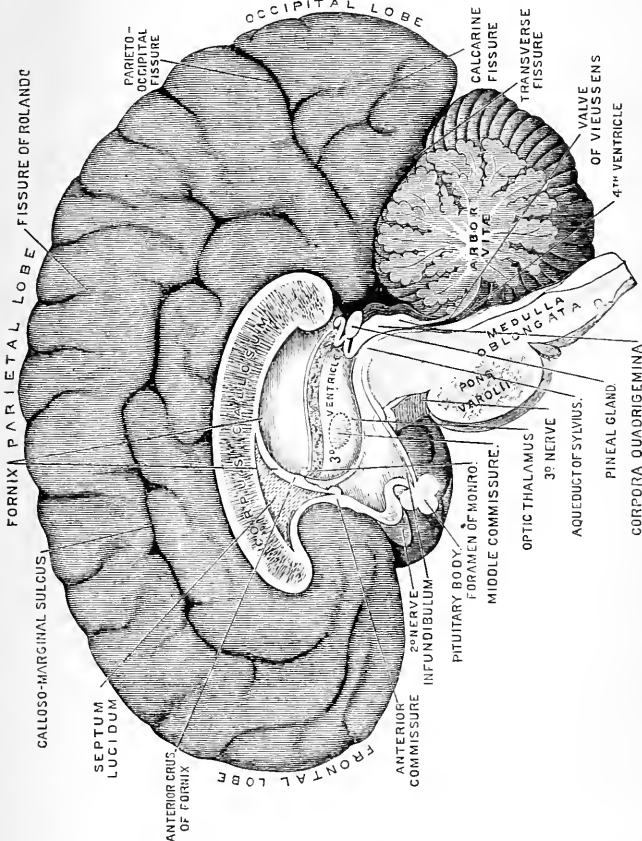

FIG. 357.—Median longitudinal section of human brain, semi-diagrammatic (after Pfaff).

The Cerebral Cortex.—We may now proceed to inquire what are the functions of the cells of the gray matter covering the surface of the cerebrum. Before the birth of physiology as a

science, Gall recognized and taught that the encephalon is a collection of organs; that these have separate functions; that the relative size of each determines the degree of its functional activity; and that the cranium developing in proportion to the growth of the brain, the former might give information as to the probable size of what lay beneath it in different regions. It will be seen that, as thus interpreted, phrenology is a very different thing from what usually passes under that name, and is paraded before wondering audiences by ignorant charlatans. In the main the doctrines of Gall are not without a certain foundation in facts; and the modern theory of localization of function bears some resemblance to what Gall taught, though with greater limitations.



FIG. 358.—Outer surface of cerebrum (after Exner). The shaded portion represents *the* motor area in man and the monkey—i. e., the area which most observers believe to be associated with certain voluntary movements of the limbs, etc.

In the mean time it has been found that in many cases it was possible to locate the site of a brain-lesion (tumor, etc.) by the symptoms, chiefly motor, of the patient; and brain-surgery

has in consequence entered upon a new era of development. Tumors thus localized have been removed successfully, and the patients restored to health. As a result of the various kinds of observations and discussions on this subject of late years, the localizationists are willing to admit that the areas of the cortex can not be marked off mathematically—that, in fact, they “overlap.” This is in itself an important concession. Again, there is less confidence in the location of the various sensory centers than of the motor centers. Most investigators are believers in a “motor area” *par excellence* (for the arm, leg, etc.) around the fissure of Rolando (Fig. 358). This view is now, so far as man is concerned, widely accepted.

There is agreement in placing the sensory centers behind the above-mentioned motor area, and especially in the occipital lobes. The tendency to locate a visual center in this region is growing stronger. There is much disagreement as to the other sensory centers formerly placed in the angular gyrus and temporo-sphenoidal lobes. The intellectual faculties have not been located in any such sense as Gall and his followers attempted to establish. The first two frontal convolutions are those, perhaps, to which localization has as yet been least applied. Chiefly on clinical and pathological grounds a center for speech has long been located in the third (left) frontal convolution (Broca's) and parts immediately behind it. It has been observed that when disease attacks this area speech is interfered with in some way.

We may say then, generally, that the tendency at the present time, both on the part of physiologists and clinical observers, is to admit localization to some degree and in some sense. This has been the result in part of experiments on the dog and especially on the monkey, combined with the discussion of clinical cases which resulted in death (followed by an autopsy), or of others marked by a successful diagnosis and removal of lesions or other treatment. In other words, the truth, if it is to be reached at all, must be sought by the plan we have advocated throughout this work—the discussion of the results of as many different methods as can be brought to bear on this or any other subject. Neither the experimental nor the pathological method alone can settle such complex questions. Although localization of function has not been established for the cerebral cortex in the case of those animals with which the practitioner of veterinary medicine has to deal as it has for man

and the monkey, we have thought it well to bring the subject before the student of comparative medicine, since it can not be doubted that future research will put the physiology of the brains of the domesticated animals in a new light, in doing which guidance will naturally be sought from what has been already done, more especially in the case of the human subject and his nearest allies. Some would maintain that in the case of the dog, motor and sensory localization has been established; that in this animal there is a motor area in the region of the crucial sulcus corresponding to that around the fissure of Rolando in man. The subject is, however, far from finally settled even in the case of the dog, the brain of which has been more thoroughly investigated than that of any other of our domestic animals. Very little can as yet be said in regard to cortical localization in the horse, ox, etc. It seems highly probable that investigation will show that cortical localization in the primates (man and the monkey tribe) exists in a far higher degree than in any other animals.

The Circulation in the Brain.—The brain, being inclosed within an air-tight bony case, its circulation is of necessity peculiar. Since any undue compression of the encephalon may lead to even a fatal stupor, it is clear that there must exist some provision to permit of the excess of arterial blood that is required for unusual activity of the brain. It is to be borne in mind that the fluid within the ventricles is continuous, through the foramen of Magendie in the roof of the fourth ventricle, with that surrounding the spinal cord (spinal cavity); so that an increase in the volume of the encephalon in consequence of an afflux of blood might be in some degree compensated by an efflux of the cerebro-spinal fluid. The part played by this arrangement has, however, been probably overestimated. But the peculiar venous sinuses do, it is likely, serve to regulate the blood-supply; being very large, they may answer as temporary overflow receptacles. An inspection of the fontanelles of an infant reveals a beating corresponding with the pulse; and, when a large part of the cranium is removed in an animal, a plethysmograph shows a rise in volume corresponding with the pulse and the respiratory movements, as in the case of the fontanelles. But, besides these, periodic waves of contraction are now known to pass over the cerebral arteries.

Whether the latter is part of a general wave traversing the whole arterial system is as yet uncertain. Though there is

considerable anastomosis of vessels in the encephalon, it is not equal to what takes place in many other organs. It is well known that a clot or other plug within a cerebral vessel is more serious than in many other regions, which is partly to be explained by the lack of sufficient anastomosis for the vascular needs of the parts. It is also well known that, in organs which constitute parts of a related series, as the different divisions of the alimentary tract, all are not usually at the same time vascular to the same extent. While they act functionally in relation to each other, they exemplify also a certain degree of independence. Such a condition of things is now known to exist in the brain—i. e., certain areas may be abundantly supplied with blood as compared with others: and it seems highly probable that a condition of equal arterial tension throughout is scarcely a normal condition. Though the quantity of blood contained within the vessels of the whole brain at any one time is not so large as in some other organs (glands), yet the foregoing facts and the rapidity of the flow must be taken into account. The capillaries are very close and abundant, in the gray matter especially; and it is to be borne in mind that it is chiefly these vessels which are concerned in the actual metabolism (nutrition) of parts. However, the chemical changes in the nervous system being feeble, it would appear probable that it does its work with less consumption of pabulum than other parts of the body. We wish to lay stress on the local nature of vascular dilatation in the brain, as it greatly assists in explaining certain phenomena about to be considered.

Sleep.—Observations upon animals from which portions of the cranium have been removed, so that the brain was visible, show that during sleep the blood-vessels are much less prominent than usual; and it is well known that means calculated to diminish the circulation in the brain, as cold and pressure, favor sleep. It is also well established by general experience that withdrawal of the usual afferent impulses through the various senses favors sleep. A remarkable case is on record of a youth whose avenues for sensory impressions were limited to one eye and a single ear, and who could be sent to sleep by closing these against the outer world. Yet this subject after a long sleep would awake of his own accord, showing that, while afferent impulses have undoubtedly much to do with maintaining the activity of the cerebral centers, yet their automaticity (independence) must also be recognized.

It is a matter of common experience that weariness, or the exhaustion following on pain, mental anxiety, etc., is favorable to sleep.

A good deal of light is thrown on this subject by *hibernation*, particularly in mammals.

From special study of the subject we have ourselves learned that, however temperature, and certain other conditions may influence this state, it will appear at definite periods in defiance, to a large extent, of the conditions prevailing. Hibernation, we are convinced, is marked by a general slowing of all of the vital processes in which the nervous system takes a prominent part. Sleep and hibernation are closely related. In both there is a diminution of the rate of the vital processes, as shown by the income and output, measured by chemical standards, with of course obvious physical signs, as slowed respiration, circulation, etc. While sleep, then, is primarily the result of a rhythmical retardation of the vital processes, especially within the nervous system, it is like hibernation in some degree (in the lowest creatures, without a nerve system) the outcome of that rhythm impressed on every cell of the organism and the influence of which is felt in a thousand ways, that no doubt we are quite unable to recognize.

Hypnotism.—By the help of the above principles the subject of hypnotism, now of absorbing interest, may be in great part explained. This condition is characterized by loss of volition and judgment. It may be induced in man and certain other animals by prolonged staring at a bright object, assisted by a concentration of the attention on that alone, as far as possible, combined with a condition of mental passivity in other respects. The individual gradually becomes drowsy, and finally falls into a state in many respects strongly resembling sleep.

Hypnotism proper may be combined with *cataplexy*, a condition in which the limbs remain rigid in whatever condition they may be placed. Modifications of the vascular and respiratory systems occur. Various animals have been hypnotized, as the fowl, rabbit, Guinea-pig, crayfish, frog, etc. This condition is readily induced in the common fowl, more especially the wilder individuals, by holding the creature with the bill down on a table and the whole animal perfectly quiet for a short time. Upon the removal of the pressure the bird remains perfectly passive and apparently asleep for some little time.

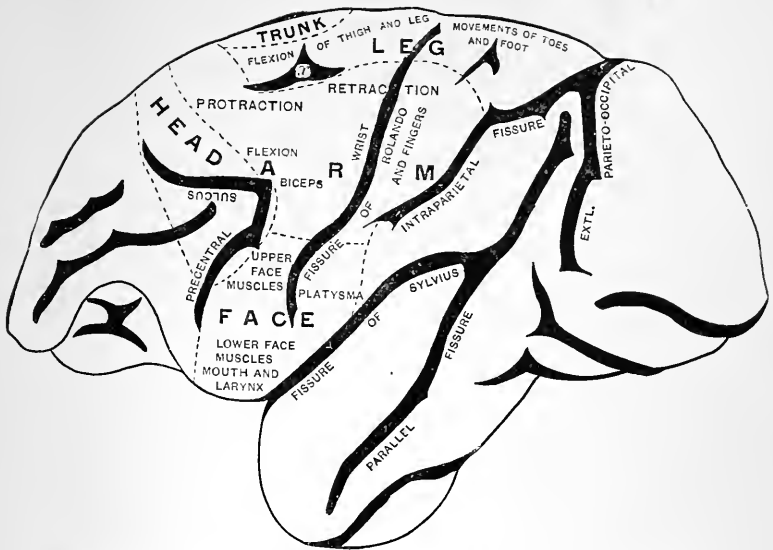

FIG. 359.—Lateral surface of brain of monkey, displaying motor areas (after Horsley and Schäfer).

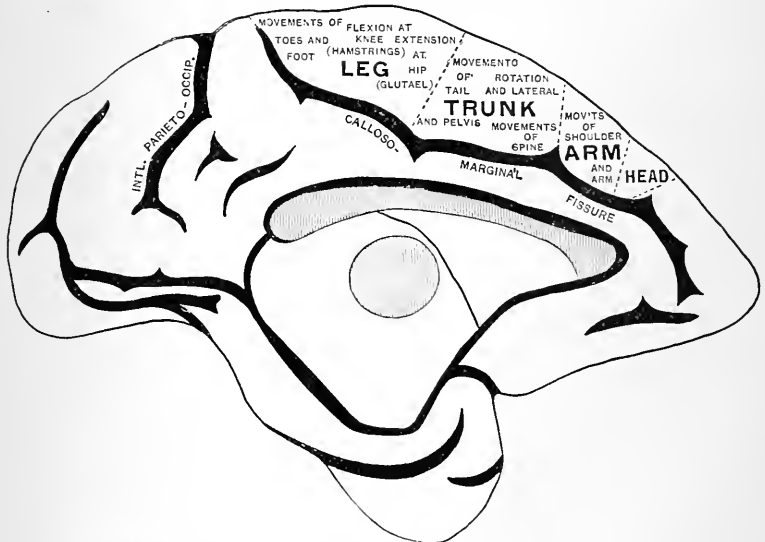

FIG. 360.—Median surface of brain of monkey (after Horsley and Schäfer).

Figs. 359 and 360 may be said to embody the views of Horsley and Schäfer more especially in regard to motor localization.

FUNCTIONS OF OTHER PORTIONS OF THE BRAIN.

Certain parts of the encephalon are spoken of as the basal ganglia, prominent among which are the corpus striatum and the optic thalamus.

The Corpus Striatum and the Optic Thalamus.—The corpus striatum consists of several parts, the main divisions being an intra-ventricular portion or caudate nucleus, and an extra-ventricular part or lenticular nucleus.

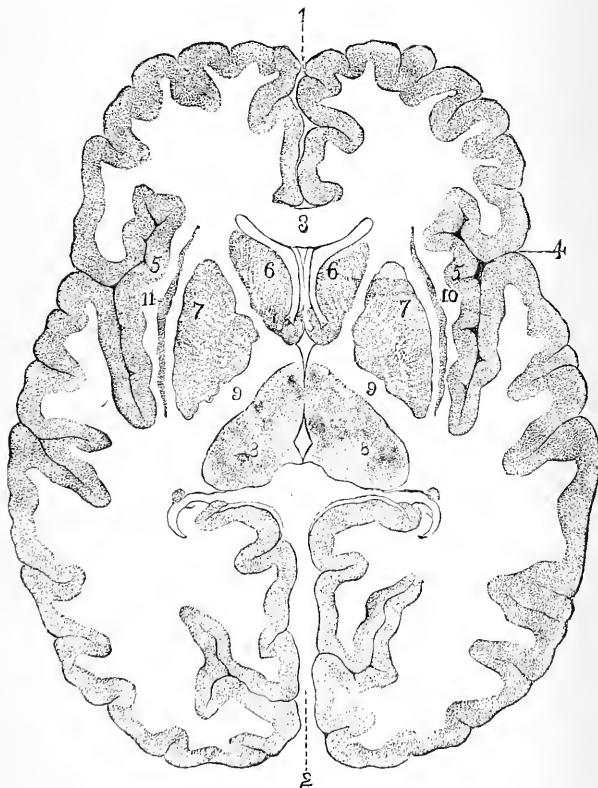

FIG. 361.—Transverse section of cerebral hemispheres of man at level of cerebral ganglia (after Dalton). 1, great longitudinal fissure; 2, part of same between occipital lobes; 3, anterior part of corpus callosum; 4, fissure of Sylvius; 5, convolutions of island of Reil (insula); 6, caudate nucleus of corpus striatum; 7, lenticular nucleus of corpus striatum; 8, optic thalamus; 9, internal capsule; 10, external capsule; 11, claustrum.

Between these lies the internal capsule, through which pass fibers that spread out toward the cortex, as the *corona radiata*.

Pathology, especially, has shown that a lesion of the intra-ventricular portion of the corpus striatum, and, above all, of the internal capsule, is followed by failure of voluntary movement (akinesia). It would appear that a great part of the fibers from the motor area around the fissure of Rolando, pass through the intra-ventricular parts of the corpus striatum, and especially its internal capsule. But it is also to be borne in mind that a large part of the fibers passing from the cortex make connection with the cells of the corpus striatum before reaching the cord. These facts render the occurrence of loss of voluntary motor power comprehensible.

The fibers of the peduncles of the brain may be divided into an interior or lower division (*crusta*), going mostly to the

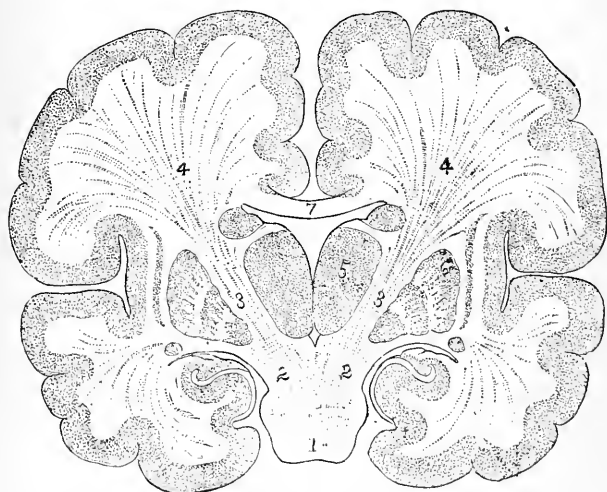

FIG. 362.—Transverse section of human brain (after Dalton). This and the preceding figure are somewhat diagrammatic. 1, pons Varolii; 2, 2, crura cerebri; 3, 3, internal capsule; 4, 4, corona radiata; 5, optic thalamus; 6, lenticular nucleus; 7, corpus callosum.

corpus striatum, and a posterior division (*tegmentum*), passing principally to the optic thalami; many, possibly most of them, ultimately reach the cortex. Many clinical observers do not hesitate to speak of the optic thalamus as sensory in function.

and the corpus striatum as motor; but the clinical and pathological evidence is conflicting—all lesions of these parts not being followed by loss of sensation and motion respectively; though an injury to the internal capsule generally results in paralysis. All are agreed that the symptoms are manifested on the side of the body opposite to the side of the lesion, so that a decussation must take place somewhere between the ganglion and the periphery of the body.

There is no doubt that the optic thalamus, especially its posterior part, is concerned with vision, for injury to it is followed by a greater or less degree of disturbance of this function. As has been already pointed out, unilateral injury of either of these ganglia leads to inco-ordination or to forced movements. That these regions act some intermediate part in the transmission of impulses to and from the brain cortex, and that the anterior one is concerned with motor, and the posterior possibly with sensory (tactile, etc.), and certainly with visual impulses, may be stated with some confidence, though further details are not yet a subject of general agreement.

Corpora Quadrigemina.—The function of these parts in vision, as in the co-ordination of the movements of the ocular muscles, and their relations to the movements of the pupil, will be considered later. However, the actual centers for these functions seem to lie in the anterior portion of the floor of the aqueduct of Sylvius, and are indirectly affected by stimulation of the corpora quadrigemina. Extirpation of these parts on one side produces blindness of the opposite eye, and in birds, etc., the same result follows when their homologues—the optic lobes—are similarly treated. There can be no doubt, therefore, that they are a part of the central nervous machinery of vision, and it seems to be probable that the anterior parts of the corpora quadrigemina alone have this visual function. But, since it is the opposite eye that is affected, and in some animals (rabbits) that alone, we are led to infer a decussation of the optic fibers, or at least of impulses. In dogs, on the other hand, the crossing seems to be but partial.

It begins to appear that there are several parts of the brain concerned with vision. After removal of almost any part of the cerebral cortex, if of sufficient extent, vision is impaired. We may say, then, that before an object is "seen" in the highest sense, processes beginning in the retina undergo further elaboration in the corpora quadrigemina, optic thalami, and,

finally in the cerebral cortex. We may safely assume that the part played by the latter is of very great importance, making the perception assume that highest completeness which is of

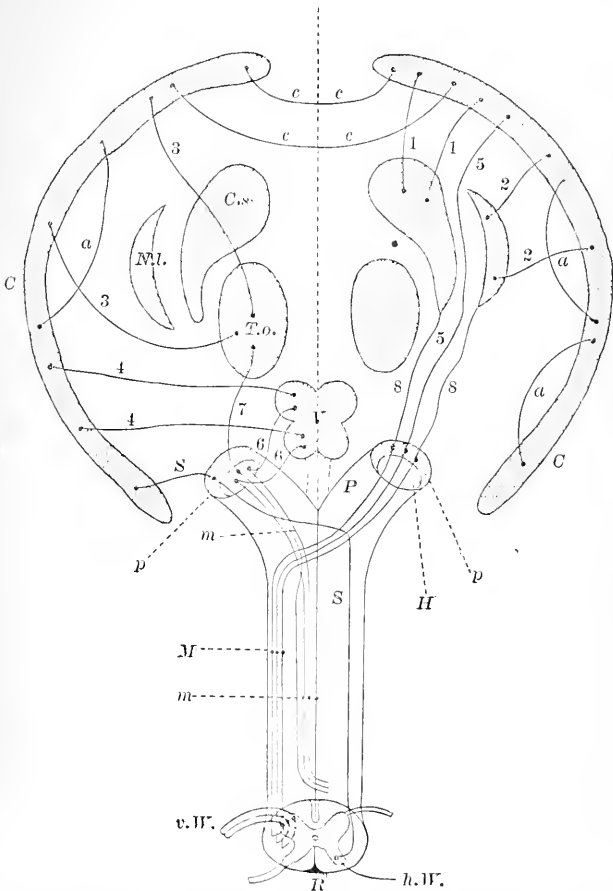

FIG. 363.—Diagrammatic representation of brain on transverse section to illustrate course of fibers (after Landois). *C, C*, cortex cerebri; *C.s.*, corpus striatum; *N.l.*, lentiform nucleus; *T.o.*, optic thalamus; *P*, peduncle; *H*, tegmentum; *p*, crusta; *T*, corpora quadrigemina; 1.1., corona radiata of corpus striatum; 2.2., of lentiform nucleus; 3.3., of optic thalamus; 4.4., of corpora quadrigemina; 5.5., direct fibers to cortex cerebri (Flechsig); 6.6., fibers from corpora quadrigemina to tegmentum; *m*, further course of these fibers; 8.8., fibers from corpus striatum and lentiform nucleus to crista of peduncle of cerebellum; *M*, further course of these; *S*, *S*, course of sensory fibers; *R*, transverse section of spinal cord; *v.W.*, anterior, and *h.W.*, posterior roots; *a, a*, system of association fibers; *c, c*, commissural fibers.

very varying character, no doubt, with different groups of animals. In a sense, all mammals may see alike, and, in another sense, they may see things very differently; for, if we may judge by the differences in this respect between educated and uneducated men, the great dissimilarity lies in the interpretation of what is seen; in a word, the cortex has to do with the perfecting of visual impulses. Nevertheless, a break anywhere in the long and complicated chain of processes must lead to some serious impairment of vision. Much of the same sort of reasoning applies to the other senses and also to speech.

To speak, therefore, of a visual center or a speech center in any very restricted sense is unjustifiable; at the same time, it is becoming clearer that there is in the occipital lobe, rather than in other parts of the cortex, an area which takes a peculiar and special share in elaborating visual impulses into visual sensations and perceptions; and there can be little doubt that the other senses are represented similarly in the cerebral cortex.

The Cerebellum.—Both physiological and pathological research point to the conclusion that the cerebellum has an important share in the co-ordination of muscular movements. Ablation of parts of the organ leads to disordered movements; and, when the whole is removed in the bird, co-ordination is all but impossible, and the same holds for mammals. Section of the middle peduncle of one side is liable to give rise to rolling forced movements. In fact, injury to the cerebellum causes symptoms very similar to those following section of the semi-circular canals, so that many have thought that in the latter case the cerebellum had itself been injured.

Pathological.—Tumors and other lesions frequently, though not invariably, give rise to unsteadiness of gait, much like that affecting an intoxicated person. It may safely be said that the cerebellum takes a very prominent share in the work of the muscular co-ordination of the body.

As has already been pointed out, several tracts of the spinal cord make connection with the cerebellum, and it is not to be forgotten that this part of the brain has, in general, most extensive connections with other regions. Insufficient study has as yet been given to the cerebellum, and it is likely that the part it takes in the functions of the encephalon is greater than has yet been rendered clear. The old notion that this organ bears any direct relation to the sexual functions seems to be

without foundation. It has now been clearly demonstrated that the lower region of the spinal cord is, in the dog and probably most mammals, the part of the nerve-centers essential for the sexual processes.

Crura Cerebri and Pons Varolii.—As has been already noted, the peduncles (*crura*) are the paths of impulses from certain parts of the cerebral cortex, the basal ganglia, and the spinal cord. The functions of the gray matter of the *crura* are unknown. But, since forced movements ensue on unilateral section, it is plain that they also have to do with muscular co-ordination.

The transverse fibers of the *pons Varolii* connect the two halves of the cerebellum. Its longitudinal fibers have extensive connections—the anterior pyramids and olivary bodies of the medulla, the lateral, and perhaps also a part of the posterior columns of the cord, while upward these fibers connect with the *crura cerebri* and so with the cortex.

Pathological.—Paralysis of the face usually occurs on the same side as that of the rest of the body ; hence it must be inferred that there is a decussation somewhere of the fibers of the facial nerve ; but there is much still to be learned about this subject.

Medulla Oblongata.—In some animals (frogs) it is certainly known that this region of the brain has a co-ordinating function, and it is probable that it is concerned with such uses in all animals that possess the organ, or rather collection of organs, seeing that this part of the brain must be regarded as especially a mass of centers, the functions of which have been already considered at length. So long as the medulla is intact, life may continue ; but, except under special circumstances, which do not invalidate this general statement, its destruction is followed by the death of the animal.

We may simply enumerate the centers that are usually located in the medulla : The respiratory (and convulsive), cardio-inhibitory, vaso-motor, center for deglutition, center for the movements of the gullet, stomach, etc., and the vomiting center ; center for the secretion of saliva and possibly other of the digestive fluids. Some add a diabetic and other centers.

SPECIAL CONSIDERATIONS.

Embryological.—The further we progress in the study of the nervous system, the greater the significance of the facts of its

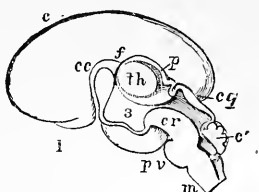

FIG. 364.—Vertical longitudinal section of brain of human embryo of fourteen weeks. 1×3 . (After Sharpey and Reichert.) *c*, cerebral hemisphere; *cc*, corpus callosum beginning to pass back; *f*, foramen of Munro; *p*, membrane over third ventricle and the pineal body; *th*, thalamus; *3*, third ventricle; *f*, olfactory bulb; *cq*, corpora quadrigemina; *cr*, crura cerebri, and above them, aqueduct of Sylvius, still wide; *c'*, cerebellum, and below it the fourth ventricle; *pv*, pons Varolii; *m*, medulla oblongata.

early development becomes. It will be remembered that from that uppermost epiblastic layer of cells, so early marked off in

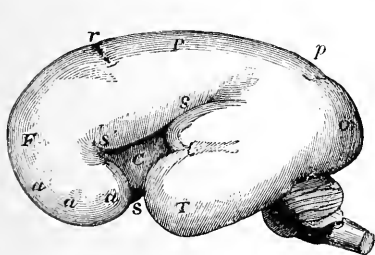

FIG. 365.

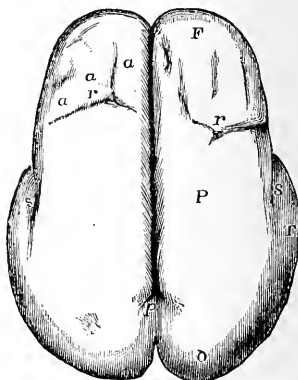

FIG. 366.

FIG. 365.—Outer surface of human fetal brain at six months, showing origin of principal fissures (after Sharpey and R. Wagner). *F*, frontal lobe; *P*, parietal; *O*, occipital; *T*, temporal; *a, a, a*, faint appearance of several frontal convolutions; *s, s*, Sylvian fissure; *s'*, anterior division of same; *C*, central lobe of island of Reil; *r*, fissure of Rolando; *p*, external perpendicular fissure.

FIG. 366.—Upper surface of brain represented in Fig. 364 (after Sharpey and R. Wagner).

the blastoderm, is formed the entire nervous system, including centers, nerves, and end organs. The brain may be regarded as a specially differentiated part of the anterior region of the

medullary groove and its subdivisions; and the close relation of the eye, ear, etc., to the brain in their early origin, is not without special meaning, while the more diffused sensory developments in the skin connect the higher animals closely with the lower—even the lowest, in which sensation is almost wholly referable to the surface of the body.

Without some knowledge of the mode of development of the encephalon, it is scarcely possible to appreciate that rising grade of complexity met with as we pass from lower to higher groups of animals, especially noticeable in vertebrates; nor is it possible to recognize fully the evidence found in the nervous system for the doctrine that higher are derived from lower forms by a process of evolution.

Evolution.—The same law applies to the nervous system as to other parts of the organism, viz., that the individual development (ontogeny) is a synoptical representation, in a general way, of the development of the group (phylogeny). A comparison of the development of even man's brain reveals the fact that, in its earliest stage, it is scarcely, if at all, distinguishable from that of any of the lower vertebrates. There is a period when even this, the most convoluted of all brains, is as smooth and devoid of gyri as the brain of a frog. The extreme com-

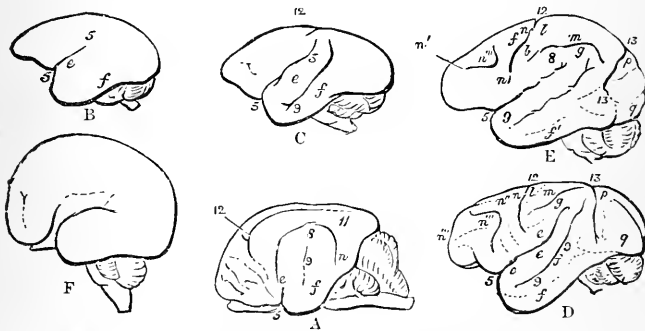

FIG. 367.—A, brain of eye-aye (*Lemur*); B, of marmoset; C, of squirrel monkey (*Calithrix*); D, of macaque monkey; E, of gibbon; F, of a fifth-month human foetus (after Owen). Although naturalists are agreed that the monkeys, apes, and lemurs are related, considerable differences are to be observed in their brains. These figures also illustrate the remark made after those following.

plexity of the human brain is referable to excessive growth of certain parts, crowding and alteration of shape, owing to the influence of its bony case, its membranes, etc.

It is evident, from an inspection of the cranial cavities of those enormous fossil forms that preceded the higher vertebrates, that their brains, in proportion to their bodies, were very small, so that any variation in the direction of increase in the encephalon—especially the cerebrum—must have given the creatures, the subject of such variation, a decided advantage in the struggle for existence, and one which may partly account, perhaps, for the extinction of those animals of vast proportions but limited intelligence. That the size of the brain

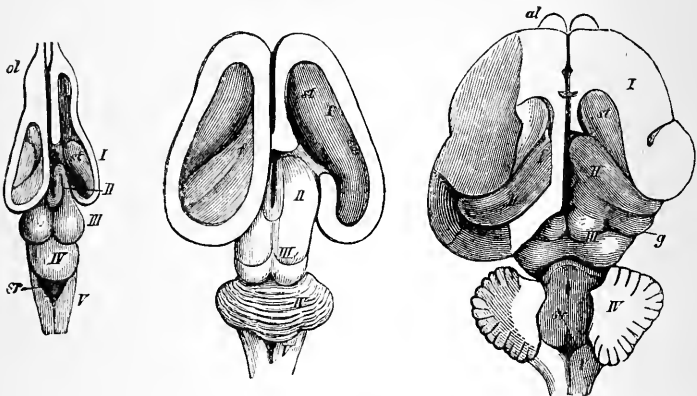

FIG. 368.—A, brain of a chelonian; B, of a fetal calf; C, of a cat. (All after Gegenbaur.) *I*, indicates cerebral hemispheres; *II*, thalamus; *III*, corpora quadrigemina; *IV*, cerebellum; *V*, medulla; *st*, corpus striatum; *f*, fornix; *h*, hippocampus; *sr*, fourth ventricle; *g*, geniculate body; *ol*, olfactory lobe. It will be observed (1) how the fetal brain in a higher animal form resembles the developed brain in a lower form, and (2) how certain parts become crowded together and covered over by more prominent regions, e. g., the cerebrum, as we ascend the animal scale.

as well as its quality can be increased by use, seems to have been established by the measurements, at different periods of development, of the heads of those engaged in intellectual pursuits, and comparing the results with those obtained by similar measurement of the heads of those not thus specially employed. Of course, it must be assumed that the head measurement is a gauge of the size of the brain, which is approximately true, if not entirely so.

Recent investigations seem to show that the development of the ganglion cells of the brain takes place first in the medulla, next in the cerebellum, after that in the mid-brain, and finally in the cerebral cortex. Animals most helpless at birth are those with the least development of such cells. The me-

dulla may be regarded in some sense as the oldest (phylogenetically) part of the brain. In it are lodged those cells (centers) which are required for the maintenance of the functions essential to somatic life. This may serve to explain how it is that so many centers are there crowded together. It is remarkable that so small a part of the brain should preside over many important functions ; but the principle of concentration with progressive development, and the law of habit making automatism prominent, throw some light upon these facts, and especially the one otherwise not easy to understand, that so much important work should be done by relatively so few cells. Possibly, however, if localization is established as fully as it may eventually be, this also will not be so astonishing.

The law of habit has, in connection with our psychic life and that of other mammals, some of its most striking developments. This has long been recognized, though that the same law is of universal application to the functions of the body has as yet received but the scantiest acknowledgment.

We shall not dwell upon the subject beyond stating that in our opinion the psychic life of animals can be but indifferently understood unless this great factor is taken into the account ; and when it is, much that is apparently quite inexplicable becomes plain. That anything that has happened once anywhere in the vital economy is liable to repetition under a

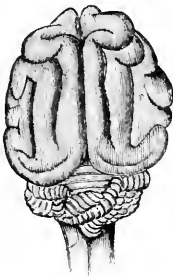

FIG. 369.

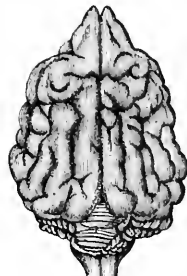

FIG. 370.

FIG. 369.—Brain of cat, seen from above (after Tiedemann).
 FIG. 370.—Brain of dog, seen from above (after Tiedemann).

slighter stimulus, is a law of the utmost importance in physiology, psychology, and pathology. The practical importance of this, especially to the young animal, is of the highest kind.

Synoptical.—There is as yet no systematized clear physiology

of "the brain." We are conversant with certain phenomena referable to this organ in a number of animals, chiefly the higher mammals ; but our knowledge is as yet insufficient to generalize, except in the broadest way, regarding the functions of the brain—i. e., to determine what is common to the brains of all vertebrates and what is peculiar to each group. Referring, then, to the higher mammals, especially to the dog, the cat, the monkey, and man, we may make the following statements :

The medulla oblongata is functionally the ruler of vegetative life—the lower functions ; and so may be regarded as the seat of a great number of "centers," or collections of cells with functions to a large degree distinct, but like close neighbors, with a mutual dependence.

Phylogenetically (ancestrally) the medulla is a very ancient region, hence the explanation apparently of so many of its functions being common to the whole vertebrate group.

Parts of the mesencephalon, the pons Varolii, the optic lobes or corpora quadrigemina, the crura cerebri, etc., are not only connecting paths between the cord and cerebrum, but seem to preside over the co-ordination of muscular movements, and to take some share in the elaboration of visual and perhaps other sensory impulses.

The cerebellum may have many functions unknown to us. Its connections with other parts of the nerve-centers are numerous, though their significance is in great part unknown. Both pathological and physiological investigation point to its having a large share in muscular co-ordination.

It is certain that the cerebrum is the part of the brain essential for all the higher psychic manifestations in the most advanced mammals and in man.

The preponderating development of man's cerebrum explains at once his domination in the animal world, his power over the inanimate forces of Nature, and his peculiar infirmities, tendencies to a certain class of diseases, etc.,—in a word, man is man, largely by virtue of the size and peculiarities of this part of his brain.

Modern research has made it clear also that there is a "projection" of sensory and motor phenomena in the cerebral cortex ; in other words, that there are sensory and motor centers in the sense that in the cortex there are certain cells which have an important share in the initiation of motor impulses, and others employed in the final elaboration of sensory ones.

It is even yet premature to dogmatize in regard to the site of these centers; especially are we not ready for large generalizations. In man the convolutions around the fissure of Rolando constitute the motor area best determined.

The whole subject of cortical localization requires much additional study, especially by the comparative method in the widest sense—i. e., by a comparison of the results of operative procedure in a variety of groups of animals, and the results of clinical, pathological, physiological, and psychological investigation. Especially must allowance be made for differences to be observed, both for the group and the individual; and also for the influence which one region exerts over another. Between the weight of the cerebrum, the extent of its cortical surface, and psychic power, there is a general relationship.

GENERAL REMARKS ON THE SENSES.

OUR studies in embryology have taught us that all the various forms of end-organs are developed from the epiblast, and so may be regarded as modified epithelial cells, with which are associated a vascular and nervous supply. These end-organs are at once protective to the delicate nerves which terminate in

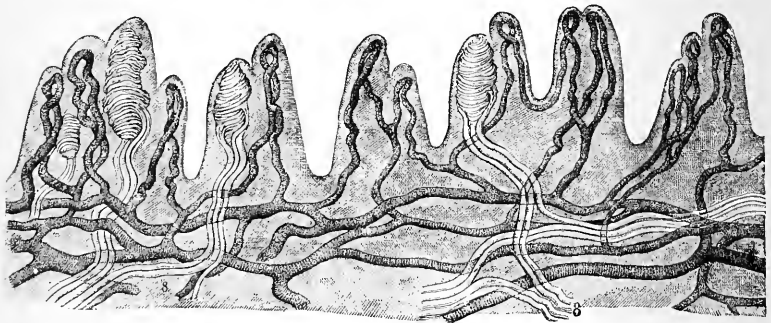

FIG. 371.—Papillæ of skin of palm of hand (after Sappey). A vascular network in all cases, and in some nerves and tactile corpuscles, enter the papillæ.

them, and serve to convey to the latter peculiar impressions which are widely different in most instances from those resulting from the direct contact of the nerve with the foreign body. All are acquainted with the fact that, when the epithelium is removed, as by a blister, we no longer possess tactile sensibility of the usual kind, and experience pain on contact with objects; in a word, the series of connections necessary to a sense-perception is broken at the commencement.

Seeing that all the end-organs on the surface of the body have a common origin morphologically, it would be reasonable to expect that the senses would have much in common, especially when these organs are all alike connected with central nervous cells by nerves. As a matter of fact, such is the case,

and in every instance we can distinguish between sensory impulses generated in the end-organ, conveyed by a nerve inward, and those in the cells of these central nervous systems, giving rise to certain molecular changes which enable the mind or the *ego* to have a perception proper; which, when taken in connection with numerous past experiences of this and other senses, furnishes the material for a sensory judgment.

The chief events are, after all, internal, and hence it is

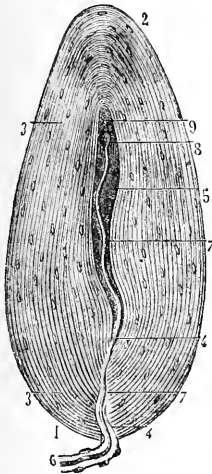
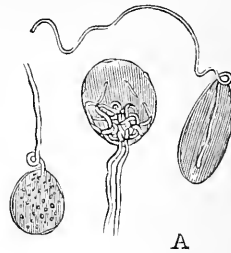
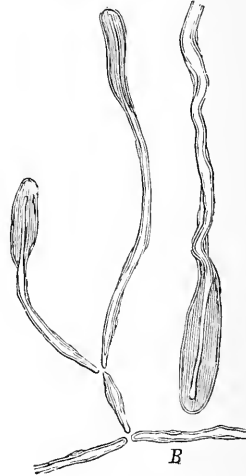

FIG. 372.

FIG. 372.—Corpuscle of Vater (after Sappey).



A



B

FIG. 373.

FIG. 373.—End-bulbs (corpuscles) of Krause (after Luddon). A, from conjunctiva of man; B, from conjunctiva of calf. It may be noticed that in all these cases the nerve loses its non-essential parts before entering the corpuscle.

found that the higher in the scale the animal ranks, the more developed its nervous centers, especially its brain, and the more it is able to capitalize its sensory impulses; also the greater the degree of possible improvement by experience, a difference well seen in blind men whose ability to succeed in life without vision is largely in proportion to their innate and acquired mental powers. Inasmuch as all cells require rest, one would expect

that under constant stimulation fatigue would soon result and perceptions be imperfect. Hence it happens that all the senses fail when exercised, even for but a short period, without change of stimulus leading to alteration of condition in the central cells. The change need not be one of entire rest, but merely a new form of exercise. Hence the freshness experienced by a change of view on passing through beautiful scenery.

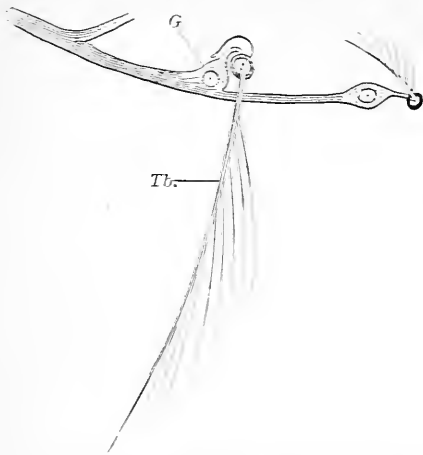

FIG. 874.—Nerves with ganglion cells (*G*) beneath a tactile bristle (*Tb.*), from skin of an arthropod (*Corithra*) larva.

Exhaustion may not be confined wholly to the central nerve-cells, but there can be little doubt that they are the most affected.

Since also there must be a certain momentum, so to speak, to molecular activity, it is not surprising that we find that the sensation outlasts the stimulus for a brief period; and this applies to all the senses, and necessarily determines the rapidity with which the successive stimuli may follow each other without causing a blending of the sensations.

Thus, then, in every sense we must recognize (1) an end-organ in which the chain of processes begins; (2) a conducting nerve through which (3) the central nerve-cells are affected; and we may speak, therefore, of (1) sensory impulses and (2) sensations, when these give rise to affections of the central nervous cells resulting in (1) perceptions and (2) judgments, when we take into account the psychic processes; and, from the nature of cell-life generally, we must recognize a certain intensity of the stimulus necessary to arouse a sensation and a limit within which alone we have power to discriminate (range of stimulation and perception); and also a limit to the rapidity with which stimuli may succeed each other to any advantage, so as to give rise to new sensations; and a limit to the endurance of the apparatus in good working condition corresponding

to clear mental perceptions, together with the value of past experience in the interpretation of our sensations. A man can necessarily have positive knowledge only of his own consciousness; but he infers similarity of conscious states by likeness in action and expression in his fellows. It is by an analogous process and by such alone that we can draw any conclusions in regard to the sensations of the lower animals. The presence of structures, undoubtedly sensory, in them is fairly good evidence that their sensations resemble ours when similar organs are employed. However, this does not absolutely follow; and the whole subject of the senses of animals incapable of articulate speech is beset with great difficulties. It only remains for us to set forth what is known regarding man, assuming that at least much of it applies to our domestic animals. Patient thoughtful observation will in time place the subject in a better position.

THE SKIN AS AN ORGAN OF SENSE.

BEARING in mind that all the sensory organs originate in the ectoderm, we find in the skin even of the highest animals the power to give the central nervous system such sense-impressions as bear a relation to the original undifferentiated sensations of lower forms as derived from the general surface of the body, but with less of specialization than is met with in the sense of hearing and vision, so that it is possible to understand how it is that the skin must be regarded not only as the original source of sensory impulses for the animal kingdom, but why it still remains perhaps the most important source of information in regard to the external world, and the condition of our own bodies; for it must be remembered that the data afforded for sensory judgments by all the other senses must be interpreted in the light of information supplied by the skin. We really perceive by the eye only retinal images. The distance, position, shape, etc., of objects are largely determined by feeling them, and thus associating with a certain visual sensation others derived from the skin and the muscles, which latter are, however, generally also associated with tactile sensations.

It is recorded of those blind from birth that, when restored to sight by surgical operations, they find themselves quite unable to interpret their visual sensations; or, in other words, seeing they do not understand, but must learn by the other senses, especially tactile sensibility, what is the real nature of the objects that form images on their retinae. All objects seen appear to be against the eyes, and any idea of distance is out of the question.

Special forms of end-organs are found scattered over the skin, mucous and serous surfaces of the body, such as Pacinian corpuscles, touch-corpuscles, end-bulbs, etc.; while in lower forms of vertebrates many others are found in parts where sensibility is acute. There seems to be little doubt that these are

all concerned with the various sensory impulses that originate in the parts where they are found, but it is not possible at present to assign definitely to each form its specific function.

It has been contended that the various specific sensations of taste, as bitter, sweet, etc., are the result of impulses conveyed to the central nervous system by fibers that have this function, and no other; and a like view has been maintained for those different sensations that originate from the skin. For such a doctrine there is a certain amount of support from experiment as well as analogy; but the more closely the subject is investigated the more it appears that the complexity of our sensations is scarcely to be explained in so simple a way as many of these theories would lead us to believe. Whether there are nerve-fibers with functions so specific, must be regarded as at least not yet demonstrated.

Let us now examine into the facts. What are the different sensations, the origin of which must be in the first instance, sought in the skin, as the impulses aroused in some form of end-organ or nerve-termination?

Suppose that one blindfolded lays his left hand and arm on a table, and a piece of iron be placed on the palm of his hand, he may be said to be conscious of the nature of the surface, whether rough or smooth, of the form, of the size, of the weight, and of the temperature of the body: in other words, the subject of the experiment has sensations of pressure, of tactile sensibility, and of temperature at least, if not also to some extent of muscular sensibility. But if the right hand be used to feel the object its form and surface characters can be much better appreciated; while, if the body be poised in the hand, a judgment as to its weight can be formed with much greater accuracy. The reason of the former is to be sought in the fact that the finger-tips are relatively very sensitive in man, and that from experience the mind has the better learned to interpret the sensory impulses originating in this quarter; which again resolves itself into the particular condition of the central nerve-cells associated with the nerve-fibers that convey inward the impulses from those regions of the skin. Manifestly if there be a sense referable to the muscles (muscular sense) at all, when they are contracted at will the impression must be clearer than when they but feebly respond to the mere pressure of some body.

PRESSURE SENSATIONS.

1. There is a relation between the intensity of the stimulus and the sensation resulting, and this limit is narrow. The greater the stimulus the more pronounced the sensation, though ordinary sensibility soon passes into pain. 2. The law of contrast may be illustrated by passing the finger up and down in a vessel containing mercury, when the pressure will be felt most distinctly at the point of contact of the fluid. 3. Pressure is much better estimated by some parts than others; hence the use of the employment of those to so large an extent.

THERMAL SENSATIONS.

1. The law of contrast is well illustrated by this sense; in fact, the temperature of a body exactly the same as that of the part of the skin applied to it can scarcely be estimated at all. The first plunge into a cold bath gives the impression that the water is much colder than it seems in a few seconds after, when the temperature has in reality changed but little; or, perhaps, the subject may be better illustrated by dipping one hand into warmer and the other into colder water than that to be adjudged. The sample feels colder than it really is to the hand that has been in the warm water, and warmer than it is to the other. 2. The limit within which we can discriminate is at most small, and the nicest determinations are made within about 27° and 33° C.—i. e., not far from the normal temperature of the body. 3. Variations for the different parts of the skin are easily ascertained, though they do not always correspond to those most sensitive to changes in pressure. The cheeks, lips, and eyelids are very sensitive to pressure.

Recent investigations have revealed the fact that there are in the human skin "pressure-spots," and "cold-spots," and "heat-spots"—i. e., the skin may be mapped out into very minute areas which give when touched a sensation of pressure different from that produced by the same stimulus in the intermediate regions; and in like manner are there areas which are sensitive to warm and to cold bodies respectively, but not to both; and these do not correspond with the pressure-spots, nor to those that give rise when touched to the sensation of pain.

It has been shown, also, that the extent of the area of skin stimulated determines to a large degree the quality of the re-

sulting sensation. Thus, the temperature of a fluid does not seem the same to a finger and the entire hand. This fact is not irreconcilable with the existence of the various kinds of thermal spots, referred to above, but it does re-enforce the view we are urging of the complexity of those sensations which seem to us to form simple wholes—as, indeed, they do—just as a piece of cloth may be made up of an unlimited number of *different* kinds of threads.

TACTILE SENSIBILITY.

As a matter of fact, one may learn, by using a pair of compasses, that the different parts of the surface of our bodies are not equally sensitive in the discrimination between the contact of objects—i. e., the judgment formed as to whether at a given instant the skin is being touched by one or two points is dependent on the part of the body with which the points are brought into contact.

Certain it is that exercise of these and all the senses greatly improves them, though it is likely that such advance must be referred rather to the central nerve-cells than to the peripheral mechanism.

We practically distinguish between a great many sensations that we can neither analyze nor describe, though the very variety of names suffices to show how much our interpretation of sense depends on past experience.

Mammals are always able to define the part of their bodies touched, and with great accuracy, no doubt, owing to the simultaneous use in the early months and years of life of vision and the senses resident in the skin.

An impression made on the trunk of a nerve is referred to the peripheral distribution of that nerve in the skin; thus, if the elbow be dipped in a freezing mixture, the skin around the joint will experience the sensation of cold, but a feeling of pain will be referred to the distribution of the ulnar nerve in the hand and arm. The same principle is illustrated by the common experience of the effects of a blow over the ulnar nerve, the pain being referred to the peripheral distribution; also by the fact that pain in the stump of an amputated limb is thought to arise in the missing toes, etc.

THE MUSCULAR SENSE.

Every one must be aware how difficult it is to regulate his movements when the limbs are cold or otherwise deadened in sensibility. We know too that, in judging of the muscular effort necessary to be put forth to accomplish a feat, as throwing a ball or lifting a weight, we judge by our past experience. It is ludicrous to witness the failure of an individual to pick up a mass of metal which was mistaken for wood. In these facts we recognize that in the successful use of the muscles we are dependent, not alone on the sensations derived from the skin, but also from the muscles themselves. True, the muscles are not very sensitive to pain when cut; it does not, however, follow that they may not be sensitive to that different effect, their own contraction. Whether the numerous Pacinian bodies around joints, or the end-organs of the nerves of muscles are directly concerned, is not determined.

Pathological.—The teaching of disease is plainly indicative of the importance of sensations derived both from the skin and the muscles for co-ordination of muscular movements.

In locomotor ataxy, in which the power of muscular co-ordination is lost to a large extent, the lesions are in the posterior columns of the spinal cord, or the posterior roots of the nerves, or both, and these are the parts involved in the transmission of afferent impulses.

Comparative.—The more closely the higher vertebrates are observed, the more convinced does one become that those sensory judgments, based upon the information derived from the skin and muscles, which they are constantly called upon to form are in extent, variety, and perfection scarcely if at all surpassed by those of man. Of course, sensory data in man, with his excessive cerebral development, may by associations in his experience be worked up into elaborate judgments impossible to the brutes, but we now refer to the judgments of sense in themselves.

The lips, the ears, the vibrissæ or stiff hairs, especially about the lips, the nose, in some cases the paws, all afford delicate and extensive sensory data.

It is a remarkable fact that the most intelligent of the groups of animals have these sensory surfaces well developed, as witness the elephant with his wonderful trunk, the hand of the monkey, and the paws and vibrissæ of the cat and dog tribe.

On the other hand, the groups with hoofs are notably inferior in the mental scale. When we pass to the lower forms of invertebrates the appreciation of vibrations of the air or water in which they live, of its temperature, of its pressure, etc., must be considerable to enable them to adapt themselves to a suitable environment.

We have not spoken of sensations derived from the internal organs and surfaces. These are ill-defined, and we know them mostly either as a vague sense of comfort or discomfort, or as actual pain. We are quite unable to refer them at present to special forms of end-organs. They are valuable as reports and warnings of the animal's own conditions.

After-impressions ("after-images") of all the senses referred to exist, mostly positive in nature—i. e., the sensation remains when the stimulus is withdrawn.

Synoptical.—The information derived from the skin in man and the other higher vertebrates relates to sensations of pressure, temperature, touch, and pain. The muscles also supply information of their condition. In how far these are referable to certain end-organs in the skin is uncertain. There are dermal areas that give rise to the sensations of heat, cold, pressure, and pain. Whether these are connected with nerve-fibers that convey no other forms of impulses than those thus arising is undetermined.

In all these senses the laws of contrast, duration of the impression, limit of discrimination, etc., hold.

The judgments based on sensations derived from the skin are syntheses or the result of the blending of many component sensations simultaneous in origin. All our sensory judgments are very largely dependent on our past experience.

VISION.

LIGHT and vision are to some degree correlatives of each other. Light is supposed to have as its physical basis the vibrations of an imponderable ether. Such is, however, to a non-seeing animal as good as non-existent, so that we may look at

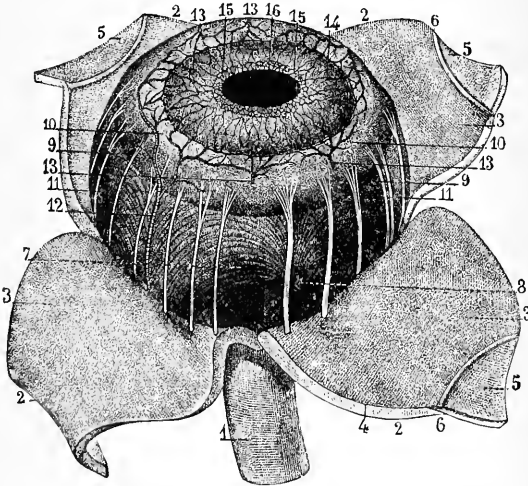

FIG. 375.—Eye partially dissected (after Sappey). 1, optic nerve; 2, 3, 4, sclerotic dissected back so as to uncover the choroid coat; 5, cornea, divided and folded back with sclerotic coat; 6, canal of Sclerum; 7, external surface of choroid, traversed by one of the long ciliary arteries and by ciliary nerves; 8, central vessel, into which the *vasa vorticosa* empty; 9, 10, choroid zone; 11, ciliary nerves; 12, long ciliary artery; 13, anterior ciliary arteries; 14, iris; 15, vascular circle of iris; 16, pupil.

this subject either with the eyes of the physiologist or the physicist, according as we regard the cause of the effects or the latter and their relations to one another. It is, however, impossible to understand the physiology of vision without a sound knowledge of the anatomy of the eye, and an apprehen-

sion of at least some of the laws of the science of optics. The student is, therefore, recommended to learn practically the

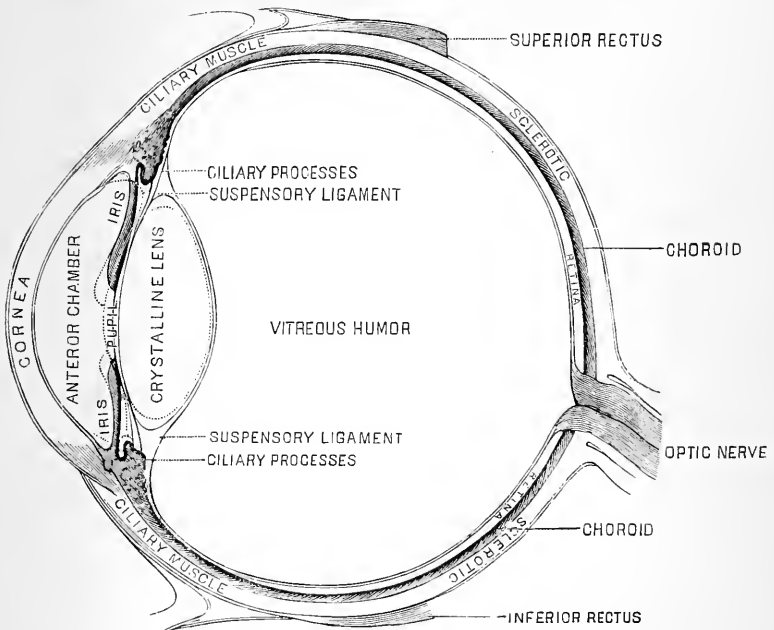

FIG. 376.—Section of human eye, somewhat diagrammatic (after Flint)

coarse and microscopic structure of the eye in detail. The eyes of mammals are sufficiently alike to make the dissection of any of them profitable. Bullocks' eyes are readily obtainable, and from their large size may be used to advantage. We recommend one to be boiled hard, another to be frozen, and sections in different meridians to be made, especially one axial vertical longitudinal section. Other specimens may be dissected with and without the use of water.

Assuming that some such work has been done, and that the student has become quite familiar with the general structure of the eye, we call attention specially to the strength of the sclerotic coat; the great vascularity of the choroid coat and its terminal ciliary processes, its pigmented character adapting it for the absorption of light; the complicated structure and protected position of the retinal expansion. It may be said that

the whole eye exists for the retina, and that the entire mechanism besides is subordinated to the formation of images on this

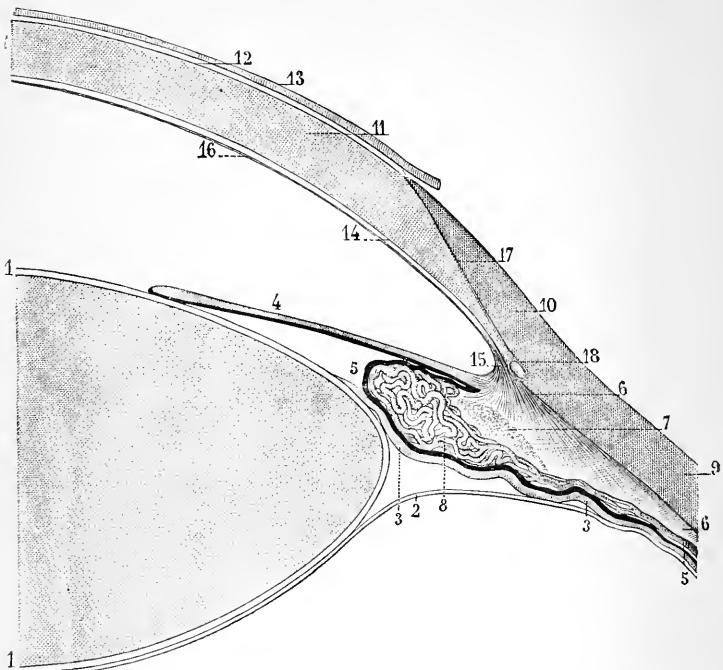

FIG. 377.—Certain parts of eye. 1×10 . (After Sappey.) 1, 1, crystalline lens; 2, hyaloid membrane; 3, zonule of Zinn; 4, iris; 5, a ciliary process; 6, radiating fibers of ciliary muscle; 7, section of circular portion of ciliary muscle; 8, venous plexus of ciliary muscle; 9, 10, sclerotic coat; 11, 12, cornea; 13, epithelial layer of cornea; 14, Descemet's membrane; 15, pectinate ligament of iris; 16, epithelium of membrane of Descemet; 17, union of sclerotic coat with cornea; 18, section of canal of Schlemm.

nervous expansion. The eye of the mammal may be regarded as an arrangement of refracting media, protected by coverings, with a window for the admission of light, a curtain regulating the quantity admitted; a sensitive screen on which the images are thrown; surfaces for the absorption of superfluous light; apparatus for the protection of the eye as a whole, and for preserving exposed parts moist and clean.

Embryological.—We have already learned that the first indication of the eye is the formation of the optic vesicle, an outgrowth from the first cerebral vesicle. This optic vesicle be-

comes more contracted at the base, and the optic stalk remains as the optic nerve.

At an early stage of development (second or third day in the chick) the outer portion of the optic vesicle is pushed inward,

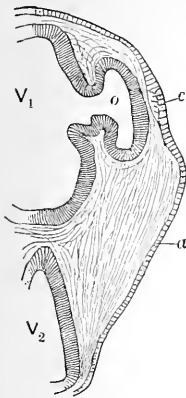

FIG. 378.

FIG. 378.—Section through head of chick on third day, showing origin of eye (after Yeo). *a*, epiblast undergoing thickening to form lens; *o*, optic vesicle; *V*₁, first cerebral vesicle; *V*₂, posterior cerebral vesicle. It will be observed that the retina is already distinctly indicated.

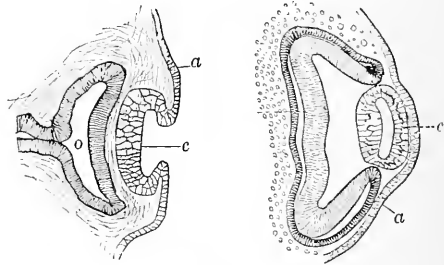

FIG. 379.

FIG. 379.—Later stages in development of eye (after Cardiat). *a*, epiblast; *c*, developing lens; *o*, optic vesicle.

so that the cavity is almost obliterated; the anterior portion, becoming thickened, ultimately forms the retina proper, while the posterior is represented by the tessellated pigment layer of the choroid.

As this retinal portion breaks away from the superficial epithelium, the latter forms an elliptical mass of cells, the future lens, the changes of which in the formation of the cells peculiar to the lens illustrate to how great lengths differentiation in structure is carried in the development of a single organ. It will thus be seen that the most essential parts of the eye, the optic nerve, the retina, and the crystalline lens, are, according to a general law, the earliest marked out. The cornea, the iris, the choroid, the vascular supply, the sclerotic, etc., are all secondary in importance and in formation to these, and are derived from the mesoblast, while the essential structures are traceable, like the nervous system itself, to the epiblastic layer.

Any act of perfect vision in a mammal may be shown to consist of the following: (1) The focusing of rays of light from

an object on the retina, so as to form a well-defined image; (2) the conduction of the sensory impulses thus generated in the

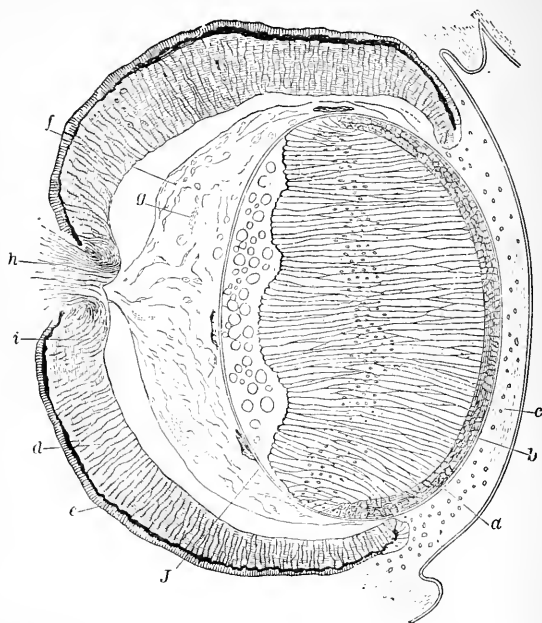

FIG. 380.—More advanced stage of development of eye (after Cardiat). *a*, epithelial cells forming lens, now much altered; *b*, lens capsule; *c*, cutaneous tissue about to form conjunctiva; *d*, *e*, two layers of optic vesicle, now folded back and forming retina; *f*, mucous tissue forming vitreous humors; *g*, intercellular substance; *h*, developing optic nerve; *i*, nerve-fibers entering retina.

retina by the optic nerve inward to certain centers; and (3) the elaboration of these data in consciousness.

We thus have the formation of an image—a physical process; sensation, perception, and judgment—physiological and psychical processes.

In the natural order of things we must discuss first those arrangements which are concerned with the focusing of light—i. e., the formation of the image on the retinal screen.

DIOPTRICS OF VISION.

One of the most satisfactory methods of ascertaining that the eye does form images of the objects in the field of vision is to remove the eye of a recently killed albino rabbit. On holding up before such an eye any small object, as a pair of forceps, it may be readily observed that an inverted image of the object is formed on the back of the eye (*fundus*). If, however, the lens be removed from such an eye, no image is formed. If the lens be itself held behind the object, an inverted image will be thrown upon a piece of paper held at a suitable (its focal) distance. By substituting an ordinary biconvex lens, the same effect follows. It thus appears, then, that the lens is the essential part of the refracting media, though the aqueous and vitreous humors and the cornea are also focusing mechanisms.

In the actual human eye the focus must correspond with the fovea of the retina if a distinct image is to be formed.

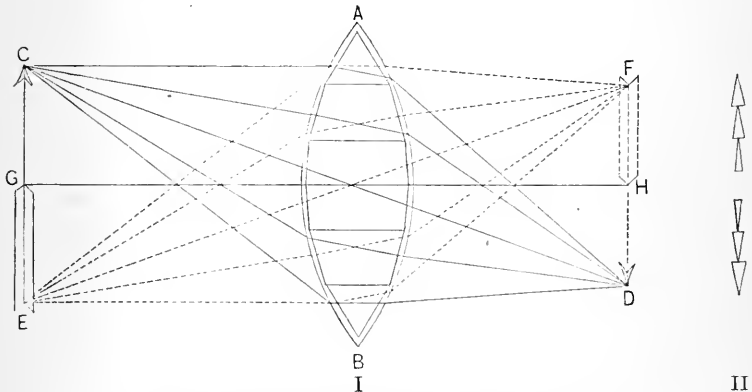

FIG. 381.—Refraction by convex lenses (after Flint and Weinhold). The lens may be assumed to consist of a series of lenses (II in figure), for the sake of simplicity, though, of course, this is not strictly accurate.

It will appear that we may represent the eye as reduced to the lens and the retina. The experiments referred to above will convince the student that such is the case.

ACCOMMODATION OF THE EYE.

Using the material already referred to, the student may observe that, with the natural eye of the albino rabbit, its lens (or better that of a bullock's eye, being larger), or a bi-convex lens of glass, there is only one position of the instruments and objects which will produce a perfectly distinct image. If either the eye (retina), the lens, or the object be shifted, instead of a distinct image, a blurred one, or simply *diffusion-circles*, appear.

A photographer must alter either the position of the object or the position of his lens when the focus is not perfect. The eye may be compared to a camera, and since the retina and lens can not change position, either the shape of the lens must change or the object assume a different position in space. As a matter of fact, any one may observe that he can not see objects *distinctly* within a certain limit of nearness to the eye, known as the *near point* (*punctum proximum*); while he becomes conscious of no effect referable to the eye until objects approach within about sixty-five to seventy yards. Beyond the latter distance objects are seen clearly without any effort.

There are many ways in which we may be led to realize these truths: 1. When one is reading a printed page it is only the very few words to which the eyes are then specially directed that are seen clearly, the rest of the page appearing blurred; and the same holds for the objects in any small room. We speak of picking out an acquaintance in an audience or crowd, which implies that each of the individuals composing the throng is not distinctly seen at the same time. 2. If an observer hold up a finger before his eyes, and direct his gaze into the distance (relax his accommodation), presently he will behold a second shadowy finger beside the real one—i. e., he sees double; his eyes being accommodated for the distant objects, can not adapt themselves at the same time for near ones.

In what does accommodation consist? From experiments it has been concluded that accommodation consists essentially in an alteration of the convexity of the anterior surface of the lens.

This change in the shape of the lens is accomplished as follows: The lens is naturally very elastic and is kept in a partially compressed condition by its capsule, to which is attached the suspensory ligament which has a posterior attachment to

the choroid and ciliary processes. When the ciliary muscle, which operates from a fixed point the corneo-sclerotic junction,

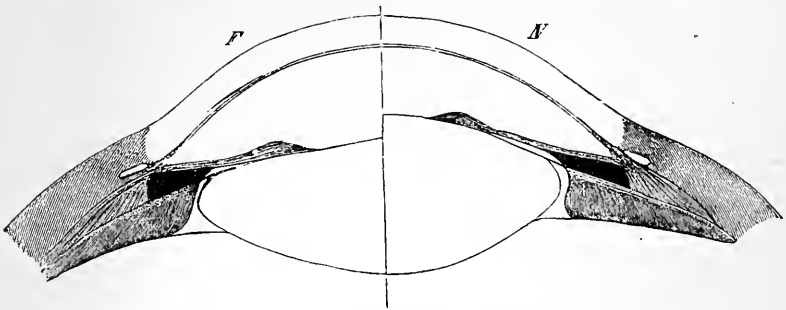

FIG. 382.—Illustrates mechanism of accommodation (after Fick). The left side depicts the relation of parts during the passive condition of the eye (negative accommodation, or accommodation for long distances); the right side, that for near objects.

pulls upon the choroid, etc., it relaxes the suspensory ligament; hence the lens, not being pressed upon in front as it is from behind by the vitreous humor (invested by its hyaloid membrane), is free to bulge and so increase its refractive power. The nearer an object approaches the eye, the greater the divergence of the rays of light proceeding from it, and hence the necessity for greater focusing power in the lens.

If an animal be observed closely when looking from a remote to a near object, it may be noticed that the eyes turn inward—i.e., the visual axes converge and the pupils contract. These are not, however, essential in the sense in which the changes in the lens are; for, as before stated, in the absence of the lens distinct vision is quite impossible.

ALTERATIONS IN THE SIZE OF THE PUPIL.

The pupil varies in size according as the iris is in a greater or less degree active. All observers are agreed that the circular fibers around the pupillary margin are muscular, forming the so-called sphincter of the iris; but great differences of opinion still exist in regard to the radiating fibers. It is thought by many that all the changes in the iris may be explained by the elasticity of its structure without assuming the existence of muscular fibers other than those of the sphincter; thus a contraction of the latter would result in diminution of the pu-

pillary aperture, its relaxation to an enlargement, provided the rest of the iris were highly elastic.

The conclusions in regard to the innervation of the iris rest largely upon the results of certain experiments which we shall

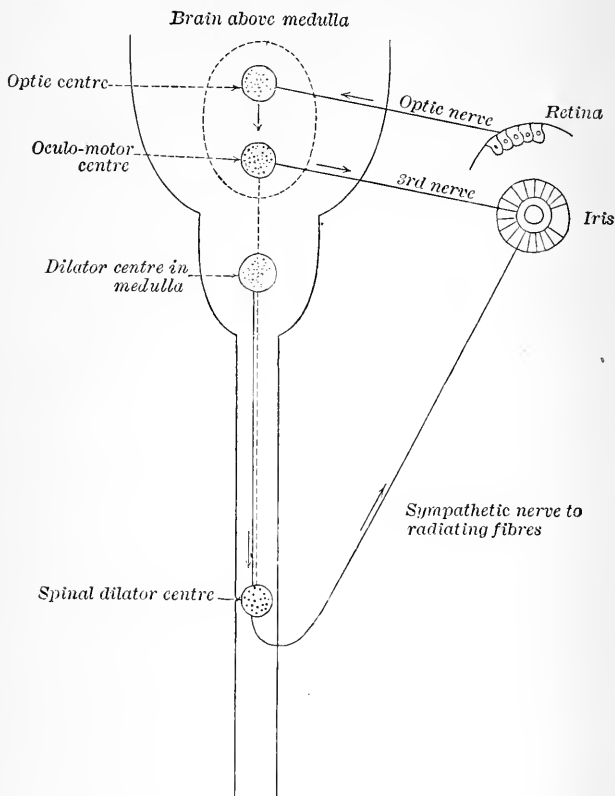

FIG. 383.—Diagram to illustrate innervation of the iris. Dotted lines indicate general functional connection (correlation). Course of impulses indicated by arrows.

now briefly detail : 1. When the third nerve is divided, stimulation of the optic nerve (or retina) does not cause contraction of the pupil as usual. 2. When the optic nerve is divided, light no longer causes a contraction of the pupil, though stimulation of the third nerve or its center in the anterior portion of the floor of the aqueduct of Sylvius does bring about this result. 3. Section of the cervical sympathetic is followed by contrac-

tion and stimulation of its peripheral end by dilatation of the pupil.

From such experiments it has been concluded that—1. The optic is the afferent nerve and the third nerve the efferent nerve concerned in the contraction of the pupil ; and that the center in the brain is situated as indicated above, so that the act is ordinarily a reflex. 2. That the cervical sympathetic is the path of the efferent impulses regulating the action of the radiating fibers of the iris.

Its center has been located near that for the contraction of the pupil, and it may be assumed to exert a tonic action over the iris comparable to that of the vaso-motor center over the blood-vessels.

The impulses may be traced through the cervical sympathetic and its ganglia back to the first thoracic ganglion, and thence to the spinal cord and brain. There may be subsidiary centers in the cervical spinal cord.

It is to be remembered that, although the dilating center is automatic in action, it may also act reflexly, or be modified by unusual afferent impulses—as, e. g., the strong stimulation of any sensory nerve which causes enlargement of the pupil through inhibition of the center. To render the paths of impulses affecting the iris somewhat clearer, it is well to bear in mind the nervous supply of the part : 1. The third nerve, through the ciliary (ophthalmic, lenticular) ganglion, supplies short ciliary nerves to the iris, ciliary muscle, and choroid. 2. The cervical sympathetic reaches the iris chiefly through the long ciliary nerves and the ophthalmic division of the fifth. 3. There are sensory fibers from the fifth nerve ; and, according to some observers, also dilating fibers from this nerve independent of the sympathetic, as well as those that may reach the eye by the long ciliary nerves without entering the ciliary ganglion. 4. The centers from which both the contracting and dilating impulses proceed are situated near to each other in the floor of the aqueduct of Sylvius. It is of practical importance to remember the various circumstances under which the pupil contracts and dilates.

Contraction (Myosis).—1. Access of strong light to the retina. 2. Associated contraction on accommodation for near objects. 3. Similar associated contraction when the visual axes converge, as in accommodation for near objects. 4. Reflex stimulation of afferent nerves, as the nasal or ophthalmic divis-

ion of the fifth nerve. 5. During sleep. 6. Upon stimulation of the optic or the third nerve, and the corpora quadrigemina or adjacent parts of the brain. 7. Under the effects of certain drugs, as physostigmin, morphia, etc.

Dilatation (Mydriasis).—1. In darkness. 2. On stimulation of the cervical sympathetic. 3. During asphyxia or dyspnœa. 4. By painful sensations from irritation of peripheral parts. 5. From the action of certain drugs, as atropin, etc. The student may impress most of these facts upon his mind by making the necessary observations, which can be readily done.

Pathological.—As showing the importance of such connections, we may instance the fact that, in certain forms of nervous disease (e. g., locomotor ataxia), the pupil contracts when the eye is accommodated to near objects, but not to light (the Argyll-Robertson pupil). In other cases, owing to brain-disease, the pupils may be constantly dilated or the reverse; or one may be dilated and the other contracted.

Comparative.—The iris varies in color in different groups of animals, and even in individuals of the same group; while the color in early life is not always the permanent one.

In shape the pupil is elliptical in solipeds and most ruminants. In the pig and dog it is circular, as also in the cat when dilated; but when greatly contracted in the latter animal, it may become a mere perpendicular slit.

The iris is covered posteriorly with a layer of pigment (*uvea*), portions of which may project through the pupil into the anterior chamber, and constitute the "sootballs" (*corpora nigra*) well seen in horses, and very suggestive of inflammatory growths, though, of course, perfectly normal.

OPTICAL IMPERFECTIONS OF THE EYE.

Anomalies of Refraction.—1. We may speak of an eye in which the refractive power is such that, under the limitations referred to before (page 531), images are focused on the retina, as the *emmetropic* eye. The latter is illustrated by Fig. 384. In the upper figure, in which the eye is represented as passive (negatively accommodated), parallel rays—i. e., rays from objects distant more than about seventy yards (according to some writers much less)—are focused on the retina; but those from objects near at hand, the rays from which are divergent, are focused behind the retina. In the lower figure the lens is rep-

resented as more bulging, from accommodation, as such divergent rays are properly focused.

2. In the *myopic* (near-sighted) eye the parallel rays cross within the vitreous humor, and diffusion-circles being formed on the retina, the image of the object is necessarily blurred,

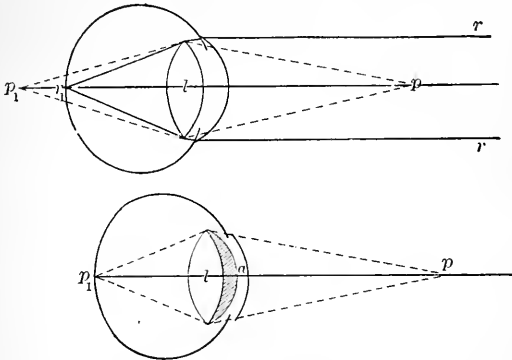

FIG. 384.—Diagrams to illustrate conditions of refraction in normal eye when unaccommodated (passive, or nearly accommodated), and when accommodated for "near" objects (after Landois).

so that an object must, in the case of such an eye, be brought unusually near, in order to be seen distinctly—i. e., the *near point* is abnormally near and the *far point* also, for parallel

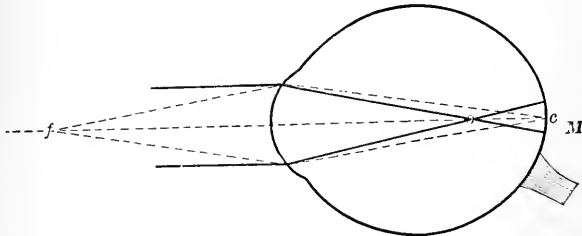

FIG. 385.—Anomalies of refraction in a myopic eye (after Landois).

rays can not be focused ; so that objects must be near enough for the rays from them that enter the eye to be divergent.

The myopic eye is usually a long eye, and, though the mechanism of accommodation may be normal, it is not so usually, the ciliary muscle being frequently defective in some of its fibers, which may be either hypertrophied or atrophied, or with some affected one way and others in the opposite. More-

over, there is also generally, in bad cases, "spasm of accommodation" (i. e., of the ciliary muscle), with increased ocular tension, etc. The remedies are, rest of the accommodation mechanism and the use of concave glasses.

3. The opposite defect is hypermetropia. The *hypermetropic* eye (Fig. 386), being too short, parallel rays are focused behind the retina; hence no distinct image of distant objects can

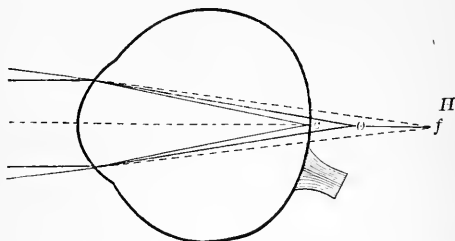

FIG. 386.—Anomalies of refraction in the hypermetropic eye (after Landois).

be formed, and they can only be seen clearly by the use of convex glasses, except by the strongest efforts at accommodation. When the eye is passive, no objects are seen distinctly beyond a certain distance—i. e., the *near point* is abnormally distant (eight to eighty inches). The defect is to be remedied by the use of convex glasses.

4. Presbyopia, resulting from the *presbyopic* eye of the old, is owing to defective focusing power, partly from diminished elasticity (and hence flattening) of the lens, but chiefly, probably, to weakness of the ciliary muscle, so that the changes required in the shape of the lens, that near objects may be distinctly seen, can not be made. The obvious remedy is to aid the weakened refractive power by convex glasses. It is practically important to bear in mind that, as soon as any of these defects in refractive power (though the same remark applies to all ocular abnormalities) are recognized, the remedy should be at once applied, otherwise complications that may be to a large extent irremediable may ensue.

VISUAL SENSATIONS.

We have thus far considered merely what takes place in the eye itself or the physical causes of vision, without reference to those nervous changes which are essential to the perception of

an object. It is true that an image of the object is formed on the retina, but it would be a very crude conception of nervous processes, indeed, to assume that anything resembling that image were formed on the cells of the brain, not to speak of the superposition of images inconsistent with that clear memory of objects we retain. Before an object is "seen," not only must there be a clear image formed on the retina, but impulses generated in that nerve expansion must be conducted to the brain, and rouse in certain cells there peculiar molecular conditions, upon which the perception finally depends.

For the sake of clearness, we may speak of the changes

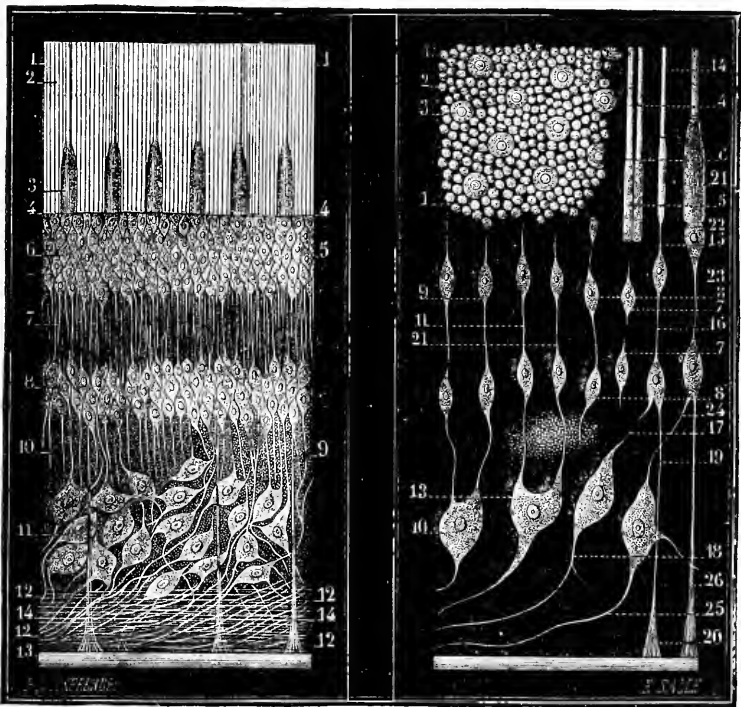

FIG. 387.

FIG. 388.

FIG. 387.—Vertical section of retina (after H. Müller). 1, layer of rods and cones; 2, rods; 3, cones; 4, 5, 6, external granule layer; 7, internal granule layer; 9, 10, finely granular gray layer; 11, layer of nerve-cells; 12, 14, fibers of optic nerve; 13, membrana limitans.

FIG. 388.—Connection of rods and cones of retina with nervous elements (after Sappey). 1, 2, 3, rods and cones seen from in front; 4, 5, 6, side view. The rest will be clear from the preceding figure.

effected in the retina as *sensory impressions* or impulses, which, when completed by corresponding changes in the brain, develop into *sensations*, which are represented psychically by *perceptions*; hence, though all these have a natural connection, they may for the moment be considered separately. It is as yet beyond our power to explain how they are related to each other except in the most general way, and the manner in which a mental perception grows out of a physical alteration in the molecules of the brain is at present entirely beyond human comprehension.

Affections of the Retina.—There is no doubt that the fibers of the optic nerves can not of themselves be directly affected by light. This may be experimentally demonstrated to one's self by a variety of methods, of which the following is readily carried out: Look at the circle (Fig. 389) on the left hand with the



FIG. 389 (after Bernstein).

right eye, the left being closed, and, with the page about twelve to fifteen inches distant, gradually approximate it to the eye, when suddenly the cross will disappear, its image at that dis-

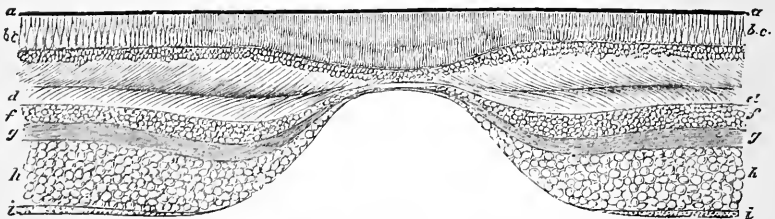

FIG. 390.—Diagrammatic section of macula lutea in man (after Huxley). *a, a*, pigment of choroid; *b, c, b, c*, rods and cones; *d, d*, outer granular or nuclear layer; *f, f*, inner granular layer; *g, g*, molecular layer; *h, h*, layer of nerve-cells; *i, i*, fibers of optic nerve.

tance having fallen on the *blind-spot*, or the point of entrance of the optic nerve.

It remains, then, to determine what part of the retina is affected by light. The evidence that it is the layers of rods and cones is convincing. It has been shown that parts of the retina itself internal to these layers cast *perceptible* shadows, the conclusion that the rods and cones are the essential parts of the sensory organ would be inevitable.

The Laws of Retinal Stimulation.—It may be noticed that, when a circular saw in a mill is rotated with extreme rapidity, it seems to be at rest.

If a stick on fire at one end be rapidly moved about, there seems to be a continuous fiery circle.

If a top painted in sections with various colors be spun, the different colors can not be distinguished, but there is a color resulting from the blending of the sensations from them all, which will be white if the spectral colors be employed.

When, on a dark night, a moving animal is illuminated by a flash of lightning, it seems to be at rest, though the attitude is one we know to be appropriate for it during locomotion.

It becomes necessary to explain these and similar phenomena. Another observation or two will furnish the data for the solution.

If on awakening in the morning, when the eyes have been well rested and the retina is therefore not so readily fatigued, one looks at the window for a few seconds and then closes the eyes, he may perceive that the picture still remains visible as a *positive after-image*; while, if a light be gazed upon at night and the eyes suddenly closed, an after-image of the light may be observed.

It thus appears, then, that the impression or sensation outlasts the stimulus in these cases, and this is the explanation into which all the above-mentioned facts fit. When the fiery point passing before the eyes in the case of the fire-brand stimulates the same parts of the retina more frequently than is consistent with the time required for the previous impression to fade, there is, of necessity, a continuous sensation, which is interpreted by the mind as referable to one object. In like manner, in the case of a moving object seen by an electric flash, the duration of the latter is so brief that the object illuminated can not make any appreciable change of position while it lasts: a second flash would show an alteration, another part of the

retina being stimulated, or the original impression having faded, etc.

In the case of a top or (better seen) color-disk, painted into black and white sectors, it may be observed that with a faint light the different colors cease to appear distinct with a slower rotation than when a bright light is used. The variation is between about $\frac{1}{10}$ and $\frac{1}{50}$ of a second, according to the intensity of the light used. Fusion is also readier with some colors than others.

It is a remarkable fact that one can distinguish as readily between the quantity of light emanating from 10 and 11 candles as between 100 and 110.

The Visual Angle.—If two points be marked out with ink on a sheet of white paper, so close together that they can be just distinguished as two at the distance of 12 to 20 inches, then on removing them a little farther away they seem to merge into one.

The principle involved may be stated thus: When the distance between two points is such that they subtend a less visual angle than 60 seconds, they cease to be distinguished as two. Fig. 391 illustrates the visual angle. It will be noticed that a larger object at a greater distance subtends the same visual angle as a smaller one much nearer.

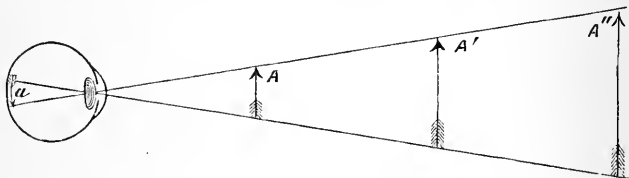

FIG. 391.—The visual angle. The object at A'' appears no larger than the one at A (Le Conte).

image corresponding to 60 seconds is .004 mm. (4μ), and this is about the diameter of a single rod or cone. It is not, however, true that when two cones are stimulated two objects are inferred to exist in every case by the mind; for the retina varies in different parts very greatly in general sensibility and in sensibility to color.

It is noticeable that visual discriminative power can be greatly improved by culture, a remark which applies especially to colors. It seems altogether probable that the change is central in the nerve-cells of the part or parts of the brain con-

cerned, especially of the cortical region, where the cell processes involved in vision are finally completed.

Color-Vision.—As we are aware by experience the range and accuracy of color perception in man is very great, though variable for different persons, a good deal being dependent on cultivation. However, there are also pronounced natural differences, some individuals being unable to differentiate between certain primary colors as red and green, and so are “color-blind.” It is of course difficult to determine in how far the lower animals can discriminate between colors; but in certain groups, as the birds, it would seem to be reasonable to conclude that their color-perceptions are highly developed.

It is further probable that in this group, and possibly some others with the eyes placed more in the lateral than the anterior portion of the head, the retinal area for the most distinct vision, including that for colors is larger than in man, at all events.

PSYCHOLOGICAL ASPECTS OF VISION.

It is impossible to ignore entirely, in treating of the physiology of the senses, the mind, or perceiving *ego*.

By virtue of our mental constitution, we refer what we “see” to the external world, though it is plain that all that we perceive is made up of certain sensations.

We recognize the “visual field” as that part of the outer world within which alone our vision can act at any one time; and this is, of course, smaller for one than for both eyes.

If one takes a large sheet of paper and marks on its center a spot on which one or both eyes are fixed, by moving a point up or down, to the right or the left, he may ascertain the limits of the visual field for a plane surface. The visual field for both eyes measures about 180° in the horizontal meridian; for one eye about 145° ; and in the vertical meridian 100° .

After-Images, etc.—Positive after-images have already been referred to; but an entirely different result, owing to exhaustion of the retina, may follow when the eye is turned from the object. If, after gazing some seconds at the sun, one turns away or merely closes the eyes, he may see black suns. In like manner, when one turns to a gray surface after keeping the eyes fixed on a black spot on a white ground, he will see a light spot. Such are termed *negative* after-images, and these may themselves be colored, as when one turns from a red to a

white surface and sees the latter green. They may be considered as the results of exhaustion.

CO-ORDINATION OF THE TWO EYES IN VISION.

As a matter of fact, we are aware that an object may be seen as one either with a single eye or with both. For *binocular* vision it may be shown that the images formed on the two retinas must fall invariably on *corresponding* points.

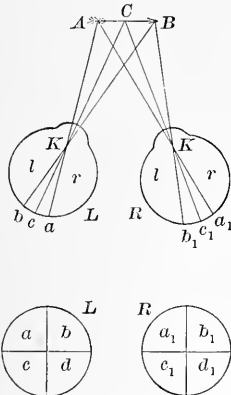

FIG. 392.—Diagram to illustrate corresponding points (after Foster). *L*, *R*, left and right eyes; *a*, *b*, *c*, are points in one eye corresponding to *a*₁, *b*₁, *c*₁, in the other. The lower figures are projections of the retina of the right (*R*) and the left (*L*) eye. It may be observed that the malar side of one retina corresponds to the nasal side of the other.

The position of the latter may be gathered from Fig. 392. It will be noticed that the *malar* side of one eye corresponds to the *nasal* side of the other, though upper always answers to upper and lower to lower. This may also be made evident if two saucers (representing the fundus of each eye) be laid over each other and marked off, as in the figure.

That such corresponding points do actually exist may be shown by turning one eye so that the image shall not fall, as indicated in the figure. Only now and then, however, is a person to be found who can voluntarily accomplish this, but it occurs in all kinds of natural or induced squint, as in alcoholism, owing to partial paralysis of some of the ocular muscles. We are thus naturally led to consider the action of these muscles.

Ocular Movements.—Upon observing the movements of an individual's eyes, the head being kept stationary, it may be noticed that (1) both eyes may converge; (2) one diverge and the other turn inward; (3) both move upward or downward; (4) these movements may be accompanied by a certain degree of rotation of the eyeball.

The eye can not be rotated around a horizontal axis without combining this movement with others. To accomplish the above movements it is obvious that certain muscles of the six with which the eye is provided must work in harmony, both as

to the direction and degree of the movement—i. e., the movements of the eyes are affected by very nice muscular co-ordinations.

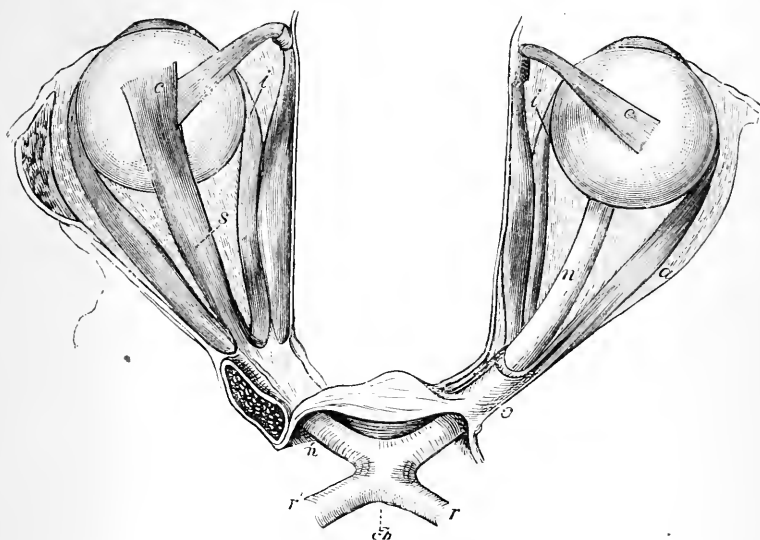

FIG. 393.—View of the two eyes and related parts (after Helmholtz.)

Fig. 394 is meant to illustrate diagrammatically the movements of the eyeball.

While the several recti muscles elevate or depress the eye, and turn it inward or outward, and the oblique muscles rotate it, the movements produced by the superior and inferior recti always corrected by the assistance of the oblique muscles, since the former tend of themselves to turn the eye somewhat inward. In like manner the oblique muscles are corrected by the recti. The following tabular statement will express the conditions of muscular contraction for the various movements of the eye in man:

Straight move- ments.	{	Elevation.....	Rectus superior and obliquus inferior.
		Depression.....	Rectus inferior and obliquus superior.
		Adduction to nasal side...	Rectus internus.
		Adduction to malar side...	Rectus externus.

Oblique movements.	}	Elevation with adduction..Rectus superior and internus, with obliquus inferior.
		Depression with adduction..Rectus inferior and internus, with obliquus superior.
		Elevation with abduction..Rectus superior and externus, with obliquus inferior.
		Depression with abduction..Rectus inferior and externus, with obliquus superior.

What is the *nervous* mechanism by which these "associated" movements of the eyes are accomplished? It has been found, experimentally, that when different parts of the corpora quadrigemina are stimulated, certain movements of the eyes follow. Thus stimulation of the right side of the nates leads to movements of both eyes to the left, and the reverse when the opposite side is stimulated; also, stimulation in the middle line causes convergence and downward movement, etc., with the corresponding movements of the iris. Since section of the nates in the middle line leads to movements confined to the eye of the same side, the center would appear to be double.

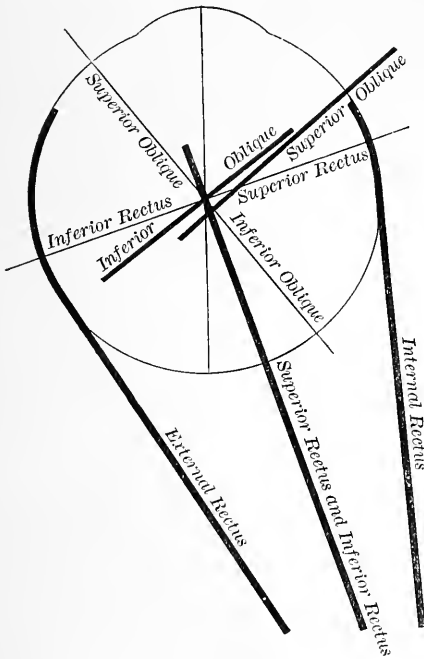

FIG. 394.—Diagram intended to illustrate action of extrinsic ocular muscles (after Fick). The heavy lines represent the muscles of the eyeball, and the fine lines the axes of movement.

However, it may be that the cells actually concerned do not lie in the corpora quadrigemina, but below or outside of them. The localization is as yet incomplete. In many groups of animals, including the solipeds, ruminants, and Carnivora, there is a posterior rectus or retractor oculi by which the eye may be

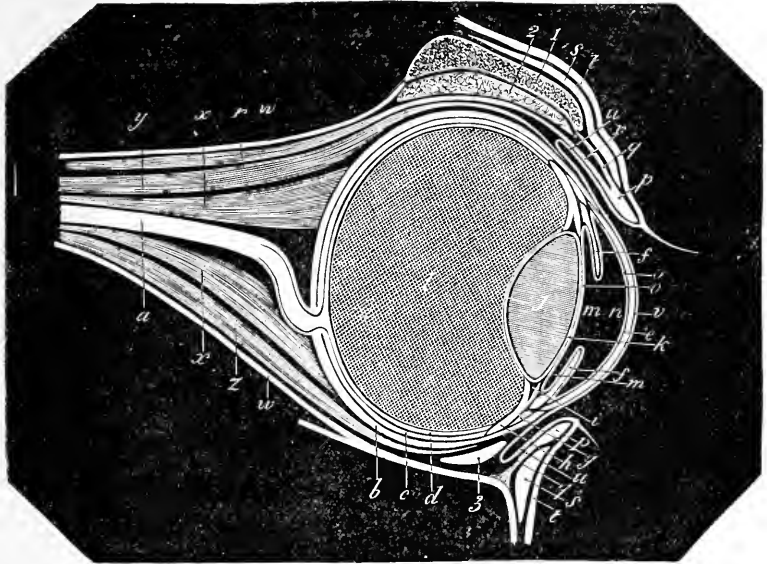

FIG. 395.—Diagrammatic section of the eye of the horse (Chauveau). *a*, optic nerve; *b*, sclerotic coat; *c*, choroid; *d*, retina; *e*, cornea; *f*, iris; *g*, *h*, ciliary ligament and processes of choroid represented as separated from it, the better to define its limits; *i*, insertion of ciliary processes on crystalline lens; *j*, crystalline lens; *k*, lens capsule; *l*, vitreous body; *m*, *m*, anterior and posterior chambers; *o*, theoretical indication of aqueous humor; *p*, *p*, tarsi (eyelids); *q*, *q*, fibrous membrane of eyelids; *r*, elevator muscle of upper eyelid; *s*, *s*, orbicularis muscle of lids; *t*, *t*, skin of eyelids; *u*, conjunctiva; *v*, epidermic layer of the latter covering cornea; *x*, posterior rectus muscle; *y*, superior rectus; *z*, inferior rectus; *w*, fibrous sheath of orbit (orbital membrane).

drawn inward and thus protected the more effectually against blows and obstacles. It seems to be of special importance in animals that feed with the head down for long periods, as in the ruminants, in which class it is most highly developed.

The *macula lutea* is believed to exist only in man, the quadrumania, and certain of the lizard tribe—i. e., in animals in which the axes of the eyeballs are parallel to each other. Nevertheless, there is no reason to doubt that the central part of the retina is more sensitive than the periphery or that there is a central retinal zone for distinct vision in all vertebrates, though not so limited in all cases as in man.

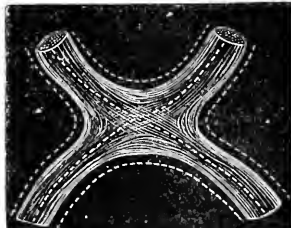

FIG. 396.—Diagram to illustrate decussation of fibers in the optic commissure of man (after Flint).

Estimation of the Size and Distance of Objects.—The processes by which we form a judgment of the size and distance of objects are closely related.

As we have already shown (page 542), the visual angle varies both with the size and the distance of an object. Knowing that two objects are at the same distance from the eye, we estimate that the one is larger than the other when the image one forms on the retina is larger, or when the visual angle it subtends is greater than in the other case, and conversely. Thus, knowing that two persons are at the distance of half a mile away, if one is judged by us to be smaller than the other, it will be because the retinal image corresponding to the object is smaller, other things being equal. But the subject is more complex than might be inferred from these statements.

Objects of a certain color seem nearer than others; also those that are brighter, as in the case of mountains on a clear day. And not only do all the qualities of the image itself enter as data into the construction of the judgment, but numerous muscular sensations. The eyes accommodating and converging for near objects, from the law of association, give rise to the idea of nearness, for habitually such takes place when near objects are viewed, so that the subject becomes very complex. That we judge imperfectly of the position of an object with but one eye is realized on attempting to stick a pin into a certain small spot, thread a needle, cork a small bottle, etc., when one eye is closed.

Solidity.—By the use of one eye alone we can form an idea of the shape of a solid body; though, in the case of such as are very complex, this process is felt to be both laborious and imperfect.

From the limited nature of the visual field for distinct vision, it follows that we can not with one eye see equally distinctly all the parts of a solid that is turned toward us. After a little practice one may learn to define for himself what he actually does see.

Such a figure as that following results from the combination, *mentally*, of two others, which answer to the images falling on the right and on the left eye respectively.

In order that such fusion shall take place, the respective images must fall on identical (corresponding) parts of the retina.

As is well known, the pictures used for stereoscopes give different views of the one object, as represented on a flat sur-

face. These are thrown upon corresponding points of the retina by the use either of prisms or mirrors, when the idea of solidity is produced. As to whether movements of the eyes (convergence) are necessary for stereoscopic vision is disputed. It has

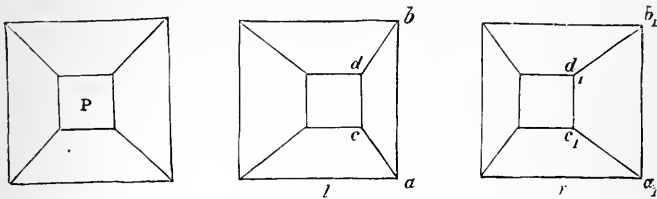

FIG. 397.—Illustrates binocular vision. If the truncated pyramid, P, be looked at with the head held perpendicularly over the figure, the image formed in the right eye when the left is closed is figured on the right, and that seen when the right eye is closed is represented by the figure in the middle. No superposition of these figures will give P, yet by a *psychic* process they are combined into P, the figure as it appears to both eyes (after Bernstein).

been inferred, from the fact that objects appear solid during an electric flash, the duration of which is far too short to permit of movements of the ocular muscles, that such movements are not essential. The truth seems to lie midway; for while simple figures may not require them, the more complex do, or, at all events, the judgment is very greatly assisted thereby. It is of the utmost importance to bear in mind that all visual judgments are the result of many processes, in which, not the sense of vision alone, but others, are concerned; and the mutual dependence of one sense on another is great, probably beyond our powers to estimate. Reference has been made to this subject previously.

PROTECTIVE MECHANISMS OF THE EYE.

The eyelids have been appropriately compared to the shutters of a window. They are, however, not impervious to light, as any one may convince himself by noticing that he can locate the position of a bright light with the eyes shut; also that a sensitive person (child) will turn away (reflexly) from a light when sleeping if it be suddenly brought near the head. The Meibomian glands, a modification of the sebaceous, secrete an oily substance that seems to protect the lids against the lachrymal fluid, and prevents the latter running over their edges as oil would on the margins of a vessel. The lachrymal gland is

not in structure unlike the parotid, the secretion of which its own somewhat resembles.

The saltiness of the tears, owing to abundance of sodium chloride, is well known to all. The nervous mechanism of secretion of tears is usually reflex, the stimulus coming from the action of the air against the eyeball or from partial desiccation owing to evaporation. When the eyeball itself, or the nose, is irritated, the afferent nerves are the branches of the fifth, to which also belong the efferent nerves. The latter include also the cervical sympathetic. But it will, of course, be understood that the afferent impulses may be derived through a large number of nerves, and that the secreting center may be acted upon directly by the cerebrum (emotions). The excess of lachrymal secretion is carried away by the nasal duct into which the lachrymal canals empty. While it is well known that closure of the lids by the orbicularis muscle favors the removal of the fluid, the method by which the latter is accomplished is not agreed upon. Some believe that the closure of the lids forces the fluid on through the tubes, when they suck in a fresh quantity; others that the orbicularis drives the fluid directly through the tubes, kept open by muscular arrangements; and there are several other divergent opinions. The prevention of winking leads to irritation of the eye, which may assume a serious character, so that

the obvious use of the secretion of tears is to keep the eye both moist and clean.

Though rudimentary in man, there is in all our domestic animals a third eyelid (*membrana nictitans*) which may be made to sweep over the eye and thus cleanse it. It is especially well developed in those groups of mammals that can not derive assistance in wiping the eyes from their forelimbs, hence is found in perfection in solipeds and ruminants. It is made up of a fibro-cartilage, prismatic at its base, and thus anteriorly where it is covered by the conjunctiva. It is most attached at the inner canthus of the eye, from which region it can spread

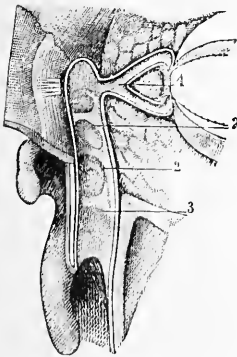

FIG. 398.—Lachrymal canals, lachrymal sac, and nasal canal in man opened from the front (after Sappey.).

over the whole globe anteriorly. The fibro-cartilage is continued backward by a fatty cushion which is loosely attached

to all the ocular muscles. When the globe of the eye is withdrawn by its muscles, the third eyelid is pushed out in a mechanical way with little or no direct assistance from muscles.

In this connection may also be mentioned the *gland of Harder*, a yellowish red glandular structure situated about the middle of the outer surface of the third eyelid, which furnishes a thick unctuous secretion, also of a protective character. These structures are all the more necessary, as in few animals is the globe of the eye so well protected by bony walls as in man.

SPECIAL CONSIDERATIONS.

Comparative.—It seems to be established that some animals devoid of eyes, as certain myriopods, are able to perceive the presence of light, even when the heat-rays are cut off. The most rudimentary beginning of a visual apparatus appears to be a mass of pigment with a nerve attached, as in certain worms; though it is questionable whether mere collections of pigment without nerves may not in some instances represent still earlier rudiments of our eyes.

The eye of the fish is characterized by flatness of the cornea; spherical form of the lens, the anterior surface of which projects far beyond the pupillary opening; the presence of a process of the choroid (*processus falciformis*); and usually the absence of eyelids, the cornea being covered with transparent skin.

The eye of the bird, in some respects the most perfect visual organ known, is of peculiar shape as a whole, presenting a large posterior surface for retinal expansion; a very convex cornea, a highly developed lens, an extremely movable iris; eyelids and a nictitating membrane (third eyelid), which may be made to cover the whole of the exposed part of the eye, and thus shield screen-like from excess of light; ossifications of the sclerotic; a structure which is a peculiar modification of the choroid, of which it is a sort of offshoot and like it very vascular, answering to the falciform process of the eye of the fish and the reptile. From its appearance it is termed the *pecten*. Birds, on account of a highly developed ciliary muscle, possess wonderful powers of accommodation, rendered important on account of their rapid mode of progression. They also seem to be able to alter the size of the pupil at will. Their iris is composed of striped muscular fibers.

A layer of fibrous tissue outside of the choroidal epithelium

forms the *tapetum*. It is most pronounced in the carnivora and gives the glare to their eyes as well seen in the cat tribe at night. It has been supposed to act as a reflector and thus assist in vision in the same way as a pair of carriage lamps light up the roadway.

Evolution.—From the above brief account of the eye in different grades of animals, it will appear that its modifications answer to differences in the environment.

Adaptation is evident. Darwin believes this to have been effected partly by natural selection—i. e., the survival of the animal in which the form of eye appeared best adapted to its needs—and partly by the use or disuse of certain parts.

The latter is illustrated by the blind fishes, insects, etc., of certain caves, as those of Kentucky; and it is of extreme interest to note that various grades of transition toward complete blindness are observable, according to the degree of darkness in which the animal lives, whether wholly within the cave or where

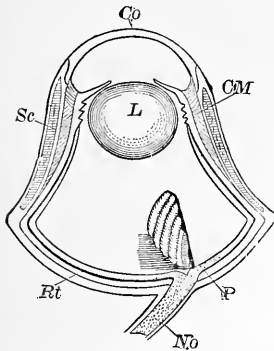

FIG. 399.—Eye of nocturnal bird of prey (after Wiedersheim). *Co*, cornea; *L*, lens; *Rt*, retina; *P*, pecten; *No*, optic nerve; *Sc*, ossification of sclerotic coat; *CM*, ciliary muscle. Birds have usually keen vision, great power of accommodation, and extreme mobility of the iris.

there is still some light. A crab has been found with the eye-stalk still present, but the eye itself atrophied. Again, animals that burrow seem to be in process of losing their eyes, through inflammation from obvious causes; and some of them, as the moles, have the eye still existing, though well-nigh or wholly covered with skin. Internal parasites are often without eyes. It is not difficult to understand how one bird of prey, with eyes superior to those of its fellows, would gain supremacy, and, in periods of scarcity, survive and leave offspring when others would perish.

It is, of course, impossible to trace each step by which the vertebrate eye has been developed from more rudimentary forms, though the data for such an attempt have greatly accumulated within the last few years; and it is not to be forgotten that even the vertebrate eye has many imperfections, so that no doctrine of complete adaptation, according to the argument from design as usually understood, can apply.

It is of great importance to recognize that what we really see depends more upon the brain and the mind than the eye. If any one will observe how frequent are his incipient errors of vision speedily corrected, he will realize the truth of the

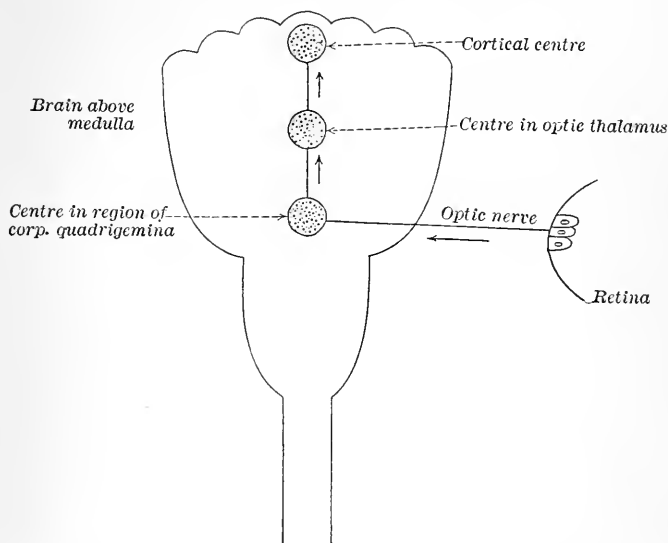

FIG. 400.—Diagram intended to illustrate the elaboration of visual impulses, beginning in retina and culminating in the cerebral cortex. Course of impulses is indicated by arrows. Knowledge of auditory centers is not yet exact enough to permit of the construction of a diagram, though doubtless eventually the central processes will be localized as with vision. The latter remark applies to the other senses to nearly the same extent, possibly quite as much.

above remark. Precisely the same data furnished by the eye are in one mind worked up in virtue of past experience (education) into an elaborate conception, while to another they answer only to certain vague forms and colors. And herein lies the great superiority of man's vision over that of all other animals.

Within the limits of their *mental* vision do all creatures see. Man has not the keen ocular discriminating power of the hawk; he can neither see so far nor so clearly; nor has he the wide field of vision of the gazelle; but he has the mental resource which enables him to make more out of the materials with which his eyes furnish him. It is by virtue of his higher cerebral development that he has added to his natural eyes others

in the microscope and telescope, which none of Nature's forms can approach.

Pathological.—There may be ulceration of the cornea, inflammation of this part, or various other disorders which lead to opacity. The low vitality of this region, probably owing to absence of blood-vessels, is evidenced by the slowness with which small ulcers heal. Opacity of the lens (cataract) when complete causes blindness, which can be only partially remedied by removal of the former. Inflammations of any part of the eye are serious, from possible adhesions, opacities, etc., following. Should such be accompanied by great excess of intra-ocular tension, serious damage to the retina may result. Of course, atrophy of the optic nerve (due to lesions in the brain, etc.) is irremediable, and involves blindness. Inspection of the internal parts of the eye (fundus oculi) often reveals the first evidence of disease in remote parts as the kidneys.

From what has been said of the movements of the two eyes in harmony, etc., the student might be led to infer that disease of one organ, in consequence of an evident close connection of the nervous mechanism of the eyes, would be likely to set up a corresponding condition in the other unless speedily checked. Such is the case, and is at once instructive and of great practical moment.

Paralysis of the various ocular muscles leads to squinting, as already noticed.

Brief Synopsis of the Physiology of Vision.—All the other parts of the eye may be said to exist for the retina, since all are related to the formation of a distinct image on this nervous expansion. The principal refractive body is the crystalline lens. The iris serves to regulate the quantity of light admitted to the eye, and to cut off too divergent rays. In order that objects at different distances may be seen distinctly, the lens alters in shape in response to the actions of the ciliary muscle on the suspensory ligament, the anterior surface becoming more convex. Accommodation is associated with convergence of the visual axes and contraction of the pupil. The latter has circular and radiating plain muscular fibers (striped in birds, that seem to be able to alter the size of the pupil at will), governed by the third, fifth, and sympathetic nerves. Contraction of the pupil is a reflex act, the nervous center lying in the front part of the floor of the aqueduct of Sylvius, while the action of the other center (near this one) through the sympathetic nerve is tonic.

Accommodation through the ciliary muscle is governed by a center situated in the hind part of the floor of the third ventricle near the anterior bundles of the third nerve, which latter is the medium of the change. When rays of light are focused anterior to the retina, the eye is myopic; when posterior to it, hypermetropic.

The presbyopic eye is one in which the mechanism of accommodation is at fault, chiefly the ciliary muscle. The point of entrance of the optic nerve (blind-spot) is insensible to light; and visual impulses can be shown to originate in the layers of rods and cones, probably through stimulation from chemical changes effected by light acting on the retina. The sensation outlasts the stimulus; hence positive after-images occur. Negative after-images occur in consequence of excessive stimulation and exhaustion of the retina, or disorder of the chemical processes that excite visual impulses. When stimuli succeed one another with a certain degree of rapidity, sensation is continuous. The eye can distinguish degrees of light within certain limits, varying by about $\frac{1}{100}$ of the total.

Objects become fused or are seen as one when the rays from them falling on the retina approximate too closely on that surface. The brain, as well as the eye itself, is concerned in such discriminations, the former probably more than the latter.

The *macula lutea*, and especially the *fovea centralis*, are in man the points of greatest retinal sensitiveness. When the images of objects are thrown on these parts, they are seen with complete distinctness; and it is to effect this result that the movements of the two eyes in concert take place. An object is seen as one when the position of the eyes (visual axes) is such that the images formed fall on corresponding parts of the retina. Binocular vision is necessary to supply the sensory data for the idea of solidity. It is important to remember that, before an object is "seen" at all, the sensory impressions furnished by the retina and conveyed inward by the optic nerve are elaborated in the brain and brought under the cognizance of the perceiving *ego*. We recognize many visual illusions and imperfections of various kinds, the course of which it is difficult to locate in any one part of the visual tract, such as are referred to "irradiation," "contrast," etc. There may also be visual phenomena that are purely subjective, and others that result from suggestion rather than any definite sensory basis of retinal

images. Hence what one sees depends on his state of mind at the time.

This applies to appreciation of size and distance also, though in such cases we have the visual angle, certain muscular movements (muscular sense), the strain of accommodation etc., as guides.

HEARING.

As the end organ of vision is protected both without and within, so is the still more complicated end-organ of the sense of hearing more perfectly guarded against injury, being enclosed within a membranous as well as bony covering and surrounded by fluid, which must shield it from stimulation, except through this medium.

Hearing proper, as distinguished from the mere recognition of jars to the tissues, can, in fact, only be attained through the impulses conveyed to the auditory brain-centers, as originated in the end-organ by the vibrations of the fluid with which it is bathed.

It will be assumed that the student has made himself familiar with the general anatomy of the ear. The essential points in regard to sound are considered in the chapter on The Voice. It will be remembered that what we term a musical tone, as distinguished from a noise, is characterized by the regularity of vibrations of the air that reach the ear; and that just as ethereal vibrations of a certain wave-length give rise to the sensation of a particular color, so do aërial vibrations of a definite wave-length originate a certain tone. In each case must we take into account a physical cause for the physiological effect, and these bear a very exact relationship to one another.

As will be seen later, while in all animals that have a well-defined sense of hearing the process is essentially such as we have indicated above, the means leading up to the final stimulation of the end-organ are very various. At present we shall consider the acoustic mechanism in mammals, with special reference to man. There are in fact three sets of apparatus: (1) one for collecting the aërial vibrations; (2) one for transmitting them; and (3) one for receiving the impression through a fluid medium; in other words, an external, middle, and internal ear.

The *external* ear in man being practically immovable, owing to the feeble development of its muscles, has, as compared with

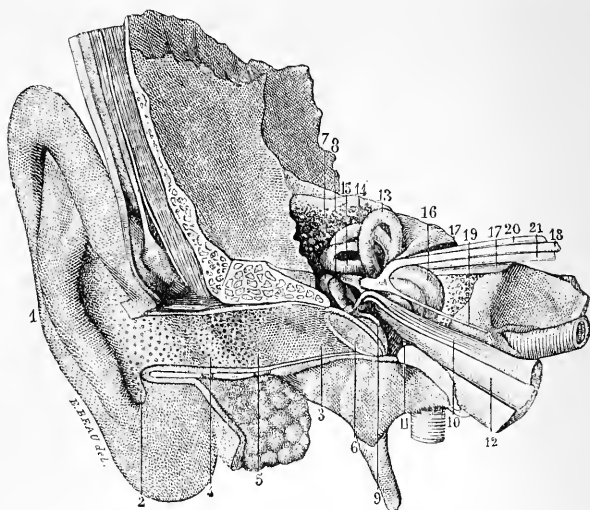

FIG. 401.—Section through auditory organ (after Sappey). 1, pinna; 2, 4, 5, cavity of concha, external and auditory meatus with opening of ceruminous glands; 6, membrana tympani; 7, anterior part of incus; 8, malleus; 9, long handle of malleus, attached to internal surface of tympanic membrane—it is here represented as strongly indrawn; 10, tensor tympani muscle; 11, tympanic cavity; 12, Eustachian tube; 13, superior semicircular canal; 14, posterior semicircular canal; 15, external semicircular canal; 16, cochlea; 17, internal auditory meatus; 18, facial nerve; 19, large petrosal nerve; 20, vestibular branch of auditory nerve; 21, cochlear branch of same.

such animals as the horse or cow, but little use as a collecting organ for the vibrations of the air. The meatus or auditory canal may be regarded both as a conductor of vibrations and as protective to the middle ear, especially the delicate drum-head, since it is provided with hairs externally in particular, and with glands that secrete a bitter substance of an unctuous nature.

The **Membrana Tympani** is concavo-convex in form, and having attached to it the chain of bones shortly to be noticed, is well adapted to take up the vibrations communicated to it from the air; though it also enters into sympathetic vibration when the bones of the head are the medium, as when a tuning-fork is held between the teeth. Ordinary stretched membranes have a fundamental (self-tone, proper tone) tone of their own, to which they respond more readily than to others.

If such held for the membrana tympani, it is evident that certain tones would be heard better than others, and that when

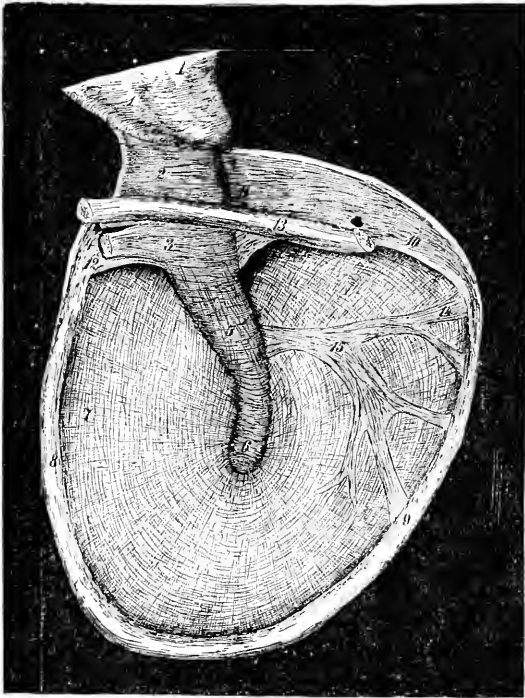

FIG. 402.—Photographic representation of right membrana tympani, viewed from within (after Flint and Rüdinger). 1, divided head of malleus; 2, neck; 3, handle, with attachment of tendon of tensor tympani; 4, divided tendon; 5, 6, long handle of malleus; 7, outer radiating and inner circular fibers of tympanic membrane; 8, fibrous ring encircling membrana tympani; 9, 14, 15, dentated fibers of Gruber; 10, 11, posterior pocket connecting with malleus; 12, anterior pocket; 13, chorda tympani nerve.

the fundamental one was produced the result might be a sensation unpleasant from its intensity. This is partially obviated by the damping effect of the auditory ossicles, which also prevent after-vibrations.

Some suppose that what we denominate shrill or harsh sounds are, in part at least, owing to the auditory meatus having a corresponding fundamental note of its own.

The Auditory Ossicles.—Though these small bones are connected by perfect joints, permitting a certain amount of play

upon one another, experiment has shown that they vibrate in response to the movements of the drum-head *en masse*; though the stapes has by no means the range of movement of the handle of the malleus; in other words, there is loss in amplitude,

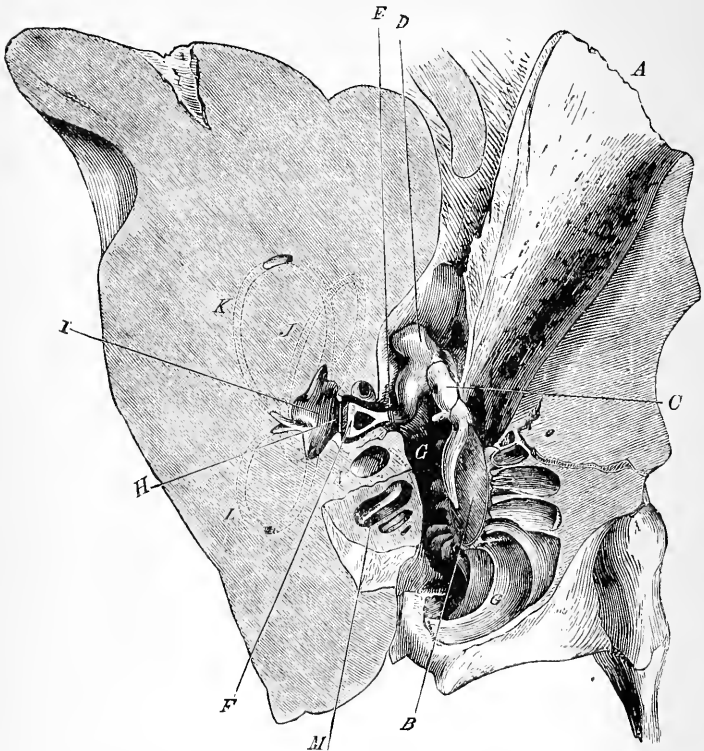

FIG. 403.—Section of auditory organ of horse (after Chauveau). *A*, auditory canal; *B*, membrana tympani; *C*, malleus; *D*, incus; *E*, stapes; *F*, mastoid cells; *G*, fenestra ovalis; *H*, vestibule; *I*, *J*, *K*, *L*, outline of semicircular canals; *M*, cochlea; *N*, commencement of scala tympani.

but gain in intensity. A glance at Fig. 404 will show that the end attained by this arrangement of membrane and bony levers, which may be virtually reduced to one (as it is in the frog, etc.), is the transmission of the vibrations to the membrane of the fenestra ovalis, through the stapes finally, and so to the fluids within the internal ear. But it might be supposed that, for the avoidance of shocks and the better adaptation of the apparatus

to its work, some regulative apparatus, in the form of a nervous and muscular mechanism, would have been evolved in the

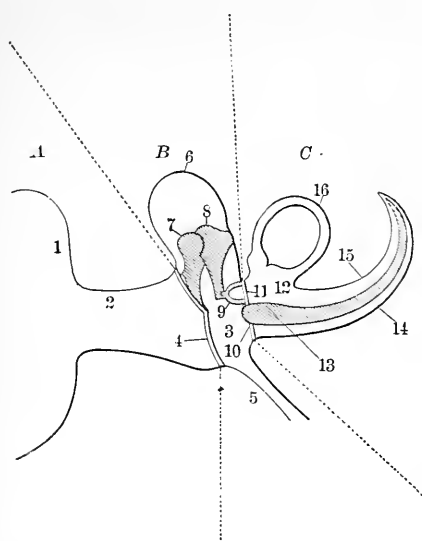

FIG. 404.—Diagrammatic representation illustrating auditory processes (after Beauvis). A, external ear; B, middle ear; C, internal ear; 1, auricle; 2, external auditory meatus; 3, tympanum; 4, membrana tympani; 5, Eustachian tube; 6, mastoid cells; 10, foramen rotundum; 11, foramen ovale; 12, vestibule; 13, cochlea; 14, scala tympani; 15, scala vestibuli; 16, semicircular canals.

N. B.—The ear is so complicated an organ that it is almost impossible to give a diagrammatic representation of it at once simple and complete in a single figure. A comparison of the whole series of cuts is therefore desirable. It is essential to understand how the end-organ within the scala media is stimulated.

higher groups of animals. Such is found in the tensor tympani, laxator tympani, and stapedius muscles, as well as the Eustachian tube.

Muscles of the Middle Ear.—The tensor tympani regulates the degree of tension of the drum-head, and hence its amplitude of vibration, having a damping effect, and thus preventing the ill results of very loud sounds.

Ordinarily, this is, doubtless, a reflex act, in which the fifth is usually the afferent nerve concerned. It is well-known that, when we are aware that an explosion is about to take place, we are not as much affected by it, which would seem to argue a voluntary power of accommodation; but of this we must speak with caution.

According to some authorities the *laxator tympani* is not a

muscle, but a supporting ligament for the malleus. The *stapedius*, however, has the important function of regulating the movements of the stapes, so that it shall not be too violently driven against the membrane covering the fenestra ovalis.

The two muscles, stapedius and tensor, suggest the accommodative mechanism of the iris. The motor nerve of the stapedius is derived from the facial; of the tensor, from the trigeminus through the otic ganglion.

The Eustachian Tube.—Manifestly, if the middle ear were closed permanently, its air would gradually be absorbed. The drum-head would be thrust in by atmospheric pressure, and become useless for its vibrating function. The Eustachian tube, by communicating with the throat, keeps the external and internal pressure of the middle ear balanced. Whether this canal is permanently open, or only during swallowing, is as yet undetermined.

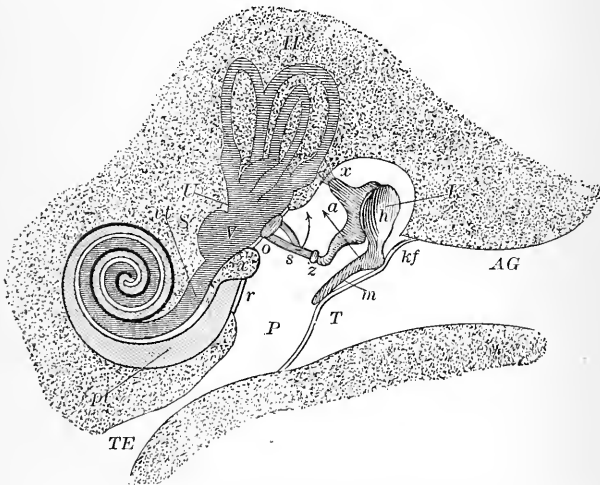

FIG. 405.—Diagram intended to illustrate the processes of hearing (after Landois) *AG*, external auditory meatus; *T*, tympanic membrane; *K*, malleus; *a*, incus; *P*, middle ear; *o*, fenestra ovalis; *r*, fenestra rotunda; *pl*, scala tympani; *pl*, scala vestibuli; *V*, vestibule; *S*, saccule; *U*, utricle; *II*, semicircular canals; *TE*, Eustachian tube. Long arrow indicates line of traction of tensor tympani; short curved one that of Stapedius.

One may satisfy himself that the middle ear and pharynx communicate, by closing the nostrils and then distending the upper air-passages by a forced expiratory effort, when a sense of distention within the ears is experienced, owing to the rise of atmospheric pressure in the tympanum.

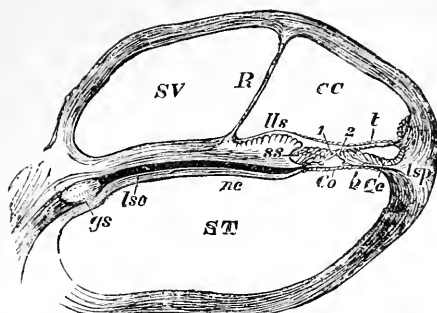

FIG. 406.—Section through one of the coils of cochlea (after Chauveau). *ST*, scala tympani; *SV*, scala vestibuli; *CC*, cochlear canal (scala media); *Co*, organ of Corti; *R*, membrane of Reissner; *b*, membrana basilaris; *lso*, lamina spiralis ossea; *l*, membrana tectoria; 1, 2, rods of Corti; *nc*, cochlear nerve with its ganglion, *gs*.

Pathological.—Inflammation of the tympanum may result in adhesions of the small bones to other parts or to each other,

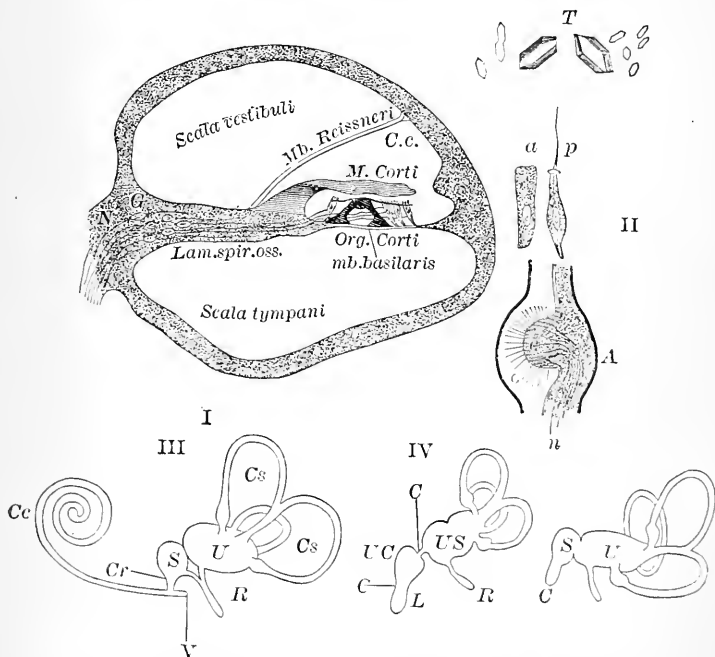

FIG. 407.—I. Transverse section of a turn of cochlea. II. Ampulla of a semicircular canal and its crista acoustica; *ap*, auditory cells, one of which is a hair-cell. III. Diagram of labyrinth of man. IV. Of bird. V. Of fish. (After Landois.)

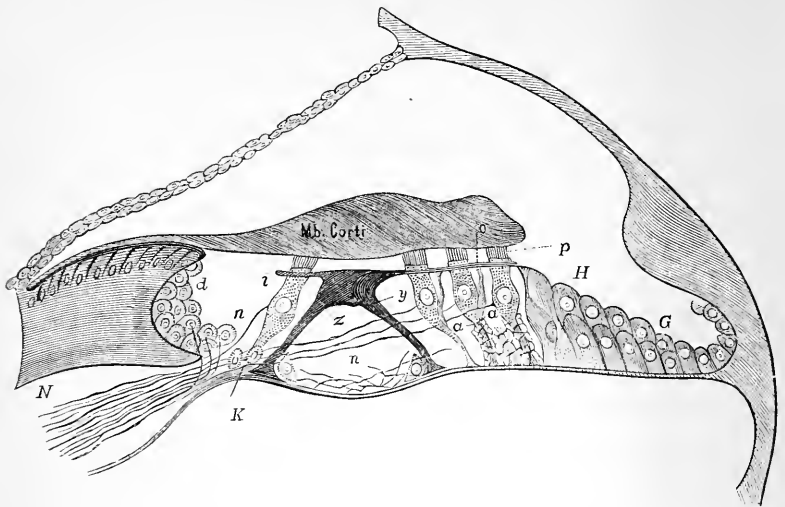

FIG. 408.—Diagrammatic representation of ductus cochlearis and organs of Corti (after Landois). *N*, nerve of cochlea; *K*, inner, and *P*, outer, hair-cells; *n*, nerve-fibrils terminating in *P*; *a, a*, supporting cells; *d*, cells of sulcus spiralis; *z*, inner rod of Corti; *y*, outer rod of Corti; *mb*, membrane of Corti (membrana tectoria); *o*, membrana reticularis; *H, G*, cells of area toward outer wall.

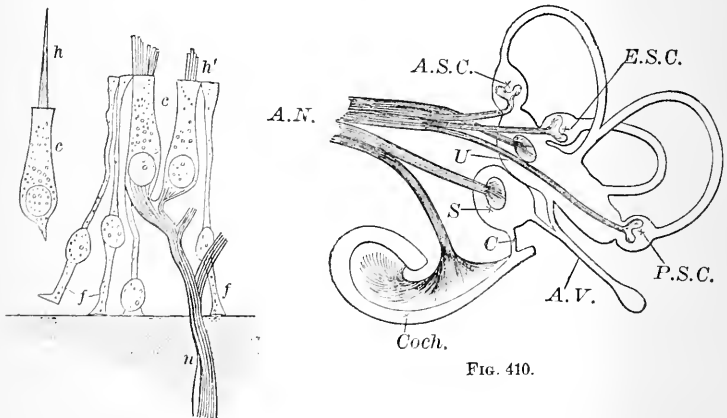

FIG. 409.

FIG. 409.—Auditory epithelium from macula acoustica of sacculus of alligator, much magnified (after Schäfer). *c, c*, columnar hair-cells; *f, f*, fiber cells; *n*, nerve-fiber losing its medullary sheath and about to terminate in columnar auditory cells; *h*, auditory hair; *h'*, base of auditory hairs split up into fibrils.

FIG. 410.—Diagrammatic representation of distribution of auditory nerve in membranous labyrinth and cochlea (after Huxley).

or to occlusion of the Eustachian tube from excess of secretion, cicatrices, etc., in consequence of which the relations of atmospheric pressure become altered, the membrana tympani being indrawn, and the whole series of conditions on which the normal transmission of vibrations depends disturbed, with the natural result, partial deafness. The hardness of hearing experienced during a severe cold in the head (catarrh, etc.) is owing in great part to the occlusion of the Eustachian tube, which may be either partial or complete.

By filling one or both of the ears external to the membrana tympani with cotton-wool, one may satisfy himself how essential for hearing is the vibratory mechanism, which is, of course, under such circumstances inactive or nearly so; hence the deafness.

When the middle ear is not functionally active, it is still possible, so long as the auditory nerve is normal, to hear vibrations of a body (as a tuning-fork) held against the head; though, as would be expected, discrimination as to pitch is very imperfect.

Auditory impulses originate within the inner ear—that is to say, in the vestibule and possibly the semicircular canals, but especially in the cochlea. It is to be remembered that the

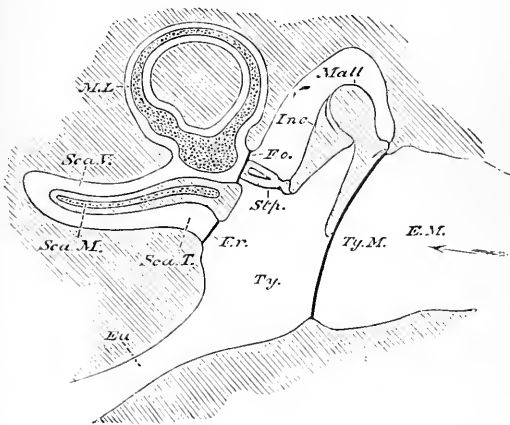

FIG. 411.—Diagram intended to illustrate relative position of various parts of ear (after Huxley). *E. M.*, external auditory meatus; *Ty. M.*, tympanic membrane; *Ty.*, tympanum; *Mall.*, malleus; *Inc.*, incus; *St.p.*, stapes; *F. o.*, fenestra ovalis; *F. r.*, fenestra rotunda; *Eu.*, Eustachian tube; *M. L.*, membranous labyrinth, only one of the semicircular canals and its ampulla being represented; *Sca. V.*, *Sca. T.*, *Sca. M.*, scale of cochlea, represented as straight (uncoiled).

whole of the end-organ concerned in hearing is bathed by endolymph; and that the vibrations of the latter are originated by corresponding vibrations of the perilymph, which again is sent



FIG. 412.—Photographic diagram of labyrinth (after Flint and Rüdinger). Upper figure: 1, utricle; 2, saccule; 3, 5, membranous cochlea; 4, canalis reuniens; 6, semicircular canals. Lower figure: 1, utricle; 2, saccule; 3, 4, 6, ampullae; 5, 7, 8, 9, semicircular canals; 10, auditory nerve (partly diagrammatic); 11, 12, 13, 14, 15, distribution of branches of nerve to vestibule and semicircular canals.

into oscillation by the movements of the stapes against the membrane covering the fenestra ovalis; so that the vibrations thus set up without the membranous labyrinth are transformed into similar ones within the vestibule and the scala vestibuli, and end, after passing over the scala tympani, against the membrane of the fenestra rotunda. The cochlear canal may be regarded as the seat of the most important part of the

organ of hearing, and answers to the macula lutea of the eye in many respects.

The function of the organ of Corti is unknown.

The structure of the ampullæ of the semicircular canals, and other parts of the labyrinth besides those specially con-

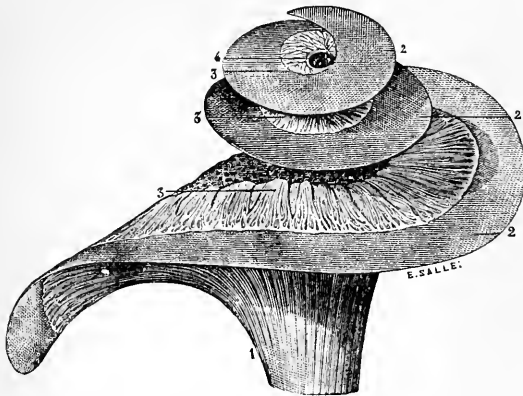

FIG. 413.—Distribution of cochlear nerve in spiral lamina of antero-inferior part of cochlea of right ear (after Sappey). 1, trunk of cochlear nerve; 2, membranous zone of spiral lamina; 3, terminal expansion of cochlear nerve exposed through-out by removal of superior plate of lamina spiralis; 4, orifice of communication between scala tympani and scala vestibuli.

sidered, with their peculiar hair-cells, suggests an auditory function ; but what that may be is as yet quite undetermined. It has been thought that the parts, other than the cochlea, are concerned with the appreciation of noise, or perhaps the intensity of sounds ; but this is a matter of pure speculation.

AUDITORY SENSATIONS, PERCEPTIONS, AND JUDGMENTS.

We have thus far been concerned with the conduction of the aërial vibrations that are the physical cause of hearing ; but before we can claim to have “ heard ” a word in the highest sense, certain processes, some of them physiological and some psychical, take place, as in the case of vision ; hence we may speak of the affection of the end-organ or of auditory impulses, and of the processes by which these become, by the mediation of the brain, auditory sensations, and when brought under the cognizance of the mind as auditory perceptions and judgments.

Auditory Judgments.—Such are much more frequently erroneous than are our visual judgments, whether the direction or the distance of the sound be considered. As in the case of the eye, the muscular sense, from accommodation of the vibratory mechanism, may assist our judgments, being aided by our stored past experiences (memory) according to the law of association. Sounds are, however, always referred to the world without us. The animals with movable ears greatly excel man in estimating the direction, if not the distance, of sounds. There are few physiological experiments more amusing than those performed on a person blindfolded, when attempting to determine either the distance or the direction of a sounding tuning-fork, so gross are the errors made.

One who makes such observations on others may notice that most persons move the ears slightly when attempting to make the necessary discriminations, which of itself tends to show how valuable mobility of these organs must be to those animals that have it highly developed.

SPECIAL CONSIDERATIONS.

Comparative.—Among invertebrates steps of progressive development can be traced. Thus, in certain of the jelly-fishes

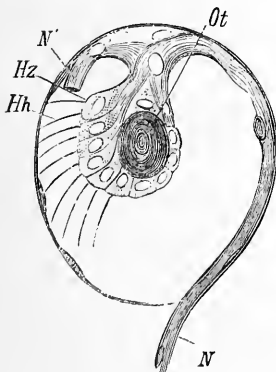

FIG. 414.—Auditory vesicle of *Geryonia* (*Carymarina*) seen from the surface (after O. and R. Hertwig). *N* and *N'*, the auditory nerves; *Ot*, otolith; *Hh*, auditory cells; *Hh*, auditory cilia (type of the auditory organ of the *Trachymedusa*).

we find an auditory vesicle (Fig. 414) inclosing fluid provided with one or more otoliths or calcareous nodules and auditory cells with attached cilia, the whole making up an end-organ connected with the auditory nerve. A not very dissimilar arrangement of parts exists in certain mollusks (Fig. 415). The vesicle may lie on a ganglion of the central nervous system. On the other hand, the vesicle may be open to the exterior, as in decapod crustaceans; and the otoliths be replaced by grains of sand from without. It is difficult to decide what the function of otoliths may be in mammals; but there seems to be little reason to doubt that they com-

municate vibrations in the invertebrates. When the cephalopod mollusks, with their highly developed nervous system, are reached, we find a membranous and cartilaginous labyrinth.

Among *vertebrates* the different parts of the mammalian ear are found in all stages of development. The outer ear may be wholly wanting, as in the frog, or it may exist as a meatus only, as in birds. The tympanic cavity is wanting in snakes. Most fishes have a utricle and three semicircular canals, but some

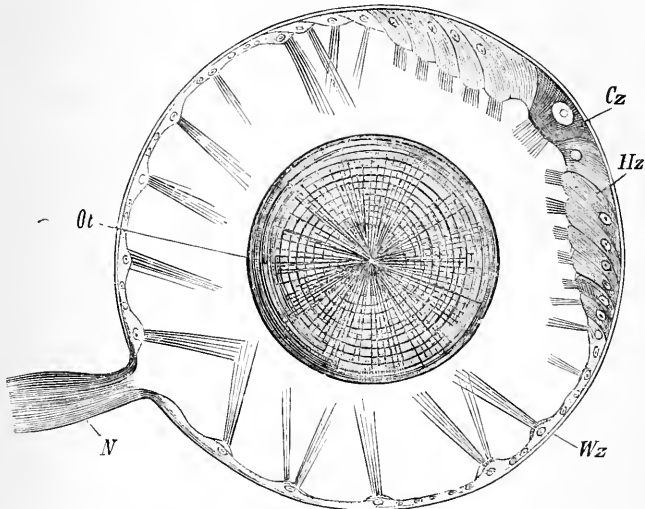

FIG. 415.—Auditory vesicle of a heteropod mollusk (*Pterotrachea*) (after Claus). *N*, auditory nerve; *Ot*, otolith in fluid of vesicle; *Wz*, ciliated cells on inner wall of vesicle; *Hz*, auditory cells; *Cz*, central cells.

have only one; and the lowest of this group have an ear not greatly removed from the invertebrate type, as may be seen in the lamprey, which has a saccule with auditory hairs and otoliths, in communication with two semicircular canals. Most of the amphibia are without a membrana tympani. The frog has (1) a membrana tympani communicating with the inner ear by (2) a bony and cartilaginous lever (*columella auris*), and (3) an inner ear consisting of three semicircular canals, a saccule and utricle containing many otoliths, and a small dilatation of the vestibule, which may indicate an undeveloped cochlea. The membranous labyrinth is contained in a periotic capsule, partly bony and partly cartilaginous, which is supplied with

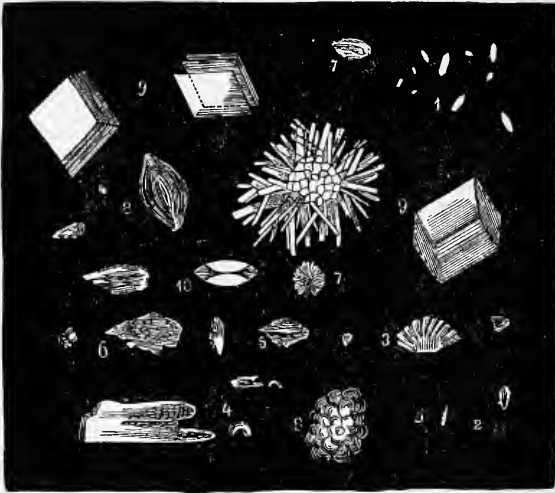

FIG. 416.—Otoliths from various animals (after Rüdinger). 1, from goat; 2, herring; 3, devil-fish; 4, mackerel; 5, flying-fish; 6, pike; 7, carp; 8, ray; 9, shark; 10, grouse.

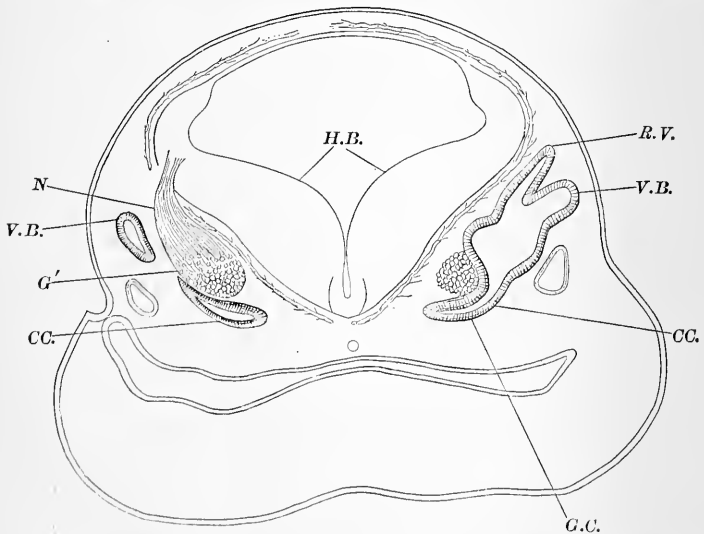

FIG. 417.—Transverse section through head of fetal sheep, in region of hind-brain, to illustrate development of ear (after Böttcher). *H. B.*, hind-brain; *N*, auditory nerve; *V. B.*, vertical semicircular canal; *CC*, canal of cochlea; *R. V.*, recessus vestibuli; *G. C.*, auditory ganglion; *G'*, terminal portion of auditory nerve.

perilymph. There is a fenestra ovalis, but not a fenestra rotunda, though the latter is present in reptiles. In crocodiles and birds the cochlea is tubular, straight, and divided into a scala tympani and a scala vestibuli. The columella of lower forms still persists. In birds and mammals the bone back of the ear is hollowed out to some extent and communicates with the tympanum. Except among the very lowest mammals (*Echidna*), the ear is such as has been described in detail already.

Evolution.—The above brief description of the auditory organ in different groups of the animal kingdom will suffice to show that there has been a progressive development or increasing differentiation of structure, while the facts of physiology point to a corresponding progress in function—in other words, there has been an evolution. No doubt natural selection has played a great part. It has been suggested that this is illustrated by cats, that can hear the high tones produced by mice, which would be inaudible to most mammals; and, as the very existence of such animals must depend on their detecting their prey, it is possible to understand how this principle has operated to determine even what cats shall survive. The author has noticed that terrier dogs also have a very acute sense of hearing, and they also kill rats, etc. But, unless it be denied that the improvement from use and the reverse can be inherited, this factor must also be taken into the account.

There seem to be great differences between hearing as it exists in man and in lower forms. Birds, and at least some horses, possibly some cats and dogs, like music, and give evidence of the possession of a sense of rhythm, as evidenced by the conduct of the steed of the soldier. On the other hand, some dogs seem to greatly dislike music. Certain animals that appear to be devoid of true hearing, as spiders, are nevertheless sensitive to aerial vibrations; whether by some special undiscovered organ or through the general cutaneous or other kind of sensibility is unknown. It also seems to be more than probable that some groups of insects can hear sounds quite inaudible to us, though by what organs is in great measure unknown.

The so-called musical ear differs from the non-musical in the ability to discriminate differences in pitch rather than in quality; in fact, that one defective in the former power may possess the latter in a high degree is a fact that has been somewhat lost sight of, both theoretically and practically. It does

not at all follow that one with little capacity for tune may not have the qualifications of ear requisite to make a first-rate elocutionist. Following custom, we have spoken as though certain defects and their opposites depended on the ear, but in reality we can not, in the case of man at all events, affirm that such is the case; indeed, it seems, on the whole more likely that they are cerebral or mental. Auditory discriminations seem to be equally if not more susceptible of improvement by culture than visual ones, especially in the case of the young.

A "good ear" seems to depend in no small degree on memory of sounds, though the latter may again have its basis in the auditory end-organs or in the cerebral cortex, as concerned in hearing. The necessity for the close connection between the co-ordinations of the laryngeal apparatus in singing and speaking and the ear might be inferred from the fact that many excellent musicians are themselves unable to vocalize the music they perfectly appreciate.

Synopsis of the Physiology of Hearing.—The ear can appreciate differences in pitch, loudness, and quality of sounds, though whether different parts of the inner ear are concerned in these discriminations is unknown. Hearing is the result of a series of processes, having their physical counterpart in aërial vibrations, which begin in the end-organ in the labyrinth and terminate in the cerebral cortex. We recognize conducting apparatus which is membranous, bony, and fluid. The auditory nerve conveys the auditory impulses to the brain, though exactly what terminal cells are concerned and how in originating them must be regarded as undetermined. The essential part of the organ of hearing is bathed by endolymph, and the principal part (in mammals) is within the cochlear canal. Man's power to locate sounds is very imperfect. The auditory brain center (or centers) has not been definitely located. Comparative anatomy and physiology point clearly to a progressive development of the sense of hearing.

THE SENSES OF SMELL AND TASTE.

SMELL.

THE nose internally may be divided into a respiratory and an olfactory region. The latter, which corresponds, of course, with the distribution of the olfactory nerve, embraces the upper and part of the middle turbinated bone and the upper part of the septum, all of which differ in microscopic structure from the respiratory region. Among the ordinary cylindrical epithelium of the olfactory region are found peculiar hair-cells highly suggestive of those of the labyrinth of the ear, and

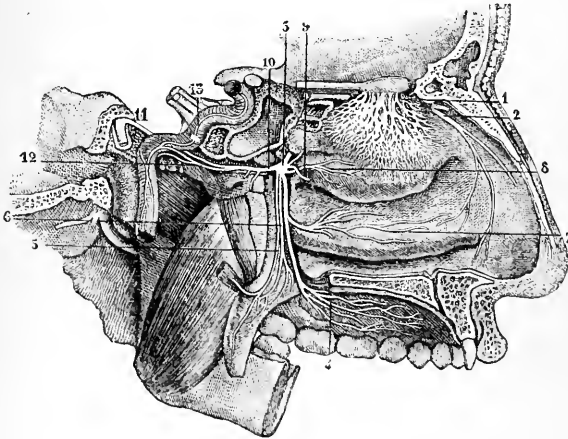

FIG. 418.—Parts concerned in smell (after Hirschfeld). 1, olfactory ganglion and nerves; 2, branch of nasal nerve, distributed over the turbinate bones.

which are to be regarded as the end-organs of smell. If aromatic bodies be held before the nose, and respiration suspended, they will not be recognized as such, and it is well known that sniff-

ing greatly assists the sense of smell. Again, if fluids, such as *eau de Cologne*, be held in the nose, their aroma is not detected;

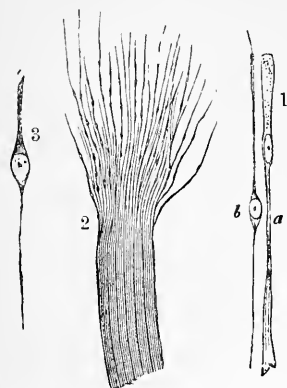

FIG. 419.—End-organs concerned in smell (after Kölliker). 1, from frog — *a*, epithelial cell of the olfactory area; *b*, olfactory cell. 2, small branch of olfactory nerve of frog, breaking up into a brush of varicose fibers. 3, olfactory cell of sheep.

and immediately after water has been kept in the nostrils for a few seconds, it may be noticed that smell is greatly blunted. Such is the case also when the mucous membrane is much swollen from a cold. There can be no doubt that the presence of fluid in the above cases is injurious to the delicate hair-cells, and that smell is dependent upon the excitation of these cells by *extremely minute* particles emanating from aromatic bodies.

When ammonia is held before the nose, a powerful sensation is experienced; but this is not smell proper, but an affection of ordinary sensation, owing to stimulation of the terminals of the fifth nerve. It is possible that the audi-

tory nerve may also participate, though certainly not so as to produce a pure sensation of smell.

Like the other sense-organs, that of smell is readily fatigued; and perhaps the satisfaction from smelling a bouquet of mixed flowers is comparable to viewing the same, one scent after another being perceived, and no one remaining predominant.

Our judgment of the position of bodies possessing smell is less perfect even than for those emitting sounds; but we always project our sensations into the outer world, never referring the object to the nose itself. Subjective sensations of smell are rare in the normal subject, though common enough among the diseased, as is complete or partial loss of smell. It has been found that injury to the fifth nerve interferes with smell, which is probably due to trophic changes in the olfactory region.

Comparative.—The investigation of the senses in the lower forms of life is extremely difficult, and in the lowest presents almost insurmountable obstacles to the physiologist because

their psychic life is so far removed from our own in terms of which we must interpret, if at all.

The earliest form of olfactory organ appears to be a depression lined with special cells in connection with a nerve, which, indeed, suggests the embryonic beginnings of the olfactory organ in vertebrates, as an involution (pit) on the epithelium of the head region. It would appear that we must believe that in some of the lower forms of invertebrates the senses of smell and taste are blended, or possibly that a perception results which is totally different from anything known to us. The close relation of smell and taste, even in man, will be referred to presently. There are, perhaps, greater individual differences in sensitiveness of the nasal organ among mankind than of any other of the sense-organs. Women usually have a much keener perception of odors than men. The sense of smell in the dog is well known to be of extraordinary acuteness; but there are not only great differences among the various breeds of dogs, but among individuals of the same breeds; and this sense is being constantly improved by a process of "artificial selection" on the part of man, owing to the institution of field trials for setters and pointers, the best dogs for hunting (largely determined by the sense of smell) being used to breed from, to the exclusion of the inferior in great part. Our own power to think in terms of smell is very feeble, and in this respect the dog and kindred animals probably have a world of their own to no small extent. Their memory of smells is also immeasurably better than our own. A dog has been known to detect an old hat, the property of his master, that had been given away two years before, as evidenced by his recovering it from a remote place.

The importance of smell as a guide in the selection of food, in detecting the presence of prey or of enemies, etc., is very obvious. By culture some persons have learned to distinguish individuals by smell alone, like the dog, though to a less degree.

TASTE.

The tongue is provided with peculiar modifications of epithelial cells, etc., known as papillæ and taste-buds which may be regarded as the end-organs of the glosso-pharyngeal and lingual nerves; though that these all, especially the taste-buds, are concerned with taste alone seems more than doubtful. In

certain animals with rough tongues, the papillæ, certain of them at least, answer to the hairs of a brush for the cleansing and general preservation of the coat of the animal in good condition. We may, perhaps, speak of certain fundamental taste-perceptions, such as *sweet*, *bitter*, *acid*, and *saline*. Certainly the natural power of gustatory discrimination is considerable;

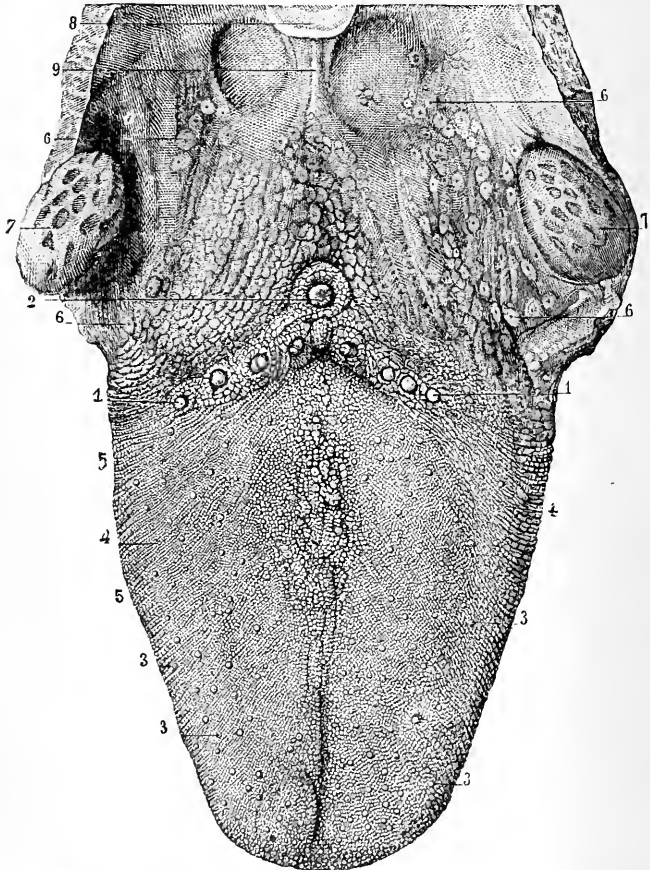

FIG. 120.—Papillæ of tongue (after Sappey). 1, circumvallate papillæ; 3, fungiform papillæ; 4, filiform papillæ; 6, glands at base of tongue; 7, tonsils.

and, as in the case of tea-tasters, capable of extraordinary cultivation. All parts of the tongue are not equally sensitive, nor

is taste-sensation confined entirely to the tongue. It can be shown that the back edges and tip of the tongue, the soft palate, the anterior pillars of the fauces, and a limited portion of the back part of the hard palate, are concerned in tasting. Making allowances for individual differences, it may be said that the back of the tongue appreciates best bitter substances, the tip, sweet ones, and the edges acids.

If any substance with a decided taste be placed upon the tongue when wiped quite dry, it can not be tasted at all, showing that solution is essential.

If a piece of apple, another of potato, and a third of onion, be placed upon the tongue of a person blindfolded, and with the nostrils closed, he will not be able to distinguish them, showing that the senses of smell and of taste are related; or, perhaps, it may be said that much that we call tasting is in large part smelling. When the electrodes from a battery are placed on the tongue, a sensation of taste is aroused, described differently by different persons; also when the tongue is quickly tapped, showing that, though taste is usually the result of chemical stimulation, it may be excited by such as are electrical or mechanical.

But it is not to be forgotten that we have usually no pure gustatory sensations, but that these are necessarily blended

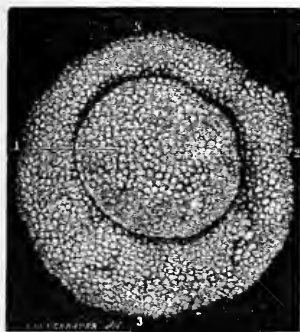

FIG. 421.

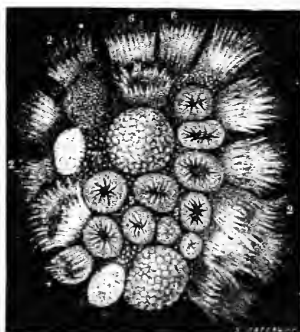

FIG. 422.

FIG. 421.—Medium-sized circumvallate papilla (after Sappey).

FIG. 422.—Various kinds of papillæ (after Sappey). 1, fungiform; 2, 3, 4, 5, 6, filiform; 7, hemispherical papillæ.

with those of common sensation, temperature, etc., and that our judgments must, in the nature of the case, be based upon highly

complex data, even leaving out of account other senses, such as vision.

The glosso-pharyngeal is the principal nerve for the back of the tongue, and for the tip the lingual ; or according to some special fibers in this nerve, derived from the chord tympani.

It is worthy of note that temperature has much to do with gustatory sensations, a very low or a very high temperature

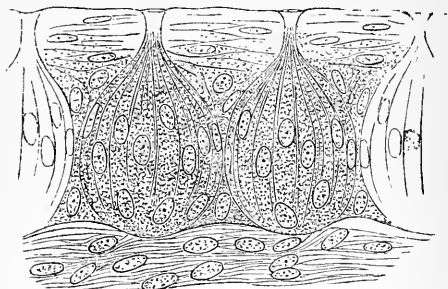

FIG. 423.—Taste-buds from tongue of rabbit (after Engelmann).

being fatal to nice discrimination, and, as would be expected, a temperature not far removed from "body-heat" (40° C.) is the most suitable.

A certain amount of pressure is favorable to tasting, as any one may easily determine by simply allowing some solution of quinine to rest on the tongue, and comparing the sensation with that resulting when the same is rubbed into the organ ; hence the importance of the movements of the tongue in appreciating the sapid qualities of food.

Comparative.—Among the lowest forms of life it is extremely difficult to determine to what extent taste and smell exist separately or at all, as we can conceive of them. The differentiation between ordinary tactile sensibility and these senses has no doubt been very gradually effected. Observations on our domestic animals show that their power of discrimination by taste as well as by smell is very pronounced, though their likes and dislikes are so different from our own in many instances. At the same time we find that they often coincide, and it is not unlikely that a dog's power of discriminating between a good beefsteak and a poor one is quite equal if not superior to man's, and certainly so if his sense of taste, as in the human subject, is developed in proportion to his smelling power.

THE CEREBRO-SPINAL SYSTEM OF NERVES.

I. SPINAL NERVES.

THESE (thirty-one pairs), which leave the spinal cord through the intervertebral foramina, are mixed nerves—i. e., their main trunks consist of motor and sensory fibers. But before they enter the spinal cord they separate into two groups, which are

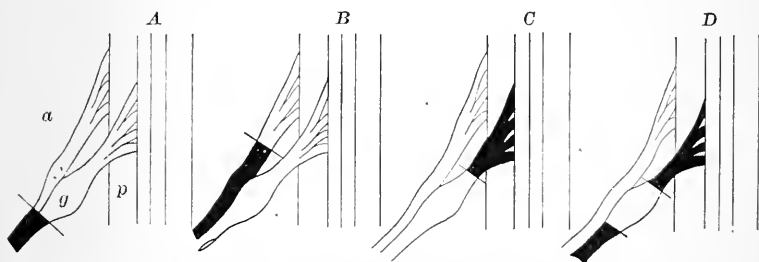

FIG. 424.—Diagram of roots of spinal nerve illustrating effects of section (after Dalton). The dark regions indicate the degenerated parts.

known as the anterior or motor and the posterior or sensory roots, which make connection with the anterior and posterior gray horns respectively.

These facts have been established by a few simple but important physiological experiments, which will now be briefly described: 1. Stimulation of the peripheral end of a spinal nerve gives rise to muscular movements; while stimulation of its central end causes pain. 2. Upon section of the anterior root, stimulation of its central end gives negative results; but of its peripheral end causes muscular movements. 3. After section of the posterior root, stimulation of the distal end is followed by no sensory or motor effects; of its central end, by sensory effects (pain).

These experiments show clearly that the anterior roots are motor, the posterior sensory, and the main trunk of the nerve made up of mixed motor and sensory fibers.

Exception.—It has been found that sometimes stimulation of the peripheral end of the anterior root has given rise to pain, an effect which disappears if the posterior root be cut. From this it is inferred that certain sensory fibers turn up into the anterior root a certain distance. Such are termed "recurrent sensory fibers."

Additional Experiments.—1. It is found that if the anterior root be cut, the fibers below the point of section degenerate, while those above it do not. 2. On the other hand, when the posterior root is divided above the ganglion, the fibers toward the cord degenerate, while those on either side of the ganglion do not. From these experiments it is inferred that the cells of the posterior ganglion are essential to the nutrition of the sensory fibers, and those of the anterior horn of the cord to the motor fibers.

Pathological.—Pathology teaches the same lesson, for it is observed that, when there is disease of the anterior gray cornua, degeneration of motor fibers is almost sure to follow. These cells, whether in the ganglion or the anterior horn, have been termed "trophic." It is true, the functions of the ganglia on the posterior roots, other than those just indicated, are unknown; on the other hand, the cells of the anterior horn are distinctly motor in function. To assume, then, that the cells of the ganglion are exclusively trophic, with the evidence now before us, would be premature.

The view we have presented of the relation of the nervous system makes all cells trophic in a certain sense; and we think the view that certain cells or certain fibers are exclusively trophic must, as yet, be regarded as an open question.

It is important, however, to recognize that certain connections between the parts of the nervous system, and indeed all of the tissues, are essential for perfect "nutrition," if we are to continue the use of that term at all.

II. THE CRANIAL NERVES.

These nerves have been divided into nerves of special sense, motor, and mixed nerves.

The first class has already been considered, with the senses to which they belong.

The physiology of the cranial nerves has been worked out by means of sections and clinico-pathological investigations.

Speaking generally, a good knowledge of the anatomy of these nerves is a great step toward the mastery of what is known of

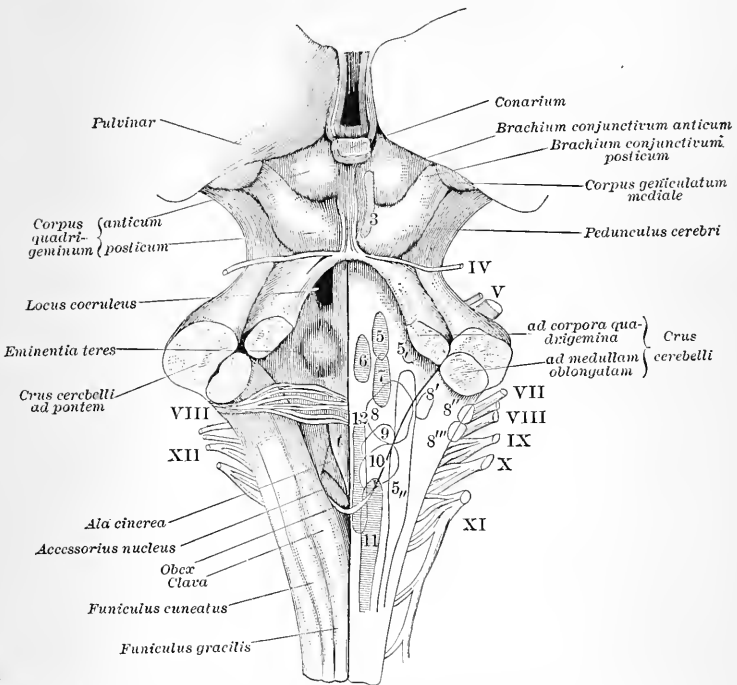

FIG. 425.—Intended to show especially the origin of both deep and superficial cranial nerves (after Landois). Roman characters are used to indicate the nerves as they emerge, and Arabic figures their nuclei or deep origin.

their functions, and such will be assumed in this chapter, so that the student may expect to find the treatment of the subject somewhat condensed.

The Motor-Oculi or Third Nerve.—With a deep origin in the gray matter of the floor and roof of the aqueduct of Sylvius, branches of distribution pass to the following muscles: 1. All of the muscles attached to the eyeball, with the exception of the external rectus and the superior oblique. 2. The levator palpebræ. 3. The circular muscle of the iris. 4. The ciliary muscle. Both the latter branches reach the muscles by the ciliary nerves, as they pass from the lenticular (ciliary, ophthalmic) ganglion. The relation of the third nerve, as seen in the

changes of the pupil with the movements of the eyeballs, has already been noticed.

Pathological.—It follows that section or lesion of the third nerve must give rise to the following symptoms: 1. Drooping of the upper lid (ptosis). 2. Fixed position of the eye in the outer angle of the orbit (lucitas). 3. Immobility, with the dilatation of the pupil (mydriasis). 4. Loss of accommodation.

The Trochlear or Fourth Nerve.—This nerve, arising in the aqueduct of Sylvius, passes to the superior oblique muscle.

Pathological.—Lesion of this nerve leads to peculiar changes. As there is double vision, some alteration must have occurred in the usual position of the globe of the eye, though this is not easily seen on looking at a subject thus affected. The double image appears when the eyes are directed downward, and appears oblique and lower than that seen by the unaffected eye.

The Abductor or Sixth Nerve.—Arising on the floor of the fourth ventricle, it passes to the external rectus of the eyeball, thus with the third and fourth nerve completing the innervation of the external ocular muscles (extrinsic muscles).

Pathological.—Lesion of this nerve causes paralysis of the above-mentioned muscle, and consequently internal squint (strabismus).

The Facial, Portia Dura, or Seventh Nerve.—It arises in a gray nucleus in the floor of the fourth ventricle, and has an extensive distribution to the muscles of the face, and may be regarded, in fact, as *the* nerve of the facial muscles, since it supplies (1) the *muscles of expression*, as those of the forehead, eyelids, nose, cheek, mouth, chin, outer ear, etc., and (2) certain *muscles of mastication*, as the buccinator, posterior belly of the digastric, the stylohyoid, and also (3) to the *stapedius*, with branches to the soft palate and uvula.

Pathological.—It follows that paralysis of this nerve must give rise to marked facial distortion, loss of expression, and flattening of the features, as well as possibly some deficiency in hearing, smelling, and swallowing. Mastication is difficult, and the food not readily retained in the mouth. Speech is affected from paralysis of the lips, etc.

Secretory fibers proceed (1) to the parotid gland by the superficial petrosal nerve, thence (2) to the otic ganglion, from which the fibers pass by the auriculo-temporal nerve to the gland.

Gustatory Fibers.—According to some, the chorda tympani

really supplies the fibers to the lingual nerve that are concerned with taste.

It will thus be seen that the facial nerve has a great variety of important functions, and that paralysis may be more or less serious, according to the number of fibers involved.

The Trigeminal, Trifacial, or Fifth Nerve.—This nerve has very extensive functions. It is *the* sensory nerve of the face : but, as will be seen, it is peculiar, being a combination of the motor and sensory ; or, in other words, has paths for both afferent and efferent impulses. The motor and less extensive division arises from a nucleus in the floor of the fourth ventricle. The sensory, much the larger, seems to have a very wide origin. The nerve-fibers may be traced from the pons Varolii through the medulla oblongata to the lower boundary of the olivary body and to the posterior horn of the spinal cord. This origin suggests a resemblance to a spinal nerve, the motor root corresponding to the anterior, and the sensory to a posterior root, the more so as there is a large ganglion connected with the sensory part of the nerve within the brain-case.

Efferent Fibers.—1. *Motor.*—To certain muscles (1) of mastication—temporal, masseter, pterygoid, mylohyoid, and the anterior part of the digastric. 2. *Secretory.*—To the lachrymal gland of the ophthalmic division of this nerve. 3. *Vaso-motor.*—Probably to the ocular vessels, those of the mucous membrane of the cheek and gums, etc. 4. *Trophic.*—From the results ensuing on section of this nerve, it has been maintained that special trophic fibers pass in it. We have discussed this subject in an earlier chapter.

Afferent Fibers.—1. *Sensory.*—To the entire face. To particularize regions: 1. The whole of the skin of the face and that of the anterior surface of the external ear. 2. The external auditory meatus. 3. The mucous lining of the cheeks, the floor of the mouth, and the anterior region of the tongue. 4. The teeth and periosteum of the jaws. 5. The lining membrane of the entire nasal cavity. 6. The conjunctiva, globe of the eye, and orbit. 7. The dura mater throughout.

Many of these afferent fibers are, of course, intimately concerned with reflexes, as sneezing, winking, etc. Certain secretory acts are often excited through this nerve, as lachrymation, when the nasal mucous membrane is stimulated ; indeed, the paths for afferent impulses giving rise to reflexes, including secretion, are very numerous.

Gustatory impulses from the anterior end and lateral edges of the tongue are conveyed by the lingual (gustatory) branch of this nerve. Many are of opinion, however, that the fibers of the chorda tympani, which afterward leave the lingual to unite with the facial nerve, alone convey such impressions. The subject can not be regarded as quite settled. Tactile sensibility in the tongue is very pronounced, as we have all experienced when a tooth, etc., has for some reason presented an unusual surface quality, and become a source of constant offense to the tongue.

The ganglia of the fifth nerve, so far as the functions of their cells are concerned, are enigmatical at present. They are doubtless in some sense trophic at least. With each of these are nerve connections ("roots" of the ganglia), which seem to contain different kinds of fibers. These ganglia are connected with the main nerve-centers by both afferent and efferent nerves, and also with the sympathetic nerves themselves. Some regard the ganglia as the representatives of the sympathetic system within the cranium.

I. *The Ciliary (Ophthalmic, Lenticular) Ganglion.*—Its three roots are : 1. From the branch of the third nerve to the inferior oblique muscle (motor root). 2. From the nasal branch of the ophthalmic division of the fifth. 3. From the carotid plexus of the sympathetic. The efferent branches pass to the iris, are derived chiefly from the sympathetic, and cause dilatation of the pupil. There

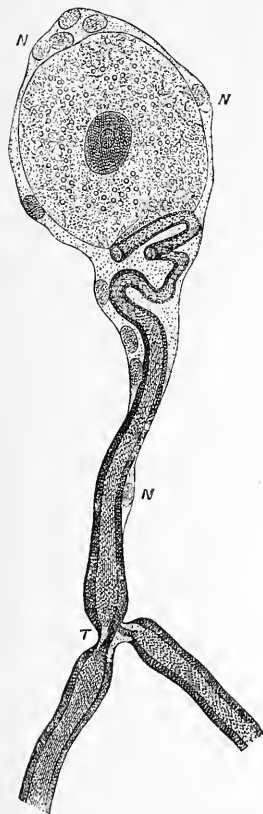

FIG. 426.—Unipolar cell from Gasserian ganglion (after Schwalbe). *N, N, N*, nuclei of sheath; *7*, fiber branching at a node of Ranvier.

are also vaso-motor fibers to the choroid, iris, and retina. The afferent fibers are sensory, passing from the conjunctiva, cornea, etc.

II. *The Nasal or Spheno-Palatine Ganglion.*—The motor

root is derived from the facial through the great superficial petrosal nerve; its sympathetic root from the carotid plexus. Both together constitute the vidian nerve. It would seem that afferent impulses from the nasal chambers pass through this ganglion. The efferent paths are : 1. Motor to the levator palati and azygos uvulae. 2. Vaso-motor, derived from the sympathetic. 3. Secretory to the glands of the cheek, etc.

III. *The Otic Ganglion.*—Its roots are : 1. Motor, from the third division. 2. Sensory, from the inferior division of the fifth. 3. Sympathetic, from the plexus around the meningeal artery. It makes communication with the chorda tympani and seventh, and supplies the parotid gland with some fine filaments. Motor fibers mixed with sensory ones pass to the tensor tympani and tensor palati.

IV. *The Submaxillary Ganglion.*—Its roots are: 1. Branches of the chorda tympani, from which pass (*a*) secretory fibers to the submaxillary and sublingual glands, (*b*) vaso-motor (dilator) fibers to the vessels of the same glands. 2. The *sympathetic*, derived from the superior cervical ganglion, passing to the submaxillary gland. It is also thought to be the path of vaso-constrictor fibers to the gland. 3. The sensory, from the lingual nerve, supplying the gland substance, its ducts, etc.

Pathological.—1. The motor division of the nerve, when the medium of efferent impulses, owing to central disorder, may cause trismus (locked-jaw) from *tonic* tetanic action of the muscles of mastication supplied by this nerve. 2. Paralysis of the same muscles may ensue from degeneration of the motor nuclei or pressure on the nerve in its course. 3. Neuralgia of any of the sensory branches may occur from a great variety of causes, and often maps out very exactly the course and distribution of the branches of the nerve. 4. Vaso-motor disturbances are not infrequently associated with neuralgia. Blushing is an evidence of the normal action of the vaso-motor fibers of the fifth nerve. 5. A variety of trophic (metabolic) disturbances may arise from disorder of this nerve, its nuclei of origin or its ganglia, such as grayness and loss of hair (imperfect nutrition), eruptions of the skin along the course of the nerves, etc. Atrophy of the face, on one or both sides, gradual and progressive, may occur. Such affections as well as others, point in the most forcible manner to the influence of the nervous system over the metabolism of the body.

The Glosso-pharyngeal or Ninth Nerve.—This nerve, to-

gether with the vagus and spinal accessory, constitutes the eighth pair, or rather trio. Functionally, however, they are quite distinct.

The glosso-pharyngeal arises in the floor of the fourth ventricle above the nucleus for the vagus. It is a mixed nerve with efferent and afferent fibers: *Efferent fibers*, furnishing motor fibers to the middle constrictor of the pharynx, stylo-pharyngeus, levator palati, and azygos uvulæ. 2. *Afferent fibers*, which are the paths of sensory impulses from the base of the tongue, the soft palate, the tonsils, the Eustachian tube, tympanum, and anterior portion of the epiglottis. Stimulation of the regions just mentioned gives rise reflexly to the movements of swallowing and to reflex secretion of saliva.

This nerve is also the special nerve of taste to the back of the tongue.

The Pneumogastric, Vagus, or Tenth Nerve.—Most of the functions of this nerve have already been considered in previous chapters.

In some of the lower vertebrates (sharks) the nerve arises by a series of distinct roots, some of which remain separate throughout. This fact explains its peculiarities, anatomical and functional, in the higher vertebrates. In these there have been concentration and blending, so that what seems to be one nerve is really made up of several distinct bundles of fibers, many of which leave the main trunk later.

It may be regarded as the *most* complicated nerve-trunk in the body, and the distribution of its fibers is of the most extensive character. Following our classification of efferent and afferent, we recognize:

1. *Efferent fibers*, which are *motor* to an extensive tract in the respiratory and alimentary regions.

Thus the constrictors of the pharynx, certain muscles of the palate, the œsophagus, the stomach, and the intestine, receive an abundant supply from this source. By the laryngeal nerves, probably derived originally from the spinal accessory, the muscles of the larynx are innervated. The muscles of the trachea, bronchi, etc., are also supplied by the pneumogastric. It is probable that *vaso-motor* fibers derived from the sympathetic run in branches of the vagus. The relations of this nerve to the heart and lungs have already been explained.

2. *Afferent Fibers.*—It may be said that afferent impulses from all the regions to which efferent fibers are supplied pass

inward by the vagus. One of the widest tracts in the body for afferent impulses giving rise to reflexes is connected with the nerve-centers by the branches of this nerve, as evidenced by the many well-known phenomena of this character referable to the pharynx, larynx, lungs, stomach, etc., as vomiting, sneezing, coughing, etc. This nerve plays some important part in secretion, no doubt, but what that is has not been as yet well established.

Pathological.—Section of both vagi, as might be expected, leads to death, which may take place from a combination of pathological changes, the factors in which vary a good deal with the class of animals the subject of experiment. Thus, the heart in some animals (dog) beats with great rapidity and tends to exhaust itself. In birds especially is fatty degeneration of heart, stomach, intestines, etc., liable to follow.

Paralysis of the muscles of the larynx renders breathing laborious. From loss of sensibility food accumulates in the pharynx and finds its way into the larynx, favoring, if not actually exciting, inflammation of the air-passages.

But it is not to be forgotten that upon the views we advocate as to the constant influence of the nervous system over all parts of the bodily metabolism, it is plain that after section of the trunk of a nerve with fibers of such wide distribution and varied functions the most profound changes in so-called nutrition must be expected, as well as the more obvious functional derangements; or, to put it otherwise, the results that follow are in themselves evidence of the strongest kind for the doctrine of a constant neuro-metabolic influence which we advocate. It will not be forgotten that the depressor nerve, which exerts reflexly so important an influence over blood-pressure, is itself derived from the vagus.

The Spinal Accessory or Eleventh Nerve.—This nerve arises from the medulla oblongata somewhat far back, and from the spinal cord in the region of the fifth to the seventh vertebra. Leaving the lateral column, its fibers run upward between the denticulate ligament and the posterior roots of the spinal nerve to enter the cranial cavity, which as they issue from the cranium subdivide into two bundles, one of which unites with the vagus, while the other pursues an independent course to reach the sterno-mastoid and trapezius muscles, to which they furnish the motor supply; so that it may be considered functionally equivalent to the anterior root of a spinal nerve. The portion

joining the vagus seems to supply a large part of the motor fibers of that nerve.

Pathological.—Tonic contraction of the flexors of the head causes wry-neck, and when they are paralyzed the head is drawn to the sound side.

The Hypoglossal or Twelfth Nerve.—It arises from the lowest part of the calamus scriptorius and perhaps from the olivary body. The manner of its emergence between the anterior pyramid and the olivary body, on a line with the anterior spinal roots, suggests that it corresponds to the latter; the more so as it is motor in function, though also containing some vaso-motor fibers, in all probability destined for the tongue. Such sensory fibers as it may contain are derived from other sources (vagus, trigeminus). It supplies motor fibers to the tongue and the muscles, attached to the hyoid bone.

Pathological.—Unilateral section of the nerve gives rise to a corresponding lingual paralysis, so that when the tongue is protruded it points to the injured side; when being drawn in, the reverse. Speech, singing, deglutition, and taste may also be abnormal, owing to the subject being unable to make the usual co-ordinated movements of the tongue essential for these acts.

RELATIONS OF THE CEREBRO-SPINAL AND SYMPATHETIC SYSTEMS.

No division of the nervous system has been so unsatisfactory, because so out of relation with other parts, as the sympathetic. It was also desirable to attempt to co-ordinate the cerebral and spinal nerves in a better fashion; and various attempts in that direction have been made. Very recently a plan, by which the whole of the nerves issuing from the brain and cord may be brought into a unity of conception, has been proposed; and, though it would be premature to pronounce definitely as yet upon the scheme, yet it does seem to be worth while to lay it before the student, as at all events better than the isolation implied in the three divisions of the nerves which has been taught hitherto.

Instead of the classification of nerves into efferent and afferent, connected with the anterior and the posterior horns of the gray matter of the spinal cord, another division has been proposed, viz., a division of nerve-fibers and their centers of origin

in the gray matter for the supply of the internal and the external parts of the body—i. e., into splanchnic and somatic nerves. The centers of origin of the splanchnic nerves are referred to groups of cells in the gray matter of the cord around the cen-



FIG. 427.

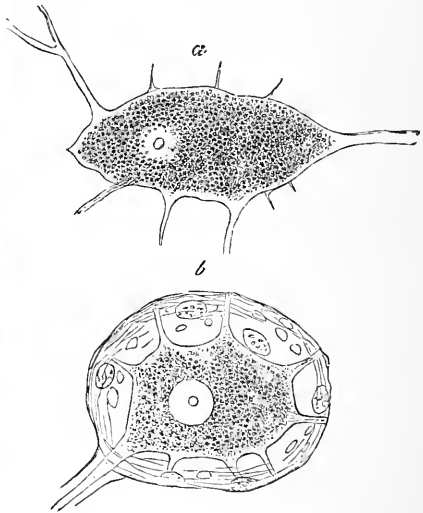

FIG. 428.

FIG. 427.—Ganglion cell from sympathetic ganglion of frog; greatly magnified, and showing both straight and coiled fibers (after Quain).
 FIG. 428.—Multipolar ganglion cells from sympathetic system of man, highly magnified (after Max Schultze). *a*, cell freed from capsule; *b*, inclosed within a nucleated capsule. In both the processes have been broken away.

tral canal; while the somatic nerves spring from the gray cornua and supply the integument and the ordinary muscles of locomotion, etc. The splanchnic nerves supply certain muscles of respiration and deglutition, derived from the embryonic lateral plates of the mesoblast; the somatic nerves, muscles formed from the muscle-plates of the same region.

It is assumed that the segmentation of the vertebrate and invertebrate animal is related; and that segmentation is pre-

served in the cranial region of the vertebrate, as shown by the nerves themselves.

The afferent fibers of both splanchnic and somatic nerves pass into the spinal ganglion, situated in the nerve-root, which may be regarded as stationary.

It is different with the anterior roots. Some of the fibers are not connected with ganglia at all; others with ganglia not fixed in position, but occurring at variable distances from the central nervous system (these being the so-called sympathetic ganglia): thus, the anterior root-fibers are divisible into two groups, both of which are efferent, viz., ganglionated and non-ganglionated. The ganglionated belong to the splanchnic system, and have relatively small fibers; the non-ganglionated include both somatic and splanchnic nerves, composing the ordinary nerve-fibers of the voluntary striped muscles of respiration, deglutition, and locomotion.

It would appear that these now isolated ganglia have been themselves derived from a primitive ganglion mass situated on the spinal nerves; so that the distinction usually made of ganglionated and non-ganglionated roots is not fundamental.

A spinal nerve is, then, formed of—1. A posterior root, the ganglion of which is stationary in position, and connected with splanchnic and somatic nerves, both of which are afferent. 2. An anterior root, the ganglion of which is vagrant, and connected with the efferent small-fibered splanchnic nerves.

Among the lower vertebrates both anterior and posterior roots pass into the same stationary ganglion. Such is also the case in the first two cervical nerves of the dog.

Does the above-mentioned plan of distribution, etc., hold for the cranial nerves?

Leaving out the nerves of special sense (olfactory, optic, and auditory), the other cranial nerves may be thus divided: 1. A foremost group of nerves, wholly efferent in man, viz., the third, fourth, motor division of the fifth, the sixth, and seventh. 2. A hindmost group of nerves of mixed character, viz., the ninth, tenth, eleventh, and twelfth.

The nerves of the first group, since they have both large-fibered, non-ganglionated motor nerves, and also small-fibered splanchnic efferent nerves, with vagrant ganglia (ganglion oculomotorii, ganglion geniculatum, etc.), resemble a spinal nerve in respect to their anterior roots. They also resemble spinal nerves as to their posterior roots, for at their exit from

the brain they pass a ganglion corresponding to the stationary posterior ganglion of the posterior root of a spinal nerve. These being, however, neither in roots nor ganglion functional, are to be regarded as the phylogenetically (ancestrally) degenerated remnants of what were once functional ganglia and nerve-fibers; in other words, the afferent roots of these nerves and their ganglia have degenerated.

The hindmost group of cranial nerves also answers to the spinal nerves. They arise from nuclei of origin in the medulla and in the cervical region of the spinal cord, directly continuous with corresponding groups of nerve-cells in other parts of the spinal cord; but in these nerves there is a scattering of the components of the corresponding spinal nerves. Certain peculiarities of these cranial nerves seem to become clearer if it be assumed that, in the development of the vertebrate, degeneration of some region once functional has occurred, in consequence of which certain portions of nerves, etc., have disappeared or become functionless.

It is also to be remembered that a double segmentation exists in the body, viz., a somatic, represented by vertebræ and their related muscles, and a splanchnic represented by visceral and branchial clefts, and that these two have not followed the same lines of development; so that in comparing spinal nerves arranged in regard to somatic segments with cranial nerves, the relations of the latter to the somatic muscles of the head must be considered; in other words, like must be compared with like.

THE VOICE.

It is convenient to speak, in the case of man, of the singing voice and the speaking voice, though there is no fundamental difference in their production. The voice of the lower animals approximates the former rather than the latter.

It is to be remembered that sound is an affection of the nervous centers through the ear, as the result of aerial vibrations.

We are now to explain how such vibrations are caused by the vocal mechanisms of animals and especially of man.

The tones of a piano or violin are demonstrably due to the vibrations of the strings; of a clarinet to the vibration of its reed. But, however musical tones may be produced, we distinguish in them differences in pitch, quantity, and quality.

The pitch is dependent solely upon the number of vibrations within a given time, as one second; the quantity or loudness upon the amplitude of the vibrations, and the quality upon the form of the vibrations. The first two scarcely require any further notice; but it is rather important for our purpose to understand clearly the nature of quality or timbre, which is a more complex matter.

If a note be sounded near an open piano, it may be observed that not only the string capable of giving out the corresponding note passes into feeble vibration, but that several others also respond. These latter produce the overtones or partials which enter into notes and determine the quality by which one instrument or one voice differs from another. In other words, every tone is in reality compound, being composed of a fundamental tone and overtones. These vary in number and in relative strength with each form of instrument and each voice; and it is now customary to explain the differences in quality of voices solely in this way; and this is, no doubt, correct in the main.

What are the mechanisms by which voice is produced in man? Observation proves that the following are essential: 1.

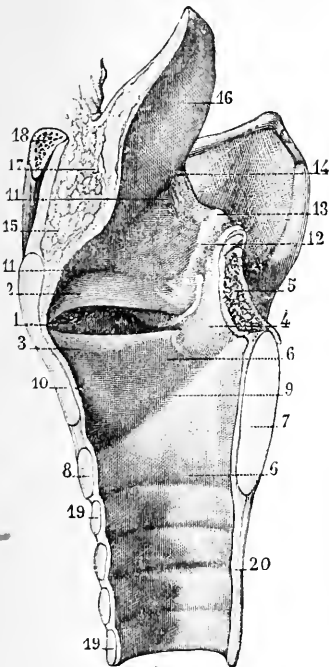

FIG. 429.

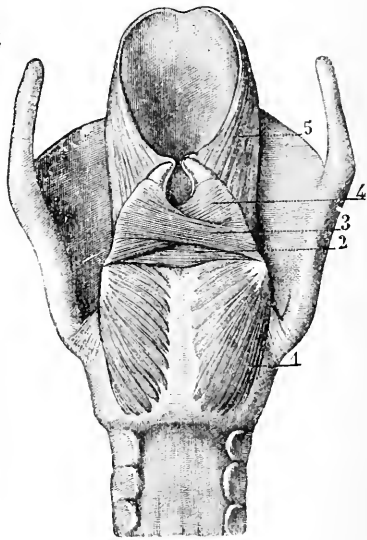

FIG. 430.

FIG. 429.—Longitudinal section of human larynx (after Sappey). 1, ventricle of larynx; 2, superior vocal cord; 3, inferior vocal cord; 4, arytenoid cartilage; 5, section of arytenoid muscle; 6, 6, inferior portion of cavity of larynx; 7, section of posterior part of cricoid cartilage; 8, section of anterior part of same; 9, superior border of cricoid cartilage; 10, section of thyroid cartilage; 11, 11, superior portion of cavity of larynx; 12, 13, arytenoid gland; 14, 16, epiglottis; 15, 17, adipose tissue; 18, section of hyoid bone; 19, 19, 20, trachea.

FIG. 430.—Posterior aspect of muscles of human larynx (after Sappey). 1, posterior crico-arytenoid muscle; 2, 3, 4, different fasciculi of arytenoid muscle; 5, aryteno-epiglottidean muscle.

A certain amount of tension of the vocal cords (bands). 2. A certain degree of approximation of their edges. 3. An expiratory blast of air.

It will be noted that these are all conditions favorable to the vibration of the vocal bands. The greater the tension the higher the pitch; and the more occluded the glottic orifice the more effective the expiratory blast of air.

The principle on which the vocal bands act may be illus-

trated in the simplest way by a well-known toy, consisting of an elastic bag tied upon a hollow stem of wood, across which rubber bands are stretched, and the vibration of which caused by the air within the distended bag gives rise to the note.

It is especially important to recognize the nature, extent, and

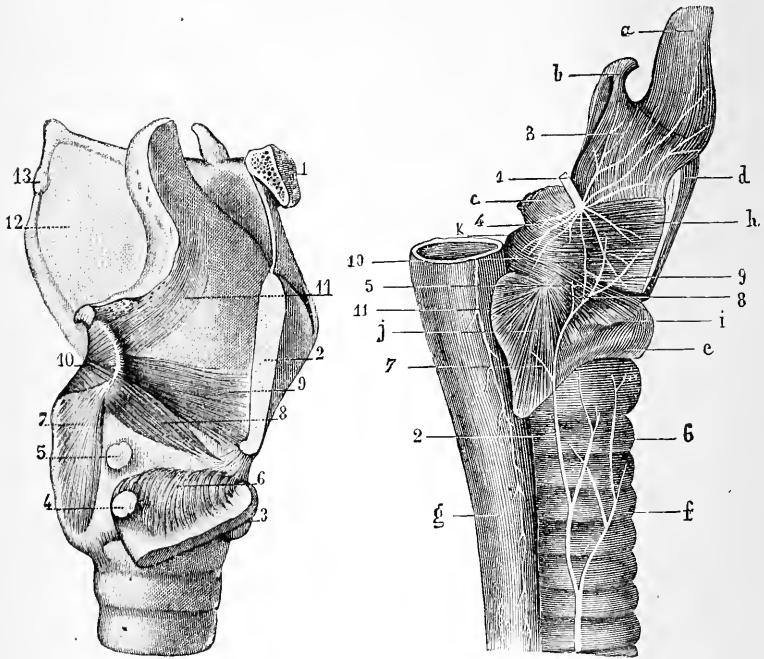

FIG. 431.

FIG. 432.

FIG. 431.—Lateral view of laryngeal muscles (after Sappey). 1, body of hyoid bone; 2, vertical section of thyroid cartilage; 3, horizontal section of thyroid cartilage, turned downward to show deep attachment of crico-thyroid muscle; 4, facet of the articulation of small cornu of thyroid cartilage with cricoid cartilage; 5, facet on cricoid cartilage; 6, superior attachment of crico-thyroid muscle; 7, posterior crico-arytenoid muscle; 8, lateral crico-arytenoid muscle; 9, thyro-arytenoid muscle; 10, arytenoid muscle proper; 11, aryteno-epiglottidean muscle; 12, middle thyro-hyoid ligament; 13, lateral thyro-hyoid ligament.

FIG. 432.—Distribution of nerves in larynx of horse (Chauveau, after Toussaint). *a*, base of tongue; *b*, epiglottis; *c*, arytenoid muscles; *d*, section of thyroid cartilage to show parts it covers; *e*, cricoid cartilage; *f*, trachea; *g*, oesophagus; *h*, thyro-arytenoid muscle; *i*, lateral crico-arytenoid muscle; *j*, posterior crico-arytenoid muscle; *k*, arytenoid muscle; 1, superior laryngeal nerve; 2, inferior laryngeal; 3, branches of superior laryngeal passing to epiglottis and tongue; 4, branches of superior laryngeal passing to oesophagus; 5, very fine multiple anastomoses between two laryngeals; 6, tracheal branches; 7, branch to posterior crico-arytenoid muscle; a portion is distributed, through the muscles, to subjacent mucous membrane; 8, branch passing to arytenoid muscle; 9, oesophageal branch to arytenoid muscle; 10, oesophageal branch of pharyngeal nerve; it sometimes comes from external laryngeal.

effect on the vocal bands of the movements of the arytenoid cartilages. These are most marked around a vertical axis, giving rise to an inward and outward movement of rotation, but

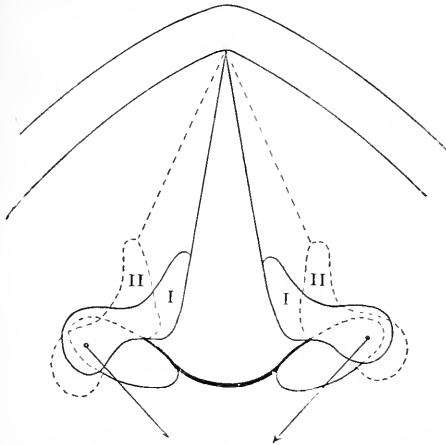

FIG. 433.—Diagrammatic section of larynx to illustrate action of *Posterior crico-arytenoid muscle* (after Landois). In this and the two following figures the dotted lines indicate the new position of the parts owing to the action of the muscles concerned.

there are also movements of less extent in all directions. It is in fact through the movements of these cartilages to which the

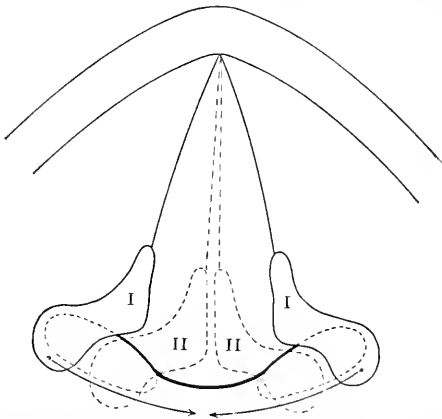

FIG. 434.—Diagrammatic section of larynx to illustrate action of *Arytenoideus proprius muscle* (after Landois).

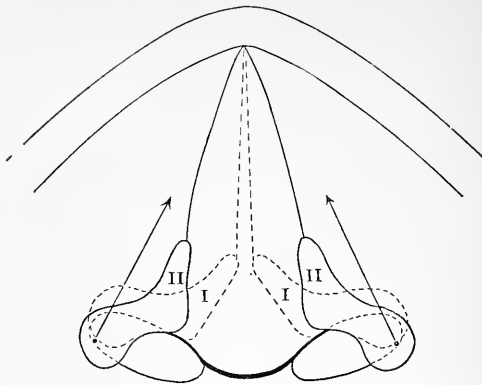

FIG. 435.—Illustrates action of thyro-arytenoideus internus.

vocal bands are attached posteriorly, that most of the important changes in the tension, approximation, etc., of the latter are produced. The lungs are to be regarded as the bellows furnishing the necessary wind-power to set the vocal bands vibrating, while the larynx has respiratory as well as vocal functions, as has been already learned. Assuming that the student has a good knowledge of the general anatomy of the larynx, we call attention briefly to the following :

Widening of the glottis is effected by the *crico-arytenoideus posticus* pulling outward the processus vocalis or attachment posteriorly of the vocal band, and a similar effect is produced by the *arytenoideus posticus* acting alone.

Narrowing of the glottis is accomplished by the *crico-arytenoideus lateralis*, and the following when acting either singly (except the *arytenoideus posticus*), or in concert, as the sphincter of the larynx, viz., the *thyro-arytenoideus externus*, *thyro-arytenoideus internus*, *thyro-aryepiglotticus* *arytenoideus posticus*.

Tension of the vocal bands is brought about by the sphincter group, and especially by the external and internal thyro-arytenoid muscles.

Nerve Supply.—The *superior laryngeal* contains the motor fibers for the crico-thyroid (possibly also the arytenoideus posticus) and also supplies the mucous membrane. The *inferior laryngeal* supplies all the other muscles. While both of these nerves are derived from the vagus, their fibers really belong to the spinal accessory. It is worthy of note that the entire group

of muscles making up the sphincter of the larynx is contracted when the inferior laryngeal is stimulated.

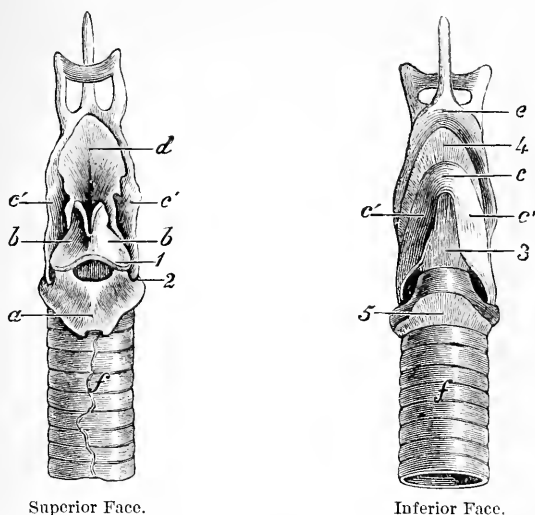

FIG. 436.—Cartilaginous pieces of the larynx of horse, maintained in their natural position by the articular ligaments (Chanveau). *a*, cricoid cartilage; *b*, *b*, arytenoid cartilages; *c*, body of the thyroid; *c'*, *c'*, lateral plates of the thyroid; *d*, epiglottis; *e*, body of the hyoid; *f*, trachea. 1, crico-arytenoid articulation; 2, capsule of the crico-thyroid articulation; 3, crico-thyroid membrane; 4, thyro-hyoid membrane; 5, crico-trachealis ligament.

Above the true vocal bands composed of elastic fibers lie the so-called false vocal bands (cords) to be regarded as folds of the mucous membrane which take no essential part in voice-production. Between these two pairs of bands are the *ventricles of Morgagni*, which, as well as the adjacent parts, secrete mucus and allow of the movements of both sets of bands and in so far only assist in phonation.

The whole of the supra-laryngeal cavities, the trachea and bronchial tubes, may be regarded as resonance-chambers, the former of which are of the most importance, so far as the quality of the voice is concerned. There seems to be little doubt that they have much to do with determining the differences by which one individual's voice at the same pitch differs from another; nor is the view that they may have a slight influence on the pitch of the voice, or even its intensity, to be ignored.

The epiglottis, in so far as it has any effect, in all probability modifies the voice in the direction of quality.

Pathological.—Paralysis of the laryngeal muscles, owing to pressure on nerves and consequent narrowing of the glottic opening, explains "roaring" in the horse, in certain instances at all events.

Comparative.—Much more is known of the sounds emanating from the lower animals than of the mechanisms by which they are produced. This applies, of course, especially to such sounds as are not produced by external parts of the body, it being very difficult to investigate these experimentally or to observe the animal closely enough when producing the various vocal effects naturally.

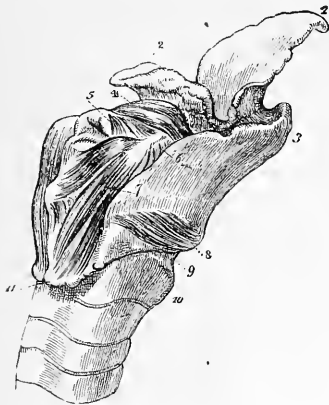

FIG. 437.—Postero-lateral view of the larynx of the horse (Chauveau). 1, epiglottis; 2, arytenoid cartilages; 3, thyroid cartilage; 4, arytenoid muscle; 5, crico-arytenoides lateralis; 6, thyro-arytenoides; 7, crico-arytenoides posticus; 8, crico-thyroides; 9, ligament between the cricoid cartilage and first ring of trachea; 10, 11, infero-posterior extremities of crico-thyroid cartilages.

All our domestic mammals have a larynx, not as widely different from that of man as might be supposed from the feeble range of their vocal powers. There are structural differences in the larynx of the domestic animals, some of which are more readily appreciated by the eye than described.

The false (superior) vocal bands are rudimentary or wanting in many mammals, including the horse, ass, etc.

In ruminants the larynx is proportionately ill-developed; the glottis is short, the vocal bands rudimentary, and the ventricles wanting.

The larynx of the pig is peculiar in that the ventricles are deep, though their opening is only a narrow slit; there is, however, a large membranous sac below the epiglottis, which, acting as a resonator, explains the great intensity of the voice of this animal.

The actual behavior of the vocal bands has been studied experimentally in the dog when growling, barking, etc. And, so far as it goes, this animal's mechanism of voice-production

is not essentially different from that of man. Growling is the result of a functional activity of the vocal mechanism, not unlike that of man when singing a bass note; barking, of that analogous to coughing or laughing, when the vocal bands are rapidly approximated and separated.

The grunting of hogs and the lowing and bawling of horned cattle are probably very similar in production, so far as the larynx is concerned, to the above. The cat has plainly very great command over the larynx, and can produce a wide range of tones. The peculiarities of the bray of the ass are owing to voice production both during inspiration and expiration.

The quality of the voice of most animals appears harsh to our ears, owing probably to a great preponderance of overtones, in consequence of an imperfect and unequal tension of the vocal bands; but the influence of the supra-laryngeal cavities, often very large, must also be taken into account.

In certain of the primates, and especially in the howling monkeys, large cheek-pouches can be inflated with air from the larynx, and so add to the intensity of the note produced by the vocal bands that their voice may be heard for miles. Song-birds produce their notes, as may be seen, by external movements low down at the bifurcation of the trachea (syrinx). The notes are owing to the vibration of two folds of the mucous membrane, which project into each bronchus, and are regulated in their movements by muscles, the bronchial rings in this region being correspondingly modified.

A large number of species of *fishes* produce sounds and in a variety of ways, in which the air-bladder, stomach, intestines, etc., take part. Most *reptiles* are voiceless, in the proper sense, though there are few that can not produce a sort of hissing sound, caused by the forcible emission of air through the upper respiratory passages.

Frogs, as is well known, produce sounds of great variety in

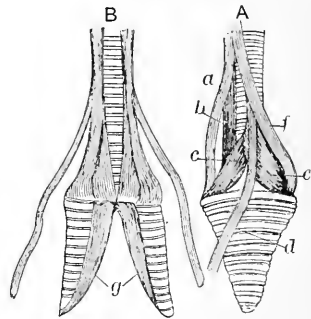

FIG. 438.—Lower larynx (*Syrinx*) of crow (after Gegenbaur). A, seen from side; B, seen from in front. *a-f*, muscles concerned in movements of lower larynx; *g*, membrana tympaniformis interna, stretching from median surface of either bronchus to a bony ridge (pessulus) which projects at the angle of bifurcation of trachea.

pitch, quality, and intensity, some species croaking so as to be heard at the distance of at least a mile. It is a matter of easy observation that when frogs croak the capacity of the mouth cavity is greatly increased, owing to the distention of resonating sacs situated at each angle of the jaws. When tree-frogs croak, their throats are greatly distended, apparently in successive waves.

SPECIAL CONSIDERATIONS AND SUMMARY.

Evolution.—The very lowest forms, and in fact most invertebrate groups, seem to be voiceless. Darwin has shown that voice is, in a large number of groups, confined either entirely to the male, or that it is so much more developed in him as to become what he terms a “sexual character.” There is abundant evidence that males are chosen as mates by the females, among birds especially, not alone for superiority in beauty of plumage, but also for their song. Thus, by a process of natural selection (sexual selection), the voice would tend to improve with the lapse of time, if we admit heredity, which is an undeniable fact, even among men—whole families for generations, as the Bachs, having been musicians.

One can also understand why on these principles voice should be especially developed in certain groups (birds), while among others (mammals) form and strength should determine sexual selection, the strongest winning in the contests for the possession of the females, and so propagating their species under the more favorable circumstance of choice of the most desirable females.

Pathology teaches that, when certain parts of the brain (speech-centers) of man are injured by accident or disease, the power of speech may be lost. From this it is evident that the vocal apparatus may be perfect and yet speech be wanting; so that it becomes comprehensible that the vocal powers of, e. g., a dog, are so limited, notwithstanding his comparatively highly developed larynx. He lacks the energizing and directive machinery situated in the brain.

Some believe that there was a period when man did not possess the power of speech at all; and many are convinced that the human race have undergone a gradual development in this as in other respects. Certain it is that races differ still very widely in capacity to express ideas by spoken words.

We may regard the development of a race of speaking animals as dependent upon a corresponding advance in brain-structure, whether that was acquired by a sudden and pronounced variation, or by gradual additions of increase in certain regions of the brain, or whether to the first there was then added the second.

Apart from speech proper, there is a language of the face and body generally, in which there is much that we share with lower forms, especially lower mammals. Darwin, noticing this resemblance, regarded it as evidence strengthening the belief that man is derived from lower forms. Why should the forms of facial expression associated so generally with certain emotions among different races of men be so similar to each other and to those which the lower animals employ, if there is not some community of origin? This is Darwin's query, and he considered, as has been stated, that the answer to be given was in harmony with his views of man's origin, as based on an altogether different sort of testimony.

The high functional development of the hand and arm in man, and the use of these parts in writing, are suggestive.

Summary.—The musical tones of the voice are caused by the vibrations of the vocal bands, owing to the action on them of an expiratory blast of air from the lungs. In order that the bands may act effectively, they must be rendered tense and approximated, which is accomplished by the action of the laryngeal muscles, especially those attached to the arytenoid cartilages. We may speak of the respiratory glottis and the vocalizing glottis, according as we consider the position and movements of the vocal bands in respiration or in phonation.

The pitch of the voice is determined by the length and the tension of the vocal bands, and frequently both shortening and increased tension are combined; perhaps we may say that altered (not necessarily increased) tension and length are always combined.

The quality of the voice depends chiefly upon the supra-laryngeal cavities.

It is important to remember that in all phonation, in the case of man at least, many parts combine to produce the result; so that voice-production is complex and variable in mechanism, beyond what would be inferred from the apparent simplicity of the mechanism involved; while the central nervous processes are, when comparison is made with phonation in lower ani-

mals, seen to be the most involved and important of the whole—a fact which the results of disease of the brain are well calculated to impress, inasmuch as interruptions anywhere among a class of cerebral connections, now known to be very extensive, suffice to abolish voice, and especially speech-production.

Among mammals below man the vocal bands and laryngeal and thoracic mechanism are very similar, but less perfectly and complexly co-ordinated; so that their vocalization is more limited in range, and their tones characterized by a quality which to the human ear is less agreeable. Man's superiority as a speaking animal is to be traced chiefly to the special development of his cerebrum, both generally and in certain definite regions.

CERTAIN TISSUES.

Prior to considering the subject of the next chapter, it may be well to give a short account of certain tissues specially concerned.

Connective Tissue.—This is the most widely distributed tissue in the body, since it binds together all other forms of tissue, and, in some of its many varieties, enters into the formation of every organ. As connective tissue proper, its function is subordinate; but when it becomes the aponeuroses of mus-

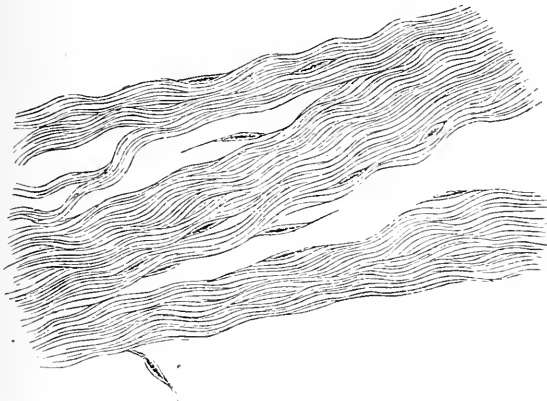

FIG. 439.—Fibers of tendon of man (Rollett).

cles, and especially tendons, by which, from its inextensibility, the muscles are rendered effective in moving the levers (bones) to which they are attached, its importance is more pronounced. In structure, this fibrous tissue consists of bundles of fine fibrils, among which, especially in the younger stage, connective-tissue cells may be found, and from which the fibers themselves are formed.

It is owing to differences in the shape and size of these cells chiefly that the structural variations of connective tissue in different regions of the body are due.

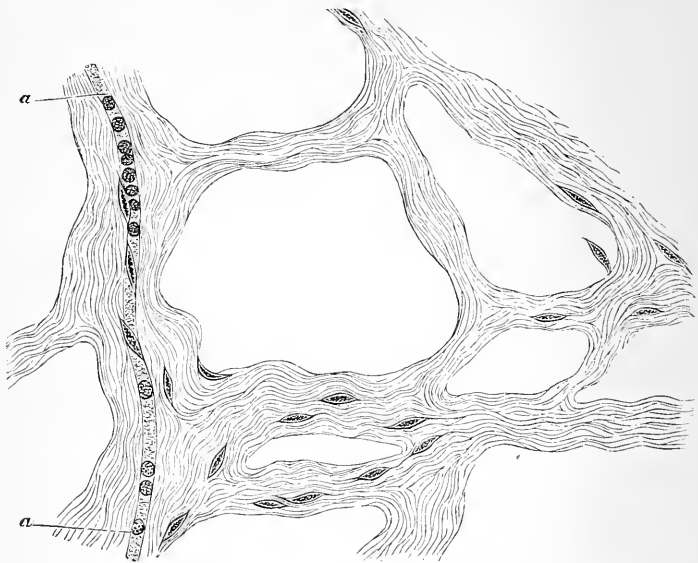

FIG. 440.—Loose network of connective tissue from man, in which are connective-tissue corpuscles among the fibers (Rollet). *a, a*, capillary with blood-cells.

Elastic Tissue.—This form of tissue is also of very wide distribution and of great importance in the economy of a complicated living organism that must constantly adapt itself to the stress and strains of existence. In its purest form it occurs, e. g., in the ligamentum nucleæ of the ox, as a somewhat yellow, tough, elastic structure easily fibrillated when boiled, but with difficulty torn asunder when fresh. Under the microscope it appears as fibers with a very distinct outline and of varying size. In the arteries, as already referred to, it forms a sort of elastic membrane of the utmost importance in the functions of these organs.

Bone.—In a long bone, as the femur, in the dried state, we recognize a compact shaft and two extremities of a more porous nature, while the central portion of the former presents a more or less circular cavity, the medullary canal. By treatment with hydrochloric acid abundance of lime salts may be ob-

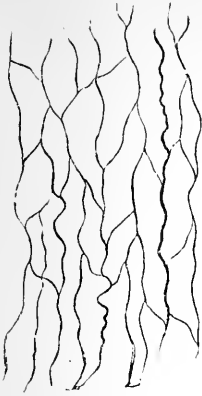

FIG. 441.



FIG. 442.

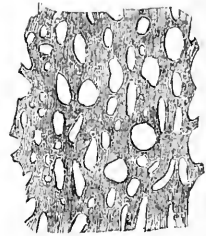

FIG. 433.

FIG. 441.—Fine elastic fibers from peritonæum, 1 × 350 (Kölliker).

FIG. 442.—Larger elastic fibers (Robin).

FIG. 443.—Elastic network (fenestrated membrane) from middle coat of carotid of horse, 1 × 350 (Kölliker).

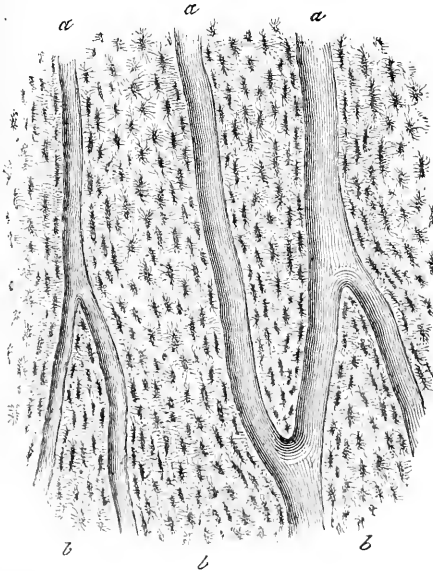

FIG. 444.—Longitudinal section of humerus, showing Haversian canals and lacunæ, 1 × 200 (Sappey).

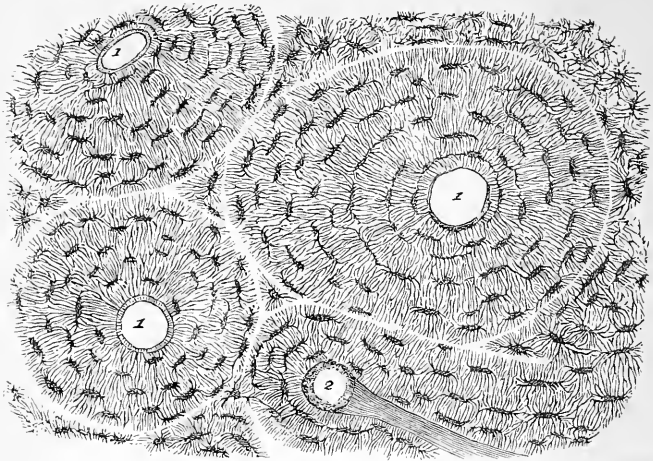

FIG. 445.—Transverse section of humerus, 1×200 (Sappey). 1, section of vascular (Haversian) cells; 2, longitudinal canal at point of junction with transverse canal. Lacunae and canaliculi arranged in concentric rings.

tained. A microscopic transverse section shows the substance of the shaft to be penetrated by longitudinal channels (Haver-

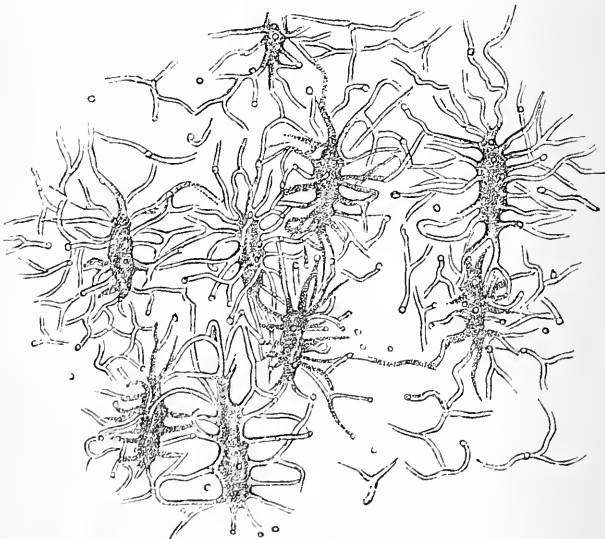

FIG. 446.—Bone-corpuscles and their processes which fill the lacunae and canaliculi (Rolleit).

sian canals), while the intermediate space is occupied by cavities (lacunæ) connected with one another by very fine canals

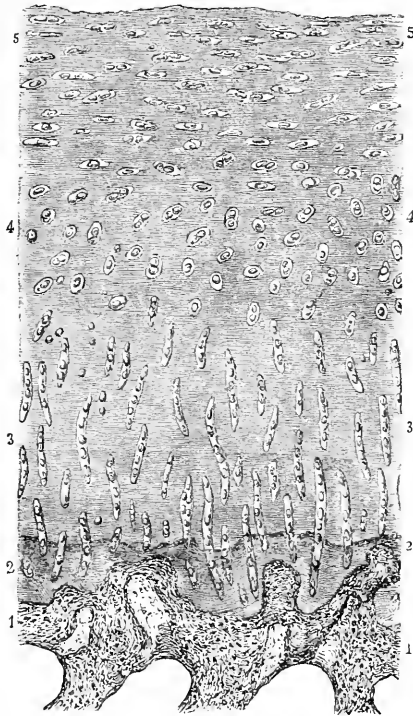

FIG. 447.—Vertical section of articular cartilage resting on bone, and showing cells and capsules arranged in layers as indicated by numerals (Sappey).

(Fig. 444). A vertical cross-section exhibits the lamellæ of which it is made up and the vascular channels cut across (Fig. 445).

All this is, however, only the framework of osseous tissue. If a bone from an animal freshly killed, without bleeding, be examined, a very different state of things will be found. The bone is heavier; its surface is covered with a closely adherent, tough, fibrous structure, the periosteum: and its medullary cavity filled with marrow. If the bone be broken across, its section looks red, and blood flows from the surface. Investigation proves that the covering periosteum is a bed in which blood-vessels and nerves ramify, and from which they enter

the openings to be seen on the surface of the dead bone. The Haversian canals are vascular channels, and the lacunæ filled with bone corpuscles (Fig. 446). The marrow in the extremities of the bone is of a red color in consequence of its great vascularity; and in the young animal a similar marrow fills the

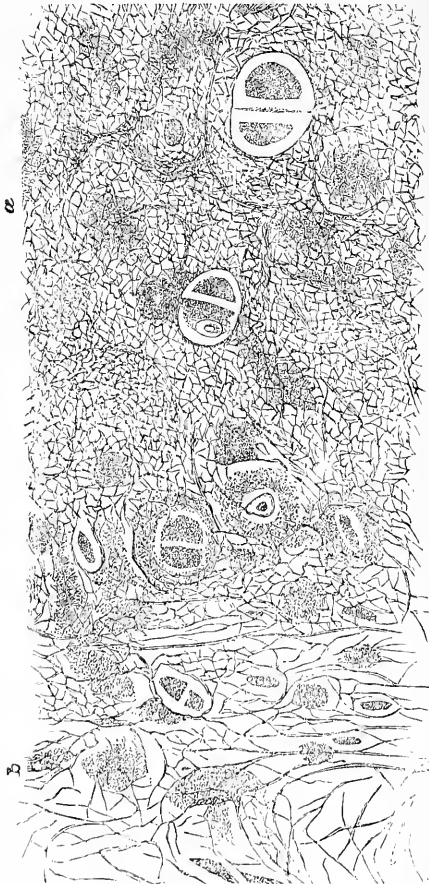

FIG. 448.—Section of cartilage of ear of man (Rollett). *a*, fibro-cartilage; *b*, connective tissue. The cartilage had been boiled and dried prior to cutting.

medullary canal, but later it is less vascular, and abounds in fat. Blood-vessels pass from it into the compact tissue of the

bone. The main artery, whence the others are derived, for the shaft of the bone, enters by the nutrient foramen on the surface, and toward the center.

The bone-corpuscles (Fig. 446), answering to the connective-tissue cells, are nutritive and formative after a considerable portion of the tissue has become the seat of the deposit of lime-salts. Bone is a living tissue, though in a less degree than most others; but it is only by bearing these relations in mind that its function in the support of the soft parts of an animal, and especially as constituting the essential levers of its locomotive mechanism, can be understood.

Cartilage.—In the earliest stages of an animal's existence the bones are represented by cartilage, and at all periods of its existence this structure forms those elastic pads that cover its articular surfaces, and shield the bones and the entire animal from undue concussion. The kind of cartilage that covers the extremities of the long bones, known as articular, is characterized by abundance of cells lying in a homogeneous bed or matrix (Fig. 447).

Fibro-cartilage (Fig. 448) abounds in fibrous tissue, some elastic fibers, characteristic cells, etc., and is found between the bodies of the vertebræ and in similar situations, as well as in the epiglottis, the ear, etc.

LOCOMOTION.

THE entire locomotor system of tissues is derived from the embryonic mesoblast. These include the muscles, bones, cartilage, and connective and fibrous tissues ; and the tissues that make up the vascular system or the motor apparatus for the circulation of the blood. Locomotion in the mammal is effected by the movement of certain bony levers, while the equilibrium

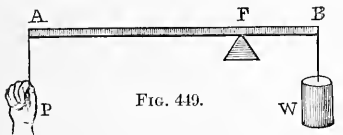

FIG. 449.

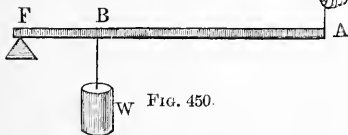

FIG. 450.

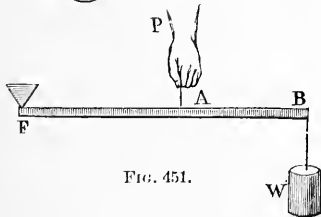

FIG. 451.

of the body is maintained. The whole series of levers is bound together by muscles, tendons, ligaments, etc., and play over one another at certain points where they are invested with cartilage, and kept moist by a secretion from the cells covering the synovial membranes that form the inner linings of joints.

Cartilage, a very low form of tissue destitute of blood-vessels, and hence badly repaired when lost by injury or disease, forms a series of smooth surfaces admirably adapted for joints, and especially fitted to act as a series of elastic buffers, and thus prevent shocks. Bone, though

brittle in the dried state, possesses, when alive, a favorable degree of elasticity, while sufficiently rigid. Provision is made by its vascular periosteum and central marrow (in the case of the long bones), as well as by the blood-supply derived from the nutrient artery and its ramifications throughout the osseous

tissue, for abundant nourishment, growth, and repair after injury.

We find in the body of mammals, including man, examples of all three kinds of levers. It sometimes happens that there is an apparent sacrifice of energy, the best leverage not being exemplified ; but on closer examination it will be seen that the weight must either be moved with nice precision or through large distances, and these objects can not be accomplished always by the arrangements that would simply furnish the most powerful lever. This is illustrated by the action of the biceps on the forearm.

It is to be remembered that, while the flexors and extensors of a limb act in a certain degree the opposite of one another,

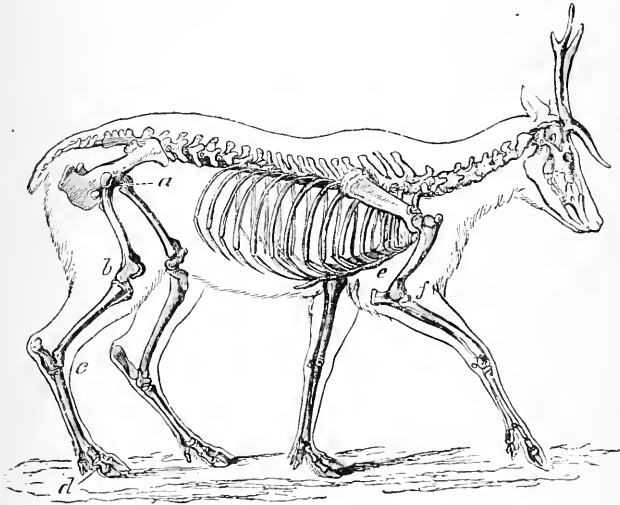

FIG. 452.—Skeleton of deer. The bones in the extremities of this the fleetest of quadrupeds are inclined very obliquely toward each other and toward the scapular and iliac bones. This arrangement increases the leverage of the muscular system and confers great rapidity on the moving parts. It augments elasticity, diminishes shock, and indirectly begets continuity of movement. *a*, angle formed by femur with ilium; *b*, angle formed by tibia and fibula with femur; *c*, angle formed by phalanges with cannon-bone; *e*, angle formed by humerus with scapula; *f*, angle formed by radius and ulna with humerus (Pettigrew).

there is also, in all cases perhaps, a united action ; the one set, however, preponderating over the other, and usually several muscles, whether of the same or different classes, act together.

Standing itself requires the exercise of a large number of

similar and antagonistic muscles so co-ordinated that the line of gravity falls within the area of the feet. An unconscious animal falls, which is itself an evidence of the truth of the above remarks.

The following statements in regard to the direction of the line of gravity in man may prove useful : 1. That for the head falls in front of the occipital articulation, as exemplified by the nodding of the head in a drowsy person occupying the sitting attitude. 2. That for the head and trunk together passes behind a line joining the centers of the two hip-joints, hence the uncorrected tendency of the erect body of man is to fall backward. 3. That for the head, trunk, and thighs falls behind the knee-joints somewhat, which would also favor falling backward (bending of the knees). 4. The line of gravity of the whole body passes in front of a line joining the two ankle-joints, so

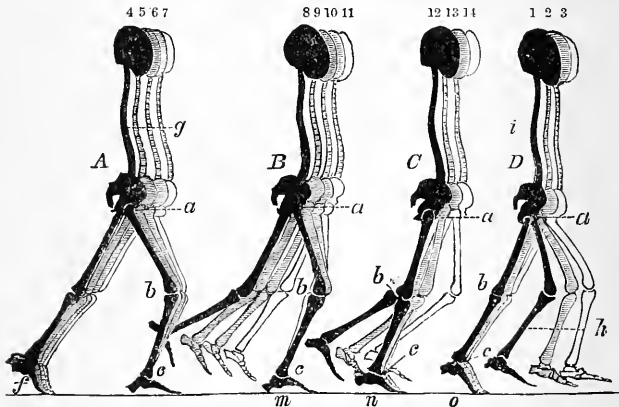

FIG. 453.—Shows the simultaneous positions of both legs during a step, divided into four groups (after Weber). First group (A), 4 to 7, gives the different positions which the legs simultaneously assume while both are on the ground; second group (B), 8 to 11, shows the various positions of both legs at the time when the posterior leg is elevated from the ground, but behind the supported one; third group (C), 12 to 14, shows the positions which the legs assume when the swinging leg overtakes the standing one; and the fourth group (D), 1 to 3, the positions during the time when the swinging leg is propelled in advance of the resting one. The letters *a*, *b*, and *c* indicate the angles formed by the bones of the right leg when engaged in making a step; the letters *m*, *n*, and *o*, the positions assumed by the right foot when the trunk is rolling over it; *g*, shows the rotating forward of the trunk upon the left foot (*f'*) as an axis; *h*, shows the rotating forward of the left leg and foot upon the trunk (*a*) as an axis.

that the body would tend, but for the contraction of the muscles of the calves of the legs, to fall forward.

Taking these different facts into consideration explains the

various directions in which an individual, when erect, may fall according as one or the other line (center) of gravity is displaced for a long enough time.

Walking (man) implies the alternate movement of each leg forward, pendulum-like, so that for a moment the entire body must be supported on one foot. When the right foot is lifted or swung forward, the left must support the weight of the body. It becomes oblique, the heel being raised, the toe still resting on the ground; and it is upon this as a fulcrum that the body-weight is moved forward, when a similar action is taken up by the opposite leg.

It follows that to prevent a fall there must be a leaning of the body to one side, so that the line of gravity may pass through each stationary foot; hence a person walking describes a series of vertical curves with the head and of horizontal ones with the body, the resulting total being complex.

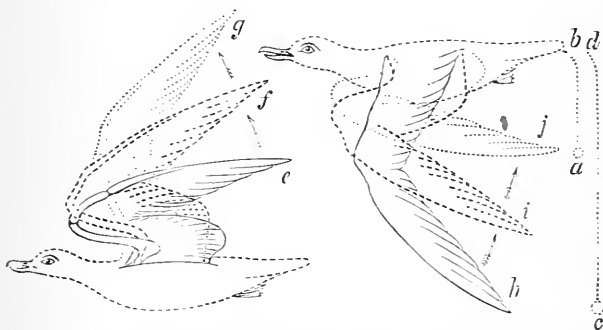

FIGS. 454 and 455.—Showing the more or less perpendicular direction of the stroke of the wing in the flight of the bird (gull); how the wing is gradually extended as it is elevated (*e, f, g*); how it descends as a long lever until it assumes the position indicated by *h*; how it is flexed toward the termination of the down-stroke, as shown at *h, i, j*, to convert it into a short lever (*a, b*) and prepare it for making the up-stroke. The difference in the length of the wing during flexion and extension is indicated by the short and long levers *a, b* and *c, d*. The sudden conversion of the wing from a long into a short lever at the end of the down-stroke is of great importance, as it robs the wing of its momentum and prepares it for reversing its movements (Pettigrew).

The peculiarities of the gait of different persons are naturally determined by their height, length of leg, and a variety of other factors, which are often inherited with great exactness. We instinctively adopt that gait which economizes energy, both physical and mental.

Running differs from walking, in that both feet are for a

The length and flexibility of their bodies must also be taken into account, rendering many legs necessary for support.

The subject of locomotion is of such great importance in the practice of comparative medicine that we shall now enter upon it in somewhat more detail, especially as regards the horse. This, of all our domestic animals, has become specialized as a locomotive mechanism. All the parts of his whole economy have been co-ordinated to that end; and, except the horse be viewed in this light, the significance of much in his nature

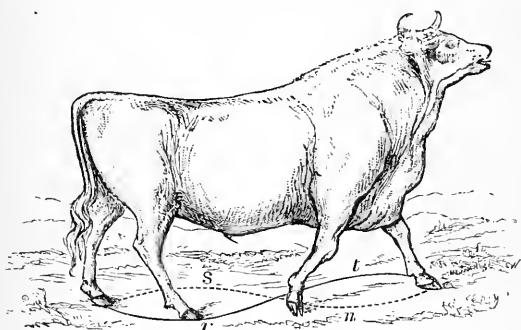

FIG. 458.—Chillingham bull (*Bos Scoticus*). Shows powerful, heavy body, and the small extremities adapted for land transit. Also the figure-of-8 movements made by the feet and limbs in walking and running. *u, t*, curves made by right and left anterior extremities; *r, s*, curves made by right and left posterior extremities. The right fore and the left hind foot move together to form the waved line (*s, u*); the left fore and the right hind foot move together to form the waved line (*r, t*). The curves formed by the anterior (*t, u*) and posterior (*r, s*) extremities form ellipses (Pettigrew).

will be missed. But, however well his other parts might be suited to this purpose, unless the feet were adapted to rapid movements and great and frequently repeated concussions, the animal must soon break down. As it is, under the unnatural conditions of our artificially constructed roads, faulty shoeing, housing, and feeding, lamenesses of the feet constitute a large proportion of the cases that fall under the care of the practitioner. It may be well at the outset to give a little consideration to the feet of the horse, in order to learn to what extent they are adapted to natural conditions. The feet of all mammals illustrate how the soft and yielding tissues are combined with the rigid, to adapt to conditions of the surface over which they are required to move. In the carnivora, beneath the outer tough skin covering the sole, there is the fatty cushion protective to the bones and more delicate soft parts; while the claws, nails, etc.

in which the toes end, are not only weapons of offense and defense, but protective against injury from contact with hard surfaces, as well as directly helpful in locomotion. These principles are admirably exemplified in the foot of solipeds.

The foot of the horse may be said to consist of terminal bones incased in soft structures adapted to shield the animal from the effects of excessive concussion and for nutrition, the

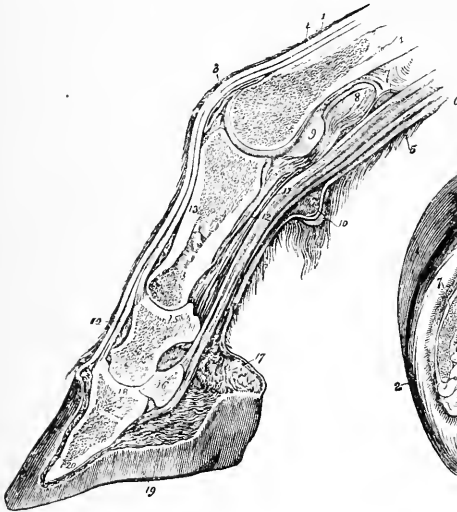

FIG. 459.

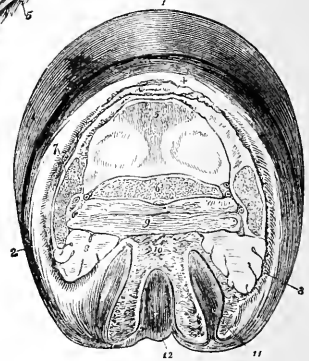

FIG. 460.

FIG. 459.—Longitudinal median section of foot. 1, anterior extensor of phalanges, or extensor pedis; 2, lateral extensor, or extensor suffraginis; 3, capsule of metacarpo-phalangeal articulation; 4, large metacarpal bone; 5, superficial flexor of phalanges, or perforatus; 6, deep flexor, or perforans; 7, sheath; 8, bursa; 9, sesamoid bone; 10, ergot and fatty cushion of fetlock; 11, crucial ligament; 12, short sesamoid bone; 13, first phalanx; 14, bursa; 15, second phalanx; 16, navicular bone; 17, plantar cushion; 18, third phalanx; 19, plantar surface of hoof; 20, sensitive or keratogenous membrane of third phalanx.

FIG. 460.—Horizontal section of horse's foot. 1, front of toe of hoof; 2, thickness of wall; 3, laminae; 4, insertion of extensor pedis; 5, os pedis; 6, navicular bone; 7, wings of os pedis; 8, lateral cartilage; 9, flexor pedis tendon; 10, plantar cushion; 11, inflexion of wall or "bar"; 12, horny frog.

whole being incased in a protective covering which in a state of nature is constantly being worn away and renewed. The hoof is the homologue of the nails and claws of other mammals, and so may be regarded as a modification of the epidermis; and thus viewed, its structure is at once more readily understood and more interesting. To speak from an anatomical standpoint, the foot of the horse is made up of the terminal

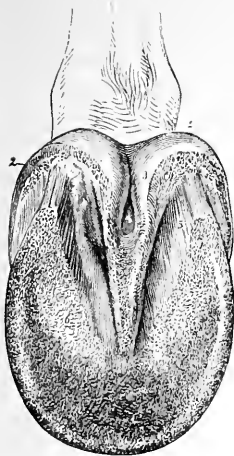

FIG. 461.



FIG. 462.

FIG. 461.—Lower face of horse's foot, hoof being removed. 1, heel; 2, coronary cushion; 3, branch of plantar cushion; 4, median lacuna; 5, lamina of the bars; 6, velvety tissue of sole.
 FIG. 462.—Lateral view of horse's foot after removal of hoof. 1, periopic ring, divided by a narrow groove from coronary cushion, 2, which is continuous with plantar cushion, 4, and joins vascular lamina, 3, through medium of white zone.

phalanx, the navicular bone, and the lower part of the second phalanx; certain ligaments entering into the articulations: the

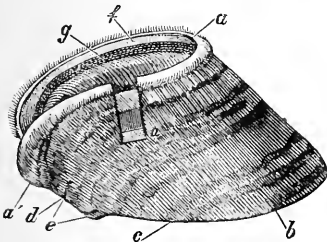

FIG. 463.

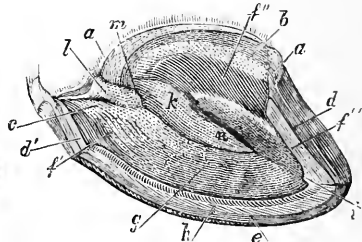

FIG. 464.

FIG. 463.—Hoof just removed from foot; side view. *a*, inner surface of periople, or coronary frog-band, with some hairs passing through; *a'*, outer surface of same at posterior part of foot; *a''*, a section through the wall to show its thickness; *b* to *c*, quarter of hoof; from *b* to front is outside (or inside) toe, from *c* to *d* the outside (or inside) heel; *e*, frog; *f*, bevel, or upper margin of wall for reception of coronary cushion; *g*, keraphylla, or horny laminae.
 FIG. 464.—Hoof, with outer portion of wall removed to show its interior. *a, a*, periople, or coronary frog-band; *b*, cavity in upper part of wall for coronary cushion; *c*, upper or inner surface of "bar"; *d*, vertical section of wall; *d'*, same, at heel; *e*, horizontal section of ditto; *f'*, horny laminae of "bar"; *f''*, ditto of wall; *f'''*, lateral aspect of a lamina; *g*, upper or inner surface of horny sole; *h*, junction of horny laminae with the sole (the "white line"); *i*, toe-stay at middle of toe; *k*, upper or inner surface of horny frog; *l*, frog-stay; *m*, cavity corresponding to a branch of the frog; *n*, ditto, corresponding to body of frog.

terminations of the common extensor and the perforans tendons ; the lateral cartilages ; a certain amount of connective and fatty tissue ; the hoof-secreting mechanism, together with the blood-vessels, nerves, lymphatics, etc., essential for all parts.

The relative size and position of parts may be gathered from the accompanying cuts. The lateral cartilages belong to the class known as fibro-cartilage, acting, no doubt, as perfect buffers ; and as springs must be of no small assistance in locomotion.

The horny matter of the foot (hoof) owes its formation to the cells of a tissue bearing various names in different regions,

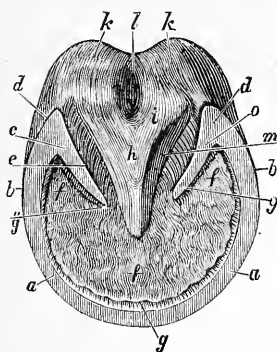

FIG. 465.



FIG. 466.

FIG. 465.—Plantar or ground surface of a hoof; right foot. The interval from *a* to *a* represents the toe; from *a* to *b*, *b*, outside and inside quarters; *c*, *o*, commencement of bars; *d*, *d*, inflexions of wall at heels or "buttresses"; *e*, lateral lacuna; *f*, *f*, *f*, sole; *g*, white line; *g*", ditto, between sole and bar; *h*, body of frog; *i*, branch of frog; *k*, *k*, glomes, or heels of frog; *l*, median lacuna.

FIG. 466.—Horn cells from sole of hoof. *a*, young cells from upper surface of sole; *b*, cells from lower surface, or dead horn of sole.

but consisting of a basis of fibrous tissue abounding in blood-vessels and nerves. The vessels from their arrangement have determined the names given to the formative tissue, such as villosities, villi, velvety tissue, vascular laminae, etc. It can not, however, be too well borne in mind that these structures are after all, only modified corium (Fig. 371).

Just as the epidermis, with its numerous layers, arises from a modification of cells in the lower layers, resting on the vascular villi of the corium, so the hoof owes its origin to a similar source. Thus from the velvety tissue is formed the sole and frog ; from the periopic ring, the periople ; and from the coronary cushion, the wall (see figures).

The arrangement of the horn-tubes, the horny laminae (Figs. 467, 468), and the horn-cells is admirably adapted to form a somewhat yielding yet very resisting structure.

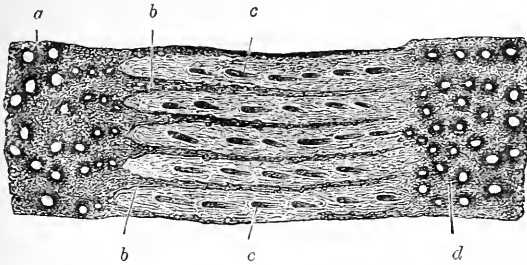

FIG. 467.—Horizontal section of junction of wall with sole of hoof. *a*, wall with its horn-tubes; *b, b*, horny laminae projecting from wall; *c, c*, horn-tubes formed by terminal villi of vascular laminae, the horn surrounding them and occupying the spaces between the horny lamina constituting the "white line"; *d*, horny sole with its tubes.

Regarded from a mechanical point of view, for speed a quadruped requires rather long limbs, so set on a somewhat rigid trunk as to allow of a long as well as a rapidly repeated stride, without undue concussion to either of the more rigid

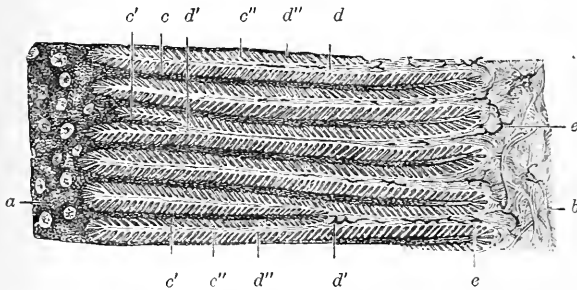

FIG. 468.—Horizontal section of wall and horny and vascular laminae to show junction of latter and laminellae. *a*, inner portion of wall with laminae arising from it; *b*, vascular laminae; *c*, horny lamina of average length; *c', c'*, unusually short laminae; *c'', c''*, laminellae on the sides of the horny laminae; *d*, vascular lamina passing between two horny ditto; *d'*, vascular lamina passing between three horny laminae; *d'', d''*, lateral laminellae; *e, e*, arteries of vascular lamina which have been injected.

cortical parts. In the horse the fore-limbs are not attached to the trunk by osseous connections, but the animal may be said to be slung between its fore-limbs, all connections with the trunk being by soft parts, as muscles, tendons, and ligaments.

The advantages of such an arrangement, to an animal in which a great deal of forward-pitching movement occurs, in breaking shocks are evident. The lengthened metatarsals and phalanges are accompanied by a very perfect bracing of joints by ligaments and tendons below, while the shoulder is strengthened and bound to the trunk by numerous muscles, so that the whole, in neatness, strength, and other qualities required in a fleet animal, is, especially when taken in connection with the feet, an example of marvelous adaptation to conditions to be constantly met, aided in the wild species by natural selection, and in our domestic varieties by artificial selection.

An examination of Fig. 470 will show the several levers (bones) and the muscles acting on them in one main movement of the fore-limb.

The hind-limbs are in all gaits of the animal its main propellers, and these are in bony connection with the pelvis.

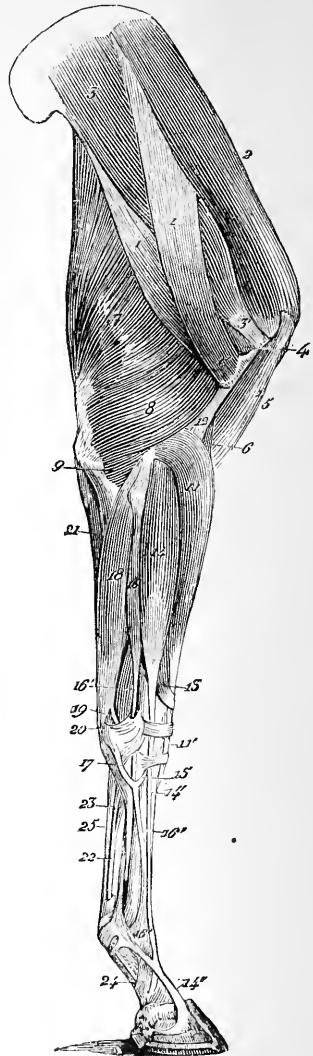

FIG. 469.—External muscles of right anterior limb (Chauveau). 1, 1, long abductor of arm; 1', its humeral insertion; 2, supraspinatus; 3, subspinosus; 3', its tendon of insertion; 4, short abductor of arm; 5, biceps; 6, anterior brachialis; 7, large extensor of forearm; 8, short extensor of forearm; 9, anconeus; 11, anterior extensor of metacarpus; 11', its tendon; 12, aponeurosis, separating that muscle from anterior brachialis; 13, oblique extensor of metacarpus; 14, anterior extensor of phalanges; 14', its principal tendon; 15, small tendinous branch it furnishes to lateral extensor; 16, lateral extensor of phalanges; 16', its tendon; 17, fibrous band it receives from carpus; 18, external flexor of metacarpus; 19, its metacarpal tendon; 20, its supracarpal tendon; 21, ulnar portion of perforans; 22, tendon of perforans; 23, its carpal ligament; 24, its re-enforcing phalangeal sheath; 25, tendon of the perforans.

It will not be forgotten that in joints the insheathing cartilages (sometimes others more or less free), the synovial fluid, etc., all tend to diminish friction and lessen concussion.

We shall now describe the principal gaits of the horse in a somewhat synoptical way.

In each gait we have to consider the relative position of the four limbs, the duration of each phase in the movement, the length of the stride, its rate, etc. Much that applies to the horse holds good, of course, of other quadrupeds.

In every gait each leg passes from a condition of flexion to one of extension, the degree being dependent on the speed or, more correctly, the effort of the animal to attain high speed or the reverse.

When the foot rests upon the ground before the limb is removed, it describes the arc of a circle, or oscillates like a pendulum so that the flexors and extensors are used alternately more and less; though in all movements it is likely that neither set is wholly relaxed. The more thoroughly muscular move-

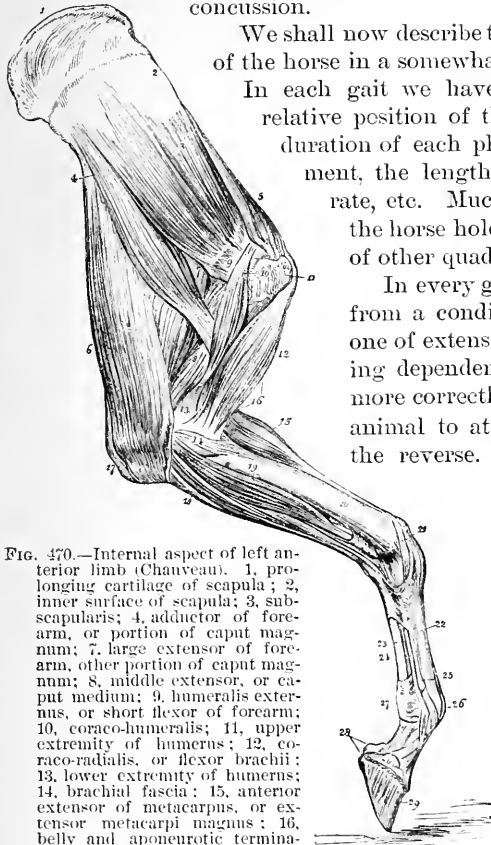

FIG. 470.—Internal aspect of left anterior limb (Chauveau). 1, prolonging cartilage of scapula; 2, inner surface of scapula; 3, subscapularis; 4, adductor of forearm, or portion of caput magnum; 7, large extensor of forearm, other portion of caput magnum; 8, middle extensor, or caput medium; 9, humeralis externus, or short flexor of forearm; 10, coraco-humeralis; 11, upper extremity of humerus; 12, coraco-radialis, or flexor brachii; 13, lower extremity of humerus; 14, brachial fascia; 15, anterior extensor of metacarpus, or extensor metacarpi magnus; 16, belly and aponeurotic termination of flexor brachii; 17, ulna; 18, ulnaris accessorius, or oblique flexor of metacarpus; 19, internal flexor of metacarpus, or epicondylometacarpus; 20, radius; 21, tendon of oblique extensor; 22, large metacarpal-bone; 23, flexor tendons of foot; 24, suspensory ligament; 25, internal rudimentary metacarpal bone; 26, extensor tendon of foot; 27, metacarpo-phalangeal sheath; 28, lateral cartilages of foot; 29, podophylle.

ments are studied the more complex, so far as the use of muscles is concerned, are they found to be, a fact which is illustrated when even a single muscle is weakened or paralyzed.

Walking.—In this gait the body rests on diagonal feet alternately with the two of the same side; the center of gravity being shifted to one side, then returned to its original position, to be moved next to the opposite side. In drawing heavy loads the body is supported on three limbs. The rate of movement is one to two metres per second.

Amble.—In this mode of progression, most common in the

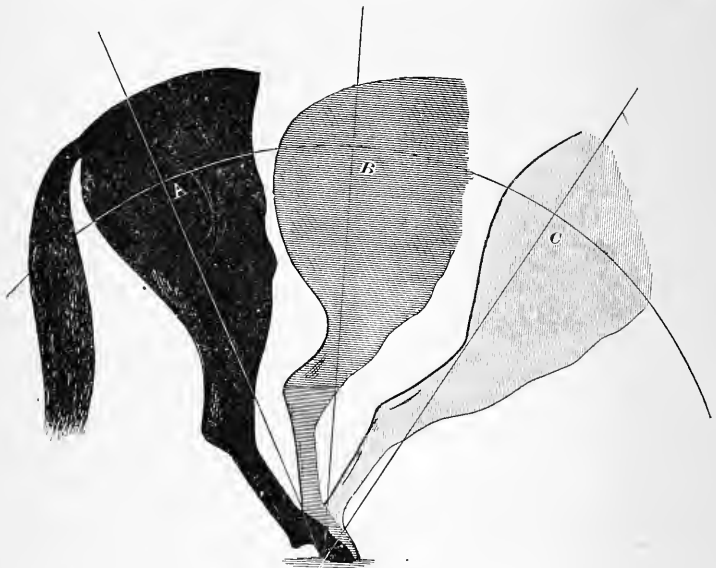

FIG. 471.—Movements (oscillation) of an extended hind-leg (Colin). The hip-joint describes the arc of a circle, A B C, while the foot is on the ground, the lines A D, B D, and C D representing the changing axis of the hind-leg.

giraffe and camel tribe, occasional in ruminants and solipeds, the body is supported by the two legs on the same side, as in the walk, but the two opposite legs are elevated simultaneously and not separately. In horses this gait is often termed *pacing*, and is frequently very fast. Only two strokes of the feet are heard in this gait.

In *racking* the hind-leg leaves the ground sooner than the corresponding fore-leg, hence four strokes of the feet are heard.

The Trot.—The diagonal feet act together, two strokes of the feet being heard at each complete step. In the fast trot there is an interval in which all four feet are in the air. The hind-feet strike the ground in front of the fore-feet. The speed in

the fast trot may reach from eight to twelve metres per second.

The Gallop.—The gallop may be regarded as a series of

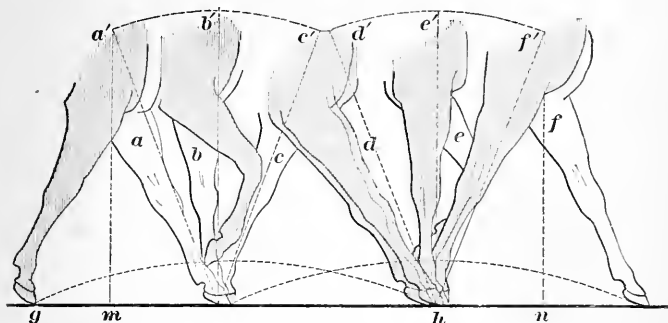

FIG. 472.—Movements of fore-limbs of horse (Colin). While one fore-leg is describing the movements figured above the other acts as a support. While the right fore-foot describes the arc gh , the left shoulder describes the arc $a'b'c'$, owing to the impulse from extension of the hind legs. The center of gravity is advanced from m to n , the left leg in one complete step occupying the six positions indicated at $abcdef$.

jumps in which the hind-legs take the greater part, though as in all gaits the fore-legs are not only supporters but propellers.

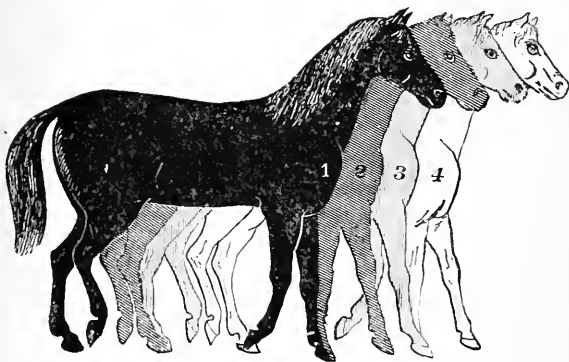

FIG. 473.—Various positions of the limbs in the trot (Colin).

In the perfect gallop only two strokes of the feet are heard; in the canter or slow gallop four, in the ordinary gallop three. According as the one or other hind-leg is extended farthest behind the body the gallop is termed right-handed or left-handed.

In the fastest gallop the length of stride may amount to six to seven metres, and the speed to twelve to fifteen metres per second. In such a rapid gait the contact of the one hind foot produces a sound lengthened by the rapid impact of the fellow-foot. The same applies to the fore-feet, hence only two sounds, while in the other varieties of this gait the interval between the impacts is sufficient to allow of three, or it may be four sounds.

The accompanying plate, constructed by the help of instantaneous photography, illustrates the different positions of a horse in the gallop.

Sloping shoulder-blades and well-bent stifle-joints are generally recognized as of great importance to an animal intended for high speed, and these are commonly to be met with in the

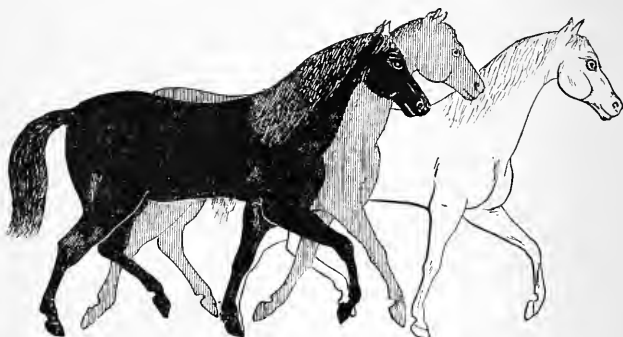

FIG. 474.—Various positions in the trot (Colin).

fleetest of horses, dogs, and other quadrupeds (Fig. 452). It may be seen that such an arrangement permits of a lengthened stride being taken with ease, tends to reduce concussion, and adds to beauty of form. To this must, in part at all events, be attributed the grace of form and fleetness of the race-horse and the greyhound, not to mention wild animals.

A horse for heavy-draught purposes requires great muscular power, which in turn implies a strongly developed osseous system; and in order that this may be attained some of those principles on which speed depends must be subordinated to those involved in strength. As is well known, the cart-horse and race-horse, the mastiff and the greyhound, are opposites in build and capacity for speed. However, between these extreme forms there are many others of an intermediate character, as the hunter, roadster, etc. When famous race-horses are studied,

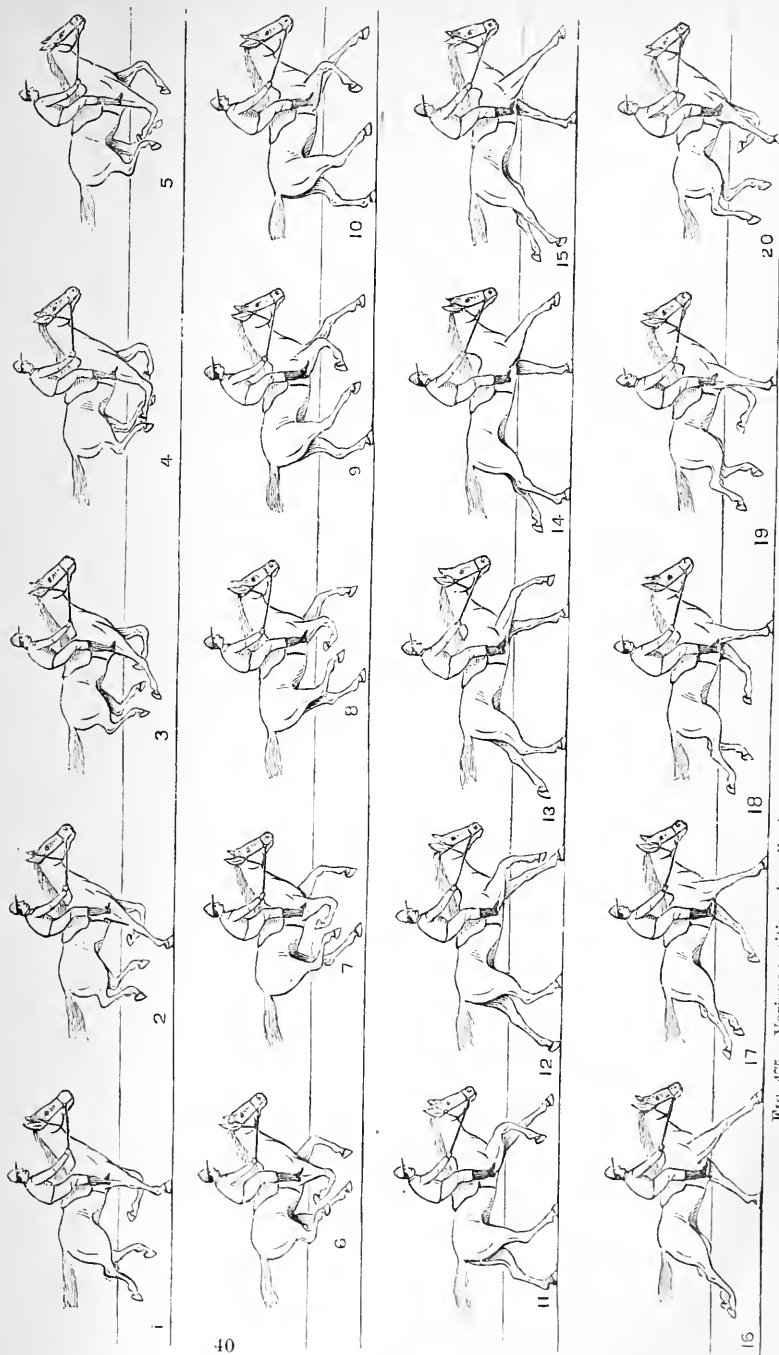

FIG. 475.—Various positions in galloping (figured by Smith from instantaneous photographs by Muybridge).

while the form of the animal generally agrees with what would have been expected on mechanical principles it is a fact that some of the fleetest horses that have ever run on the course have not in all respects been built in conformity with them. But it is to be remembered that a vital mechanism differs from all others in that the whole consists of parts dependent not only as one portion of any machine is on the other, but that every part is energized and directed by a governing nervous system; that every cell is being in a sense constantly renewed, so that the comparison between any ordinary mechanism and the body of a living animal holds only to a limited extent. Moreover, apart from peculiarities in the muscles of animals, to which attention has been drawn (page 205), it is well to bear in mind that not only every animal, but every tissue has its own functional individuality; and to this especially (as exemplified in the most important of all the tissues, the nervous) must we attribute the undoubted fact that the speed, endurance, etc., of animals can not be explained on mechanical principles alone—a truth to which too little attention has hitherto been drawn. These principles have, however, been unconsciously recognized practically, hence the great attention paid by breeders to using animals for stock purposes that have actually shown merit by their performances.

Evolution.—It is noteworthy that with almost all quadrupeds the gallop is the natural method for rapid propulsion. In all animals, either bred by man to attain great speed, as the race-horse and greyhound, or those that have become so by the process of natural selection, the entire conformation of the body has been modified in harmony with the changes that have taken place in the legs and feet. This is seen in the greyhound among domestic animals, and in the wild deer of the plain and forest. Such instances illustrate not only the principle of natural selection as a whole, but the subordinate one of correlated growth.

Any one observing the modes of locomotion of quadrupeds, especially horses and dogs, will perceive the advantages of the four-legged arrangement. Not only is there a variety of modes of progression, as walking, trotting, galloping, cantering, the alternations of which permit of rest to certain groups of muscles, with their corresponding nervous connections, etc., but on occasion some of these animals can progress fairly well with three legs. Sometimes it may also be noticed that a horse that

prefers one gait, as pacing, for his easy, slow movements, will break into a trot when pushed to a higher rate of speed.

Trotting can not be considered the natural gait for high speed in the horse, yet, by a process of "artificial selection" (by man) from horses that have shown capacity for great speed by this mode of progression, strains of racers have been bred, showing that even an acquired mode of locomotion may be hereditary; while that galloping is the more natural mode of locomotion of the horse is evident, among other things, by the tendency of even the best trotting racers to break into a gallop when unduly pushed—an instance also of an hereditary tendency of more ancient origin prevailing over one more recent.

The bipedal modes of progression of birds are naturally very like those of man.

I N D E X .

- Abductor or sixth nerve, 582.
Abnormal urine, 421.
Accelerator nerves of heart, 258.
Accommodation of eye, 532.
Action of mammalian heart, 222.
Affections of retina, 540.
Afferent fibers, 583.
After-images, etc., 543.
Alimentary canal of vertebrate,
331.
Allantois, 77.
Allantoic cavity, 80.
Albumins, 145.
derived, 145.
Alterations in size of pupil, 533.
Amble, 624.
Amnion, 76.
Amœba, 13.
Amyolytic action of saliva, 297.
Animal body, 28.
Animal foods (table), 277.
Animal heat, 445.
Animals deprived of cerebrum, 482.
Anæmia, 117.
Anomalies of refraction, 536.
Apnoea, 395.
Apparatus used for stimulation of
muscle, 179.
for transmission of muscular move-
ments by tambours, 182.
Asphyxia, respiration and circulation
in, 399.
Auditory ossicles, 559.
Auditory impulses, 565.
sensations, etc., 567.
Automatism, nervous system, 211.
Automatic functions of spinal cord,
475.
Bacteria, 18.
Barking, 402.
Bawling, neighing, braying, 403.
Beat of the heart and its modifica-
tions, 248.
Bell-animalcule, 21.
Bile, digestive action of, 303 .
salts, 302.
pigments, 302.
Biology, general, 1.
table, 4.
Blastodermic vesicle, 78.
Blood, 154.
cells, 158.
cells, decline, and death, 160.
chemical composition of, 160.
pressure, 223-227.
flow, 227.
Bone, 604.
Botany, 4.
Brain, 481.
Capillaries, 264.
Carbon-dioxide of blood, 389.
Carbohydrates, 146.
Cardiac movements, 231.
sounds, 234.

- Cartilage, 609.
 Causes of the sounds of the heart, 235.
 Cell, 5.
 the male, 61.
 Cellulose, 9.
 Cerebellum, 508.
 Cerebral cortex, 497.
 Cerebro-spinal system of nerves, 580.
 and sympathetic systems, relations
 of, 588.
 Certain tissues, 603.
 Characteristics of proteids, general,
 144.
 of blood-flow, 226.
 of secretion of different glands,
 298.
 Changes in muscle during contrac-
 tion, 189.
 produced in food in alimentary
 canal, 354.
 in circulation after birth, 129.
 Chemical constitution of animal body,
 142.
 changes in muscle, 189.
 composition of blood, 160.
 Chemistry of unicellular plants, 9.
 Chondrin, 145.
 Chorion, 79.
 Chronographs, 176.
 Ciliary movements, 179.
 (ophthalmic lenticular), ganglion,
 584.
 Circulation of blood, 214.
 in mammal, 219,
 under microscope, 224.
 in brain, 500.
 Circumstances influencing character
 of muscular and nervous activ-
 ity, 199.
 Classification of animal kingdom, 34.
 of proteids, 145.
 Clinical and pathological *re* blood,
 167.
 Coagulation of blood, 163.
 Coitus, 129.
 Color-vision, 543.
 Comparative *re* blood, 154, 172.
 unstripped muscle, 202.
 blood-pressure, 224.
 cardiac pulsation, 240.
 circulation, 244, 267.
 digestion, 280, 310, 357.
 metabolism, 436.
 diet, 438.
 digestive juices, 298.
 digestive organs, 324, 337.
 bile, 303.
 feeding experiments, 441.
 fats and carbohydrates, 442.
 animal heat, 445.
 spinal cord, 477.
 cerebral convolutions, 485.
 muscular sense, 524.
 vision, 536-551.
 hearing, 568.
 senses of smell and taste, 574, 578.
 voice, 598.
 locomotion, 614.
 swallowing, 336.
 vomiting, 340.
 movements of lymph, 344.
 respiration, 376, 398.
 hæmoglobin, 389.
 respiratory movements, 402.
 respiration by skin, 412.
 perspiration, 413.
 expulsion of urine, 426.
 Comparison of inspired and expired
 air, 382.
 Composition of serum, 131.
 of corpuscles, 162.
 of milk, 275.
 Conclusions *re* unicellular plants, 10.
 protococcus, 12.
 unicellular animals, 15.
 nervous system, 212.
 heart, 257.
 salivary secretion, 314.

- Condiments, 278.
 Connective tissue, 603.
 Contractile tissues, 171.
 Connection of one part of brain with another, 491.
 Construction of fat, 432.
 Conditions under which gases exist in blood, 384.
 Co-ordination of two eyes in vision, 544.
 Coughing, 401.
 Corpuscles, 156.
 action of the, 227.
 Corpora quadrigemina, 506.
 Corpus striatum and optic thalamus, 504.
 Cranial nerves, 580.
 Crying, 402.

 Decussation, 471.
 Defecation, 338.
 Deglutition, 333.
 Dentition of domestic animals (table), 290-296.
 Development of embryo, 95.
 of vascular system in vertebrates, 108.
 of urogenital system, 112.
 Dextrin, 146.
 Diet, 437-439.
 effects of gelatin in, 441.
 effects of salts, water, etc., 443.
 Digestion of food, 274.
 Digestive juices, 297.
 action of bile, 303.
 organs, movements of, 332.
 Dioptrics of vision, 531.
 Discoidal placenta, 83.
 Domesticated animals, 47.
 Dyspnœa, 396.

 Effects of gelatin in diet, 441.
 Efferent nerve-fibers, 583.
 Entrance and exit of air, 370.

 Elasticity of muscle, 189.
 Elastin, 145.
 Elastic tissues, 604.
 Electrical phenomena of muscle, 191.
 organs, 197.
 Embryological *re* digestion, 279.
 brain, 510.
 vision, 528.
 Embryo, development of, 95.
 Embryology, applied to evolution, 45.
 Embryonic membrane of birds, 74.
 Endocardiac pressure, 236.
 Energy of animal body, 443.
 Epiblast, 98.
 Epithelium, 7.
 Evolution, 42.
 re reproduction, 93.
 circulation, 268.
 digestion, 363.
 respiration, 404.
 metabolism, 450.
 spinal cord, 478.
 brain, 511.
 vision, 552.
 hearing, 571.
 voice, 600.
 locomotion, 627.
 Estimation of size, etc., of objects, 548.
 Excretory function of skin, 411.
 Excretion of perspiration, 412.
 by the kidney, 415.
 Experimental facts, 185.
 re nervous system, 210.
 digestion, 305.
 spinal nerves, 580.
 Eustachian tube, 562.
 Eye, accommodation of, 532.
 optical imperfections of, 536.
 protective mechanisms of, 549.

 Facial nerve, 581.
 and laryngeal respiration, 374.
 Fat, construction of, 432.

- Fats, 145.
 and carbohydrates, 442.
- Fatigue, 199.
- Feeding experiments, 439.
- Features of an arterial pulse tracing,
 242.
- Fertilization of ovum, 63.
- Fibrin, 145, 164.
- Fæces, 352.
- Fœtal circulation, 125.
 later stages of, 109.
 membranes of mammals, 78.
- Food, digestion of, 274.
 stuffs, 274.
- Foods, animal, table of, 277.
 vegetable, table of, 277.
- Foreign gases in respiration, 391.
- Forced movements, 484.
- Fossil and existing species, 46.
- Fresh-water polyps, 23.
- Fungi, 15.
- Functional variations, 204.
- Functions of cerebral convolutions,
 485.
 of other portions of brain, 504.
- Gastrula, 68.
- Gastric juice, 299.
- Gelatin, 145.
- Geographical distribution, 46.
- Globulins, 145.
- Glosso-pharyngeal or ninth nerve,
 585.
- Glycogen, 428.
 uses of, 429.
- Glycocholic acid, 302.
- Gout, 139.
- Graafian follicle, 58.
- Graphic method and study of muscle
 physiology, 176.
- Gustatory fibers, 582.
- Hæmoglobin and its derivatives, 385.
- Hearing, 557.
- Heart, 231.
 of various animals, 245, 246.
 beat in cold-blooded animals, 250.
 causation of beat of, 253.
 influence of vagus nerve on, 253.
 accelerator nerves of, 258.
 in relation to blood-pressure, 260.
- Hen's egg, 69.
- Hiccough, 402.
- History of blood-cells, 158.
- Hydra, 26.
- Hypoblast, 98.
- Hypertrophy, 265.
- Hypnotism, 502.
- Hypoglossal or twelfth nerve, 588.
- Impulse of heart, 232.
- Influence of blood-supply, 199.
 of temperature, 201.
 of vagus nerve upon heart, 253.
 of condition of blood in respira-
 tion, 393.
 of respiration on circulation, 396.
 of nervous system on metabolism,
 452.
- Inhibition of reflexes, 469.
- Inorganic food-stuffs, 144, 274.
- Inosit, 145.
- Inorganic salts, 420.
- Instincts, 42.
- Investigation of heart-beat from
 within, 233.
- Intestinal movements, 337.
- Irritability of muscle and nerve, 175.
- Juices, digestive, 297.
- Keratin, 145.
- Lactose, 146.
- Law of periodicity or rhythm in na-
 ture, 37.
 of habit, 41, 405.
 of rhythm, 269.

- Laws of retinal stimulation, 541.
 Laughing, 401.
 Living things, 2.
 Living and lifeless matter, 32.
 Lymphatic system, 342.
 Lymph and chyle, 343.
 Locomotion, 610.
- Maltose, 146.
 Mammalian heart, 215, 222.
 Man's place in animal kingdom, 36.
 Medulla oblongata, 509.
 Membrana tympani, 558.
 Mesoblast, 98.
 Metadiscoidal placenta, 84.
 Metabolism, 27, 428.
 of liver, 428.
 of spleen, 429.
 influence of nervous system on, 452.
 summary of, 458.
 Metazoa, 5, 53.
 Milk, composition of, 275.
 sugar, 276.
 Mimicry, 45.
 Molds, 15.
 Morphology of unicellular plants, 9.
 of protococcus, 12.
 of unicellular animals, 13.
 applied to evolution, 45.
 Motor oculi nerve, 581.
 Movements of digestive organs, 332.
 stomach, 336.
 lymph, 344.
 Mucin, 145.
 Mucor mucedo, 17.
 Müllerian duct, 115.
 Multicellular organisms, 23.
 Muscular contraction, 185.
 Muscle tone, 189.
 Muscular work, 198.
 Muscles of respiration, 373.
 of middle ear, 561.
 Muscular sense, 524.
- Nasal or spheno-palatine ganglion, 584.
 Nature of act of secretion, 318.
 Nerve-cells, 209.
 supply (voice), 596.
 Nervous mechanism, 134.
 system, 208.
 inhibition, 212.
 system in relation to heart, 249.
 supply—digestion, 333.
 system in relation to respiration, 393.
 Nitrogen of blood, 389.
 Nitrogenous metabolites, 147.
 crystalline bodies, 420.
 equilibrium, 440.
 Non-nitrogenous metabolites, 147.
 organic bodies, 420.
 Non-crystalline bodies, 145.
 Notochord, 99.
 Nucleus, 5.
 Nucleolus, 5.
 Nuclear division, 6.
 Nuclein, 145.
 Nutrition of ovum, 123.
- Ocular movements, 544.
 Estrum, 121.
 Optical imperfections of the eye, 536.
 Origin of forms of life, 42.
 of spermatozoön, 61.
 of fowl's egg, 70.
 Organic evolution reconsidered, 137.
 food-stuffs, 144-274.
 Otic ganglion, 585.
 Ovulation, 120.
 Ovum, 55.
 origin and development of, 57.
 changes in, 58.
 Oxy-hæmoglobin, 386.
- Paleontology, 46.
 Pancreatic juice, 305.
 Parasitic organisms, 15.

- Parturition, 128.
- Pathological *re* food-stuffs, 147.
 muscle, 197.
 circulation, 244, 265.
 bile, 318.
 stomach, 330, 337.
 lymphatics, 352.
 fæces, 354.
 digestion, 359.
 respiration, 379, 401, 403.
 skin, 411.
 urine, 423.
 expulsion of urine, 426.
 metabolism, 435, 443.
 temperature, 449.
 spinal cord, 471.
 brain, 508, 509.
 muscular sense, 524.
 vision, 536, 554.
 hearing, 563.
 spinal nerves, 580.
 third and other nerves, 582, 585,
 587, 588.
 voice, 598.
- Peculiar respiratory movements, 401.
- Peptones, 145.
- Pendulum myograph, 184.
- Perspiration, excretion of, 412.
- Periods of gestation, 127.
- Pflüger's monograph, 181.
- Physiology of unicellular plants, 10.
 of protococcus, 12.
 unicellular animals, 13.
 nerves, 195.
- Physiological aspects of development,
 118.
 research and reasoning, 148.
- Placenta, 82.
 discoidal, 83.
 metadiscoidal, 84.
 zonary, 89.
 diffuse, 89.
 polycotyledonary, 89.
 Simple, 90.
- Placenta multiple, 90.
 microscopic structure of, 90.
 Pneumogastric nerve, 586.
- Polyps, 23.
- Pressure, endocardiac, 236.
- Pressure sensations, 522.
- Proteids, general characteristics of,
 144.
 of milk, 276.
- Proteus animalcule, 13.
- Protococcus, 11.
- Protozoa, 5, 53.
- Protective and excretory function of
 skin, 408.
- Protective mechanism of the eye, 549.
- Protoplasm, 3.
- Proximate principles, 144.
- Pulse, 241.
 the venous, 244.
- Psychological aspects of vision, 543.
- Quantity and distribution of blood,
 163.
 of blood, influence on blood-pressure,
 261.
 of air respired, 378.
- Reflex functions of the spinal cord,
 466.
- Regulation of temperature, 447.
- Relations of cerebro-spinal and sym-
 pathetic symptoms, 588.
- Relative value of food-stuffs, 444.
 time occupied by cardiac cycle, 237.
- Removal of digested products from
 the alimentary canal, 341.
- Reproduction, 51.
- Retinal stimulation, laws of, 541.
- Respiratory system, 366.
 rhythm, 379.
 sounds, 81.
- Respiration, muscles of, 373.
 facial and laryngeal, 374.
 types of, 375.
 in blood, 383.

- Respiration in tissues, 391.
 Respiration and circulation in asphyxia, 399.
 in mammal, 405.
 by skin, 412.
 Rigor mortis, 206.
 Rhythm, 37.
 law of, 269.
 Rudimentary organs, 46.
- Salts, 144, 276.
 inorganic, 420.
 Saliva, 297.
 amylolytic action of, 297.
 Scar-tissue, 139.
 Serum, composition of, 161.
 Secretion as a physiological process,
 of salivary glands, 311.
 by stomach, 315, 321.
 of bile and pancreatic juice, 316.
 nature of the act, 318.
 of urine, 421.
 Secretory fibers, 582.
 Segmentation and subsequent changes,
 64.
 Self-digestion of digestive organs,
 323.
 Sense organs, 31.
 Sexual selection, 43.
 Separation of muscle from central nervous system, 201.
 Semicircular canals, function of, 484.
 Sighing, 402.
 Senses, general remarks, 516.
 of smell and taste, 573.
 Skin as an organ of sense, 520.
 Smell, 573.
 Sleep, 501.
 Sobbing, 402.
 Solidity, 548.
 Soap, 146.
 Sneezing, 402.
 Special considerations *re* muscle, 203.
 circulation, 265.
- Special considerations *re* digestion,
 359.
 metabolism, 450.
 spinal cord, 477.
 brain, 510.
 vision, 551.
 hearing, 568.
 voice, 600.
 Specific gravity of urine, 419.
 Spermatozoa, 61.
 Sphygmograph, 243.
 Spinal cord, general, 461.
 reflex functions of, 466.
 as a conductor of impulses, 469.
 automatic functions of, 475.
 nerves, 579.
 accessory, 587.
 Sporangia, 17.
 Starches, 147.
 Study of metabolic processes, 436.
 Submaxillary ganglion, 585.
 Succus entericus, 307.
 Sugars, 146.
 Summary of biology, 9.
 of evolution, 50.
 of reproduction, 93.
 development of the embryo, 135.
 physiological research, etc., 152.
 blood, 169.
 muscle and nerve, 205.
 circulation, 269.
 blood-cells, 158.
 digestion, 364.
 respiration, 405.
 perspiration, 413.
 urine, 426.
 metabolism, 458.
 voice, 601.
 Synoptical *re* spinal cord, 479.
 brain, 513.
 skin, 525.
 vision, 554.
 hearing, 572.
 Swallowing, 335.

- Tactile sensibility, 523.
 Tambour of Marey, 183.
 Taste, 575.
 Teeth, 284.
 structure and arrangement of the, 286.
 Temperature, regulation of, 447.
 Tetanizing key of Du Bois-Reymond, 181.
 Tetanic contraction, 187.
 Thermal changes in contracting muscle, 195.
 sensations, 522.
 Tissues, 8.
 Trigeminal, trifacial or fifth nerve, 583.
 Trochlear or fourth nerve, 582.
 Trot, 624.
 Types of respiration, 375.
 Unicellular plants, 9.
 animals, 13.
 with differentiation of structure, 21.
 Unstriated muscle, 202.
 Urea, 147.
 Urine considered physically and chemically, 419.
 abnormal, 421.
 Urine, secretion of, 421.
 expulsion of, 424.
 Variations in cardiac pulsation, 239.
 of average temperature, 446.
 Vaso-motor nerves, 262.
 Vegetable foods (table), 277.
 Velocity of blood and blood-pressure, 223.
 Venous pulse, 244.
 Vision, 526.
 dioptries of, 531.
 psychological aspects, 543.
 Visual sensations, 538.
 angle, 542.
 Voice, 593.
 Vomiting, 339.
 Vorticella, 21.
 Walking, 623.
 Water, 443.
 Wolfian duct, 115.
 Work of the heart, 238.
 Yeast, 9.
 cells, 10.
 Yawning, 402.
 Zoölogy, 4.

MEDICAL

AND

HYGIENIC WORKS

PUBLISHED BY

D. APPLETON & CO., 1, 3, & 5 Bond Street, New York.

- AULDE (JOHN). The Pocket Pharmacy, with Therapeutic Index. A *résumé* of the Clinical Applications of Remedies adapted to the Pocket-case, for the Treatment of Emergencies and Acute Diseases. 12mo. Cloth, \$2.00.
- BARKER (FORDYCE). On Sea-Sickness. A Popular Treatise for Travelers and the General Reader. Small 12mo. Cloth, 75 cents.
- BARKER (FORDYCE). On Puerperal Disease. Clinical Lectures delivered at Bellevue Hospital. A Course of Lectures valuable alike to the Student and the Practitioner. Third edition. 8vo. Cloth, \$5.00; sheep, \$6.00.
- BARTHOLOW (ROBERTS). A Treatise on Materia Medica and Therapeutics. **Seventh edition.** Revised, enlarged, and adapted to "The New Pharmacopœia." 8vo. Cloth, \$5.00; sheep, \$6.00.
- BARTHOLOW (ROBERTS). A Treatise on the Practice of Medicine, for the Use of Students and Practitioners. **Sixth edition,** revised and enlarged. 8vo. Cloth, \$5.00; sheep, \$6.00.
- BARTHOLOW (ROBERTS). On the Antagonism between Medicines and between Remedies and Diseases. Being the Cartwright Lectures for the Year 1880. 8vo. Cloth, \$1.25.
- BASTIAN (H. CHARLTON). Paralysis: Cerebral, Bulbar, and Spinal. A Manual of Diagnosis for Students and Practitioners. With 136 Illustrations. Small 8vo, 671 pages. Cloth, \$4.50.
- BASTIAN (H. CHARLTON). Paralysis from Brain Disease in its Common Forms. With Illustrations. 12mo, 340 pages. Cloth, \$1.75.
- BILLINGS (F. S.). The Relation of Animal Diseases to the Public Health, and their Prevention. 8vo. Cloth, \$4.00.
- BILLROTH (THEODOR). General Surgical Pathology and Therapeutics. A Text-Book for Students and Physicians. Translated from the tenth German edition, by special permission of the author, by Charles E. Hackley, M. D. **Fifth American edition, revised and enlarged.** 8vo. Cloth, \$5.00; sheep, \$6.00.
- BOYCE (RUBERT). A Text-Book of Morbid Histology. For Students and Practitioners. With 130 Colored Illustrations. Cloth, \$7.50.
- BRAMWELL (BYROM). Diseases of the Heart and Thoracic Aorta. Illustrated with 226 Wood-Engravings and 68 Lithograph Plates—showing 91 Figures—in all 317 Illustrations. 8vo. Cloth, \$8.00; sheep, \$9.00.
- BRYANT (JOSEPH D.). A Manual of Operative Surgery. **New edition, revised and enlarged.** 793 Illustrations. 8vo. Cloth, \$5.00; sheep, \$6.00.

- BURT (STEPHEN S.). Exploration of the Chest in Health and Disease. 8vo. 210 pages. With Illustrations. Cloth, \$1.50.
- CAMPBELL (F. R.). The Language of Medicine. A Manual giving the Origin, Etymology, Pronunciation, and Meaning of the Technical Terms found in Medical Literature. 8vo. Cloth, \$3.00.
- CARMICHAEL (JAMES). Disease in Children. A Manual for Students and Practitioners. Illustrated with Thirty-one Charts. 12mo, 591 pages. (STUDENTS' SERIES.) Cloth, \$3.00.
- CASTRO (D'OLIVEIRA). Elements of Therapeutics and Practice according to the Dosimetric System. 8vo. Cloth, \$4.00.
- CHAUVEAU (A.). The Comparative Anatomy of the Domesticated Animals. Revised and enlarged, with the co-operation of S. Arloing, Director of the Lyons Veterinary School. Second English edition. Translated and edited by George Fleming, C. B., LL. D., F. R. C. V. S., late Principal Veterinary Surgeon of the British Army; Foreign Corresponding Member of the Société Royale de Médecine, and of the Société Royale de Médecine Publique, of Belgium, etc. 8vo, 1084 pages, with 585 Illustrations. Cloth, \$7.00.
- CORNING (J. L.). Brain Exhaustion, with some Preliminary Considerations on Cerebral Dynamics. Crown 8vo. Cloth, \$2.00.
- CORNING (J. L.). Local Anæsthesia in General Medicine and Surgery. Being the Practical Application of the Author's Recent Discoveries. With Illustrations. Small 8vo. Cloth, \$1.25.
- DAVIDSON (ANDREW). Geographical Pathology: An Inquiry into the Geographical Distribution of Infective and Climatic Diseases. 2 vols. 8vo. Cloth, \$7.00.
- DEXTER (FRANKLIN). The Anatomy of the Peritonæum. 12mo. With 39 colored Illustrations. Cloth, \$1.50.
- DOTY (ALVAH H.). A Manual of Instruction in the Principles of Prompt Aid to the Injured. Designed for Military and Civil Use. 96 Illustrations. 12mo. Cloth, \$1.25.
- ELLIOT (GEORGE T.). Obstetric Clinic: A Practical Contribution to the Study of Obstetrics and the Diseases of Women and Children. 8vo. Cloth, \$4.50.
- EVANS (GEORGE A.). Hand-Book of Historical and Geographical Phthisiology. With Special Reference to the Distribution of Consumption in the United States. 8vo. Cloth, \$2.00.
- EWALD (C. A.). Lectures on the Diseases of the Stomach. By Dr. C. A. Ewald, Professor of Pathology and Therapeutics in the University of Berlin, etc. Translated from the German by special permission of the author, by Morris Manges, A. M., M. D. Cloth, \$5.00; sheep, \$6.00.
- FLINT (AUSTIN). Medical Ethics and Etiquette. Commentaries on the National Code of Ethics. 12mo. Cloth, 60 cents.
- FLINT (AUSTIN). Medicine of the Future. An Address prepared for the Annual Meeting of the British Medical Association in 1886. With Portrait of Dr. Flint. 12mo. Cloth, \$1.00.
- FLINT (AUSTIN, JR.). Text-Book of Human Physiology; designed for the Use of Practitioners and Students of Medicine. Illustrated with three hundred and sixteen Woodcuts and Two Plates. **Fourth edition, revised.** Imperial 8vo. Cloth, \$6.00; sheep, \$7.00.
- FLINT (AUSTIN, JR.). The Physiological Effects of Severe and Protracted Muscular Exercise; with Special Reference to its Influence upon the Excretion of Nitrogen. 12mo. Cloth, \$1.00.

- FLINT (AUSTIN, JR.). The Source of Muscular Power. Arguments and Conclusions drawn from Observation upon the Human Subject under Conditions of Rest and of Muscular Exercise. 12mo. Cloth, \$1.00.
- FLINT (AUSTIN, JR.). Physiology of Man. Designed to represent the Existing State of Physiological Science as applied to the Functions of the Human Body. Complete in 5 vols., 8vo. Per vol., cloth, \$4.50; sheep, \$5.50.
* * Vols. I and II can be had in cloth and sheep binding; Vol. III in sheep only. Vol. IV is at present out of print.
- FLINT (AUSTIN, JR.). Manual of Chemical Examinations of the Urine in Disease; with Brief Directions for the Examination of the most Common Varieties of Urinary Calculi. Revised edition. 12mo. Cloth, \$1.00.
- FOSTER (FRANK P.). Illustrated Encyclopædic Medical Dictionary, being a Dictionary of the Technical Terms used by Writers on Medicine and the Collateral Sciences in the Latin, English, French, and German Languages. This work will be completed in four volumes. (*Sold only by subscription.*) The work will consist of Four Volumes, and will be sold in Parts; Three Parts to a Volume. Ten Parts are now ready for delivery.
- FOURNIER (ALFRED). Syphilis and Marriage. Translated by P. Albert Morrow, M. D. 8vo. Cloth, \$2.00; sheep, \$3.00.
- FREY (HEINRICH). The Histology and Histochemistry of Man. A Treatise on the Elements of Composition and Structure of the Human Body. Translated from the fourth German edition by Arthur E. J. Barker, M. D., and revised by the author. With 608 Engravings on Wood. 8vo. Cloth, \$5.00; sheep, \$6.00.
- FRIEDLANDER (CARL). The Use of the Microscope in Clinical and Pathological Examinations. Second edition, enlarged and improved, with a Chromolithograph Plate. Translated, with the permission of the author by Henry C. Coe, M. D. 8vo. Cloth, \$1.00.
- FUCHS (ERNEST). Text-Book of Ophthalmology. By Dr. Ernest Fuchs, Professor of Ophthalmology in the University of Vienna. With 178 Woodcuts. Authorized translation from the second enlarged and improved German edition, by A. Duane, M. D. Cloth, \$5.00; sheep, \$6.00.
- GARMANY (JASPER J.). Operative Surgery on the Cadaver. With Two Colored Diagrams showing the Collateral Circulation after Ligatures of Arteries of Arm, Abdomen, and Lower Extremity. Small 8vo. Cloth, \$2.00.
- GERSTER (ARPAD G.). The Rules of Aseptic and Antiseptic Surgery. A Practical Treatise for the Use of Students and the General Practitioner. Illustrated with over two hundred fine Engravings. 8vo. Cloth, \$5.00; sheep, \$6.00.
- GIBSON-RUSSELL. Physical Diagnosis: A Guide to Methods of Clinical Investigation. By G. A. Gibson, M. D., and William Russell, M. D. With 101 Illustrations. 12mo. (STUDENT'S SERIES.) Cloth, \$2.50.
- GOULEY (JOHN W. S.). Diseases of the Urinary Apparatus. Part I. Phlegmasic Affections. Being a Series of Twelve Lectures delivered during the autumn of 1891. With an Addendum on Retention of Urine from Prostatic Obstruction in Elderly Men. Cloth, \$1.50.
- GROSS (SAMUEL W.). A Practical Treatise on Tumors of the Mammary Gland. Illustrated. 8vo. Cloth, \$2.50.
- GRUBER (JOSEF). A Text-Book of the Diseases of the Ear. Translated from the second German edition by special permission of the author, and edited by Edward Law, M. D., and Coleman Jewell, M. D. With 150 Illustrations and 70 Colored Figures on Two Lithographic Plates. 8vo. Cloth, \$5.00.

- GUTMANN (EDWARD). The Watering-Places and Mineral Springs of Germany, Austria, and Switzerland. Illustrated. 12mo. Cloth, \$2.50.
- HAMMOND (W. A.). A Treatise on Diseases of the Nervous System. With the Collaboration of Graeme M. Hammond, M. D. With One Hundred and Eighteen Illustrations. **Ninth edition**, with corrections and additions. 8vo. Cloth, \$5.00; sheep, \$6.00.
- HAMMOND (W. A.). A Treatise on Insanity, in its Medical Relations. 8vo. Cloth, \$5.00; sheep, \$6.00.
- HAMMOND (W. A.). Clinical Lectures on Diseases of the Nervous System. Delivered at Bellevue Hospital Medical College. Edited by T. M. B. Cross, M. D. 8vo. Cloth, \$3.50.
- HARVEY (A.). First Lines of Therapeutics. 12mo. Cloth, \$1.50.
- HIRT (LUDWIG). The Diseases of the Nervous System. A Text-Book for Physicians and Students. Translated, with permission of the Author, by August Hoeh, M. D., assisted by Frank R. Smith, A. M. (Cantab.), M. D., Assistant Physicians to the Johns Hopkins Hospital. With an Introduction by William Osler, M. D., F. R. C. P., Professor of Medicine in the Johns Hopkins University, and Physician-in-Chief to the Johns Hopkins Hospital, Baltimore. 8vo, 671 pages. With 178 Illustrations. Cloth, \$5.00; sheep, \$6.00.
- HOFFMANN-ULTZMANN. Analysis of the Urine, with Special Reference to Diseases of the Urinary Apparatus. By M. B. Hoffmann, Professor in the University of Gratz, and R. Ultzmann, Tutor in the University of Vienna. **Third edition, revised and enlarged.** 8vo. Cloth, \$2.00.
- HOWE (JOSEPH W.). Emergencies, and how to treat them. Fourth edition, revised. 8vo. Cloth, \$2.50.
- HOWE (JOSEPH W.). The Breath, and the Diseases which give it a Fetid Odor. With Directions for Treatment. **Second edition**, revised and corrected. 12mo. Cloth, \$1.00.
- HUEPPE (FERDINAND). The Methods of Bacteriological Investigation. Written at the request of Dr. Robert Koch. Translated by Hermann M. Biggs, M. D. Illustrated. 8vo. Cloth, \$2.50.
- JACCOUD (S.). The Curability and Treatment of Pulmonary Phthisis. Translated and edited by Montagu Lubbock, M. D. 8vo. Cloth, \$4.00.
- JOHNSTONE (ALEX.). Botany: A Concise Manual for Students of Medicine and Science. With 164 Illustrations and a Series of Floral Diagrams. 12mo. (STUDENT'S SERIES.) Cloth, \$1.75.
- JONES (II. MACNAUGHTON). Practical Manual of Diseases of Women and Uterine Therapeutics. For Students and Practitioners. 188 Illustrations 12mo. Cloth, \$3.00.
- JOURNAL OF CUTANEOUS AND GENITO-URINARY DISEASES. Published Monthly. Edited by John A. Fordyce, M. D. Terms \$2.50 per annum.
- KEYES (E. L.). A Practical Treatise on Genito-Urinary Diseases, including Syphilis. Being a new edition of a work with the same title by Van Buren and Keyes. Almost entirely rewritten. 8vo. With Illustrations. Cloth, \$5.00; sheep, \$6.00.
- KEYES (E. L.). The Tonic Treatment of Syphilis, including Local Treatment of Lesions. 8vo. Cloth, \$1.00.
- KINGSLEY (N. W.). A Treatise on Oral Deformities as a Branch of Mechanical Surgery. With over 350 Illustrations. 8vo. Cloth, \$5.00; sheep, \$6.00.

- LEGG (J. WICKHAM). On the Bile, Jaundice, and Bilious Diseases. With Illustrations in Chromolithography. 8vo. Cloth, \$6.00; sheep, \$7.00.
- LITTLE (W. J.). Medical and Surgical Aspects of In-Knee (Genu-Valgum): Its Relation to Rickets, its Prevention, and its Treatment, with and without Surgical Operation. Illustrated by upward of Fifty Figures and Diagrams. 8vo. Cloth, \$2.00.
- LORING (EDWARD G.). A Text-Book of Ophthalmoscopy.
 Part I. The Normal Eye, Determination of Refraction, and Diseases of the Media. With 131 Illustrations, and 4 Chromolithographs. 8vo. Buckram, \$5.00.
 Part II. Diseases of the Retina, Optic Nerve, and Choroid: their Varieties and Complications. The manuscript of this volume, which the author finished just prior to his death, has been thoroughly edited and revised by F. B. Loring, M. D., of Washington, D. C., and is now issued in the same style as the first volume. Profusely illustrated. Part II, buckram, \$5.00. Two Parts, buckram, \$10.00.
- LUSK (WILLIAM T.). The Science and Art of Midwifery. With 246 Illustrations. Fourth edition, revised and enlarged. 8vo. Cloth, \$5.00; sheep, \$6.00.
- MARCY (HENRY O.). The Anatomy and Surgical Treatment of Hernia. 4to, with about Sixty full-page Heliotype and Lithographic Reproductions from the Old Masters, and numerous Illustrations in the Text. (*Sold only by subscription.*)
- MARKOE (T. M.). A Treatise on Diseases of the Bones. With Illustrations. 8vo. Cloth, \$4.50.
- MATHEWS (JOSEPH M.). A Treatise on Diseases of the Rectum, Anus, and Sigmoid Flexure. 8vo. With Six Chromolithographs, and Illustrations in the text. (*Sold only by subscription.*)
- MILLS (WESLEY). A Text-Book of Animal Physiology, with Introductory Chapters on General Biology and a full Treatment of Reproduction for Students of Human and Comparative Medicine. 8vo. With 505 Illustrations. Cloth, \$5.00; sheep, \$6.00.
- MILLS (WESLEY). A Text-Book of Comparative Physiology. For Students and Practitioners of Veterinary Medicine. Small 8vo. Cloth, \$3.00.
- MORROW (PRINCE A.). A System of Genito-Urinary Diseases, Syphilology, and Dermatology. By various Authors. In Three Volumes, beautifully illustrated. (*Sold only by subscription.*) Vol. I. (*Vols. II and III in press.*)
- THE NEW YORK MEDICAL JOURNAL (weekly). Edited by Frank P. Foster, M. D. Terms, \$5.00 per annum.
 Binding Cases, cloth, 50 cents each.
 "Self-Binder" (this is used for temporary binding only), 90 cents.
- GENERAL INDEX, from April, 1865, to June, 1876 (23 vols.). 8vo. Cloth, 75 cts.
- NIEMEYER (FELIX VON). A Text-Book of Practical Medicine, with particular reference to Physiology and Pathological Anatomy. Containing all the author's Additions and Revisions in the eighth and last German edition. Translated by George H. Humphreys, M. D., and Charles E. Hackley, M. D. 2 vols., 8vo. Cloth, \$9.00; sheep, \$11.00.
- NIGHTINGALE'S (FLORENCE) Notes on Nursing. 12mo. Cloth, 75 cents.
- OSLER (WILLIAM). The Principles and Practice of Medicine. Designed for the Use of Practitioners and Students of Medicine. (*Sold only by subscription.*) Cloth, \$5.50; sheep, \$6.50; half morocco, \$7.00.

- PELLEW (C. E.). A Manual of Practical Medical Chemistry. 12mo. With Illustrations. Cloth, \$2.50.
- PEREIRA'S (Dr.) Elements of Materia Medica and Therapeutics. Abridged and adapted for the Use of Medical and Pharmaceutical Practitioners and Students, and comprising all the Medicines of the British Pharmacopœia, with such others as are frequently ordered in Prescriptions, or required by the Physician. Edited by Robert Bentley and Theophilus Redwood. Royal 8vo. Cloth, \$7.00; sheep, \$8.00.
- PEYER (ALEXANDER). An Atlas of Clinical Microscopy. Translated and edited by Alfred C. Girard, M. D. First American, from the manuscript of the second German edition, with Additions. Ninety Plates, with 105 Illustrations, Chromolithographs. Square 8vo. Cloth, \$6.00.
- PIFFARD (HENRY G.). A Practical Treatise on Diseases of the Skin. By Henry G. Piffard, A. M., M. D., assisted by Robert M. Fuller, M. D. With Fifty full-page Original Plates and Thirty-three Illustrations in the Text. 4to. (*Sold only by subscription.*)
- POMEROY (OREN D.). The Diagnosis and Treatment of Diseases of the Ear. With One Hundred Illustrations. **Second edition**, revised and enlarged. 8vo. Cloth, \$3.00.
- POORE (C. T.). Osteotomy and Osteoclasis, for the Correction of Deformities of the Lower Limbs. 50 Illustrations. 8vo. Cloth, \$2.50.
- QUAIN (RICHARD). A Dictionary of Medicine, including General Pathology, General Therapeutics, Hygiene, and the Diseases peculiar to Women and Children. By Various Writers. Edited by Richard Quain, M. D. In one large 8vo volume, with complete Index, and 138 Illustrations. (*Sold only by subscription.*)
- RANNEY (AMBROSE L.). Applied Anatomy of the Nervous System, being a Study of this Portion of the Human Body from a Standpoint of its General Interest and Practical Utility, designed for Use as a Text-Book and as a Work of Reference. **Second edition, revised and enlarged.** Profusely illustrated. 8vo. Cloth, \$5.00; sheep, \$6.00.
- ROBINSON (A. R.). A Manual of Dermatology. Revised and corrected. 8vo. Cloth, \$5.00.
- ROSCOE-SCHORLEMMER. Treatise on Chemistry.
- Vol. 1. Non-Metallic Elements. 8vo. Cloth, \$5.00.
 - Vol. 2. Part I. Metals. 8vo. Cloth, \$3.00.
 - Vol. 2. Part II. Metals. 8vo. Cloth, \$3.00.
 - Vol. 3. Part I. The Chemistry of the Hydrocarbons and their Derivatives. 8vo. Cloth, \$5.00.
 - Vol. 3. Part II. The Chemistry of the Hydrocarbons and their Derivatives. 8vo. Cloth, \$5.00.
 - Vol. 3. Part III. The Chemistry of the Hydrocarbons and their Derivatives. 8vo. Cloth, \$3.00.
 - Vol. 3. Part IV. The Chemistry of the Hydrocarbons and their Derivatives. 8vo. Cloth, \$3.00.
 - Vol. 3. Part V. The Chemistry of the Hydrocarbons and their Derivatives. 8vo. Cloth, \$3.00.
- ROSENTHAL (I.). General Physiology of Muscles and Nerves. With 75 Woodcuts. 12mo. Cloth, \$1.50.

- SAYRE (LEWIS A.). Practical Manual of the Treatment of Club-Foot. **Fourth edition, enlarged and corrected.** 12mo. Cloth, \$1.25.
- SAYRE (LEWIS A.). Lectures on Orthopedic Surgery and Diseases of the Joints, delivered at Bellevue Hospital Medical College. **New edition, illustrated with 24 Engravings on Wood.** 8vo. Cloth, \$5.00; sheep, \$6.00.
- SCHULTZE (B. S.). The Pathology and Treatment of Displacements of the Uterus. Translated from the German by Jameson J. Macan, M. A., etc.; and edited by Arthur V. Macan, M. B., etc. With one hundred and twenty Illustrations. 8vo. Cloth, \$3.50.
- SHIELD (A. MARMADUKE). Surgical Anatomy for Students. 12mo. (STUDENT'S SERIES.) Cloth, \$1.75.
- SHOEMAKER (JOHN V.). A Text-Book of Diseases of the Skin. Six Chromolithographs and numerous Engravings. Second edition, revised and enlarged. 8vo. Cloth, \$5.00; sheep, \$6.00.
- SIMPSON (JAMES Y.). Selected Works: Anaesthesia, Diseases of Women. 3 vols., 8vo. Per volume. Cloth, \$3.00; sheep, \$4.00.
- SIMS (J. MARION). The Story of my Life. Edited by his Son, H. Marion-Sims, M. D. With Portrait. 12mo. Cloth, \$1.50.
- SKENE (ALEXANDER J. C.). A Text-Book on the Diseases of Women. Illustrated with two hundred and fifty-four Illustrations, of which one hundred and sixty-five are original, and nine chromolithographs. Second edition. 8vo. (*Sold only by subscription.*)
- STEINER (JOHANNES). Compendium of Children's Diseases: a Hand-Book for Practitioners and Students. Translated from the second German edition, by Lawson Tait. 8vo. Cloth, \$3.50; sheep, \$4.50.
- STEVENS (GEORGE T.) Functional Nervous Diseases: their Causes and their Treatment. Memoir for the Concourse of 1881-1883, Académie Royal de Médecine de Belgique. With a Supplement, on the Anomalies of Refraction and Accommodation of the Eye, and of the Ocular Muscles. Small 8vo. With six Photographic Plates and twelve Illustrations. Cloth, \$2.50.
- STONE (R. FRENCH). Elements of Modern Medicine, including Principles of Pathology and of Therapeutics, with many Useful Memoranda and Valuable Tables of Reference. Accompanied by Pocket Fever Charts. Designed for the Use of Students and Practitioners of Medicine. In wallet-book form, with pockets on each cover for Memoranda, Temperature Charts, etc. Roan, tuck, \$2.50.
- STRECKER (ADOLPH). Short Text-Book of Organic Chemistry. By Dr. Johannes Wislicenus. Translated and edited, with Extensive Additions, by W. H. Hodgkinson and A. J. Greenaway. 8vo. Cloth, \$5.00.
- STRÜMPPELL (ADOLPH). A Text-Book of Medicine, for Students and Practitioners. Translated, by permission, from the sixth German edition by Herman F. Vickery, A. B., M. D., Instructor in Clinical Medicine, Harvard Medical School, etc., and Philip Coombs Knapp, Physician to Out-patients with Diseases of the Nervous System, Boston City Hospital, etc. With Editorial Notes by Frederick C. Shattuck, A. M., M. D., Jackson Professor of Clinical Medicine, Harvard Medical School, etc. Second American edition. With 111 Illustrations. 8vo. 981 pages. Cloth, \$6.00; sheep, \$7.00.

- THOMAS (T. GAILLARD). *Abortion and its Treatment, from the Standpoint of Practical Experience. A Special Course of Lectures delivered before the College of Physicians and Surgeons, New York, Session of 1889-'90. From Notes by P. Brynberg Porter, M. D. Revised by the Author.* 12mo. Cloth, \$1.00.
- THOMSON (J. ARTHUR). *Outlines of Zoölogy. With thirty-two full page Illustrations.* 12mo. (STUDENTS' SERIES.) Cloth, \$3.00.
- TRACY (ROGER S.). *The Essentials of Anatomy, Physiology, and Hygiene.* 12mo. Cloth, \$1.25.
- TYNDALL (JOHN). *Essays on the Floating Matter of the Air, in Relation to Putrefaction and Infection.* 12mo. Cloth, \$1.50.
- ULTZMANN (ROBERT). *Pyuria, or Pus in the Urine, and its Treatment. Translated by permission, by Dr. Walter B. Platt.* 12mo. Cloth, \$1.00.
- VAN BUREN (W. H.). *Lectures upon Diseases of the Rectum, and the Surgery of the Lower Bowel, delivered at Bellevue Hospital Medical College. Second edition, revised and enlarged.* 8vo. Cloth, \$3.00; sheep, \$4.00.
- VAN BUREN (W. H.). *Lectures on the Principles and Practice of Surgery. Delivered at Bellevue Hospital Medical College. Edited by Lewis A. Stimson, M. D.* 8vo. Cloth, \$4.00; sheep, \$5.00.
- VOGEL (A.). *A Practical Treatise on the Diseases of Children. Translated and edited by H. Raphael, M. D. Third American from the eighth German edition, revised and enlarged.* Illustrated by six Lithographic Plates. 8vo. Cloth, \$4.50; sheep, \$5.50.
- VON ZEISSL (HERMANN). *Outlines of the Pathology and Treatment of Syphilis and Allied Venereal Diseases. Second edition, revised by Maximilian von Zeissl. Authorized edition. Translated, with Notes, by H. Raphael, M. D.* 8vo. Cloth, \$4.00; sheep, \$5.00.
- WAGNER (RUDOLF). *Hand-Book of Chemical Technology. Translated and edited from the eighth German edition, with extensive Additions, by William Crookes. With 336 Illustrations.* 8vo. Cloth, \$5.00.
- WALTON (GEORGE E.). *Mineral Springs of the United States and Canadas. Containing the latest Analyses, with full Description of Localities, Routes, etc. Second edition, revised and enlarged.* 12mo. Cloth, \$2.00.
- WEBBER (S. G.). *A Treatise on Nervous Diseases: Their Symptoms and Treatment. A Text-Book for Students and Practitioners.* 8vo. Cloth, \$3.00.
- WEEKS-SHAW (CLARA S.). *A Text-Book of Nursing. For the Use of Training-Schools, Families, and Private Students. Second edition, revised and enlarged.* 12mo. With Illustrations, Questions for Review and Examination, and Vocabulary of Medical Terms. 12mo. Cloth, \$1.75.
- WELLS (T. SPENCER). *Diseases of the Ovaries.* 8vo. Cloth, \$4.50.
- WORCESTER (A.). *Monthly Nursing. Second edition, revised.* Cloth, \$1.25.
- WYETH (JOHN A.). *A Text-Book on Surgery: General, Operative, and Mechanical. Profusely illustrated. Second edition, revised and enlarged.* 8vo. (*Sold only by subscription.*)



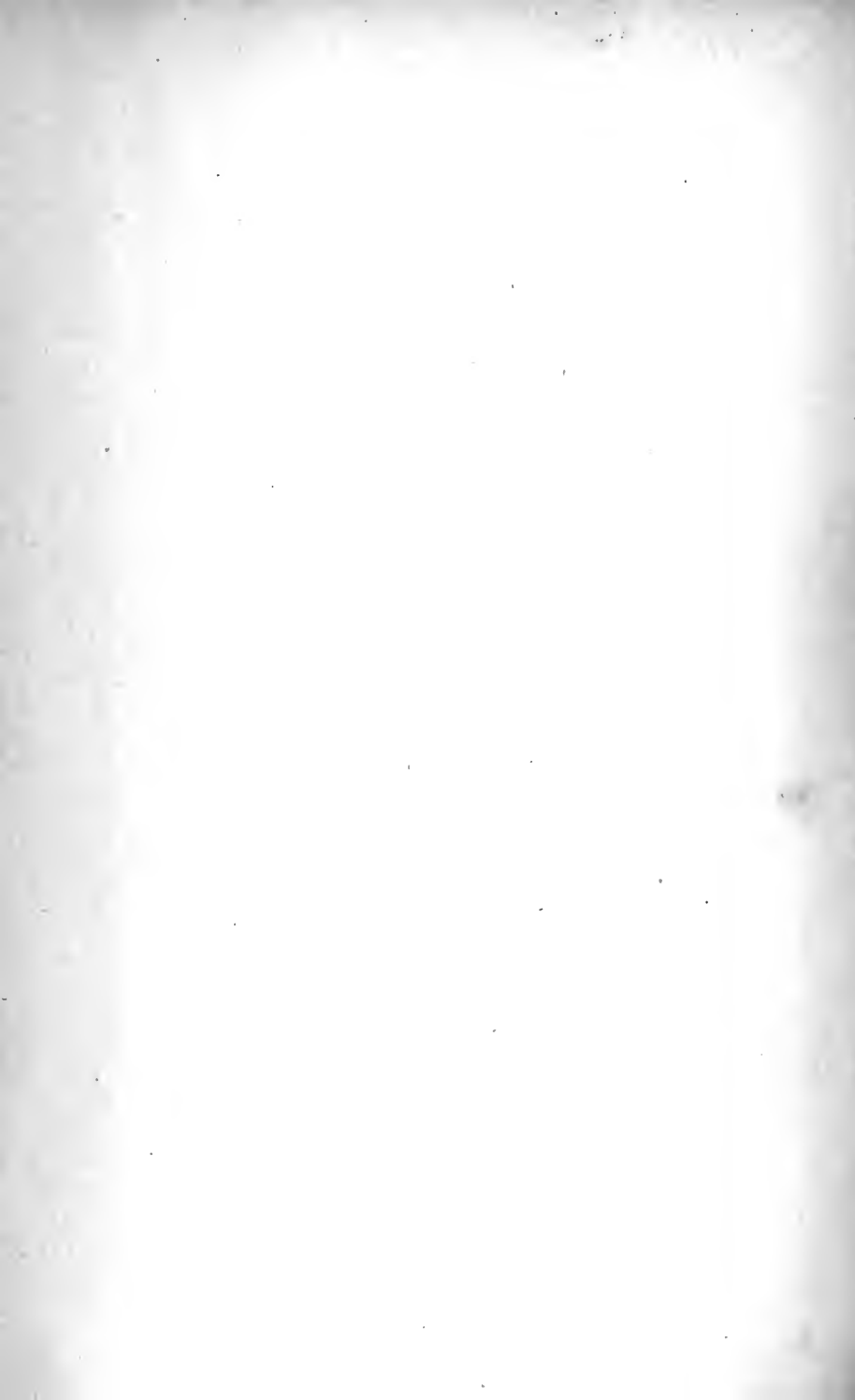



QP31

M62

Mills.

Compar. Physiology,

~~3/8/54.~~

