

From the collection of the

o P^{z n m}re^ainger
v L^aibrary
t p

San Francisco, California
2006

15-



Digitized by the Internet Archive
in 2007 with funding from
Microsoft Corporation

TEXT-BOOK
OF
MEAT HYGIENE

WITH SPECIAL CONSIDERATION OF ANTEMORTEM
AND POSTMORTEM INSPECTION OF FOOD-
PRODUCING ANIMALS

BY

RICHARD EDELMANN, Ph.D.

MEDICAL COUNSELLOR; ROYAL STATE VETERINARIAN OF SAXONY; PROFESSOR AT THE
ROYAL VETERINARY HIGH SCHOOL IN DRESDEN

SEVENTH REVISED EDITION

BY

JOHN R. MOHLER, A.M., V.M.D., D.Sc.

CHIEF, UNITED STATES BUREAU OF ANIMAL INDUSTRY

AND

ADOLPH EICHHORN, D.V.S.

DIRECTOR ANIMAL DISEASE STATION, UNITED STATES BUREAU OF ANIMAL INDUSTRY;
FORMERLY DIRECTOR VETERINARY DEPARTMENT, LEDERLE LABORATORIES; FORMERLY
CHIEF, PATHOLOGICAL DIVISION, UNITED STATES BUREAU OF ANIMAL INDUSTRY

WITH 157 ILLUSTRATIONS AND 5 COLORED PLATES



LEA & FEBIGER
PHILADELPHIA

COPYRIGHT
LEA & FEBIGER
1939

PRINTED IN U. S. A.

PREFACE TO THE SEVENTH EDITION.

SANITARY science and especially food hygiene have made considerable progress since the publication of the last edition of this *Text-book of Meat Hygiene*. Federal, state and municipal health authorities are cognizant of the importance of proper supervision of the food supply to the consuming public and they are ever more stringent in the enforcement of laws, rules and regulations which have been promulgated for guarding the safety of food.

Until more recently the control of meat and meat food products was practically limited to inspection by the Federal authorities of establishments engaged in interstate business, leaving a large proportion of the population without proper supervision of their meat supply. In the general progress of food hygiene such shortcomings have been recognized and accordingly the supervision is being more and more extended to include the food supply of those who heretofore were not given such protection.

The present Federal Meat Inspection system is unquestionably most complete and amendments which are issued from time to time are primarily designed to safeguard further the public health from the consumption of harmful meat food. In the present edition, therefore, it was deemed necessary to incorporate all additions and amendments for the purpose of furnishing those interested in meat hygiene an up-to-date treatise on the subject.

Likewise in the discussion of diseases a number of changes have been made to conform with the latest scientific development of our knowledge on pathological conditions which might render meat and meat food products unfit for consumption.

A new section has been included dealing entirely with the ductless glands. These glands in the last decade having gained in importance as the hormones extracted from them are being used very extensively in the treatment of many irregularities of the human body. Furthermore, it was deemed advisable to substitute for the equipment described in the original German publication for the rendering of edible and inedible products the modern American apparatus used for such purposes, as it is recognized that in recent years very important advances have been made in that particular phase of the industry.

It is hoped that the veterinary profession and all those interested in meat hygiene will give this present edition the same favorable reception as the previous editions received. It is again our pleasant obligation to express our gratitude to Drs. Thomas Castor, Archie Frank, Benjamin Schwartz, and Robert H. Kerr of the Bureau of Animal Industry, who rendered very valuable assistance in the preparation of this new edition, and also to the publishers who at all times cheerfully assisted in the technical execution of the publication.

J. R. M.

A. E.

WASHINGTON, D.C.

CONTENTS.

INTRODUCTION	7
CHAPTER I.	
ORIGIN AND SOURCE OF MEAT FOOD	9
CHAPTER II.	
MORPHOLOGY AND CHEMISTRY OF THE PRINCIPAL TISSUES AND ORGANS OF FOOD ANIMALS	42
CHAPTER III.	
THE PRODUCTION, PREPARATION AND CONSERVATION OF MEAT	77
CHAPTER IV.	
REGULATIONS GOVERNING THE MEAT INSPECTION OF THE UNITED STATES DEPARTMENT OF AGRICULTURE	99
CHAPTER V.	
ORGANIZATION AND METHODS OF PROCEDURE OF THE INSPECTION FORCE	162
CHAPTER VI.	
DECISIONS OF THE VETERINARY INSPECTORS AND DISPOSAL OF THE CONDEMNED MEAT	192
CHAPTER VII.	
ABNORMAL CONDITIONS AND DISEASES OF FOOD-PRODUCING ANIMALS	207
CHAPTER VIII.	
INFECTIOUS DISEASES IN FOOD-PRODUCING ANIMALS	281
CHAPTER IX.	
POSTMORTEM CHANGES OF MEAT	341
CHAPTER X.	
EXAMINATION AND JUDGMENT OF PREPARED AND PRESERVED MEATS, CHICKENS, GAME, FISH, AMPHIBIA AND CRUSTACEANS	354

	CHAPTER XI.	
FOOD POISONING		370
	CHAPTER XII.	
HISTORY OF MEAT HYGIENE		380
	CHAPTER XIII.	
ABATTOIRS AND STOCKYARDS		390
	CHAPTER XIV.	
PREPARATION AND CONTROL OF MEAT-FOOD PRODUCTS		401
	CHAPTER XV.	
CHEMICAL ANALYSIS OF MEAT-FOOD PRODUCTS		436

MEAT HYGIENE.

INTRODUCTION.

REGULATION of the diet or hygiene has for its purpose the retaining and strengthening of the health of the human or animal organism, by increasing its internal resistance, and by preventing any noxious effects. In doing this it is necessary, in the first place, to consider the nourishment of the organism. Inasmuch as meat constitutes the principal foodstuff for the human body, the regulation of the diet of man must also extend to meat products. And since there has been considerable attention paid to the latter from a hygienic standpoint, justification is had for the use of the words "meat hygiene," by which is understood that part of the regimen which concerns the procurement of wholesome meat foods for man, their value to public health, as well as the dangers which threaten the consumers of diseased or unsound meats.

For the prevention of these dangers there should be, in the first place, an expert supervision of the meat-food products of man. Everything which constitutes such a supervision may be comprised in the term of meat inspection or meat examination. By this should be understood the examination of meat and the products made of the same, relative to their proper origin and desirability as food for man.

Inasmuch as these food substances are the products of animals, the examination can only be complete when it extends not alone to all parts of the slaughtered animals, but also to the food-producing animals in life. Accordingly it is more correct to speak of the examination as an *antemortem* and *postmortem* inspection.

When in the sense of this inspection the term meat is mentioned it should not be applied exclusively to the striated muscles of the body and the tissues in connection therewith (fat, connective tissue, nerves, blood, lymph glands, bones and cartilages), but rather to all parts of the animal which are suitable for human consumption.

And while the objects and duties of meat inspection are in the first place the prevention of the dangers which threaten human health from noxious meat products, yet at the same time a well-organized meat inspection also undertakes the task of protecting the meat consumers in an economic relation from frauds and deceptions, by causing the meat which is not altogether unobjectionable regarding its origin and consistence to be sold under a compulsory declaration.

In the execution of these main objects, meat inspection may also render important services in veterinary police work by detecting animal plagues, and also by extending a beneficial influence from a general

hygienic standpoint to animal and man, by the complete harmless disposition of all products of diseases and their specific causes. In relation to the latter, meat inspection should not be underestimated in its value and importance to general stock raising. It not only discloses to the intelligent owner of stock obscure diseases of food animals, but shows to him also the means and ways by which such disease may be eradicated and prevented.

So far as the extension of jurisdiction of meat inspection is concerned, it reaches all the food animals which are customarily found in the respective countries (page 9), and which produce the principal mass of meat food. And while, in the question of inspection, only those food animals are concerned the meat of which is to be utilized commercially, yet it is of no less importance to the public interest that those animals should be subject to inspection which are slaughtered for private purposes. The reasons for this absolute generalization of meat inspection for all animals coming for slaughter can only be indicated at this time. They lie above all in the importance of meat inspection to general hygiene, which cannot be ignored even though private property be condemned.

Furthermore, it is not feasible to control the possibility that meat of animals supposed to be slaughtered for private uses might not serve exclusively for these purposes, but might be brought, in spite of assurances, into the public traffic. There also belongs to a thorough meat inspection the control of meat products (prepared meat) which are prepared from food animals, as well as the inspection of all other animals which are marketed and served for human food, such as game, poultry, fish, crustaceans, mollusks, reptiles and amphibians.

CHAPTER I.

ORIGIN AND SOURCE OF MEAT FOOD.

MAN takes his meat-food diet from almost all classes of animal life, and, therefore, the bromatological fauna extends from the celenterates to the vertebrates. In general, animals which live on plant food or on the lower animals are furnishing the civilized nations with palatable meat, while the meat of animals which consume higher animals (fish, amphibia, reptiles, birds) is less adapted for human food. The principal meat foods are obtained from the class of mammals, and among this class the first place is taken by herbivorous and certain omnivorous animals, while those mammals which are solely carnivorous serve only rarely for human food. Next to mammals, birds and then fish supply most of the meat for man. Other foods which are derived from the other classes of animal life play only the part of delicacies, or are consumed only occasionally.

FOOD ANIMALS.

Although the animals which are slaughtered, and all those which are killed through the abstraction of blood, may be designated as food animals, yet only the slaughterable domesticated mammals are popularly regarded as such, while domestic poultry which serve as human food are in general not considered in the narrow sense under the conception of food animals.

The domesticated mammals which are slaughtered are divided into large stock, hogs and small stock. Depending upon the nutritive condition, they may be distinguished as lean stock and fat stock. Besides these designations there is also the pasture stock, which is composed of lean as well as of fattened animals.

In many foreign countries, solipeds are also quite extensively slaughtered for food purposes. In the United States, during 1932, there were 100,360 horses slaughtered, under Federal inspection, producing 53,381,350 pounds of horse-meat products, of which 46,127,054 pounds were canned and 5,284,672 pounds were exported in other than cans. Most of this canned horse meat is used as animal food, while practically all horse meat intended for human consumption enters foreign trade.

Buffaloes constitute an important source of meat food in southern and southeastern Europe, as do reindeer in Alaska and other northern countries.

The encouragement given to the reindeer industry in Alaska by the United States Government has resulted in a material increase of these animals in that territory. The annual surplus is now being advantage-

ously utilized for food purposes, not only in their native section but also in certain sections of the United States.

Cattle are slaughtered as male animals (bulls, bullocks); as castrated males (steers); and as female animals (cows, heifers).

The designation steer has not the same meaning everywhere. While in some places it is understood that steers are young male animals, in other parts that designation applies to all castrated male cattle. For the purpose of ante- and postmortem inspection the following designations are made:

Bull is the uncastrated male.

Steer is a male, castrated early in life.

Stag is a male, castrated late in life, bull-like in appearance.

Cow is a female that has given birth to one or more young.

Heifer is a female that has never given birth to a calf.

Calves are young cattle under one year of age.

In horses the different sexes are known as stallions (male), mares (female), geldings (castrated male horses); young horses are called foals, or fillies.

Hogs, which furnish a large proportion of the meat and which are of the greatest importance from the standpoint of general maintenance, are principally slaughtered as castrated males (barrows; also stags when they are castrated after being used for breeding purposes) and female animals. Besides these, boars (wild boars) and cryptorchids, as well as sucking and breeding sows, and occasionally very young pigs as roasters and suckling pigs, are also slaughtered.

The term "small stock" embraces calves, sheep and goats. Certain types of calves are distinguished by marked development of the muscles, especially on the chest and legs. Sheep and goats when young are called lambs and kids, respectively; the male animals are designated as bucks and rams; when castrated they are known as wethers. In the language of the butcher, however, the meat of all sheep, without consideration of the sex, is called mutton or lamb.

Of the other domesticated animals the following may also be slaughtered and consumed: In Germany dogs are principally slaughtered in large cities or in localities densely populated with the laboring class, and, as a rule, secretly only and for home use. The meat-inspection laws of Germany subject dogs to compulsory inspection. They have been slaughtered and used for food in noteworthy number, especially in Saxony. Cats are also occasionally slaughtered, and have been known to be substituted for rabbits.

Rabbits are consumed to a considerable extent in many countries. When the price of meats in general is high, this species of animal is apt to play an important part in the supply of meat. The average consumption of rabbits throughout the world is rapidly increasing and their meat now constitutes a noteworthy commercial product. According to Bentel, the daily consumption of rabbits in Paris amounts to 10,000, and in London to 75,000. According to Schlieger, rabbits to the value of 80,000,000 to 90,000,000 francs are annually raised in France, and Paris alone annually consumes rabbits valued at \$1,200,000. In France, England, Belgium and in some parts of Holland, rabbits

are not a general food of the people, but rabbit meat may be found daily on the tables of the rich. According to Schlieger's calculation, a breeding farm in France which produces 600 rabbits monthly, weighing 3 kg. each, affords an annual clear profit of \$1250.

In relation to rapid meat production the rabbit stands first among meat-producing animals. A female rabbit may be pregnant eight or ten times annually, giving birth to a litter averaging six young, each of which may within four months reach a weight of 2.5 kg. Such a female may accordingly produce 150 kg. of meat inside of a year.

Traffic in Food Animals.—The need of food animals is preferably supplied through home stock raising, while importation from foreign countries (page 17) is at present slight, owing to the prohibition or considerable restriction of federal regulations.

Food animals which supply the demand of the butchers in the rural districts and the small cities usually originate locally in the neighborhood, at least if there is sufficient stock raising in the vicinity to satisfy the demand. In larger cities and industrial centers the demand for food animals cannot be supplied from the surrounding country, and shipment from stock-raising districts becomes a necessity. These shipments are made into the various stockyards which are the collecting centers for the marketing of food animals (see Chapter XII). These, together with the large packing houses always to be found at such stockyards, are important and conspicuous factors in the supply of large cities and extensive territories.

Trading in food animals is principally carried out from a business standpoint, which even applies to the constant small tradings. The purchase of a food animal is either conducted according to liveweight or by dressed weight or off-hand (so much for each animal).

Each deal is made through the judgment of the quality of the individual food animal. For this purpose, besides the general inspection, the buyer preferably palpates or grasps certain parts of the body which are especially considered on account of the fat deposits at these points.

As a rule, it is applied in cattle to the shoulder, withers, outside surface of the false ribs, hind border and inner surface of the last rib, haunch, rump, flank, base of the tail, scrotal region in steers and the front of the udder in cows.

In sheep the buyer examines the subcutaneous development of fat, especially on the back, the lumbar region and the base of the tail; he also estimates the weight by lifting the animal from the ground and by the age.

Calves are judged by their general condition, age, development of meat on the back and leg, also by lifting the animal off the ground.

In hogs the chest wall, the back, especially the withers, and the abdomen are preferably examined.

Besides the nutritive condition, the following examinations are generally made: General conformation of the food animal, size, age, condition of health, intestinal contents, skin, hair, etc. From these conditions the buyer estimates the value of the animal for slaughter, and above all as to its live weight. On the correct estimate of the

latter in connection with pertinent judging of other peculiarities of the animal depends entirely the principle of buying off-hand (by the head).

Buying by live weight is based on an estimate of the value of the animal by weight during life and by the advantages and disadvantages which the carcass possesses for its utilization as food. Occasionally a discount is allowed in such trades representing part of the waste from the intestinal content. This is most frequently the case in the marketing of hogs, when a discount of 20 to 22 per cent is sometimes agreed upon. Naturally the price per kilo of the live body weight is arranged accordingly.

Rieck established that the losses in weight resulting from transportation of 212 cattle from the time they left the place of feeding until they reached the stockyards amounted to 7.97 to 8.95 per cent of their live weight.

In buying by dressed weight, a certain price is agreed upon at the time of the deal to be paid in accordance with the weight of the cooled, dressed carcass. By dressed weight is generally understood, with the exception of certain regional variations:

(a) For cattle, the weight of a bled and skinned carcass after removal of the head at the atlanto-occipital joint, feet at the carpus, the external and internal sexual organs and other viscera, with the exception of the kidneys; in other words, the weight of the four quarters.

(b) For calves and sheep, the same conditions as for cattle.

(c) For hogs, the weight of the bled and eviscerated carcass. Only the kidneys with the leaf fat remain in the animal. The head, however, is weighed with the carcass, but the tongue, which remains on the pluck (haslets, consisting of the larynx, trachea, heart, lungs and liver) is not included.

In all species of animals there exists a certain proportion between live and dressed weight, which principally depends on the nutritive condition of the animals. Well-fattened animals naturally produce a higher dressed weight than those which are in poor condition. The proportion of dressed to live weight is given in the following table expressed in percentage:

DRESSED WEIGHT REPRESENTED IN PERCENTAGE OF LIVE WEIGHT.

Quality.	Steers.	Bulls.	Cows.	Calves.	Sheep.	Hogs.
Full flesh, fattened, highest dressed value	58 to 61	58 to 62	55 to 60	62 to 68	48 to 53	80 to 85
Young, fleshy, but not fattened, older cattle fattened	53 to 55	50 to 56	50 to 54	58 to 62	45 to 48	78 to 82
Third class	48 to 52	46 to 50	48 to 52	50 to 56	38 to 44	70 to 78
Fourth class	42 to 46	42 to 46	40 to 45	76 to 80

In specially good animals even a higher dressed weight can be obtained, as, for instance, good, well-developed young bulls may dress over 70 per cent, and the best fattened hogs may even dress out 90 per cent of their live weight.

Hengst, at the Leipzig stockyards and abattoirs, established the average weights in a large number of food animals as follows:

Animal species.	Live weight.		Dressed weight.		Average dressed in percentage of the live weight.
	Number of the weighed animals.	Average weight per head.	Number of the weighed animals.	Average weight per head.	
		<i>Kg.</i>		<i>Kg.</i>	
Steers	9,518	695.81	90,115	374.55	53.83
Bulls	4,119	647.93	20,559	365.96	56.48
Cows	5,067	560.01	62,689	277.79	49.60
Heifers	841	408.55	8,028	253.80	54.17
Calves	14,197	69.58	6,653	44.01	63.25
Sheep	5,471	53.58	25,281	29.11	54.33
Hogs	6,823	107.30	146,205	89.89	83.77

For establishing the dressed weight, dealers and butchers have, as a rule, agreed upon certain principles, which are usually carried out in slaughtering the animals.

The amount of foodstuffs in the digestive tract has a marked effect on the relation between the live and dressed weight in the food animals. This depends on the kind of food, the time of slaughter and the extent of driving or transportation to which the animal has been subjected after the last feeding. As occasionally this gives rise to deception and fraudulent action and causes differences between buyer and seller, knowledge of certain average figures of the weight of the gastro-intestinal canal and its contents is of importance.

With reference to this, Wolff makes the following statement: In fasting animals the weight of the gastro-intestinal canal, including its contents, amounted in fat steers to 16.1 per cent; in medium fat steers, 19.5 per cent; in medium fattened steers, 24.5 per cent; in fat calves, 10.6 per cent; in fat hogs, 7.9 per cent; in medium fattened hogs, 12.1 per cent.

According to Hintzen's examinations, the relative weight of this material averaged in fasting cows 18.2 per cent; in fasting calves, 9.2 per cent; in fasting hogs, 7.6 per cent.

P. Falk ascertained the average weight of the contents of the stomach and intestines in 37 cattle, and found that it represented 16.35 per cent of the live weight.

Noack in his investigation on the indigestions of food animals considered only the weight of the stomachs and their contents, and computed the results in relation to the dressed weights.

The latter are shown in the following comparisons:

Species of animals.	Number.	Dressed weights, limits in kg.	Average weight in kg.	Weight limits of normally and abnormally filled stomachs in kg.	Average weight in kg.	Percentage relation of the average stomach weights to the average dressed weight.
Steers	10	300 to 500	400.0	49 to 140	94.5	21.1
Cows	7	225 to 375	300.0	45 to 120	82.5	27.5
Bulls	17	250 to 600	425.0	45 to 105	75.0	17.6
Total cattle	34	225 to 600	412.5	45 to 140	92.5	22.4
Calves	12	25.5 to 55.5	40.5	1.5 to 8.0	4.75	11.7
Sheep	17	11.5 to 37.0	24.25	3.5 to 9.5	6.5	26.8
Hogs	15	57.0 to 109.0	83.0	1.5 to 7.5	4.5	5.4

In contrast to these figures, Noack found the weight of stomachs from 11 steers with indigestion between 23 and 42 per cent of the dressed weight.

With reference to the absolute and relative weights of the principal organs of cattle (heart, lungs, liver, kidneys and spleen), calculated on the live and dressed weights, see Chapter II, p. 67.

Classification of Food Animals.—In the larger stockyards the average prices which prevail are officially published after the close of the market. These prices generally refer to the live and dressed weight of the various food animals, but at some places only one of the two prices is quoted. The market quotations serve not only as a guide to the condition of the markets, but also afford a comparison of the various markets, and above all they disclose to the stock raiser, from time to time, the market values of food animals.

In order to obtain the greatest benefit from market quotations, representative of the interested parties (stockyard managers, stock dealers, butchers, stock raisers) established the following uniform scheme for the classification of food animals, which forms the present basis of market quotations at the larger stockyards:

Steers:

1. Choice to prime steers, finished as regards fattening, and of the highest slaughter value.
2. Weighty corn-fed steers.
3. Short-fed steers.
4. Poorly nourished steers of all ages. (Light killing steers.)

Bulls:

1. Bulls in full flesh of the highest slaughter value. (Good to prime heavy beef.)
2. Plain to good butchers.
3. Common to medium bolognas.
4. Canners and poor light bulls.

Heifers and Cows:

1. Heifers in full flesh, finished in fattening and of the highest slaughter value. (Prime to fancy.)
2. Cows up to seven years in full flesh, finished as regards fattening, and of the highest slaughter value. (Prime to fancy.)
3. Older cows finished in fattening and more poorly developed younger cows and heifers. (Good to choice.)
4. Moderately nourished cows and heifers. (Plain to good.)
5. Poorly nourished cows and heifers. (Inferior to common.) (Canners.)

Calves:

1. The finest fattened calves (fattened on milk) and the best suckling calves. (Good to prime vealers.)
2. Moderately fattened and good suckling calves. (Medium calves.)
3. Poor suckling calves. (Light vealers.)
4. Older poorly nourished calves (feeders). (Inferior to fair.)

Sheep:

1. Fattened lambs. (Fair to prime.)
2. Young fattened wethers. (Fair to choice.)
3. Old fattened wethers. (Medium to choice.)
4. Moderately nourished wethers and ewes. (Common to good.)
5. Bucks. (Common to good.)

Hogs:

1. (a) Hogs in full flesh, of fine breeds and their crossings up to one and one-quarter years old (weight 220 to 280 pounds) (top selected butchers), (b) fattened hogs (heavy butchers).
2. Fleshy hogs. (Heavy, medium and mixed packing hogs.)
3. Poorly developed hogs. (Light weights.)
4. Sows and boars. (Inferior to good.)
5. Stags and roughs.

Transportation of Food Animals.—The transportation of food animals should also be given consideration in the inspection of meat, since as a result of shipment the condition of the animals, as well as the consistency of the flesh, may be more or less affected. Transportation may take place by driving, trucking, railroad or by boat.

Transportation by driving affects food animals to a degree corresponding with their being accustomed to outdoor exercise and the temperature of the season. This transportation is conducted with the least effect on horses, sheep and such cattle as were raised on pasture; more difficulty is met with stabled cattle, calves and hogs. At present, driving of cattle is usually only employed for short distances, and for longer distances only when the cattle are well accustomed to long drives. As the driving of fattened cattle affects them unfavorably, in proportion to their fleshiness, they are driven only over very short distances. The voice, sticks and dogs are employed in driving the animals. While dogs can be scarcely spared in driving sheep, they frequently cause considerable excitement among animals of other species. Sometimes as a means of compulsion to stubborn cattle the tail of the animal is twisted, which, however, may degenerate into cruelty and produce anatomical lesions in the tail (fractures, bruises, etc.).

All animals transported will get more or less excited and tire to a certain extent. Should such excited and tired animals be slaughtered immediately, they will bleed out incompletely in most instances, and the keeping quality of their meat will frequently be decreased. Accordingly, transported animals, as a rule, are slaughtered after they have been allowed a period of rest, the length of which depends on the temperature of the season and the condition and fatigue of the animal. Some animal and meat inspection regulations prescribe a certain number of hours as a resting period before slaughter of transported animals. When this is not the case the veterinary inspector should, in accordance with his findings of the antemortem inspection, forbid the slaughter of the animals until they have regained a comfortable state and have entirely recovered from the effects of the transportation.

In transporting by trucks the vehicles must be suitably constructed for the respective species of animals, and must permit a careful loading and unloading. Animals should be fettered only to the extent of preventing them from jumping out of the truck. Forcible and painful tying of the legs of calves and sheep, especially with thin, cutting strings, is unwarranted. The frequent practice of crowding animals into a too limited space is also to be condemned. The more the animals are fettered the more they struggle, and for this reason the advantages of transporting by wagon are limited. In summer, animals should be

protected against the heat of the sun. Hogs are advantageously cooled by occasionally pouring cold water over them, or, still better, by transporting them at night.



FIG. 1.—Loading cattle for market.



FIG. 2.—Stock car for transportation of live animals.

Today transportation by rail plays the most important part, and is generally carried out in accordance with appropriate regulations. For this method of transportation a special type of car is employed, built

especially for the transportation of live stock (Fig. 2). It is of prescribed size, and is equipped with appropriate ventilation, as well as with contrivances for feeding and watering.

A special type of stock car is the so-called double-deck car, or two-story car, which consists of two divisions, one above the other. It is used for the shipment of sheep and hogs.

For loading and transporting of animals by rail, appropriate regulations are in existence. Cattle, as a rule, are placed crosswise in a fully loaded car; that is, perpendicularly to the long axis of the car. According to Zschokke, adult bulls and steers require for this purpose 66 cm. and cows 57 cm. of the car length. For hogs an average of 0.4 sq. m. of floor space should be required; for calves, 0.31 sq. m.; and for sheep, 0.24 sq. m. per animal.

For the transportation of hogs and small stock it is advisable to divide the cars with cross partitions into several compartments, and in mixed shipments separate divisions for the different species of animals should be required. Only suckling calves are allowed to be loaded together with their mothers.

The disadvantages and dangers of railroad transportation of food animals depend on various conditions. It is greater for fat animals than for lean ones. The closer they are loaded, the higher the temperature, the greater the distance, and the less suitably the cars are arranged, the greater are the disadvantages. Hogs suffer comparatively the most, and deaths from suffocation and paralysis of the heart are not infrequent. Cattle are often greatly affected by the frequent switching of the cars. They may be thrown down, and are then stepped upon by others, and may die as a result of the injuries, or even from suffocation.

A peculiar disease, sometimes observed in cattle as a result of railroad transportation, is designated as railroad sickness. This affection manifests itself as a severe nervous disorder, which, in a well-developed state, does not appear unlike parturient apoplexy. The termination of the disease is usually unfavorable. Animals affected with railroad sickness are condemned. (B.A.I. Order 211, Regulation 9, Section 2, Paragraph 4.)

The transportation of food animals by boat comes principally into consideration in importations from across the sea, and for this service specially equipped steamers are employed. The loading and unloading of the animals is sometimes accompanied by considerable difficulties, while the transportation itself, if the weather is not stormy, is not followed by any more marked disadvantages than railroad transportation. In regard to the sheltering of the animals on boats, everything said in relation to railroad transportation may be applied here.

A period of rest before slaughter should be required for animals transported by any of these methods, and it should be extended in accordance with the condition of the animals. Generally the time will be considerably shorter than in animals transported afoot.

It is readily understood that food animals lose more or less of their live weight as a result of all kinds of transportation. It is impossible, however, to establish definite figures relative to that loss, on account of the great differences in feeding and the conditions of transportation.

The transportation of animals is governed by a degree (Public No. 340), enacted by the Congress of the United States, and approved, June 29, 1906.

Importation of Food Animals from Foreign Countries.—The importation of animals into the United States is governed by inspection and

quarantine regulations contained in Bureau of Animal Industry, Orders 301 and 327, the latter relating specifically to importations from Mexico under a treaty between the United States of America and the United Mexican states, ratified on January 17, 1930. These regulations are issued by the Secretary of Agriculture under authority of various acts of Congress, including those of August 30, 1890, and February 2, 1903. Further regulations incorporated in Bureau of Animal Industry, Order 334, specify countries from which cattle, sheep and other domestic ruminants and swine are prohibited importation by an act of Congress, approved June 17, 1930, owing to the existence in those countries of either foot-and-mouth disease or rinderpest. The regulations designate ports for the importation of animals, specify the procedure of obtaining permits for their importation and outline the character of certificates which must accompany them. They also specify the period of quarantine required for various kinds of animals and provide rules for the handling and treatment of all such animals from time of arrival at the port of entry until released for shipment to destination.

All cattle imported into the United States from any part of the world except Great Britain, Ireland, the Channel Islands, Canada, Mexico, Central America and the West Indies are subject to a quarantine of not less than sixty days, counting from the date of arrival at the port of entry. The period of quarantine for cattle imported from Great Britain, Ireland and the Channel Islands is thirty days, counting from the date of arrival at the quarantine station. Sheep, goats and swine from any part of the world except Canada, Mexico, Central America and the West Indies are quarantined for not less than fifteen days at the port of entry, and if from Central America or the West Indies the time of detention is from one to two weeks. Except in the case of certain shipments for immediate slaughter, cattle, sheep, goats and swine from Canada and Mexico, when not accompanied by proper certificates showing freedom from disease and exposure thereto, are subject to detention for such observations and tests as deemed necessary. The importer of cattle, sheep, goats and swine from Canada or Mexico is required to declare at time of entry the purpose for which his animals are being imported. If intended for slaughter they are consigned to some recognized slaughtering center and there slaughtered within two weeks from the date of entry. Animals from Canada or Mexico entering the United States in bond for export to some other country are subjected to inspection. Horses from all countries are inspected at time of entry and are quarantined and tested whenever found necessary to establish their freedom from disease.

Regulations governing the importation of animals are revised from time to time in order to meet changes in the livestock disease situation in various foreign countries.

Insurance of Food Animals.—There is at present no food animal insurance in the United States, but as such splendid results have been obtained in the different countries of Europe by various methods of insurance, it is quite probable that in the course of time an insurance

will be established which will protect the packers and shippers from the great losses sustained from the transportation and condemnation of food-producing animals. As the insurance of food animals is of great importance to the trade in food animals, as well as to the antemortem and postmortem meat inspection, and as the experts on meat inspection have frequently to coöperate in this matter, it seems advisable that the methods of insurance should be at least superficially treated at this time.

The insurance of food animals may be carried out in many various forms. These are distinguished in accordance with their territorial bounds, as local, regional, provincial and continental insurances. Regarding the managements, there are private, coöperative, community and State insurances. Participation in the insurance may be voluntary or compulsory; in the same way it may be extended to all the food animals or only to a certain species of them. The insurance pre-

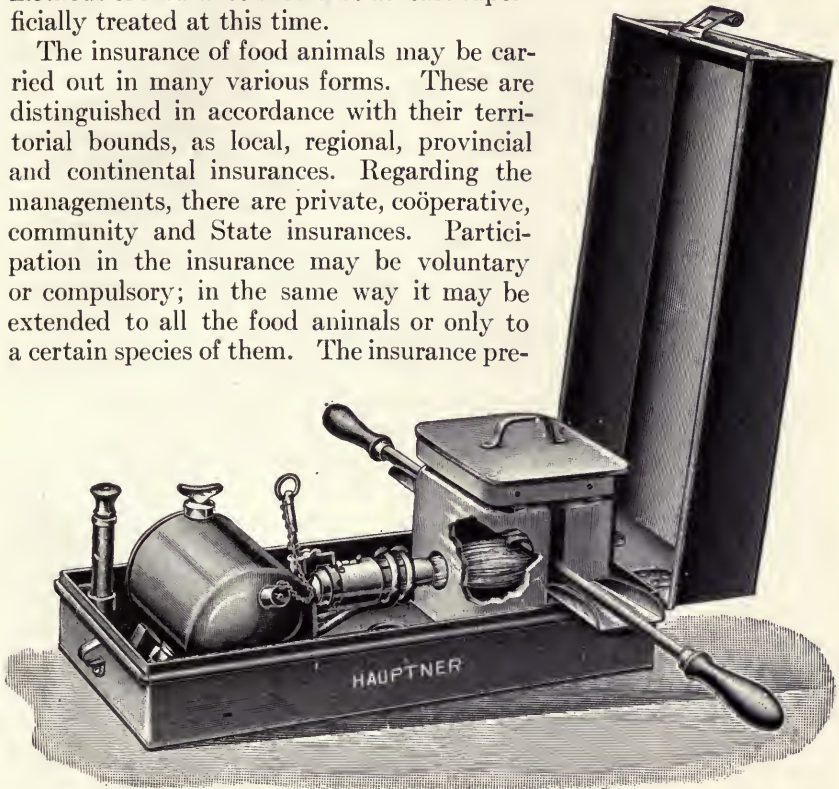

FIG. 3.—Large benzin apparatus for heating irons (Hauptner, Berlin). The flame passes into a box lined with fire clay, which accommodates two firing irons; they are heated in a few minutes to a red heat. Size of the apparatus, 53 x 22 x 18 cm.; weight, 14.5 kg.

mium is, as a rule, a certain definite sum, and is paid for every animal at the place where the animals are marketed or slaughtered; and in either instance it is supposed that the animals are examined by an expert and found acceptable of insurance. This is occasionally manifested by a special marking of the live animals, and for this purpose branding on the horns or claws (Fig. 3), or the use of ear tags, is considered the most appropriate (Figs. 4 to 7). Such marking may also be applied to small stock. For live hogs the pricking stamps, with or without stains (Fig. 8), are highly satisfactory, or tattooing pincers, with which markings are applied to the ears (Fig. 9).

The insurance company pays indemnity, as a rule, only when the entire carcass, or a large part of it, is declared unsuitable for human food, or is only conditionally passed by the veterinary inspector. The indemnity is paid, chiefly to the full value of the animal, which is determined either from the declared sales price, or after slaughter by



FIG. 4.—Anchor ear tags, according to Schumann. The tags, which are also supplied in white or colored tin, can be easily marked or numbered with a steel needle. The tags are also supplied with any kind of marking which may be desired.



FIG. 5.—Showing application of tag.

the establishment of the weight and the estimation of the quality of the meat. Besides this many insurance companies remit the expenses which result from the charges for slaughter and other fees in connection with the latter. Other insurance companies allow only a certain proportion of the value of the animal as indemnity.

Condition of Obligations (Guarantee).—In the purchase of live stock in the United States no guarantee, as a rule,



FIG. 6.—Improved ear tags, according to Hink-Drawert, of the firm of Hauptner, Berlin.

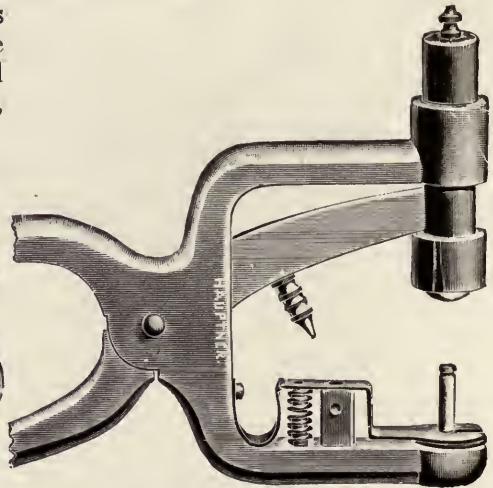

FIG. 7.—Nippers for inserting the tags.

accompanies the transaction, with the possible exception of the custom followed in certain localities whereby the stock is bought subject to post-mortem inspection. This method, however, is generally applied only to wagonloads of hogs, and animals which have been tuberculin-tested and have reacted to the test. Furthermore, the animals which are condemned or marked as inspected by State inspectors in certain stockyards are also

sold subject to the postmortem examination of the Federal inspector. The practice which formerly obtained with reference to the resale to other packers of animals marked as suspected by a Federal antemortem inspector does not obtain under the new law as, at present, all antemortem inspections are made by the Government only after the animals have been sold to the packer who wishes the carcasses, and such suspect animals are then killed separately from the regular kill. The principal defects and guarantee limits for trade in food animals in Germany are regulated as follows:



FIG. 8.—Pricking stamp with hollow probe-like pins, according to Siedamgrotzky.

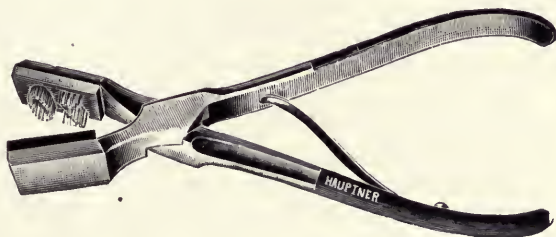

FIG. 9.—Tattooing pincers with two letters and impression. (After Hauptner, Berlin.)

For the sale of animals which are to be slaughtered and are destined as food for human beings (food animals), the following principal defects are to be considered:

I. In horses, asses and mules: Glanders (farcy), providing the disease occurs within a time guarantee of fourteen days.

II. In cattle: Tuberculous affections. In cases where the extension of the disease is so great that more than half of the dressed weight is condemned or is only conditionally passed for human food, providing such lesions are found within the time guarantee of fourteen days.

III. In sheep: General dropsy, with a time guarantee of fourteen days; under general dropsy is to be considered a dropsical condition of the meat, brought on by an internal affection or by insufficient nutrition.

IV. In hogs:

1. Tuberculous affections as mentioned in No. II, with a time guarantee of fourteen days.
2. Trichinosis, with a time guarantee of fourteen days.
3. Measles (*Cysticercus cellulosæ*), with a time limit of fourteen days.

Age of Food Animals.—In the inspection of animals and meats, strictly speaking, only the age of calves play an important part, while the age of other food animals is of minor value.

1. The age of calves is of importance, since in the United States it is accepted by the public that veal comes on the market in a certain state of development when it has attained the proper maturity for slaughter. (See B. A. I. Order 211, Regulation 9, Section 2, Paragraph 5.) As in general this fitness for slaughter is only reached after a certain age, the veterinary inspector must decide the age of calves in doubtful cases. For establishing the age in calves the following should be considered:

(a) Calves are born with eight milk incisors and the premolar teeth. Should the corner incisors at the time of birth be covered by the mucous membrane, so that their presence can be both seen and felt, they will break through in two to six days. In the beginning the highly reddened gum lies closely on the incisors and almost covers them, but after seven to ten days it recedes gradually, so that the shovel form of the incisors becomes more and more apparent. In this way, after two weeks the shovel form appears free in the central and first lateral incisors; soon this is followed on the second lateral incisors, and finally, after three to four weeks, on the corner teeth. At the age of one month all the crowns of the incisors grow entirely out of the gum, which retains its permanent pale pinkish-red color, and lies against the crowns of the incisors in the form of the characteristic pad.

(b) The stump of the navel cord, which remains on the newly born calf, dries in the first four to six days, and separates from the abdominal wall in the second week of life, leaving a moist, sensitive surface, which is soon covered by a scab. In two to three weeks the cicatrization of the navel wound takes place, from which the scab falls off generally inside of the fourth to fifth week. Exceptions to this rule may occur, and are frequently caused by inflammatory suppurative processes of the navel.

(c) During the first week of life the lumen of the umbilical vein is found to be still wide open and filled with liquid blood.

(d) The soft, arched pad on the sole of the claws of the newly born calf becomes hard in the first days after birth and wears off in proportion to the amount of moving about that is done by the animal.

(e) The formation of the horns on the frontal bones appears from the third week on in the form of a slight thickening of the skin. By the fifth week the hair becomes scanty at these points, and at the end of the second month the horn cap makes its appearance. After three months a movable horn point may be distinguished, which in heifer calves is 2 cm. long, while in bull calves it is 3 cm. long. The fixed condition of the small horns appears in bull calves after four months, and in heifer calves after five to six months.

(f) The change in the color of the kidneys, described by Villain and Bascou for establishing the age of calves, is not admissible, as it is not typical.

(g) Marot has also attempted to establish a relationship between the ossification of the metacarpal and metatarsal bones and the age. Up to five to six weeks of age the longitudinal halves of these bones separate if they are cut or strongly boiled. The surfaces of separation

are rectilinear, but uneven and wrinkled. Each half of the bone shows its special marrow cavity.

In deciding whether the calf is old enough for slaughter, these signs to determine the ages of calves may be supplemented by considering the consistence of the meat and fat, which in doubtful cases is the only guide for the inspector.

Regarding the peculiarities of mature veal, see Chapter II; the signs of immaturity are given in Chapter VII, page 208.

Although the age of the other animals, as already mentioned, is of minor importance in meat inspection, the tabulated exhibit on pages 24 and 25 should furnish some information in regard to the age of food animals as determined by the teeth (Ellenberger and Baum, *Handbuch der Anatomie*).

As the appearance and change of the teeth is influenced in domestic animals by breed, precocity and care, it is evident that in determining the age in doubtful cases special works on animal breeding and anatomy should be consulted.

It is a well-known fact to all veterinarians that with the aid of the rings on the horns of the cow, which develop from the influence of pregnancy, an inspector may be able to determine the age up to a certain point. Two added to the number of rings on horns of the cow will generally give the age. This applies to cases in which pregnancy appeared regularly. Irregular distances between the rings are indications of irregular intervals between pregnancies.

For determining the age of slaughtered cattle, certain points of ossification, and especially the cartilaginous extensions of the first four to five spines of the dorsal vertebræ, may be advantageously utilized. On the split extensions of the vertebral spines the following changes are manifested with the advancement of age:

One year, cartilaginous extension entirely cartilaginous.

Two years, cartilaginous extension interwoven with small single bone centers.

Three years, cartilaginous extension diffused with bone islands.

Four years, cartilaginous extension more so.

Five years, the bony structure exceeds the cartilage.

Six years, the cartilaginous extension almost entirely ossified; however, the cartilaginous border can be plainly distinguished between the bony process and the cartilaginous extension.

Seven years, the cartilaginous border zone still plainly visible.

Eight years, the cartilaginous border zone only slightly perceptible.

Nine years, all cartilage disappeared.

The ossified cartilaginous extension is, however, of a lighter color and more compact than the bony substance of the vertebra proper, but sometimes a narrow red zone forms in the body substance of the former cartilaginous border. If, therefore, the first spinal extensions in their upper third are uniformly compact, the cow is at least ten years old. If the age exceeds twelve years the spinal extensions gradually change into a grayish-yellow, compact bony substance.

Slaughtering of Animals.—The commercial slaughtering of animals begins with the killing, which is carried out by bleeding. The latter must be done as thoroughly as possible, since the content of the blood in the meat influences its keeping qualities. Bleeding is most thorough when the heart and respiratory functions remain in action as long as possible. These functions depend principally on the intactness of the medulla oblongata with the respiratory, cardiac and vasomotor centers, and consequently the most satisfactory methods of killing are those in

TABULATED COMPARISONS OF THE ERUPTION AND THE REPLACEMENT OF THE TEETH.¹

	Horse. ²	Cattle. ³			Sheep and goats. ⁴	Hog.			Dog. ⁶	Men.
		Early mature breeds.	Normal breeds.	Late mature breeds.		Early mature breeds.	Normal breeds.	Late mature breeds.		
1. Incisors. Eruption of central incisors (I)*	Before or in the first 2 weeks after birth	Before birth	Before birth	Before or in first week after birth	2 weeks	3 to 4 weeks	5 weeks	From 5 to 6 weeks (3 to 4 weeks according to Cornavin and Lesbre)	6 to 8 months.	
Eruption of first lateral incisors (I ²)	At an age 2 to 4 weeks; more seldom 4 to 8 weeks	Before birth	Before birth	From 8 to 14 days	Above 8 weeks Below 5 weeks	12 weeks 8 weeks	16 weeks 12 weeks		7 to 9 months.	
Eruption of second lateral incisors of ruminants	Absent	Before birth	2 to 6 days	From 10 to 21 days	Absent	Absent	Absent	Absent	Absent.	
Eruption of the corner incisors (I ³) in horse, hog, dog (I ⁴), and ruminants	At the age of 5 to 9 months	Before birth	2 to 14 days	From 3 to 4 weeks	Before birth	Before birth	Before birth	From 5 to 6 weeks	Absent.	
Replacement of the central incisors	At the age of 2½ to 3 years	17 months	21 months	From 12 to 16 months sometimes 18	11 months	12 months	14 months		8 years.	
Replacement of the first lateral incisors	At the age of 3½ to 4 years	22 months	27 months	From 1½ to 2 years	Above 16 months Below 16 months	18 months 17 months	20 months 18 months	All 6 incisors at age from 2 to 5 months, mostly at 5 months	9 years.	
Replacement of the second lateral incisors	Absent	32 months	36 months	From 2½ to 3 years	Absent	Absent	Absent		Absent.	
Replacement of corner incisors	At the age of 4½ to 5 years	36 months	45 months	From 3½ to 4 years	7 to 8 months	9 months	10 months		Absent.	
2. Canine teeth. Eruption of the temporary canines	As a rule, eruption does not take place, but if present, erupt not later than 6 months after birth	Absent	Absent	Absent	Before birth	Before birth	Before birth	4 weeks	16 to 20 months.	
Eruption of the permanent canines	At the age of 3½ to 5 years	Absent	Absent	Absent	8½ months	9 months	10 months	4½ to 5½ months	11 to 13 years.	

3. Molar teeth. Eruption of the first molar (P ¹)	Before or 1 week after birth	Before birth	After a few days	14 to 21 days	Before or in the first 4 weeks after birth	5 weeks	7 weeks	9 weeks	From 5 to 6 weeks (according to Cornevin and Lesbre, P ² after 4 to 5 weeks and P ³ after 3 to 4 weeks)	Absent.
Eruption of the second molar (P ²)						Above days	8 days	14 days		
Eruption of the third molar (P ³)						Below weeks	3 to 4 weeks	5 weeks		12 to 15 months.
Replacement of first molar (P ¹)	At the age of 2½ years	24 months	26 months	28 months	From 1½ to 2 years	Above days	8 days	14 days		20 to 24 months.
Replacement of second molar (P ²)	At the age of 2½ years					Below weeks	3 to 7 weeks	5 weeks		
Replacement of third molar (P ³)	At the age of 3½ to 4 years	28 months	31 months	34 months	3 months in lower jaw, 5 months in upper jaw	13 months	14 to 15 months	16 months	From 5 to 5½ months (according to Cornevin and Lesbre, P ² and P ³ after 6 months, P ³ after 5 to 6 months)	Absent.
Eruption of fourth molar (M ¹)	At the age of 6 to 9 months, sometimes up to 14 months	5 months	5 months	6 months	9 to 12 months	12 months	13 to 14 months	15 months		10 years.
Eruption of fifth molar (M ²)	At the age of 2 to 2½ years	15 months	16 months	18 months		4 months	13 to 14 months	15 months		11 to 15 years.
Eruption of sixth molar (M ³)	At the age of 3½ to 4½ years	24 months	26 months	28 months	1½ to 2 years	7 to 8 months	5 months	6 months ⁴	5 to 6 months	7 years.
Eruption of the wolf teeth	Uncertain, mostly in first half year of life	Absent	Absent	Absent	Absent	4 months	5 months	6 months	4 to 5 months	
						17 months	9 to 10 months	12 to 13 months	5 to 6 months	13 to 16 years.
						4 months	18 to 19 months	20 to 22 months	6 to 7 months	18 to 30 years.
						4 months	5 months	6 months	4 to 5 months	Absent.

¹ Information regarding the eruption and replacement of the teeth was obtained for this table from Deutsche Landwirtschafts. Presse, 1899 u. 1900. Cornevin et Lesbre, Traité de l'âge des animaux domestiques, Paris, 1894. Rauber, Anatomie des Menschen, Leipzig, 1897, and elsewhere.

² In the horse, as a rule, the incisors of the upper jaw are replaced from two to eight weeks earlier than those of the lower jaw. In early mature horses the replacing of the teeth occurs generally two months earlier than in late mature horses (Frank-Martin, Anatomie).

³ Regarding the temporary teeth of calves, see also p. 23.

⁴ In the goat the incisors are replaced somewhat earlier than in sheep. It is generally accepted that a goat is as many years old as there are pairs of replaced incisors present. Accordingly, a goat in which the corner incisors are replaced would be four years old. Sometimes in the sheep the second lateral temporary incisors appear earlier than the first lateral temporary incisors. According to Misernus, it is a rule in sheep that at two years the central incisors are replaced, at three years the first laterals appear, at four the second laterals, and at five all eight incisors are present.

⁵ Sometimes it appears at four weeks, or even earlier (Nathusius).

⁶ According to Cornevin and Lesbre, large breeds of dogs are a few weeks ahead in the replacing of teeth compared to small breeds. Also, considerable differences might exist through the influence of the various breeds. The wearing of the teeth is subject to considerable irregularities, depending on the food habits, etc., of the dog.

[* I signifies incisor; P, premolar; M, molar; while the numbers after these letters indicate the first, second, or third tooth of each group.]

which the medulla oblongata is not injured. From a humane standpoint the withdrawal of blood should always be preceded by stunning the animals, which, as a matter of fact, is carried out in almost all cases with the exception of those slaughtered in accordance with the Jewish rite. As a result of stunning, the excessive struggles of the animals are prevented, and in consequence the dangers to the butchers from such struggling are also averted.

The following killing methods are distinguished as a result of the different methods of stunning:

Killing Methods with Stunning.—(a) The blow on the head (forehead blow) is made usually with a knocking hammer. It may be employed on all food animals, and causes, when proficently applied, an immediate insensibility of the animal.

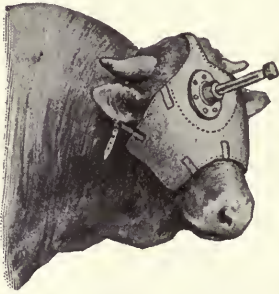

FIG. 10.—Head of bull with slaughter mask attached.

The action of the blow on the head depends on the position of the brain in the various animals and its greater or lesser protection by the cranium. In the horse the condition for stunning with the blow on the head are the most favorable, as the brain is practically only covered by the comparatively thin bone plates formed by the frontal and parietal bones. Therefore, a blow directed at this point will act directly on the brain. Similar conditions obtain in sheep and goats; in these animals, however, it should be remembered that the strong roots of the horn processes of the temporal bone considerably strengthen the cranial roof, and

besides the effect of the blow in sheep is also diminished by the woolly covering. The brain in these animals is more easily reached from the base of the head than from the forehead. In cattle, as is well known, the frontal lobe also forms the entire brain covering, which, on account of the strong development of the frontal sinuses, is divided into a lateral and median lamella. The effect of the blow is broken by the frontal sinuses, and the farther the blow strikes from the middle point the less effective it will prove. The proper point to strike is situated where the diagonals from the base of the horns to the opposite orbital arches cross.

These anatomical peculiarities do not interfere in calves, as the undeveloped soft skull does not resist the blow to any marked degree. While the roof of the cranium in hogs is similar in structure to that in cattle, due to the prominent development of the frontal sinuses, yet these anatomical relations play no special part, as the majority of hogs are slaughtered at a young age, when the roof of the cranium is not very compact. Only in breeds of hogs with a strongly protruding skull and receding face is the bony development of the skull very marked, and in these the front part of the head is frequently covered with thick woolly hair, which considerably diminishes the effect of the blow.

(b) The frontal blow with a slaughter ax or bolt hammer is executed by the use of a short ax, to which a round, chisel-shaped bolt is fastened, and this is driven into the brain. The application of this apparatus, which in general is not to be recommended, requires skill in sure hitting and much strength.

(c) The frontal blow with the application of the so-called slaughter mask. The construction of this apparatus can be seen in Fig. 10, but it is never employed in this country.

The bolt is driven into the brain, causing the animal to collapse immediately. Rissling prefers a strong, hollow cylinder to the solid bolt. Other slight changes in the mask have been undertaken occasionally. After the removal of the mask, as a rule, a small piece of cane is introduced in the opening of the cranium in order to destroy further the posterior portion of the brain. This is also usually carried out in the use of the previously described apparatus, which, however, is absolutely unnecessary when the bolt is driven at the right place into the brain. While the convulsive struggling which results from the introduction of the small piece of cane into the brain has a repulsive effect, there is total absence of consciousness. The statement of Dembo, in which he expressed his doubt regarding the reliability of the slaughter mask, may be considered as disproved through the statistics compiled by Siedamgrotzky.

(d) The blow on the forehead with the spring-bolt apparatus designed by Kleinschmidt, or with the bolt apparatus of Kögler, is used in certain foreign countries for stunning hogs and sheep (Figs. 11 and 12).

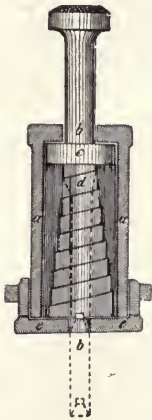

FIG. 11.—Vertical section through Kleinschmidt's spring-bolt apparatus: a, iron covering; b, bolt; c, groove; d, spring; e, head piece.

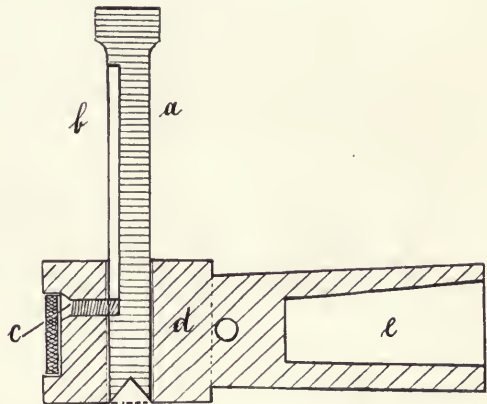

FIG. 12.—Vertical section through a bolt apparatus, according to Kögler: a, bolt; b, groove; c, screw for the bolt; d, iron middle cylinder; e, eye for opening the wooden handle.

(e) Killing of food animals with bullet-shooting apparatus. The oldest instrument belonging to this class was originated by Siegmund. A similar apparatus without the leather mask has been placed on the market for several years according to Staehl's patent (Fig. 13). However, these instruments are not used in the United States, although in a few packing houses old bulls are occasionally shot with a rifle instead of stunned with a hammer, owing to their very thick skulls.

(f) Shooting with the shooting-bolt apparatus, such as those designed by Flessa, Liebe, Schrader, and further with Behr's bolt pistol (Fig. 14), etc., which, by the pressure of the gases from the powder of an inflammable shell, drives a bolt into the brain in a similar way as the blow-bolt apparatus. Flessa's bolt-shooting apparatus is very simple, as the discharge occurs only on the head of the animal to be killed, through the ejections of the bolt, which extends for about 1 cm., whereby

the other sharpened end of the bolt causes an explosion of the strongly active copper cap. On account of the slight danger from the bolt-shooting apparatus they are preferred to the bullet-shooting apparatuses in Germany.

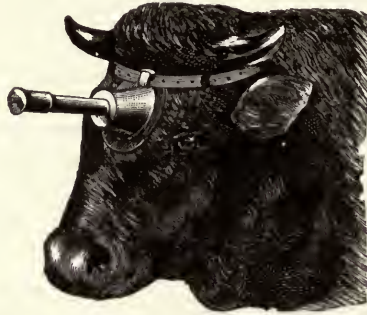

FIG. 13.—Head of bull with shooting apparatus, attached, according to Staehl-Stoff.

(g) The blow on the base of the head or on the forehead is carried out with an ax, cleaver, club or with the end of a heavy hammer (Fig. 15). The stunning results from the contusion of the brain. This method

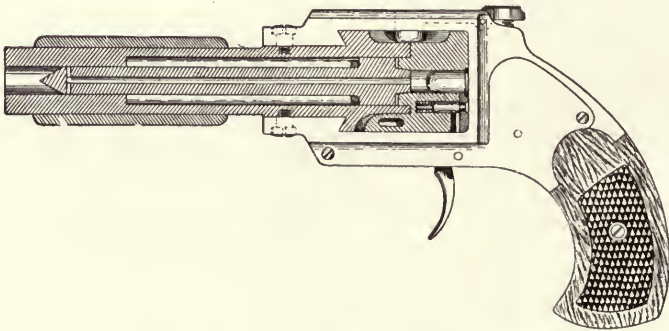

FIG. 14.—Behr's bolt pistol in section. (Behr's Industrial Company.)

is the simplest for large-horned or aged sheep and goats, and is the principal method adopted in the United States for stunning animals.



FIG. 15.—Knocking hammer.

The slaughtering methods employed for cattle in the United States are preceded, with the exception of those selected for Hebrew consumption, by stunning which is carried out with a long-handled hammer.

While there is no doubt that the stunning of the animals with the various above-described apparatuses has some advantages, yet such methods could not be satisfactorily carried out in the large slaughtering centers of this country, as a large percentage of the food animals are range cattle which have never been accustomed to being handled, and therefore the attachment of an apparatus to them or even approaching them for that purpose would be not only impracticable, but an impossibility in most cases. Besides, the construction of the killing pens and the skill of the men employed for this particular work of "knocking," render this method perfectly satisfactory and without any unnecessary cruelty, as it occurs only exceptionally that the animal is not completely stunned with a single, well-directed blow.

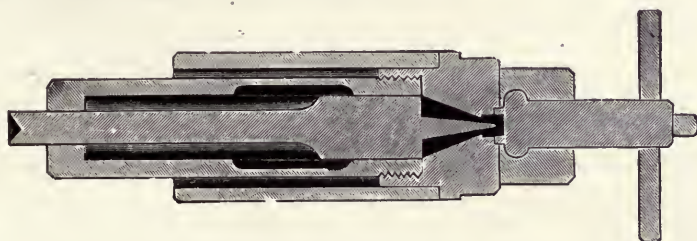

FIG. 16.—Bolt-shooting apparatus by abattoir director Flessa, longitudinal section (Hauptner, Berlin.)

Slaughtering Method without Stunning.—(a) In pithing, a strong knife is stuck between the atlas and occipital bone and the medulla oblongata is thereby severed or injured. The animals collapse immediately. They are, however, not stunned, but only helpless, as conscious movement is arrested. Unconsciousness only takes place when, after subsequent bleeding, the resulting cerebral anemia has reached a certain degree. The bleeding of such "pithed" animals is sometimes unsatisfactory, owing to the injury of the vasomotor centers, also of the heart and respiratory centers in the medulla oblongata. Pithing, therefore, should be discarded from a humane as well as from a practical standpoint.

The "blow on the base of the head" has the disadvantage of pithing only when the blow has not been sufficiently strong to produce a contusion of the brain.

(b) "Schachten" (from the Hebrew verb "schachat," to draw; to draw the knife to and from) is the oldest slaughtering method, and is applied by the Jews and Mohammedans to cattle and small stock.

For this purpose the animals are secured and thrown, and then follows the cutting of the throat with a very sharp knife with a wide blade. The latter is performed by an especially appointed member of the faith. Death of the animals occurs through the slow loss of blood from the large vessels of the neck. The throwing and securing of large and strong cattle is frequently associated with difficulties and dangers, and accompanied generally by considerable cruelty to the animal. Since the middle of the last century there has been much argument regarding the advantages and disadvantages of the Jewish method of slaughter from a humanitarian, physiological and hygienic standpoint, and also as to its authority from a religious consideration, which will not be further discussed here. It should only be mentioned that this method of slaughter without previously stunning the animal was prohibited

in the Kingdom of Saxony and in Switzerland, a regulation which, from the humanitarian standpoint, should receive the fullest approval. Further information may be obtained in the extensive works and publications on this subject.

For diminishing the cruelty in throwing animals, various apparatuses have been constructed, which, however, only slightly improve the repulsiveness of the Jewish method. This is also true of the equipment now in use for the stretching of the neck and head by the so-called head holder before "Schachten."

It should also be mentioned that experiments have been made to kill animals with electricity (Bockelmann).

To improve the method of securing hogs for stunning, Renger constructed a slaughtering machine, which can be utilized to only a very limited extent.

For acquiring steadiness in taking aim on the part of the butcher apprentices, various apparatuses have been constructed. They are even supplied with an indicator registering the force of the blow, and are maintained by the butchers' association of larger cities. On these machines the apprentices receive their instruction and practice in striking.

Bleeding.—Extraction of the blood is accomplished in large stock and hogs by cutting the blood-vessels at the entrance of the thoracic cavity; in small stock by sticking in the neck or cutting the throat. The latter is also sometimes employed in cattle, especially when slaughtering them in accordance with the Jewish rite (Schachten). As the keeping qualities of meat depend considerably on thorough bleeding, this should be as complete as possible. It depends on the following conditions:

(a) The health of the animal considerably influences thorough bleeding' as all severe affections weaken the vitality, which involves the action of the heart, lungs and muscles, thus influencing the driving out of the blood. Bleeding is retarded especially in febrile conditions, also in cases of severe indigestion, acute disturbances of the portal circulation and severe lung and heart affections. As a rule, animals so affected bleed out very poorly.

(b) Sufficient rest of the animals before slaughter is also essential to assure a thorough bleeding. Animals that are excited or are thoroughly tired usually bleed out insufficiently.

(c) Strong and long-continued respiratory and cardiac action, as well as energetic convulsions of the body muscles, favor thorough bleeding for reasons that are self-explanatory. As these functions are regulated by the central nervous system, and especially by the medulla oblongata, thorough bleeding depends to no small degree upon the:

(d) Slaughtering and stunning method, which favorably influences bleeding when the medulla oblongata remains intact.

(e) The performance of sticking or cutting considerably promotes or retards the bleeding. When thoracic bleeding is performed the heart must not be injured, and also bleeding into the thoracic cavity must be prevented (over-sticking), as compression of the heart and lungs takes place through the quick accumulation of blood in the chest cavity.

The anemic state of the arteries and large and medium vein trunks is not the only indication of thorough bleeding, but a certain dryness of the parenchymatous organs and especially of the muscles is even more important in this respect. Only a few drops of blood can be obtained on pressure of the cut surfaces, and only in the smallest veins can there be found traces of blood.

The quantity of blood, which averages one-thirteenth of the body weight, naturally cannot be totally abstracted; however, the larger por-

tion of it may be withdrawn. The quantity of the blood depends on the sex, size and nutritive state, and on the above-mentioned conditions, which influence the bleeding of the slaughtered animals. The quantity of the withdrawn blood amounts in cattle to 15 to 25 liters; in horses, 20 to 30; in hogs, 2 to 3; in small stock, $1\frac{1}{2}$ liters. In hogs the quantity of blood is considerably diminished with the increase of fat on the animal.

Various experiments have been made regarding the quantity of blood drawn from slaughtered animals. Heissler found the quantity of blood from horses to be 3.93 to 9 per cent of the body weights; in cows, 4.02 to 5.75 per cent; in calves, 4.4 to 6.65 per cent; in sheep, 4.37 to 7.56 per cent; in hogs, 1.45 to 5.74 per cent. According to Goltz the quantity of blood amounted in cattle to 3.1 to 3.3 per cent of the body weight; in calves, 4.9 to 5 per cent; in sheep, 4.1 to 4.3 per cent. At the same time Goltz established that the method of killing—whether the animal was slaughtered in accordance with the Jewish rite or whether the withdrawal of blood is preceded by stunning—has no influence on the quantity of blood flowing from the animal. The same results were obtained by Falk, who also believes that cows possess a larger quantity of blood than heifers, or even bulls and steers. Fjelstrup determined the quantity of blood by washing out the blood-vessels with salt-water infusions, according to a special formula.

The blood from animals slaughtered by cutting the throat is, as a rule, polluted with the vomited contents of the stomach, and, therefore, cannot be utilized for human food.

Further Dressing of Carcasses.—Regarding the further course of commercial slaughter the following notations may contain some information. The extent of the dressing and cutting with consideration for the intended postmortem inspection is established by the Federal Regulations.

Cattle are partly skinned while on the floor. This is then followed by the removal of the feet at the carpal and tarsal joints and of the head. The abdomen is cut for a short distance along the median line for the removal of the connected masses of fat of the mesentery. After the penis, scrotum or udder is cut off, the breast bone and the pelvis sawed, the latter in the symphysis, the animal is hoisted with the aid of a beam which is inserted through an opening made between the tendo Achillis and the metatarsal bone, or by hooks which are inserted into the same openings. The carcass is then further skinned and finally eviscerated, leaving only the kidneys. In the process of evisceration (gutting) the uterus and bladder are first removed, followed by the intestines and mesentery; then the stomach (or stomachs), with the adherent spleen, then the liver and finally the heart, lungs and trachea. In some places the liver and parts of the diaphragm are removed, together with the thoracic viscera. From the head the brain is removed and the tongue is separated from the connection with the lower jaw, in such a way that the buccal and laryngeal cavities become entirely exposed. With hogs, which are subjected to so-called scalding in water at 60° to 70° C., the hair and epidermis are loosened, which may then be removed by scraping. After washing and hanging by the flexor pedis tendons of the hind legs, the evisceration takes place. Only the kidneys are left in place, provided they do not come out with the removal of the retroperitoneal layer of fat (leaf lard). Stomach and intestines remain in their natural connection; also the liver, with the thoracic viscera, together with the trachea and esophagus. In France the bristles of the hog are removed by singeing. Singeing is followed in the United States, only for certain export hogs. At present this custom appears to be declining, and is gradually being replaced by scalding. As singeing makes the examination of the skin difficult,

it should be considered as a procedure to which the hogs should not be subjected without having had a previous careful inspection.

Recently a new method has been developed for dehairing hog carcasses by dipping the entire body (except the hind feet) in a mixture of rosin and oil maintained at 300° to 340° F. This treatment produces clean carcasses, removes hair roots and eliminates cuts by the shavers' knives. It follows the usual operations of scalding and dehairing which are still conducted as heretofore. After leaving the dehairing machine the carcasses are gambreled and suspended from



FIG. 17.—Showing ease with which adhesive is removed. (Courtesy of Allbright-Nell Co.)

an overhead rail in the usual manner. Plugs of cotton are then inserted in the nostrils and a rubber band is placed around the snout and lower jaw to prevent the rosin mixture from entering the nose and mouth. By a mechanical device the carcasses are now lowered into the proximal end of a dipping tank containing the rosin mixture and a few minutes later are removed from the distal end by an electric hoist. After emerging from the dipping tank the rosin coated carcasses pass beneath a cold water spray in warm weather which facilitates the "setting" of the coating to rubbery consistency, but in cool weather the air accomplishes the same purpose. This plastic coating is then stripped from the hind legs,

split in the region of the crotch, rolled down over the body, shoulders and head and removed in a mass and placed in appropriate equipment to be reclaimed for further use after remelting and straining. (See Fig. 17.)

Small stock are skinned after the removal of the feet, partly while lying on a rack and partly when hung up. They are then eviscerated in the same manner as hogs; the kidneys, sometimes the liver and spleen, as well as the thoracic viscera, are left in place. The inflation of carcasses of calves and sheep by blowing air into the subcutis with the mouth, bellows, or air pump, is prohibited here and is becoming less frequent in Germany. This is also true of the inflation of the lungs with air. Meat which shows changes through the blowing must be declared as unfit for human consumption. Frequently calves are left with their hides on for reasons of cleanliness in transportation. As a rule, cattle and hogs are split into halves through their vertebral columns immediately after slaughter, while small stock are left intact for the time being. Until the carcasses are cooled no further cutting takes place. At this time each side of the beef is transversely cut and divided into a fore- and hind-quarter, by which procedure one to four ribs are, as a rule, cut off with the hind-quarter. The further cutting of the dressed meat depends on the commercial customs, which vary not only in the various species of animals but also in different countries and localities. For further particulars on this subject, as well as the commercial designation of the various parts of the dressed carcass, see page 35.

In relation to the further manipulations in the slaughter of animals for Jews, it should be briefly mentioned that a certain examination of food animals as to health is made. In cattle the "Schachter," after the abdomen has been opened, and before the breast bone has been divided, places his arm into the thoracic cavity through an opening in the diaphragm and explores the pleura for adhesions, etc. After the removal of the internal organ from the body their further examination is made principally with the eye, but whether the carcass should be considered as pure and proper food for Israelites (kosher) depends especially upon the palpation of the lungs for abnormalities. Besides, certain lesions of the other viscera are also considered. In case the slaughtered animal cannot be passed for food in accordance with the ritual requirements, it is declared as unclean (trepha). The kosher meat is marked for the benefit of the consumers with the Hebrew lettering **כשר** and frequently also it is sealed or stamped with the date of the slaughter. As certain large bloodvessels, certain strips of fat, tendinous parts, etc., should not be consumed, these parts are removed by the "Schachter," and designated as "Triebern" and "Porschen" of the meat. As this would result in considerable cutting if applied to the hind-quarters, and consequently would diminish the value of the meat, they are not "porsched," and are, therefore, not eaten by religious Jews. Further particulars of the Jewish ritual slaughter can be found in Goltz's *History of Meat Food*.

Emergency Slaughter.—The form of slaughtering which is everywhere designated as emergency slaughter deserves special mention, and, furthermore, requires particular attention from the standpoint of meat inspection.

Emergency slaughter involves injured and sick animals whose life appears to be more or less threatened, and in order to endeavor to save the meat for human food they are hastily slaughtered. While there are various diseases which occasion an emergency slaughter, they may not affect the meat so as to render it unwholesome. Others again are of a doubtful character, and have endangered the life and health of numerous people. This was proved in a long series of epidemics which resulted from meat poisoning, and Bollinger rightly claims that at least four-fifths of these outbreaks were in connection with emergency slaughter.

The principal cause for emergency slaughter in cattle, as shown by experience and also by the tabulated statistics of A. Maier, are affections of the digestive and sexual organs, and infectious diseases. In small stock and hogs injuries play the most important part.

According to Lydtin's statistics the danger from meat produced by emergency slaughter, when compared with the meat obtained by commercial killing, is 80 times greater in cattle, 12 times in calves, 100 times in sheep, 90 times in goats, 211 times in hogs and 3 times in horses.

Although such statistics sufficiently indicate the general sanitary importance of emergency slaughter, this is further increased when it is considered that the emergency killings, as Ostertag rightly remarks, "include not always the typical affections, but in many instances diseases of unknown origin (cryptogenetic sepsis)." For these reasons the judging of animals slaughtered in emergency is in many cases associated with difficulties, which, even for the scientifically trained veterinary inspector, frequently prove a hard test of his knowledge and conscientiousness. Owing to the dangers of emergency slaughter from a sanitary standpoint, in Germany all efforts for years were directed toward the subjection of these animals under all conditions to a veterinary inspection. The imperial meat-inspection law shows a flaw on this important point, which might easily prove serious. In accordance with this law the inspection may be omitted if the animals are slaughtered for home consumption, and it frequently happens that many instances of emergency slaughter are carried out on just such occasions. In this law the limitation is made that inspection may be omitted only in those animals which before or after slaughter show no signs of disease that would render the meat unwholesome. This regulation has, however, only a limited value, as in some cases an important disease might not show striking appearances in the eyes of a layman; then again unscrupulous stock owners may either disregard the requirements of the law altogether or in case of trouble assert that the symptoms of disease manifested by the animals were not such as to warrant the opinion that the meat was unfit for consumption. While the animals slaughtered for home consumption, and, therefore, uninspected, cannot be commercially utilized, the probable affections should be considered which might result from partaking of infected meat by the family and servants. Besides, it is a well-known fact that frequently the meat of home-slaughtered animals is openly or indirectly brought to market or is worked up for this purpose.

By cold slaughtering is understood in butchers' circles those fraudulent manipulations which aim to utilize carcasses of dead unslaughtered animals, as if they had been slaughtered, by performing the sticking or cutting post-mortem. The absence of bloody infiltration of the edges of the wound and other manifestations make the detection easy for the expert.

Utilization of Food Animals.—As all parts of a slaughtered animal are utilized to the best advantage as human food, it is aimed to effect this utilization to the greatest extent possible. All parts not suitable for food are designated as offal. While in ordinary usage most of the

edible parts of food animals are erroneously included in the word meat, yet in commerce and trade the term meat, in a narrow sense, includes only the skeletal muscles with the organically connected parts (bones, fat, tendons, blood-vessels, nerves, lymph glands, etc.), while the fat, the blood and all viscera utilizable for human food are not considered. All these portions are partly marketed in their fresh state, partly again worked up and naturally possesses great extremes of value.

Meat in a Narrow Sense.—Meat is the properly dressed flesh derived from cattle, swine, sheep, or goats, sufficiently mature and in good health at the time of slaughter, but is restricted to that part of the striated muscle which is skeletal or that which is found in the tongue, diaphragm, heart, or esophagus, and does not include that found in the lips, snout, or ears; with or without the accompanying and overlying fat, and the portions of bone, skin, sinew, nerve, and blood-vessels which normally accompany the flesh and which may not have been separated from it in the process of dressing it for sale. The principal value of food animals lies in the meat proper,¹ namely, in the striated or skeletal muscles, which, in accordance with their location and their coarse anatomical structure, possess different values as human food. In this valuation the actual, nutritive worth of the meat is generally not considered (Chapter II), but more depends on its usefulness and flavor. The latter is principally based upon the firmness and tenderness of the muscle fibers, the arrangement and contents of the connective tissue, the deficiency or richness of fat and the amount of the extractive matter on which the taste of the meat depends. As these relations vary considerably in the different regions of the animal body, the sale value of the meat of certain parts varies likewise. This is also influenced, however, by fondness for certain cuts in different parts of the country. Corresponding with these conditions various meat qualities are distinguished in all animals, and the regional limits, valuations and designations differ considerably in the various countries and territories.

Various Cuts of Meat.—The different meat cuts from the various food animals are sold in accordance with a certain classification, and a considerable variation exists in the market value of the meat from the different parts of the animal. But, inasmuch as there is no distinct ratio as to the market value of these various meat cuts, it will be only necessary to name them, indicating also their location on the carcass in the accompanying illustrations. (See Figs. 18, 19 and 20.)

The veal cuts are: *b*, leg; *d*, loin; *c*, flank; *e*, breast; *g*, shoulder; *i*, neck (Fig. 19).

The tongue of all animals is sold as meat. When meat is not sold in a raw or pickled state, with or without the bones, etc., it is worked up for the various meat products (see Chapter III).

Fat.—The fat which is obtained from food animals in coherent masses is utilized for food purposes either in a raw or rendered state. The term bacon is applied to the deposition of fat in hogs, with or

¹ For the morphology and chemistry of meat, also the peculiarities of the meat of various food animals, see Chapter II.

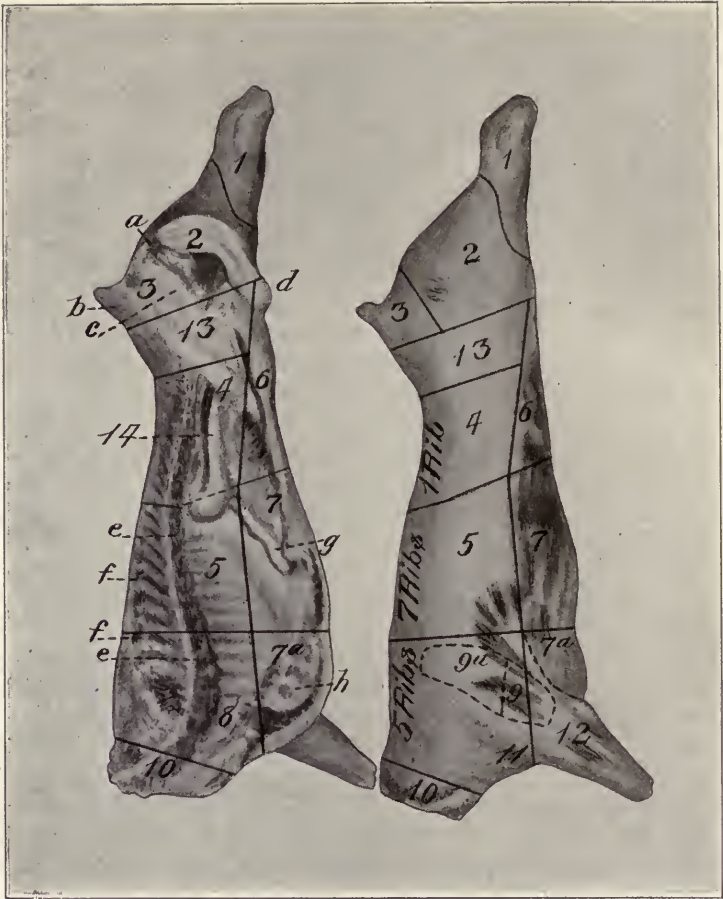

FIG. 18.—Sides of beef showing market cuts.

- | | |
|---|--|
| <i>a</i> , Aitch bone (pelvis). | 5, 7, Piece. |
| <i>b</i> , Rump bone (sacrum). | 6, Flank. |
| <i>c</i> , Crotch (pelvic cavity). | 7, Navel or plate. |
| <i>d</i> , Cod (serotal fat). | 7, 7 <i>a</i> , Full plate. |
| <i>e</i> , Chine (vertebra). | 7 <i>a</i> , Brisket. |
| <i>f</i> , "Buttons." | 7, 7 <i>a</i> , 8, 9, 10, 11, 12, Rattle; triangle; "slug"; "L's"; or knockouts. |
| <i>g</i> , Skirt (diaphragm muscle). | 7 <i>a</i> , 8, 9, 10, 11, 12, Cross-cut or kosher chuck. |
| <i>h</i> , Breast-bone (sternum). | 8, 10, Chuck. |
| 1, Hind shank. | 9, 9 <i>a</i> , Shoulder clod. |
| 1, 2, 3, Round (Chicago cut). | 10, Neck. |
| 2, Round; rump and shin off. | 11, Sticking piece; usually cut as part of chuck. |
| 3, Rump. | 12, Shank. |
| 4, 13, Loin (full loin). | 13, Loin end (sirloin steaks). |
| 4, Short loin or pin-bone loin (porter-house and "T"-bone steak). | 14, Suet (kidney capsule). |
| 5, Rib or prime rib. | |
| 5, 8, 10, Back. | |

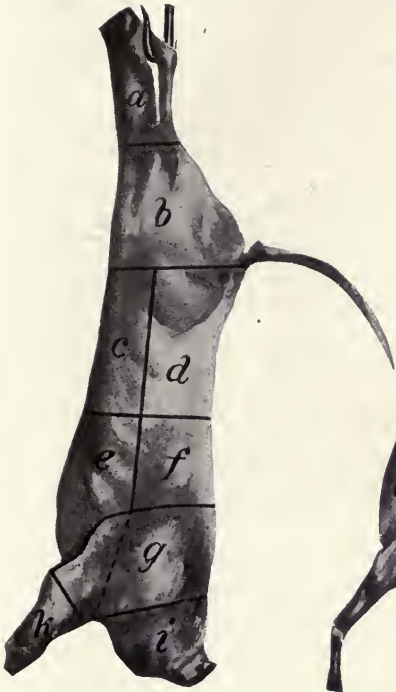

FIG. 19.—Side of veal showing the commercial cuts.

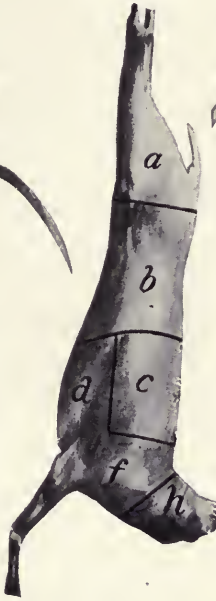

FIG. 20.—Side of mutton showing the commercial cuts.



FIG. 21.—Side of hog showing the commercial cuts.

FIG. 20.—Sheep cuts.

Legs (a)	30 per cent	(hind-quarter with loins off).
Loins (b)	16	“ (cut with flank in).
Racks (c)	20	“ (same as beef ribs with 10 to 13 ribs).
Wings (d, f, h)	33	“
	99	“
Fore-saddle	52 per cent	(rack and wing).
Hind-saddle	48	“ (leg and loin).
Back (or long rack)	37	“ (rack and loin).
Modock	67	“ (rack, loin and leg).

FIG. 21.—Hog cuts.

Loins (d)	16.17 per cent
Shoulders (g)	9.55 “
Hams (c)	16.17 “
Bellies (e)	14.70 “
Feet	2.94 “
Head bones (with meat off into the fat)	2.94 “
Fat	37.50 “
	<hr/> 99.97

without the skin, which lies between the skin and the muscular meat, especially on the back and on the side of the body; it is always intermixed with thin muscular layers. In commerce, the following varieties of cuts are distinguished:

Regular Short Clear.—Side of hog with ham and shoulder cut off, back bone saved off; full rib taken out, back-strapped and lightly squared at each end.

Extra Short Clear.—Side of hog ham and shoulder off; loin and rib taken out.

Long Clear.—Side of hog ham off, back bone and rib taken out, shoulder blade and leg bone pulled, and the left cut off close to the breast.

Rough Rib.—Side of hog ham and shoulder off.

Extra Short Rib.—Side of hog ham and shoulder off; loin pulled, but rib left in.

Regular Short Rib.—Side of hog ham and shoulder off; back bone removed.

Regular Loin Back.—Pork loin with back fat left on back, strapped and end squared off.

Clear Loin Back.—Cut like a regular loin back, but the back bone and short ribs removed.

Mess Pork.—Rough ribs cut crosswise into four or five pieces of reasonably uniform sizes, and packed in barrels with all the pieces of one rough rib in the same barrel.

Family Mess Pork.—A cut about 4 inches wide cut from the shoulder end of a belly. (Packing-house term is the "brisket end of a belly.")

New York Shoulders.—Chopped two ribs wide, trimmed square, butted heavy, the neck side is trimmed rather close; blood vein cut out and they must not be bruised; the neck bone is also removed.

New Orleans Shoulder.—Chopped one and a half ribs wide, it is butted very lightly, blood vein removed; neck bone removed and must be free from bruises.

Three Rib Shoulder.—Chopped three ribs wide, and should be trimmed perfectly square; butted off square where lean and fat meet; neck bone and blood vein removed; must be cut from hogs with smooth skin and be free from bruises.

Picnics or California Style Hams.—Chopped two ribs wide, butt sawed entirely off midway between neck and butt end, which leaves half of blade bone in shoulder, the other half in butt or plate. Neck bone removed, trimmed round on the style of a ham, with blood vein removed.

Boston Style Butt.—A cut obtained only when making picnics; at the larger establishments a semi-round draw knife is used, the knife is drawn through the meat crosswise at the junction of the fat and lean meat so as to leave the blade bone in the butt; the remainder constitutes a *Clear Plate*.

Boneless Shoulder Butt (formerly termed Boneless Ham).—Derived from the same source as a Boston style butt, the drawn knife is pulled

through so as to leave the blade bone in the plate; the remainder in this instance constitutes a *Regular Plate*.

Hocks.—Hocks are obtained only when the sides of hogs are made into long clears or when shoulders are cut "shankless;" a hock, in other words, is that part of the hog's fore-leg measured from knee-joint to the breast.

Stuck Shoulder.—A packing-house term used to express an error on the part of the hog sticker, when through some accident his knife point penetrates into the shoulder of the hog. This, as a rule, forms a sort of a pocket where blood gathers, becomes coagulated and shows up in the form of a clot when the hog is chilled, and usually necessitates the removal of considerable part of the face of the shoulder, causing no small loss when it happens too often.

Those pieces of fat and trimmings which are not suitable for sale in the shop are melted for lard, or are conveyed to soap, grease and other factories, where they are utilized in the industrial arts. For further information on this subject see Chapter III.

Blood.—It is principally the blood of cattle, obtained by thoracic bleeding, that is worked up in sausage. The use of hog blood is prohibited as it is impracticable to obtain it free from contamination. Also blood from cattle slaughtered by the Jewish method cannot be used for food as it is invariably contaminated with stomach contents from the severed esophagus. Fibrin is removed by stirring the blood with a paddle.

Albumin was formerly made from blood offal, but its production is now diminishing. Recently efforts have been directed toward utilizing the dried and ground blood for fertilizing and cattle-feeding purposes, since the high nitrogenous content of the pulverized blood, 12 to 18 per cent, makes it very adaptable. Small concerns usually dispose of the unused blood with the manure and other offal.

Viscera.—The heart, liver, lungs (excepting hog lungs), kidneys, spleen, brain and thymus gland of calves (sweetbread) are sold in their fresh state or they are worked up for sausage or other meat products.

The stomachs of hogs are used for sausage coverings; the stomachs of cattle are sold after scalding and removal of the epithelium as the so-called tripe, or are utilized to a limited extent in ordinary kinds of sausage. Stomach and intestines of calves are consumed as "calf-ruffle." The stomachs of sheep are used either for manufacturing sausage or for food purposes. The stomach of calves yields also the rennet ferment for manufacturing cheese. The intestinal canals of cattle and hogs serve as sausage coverings after they have been scraped and thoroughly cleaned. In a similar way, but to a limited extent, the small intestines of sheep are employed; otherwise they are utilized for the manufacture of violin strings. The serous membrane of the cecum of cattle is used as the so-called "goldbeater skins." The bladders of cattle and hogs are utilized for sausage coverings.

It should be remarked in passing that certain organs, especially the thyroids, ovaries, as well as testicles, bone-marrow and adrenal

capsules, are used in the preparation of therapeutic remedies, which are extensively employed in human medicine.

Offal.—The most important constituent of food animals belonging in this class is the skin, which, with the exception of the hog skin, is worked up into leather.

The latter serves for this purpose only in exceptional cases (boar, old hogs), as it is otherwise sold with the meat, remains on the bacon or is mixed in the filling of various kinds of sausage. This is also done with the skin of the heads of calves, and exceptionally with the skin of the heads of young cattle. Besides, the skin of the head of cattle, especially of the lips and muzzle, as well as the ears, is worked up for food. The utilization of cattle and calf skin for sausage, with the exception of the parts above mentioned, is only permitted under declaration. From the bones, which are not sold with the meat, and which, in well-fattened cattle, amount to 15.1 to 15.4 per cent of the dressed weight, the marrow is extracted for various purposes, but that from the lower bones of the legs is especially worked up for neat's-foot oil. Otherwise the offal bones are converted into glue and bone-meal in factories, while the long bones are also used for industrial purposes. The same applies to the horns of cattle. Tendinous and cartilaginous tissues are utilized in glue factories.

Brushes are made from the better hog bristles, while the poorer qualities are used for minor purposes. Hoofs and claws, as well as inferior horns, are worked into fertilizer.

OFFAL OF BEEF.

UTILIZATION.

Heads:

Skulls.	Extract and edible tallow.
Lower jaw.	Fertilizer and glue.
Nose.	Glue and edible tallow.
Horns.	Horn stock and the arts.
Scrap.	Inedible tallow and fertilizer.

Meats:

Cheek meat.	Fresh and cured for sausage, and marketed.
Head meat.	Fresh and cured for sausage, and marketed.
Tongue meat.	Fresh and cured for sausage, and marketed.
Lips.	Fresh and cured for sausage, and marketed.
Tongues.	Market fresh, cured, smoked, and canned.
Brains.	Market fresh and frozen.

Fats:

Tongue fat.	Glue and edible tallow.
Cheek fat.	Edible tallow.

Plucks:

Hearts.	Market fresh, cured, and sausage.
Liver.	Market fresh, frozen, and sausage.
Lungs.	Inedible tallow.
Wind pipe (trachea).	Glue and edible tallow.
Weasand (mucous membrane of esophagus).	Skinned and dried for casings.
Weasand meat (muscular layer of esophagus).	Sausage.
Fat.	Edible tallow and oleo oil.

OFFAL OF BEEF.

UTILIZATION.

Stomachs:

Paunch (rumen).	Market as tripe, fresh and cured.
Peck (omasum).	Inedible tallow and fertilizer.
Rennet (abomasum).	Inedible tallow and fertilizer.
Fat.	Edible tallow and oleo oil.

Guts:

Rounds	} Small intestines, large intestines, and cecum. }	} Casings for sausage containers.
Middles		
Bungs		
Bladders		
Bung gut skins (cecum).		Arts.
Gut fat.		Oleo oil.
Scrap guts and slime.		Inedible tallow.

Slunks:

Unborn calves.	Inedible tallow and fertilizer.
	Hides are cured.

Hides:—

Cured and glue.

Miscellaneous:

Sinews (tendons).	Neat's-foot oil.
Shanks and feet.	Inedible tallow and neat's-foot oil.
Hoofs.	Hoof stock and arts.
Blood.	Fertilizer, sausage, and beef extract.
Sweetbreads (thymus gland).	Market fresh and frozen.
Caul fat (visceral peritoneum).	Oleo oil.
Ox tails.	Market fresh and frozen.
Melts (spleen).	Inedible tallow.
Scrap.	Inedible tallow.
Fat trimmings.	Oleo oil and edible tallow.

The bile, which is collected at some places, is used in the cleaning of clothes and also for the manufacture of soap.

The contents of the stomachs of ruminants and hogs are sometimes also used mixed with blood or molasses, for the preparation of animal food.

CHAPTER II.

MORPHOLOGY AND CHEMISTRY OF THE PRINCIPAL TISSUES AND ORGANS OF FOOD ANIMALS.

THE morphology and chemical properties of meat and its constituents should be mentioned here, since they are of importance in the examination of meat and in determining its significance as human food.

MEAT PROPER AND ITS CONSTITUENTS.

Muscles.—Of the three kinds of muscles—the striated, non-striated and heart muscle—only the first, which is bought and consumed as meat proper or muscle meat, comes under consideration here. The tissues which are in natural connection with the muscle proper (fat, connective, elastic, nerve, bone tissues), and organs (blood and lymph vessels, lymph glands, etc.), are also included. According to Friedel the “meat” purchased at the butcher shop contains an average of 83 per cent meat, 8.4 per cent bone, 8.6 per cent fat. The quantitative proportion between the striated muscle and the other constituents of the body varies between 30 and 50 per cent of the live weight, and in medium fat animals this is higher than in lean or very fat ones.

The structure of the muscle consists of fibrous tissue, which possesses a peculiar luster and a semisolid consistence. The firmness of the fiber is different in the various animals, and has an influence on the tastefulness of the meat. The tenderness or toughness, however, does not entirely depend on this, but is more intimately associated with the race, age, nutritive condition of the animal, and the amount of connective tissue present. Relative to the latter, the experiment of K. B. Lehmann shows that the cutaneous muscles are 2.5 times tougher than the tenderloin, the consistency of which is hardly influenced by cooking; but cooking considerably diminished the toughness of the cutaneous muscles, almost to the consistency of the tenderloin. The toughness of meat is diminished at least 25 per cent in a few days through the ripening process, which is due to the formation of acid in the muscles.

The experiments performed by Isaak regarding the toughness of meat are not sufficiently extensive for positive conclusions.

The color of the muscles varies between a pale red, gray-red and dark red. Pale muscles occur in vertebrates, birds and certain fish. Almost all the food animals show pale meat at certain ages (calves, young pigs), while in rabbits the meat remains pale throughout life. Pale meat may also appear in some animals in certain groups of muscles alongside of dark red muscles (hogs, birds). While the color of the muscles is somewhat influenced by the blood content, it is not pro-

duced by the blood. The muscular coloring matter, which is identical with the hemoglobin, is rather bound to the myosin and develops in it. Further, the color of the meat is influenced by age, sex, race, work, feeding, etc. Especially in the ripening of meat a specific aroma is developed, which, as a result of the autolytic action, manifests itself both by the odor and taste. (See Ripening of Beef, page 341.)

Rigor mortis, which occurs after death, is probably the result of a coagulation of the myosin through the formation of lactic acid in the muscles. It may possibly be due to a particular "rigor mortis ferment." It first affects the muscles of the head, and then spreads, in accordance to Nysten's law, backward over the body. The time of appearance of rigor mortis depends on the muscular activity before death; the stronger the activity of the muscles during life, the sooner rigor mortis sets in. In exhausted animals, rigor mortis, under certain condition, appears immediately after death, as also in tetanic muscles. According to Ostertag, the administration of certain medicines, such as veratrin, alcohol, ether, etheric oils, favors the early appearance of rigor mortis. In animals which were affected with severe febrile diseases, rigor mortis is either not manifested or only very slightly, being hardly noticeable. High atmospheric temperature favors the appearance of rigor mortis, while cold retards it. The occurrence of rigor mortis is in the same relation to its dissolution; the sooner rigor mortis sets in the quicker the muscles will relax again. Whether the dissolution of rigor mortis results from an increase of acid formation in the muscles, which again affects the solution of the myosin, or whether it is due to other influences, is still the subject of controversy.

Von Fürth, in his experiments of extracting the muscle albuminoid bodies and of their supposed relation to rigor mortis, obtained results which appear to exclude that rigor mortis is affected by an acid precipitation of the muscle albumin; but an attempt to deny that the degree of muscular acidity has no influence on the appearance of rigor mortis would be too far-reaching. The postmortem acid formation is certainly due to lactic acid, as the setting free of inorganic phosphoric acid does not take place. For the utilization of muscles for manufacturing sausage the fact is noteworthy that muscles which still contain the animal heat and in which rigor mortis has not appeared may absorb up to 70 per cent of water by volume if they have been previously beaten, or if they are torn in shreds (Ostertag).

The reaction of living muscles is slightly alkaline or neutral, but under normal conditions is changed to acid within three to six hours after death through the formation of lactic acid, formic acid and potassium acid phosphate. The latter causes a swelling and loosening of the connective-tissue elements of the meat, and renders the meat tender. By this process the so-called ripening of the meat takes place, the nature and further development of which are discussed in Chapter IX. The acid reaction of the muscles becomes changed to an alkaline reaction with the advancement of putrefaction.

An alkaline reaction of completely cooled meat from freshly killed animals always indicates an abnormal condition before slaughter. According to Edelmann and Noack, this is very frequently met in animals which were slaughtered

under manifestations of suffocation or in condition of exhaustion; also in severe febrile diseases, especially septic conditions and pyemia, there may be an alkalinity of the meat. In the latter cases the alkalinity remains permanently, while in the first-mentioned conditions an acid reaction sometimes occurs after forty-eight to seventy-two hours. An alkaline reaction of meat is, therefore, an unsatisfactory indication only when it is lasting, resulting soon in putrefaction of the meat.

The principal chemical constituents of the muscles are the proteins and gelatin, yielding nitrogenous bodies which are present in the proportion of from 16 to 25 per cent. Calculated on the basis of dry substances meat contains, according to Salkowski, 77.4 per cent insoluble albumin, 10 per cent albumin which is soluble in cold water and coagulable through heat, and 12 per cent of substance soluble in cold water, but uncoagulable (meat bases, lactic acid, albumose, peptone, salts, especially phosphocarnic acid [Siegfried]). Fat which is found between the muscle fibers in the form of globules is present to the extent of 1 per cent, while water will average about 75 per cent. The taste of the meat is dependent upon the extractive bodies, principally osmazon (Landois), and the so-called meat bases: Karnin, kreatin, kreatinin, xanthin, sarkin, hypoxanthin and the muscle salts. The most important salts are potassium phosphate, with magnesium and calcium phosphate and the iron compounds, which amount to 1 to 1.5 per cent. Of the carbohydrates, glycogen generally occurs in muscles in very small but widely varying quantities, especially in the horse, dog and fetus.

Of the gases which are present in the muscle substance, carbonic acid is found in 15 to 18 volume per cent (Stintzing), while oxygen is absent (Hermann). Besides, it is probable that the volatile sulphur compounds first demonstrated by Eber, especially H_2S , play an important part in the changes of the color of the meat after death and in its preservation (Glage). Finally, enzymes (soluble ferments) are also present in the muscle, and these play a principal part in the ripening of meat.

The composition of the meat in various animals and of some of the important meat-food products is tabulated, according to König, in the tables on pages 45 to 47. As a rule, meat rich in fat is always poorer in water, and its content of albumin stands in an inverse relation to the richness of the fat. Food chemists have determined that, on the average, meat contains normally somewhat less than 4 parts of water to 1 part of protein. This is used in laboratory determination of suspected fraudulent addition of water to manufactured meat products. According to Ignatiew, meat should be valued in accordance with its content of the two albuminoid substances, myosin and myostromin (Danilewsky). The first is supposed to increase gradually from the muscles of the head toward the tail, while the latter increases in the reverse order.

The reductive properties of muscles, through which poisons are split into harmless compounds, and coloring matter (bilirubin) is changed into colorless modifications, should also be mentioned among the chemical qualities.

Connective and Elastic Tissues.—The connective tissue containing a fibrous structure occurs in every part of the body in the most varied

forms and connections. The color is usually white or bluish-white, but if rich in elastic fibers the color is yellowish. The chemical base of connective tissue is formed by the albuminoid collagen containing sulphur, which in cooking is changed into gluten (gelatin). The elastic tissue (ligamentum nuchæ, yellow abdominal fascia, etc.), which is distinguished by tough fibers and a yellow color, consists chiefly of the albuminoid elastin, which cannot be converted through heat into gluten.

Fat Tissue.—Fat tissue occurs in closest relation to the connective tissue and is characterized by the depositions of fat cells in the loose connective tissue. It occurs almost all over the body in single or in larger connecting masses. The largest fatty deposits are about the kidneys and heart, in the mesentery (ruffle fat) and retroperitoneal region (leaf lard in hogs), while the subcutaneous fat cushion (bacon of hogs) is in some parts of the body particularly bulky. The fat of cattle, sheep and goats is termed tallow, while that from hogs is called lard. The properties of fat are considerably influenced by the species of animal, age, sex and nutritive condition. The structure and consistency of fat tissues still retaining the animal heat are transparent, homogeneous or slightly stringy and oily. After fat stiffens, which depends on its melting-point and the surrounding temperature, it becomes dull, greasy and crumbling.

The color of fat varies between the purest white (hog, sheep) and a dark yellow (horse); also gray and grayish-red color tints may be observed (calf).

TABLE COMPARING THE COMPOSITION AND UTILIZATION OF VARIOUS MEATS AND FOOD PRODUCTS, ACCORDING TO KÖNIG.¹

No.	Designation.	Raw nutritive substances.						Utilizable nutritive substances.			Nutritive relations ² of nitrogenous to nitrogen-free substances.
		Water.	Nitrogenous substances.	Fat.	Carbohydrate.	Raw fibers.	Ash.	Nitrogenous substances.	Fat.	Carbohydrate.	
		Per cent.	Per cent.	Per cent.	Per cent.	Per cent.	Per cent.	Per cent.	Per cent.	Per cent.	As 1:
1	Beef { fat medium fat lean	56.20	18.00	25.00	0.80	17.55	23.75	3.4
2		71.50	20.10	7.40	1.00	19.60	7.03	0.9
3		75.00	20.50	2.80	1.20	19.99	2.66	0.3
4	Veal, first quality	71.00	19.95	8.00	1.05	19.45	7.60	1.0
5	Goat meat	73.80	20.65	4.30	1.25	20.13	4.09	0.5
6	Mutton, first quality	55.25	16.85	27.00	0.90	16.43	25.65	4.5
7	Pork, first quality	57.40	17.65	24.00	0.95	17.21	22.80	3.3
8	Horse meat	74.20	21.50	2.50	0.80 ³	1.00	20.96	2.38	0.76	0.3
9	Blood	80.82	18.12	0.18	0.03 ⁴	0.85	17.67	0.17	0.03	0.03
10	Lung	79.89	15.21	2.47	0.56 ⁴	1.87	13.54	2.30	0.55	0.5
11	Heart	71.07	17.55	10.12	0.31 ⁴	0.95	15.62	9.41	0.31	1.5
12	Kidneys	75.55	18.43	4.45	0.38 ⁴	1.19	16.40	4.14	0.38	0.7
13	Spleen	75.47	17.77	4.19	1.01 ⁴	1.56	15.82	3.90	1.00	0.7
14	Liver	71.55	19.92	3.65	3.33 ⁴	1.55	17.73	3.39	3.30	0.7
15	Udder	39.45	10.15	27.93	21.39 ⁴	1.08	9.03	25.97	21.18	9.5
16	Bone	25.00	15.50	17.00	42.50
17	Cattle tallow	1.33	0.44	98.15	0.08	0.39	91.28	585.1
18	Lard	0.70	0.26	99.04	0.23	95.08	1033.5

¹ The Human Foods and Delicacies, etc., fourth edition, 1904, Bd. 2, s. 1467.

² For utilizable nutritive substances.

³ Glycogen.

⁴ Carbohydrate.

TABLE COMPARING THE COMPOSITION AND UTILIZATION OF VARIOUS MEATS AND FOOD PRODUCTS, ACCORDING TO KÖNIG—Continued.

PRESERVED MEATS AND SAUSAGES.

No.	Designation.	Raw nutritive substances.					Utilizable nutritive substances.			Nutritive relations ¹ of nitrogenous to nitrogen-free substances.	
		Water.	Nitrogenous substances.	Fat.	Carbohydrate.	Raw fibers.	Ash.	Nitrogenous substances.	Fat.		Carbohydrate.
		Per cent.	Per cent.	Per cent.	Per cent.	Per cent.	Per cent.	Per cent.	Per cent.		Per cent.
19	Smoked meat from steer	47.62	27.10	15.35	10.59	26.42	14.50	1.4
20	Ham, pickled or smoked	28.11	24.74	36.45	10.54	24.12	34.68	3.7
21	Bacon, pickled or smoked	10.21	8.95	72.82	8.02	8.73	69.18	19.8
22	Goose breast	41.35	21.45	31.49	1.15	4.56	20.91	29.92	1.14	3.7
23	Beef sausage	48.24	20.39	26.99	4.43	19.83	25.64	3.2
24	Cervelat sausage	24.18	23.93	45.93	5.96	23.33	43.63	4.7
25	Frankfurter sausage	42.80	12.51	39.11	2.49	3.09	12.20	37.15	2.47	7.8
26	Blood sausage, best quality	49.93	11.81	11.48	25.09	1.69	10.51	10.45	23.84	4.8
27	Liver sausage, medium quality	47.80	12.89	25.10	12.00	2.21	11.47	22.84	11.40	5.9
28	Link sausage	7.07	16.36	34.00	32.39	0.80	9.48	13.82	31.60	30.67	7.2

MEAT OF GAME AND FOWL.

29	Rabbit	74.16	23.34	1.13	0.19	1.18	22.76	1.07	0.19	0.1
30	Deer	75.76	19.11	1.92	0.42	1.13	19.28	1.82	1.41	0.3
31	Chicken, lean	76.22	19.72	1.42	1.27	1.37	19.23	1.35	1.26	0.2
32	Chicken, fat	70.06	18.49	9.34	1.20	0.91	18.03	8.87	1.19	1.3
33	Turkey, medium fat	65.60	24.70	8.50	1.20	24.08	8.07	0.8
34	Duck, wild	70.82	22.65	3.11	2.33	1.09	22.08	2.95	2.31	0.4
35	Goose, fat	38.02	15.91	45.59	0.48	15.51	43.31	7.0
36	Pigeon	75.10	22.14	1.00	0.76	1.00	21.59	0.95	0.75	0.1

MEAT OF FISH.

37	Salmon	64.00	21.14	13.53	1.22	20.51	12.31	1.5
38	River eel	58.21	12.24	27.48	11.87	25.01	5.2
39	Sea eel	72.90	17.96	7.82	17.42	7.12	1.0
40	Herring	75.09	15.44	7.63	14.98	6.94	1.2
41	Halibut	75.24	18.53	5.16	17.97	9.70	0.6
42	Carp	73.47	16.67	8.73	16.70	7.94	1.2
43	Pike	79.63	18.42	0.53	17.87	0.48	0.7
44	Haddock	81.50	16.93	0.26	16.42	0.24	0.04
45	Codfish	82.42	15.97	0.31	15.49	0.28	0.04
46	Haddock, dried and smoked	17.21	72.37	2.47	70.20	2.25	0.1
47	Frog leg	63.64	24.17	0.91	2.98	22.96	0.83	2.89	0.3
48	Giant turtle	79.78	18.49	0.53	17.57	0.48	0.1
49	Sole	82.67	14.60	0.53	14.16	0.48	0.1
50	Trout	77.51	19.18	2.10	18.60	1.91	0.3
51	Salmon trout	80.50	17.52	0.74	16.99	0.67	0.1
52	Tench	80.00	17.47	0.39	16.95	0.35	0.05
53	Turbot	77.60	18.10	2.28	17.56	2.07	0.3
54	Cavair	47.86	29.34	13.98	1.30	28.46	13.28	1.27	1.2

MEAT OF INVERTEBRATE ANIMALS.

55	Oysters, meat juice	87.36	5.95	1.15	3.57	2.03	5.77	1.05	3.53	1.1
56	Common mussel	83.61	9.97	1.17	3.57	1.61	9.47	1.06	3.53	0.6
57	Lobster, fresh	81.84	14.49	1.84	0.12	1.71	13.77	1.67	0.12	0.3
58	Lobsters, preserved	77.75	18.13	1.07	0.58	2.47	17.22	0.97	0.57	0.2
59	River crabs, fresh	81.22	16.00	0.46	1.01	1.31	15.20	0.42	1.00	0.1
60	River crabs, preserved	72.74	13.63	0.36	0.21	13.06	12.95	0.33	0.21	0.1
61	Crab, fresh	78.81	15.83	1.32	2.42	1.62	15.04	1.20	2.40	0.3
62	Crab, preserved	70.80	25.38	1.00	0.24	2.58	24.11	0.91	0.24	0.1
63	Great snail	30.50	16.34	1.38	0.45	1.33	15.52	1.26	0.45	0.3

¹ For utilizable nutritive substances.

TABLE COMPARING THE COMPOSITION AND UTILIZATION OF VARIOUS MEATS AND FOOD PRODUCTS, ACCORDING TO KÖNIG—Continued.
MEAT EXTRACTS.

No.	Designation.	Water.	Entire nitrogen.	Albumoses.	Pepton + Bases.	Amids.	Ammonia.	Xanthin basic nitrogen.	Fat.	Carbohydrates.	Ash.	Market price per kilogram.
		Per cent.	Per cent.	Per cent.	Per cent.	Per cent.	Per cent.	Per cent.	Per cent.	Per cent.	Per cent.	
64	Liebig's meat extract	17.70	9.17	6.37	53.87	0.59	0.648	0.21	21.26		\$3.75
65	Abil's fluid extract	65.80	3.03	6.91	9.26	0.35	0.148	0.35	17.33		1.35
66	Armour's (solid) extract	21.00	9.32	16.12	42.08		0.567	0.58	20.25		3.70
67	Flagg's (solid) extract	21.37	10.01	17.37	41.18		0.687	0.35	10.23		3.25

Chemically, fats are the richest substances among hydrocarbons. Fresh adipose tissue shows the following composition in 100 parts according to E. Schulz and Reinecke:

Species.	Nitrogenous substances.	Fat.	Water.
Steer	1.16	88.88	9.96
Sheep	1.64	87.88	10.48
Hog	1.3.5	92.21	6.44

The fat itself is a mixture of glycerides (ester, derivative of tri-equivalent alcohol), tripalmitin, tristearin and triolein, which, depending upon their predominance, influence the consistency of the fat.

Bones and Bone-marrow.—In meat inspection the bones come into consideration, principally in regard to their form, for the purpose of recognizing the origin and derivation of the meat. Structural relations, color and compactness of bones are only rarely of importance in connection with the other properties.

The chemical constituents of bones are bone cartilage (ossein), 30 per cent, inorganic material, 70 per cent, and a small quantity of fat. The first consists principally of collagen, which is converted through boiling into gelatin, also called glutin. The salts in the dry bone consists of an average of 87.7 per cent calcium phosphate, 9.1 per cent calcium carbonate, 2 per cent calcium fluoride and 1.2 per cent magnesium phosphate. Heinze reports the following composition for cattle and sheep bones:

	Cattle bones, per cent.	Sheep bones, per cent.
Calcium carbonate	7.07	7.00
Magnesium phosphate	2.09	1.59
Calcium phosphate	58.30	72.70
Calcium fluoride	1.96	2.17
Organic substance	30.58	26.54

The bone-marrow appears as a red or reddish-white substance (fat-marrow). The latter consists of about 96 per cent fat, and contains a firmness in the various animals which corresponds to the consistence of fat in the respective species. The red bone-marrow is semisolid.

Cartilage.—From the standpoint of meat inspection cartilage is of very slight importance. It consists of a collagenous basic substance which by boiling is converted into gelatin.

Blood and Bloodvessels.—The question regarding the quantity of blood in the body has already been considered on page 31. In thoroughly bled animals liquid blood is only found in the small veins of the muscles and organs, while coagulated blood may be seen in the heart and in the large vein. The arteries are always empty of blood. The color, coagulation and microscopic appearance of the blood of healthy animals should not show a deviation from the normal. There is a peculiar odor to the blood, characteristic of each animal species. It results from the volatile fatty acids, and appears more pronounced upon the addition of sulphuric acid.

The chemical composition of the blood consists, according to König, of 80.82 per cent water, 18.12 per cent nitrogenous substances, 0.18 per cent fat, 0.03 per cent nitrogen-free extractive bodies and 0.85 per cent ash. On account of the richness of the blood in albumin, it is a very nutritive food.

Lymph Glands and Lymph Vessels.—The lymph glands, which lately have been designated as lymph nodes, are of special importance in meat inspection. In size they appear relatively larger in young animals than in old ones. This is likewise true of the lymph contents of the glands, and the intestinal glands also are richer in lymph than the body glands. All the lymph vessels of a certain region empty into a certain lymph gland, but the anatomical borders of such a region are not established in the entire body. As far as present knowledge of the lymphatic system permits separation of the regions of the various lymph glands, it may be accepted that these are not connected with each other, and that for every part of the body there are one or more distinct lymph glands (corresponding lymph glands). Their size, number and location are subject to certain deviations.

For the purpose of meat inspection, it is best to classify the lymph glands, in accord-



FIG. 22.—Head of cow with the tongue cut out: *a*, *a'*, retropharyngeal lymph glands; *b*, submaxillary glands; *c*, tonsils; *d*, posterior nares; *e*, cephalic flexure; *f*, submaxillary salivary gland; *g*, styloid processes of the hyoid bone.

ance with their draining regions, into visceral lymph glands, muscular or body lymph glands and mixed lymph glands. To the latter class belong all those lymph glands which receive their lymph not alone from the viscera, but also from the muscles (muscles, skeleton, etc.).

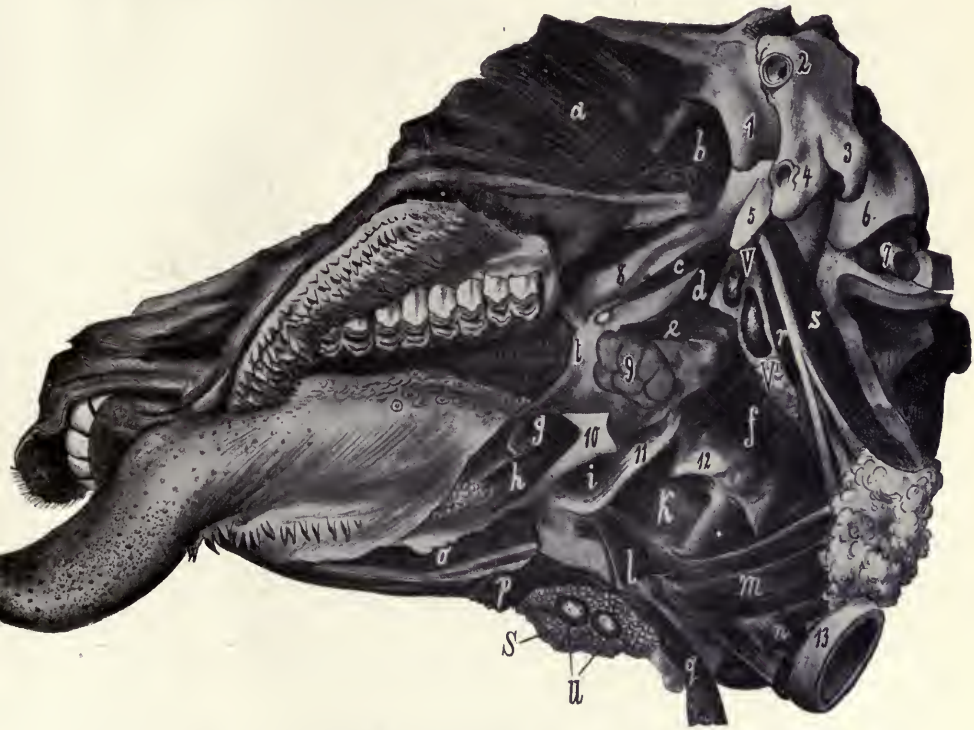

FIG. 23.—Head of cow, the right submaxillary and left styloid of the hyoid bone of which are removed: 1, articular surface of the temporal bone; 2, external auditory meatus; 3, jugular process of the occipital bone; 4, petrous bone; 5, muscular attachment to petrous bone; 6, occipital condyle; 7, medulla oblongata; 8, pterygoid bone; 9, tonsils; 10, styloid process of the hyoid bone; 11, thyroid cornua of the hyoid bone; 12, cricoid laryngeal cartilage; 13, ring of the trachea; *a*, masseter muscle; *b*, temporal muscle; *c*, tensor muscle of the palate; *d*, levator muscle of the palate; *e*, pterygopharyngeal muscle; *f*, chondrocrico, thyropharyngeus muscle; *g*, hyoglossal muscle; *h*, styloglossal muscle; *i*, *M. keratohyoideus brevis*; *k*, *M. hyothyreoideus*; *l* and *m*, *M. omohyoideus*; *n*, *o*, *M. myoglossus*; *p*, *M. mylohyoid*; *q*, *M. sternohyoideus*; *r*, *M. longus capit*; *s*, *M. rectus capit*; *t*, *arcus palatoglossus*; *S*, submaxillary salivary gland; *u*, submaxillary lymph gland; *V*, retropharyngeal lymph glands.

Visceral Lymph Glands.—Visceral lymph glands are those which receive their lymph principally from the viscera to which they belong. Those lymph glands which belong functionally to the various organs or viscera of the body, and which are important in meat inspection, are described as follows:†

(a) LYMPH GLANDS OF THE DIGESTIVE APPARATUS, INCLUDING THE ABDOMINAL AND PELVIC CAVITIES.—1. *Submaxillary Lymph Glands.*—*L.* Superficially in the submaxillary space; in cattle at the angle of

† *L* signifies the location of the lymph gland; *A*, afferent vessels; *E*, efferent vessels.

the lower jaw bone, sometimes present as two small nodes; in hogs, adjacent and to the inside of the submaxillary salivary gland. *A.* Superficial parts of the head, interior nasal passages and buccal cavity. *E.* Superior cervical lymph glands (Fig. 22, *b*, Fig. 23, *u*, and Fig. 24, *u*).

2. *Parotid Lymph Gland.*—*L.* Median surface of the parotid and submaxillary salivary glands. In cattle a special large gland extend-

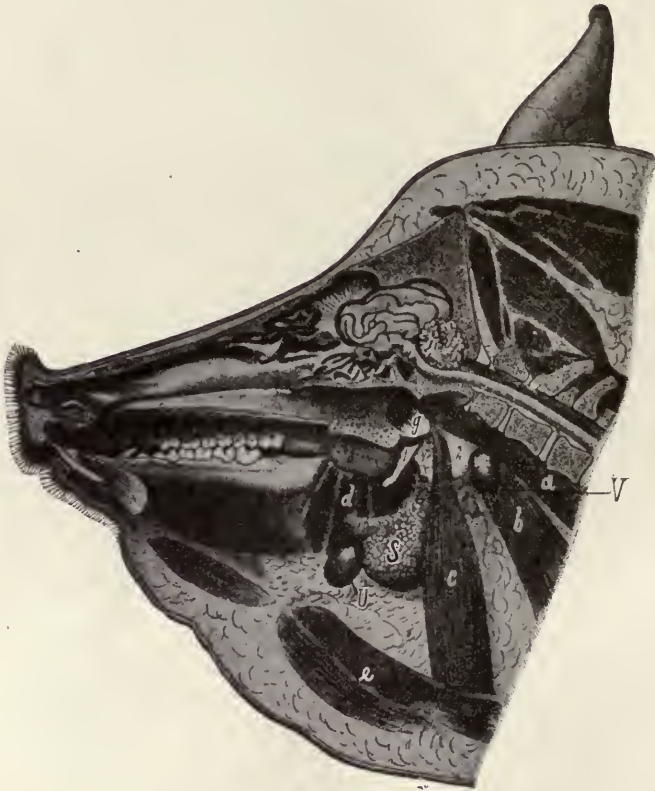

FIG. 24.—Right half of a vertical section of a hog's head: 1, cartilaginous nucleus attaching the hyoid to the temporal bone; 2, jugular process of the occipital bone; *a*, *M. longus colli*; *b*, *M. sternocleidomastoid*; *c*, *M. sternocephalic*; *d*, *M. pterygoid medial*; *e*, *M. sternohyoid*; *f*, soft palate; *g*, posterior nares; *S*, submaxillary salivary gland; *u*, submaxillary lymph gland; *V*, retropharyngeal lymph gland.

ing over the maxillary border of the parotid, and partly lying on the masseter muscle. In hogs very numerous, large and red in color. *A.* Dorsal half of the head, cranial cavity, base of the cranium, tongue, soft palate, esophagus and larynx. *E.* Superior cervical lymph glands.

3. *Superior Cervical Lymph Glands.*—Partly united with portions of the previous gland; also called retropharyngeal lymph glands. *L.* Posterior to the larynx and pharynx near the thyroid gland; in cattle at

the base of the cranium, in the superior part of the pharyngeal cavity forming two large bodies. *A.* Inside of the head, together with the cranial, buccal and tracheal cavities and the efferent lymph vessels of 1 and 2. *E.* Middle and inferior cervical lymph glands (Fig. 22, *a*, Fig. 23, *V*, and Fig. 24, *V*).

4. *Middle Cervical Glands.*—*L.* Middle of the neck at the side of the trachea, anterior to the carotid artery. *A.* Esophagus and trachea, superior cervical glands. *E.* Inferior cervical lymph glands.

5. *Inferior Cervical Glands, Prepectoral Glands.*—*L.* At the entrance of the thorax anterior to the trachea and extending into the thoracic cavity. *A.* Neighboring parts, shoulder, upper arm and efferent lymph

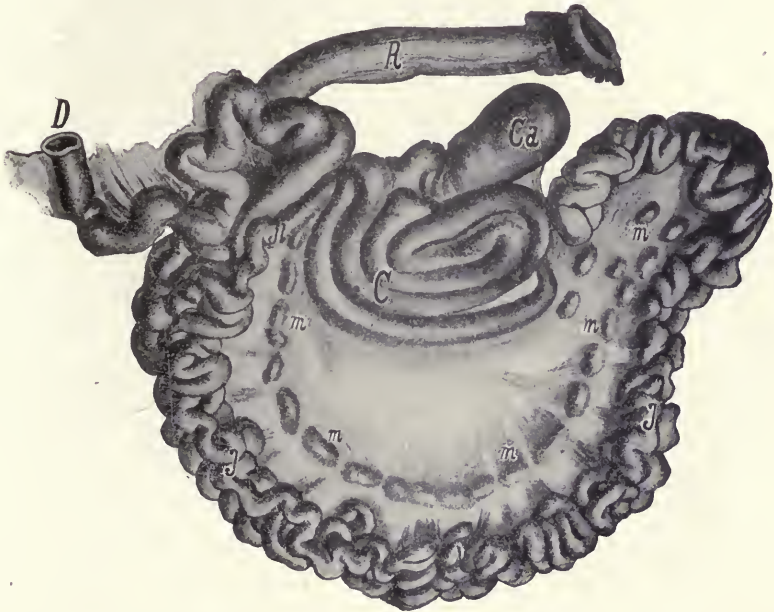

FIG. 25.—Intestinal canal of cattle spread out: *C*, colon; *Ca*, cecum; *D*, duodenum; *J*, jejunum; *Il*, ileum; *R*, rectum; *m*, mesenteric lymph glands of the small intestines.

vessels from middle cervical glands (and therefore, also, from 1 and 3), and also from the prepectoral lymph gland. *E.* Thoracic duct, *i. e.*, the great right lymph vein (Fig. 30, *b*).

6. *Gastric Lymph Glands.*—*L.* Small curvature, toward both surfaces of the stomach. In ruminants in the long groove of the rumen and at the attachment of the small mesentery. *A.* Wall of the stomach. *E.* Receptaculum chyli (Fig. 26).

7. *Mesenteric Lymph Glands.*—*L.* Between the peritoneal folds of the mesentery along the small curvature of the small intestines, between the flexures of the colon and in the mesentery of the same. In hogs also a group at the superior border of the mesentery. In dogs on the

jejunum there is a very long mesenteric lymph gland, the so-called pancreas Aselli. *A.* Wall of large and small intestines. *E.* Receptaculum chyli (Fig. 25).

8. *Anal Lymph Glands.*—*L.* Two or three lymph glands in the periproctal connective tissue in the vicinity of the levator ani muscle. *A.* Rectum, perineum and root of the tail. *E.* Sublumbar lymph glands (Fig. 28, *b*).



FIG. 26.—Stomach and portion of the intestinal canal of a hog: *a*, pyloric portion of the stomach; *b*, duodenum; *c*, jejunum; *d*, cecum; *e*, colon; *f*, rectum; *h*, foramen of Winslow; *i*, portal vein; *k*, hepatic lymph glands; *l*, gastric lymph glands; *m*, esophagus.

9. *Hepatic Lymph Glands—Portal Lymph Glands.*—*L.* In the posterior hepatic fissure (Porta hepatis); in hogs on the portal vein around the foramen of Winslow, usually conspicuous by their brown color. *A.* Liver tissue. *E.* Receptaculum chyli (Fig. 26, *k*, and Fig. 27, *c*).

10. *Splenic Lymph Glands.*—*L.* Hilus of the spleen, between the layers of the gastrosplenic ligament. *A.* Spleen, stomach and omentum. *E.* Receptaculum chyli.

11. *Sublumbar Lymph Glands.*—*L.* Side and ventral surface of the lumbar vertebræ, dorsal to the great bloodvessels, partially covered by the lumbar muscles. *A.* Dorsal abdominal wall, lumbar vertebræ, internal genital organs. Lymph vessels from the external and internal

iliacs, deep inguinal, sacral and popliteal glands. *E.* Receptaculum chyli (Fig. 28, *e*).

12. *Sacral Lymph Glands.*—*L.* Along the ventral border of the sacrum. *A.* Dorsal pelvic wall, rectum and internal genital organs. *E.* Sublumbar glands (Fig. 28, *d*).

13. *Internal Iliac Lymph Glands.*—*L.* At the angle between the external iliac and the hypogastric arteries, *i. e.*, between the former and the abdominal aorta, on the ventral side of the ileum. *A.* Abdominal and pelvic walls, bones of the pelvis, sacrum, muscles of the croup, rectum, internal genital organs, external iliac lymph glands. *E.* Sublumbar lymph glands and the receptaculum chyli (Fig. 28, *c*).

14. *External Iliac Lymph Glands.*—*L.* Small and detached in the neighborhood of the angle of the ileum, in the angle between both branches of the circumflex iliac artery. *A.* Abdominal wall, lateral surface of the upper part of the thigh. *E.* Sublumbar lymph glands.



FIG. 27.—Gastric surface of the liver of cattle: *a*, vena cava; *b*, entrance of the portal vein; *c*, portal lymph glands; *d*, lobus caudatus (Spigelium); *e*, gall-bladder.

(*b*) **LYMPH GLANDS OF THE RESPIRATORY APPARATUS AND THORACIC CAVITY.**—The lymph glands described under (*a*) from 1 to 5 belong also to the respiratory apparatus. As previously stated, they receive lymph from regions belonging in part to the digestive as well as to the respiratory apparatus.

6. *Bronchial Lymph Glands.*—*L.* Bifurcation of the trachea, in the lung substance at the branching of the bronchi. In cattle they form a continuous chain with the posterior mediastinal lymph glands; there is one large or several small glands to the left of the arch of the aorta; one on the right, at the branching of the bronchus of the cephalic lobe, or at the root of the lobule of the right lobe, besides a lymph gland of the size of a hazelnut at the base of the division between the cardiac and diaphragmatic lobes of the right lung. In hogs there is generally

another lymph gland at the attachment of the mediastinum at the dorsal angle of the bifurcation of the two principal bronchi (middle bronchial lymph gland). *A.* Lungs and lymph vessels from the posterior mediastinal gland. *E.* Thoracic duct and partly to the posterior mediastinal glands (Fig. 29, *a, b*).

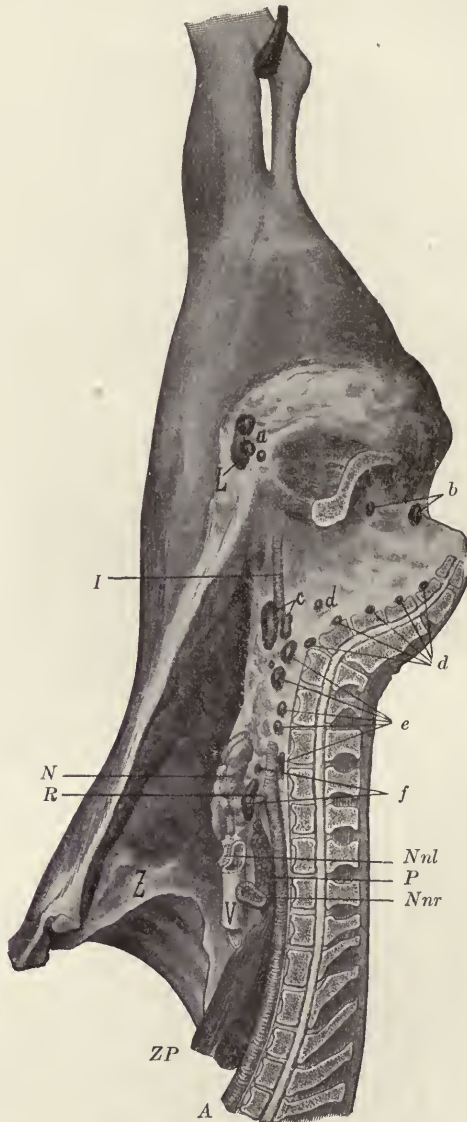

FIG. 28.—Left hind-quarter of a bull, cut very long: *A*, aorta; *V*, vena cava; *Z*, diaphragm; *ZP*, pillars of the diaphragm; *L*, external inguinal canal; *N*, left kidney; *Nnr*, right adrenal capsule; *Nnl*, left adrenal capsule; *P*, pancreas; *R*, renal artery; *I*, external iliac artery; *a*, superficial inguinal lymph gland; *b*, anal lymph gland; *c*, internal iliac artery; *d*, sacral lymph gland; *e*, lumbar glands; *f*, renal lymph gland.

7. *Mediastinal Lymph Glands.*—(a) Anterior mediastinal glands: *L.* Numerous in the precardial mediastinal space near the superior vena cava. In cattle several large lymph glands (Fig. 30, *a*), above the first section of the breast-bone, near the entrance of the thorax. *A.* Heart, pericardium, thymus glands, thoracic wall, diaphragm, mediastinum. *E.* Thoracic duct or great right lymph vein.

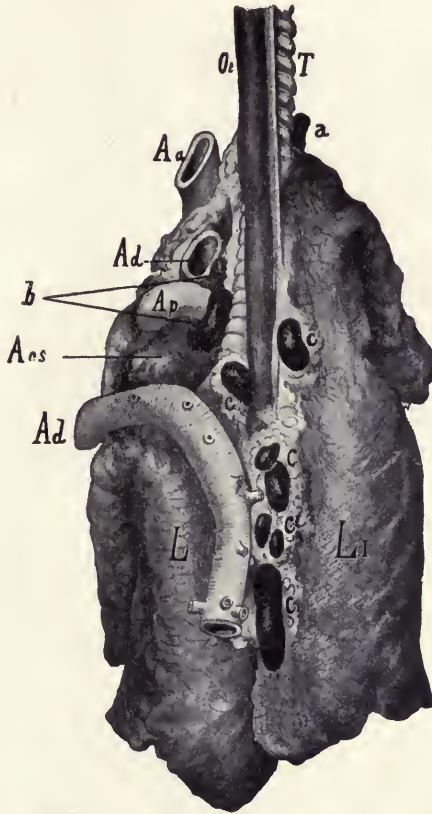

FIG. 29.—Lungs and heart of steer, suspended dorsal view: *Aa*, aorta ascendens; *Ad*, aorta descendens cut and flapped over to the left; *Ap*, arteria pulmonalis; *Acs*, left cordal atrium; *L*, left; *L1*, right lung; *e*, esophagus; *T*, trachea; *a*, right superior bronchial lymph gland; *b*, left bronchial lymph gland; *c*, posterior mediastinal lymph glands.

(b) Posterior mediastinal lymph glands: *L.* In the postcardial mediastinum, along the esophagus and posterior aorta. In cattle, 8 to 12 lymph glands are located along the dorsal wall of the esophagus, the posterior node of which is usually strikingly large (Fig. 29, *c*). In hogs they are very small or absent. *A.* Esophagus, pericardium, diaphragm, mediastinum, parietal surface of the liver. *E.* Efferent vessels empty in part into the bronchial glands, in part into the anterior mediastinal glands and in part into the thoracic duct.

8. *Lymph Glands of the Thoracic Wall.*—(a) Dorsal lymph glands: *L.* Small, to the side of the vertebræ, between the consecutive articulations of the heads of the ribs, and between the layers of the intercostal muscles. *A.* Dorsal vertebræ, muscles of the same, pleura, diaphragm and intercostal muscles. *E.* Thoracic duct.

(b) Inferior thoracic lymph glands: *L.* Dorsal surface of the breast-bone along the internal thoracic vein, *i. e.*, between the costal cartilage



FIG. 30.—Portion of the left thoracic wall of heifer: *A*, art. thoracic int.; *V*, vena thoracic int.; *l*, musc. sternocephalic; *M*, musc. transverse thoracic cut through; *P P'*, musc. pectoral; *R*, ribs; *Z*, diaphragm; *a*, inferior thoracic lymph glands; *a'*, anterior mediastinal gland; *b*, inferior cervical or prepectoral lymph glands.

breast-bone articulations. In hogs they are only exceptionally present. *A.* Straight abdominal, transverse abdominal, thoracic and intercostal muscles, pleura and diaphragm. *E.* Receptaculum chyli, inferior cervical glands (Fig. 30, *a*).

(c) LYMPH GLANDS OF THE GENITO-URINARY APPARATUS.—1. *Renal Lymph Glands.*—*L.* Hilus of the kidneys, at the angle between the aorta

and renal artery or posterior vena cava and renal vein. *A.* Kidneys. *E.* Receptaculum chyli (Fig. 28, *b*).

2 to 4. Lymph glands, which have been described under (*a*), 11 to 13. *A.* Ureters, bladder, urethra and genitals inside of the pelvic cavity. *E.* Receptaculum chyli and sublumbar lymph glands.

5. *Superficial Inguinal Glands.*—*L.* In male animals these include several lymph nodes, between the abdominal wall and the prepuce and scrotum. In female animals they are located superficially behind the udder. In cows these are the large lymph glands on each side behind and above the udder (supramammary lymph glands). *A.* External genitals, udder, ventral abdominal wall and median surface of the thigh. *E.* Deep inguinal lymph gland (Fig. 28, *a*).



FIG. 31.—Left fore-quarter of heifer with exposed prescapular lymph gland: *a, a*, *M.* trapezius cervical and thoracalis; *b b'*, *M.* omotransversarius; *c, c', c''*, *d*, *M.* brachiocephalic (of which *d* is the *M.* cleidomastoideus); *e*, jugular vein; *f* and *g*, *M.* sternocephalic (superficial and deep portion); *h*, sternum; *i*, *M.* pectoralis superficial.; *k*, spinal scapular; *l*, prescapular lymph gland; *m*, pars acromial and *m'*, pars scapular of the *M.* deltoideus; *n*, caput lateralis, and *n'*, caput longus of the *M.* triceps brachii; *o*, *M.* latissimus dorsi; *p*, *M.* serratus ventralis; *q*, *M.* pectoralis profundus; *r*, *M.* obliquus externus abdominalis.

Body Lymph Glands.—As applied to meat inspection the term muscle or body lymph gland refers to those lymph glands which drain regions in the skeleton and muscles, *i. e.*, those tissues which enclose them as well as the bones and skin, but they do not receive lymph from the viscera.

The body lymph glands, which are important in meat inspection, are the following:

1. *Prescapular Lymph Glands.*—*L.* Anterior border of the shoulder, above the scapulo-humeral articulation, and exerted principally by the angularis scapulae muscle and sometimes by the dorsal border of the

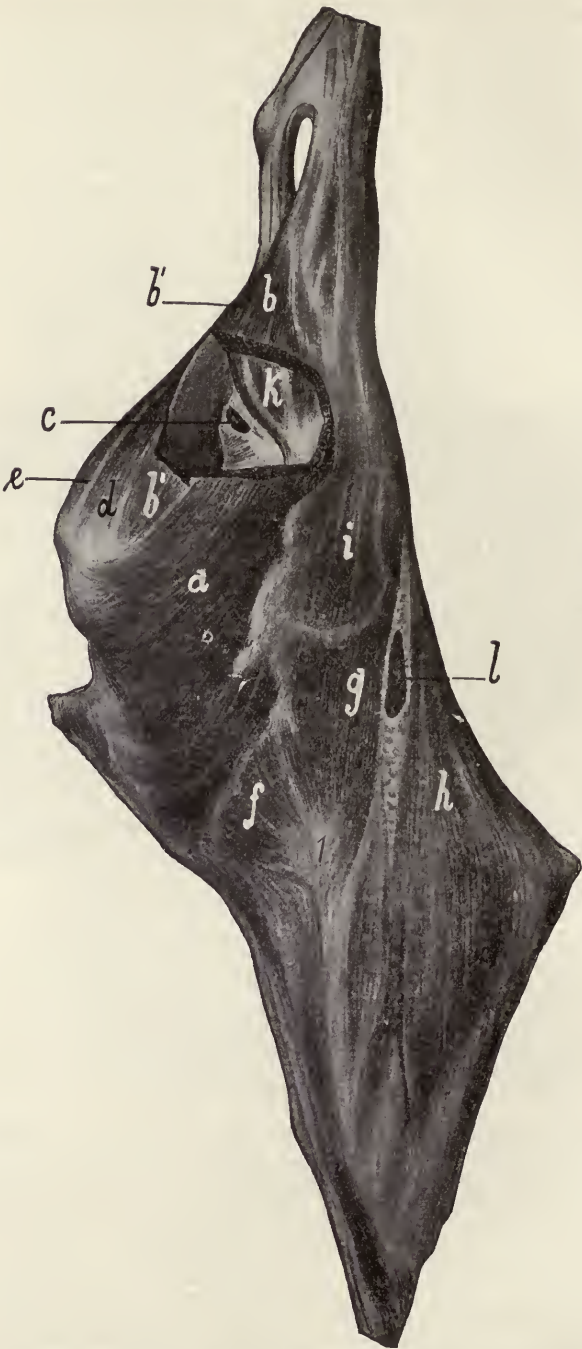

FIG. 32.—Left hind-quarter of steer with exposed precural and popliteal lymph glands: *a*, *M. gluteus superficialis*, which fuse with *b* and *b'*, the *M. biceps femoris*; *c*, popliteal lymph gland; *d*, *M. semitendinosus*; *e*, *M. semimembranosus*; *f*, *M. gluteus medius*; *g*, *M. tensor fasciæ lata*; *h*, *M. cutaneous maximus*; *i*, *M. quadriceps femoris*; *l*, precural or knee-fold lymph gland; *1*, lateral angle of the ileum (hip bone).

mastoido-humeralis muscle. *A.* Neck, shoulder, upper and lower leg. *E.* Inferior cervical lymph glands (Fig. 31, *l*).

2. *Axillary Lymph Glands.*—*L.* Median surface of the shoulder, dorsal border of the pectoralis minor muscle, posteriorly to the shoulder-joint, near the entrance of the lateral thoracic vein into the axillary vein. They are usually absent in hogs. *A.* Shoulder, upper arm, thoracic wall and elbow lymph gland. *E.* Inferior cervical lymph glands.

3. *Elbow Lymph Glands.*—They occur only in the horse. *L.* Median side of the upper arm near the cubital articulation between the biceps brachii muscle and the median anconeus muscle on the brachial vein. *A.* Foot and lower arm. *E.* Axillary and prescapular lymph glands.

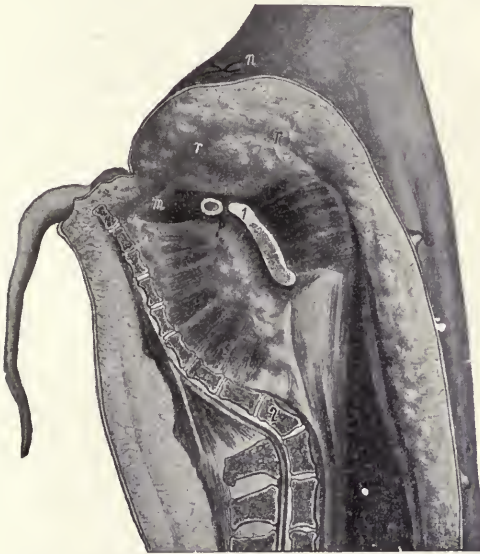

FIG. 33.—Median view of the right hind-quarter of a hog with exposed precrural lymph gland: 1, pelvic symphysis; 2, first sacral vertebra; *a*, *M. gracilis*; *b*, *M. quadriceps femoris*; *c*, *M. tensor fascia lata*; *d*, *M. obliquus internus and transversus abdominalis*; *e*, *M. iliopsoas*; *f*, precrural lymph gland.

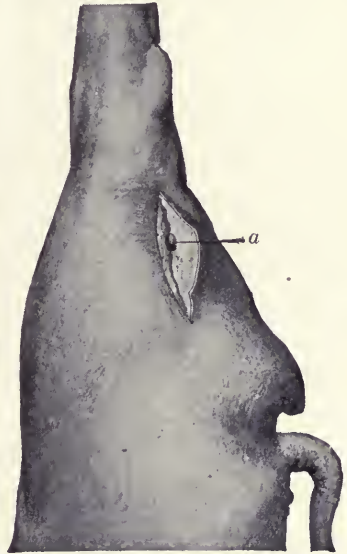
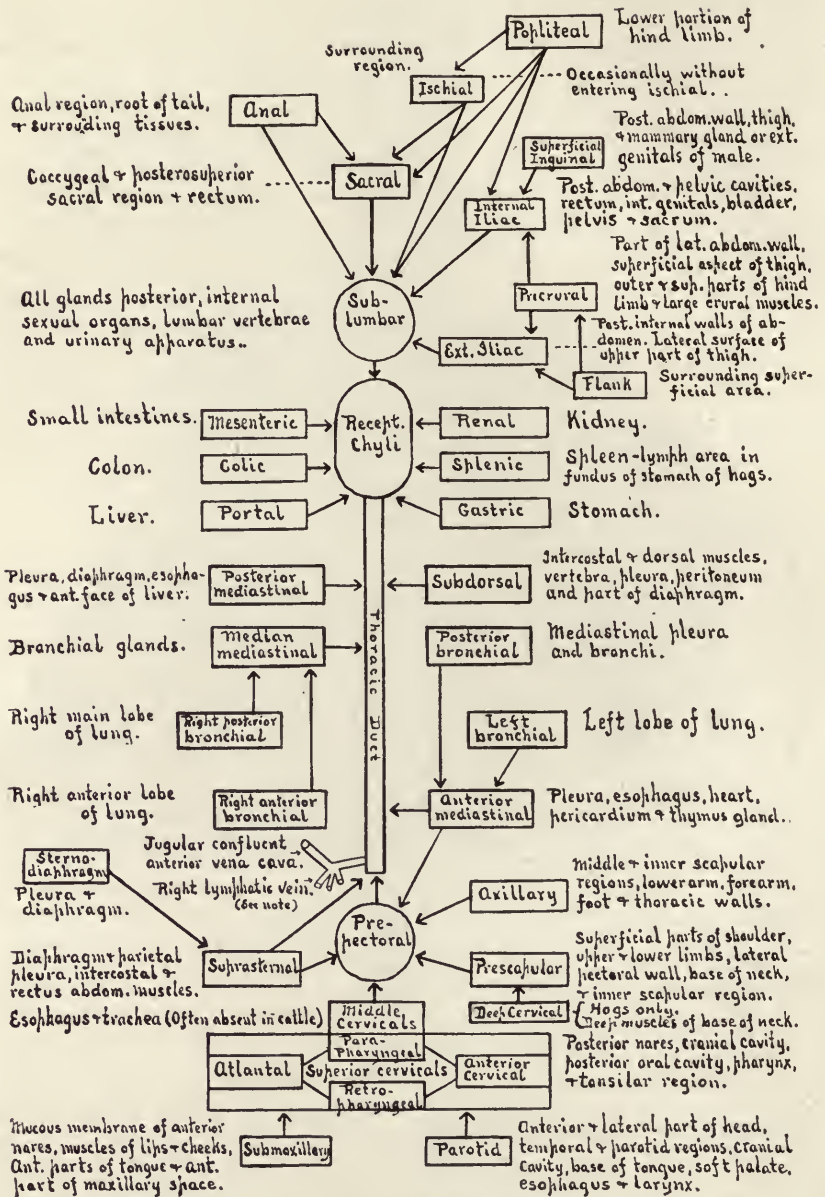

FIG. 34.—Lateral view of the right hind-quarter of a hog with exposed popliteal lymph gland *a*.

4. *Precrural Lymph Glands.*—*L.* In the tendinous portion of the external abdominal muscle on the free border of the fascia lata muscle in the middle, between the patella and the external angle of the ileum. In cattle and hogs this gland is a long single one. *A.* Abdominal wall and lateral surface of the posterior limb. *E.* Sublumbar and internal iliac glands (Fig. 32, *l*, and Fig. 33, *f*).

5. *Popliteal Lymph Glands.*—*L.* On the gastrocnemius muscle between the biceps femoris muscle and the semitendinosus muscle. It is frequently absent in hogs, but there is always present a superficial gland, the size of a small hazelnut, in the subcutis of the hollow of the hock



Note: Right anterior limb, right side of head, neck & thorax drain into the right lymphatic vein through the right prepectoral.

FIG. 35.—Regional lymph glands of food animals. (Original by Dr. Henry J. Boyer and revised by Dr. Thomas Castor.)

about a handbreath from the point of the hock. *A.* Lower part of leg and foot. *E.* Deep inguinal, sublumbar and external ischial lymph glands (Fig. 32, *c*, and Fig. 34, *a*).

6. *Deep Inguinal Lymph Glands*.—*L.* In the inguinal canal lying above the femoral artery and vein. Only in the horse do they exist as large glands. *A.* Posterior limb with the exception of the external surface of the thigh and muscle thereof; abdominal wall. *E.* Sublumbar lymph glands and receptaculum chyli.

7. *External Ischial Lymph Gland* (Franck).—*L.* In cattle about the size of a walnut on the ventral border of the coccygeus, covered by the broad ligament of the pelvis (Stroh). In hogs it lies usually more superficially. *A.* Pelvic and rump muscles and popliteal lymph gland. *E.* Sacral and sublumbar lymph glands.

8. *Flank Lymph Gland* (Franck).—*L.* In ruminants under the skin of the triangle in front of the external angle of the ileum. *A.* Neighboring parts of the skin. *E.* Precrural lymph gland.

In the subcutis there are besides small lymph glands at various parts; they are, however, not constant in their position and they also vary in size.

The Endocrine Glands.—The extensive studies and research work of the past few years on the functions of the endocrine glands have definitely established their great importance. Through various methods of extraction and purification of the glandular secretions, their specific physiological activities have been proved and subsequently their application in functional disorders have been affirmed. Thus, at the present time, the active principles of these glands in extract forms constitute very important agents which are very valuable in the treatment of many abnormalities resulting from their defective or irregular functions.

The chemistry of the extracts or hormones has not yet been established, with one or two exceptions, and therefore their synthetic production has not been successful. Because of their very great importance in therapy and their extensive usage, the extraction from the fresh glands derived from the freshly slaughtered animals constitutes the only available source.

These hormones are not species specific and are most readily obtained from various species of food animals. It is of course important that the glands be free from disease and from animals suitable for food purposes. Since the active principle deteriorates rapidly if the glands are not properly preserved, it is essential to chill or freeze them as soon as possible following their collection and they should be maintained in that condition until ready for use in the laboratory.

The thyroid gland consists of two lobes situated one on each side of the anterior part of the trachea near to or in contact with the larynx. These lobes are connected across the ventral face of the trachea by a narrow band of glandular cells called the isthmus. In the pig the lobes come in contact in such a way that one cannot distinguish the isthmus, but in the cow they are irregular in outline, about 3 inches long, and so soft and loose in texture that they retain their true shape only in hardened specimens. In the mature ox the thyroid is pale in color, and dark red in the calf and sheep.

Following thyroidectomy, regardless of age or species, the oxidations of the body, or heat production, as measured by basal metabolism, are diminished, finally leading to physical and mental sluggishness and general malnutrition—myxedema in adult man. These manifestations vary according to species. Young animals of all species are stunted in mental, sexual, and physical development. Their bones do not grow and remain soft, the animal developing into a

dwarf, called cretinism in children. In direct contrast, mature herbivori may not develop clinical symptoms.

Thyroidectomized animals may be kept in normal health by transplantation of glandular tissue to some other part of the body, by feeding of dried tissue, or by injection of the active extract of the gland, also known as thyroxin. Its injection into normal animals greatly increases body oxidations. The stimulus for activation of the thyroid gland in the secretion of thyroxin is produced or controlled by an anterior pituitary hormone called thyrotropin. Thyroxin is rich in iodine as shown by chemical analysis.

The parathyroid glands, four in most species and two in others, are usually situated near the posterior extremity or on the deep face of the thyroid lobes. In the cow each gland, which is very small in all animals, is about the size of a wheat kernel. Because of irregularity in location, small size, and close relationship to the thyroid, which is of similar color, it is quite difficult for individuals not thoroughly familiar with these glands to locate and dissect them from the adjacent tissues.

These glands secrete a hormone called parathormone, which maintains or regulates the percentage of calcium in the blood. In the absence of this hormone, as exhibited in parathyroidectomized animals, tetany soon develops and death occurs in twelve hours to three or four days in most species, due to a diminished calcium content of the blood. When an excess of parathormone is injected into a normal animal the blood calcium is raised to above normal and, if maintained, the circulation becomes sluggish, kidney function fails, and hemorrhages occur in the gastrointestinal tract.

After the surgical removal of these glands the animals may be kept alive by transplantation of glandular tissue, by injection of the glandular extract, parathormone, and as recorded by few workers, by feeding of calcium.

The adrenal glands, two in number, are situated anterior to and in close proximity to each kidney. In each species the glands have their own characteristic shape. They are red-brown in color, and in the sheep are about 1 inch long and $\frac{1}{2}$ inch wide. They consist of two parts, the medulla and cortex, each of which has a different embryonic origin and produces separate physiological actions.

The medullary portion secretes the hormone called epinephrine. Its injection into normal animals slows the heart-rate and raises the blood-pressure. Blood-pressure is raised by its contractile action on the arterioles and capillaries of the digestive tract which forces the blood into the skeletal muscles. This gives the animal additional energy. An increase in secretion may occur in normal animals in times of emergency. Such action, however, is of short duration, but additional injections will produce similar effects. In animals from which these glands have been removed, the blood-pressure falls slightly below normal, but no other clinical symptoms are apparent.

The medullary portion is not essential to life; however, after removal of the cortical portion, the animal dies in a few days. The most pronounced clinical symptom is progressive muscular weakness accompanied by an increased water elimination, a disturbed carbohydrate metabolism, and an excessive loss of minerals. The animal may be kept in a normal condition by continued injections of the active extract called cortin. Its injection into young animals produces a significant growth and development of the gonads. It is especially rich in an active principle which is similar to the male sex hormone produced by the testicle, called testosterone. An overproduction of cortin, as observed in young girls with tumor formation of the cortex, leads to the development of male characteristics or hermaphroditism. Cortin has not been isolated in pure form, but experimental evidence indicates the presence of several active principles.

The pineal body is situated above the third ventricle of the brain and is attached to it by a stalk. It contains glandular cells during early life, and in man reaches its greatest development about the seventh year, after which time involution sets in. Fibrous tissue replaces the glandular cells soon after puberty. In children where the gland has been destroyed or invaded by infection, development

of the reproductive organs and skeleton is accelerated. The isolation of an active hormone from this gland has met with conflicting experimental results.

The *thymus gland* in young animals is comprised of two lobes which partially occupy the anterior mediastinal space and extend anterior along each side of the trachea to the thyroid. At puberty this gland begins to atrophy, and in old animals it is present only in vestigial portions. Experiments fail to show a definite function derived from the gland; however, there is some evidence that the rate of growth is slower in young animals from which this gland has been removed.

The *pituitary gland*, or *hypophysis cerebri*, is located at the base of the brain, in the hypophyseal fossa of the sphenoid bone, and is attached to the third ventricle by a hollow stalk, the infundibulum. It is the same color as the brain and is usually described as consisting of two parts, a smaller posterior lobe and a larger anterior lobe. These two lobes have different embryonic origins, and the extracts are definitely separate in their physiological actions.

The gland is very small, about an inch in diameter in the cow. The hormonal content of the lobes is decidedly small because they are devoid of storage capacity and consist entirely of secretory tissue. Some of the active principles are very unstable and deterioration begins at the time of death. These facts, aside from their high economic value, make it necessary for special handling. For best results they should be removed and iced immediately upon death of the animal and kept iced until extracted.

The posterior lobe secretes the commonly known hormone, pituitrin. Research in the further purification of this hormone points to the presence of at least three separate principles, the pressor or pitressin, the oxytocic or oxytocin, and the renal.

The principle, pitressin, produces a slower heart-rate accompanied by a rise in blood-pressure. Its action is less marked and persists longer than that of adrenalin. The smooth muscles of the intestinal and urinary tract are stimulated. During the milking process pituitrin, possibly the pressor principle, is responsible for the phenomenon of "letting down of the milk."

The principle, oxytocin, exerts a specific contractile action upon the smooth muscle of the uterine wall. It may be used in selected obstetrical cases.

In patients suffering from diabetes insipidus, the excessive renal secretion is alleviated by injections of the renal principle.

Removal of the posterior lobe does not produce clinical symptoms. However, two major clinical symptoms have been reported as resulting from the removal of the whole pituitary gland or anterior lobe. It is first followed by a marked polyuria and excessive thirst, and later by malnutrition. If life is prolonged other symptoms develop such as infantilism or atrophy of the sex organs in mature animals and cessation of growth in young animals. These animals may be kept in normal health by injections or transplants of the anterior lobe.

Secretions of the anterior lobe regulate some bodily functions directly and some indirectly by their interrelationship with other secretory glands. The number of active principles in this lobe has not been determined. An active principle, phyone or growth hormone, produces a direct influence upon growth. Without this hormone young animals fail to grow; but if it is produced in excess or injected into young growing individuals, it not only accelerates the rate, but also produces an overgrowth called gigantism. An excessive secretion in mature animals results in a thickening of the facial bones and an increase in length of the long bones called acromegaly in man. Ketone substances of the blood of normal animals may be increased by the injection of a ketogenic principle.

The specific action of anterior lobe hormones upon certain secretory glands has been established, while an active influence has been experimentally indicated in others. It may influence the thyroid as is indicated after the operation called hypophysectomy, when the thyroid atrophies. This may be prevented, however, by the injection of the thyroid principle, thyrotropin. A similar condition, which may be prevented by the injection of the adrenotropic principle, occurs in the adrenal cortex. The injection of normal animals with a parathyrotropic prin-

ciple stimulates a proliferation of the parathyroid cells. A diabetic factor is indicated, for severe hyperglycemia (excess sugar in the blood) and glycosuria (sugar in the urine) do not take place in pancreatomized animals if the anterior lobe is also removed.

The sexual activities of male and female animals are definitely influenced by the anterior lobe. In the male it stimulates spermatogenesis and the secretion of male sex hormone called testosterone. In the female at least two ovarian principles influence the sexual cycle, and a third stimulates lactation. A follicle stimulating hormone, prolan A, matures and ruptures the Graafian follicle. This is followed by a leutinizing hormone, prolan B, which stimulates growth of the corpus luteum. At parturition the initiation of milk secretion is stimulated by the hormone, galactin.

The true ductless glands do not secrete all of the hormones of the body. The *pancreas* and *gonads* play important parts in hormone production. These glands have ducts leading from them, but like the true ductless glands, they are dependent upon the blood stream for transportation of their hormones.

The pancreas contains small islets of glandular cells called islets of Langerhans, which have no connection with the pancreatic duct. These islets secrete the hormone, insulin, which regulates the percentage of sugar in the blood and aids in carbohydrate metabolism. Removal of the gland brings on the well known disease, diabetes mellitus.

The testicles of mature males secrete the male sex hormone, testosterone. This hormone produces the secondary sex characteristics. Its injection into castrated males has a variable effect depending upon the age and species. They tend to develop into normal males and carry on normal sexual functions. Bulls' testicles are rich sources of this hormone.

The *Graafian follicles* of the *ovaries* of mature females secrete the female sex hormone, oestrone. This hormone produces the secondary female sex characteristics. Its injection into castrated females induces estrum or heat, as characterized in normal females. It initiates growth of the epithelial lining of the uterus and vagina. After the follicle ruptures, the cavity is filled by the growth of the corpus luteum. This in turn secretes a hormone, corporin, which helps to further prepare the uterine lining for implantation of the fertilized ovum, and prevents the recurrence of estrum. It secretes a hormone, relaxin, which relaxes the pelvic ligaments at time of parturition. The simultaneous injection of oestrone and corporin into male and young castrated females induces growth of the mammary gland comparable to that in the multipara.

Comparative Anatomy of the Most Important Viscera.—Every veterinary inspector should be thoroughly versed in the anatomical characteristics of the normal viscera of the domestic animals, and therefore the principal differential signs of certain viscera will be briefly specified later.

Tongue.—*Cattle*:¹ Round, large body; mucous membrane frequently shows blackish spots; the filiform papillæ are horny, especially strong along the lateral border; numerous fungiform papillæ mostly arranged in groups and scattered over the entire dorsum; 28 to 34 circumvallate papillæ, which are arranged in two rows in the form of a V; the foliate papillæ are absent; the epiglottis is frequently attached and appears oval. *Sheep and Goats*: Similar to cattle; the center of the tip is slightly grooved; the papillæ of the body are comparatively even larger than in cattle and are grouped into compact masses; filiform and fungiform papillæ are also present on the inferior surface; sheep have 18 to 24, while goats have 12 circumvallate papillæ. *Hogs*: Long and narrow; 2 circumvallate papillæ and numerous fungiform papillæ at the base; long; soft papillæ directed backward; foliate papillæ have mostly five cross fissures, epiglottis broad, at the free border flatly rounded. *Horses*: Flat, even, long

¹ Regarding the weight of the liver, heart, spleen, kidneys and lungs of cattle, see also page 67.

point; intense toughness of the mucous membrane in the dorsum; fungiform papillæ especially well defined on the lateral surface; 2 circumvallate and 2 foliate papillæ with 3 to 10 cross-furrows; epiglottis leaf-shaped. *Dogs*: Broad, flat, sharp lateral borders, bright red color; under the mucous membrane on the posterior surface is found the flask-shaped cartilage-like body, the so-called lyssa; long, soft papillæ at the base; 4 to 6 circumvallate papillæ; foliate papillæ indistinct, with 5 to 7 cross-fissures; epiglottis rhomboidal.

Stomach.—The relations of the stomachs of the ruminants do not require special mention. *Hogs*: Triangular dilatation on the left dorsal end; cardiac portion funnel-shaped; the portion covered by esophageal mucous membrane is small; at the elongation of the small curvature lies the cone-shaped pylorus, which contains a sphincter muscle. *Horses*: Left half of the stomach covered by esophageal mucous membrane, which is sharply separated by a jagged border from the glandular mucous membrane; esophageal orifice is slanting, with sphincter muscle; double pyloric sphincter. *Dogs*: Left half-round, pyloric part shaped like intestines; esophageal orifice conical, single pyloric sphincter; esophageal region absent.

Intestinal Canal.—In cattle, swine and goats the colon is spirally coiled upon itself while externally and ventrally to it lies the jejunum on a short mesentery, hanging in numerous convolutions. In hogs the colon forms a convolution the shape of a nine-pin. Regarding the diameter, the colon of cattle, sheep, goats and dogs differs only slightly from the small intestines; in horses and hogs the colon is considerably larger than the small intestines. Colon and cecum of the hog and horse have longitudinal muscular bands and are sacculated.

Liver.—Color is generally reddish-brown; in fat animals and in those of advanced pregnancy it is yellowish-brown. *Cattle*: Indistinctly three-lobes, Spigelian lobe rounded on the right lobe; falciform ligament absent, and, as a rule, the ligamentum teres; gall-bladder pear-shaped, extending a long distance over the ventral border of the liver; average weight, according to Schmaltz, $\frac{1}{52}$ of the dressed weight; in cattle of over 250 kg., dressed weight, 5 to 6 kg.; in lighter animals, 3 to 4½ kg. *Sheep and Goats*: Covering of the ventral border at the height of the attachment of the round ligament relatively deeper than in cattle, the lobus Spigelii triangular running into a point; the gall-bladder appears similar to that in cattle; weight $\frac{1}{3}$ of the dressed weight, from 375 to 875 grams. *Hogs*: Four lobes besides the lobus quadratus and caudatus; prominent esophageal notch, the gall-bladder deep in the right portion of the middle lobe; the head of the gall-bladder does not quite reach the ventral border of the liver; the portal vein is at the dorsal border of the liver, more or less surrounded by the liver parenchyma; lateral ligaments are absent; liver lobules are remarkably distinct, due to the rich development of the interlobular connective tissue; weight $\frac{1}{40}$ of the dressed weight, $\frac{1}{2}$ kg. *Horses*: Three distinct lobes, the lobus and processus caudatus running into a point (lobus Spigelii), deep esophageal notches; gall-bladder absent; average weight, 5 kg., in old horse often only 2.5 to 3.5 kg. *Dogs*: From the parietal surface four lobes, and from the visceral 6 lobes are noticeable; deep esophageal notch; the cavity for the gall-bladder is formed by the right border of the lobus quadratus and the left border of the right middle lobe; the head of the gall-bladder does not reach the ventral border of the liver.

Pancreas.—*Cattle*: Light yellow-brown to reddish-yellow brown, free of fat. *Calves and Sheep*: Similar to cattle; in fattened animals it is lighter in color. *Hogs*: Grayish-yellow, extensively intermixed with fat. *Horses*: Reddish-yellow to reddish-gray. *Dogs*: Pale red.

Spleen.—*Cattle*: Long and flat, uniformly broad, with rounded edges; in bulls and fattened steers, reddish-brown; in cows, grayish-blue; consistence in bulls and fattened steers quite dense, in the cow loose; the borders of the first are rounded, in the latter they are sharp. The surfaces in the bulls and steers are arched; in the cow flat; the follicles in the first are larger (up to the size of hempseed) than in the latter; weight in animals dressing over 250 kg., 1 kg.; in those dressing below that weight, 0.5 to 0.75 kg. *Calves*: Reddish-

brown to bluish-violet; borders and surfaces are rounded; consistence soft. *Sheep and Goats*: Blunt, angular, of the shape of a palm of the hand; reddish-brown; consistence soft to elastic. *Hogs*: Long, tongue-shaped, with the exception of the ends, which are almost uniformly broad; cross-section is triangular; pale red; consistence soft, loose. *Horses*: Flat, elongated, triangular and slightly bent in the shape of a scythe; bluish-red, assuming a shade of reddish-brown; the curved anterior border is thinner than the rounded posterior border; weight, $\frac{1}{240}$ of the body weight, 0.5 to 1.5 kg. *Dogs*: Tongue-shaped, broad at the ventral extremity; light red; weight, $\frac{1}{500}$ to $\frac{1}{600}$ of the body weight.

Lungs.—*Cattle*: Left lung has three lobes, cephalic, cardiac and diaphragmatic; right lung four to five lobes; the division of lobules is more pronounced than in any other food animal; intralobular connective tissue is well developed. *Sheep*: Structure of lobules very indistinct; in the goat, however, it is more distinct. *Hogs*: In the left lung, two to three lobes (the cephalic lobe, which is sometimes divided and the principal lobe), the right lung has four lobes. *Horses*: The left lung has two lobes (cephalic and principal lobes); the right has three; lobular structure not very distinct; the bronchial tube for the cephalic lobe of right lung, which originates directly from the trachea and which is present in ruminants and hogs, is absent. *Dogs*: Left lung has three, right lung has four separate lobes, the notches of which extend up to the principal bronchi; lobular structure is indistinct, frequently anthracosis is seen.

Thyroid Gland.—*Cattle*: Two flat lobes connected by an isthmus which is 1 to 1.5 cm. broad; structure lobulated, light reddish-brown. *Calves*: Darker, isthmus stronger. *Sheep*: On each side a thick brownish-red lobe, with the appearance very much like muscle; isthmus very indistinct. *Hogs*: Connected, flat, not lobulated, dark red. *Horses*: Each side portion roundish, oval, of the size of a prune, reddish-brown, isthmus consists mostly of connective tissue. *Dogs*: Side lobe large, elongated; isthmus in large dogs very distinct, in smaller dogs only slightly or unobservable.

Thymus Gland.—(Sweetbread).—*Cattle*: Divided, lobulated, whitish-yellow, first disappears from the neck portion; in the thorax even after eight to nine years it is plainly noticeable. *Calves*: Reaches up to the larynx; in the first week of life it weighs 100 to 200 grams; after four to six weeks, 400 to 600 grams. *Hogs*: Both cervical lobes reach to the throat, color grayish-yellow. *Horses*: Disappears at two to two and a half years. *Dogs*: Flat body, which divides anteriorly and also posteriorly into two lobes; pale gray; only traces left after two to three years.

Heart.—In all animals reddish-brown; consistence firm. *Cattle*: In the fibrous ring of the aorta are two heart bones, which in calves are cartilaginous until the fourth week. *Hogs*: Apex more rounded than in sheep; heart cartilage ossifies in older age, as in the horse. *Dogs*: Almost round; heart cartilage is absent, or is very small.

Kidneys.—*Cattle*: Consists of 16 to 26 lobules, which fuse in the deeper portion, and as there are just as many calyces and renal papillæ, there is no true pelvis of the kidney; reddish-brown; average weight, $\frac{1}{300}$ of the body weight, 952 grams. *Sheep and Goats*: Bean-shaped; not lobulated, thick, arched; dark brown to brown; mutual renal papillæ and pelvis. *Hogs*: Bean-shaped, not lobulated, flattened; brown to yellowish-brown; 10 to 12 renal papillæ; pelvis with several calyces; average weight, $\frac{1}{50}$ of the body weight, 420 grams. *Horses*: Left kidney longer than broad (bean-shaped); the right is triangular, flat, not lobulated; brown; renal papillæ are fused into a crescent projection; kidney pelvis has two terminal recesses. *Dogs*: Bean-shaped, thick, only one renal papilla; reddish-brown; kidney pelvis has two terminal recesses.

Urinary Bladder.—*Cattle*: Very large, almost entirely covered by the peritoneum; the triangular space between the orifices of the ureters and the urethra called the trigone, is very small, hardly perceptible; similar in sheep, goats, hogs and horses; covered by the peritoneum in the form of a cap; mucous membrane contains noduli lymphatici. *Dogs*: Roundish, almost entirely covered by peritoneum; ligamentum vesico-umbilicale is present.

Uterus.—*Cattle*: Two horns; from external appearances a body is apparently present, but actually it is only 1 to 2 cm. long; mucous membrane forms cotyledons. *Sheep and Goats*: Horns longer, at the extremities round, like intestines; mucous membrane forms very small cotyledons, which in pregnancy become cup-shaped (uterine cups); screw-shaped folds in the cervix. *Hogs*: Horns long, having the appearance of small intestines; body short, 5 cm. long; the cervix proper is absent; mucous membrane on the corresponding place in the form of oblique rolls (pads); mucous membrane in thin folds. *Horses*: Two horns, very long body (13 to 15 cm.), prominent cervix with close folds of the mucous membrane arranged lengthwise. *Dogs*: Long, straight horns, short body, with a strong muscle wall for a cervix.

Ovaries.—*Cattle*: Oval, flat, with a large ovulation surface. *Sheep and Goats*: Roundish, relatively large. *Hogs*: Roundish, nodular, like a blackberry, more or less enveloped by the ovarian sac. *Horses*: Almost bean-shaped, dense, entirely covered by peritoneum, up to the notches of the ovulation grooves. *Dogs*: Elongated, has no notches, enveloped by ovarian sac and fat.

Mammæ.—*Cattle*: Four quarters, with one teat each, which has only one opening; parenchyma gray to whitish-red. *Sheep*: Two halves, each has one small teat with one opening. *Goats*: Two large, loose-hanging halves, each having a strong teat which is turned forward, and has one opening. *Hogs*: The mammæ extends from the vulva to the sternum, and has 5 to 6 divisions on each side, each having one teat, which contains one or two openings; the parenchyma is richly intermixed with fat. *Horses*: Two longated round halves, each having one flat triangular teat, which has two openings; parenchyma, whitish-red. *Dogs*: As in the hog on each side there are 4 to 5 divisions, each having one teat, the point of which is pierced by 8 to 12 openings like a sieve.

Schneider undertook to investigate the absolute and relative weight of the heart, lungs, liver, kidneys and spleen of cattle; the results of which are compiled in the following table:

	Absolute average weight in				Relative average weight.							
					To the live weight of the animal.				To the dressed weight of the carcass.			
	Steers.	Bulls.	Cows.	Heifers.	Steers.	Bulls.	Cows.	Heifers.	Steers.	Bulls.	Cows.	Heifers.
Liver . . .	Kg. 7.607	Kg. 5.947	Kg. 5.497	Kg. 4.787	Per cent. 1.038	Per cent. 1.023	Per cent. 1.206	Per cent. 1.156	Per cent. 1.825	Per cent. 1.924	Per cent. 2.531	Per cent. 2.203
Heart . . .	3.012	2.592	2.205	1.890	0.414	0.442	0.492	0.457	0.727	0.835	0.997	0.875
Spleen . . .	1.155	0.878	0.789	0.744	0.159	0.152	0.171	0.163	0.278	0.285	0.356	0.334
Kidneys . . .	0.727	0.613	0.617	0.497	0.100	0.105	0.129	0.115	0.176	0.199	0.278	0.235
Lungs . . .	3.930	3.330	2.990	2.657	0.541	0.560	0.653	0.660	0.950	1.056	1.326	1.102

Accordingly the absolute weight of the five organs averages the highest in steers, and gradually diminishes from the steers to the heifers. The relative weight averages the smallest in steers and increases from the steers to the heifers and cows.

PECULIARITIES OF THE MEAT FROM VARIOUS ANIMALS.

Meat and fat of all animal species possess certain peculiarities which are more or less influenced by breed, sex, age, feeding and condition of health of the respective animals, and thus they fluctuate within certain limits.

Beef.—Generally beef shows a saturated red color with a slight tint of brown; it has a firm consistency and its cut surface is shiny. The odor is characteristic and the meat is generally intermingled with fat. The connective tissue is white and soft. After chilling the fat shows quite a firm consistence, a white to yellow color and a peculiar odor. In old cattle the fat assumes a more yellowish color, and is looser in consistency. Intensive yellow coloration of the fat may also be met in pasture-fed cattle. Rich feeding with slop, oil cake, acorn cake or cottonseed meal produces a soft, loose, yellow fat. The bone-marrow is pure white to reddish-yellow, and of a moderately firm consistence. Fattened steers up to six years old have bright, dark brick-red meat, which is moderately coarse in fiber, and which as a result of the intermingling with fat has a marbled shiny appearance on its cut surface. The fat is white to whitish-yellow and firm.

The meat and fat of fattened calves and fattened young cows up to the age of seven years appear similar to that of fattened steers.

The meat of old milch cows shows, as a rule, a lighter coloration and coarser fibers; the connective tissue stands out more prominently and is close in texture or flabby, and contains more moisture. The fat is yellow, even to an intensive lemon-yellow color, and appears less firm and intermixed only in small amounts with the meat. It is more abundant in the subcutaneous tissues, mesentery, peritoneum and kidney capsule. The odor of cow meat sometimes resembles the odor of cow milk (Baranski).

Young cattle possess a loose, fine-fibered meat of a pale to light brick-red color only slightly intermingled with fat. The fat is white and firm.

In older bulls the meat is dark copper-red in color, coarse-fibered, tough, poor in fat and dry. In large masses, and especially where the muscles are covered by a fascia, the meat has a light bluish hue; the fat is white. The dried surface of the meat of older bulls appears very dark and the butchers designate it as "black." The meat of young fattened bulls differs only slightly from that of fattened steers, with the exception of showing coarser fibers.

The disagreeable odor of bull meat, which was observed by Goltz, and which resembles the effluvium of the live bull, appears relatively rare. The subject of sexual odor of meat is further treated in Chapter VII, p. 210.

Veal.—The meat of calves slaughtered at an age from two to four weeks is generally pale, gray to grayish-red, has fine, somewhat tough fibers, and is not intermixed with fat. The consistency is from moderately firm to loose. The odor is specific; in calves which have been slaughtered for a long period (old slaughter) it is slightly sour. The fat is reddish-yellow to white-yellow, or pure white, loose and greasy. The bone-marrow is pink-red. Older fattened calves show a darker, redder, tougher meat, which in the so-called "double-loined calves or sturgeon calves," is poor in fat and dry. Veal in general contains more water and gelatin-forming substances; on the other hand, it is poorer in muscle albumin than beef.

Concerning the meat of immature calves, see Chapter VII.

Mutton.—Mutton (sheep meat) is distinguished by the firm, dense fine fibers and its dark red color. Its consistence is moderately firm. The odor is specific, slightly ammoniacal, sometimes resembling the odor of a sheep stable. The muscles are not intermixed with fat. In fattened animals, however, there are rich deposits of fat between the groups of muscles, and especially in the subcutis and the kidney capsule. The fat is pure white, hard, firm, brittle and has no odor. The bone-marrow is firm and slightly red.

Goat Meat.—Goat meat is in general paler than sheep meat. The fat and bone-marrow simulate that of sheep. The fat is chiefly located in the kidney capsules, while in the subcutis it is only present in small quantities. The muscles also contain only a little fat. The odor of the meat and fat is peculiarly strong, resembling the odor of the living mature male goat. (See Chapter VII, p. 210).

Pork.—In hogs, age, nutritive condition and the particular body region influence the color of the meat considerably, which appears whitish-gray, pale red, gray-red to dark red. The fibers are fine, the consistence soft to moderately firm, and the odor indefinable. It is considerably intermixed with fat, which also envelops the larger groups of muscles. The fat is pure white, finely granular and soft. The bone-marrow is soft and pink-red.

On boiling pork becomes whitish-gray and is then much lighter than the meat of other food animals.

In animals fattened with corn the fat is firm and white, and in those fed on fish, a gray color. Feeding with acorns yields an oily fat. Feeding fish gives the fat a fishy odor.

In older sows kept for breeding, and stags (boars castrated after they have matured), the meat is dark red, poor in fat and firm.

The odor of the meat from boars and cryptorchids is more or less repulsive, resembling urine. It is frequently perceptible on the fresh meat, but sometimes it appears only in cooking or roasting. (See Chapter VII, p. 210.)

Horse Meat.—Horse meat is marked by its dark red or even brown color. When exposed to the air it has a bluish luster, and even becomes blackish-red to black. The fibers are very fine, the consistence is firm, and fasciæ are very prominent. There is no intermixing of fat in the muscles. The odor is peculiar, sweet and almost repulsive. The fat is soft, oily and light gold to dark yellow in color, but in well-nourished horses it is whiter and firmer. The bone-marrow is wax-yellow, greasy and soft, but becomes stiffened in the air.

Dog Meat.—Generally the meat of dogs is dark red, firm, fibered and only slightly intermixed with fat, which occurs chiefly between the groups of the muscles and in the subcutis. The consistence of the meat is soft and smeary; the odor is disagreeably repulsive. The color of the fat is white to whitish-gray, and its consistence oily and greasy.

Rabbit Meat.—The meat of rabbits is distinguished by its pale red, gray-red and gray color. The fibers are fine; the fat in the muscles is absent and the consistence loose. The fat is whitish-yellow, and is principally confined to the body cavities.

Poultry Meat.—The muscular tissues of fowls are firm, fine-fibered and without intermixing with fat. The color of the preponderating meat is pale; however, there are also red muscles. Generally the meat of chickens, capons and turkeys is called white, while that of geese, ducks and pigeons is considered as dark. The consistence is principally firm and the alkalinity subsists after slaughter for a long time (Postolka and Toscano). Odor and taste vary in accordance with the species and feeding. The fat content of the muscles proper is very small, except in the case of the fattened fowl. The fat is very variable in its consistence, color and odor; generally, however, it is soft and oily. In chemical composition (page 46) the meat contains few gelatin-forming substances, but considerable albumin.

Meat of Game.—The general characteristics of the flesh of fowls may be applied to the meat of game, but the color is always darker, shading from red to brownish-red. The odor and taste are peculiar to each kind of game. Meat of animals which were exhausted in the chase before death, or which were injured by shot and had to endure a long agony, is said to be bitter in taste; moreover, the greater content of blood in the meat of game should be considered. This, however, apparently does not influence its keeping qualities to any extent, although it does in the case of the meat of other animals.

Regarding its chemical composition (page 46) what was said about the meat of fowls applies to the meat of game.

Fish Meat.—The color of fish meat is white; only few fish have red meat (salmon, trout). The structure is peculiar, inasmuch as the entire muscular mass of each side of the fish consists of a single muscle plate (side muscle), which is divided by a long furrow into a dorsal and ventral part. Each side muscle consists of a large number of muscle plates (myomeres), which are separated by thin, connective-tissue membranes, and which easily fall apart, especially in boiling. The odor and taste, which principally depend on the consistence of the fat, have no characteristic features. Taste, however, is principally influenced by the food of the fish. The meat of fish of prey is better in taste than that of those which seek their food in the mud. In the same way the season, especially the spawning period, influences the taste of the meat not inconsiderably. Lichtenfelt, in a study of the periodical changes of the consistence of meat of various kinds of fish, found that during the spawning period the albumin diminishes in the side body muscle in females from 17.5 per cent to 13.3 per cent, and in males from 17.9 to 19 per cent to 13 to 14.3 per cent. In a still larger degree the fat contents of the muscles decrease. The fat, when present, is finely distributed in the meat.

In chemical composition the fish meat contains a larger quantity of water than that of mammals. This, however, is considerably reduced in fish which are rich in fat to the advantage of the fat contents (eel meat, 55 to 60 per cent of water). Of the nitrogenous constituents, the extractive and glue-forming substances amount to one-third. The

supposition that fish meat is not as satiating as other meat appears to be contradicted by Rosenfeld's investigations.

For the poisonous effects of some fish, see Chapter X, p. 367.

Meat of Crustaceans and Mollusks.—In these animals the muscles are white or whitish-gray. Consistence, odor and taste vary greatly. There is a remarkably slight amount of fat. For the chemical composition, see page 46.

Meats of Reptiles and Amphibians.—The meat of frogs and turtles is always of a pale color, usually white, yellowish-gray, yellowish or yellowish-red. The fat content is limited and slight. For the chemical composition, see page 46.

FRAUDULENT SUBSTITUTIONS FOR MEAT AND THEIR RECOGNITION.

In the handling of meats and preparation of meat-food products, attempts are sometimes made to substitute meat of a lesser quality for that of higher quality. To detect such frauds frequently causes the expert considerable trouble, and not infrequently, especially in prepared meat-food products, it is altogether impossible.

If bones are present in the suspected meat they should be taken for comparison, and all other characteristic peculiarities of the meat and fat, which have been already described for the individual species of animals, should be considered. Relative to the manifold differences in the skeleton, reference should be made to the text-books on comparative anatomy of the domestic animals.

Differentiation of Meat by Biological Method.—For distinguishing the various kinds of meats from a scientific standpoint the biological method deserves the greatest consideration. The method is based on the formation of precipitins in the blood serum of animals (for instance, rabbits), which received for a certain time intraperitoneally blood serum or meat juice of other animals (for instance, horses). If then, such blood serum of rabbits is added to the blood serum or meat juice of the horse, a cloudiness will develop in the latter which results in a precipitate. This reaction appears only with the blood serum or meat juice of the same species of animal which was employed for the preparatory treatment of the rabbit, and from which the serum, which supplies the precipitating serum originated. The reaction is, therefore, a specific precipitation.

The method was first employed by Ehlenthuth, Wassermann and Schütz for the recognition of human blood, and later improvements by Jess, Uhlenhuth, Miessner and Herbst, Notel, v. Rigler, Grönlén, Borschmann and others made it applicable for use on meats. The biological method can be applied to fresh meat, and also to dried, pickled and salt meat as well as for distinguishing meat mixtures, bones and viscera. On the other hand, the method does not prove satisfactory for the differentiation of cooked meats. For distinguishing horse meat from beef the biological method is successful, but whether the

application of the same will prove unobjectionable on the meat of other animals, which zoölogically are in closer relation, is yet to be determined. The production of the sera and meat extracts and the procedure of the reaction are accompanied by various difficulties and require certain precautions. Therefore, the application of the biological method presumes great skill, and is accordingly adapted only for scientific institutions and for larger meat-inspection bureaus conducted by veterinarians. Owing to the technic and the numerous details to be considered in connection with the test, the reader is referred to the original works for a full description.

Differentiation Between Meats from Various Species of Animals.—

Other differentiating indications between the species which occasionally may appear for comparison are described in the following:

Sheep and Goat.—In comparing the whole slaughtered carcass the goat appears to have longer bones, especially in the flank, than the sheep. The latter has a round back and fleshy, rounded croup, while the goat manifests a sharp back and a sloping croup. Goats usually have a shorter tail (12 caudal vertebræ) than sheep (18 to 24 caudal vertebræ); however, there are also short-tailed (12 to 16 caudal vertebræ) and tailless breeds of sheep (3 caudal vertebræ). The thorax of the goat is flat, that of the sheep is barrel-shaped. On the somewhat sticky surface of the slaughtered goat frequently goat-hairs are found adhering; the skin muscles of goats are darker than those of sheep. The subcutis of goats contains less fat and the muscles are not enveloped in fat to the extent that they are in sheep. The meat has a characteristic odor, especially pronounced in males. Of the skeletal peculiarities it should be noted that all bones of goats in general are more slender in form than those of sheep. In the skull of the goat the external lacrimal notch is absent while it is present in sheep. The spinal processes of the cervical vertebræ are, according to Bützler, long, pointed and sharp-edged in the goat, while in the sheep they are broad and dull. There are at least four sacral vertebræ in the goat, never three, as occasionally in sheep. The lateral sacral borders of the goat are thin and sharp; in the sheep they are thickened in the form of rolls. The pelvic opening is considerably smaller in the goat than in the sheep. The scapula in the sheep is broad and short; the well-developed spine has in the center a round thickening which is bent backward in a bow. In goats the scapular spine is flat and straight; the neck of the scapula is distinctly outlined. The tibia in the sheep is strongly turned spirally, and its posterior surface is concave. The bones of the goat are, according to Lohoff, harder and more brittle than the bones of the sheep.

Sheep, Goats and Deer.—The conformation of the bones in deer is always more slender and neater than in the sheep or goat. The cervical vertebræ of deer are longer than in sheep and goat compared to the size of the animals. The spinal processes of the dorsal vertebræ of the deer are turned forward, beginning at the third; on the lumbar vertebræ they are elongated toward in the form of a sharp hook, which in sheep is considerably smaller. In the scapula of the deer the acro-

mion is elongated into a sharp point, which is directed ventrally; it is absent in the sheep and goat, or is considerably smaller. The radio-ular arch which forms an oval opening in the sheep and goat is very long in the deer. The lacrimal bone in the deer is also deeply grooved, but its surface appears incomplete. In the deer the subcutaneous layer of fat is not as well developed as in the sheep; the meat is poor in fat and possesses the odor of venison, which is to be distinguished from the odor of sheep.

Smith pointed out the difference between goat hair and deer hair. In the first the cortical substance in the microscopic picture is as broad as the marrow substance, while deer hair is characterized by the remarkable development of the marrow substance. The cortical layer in deer hair is almost unrecognizable, so that the hair appears to be a cylinder entirely made up of polyhedral cells. The hair of elk and chamois has also a similar structure.

According to Stadies, the kidneys of deer can only be positively distinguished from those of the sheep with the aid of an anatomical fluid injected into the pelvis of the kidneys. The pelvis of the kidney is injected with a solution of celloidin, rosin and turpentine in alcoholic ether; after the stiffening of the solution the kidney is placed into hydrochloric acid, which in a few days completely destroys the kidney substance. The cast from the pelvis of the deer kidney is small and oval without any bulgings, while that from the pelvis of sheep shows long prolongations.

Hog and Dog.—Besides the manifold differences in the skeleton, which are described in text-books on anatomy, it may be also noted that the color of dog meat is much darker than hog meat, and this difference can be especially observed in the cooked flesh (see page 69).

The muscles of dog meat are more smeary and the fat is more oily than in the hog; the odor is entirely different.

Rabbit (Hare) and Cat.—The following differences in the skeleton are especially to be noted: The lateral processes of the lumbar vertebræ which are directed forward terminate in the rabbit (Fig. 36) in two extensions, one of which is directed forward, the other backward; in the cat they terminate in a point. The body of the first three lumbar vertebræ in the rabbit contains thorn-shaped ventral processes (Fig. 36, *a*). The ribs of the rabbit are flat and broad; those of the cat are rounded. On the scapula of the rabbit the acromion turns around posteriorly and terminates in a long point, which is directed backward (Fig. 39). The radius and ulna are completely separated in the cat (Fig. 37); in the rabbit they are united (Fig. 38). On the humerus of the cat is an elongated fissure over the median condyle of the distal end (Fig. 41). The femur of the rabbit (Fig. 43) contains below the trochanter major a specially strong smaller trochanter, which is absent in the cat (Fig. 44). Tibia and fibula are complete in the cat (Fig. 45); in the rabbit (Fig. 46) they are only separated in the upper half.

The whole carcass of the cat can be immediately recognized by its head, penis bone and the tail, and for these reasons, if offered for sale, these parts are always removed on the slaughtered animal. Rabbits generally have the shot wounds, but these are naturally absent in the slaughtered domesticated rabbits. The meat of the cat is paler than rabbit meat; the fat of the cat appears whitish in contrast to rabbit fat, which is honey-yellow.

Hare and Rabbit.—The cervical vertebræ in the hare are, according to Lesbre, shorter than those of the rabbit. The spinal processes of the dorsal vertebræ in the rabbit are slightly turned backward, and they do not have the hook-shaped extensions which are present in the hare. The well-marked bifurcations of the ends of the lateral processes of the lumbar vertebræ in the hare are only perceptible on the first lumbar vertebra of the rabbit. The sacrum of the hare consists of four united vertebræ; the spinal processes are all united. In the rabbit the sacrum is narrower than in the hare. The ribs and scapula are longer in the hare than in the rabbit. The spine of the scapula lies considerably nearer

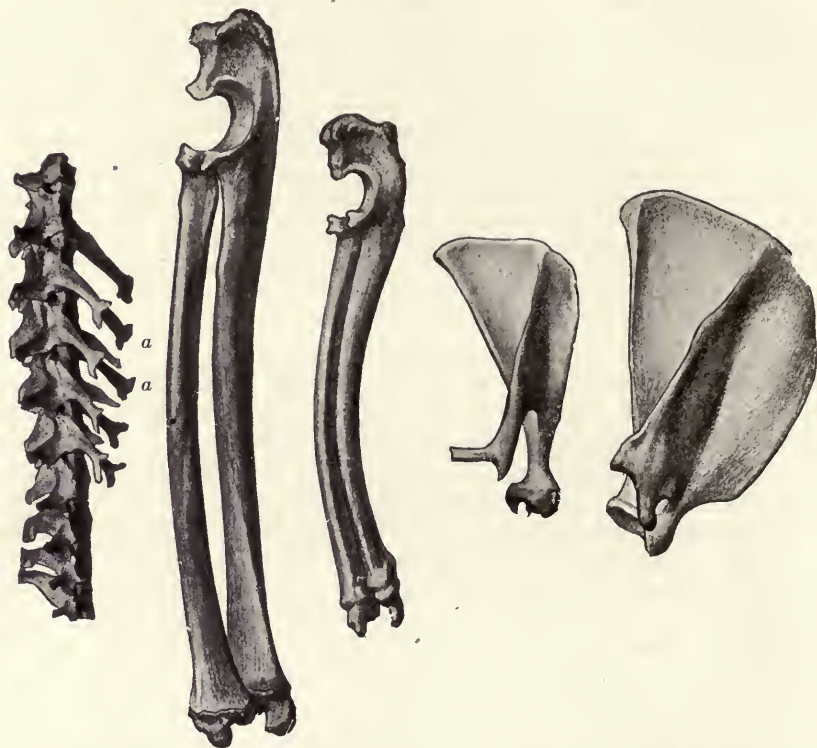

FIG. 36

FIG. 37

FIG. 38

FIG. 39

FIG. 40

FIG. 36.—Lumbar vertebræ, with ventral spinal processes.

FIG. 37.—Right forearm of the cat, inside view.

FIG. 38.—Right forearm of rabbit, inside view.

FIG. 39.—Right scapula of the rabbit.

FIG. 40.—Right scapula of the cat.

to the anterior border of this bone in the rabbit. The acromion of the hare terminates suddenly at the attachment of the processus hamatus, while in the rabbit it continues for 3 to 5 mm. in a long point (Fig. 39). Upper arm is larger in the hare than in the rabbit. The radius is longer in the hare than in the rabbit; the middle part is cylindrical in the latter, while in the former it is considerably flattened. The ulna of the hare becomes gradually thinner at the distal end, and proceeds almost entirely behind the volar surface of the radius; in the rabbit, on the other hand, it is well developed in the entire length, and lies almost completely on the lateral surface of the radius. With the hind legs there is no perceptible difference.

Cattle and Horses.—In the horse the greater length of the extremities and of the thorax appears in marked contrast to the size of these parts in cattle, while in the latter, on the other hand, the pelvis is longer than that of the horse. The characteristics of the meat were discussed on page 69. The numerous osteological differences must be left unconsidered. It is seldom necessary to pass an opinion on large pieces of meat; it is much more frequently necessary to determine the presence of horse meat which has been prepared for food, especially in sausage. Such determination is usually difficult and in many cases cannot be accomplished with certainty. It may often, however, be accomplished



FIG. 41

FIG. 42

FIG. 43

FIG. 44

FIG. 45

FIG. 46

FIG. 41.—Right humerus of cat, front view.

FIG. 42.—Right humerus of rabbit.

FIG. 43.—Right femur of rabbit, front and inside view.

FIG. 44.—Right femur of cat.

FIG. 45.—Right tibia and fibula of cat, front view.

FIG. 46.—Right tibia and fibula of rabbit.

by determination of glycogen, by examination of the fat, or by the biological test.

Horse meat normally contains a considerable quantity of glycogen (0.373 to 1.072 per cent). This quantity far exceeds that normally occurring in the flesh of other domestic animals. Determination of glycogen by chemical analysis may, therefore, be applied to the detection of horse meat in sausage. Results of a glycogen determination may not, however, be accepted as conclusive. The quantity of glycogen in horse meat is variable, and in some cases may be no greater than that contained in other meat. There is also a tendency for glycogen to

become converted into glucose on standing. Absence of glycogen does not, therefore, prove the absence of horse meat. Meat and edible organs of other domestic animals may also contain glycogen. The flesh of dogs, cats, fetuses and starved calves are known to contain notable quantities of glycogen. Hog livers are especially rich in glycogen. The presence of abnormal quantities of glycogen in sausage may not, therefore, be taken as conclusive evidence of horse meat.

Horse fat differs from that of cattle, sheep and goats in that it contains a considerable proportion of the glycerides of linolic acid and practically no glycerides of stearic acid. It consists almost entirely of glycerides of oleic, linolic and palmitic acids. As linolic acid does not occur normally in the fat of cattle, sheep and goats, and those fats normally contain a large proportion of the glycerides of stearic acid, horse meat can easily be distinguished from beef, mutton and goat meat by examination of the fat. It is more difficult to distinguish horse fat from hog fat, as the latter also contains glycerides of linolic acid in considerable quantity. Hog fat differs from horse fat in the presence of a palmito-di-stearin, a glyceride which occurs exclusively in hog fat, and in the presence of glycerides of lauric and myristic acids. Detection of horse meat in a mixture of horse meat and pork by examination of the fat is not often possible. The biological method is reliable when it can be applied but is inapplicable in many cases, particularly to smoked and cooked sausage and to canned meat products.

Cattle and Deer.—The muscle fibers of beef are coarser than those of deer, and the bones are also stronger. Deer meat is darker than beef, and is not so mottled with fat. The fat of deer appears much like mutton fat; it is harder and more brittle than beef fat.

Cattle and Buffalo.—Generally fresh buffalo meat is darker (more reddish-brown) and the fibers are coarser and looser in structure than beef. The odor of buffalo meat and fat resembles that of musk, and if boiled in strong acidified (sulphuric acid) water it develops a disagreeable odor similar to that of cattle manure (Puntigam and Halusa). The cutaneous shoulder muscle of buffalo is only 3 to 5 fingers broad, while that of cattle is considerably broader. The fat of buffalo is strikingly white, and is drier and less sticky than in cattle. The conformation of the bones of the buffalo is generally finer and the bones are more brittle. The pubic symphysis of the buffalo appears strikingly plane.

CHAPTER III.

THE PRODUCTION, PREPARATION AND CONSERVATION OF MEAT.

In the utilization of meat for human food it undergoes various processes or preparations and should it not be consumed within a certain period it must be conserved in order that it may be kept.

CHOPPED MEAT.

The production of chopped meat by means of cutting the flesh with a knife, cleaver, rocking knife or meat grinder is the simplest method of preparation. For this purpose beef and pork are principally used, but veal is likewise utilized to a small extent. The short tendinous meat of the head, leg and all other parts of the body, which does not find a ready sale in the butcher shop, is thus worked up into a more salable product. Naturally fat is also added and chopped up with the meat in larger or smaller quantities.

Chopped meat is consumed either raw, after flavoring with salt, pepper and onions, or is used for the preparation of meat sausage, meat balls and various other dishes (hamburger steak).

To make the chopped meat retain the red muscular coloring matter, certain salts are frequently added, which, however, do not retard all decomposition.

Meyer examined the bacterial content of chopped meat by sowings on gelatin plates and found 1,695,000 to 12,717,000 bacteria to 1 gram of meat. The number of bacteria was not influenced by the usual addition of preservative salts.

SAUSAGE.

By sausage is understood a mixture of meat which is placed into a sausage covering. For coverings the intestines are principally employed, the serous membrane being inverted (see page 41); besides, the esophagus of cattle, the stomach of hogs and urinary bladder of various food animals are also used. Cellulose casings are now being manufactured and used to a great extent to replace animal casings as sausage containers. They are clean, of uniform size, have a good appearance and can easily be printed to show the marks of inspection and the name of the product.

Sausages and their preparation vary considerably in different countries. This applies especially to those varieties to which larger quantities of vegetable ingredients are added. The principal ingredients of sausage are always muscle meat and fat, besides blood, heart, tongue, connective tissue, hog skin, liver and various other parts of the viscera. In order to make the sausage tasty, spices (salt, saltpeter, sugar, pepper, paprika, caraway, marjoram, garlic, onions, coriander, cinnamon, clove, truffle, sardelle, etc.) are added to the animal ingredients. Many varieties of sausages are prepared for an early (immediate) consumption;

in order to increase the keeping qualities of sausage they are either smoked only or they are at first boiled and then smoked.

In accordance with the composition of the filling the following varieties of sausages may be distinguished:

Meat Sausages.—Meat sausages consist chiefly of chopped beef, pork or veal. For commercial purposes they are divided into:

1. Fresh sausage and sausage for boiling or scalding, which are sold under various names.

2. Sausages of keeping qualities, which are known as cervelat, summer sausage, etc.

Since fresh sausage and sausage for boiling are destined for early consumption, they do not contain any preservatives; at most they might be slightly smoked in order to improve the taste. The sausages with keeping qualities, on the other hand, should keep for a longer period. This is accomplished by the reduction of the content of water in the filling by drying and by smoking. The addition of water to sausage filling of fresh sausage or those for boiling or scalding is usual and positively necessary when the mass is to be filled in the narrow casings. The absorbing power of sausages for water (see page 43) depends on the binding quality of the meat. The higher or lower binding quality of the meat influences the consistence of the sausage mass inside of the covering, and, therefore, the slicing of the sausage as well as the appearance of the cut surface. The quantity of the added water, which amounts to about 24 per cent, according to Hoffmann, is of no special importance, since through the hot smoking of boiled sausages and others not only the added water is lost, but frequently even a portion of the natural content of water of the meat. For this reason, and also because the public demands juicy, well-stuffed sausages, the addition of water to the filling of this variety of sausages cannot be considered as an adulteration. B. A. I. regulations permit the addition of not more than 3 per cent of water to fresh sausage and not over 10 per cent of added water may be present in smoked or boiled sausage in the finished product.

The addition of cereal to sausage filling, which for a time had assumed considerable proportions, was declared by the butchers to be an absolute necessity, on account of the meat losing its binding qualities through the fattening used by the hog raisers. This, however, cannot be confirmed, as there are places where the addition of cereal is never practised, yet they produce excellent sausage. If the addition of cereals is kept within a certain limit (about 2 per cent) it does not necessarily indicate a deterioration in boiled or scalded sausages, as it thickens the juice and makes the sausage more palatable. However, the addition of cereal is only permissible when the consumers are aware of that practice. In sausage with keeping qualities the addition of any quantity of cereal means an adulteration. The supposition that the addition of cereal to the sausage filling makes the absorption of a larger quantity of water possible is erroneous, as cereal absorbs water only in boiling, and boiling water or prepared paste is not employed in the preparation of sausage.

With the addition of mixtures of egg albumen and tragacanth, the so-called "albumina," it is possible to produce a sausage filling consisting of 35 kg. meat and 50 kg. water, with a content of only 3 per cent of "albumina." Therefore such an addition must be considered as an adulteration.

The use of coloring matters in the preparation of sausage is prohibited in the United States. This, however, applies only to the sausage filling, while for the casings harmless dyes which are approved by the Secretary of Agriculture may be used. (See B. A. I. Order 211, Regulation 18, Section 6, Par. 3.)

The coloring, which was formerly employed in the production of sausages of keeping qualities, was principally to prevent the filling from turning gray and especially in order to prevent this occurrence on the cut surfaces. The turning of the color is due to a change of the muscle coloring matter into a colorless modification, which does not necessarily indicate a simultaneous spoiling of the muscle substance. The causes for the sausage turning gray have not yet been satisfactorily established. According to Meyer, this occurs through a loss of salt in the sausage filling, progressing gradually toward the center by means of osmosis, and naturally, may soon affect the cut surface uniformly, thereby turning it gray. It is possible that an insufficient nitrite formation from the saltpeter of the sausage filling might play a part in the change of the color, which, as has been indicated by K. B. Lehmann and Kalbrenner, changes the hemoglobin into a new red blood coloring derivative (the hemorrhodin). (See also page 93.) Glage attributes the turning gray of the sausage to the action of the volatile sulphur compound in the meat (N_2S) in combination with oxygen on the muscle coloring matter.

As coloring matter, cochineal or the carmine which is derived from it, is employed most frequently. Numerous preparations with various names (karnit, albon-karnit, rubro-karnit, etc.) are also used, but coal-tar preparations, as fuchsin, safranin, ponceau, rosalin and eosin, are seldom used.

Through coloring, meat of a lesser value and that which contains only a small amount of muscle-coloring matter may be changed into better appearing meat, and the fat in the sausage may also be changed to such an extent as to simulate meat.

The coloring of the casings (sausage cover) is not affected by the above-mentioned prohibition. However, unwholesome stains, as, for instance, korolin, should not be permitted to be used.

Blood Sausages.—Blood sausages are prepared from blood, mixed with small cubes of cooked fats and lean pork meat, heart, tongue, hog skin, and spices. The meat ingredients mixed with blood are filled into casings and the sausages are boiled for the purpose of coagulating the blood. This must be done carefully and the larger the dimensions of the sausage and the more vegetable substance they contain the more attention they require. To insure the keeping qualities of the sausage they are smoked and are sold under the names of red sausage, black sausage, tongue sausage.

White Sausages.—These varieties of sausages, which are also called soft sausages on account of their consistence, are prepared from boiled and chopped visceral parts, especially from the liver. In these sausages the stomachs of ruminants, brains, finely cut pork and veal, with the addition of considerable quantities of rendered or cook fat in cubes, are also utilized. The addition of the various kinds of spices makes these sausages especially tasteful, and they are named accordingly (onion, charlotte, sardelle, truffle and liver sausage, etc.). After cooking they are consumed either in a fresh or smoked state. The light color of the cooked ingredients of the sausage gives the cut surface the gray to whitish color (white sausage).

Similar to these varieties of sausage are the preparation and consistence of most of the commercially known meat pastes (goose liver, fowl paste, etc.), in which liver is the principal constituent.

Jelly Sausages.—These are prepared from parts of the body rich in connective tissue, such as skin and head of hogs, head and feet with the skin of calves, the muzzle of cattle, etc. Fat and lean meat as well as spices are also added. The cooked or scalded meat and other ingredients are cut and filled, as a rule, into a stomach or bladder of a hog, and the voluminous sausages are then thoroughly boiled. In this process jelly forms inside of the sausage, which after cooling coagulates and thereby binds the ingredients of the sausage. In order that the binding should be as uniform as possible, and that the sausage should attain the desired firmness and should slice well, it is pressed until completely cooled. Jelly sausage is mostly consumed in the fresh state, but also may be smoked to increase its keeping qualities. It is known under the names, pressed hogs head, pressed sack, pressed sausage.

Sausages with Larger Quantities of Vegetable Matter.—The animal basic substances of these sausages are usually blood with fat or lean pork meat, or a white sausage filling. To these are added, beside various spices, larger quantities of vegetable substances, which are rich in carbohydrates, as groats, bread, boiled rice, rolls, boiled potatoes, corinths, raisins, sugar, etc. The filled sausages for which the stomach or bladder of hogs are frequently used as containers are cooked and consumed when fresh, or they may be preserved by smoking. This kind of sausage is principally prepared for the household, and, therefore, almost every locality has its own characteristic sausage belonging to this group. Detailed descriptions of methods of preparation of various kinds of sausages are given in Chapter XIV.

CULINARY PREPARATION OF MEAT.

Culinary preparation should render meat tasteful and more tender, but it is not necessarily made more digestible.

Considering the digestibility of culinary prepared meat, Popoff established the following scale of values:

If of raw beef, 100 parts are digested, then the digestibility of boiled beef is 83.4 parts; smoked beef, 71 parts; smoked and boiled beef, 60 parts.

Different results were obtained by Lebbin, who found that the nutritive value stands the highest in smoked beef; this is followed in a gradual decline by roasted meat, pickled meat, raw chopped meat, soup meat and broiled meat.

A. H. Chittenden and W. Commins found the following results on the digestibility of the various kinds of meats by artificial gastric juice. If the digestibility of beef is placed at 100, then

	Per cent.		Per cent.
Veal	= 94.89	Trout	= 78.45
Mutton	= 92.15	Eel	= 71.82
Lamb	= 87.93	Haddock	= 82.50
Fowl (white meat)	= 86.72	Herring	= 82.34
Fowl (dark meat)	= 84.42	Lobster	= 87.81
Salmon	= 92.29	Crab	= 67.13

If under the same condition 100 per cent of boiled beef would be digested, that of raw beef would amount to 142.38 per cent.

The experiments with artificial gastric juice do not disclose the actual utilization of the meat in the body, especially the nitrogenous substance, as the intestinal digestion completes that of the stomach.

The tastefulness and tenderness of meat can be best accomplished in the kitchen, provided the meat has attained the required ripeness by which the developing lactic acid swells and loosens the connective-tissue parts of the muscles. Such loosening may be also obtained by placing the meat into vinegar or milk.

According to Sygoal and Schmidt-Nielson's investigations fish meat also undergoes a ripening process, and salted fish especially should be allowed to go through the process. Fish rich in fat, as herring, salmon, trout, mackerel and others, ripen even when in pickle, while in the salting of haddock and other lean fish the ripening does not take place. The fish muscles contain enzymes like those of the mammals, which accomplish the splitting that represents the ripening process. The latter is brought on by autolysis.

On the other hand, according to the investigation of Haldik, freshly slaughtered meat, with a suitable preparation (cooking in small pieces or stewing as goulash in small pieces), is usually just as tasty as ripened meat; however, in roasting it becomes very tough and unpalatable.

Boiling.—To obtain a good meat broth by the boiling of meat the latter must set on the fire with cold water and boil slowly for three to four hours. But if boiled meat which is juicy is desired, the raw meat must be placed in boiling water and the boiling heat must not be reduced to any great extent. In this way, a coagulated layer soon forms on the surface of the meat, and prevents the juices from escaping. In consequence, only traces of muscle albumin pass into the water and they are manifested on the surface of the water in the form of a light coagulated scum. The heat enters the inside of the meat slowly, and is indicated by the change of the red muscle coloring matter to the familiar gray color of the meat, the change requiring a temperature of at least 73° C.

The reddening of the meat on the surface in boiling is, according to Kisskalt, the result of the presence of anhydride of nitrous acid (N_2O_3) in the water in which the boiling takes place. Especially does the superficial reddening of the meat readily occur if fresh meat is boiled in bouillon, which is twelve to twenty-four hours old, as in such bouillon N_2O_3 reducing bacteria are remarkably propagated. But the N_2O_3 enters the bouillon either from the water or from the customary soup vegetables which are used in its preparation. It is natural that meat which has been treated with sulphurous salts will also become carmine red on boiling, but the use of these salts is prohibited by the federal meat inspection regulations.

Sodium sulphite is considered particularly objectionable as a meat preservative for the reason that it restrains the bacteria producing the ordinary physical signs of decomposition without inhibiting actual decomposition in like degree. The real object in using sodium sulphite is, therefore, to conceal decomposition and inferiority.

The unchanged red color of the salted or pickled meat which remains after boiling is produced, according to Haldane, through the presence of nitric oxide hemochromogen, which is formed as a result of heating from nitric oxide hemoglobin, to which also the unboiled pickled meat owes its redness.

Steaming.—In steaming or stewing it is best not to allow the meat to come in contact with water, but only steam heat. For this purpose

Mapin's steam boiling pot is well adapted. The stewing may also be accomplished by placing the meat in a boiling hot fat gravy, which is constantly poured over the meat to obtain quickly a superficially coagulated layer, in order to retain the juice in the inside of the meat. As a result of this, well-stewed meat is generally more tasteful than boiled meat.

Roasting.—The aim in roasting meat at a high temperature (boiling fat) is to produce quickly an external coagulated layer in order to retain as much as possible of the juice in the meat, which will be replaced by a gradual infiltration of fat. The latter serves also to increase the juiciness and the tastefulness of the roast, while the other peculiarities may be attributed (Stutzer) to the penetration of burning products and to the decomposition of the meat bases (keratin, sarkin). If it is desired to prepare a so-called English roast, the interior of which remains red, the inside temperature should not rise over 63° to 65° C.

Penetration of Meat by High Temperature.—As meat is a poor conductor of heat, high temperatures penetrate slowly into it. Bones in the meat increase conduction of heat. Concerning the penetration of heat into meat and meat products, the following investigations were made:

Rupprecht established that in boiling blood sausage the inside temperature of the meat only reached 66° C.; in jelly and tongue sausage, 62.5°; and in pressed hog's stomach sausage, only 58.7° C. The temperature of the inside of boiled ham he established at 65° C., and the same for pork, when prepared in the usual way, cooked with vegetables. In frying meat balls the inside temperature rises to 58.75° C., and in quick frying of sausage, only to 28.75° C.

According to Küchenmeister, in boiling larger pieces of meat for one-half an hour a temperature of only 55° C. is reached; even after boiling for several hours it reaches only to 77° to 80° C.

Leuckart states that in fried sausage and cutlets a temperature of 62.5° and in roast pork 75° C. is obtained, which, however, does not rise over 65° C. if the roast is prepared in the English style.

Wolfhügel and Hüppe, in their extensive experiments, established the following:

1. Three thermometers inserted into a calf leg of 14.25 kg. after roasting of three and a half hours at a maximal temperature of 103° C. registered 71°, 76° and 89° C.

2. A similar experiment with a smoked ham of 4.5 kg. after four hours boiling in salt water with a maximal temperature of 102° C. showed 75°, 77° and 78° C.

3. The thermometer registered 93.96° and 98° C. in a fresh piece of veal weighing 3 kg. after three hours of roasting, in which the heat in the roasting oven reached 155° C.

4. A temperature of 91° and 92° C. was obtained in the interior of a piece of beef weighing 3 kg. placed on the fire in boiling water and kept boiling for two and a half hours by which a temperature of 105° C. was reached in the water.

5. In the same size piece of beef, but which was placed on a fire in cold water, the temperature registered 95° and 96° C.

From these experiments it may be observed that the inside temperature of larger pieces of meat (over 3 to 4 kg.) even in boiling or roasting for several hours never reaches a temperature of 100° C.

In the application of steam under pressure the temperature of the meat rises in a comparatively short time to over 100° C.

Losses in Meat of its Preparation in the Kitchen.—Losses in Weight.—In culinary preparation meat loses in the first place water. According to Voit, after boiling 100 grams of fresh meat it gives an average of 57 grams with about 40 per cent dry substance. Forster established the content of dry substance in boiled meat at 40 to 46 per cent; in roast meat at 30 to 40 per cent. Nothwang found that 100 grams of fresh meat, give after boiling one, one and a half and two hours, respectively, 68.9, 59, 54.6 grams; in stewing, 68.2, 48 and 48.2 grams.

In stewing or steaming the loss in weight is generally smaller; it fluctuates between 20 to 30 per cent.

According to Peters, fish meat loses about 30.18 per cent of its weight in stewing through the loss of water; from the dry substance only 2 per cent is lost.

In roasting the loss of weight depends on the degree of the roasting; 100 grams raw lean meat, according to König, produce 62 to 85 grams moderately roasted meat; in thorough roasting, however, only 58 grams.

According to Grindley and Timothy Mojonner, in the boiling of beef 3.25 to 12.67 per cent nitrogenous substances, 0.6 to 37.4 per cent fat, and 20.04 to 67.39 per cent mineral constituents pass into the water from the original meat. In heating the meat with fat, on an average 2.15 per cent nitrogenous substances and 3.07 per cent ash are absorbed by the fat, while the meat contains 2.3 times the quantity of fat as before the frying.

Losses in Nutritive Substances.—Still more important are the losses of extractives and phosphoric acid. Nothwang found that the loss of the first in boiling and stewing was 50 to 60 per cent, while the loss of the latter was about 35 per cent. In the roasting of meat the losses are somewhat slighter.

In the boiling of pickled meat, which already suffers a loss of extractives and phosphoric acid in the pickling, a further loss of 23.4 per cent of extractives and 19.05 per cent of phosphoric acid is sustained; and in stewing these losses amount to 20.6 per cent and 19.3 per cent. The combined losses of pickled meat in boiling and stewing amount to 65.6 to 67 per cent in the extractives and 39.5 to 44.45 per cent in phosphoric acid.

METHODS OF CONSERVING MEAT.

All meats contain certain preservative qualities which depend on conditions in the meat itself, and also on external influences. To the first belong especially the blood and juice contents of the meat, and the health or disease as well as the exhaustion or rest of the animal before slaughter. The influence of the external conditions on the meat depends principally on the activity of the putrefactive organisms. They reach the meat from the air or from soiling the meat, and enter from the contaminated portions of the surface, through the blood or lymph vessels, the excretory ducts of the glands, the connective-tissue spaces, etc., into the interior of the meat.

While all the requirements which favor the development of putrefactive bacteria (moisture, heat, deficiency in oxygen) reduce the keeping qualities of meat, the latter will be increased if conditions adverse to bacteria are present. Consequently all methods of conserving meat are directed toward keeping away and diminishing external factors favoring the development of putrefactive bacteria. This is accomplished by physical or chemical agents and methods, or with the aid of both.

Deichstetter and Emmerich recommend the use of sterile instruments in the slaughter of animals to as great an extent as is possible, and spraying of the surface of the meat with glacial acetic acid, and for dry keeping, packing it in sterilized sawdust, which has been saturated with sodium chloride. If it is not to be transported, but allowed to hang, it should be wrapped with cloth saturated in glycerin-acetic acid. The method, however, is not satisfactory for keeping the meat for a long time in a fresh state. A better method is described by Deichstetter and Emmerich (page 95), which, combined with the previous method, if carefully carried out, enables meat to be kept in a fresh state for weeks.

Physical Conserving Methods.—Conserving by Extraction of Water.—

Drying of Meat.—By this very old and simple method the meat is cut into strips and is dried quickly in the air. In this way the meat becomes so hard and tough that even a later soaking and cooking do not make it perfectly soft. In the fish trade this method is principally employed for the conserving of haddock.

A meat preparation made in South America in a similar manner (chargue dulce), or by previous salting of the meat (chargue, tasajo, or jerked beef, Knuth), is not brought to this country.

The so-called "paprica bacon" may also be correctly included here, as it represents fresh bacon rubbed with paprika and dried in the air.

Preparation of Meat Flour.—The meat flour which is prepared and sold in South America under the name "carne pura," or meat powder, is prepared from muscle, which is ground to pulp, then dried, milled to a fine powder, and mixed with a small quantity of salt. The preparation contains about 70 per cent digestible nitrogen, but has a burned odor and taste. Because of this and its high price it has not found a general market.

Conserving by Excluding the Air.—This very old method, especially employed in the household, consists in pouring over the fresh, boiled or roasted meat, liquid fats which on hardening supply the meat with an air-proof covering. For the wholesale trade in meats this method of preservation is useless.

Enclosing in Air-tight Containers.—Sterilization by Boiling.—This method, which was discovered by Appert, in 1809, led to the production of canned meat. In this procedure the meat is freed from bones, tendons and fat, cut into small pieces and then packed as fresh, pickled, or boiled meat into tin cans to which the covers are tightly soldered. The cans are boiled for three to four hours under steam pressure, which causes the cans to swell. According to Gröning the cans are punched in one place to permit the pouring off of a possible surplus of fat and extraction of the air from the cans in the vacuum apparatus. The drawing-in of the walls during this procedure is a positive indication that the cans are tight. After soldering the small opening the cans are again heated for a longer period, and as a result of the heat the meat is sterilized. In cooling the cans must be constantly moved to distribute the liquid ingredients within uniformly so that when they have coagulated into a jelly the pieces of meat in the containers may be held together firmly.

Any form of meat food may be preserved in a similar way with or without the addition of vegetables, and such canned preserves are a necessity for army maintenance in the field, ships, etc.

The canned-meat industry has assumed extensive proportions in the United States, and as the Meat-inspection Law of 1906 has control of these meat products a knowledge of the process of their preparation is deemed essential in connection with the supervision of the work.

The preparation of canned meats differs not alone with the different kinds of meats to be preserved, but also the process may differ considerably in the various establishments. The differences, however, affect only some minor details, while the essential points of the process are the same. As the principal canned products are corned beef and potted meats, only the manufacture of these two will be described, all others being more or less similar to the one or the other of the processes.

In canning potted meats the meat is boiled for about forty minutes, after which it is hashed sufficiently fine, and immediately spread in shallow pans or trays, which are placed in a retort and heated to 82° C. (180° F.) for twenty minutes and then emptied into receptacles from which the meat is conveyed into the stuffing machine. In handling the meats all delays should be avoided, and the cans should be filled as rapidly as possible. The tops of the cans, after they leave the stuffer are cleaned off and the can is then capped. The caps are soldered immediately by passing the cans through an automatic soldering machine, and the vent in the cap is closed by hand, soldering shortly after they pass through the machine. At this time the can receives the first inspection. If the can appears perfectly closed, it is passed directly to the process retort, where it remains for one and a quarter to one and a half hours (according to the size of the can), under a pressure of 7 pounds at 110° C. (233° F.). If inspection, however, shows that the can is imperfectly closed it is repaired before it is placed into the retort.

Small cans are not passed through the vacuum machine before going to the process retort, as they are handled so rapidly that sufficient heat is retained in the product after being placed in the can and capped to establish their own vacuum before the vent in the cap is closed.

By establishing about 22" vacuum on the cans they collapse and distend again from internal pressure, after being placed in the processing retort, which pressure will develop some leaks and imperfections that were not detected on the first inspection. Therefore, a second inspection is made as soon as the cans are taken from the processing retort, and any defective cans are repaired and once more passed through the retort. The treatment of cans by passing them through this retort for varying periods at various temperatures, according to the size of the can and the material under treatment, is known in the canning business by the term "processing."

After the cans are sufficiently processed they are passed through a tub of hot lye for the purpose of removing all grease from the outside of the can. From the lye tub the cans pass under a spray of cold water, which causes them to collapse, after which they are removed into the label room. From this time any can showing an imperfect condition is rejected as unfit for food. (B. A. I. Order 211, Regulation 18, Section 7, Par. 1.)

In the canning of corned beef the meat is first boiled for one hour and then placed in the can, which is capped with the vent open. The can is then placed in the vacuum machine, under a 22" vacuum, and the vent soldered, or the vacuum may be also established by leaving the vent open and placing the can in the process retort for forty-five minutes at 104.5° C. (220° F.), then removing the can and closing the vent immediately after it ceases blowing. Another method of establishing the vacuum is to seal the can and place it in a vat of boiling water for one hour, then it is removed and punctured with a sharp instrument and sealed as soon as the can stops blowing. If the can contains more than 1 pound of meat the time in the retort or boiling water is extended according to the size of the can. If the vacuum has been established by the vacuum machine the meat is then placed in the process retort for one hour and forty-five minutes at 8 pounds' pressure (111° C.); if the vacuum has been established in the retort the can is returned to the retort as soon as the vent is closed and remains in the retort for one and a half hours at 7 pounds' pressure (110° C.). If again the vacuum has been established by the boiling water method the can is processed by returning to the boiling water for two hours, or by placing in the retort at 7 pounds' pressure for one and a half hours. The processing time given above applies to 1-pound cans. In larger sizes the procedure is the same, only the time is increased about fifteen minutes for each additional pound.

In canning roast meat, the meat is parboiled only for thirty minutes and the water method is not used to establish a vacuum; otherwise the method is the same as that for canning corned beef, but a higher temperature is maintained in the retort. After the processing is completed the method is similar to that described above for potted meats.

The following imperfect condition may occur in the preparation of canned meats:

1. Leaker: A can in which air has gained admittance after the can has been supposedly hermetically closed.

2. Slow leaker: The same as leaker, only it develops in the course of time after the completion of the process.

3. Sweller: A can in which the product is undergoing some putrefactive or fermentative change, which was unnoticeable at the time of the canning.

4. Short process can: One which has not had the regular amount of processing for the cooking and sterilizing of the product.

5. Collapsed can: One which has been collapsed by the application of too much vacuum. The condition occurs principally in cans which have not been properly stuffed.

6. Overstuffed can: One which has been strained in packing, by forcing too much of the product into it.

7. Strained can: One which has been overstuffed or strained by overprocessing.

8. Do-over can: One which springs a leak after the processing, but before entering the washing machine containing the lye water.

9. "Springers" and "flippers:" Cans which show loose tin or insufficient vacuum.

Canners of vegetables, fish, and meat-food products occasionally find that some of their products start to get sour on the tables or elsewhere before going into the cans, or begin to spoil after the cans are closed and sealed but before they go into the retort for cooking. When the processing is fully effective the product will keep, but when it is not these cans subsequently become swellers.

Judgment.—All the defects of cans which are the result of mechanical imperfections, and which are noticed in the course of preparation, do not render the meat unwholesome, provided such defects are corrected within six hours of the original sterilization. In all other cases the contents of the cans should be considered as unwholesome, and should be condemned in accordance with B. A. I. Order 211, Regulation 18, Section 7, Par. 1.

Replacing the Air with Oil.—Of the various methods employed to replace the air in the spaces between pieces of meat in cans, which include pouring meat jelly (gelatin), meat broth and liquid fat over the meat, only the use of oil has attained practical importance. The latter is particularly employed with fish, which are cooked in oil, packed into tin boxes and covered with oil (oil sardines).

Preservation with Cold.—This is the oldest preserving method and at the same time the simplest and best for wholesale industry. The quality of the meat is only slightly influenced by the loss of a small amount of the tasty substances; otherwise it ripens and becomes delicate and tender. The preservative action of cold consists in checking the development of the causes of putrefaction. That numerous bacteria, especially the pathogenic forms, are not destroyed by low temperatures was proved by the experiments of Forster, Pictet and Young, Coleman and Mickendrick, Havemann and others.

LAYING ON ICE.—This is the simplest application of cold, but should be rejected, especially when the meat is placed directly on natural ice, as pathogenic bacteria which the ice might contain may be transmitted to the meat. Besides, through the melting of the ice, unnecessary moisture is added to the meat, which under certain conditions would put the buyer at a disadvantage regarding the weight of such meat.

INFLUENCE OF COLD AIR.—*Cooling of Air by Ice.*—Through the storing of ice and its gradual melting, the surrounding air is cooled. The preservative properties of ice-boxes, ice-cellars, ice-houses are based on this principle. The various constructions of these containers cannot be treated here. Their qualities depend on the circulation of the air in the meat-keeping rooms, and on their thorough insulation against radiating heat. For larger plants these methods are not satisfactory, as they are dependent on numerous contingencies (deficiency of ice, excessive summer heat, failure of the ventilation arrangement, etc.).

On this principle rests also the transportation of meat in refrigerator cars which are constructed in accordance with various systems (Straschiripka and Tiffany; Anderson, Zimmermann, Acelom, Jaschka, Wickes, Schreiber, Trapp and others). The construction of a refrigeration car, such as is used in the United States, is illustrated in Fig. 47.

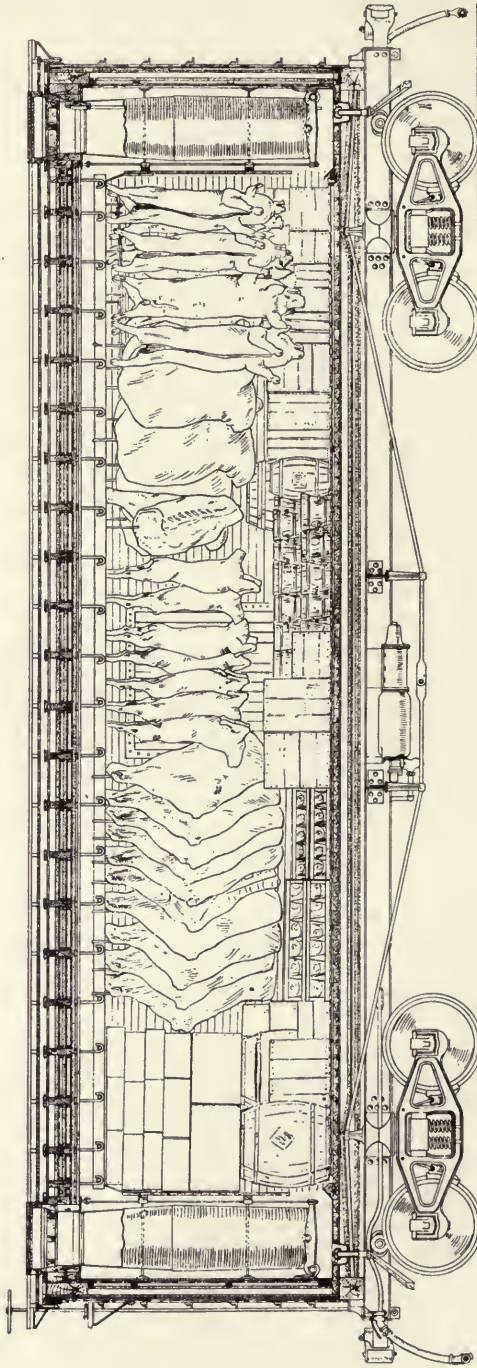

FIG. 47.—Refrigerating railroad car for transportation of meat. (After Swift.)

Refrigeration Plant Machines.—The modern refrigeration plant with machine power has for its object the continued maintenance of a temperature ranging from 4° to 20° C. in the storage room for meat independent of external influences. At the same time it reduces the content of moisture to at least 70 per cent of the relative moisture, and provides for a continual renewal of air, which it purifies. For this purpose every refrigeration plant consists of the following three principal parts: The cold generator, the cold transmitter and the chilling room proper, which in the various systems is differently constructed and arranged.

The only refrigeration machines to be considered are the "cold steam" or "compression" machines, although the absorption system is being utilized more and more in the meat industry. The compression system is found in most of the plants in the United States but in many cases the latter may be utilized advantageously in conjunction with the absorption system.

Refrigeration machines act in accordance with the physical law that the evaporation of liquids consumes heat. For this purpose liquid carbonic acid, ammonia and sulphurous acid are principally used. They pass in a circle through the system of pipes and are compelled to remain in a portion of the pipe system in a liquid state, as a result of low temperature and pressure, while in another part of the system they have an opportunity for evaporation. The principal parts of refrigeration machines are the compressor, condenser and evaporator. The operation schematically produced according to Fig. 48 is as follows:

In the engine room is a steam engine, *A*, directly connected with the compressor, *B*. From the latter a pressure pipe connection, *D*, leads to the condenser, *K*, from which a pipe connection with the regulating valve, *C*, leads to the evaporator, *V*. The condenser and evaporator are large, cylindrical, galvanized-iron containers, in which these pipes run in numerous spiral windings, which are rinsed with cold and continually renewed water in the condenser, and in the evaporator by a salt or chloride of calcium solution. These solutions are continually kept moving by a stirring apparatus which is also operated by the engine, and which turns around a perpendicular axis within the spiral tubing. The spiral piping of the evaporator returns to the compressor as a suction tube, *S*. If the pipe system, *D*, *C*, *S*, is filled with one of the mentioned gases, it will, as a result of the pressure of the compressor piston and from the cold water running through the spiral piping of the condenser, change into a liquid state with a constant effort to return to a gaseous condition. The latter occurs in the evaporator into which the gas is admitted and is regulated by the valve *C*, and in which the gas is no longer kept under pressure, but on the contrary suction is applied to it through the pipe *S* from the compressor. During the evaporation, the gas abstracts heat from the spiral pipes which enclose it, and these again from the salt water (salt + chloride of calcium solution) which surrounds them, by which the latter is cooled down to minus 10° to 12° C. But the evaporated gas passes again into the compressor and makes the described circle over again. The cooled salt water acts further as a transmitter of cold and is pumped by the pump, *P*, from the evaporator, is then pressed into the piping, *W*, and is conveyed into the air-cooling chamber, *L* and *L'*, from which it enters the ice-manufacturing tank, *Z*, and thence returned.

In the air-cooling chamber, the salt-water pipes are spread in numerous windings in such a way that the connection of each chamber may be detached from the other; therefore, each chamber may be operated separately. The

air-cooling chambers are connected by air shafts with the meat cooler proper in such a manner that, for instance, the air shaft, *T*, conveys the air from the cooler into the air-cooling chamber and the air shafts, *U* and *U'*, permit the return of the air from the air-cooling chambers into the meat cooler. In the latter the distribution of the cooled air is accomplished by canals supplied with openings which are attached to the ceiling. In a similar way special canals

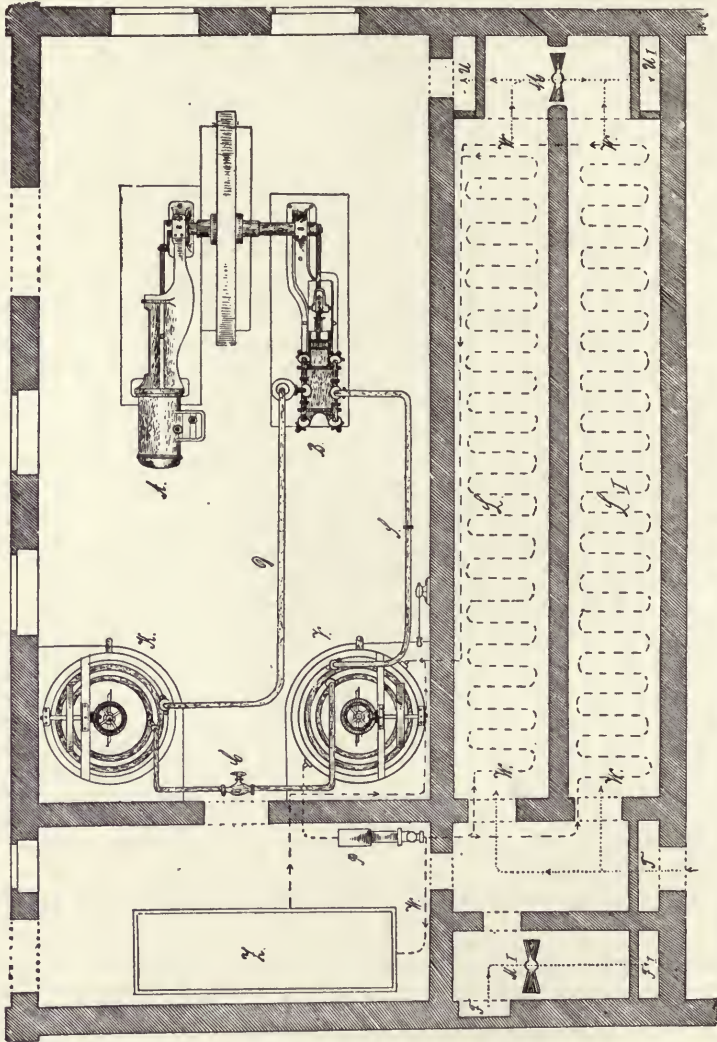

Fig. 48.—Schematic sketch of the principal parts of a cold air refrigerating apparatus.

are present for the air to be drawn away by suction. Movement of the air between the rooms is accomplished by a ventilator, *M*, which is operated either by electricity or by transmission from the steam engine in such a way that by an alternating opening or closing of valves the air in the meat cooler is ventilated while passing around the pipes of the air-cooling chambers, *L* and *L'*. At the same time the network of pipes, which is cooled to zero, abstracts from the moving air heat, impurities and moisture so that the air is returned

to the cooler cooled, purified and dried. That moisture is abstracted from the air is manifested by the ice deposits on the pipes, which gradually get thicker, and also enclose the impurities which the air contains. The layer of ice around the pipes, however, retards more and more the radiation of cold from the pipe system, and therefore, considerably diminishes the cooling action. For this reason, after certain intervals the active pipe system of one of the air-cooling chambers is detached and the other placed into operation, which acts like the first. In the meantime, the first thaws out, and may then be again operated when the second has to be detached on account of the thick ice covering. The ice-producing tank, *Z*, serves for the production of artificial ice. For this purpose galvanized-iron containers are filled with water and hung into the salt water of the tank; the water is permitted to freeze and the containers are then taken out of the salt water. The latter are then dipped into warm water in order to loosen the ice from the sides of the container and the ice is then emptied out. Practical mechanical installations greatly facilitate the necessary work. To supply the meat coolers with fresh air, and to ventilate them when they do not contain anything for cooling, the ventilator, *M*, is employed, which transmits the change of air through the air shafts, *F* and *F'*.

In place of the salt-water piping, which can also be connected with the meat cooler, although this cannot be recommended, certain arrangements for cooling the air may be used in which artificially moving air is run over the surfaces irrigated by cold salt water or is directed through the salt water. Of the various systems of refrigeration machines those of Linde-Weisbaden (ammonia), Humboldt-Kalk (ammonia), Riedinger-Ausburg (carbonic acid), Borsig-Tegel near Berlin (sulphurous acid) are the best known.

The meat coolers proper contain racks constructed of iron railings with arrangements for hanging the meat. In abattoirs usually special chillrooms and cutting rooms are also constructed. The chilling rooms are brought into direct connection with the killing floor, from which the dressed carcass is conveyed without much effort into the cooling rooms, the temperature of which is not kept as low as in the coolers proper. For the preservation of fish, game, poultry, etc., special cooling rooms are constructed, the air of which should not be connected with the rooms where fresh meat is kept.

For controlling the temperature and the moisture of air in the cooling rooms, self-registering thermometers and hygrometers should be installed. In some places they are required by regulation.

In the case of beef intended for export in the chilled condition it is necessary to take special precautions to prevent avoidable contamination of the carcass with microorganisms both during and subsequent to the processes of slaughtering and dressing. This is necessary because of the relatively long period which must elapse from the time of slaughter and delivery to the consumer.

The storage-life of meat means the period of time after slaughter during which the meat undergoes no appreciable deterioration in appearance or condition.

The use of carbon dioxide gas as a preservative of meat has made the export of chilled beef a practical proposition. The best results are obtained by using an atmosphere containing 10 to 20 per cent of CO_2 , as this at 32° F. (0° C.) almost completely arrests the growth of moulds, and reduces the rate of growth of the usual spoilage bacteria by more than 50 per cent.

Shipments of chilled beef have been sent quite frequently from Australia to England in an atmosphere rich in CO_2 , and at a controlled temperature of 29.5°F . (1.4°C .) with very good results.

Freezing.—The slow freezing of meat is accomplished for preserving meat, particularly the halves and quarters of carcasses, an unlimited time, as for transatlantic transportation. The equipment for this purpose is the same as that described for the refrigeration plants; the air, however, is cooled below 0°C ., and is kept constantly under the freezing temperature.

The quick freezing process, known as the Birdseye system, has now been in use for several years and has met with increasing favor. It is especially applicable in handling the smaller cuts which are placed in vapor-proof packages before freezing. These packages are placed on a flexible metal belt which is run into a frigid compartment or tunnel where the temperature is considerably below 0° . An overhead belt of similar material meets the upper surface of these packages as they enter the freezing chamber and presses down automatically upon the packages. As soon as all the packages to be frozen are in the chamber the belts are stopped and a spray of calcium chloride brine is sprayed on the lower side of the lower belt and the upper side of the upper belt, but is prevented from reaching the product by a mechanical device. As soon as the product has been satisfactorily frozen from the top and bottom simultaneously, the belts are again automatically put in motion and the product emerges from the opposite end of the chamber solidly frozen and ready for packing and delivery.

Chemical Preserving Methods.—**Preservation with Salt.**—The preservative action of salt forms the basis of the oldest method of preserving meat. This is generally practised in the household, as well as in the wholesale trade, and known as the salting, or pickling of meat. Salting indicates a superficial preservation for a shorter time, while in pickling a complete penetration of the meat with salt is obtained, and therefore a lasting preservation. This is based principally on the dehydrating action of the salt and less on its germicidal action.

While superficial salting may be applied to all kinds of meats, pickling is best adapted for pork, especially bacon, on account of its high fat content; fine-fibered beef intermixed with fat (brisket) also produces a good pickled meat. Lean beef as well as veal and mutton get dry and unpalatable from pickling.

Regarding the application of the salt, nothing further need be said. The procedure of pickling depends on the time to be consumed and the desire for a certain degree of preservation of the meat products. If a hurried pickling (forced pickling) is desired and abstraction of only a little moisture, it is best to place the meat in a salt solution (brine) or to inject it into the meat along the side of a bone or into the connective tissue with a special brine syringe supplied with a hollow needle.

In the latter case the salt acts osmotically on the meat, both from the outside and from the inside. The keeping quality of such pickled meat is not very high, on account of the large content of water, and, therefore, such meat is usually destined for early consumption, or it is further preserved by smoking. In slow pickling the surfaces of the smaller cuts of meat are rubbed with

salt, and the pieces are packed into barrels, each layer of meat being thoroughly covered with a layer of salt. The quantity of salt to be used is about 50 grams to 1 kg. of meat. By this process a brine also forms, the water content of which originates almost entirely from the meat. The latter, therefore, dries out considerably, and in consequence such meat possesses a better keeping quality. The recommended "injection pickling" by Fjelstrup, by injecting the blood-vessels with brine immediately after slaughter, has not yet reached a practical importance, except for pork hams and shoulders.

A more detailed description of the various methods of pickling is contained in Chapter XIV.

Meat undergoes the following changes in pickling:

(a) The muscles turn gray owing to changes in the muscle coloring matter. To prevent this, saltpeter is added to the salt, as it is readily reduced to nitrous acid, which changes the hemoglobin into a bright red derivative (hemorrhodin, Lehmann). According to Haldane, the action of the nitrates on the hemoglobin, in the presence of oxygen and reducing substances, develop nitric oxide hemoglobin, to which the uncooked pickled meat also owes its red color. Regarding the red color of the pickled meat after cooking, see page 81. The quantity of saltpeter usually added amounts to $1\frac{1}{2}$ to 2 grams to each kilo of meat, and no injurious quantities of this cardiac depressant have ever been found in pickled meat. Glage prefers the direct use of small quantities of nitrites in the pickling, or the addition of alkaline phosphates to the brine to obtain a high red color. B. A. I. requires that there shall not be over 200 parts of sodium nitrite to 1,000,000 parts of the finished meat or meat product. The addition of cane sugar to the brine or salt mixture increases their powers of checking putrefaction.

(b) The previously mentioned loss of water depends on the method of pickling and the original contents of moisture in the meat; it may amount to 10 to 15 per cent.

(c) The abstraction of nutritive substances, as a result of pickling, is not to be underestimated.

According to Polenske it amounts to:

In three weeks' pickling 7.77 per cent N and 34.72 per cent phosphoric acid anhydride.

In three months' pickling 10.08 per cent N and 54.46 per cent phosphoric acid anhydride.

In six months' pickling 13.78 per cent N and 54.6 per cent phosphoric acid anhydride.

Besides a considerable loss of extractive substances (meat bases) and potassium salts occurs to such an extent that pickled meat not only possesses a relative smaller nutritive value than fresh meat, but it is also, as a rule, more difficult to digest. (see page 83). These statements were substantiated by Nothwang, who further established that in boiling and stewing, pickled meat also loses extractive ingredients and phosphoric acid.

(d) The increase of weight of meat in pickling also depends on the method of procedure. In pickling in brine, beef gained 9.4 per cent after three weeks, and after three months 13 per cent of the original

weight (Polenske). The absorption of salts after fourteen days' pickling of beef at 4° C. amounted to an average of 8.35 per cent of saltpeter and 15.69 per cent of common salt (Kuschel).

The influence of pickling on the meat of diseased animals has been over-estimated. Although in accordance with Forster's investigations, cultures of anthrax bacilli under the influence of common salt are destroyed in from eighteen to twenty-four hours, cultures containing spores retain their virulence for months. Tubercle bacilli retained their infectivity for eighteen days in pickled pieces of organs, and cultures sprinkled over with common salt remained virulent for two months. *Flavobacterium morbificans* and *Salmonella enteritidis* were, according to Stadler, destroyed in concentrated salt solution only after three and four and a half weeks. Culture of the bacillus of swine erysipelas are only slowly killed through salt in substance, but somewhat more quickly by concentrated salt solution; brine exceeds both the former in its bactericidal action. It destroys the erysipelas organisms in about eight days, but nevertheless it was possible to demonstrate virulent bacilli in meat which had been soaked in brine for about seven weeks. Pickled meat contains virulent erysipelas bacilli even after four months (Stadie). The cultures of pyogenic staphylococci and streptococci acted in the same manner. Animal parasites, if present in the meat (cysticercus, trichinæ) are positively killed by thorough pickling.

Preservation with Boracic Acid.—Although the preservative action of boracic acid (BO_3H_3) and its salt is not great, as they act only in checking the development of bacteria, yet they may prevent infection and decomposition, and keep fresh meat in its natural color. Therefore, preservatives containing boracic acid have been used in the meat industry to a considerable extent. In many meat products boracic acid causes to some extent increase in weight through an increase of their water contents.

Preservative salts containing borax are on the market under various trade names.

The injurious effect of boracic acid and its salt on the human system has been debated for many years. In the practice of meat inspection the use of boracic acid and its salt in the preservation of meat foods is prohibited by B. A. I. Order 211, Regulation 18, Section 6, Paragraph 1.

Preservation with Sulphurous Acid.—The salts of sulphurous acid and especially the sulphites are brought into trade under the name of preservative salts, the acid or primary calcium sulphite ($\text{SO}_2\text{H}_2\text{Ca}$), or acid potassium and sodium sulphite (so-called bisulphite), SO_2HK and SO_2HNa , or also neutral sodium sulphite, SO_2Na_2 , mixed with common salt, Glauber's salt, sugar, etc. As already indicated, sulphurous acid salts are not so much conserving substances for meat as preservatives of muscle coloring matter. Therefore, they were principally employed for the preservation of the fresh meat color on the surface of pieces of meat, and especially to prevent chopped meat from turning gray. The action of the sulphites in preventing putrefaction is only slight, so that putrefaction may develop in meat containing sulphites. But as the initial putrefaction is hidden by the redness of the muscle coloring matter, the use of these preserving salts in connection with the meat trade leads not only to deceptions regarding the freshness of meat, but also to the consumption of meat which may have injurious properties through putrefaction.

There has been much diversity of opinion regarding the immediate influence of sulphites on the health of human beings. According to B. A. I. Order 211, Regulation 18, Section 6, Paragraph 1, the addition of sulphites to meat products is prohibited.

For the test of meat for sulphites, see Chapter XV.

Other Chemical Conserving Substance.—Chemical conserving substances, such as salicylic acid, sodium silicofluoride, ammonium acetate, sodium acetate, formaldehyde, lactic acid, glycerin and others have been tried in an experimental way for the conservation of meats, but they have not attained any practical importance.

The use of chemical preservatives in the preparation and preservation of meat and meat-food products with the exception of common salt, nitrate of soda, nitrite of soda and saltpeter is prohibited in the United States, and the measures governing the same are contained in B. A. I. Regulations.

The bactericidal action of acetic acid is utilized in the Deichstetter-Emmerich method (see page 84) for keeping meat fresh. The animal is slaughtered with the greatest possible cleanliness; then the large blood-vessels are infused with dilute acetic acid, and the surface of the meat is sprayed with acetic acid. The keeping of the meat has to be carried out as described on page 84. This method, which proves an undeniable success if carefully executed is, however, a failure in large practice, owing to the frequent untrustworthiness of persons having the work in charge.

Conservation by Smoking.—The preparation of meat products for keeping under the preservative influence of smoke (smoked products, ham, bacon, smoked meat, pickled smoked meat) has been known since the oldest times. However, only such meat is adapted for preservation with smoke as contains a comparatively small quantity of water (pickled meat), or is of such consistency that the latter is readily diminished in the smoking, making an easy penetration of the smoke possible (sausages). Meat is also subjected to smoking not so much for preservation as for the palatableness secured from the penetration of the burning substances of the smoke.

The application of smoke consists in the development of proper smoke, and this is best accomplished by a slow burning of wood in the form of sawdust. Hard woods, and especially juniper bush, furnish the best smoke, while pine wood is unsuitable for smoking purposes on account of the large amount of turpentine which it contains. The smoking process may be carried out as slow or as forced smoking. In the slow smoking the meat is kept for days and weeks in a room of 20° to 25° C., the air of which is impregnated with smoke (smoking room), while in the forced or hot smoking the products (fish, sausages) are exposed only a short time to the smoke at 70° to 100° C. There is also a so-called artificial or quick smoking, in which the meat or sausage is dipped into a mixture of pyroligneous acid, water and juniper oil, or the meat is covered with the same and then dried in an airy place. Decoctions of shining soot which is formed in the burning of wood with or without the addition of salts are also supposed to be applied to meat products. With such methods, however, the aim is not to conserve the meat preparations, but to impart to them a smoky taste. Application of chemicals in lieu of smoking is prohibited under B. A. I. regulations.

The conserving effect of smoking on meat depends upon the extraction of water and the penetration of the meat with gases and fumes of the smoke, which are substances preventing putrefaction. Among these are the tar products and hydrocarbons insoluble in water; also acetic acid, creosote, phenol, carbonic acid, ammonia, etc.

Concerning the action of smoking on microorganisms, the investigations of Beu, Serafini and Ungaro showed that even pathogenic germs are destroyed in a short time if they are easily reached by the smoke. In the smoking of infected meat it must be remembered, however, that a coagulated layer soon forms on the surface making the penetration of the smoke more difficult. There-

fore, the germs contained on the inside of large pieces of meat may be destroyed only with difficulty. This is also influenced by the water content of the meat, as the water prevents the penetration of the smoke. The bacilli of hog erysipelas are destroyed in two weeks' continual and intensive smoking of pickled meat, provided the pieces do not exceed 2.5 kg. in weight (Stadie).

Further information on smoking is contained in Chapter XIV.

VARIOUS FOOD PREPARATIONS DERIVED FROM FOOD ANIMALS.

Meat Extract.—Although meat extract is not a food but a delicacy of animal origin, still, on account of its extensive consumption, it should be briefly mentioned here. The principal brand of meat extract is that discovered by Pettenkofer, and named in honor of Liebig. It is almost exclusively prepared in America from lean beef, which is chopped by machine, and is boiled with little water under high steam pressure in an apparatus. After the separation of fat, coagulated albumin and fibrin, the filtered meat broth is concentrated in a vacuum, and is then again boiled down in open kettles which are supplied with stirring apparatuses until a thick pap is formed, which is filled into jars; 30 to 32 kg. of lean meat gives about 1 kg. of meat extract. The extracted meat fibers are dried and ground and shipped to Europe as American meat flour, where it is utilized for food purposes, and recently also for the preparation of albumin.

According to Stutzer, meat extract contains about 60 per cent of organic substances, 20 per cent salt and 20 per cent of water. The organic substances consist principally of so-called meat bases—creatin, creatinin, sarkin, xanthin, inosin acid, karnosin, amino-acids (Bauer and Barschall) and others, as well as small quantities of phosphocarnic acid and lactic acid. Glycogen is also generally present. The presence of succinic acid in the meat extract cannot be considered as a positive indication of putrefaction. The salts consist of about two-thirds of potassium phosphate.

Owing to this composition, the meat extract appears as a spicy delicacy which stimulates the nerves of taste, smell and digestion.

The liquid meat extracts which are brought into trade as Cibil's, Koch's, and Maggi's extracts, contain much less organic substances than Liebig's and Kammerich's meat extract.

Meat extract is also prepared to a large extent from the meat broth obtained from the boiling of meats for canning purposes. This is boiled down and concentrated in a vacuum to a desired consistency, and is then drawn off into various sized containers.

Peptones.—The effort of chemistry to convert the albumins of meat into soluble preparations which may be absorbed without any further change in the body by the digestive apparatus led to the preparation of peptones.

According to Stutzer, pepsin peptones and pancreatic peptones may be distinguished. The preparation of the latter has ceased at the present time. The former are prepared by subjecting meat to the action of a mixture of pepsin (extract of the mucous membrane of the stomach) and hydrochloric acid is the known physiological dilution; the solution is then filtered, is accurately neutralized with a small quantity of bicarbonate of soda, and finally steam in vacuum. The peptone thus prepared, contains albumose as the principal ingredient.

The opinions regarding the nutritive value of peptones differ widely, and this is readily explainable, as the various trade preparations contain a greatly varying content of true peptones. Thus Stutzer, found in a fluid meat peptone preparation, 12 to 15 per cent peptone equal to 1.91 per cent nitrogen; and in another, dry fibrin peptone, 81 per cent equal to 14.56 per cent nitrogen.

Fat and Tallow.—The fats of food animals which are not sold in the raw state, or as prepared meat products (bacon, etc.), are rendered to

serve as human food, and the connective-tissue constituents of the fat tissue are separated from it in the form of cracklings. The rendered hog fat, under the name of lard, forms an important article of trade, which is principally shipped from America. The freshly rendered beef tallow is also sold directly for food purposes. Larger quantities of it are utilized for the manufacture of oleomargarin (olein), while the superfluous quantities of tallow are chiefly used for industrial purposes.

Lard forms a fine, milk-white homogeneous mass of oleaceous consistence and peculiarly agreeable odor and taste. Lard was formerly adulterated on a large scale but at the present time is little subject to adulteration.

Lard substitutes consisting of cottonseed oil or other vegetable oils hardened by hydrogenation to approximately the consistency of lard or of mixtures of vegetable oils with hydrogenated vegetable oil, or of mixtures of vegetable oils and hard animal fats, are common and have within the past few years attained a dominating position in the market. All of these are sold under trade names in which the word "lard" does not appear.

In accordance with the Regulations of July 30, 1914, governing meat inspection in the United States, all products sold under the trade name of lard must consist of hog fat, as the said regulations provide that the true name must be given to all products, and that false or deceptive names of meat and meat-food products are prohibited. Further, it is provided that the meat-food products which contain substances which are added to adulterate the same must bear a label stating that such substances have been added. (See B. A. I. Order 211, Regulation 17.)

The so-called sausage fat, known principally in the retail trade, is obtained from the skimmings of the sausage broth in which the sausages are cooked. It is mixed fat containing a considerable amount of water of a gray to grayish-green color, with a spicy sausage taste (principally like marjoram), and which contains small meat particles and unmelted pieces of fat. It spoils very easily.

Under the term butterine (margarin or oleomargarin), formerly also called artificial butter, sweet cream butterine, Holland butter, etc., are included all those preparations which resemble cow butter or butter fat, but which do not entirely originate from milk. Butterine was first prepared by the French chemist Mege-Mouries, who, in 1869, made public the process of its preparation. Except for slight changes this was practically identical with the present method. The fresh beef fat is washed, macerated and after adding water and salt it is heated to about 50° C., causing the liquid fat to accumulate on the surface. The fat—the so-called "Premier jus"—is then taken off, is clarified and solidified at 25°, by which the tristearin separates in crystals, while the triolein and tripalmitin, which together are also called oleo oil, remain fluid, and are separated from the first by pressing. To every 50 kg. of oleomargarin 25 liters of cow's milk and 25 liters of water are added, and

the mass is then churned. The fat mixture so obtained yields after washing and salting a fat which tastes like butter.

If butterine is cleanly prepared from good fat, and is sold under declaration, no objection can be made to it from a hygienic standpoint. According to Jolle's experiments with dogs, butterine is just as profitably utilized in the intestines as butter; Adolph Mayer, as well as Kienzl, found in the comparative experiments on men only very slight differences in favor of butter. Tubercle bacilli have been found in butterine as well as in butter (Morgenroth).

The preparation of oleo oil, which is a product of beef fat, comprises an important industry in the largest packing houses of the United States. It is the principal ingredient of butterine. The largest part of oleo oil manufactured in the United States is exported to Europe, principally to Holland and Germany, where it is utilized for the manufacture of butterine. There is at the present time only a comparatively small amount of butterine manufactured in the United States, the demand for that product being somewhat limited.

In accordance with an act of Congress, butterine must be sold in the United States under declaration, and no coloring is permitted to be used in its preparation, except by the payment of a heavy license.

A more detailed description of the preparation of butterine is contained in Chapter XIV.

CHAPTER IV.

REGULATIONS GOVERNING THE MEAT INSPECTION OF THE UNITED STATES DEPARTMENT OF AGRICULTURE.

(B. A. I. ORDER 211.—REVISED.)

REGULATION 1. DEFINITIONS.

SECTION 1. For the purposes of these regulations the following words, phrases, names and terms shall be construed, respectively, to mean—

Paragraph 1. The Meat Inspection Act or Act of June 30, 1906, or Act of Congress of June 30, 1906.—“An Act making appropriations for the Department of Agriculture for the fiscal year ending June thirtieth, nineteen hundred and seven,” approved June 30, 1906 (34 United States Statutes at Large, pages 674 to 679), as reenacted by “An Act making appropriations for the Department of Agriculture for the fiscal year ending June thirtieth, nineteen hundred and eight,” approved March 4, 1907 (34 United States Statutes at Large, pages 1260 to 1265).

Paragraph 3. The Imported Meat Act.—Section 306 of an act entitled “An act to provide revenue, to regulate commerce with foreign countries, to encourage the industries of the United States, to protect American labor, and for other purposes,” approved June 17, 1930 (Public No. 361, 71st Cong.).

Paragraph 3. The Food and Drug Act.—“An Act for preventing the manufacture, sale, or transportation of adulterated or misbranded or poisonous or deleterious foods, drugs, medicines, and liquors, and for regulating traffic therein, and for other purposes,” approved June 30, 1906 (34 United States Statutes at Large, pages 768 to 772), as amended by “An Act to amend Section eight of the Food and Drugs Act approved June thirtieth, nineteen hundred and six,” approved August 23, 1912 (37 United States Statutes at Large, pages 416 and 417), by “An Act to amend Section eight of an act entitled ‘An Act for preventing the manufacture, sale, or transportation of adulterated or misbranded or poisonous or deleterious foods, drugs, medicines and liquors, and for regulating traffic therein, and for other purposes,’ approved June thirtieth, nineteen hundred and six,” approved March 3, 1913 (37 United States Statutes at Large, page 732), and by the Act of Congress approved July 24, 1919, entitled “An Act making appropriations for the Department of Agriculture for the fiscal year ending June 30, 1920” (41 United States Statutes at Large, page 271).

Paragraph 4. The Department.—The United States Department of Agriculture.

Paragraph 5. Bureau.—The Bureau of Animal Industry of the United States Department of Agriculture.

Paragraph 6. Inspector.—An inspector of the Bureau of Animal Industry.

Paragraph 7. Bureau Employees.—Inspectors and all other individuals employed in the Bureau of Animal Industry who are authorized by the chief of bureau to do any work or perform any duty in connection with meat inspection.

Paragraph 8. Official Establishment.—Any slaughtering, meat canning, curing, smoking, salting, packing, rendering, or other similar establishment at which inspection is maintained under these regulations.

Paragraph 9. Official Station.—One or more official establishments included under a single supervision.

Paragraph 10. **"Inspected and Passed,"** or **"U. S. Inspected and Passed,"** or **"U. S. Inspected and Passed under the Act of Congress of June 30, 1906,"** or **"U. S. Inspected and Passed by Department of Agriculture,"** or any Authorized Abbreviations Thereof.—That the carcasses, parts of carcasses, meat, meat products, or meat-food products so marked have been inspected and passed under these regulations, and that at the time they were inspected, passed, and so marked they were found to be sound, healthful, wholesome, and fit for human food.

Paragraph 11. **"U. S. Passed for Sterilization."**—That the carcasses and parts of carcasses so marked have been inspected and passed on condition that they be rendered into lard or tallow as prescribed by Regulation 15 or otherwise sterilized by methods approved by the chief of bureau.

Paragraph 12. **"U. S. Inspected and Condemned,"** or any Authorized Abbreviation Thereof.—That the carcasses, parts of carcasses, meat, meat products, or meat-food products so marked are unsound, unhealthful, unwholesome, or otherwise unfit for human food.

Paragraph 13. **"U. S. Retained."**—That the article so marked is held for further examination by an inspector to determine its disposal.

Paragraph 14. **"U. S. Suspect,"** or any Authorized Abbreviation Thereof.—That the animal so marked is suspected of being affected with a disease or condition which may require its condemnation, in whole or in part, when slaughtered, and is subject to further examination by an inspector to determine its disposal.

Paragraph 15. **"U. S. Condemned."**—That the animal so marked has been inspected and found to be immature, or in a dying condition, or to have died otherwise than by slaughter, or to be affected with any other condition or with any disease that will require condemnation of its carcass.

Paragraph 16. **"U. S. Refused Entry."**—That the article so marked, offered for importation, contains a preservative not permitted by these regulations, but contains no substance in conflict with the laws of the foreign country from which exported, and has not been found to be otherwise unsound, unhealthful, unwholesome or unfit for human food.

Paragraph 17. **Inspection Legend.**—A mark, or a statement, authorized by these regulations, on an article or on the container of an article, indicating that the article has been inspected and passed for food by an inspector.

Paragraph 18. **Carcass.**—All parts, including viscera, of a slaughtered animal that are capable of being used for human food.

Paragraph 19. **Primal Parts.**—The usual sections, cuts, or parts of the dressed carcass commonly known in the trade, such as sides, quarters, shoulders, hams, backs, bellies, beef tongues and beef livers, before they have been cut, shredded or otherwise subdivided preliminary to use in the manufacture of meat-food products.

Paragraph 20. **Meat Product.**—Any edible part of the carcass of any cattle, sheep, swine, or goat, which is not manufactured, cured, smoked, processed, or otherwise treated: *Provided,* That for labeling purposes the terms "meat," "meat products," or "meat by-products," shall be construed as these terms are described in Paragraph 5 of Section 9 of Regulation 17.

Paragraph 21. **Meat-food Product.**—Any article of food or any article which enters into the composition of food for human consumption, which is derived or prepared, in whole or in part, from any portion of the carcass of any cattle, sheep, swine, or goat, if such portion is all or a considerable and definite portion of the article, except such articles as organotherapeutic substances, meat juice, meat extract and the like, which are only for medicinal purposes and are advertised only to the medical profession.

Paragraph 22. **Meat and Products.**—Carcasses, parts of carcasses, meat, products, food products, meat products, and meat-food products of, or derived from, cattle, sheep, swine, and goats, which are capable of being used as food by man.

Paragraph 23. **Meat or Product.**—Any part or all of meat and products.

Paragraph 24. Immediate Container, or True Container.—The unit can, pot, tin, canvas, or other receptacle or covering in which any meat product is customarily delivered to consumers.

Paragraph 25. Shipping Container, or Outside Container.—The box, bag,, barrel, crate, or other receptacle or covering inclosing any meat or product packed in two or more immediate or true containers.

Paragraph 26. Person.—Natural persons, individuals, firms, partnerships, corporations, companies, societies, and associations, and every agent, officer, or employee of any thereof. This term shall import both the plural and the singular as the case may be.

Paragraph 27. Subsidiary.—Any individual, firm, partnership, corporation, company, or association, in whose name any business is done, controlled, or owned, in whole or in part, directly or indirectly, by another.

Paragraph 28. "U. S. Passed for Cooking."—That the carcasses and parts of carcasses so marked have been inspected and passed on condition that they be rendered into lard or tallow as prescribed by Regulation 15 or otherwise cooked by methods approved by the chief of bureau.

SECTION 2. Labels which bear the legend "Inspected and passed under the provisions of (or according to) the Act of Congress of June 30, 1906," may be authorized by the Secretary of Agriculture to be used for a limited time in lieu of labels bearing the phrase "U. S. inspected and passed by Department of Agriculture" on products containing no imported meats or meat product, provided such labels have been previously approved and conform to existing regulations in all other respects, and that it is shown to the satisfaction of the department that continuance of the use of such labels is equitable and is rendered necessary in order to utilize stocks of labels prepared prior to November 1, 1914. *

REGULATION 2. SCOPE OF INSPECTION.

SECTION 1. Every establishment in which cattle, sheep, swine, or goats are slaughtered for transportation or sale as articles of interstate or foreign commerce, or in which carcasses, parts of carcasses, meat, meat products, or meat-food products of, or derived from, cattle, sheep, swine, or goats are, wholly or in part, canned, cured, smoked, salted, packed, rendered, or otherwise prepared for transportation or sale as articles of interstate or foreign commerce which are capable of being used as food for man, shall have inspection under these regulations, except as expressly exempted by Regulation 4 or as provided in Regulation 28 of these regulations.

SECTION 2. All cattle, sheep, swine, and goats and all meat and products entering an establishment at which inspection is required by these regulations, and all meat and products prepared, in whole or in part, therein, shall be inspected, handled, prepared, and marked as required by these regulations.

SECTION 3. Every establishment in which horses are slaughtered for transportation or sale as articles of interstate or foreign commerce, or in which carcasses, parts of carcasses, meat, meat products, or meat-food products of or derived from horses are, wholly or in part, canned, cured, smoked, salted, packed, rendered, or otherwise prepared for transportation or sale as articles of interstate or foreign commerce which are capable of being used as food for man, shall have inspection in accordance with the terms prescribed in Regulation 29, of these regulations.

REGULATION 3. ORGANIZATION OF FORCE.

SECTION 1. Meat inspection is conducted, under the direction of the Secretary of Agriculture, by the Bureau of Animal Industry. All permanent employees engaged in the work of meat inspection are appointed upon certification of the United States Civil Service Commission that they have passed the examination prescribed by that commission. These employees are classified as shown

in the following sections of this regulation. Promotions are made on the basis of efficiency department and length of service.

SECTION 2. Inspectors in Charge.—These are inspectors assigned to supervise and perform official work at each official station. Such employees report directly to the chief of bureau and are chosen by reason of their fitness for responsibility as determined by their records in the service. At stations where slaughtering is conducted, only veterinary inspectors are placed in charge.

SECTION 3. Veterinary Inspectors.—All applicants examined for these positions must be graduates of veterinary colleges, accredited by the United States Civil Service Commission. Veterinary inspectors make all final postmortem examinations, enforce the sanitary requirements in their respective departments, and perform various other duties under the direction of the inspector in charge.

SECTION 4. Travelling Veterinary Inspectors.—These employees inspect official stations and the conduct of operations and ascertain whether the regulations and instructions governing meat inspection are properly observed. They also confer with and instruct bureau employees with a view to uniformity and efficiency of the service, and report thereon, with recommendations, to the chief of bureau.

SECTION 5. Laboratory Inspectors.—These employees possess technical education and training in the microscopical and chemical examination of meat and products, and their inspections are conducted in laboratories located at various slaughtering centers. Pathological laboratories are also maintained to which diseased specimens may be sent, when necessary, for diagnosis.

SECTION 6. Lay Inspectors.—These employees are laymen who assist veterinary inspectors in antemortem and postmortem inspections, supervise the curing, canning, packing, and other preparations, handling, and marking of meat and products, examine such articles to detect unsound or unfit conditions, assist in the enforcement of sanitary requirements, and perform various other duties.

REGULATION 4. APPLICATIONS FOR INSPECTION OR EXEMPTION; RETAIL BUTCHERS, RETAIL DEALERS AND FARMERS; DECLARATIONS FOR INEDIBLE PRODUCTS ESTABLISHMENTS.

SECTION 1. Paragraph 1. The proprietor or operator of each establishment of the kind specified in Section 1 of Regulation 2 shall make application to the Secretary of Agriculture for inspection or for exemption from inspection. Every application under this regulation shall be made on a form furnished by the Bureau of Animal Industry, Washington, D. C. In cases where inspection or exemption is already in effect, new applications for inspection or exemption shall not be required. In cases of change of ownership or change of location, a new application shall be made.

Paragraph 2. Triplicate copies of complete drawings, consisting of floor plans, elevations, and sections, properly drawn to scale, and of specifications, including plumbing and drainage, of plants shall accompany, and the prints or diagrams required by Section 2 of Regulation 13 should accompany applications for inspection.

Paragraph 3. Each application shall specify the names and addresses of all the applicant's subsidiaries doing any of the business described in Section 1 of Regulation 2 and the location of each establishment of such subsidiaries. Each subsidiary making an application shall specify the name and address of the person, firm, corporation, or association of which it is a subsidiary.

Paragraph 4. Notice in writing shall be given to each applicant granted inspection, specifying the establishment to which the same applies.

Paragraph 5. Inspection or exemption may be refused, or if granted may be revoked, for any false statement in the application therefor.

SECTION 2. Retail butchers and retail dealers in meat and meat-food products, supplying their customers, upon making application, pursuant to Sec-

tion 1 of this regulation, may be exempted from inspection. To each one so exempted a numbered certificate of exemption shall be furnished for use with transportation agencies to procure the movement of his products in interstate or foreign commerce. No certificate shall be issued unless all the premises on which the products are prepared and handled are maintained in a sanitary condition. Failure by certificate holders to maintain sanitary conditions or to conform to such of these regulations as apply to them shall be cause for withdrawal of exemption and the cancellation of certificates. Such exempted establishments shall conform to the same regulations as govern official establishments in regard to labeling and the use of dyes, chemicals, and preservatives.

SECTION 3. No holder of a certificate of exemption shall use the same for any purpose except for making shipments in supplying his own customers.

SECTION 4. The carcasses and products of animals slaughtered by any farmer on the farm, provided they can be identified as such and are sound, healthful, wholesome, and fit for human food, and otherwise meet the requirements of these regulations, may be transported in interstate or foreign commerce under the provisions of Section 8 of Regulation 25. In order to procure the transportation of such products, a farmer need not apply for exemption from inspection.

SECTION 5. Inspectors shall make inspections to ascertain whether any of these regulations applying to retail butchers, retail dealers, farmers, or other persons have been violated.

REGULATION 5. OFFICIAL NUMBERS AND INAUGURATION AND WITHDRAWAL OF INSPECTION.

SECTION 1. *Paragraph 1.* To each establishment granted inspection an official number shall be assigned. Such number shall be used to identify all inspected and passed meat and products prepared in the establishment.

Paragraph 2. Two or more official establishments under the same ownership or control may be granted the same official number, provided a serial letter is added in each case to identify each establishment and the products thereof.

Paragraph 3. No meat or products shall be handled or prepared in an official establishment for a subsidiary of the proprietor or operator, nor shall any article handled or prepared therein be sold or transported in interstate or foreign commerce by or in the name of a subsidiary of the proprietor or operator, unless such subsidiary is named in an application of the establishment for inspection, and is granted inspection in such establishment, under these regulations.

SECTION 2. *Paragraph 1.* Each official establishment shall be separate and distinct from any unofficial establishment in which any meat or product is handled.

Paragraph 2. Inspection shall not be inaugurated in any building any part of which is used as living quarters, unless the part for which inspection is requested shall be so constructed that the floors, walls, and ceilings are of solid concrete, brick, or similar material, and the floors, walls, and ceilings are without opening that directly or indirectly communicates with any part of the building used as living quarters.

SECTION 3. Inspection shall not be begun if an establishment is not in a sanitary condition nor unless the establishment provides and agrees to maintain adequate facilities for conducting such inspection.

SECTION 4. When an application for inspection is granted, the inspector in charge shall, at or prior to the inauguration of inspection, inform the proprietor or operator of the establishment of the requirements of these regulations. If the establishment, at the time inspection is inaugurated, contains any meat or product which has not theretofore been inspected, passed, and marked in compliance with these regulations, the identity of the same shall be maintained and it shall not be transported or offered for transportation in interstate or

foreign commerce, or otherwise dealt with, as inspected and passed under these regulations. The establishment shall adopt and enforce all necessary measures, and shall comply with all such directions as the inspector in charge may prescribe, for carrying out the purposes of this section.

SECTION 5. Inspection may be withdrawn from any official establishment which violates or fails to comply with any provision of the Meat-inspection Act or of these regulations.

SECTION 6. Inspectors and other bureau employees shall report to the inspector in charge all violations and failures under Section 5 of this regulation of which they have knowledge, and the inspector in charge shall report the same to the chief of bureau.

REGULATION 6. ASSIGNMENT OF BUREAU EMPLOYEES.

SECTION 1. The chief of bureau shall designate an inspector in charge of the inspection at each official station, and assign to said inspector such assistants as may be necessary.

SECTION 2. For the purpose of any examination or inspection, bureau employees shall have access at all times, by day or night, whether the establishment is operated or not, to every part of any official establishment to which they are assigned.

SECTION 3. Each bureau employee will be furnished with a numbered official badge, which he shall not allow to leave his possession, and which he shall wear in such manner and at such times as the chief of the bureau may prescribe. This badge shall be sufficient identification to entitle him to admittance at all regular entrances and to all parts of the establishment and premises to which he is assigned, and to any place, at any time, for the purpose of making an inspection pursuant to Section 3 of Regulation 23.

SECTION 4. No bureau employee shall be detailed for duty at an establishment where any member of his family is employed by the establishment, nor shall any inspector in charge or other employee acting in a supervisory capacity be continued on duty at an official station where any member of his family is employed by any establishment under his jurisdiction. Bureau employees are forbidden to solicit, for any person, employment at any official establishment, or by any officer, manager or employee thereof.

REGULATION 7. FACILITIES FOR INSPECTION.

SECTION 1. Office room, including light, heat, and janitor service, shall be provided by official establishments, rent free, for the exclusive use, for official purposes, of the inspector and other bureau employees assigned thereto. The room or rooms set apart for this purpose shall meet with the approval of the inspector in charge and shall be conveniently located, properly ventilated, and provided with lockers suitable for the protection and storage of bureau supplies and with facilities suitable for the dressing of bureau employees.

SECTION 2. Each official establishment shall inform the inspector in charge, or his assistant, when work in each department has been concluded for the day, and of the day and hour when work will be resumed therein. Whenever any meat or product is to be overhauled or otherwise handled in an official establishment during unusual hours, the establishment shall, a reasonable time in advance, notify the inspector in charge, or his assistant, of the day and hour when such work will be commenced, and such articles shall not be so handled except after such notice has been given. No department of an official establishment shall be operated except under the supervision of a bureau employee. All slaughtering of animals and preparation of meat and products shall be done within reasonable hours, and with reasonable speed, the facilities of the establishment being considered. No shipment of any meat or product shall be made from an official establishment until after due notice has been given to the inspector in charge or his assistant.

SECTION 3. When one inspector is detailed to conduct the work at two or more official establishments where few animals are slaughtered or where but a small quantity of any meat or product is prepared, the inspector in charge may designate the hours during which such establishment may be operated.

SECTION 4. No work shall be performed at official establishments during any day on which such work is prohibited by the law of the State, or Territory, or District of Columbia in which the establishment is located. However, the department requires that it be judicially determined that such work is so prohibited.

SECTION 5. When required by the chief of bureau or the inspector in charge, the following facilities and conditions, and such others as may be essential to efficient conduct of inspection, shall be provided by each official establishment:

(a) Satisfactory pens, equipment, and assistants for conducting antemortem inspection and for separating, marking, and holding apart from passed animals those marked "U. S. suspect" and those marked "U. S. condemned."

(b) Sufficient natural light, and abundant artificial light at times of the day when natural light may not be adequate, at places for inspection. Such places shall be kept sufficiently free of steam and vapors for inspection to be properly made.

(c) Racks, receptacles, or other suitable devices for retaining such parts as the head, tongue, tail, thymus gland, and viscera, and all parts and blood to be used in the preparation of meat-food products or medical products, until after the postmortem examination is completed, in order that they may be identified in case of condemnation of the carcass; equipment, trucks, and receptacles for the handling of viscera of slaughtered animals so as to prevent contact with the floor; trucks, racks, marked receptacles, tables, or other necessary equipment for the separate and sanitary handling of carcasses or parts passed for sterilization.

(d) Tables, benches, and other equipment on which inspection is performed of such design, material, and construction as to enable bureau employees to conduct their inspection in a ready, efficient, and cleanly manner.

(e) Sanitary, water-tight metal trucks or receptacles for holding and handling diseased carcasses and parts; such trucks or receptacles to be marked in a conspicuous manner with the phrase "U. S. condemned," in letters not less than 2 inches high, and, when required by the inspector in charge, to be equipped with facilities for locking or sealing.

(f) Adequate arrangements, including disinfectants for cleansing and disinfecting hands, for sterilizing all implements used in dressing diseased carcasses, and for disinfecting hides, floors, and such other articles and places as may be contaminated by diseased carcasses or otherwise.

(g) In establishments in which slaughtering is done, rooms, compartments, or specially prepared open places, to be known as "final inspection places," at which the final inspection of retained carcasses shall be conducted. Final inspection places shall be sufficient in size and their rail arrangement and other equipment shall be adequate to prevent carcasses and parts, passed for food or sterilization, from being contaminated by contact with condemned carcasses or parts. They shall be equipped with hot water, stationary washstands, sanitary tables, and other apparatus essential to a ready, efficient, and sanitary conduct of the inspection. The floors shall be of sanitary construction and shall have proper sewer connections, and when the final inspection place is part of a larger floor it shall be separated by a curb and railing.

(h) In each establishment at which any condemned article is held until a day subsequent to its condemnation, a suitably located room or compartment in which the same shall be placed. This room or compartment shall be secure, rat proof, and susceptible of being kept clean, including a sanitary disposal of the floor liquids. It shall be equipped for secure locking, and shall be held under a lock furnished by the department, the key of which shall not leave the custody of a bureau employee. The door or doors of such room or com-

partment shall be conspicuously marked with the phrase "U. S. condemned," in letters not less than 2 inches high.

(i) Rooms, compartments, and receptacles in such number and in such locations as the needs of the inspection in the establishment may require, in which carcasses and products may be held for further inspection. These shall be equipped for secure locking and shall be held under locks furnished by the department, the keys of which shall not leave the custody of bureau employees. Every such room, compartment, or receptacle shall be conspicuously marked with the phrase "U. S. retained," in letters not less than 2 inches high.

(j) Adequate facilities, including denaturing materials, for the proper disposal of condemned articles in accordance with these regulations. Tanks which, under these regulations, must be sealed shall be properly equipped for sealing as may be specified by the chief of bureau.

(k) Docks and receiving rooms, to be designated by the establishment, with the approval of the inspector in charge, for the receipt and inspection of all meat and products as provided in Section 4 of Regulation 18.

(l) Suitable lockers in which brands bearing the inspection legend shall be kept when not in use. All such lockers shall be equipped for locking with locks to be supplied by the department, the keys of which shall not leave the custody of bureau employees.

SECTION 6. Inspectors shall furnish their own implements, such as knives, steels, and triers, for conducting inspection, and shall cleanse their hands and implements as prescribed by Paragraph 3 of Section 7 of Regulation 8.

REGULATION 8. SANITATION.

SECTION 1. Prior to the inauguration of inspection, an examination of the establishment and premises shall be made by a bureau employee and the requirements for sanitation and the necessary facilities for inspection specified.

SECTION 2. Triplicate copies of complete drawings, consisting of floor plans, elevations, and sections, properly drawn to scale, and of specifications, including plumbing and drainage, for remodeling plants of official establishments and for new structures, shall be submitted to the chief of bureau in advance of construction.

SECTION 3. *Paragraph 1.* Official establishments, establishments at which market inspection is conducted, and premises on or in which any meat or product is prepared or handled by or for persons to whom certificates of exemption have been issued, shall be maintained in sanitary condition, and to this end the requirements of Paragraphs 2 to 8, inclusive, of this section shall be complied with.

Paragraph 2. There shall be abundant light, both natural and artificial, and sufficient ventilation for all rooms and compartments, to insure sanitary condition.

Paragraph 3. There shall be an efficient drainage and plumbing system for the establishment and premises, and all drains and gutters shall be properly installed with approved traps and vents.

Paragraph 4. The water supply shall be ample, clean, and potable, with adequate facilities for its distribution in the plant. Every establishment shall make known, and whenever required shall afford opportunity for inspection of, the source of its water supply and the location and character of its reservoir and storage tanks.

Paragraph 5. The floors, walls, ceilings, partitions, posts, doors, and other parts of all structures shall be of such materials, construction, and finish as will make them susceptible of being readily and thoroughly cleaned. The floors shall be kept water-tight. The rooms and compartments used for edible products shall be separate and distinct from those used for inedible products.

Paragraph 6. The rooms and compartments in which any meat or product is prepared or handled shall be free from odors from dressing and toilet rooms, catch basins, hide cellars, casing rooms, inedible tank and fertilizer rooms and stables.

Paragraph 7. Every practicable precaution shall be taken to keep establishments free of flies, rats, mice, and other vermin. The use of poisons for any purpose in rooms or compartments where any unpacked meat or product is stored or handled is forbidden, except under such restrictions and precautions as the chief of bureau may prescribe. The use of bait poisons in hide cellars, inedible compartments, outbuildings, or similar places, or in storerooms containing canned or tierced products is not forbidden, but so-called rat viruses shall not be used in any part of an establishment or the premises thereof.

Paragraph 8. Dogs shall not be admitted into official establishments.

SECTION 4. Adequate sanitary facilities and accommodations shall be furnished by every official establishment. Of these the following are specifically required:

(a) Dressing rooms, toilet rooms, and urinals, sufficient in number, ample in size, conveniently located, provided with windows to admit direct, natural light, properly ventilated, and meeting all requirements as to sanitary construction and equipment. These shall be separate from the rooms and compartments in which meat and products are prepared, stored, or handled. Where both sexes are employed, separate facilities shall be provided.

(b) Modern lavatory accommodations, including running hot and cold water, soap, towels, etc. These shall be placed in or near toilet and urinal rooms and also at such other places in the establishment as may be essential to assure cleanliness of all persons handling any meat or product.

(c) Properly located facilities for disinfecting and cleansing utensils and hands of all persons handling any meat or product.

(d) Cuspidors of such shape as not readily to be upset and of such material as to be readily disinfected. They shall be sufficient in number and accessibly placed in all rooms and places designated by the inspector in charge, and all persons who expectorate shall be required to use them.

SECTION 5. Equipment and utensils used for preparing, processing, and otherwise handling any meat or product shall be of such materials and construction as will make them susceptible of being readily and thoroughly cleaned and such as will insure strict cleanliness in the preparation and handling of all meats and products. Trucks and receptacles used for inedible products shall bear some conspicuous and distinctive mark and shall not be used for handling edible products.

SECTION 6. Rooms, compartments, places, equipment, and utensils used for preparing, storing, or otherwise handling any meat or product, and all other parts of the establishment, shall be kept clean and sanitary.

SECTION 7. *Paragraph 1.* Operations and procedures involving the preparation, storing, or handling of any meat or product shall be strictly in accord with cleanly and sanitary methods.

Paragraph 2. Rooms and compartments in which inspections are made and those in which animals are slaughtered or any meat or product is processed or prepared shall be kept sufficiently free of steam and vapors to enable bureau employees to make inspections and to insure cleanly operations. The walls and ceilings of rooms and compartments under refrigeration shall be kept reasonably free from moisture.

Paragraph 3. Butchers and others who dress or handle diseased carcasses or parts shall, before handling or dressing other carcasses or parts, cleanse their hands of grease, immerse them in a prescribed disinfectant, and rinse them in clean water. Implements used in dressing diseased carcasses shall be thoroughly cleansed in boiling water or in a prescribed disinfectant, followed by rinsing in clean water. The employees of the establishment who handle any meat or product shall keep their hands clean, and in all cases after visiting the toilet rooms or urinals shall wash their hands before handling any meat or product or implements used in the preparation of the same.

Paragraph 4. Aprons, frocks, and other outer clothing worn by persons who handle any meat or product shall be of material that is readily cleansed, and only clean garments shall be worn. Knife scabbards shall be kept clean.

Paragraph 5. Such practices as spitting on whetstones, placing skewers or knives in the mouth, inflating lungs or casings, or testing with air from the mouth such receptacles as tierces, kegs, casks, and the like, containing or intended as containers of any meat or product, are prohibited. Only mechanical means may be used for testing. Care shall be taken to prevent the contamination of meats and products with perspiration.

SECTION 8. The wagons and cars in which any meat or product is transported shall be kept in a clean and sanitary condition. Wagons used in transferring loose meat and products between official establishments shall be closed or so covered that the contents shall be kept clean.

SECTION 9. *Paragraph 1.* Second-hand tubs, barrels, and boxes intended for use as containers of any meat or product shall be inspected when received at the establishment and before they are cleaned. Those showing evidence of misuse rendering them unfit to serve as containers for food products shall be rejected. The use of those showing no evidence of previous misuse may be allowed after they have been thoroughly and properly cleaned. Steaming, after thorough scrubbing and rinsing, is essential to cleaning tubs and barrels.

Paragraph 2. Interiors of tank cars about to be used for the transportation of any meat-food products shall be carefully inspected for cleanliness even though the last previous content was edible. Lye and soda solutions used in cleaning must be thoroughly removed by rinsing with clean water. In their examinations bureau employees shall enter the tank with a light and examine all parts of the interior.

SECTION 10. *Paragraph 1.* All operating and storage rooms and departments of official establishments used for inedible products shall be maintained in acceptably clean condition. The outer premises of every official establishment, embracing docks and areas where cars and wagons are loaded, and the driveways, approaches, yards, pens and alleys, shall be properly drained and kept in clean and orderly condition. All catch basins on the premises shall be of such construction and location and be given such attention as will insure their being kept in acceptable condition as regards odors and cleanliness. The accumulation on the premises of establishments of any material in which flies may breed, such as hog hair, bones, paunch contents, or manure, is forbidden. No nuisance shall be allowed in any establishment or on its premises.

SECTION 11. *Paragraph 1.* No establishment shall employ, in any department where any meat or meat product is handled or prepared, any person affected with tuberculosis or other communicable disease.

Paragraph 2. Equines owned or used by official establishments on the premises thereof shall be free of diseases communicable to man. Inspectors will be alert for the detection of such diseases in work stock on the premises of official establishments.

SECTION 12. When necessary, bureau employees shall attach a "U. S. rejected" tag to any equipment or utensil which is insanitary, or the use of which would be in violation of these regulations. No equipment or utensil so tagged shall again be used until made sanitary. Such tag so placed shall not be removed by any one other than a bureau employee.

REGULATION 9. ANTEMORTEM INSPECTION.

SECTION 1. *Paragraph 1.* An antemortem examination and inspection shall be made of all cattle, sheep, swine, and goats about to be slaughtered in an official establishment before their slaughter shall be allowed.

Paragraph 2. Such antemortem inspection shall be made in pens on the premises of the establishment in which the animals are about to be slaughtered, except as provided in Paragraph 3 of this section.

Paragraph 3. At each official station where there are public stockyards, upon approval of the chief of bureau, antemortem inspection may be conducted at the scales or in the pens of the yards. Inspection under this paragraph shall be performed only on animals presented for inspection by an official

establishment. Except as provided in Section 7 of this regulation, every animal marked as a suspect on such inspection shall be slaughtered at an official establishment of the official station at which the inspection was made. If any such animal be not so slaughtered or disposed of in compliance with Section 7 of this regulation, then thereafter no antemortem inspection shall be done under this paragraph for the official establishment which presented the animal for inspection, and antemortem inspection for that establishment shall be performed only in pens on its premises in accordance with Paragraph 2 of this section. When the chief of bureau is satisfied at any time that inspection at scales or in pens of public stockyards is being used for unfair or unjust purposes by an official establishment or by any one in whose behalf it presents animals for inspection under this paragraph, then he shall require antemortem inspection for that establishment thereafter to be made only in accordance with Paragraph 2 of this section. The chief of bureau may at any time withdraw antemortem inspection, in whole or in part, from any public stockyards.

Paragraph 4. If an animal marked as a suspect on inspection at public stockyards is not slaughtered by the establishment by which it was presented for inspection, then such animal shall be removed from the place of inspection only under the supervision of a bureau employee, and, until slaughtered in compliance with Paragraph 3 of this section or disposed of pursuant to Section 7 of this regulation, shall remain under the supervision of a bureau employee. Every animal marked as a suspect on inspection in the pens of an official establishment shall be slaughtered on the premises of that establishment unless disposed of pursuant to Section 7 of this regulation.

Paragraph 5. The withdrawal of antemortem inspection from public stockyards, in whole or in part, shall not be a substitute for, but shall be in addition to, any penalty for violating these regulations elsewhere prescribed by these regulations of prescribed by the Meat-inspection Act.

SECTION 2. *Paragraph 1.* All animals plainly showing on antemortem inspection any disease of condition that under these regulations would cause condemnation of their carcasses on postmortem inspection shall be marked "U. S. condemned" and disposed of in accordance with Section 8 of this regulation.

Paragraph 2. All hogs plainly showing on antemortem inspection that they are affected with either hog cholera or swine plague shall be marked "U. S. condemned" and disposed of in accordance with Section 8 of this regulation.

Paragraph 3. If a hog has a temperature of 106° F. or higher, and is of a lot in which there are symptoms of either hog cholera or swine plague, in case of doubt as to the cause of the high temperature, and after being marked for identification, it may be held for a reasonable time, under the supervision of an inspector, for further observation and taking of temperature. Any hog so held shall be reinspected on the day it is slaughtered. If upon such reinspection, or when not held for further observation and taking of temperature, then on the original inspection, the hog has a temperature of 106° F. or higher, it shall be condemned and disposed of in accordance with Section 8 of this regulation.

Paragraph 4. All animals showing on antemortem inspection symptoms of rabies, tetanus, milk fever, or railroad sickness shall be marked "U. S. condemned" and disposed of in accordance with Section 8 of this regulation.

Paragraph 5. Animals which are offered for antemortem inspection under this regulation, and which are regarded as immature, shall be marked "U. S. suspect," and if slaughtered the disposition of their carcasses shall be determined by the postmortem findings in conjunction with the antemortem conditions. If not slaughtered as suspects, such animals shall be held under bureau supervision and after sufficient development may be released for slaughter, or may be released for any other purpose, provided they have not been exposed to any infectious or contagious disease. Animals found dead or in a dying condition on premises of an official establishment shall be marked "U. S. condemned" and disposed of in accordance with Section 8 of this regulation.

Paragraph 6. All animals which, on antemortem inspection, do not plainly show, but are suspected of being affected with, any disease or condition that,

under these regulations, may cause condemnation, in whole or in part, on post-mortem inspection, shall be so marked as to retain their identity as suspects until final postmortem inspection, when the carcasses shall be marked and disposed of as provided elsewhere in these regulations, or until disposed of in accordance with Section 7 of this regulation.

Paragraph 7. All seriously crippled animals and animals commonly termed "downers," if not marked "U. S. condemned" under Paragraphs 1, 2, 3, or 4 shall be marked and treated as suspects in accordance with Paragraph 6 of this section.

Paragraph 8. Animals which are known to have reacted to the tuberculin test and which are to be slaughtered at an official establishment shall be marked and treated as suspects in accordance with Paragraph 6 of this section.

SECTION 3. All animals required by these regulations to be treated as suspects, or to be marked as suspects, or to be marked so as to retain their identity as suspects, shall be marked by or under the supervision of a bureau employee "U. S. suspect," or with such other distinctive mark or marks to indicate that they are suspects as the chief of bureau may adopt. No such mark shall be removed except by a bureau employee.

SECTION 4. *Paragraph 1.* All hogs, even though not themselves marked as suspects, which are of lots one or more of which have been condemned or marked suspects under Section 2 of this regulation for either hog cholera or swine plague, shall, so far as possible, be slaughtered separately and apart from all other animals passed on antemortem inspection.

Paragraph 2. All animals required to be marked as suspects shall be set apart and, except as hereinafter provided, shall be slaughtered separately from other animals at an official establishment. In order to avoid unnecessary suffering, crippled animals and animals commonly termed "downers" should be slaughtered without delay.

SECTION 5. In all cases of emergency slaughter, except as provided in Section 23 of Regulation 11, the animals shall be inspected immediately before slaughter, whether heretofore inspected or not. When the necessity for emergency slaughter exists, the establishment shall notify the inspector in charge, or his assistant, so that such inspection may be made.

SECTION 6. *Paragraph 1.* When any condition is suspected in which the question of temperature is important, such as hog cholera, swine plague, Texas fever, anthrax, blackleg, pneumonia, or septicemia, and in the case of animals commonly termed "downers," the exact temperature shall be taken and recorded.

Paragraph 2. If any animal has a temperature indicating a diseased condition, in case of doubt as to the cause of the high temperature, after being marked for identification, it may be held for a reasonable time, under the supervision of an inspector for further observation and taking of temperature before its final disposal is determined.

SECTION 7. *Paragraph 1.* The slaughter of an animal which has been marked as a suspect on account of pregnancy or on account of having recently given birth to young, and which has not been exposed to any infectious or contagious disease, is not required. Such animal, together with its young, may be released for breeding or dairy purposes, and when released shall be promptly removed from the stockyards or premises of the establishment where inspected. At the time the animal is released, and immediately before removal, the suspect mark if detachable shall be detached by a bureau employee, who shall report his action to the inspector in charge.

Paragraph 2. Vaccine animals with unhealed lesions of vaccinia, accompanied by fever, which have not been exposed to any other infectious or contagious disease, are not required to be slaughtered and may be disposed of in accordance with Paragraph 1 of this section.

Paragraph 3. A hog suspected of being affected with hog cholera or swine plague may be set apart and held, under bureau supervision, for treatment with anti-hog-cholera serum. If at the expiration of the treatment period

the animal, upon examination, if found to be free from disease, it may be released for any purpose.

SECTION 8. Except as hereinafter provided in this section, animals marked "U. S. condemned" shall be killed by the establishment, if not already dead, and shall not be taken into an establishment to be slaughtered or dressed; nor shall they be conveyed into any department of the establishment used for edible products; but they shall be disposed of and tanked in the manner provided for condemned carcasses in Regulation 14. The "U. S. condemned" tag shall not be removed from, but shall remain on, the animal when it goes into the tank. The number of such tag shall be reported to the inspector in charge by the bureau employee who affixed it, and also by the bureau employee who supervised the tanking of the animal: *Provided*, That any animal condemned on account of hog cholera or swine plague, as prescribed in Paragraphs 1, 2, or 3 of Section 2 of this regulation, may be set apart and held, under bureau supervision, for treatment with anti-hog-cholera serum; the requirement that such animal be killed shall be held in abeyance to await the result of the treatment. If at the expiration of the treatment period the animal upon examination is found to be free from disease, the "U. S. condemned" tag shall be removed and the animal released for any purpose.

REGULATION 10. POSTMORTEM INSPECTION.

SECTION 1. A careful postmortem examination and inspection shall be made of the carcasses and parts thereof of all cattle, sheep, swine, and goats slaughtered at official establishments. Such inspection and examination shall be made at the time of slaughter, except in cases of emergencies provided for in Section 23 of Regulation 11.

SECTION 2. The head, tongue, tail, thymus gland, and all viscera, and all parts and blood to be used in the preparation of meat-food products or medical products, shall be held in such manner as to preserve their identity until after postmortem examination has been completed, in order that they may be identified in case of condemnation of the carcass.

SECTION 3. *Paragraph 1.* Each carcass, including all parts and detached organs thereof, in which any lesion of disease or other condition is found that might render the meat or any organ unfit for food purposes, and which for that reason would require a subsequent inspection, shall be retained by the bureau employee at the time of inspection. The identity of every such retained carcass, part, and detached organ thereof shall be maintained until the final inspection has been completed. Retained carcasses shall not be either washed or trimmed unless authorized by the Inspector.

Paragraph 2. Such devices and methods as may be approved by the chief of bureau may be used for the temporary identification of retained carcasses, parts, or organs. In all cases the identification shall be further established by affixing "U. S. retained" tags as soon as practicable and before final inspection. These tags shall not be removed except by a bureau employee.

SECTION 4. Each carcass or part which is found on final inspection to be unsound, unhealthful, unwholesome, or otherwise unfit for human food shall be conspicuously marked on the surface tissues thereof by a bureau employee at the time of inspection "U. S. inspected and condemned." Condemned detached organs and parts of such character that they cannot be so marked shall be immediately placed in trucks or receptacles which shall be kept plainly marked "U. S. inspected and condemned" in letters not less than 2 inches high. All condemned carcasses, parts, and organs shall remain in the custody of a bureau employee and shall be tanked as required in these regulations at or before the close of the day on which they are condemned, or be locked in the "U. S. condemned" room or compartment. Condemned articles shall not be allowed to accumulate unnecessarily in the condemned room or compartment.

SECTION 5. *Paragraph 1.* Carcasses and parts passed for cooking shall be conspicuously marked on the surface tissues thereof by a bureau employee at

the time of inspection. "U. S. passed for cooking," or "U. S. passed for sterilization." All such carcasses and parts shall be cooked in accordance with Regulation 15, and until so cooked shall remain in the custody of a bureau employee.

Paragraph 2. In all cases where carcasses showing localized lesions of disease are passed for food or for sterilization the diseased parts shall be removed before the "U. S. retained" tag is taken from the carcass, and such parts shall be condemned.

SECTION 6. Carcasses and parts found to be sound, healthful, wholesome, and fit for human food shall be passed and marked as provided in these regulations.

SECTION 7. Hog carcasses found before evisceration to be affected with an infectious or contagious disease, including tuberculosis, shall not be eviscerated at the regular killing bed or bench, but shall be retained and separated from other carcasses and taken to the final inspection room or placed and there opened and examined. This requirement, however, may be waived for those slaughter floors where the number of animals slaughtered per hour is small and on which the inspection facilities are such as permit a ready, efficient and sanitary performance of the final inspection without such separation. It may also be waived for those slaughter floors on which there are in use moving-top inspection table installations which conform to bureau requirements.

SECTION 8. Paragraph 1. When a carcass is to be dressed with the skin or hide left on, the skin or hide shall be thoroughly washed and cleaned before any incision is made for the purpose of removing any part thereof or evisceration.

Paragraph 2. All hair, scurf, and dirt, including all hoofs and claws, shall be removed from hog carcasses, and the carcasses thoroughly washed and cleaned, before any incision is made for inspection or evisceration.

Paragraph 3. The skins from swine condemned for tuberculosis or any disease communicable to man or other animal may be removed from the establishment, except as provided in Section 2 of Regulation 11, for tanning or other industrial use; but they shall be removed for these uses only after they have been disinfected, as follows: Each skin shall be immersed for not less than five minutes in a 5 per cent solution of liquor cresolis compositus, or a 5 per cent solution of carbolic acid, or shall be otherwise treated as prescribed by the chief of bureau. The process of skinning and disinfecting shall be conducted in a specially prepared place approved by the inspector in charge, and under the supervision of a bureau employee.

SECTION 9. The sternum of each carcass shall be split and spread apart at the time of slaughter so as to expose the lungs, heart, liver, and thoracic cavity, in order to allow proper inspection and drainage.

SECTION 10. Carcasses or parts of carcasses shall not be inflated with air. Transferring the caul or other fat from a fat to a lean carcass is prohibited.

SECTION 11. When only a portion of a carcass is to be condemned on account of slight bruises, either the bruised portion shall be removed immediately and tanked, or the carcass shall be immediately placed in a retaining room and kept until chilled and the bruised portion then removed and tanked.

REGULATION 11. DISPOSAL OF DISEASED CARCASSES AND PARTS.

SECTION 1. The carcasses or parts of carcasses of all animals slaughtered at an official establishment and found at the time of slaughter or at any subsequent inspection to be affected with any of the diseases or conditions named in other sections of this regulation shall be disposed of according to the section of this regulation pertaining to the disease or condition. Owing to the fact that it is impracticable to formulate rules covering every case and to designate at just what stage a process becomes loathsome or a disease noxious, the decision as to the disposal of all carcasses, parts, or organs not specifically covered by these regulations shall be left to the inspector in charge.

SECTION 2. All parts, including hides, hoofs, horns, viscera, intestinal contents, fat and blood of animals, the carcasses of which show lesions of anthrax,

regardless of the extent of the disease, shall be condemned and immediately incinerated or otherwise completely destroyed. The killing bed upon which the animal was slaughtered shall be disinfected with a 1 to 1000 solution of bichloride of mercury, and all knives, saws, cleavers, and other instruments which have come in contact with the carcass shall be treated as provided in Paragraph 3 of Section 7 of Regulation 8 before being used upon another carcass.

SECTION 3. Paragraph 1. The following principles are declared for guidance in passing on carcasses affected with tuberculosis:

Principle A.—No meat should be used for food if it contains tubercle bacilli, or if there is a reasonable possibility that it may contain tubercle bacilli, or if it is impregnated with toxic substance of tuberculosis or associated septic infections.

Principle B.—Meat should not be destroyed if the lesions are localized and not numerous, if there is no evidence of distribution of tubercle bacilli through the blood or by other means to the muscles or to parts that may be eaten with muscles, and if the animal is well nourished and in good condition, since in this case there is no proof, or even reason to suspect, that the flesh is unwholesome.

Principle C.—Evidences of generalized tuberculosis are to be sought in such distribution and number of tuberculous lesions as can be explained only upon the supposition of the entrance of tubercle bacilli in considerable number into the systemic circulation. Significant of such generalization is the presence of numerous uniformly distributed tubercles through both lungs, also tubercles in the spleen, kidneys, bones, joints, and sexual glands, and in the lymph gland connected with these organs and parts, or in the splenic, renal, prescapular, popliteal, and inguinal glands, when several of these organs and parts are coincidentally affected.

Principle D.—Localized tuberculosis is tuberculosis limited to a single or several parts or organs of the body without evidence of recent invasion of numerous bacilli into the systemic circulation.

Paragraph 2. The meat of animals affected with tuberculosis shall be disposed of as follows:

Rule A.—The entire carcass shall be condemned if any of the following conditions occur:

(a) When it was observed before the animal was killed that it was suffering with fever.

(b) When there is a tuberculous or other cachexia, as shown by anemia and emaciation.

(c) When the lesions of tuberculosis are generalized, as shown by their presence not only at the usual seats of primary infection but also in parts of the carcass or in the organs that may be reached by the bacilli of tuberculosis only when they are carried in the systemic circulation. Tuberculous lesions in any two of the following-mentioned organs are to be accepted as evidence of generalization when they occur in addition to local tuberculous lesions in the digestive or respiratory tracts including the lymph glands connected therewith: Spleen, kidney, uterus, udder, ovary, testicle, adrenal gland, and brain or spinal cord or their membranes. Numerous tubercles uniformly distributed throughout both lungs also afford evidence of generalization.

(d) When the lesions of tuberculosis are found in the muscles or intermuscular tissue or bones or joints, or in the body lymph glands as a result of draining the muscles, bones, or joints.

(e) When the lesions are extensive in one or both body cavities.

(f) When the lesions are multiple, acute, and actively progressive. (Evidence of active progress consists of signs of acute inflammation about the lesions, or liquefaction necrosis, or the presence of young tubercles.)

Rule B.—An organ or a part of a carcass shall be condemned under any of the following conditions:

(a) When it contains lesions of tuberculosis.

(b) When the lesion is localized but immediately adjacent to the flesh as in the case of tuberculosis of the parietal pleura or peritoneum. In this case

not only the membrane or part affected but also the adjacent thoracic or abdominal wall is to be condemned.

(c) When it has been contaminated by tuberculous material through contact with the floor or a soiled knife or otherwise.

(d) Heads showing lesions of tuberculosis shall be condemned, except that when a head is from a carcass passed for food or for sterilization and the lesions are slight, or calcified, or encapsulated, and are confined to lymph glands in which not more than two glands are involved, the head may be passed for sterilization after the diseased tissues have been removed and condemned.

(e) An organ shall be condemned when the corresponding lymph gland is tuberculous.

Rule C.—Carcasses showing lesions of tuberculosis should be passed for food when the lesions are slight, localized, and calcified or encapsulated, or are limited to a single or several parts or organs of the body (except as noted in Rule A), and there is no evidence of recent invasion of tubercle bacilli into the systemic circulation. Under this rule carcasses showing such lesions as the following may be passed, after the parts containing the lesions are removed and condemned in accordance with Rule B:

(a) In the cervical lymph glands and two groups of visceral lymph glands in a single body cavity, such as the cervical, bronchial, and mediastinal glands, or the cervical, hepatic, and mesenteric glands.

(b) In the cervical lymph glands and one group of visceral lymph glands and one organ in a single body cavity, such as the cervical and bronchial glands and the lungs, or the cervical and hepatic glands and the liver.

(c) In two groups of visceral lymph glands and one organ in a single body cavity, such as the bronchial and mediastinal glands and the lung, or the hepatic and mesenteric glands and the liver.

(d) In two groups of visceral lymph glands in the thoracic cavity and one group in the abdominal cavity, or in one group of visceral lymph glands in the thoracic cavity and two groups in the abdominal cavity, such as the bronchial, mediastinal, and hepatic glands, or the bronchial, hepatic, and mesenteric glands.

(e) In the cervical lymph glands and one group of visceral lymph glands in each body cavity, such as the cervical, bronchial, and hepatic glands.

(f) If the cervical lymph glands and one group of visceral lymph glands in each body cavity, together with the liver when the latter contains but few localized foci. In this class of carcasses, which will be chiefly those of hogs, the lesions of the liver are considered to be primary, as the disease is practically always of alimentary origin.

Rule D.—Carcasses which reveal lesions more severe or more numerous than those described for carcasses to be passed (Rule C), but not so severe nor so numerous as the lesions described for carcasses to be condemned (Rule A), may be rendered into lard or tallow or otherwise sterilized in accordance with Regulation 15, if the distribution of the lesions is such that all parts containing tuberculous lesions can be removed.

SECTION 4. Paragraph 1. The carcasses of all hogs marked as suspects on antemortem inspection shall be given careful postmortem inspection; and if it appears that they are affected with either acute hog cholera or swine plague, they shall be disposed of in accordance with Paragraph 2 of this section.

Paragraph 2. Carcasses of hogs which show acute and characteristic lesions of either hog cholera or swine plague in any organ or tissue other than the kidneys or lymph glands shall be condemned. Inasmuch as lesions resembling lesions of hog cholera or swine plague occur in the kidneys and lymph glands of hogs not affected with either hog cholera or swine plague, carcasses of hogs in the kidneys or lymph glands of which appear any lesions resembling lesions of either hog cholera or swine plague shall be carefully further inspected for corroborative lesions. On such further inspection—

(a) If the carcass shows such lesions in the kidneys or in the lymph glands or in both, accompanied by characteristic lesions in some organ or tissue, then all lesions shall be regarded as those of hog cholera or swine plague, and the carcass shall be condemned.

(b) If the carcass shows in any organ or tissue other than the kidneys or lymph glands lesions of either hog cholera or swine plague which are slight and limited in extent, it shall be passed for sterilization in accordance with Regulation 15.

(c) If the carcass shows no indication of either hog cholera or swine plague in any organ or tissue other than the kidneys or lymph glands, it shall be passed for food unless some other provision of these regulations requires a different disposal.

SECTION 5. *Paragraph 1.* Carcasses of animals showing generalized actinomycosis (lumpy jaw) shall be condemned.

Paragraph 2. Carcasses of animals in a well-nourished condition showing uncomplicated localized actinomycotic lesions may be passed after the infected organs or parts have been removed and condemned, except as provided in Paragraph 3 of this section.

Paragraph 3. Heads affected with actinomycosis, including the tongue, shall be condemned, except that when the disease of the jaw is slight, strictly localized, and without suppuration, fistulous tracts, or lymph-gland involvement, the tongue, if free from disease, may be passed, or, when the disease is slight and confined to the lymph glands, the head, including the tongue, may be passed after the affected glands have been removed and condemned.

SECTION 6. Carcasses of animals affected with or showing lesions of any of the following-named disease or conditions shall be condemned,

- (a) Blackleg.
- (b) Hemorrhagic septicemia.
- (c) Pyemia.
- (d) Septicemia.
- (e) Splenetic fever.
- (f) Malignant epizootic catarrh.
- (g) Unhealed vaccine lesions.
- (h) Parasitic icterohematuria in sheep.

SECTION 7. Any individual organ or part of a carcass affected with carcinoma or sarcoma shall be condemned. In case the carcinoma or sarcoma involves any internal organ to a marked extent, or affects the muscles, skeleton, or body lymph glands, even primarily, the carcass shall be condemned. In case of metastasis to any other organ or part of a carcass, or if metastasis has not occurred but there are present secondary changes in the muscles (serous infiltration, flabbiness, or the like), the carcass shall be condemned.

SECTION 8. Carcasses of animals showing any disease such as generalized melanosis, pseudoleukemia, and the like, which affects the system of the animal, shall be condemned.

SECTION 9. All slight, well-limited abrasions on the tongue and inner surface of the lips and mouth, when without lymph-gland involvement, shall be carefully excised, leaving only sound, normal tissue, which may be passed. Any organ or part of a carcass which is badly bruised or which is affected by a tumor, an abscess, or a suppurating sore, shall be condemned; and when the lesions are of such character or extent as to affect the whole carcass, the whole carcass shall be condemned. Parts of carcasses which are contaminated by pus shall be condemned.

SECTION 10. All carcasses of animals so infected that consumption of the meat or meat-food products thereof may give rise to meat poisoning shall be condemned. This includes all carcasses showing signs of either—

- (a) Acute inflammation of the lungs, pleura, pericardium, peritoneum, or meninges.
- (b) Septicemia or pyemia, whether puerperal, traumatic, or without any evident cause.

- (c) Gangrenous or severe hemorrhagic enteritis or gastritis.
- (d) Acute diffuse metritis or mastitis.
- (e) Polyarthritis.
- (f) Phlebitis of the umbilical veins.
- (g) Traumatic pericarditis.
- (h) Any acute inflammation, abscess, or suppurating sore, if associated with acute nephritis, fatty and degenerated liver, swollen soft spleen, marked pulmonary hyperemia, general swelling of lymph glands, or diffuse redness of the skin, either singly or in combination.

Immediately after the slaughter of any animals so diseased, the premises and implements used shall be thoroughly disinfected as prescribed elsewhere in these regulations. The part of any carcass coming into contact with the carcass or any part of the carcass of any animals covered by this section, other than those affected with the diseases mentioned in (a) above, or with the place where such diseased animal was slaughtered, or with the implements used in the slaughter thereof, before thorough disinfection of such place and implements has been accomplished, or with any other contaminated object, shall be condemned. In case the contaminated part is not removed from the carcass within two hours after such contact the whole carcass shall be condemned.

SECTION 11. From the standpoint of meat inspection, necrobacillosis (lip and leg ulceration) may be regarded as a local affection at the beginning, and carcasses in which the lesions are so localized may be passed for food if in a good state of nutrition, after removing and condemning those portions affected with necrotic lesions. On the other hand, when emaciation, cloudy swelling of the glandular organs, or enlargement and discoloration of the lymph glands are associated with the affection, it is evident that the disease has progressed beyond the condition of localization to a state of toxemia, and the entire carcass should therefore be condemned as both innutritious and noxious. Pyemia or septicemia may intervene as a complication of the local necrosis, and when present the carcass shall be condemned in accordance with Section 6 (c, d) of this regulation.

SECTION 12. Caseous lymphadenitis.

(a) A thin carcass showing well-marked lesions in the viscera and the skeletal lymph glands, or such a carcass showing extensive lesions in any part, shall be condemned.

(b) A thin carcass showing well-marked lesions in the viscera with only slight lesions elsewhere or showing well-marked lesions in the skeletal lymph glands with only slight lesions elsewhere may be passed for sterilization.

(c) A thin carcass showing only slight lesions in the skeletal lymph glands and in the viscera may be passed without restriction.

(d) A well-nourished carcass showing well-marked lesions confined to the skeletal lymph glands with only slight lesions elsewhere may be passed without restriction.

(e) A well-nourished carcass showing well-marked lesions in the viscera and the skeletal lymph glands may be passed for sterilization; but where the lesions in a well-nourished carcass are both numerous and extensive it shall be condemned.

(f) All affected organs and glands of carcasses passed without restriction or passed for sterilization shall be removed and condemned. The term "thin" as used in this section shall not be held applicable to a carcass which is anemic or emaciated.

SECTION 13. Carcasses showing any degree of icterus with a parenchymatous degeneration of organs, the result of infection of intoxication, and those which show an intense yellow or greenish-yellow discoloration without evidence of infection or intoxication, shall be condemned. Carcasses affected with icterus, the result of conditions other than those before stated in this section, but which lose such discoloration on chilling, shall be passed for food, while those which do not so lose such discoloration may be passed for sterilization.

No carcass affected with icterus may be passed for food or for sterilization unless the final inspection thereof is completed under natural light.

SECTION 14. Carcasses which give off the odor of urine or a sexual odor shall be condemned. When the final inspection of such carcasses is deferred until they have been chilled, the disposal shall be determined by the heating test.

SECTION 15. *Paragraph 1.* Carcasses of animals affected with mange or scab in advanced stages, or showing emaciation or extension of the inflammation to the flesh, shall be condemned. When the disease is slight, the carcass may be passed.

Paragraph 2. Carcasses of hogs affected with urticaria (diamond skin disease), *Tinea tonsurans*, *Demodex folliculorum*, or erythema may be passed after detaching the affected skin, if the carcass is otherwise fit for food.

SECTION 16. *Paragraph 1.* Carcasses of cattle (including the viscera) infested with tapeworm cysts known as *Cysticercus bovis* shall be condemned if the infestation is excessive or if the meat is watery or discolored. Carcasses shall be considered excessively infested if incisions in various parts of the musculature expose on most of the cut surfaces two or more cysts within an area the size of the palm of the hand.

Paragraph 2. A carcass in which infestation with *Cysticercus bovis* is limited to one dead and degenerated cyst may be passed for food after removal and condemnation of the cyst.

Paragraph 3. Carcasses of cattle showing a slight or moderate infestation other than that indicated in Paragraph 2, but not so extensive as indicated in Paragraph 1 of this section, as determined by a careful examination of the heart, muscles of mastication, tongue, diaphragm and its pillars, and of portions of the carcass rendered visible by the process of dressing, may be passed for food after removal and condemnation of the cysts, with the surrounding tissues, provided the carcasses and parts, appropriately identified by retained tags are held in cold storage at a temperature not higher than 15° F., continuously for a period of not less than six days. As an alternative to retention in cold storage as herein provided, such carcasses and parts may be passed for sterilization.

Paragraph 4. Fats of carcasses passed for food or for sterilization under the provisions of Paragraphs 2 and 3 may be passed for food provided they are melted at a temperature of not less than 140° F. The edible viscera, except the lungs and heart, of carcasses passed for food or for sterilization under the provisions of Paragraphs 2 and 3 may be passed for food without refrigeration or other process of sterilization provided they are found to be free from infestation upon final inspection. The intestines, weasands, and bladders from beef carcasses, affected with *Cysticercus bovis*, which have been passed for food or for sterilization may be used for casings after they have been subjected to the usual methods of preparation and may be passed for such purposes upon completion of the final inspection.

Paragraph 5. The inspection for *Cysticercus bovis* may be omitted in the case of calves under six weeks old. The routine inspection of calves over six weeks old for *Cysticercus bovis* may be limited to a careful examination of the surface of the heart and such surfaces of the body musculature as are rendered visible by the process of dressing.

SECTION 17. Carcasses of hogs affected with tapeworm cysts (*Cysticercus cellulosa*) may be passed for sterilization, but if the infestation is excessive the carcass shall be condemned.

SECTION 18. *Paragraph 1.* In the disposal of carcasses, edible organs, and parts of carcasses showing evidence of infestation with parasites not transmissible to man, the following general rules shall govern: If the lesions are localized in such manner and are of such character that the parasites and the lesions caused by them may be radically removed, the non-affected portion of the carcass, organ, or part of the carcass may be passed for food after the removal and condemnation of the affected portions. If an organ or a part of a carcass shows numerous lesions caused by parasites, or if the character of

the infestation is such that complete extirpation of the parasites and lesions is difficult and uncertainly accomplished, or if the parasitic infestation or invasion renders the organ or part in any way unfit for food, the affected organ or part shall be condemned. If parasites are found to be distributed in a carcass in such a manner or to be of such a character that their removal and the removal of the lesions caused by them are impracticable, no part of the carcass shall be passed for food. If the infestation is excessive the carcass shall be condemned. If the infestation is moderate the carcass may be passed for sterilization, but in case such carcass is not sterilized as required by Regulation 15 it shall be condemned.

Paragraph 2. In the case of sheep carcasses affected with tapeworm cysts located in the muscles (*Cysticercus ovis*, so-called sheep measles, not transmissible to man) the carcass may be passed after the removal and condemnation of the affected portions: *Provided, however,* That if upon the final inspection of sheep carcasses retained on account of measles the total number of cysts found embedded in muscle or in the immediate relation with muscular tissue, including the heart, exceeds five, this shall be taken to indicate that the cysts are so generally distributed and so numerous that their removal would be impracticable, and the entire carcass shall be condemned or passed for sterilization, according to the degree of infestation. If not to exceed five cysts are found upon final inspection, the carcass may be passed after the removal and condemnation of the affected portions.

Paragraph 3. Carcasses of animals found infested with gid bladder worms (*Cænurus cerebralis*, *Multiceps multiceps*) may be passed after condemnation of the affected organ (brain or spinal cord).

Paragraph 4. Organs or parts of carcasses infected with hydatid cysts (*Echinococcus*) shall be condemned.

Paragraph 5. Livers infested with flukes shall be condemned.

SECTION 19. Carcasses of animals too emaciated or anemic to produce wholesome meat, and carcasses which show a slimy degeneration of the fat or a serous infiltration of the muscles, shall be condemned.

SECTION 20. Carcasses of animals in advanced stages of pregnancy (showing signs of parturition), also carcasses of animals which have within ten days given birth to young and in which there is no evidence of septic infection, may be passed for sterilization; otherwise, they shall be condemned.

SECTION 21. *Paragraph 1.* Carcasses of young calves, pigs, kids, and lambs are unwholesome and shall be condemned if (a) the meat has the appearance of being water-soaked, is loose, flabby, tears easily, and can be perforated with the fingers; or (b) its color is grayish-red; or (c) good muscular development as a whole is lacking, especially noticeable on the upper shank of the leg, where small amounts of serous infiltrates or small edematous patches are sometimes present between the muscles; or (d) the tissue which later develops as the fat capsule of the kidneys is edematous, dirty yellow or grayish-red, tough and intermixed with islands of fat.

Paragraph 2. All unborn and stillborn animals shall be condemned, and no hide or skin thereof shall be removed from the carcass within a room in which edible products are handled.

Paragraph 3. Meat and organs, such as lungs and livers, which have been condemned on account of parasitic infestation or invasion, and the flesh of immature and unborn animals and of animals which have been condemned on account of emaciation and recent parturition, may be utilized at official establishments in the manufacture of poultry feed, provided that such organ or tissues are sterilized by thorough cooking, steam rendering, or desiccation under high temperature. If so utilized, such organs and tissues shall be handled and prepared in rooms or places separate and apart from those in which edible products are handled, prepared, or stored.

SECTION 22. Hogs which have entered the scalding vat alive or which have been suffocated in any way shall be condemned.

SECTION 23. When it is necessary for humane reasons to slaughter an injured animal at night, or on Sunday or a holiday when the inspector cannot be obtained the carcass and all parts shall be kept for inspection, with the head and all viscera except the stomach, bladder and intestines held by the natural attachments. If all parts are not so kept for inspection, the carcass shall be condemned. If on inspection of a carcass slaughtered in the absence of an inspector any lesion or condition is found indicating that the animal was sick or diseased, the carcass shall be condemned.

REGULATION 12. CARCASSES OF ANIMALS SLAUGHTERED WITHOUT ANTEMORTEM INSPECTION.

SECTION 1. No carcass of an animal slaughtered in the United States, which has not had antemortem inspection by a bureau employee shall be brought into an official establishment, except that carcasses of cattle, sheep, swine, and goats, slaughtered by a farmer on the farm, to which the head and all viscera other than the stomach, bladder, and intestines, are held by the natural attachments, may be received for inspection at official establishments where there is a veterinary inspector, upon the conditions prescribed in this section. After receipt in an official establishment, every such carcass shall be inspected, and if found to be free from disease and otherwise sound, healthful, wholesome, and fit for human food, it shall be marked with the inspection legend. If found to be diseased, unsound, unhealthful, unwholesome, or otherwise unfit for human food, it shall be marked "U. S. inspected and condemned" and destroyed for food purposes as provided in Regulation 14.

REGULATION 13. TANK ROOMS AND TANKS.

SECTION 1. *Paragraph 1.* All tanks and equipment used for rendering or preparing inedible products shall be in rooms or compartments separate from those used for rendering or preparing edible products. There shall be no connection, by means of pipes or otherwise, between tanks, rooms or compartments containing inedible products and those containing edible products.

Paragraph 2. Tanks, fertilizers, driers and other equipment used in the preparation of inedible product shall be properly equipped with condensers and other appliances which will acceptably suppress odors incident to such preparation.

SECTION 2. Every official establishment shall file with the department blue prints or other accurate diagrams showing all underground pipe lines and other equipment used to convey edible products and those used to convey inedible products, with a description giving the exact location, terminals, and dimensions of such pipes and other equipment and of all gates, valves, or other controlling apparatus, and designating the lines used for conveying edible products and those used for conveying inedible products, and shall also file a copy thereof with the inspector in charge. Like prints or diagrams of alterations in existing tank rooms or tanks and of new tank rooms or tanks of official establishments shall be furnished to the department and approved by the chief of bureau before the same are constructed. If no such underground pipe line or equipment is used for any of the purposes mentioned in this section, a written statement certifying to that fact and duly signed by the proprietor or operator of the establishment shall be filed with the department.

SECTION 3. *Paragraph 1.* In conveying to the inedible-product tank carcasses of animals which have been condemned on antemortem inspection, they shall not be taken through rooms or compartments in which any meat or product is prepared, handled or stored.

Paragraph 2. Under no circumstances shall the carcass of any animal which has died otherwise than by slaughter be brought into any room or compartment in which any meat or product is prepared, handled, or stored.

Paragraph 3. No dead animal shall, under any circumstances, be brought from outside the premises of an official establishment into any room or compartment thereof where any meat or product is prepared; nor, unless permission therefor in advance shall be obtained from the Secretary of Agriculture, shall any dead animal be brought into rooms or compartments where inedible products are prepared. "Dead animal," within the meaning of this paragraph, shall be construed to include any animal which died without having been inspected under these regulations.

Paragraph 4. Inedible fats from outside the premises of an official establishment shall not be received except into the tank room provided for inedible products, and then only when their receipt into the tank room produces no unsanitary condition on the premises. When so received, they shall not enter any room or compartment used for edible products.

REGULATION 14. TANKING AND DENATURING CONDEMNED CARCASSES AND PRODUCTS.

SECTION 1. Paragraph 1. Condemned meat and products at official establishments having facilities for tanking shall, except as hereinafter provided, be disposed of by tanking as follows: The lower opening of the tank shall first be securely sealed by a bureau employee; then the condemned meat and products and a sufficient quantity of coloring matter or other substance to be designated by the department shall be placed in the tank in his presence, after which the upper opening shall also be securely sealed by such employee, who shall then see that a sufficient force of steam (not less than 40 pounds) is turned into the tank and maintained a sufficient time effectually to destroy the contents for food purposes.

Paragraph 2. The seals of tanks shall be broken only by a bureau employee after the products has been rendered as provided in Paragraph 1 of this section. The drawing-off of the contents of such tanks shall be supervised by a bureau employee. Samples shall be taken by bureau employees as often as required to determine whether the fat or grease is effectively denatured.

Paragraph 3. Rendered fats and greases condemned on reinspection shall be destroyed for food purposes by denaturing with coloring matter or other designated substance.

SECTION 2. Any meat or product condemned at an official establishment which has no facilities for tanking shall, under the supervision of a bureau employee be denatured with crude carbolic acid or other prescribed agent, or destroyed by incineration. When such meat or product is not incinerated, all containers thereof shall be opened, and all meat shall be freely slashed with a knife, before the denaturing agent is applied.

REGULATION 15. RENDERING CARCASSES AND PARTS INTO LARD AND TALLOW, AND OTHER STERILIZATION.

SECTION 1. Carcasses and parts passed for sterilization may be rendered into lard or tallow, provided that such rendering is done in the following manner: The lower opening of the tank shall first be securely sealed by a bureau employee, then the carcasses or parts shall be placed in the tank in his presence, after which the upper opening shall be securely sealed by such employee, who shall then see that a sufficient force of steam is turned into the tank. Such carcasses and parts shall be cooked at a temperature not lower than 220° F. for a time sufficient to render them effectually into lard or tallow.

SECTION 2. Establishments not equipped with steaming tanks for rendering carcasses and parts into lard or tallow as provided in Section 1 of this regulation may render such carcasses or parts in open kettles under the direct supervision of a bureau employee. Such rendering shall be done at a temperature and for a time sufficient to render the carcasses and parts effectually into lard or tallow, and shall be done only during regular hours of work.

SECTION 3. *Paragraph 1.* Carcasses and parts passed for sterilization and which are not rendered into lard or tallow may be utilized for food purposes provided they are first sterilized by methods and handled and marked in a manner approved by the chief of bureau.

Paragraph 2. Any carcasses or part prepared in compliance with Paragraph 1 of this section, whether canned or placed in other approved container or not, shall be plainly and conspicuously marked "Prepared from product passed after sterilization," or "Prepared from meat passed for sterilization."

Paragraph 3. Wherever in these regulations the statement "passed for sterilization" is employed it shall be construed to be synonymous with the statement "passed for cooking" or "passed after cooking," as may be applicable.

REGULATION 16. MARKING, BRANDING AND IDENTIFYING MEAT AND PRODUCTS.

SECTION 1. *Paragraph 1.* The chief of bureau may approve and authorize the use of abbreviations of marks of inspection under these regulations. Such abbreviations shall have the same force and effect as the respective marks for which they are so authorized to be used.

Paragraph 2. Except for the purpose of submitting a sample or samples of the same to the chief of bureau for approval no person shall make or prepare, or cause to be made or prepared, labels, inserts, brands, tags, or other marking devices bearing the inspection legend or any abbreviation, copy, or representation thereof, for use on any meat or product, without the written authority therefor of the chief of bureau given in advance.

Paragraph 3. No person shall affix or place, or cause to be affixed or placed, the inspection legend, or any abbreviation, copy, or representation thereof to or on any meat or product, except under the supervision of a bureau employee.

Paragraph 4. No person shall fill, or cause to be filled, in whole or in part, with any meat or product, any container bearing, or, within the United States, any container intended to bear, the inspection legend, or any abbreviation, copy, or representation thereof, except under the supervision of a bureau employee.

Paragraph 5. No person shall affix or place, or cause to be affixed or placed, the inspection legend, or any abbreviation, copy, or representation thereof, to or on any container of any meat or product, except under the supervision of a bureau employee.

Paragraph 6. Revoked.

Paragraph 7. Revoked.

Paragraph 8. All marks of inspection shall be carefully applied and securely affixed.

Paragraph 9. No person shall remove or cause to be removed from an official establishment any article which these regulations require to be marked in any way unless the same is clearly and legibly marked in compliance with these regulations.

SECTION 2. *Paragraph 1.* Each carcass which has been inspected and passed in an official establishment shall be marked at the time of inspection with the inspection legend and with the number of the establishment. Each primal part shall be likewise marked before it leaves the establishment in which it is first inspected and passed, except as provided in Paragraphs 2 and 6 of this section and Section 6 of Regulation 25.

Paragraph 2. Primal parts which have been inspected and passed but do not bear the inspection legend may be transported from one official establishment to another official establishment for further processing, in a car, wagon, or other closed container, if the car, wagon, or container be sealed with a department seal bearing the inspection legend in compliance with these regulations.

Paragraph 3. All primal parts which have been inspected and passed shall, after processing, bear, plainly and legibly, the inspection legend and the number of the official establishment at which the processing was completed.

Paragraph 4. Inspected and passed sausage and other meat food products in casings, of the ordinary "ring" variety or larger, shall bear on the casings the inspection legend and the number of the establishment. Inspected and passed sausage and other meat food products in casings, of the smaller varieties, shall bear on the casings one or more inspection marks to each chain or two or more of such marks to each bunch, except in cases where such smaller varieties of sausage and products leave establishments completely inclosed in properly labeled cartons or wrappers, having a capacity of 10 pounds or less and containing a single kind of product. All markings may be omitted from sausage and other meat food products in casings when these articles are to be packed in sealed cans.

Paragraph 5. Meat food products in casings, other than sausage, which possess the characteristics of or resemble sausage, shall bear on each link or piece the word "imitation," prominently displayed: *Provided*, That such products in casings as coppa, capicola, lachschinken, bacon, pork loins, pork shoulder butts, and like cuts of meat which are prepared without added substances other than curing materials or condiments, and that meat rolls, bockwurst, and similar products in casings which do not contain cereal or vegetables, and the head-cheese, souse, sulze, scrapple, blood pudding, and liver pudding in casings, need be marked on the casing with the work "imitation" or the true name of the product, and the other products in casings such as loaves, luncheon meats, and chili con carne, may bear on each link or piece the true name of the product in lieu of the word "imitation": *Provided also*, That all markings may be omitted when the articles are placed in sealed cans processed in the official establishment.

Paragraph 6. Any meat or product of such character or so small that it can not be marked with a brand, and which has been inspected and passed, but does not bear the inspection legend, may be removed from an official establishment for local or interstate transportation in closed containers bearing the inspection legend and such other marks as are required by these regulations, or in open containers bearing the inspection legend applied by means of a domestic-meat label or trade label: *Provided*, That upon removal from such closed or open containers the meat or product may not be further transported in interstate or foreign commerce unless reinspected by a bureau employee and packed under his supervision in a container or containers bearing the inspection legend and such other marks as are required by these regulations.

SECTION 3. *Paragraph 1.* When cereal, vegetable starch, starchy vegetable flour, dried milk, or dried skim milk is added to sausage within the limits prescribed under Paragraph 5 of Section 6 of Regulation 18, the product shall be marked with the specific name of each of such added ingredients, as, of example, "cereal added," "potato flour added," "cereal and potato flour added," "dried skim milk added," "cereal and dried skim milk added," and so forth, as the case may be. On sausage of the small varieties the marking prescribed in this paragraph may be limited to links bearing the inspection legend.

Paragraph 2. Casings that are colored as provided in Paragraph 3 of Section 6 of Regulation 18, when used as containers of meat or product, shall be legibly and conspicuously marked by branding or printing thereon one of the statements as follows: "Artificially colored," or "casing colored."

Paragraph 3. When benzoate of soda is added to sausage or other meat-food products in animals casings the product shall be marked to show the presence and the percentage amount of such ingredient.

SECTION 4. *Paragraph 1.* Official establishments shall furnish such ink brands, burning brands, and like devices for marking meat and products as the chief of bureau may require. In advance of manufacture, complete and accurate descriptions and designs of the same shall be submitted to and approved by the chief of bureau. Every such brand and device which bears the inspection legend shall, immediately upon being manufactured, be delivered into the custody of the inspector in charge of the establishment, and shall be used only under the supervision of a bureau employee. When not in use for marking inspected and passed meat and products, all such brands and devices bear-

ing the inspection legend shall be kept locked in properly equipped lockers or compartments, the keys of which shall not leave the possession of a bureau employee.

Paragraph 2. Official establishments shall furnish all ink for marking meats and products. Before being used, samples of the same shall be submitted to and approved by the chief of bureau.

SECTION 5. All brands and devices furnished by the bureau for marking articles with the inspection legend, including self-locking seals and presses for lead and wire seals, shall be used only under the supervision of a bureau employee, and, when not in use for marking, shall be kept locked in properly equipped lockers or compartments, the keys of which shall not leave the possession of a bureau employee.

SECTION 6. No brand or device shall be false or misleading. The letters and figures thereon shall be of such style and type as will make a clear impression. The inspection legend and establishment number on brands shall be separate and apart from trade names, marks, or other devices.



SECTION 7. Paragraph 1. Except as provided in Paragraphs 2 and 3 of this section and in Section 6 of Regulation 25, when any inspected and passed meat or product for domestic commerce is moved from an official establishment, or meat or product of such character or so small that it cannot be marked is moved for domestic commerce from a place having market inspection under these regulations, the shipping container shall bear a domestic meat label which has been submitted to and received the approval of the department and conforms to the following specifications: The label shall be printed with black ink on white paper of good quality, and shall be not less than $2\frac{3}{4}$ by 4 inches in size. The phrase "domestic meat label" shall be printed inside the border across one end of the label. The word "establishment" and the official number shall constitute the top line of the label and shall be printed in type of such size and style as to make them the most conspicuous part of the label. The following statement shall be printed in uniform style: "The meat or meat-food product contained herein has been U. S. inspected and passed by Department of Agriculture." The name and address of the establishment, or the name only may also be printed on the label, at the bottom thereof, in type of such size and style as to be less conspicuous than the establishment number. No work or statement, except as permitted by this paragraph, and

no picture or other advertising matter, device, or design, shall appear upon the domestic meat label, which in form and substance appears on page 123.

Paragraph 2. When any meat or product prepared in an official establishment for domestic commerce has been inspected and passed and is inclosed in a cloth wrapping as a shipping container, such wrapping shall bear the inspection legend and establishment number applied by an ink brand, except in those cases in which the inspection legend and establishment number on the article themselves are clearly legible through the wrapping.

Paragraph 3. The use of domestic meat labels is not required on containers bearing trade labels which have been approved by the department and on which the inspection legend appears in plain view after the package is prepared for shipment.

SECTION 8. The shipping or outside containers of meat and products for export shall be marked in compliance with Sections 1 and 6 of Regulation 24.

SECTION 9. Inedible grease, inedible tallow, or other inedible fat having the physical characteristics of an edible product shall be denatured or otherwise destroyed for food purposes. Containers of such inedible grease, inedible tallow, or other inedible fat shall be conspicuously marked with the word "Inedible." Such containers as tierces, barrels and half barrels shall have both ends painted white with durable paint and the word "Inedible" marked thereon in letters not less than 2 inches high, while on tank cars the letters shall be not less than 4 inches high.

SECTION 10. *Paragraph 1.* Tank cars carrying inspected and passed product between official establishments shall be equipped for sealing and be securely sealed with seals bearing the inspection legend furnished by the department and affixed by bureau employees.

Paragraph 2. Each tank car carrying inspected and passed product from an official establishment to any destination other than an official establishment shall bear a label containing the true name of the produce, the inspection legend, the establishment number, and the words "date of loading," followed by a suitable space of the insertion of the date. The label shall be conspicuously located and shall be printed on material of such character and be so affixed as to preclude detachment or effacement upon exposure to the weather. Before the car is removed from the place where it is unloaded, the carrier shall remove or obliterate such label.

Paragraph 3. When inspected and passed products for export are transferred from tank cars to other containers on boats, such transfer shall be under bureau supervision, and the containers on the boats shall be likewise labeled.

SECTION 11. *Paragraph 1.* All meat and meat-food products intended for the United States Navy and found, upon inspection by bureau inspectors, to conform to the Navy specifications shall bear a special mark composed of the letters U. S. N. inclosed within a heart-shaped shield, the top of which is formed of two depressed curved lines meeting at the center.

Paragraph 2. All meat and meat-food products intended for the United States Marine Corps and found, upon inspection by bureau inspectors, to conform to the Marine Corps specifications shall bear a special mark composed of the letters U. S. M. C. and the Marine Corps insignia inclosed within an oblong.

REGULATION 17. LABELING.

SECTION 1. *Paragraph 1.* When any inspected and passed meat or product is placed or packed in an official establishment, in any can, pot, tin, canvas, or other receptacle or covering constituting an immediate or true container within the meaning of these regulations there shall be attached to such container or covering a trade label as hereinafter described in this regulation.

Paragraph 2. No container or covering which bears or is to bear a trade label shall be filled, in whole or in part, except with articles which have been inspected and passed in compliance with these regulations and which are sound, healthful, wholesome, fit for human food and strictly in accordance with the

statements on the label. No such container or covering shall be filled, in whole or in part, and no trade label shall be affixed, except under the supervision of a bureau employee.

SECTION 2. Paragraph 1. Trade labels shall bear the true name of the meat or product contained in the package, and, except as provided in Paragraphs 2 and 5 of this section, or as hereinafter specified in this paragraph shall bear, in prominent letters and figures of uniform size, the phrase "U. S. inspected and passed by Department of Agriculture," and the number of the official establishment at which the meat or product was prepared, or, if processed, the number of the establishment at which last processed. The establishment number may be omitted from labels applied to metal containers on which such number is embossed and from cartons used as containers of oleomargarine, lard, or compound and the product is immediately inclosed in an approved wrapper bearing the inspection legend and establishment number. Labels may also bear any other statement, not false or misleading, which has been approved by the department.

Paragraph 2. Trade labels within the meaning of these regulations shall include printed, lithographed, or embossed labels, stickers, seals, wrappers, and receptacles. Metal containers on which the inspection legend is embossed may, with the approval of the department, bear the inspection legend in abbreviated form.

Paragraph 3. Stencils, box dies, inserts, tags, so-called "liners" and "circles" and like devices shall not be used in an official establishment unless previously approved by the department, nor shall they bear the inspection legend or any abbreviation or representation thereof: *Provided*, That wooden boxes of light material and having a maximum capacity of 5 pounds may, upon specific approval by the chief of bureau, have the inspection legend and establishment number imprinted thereon. Sketches of inserts, tags, liners, circles, and like devices shall be submitted for approval in the same manner as prescribed for labels in Paragraph 1 of Section 3 of this regulation.

Paragraph 4. The establishment number shall be embossed on all sealed tin containers of inspected and passed meat and products filled in an official establishment except that sealed cans, such as those used for sausage in oil and which bear lithographed labels in which the establishment number is incorporated, need not have the establishment number embossed thereon. Trade labels shall not be affixed to containers so as to obscure the embossed establishment number.

Paragraph 5. When any meat or product is placed in cartons or in wrappers of paper or cloth, or in such other containers as the department may approve, the inspection legend and the establishment number may be embodied in a sticker or seal prominently displayed with the trade label, but not necessarily a part thereof. Such stickers or seals shall not be used without the approval of the department, and shall be securely affixed to the containers under the supervision of a bureau employee after an approved trade label has been affixed.

Paragraph 6. No detachable device bearing the inspection legend or any abbreviation or representation thereof shall be affixed to any meat or product or the container thereof.

SECTION 3. Paragraph 1. No trade label shall be used until it has been approved in its final form by the department. Triplicates of new trade labels in the form of sketches, proofs, or photographic copies shall be submitted through the inspector in charge to the department for approval, and finished trade labels shall not be prepared in advance of such approval of sketches. After trade labels have been printed, lithographed, or embossed in accordance with the approval sketches or proofs, they shall be submitted in quadruplicate through the inspector in charge for final approval and filing.

Paragraph 2. All trade labels, whether in the form of sketches, proofs, or finished labels, which are submitted to the department for final approval, shall, when the chief of bureau shall so require, be accompanied by a statement showing the kinds and percentages of the ingredients of the product in any

container on which it is desired to use the label. Approximate percentages may be given in cases where the percentages of ingredients may vary from time to time, if the limits of variations are stated.

SECTION 4. Trade labels shall be used only on products for which they are approved. They shall not be applied to any meat or product the container of which bears any statement that is false or misleading.

SECTION 5. Trade labels to be affixed to packages of any meat or product for foreign commerce may be printed in a foreign language. The inspection legend and the official establishment number shall in all cases appear thereon in English; but, in addition, may appear, literally translated, in foreign languages.

SECTION 6. The name under which inspection is granted to an official establishment may appear, without qualification, upon the label or the container of an article prepared by the official establishment so named. When an article is prepared by an official establishment for a person other than one of those to whom inspection has been granted at that establishment, and the name of such person is to appear upon the label of container thereof, a prominent and conspicuous statement shall appear upon the label to the effect that the article was prepared for such person, or the name of such person shall be immediately followed by the word "Brand" in the same size and style of lettering as in the name.

SECTION 7. *Paragraph 1.* No meat or product, and no container thereof, shall be labeled with any false or deceptive name; but established trade names which are usual to such articles and are not false or deceptive and which have been approved by the Secretary of Agriculture may be used.

Paragraph 2. No statement, word, picture, design, or device which conveys any false impression or gives any false indication of origin or quality shall appear on any label. For example:

(a) The picture of any swine shall be allowed only on labels used in connection with pork products.

(b) Names of countries, States, and Territories, and such other geographical names as the department may approve, may be used on labels only when followed by the word "style," "type," "cut," or "brand," in the same size and style of lettering as the geographical name, unless the products for which the labels are intended are prepared in the localities named: *Provided*, That when a geographical name by reason of long usage is recognized as a generic term, indicating a certain style, type, or brand, such name may be used without the words "style," "type," or "brand," when accompanied by a statement showing the State or Territory in which the product is prepared, if prepared in a State or Territory, and showing the locality in which the product is prepared, if not prepared in a State or Territory. For example, sausage of the kind commonly known as Vienna sausage may be labeled either "Vienna style sausage" or "Vienna sausage, made in Illinois." In the latter case the words showing the place of manufacture need not be in the same size and style of lettering as the name of the product, but shall be plain and conspicuous.

(c) Names or illustrations indicative or imitative of distinctive types or breeds of livestock shall not be used on labels unless the products for which such labels are intended are actually derived from carcasses of animals of the type or breed specified.

(d) The word "ham" without any prefix indicating the species of animal from which derived shall be used on labels only in connection with pork hams.

(e) The word "fresh" shall not be used on labels in connection with any meat or product the ingredients of which, in whole or in part, have undergone any process of curing.

(f) Such terms as "meat extract" or "extract of beef," without qualification, shall not be permitted on labels in connection with products prepared from organs or parts of the carcass other than fresh flesh. Extracts prepared entirely from parts of the carcass other than fresh flesh shall not be labeled "meat extract," but may be properly labeled with the true names of the parts from

which prepared, as, for example, "liver extract." The terms "beef extract" and "extract of beef" without qualification shall be applied only to extracts of fresh beef. Extract of cured beef or of other cured meat shall be designated, respectively, as "extract of cured beef," "extract of cured meat," or "cured-meat extract." In the latter case the words "cured" and "meat" shall appear on one line in the same size and style of lettering and shall be connected by a hyphen. When beef extract or meat extract is mixed with extract from cured meat or extract derived from the other parts of the carcass, such mixture shall be designated as "compound meat extract," and in addition there shall appear on the label a statement showing the ingredients, other than fresh flesh which have been used in preparing the extract. In the case of fluid extract the word "fluid" shall also appear on the label, as, for example, "fluid extract of beef." The word "fluid" merely indicates a lower percentage of solid matter.

(g) Such terms as "country," "farm," and the like, shall not be used on labels in connection with meat and products unless such meat and products are actually prepared in the country or on the farm. However, if the articles are prepared in the same way as in the country or on the farm, these terms, if qualified by the word "style" in the same size and style of lettering, may be used. Sausage containing cereal shall not be labeled "country style," and lard not rendered in an open kettle shall not be designated as "country style."

(h) The word "leaf" shall not be used in connection with lard prepared from fat other than leaf fat. The qualification "prime steam" shall not be applied to lard rendered in whole or in part from fats obtained from cured meats or trimmings.

(i) Oil, stearine, or stock obtained from beef or mutton fats rendered at a temperature above 170° F. shall not be designated as "oleo oil," "oleo stearine," or "oleo stock," respectively.

SECTION 8. A meat-food product when composed of more than one ingredient shall not bear a label with a name stating or indicating the the product is a substance which is not the principal ingredient contained therein, even though such name be an established trade name. The term "principal ingredient," as used in this section, shall be construed to mean that such ingredient is equal to or exceeds in amount the other ingredients combined, exclusive of cereal and water. If the ingredients are stated on the label, they shall appear in the order of their percentages. For example, sausage containing pork and beef shall not be labeled "pork sausage," but shall be labeled "pork and beef sausage." However, if the pork ingredient equals or exceeds 50 per cent of the meat content, the sausage may be labeled "pork sausage, beef added." A product consisting of veal, pork, and beef shall not be labeled "veal loaf," but may be designated as "veal, pork, and beef loaf." However, if the veal ingredient is not less than 50 per cent of the meat content of the product, the product may be labeled "veal loaf, pork and beef added," the words "pork" and "beef" to appear in the order of their percentages, as above indicated.

SECTION 9. *Paragraph 1.* When a meat-food product contains an added substance or substances, the label shall show the added substance or substances except as provided in the succeeding paragraph of this section.

Paragraph 2. When cereal, vegetable starch, starchy vegetable flour, dried milk, or dried skim milk is added to sausage within the limits prescribed under Paragraph 5 of Section 6 of Regulation 18, there shall appear on the label in a prominent manner, contiguous to the name of the product, the specific name of each such added ingredient, as for example, "cereal added," "with cereal," "potato flour added," "cereal and potato flour added," "dried skim milk added," "cereal and dried skim milk added," and so forth, as the case may be.

Paragraph 3. When meat food products in casings, other than sausage, are placed in wrappers, cartons, or other containers, there shall be prominently displayed on such containers the word "imitation," the words "composed of," or equivalent statement, and the names of the ingredients arranged in the order of their percentages: *Provided,* That such products in casings as coppa, capicola, lachschinken, bacon, pork loins, pork shoulder butts, and like cuts of meat

which are prepared without added substances other than curing materials or condiments, and that meat rolls, bockwurst, and similar products in casings which do not contain cereal or vegetables, and that headcheese, souse, sulze, scrapple, blood pudding, and liver pudding in casings, and that other products in casings such as loaves, luncheon meats, and chili con carne, may be labeled with the true name of the product without the word "imitation" and other qualifications prescribed in this paragraph.

Paragraph 4. When there is added to any meat-food product other than sausage and products referred to in Paragraphs 2 and 3 of this section, cereal, vegetable starch, or vegetable flour not in excess of 5 per cent individually or collectively, there shall appear on the label in a conspicuous manner contiguous to the name of the product, the specific name of each of the added ingredients, followed by the word "added," as, for example, "cereal added," "potato flour added," "cereal and potato flour added," and so forth, as the case may be. If any such product contains cereal, vegetable starch, or vegetable flour, individually or collectively, in excess of 5 per cent the specific name or names of such added ingredients shall appear as a part of the name of the product in uniform size and style of letters, for example, "potted meat and cereal," "potted meat and potato flour," "potted meat, cereal and potato flour." *Provided, however:* That products such as meat loaves, pâtés, soups, tripe with onion sauce, Irish stew, stewed kidneys, hash, chile con carne, tamales, boiled dinners, chop suey, scrapple, and the like, may contain cereal and similar substances without the presence of such substances being indicated on the labels.

Paragraph 5. When edible parts of the head other than flesh and fat, edible parts of the viscera, or other similar edible parts, are added to any meat or product bearing a name, such as "meat," "beef," "pork," "veal," and the like, there shall appear on the label, in a prominent manner and contiguous to the name of the products, the statement "meat products added," or "meat by-products added," provided such parts are not in excess of 20 per cent. If this percentage is exceeded, the words "and meat products," or "and meat by-products" shall appear as a part of the name of the product and in the same size and style of lettering. The percentage of such parts added to any meat or product shall be based on the weight of the meat ingredient of the product exclusive of added substances. When a potted, deviled, or similar article of food is prepared exclusively from the above-mentioned parts, the product shall be labeled "potted-meat products," "potted-meat by-products," "deviled-meat products," "deviled-meat by-products," and the like.

Paragraph 6. On and after three years from the date of the order adopting these regulations the term "meat products" shall not be used to declare the presence of edible parts of the head other than flesh and fat, edible parts of the viscera, or other similar edible parts, as provided for in Paragraph 5 of this section, unless hereafter expressly authorized by the Secretary of Agriculture upon its being shown to his satisfaction that continuance of the use thereof for a longer period is equitable and is rendered necessary in order to utilize stocks of labels on hand or ordered at the time the regulation takes effect.

Paragraph 7. Lard may have added thereto lard stearin or stearin made from lard (hydrogenated lard) without the presence of such added substance being shown on the label.

Paragraph 8. When not over 20 per cent of oleo stearin, beef fat, mutton fat, or vegetable stearin is added to lard, there shall appear on the label, contiguous to and in the same size and style of lettering as the name of the product, the statement "oleo stearin added," "beef fat added," "mutton fat added," or "vegetable stearin added," respectively, as the case may be.

Paragraph 9. Labels for a mixture, other than oleomargarine and product referred to in Paragraph 8 of this section, consisting of fat derived from carcasses of cattle, sheep, swine, or goats, shall bear the names of the ingredients in a prominent manner in the order of their percentages, preceded by the statement "com-

posed of" or "made from," or an equivalent statement. If such product consists of a mixture of vegetable fat and fat derived from carcasses of cattle, sheep, swine, or goats, the specific name or names of the vegetable fat shall appear among the names of the other ingredients: *Provided*, That in cases where the label bears the designation "compound," "lard substitute," or "shortening," prominently displayed, the terms "vegetable fat" and "animal fat," respectively, may be employed to denote these constituents. Tierces, barrels, and half barrels containing "compound," or "lard substitutes," or "lard compound," shall, immediately after filling, be legibly marked on one end, and on the side near the end, with the true name of the product. Tin pails, drums, tubs, and similar containers of such products shall bear the true name of the product also on the side at the time of filling. Mixtures of which the lard ingredient equals or exceeds in amount the other ingredients combined may bear the name "lard compound" preceding the statement of composition provided for in this paragraph if such statement contains the specific names of the animal fat constituents.

Paragraph 19. Containers of meat packed in borax shall, at the time of packing, be marked "for export," followed on the next line by the words "packed in preservative" or such equivalent statement as may be approved for this purpose by the department, and directly beneath this there shall appear the word "establishment" or abbreviation thereof, followed by the number of the establishment at which the product is packed. The complete statement shall be applied in a conspicuous location and in letters not less than 1 inch in height.

Paragraph 11. Any meat or product containing any benzoate of soda shall be plainly labeled so as to show the presence and percentage amount of such benzoate of soda.

Paragraph 12. Coloring matter added to lard or other animal fat, except oleomargarine, under the provisions of Paragraph 3 of Section 6 of Regulation 18, shall be declared on the label in a prominent manner and contiguous to the name of the product by the statement "Artificially colored." When meat or product is placed in casings colored under the provisions of Paragraph 3 of Section 6 of Regulation 18, there shall appear on the label in a prominent manner and contiguous to the name of the meat or product one of the statements as follows: "Artificially colored," or "casing colored."

SECTION 10. No false or misleading statement of quantity shall appear on any container of meat or product.

SECTION 11. *Paragraph 1.* No marks of Federal inspection which have been previously used shall be again used for the identification of any meat or product except as provided in Paragraph 2 of this section.

Paragraph 2. All stencils, marks, labels, or other devices, whether relating to any meat or product or otherwise, on previously used containers, shall be removed or obliterated before such containers are used for any meat or product, unless such stencils, marks, labels, or devices correctly indicate the article to be packed therein and such containers are refilled under the supervision of bureau employees.

SECTION 12. *Paragraph 1.* All labeling of meat and products required to be inspected by bureau employees shall be in compliance with these regulations.

Paragraph 2. No person shall apply or affix, or cause to be applied or affixed, any label to any article prepared or received in an official establishment or to any container thereof except in compliance with these regulations.

Paragraph 3. No person shall, in an official establishment, fill or cause to be filled, in whole or in part, any container with any article required by these regulations to bear a label, except in compliance with these regulations.

Paragraph 4. No person shall remove or cause to be removed from an official establishment any meat or product bearing a label unless such label be in compliance with these regulations.

REGULATION 18. REINSPECTION AND PREPARATION OF MEAT AND PRODUCTS.

SECTION 1. Paragraph 1. All meat and products, whether fresh or cured, even though previously inspected and passed, shall be reinspected by bureau employees as often as may be necessary, in order to ascertain whether the same are sound, healthful, wholesome and fit for human food at the time the same leave official establishments. If upon reinspection any article is found to have become unsound, unhealthful, unwholesome, or in any way unfit for human food, the original mark, stamp, or label thereon shall be removed or defaced and the article condemned: *Provided, That*

(a) If an article becomes soiled or unclean by falling on the floor or in any other accidental way it may be cleaned and presented for reinspection.

(b) If an article is found to have absorbed a foreign odor, contains mould or similar substance or in the case of lard there is present the condition known as tank-water sourness in the first stage, and the article is capable of being rehandled by approved methods for food purposes, the official establishment may be permitted, if the necessary steps are immediately taken, to so rehandle it in a manner prescribed by the chief of bureau.

If upon final reinspection the article is found to be sound, healthful and wholesome, it shall be passed for human food; otherwise it shall be condemned.

Paragraph 2. Care shall be taken to see that meats and products are in good condition when placed in freezers. In case there is any doubt as to the soundness of any frozen meat or product the inspector will require the defrosting and reinspection of a sufficient quantity thereof to determine its actual condition.

SECTION 2. Upon all meat and products which are suspected on reinspection of being unsound, unhealthful, unwholesome, or in any way unfit for human food, or upon the containers thereof, there shall be placed by a bureau employee, at the time of reinspection, a "U. S. retained" tag. The employee who affixes the tag shall record the tag number and the kind and amount of the article retained. Such tag shall accompany such article to the retaining room or other special place for final inspection. When the final inspection is made, if the article is condemned, the original mark, stamp, or label thereon shall be removed or defaced and the inspector shall stamp on or write across the face of the retained tag the phrases "U. S. inspected and condemned," and this tag shall accompany such article into the tank. The inspector shall make a complete record of the transaction and shall report his action to the inspector in charge. If, however, upon final inspection the article is passed for food, the inspector shall remove the retained tag, record the transaction, and report his action to the inspector in charge.

SECTION 3. Paragraph 1. Except as provided in Regulation 12 no meat or product shall be brought into an official establishment unless it has been previously inspected and passed by a bureau employee, nor unless it can be identified by marks, seals, brands, or labels as having been so inspected and passed, nor, except as provided in Paragraph 2 of Section 12 of Regulation 27, if it has been processed elsewhere than in an official establishment. All meat and products brought into an official establishment in compliance with these regulations shall be identified and reinspected at the time of receipt, and be subjected to further reinspection in such manner and at such times as may be deemed necessary. If upon such reinspection any article is found to be unsound, unhealthful, unwholesome, or otherwise unfit for human food, the original mark, stamp, or label shall be removed or defaced and the article condemned.

Paragraph 2. Any meat or product which has been inspected and passed under these regulations and bears the inspection legend may be shipped in interstate or foreign commerce, provided it is sound, healthful, wholesome, and fit for human food and has not been processed, reprocessed, or changed in any manner so as to alter the character of the product.

Paragraph 3. Except as prohibited by Paragraph 2 of this section, cod, kidney, and breast fat from inspected and passed beef carcasses may be brought from unofficial establishments, markets, or shops which handle no beef carcasses except those which have been inspected and passed, into official establishments, provided such fats have been handled at all times in a sanitary manner and are found on reinspection, when received, to be sound, healthful, wholesome, and fit for human food.

SECTION 4. Every official establishment shall designate, with the approval of the inspector in charge, a dock or place at which returned meat and products shall be received, and such meat and products shall be received only at such docks or places and shall be there inspected by a bureau employee before entering the establishment.

SECTION 5. *Paragraph 1.* All processes used in curing, pickling, rendering, canning, or otherwise preparing any meat or product in official establishments shall be supervised by bureau employees. No fixtures or appliances, such as tables, trucks, trays, tanks, vats, machines, implements, cans, or containers of any kind, shall be used unless they are of such materials and construction as will not contaminate the meat and products and are clean and sanitary. All steps in the processes of manufacture shall be conducted carefully and with strict cleanliness in rooms or compartments separate from those used for inedible products.

Paragraph 2. All substances and ingredients used in the manufacture or preparation of any meat or product shall be clean, sound, healthful, wholesome, and otherwise fit for human food.

Paragraph 3. Pumps, pipes, conductors and fittings used to conduct milk, cream, or mixtures of milk or cream in the manufacture of oleomargarine shall be of sanitary construction, with smooth inner and outer surfaces of non-corrosive material or coated with nickel, tin, or other approved material, readily demountable for cleaning, and shall be kept clean and sanitary.

Paragraph 4. All milk and cream used in the preparation of oleomargarine shall be pasteurized and all butter used for this purpose shall be made from pasteurized products or pasteurized within the establishment.

SECTION 6. *Paragraph 1.* No meat or product shall contain any substance which impairs its wholesomeness, nor contain, except as permitted by Paragraphs 2, 3 and 8 of this section, any dye, preservative, or added chemical.

Paragraph 2. There may be added to meat and products common salt, sugar, wood smoke, cider vinegar, wine vinegar, malt vinegar, sugar vinegar, glucose vinegar, spirit vinegar, pure spices, saltpeter, nitrate of soda, and nitrite of soda. Benzoate of soda may be added to meat and products only when declared on the label, as provided by Paragraph 11 of Section 9 of Regulation 17.

Paragraph 3. Only harmless coloring matters may be used, and these only with the approval of and in such manner as may be prescribed by the chief of bureau. Such coloring matters may be used in the manner and under the conditions as follows:

(a) They may be added to prepared fats.

(b) They may be used in the preparation of casings, or by dipping casing-covered meat or product, or by other approved method, provided they do not penetrate the meat or product contained in the casing.

(c) They shall be declared as required by Paragraph 2 of Section 3 of Regulation 16 and Paragraph 12 of Section 9 of Regulation 17.

Paragraph 4. Except as otherwise provided sausage shall be prepared from meat or meat and meat by-products, seasoned with condimental proportions of condimental substances.

Paragraph 4 (a). The term "sausage" shall be construed to include head cheese, liver pudding, and blood pudding.

Paragraph 5. Under appropriate declaration, sausage may contain not more than 3.5 per cent, individually or collectively, of cereal, vegetable starch, starchy vegetable flour, dried milk, or dried skim milk.

Paragraph 5 (a). For the purpose of facilitating grinding, chopping, and mixing, not more than 3 per cent of water or ice may be added to sausage which is not cooked; sausage of the type which is cooked, such as Frankfurt style, Vienna style, and Bologna style, may contain not more than 10 per cent of added water or moisture, to make the product palatable.

Paragraph 6. No "compound," lard substitute, lard, or lard compound shall contain added water.

Paragraph 7. The use of substances necessary for the proper preparation, clarification, or refining of meat and products may be permitted, subject to the approval of the Secretary of Agriculture, provided they do not impair the quality of the meat or product and are eliminated during the further process of manufacture; as, for example, the use of bicarbonate of soda and fuller's earth in the preparation of fats, and the use of sal soda or lime in the cleansing of tripe.

Paragraph 8. When no substance is used in the preparation of packing thereof which, either in kind or in proportion, conflicts with the laws of the foreign country to which they are to be exported, and the foreign purchaser so directs in writing, meat-food products for export to such foreign country may contain preservatives in accordance with such direction. Such products shall be prepared and packed in compartments of the establishment separate and apart from the compartments in which any meat or product is prepared or packed for domestic use or consumption, except as permitted by Paragraph 9 of this section, and shall be kept separate.

Paragraph 9. The packing of articles which are prepared, as provided for in Paragraph 8 of this section, with any preservatives not permitted by Paragraph 2 of this section may be done in the regular packing room, provided no other meat or product be allowed in the packing room during the time of such packing. After the packing is completed, the packing room shall be thoroughly cleansed of the preservative before the packing of other articles therein is resumed. A separate room or compartment constructed of tight partitions or walls shall be set apart for storing the preservatives, trays, and other appliances used in connection with the packing. This room or compartment shall be held under a lock furnished by the department, the key of which shall not leave the custody of a bureau employee.

Paragraph 10. The packing of all articles under Paragraphs 8 and 9 of this section shall be conducted under the personal supervision of a bureau employee.

Paragraph 11. No article prepared or packed for export under Paragraph 8 or 9 of this section shall be sold or offered for sale for domestic use or consumption, unless and until destroyed for food purposes under the personal supervision of a bureau employee.

Paragraph 12. The contents of the container of any article prepared or packed for export under Paragraph 8 or 9 of this section shall not be removed, in whole or in part, prior to exportation, except under the supervision of a bureau employee. If such contents be removed prior to exportation, then the article shall be either repacked, in accordance with the provisions of Paragraphs 8 or 9 and Paragraph 10 of this section, or destroyed for food purposes under the personal supervision of a bureau employee.

Paragraph 13. Milk, skimmed milk, dried milk, dried skimmed milk, malted milk, and analogous substances and products which may be approved for such purpose by the Secretary of Agriculture, may be added to sausage, provided their use does not result in added water or moisture in excess of the amount permitted in Paragraph 5 of this section. Sausage shall not contain dried milk, dried skimmed milk, malted milk, or other dehydrated milk product, in excess of 3.5 per cent, and if cereal, vegetable starch, or vegetable flour is also added the combined amount of cereal, vegetable starch, vegetable flour, and dehydrated milk product shall not exceed 3.5 per cent.

Paragraph 14. Oleomargarine shall contain not less than 80 per cent fat.

SECTION 7. *Paragraph 1.* Any canned meat or product which requires sterilization to preserve it shall be sterilized on the same day that the cans are filled. Defective or leaky cans discovered after the process of sterilization has been completed shall not be repaired or repacked unless (a) the repairing or repacking be completed within six hours after the process of sterilization has been completed, or (b) if their defective or leaky condition be discovered during an afternoon run they be held in coolers of a temperature not exceeding 34° F. until the following day, when they may be repaired or repacked. Sterilization will be deemed completed within the meaning of this paragraph when the cans have sufficiently cooled for inspection and handling. The contents of all defective or leaky cans not repaired or repacked in compliance with paragraph shall be condemned.

Paragraph 2. Sausage prepared or packed in oil shall be heated to a temperature of at least 160° F. and this temperature maintained within the can for not less than thirty minutes. Cans should show a good vacuum.

Paragraph 3. Meat and products cooked in official establishments shall be cooked only in such manner as may be approved by the chief of bureau.

Paragraph 4. Inasmuch as it cannot certainly be determined, by any present known method of inspection, whether the muscle tissue of pork contains trichinæ, and inasmuch as live trichinæ are dangerous to health, no article of a kind prepared customarily to be eaten without cooking shall contain any muscle tissue of pork unless the pork has been subjected to a temperature sufficient to destroy all live trichinæ, or other treatment prescribed by the chief of bureau.

Paragraph 5. Meat and product passed for cooking may be used for the preparation of such meat and product as canned meat, sausage, cooked or boiled meat, meat loaves, and similar products, provided all parts of the meat or product are heated to a temperature not lower than 170° F. for a period of not less than thirty minutes, and further that the articles so prepared be marked in accordance with bureau requirements.

SECTION 8. Unless labeled at once, canned meat and products shall be marked so as to maintain their identity until the final label is attached.

SECTION 9. *Paragraph 1.* The only animal casings that may be used as containers of any meat or product are those from cattle, sheep, swine or goats.

Paragraph 2. Casings for meat and products shall be carefully inspected by bureau employees. Only those which have been carefully washed and thoroughly flushed with clean water, are suitable for containers, are clean, and are passed on such inspection, shall be used.

Paragraph 3. Portions of casings which show infestation with *Esophagostoma* or other nodule-producing parasite, and weasands infested with the larvæ of *Hypoderma lineata*, shall be rejected, except that when the infestation is slight and the nodules and larvæ are removed, the casing or weasand may be passed.

Paragraph 4. Intestines shall not be used as ingredients of meat-food products, except under such terms and restrictions as the chief of bureau may specifically prescribe.

Paragraph 5. The fermenting and sliming of hog and sheep casings shall be done only in compartments separate from those in which either edible or inedible products are handled.

SECTION 10. *Paragraph 1.* Heads for use in the preparation of meat-food products shall be split and the bodies of the teeth, the turbinated and ethmoid bones, ear tubes, and horn butts removed and the heads then thoroughly cleaned.

Paragraph 2. Kidneys for use in the preparation of meat-food products shall first be freely sectioned and then thoroughly soaked and washed. All detached kidneys, including beef kidneys detached with kidney fat, shall be inspected before being used in or shipped from the establishment.

Paragraph 3. Cattle paunches and hog stomachs for use in the preparation of meat-food products shall be thoroughly cleaned on all surfaces and parts immediately after being emptied of their contents.

Paragraph 4. Tonsils shall be removed and shall not be used as ingredients of meat-food products.

SECTION 11. No blood which comes in contact with the surface of the body of an animal or is otherwise contaminated shall be collected for food purposes. Only blood from animals the carcasses of which are inspected and passed may be used for meat-food products. The defibrination of blood intended for food purposes shall not be performed with the hands.

SECTION 12. Lard which is to be labeled as such shall be prepared in equipment used exclusively for that product, except that permission may be granted by the chief of bureau for restricted use of lard equipment for the preparation of other edible products. The pipes and equipment used for edible fats shall be so arranged that the identity of each product shall be maintained until the product is properly labeled.

SECTION 13. Samples of meat and products, water, dyes, chemicals, preservatives, spices, or other articles in any official or exempted establishment shall be taken, without cost to the department, for examination, as often as may be deemed necessary by the bureau.

SECTION 14. No dye, chemical, preservative, or other substance, the use of which is prohibited by these regulations, shall be brought into or kept in an official establishment.

SECTION 15. No mixture which does not contain a considerable and definite proportion of inspected and passed meat or products shall bear the inspection legend or any abbreviation or representation thereof. If any mixture of which meat or product is an ingredient contains only inspected and passed meat or product, and such ingredient is not a considerable and definite proportion thereof, and any reference is made to inspection on the label or container thereof such reference shall be in the following form: "The meat contained herein has been inspected and passed at an establishment where Federal inspection is maintained." Any mixture which does not contain a definite or considerable proportion of any meat or product may be transported in interstate or foreign commerce without being inspected or labeled under these regulations, but subject to the provisions and requirement of the Food and Drugs Act and the regulations made thereunder: *Provided*, That where such mixture is prepared in a part of an official establishment, the sanitation of that part of the establishment shall be supervised by bureau employees and the meat or product used as an ingredient therein shall be inspected before it enters the mixture.

SECTION 16. No person shall affix or place, or cause to be affixed or placed, the inspection legend, or any abbreviation, copy, or representation thereof, or the number designating an establishment where Federal meat inspection is maintained, or a statement that any ingredient has been inspected and passed at an establishment where Federal meat inspection is maintained, to or on any can, pot, tin, canvas, or other receptacle or covering constituting an immediate or true container within the meaning of these regulations, of any dog food, cat food, fox food, and the like prepared in whole or in part of meat or meat by-product: *Provided*, That dog food, cat food, fox food, and the like which are prepared in an establishment where Federal meat inspection is maintained, in whole or in part of meat or meat by-product, and which are placed in a can, pot, tin, canvas, or other receptacle or covering, may bear a statement in the following form: "The meat of meat by-product ingredient of this article has been examined and passed under Federal supervision. This article has been prepared in an establishment operating under Federal meat inspection."

When any dog food, cat food, fox food, or like article is prepared in a part of an official establishment, the sanitation of that part of the establishment shall be supervised by the bureau employees on the same basis as other parts of the establishment.

REGULATION 19. MARKET INSPECTION.

SECTION 1. *Paragraph 1.* Market inspection may be established to provide for the interstate transportation or export, from public markets and other places of portions of inspected and passed meat and products which, when cut or otherwise removed from a marked carcass, part, or container, do not show the inspection legend. Each city in which the market inspection is established shall be assigned an official number by the chief of bureau, and all articles transported under such inspection shall bear the inspection legend and the official number of the city.

Paragraph 2. Persons granted inspection under Paragraph 1 of this section shall conform to the requirements of the department governing sanitation, the use of dyes, chemicals, and preservatives, and such other matters as may be specified from time to time by the chief of bureau as applicable thereto.

SECTION 2. Unmarked portions cut from a marked carcass or part or removed from a marked container, under market inspection, for interstate transportation or for export, shall be inspected by a bureau employee at the time they are so cut or removed, and, if found to be sound, healthful, wholesome, and fit for human food, shall be marked with the inspection legend. Whenever practicable, the brand shall be applied to the meat itself. When this cannot be done, the container thereof shall be marked, for interstate transportation, as required by Regulation 16, or, for export, as required by Regulation 24.

REGULATION 20. REPORTS.

SECTION 1. Reports of the work of inspection carried on in every official establishment shall be forwarded to the department by the inspector in charge on such blank forms and in such manner as may be specified by the chief of bureau.

SECTION 2. Bureau employees shall make daily reports of the amounts of articles handled or prepared in the subdivisions of the establishments to which they are assigned and of such other things as the chief of bureau may require.

SECTION 3. Each official establishment shall furnish to bureau employees accurate information as to all matters needed by them for making their reports pursuant to Section 2 of this regulation.

SECTION 4. Reports on sanitation shall be made by the bureau employees assigned to the various subdivisions of official establishments to the inspector in charge, and by the inspector in charge to the chief of bureau.

REGULATION 21. APPEALS.

SECTION 1. When the action of an inspector in condemning any meat or product is questioned, appeal may be made to the inspector in charge, and from his decision appeal may be made to the chief of bureau or to the Secretary of Agriculture, whose decision shall be final.

REGULATION 22. COÖPERATION WITH LOCAL AUTHORITIES.

SECTION 1. Inspectors in charge shall coöperate, whenever practicable to do so in compliance with these regulations, with State, municipal, and other local officials in matters pertaining to meat inspection.

SECTION 2. Inspectors in charge shall confer with such officials at their stations and inform them of the Federal meat-inspection service, what the bureau is accomplishing in that particular locality, and, in turn, ascertain what is being done by the local officials. Such conferences shall be had from time to time, as may be practicable and mutually agreeable, with a view to Federal and local officials, each being helpful to the other in handling problems where assistance is required for the good of the service, and particularly for the purpose of preventing the use of unfit meat and products for food.

SECTION 3. If it be proposed to adopt a definite coöperative arrangement, the details thereof shall be submitted to and approved by the chief of bureau before it is put into effect.

REGULATION 23. BRIBERY, COUNTERFEITING, ETC.

SECTION 1. It is a felony, punishable by fine and imprisonment, for any person, firm, or corporation to give, pay, or offer, directly or indirectly, to any bureau employee authorized to perform any duty prescribed by the Meat-inspection Act or these regulations, any money or other thing of value with intent to influence such employee in the discharge of his duty. It is also a felony, punishable by fine and imprisonment, for any bureau employee engaged in the performance of any duty prescribed by the Meat-inspection Act or these regulations to receive or accept from any person, firm, or corporation engaged in interstate or foreign commerce any gift, money, or other thing of value given with any purpose or intent whatsoever.

SECTION 2. It is a misdemeanor, punishable by fine and imprisonment, for any person, firm, or corporation, or officer, agent, or employee thereof, to forge, counterfeit, simulate, or falsely represent, or without proper authority to use, fail to use, or detach, or knowingly or wrongfully to alter, deface, or destroy, or to fail to deface or destroy, any of the marks, stamps, tags, labels, or other identification devices provided for in the Meat-inspection Act or in and as directed by these regulations, on any carcass, part of carcass, or the food product or containers thereof, subject to the provisions of the Meat-inspection Act, or any certificate in relation thereto authorized or required in the Meat-inspection Act or as directed in these regulations.

SECTION 3. Any meat or product which bears, or the container of which bears, the inspection legend or any other mark prescribed by the Meat-inspection Act, the Imported-meat Act, or these regulations shall be subject to inspection at any time or place.

SECTION 4. Bureau employees shall report, in such form and manner as the chief of bureau shall prescribe, any meat or product which bears, or the container of which bears, the inspection legend or any other mark prescribed by the Meat-inspection Act, the Imported-meat Act, or these regulations, discovered by them outside of official establishments and which is unsound, unhealthful, unwholesome, or in any way unfit for human food, so that criminal proceedings, proceedings for the seizure of any such article under the Food and Drugs Act, or other proceedings may be instituted, as the facts may warrant.

REGULATION 24. EXPORT STAMPS AND CERTIFICATES.¹

SECTION 1. *Paragraph 1.* A numbered meat-inspection stamp shall be affixed to each outside container (except cloth wrappings) of any inspected and passed meat or product for export or to the Philippines, except ship stores and small quantities exclusively for the personal use of the consignee and not for sale or distribution.

Paragraph 2. Such stamps shall be securely affixed either (a) in a grooved space made by removing a portion of the wood of sufficient size to admit the stamp, or (b) on either end of the package, provided that the sides thereof are made to project at least $\frac{1}{8}$ of an inch to afford the necessary protection from abrasion.

Paragraph 3. The cloth wrapping used as an outside container of any inspected and passed meat or product for export shall bear the inspection legend and the establishment number applied by an ink brand.

¹ Attention is directed to the requirements of Regulation 25 governing transportation, and to the requirement of Paragraph 11 of Section 6 of Regulation 18 that articles prepared under said Section 6 for export be destroyed for food purposes before being sold or offered for sale for domestic use or consumption.

Paragraph 4. A numbered modified meat-inspection stamp containing the special certification required by the British authorities shall be affixed to each outside container of inspected and passed fresh pork cuts and organs exported to Great Britain.

Paragraph 5. A numbered meat-inspection stamp shall be affixed to each tank car of inspected and passed lard or similar edible product for shipment to Canada.

SECTION 2. *Paragraph 1.* Upon application of the exporter, the inspector in charge is authorized to issue certificates for shipments of inspected and passed meats and products to any foreign country or to the Philippines. Certificates should be issued at the time the articles leave the establishment; if not issued at that time, they may be issued later only after identification and reinspection of the article.

Paragraph 2. Export certificates shall be issued in serial numbers and in triplicate form. Each certificate shall show the names of the exporter and the consignee, the destination, the numbers of the stamps, if any, attached to the articles to be exported, the shipping marks, the kind of product, and the weight.

Paragraph 3. Only one certificate shall be issued for each consignment, unless otherwise directed by the chief of bureau.

Paragraph 4. The original certificate shall be delivered to the shipper and shall be used only for the purpose of effecting the transportation and delivery of the consignment.

Paragraph 5. The duplicate of the certificate shall be delivered to the shipper and by him delivered to the agent of the railroad or other carrier which transports the consignment from the United States otherwise than by water, or to the chief officer of the vessel on which the export shipment is made and without which no clearance shall be given to any vessel having aboard any meat or product, and shall be used only by these agencies and for the purpose of effecting the transportation of the consignment certified. The chief officer of the vessel shall file such duplicate with the customs officer at the time of filing the master's manifest or the supplemental manifest.

Paragraph 6. The triplicate of the certificate shall be retained by the inspector in charge issuing the same and forwarded to the department for filing.

Paragraph 7. Under no circumstances shall the original or the triplicate of such certificate be used for the purpose for which it is prescribed by Paragraph 5 of this section that the duplicate shall be used.

SECTION 3. *Paragraph 1.* No person operating any steam or sailing vessel, and no railroad or other carrier shall receive for transportation or transport from the United States to Great Britain or Ireland, or any of the countries of continental Europe, or to Canada, Venezuela, Argentina, Peru, Columbia, or the French Antilles, any meat or product, except ship stores and small quantities exclusively for the personal use of the consignee and not for sale or distribution, unless and until a certificate of inspection covering the same has been issued and delivered as provided in this regulation. The requirement of export certificates is waived for meat and products exported to countries other than those named in this paragraph.

Paragraph 2. Export certificates for shipments of inspected and passed meat and products to Italy, Argentina, and Venezuela shall be visaed by the consul of the country of destination at the place of origin or the first port.

Paragraph 3. The original certificate issued for shipments of inspected and passed meat and products to Peru shall be countersigned by the chief of the Bureau of Animal Industry.

Paragraph 4. The special forms of certificate required by the Canadian authorities shall appear on the reverse side of certificates issued for shipments of inspected and passed meat and products to Canada.

Paragraph 5. The certificate and description of the shipment shall appear in the French language on the reverse side of certificates issued for shipments of inspected and passed meat and products to Switzerland.

Paragraph 6. Export certificates shall not be issued for shipments of livers to Canada unless the portal lymph glands are intact.

Paragraph 7. Export certificates shall not be issued for any shipment of artificially colored meat or product for Canada.

Paragraph 8. Export certificates for carload shipments of inspected and passed meats in bulk to Canada shall show the car numbers and initials.

SECTION 4. *Paragraph 1.* Numbered inedible-product stamps and certificates of a distinctive color may be issued, upon request of the shipper, for export shipments of casings, bladders, hoofs, horns, grease, and similar inedible animal products.

Paragraph 2. Inedible-product certificates for shipments to Norway and Sweden shall have the statement "of American origin" inserted after the word "animals."

SECTION 5. No tallow, stearin, oleo oil, or the rendered fat derived from cattle, sheep, swine, or goats, that has not been inspected, passed, and marked in compliance with these regulations shall be exported, unless the shipper files with the collector of customs at the port from which the export shipment is made an affidavit by the exporter that such article is inedible.

SECTION 6. *Paragraph 1* Numbered stamps and certificates of a distinctive color, known as preservative stamps and certificates, shall be issued to identify all articles prepared or packed with preservatives for export. The stamps shall be securely affixed to containers of the article before they leave the establishment, in the manner prescribed by Paragraph 2 of Section 1 of this regulation. Unless, upon special application to him, the chief of bureau shall otherwise direct, the certificates shall be issued before the articles leave the establishment, and shall be issued and used in the same way and shall serve the same purposes, respectively, as the certificates issued pursuant to Section 2 of this regulation.

Paragraph 2. Prior to export no preservative stamp required by this section shall be detached from the container except under the personal supervision of a bureau employee. If the preservative stamp is detached, then the article in the container shall be either repacked, in accordance with the provisions of Paragraphs 8 or 9 and Paragraph 10 of Section 6 of Regulation 18, or destroyed for food purposes under the supervision of a bureau employ.

REGULATION 25. TRANSPORTATION.¹

SECTION 1. No carrier or other person shall transport or receive for transportation from one State or Territory or the District of Columbia to another State or Territory or the District of Columbia, or to any place under the jurisdiction of the United States, or to a foreign country, any article derived wholly or in part from cattle, sheep, swine, or goats unless and until a certificate is made and furnished to him in one of the forms prescribed therefor in this regulation: *Provided, however,* That any such article offered for importation into the United States may be transported and received for transportation from one State or Territory or the District of Columbia into another State or Territory or the District of Columbia, without such a certificate, if such meat or product is conveyed, prior to inspection, in cars, wagons, vehicles, or packages, sealed with special import-meat seals of the Department of Agriculture or with customs or consular seals as provided in Paragraph 8 of Section 7 of Regulation 27.

SECTION 2. *Paragraph 1.* For the purposes of these regulations the United States parcel post shall be deemed a carrier, and the provisions of these regu-

¹ Attention is directed to the facts that the Meat-inspection Act prohibits the transportation of any meat or product which does not comply with the law and these regulations, and makes a violation either of the Act or of these regulations a criminal offense punishable by a fine of \$10,000 and imprisonment for two years. Attention is also directed to the additional requirements of Regulation 24 governing export stamps and certificates, and to Section 10 of Regulation 16.

lations relating to transportation by carriers shall apply, so far as they may be applicable, to transportation by parcel post.

Paragraph 2. For the purposes of these regulations every ferry and ferry line shall be deemed a carrier, and the provisions of these regulations relating to transportation by carriers shall apply to transportation by ferry or ferry line of any meat or product loaded on a truck, wagon, cart, or other vehicle, or otherwise prepared for transportation.

SECTION 3. When any shipment of any meat or product is offered to any carrier for transportation within the United States as a part of a foreign movement, the same certificate shall be required as if the shipment were destined to a point within the United States.

SECTION 4. Paragraph 1. Jobbers, wholesalers, and others who do no slaughtering or processing and who receive meat and products which have not been processed other than under inspection in compliance with these regulations may break bulk, repack, and ship the same in interstate commerce under Section 5 of this regulation: *Provided*, That each article so shipped bears the inspection legend and is sound, healthful, wholesome, and fit for human food at the time of such shipment.

Paragraph 2. Jobbers, wholesalers, and others who do no slaughtering or processing and who receive meat and products which have not been processed other than under inspection in compliance with these regulations may ship such articles in interstate commerce under Section 5 of this regulation in the original containers in which the same were received by them: *Provided*, That such containers bear the inspection legend and the articles are sound, healthful, wholesome, and fit for human food at the time of such shipment.

Paragraph 3. Jobbers, wholesalers, and others who operate establishments in which slaughtering or processing is done without the inspection provided for in these regulations and who receive meat or products which have not been processed other than under inspection in compliance with these regulations may ship from such establishment in interstate or foreign commerce under Section 5 of this regulation any meat or product which bears the inspection legend and is sound, healthful, wholesome, and fit for human food and has not been processed, reprocessed, or changed in any manner so as to alter the character of the product.

Paragraph 4. Nothing contained in this section shall be construed as limiting the authority of bureau employees under other regulations to make inspections and reinspections of articles bearing marks of inspection.

SECTION 5. When any meat or product which has been inspected and passed and bears the inspection legend is offered to any carrier for transportation from one State or Territory or the District of Columbia, to or through another State or Territory or the District of Columbia, or to any place under the jurisdiction of the United States, or to a foreign country, the carrier shall require, and the shipper shall make and deliver to the carrier, a certificate in the following form, except as provided in Section 6 of this regulation.

Date 193

Name of carrier
 Shipper
 Point of shipment
 Consignee
 Destination

I hereby certify that the following described meat or meat-food products, which are offered for shipment in interstate or foreign commerce, have been U. S. inspected and passed by Department of Agriculture, are so marked, and at this date are sound, healthful, wholesome, and fit for human food.

Kind of product.	Amount and weight.
.....
.....
.....
..... (Signature of shipper.)	
..... (Address of shipper.)	

The signature of the shipper or of his agent shall be written in full. This certificate may be stamped upon or incorporated in any form which is ordinarily used in the transportation of meat and products. Certificates of this form or copies thereof need not be forwarded to the department at Washington.

SECTION 6. *Paragraph 1.* Any meat or product which has been inspected and passed may be transported from one official establishment to any other official establishment for further processing without each article being marked with the inspection legened, provided that the same is placed in a railroad car which is sealed¹ by a bureau employee with the official seal of the department bearing the inspection legend. Unless 25 per cent or more of the contents of each car consists of meat and products not marked with the inspection legend, transportation will not be permitted under this paragraph.

Paragraph 2. When articles are offered for transportation under Paragraph 1 of this section the carrier shall require, and the shipper shall make and deliver to the carrier, a certificate in duplicate in the following form.²

	Date.....	193.....
Name of carrier.....		
Establishment number of consignor.....		
Point of shipment.....		
Establishment number of consignee.....		
Destination.....		
Car number and initials.....		

I hereby certify that the following described meat or meat-food products have been U. S. inspected and passed by Department of Agriculture. They are not marked "U. S. inspected and passed," but have been placed in the above car under the supervision of an employee of the Bureau of Animal Industry and the car has been sealed by him with Government seals Nos. ... and ..

Kind of product.	Amount and weight.
.....
.....
.....
..... (Signature of shipper.)	
..... (Address of shipper.)	

The signature of the shipper or of his agent shall be written in full. This certificate shall be separate and apart from any waybill, bill of lading, or other form ordinarily used in the transportation of meat. The duplicate certificate

¹ Attention is directed to the law which provides a penalty of fine and imprisonment for breaking a seal on such cars without authority.

² For convenience in filing it is requested that these certificates be made on paper 5½ x 8 inches in size.

shall be forwarded immediately by the initial carrier to the Chief of the Bureau of Animal Industry, Washington, D. C.

For the purpose of the certificate under this paragraph all articles in cars permitted by Paragraph 1 of this section to be sealed shall be deemed to be "not marked."

Paragraph 3. When shipments are made under Paragraph 1 of this section the inspector in charge at the point of origin shall immediately notify the chief of bureau and the inspector in charge at the point of destination.

Paragraph 4. Inspected and passed articles may be transported from one official establishment to any other official establishment for further processing without each article being marked with the inspection legend, in a wagon securely sealed by a bureau employee with the official seal of the department bearing the inspection legend. Only wagons properly equipped for the purpose may be sealed under this paragraph.

Paragraph 5. Except as provided in Paragraph 2 of Section 13 of this regulation, seals affixed under this section shall be broken by bureau employees, and no person other than a bureau employee shall detach, break, change, or tamper with any such seal in any way whatever.

SECTION 7.—When any meat or product which has not been inspected and passed under these regulations is offered for transportation from one State or Territory or the District of Columbia to or through another State or Territory or the District of Columbia, or to any place under the jurisdiction of the United States, or to a foreign country, by any retail butcher or retail dealer who holds a certificate of exemption issued in compliance with these regulations, the carrier shall require, and such retail butcher or retail dealer shall make and deliver to the carrier's certificate in duplicate in the following form.¹

Date 193.....

Name of carrier
 Shipper
 Point of shipment
 Consignee
 Destination
 Number of exemption certificate

I hereby certify that I am a retail butcher or a retail dealer in meat or meat-food products; that the following described meat or meat-food products are offered for shipment in interstate or foreign commerce under a certificate of exemption issued to me by the United States Department of Agriculture, and that at this date they are sound, healthful, wholesome, and fit for human food, and contain no preservative or coloring matter or other substance prohibited by the regulations of the Secretary of Agriculture governing meat inspection.

Kind of product.	Amount and weight.
.....
.....
.....
	(Signature of shipper.)
	(Address of shipper.)

The signature of the shipper or of his agent shall be written in full, and each certificate shall show the exemption number of the shipper. This certificate shall be separate and apart from any waybill, bill of lading, or other form

¹ For convenience in filing it is requested that these certificates be made on paper 5½ x 8 inches in size.

ordinarily used in the transportation of meat. The duplicate certificate shall be forwarded immediately by the initial carrier to the Chief of the Bureau of Animal Industry, Washington, D. C.

SECTION 8.—When cattle, sheep, swine, or goats have been slaughtered by a farmer on the farm, and any meat or product derived therefrom is offered to a carrier for transportation from one State or Territory or the District of Columbia to or through another State or Territory or the District of Columbia or to any place under the jurisdiction of the United States, or to a foreign country, the carrier may so transport such meat or product which is identified as derived from any of such animals slaughtered by a farmer on the farm. The carrier shall require, and the shipper shall make and deliver to the carrier a certificate in duplicate in the following form.¹

Date.....193....

Name of carrier.....

Shipper.....

Point of shipment.....

Consignee.....

Destination.....

I hereby certify that the following described uninspected meat or meat-food products are from animals slaughtered by a farmer on the farm, and are offered for transportation in interstate or foreign commerce as exempted from inspection according to the Act of Congress of June 30, 1906, and that at this date they are sound, healthful, wholesome, and fit for human food, and contain no preservative or coloring matter or other substance prohibited by the regulations of the Secretary of Agriculture governing meat inspection.

Kind of product.	Amount and weight.
.....
.....
.....
 (Signature of shipper.)
 (Address of shipper.)

The signature of the shipper or of his agent shall be written in full. This certificate shall be separate and apart from any waybill, bill of lading, or other form ordinarily used in the transportation of meat. The duplicate certificate shall be forwarded immediately by the initial carrier to the Chief of the Bureau of Animal Industry, Washington, D. C.

SECTION 9.—All waybills, transfer bills, running slips, conductor's cards or other papers accompanying an interstate or foreign shipment of any meat or product shall have embodied therein, stamped thereon, or attached thereto a signed statement which shall be evidence to connecting carriers that the proper shipper's certificate, as required by Sections 5, 6, 7, and 8 of this regulation, is on file with the initial carrier; and no connecting carrier shall receive for transportation or transport any interstate or foreign shipment of any meat or product unless the waybill, transfer bill, running slip, conductor's card or other paper accompanying the same includes the aforesaid signed statement in one of the following forms:

¹ For convenience in filing these certificates shall be made on paper 5½ x 8 inches in size.

When shipment is made under Section 5 or 6:

(Name of transportation company.)

U. S. inspected and passed, as evidenced by shipper's certificates on file with initial carrier.

(Signed)..... Agent.

When shipment is made under Section 7 or 8:

(Name of transportation company.)

Exempted from inspection, as evidenced by shipper's certificate on file with initial carrier.

(Signed)..... Agent.

Signatures of agents to statements required under this section shall be written in full.

SECTION 10. When it is claimed that any meat or product, which has theretofore been inspected and passed and marked with the inspection legend, has become unsound, unhealthful, unwholesome, or in any way unfit for human food after it has been transported for sale away from an official establishment, then, in order to ascertain whether it is unsound, unhealthful, unwholesome, or in any way unfit for human food, the same may be transported from one State or Territory or the District of Columbia to any official establishment in the same or another State or Territory or the District of Columbia if a written permit in duplicate for such shipment is first obtained from the inspector in charge of the establishment to which the shipment is destined. In case of every such shipment both the original and the duplicate of the permit shall be surrendered to the carrier, and the carrier shall require and the shipper shall make and deliver to the carrier a certificate in duplicate in the following form.¹

Date.....193....

Name of carrier.....
Consignor.....
Point of shipment.....
Consignee.....
Destination.....
Number of permit.....

I hereby certify that the following described meat or meat-food products have been U. S. inspected and passed by Department of Agriculture and are so marked. It is alleged that the said meat or meat-food products are unsound, unhealthful, unwholesome, and unfit for human food.

Table with 2 columns: Kind of product, Amount and weight. Includes dotted lines for entries.

(Signature of shipper.)

(Business or occupation of shipper.)

(Address of shipper.)

¹ For convenience in filing it is requested that these certificates be made on paper 5 1/2 x 8 inches in size.

The signature of the shipper or of his agent shall be written in full, and the certificate shall in every case contain a description and the weight of the meat or product. This certificate shall be separate and apart from any waybill, bill of lading, or other form ordinarily used in the transportation of meat. One of these certificates and the duplicate copy of the inspector's permit shall be retained by the carrier; the other copy of the certificate and the original inspector's permit shall be forwarded immediately to the Chief of the Bureau of Animal Industry, Washington, D. C.

As evidence to connecting carriers that the proper shipper's certificate as required by this paragraph is on file with the initial carrier, the waybills, transfer bills, running slips, conductor's cards, or other papers accompanying such shipments shall have embodied therein, stamped thereon, or attached thereto a signed statement in the following form:

(Name of transportation company.)

U. S. inspected and passed meat or meat-food product alleged to be unsound, unwholesome, or otherwise unfit for food, as evidenced by permit and shipper's certificate on file with initial carrier.

(Signed)..... Agent.

The signature of the agent shall be written in full.

Upon the arrival of the shipment at the establishment, a careful inspection shall be made of the meat or product by a bureau inspector, and if it is found that the article is sound, healthful, wholesome, and fit for human food, the same may be received into the establishment; but if the article is found to be unsound, unhealthful, unwholesome, or in any way unfit for human food, the same shall at once be stamped "U. S. inspected and condemned" and disposed of in accordance with their regulations.

No meat or product which is unsound, unhealthful, unwholesome, or in any way unfit for human food shall be transported from an official establishment under this section, but it shall be disposed of at the official establishment in accordance with these regulations: *Provided*, That when a product is found to come within one of the classes designated in Regulation 18, Section 1 (b) in respect to which rehandling is permitted it may be transported from an official establishment and admitted into another official establishment for such rehandling. The transportation of such a product from an official establishment shall be in a manner prescribed by the Chief of the Bureau of Animal Industry.

SECTION 11. No uninspected meat or product and no inspected and passed meat or product, which is known to have become unsound, unhealthful, unwholesome, or in any way unfit for human food, including any rendered or unrendered inedible grease, inedible tallow, or other inedible fat from the carcasses of cattle, sheep, swine, or goats, and possessing the physical characteristics of an edible product, shall be transported from one State or Territory or the District of Columbia to or through another State or Territory or the District of Columbia, or to any place under the jurisdiction of the United States, or to a foreign country, for industrial use, unless it is first denatured or otherwise destroyed for food purposes. The shipper shall not offer nor the carrier accept for interstate or foreign transportation any such article until it has been denatured or otherwise destroyed for food purposes as required by this section. The carrier shall require and the shipper shall make and deliver to the carrier a certificate in duplicate in the following form:¹

Date.....	193....
Name of carrier.....
Consignor.....
Point of shipment.....
Consignee.....
Destination.....

¹ For the convenience in filing it is requested that these certificates be made on paper 5½ x 8 inches in size.

I hereby certify that the following-described inedible meat or product, or inedible grease, inedible tallow, or other inedible fat has been denatured or otherwise rendered unavailable for food purposes and is offered for shipment in interstate or foreign commerce for industrial use exclusively.

Kind of product.	Amount and weight.
.....
.....
.....
 (Signature of shipper.)
 (Business or occupation of shipper.)
 (Address of shipper.)

The signature of the shipper or of his agent shall be written in full. This certificate shall be separate and apart from any waybill, bill of lading, or other form ordinarily used in the transportation of meat. The duplicate certificate shall be forwarded immediately by the initial carrier to the Chief of the Bureau of Animal Industry, Washington, D. C.

As evidence to connecting carriers that the proper shipper's certificate is on file with the initial carrier, the waybills, transfer bills, running slips, conductor's cards or other papers accompanying such shipments shall have embodied therein, stamped thereon, or attached thereto a signed statement in the following form:

(Name of transportation company.)

Unsound, unwholesome, or otherwise unfit for human food, and denatured or otherwise rendered unavailable for food purposes, as evidenced by shipper's certificate on file with initial carrier.

(Signed).....*Agent.*

The signature of the agent shall be written in full.

SECTION 12. All original certificates delivered to a carrier in accordance with this regulation shall be filed separate and apart from all its other papers and records and retained by it for one year, in order that they may be readily checked in such manner as the Secretary of Agriculture may from time to time prescribe.

SECTION 12. *Paragraph 1.* Shipments of inspected and passed meat and products that bear the inspection legend may be diverted from the original destination without a reinspection of the articles, or in case of wreck or other extraordinary emergency the carrier may divert such shipments from the original destination without a reinspection of the articles, provided the waybills, transfer bills, running slips, conductor's cards or other papers accompanying the shipments are marked, stamped, or have attached thereto signed statements in accordance with Section 9 of this regulation.

Paragraph 2. In case of wreck or other extraordinary emergency, the department seals on a car containing any inspected and passed meat or product may be broken by the carrier, and, if necessary, the articles may be reloaded into another car, or the shipment may be diverted from the original destination, without another shipper's certificate; but in all such cases the carrier shall immediately report the facts by telegraph to the Chief of the Bureau of Animal Industry, Washington, D. C. Such report shall include the following information:

- (a) Nature of the emergency.
- (b) Place where seals were broken.
- (c) Original points of shipment and destination.

- (d) Number and initials of the original car.
- (e) Number and initials of the car into which the articles are reloaded.
- (f) New destination of the shipment.
- (g) Kind and amount of articles.

SECTION 14. The provisions of this regulation do not apply to specimens of meat and products sent to or by the Department of Agriculture or branches thereof in Washington, D. C., or elsewhere, for laboratory examination, exhibition purposes, or other official use, or to hoofs, horns, hides, etc., or inedible grease, inedible tallow, or other inedible fats, possessing none of the physical characteristics of an edible product:

REGULATION 26. FOOD AND DRUGS ACT.

SECTION 1. Inspected and passed meat and products, like uninspected meat and products, shall comply with the provisions of the Food and Drugs Act in every respect. Failure to comply renders all such articles sold or offered for sale in the District of Columbia or any territory or other place under the jurisdiction of the United States, or shipped or delivered for shipment from one State or Territory or the District of Columbia to another State or Territory or the District of Columbia, or to any foreign country, liable to seizure for condemnation, and renders manufacturers, vendors, and shippers in appropriate cases amenable to prosecution under the Food and Drugs Act.

REGULATION 27. IMPORTED MEAT AND PRODUCTS.¹

SECTION 1. *Paragraph 1.* This regulation shall apply only to meat and products derived from cattle, sheep, swine, and goats.²

Paragraph 2. The term United States, as used in this regulation, includes Alaska, Hawaii, and Puerto Rico.

SECTION 2. Whenever it shall be determined by the Secretary of Agriculture that the system of meat inspection maintained by any foreign country is not the substantial equivalent of, or is not so efficient as, the system established and maintained by the United States, or that the inspection made by any foreign country is not the substantial equivalent of, or is not so efficient as the inspection made by the United States, or that reliance cannot be placed upon certificates required under this regulation from authorities of such foreign country, due notice will be given of that fact by proclamation or otherwise, and thereafter no meat or product as to which the inspection or certification is determined to be insufficient shall be admitted into the United States from such foreign country.

SECTION 3. *Paragraph 1.* No meat or product of a kind forbidden entry into, or forbidden to be sold or restricted in sale in, the country in which the animal from which it was derived was slaughtered, or in which the article was prepared or processed, shall be admitted into the United States.

Paragraph 2. No meat or product which contains or has been treated with any preservative, coloring matter, or other substance, except as permitted by Regulation 18, shall be admitted into the United States. No article of a kind mentioned in Paragraph 4 of Section 7 of Regulation 18, unless treated in compliance therewith, shall be admitted into the United States.

Paragraph 3. No meat or product which bears, or the container of which bears, any statement, design, or device prohibited by sections 7 to 11, inclusive, of Regulation 17, or which fail to bear any qualifications with reference to added substances provided by Section 9, Regulation 17, or which is in any

¹ Imported meat and products after admission into the United States are deemed and treated as domestic articles (38 Stat. 159). Attention is invited particularly to Regulations 1, 16, 17 (Secs. 7-12, inclusive), 18 (Secs. 3, 6, 9 [Par. 1], 15), 25, 26.

² The importation of edible products derived wholly or in part from animals other than cattle, sheep, swine and goats is governed by the Food and Drugs Act as amended and the rules and regulations made pursuant thereto.

meat or product comprising the consignment, together with a description of the identification marks on the meat and products or on the packages containing the same, a description of the shipping marks, the name and address of the consignor, the name of the consignee, and the final destination of the consignment in the United States and except as provided in Paragraph 5 of this section shall be in the English language.

Paragraph 4. The foreign meat-inspection certificate required by this section to accompany each consignment containing any meat or product shall be delivered by the consignee, or his agent, in the United States to the department inspector at the place of inspection, and inspection of the meat or product will not be commenced prior to such delivery.

Paragraph 5. The foreign meat-inspection certificate of the national government of a foreign country, the form and substance of which has been approved by the department and which is issued for any meat or product, may be accepted in lieu of the certificate prescribed in Section 5, Paragraph 1, of this regulation, notwithstanding the fact that the name of the foreign official who signed such certificate has not been published by the department.

Paragraph 6. Except as provided in Section 11 of this regulation, each consignment of any meat or product of a kind prepared customarily to be eaten without cooking (such as summer sausage, "Italian" and "Westphalia" hams, and the like), which contains any muscle tissue of pork, shall be accompanied, in addition, to any other certificate required by this section, by a separate foreign meat-inspection certificate in the following form:

OFFICIAL MEAT-INSPECTION CERTIFICATE FOR PORK AND PORK PRODUCTS.

(For shipment to the United States of articles of a kind prepared customarily to be eaten without cooking, which contain muscle tissue of pork.)

Place..... Date.....193....
 (City.) (Country.)

I hereby certify that the article or articles herein described are of a kind prepared customarily to be eaten without cooking, and contain muscle tissue of pork which, when fresh or freshly cured in salt, were subjected to a temperature not higher than 5° F. for not less than twenty days, or otherwise treated as specified by the Chief of the Bureau of Animal Industry, and that said articles contain no muscle tissue of pork which has not been treated as herein specified.

Kind of product.	Number of pieces or packages.	Weight.
.....
.....
.....
Identification marks on meats and packages.....		
Consignor.....	Address.....	
Consignee.....	Destination.....	
Shipping marks.....	(Signature).....	
	(Name of official of national foreign government authorized to issue inspection certificates for meat and meat-food products exported to the United States.)	
	(Official title).....	

NOTE.—A certificate in the above form is required to accompany each consignment of any meat or product of a kind prepared customarily to be eaten without cooking (such as summer sausage, "Italian" and "Westphalia" hams, and the like), which contains any muscle tissue of pork. This certificate is to

be delivered by the consignee, or his agent, to the inspector of the Department of Agriculture at the point of inspection in the United States.

Each such foreign meat-inspection certificate shall be subject to the provisions of Paragraphs 2 to 4, inclusive, of this section.

SECTION 6. Each importer shall make application for inspection to the inspector in charge, if one be stationed at the port where any meat or product is to be offered for importation, or, if not, to the Chief of the Bureau of Animal Industry, Department of Agriculture, Washington, D. C., as long as possible in advance of the anticipated arrival of each consignment, except in the case of consignments of meat and products expressly exempted from inspection by Section 11 of this regulation. Each application shall state the approximate date on which the consignment is due to arrive in the United States, the name of the boat or other carrier transporting it, the name of the country from which the meat and products were shipped, the place of destination, the quantity and kind of the product, and whether fresh, cured, or canned. In case of consignments arriving in the United States by water, the application should also state the port of first arrival in the United States.

SECTION 7. *Paragraph 1.* Except as provided in Section 11 of this regulation, all meat and products offered for importation from any foreign country shall be inspected by a department inspector before the same shall be admitted into the United States.

Paragraph 2. All meat and products required by this regulation to be inspected, which arrive in the United States by water at any port where a department inspector is stationed, shall be inspected on the wharf at the time of unloading, except that if, upon the application of the consignee, or his agent, the inspector in charge at such port shall so direct, the articles may be inspected at any other place within the limits of the port or elsewhere in the United States.

Paragraph 3. All meat and products required by this regulation to be inspected, which arrive in the United States by water at a port where no department inspector is stationed and which are consigned to any place where a department inspector is stationed, shall be inspected at destination.

Paragraph 4. All meat and products required by this regulation to be inspected, which arrive in the United States by water at a port where no department inspector is stationed and which are consigned to any place where no department inspector is stationed, shall be inspected at such place as the chief of bureau, on application of the consignee or his agent, or upon the request of the customs officer at the port of arrival, shall direct.

Paragraph 5. All meat and products required by this regulation to be inspected, which arrive in the United States otherwise than by water and which are consigned to any place where a department inspector is stationed, shall be inspected at destination.

Paragraph 6. All meat and products required by this regulation to be inspected, which arrive in the United States otherwise than by water and which are consigned to any place where no department inspector is stationed, shall be inspected at such place as the chief of bureau, on application of the consignee or his agent, or upon the request of the customs officer at the port of arrival, shall direct.

Paragraph 7. No meat or product required by this regulation to be inspected shall be moved, prior to inspection, from the port of first arrival in the United States, or, if arriving by water, from the wharf where unloaded, unless the same is conveyed in cars, wagons, or other vehicles, sealed, or in packages corded and sealed, in compliance with Paragraph 8 of this section.

Paragraph 8. Cars, wagons, vehicles, or packages in which any meat or product is conveyed in accordance with this section, prior to inspection, from the port of first arrival in the United States, or, if arriving by water, from the wharf where unloaded, unless already sealed with customs or consular seals in accordance with the customs regulations, shall be sealed with special import-meat seals of the Department of Agriculture. Packages shall be securely

corded before being offered for sealing. Such special seals shall be affixed by department inspectors, or, if there be no department inspector at such port or wharf, then by customs officers.

Paragraph 9. Except customs officers and department inspectors, no person shall affix, break, alter, deface, mutilate, remove, or destroy any special import-meat seal of the Department of Agriculture.

Paragraph 10. No meat or product shall be removed from any car, wagon, vehicle, or package sealed with a special import-meat seal of the Department of Agriculture except under the supervision of a department inspector or a customs officer.

Paragraph 11. No meat or product required by this regulation to be inspected shall be moved, prior to inspection, from any port, or, if arriving by water, from the wharf where first unloaded, to any place other than the place designated by, or in accordance with, this section as the place where the same shall be inspected.

Paragraph 12. No meat or product required by this regulation to be inspected shall be conveyed, prior to inspection, from any port, or, if arriving by water, from the wharf where first unloaded, in any manner other than in compliance with this section.

Paragraph 13. No meat or product required by this regulation to be inspected shall be delivered to the consignee or his agent prior to inspection, unless the consignee shall furnish a bond, in form prescribed by the Secretary of Treasury, conditioned that the meat or product shall be returned, if demanded, to the collector of the port where the same is offered for clearance through the customs.

Paragraph 14. The consignee or his agent shall furnish such facilities and shall provide such assistants for handling and marking meat and products offered for importance as department inspectors may require.

SECTION 8.—Compartments of steamships, sailing vessels, railroad cars, and other conveyances transporting any meat or product to the United States, and all trucks, chutes, platforms, racks, tables, tools, utensils, and all other devices used in moving and handling any meat or product offered for importation into the United States, shall be maintained in a sanitary condition.

SECTION 9. *Paragraph 1.* Department inspectors shall take, without cost to the United States, from each consignment offered for importation, samples of any meat or product which is subject to chemical analysis, except that samples of any meat or product offered for importation without inspection under Section 11 of this regulation shall not be taken unless there is reason for suspecting the presence therein of a substance in violation of that section.

Paragraph 2. If the inspection of samples indicates that any meat or product offered for importation into the United States is unsound, unhealthful, unwholesome, or otherwise unfit for human food, a thorough inspection of the whole consignment from which the samples were taken shall be made.

Paragraph 3. Carcasses and parts of carcasses offered for importation from which such tissues as the peritoneum, pleura, body lymph glands, or the portal glands of the liver have been removed, shall be condemned.

Paragraph 4. Any meat or product offered for importation which is found upon inspection to be unsound, unhealthful, unwholesome, or otherwise unfit for human food, or to contain any dye, chemical, preservative or ingredient not permitted by Regulation 18, or which is of a kind required by Paragraph 1 of Section 3 of this regulation to be refused admission, shall be condemned and marked "U. S. inspected and condemned," except that, upon application to the inspector, any meat or product which is found to contain preservatives not permitted by these regulations, but in the preparation or packing of which no substance has been used in conflict with the laws of the foreign country from which exported, and which is not found to be otherwise unsound, unhealthful, unwholesome, or unfit for human food, may be marked "U. S. refused entry."

Paragraph 5. Any meat or product, or the container thereof, offered for importation from any foreign country and accompanied by a foreign certificate of inspection as required by this regulation, which, upon inspection by depart-

ment inspectors, is not found to be unsound, unhealthful, unwholesome, or otherwise unfit for human food, or to contain any dye, chemical, preservative, or ingredient not permitted by Regulation 18, or to violate this regulation in any respect, shall be marked "U. S. inspected and passed by Department of Agriculture" and with the official name or abbreviation of the station to which the inspector is assigned. All meat and products so marked, in compliance with this regulation, shall, so far as the Department of Agriculture has jurisdiction over the same, be admitted into the United States.

Paragraph 6. Department inspectors shall report their findings as to any meat or product which has been inspected, in accordance with this regulation, to the collector at the port where the same is offered for clearance through the customs, and shall request the collector to refuse admission to all meat and products which are marked either "U. S. Inspected and condemned" or "U. S. refused entry," and to direct that the same be exported by the consignee within a specified time, unless the consignee, within such specified time, shall cause the destruction thereof for food purposes under the supervision of a department inspector. Such specified time shall be thirty days after such notice to customs officers, unless a different time be fixed by the Secretary of Agriculture upon application to him. If any such meat or product be destroyed for food purposes under the supervision of a department inspector, he shall give prompt notice thereof to the collector.

Paragraph 7. Upon the request of the collector, consignees shall, at their own expense, immediately return to him any meat or product which is marked either "U. S. inspected and condemned" or "U. S. refused entry," or which, in any respect, does not comply with this regulation. All such meat and products shall be conveyed in cars, wagons, or other vehicles, or in corded packages, sealed with the special import-meat seal of the Department of Agriculture.

Paragraph 8. No person shall remove or cause to be removed from any place designated by, or in accordance with, these regulations as a place of inspection any meat or product which these regulations require to be marked in any way, unless the same has been clearly and legibly marked in compliance with these regulations.

Paragraph 9. The marks required by Paragraphs 4 and 5 of this section shall be applied by branding to carcasses and parts of carcasses offered for importation which are unwrapped or not inclosed in a container. No less than one brand shall be applied to each quarter of a beef carcass.

SECTION 10. *Paragraph 1.* Cans, tins, pots, glass, and wrappers of paper, wood, or similar material containing any meat or product offered for importation shall be marked as required by this section.

Paragraph 2. Labels bearing the true name of the product shall be securely affixed to all true containers. There shall be on each true container a space for the application of the inspection legend and other marks required by Paragraph 3 of this section. When true containers are placed within other containers, the outside container shall be marked with the true name of the meat or product. All meats and products in package form shall have the quantity of the contents thereof plainly and conspicuously marked on the outside of the package in terms of weight, measure, or numerical count: *Provided*, That such reasonable variations and tolerance and also exemptions as to small packages shall be permitted as shall be established by rules and regulations made pursuant to the Food and Drugs Act.

Paragraph 3. (a) All outside containers of meat and products which have been inspected and passed in compliance with this regulation shall be marked by the inspector, or under his supervision, "U. S. inspected and passed by Department of Agriculture," and with the official name or abbreviation of the station to which the inspector is assigned.

(b) All true containers of meat and products which have been inspected and passed in compliance with this regulation, and which are to be removed from the outside containers and thereafter to be transported in interstate or foreign commerce or to an official establishment, shall be marked by the inspector, or

under his supervision, by means of labels or stickers securely affixed thereto, "U. S. inspected and passed by Department of Agriculture," and with the official name or abbreviation of the station to which the inspector is assigned.

(c) To each true container of imported meat and products received at an official establishment and there removed from an outside container there shall be securely affixed, before the same shall be allowed to leave the establishment, a label or sticker bearing the inspection legend "U. S. inspected and passed by Department of Agriculture," and the establishment number.

SECTION 11. Paragraph 1. Any meat or product offered for importation in small quantity exclusively for the personal use of the consignee, and not for sale or distribution, which is sound, healthful, wholesome, and fit for human food, and contains no dye, chemical, preservative, or ingredient not permitted by Regulation 18, and which is not adulterated or misbranded within the meaning of the Food and Drugs Act as amended, may be admitted into the United States without foreign meat-inspection certificates and without inspection and marking; but department inspectors may inspect any meat or product offered for importation under this paragraph if there is reason for suspecting that it is unsound, unhealthful, unwholesome, or otherwise unfit for food, or contains any dye, chemical, preservative, or ingredient not permitted by Regulation 18, or is adulterated or misbranded within the meaning of the Food and Drugs Act as amended.

Paragraph 2. No meat or product offered for importation under Paragraph 1 of this section shall be admitted into the United States if it is unsound, unhealthful, unwholesome, or otherwise unfit for human food, or if it contains any dye, chemical, preservative, or ingredient not permitted by Regulation 18, or if it is adulterated or misbranded within the meaning of the Food and Drugs Act as amended.

Paragraph 3. No carrier or other person shall transport or receive for transportation from any State or Territory or the District of Columbia to or through any other State, Territory, or the District of Columbia, or to any place under the jurisdiction of the United States, any meat or product exempted from inspection and admitted into the United States in compliance with this section unless the shipper shall make and deliver to the carrier a certificate in duplicate in the following form.¹

Date.....193....

Name of carrier.....
Shipper.....
Point of shipment.....
Consignee.....

I hereby certify that the following described uninspected meat or meat-food products, offered for transportation in interstate commerce, were imported into the United States exclusively for the personal use of the consignee, and not for sale or distribution, and are exempted from inspection by the regulations governing the meat inspection of the United States Department of Agriculture.

Kind of product.	Amount and weight.
.....
.....
.....
	(Signature of shipper.)
	(Address of shipper.)

The signature of the shipper or of his agent shall be written in full. This certificate shall be separate and apart from any waybill, bill of lading, or other

¹ For the convenience in filing it is requested that these certificates be made on paper 5½ x 8 inches in size.

form ordinarily used in the shipment of meat. The duplicate certificate shall be forwarded immediately by the initial carrier to the Chief of the Bureau of Animal Industry, Washington, D. C. All waybills, transfer bills, running slips, or conductor's cards accompanying an interstate shipment of any meat or product transported in compliance with this section shall have embodied therein, stamped thereon, or attached thereto a signed statement which shall be evidence to connecting carriers that the shipper's certificate required by this section is on file with the initial carrier; and no connecting carrier shall receive for transportation or transport any interstate shipment of any meat or product under this section unless the waybill, transfer bill, running slip, conductor's card, or other paper, accompanying the same includes the aforesaid signed statement, in the following form:

(Name of transportation company.)

Imported for the personal use of consignee and exempt from inspection, as evidenced by shipper's certificate on file with initial carrier.

(Signed).....Agent.

The signature of the agent shall be written in full.

SECTION 12.—*Paragraph 1.* All imported meat and products, after admission into the United States in compliance with this regulation, shall be deemed and treated, and, except as provided in Paragraph 3 of Section 11 of this regulation, shall be handled and transported as domestic meat and products, and shall be subject to all these regulations and to the provisions, prohibitions, and penalties of the Meat-inspection Act.

Paragraph 2. Imported meat and products inspected, passed, and marked in accordance with the regulation may, subject to the provisions of Paragraph 1 of Section 3 of Regulation 18, be taken into official establishments and be mixed with or added to meat and products in such establishments which have been inspected and passed therein.

Paragraph 3. Imported meat and products which have been inspected, passed, and marked under the regulation may be transported from one State or Territory or the District of Columbia to or through another State or Territory or the District of Columbia, or to any place under the jurisdiction of the United States, or to a foreign country, only upon compliance with Regulation 25.

REGULATION 28. THE INSPECTION OF CATTLE AT UNOFFICIAL PLACES.

SECTION 1. The carcasses of cattle which are slaughtered on the farm or other place designated by the chief of the Bureau of Animal Industry and which are examined by bureau inspectors at the time of slaughter, may be marked "U. S. inspected and passed" by the inspectors if, upon inspection, they are found to be sound, healthful, wholesome, and fit for human food, or if they otherwise meet the requirements of these regulations, they may be passed for sterilization and shall then be handled in accordance with the provisions of these regulations.

REGULATION 29. THE INSPECTION AND HANDLING OF HORSE MEAT AND MEAT-FOOD PRODUCTS THEREOF, AND THE ANIMALS FROM WHICH THEY ARE DERIVED.

SECTION 1. Every establishment in which horses are slaughtered for transportation or sale as articles of interstate or foreign commerce, or in which carcasses, parts of carcasses, meat, meat products, or meat-food products of, or derived from, horses are, wholly or in part, canned, cured, smoked, salted, packed, rendered or otherwise prepared for transportation or sale as articles for interstate or foreign commerce which are capable of being used as food for man, shall have inspection under these regulations.

SECTION 2. The slaughter of horses and the preparation and handling of the meat and meat-food products thereof shall be conducted in establishments

separate and apart from any establishment in which cattle, sheep, swine, or goats are slaughtered, or the meat or meat-food products thereof are prepared or handled.

SECTION 3. *Paragraph 1.* All horses found upon either antemortem or postmortem inspection or examination to be affected with strangles, purpura hemorrhagica, azoturia, forage poisoning or so-called cerebrospinal meningitis, dourine, acute influenza, generalized osteoporosis, glanders, farcy, or other malignant disorder, acute inflammatory lameness or extensive fistula, shall be condemned.

Paragraph 2. Any horse which is suspected on the antemortem inspection of being infected with glanders shall be tested with mallein; and any horse which on physical examination is suspected of being affected with dourine shall be held for further examination or for such test as the chief of the bureau may prescribe.

SECTION 4. All horse carcasses, parts of carcasses, meat and meat-food products thereof shall be conspicuously labeled, marked, branded, or tagged "Horse meat" or "Horse-meat product."

SECTION 5. The domestic-meat labels for horse meat or meat-food products thereof shall be printed on paper, light green in color. The legend composing the body of each label shall be as follows: "The horse meat or meat-food product thereof contained herein has been U. S. inspected and passed by Department of Agriculture," and in lieu of the phrase "Domestic-meat label" there shall be printed thereon the phrase "Domestic horse meat or horse-meat product."

SECTION 6. Numbered stamps and certificates printed on paper light green in color, to be known as export horse-meat stamps and certificates, shall be issued to identify all horse meat and meat-food products thereof packed for export. Such stamp or stamps and certificate shall be issued for each consignment of horse meat or meat-food product thereof forwarded from the United States.

SECTION 7.—All the provisions of the other regulations governing the meat inspection of the United States Department of Agriculture, unless specifically inapplicable, are hereby made applicable to the inspection and handling of horse meat and meat-food products thereof and the animals from which they are derived.

LAWS UNDER WHICH THE FOREGOING REGULATIONS ARE MADE.

THE MEAT-INSPECTION ACT.

Extract from an Act of Congress entitled "An Act making appropriations for the Department of Agriculture for the fiscal year ending June thirtieth, nineteen hundred and seven," approved June 30, 1906 (34 Stat. 674), and from an Act of Congress entitled "An Act making appropriations for the Department of Agriculture for the fiscal year ending June thirtieth, nineteen hundred and eight," approved March 4, 1907 (34 Stat. 1260).

[1] That [hereafter],¹ for the purpose of preventing the use in interstate or foreign commerce, as hereinafter provided, of meat and meat-food products which are unsound, unhealthful, unwholesome, or otherwise unfit for human food, the Secretary of Agriculture, at his discretion, may cause to be made, by inspectors appointed for that purpose, an examination and inspection of all cattle, sheep, swine, and goats before they shall be allowed to enter into any slaughtering, packing, meat-canning, rendering, or similar establishment, in which they are to be slaughtered and the meat and meat-food products thereof are to be used in interstate or foreign commerce; and all cattle, swine, sheep, and goats found on such inspection to show symptoms of disease shall be set

¹ The word "hereafter" is used in the Act of 1907 but not in that of 1906. Otherwise the extract here given is identical in both laws.

apart and slaughtered separately from all other cattle, sheep, swine, or goats, and when so slaughtered the carcasses of said cattle, sheep, swine, or goats shall be subject to a careful examination and inspection, all as provided by the rules and regulations to be prescribed by the Secretary of Agriculture as herein provided for.

[2] That for the purposes hereinbefore set forth the Secretary of Agriculture shall cause to be made by inspectors appointed for that purpose, as herein-after provided, a postmortem examination and inspection of the carcasses and parts thereof of all cattle, sheep, swine, and goats to be prepared for human consumption at any slaughtering, meat-canning, salting, packing, rendering, or similar establishment in any State, Territory, or the District of Columbia for transportation or sale as articles of interstate or foreign commerce; and the carcasses and parts thereof of all such animals found to be sound, healthful, wholesome, and fit for human food shall be marked, stamped, tagged, or labeled as "Inspected and Passed;" and said inspectors shall label, mark, stamp, or tag as "Inspected and Condemned," all carcasses and parts thereof of animals found to be unsound, unhealthful, unwholesome, or otherwise unfit for human food; and all carcasses and parts thereof thus inspected and condemned shall be destroyed for food purposes by the said establishment in the presence of an inspector, and the Secretary of Agriculture may remove inspectors from any such establishment which fails to so destroy any such condemned carcass or part thereof, and said inspectors, after said first inspection shall, when they deem it necessary, reinspect said carcasses or parts thereof to determine whether since the first inspection the same have become unsound, unhealthful, unwholesome, or in any way unfit for human food, and if any carcass or any part thereof shall, upon examination and inspection subsequent to the first examination and inspection, be found to be unsound, unhealthful, unwholesome, or otherwise unfit for human food, it shall be destroyed for food purposes by the said establishment in the presence of an inspector, and the Secretary of Agriculture may remove inspectors from any establishment which fails to so destroy any such condemned carcass or part thereof.

[3] The foregoing provisions shall apply to all carcasses or parts of carcasses of cattle, sheep, swine, and goats, or the meat or meat products thereof which may be brought into any slaughtering, meat-canning, salting, packing, rendering, or similar establishment, and such examination and inspection shall be had before the said carcasses or parts thereof shall be allowed to enter into any department wherein the same are to be treated and prepared for meat-food products; and the foregoing provisions shall also apply to all such products which, after having been issued from any slaughtering, meat-canning, salting, packing, rendering, or similar establishment, shall be returned to the same or to any similar establishment where such inspection is maintained.

[4] That for the purpose hereinbefore set forth the Secretary of Agriculture shall cause to be made by inspectors appointed for that purpose an examination and inspection of all meat-food products prepared for interstate or foreign commerce in any slaughtering, meat-canning, salting, packing, rendering, or similar establishment, and for the purpose of any examination and inspection said inspector shall have access at all times, by day or night, whether the establishment be operated or not, to every part of said establishment; and said inspectors shall mark, stamp, tag, or label as "Inspected and Passed" all such products found to be sound, healthful, and wholesome, and which contain no dyes, chemicals, preservatives, or ingredients which render such meat or meat-food products unsound, unhealthful, unwholesome, or unfit for human food; and said inspectors shall label, mark, stamp, or tag as "Inspected and Condemned" all such products found unsound, unhealthful, and unwholesome, or which contain dyes, chemicals, preservatives, or ingredients which render such meat or meat-food products unsound, unhealthful, unwholesome, or unfit for human food, and all such condemned meat-food products shall be destroyed for food purposes, as hereinbefore provided, and the Secretary of Agriculture may remove inspectors from any establishment which fails to so destroy such

condemned meat-food products: *Provided*, That, subject to the rules and regulations of the Secretary of Agriculture, the provisions hereof in regard to preservatives shall not apply to meat-food products for export to any foreign country and which are prepared or packed according to the specifications or directions of the foreign purchaser, when no substance is used in the preparation or packing thereof in conflict with the laws of the foreign country to which said article is to be exported; but if said article shall be in fact sold or offered for sale for domestic use or consumption, then this proviso shall not exempt said article from the operation of all the other provisions of this act.

[5] That when any meat or meat-food product prepared for interstate or foreign commerce which has been inspected as hereinbefore provided and marked "Inspected and Passed" shall be placed or packed in any can, pot, tin, canvas, or other receptacle or covering in any establishment where inspection under the provisions of this act is maintained, the person, firm or corporation preparing said product shall cause a label to be attached to said can, pot, tin, canvas, or other receptacle or covering, under the supervision of an inspector, which label shall state that the contents thereof have been "Inspected and Passed" under the provisions of this act; and no inspection and examination of meat or meat-food products deposited or inclosed in cans, tins, pots, canvas, or other receptacle or covering in any establishment where inspection under the provisions of this act is maintained shall be deemed to be complete until such meat or meat-food products have been sealed or inclosed in said can, tin, pot, canvas, or other receptacle or covering under the supervision of an inspector, and no such meat or meat-food products shall be sold or offered for sale by any person, firm, or corporation in interstate or foreign commerce under any false or deceptive name; but established trade name or names which are usual to such products and which are not false and deceptive and which shall be approved by the Secretary of Agriculture are permitted.

[6] The Secretary of Agriculture shall cause to be made, by experts in sanitation or by other competent inspectors, such inspection of all slaughtering, meat-canning, salting, packing, rendering, or similar establishments in which cattle, sheep, swine, and goats are slaughtered and the meat and meat-food products thereof are prepared for interstate or foreign commerce as may be necessary to inform himself concerning the sanitary conditions of the same, and to prescribe the rules and regulations of sanitation under which such establishments shall be maintained, and where the sanitary conditions of any such establishment are such that the meat or meat-food products are rendered unclean, unsound, unhealthful, unwholesome, or otherwise unfit for human food, he shall refuse to allow said meat or meat-food products to be labeled, marked, stamped, or tagged as "Inspected and Passed."

[7] That the Secretary of Agriculture shall cause an examination and inspection of all cattle, sheep, swine, and goats, and the food products thereof, slaughtered and prepared in the establishments hereinbefore described for the purposes of interstate or foreign commerce to be made during the nighttime as well as during the daytime when the slaughtering of said cattle, sheep, swine, and goats, or the preparation of said food products is conducted during the nighttime.

[8] That on and after October first, nineteen hundred and six, no person, firm, or corporation shall transport or offer for transportation, and no carrier of interstate or foreign commerce shall transport or receive for transportation from one State or Territory or the District of Columbia to any other State or Territory or the District of Columbia, or to any place under the jurisdiction of the United States or to any foreign country, any carcasses or parts thereof, meat, or meat-food products thereof which have not been inspected, examined, and marked as "Inspected and Passed," in accordance with the terms of this act and with the rules and regulations prescribed by the Secretary of Agriculture: *Provided*, That all meat and meat-food products on hand on October first, nineteen hundred and six, at establishments where inspection has not been maintained, or which have been inspected under existing law, shall be

examined and labeled under such rules and regulations as the Secretary of Agriculture shall prescribe, and then shall be allowed to be sold in interstate or foreign commerce.

[9] That no person, firm, or corporation, or officer, agent, or employee thereof, shall forge, counterfeit, simulate, or falsely represent, or shall without proper authority use, fail to use, or detach, or shall knowingly or wrongfully alter, deface, or destroy, or fail to deface or destroy, any of the marks, stamps, tags, labels, or other identification devices provided for in this act, or in and as directed by the rules and regulations prescribed hereunder by the Secretary of Agriculture, on any carcasses, parts of carcasses, or the food product, or containers thereof, subject to the provisions of this act, or any certificate in relation thereto, authorized or required by this act or by the said rules and regulations of the Secretary of Agriculture.

[10] That the Secretary of Agriculture shall cause to be made a careful inspection of all cattle, sheep, swine, and goats intended and offered for export to foreign countries at such times and places, and in such manner as he may deem proper, to ascertain whether such cattle, sheep, swine, and goats are free from disease.

[11] And for this purpose he may appoint inspectors who shall be authorized to give an official certificate clearly stating the condition in which such cattle, sheep, swine, and goats are found.

[12] And no clearance shall be given to any vessel having on board cattle, sheep, swine, or goats for export to a foreign country until the owner or shipper of such cattle, sheep, swine, or goats has a certificate from the inspector herein authorized to be appointed, stating that the said cattle, sheep, swine, or goats are sound and healthy, or unless the Secretary of Agriculture shall have waived the requirement of such certificate of export to the particular country to which such cattle, sheep, swine, or goats are to be exported.

[13] That the Secretary of Agriculture shall also cause to be made a careful inspection of the carcasses and parts thereof of all cattle, sheep, swine and goats, the meat of which, fresh, salted, canned, corned, packed, cured, or otherwise prepared, is intended and offered for export to any foreign country, at such time and places and in such manner as he may deem proper.

[14] And for this purpose he may appoint inspectors who shall be authorized to give an official certificate stating the condition in which said cattle, sheep, swine, or goats, and the meat thereof, are found.

[15] And no clearance shall be given to any vessel having on board any fresh, salted, canned, corned, or packed beef, mutton, pork, or goat meat, being the meat of animals killed after the passage of this act, or except as hereinbefore provided for export to and sale in a foreign country from any port in the United States, until the owner or shipper thereof shall obtain from an inspector appointed under the provisions of this act a certificate that the said cattle, sheep, swine, and goats were sound and healthy at the time of inspection, and that their meat is sound and wholesome, unless the Secretary of Agriculture shall have waived the requirements of such certificate for the country to which said cattle, sheep, swine, and goats or meats are to be exported.

[16] That the inspectors provided for herein shall be authorized to give official certificates of the sound and wholesome condition of the cattle, sheep, swine, and goats, their carcasses and products as herein described, and one copy of every certificate granted under the provisions of this act shall be filed in the Department of Agriculture, another copy shall be delivered to the owner or shipper, and when the cattle, sheep, swine, and goats or their carcasses and products are sent abroad, a third copy shall be delivered to the chief officer or the vessel on which the shipment shall be made.

[17] That no person, firm, or corporation engaged in the interstate commerce of meat or meat-food products shall transport or offer for transportation, sell or offer to sell any such meat or meat-food products in any State or Territory or in the District of Columbia or any place under the jurisdiction of the United States, other than the State or Territory or in the District of Columbia or

any place under the jurisdiction of the United States in which the slaughtering, packing, canning, rendering, or other similar establishment owned, leased, operated by said firm, person, or corporation is located unless and until said person, firm, or corporation shall have complied with all of the provisions of this act.

[18] That any person, firm, corporation, or any officer or agent of any such person, firm, or corporation, who shall violate any of the provisions of this act shall be deemed guilty of a misdemeanor, and shall be punished on conviction thereof by a fine of not exceeding ten thousand dollars or imprisonment for a period of not more than two years, or by both such fine and imprisonment, in the discretion of the court.

[19] That the Secretary of Agriculture shall appoint from time to time inspectors to make examination and inspection of all cattle, sheep, swine, and goats, the inspection of which is hereby provided for, and of all carcasses and parts thereof, and of all meats and meat-food products thereof, and of the sanitary conditions of all establishments in which such meat and meat-food products hereinbefore described are prepared; and said inspectors shall refuse to stamp, mark, tag, or label any carcass or any part thereof, or meat-food product therefrom, prepared in any establishment hereinbefore mentioned, until the same shall have actually been inspected and found to be sound, healthful, wholesome, and fit for human food, and to contain no dyes, chemicals, preservatives, or ingredients which render such meat-food product unsound, unhealthful, unwholesome, or unfit for human food; and to have been prepared under proper sanitary conditions, hereinbefore provided for; and shall perform such other duties as are provided by this act and by the rules and regulations to be prescribed by said Secretary of Agriculture; and said Secretary of Agriculture shall, from time to time, make such rules and regulations as are necessary for the efficient execution of the provisions of this act, and all inspections and examinations made under this act shall be such and made in such manner as described in the rules and regulations prescribed by said Secretary of Agriculture not inconsistent with the provisions of this act.

[20] That any person, firm, or corporation, or any agent or employee of any person, firm, or corporation, who shall give, pay, or offer, directly or indirectly to any inspector, deputy inspector, chief inspector, or any other officer or employee of the United States authorized to perform any of the duties prescribed by this act or by the rules and regulations of the Secretary of Agriculture any money or other thing of value, with intent to influence said inspector, deputy inspector, chief inspector, or other officer or employee of the United States in the discharge of any duty herein provided for, shall be deemed guilty of a felony and, upon conviction thereof, shall be punished by a fine not less than five thousand dollars nor more than ten thousand dollars and by imprisonment not less than one year nor more than three years; and any inspector, deputy inspector, chief inspector, or other officer or employee of the United States authorized to perform any of the duties prescribed by this act who shall accept any money, gift, or other thing of value from any person, firm, or corporation, or officers, agents, or employees thereof, given with intent to influence his official action, or who shall receive or accept from any person, firm, or corporation engaged in interstate or foreign commerce any gift, money, or other thing of value given with any purpose or intent whatsoever, shall be deemed guilty of a felony and shall, upon conviction thereof, be summarily discharged from office and shall be punished by a fine not less than one thousand dollars nor more than ten thousand dollars and by imprisonment not less than one year nor more than three years.

(PUBLIC—No. 776—75TH CONGRESS)

(CHAPTER 810—3D SESSION)

[H. R. 8047]

AN ACT

To amend the Meat Inspection Act of March 4, 1907, as amended and extended, with respect to its application to farmers, retail butchers, and retail dealers.

Be it enacted by the Senate and House of Representatives of the United States of America in Congress assembled, That the Meat Inspection Act of March 4, 1907, as amended and extended, is amended by substituting for the concluding paragraph thereof the following:

"That within the meaning of this Act—

"(a) A 'farmer' means any person or partnership chiefly engaged in producing agricultural products on whose farm the number of cattle, calves, sheep, lambs, swine, or goats is in keeping with the size of the farm or with the volume or character of the agricultural products produced thereon, but does not mean any person or partnership engaged in producing agricultural products who—

"(1) actively engages in buying or trading in cattle, calves, sheep, lambs, swine, or goats; or

"(2) actively engages, directly or indirectly, in conducting a business which includes the slaughter of cattle, calves, sheep, lambs, swine, or goats for food purposes; or

"(3) actively engages, directly or indirectly, in buying or selling meat or meat food products other than those prepared by any farmer on the farm; or

"(4) actively engages, directly or indirectly, in salting, curing, or canning meat, or in preparing sausage, lard, or other meat food products; or

"(5) slaughters, or permits any person to slaughter, on his or their farm cattle, calves, sheep, lambs, swine, or goats which are not actually owned by him or them.

"(b) A 'retail butcher' means any person, partnership, association, or corporation chiefly engaged in selling meat or meat food products to consumers only, except that the Secretary of Agriculture, at his discretion, may permit any retail butcher to transport in interstate or foreign commerce to consumers and meat retailers in any one week not more than five carcasses of cattle, twenty-five carcasses of calves, twenty carcasses of sheep, twenty-five carcasses of lambs, ten carcasses of swine, twenty carcasses of goats, or twenty-five carcasses of goat kids, or the equivalent of fresh meat therefrom, and to transport in interstate or foreign commerce to consumers only meat and meat food products which have been salted, cured, canned, or prepared as sausage, lard, or other meat food products, and which have not been inspected, examined, and marked as 'Inspected and Passed' in accordance with the terms of the Meat Inspection Act of March 4, 1907, and Acts supplemental thereto, and with the rules and regulations prescribed by the Secretary of Agriculture.

"(c) A 'retail dealer' means any person, partnership, association, or corporation chiefly engaged in selling meat or meat food products to consumers only except that the Secretary of Agriculture, at his discretion, may permit any retail dealer to transport in interstate trade or foreign commerce to consumers and meat retailers in any one week not more than five carcasses of cattle, twenty-five carcasses of calves, twenty carcasses of sheep, twenty-five carcasses of lambs, ten carcasses of swine, twenty carcasses of goats, or twenty-five carcasses of goat kids, or the equivalent of fresh meat therefrom, and to transport in interstate or foreign commerce to consumers only meat and meat food products which have been salted, cured, canned, or prepared as sausage, lard, or other meat food products which have not been inspected, examined and marked as 'Inspected and Passed' in accordance with the terms of the Meat Inspection Act of March 4, 1907, and Acts supplemental thereto, and with the rules and regulations prescribed by the Secretary of Agriculture.

"That the provisions of the Meat Inspection Act of March 4, 1907, requiring inspection to be made by the Secretary of Agriculture shall not apply to animals slaughtered by any farmer on the farm and sold and transported in interstate or foreign commerce, nor to retail butchers and retail dealers in meat and meat food products, supplying their customers: *Provided*, That all meat and meat food products derived from animals slaughtered by any farmer on the farm which are salted, cured, canned, or prepared into sausage, lard, or other meat food products at any place than by the farmer on the farm upon which the animals were slaughtered shall not be transported in interstate or foreign commerce under the farmer's

exemption herein provided, and all fresh meat and all farm-cured or prepared meat and meat food products derived from animals slaughtered by any farmer on the farm which are to be used in interstate or foreign commerce shall be clearly marked with the name and address of the farmer on whose farm the animals were slaughtered: *Provided further*, That if any person shall sell or offer for sale or transportation for interstate or foreign commerce any meat or meat food products which are diseased, unsound, unhealthful, unwholesome, or otherwise unfit for human food, knowing that such meat food products are intended for human consumption, he shall be guilty of a misdemeanor and on conviction thereof shall be punished by a fine not exceeding \$1,000 or by imprisonment for a period of not exceeding one year, or by both such fine and imprisonment: *And provided further*, That the Secretary of Agriculture is authorized to maintain the inspection in this Act provided for at any slaughtering, meat canning, salting, packing, rendering, or similar establishment notwithstanding this exception, and that the persons operating the same may be retail butchers and retail dealers or farmers; and where the Secretary of Agriculture shall establish such inspection then the provisions of this Act shall apply notwithstanding this exception."

Approved, June 29, 1938.

THE IMPORTED MEAT ACT.

Extract from an act of Congress entitled "An act to provide revenue, to regulate commerce with foreign countries, to encourage the industries of the United States, to protect American labor, and for other purposes," approved June 17, 1930 (Public No. 361, 71st Cong.).

TITLE III.—SPECIAL PROVISIONS.

PART I—MISCELLANEOUS.

*	*	*	*	*	*	*
SECTION 306.	*	*	*	Meats—importation prohibited in certain cases.		
*	*	*	*	*	*	*

(b) Meats unfit for human food.—No meat of any kind shall be imported into the United States unless such meat is healthful, wholesome, and fit for human food and contains no dye, chemical, preservative, or ingredient which renders such meat unhealthful, unwholesome, or unfit for human food, and unless such meat also complies with the rules and regulations made by the Secretary of Agriculture. All imported meats shall, after entry into the United States in compliance with such rules and regulations, be deemed and treated as domestic meats within the meaning of and subject to the provisions of the act of June 30, 1906, (Thirty-fourth Statutes at Large, page 674), commonly called the "meat inspection amendment," and the act of June 30, 1906 (Thirty-fourth Statutes at Large, page 768) commonly called the "Food and Drugs Act," and acts amendatory of, supplementary to, or in substitution for such acts.

(c) Regulations.—The Secretary of Agriculture is authorized to make rules and regulations to carry out the purposes of this section, and in such rules and regulations the Secretary of Agriculture may prescribe the terms and conditions for the destruction of all * * * meats, offered for entry and refused admission into the United States, unless such * * * meats be exported by the consignee within the time fixed therefor in such rules and regulations.

*	*	*	*	*	*	*
---	---	---	---	---	---	---

SECTION 653. Effective date of act.—Except as otherwise provided, this act shall take effect on the day following the date of its enactment.

HORSE-MEAT ACT.

Extract from an Act of Congress entitled "An Act making appropriations for the Department of Agriculture for the fiscal year ending June 30, 1920," approved July 24, 1919 (41 Stat. 241).

For additional expenses in carrying out the provisions of the Meat-inspection Act of June 30, 1906 (Thirty-fourth Statutes at Large, p. 674), as amended by the Act of March 4, 1907 (Thirty-fourth Statutes at Large, p. 1256), there is hereby appropriated for the fiscal year ending June 30, 1920, \$903,960, of which sum \$100,000 may be used for the inspection of equine meat in the manner provided in said act, as amended. And, hereafter, no person, firm, or corporation, or officer, agent, or employee thereof, shall transport or offer for transportation, and no carrier of interstate or foreign commerce, shall transport or receive for transportation from one State or Territory or the District of Columbia to any other State or Territory, or the District of Columbia or to any place under the jurisdiction of the United States or to any foreign country any of such meat or food products thereof unless plainly and conspicuously labeled, marked, branded, or tagged "Horse meat" or "Horse-meat Product" as the case may be, under such rules and regulations as may be prescribed by the Secretary of Agriculture. All the penalties, terms, and provisions in said act, as amended, except the exemption therein applying to animals slaughtered by any farmer on a farm, to retail butchers and retail dealers in meat-food products supplying their customers, are hereby made applicable to horses, their carcasses, parts of carcasses, and meat-food products thereof, and the establishments and other places where such animals are slaughtered or the meat of meat-food products thereof are prepared or packed for the interstate or foreign commerce, and to all persons, firms, corporations and officers, agents and employees thereof who slaughter such animals or prepare or handle such meat or meat-food products for interstate or foreign commerce.

CHAPTER V.

ORGANIZATION AND METHODS OF PROCEDURE OF THE INSPECTION FORCE.

As the organization of meat inspection in the United States varies somewhat from that of Germany, it is deemed essential to incorporate in this text-book the conditions applying to the meat-inspection force in this country, and also to describe the methods of procedure which are required in the execution of the antemortem and postmortem inspection by the Government inspector. As this subject is so thoroughly treated by Dr. A. D. Melvin, late Chief of the Bureau of Animal Industry in his work on the *Federal Meat-inspection Service*,¹ he will be quoted in substance in the following:

PERSONNEL OF THE INSPECTION FORCE.

The Bureau's employees are both capable and expert. The men in charge of all stations where slaughtering is done, and the men who do the postmortem work at all stations, are veterinarians. These men must first have successfully completed a four years' course in veterinary medicine at a reputable veterinary college. The Department recognizes twenty-nine such institutions, excluding several so-called colleges that aspire to cover this field of knowledge. The Civil Service Commission examines these graduates, and about 50 per cent of those examined make the required grade of 70.

For the information of those who believe that a letter written to the Secretary of Agriculture by an influential citizen is all that is necessary for appointment to this service, it may be stated that the Department makes absolutely no permanent appointments except of men whose names are certified to it by the Civil Service Commission. During a period of six months one so appointed is on probation, and if he fails to measure up to the requirements he is dropped. If at the end of this six months he attains his absolute appointment, he is not at once freed of supervision and clothed with full authority to pass or condemn. The force is large, and he is so placed on it under experienced inspectors that he may learn the law and regulations and the methods of their application. A set of rules, supplemented, of course, by some necessary discretion on the part of the heads of the service, govern his advancement in authority and salary. On the latter men rests the burden of inspection. The Bureau holds them responsible, and they well understand that their promotion depends on efficient and faithful service. They have ample opportunity to become experts in detecting diseased animals, and they do. The Department demands all their time during the working day, and a man must be dull indeed if in the days, months and years spend amid the swift work of the killing floors he fails to develop a most masterly dexterity in discovering abnormalities in the carcasses that come before him.

The laboratory inspectors constitute another class of employees. They also are selected through civil service examination in the principles of bacteriology and chemistry, with special application to meats.

¹ Bureau of Animal Industry Circular 125.

A third grade of employce is the lay inspector (Grade 1). Being under the direction of the veterinarian, he is not required to be himself regularly educated along this line. He examines live stock, tags animals, stamps carcasses, seals cars, patrols the houses at night, superintends the removal and tanking of condemned carcasses—In short, he does everything he can, where expert pathological knowledge is unnecessary, to relieve and assist the veterinarian.

The lay inspector (Grade 2) is a fourth class. He is expert in pickling, salting, smoking, and otherwise curing meat. He likewise enters the service through the civil service examinations, and his previous experience is taken into account in grading him. By means of the educated senses of sight and smell he can tell when a piece of meat is unfit, and he knows whether it is irretrievably bad or whether it can be utilized. (This class of employees condemned over 5,383,000 pounds of meat in the fiscal year 1938.)

The Bureau selects certain of the most experienced veterinary inspectors, divides the country into districts, and sends these men traveling through them, visiting very station and every plant. Their visits are unannounced, and they submit reports with recommendations to the Washington office. They are able, out of their wider experience, to instruct the inspectors in charge at the various stations, and their reports are of great value to the Department in its effort to secure a uniform inspection and to learn of unsanitary conditions and have them corrected. That the regulations are enforced is capable of demonstration by an examination of the reports of the number of animals condemned. Other safeguards, however, are provided. The law promises to fine not less than \$5000 and to imprison for at least a year any man who gives anything of value, even a piece of meat, to a Government employce to influence him in the performance of his duties; it is stricter still with such employces; for it holds over them the menace of similar fine and imprisonment if they accept anything of value, no matter what the intent of the donor or the purpose of the gift may be. It is thus dangerous for the packer to bribe, and it is more dangerous still for the employce to accept.

The Bureau places further obstacles in the way of collusion between inspector and owner by frequent changes at the larger stations of employces from house to house, and by changes, less frequent, of employces from station to station. It is working constantly, also, to secure uniformity in the inspection at all stations. It has a very complex system of reports, and its experts scrutinize these with the view of discovering abnormalities in results and making the proper corrections. Again, practically all the operations of slaughtering and preparing meats are open to the world, and are, indeed, in the larger centers one of the sights to which visitors flock. It is well known that accredited representatives of foreign governments, expert and otherwise, see all the processes of inspection, and more than one has satisfied himself and his government, sometimes to the surprise of both, that inspection is all that it is claimed to be.

On the whole, it is submitted that no material dishonesty in the inspection can long exist, in view of the above methods and facts, and owing further to the involuntary espionage that each employce undergoes from his fellow-employces, which, while it is not depended upon by the Department, is yet a powerful factor in maintaining a strict integrity in the enforcement of the law.

THE PERFORMANCE OF ANTEMORTEM AND POSTMORTEM INSPECTION.

For the carrying on of the antemortem and postmortem inspection, the published regulations of the meat-inspection law prescribe the detailed requirements. These instructions of the U. S. Inspector of Meats are contained in the regulations of the Federal Meat-inspection Service, B. A. I. Order No. 211. It will, therefore, be necessary to discuss here only a few technical and especially important conditions.

Action in General.—Antemortem Inspection of Food Animals.—The performance of the antemortem inspection is regulated by the regulations governing the enforcement of the meat-inspection law, and does not necessitate a further explanation for the veterinary inspector.

Concerning the age of the food animals the most important information has already been given on page 21.

The influence of transportation on the condition of food animals was considered on page 15.

Regarding the diseases which may be observed, reference should be made to Chapters VII and VIII.

Concerning the judgment on living food animals, see page 192. Under certain conditions slaughter can be permitted only after a period of rest (see page 15). The inspector has also the authority to request that the slaughter should be undertaken at an established hour and in his presence. A reinspection must be made should the slaughter have been delayed for over one day after permission was granted.

The antemortem inspection of live stock is highly important and a valuable safeguard to the health of the meat consumer, as there are certain diseases and conditions not attended with any gross lesions in the carcass, albeit they are noxious and repugnant. Direct proof of this is found in the literature of meat poisoning, the great majority of which cases could be directly traced to eating the meat of cattle slaughtered in emergency without any noticeable changes being observed in the tissues on postmortem examination. The interests of the live stock industry are also protected by this examination, since none but healthy animals which have not been exposed to any infectious disease are permitted to be shipped from the Public Stock Yards to the farms as breeders and feeders or to the abattoirs of other cities not having Federal inspection. A brief description of the condition of each rejected animal is recorded on a permit signed by the yard inspector, which permit is delivered to the abattoir inspector in order that the animal may be properly identified on the killing floor. It is then held for final disposition on postmortem examination, with the exception of those animals that have been rejected for advanced pregnancy and recent parturition. These latter may be held until they have fully recovered from the parturient state (ten days) and then slaughtered; or in case they are not affected with, or have not been exposed to, any infectious disease they may be sold for stock purposes.

As conducted at present, the first step in actual inspection is the examination of the living animal. The law does not absolutely require this, but places it within the discretion of the Secretary. Government inspectors make this examination in the stockyards or in the pens, alleys, etc., of the establishment by which the animals have been bought and in the slaughter house of which they are proposed to be slaughtered, and no animals which have not undergone this examination are allowed to enter the slaughter house proper. The pens contain from as low as 10 to as high as 200 animals each. The inspector goes into the pen and looks carefully over each animal. When he finds one that to his mind is not perfectly sound and healthy, he or his assistant affixes to its ear a numbered metal tag bearing the words "U. S. Suspect." Such animals are segregated and slaughtered separately from other animals, either

before or after the regular course of the killing. If the postmortem examination of an animal does not confirm the suspicions aroused by the appearance of the live animal, and no lesions of the disease are found, the tag is taken off and sent to the office of the inspector in charge of the station, who has already been informed of the number of the tag after it was affixed on suspicion, and the carcass is sent along as edible meat. If lesions are found which warrant condemnation, the carcass is sent to the tank, the tag being removed and taken with a report to the office. The antemortem inspection is governed by B. A. I. Order 211, Regulation 9.

Inspection of the Slaughtered Animals (Postmortem Inspection).—For the examination of the slaughtered animals exact directions are given in the regulations of the meat-inspection law. The presence of veterinary inspectors at the slaughter is urgently desired, especially in certain diseases (for instance, peritonitis, pleuritis, pericarditis and certain abscess formations).



FIG. 49.—Final inspection of retained beef carcasses.

Although it is desirable to limit the work of the inspection to those hours showing sufficient daylight, this cannot always be accomplished for obvious reasons. For inspection by artificial light an abundant, and, if possible, a white light should be demanded.

Technic of Meat Inspection.—Inspection of slaughtered animals in accordance with these instructions consists in the following:

1. Inspection of all organs and parts (Fig. 49).
2. Feeling of certain parts, as lungs, liver, spleen, uterus, udder, tongue.
3. Incision of lymph glands, the location of which is given on page 48, in connection with Figs. 22 to 35; also muscles, organs with cavities,



FIG. 50.—Modern aluminum scabbard holding two butcher knives.

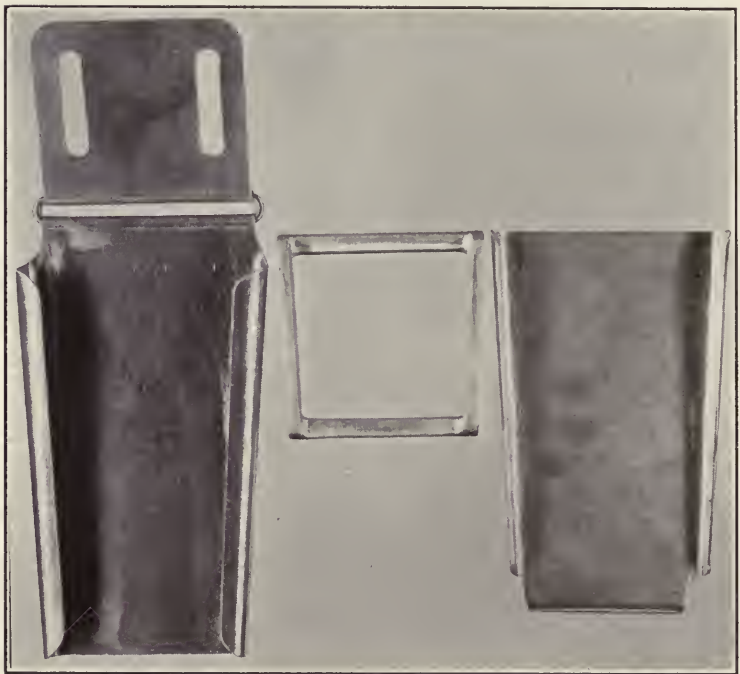

FIG. 51.—Component parts of aluminum scabbard showing ease of sterilization.

and suspected or diseased parts. However, this should be restrained as much as possible in tuberculosis, suppurations, etc., on account of the danger of spreading the infective-substance and the contamination of the meat with this material. Suitable knives, with cases, especially well adapted for postmortem inspection, and which can be easily cleaned and disinfected, are illustrated under Figs. 50 and 51. The knives of the inspectors should be smooth and free from scratches and splints. For the disinfection of knives and their cases boiling in a 2 per cent soda solution is sufficient. A highly satisfactory sterilizing and wash stand is shown in Fig. 52.

4. Squeezing out the contents of the passages and the cavities of organs (bile ducts of the liver, cut surface of the lungs, etc.). Besides, under special conditions the following additional methods may also be applied:

5. Reaction test of muscles with blue or red litmus paper, which after moistening should be pressed with a forceps or knife against a fresh cut surface of the muscles. In this work the cuts must be made at various intervals and in muscles lying at various distances apart (see page 43).

6. Microscopic examination of blood, muscles, various tissues, diseased parts, secretions and excretions, parasites, etc.

7. Bacteriological examination of blood, parenchymatous fluids, etc., in infectious diseases.

8. Bacteriological examinations through the inoculation of culture media, inoculations of test animals, etc.

Directions for the bacteriological examination of imported meat may also be applied in the inspection of fresh slaughtered animals in case of necessity, and are described on page 168.

Bacteriological meat inspection was first recommended by Basenau for cases of doubtful affections, especially in emergency slaughters, in which an unobjectionable positive result cannot be obtained in any other way. In such inspection bacterial blood intoxications are included first of all (see Chapter VIII, page 314), and a diagnosis even in these cases may prove quite difficult. The presence of bacteria of the paratyphoid-enteritidis group in the organs and flesh of animals in which blood-poisoning or other sickness is suspected or the occurrence of the causative agents of meat poisoning in the suspected meat itself, is more easily demonstrated. Basenau himself gives the following directions: "It is practicable to undertake the examination twenty-four hours after slaughter, as all the meat-poisoning bacteria grow even at a low temperature, thereby increasing their numbers, which facilitates the examination. In this study it is presumed that after slaughter the stomach, intestines, etc., were



FIG. 52.—Wash and sterilizing stand. (Courtesy of Allbright-Nell Company.)

removed in the usual order. This excludes the possibility that bacteria, which may be found in the interior of the meat, have reached the point through post-mortem invasion from the intestines. According to numerous experiences which have been confirmed by A. Chillées, microorganisms are not present in the interior of the meat of healthy animals even for a longer time following slaughter. From the interior of the meat, which is rich in connective tissue, cover-glass preparations are made and gelatin plates are inoculated. Gelatin plates suffice perfectly for this purpose, if Forster's gelatin with a high melting-point is used. At the same time two mice are fed with raw pieces of the meat and two others are fed with meat which has been exposed to 100° C. for one hour.

If no microorganisms are present in the smear preparations, and if no colonies will develop within twenty-four hours on the plates, the meat should be released without any further action.

If these preparations or plates establish the presence of bacteria, the meat should be temporarily held in a suitable place and the results of the animal experiments, which, when positive, appear in most cases within three days, should be taken into consideration for final judgment. Should the mice which were fed with the raw meat die, while those given the boiled meat remain well, it serves to prove that the toxic substances were destroyed by boiling. Then, in accordance with present experiences, the meat can be released for consumption without danger to human health, after a sufficient sterilization in the steam apparatus. If no sterilizing apparatus is available, the proof of the presence of a large number of bacteria in the meat would be sufficient for its condemnation. Should the mice fed with the boiled material containing the bacteria succumb, the meat should be withheld from commerce and permission should only be given for its technical utilization.

V. Drigalski recommends surface sowings on alkaline lactose-litmus-agar with particles of the spleen and muscles and in addition, the inoculation of similar particles into slightly alkaline nutrient bouillon at 22° C. until the following day for the purpose of growing the organism, and afterward inoculation of new plates from the growth in bouillon. If the growth on the plates shows predominantly bluish, transparent colonies, a specific infection of the concerned animal (*Salmonella enteritidis*, Gärtner) is indicated. For further determinations test inoculations have to be undertaken.

The above scientific tests, however, have been largely replaced by the more accurate and recently developed enrichment method of Conradi which consists of a picric acid, brilliant green medium that permits the separation of the paratyphoid-enteritidis group from other contaminating organisms. This medium contains:

Liebig's meat extract	20 grams
Aqueous solution of Witte's Peptone (10 per cent)	100 cc.
Agar	30 grams
Water	900 cc.
Dissolve and filter.	

Bring reaction to 3 per cent acid to phenolphthalein. Sterilize and keep in bulk. Before use add 10 cc. of a 1 to 1000 aqueous solution of brilliant green and 10 cc. of a 10 per cent aqueous solution of picric acid to 1½ liters of agar. Pour into large Petri plates and inoculate by streaking the surface with suspected material. The colonies of *E. typhi* are light green, those of the paratyphoids are yellowish green.

The material to be cultured is taken by means of a sterilized platinum wire from the depths of the visceral organs and muscles with aseptic care in order to exclude error which might arise from superficial contamination of the samples. At the same time the usual media should also be inoculated as it is essential to eliminate the causative agents of anthrax, hemorrhagic septicemia, swine erysipelas, etc., as well as those of meat poisoning. Moreover, the examination should be extended to determine the absence of anaerobic bacteria. When the latter are present in vast numbers, it is an indication that evisceration was

long enough delayed after slaughter to permit anaërobic intestinal bacteria to gain access to the flesh.

If any suspicious colonies develop on Conradi's special media, they are tested after eighteen to twenty hours by agglutination for their relationship to the paratyphoid-enteritidis group. Either multivalent sera or still better mixed sera of the same animal species are applied, as univalent sera have a restricted agglutination application and may fail against certain paratyphoid strains. Ostertag considers that the multivalent immune sera of the ass prepared by the simultaneous use of cultures of the paratyphoid B, enteritidis and suipestifer groups are better for this purpose than rabbit sera, as they generally have a greater breadth of action. Schönberg's agglutination method is also applicable (page 373).

Following Conradi's enrichment method, Bugge and Kiessig examined the muscles of healthy animals slaughtered under the best sanitary conditions possible, and found them germ-free with the exception of 3.2 per cent of the samples. The latter were considered with certainty to be external invasions during the slaughter and evisceration of the animals. The lung and liver, closely connected with the exterior, contained bacteria in a relatively large percentage. No bacteria were demonstrated in the heart, spleen, kidney, brain, testicles, and long bones in these experiments.

9. Chemical examinations may be necessary for certain purposes as testing for the use of preservative substances.

10. Examination for odor is in many cases requisite. It is especially necessary, even though it is not final, in cases where the boiling test has to be made of the examination of meat for spoiling.

11. The boiling test is frequently of great aid in the examination of the odor and taste of meat.

This should always be made with chilled meat twenty-four hours after slaughter, as certain peculiarities of odor and taste undergo a change in cooled meat. It is also inadvisable to place the meat to be examined in boiling water, but preferably to place it in a covered receptacle with cold water in which it may be gradually heated to the boiling-point; from time to time the developing steam should be tested for the odor. The taste of the meat and the meat broth should be determined after the meat is thoroughly boiled through. The boiling test should be especially undertaken with the meat of boars, cryptorchids, male goats, and emergency slaughtered animals, when there is suspicion of an administration of drugs that may give a taste or odor to the meat, such as large quantities of iodide of potassium or inhalation of bad-smelling gases and vapors. There are pronounced changes in the odor of meat when offensive abscesses are encapsulated in large body cavities, in certain forms of icterus of hogs, in parasitism of calves, etc.

Procedure of Meat Inspection.—The procedure of the postmortem inspection is as follows:

At the first exposure of the glands when the head is severed—these being common seats of tuberculous infection—a Federal inspector makes an examination for evidences of disease, himself cutting into the glands (see Fig. 53). Another inspector stands at the elbow of the gutter and, as the viscera are revealed, watches with practised eye for abnormalities, carefully examining and handling the various parts in order that any obscure indication of disease may be discovered. The Bureau requires this inspector to handle the viscera and, if necessary, to cut into them. This is rapid as well as exacting work, and the head and visceral inspectors frequently exchange places, or the visceral inspector is relieved by another, after two hour's work.

When the inspector finds a diseased carcass he attaches to it, by means of a

wire and seal, a paper tag with the words "U. S. Retained" on it and numbered to correspond with the number on the stub from which it is taken. He sends the numbered stub to the office with his report. The carcass, with the parts that have been separated, none of which is allowed to lose its identity, is now sent directly to a compartment called the "retaining room". The Government requires this important room to be rat-proof, well lighted, to have floors of cement, or of metal or brick laid in cement, and to be provided with facilities for locking. The Government also provides a special lock for the room, and the keys remain in the custody of the inspector. At convenient periods the retained carcasses undergo in this room at the hands of other inspectors a more leisurely and careful inspection (see Fig. 54).

This is the final step in the postmortem examination. The inspectors here have a good deal of personal discretion. Certain definite rules are laid down by the bureau, but something must be left to the judgment of the inspectors. They must pass upon the question of the extent of the affection and decide



FIG. 53.—Head inspection of hogs.

whether or not the whole carcass or only parts of it should go to the tank. Not being pushed by the exigencies of the rapid work, on the killing beds and the necessity of keeping up with the never-ending stream of carcasses, they are deliberate and careful in making their examinations and in forming their judgment. Carcasses which they decide to be fit for food they permit to be removed and placed with other healthy carcasses, which have been passed on the first inspection. They take off the "U. S. Retained" tag, return it with their report to the office and stamp it "U. S. Inspected and Passed."

When their examination confirms the suspicious indications of the first examination, however, they stamp conspicuously on the carcass, also on the tag, the words "U. S. Inspected and Condemned." The carcass is removed immediately from the retaining room under the eye of a Government employee, and goes either to the tank, or, if it is not convenient to tank it immediately, to the condemned-meat room, which like the retaining room is provided with a lock, the key of which is kept by a Government employee, and which is opened only by Government employees. As soon as practicable Government

men remove the carcass to the tank, keeping a record of the tag numbers, which they forward with their reports to the office. At houses which do not provide a "condemned room," the carcass is sent directly to the tank. About 25 per cent of the carcasses retained are condemned.

All carcasses, both fit and unfit, having been removed from the retaining room, the floor and walls are washed with hot water and disinfected in order that the room may be clean and free from disease infection for the reception of the next batch of retained carcasses.

In the performances of meat inspection it is advisable to maintain the following method of procedure in the inspection of the various species of animals.

CATTLE.—*The (Suitably Prepared) Head.*—Viewing, cutting the lymph glands (retropharyngeal, submaxillary, parotid lymph glands) and ton-

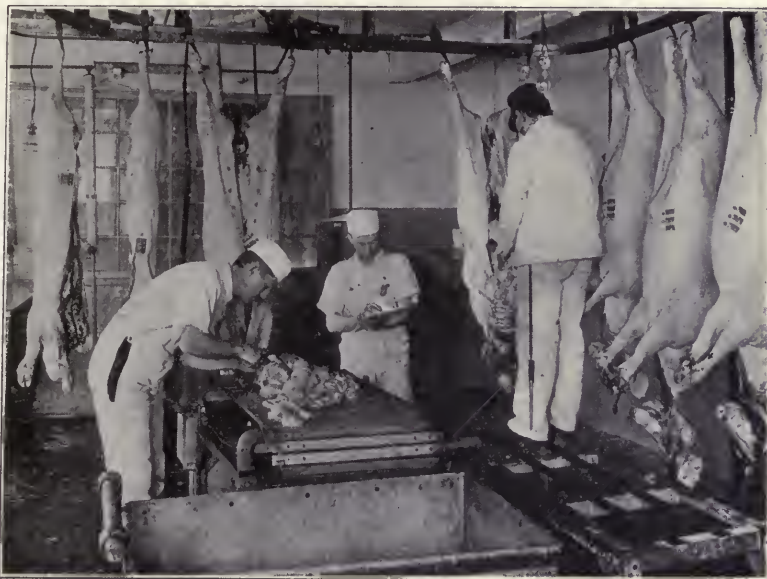

FIG. 54.—Final inspection of retained hog carcasses.

sils in section. Viewing and feeling the tongue, applying extensive cuts to the muscles of mastication on both sides (beginning at the maxillary border and running parallel with the branches of the inferior maxilla).

Viscera of the Thoracic Cavity.—1. Lungs: Viewing and palpating. Cutting the lymph glands in sections (right and left bronchial glands, also the mediastinal glands [the anterior mediastinal glands are hanging, as a rule, near the thoracic entrance on the fore-quarter]) and cross-section through each lobe of the lungs at about the last third, extending to the larger bronchial tubes. In cutting the bronchial gland it is also advisable to cut into the principal bronchi (look for evidence of aspiration of the contents of the stomach).

2. Heart: Opening of the pericardium; viewing and opening of both ventricles by a longitudinal cut which should extend through the septum.

Viscera of the Abdominal and Pelvic Cavity.—1. Stomach, mesentery, omentum, with small and large intestines. Viewing and cutting their lymph glands.

2. Liver: Viewing of both surfaces, feeling and cutting the lymph glands lying around the portal ring; longitudinal incision through the larger bile ducts on the gastric surface and in the Spigelian lobe.

3. Spleen: Palpation and cutting for the examination of the pulp.

4. Urinary bladder: Viewing and cutting only if it shows a diseased condition.

5. Uterus with vagina and vulva: Viewing and cutting transversely through both horns of the uterus, and also longitudinally, if necessary.

6. Udder: Feeling, viewing and cutting the organ according to necessity; cutting of the lymph glands, which occasionally remain attached to the hind-quarter.

In the male cattle, the testicles with the penis and the accessory sexual lymph glands are to be viewed instead of the organs mentioned in 5 and 6.

The Carcass Proper.—1. In every case viewing of the serous coverings of the large body cavities, the accessible cut surfaces of the meat and bones, the kidneys loosened from their fat envelope, and the surfaces of the meat quarters.

2. In suspicious and retained cases, especially in emergency slaughter and in tuberculosis with extension through the systemic circulation, namely, the portal and pulmonary circulation or the occurrence of extensively softened areas or in pronounced affections of the serous membranes, and of the uterus, the carcass should be cut into:

(a) The body-wall lymph glands; inferior cervical lymph glands (including also the anterior mediastinal glands), lymph glands of the superior and inferior thoracic walls, lumbar, internal iliac and external ischial lymph glands.

(b) The body lymph glands proper; prescapular, axillary, external iliac, popliteal and superficial inguinal lymph glands.

CALF.—Inspection of the viscera, thoracic and abdominal cavities, as in cattle, omitting the cutting of the bile ducts. It is necessary to consider especially the umbilical vein. The kidneys should be loosened from the fat capsule only in suspicious cases.

Special attention should be paid to the navel and to the joints of the carcass, which, as a rule, is only partially skinned. Extensive lymph-gland examinations under such conditions as were given for cattle should be carried out in the same manner. An inspection for measles (cutting into the heart and muscles of mastication, examination of the tongue) should only take place in calves over six weeks of age, except in suspicious cases; likewise the lymph glands of the head should be cut only in cases of suspicion.

SHEEP AND GOAT.—The examination is conducted the same as in calves. The cutting of the heart, head and pulmonary lymph glands

is undertaken only in cases of suspicion. Likewise an inspection of the body lymph glands should be made only under those conditions which apply to cattle. For examination of pseudo-tuberculosis the prescapular and precrural lymph glands should be palpated in old sheep.

HOG.—Pluck (Haslets).—Incising the submaxillary lymph glands, viewing the tongue and the muscles on the inferior surface, the muscles of the larynx and of the heart and cutting into the latter. *Lungs* (cross-section through the posterior portion): Incising the bronchial lymph glands. *Liver*: Viewing, palpating, cutting the lymph glands (for the absent mediastinal glands, examine the middle bronchial gland at the bifurcation of the trachea; the portal glands, as a rule, are attached to the mesentery near the pancreas).

Mesentery with stomach, intestines, spleen, omentum, urinary bladder and uterus. Viewing, palpating, cutting the gastric (and if present, the attached portal) lymph glands, also the mesenteric lymph glands of the small and large intestines.

The Carcass.—1. In every case view the serous lining of the body cavities, the accessible parts and cut surfaces of the meat, bones and surface of the skin; incise the submaxillary and the superior cervical lymph glands.

2. In a suspicious or retained case (under conditions as applied to cattle), incise the superior, middle and inferior cervical lymph glands, internal iliac and external ischial lymph glands, the prescapular, external iliac, popliteal and superficial inguinal glands. The external ischial lymph glands lie, as a rule, superficially, but they are also frequently detached from the pelvic wall, on the rectum; the lymph glands of the inferior thoracic wall are generally absent, those of the superior thoracic wall are frequently cut off with portions of the aorta, in the evisceration of the pluck; as a rule, the axillary lymph glands are also absent.

At the request of the owner, and if there is no reason for suspicion, the splitting of the vertebral column may be waived, and this is also omitted in suckling pigs.

HORSE.—The inspection is carried out practically as in cattle, but a thorough examination of the nasal mucous membrane should be made, the head must be split longitudinally, and the septum nasi should be taken out in every case.

Inspection of Meat in Emergency Slaughter.—In emergency slaughter the inspection must be carried out with special care, and particularly where special instructions have been given to the inspectors to cover such cases.

In an emergency slaughter the inspector should be especially careful about the presence of all the organs, and should there be the slightest suspicion after the first inspection as to the wholesomeness of the meat for human consumption he should undertake a second inspection on the slaughtered animal. If blood poisoning is suspected it is especially necessary to ascertain whether early changes will appear in connection with the keeping quality, color and odor of the meat; in addition, a boiling test should also be undertaken with the meat. A repetition of the inspection is always necessary if for an excep-

tional cause the inspection was made by artificial light. It must be apparent, however, that the second inspection should not be delayed too long, thus permitting the questionable meat to be come affected by putrefactive changes. Therefore, in summer the second inspection should never take place later than twenty-four hours after the slaughter.

Determination of Age.—Indications of age of the slaughtered animals were mentioned on page 21.

Determination of Sex.—The determination of the sex in the dressed animals may ensue from the following indications:

Cattle.—The bulls are conspicuous by their strong development of the muscles, especially on the withers (Fig. 55) and shoulders, as well as by their compact development in general. The color of the meat is in general darker (see page 68), and the quantity of fat is smaller than in steers and cows. On the hind-quarters the following characteristics are to be noted (Fig. 56): The opened inguinal canal, the small quantity of scrotal fat, the triangular or irregular rhomboidal-shaped cut section of the gracilis muscles, the place of attachment of which on the ischial portion of the pelvic floor is, as a rule, covered with fascia and fat tissue; on the ischial notch there generally remains

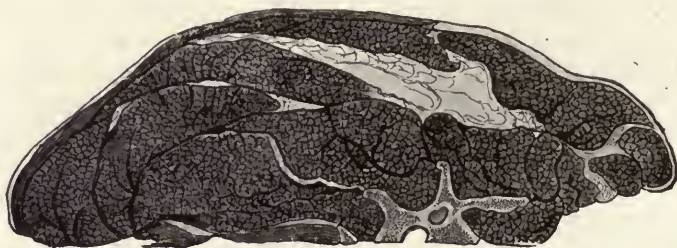

FIG. 55.—Transverse section through the neck of a bull.

a large portion of the bulbocavernosus muscle, sometimes with adhering parts of the corpora cavernosa of the penis; the striking angularity of the pelvic floor with strongly developed tuberculum pubicum, and the slightly developed fat capsule of the kidneys. Sometimes the channel of the penis can be followed in the fat on the inner surface of the thigh and abdominal wall.

In steers the development of the body is not as compact, and especially the muscles of the neck and withers are not as well developed (Fig. 56); the color of the muscles is also lighter (see page 68) than in the bull; the development of fat is always greater, the inguinal canal is closed and the scrotal region contains a large quantity of fat (cod fat). Cows are characterized by a more slender, finer development of the body; the muscles are not as well developed and their color is lighter (see page 176, Fig. 59); the color of the fat is sometimes conspicuously yellow; on the hind-quarter the large loose udder is noticeable; after being cut away it leaves a defect in the posterior abdominal region; the cut surface of the gracilis muscle is bean- or crescent-shaped and reaches

to the ischial notch; the floor of the pelvis appears only slightly angular or arched; the tuberculum pubicum is not well developed (Fig. 59). Heifers may be distinguished from the cows by the slightly developed milkless udder which in well-fattened animals is considerably intermixed with fat.

Calves.—Bull calves are easily recognized by the small testicles, the openings in the inguinal canal, the stump of the penis, etc., and by the ischial notch, while heifer calves are recognized by the presence of the udder.

Calves in the skin: In bull calves the scrotum and the brush (a tuft of long hairs at the orifice of the sheath) are present. In heifer calves the teats, which are present in both sexes, are better developed.

Sheep and Goats.—The distinguishing of rams from wethers and ewes has to be followed by the same indication as in cattle. In bucks the peculiar sexual odor is conspicuous (see Chapter VII, page 210).

Hogs.—In boars, besides the small deposits of fat there is strikingly noticeable the dark color of the muscles, the thickness of the skin on the neck and shoulders, as well as the strong sexual odor (see Chapter VII, page 210). If the testicles with

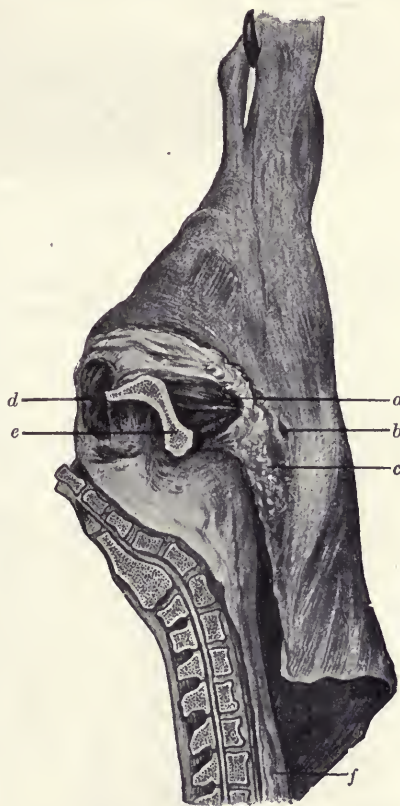

FIG. 56.—Median side of the right hind-quarter of a bull: *a*, cut surface of the musc. gracilis; *b*, external inguinal ring; *c*, scrotal fat tissue; *d*, part of the musc. bulbocavernosus (represented somewhat enlarged); *e*, tuberculum pubicum; *f*, fat capsule of the kidney.



FIG. 57.—Transverse section through the neck of a cow.

the scrotum have been cut out, the large skin defect becomes conspicuous. The remaining parts of the penis and the bulbocavernosus muscles, the

channel of the penis, and the cut surface of the gracilis muscles (Fig. 60) appear in a condition similar to bulls. The opening cut of the



FIG. 58.—Transverse section through the neck of a steer

abdomen shows in the navel region on both sides, or more to one side a defect as a result of a cutting-out of the navel sac. Cryptorchid

boars may appear according to the functional ability of the testicles more or less as boars or castrated animals; this also applies to the so-called stags (page 10).

The sexual characteristics of the slaughtered castrated male hogs are in general almost identical with those of boars; however, the castration scars (Fig. 60, *n*) are noticeable on the posterior contour of the leg, and development of the body resembles very much that of the female hogs.

In female hogs the pelvis appears wider, and the posterior pelvic notch larger than in male animals; the cut surface of the gracilis muscle is bean-shaped; on the opening cut of the abdomen the place of the excision of the navel is not present; the development of the udder and teats depends on the number of times the animals have suckled young. In female hogs which have been spayed, scars of the operation are visible on the left flank.

Horses.—The sex of the dressed horses may be determined by the same characteristics as were described for cattle. In stallions the fat is generally of a lighter color

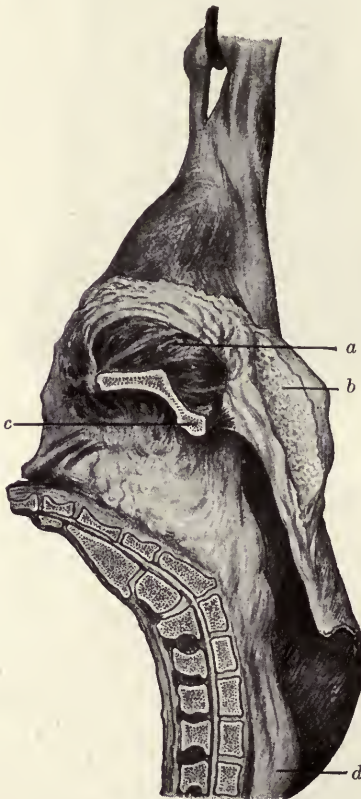

FIG. 59.—Median side of a right-hind quarter of a cow: *a*, cut surface of the musc. gracilis; *b*, udder; *c*, tuberculum pubicum; *d*, fat capsule of the kidney.

and almost white, in contradistinction to the intensely yellow fat of geldings and mares.

Judgment of Slaughtered Animals.—For the judgment of slaughtered animals after inspection is accomplished, the points outlined on page 196 should be considered.

Stamping of Meat.—Regarding the stamping of meat after inspection is made, see page 194.

Inspection of Imported Meat.—*Meat from Foreign Countries.*—The inauguration of a general antemortem and postmortem inspection makes it naturally essential to subject imported fresh and prepared meats to a careful inspection and strict judgment. For this purpose exact directions were issued in the regulations in connection with the meat-inspec-

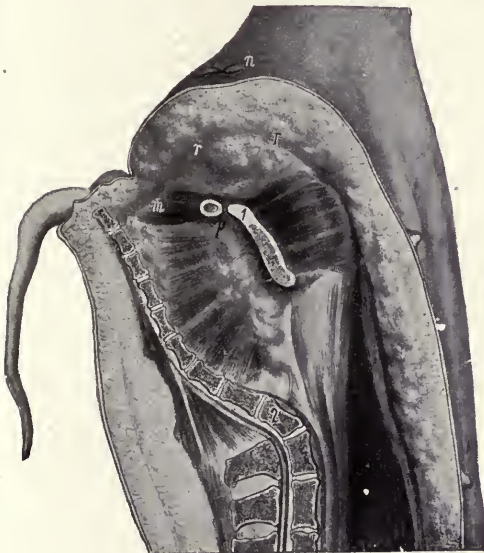

FIG. 60.—Right hind-quarter of a castrated male hog: 1, ischiopubic symphysis; 2, first sacral vertebra; *m*, musc. bulbocavernosus enclosing a portion of the corpus cavernosum of the penis; *n*, castration scar; *r*, groove of the penis in the fat tissue.



FIG. 61.—Right hind-quarter of a female hog. Here comes into consideration the bean-shaped cross-section musc. gracilis (*a*) lying distal (in the picture above) to the ischiopubic symphysis.

tion law, which also may include the chemical examination of such meat. As the judgment of diseased imported meat sometimes varies from the disposition to be taken by native meat, it is advisable to consider carefully the regulations in every case of condemnation.

Regarding the designation of imported salted intestines (casings), Gröning distinguishes 5 parts in the intestines of cattle: "Wreath intestines" (small intestines), "cap" (cecum), "butt" (cecum, with the orifice of the ileum and a small portion of the colon), "middle intestines" (colon), and "fat end" (rectum). Every bundle of intestines has, in accordance with its origin from the various countries, a certain length, or it contains a certain number of intestines. A bundle of "wreath" intestines is 24 to 32; a bundle of "middle" intestines is generally 18 mm. long. So-called nodular intestines (Chapter VII) (see B. A. I. Order 211, Regulation 18, Section 9, Paragraph 3) are frequently packed separately as inferior in quality. These bundles are longer and, there-

fore, a barrel packed with them contains, as a rule, about 180 bundles, while of the good quality, over 200 bundles are contained in each barrel.

The following distinctions between salted horse intestines and cattle intestines are noted by Wentzel: The "middle" intestines of cattle run in a straight line, while those of the horse are curved because the wall to which the mesentery is attached is shorter than that of the opposite side. Furthermore, the external surface of the small intestines of the horse (that is, the mucous membrane turned out) cannot be thoroughly and readily separated, as a result of the firmer consistence of the submucosa and the small quantity of fat it contains. Usually, larger shreds of the mucous membrane remain attached to the intestines of the horse and give them a brown appearance. In the small intestines of the horse the place of attachment of the mesentery is conspicuous, but this cannot be noticed on the middle portion of the intestines in cattle. In inflating the small intestines of the horse with air they will arrange themselves in coils, while those of cattle will run straight. If inflated, the walls of the intestines of cattle show an interweaving with fat tissue in all directions, which is absent in the intestines of the horse.

The importation of meat and meat products into the United States is subject to Regulation 27, of B. A. I. Order 211.

Under this regulation, all meat-food products of food animals are subject to a rigid inspection before permission for entry is granted. It is further provided that whenever it shall be determined that the system of meat inspection maintained by any foreign country is not as efficient as the system maintained by the United States, or that reliance cannot be placed upon certificates required under the regulations from authorities of foreign countries, due notice will be given of that fact by proclamation or otherwise, and thereafter no meat or product, as to which the inspection or certification is determined to be insufficient, shall be admitted into the United States from such foreign country. The importation of edible products derived wholly or in part from animals other than cattle, sheep, swine or goats is governed by the Federal Food and Drugs Act as amended and the rules and regulations made pursuant thereto.

Domestic Meat.—Even where regulations governing the meat inspection of a country are compulsory and uniform, the reinspection of meat shipped from one place to another appears to be desirable in order to control such introduced meat, especially when there are extensive shipments to a certain locality. In order to make this control effective, it appears necessary that the meat should originate from regularly inspected food animals, and should comply with all the general requirements which are demanded of marketed meat in the respective localities. A supervision of shipped meat is also necessary on account of the manifold changes to which it is exposed (putrefaction, spoiling, etc.). The need of reinspection for meat shipped to places having Federal inspection is also essential, and such meat must be from animals inspected and passed at the time of slaughter. Reinspection of meats prepared under Federal meat inspection is provided for in B. A. I. Order 211, Regulation 18.

In localities to which extensive shipping of meat takes place the establishment of an inspection office appears very essential. Its equip-

ment should include everything necessary for a thorough expert inspection of the meat, such as arrangements for hanging up the meat, inspection tables, good light, microscopes and reagents, stamping apparatus, etc. Veterinarians alone should be employed as experts. The time for inspection should be restricted as far as possible to daylight hours unless there is a very good artificial light (electric light, glowing gas light, acetylene light). Where the quantity of fresh meat is inconsiderable, it may be inspected on the premises of the consignee, or may be brought directly to the inspector, who, however, in all cases should be a veterinarian. The inspection of prepared meat or meat products may be undertaken by lay inspectors, since the meat of these products has been previously subjected to veterinary examination.

The method adopted in the veterinary inspection of meat imported from foreign countries may serve as guidance in the examination of fresh and prepared domestic meat brought in from other localities.

Should a chemical examination of such meat be necessary, the directions for the chemical examination of meats and fats give the necessary information.

The judging of imported foreign meat must be carried out in accordance with the regulations of the meat-inspection law.

Inspection for Trichinæ.—Trichinosis in hogs (see Chapter VII, page 271) requires a microscopic examination of the muscles of these animals for the determination of trichinæ.

The authorized regulation of this examination—the trichina inspection—has been issued only in Germany and its enforcement is left to the various State governments. The inspection has already been made obligatory and inaugurated in North Germany through State government police regulations; while in States of South Germany it is carried out only exceptionally, and almost exclusively in some of the larger cities.

Formerly in the United States trichina inspection was maintained only for export pork. This, however, has also been abandoned, as it was found that some of the foreign governments were not giving any attention to the certificates. Quite adequate reasons for not maintaining a trichina examination in the United States are given by Dr. A. D. Melvin in his work on the "Federal Meat-inspection Service" (B. A. I. Circular 125, page 35), which is quoted in the following:

"While the Federal meat inspection in this country is as thorough as a comprehensive law, stringent regulations and a liberal appropriation of money can make it, and the consumer of meats bearing the stamp 'U. S. Inspected and Passed' may in general have the comfortable assurance that he is buying and eating products from healthy animals prepared under clean and sanitary conditions, and the danger of contracting disease from eating these meats is practically eliminated, yet the fact should not be overlooked that there is one disease against which the meat-inspection legend does not pretend to be a safeguard. For the detection of most of the diseases affecting meat the human eye needs no assistance. The disease called trichinosis, however, to which hogs are subject, is caused by a parasite so small that the microscope must be employed to detect it. Thorough curing or thorough cooking of the meat kills this parasite. It seems, however, that some European peoples have a habit of eating of raw or half-raw pork, and consequently they have suffered from this disease.

Very elaborate measures have been taken in some countries to do away with or to lessen the danger. In Germany, for instance, there is an army of inspectors who use the microscope to detect these parasites in pork. These countries some years ago forbade the importation of American pork products unless they had been microscopically inspected. To meet this requirement the Bureau instituted several years ago a system of microscopical inspection of pork intended for shipment to such countries. No microscopical inspection of pork intended for home consumption, however, has ever been made or even contemplated. The Department takes the ground that from the nature of the disease an examination of certain parts of a hog carcass can only minimize and not eliminate the danger.

"The parasites, it is true, are usually found, if found at all, in certain parts, as the pillar of the diaphragm, the psoas muscle, the inner aspect of the shoulder, or the base of the tongue. Not finding them in these parts by the usual methods, it may be assumed to be probable that they do not exist in the remainder of the carcass. This is, however, only a probability, as they may exist, and even to such an extent as to produce disease if the flesh is eaten raw. Many cases are on record where twenty, even thirty examinations were made before trichinae were found; and out of 6329 cases of trichinosis in Germany, between 1881 and 1898, a careful inquiry traced 2042 cases (over 32 per cent) to meat which had been microscopically examined and passed as free from trichinae. In view of these facts the Department has regarded it as utterly impracticable to inspect hog carcasses for this disease. It has further taken the view that such inspection—which as formerly carried on for exported products would cost about \$3,700,000 a year if all hogs killed at inspected houses were so examined—would do more harm than good. It would create in the minds of the consumers a feeling of false security, which might lead them to omit the only sure means of escaping danger, namely, to refrain from eating uncooked or uncured pork; and it would thus defeat its very purpose and render the great trouble and expense worse than useless."

The inspection of trichina inspection on fresh or prepared meats may be assigned to special trichina examiners, and should be carried out in accordance with the numerous special publications on trichina inspection.¹

Compressors are now generally adopted in preparing squeeze preparations. Fig. 61 represents a very commonly used compressor divided into 24 parts; Figs 62 and 63 represent a practical American compressor which, however, is not divided into fields; it is shown in both open and closed condition.

Numerous so-called trichina microscopes are constructed for the easy microscopic examination of prepared squeeze preparations. In Germany, projection apparatuses are also employed in larger abattoirs and inspection bureaus under the designation of trichina scopes, which serve for a quick, purely mechanical search of the preparations. Regarding the importance and execution of these projection trichina inspections, the reader is referred to the publication of Kohler, Bockelmann, Schüller, in the *Zeitschrift f. Fleisch- und Milch-hygiene*.

Under this plan, instead of examining the compressor under the microscope, it is placed on a reflectoscope which throws the image upon a screen. With this method the number of examiners can be reduced two-thirds. In Germany, in 1913, there were 26 cases of trichinosis detected in hog carcasses, or 1 case in every 50,000 hogs examined. The Germans eat a great amount of ham and sausage in a raw state, and they realize the danger from consuming trichinous pork.

The taking of samples of meat required for the examination of trichinae should be undertaken by special sample takers. These sample takers must possess the same qualifications as the trichina examiners. The latter, but especially the sample takers, should be required to perform the examination of these samples for measles.

¹ For instance: John (The Trichina Examiner, Berlin, 1904, 9th ed.), Long-Preusse (Practical Guide for Trichina Inspection, Berlin, 1905, 6th ed.) and others.

The judging of the results of the examination for trichinæ and measles should not be trusted to the trichina examiners, but it is necessary that they be re-examined by veterinary inspectors. Regarding the disposition of meat found to be infested with trichinæ or measles, see the regulations governing the meat-inspection law, as well as Chapter VII, page 275.

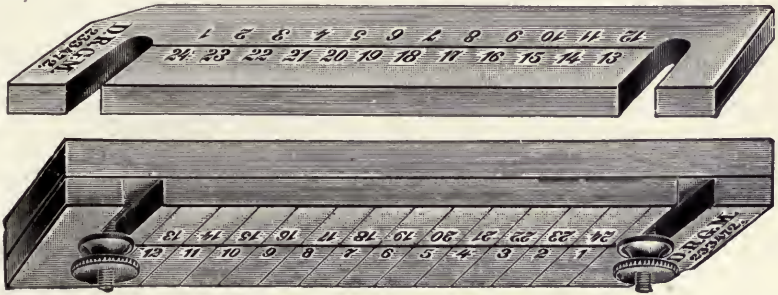

FIG. 62.—Compressor, the upper plate of which may be drawn out

In the United States, safer methods than microscopic inspection for trichinæ have been found to prevent trichinosis as a result of eating infected pork. These methods which provide a treatment sufficient to destroy all live trichinæ in pork products consumed raw are as follows:



FIG. 63.—American compressor (closed).



FIG. 64.—American compressor (opened)

Curing Methods.—**SAUSAGE.**—In the preparation of sausage under methods Nos. 1, 2, 3, and 4 as hereinafter provided, the sausage may be stuffed in animal casings, hydrocellulose casings, or cloth bags. During any stage of treating the sausage for the destruction of live trichinæ, these coverings shall not be coated with paraffin or like substance.

Method No. 1.—The meat shall be ground or chopped into pieces not exceeding $\frac{3}{4}$ inch in diameter. A dry-curing mixture containing not less than $3\frac{1}{2}$ pounds of salt to each hundredweight of the unstuffed sausage shall be thoroughly mixed with the ground or chopped meat. After being stuffed, the sausage having a diameter not exceeding $3\frac{1}{2}$ inches, measured at the time of stuffing, shall be held in a drying room not less than twenty days at a temperature not lower than 45° F., except that in the case of sausage of the variety known as pepperoni, if in casings not exceeding $1\frac{3}{4}$ inches in diameter measured at the time of stuffing, the period of drying may be reduced to fifteen days. In no case, however, shall the sausage be released from the drying room in less than twenty-five days from the time the curing materials are added, except that sausage of the variety known as

pepperoni, if in casings not exceeding the size specified, may be released at the expiration of twenty days from the time the curing materials are added. Sausage in casings exceeding $3\frac{1}{2}$ inches in diameter at the time of stuffing, but not exceeding a diameter of 4 inches, shall be held in a drying room not less than thirty-five days at a temperature not lower than 45° F., and in no case shall the sausage be released from the drying room in less than forty days from the time the curing mixture is added to the meat.

Method No. 2.—The meat shall be ground or chopped into pieces not exceeding $\frac{3}{4}$ inch in diameter. A dry-curing mixture containing not less than $3\frac{1}{2}$ pounds of salt to each hundredweight of the unstuffed sausage shall be thoroughly mixed with the ground or chopped meat. After being stuffed, the sausage having a diameter not exceeding $3\frac{1}{2}$ inches, measured at the time of stuffing, shall be smoked not less than forty hours at a temperature not lower than 80° F., and finally held in a drying room not less than ten days at a temperature not lower than 45° F. In no case, however, shall the sausage be released from the drying room in less than eighteen days from the time the curing mixture is added to the meat. Sausage exceeding $3\frac{1}{2}$ inches in diameter at the time of stuffing, but not exceeding a diameter of 4 inches, shall be held in a drying room, following smoking as above indicated, not less than twenty-five days at a temperature not lower than 45° F., and in no case shall the sausage be released from the drying room in less than thirty-three days from the time the curing mixture is added to the meat.

Method No. 3.—The meat shall be ground or chopped into pieces not exceeding $\frac{3}{4}$ inch in diameter. A dry-curing mixture containing not less than $3\frac{1}{2}$ pounds of salt to each hundred weight of the unstuffed sausage shall be thoroughly mixed with the ground or chopped meat. After admixture with the salt and other curing materials and before stuffing, the ground or chopped meat shall be held at a temperature not lower than 34° F. for not less than thirty-six hours. After being stuffed the sausage shall be held at a temperature not lower than 34° F. for an additional period of time sufficient to make a total of not less than one hundred forty-four hours from the time the curing mixture is added to the meat, or the sausage shall be held for the time specified in a pickle-curing medium of not less than 50° strength (salometer reading) at a temperature not lower than 44° F. Finally, the sausage having a diameter not exceeding $3\frac{1}{2}$ inches, measured at the time of stuffing, shall be smoked for not less than twelve hours. The temperature of the smokehouse during this period at no time shall be lower than 90° F.; and for four consecutive hours of this period the smokehouse shall be maintained at a temperature not lower than 128° F. Sausage exceeding $3\frac{1}{2}$ inches in diameter at the time of stuffing, but not exceeding a diameter of 4 inches, shall be smoked, following the prescribed curing, for not less than fifteen hours. The temperature of the smokehouse during the fifteen hour period shall at no time be lower than 90° F. and for seven consecutive hours of this period the smokehouse shall be maintained at a temperature not lower than 128° F. In regulating the temperature of the smokehouse for the treatment of sausage under this method, the temperature of 128° F. shall be attained gradually during a period of not less than four hours.

Method No. 4.—The meat shall be ground or chopped into pieces not exceeding $\frac{1}{2}$ inch in diameter. A dry-curing mixture containing not less than $2\frac{1}{2}$ pounds of salt to each hundred weight of the unstuffed sausage shall be thoroughly mixed with the ground or chopped meat. After admixture with the salt and other curing materials and before stuffing, the ground or chopped sausage shall then be held as a compact mass, not more than 6 inches in depth, at a temperature not lower than 36° F. for not less than ten days. At the termination of the holding period, the sausage shall be stuffed in casings or cloth bags not exceeding $3\frac{1}{2}$ inches in diameter, measured at the time of stuffing. After being stuffed, the sausage shall be held in a drying room at a temperature not lower than 45° F. for the remainder of a thirty-five period, measured from the time the curing mixture is added to the meat.

At any time after stuffing, if a firm deems it desirable, the product may be

heated in a water-bath for a period not to exceed three hours at a temperature not lower than 85° F., or subjected to smoking at a temperature not lower than 80° F. or the product may be both heated and smoked as specified. The time consumed in heating and smoking, however, shall be in addition to the thirty-five day holding period specified.

HAMS.—*Method No. 1.*—The hams shall be cured by a dry-salt curing process not less than forty days at a temperature not lower than 36° F. The hams shall be laid down in salt, not less than 4 pounds to each hundred weight of hams, the salt being applied in a thorough manner to the lean meat of each ham. When placed to cure the hams may be pumped with pickle if desired. At least once during the curing process the hams shall be overhauled and additional salt applied, if necessary, so that the lean meat of each ham is thoroughly covered.

After removal from the cure the hams may be soaked in water at a temperature not higher than 70° F. for not more than fifteen hours, during which time the water may be changed once; but they shall not be subjected to any other treatment designed to remove salt from the meat, except that superficial washing may be allowed. The hams shall finally be dried or smoked not less than ten days at a temperature not lower than 95° F.

Method No. 2.—The hams shall be cured by a dry-salt curing process at a temperature not lower than 36° F. for a period of not less than three days for each pound of weight (green) of the individual hams, calculating the time of cure of each lot of hams placed in cure upon a basis of the weight of the heaviest ham of the lot. Hams cured by this method, before they are placed in cure, shall be pumped with pickle containing not less than 25 per cent of salt, about 4 ounces of the solution being injected into the shank and a like quantity along the flank side of the body bone (femur). The hams shall be laid down in salt, not less than 4 pounds of salt to each hundred weight of hams, the salt being applied in a thorough manner to the lean meat of each ham. At least once during the curing process the hams shall be overhauled and additional salt applied, if necessary, so that the lean meat of each ham is thoroughly covered. After removal from the cure the hams may be soaked in water at a temperature not higher than 70° F. for not more than four hours, but shall not be subjected to any other treatment designed to remove salt from the meat, except that superficial washing may be allowed. The hams shall then be dried or smoked not less than forty-eight hours at a temperature not lower than 80° F., and finally shall be held in a drying room not less than twenty days at a temperature not lower than 45° F.

CAPACOLA (CAPICOLA, CAPOCOLLO).—Boneless pork butts for capicola shall be cured in a dry-curing mixture containing not less than 4½ pounds of salt per hundredweight of meat for a period of not less than twenty-five days at a temperature not lower than 36° F. If the curing mixture is applied to the butts by the process known as churning a small quantity of pickle may be added. During the curing period the butts may be overhauled according to any of the usual processes of overhauling, including the addition of pickle or dry salt if desired. The butts shall not be subjected during or after curing to any treatment designed to remove salt from the meat, except that superficial washing may be allowed. After stuffing, the product shall be smoked for a period of not less than thirty hours at a temperature not lower than 80° F., and shall finally be held in a drying room not less than twenty days at a temperature not lower than 45° F.

COPPA.—Boneless pork butts for coppa shall be cured in a dry-curing mixture containing not less than 4½ pounds of salt per hundredweight of meat for a period of not less than eighteen days at a temperature not lower than 36° F. If the curing mixture is applied to the butts by the process known as churning a small quantity of pickle may be added. During the curing period the butts may be overhauled according to any of the usual processes of overhauling, including the addition of pickle or dry salt if desired. The butts shall not be subjected during or after curing to any treatment designed to remove salt from the meat, except that superficial washing may be allowed. After stuffing, the product

shall be held in a drying room not less than thirty-five days at a temperature not lower than 45° F.

Refrigeration Method.—At any stage of preparation and after chilling or preliminary freezing, all parts of the pork muscle tissue or article containing such tissue shall be subjected to a temperature not higher than 5° F. for a continuous period of (a) not less than twenty days in case the meat is in separate pieces, or arranged in separate racks with the layers of meat not exceeding 6 inches in depth, or stored in separate boxes or crates not exceeding 6 inches in depth, or stored, properly separated, as solidly frozen blocks not exceeding 6 inches in depth; and (b) not less than thirty days in case the pork to be treated is in layers or in containers of a thickness exceeding 6 inches but not more than 27 inches, including ordinary tierces. This requirement is necessary in order to allow time for the meat at the center of the layer or container to reach the necessary temperature. The meat undergoing freezing or the containers thereof shall be so spaced while in the freezer as to insure a free circulation of air between the pieces of meat, layers, blocks, boxes, barrels, and tierces in order that the temperature of the meat throughout be reduced promptly to 5° F. or less.

During the period of refrigeration the meat or article or lot of meat shall be kept separate from other products and in the custody of the Bureau. Rooms or compartments equipped for securing with Bureau lock or seal shall be provided. The room or compartment containing meat undergoing freezing shall be equipped with accurate thermometers placed at or above the highest level at which the product undergoing treatment is stored and away from refrigerating coils. After the prescribed freezing has been finished, the meat or article shall be kept under close supervision of the inspector until it is prepared in final form or until it is transferred to another establishment for preparation into finished form.

Pork which has been refrigerated as herein specified may be transferred in sealed railroad cars, sealed auto trucks, sealed wagons, or sealed closed containers to another official establishment at the same or another station for use in the preparation of articles of a kind customarily to be eaten without cooking by the consumer. The sealing of closed containers such as boxes and slack barrels shall be effected by cording and affixing thereto Bureau seals, and such containers as tierces and kegs shall be held in Bureau custody by sealing with wax impressed with a metal Bureau brand. Railroad cars, auto trucks, and wagons shall be Bureau car seals. Properly sealed and marked closed containers may be shipped in unsealed railroad cars, trucks, and wagons with other meat. Containers such as boxes, barrels, and tierces shall be plainly and conspicuously marked with a label or stencil furnished by the establishment reading as follows: "Pork product 5° F. twenty days' refrigeration" or "Pork product 5° F. thirty days' refrigeration" as the case may be. For each consignment there shall be promptly issued and forwarded to the inspector in charge at destination a copy of M. I. Form 109—F, appropriately changed to show the character of the container and that the contents are "Pork product 5° F. twenty days' refrigeration" or "Pork product 5° F. thirty days' refrigeration." A duplicate copy should be forwarded to the Washington office of the Bureau. M. I. Forms 109—J (revised) reporting the importation of such pork product should be similarly prepared and handled.

Heated Products.—All parts of the pork muscle tissue shall be subjected to a temperature not lower than 137° F.

Only such methods shall be employed as are known to insure a temperature not lower than 137° F. in all portions of the meat or article. On account of differences in methods of heating and in weights of articles undergoing treatment it is impracticable to specify exact procedures.

Procedures shall be adopted which insure the proper heating of all parts of the meat or article. It is important that each piece of sausage, each ham, and other article treated by heating in water be kept entirely submerged throughout the heating period; and that the largest articles in a lot, the innermost links of bunched sausage or other massed articles, and articles placed in the coolest part of a heating cabinet or compartment or vat be included in the temperature tests.

BONELESS PORK LOINS.—In lieu of heating or refrigerating to destroy trichinæ in boneless loins, the following treatment is prescribed:

The loins shall be cured for a period of not less than twenty-five days at a temperature not lower than 36° F. under one of the following methods:

No. 1.—A dry-salt curing mixture containing not less than 5 pounds of salt to each hundredweight of meat.

No. 2.—A pickle solution of not less than 80 degrees strength (salometer) on the basis of not less than 60 pounds of pickle to each hundredweight of meat.

No. 3.—A pickle solution may be added to the approved dry-salt cure, provided the pickle solution is not less than 80 degrees strength (salometer).

After removal from cure, the loins may be soaked in water for not more than one hour at a temperature not higher than 70° F. or washed under a spray, but shall not be subjected, during or after the curing process, to any other treatment designed to remove salt.

Following curing, the loins shall be smoked for not less than twelve hours; the minimum temperature of the smokehouse during this period at no time shall be lower than 100° F., and for four consecutive hours of this period the smokehouse shall be maintained at a temperature not lower than 125° F.

Finally, the product shall be held in a drying room for a period of not less than twelve days at a temperature not lower than 45° F.

GENERAL.—The smokehouses, drying rooms, and other compartments, as may be necessary, used in the treatment of pork to destroy trichinæ shall be suitably equipped by the establishment with accurate automatic recording thermometers. Inspectors in charge are authorized to approve, for use in sausage smokehouses, drying rooms, and other compartments, such automatic recording thermometers as are found to give satisfactory service.

In addition to the foregoing, inspectors who supervise the handling and treatment of pork to destroy live trichinæ shall:

(a) Recognize the importance of safeguarding the consumer and follow carefully the instruction concerning the treatment of pork to destroy trichinæ.

(b) Check the internal temperatures, with Bureau thermometers, of all products subjected to the heating method.

(c) Test frequently, with Bureau thermometers, the reliability of establishment thermometers (including automatic recording thermometers) and reject for use any found not accurate and reliable.

(d) Observe Bureau thermometers carefully in order that none be used which has become defective or questionable as to accuracy.

(e) Supervise, in a methodical manner, the handling in drying, refrigerating, and curing departments, of pork product under treatment for the destruction of live trichinæ, and keep, conveniently available at the official establishment for Bureau use, such records as may be necessary and informative of each lot of product under treatment.

When any article of a kind hereinbefore referred to which requires treatment for the destruction of live trichinæ is to be offered for importation into the United States, it shall be accompanied by a certificate as prescribed in regulation 27, section 5, paragraph 6, B. A. I. Order 211 (revised). This certificate is in addition to any other certificate required by the regulations.

Legal Means of Redress and Complaints in the Execution of Meat Inspection.—An appeal to higher authority against the decisions of the inspector in matters pertaining to food animals and meat inspection must be granted to the owners. The regulations of the meat-inspection law accordingly determine precisely the manner of complaints and the legal means of redress. The regulations governing the Federal meat inspection prescribe that when the action of an inspector in condemning any meat or product is questioned, appeal may be made to the inspector in charge, and from his decision appeal may be made to the chief of

bureau, or to the Secretary of Agriculture, whose decision shall be final. (See B. A. I. Order 211, Regulation 21.)

REPORTS.—According to B. A. I. Order 211, Regulation 20, reports of the work of inspection carried on in every official establishment shall be forwarded to the department by the inspector in charge, on such blank forms and in such manner as may be specified by the chief of bureau. Bureau employees shall make daily reports of the amounts of articles handled or prepared in the subdivisions of the establishments to which they are assigned, and of such other things as the chief of bureau may require. Each official establishment shall furnish to bureau employees accurate information as to all matters needed by them for making their reports. Reports on sanitation shall be made by the bureau employees assigned to the various subdivisions of official establishments to the inspector in charge, and by the inspector in charge to the chief of bureau.

These reports do not alone cover the inspections made of slaughtered animals, but also include the prepared articles in the various departments of an establishment, as well as its sanitary condition.

Statistics of Antemortem and Postmortem Inspection.—In order to utilize the results of the inspection statistically, it is desirable to collect the data embodied in the reports for such purposes. With such an object in view the inspectors in Germany are directed to prepare quarterly reports (slaughter statistics) of the inspected animals, on a specially printed form. These reports must be transmitted to the places determined by the State governments. In addition annual statistical compilations on the results of the antemortem and postmortem inspection on specially prepared forms must be submitted. The veterinary and non-veterinary inspectors use different forms, adapted to the differing duties of these experts. The inspection stations for foreign meats must also prepare annual reports of the results of inspection, and, until further orders, the findings of tuberculosis in the slaughtered animals must be prepared and compiled in an annual statistical report.

Fees for Antemortem and Postmortem Inspection.—For the practice of antemortem and postmortem inspection in Germany the experts are allowed a compensation, which is designated as "slaughter fees." For the inspection of foreign meats the amount is regulated by the Federal Council; for all other inspections it is left to the State governments. The amount of the fee should not be an unreasonable burden upon the slaughterer, yet it ought to assure the expert an adequate pay.

An underbidding of the authoritatively adjusted fees by the experts should be condemned and severely punished.

The collection of the inspection fees in abattoirs and in places which have special inspection offices (page 190) established for ambulatory inspection is made through the respective treasuries, and also through the local police authorities; otherwise the fees are, as a rule, directly paid to the inspector. The latter should be restricted as much as possible by the police in consideration of the authority of the inspector as an expert. By not having to accept his fee directly from the owner it would make the inspector more or less independent of the public. Therefore, it is best for the police authorities, as well as for the inspectors, if the latter are appointed with a fixed salary and the fees for the

inspection are collected by the authorities. This plan must also be followed when the payment of the inspection fee to the inspector is not made.

The fees are also to be payable in cases where the inspector was called, but was unable to perform the duties through no neglect of his.

Supervision of the Antemortem and Postmortem Inspection.—That the entire system of meat inspection must be placed under supervision and under the ultimate control of a central office is self-evident. According to the regulations the State governments are required to issue suitable directions for the examination of every inspection district at least every two years. In most instances it is best to assign this work to official veterinarians, while the central direction of the office should rest in the hands of higher State veterinarians (State, department or district veterinarians).

Freibank.—By the term Freibank is understood a place (shop) for the selling of meat of inferior quality, not first-class, marketable meat (page 196). The term "bank," in its present application, originates from the old designation of the meat-selling places as "meat banks." At the places so designated, only such meat was sold which possessed all the requirements of high-grade meat, and, therefore, it was accepted as "marketable" (suitable for market, shop clean, meat of full value). All other meat, which while still salable was designated as "not marketable" (not suitable for market, not shop clean, inferior quality, deficient), and its sale was restricted to a special bank (Freibank) located apart from the other meat shops. At present the Freibank is an indispensable establishment for meat inspection in Germany, the necessity for which need not be further discussed here. The Freibank was legalized by the German food law of May 14, 1879, in the regulations based on the same, in the Imperial meat-inspection law of June 3, 1900, and also by State as well as local statutory legislation.

The principle of the modern Freibank and of other similar establishments is selling under declaration, namely, but stating the cause which makes the meat otherwise unmarketable. As a consequence of the "non-marketable" condition of the meat the price of the meat is, as a rule, lower than that of marketable meat. This is, however, not absolutely necessary, and depends on the local conditions of the meat trade. The adjusting of the price of the meat ought to be left to the owners, as an official fixing of the price is not permissible legally. In case the compulsory declaration cannot be sufficiently carried out, meat which is "non-marketable" must be excluded for further trade purposes. Therefore, the purchase of such non-marketable meat and its utilization by butchers, manufacturers of meat products, hotel, restaurant and boarding-house keepers is inadmissible and punishable. As a rule, the sale of meat is limited to small quantities. The official supervision of the entire Freibank management is accomplished most simply and successfully in places where only authoritatively appointed, sufficiently compensated and otherwise independent persons are employed. A supervision of the Freibank, if possible, by veterinarians, or at least by non-veterinary inspectors, is necessary under all conditions.

The operation of the Freibanks may be advantageously united with the equipment for storing conditionally passed meat, such as requires refrigerating, boiling or pickling, as well as for the rendering of fat. The location of Freibanks in places which have abattoirs is best established on the premises, as by such arrangements their operation is the simplest and cheapest. For large cities with abattoirs one Freibank would be insufficient, and it is necessary to establish one or more additional Freibanks within the city limits. Furthermore, and this applies also to localities without abattoirs, such places should be selected which are inhabited principally by the laboring class, and not in the immediate vicinity of a regular butcher shop.

Recently it was recommended to establish ambulatory Freibanks also, and special wagons were constructed for this purpose.

For the maintenance of the Freibank the authorities may levy appropriate dues, and the expenses may also be covered by the receipts from the sales.

The sale of meat under police supervision resembles the Freibank. This may occur at any place where the meat was declared inferior in quality. This disposition of the non-marketable meat proves very suitable, especially for smaller towns which cannot afford to maintain a permanently equipped Freibank.

Under certain conditions such meat may be immediately disposed of on the premises of the butcher. It is apparent that supervision by the authorities must be especially strict, otherwise all the requirements which constitute the principles of the Freibank system must be carried out.

The establishment of the Freibanks in various countries of Europe has proved a great success. The strict official supervision of them assures the poor classes a wholesome, palatable and yet inexpensive meat. Such meat thus advantageously utilized in the Freibanks would otherwise have to be condemned and only its value in by-products would come into consideration; hence the economic importance of this system can be readily recognized.

The establishment of the Freibank in the United States, making a three-class meat system, would afford the same advantages that obtain in the countries where it is now in operation. The system would not create any prejudice among that class of people who would patronize it, as there are at the present time a large number of families in this country who have emigrated from the countries where the Freibank system has been in existence for many years, and, therefore, they are thoroughly familiar with this institution, and would gladly take advantage of the opportunities afforded thereby.

Besides the above-mentioned advantages to be gained from the Freibank, there is one which would have a far-reaching effect toward the eradication of tuberculosis. By the establishment of the Freibank a large percentage of carcasses which are under the present system of meat inspection condemned for tuberculosis would be passed for the Freibank,¹ which would greatly diminish the losses to the stock raiser, shipper and packer, and hence the existing feeling of the stock owners toward the application of the tuberculin test to their herds would be beneficially influenced in that a greater compensation would be obtained for their tuberculous cattle.

¹ For detailed information on this subject the reader is referred to Dr. Charles W. Stiles's work on *The Three-class (Freibank) Meat System as an Aid in Eradicating Tuberculosis* (*Jour. Am. Med. Assn.*, November 2, 1907, p. 1483).

As a substitute for the European Freibank, the Federal regulations provide that where animals show lesions more severe or more numerous than those described for carcasses to be passed but not sufficient to cause their condemnation, the carcasses may be rendered into lard or tallow or otherwise sterilized. When the meat has been sterilized by methods approved by the government, and whether canned or placed in other approved containers, it shall be plainly and conspicuously marked "Prepared from Meat Passed for Sterilization." Each official establishment which desires to can such products must submit a written statement setting forth in detail how it is proposed to conduct the work throughout, how it is proposed to handle the carcasses, quarters and parts prior to canning, what methods of curing or other processing will be employed, and also how the actual canning operations and labeling will be conducted, in order that the meats may be constantly identified, and that they may be kept separate from other products until canned and labeled. In order that carcasses and parts passed for lard or tallow may be canned as second-grade class or quality, in lieu of being rendered into lard or tallow, it is permissible to store such carcasses and parts in the establishment where the animals are slaughtered or to transfer them in cars or wagons under Bureau seals between official establishments at the same or different official stations for storage. Such carcasses may be cut and boned and portions thereof disposed of without delay by rendering into lard or tallow. The operations involved shall be conducted in a manner to insure that there will be no error in the final disposal of the various parts. The cars and wagons in which such products are transferred shall not contain any other class of product, and for each consignment there shall be issued and forwarded a copy of a proper notification blank to show that the product is for sterilization.

Performance of the Antemortem and Postmortem Inspection in the Stockyards and Abattoirs.—The purpose of the public abattoirs and stockyards (Chapter XII) is primarily to centralize at one point all the slaughtering of a community. They are, however, of greater importance in the performance of meat inspection because of the inauguration of compulsory slaughter therein. In the public stockyards and abattoirs the inspection of animals, both alive and after slaughter, is not restricted to the animals brought there, but the meat which is shipped from outside into such a community is also inspected. In very large cities, however, it is sometimes necessary to establish special inspection stations inside of the city for the inspection of meat or carcasses which are brought or shipped into the city. In the abattoirs the meat-inspection authorities are in charge of the further disposition of the condemned meat (page 200), the sale of inferior or impaired meat, etc.

In the extensive and varied inspection service in stockyards and abattoirs it is natural that this work can be carried out in a complete manner only by veterinarians. As they may, at the same time, manage the establishment, conduct the affairs of the food-animal insurance, etc., a requirement to have only veterinarians assigned to the manage-

ment of public abattoirs would not be unjust. Besides the veterinary director the services of special veterinarians to carry out the inspection in larger abattoirs are also required. The performance of certain work in connection with meat inspection in stockyards and abattoirs may be assigned to non-veterinary inspectors or to other appointed experts (trichina examiners), under veterinary supervisions and responsibility; however, this should be followed only when it is absolutely necessary. The employment of lay inspectors exclusively for meat-inspection work in stockyards and abattoirs cannot be approved. When lay inspectors are substituted for veterinary experts the arrangement should be such that the inspection should be regularly performed during the prescribed hours. The antemortem and a postmortem inspection in stockyards and abattoirs finally necessitates a personnel for the supervision of the order and the operation of the abattoirs, as well as skilled and conscientious assistants for the discharge of incidental labor and duties in connection with the meat-inspection service.

In large abattoirs the time for inspection extends, as a rule, to all hours of the day, and in several places it is even continued during the night. In small and medium-sized abattoirs it is reasonable to limit the service of inspection to certain hours, adapted to local necessities.

The Ambulatory Antemortem and Postmortem Inspection.—In places which do not possess stockyards and abattoirs, meat inspection must be performed on the premises of the slaughtering party. This is naturally far more troublesome, more difficult and not as thorough as inspection in public abattoirs. Where the size of the place and other conditions permit, the inspection should be performed by veterinarians, and only in case they cannot be obtained should non-veterinary inspectors be called upon to perform the inspection. The latter will probably never be dispensed with in small towns and in sparsely populated localities. In ambulatory meat inspection it is always necessary to form inspection districts, which assure the appointed meat inspectors suitable and exclusive spheres of activity. In those localities in which the inspection cannot be performed by an individual expert, inspection stations are frequently established in which the inspections to be made are reported, and the fees paid. Here the meat brought or shipped into that locality is also inspected, and all matters affecting food animals and meat inspection are regulated.

In regard to the time of inspection, the distance to be covered by the inspector should always be considered, and sufficient notice should be given in order that the inspector may regulate his duties accordingly. If, as in hogs, the postmortem inspection and examination for trichinæ are not carried out by one and the same inspector, care should be taken that neither of the inspections should remain unperformed.

Extraordinary Meat Inspection.—By this term is understood special examinations which the experts of meat inspection have to carry out either alone or accompanied by the sanitary authorities. They include not only slaughtering places, but also the premises for storing, preparing and marketing meat. Although veterinary inspectors should

always pay attention to the condition and equipment of the industrial premises which they may enter in the execution of their office, yet unexpected special examinations must not be dispensed with. To counteract any possible objections to these examinations, it is advisable that extraordinary meat inspection should be considered in the local statutory regulations in connection with the general meat inspection.

This form of inspection should be extended to:

1. Proper condition and equipment of the rooms used in connection with the operation of the butcher shop, sausage-making or preparation of meat products.

2. Cleanliness of the plants.

3. The presence of uninspected meat, or

4. Tainted meat.

5. The use of prohibited preservatives and conserving substances.

6. Consideration of contingent, special regulations for the meat brought in.

7. Proper condition of the books pertaining to slaughter, and the meat.

Not too long an interval should elapse between the examinations, and during the warmer season they should be undertaken frequently.

Such examinations may also extend to the stores which market game, fowl, fish, or products prepared from them, even if these food substances in themselves are not subject to a compulsory inspection.

CHAPTER VI.

DECISIONS OF THE VETERINARY INSPECTORS AND DISPOSAL OF THE CONDEMNED MEAT.

ALL decisions of the veterinary inspectors are based upon the meat-inspection law and regulations issued in connection therewith. As the authority for such decisions as the non-veterinary inspectors may make is subject to veterinary supervision, the following representations apply only to the veterinary inspection force:

ANTEMORTEM INSPECTIONS.

The decision of the inspector may determine the following:

(a) Prohibition of slaughter when the animals show the presence of anthrax, blackleg, rinderpest, rabies, glanders, hemorrhagic septicemia, or if there is a suspicion of any of these infections.

The Federal regulations provide that all animals plainly showing on antemortem inspection any disease or condition that under these regulations would cause condemnation of their carcasses on postmortem inspection shall be marked "U. S. Condemned," and they shall be killed by the establishment, if not already dead, and shall not be taken into an establishment to be slaughtered or dressed, nor shall they be conveyed into any department of the establishment used for edible products, but they shall be disposed of and tanked in the manner provided for condemned carcasses.

(b) Deferring the slaughter of the animals which are exhausted or overheated through transportation, and of those females which are in an advanced stage of pregnancy. While there are no legislative measures in the regulations for this action, such an order is justified from a technical standpoint; besides it is also in the interest of the owners of the animal.

(c) Authorization of slaughter in all other cases.

INSPECTION OF THE SLAUGHTERED ANIMALS.

After the conclusion of the inspection of the slaughtered animal the decision of the inspector may be as follows:

(a) The meat, including the entire carcass (meat with bones, fat, viscera and all other parts which may be utilized for human food, the skin as well as the blood), is passed for consumption (marketable).

(b) The meat is passed for consumption (marketable) after the removal and condemnation of certain affected parts.

(c) The meat is passed for consumption, but is considered of second quality, and, as a rule, one or more diseased parts of the carcass are removed and condemned.

(d) The fat is passed without restrictions, while the meat is either condemned, conditionally passed, or passed without restriction.

The unaffected viscera of measly animals, the meat of which should be either condemned, conditionally passed of second quality, or passed without any restrictions, are also included in this group.

(e) The entire carcass is conditionally passed for sterilization with the exception of the part which might have to be condemned.

(f) The entire carcass is condemned for human consumption.



FIG. 65.—Jar stamp.



• FIG. 66.—Rail inspection and branding of hogs.

While in Germany, as the result of the postmortem examination, any one of the above-described actions may be taken with the carcass, in the United States only two methods of procedure are followed.

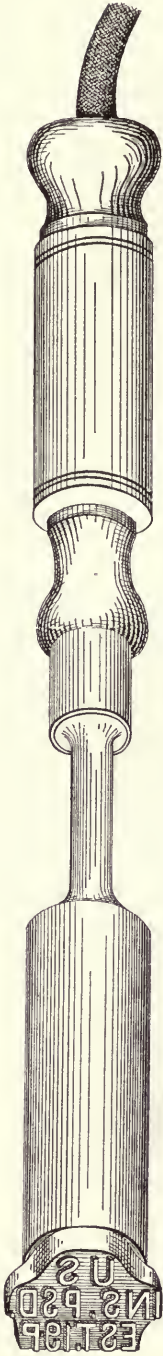

FIG. 67.—Electric branding iron.

The carcasses are either passed for consumption or they are condemned for the offal tank. Those of the first group are either passed in their entirety or they are passed only for the preparation of sterilized meat or lard; in the second group the meat cannot be utilized in any form. For instance, in slight lesions of tuberculosis, governed by B. A. I. Order 211, Regulation 11, Section 3, Rule C, or mild cases of hog cholera and swine plague, Regulation 11, Section 4, Paragraph 2 (c), or in localized affections, such as bruised parts, fractures, limited lesions in one of the viscera, etc., only the affected parts are condemned, while the carcass may be passed for lard.

Marking of Meat.—The inspected meat should be marked without delay (Fig. 66). (See B. A. I. Order 211, Regulation 16.) For this marking the ink stamps, which may be cut out of metal and variously constructed, seem to serve best. Rubber stamps cannot be recommended on account of their lesser durability. For convenient transportation, a box stamp is very well adapted, while for the great amount of stamping in abattoirs and inspection offices a box stamp similar to that of Fig. 65 may be advantageously employed.

As stamping ink for marking of meat of native slaughtered animals a purple ink has been prescribed. It must be harmless, stable, adhere easily and dry quickly. It should also penetrate into the superficial layers of the meat, and the impressions should not disappear after pickling or smoking. Green ink is used for stamping horse meat and is applied with an octagonal stamp.

Branding irons of suitable construction are used for marking, and may be heated by electricity (Fig. 67), gas flames (Bunsen burner) and alcohol or gasoline apparatus. The construction of a gasoline branding stamp, which the author had constructed from a gasoline soldering iron, is illustrated and described under Fig. 68. This simple and cheap stamping apparatus can be highly recommended, and there is no danger of burning the meat with the gasoline flame, which streams from the heat tube, thereby constantly heating the stamp. For the quick heating of several branding stamps, the large gasoline heating apparatus of the firm of Hauptner, Berlin, illustrated on page 19, may be highly recommended.

B. A. I. Order 211, Regulation 16, Section 1 to

10, describes in detail the procedure of marking all of the meat, whether passed, retained or condemned. Dr. Melvin is quoted on this subject as follows:

“The marking is done by means of a metal or rubber stamp and a purple indelible ink, and the words thus stamped are ‘U. S. Inspected and Passed,’ or an abbreviation of these words, with the establishment number (Fig. 69). The number is one assigned to the house by the Department at the time inspection is begun. It is registered in the Department records, and besides serving as a convenient means of reference, it provides a sure method of tracing meat about which questions may subsequently arise.

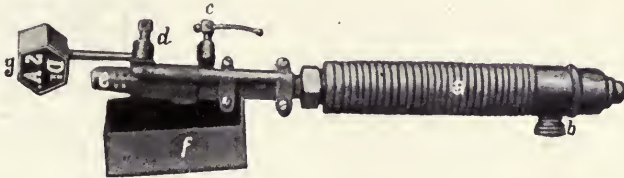

FIG. 68.—A gasoline branding stamp: *a*, gasoline container, one end of which is closed by a cap screwed on, but to which may be attached a small pumping arrangement for increasing the pressure in the gasoline container; *b*, opening for filling; *c*, screw for the regulation of the gasoline vapors; *d*, fastening screw for the stamp; *e*, heating pipe; *f*, iron box, which, filled with alcohol, serves for the heating of the apparatus in order to develop the gasoline vapors; *g*, stamp.

“This mark is absolutely necessary under the law to procure the movement of meats between States. The law forbids carriers to transport from one State to another any meats that are not so marked, except the meats of farmers and of retail butchers and dealers. It may as well be repeated here, in order to emphasize the statement, that the Federal law does not and cannot forbid the carriage of unmarked meats inside a State, so that in the absence of State laws the carriers may, unmolested, carry any kinds of meat from one part of a State to another.”



a

U.S. PASSED FOR
STERILIZATION

b

U.S. INSP'D AND
CONDEMNED

c

FIG. 69.—American stamp marks.

Disposal of Condemned Meat.—If a condemnation is to be made in accordance with the decisions enumerated in Paragraphs *b* to *f*, page 193, the inspector should temporarily seize the affected parts or the

entire carcass and notify the owner, stating also the cause of the condemnation.

The disposal of condemned meat is carried out in accordance with B. A. I. Order 211, Regulations 13 to 15, which contain the instructions as to the course to be followed with condemned carcasses and meat-food products.

Meat Passed with Restrictions (Passed Conditionally).—There are five methods employed to remove the injurious properties of meat belonging to this group. Boiling, steaming in steam-boiling apparatus, rendering, pickling and refrigerating.

BOILING.—The boiling method is well adapted for the destruction of all animal parasites occurring in meat and also of the vegetative forms of the infectious disease producers, which the meat may contain. For the killing of spores, on the other hand, simple boiling is not sufficiently certain, and for chemical poisons it is, as a rule, entirely ineffective. The satisfactory boiling of meat can be easily recognized by the appearance of a gray or white coloration of the meat, which should affect even the deepest layers.

The simple boiling in open boilers can be easily carried out everywhere, but it has the disadvantage that in the process a comparatively large quantity of the soluble nutritive substances are extracted from the meat.

STEAMING.—This method aims at obtaining a high temperature in the interior of meat infected with certain diseases, through the application of steam under pressure. It renders larger quantities of meat suitable for human food with as slight influence as possible on its nutritive value. Various steam-boiling apparatuses have been constructed, information pertaining to which may be obtained in special literature.

In the United States edible products are rendered in special apparatuses designed for this purpose. The Anco Laabs System (Fig. 70) is successfully operated in many plants.

This sanitary rendering cooker for edible products consists of an apparatus equipped to render any animal products that may be passed through an 18 inch diameter charging dome. It is an electrical welded heavy steel plate, steam jacketed, horizontal tank (*A*) having a central agitator shaft (*B*) driven by motor through a fully enclosed herringbone gear reducer, or through pulleys if belt drive is desired. Product is charged into door (*C*) mounted on charge dome (*D*) located in center at top on straight side of tank and discharged from door located at bottom on end of tank opposite from driving end. These doors are closed securely to permit pressure and vacuum cooking operations, all rendering being done without the action of direct steam. The agitator shaft is a special alloy hexagon steel machined drop forging, with special designed cast steel paddles, constructed so that all product is under complete agitation during the cooking period and by reversing the rotation of shaft the product is completely dispelled through the discharge door.

Steam inlets (*E*) to jacket of cooker are located at top near each end, a vapor outlet with shield arrangement over top of opening is located in

the lower part of charge dome, this vapor pipe (*F*) connecting to a jet condensing vacuum pump (*G*) and the various stages of the cooking operation controlled by valves (*H*). The condensed water from the jacket is led off through a steam trap (*I*) and the hot water then returns by a boiler feed pump to a boiler.

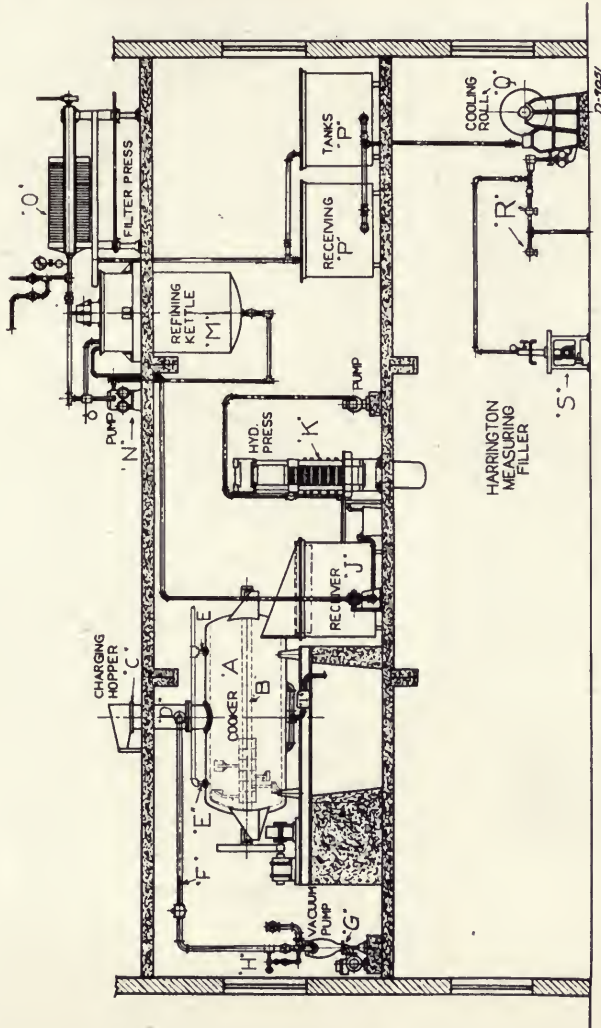

Fig. 70.—Rendering plant for edible products (Courtesy of the Allbright-Nell Company.)

Accessory machines are necessary including a crackling drain receiving pan (*J*) hydraulic curb crackling press (*K*) with hydraulic pump (*L*) and pump and motor or steam engine for driving cooker.

Description of Operation.—The product is charged into the Laabs Cooker through the Charge door (*C*) (the agitator may be in motion while charging) the door is then closed air tight and steam (approximately No. 60 to 90 gauge pressure) turned on into jacket, the agitator being

in rotation. Operating valve (*H*) being full opened which allows vapor (generated from moisture in product) to pass off on into jet condenser of vacuum pump (*G*). The odors of this vapor are mostly condensable in water, and discharge pipe from vacuum pump is connected directly to sewer line or injected direct into river or deep well.

The vapor is allowed to be drawn off for approximately one-half to three-quarters hour; then valve (*H*) is partially closed and an internal pressure allowed to build up inside of cooker (*A*) until approximately up to 30 lbs. pressure is obtained on gauge (*O*). This pressure is maintained for approximately up to thirty minutes, then allowed to recede very gradually through opening of valve (*H*) after which a vacuum is maintained until the product reaches correct condition for discharging. The entire process only lasts two and one-half to three hours.

The object of the vacuum period is to maintain low temperatures while the cracklings are being reduced to moisture content suitable for efficient pressing in hydraulic press (*K*). This cooking process insures sanitary product, the fat substances being separated, and a bleachable lard of highest quality (low in moisture and acid) is produced. The disintegration of all products, including the largest bones will be accomplished as all product is cooked to a pulp and consequently no grinding of such materials is necessary.

Upon completion of the cooking process, entire contents of cooker is discharged through the special arranged discharge door into receiving pan (*J*).

In this pan there is a perforated basket mounted on wheels into which all product is discharged. The majority of the product being a free lard fat immediately drains through perforated basket into the receiving pan, which is of ample area to hold all lard produced from one cooker charge. Cracklings remaining in the perforated pan are then loaded into hydraulic press (*K*) which produces finished crackling cakes approximately 20 inches diameter, $1\frac{1}{2}$ inches thick weighing approximately 16 to 20 lbs. each. These cakes are fairly low in fat content and extremely high in protein. Cakes could be stored for an indefinite period as there is no deterioration or any danger of internal combustion. These cakes are generally used for stock or poultry feed after being ground

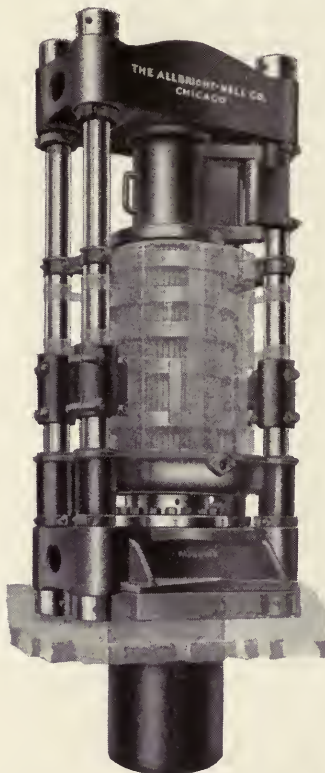

FIG. 71.—Hydraulic cracking press.

through a crackling grinder. Lard recovered from the crackling drain through a crackling grinder. Lard recovered from the pressing operation is added to the free lard recovered from the crackling drain receiving pan (*J*) and then pumped to refining kettle (*M*).

In this kettle filter cell or such type of clarifying agent is added, agitated and then pumped by means of pump (*N*) to filter press (*O*). The filter press filters out the clarifying agent allowing the clear lard to drain into receiving tanks (*P*) from where it is run on to cooling roll (*Q*) which furnishes a quick chill to the lard (preventing any separation of the stearine from the oil fats) scraped off from the roll into a picker box that stirs up the lard into a semi-liquid condition from where it is pumped through strainers and filled through filling nozzles (*R*) or through the Anco Harrington Measuring Filler Machine (*S*).

RENDERING FAT.—The process of rendering fat which is employed for the extraction of fat from diseased carcasses (tuberculosis, measles) will be described more fully on page 202.

Cut or mashed fat is rendered in ordinary open kettles, during which the temperature rises to 150° C. The meat steamers as well as the jacketed boilers with steam running through, are also adapted for this purpose. However, the liquid fat must not be drawn off before a temperature of at least 100° C. is registered. The connective-tissue residue of the fatty tissues is then scooped off and subjected to pressure in order to obtain as much of the remaining fat as possible.

Carcasses showing lesions which justify the passing of the tissues for lard have to be subjected, according to B. A. I. Order 211, Regulation 15, to a temperature of 220° F. for a time sufficient to render them effectively into lard or tallow. Meat subject to sterilization is required to be cooked at 170° F., inside temperature, for thirty minutes.

PICKLING.—The commercial method of pickling may render measly meat innocuous if the pickling is carried out sufficiently long (three to four weeks) and if the pieces of meat do not exceed over 2 kg. The destructive action of pickling on pathogenic bacteria or their products is very slight.

THOROUGH CHILLING.—The method designated as “thorough chilling” is employed exclusively on slightly measled beef, and serves to keep the meat in a fresh condition. The action of low temperature on the measles does not destroy them, but they lose their power to develop during the time the meat is retained. The employment of this method necessitates well-arranged meat-cooling rooms in all seasons.

The sale of conditionally passed meat which has been rendered fit for human consumption is only permitted after making known this condition, and in accordance with the instructions after it has been satisfactorily marked.

In order to completely destroy the vitality of *Cysticercus bovis*, beef carcasses should be retained in a freezer for a period not less than six days at a temperature not exceeding 15° F. Under no circumstances is the chilling method permissible in the case of measly pork.

Meat of Inferior Quality.—The conditions stated for conditionally passed meat should also be applied to the sale and utilization of meat which has been declared of inferior quality (non-marketable).

The regulations governing the meat inspection in the United States contain no provisions for passing certain dressed carcasses conditionally. An exception is only made with certain slight cases of tuberculosis and hog cholera, when the carcasses may be passed for sterilization, or for lard or tallow. Accordingly, the Freibank system of disposing of conditionally passed meat is not practised in the United States at the present time.

Absolutely Condemned Meat.—Meat condemned as unfit for human consumption may be disposed of harmlessly by subjecting it to a higher degree of heat (cooking or steaming until the maceration of the soft parts, dry distillation, burning), treating it with chemicals which will bring about the dissolution of the soft parts or burying it. The products obtained by the first method may be utilized in the industrial arts.

Before burying, deep cuts should be made into the meat, and it should be sprinkled over with lime or fine dry sand; or tar, crude oil (carbolic acid, cresol, power distillate), or alpha-naphthylamine in 5 per cent solution should be poured over it (denaturing). The latter procedure is also recommended when the condemned meat cannot be disposed of at once under the supervision of the inspector. Condemned meat must always be marked except in the case of single portions of meat, which are disposed of immediately in the presence of the inspector. All other condemned organs and parts must be marked positively with a condemned stamp, whereby the condemnation becomes official.

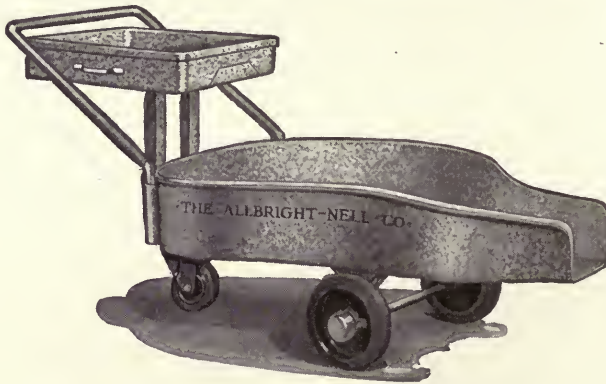

FIG. 72.—Paunch truck.

For temporary storing of condemned meat, especially in larger abattoirs, special containers should be provided from which removal of condemned parts should be impossible except by the proper authorities. The paunch truck shown in Fig. 72 is especially adapted to the receiving and handling of viscera, paunch, and liver in beef slaughtering departments. This truck is designed according to government requirements to facilitate inspection, as well as handling and dumping. The liver pan, mounted well out of the way of the inspector, is large and easily removed.

SIMPLE BOILING.—Simple boiling of the meat in open boilers until the soft parts fall apart is carried out in old flaying plants in order to obtain the fat, bones and the mass of meat boiled to pieces; the method is not good, and from a hygienic standpoint is not without objection.

BOILING UNDER HIGH PRESSURE.—Boiling meat to pieces in a high-pressure steam apparatus includes the advantages of certain sterilization, together with the gaining of valuable products. The apparatus is operated by means of high-pressure steam, conveying to the meat a temperature up to 150° C. The meat is broken up to such an extent that the principal constituents, such as bones, fat, insoluble albumin, glue and other substances as well as glue substances may be obtained separately.

CHEMICAL DESTRUCTION.—There are various methods for chemical destruction of meat. One of the older consists in the treatment of the meat with sulphuric acid and steam. The meat is placed into acid tanks or into wooden containers lined with sheet lead, and sulphuric acid at 45° C. is added, after which steam is conducted into the containers. As a result, a breaking-up and liberation of fat in the meat take place. The fat is skimmed off, and the remaining shiny, pulpy mass is mixed with bonemeal, lime phosphate, etc., and dried. In the drying, disagreeable odors develop, and consequently the method can only find application in fertilizer plants.

Franke recommends the treatment of condemned meat with a 3 per cent solution of sodium hydrate (NaOH) for about twenty-four hours, and subsequently boiling it for two to three hours with steam or direct fire, until a complete breaking-up of the soft parts. This method is very inexpensive and will probably be more widely employed in the future; it yields fat, glue broth and alkali albuminate. Saponification of the fat does not occur.

DRY DISTILLATION.—The dry distillation of the meat is not used as a practical method of disposal.

BURNING.—Burning of small parts may be undertaken at any place in the heating arrangements of the household, and is without a doubt the safest method of disposition. Where steam boilers are present even larger parts and divided carcasses of large animals may be burned.

BURIAL.—Burial of meat occurs principally in flat countries, after the meat has been previously denatured (page 200). The ditch should be laid out so that the surface of the meat may be covered with a layer of earth of at least 1 mm. thickness. According to the regulations of the Imperial Meat-inspection Law, trichinous meat is not allowed to be disposed of by burial.

TANKING.—Condemned carcasses or parts, as well as condemned meat and its products, and the offals, of the abattoir, are rendered in the United States in tanks, also called digesters. Such tanks are usually installed in abattoirs, and in the large establishments a large number of such tanks are placed in the so-called tank-house or tank-room. The tanks which receive the condemned meat are sealed by a Federal employee, who also supervises the tanking of the condemned material (see Fig. 73).

After the process of rendering is concluded, the seal is broken by the Federal employee and the contents of the tank are also removed under his supervision (see B. A. I. Order 211, Regulation 13, Sections 1 to 3). In the rendering process the regulations prescribe steam pressure, which should be maintained a sufficient time effectually to destroy the contents for food purposes. Before tanking the meat is always denatured. Through the rendering process all of the solids are thoroughly disintegrated, forming a pulpy mass. The grease is then drawn off through a conveniently placed draw-off valve, and the product is stored and shipped with the word "inedible" marked on the containers. After the fat is drawn off, the residue of the tank is dumped into a scrap vat in which it is allowed to settle, the grease is next skimmed off and



FIG. 73.—Method of locking with government seal the top of a tank containing condemned products.

the residue is placed in a press, usually a hydraulic press, where it is separated from all the moisture and grease, the dry substance being then prepared for fertilizers. In various places the tank water, which contains from 10 to 15 per cent solids, is utilized for the preparation of ammonia. The entire rendering process in the tanks requires from eight to ten hours.

The above method of rendering known as "wet rendering" has been supplanted in the United States in many instances by a more recently developed method commonly termed "dry rendering" or by a combination of both of these methods.

Dry Rendering.—Dry rendering is carried on in horizontal cylindrical steam-jacketed tanks which are provided with agitator shaft assem-

blies. Materials are fed into the tanks through a top opening and rendered at atmospheric pressure. Upon completion of the cooking the contents of the melter are discharged into a percolator containing perforated false bottom for draining grease from the cracklings. The remaining grease in the cracklings is pressed out by a hydraulic press. In these older models, in order to prevent the under-cooking of large pieces and the over-cooking of small pieces, the product is reduced to uniformly small pieces by a crusher before the material is put into the melter.

The latest dry rendering process, however, makes use of internal pressure and vacuum in its operation. This system handles both edible and inedible materials and produces better and more finished products than any other system. This new process of pressure and vacuum rendering is one of the outstanding improvements in packing-house practice, especially in salvaging inedible and condemned fats. The apparatus is equipped to receive any product that may be passed through an 18-inch charging dome. No grinding of raw material is necessary. It also is a horizontal tank with steam jacket and cylindrical agitator shaft with the ends of the tank securely closed to permit pressure and vacuum cooking operations as in an autoclave. All the gases (odors) pass from these modern tanks through water spray condensers which dissolve most of the odorous gases and thus carry the cooking odors away without them giving any offense. Such a modern rendering process overcomes one of the main objections to the location of a packing house within a town or city where the local health authorities have supervision, instead of having these plants located in the country where various objectionable conditions may exist without hindrance. The rendered material or tankage is discharged from a door into a crackling draining pan where the free grease is allowed to drain off. The cracklings are then conveyed to a machine called the expeller. This machine acts as a press and is used to press out additional grease.

The grease thus rendered is of better quality and the nitrogenous dry residue discharged from the expeller constitutes a valuable feeding material for animals or may be used in the manufacture of fertilizer.

For rendering inedible products the Anco Laabs apparatus (Figs. 74 and 75) has proved highly satisfactory.

Accessory machines are necessary including a crackling drain pan (*J*) hydraulic curb crackling press (*K*) with hydraulic pump (*L*) motor or steam engine for driving cooker, crackling grinder (*M*) and entrail cutter-washer (*N*) for hashing and washing guts and pecks before same are charged into cooker.

Description of Operation.—The inedible products are charged into the Laabs cooker in the same manner as in the rendering of edible products (page 197.)

The vapor is allowed to be drawn off for approximately 2 hours; then valve (*H*) is partially closed and an internal pressure allowed to build up inside of cooker (*A*) until—20 lbs. to 40 lbs. pressure is obtained on gauge (*O*). This pressure is maintained for approximately 30 minutes,

then allowed to recede very gradually through opening of valve (*H*) after which a vacuum is maintained until the product reaches correct condition for discharging. The entire process only lasts 5 to 7 hours.

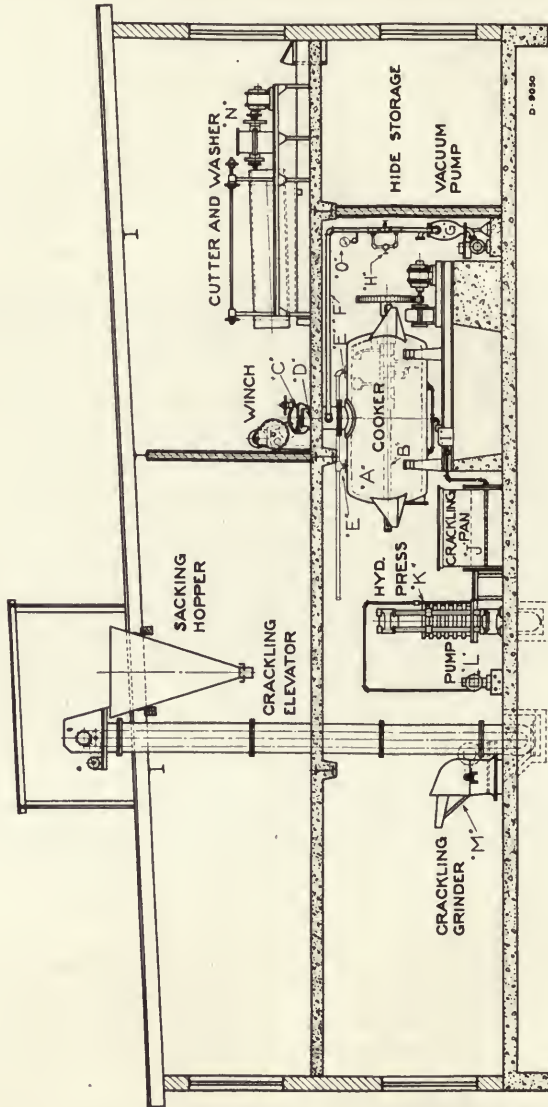

Fig. 74.—Rendering plant for inedible products. (Courtesy of the Allbright-Nell Company.)

The object of the vacuum period is to maintain low temperatures while the cracklings are being reduced to moisture content suitable for efficient pressing in hydraulic press (*K*). This cooking process destroys all disease germs with a certainty to insure a sanitary product, while the fat substances are separated and a bleachable fat of highest quality (low in moisture and acid) is produced. The disintegration of all pro-

ducts, including the largest bones will be accomplished as the carcass is cooked to a pulp and consequently no grinding of such materials is necessary. Guts and pecks are hashed and washed before charging into cooker, as it is best to exclude all manure, thus preventing a high fiber contents in the pressed cracklings (which are used as stock and poultry food).



FIG. 75.—The Anco Laabs cooker. (Courtesy Allbright-Nell Company.)

Upon completion of the cooking process, entire contents of cooker is discharged through the special arranged discharge door into crackling pan (*J*). This pan has a steam jacketed bottom with double perforated drain plates located approximately 9 inches above top of jacket. Free liquid fats allowed to drain through these plates for a period of hour or longer, then cracklings are loaded into hydraulic press (*K*) which produces finished crackling cakes as in the rendering of edible products. These cakes are then broken up and ground through crackling grinder (*M*), sacked and sold as stock or poultry food. Fats (greases or tallow) recovered from the pressing operation are added to the free fats recovered from crackling drain pan (*J*) and allowed to settle before loading into storage tanks or drums for shipment.

INSPECTION OF MEAT IMPORTED FROM FOREIGN COUNTRIES.

The decisions of the inspectors and the treatment of meat imported from foreign countries after inspection must be in accordance with the regulations of the meat-inspection law.

The decision may be one of the following:

- (a) Passed and admitted for traffic in the State.
- (b) Condemned and rejected from importation.
- (c) Condemned with harmless disposal.
- (d) Condemned and admitted after rendering it useless.

These decisions may extend in accordance with the conditions in fresh meat, to the entire shipment, to single carcasses, to single affected parts, and in prepared meat, to the entire shipment, to single packages, or to single pieces of meat.

All final decisions are made by the inspection office in accordance with the opinion of the veterinarian assigned to the inspection, to whom the results of the chemical examinations, if such were necessary, should be reported in writing.

The inspector-in-charge has control of the final disposition of condemned meat.

The marking of meat (page 194) is carried out in accordance with the regulations, with colored or branding stamps on the meat proper, and on the containers.

In condemnations the meat should be temporarily retained, and provided with a suitable identification mark. Immediate notice of the retention should be given to the authorities of the customs office, as well as to the owner, designating the cause of the condemnation.

The harmless disposal of condemned imported meat has to be carried out under the same conditions as for domestic meat.

For rendering useless foreign meat which is not permitted for consumption, the regulations give the necessary orders.

CHAPTER VII.

ABNORMAL CONDITIONS AND DISEASES OF FOOD-PRODUCING ANIMALS.

PECULIARITIES WITHIN PHYSIOLOGICAL LIMITS.

Fetuses and Dead-born Animals.—Unscrupulous butchers sometimes attempt to place the meat of almost mature fetuses or dead-born animals on the market as normal veal. If this meat is worked into various preparations it can only be found out, as a rule, by obtaining trustworthy information; it is very difficult to recognize in meat products. At best, the high glycogen content (see page 44) of meat mixtures might be an indication, as fetal meat contains a relatively large amount of this carbohydrate.

Postmortem Examination.—The undressed carcass of a calf fetus presents the following: Soft claws with untouched convex sole-pads; remains of the umbilical cord hanging from the open navel ring; umbilical vessels open, containing fluid blood; sometimes the throat is cut or is so stuck as to simulate slaughter by bleeding, but the edges of the wound are not infiltrated by blood. The dressed carcass shows the following:

Gaping condition of the umbilical vessels, in which the points of origin of the arteries from the internal pudenda artery should be especially noticed; open urachus; stomach and intestines free of coagulated milk; absence of milk feces; lungs atelectatic if they were not blown up by the butcher; muscles loose, flabby and watery; so, likewise, is the undeveloped fat tissue, especially around the kidneys, which is jelly-like; bone-marrow is red.

Judgment.—As the consumption of fetal meat would awaken a feeling or repulsion in most cases, such meat should be considered as unfit for human food. B. A. I. Order 211, Regulation 11, Section 21, Paragraph 2.)

Immature Animals.—Only calves which are too young come into consideration here, as young pigs, lambs, and kids are consumed when only a few days old. Calves are considered mature, or mature for slaughter when the meat and fat have attained a certain development, which, as a rule, is only reached within eight to ten days after birth. However, the requirements of the public relative to this vary greatly. In North Germany, especially in Mecklenburg and Holstein, calves are frequently slaughtered as so-called "fasting calves" when only three or four days old, and even shortly after birth; but they are allowed to become much older in South Germany, being generally two to three weeks old. Young pigs (roasting pigs), lambs (Easter lambs), and kids

are considered mature for slaughter at an age of about three or four weeks.

Chemical Composition.—Mr. David Edelman of the Bureau of Animal Industry has compared the composition of immature and mature calf carcasses. Seven samples, representing calves one to three weeks old and condemned as immature on postmortem inspection, were found to contain from 77.18 per cent to 79.11 per cent moisture and from 19.74 per cent to 20.85 per cent protein. Nine samples, representing normal calves one to four months of age and passed as sufficiently mature for food purposes on postmortem inspection, were found to contain from 65.40 per cent to 76.09 per cent moisture and from 18.43 per cent to 20.94 per cent protein. Two eight-month fetuses contained respectively 78.49 per cent and 80.54 per cent moisture and 13.43 per cent and 16.87 per cent protein. Mr. Edelman's findings indicate that the water content of the flesh of immature calves may be expected to exceed a minimum, approximately 77 per cent, which is greater than the maximum for normal mature calves.

Symptoms and Lesions.—The meat of immature calves is very moist, loose, tender and tears easily; can be perforated with the fingers, and is grayish-red. The muscular development, as a whole, is but slight, which can be especially noticed on the leg (upper shank). The tissue, which later develops as the fat capsule of the kidneys, is edematous, dirty yellow, or grayish-red, tough, and intermixed with some islands of fat. For characteristic signs of age, see page 21.

Judgment.—According to the meat-inspection regulations, immature or insufficiently developed calves shall be condemned.

The same practice should be followed with the immature meat of other animals.

(See B. A. I. Order 211, Regulation 11, Section 21, Paragraph 1.)

Emaciated Animals.—Emaciation must not be confused with *leanness*. Leanness is a physiological condition which may coincide with perfect health of the individual, and the animal after slaughter may show no disease, or only insignificant indications of diseased changes. Leanness can be observed in all animals which are in the stage of development, in most of the male breeding animals, in cows which are in a period of strong lactation, and in poorly nourished animals, or in those not properly taken care of.

The meat of lean animals contains a small amount of fat, but is otherwise firm, tense and, as a rule, darker in color than normal, and sometimes the connective tissue appears strongly developed, which causes toughness of the meat.

Emaciation is always the result of disease or old age, and is characterized by a retrogression of the general nutritive condition below the normal. In well-marked cases, and when associated with a pronounced loss of strength, it is designated as cachexia. Emaciation may develop rapidly in febrile diseases. Occasionally anemic and dhremic conditions are associated with emaciation.

Chemical Composition.—Hoagland and Powick¹ compared the composition of the flesh of emaciated, very thin, and fat cattle. Their results are summarized in the following table:

	Moisture, per cent.	Ash, per cent.	Total nitrogen, per cent.	Protein (N x 6.25), per cent.	Ratio protein to moisture.
Extremely emaciated	80.45	0.99	3.03	18.94	1 to 4.2
Very thin	79.38	1.03	3.17	19.80	1 to 4.0
Fat	76.27	1.10	3.54	22.09	1 to 3.5

These authors draw the following conclusions from the results of their investigations:

1. The flesh of extremely emaciated cattle is characterized by a relatively high moisture content and by a low content of fat, protein, ash, and probably of sugar.

2. The ratio of protein to moisture in the flesh of extremely emaciated cattle, with but rare exceptions, is wider than 1 to 4, whereas the ratio for the flesh of normal cattle is usually much narrower.

3. It is believed that the ratio between protein and moisture in the flesh of "very thin" or "extremely emaciated" cattle will prove to be of value in classifying such animals for food purposes.

Symptoms and Lesions.—The following characteristics are noted on living animals: Marked projections of prominent portions of the bones, sunken muscles, flabby skin without elasticity and laid in folds with much desquamation, scrubby, dull hair, tired look from sunken eyes and decided weakness when in motion, with relaxed muscles while standing.

In slaughtered animals the most striking appearance is shown in emaciated hogs, as with the exception of boars and brood sows these animals are generally slaughtered in a fattened condition, unless the slaughter is necessitated by disease. In general, absence of fat in all emaciated animals is noted first in the subcutis, which is shrunken away like all other places of fat deposit, and is replaced by a loose yellowish or reddish, more moist, and even jelly-like tissue. Advanced changes are naturally dependent upon more severe cases, which are especially distinguished by pronounced changes of the kidney fat. The muscular tissues are atrophied, sunken, loose, pale, more moist, and very rich in connective-tissue elements. Lymph glands and lymphoid tissue are frequently very prominent in young individuals, while they may be atrophied in older subjects. Bone-marrow is, in advanced cases, poor in fat, red, watery; or in older animals even slimy. Sometimes, also signs of atrophy of the liver and spleen are noted.

Judgment.—Carcasses showing a marked slimy degeneration of fatty tissue in the region of the auricles of the heart, the mediastinal space, the interspinous spaces, bone-marrow and around the kidney, along with a serous infiltration of the musculature, are to be considered too emaciated for food purposes.

¹ Hoagland, Ralph, and Powick, Wilmer C.: A Chemical Study of the Flesh of Emaciated Cattle, Washington, D. C., Jour. Agric. Res., December 1, 1925, vol. 31, No. 11.

Extreme thinness without these lesions should be considered physiological and may coincide with perfect health.

According to B. A. I. Order 211, Regulation 11, Section, 19, carcasses which show advanced emaciation should be condemned; the association of the emaciation with a disease condition would naturally exclude the carcass for food purposes.

Abnormal Odor and Taste of Meat.—Sexual Peculiarities.—Abnormalities of odor and taste in meat, associated with sexual activity, are manifested in the most pronounced form in boars and male goats, and then in cryptorchid boars.

Findings.—A specific odor of the meat is always perceived in old boars immediately after slaughter; it resembles the odor of living boars, and is designated as a urine-like or sexual odor. Although this gradually diminishes through cooling the meat, it again becomes marked as soon as the meat is warmed by boiling or roasting.

Therefore, it is necessary to undertake a boiling test (page 169) with the meat of every boar twenty-four hours after slaughter. The odor is most perceptible when the boiled meat begins to cool. In doubtful cases the odor test should be made by several persons. The characteristic repulsive odor is also accompanied by a similar taste.

Besides the disagreeable odor and taste, the meat of boars possesses also a peculiar toughness, and the skin of the back, shoulders, neck, and chest walls is of a cartilaginous hardness (Schild).

As the boar odor is retained for some time after castration, recently castrated animals must be judged like those not castrated. Careful attention should be given to so-called stags.

In larger abattoirs, when the antemortem and postmortem inspection is seldom made by the same person, it is advisable to practise care in meat inspections, for butchers, as a rule, remove the testicles with a portion of the scrotum in dressing the animal. In such cases the cutting away of the skin on the inside of the thigh is conspicuous, which, in connection with other sexual peculiarities (thickness of the skin, penis or its roots at the notch of the pubis, and the marked development of the bulbo-cavernosus muscle) must excite suspicion.

In the meat of cryptorchid boars the sexual odor is almost invariably present if the retained testicles possess functional activity. At any rate, it is advisable to condemn temporarily every cryptorchid boar until a boiling test with the cooled meat can be made.

Meats of male goats has a very pronounced disagreeable, goatish odor and taste, resembling the odor of the living animal. The boiling test with the cooled meat is decisive.

Meat of specially strong full-fleshed bulls may, according to Goltz, develop an exceptionally noticeable odor, which is similar to the odor from the skin of these animals in life, and which is also manifested after boiling.

Before being chilled the meat of rams has frequently a peculiar odor which is quite noticeable, but it cannot be designated as repulsive. For judgment of such meat, see below,

Influences of Feeding.—As a result of extensive feeding with fish, which sometimes occurs near the sea coasts, the meat, and especially the fat of hogs, acquires a fishy odor and taste. Extensive feeding of garbage (food remnants and offal from hotels, institutions, etc.) gives meat an insipid, rancid odor and taste, and changes the firm consistence of the meat and especially the fat.

After feeding fenugreek, meat, according to observations made in France, acquires an odor and taste resembling that of hog manure. This may also occur in calves given milk from cows fed with this plant.

Ollman observed a rancid odor and a soapy taste in the meat of lambs fed with beets in which fermentation had begun to develop.

The flesh of poultry acquires an oily flavor in animals fattened with oil seed, oil cake, colza, or hempseed; and a fishy odor and taste from feeding with fish. Turnips are supposed to produce a bitter taste, and pond mussels also cause a very disagreeable flavor in the meat of ducks.

All these abnormalities of odor and taste produced by the influence of food are, as a rule, only perceivable after heating the meat. For judgment of the meat, see below.

Absorption of Odors.—The ingestion and administration of odor-producing substances in the body of animals may also cause an abnormal odor and flavor in the meat. While not always strictly within the physiological limits, they may, however, be mentioned here. These substances may be taken up accidentally, or may be administered as medicines, and especially come into consideration in emergency slaughter. Among the more important to which attention should be called are: Ether, anise, asafoetida, valerian, benzine, camphor, carbolic acid, chloroform, petroleum, tar and fennel.

It is especially noteworthy that inhalations of carbolic acid, chlorine, ether and chloroform vapors by animals cause their meat to absorb the corresponding abnormalities of odor and taste. This may occur in stable and railroad stock-car disinfection.

These odors may be manifested to a high degree in freshly slaughtered animals, but they appear most distinct after boiling or roasting the meat.

Judgment.—Meat which possesses to a high degree a repulsive odor of flavor is unfit for human food. (According to B. A. I. Order 211, Regulation 11, Section 14, carcasses giving off urine or sexual odors should be condemned.)

For deviations in the odor and taste of meat of diseased animals, and those with intestinal parasites, see Chapters VII and VIII, pages 223 to 340. For postmortem abnormalities of odor, see Chapter IX, page 341.

Animals in Advanced Pregnancy.—It is generally believed among butchers that the meat of animals in advanced pregnancy is of inferior quality because it contains more moisture, has a looser consistence, and therefore does not keep so well, and is not suitable for the preparation of sausages which require keeping qualities. This, however, cannot be in general substantiated. There are cases in which the

meat, especially of the hind-quarters, possesses these peculiarities, but they are restricted principally to sows in the last stages of pregnancy.

Judgment.—The judgment can, therefore, be applied only to cases individually, and must be directed in accordance with carefully observed objective finding on the animal itself.

In accordance with B. A. I. Order 211, Regulation 11, Section 20, carcasses of animals in the advanced stages of pregnancy (showing signs of parturition), also carcasses of animals which have given birth to young within ten days, and in which there is no evidence of septic infection, may be passed for sterilization; otherwise they shall be condemned.

If the terms of purchase include absence of pregnancy the buyer is entitled to claim indemnification from the seller.

Abnormal Color of the Fat.—An intense yellow coloring of the fat appears in old cows as a sign of advanced age. Feeding also, as a rule, influences the color of fat. Cattle principally fattened on the pasture, for example, possess a yellow fat; hogs extensively fed on corn or cottonseed meal have a milder yellow coloration of the fat. A more saturated, dirty yellow color is observed in the fat of calves, nourished on cottonseed meal or acorn cake. If hogs are fed on fish or garbage the fat manifests a blackish-gray or grayish-yellow coloration. The fat of certain breeds as the Jerseys and Guernseys is always of a deep yellow color and should not be mistaken for icterus.

According to Procher, the yellow coloration which results from feeding depends upon a pigment belonging to the "lutein" group. It is entirely distinct from bilirubin.

Lutein is soluble in chloroform, amyl alcohol, common alcohol, benzene, turpentine, and ether; bilirubin, on the other hand, is soluble only in chloroform and amyl alcohol. Lutein has two absorption bands (green blue and blue); bilirubin has none. Solutions of bilirubin in CHCl_3 , shaken with a small quantity of soda solution, lose the pigment rapidly, while the lutein does not. Lutein solutions exposed to the air are soon discolored while those of bilirubin retain their color; and lutein solutions do not give the Ehrlich reaction.

Judgment.—Meat and fat of so-called pasture- or grass-fed cattle should not be condemned. This also applies to calves with yellow coloration of fat. Otherwise, moderate deviations relative to color render the meat of a lesser quality. In more marked changes of color the meat, as a rule, shows also abnormalities of odor and taste, and should be judged according to the provisions of the regulations. The discolorations cannot be mistaken for jaundice by a careful inspector, as in the yellow coloration resulting from feeding the fat only shows the yellow color, while in icteric animals all connective-tissue substances, and particularly the serous membranes, manifest a yellow coloration. For further influences on the meat of hogs from feeding upon fish and garbage, see page 211.

Carcasses showing any degree of icterus with a parenchymatous degeneration of organs, the result of infection or intoxication, and

those which show an intense yellow or greenish-yellow discoloration without evidence of infection or intoxication, shall be condemned. Carcasses affected with icterus, the result of conditions other than those before stated in this section, but which lose such discoloration on chilling, shall be passed for food, while those which do not so lose such discoloration may be passed for sterilization. No carcass affected with icterus may be passed for food or for sterilization unless the final inspection thereof is completed under natural light. (B. A. I. Order 211, Regulation 11, Section 13.)

Incompletely Bled Animals.—Since the aim in the slaughter of animals is to abstract as much blood as possible from the body, insufficient bleeding is always somewhat unusual and conspicuous.

Lesions.—An unusual blood content is observed in the viscera, especially of the liver and intestinal veins, and a marked fulness is noted in the ventricles of the heart, the subcutaneous veins, and those of the muscles, which also contain more moisture. The spongy parts of the bones are richer in blood, and under certain conditions the bone-marrow is also. In accordance with the degree of bleeding, the increased blood content is more or less marked.

Judgment.—In judgment it is first of all necessary to decide the cause of insufficient bleeding. If it was the result of disease, then the nature of the disease is the standard for decision.

If insufficient bleeding results as a consequence of long transportation, overexertion, overfeeding, heat stroke, lightning stroke, violent brain or spinal-cord injuries, sudden internal bleedings, etc., the carcass should be judged in accordance with the severity of the condition.

In most instances incomplete bleeding is an evidence of a serious condition of the animal before slaughter and carcasses showing these indications should be condemned.

Exhausted Animals.—Although meat of exhausted animals usually must be judged in association with insufficient bleeding, there are instances in which the meat contains some other peculiarities, as a result of exhaustion. According to Ficker, the exhaustion of animals facilitates considerably the penetration of bacteria through the intestinal walls. The *Escherichia coli* was demonstrated in the kidneys, liver and mesenteric glands of exhausted dogs, and *Proteus vulgaris* in the liver. It produces a similar condition as in the dying animal. This also explains why the meat of exhausted food animals spoils soon after slaughter, while it will keep well if the animals rest for several days before being put to death.

Lesions.—The color of the meat is, according to Villain, brown or dark red, frequently even blackish; the odor is repulsive, slightly sour, sometimes resembling ether; the muscle fibers are dry in cutting; no muscle juice oozes out, and the meat cuts like rubber; hemorrhages and ruptures occur in the muscle fiber; the spongy parts of the bones are dark, the bone-marrow hemorrhagic and the lymph glands injected. The muscles are supposed to contain ten times as much kreatin as normal muscles.

Judgment.—As a rule, the meat of exhausted animals acquires pronounced repulsive changes, which make it unfit for human food.

Dead Animals.—Animals are dressed sometimes after they have died, and manipulations are undertaken on dead animals to give the

appearance of slaughter ("cold slaughter"). Therefore, the meat of dead animals sometimes appears for inspection.

Lesions.—Absence of signs of a regular slaughter; complete fulness of all the venous vessels, especially noticeable in the liver, intestines, and subcutis; a varied content of blood in the lungs and kidneys (hypostasis); marked fluid content of the subcutis and muscles.

Judgment.—The meat of dead animals is, according to the regulations, unfit for human food.

Whether such meat is objectively unwholesome depends on the cause (disease, accident) of death. Furthermore, meat of dead animals undergoes putrefactive changes very soon (see page 213) and as a result may be rendered unwholesome.

The meat of animals seriously ill, as from injury, stroke or lightning, cardiac or cerebral apoplexy, suffocation, and from other causes, may receive a more liberal decision if some blood could be extracted from the body and the dressing were hastily performed (see page 213).

According to B. A. I. Order 211, Regulation 9, Section 2, Paragraph 7 and Regulation 13, Section 3, Paragraph 2, animals which die in the abattoirs and those in a dying condition should be condemned; the same provision is made for suffocated animals. Besides, the regulations also specify that the carcasses of such animals when conveyed to the tank-room should not pass through the compartments in which food products are prepared.

GENERAL PATHOLOGICAL CHANGES AS RELATED TO MEAT INSPECTION.

Disturbances of the Circulation.—**Hyperemia.**—An increased quantity of blood in various parts of the animal body may occur as functional, active, passive, collateral, or inflammatory hyperemia, and its recognition is not difficult. However, it should be remembered that all changes in organs caused by the quantity of blood in them become, with rare exceptions (local active hyperemia), more or less indistinct after the bleeding of slaughtered animals. On the other hand, after natural death or insufficient bleeding, hyperemia is so pronounced that it may serve as a sign for recognition of these last-named conditions. For judgment, see page 216.

Hyperemia should not be confused with hemorrhagic saturation or imbibition which does not represent an engorgement of bloodvessels, but consists of a red coloration of tissues by the blood-coloring matter, dissolved by blood serum (see Septicemia and Putrefaction).

Postmortem spots (cadaver spots, livid areas, postmortem hypostasis) are blue discolorations of the skin of dead animals which result from the tendency of blood after death to sink to the dependent tissues, finally filling the capillaries.

Anemia.—This condition, which is characterized by a local deficiency of blood (ischemia) in the respective parts, can also be readily detected; and in this connection, the influence of stronger or lesser bleeding should always be taken under consideration. For disposition of such carcasses, see page 216.

For general anemia, see Chapter VII, page 238.

PLATE I

FIG. 1

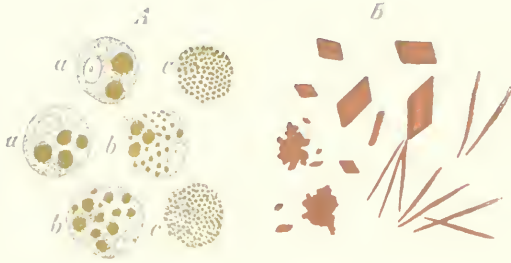

A, cells containing amorphous blood pigment: *a*, with a few larger broken-down products; *b* and *c*, with numerous small degenerated products of red blood corpuscles. B, rhomboid crystals and needles of hematoidin. $\times 300$. (After Ziegler.)

FIG. 2

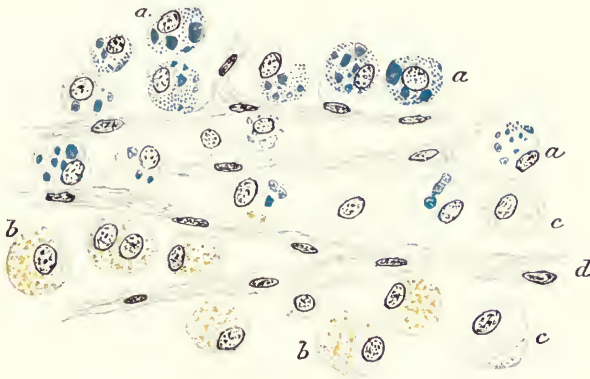

Cells Containing Hemosiderin and Hematoidin from an Old Hemorrhagic Area in the Brain (Alkaline Berlin Blue Reaction).

a, cells with hemosiderin; *b*, cells with hematoidin; *c*, fat granule cells which became cleared; *d*, newformed connective tissue. $\times 300$. (After Ziegler.)

Hemorrhages.—In the occurrence of hemorrhages, it is necessary to distinguish between the escape of blood into the tissues due to tearing of the heart muscle or the walls of the blood vessels (hemorrhages by rupture [*per rhexis*] resulting from traumatism, greatly increased blood-pressure or nutritive disturbances of the walls of the blood-vessels), and hemorrhages without separation of the continuity of the blood-vessel, in which blood corpuscles and serum escape by *diapedesis*, through dilated pores of the walls of the vessels. In the former, large-hemorrhages and blood effusions are produced (extravasations, suggillations, hemorrhagic areas, infarcts, hematomas); in the latter, punctiform and circumscribed hemorrhages (petechi and ecchymosis).

The consistency of the hemorrhages is not affected by the animal being bled to death.

Drück determines the time of the occurrence of hemorrhages, as follows: First, the red blood corpuscles swell and begin to clear. As a result of clearing they become pale after two days and finally almost completely transparent, while as a result of the swelling the bi-concave blood plates gradually adopt a round form. From the fifth day, shrinkage takes place with formation of very fine crenations on the periphery of the blood corpuscles. The increased shrinkage changes the blood corpuscles up to the sixth to eighth day into either irregular polygonal or star-shaped formations, or into key- or cup-shaped bodies. The hemoglobin penetrates the surrounding tissues uniformly until the sixth day, and produces a brownish tint. At the seventh day hemosiderin, which contains iron (Plate I, Fig. 2), develops and soon diffuses through the entire tissue. However, from the twelfth day it is exclusively found in the contracted cells. From the twelfth day the pigment, which is at first in solution in the white blood corpuscles, becomes granular; and from the eighteenth to the twenty-fifth day it gradually breaks up into finer and finer granules. At the same time the white corpuscles containing granules also break up, so that from the eighteenth day the first free pigment granules may be noticed in the tissues. In the latter, about the sixtieth day, there is a very fine granular pigment exclusively present, which is free of iron. Besides, under certain but entirely unknown conditions, coloring matter crystals may form (hematoidin, a derivative of hemoglobin, containing iron, Plate I, Fig. 1).

For judgment, see under page 216.

Transudates.—The increased escape of fluid constituents of the blood through the uninjured walls of the vessels, which results inside of the tissue in edema (anasarca, hyposarca) and in the body cavities in effusions, is either the result of changes of the blood (hydremia) or of disturbances of circulation, the recognition of which is very difficult, although the causes are quite significant. While edemas are, as a rule, not changed by slaughter, observation of suspected transudation in the large body cavities requires the personal presence of the inspector at the opening of the carcass.

For judgment, see below.

Thrombosis and Embolism.—Obstructions of the blood-vessels, as a rule, are recognized in meat inspection only when they affect large blood-vessels, or when thrombosis is present in organs in which a hemorrhagic infarct develops. The infarct usually possesses a wedge-shaped cross-section, and is chiefly conspicuous by its dark red color, which gradually turns to a dim gray and dull yellow. Hemorrhagic infarcts

are principally found in organs with terminal arteries (spleen, kidneys, brain, retina), but also in the lungs. If the region of the obstructing blood-vessels does not anastomose with other vessels from which it may receive blood, that region remains free of blood and dies off. It will develop an anemic, pale infarct, which may be principally observed in the heart, spleen and kidneys. Later, it results in connective-tissue degeneration and cicatrization of the region cut off from the arterial blood supply.

Judgment.—In the judgment of meat included under the described local circulatory disturbances, the extent and cause of conditions must be considered; also whether these changes are purely local and appear independently, or whether they are the accompanying manifestations of a general affection. In purely local changes, as a rule, only the diseased part of the body, or the entire affected organ is condemned as unfit for human food on account of its altered consistence.

When circulatory disturbances are manifested in numerous parts of the body it is usually indicative of a general affection and should be judged accordingly, but when the circulatory disturbances are not symptomatic of a generally diseased condition, and yet appear extensively throughout the body, their significance should be considered under Organic Diseases (page 223).

Inflammations.—For the purposes of meat inspection it appears most appropriate to consider various inflammations in accordance with the character of their exudates. Accordingly the following forms are distinguished:

1. Serous and catarrhal inflammation.
2. Fibrinous inflammation.
3. Suppurative and ulcerative inflammation.
4. Hemorrhagic inflammation.
5. Croupous inflammation.
6. Diphtheritic inflammation.
7. Gangrenous inflammation.
8. Productive inflammation.

There are also variously related and mixed forms (serofibrinous inflammations, croupous-diphtheritic inflammation, etc.). The parenchymatous and interstitial inflammations of glandular organs, from a practical standpoint are better kept apart.

In regard to the lesions found in various forms of inflammations, nothing need be said here, as their manifestations should be familiar to everyone who has studied pathology. For the same reason the cause of inflammations will not be treated here.

Judgment.—In judging the meat of affected carcasses the purely local forms of inflammation must be separated from those which appear as accompanying symptoms of general disease. The purely local forms are frequently the results of traumatic lesions and are more or less confined to certain areas; accordingly only the inflamed parts or at most the affected organ should be condemned as unfit for human food. In serous and catarrhal inflammations of the mucous membranes this is frequently unnecessary, as the diseased organs are either not used in any form for human food, or in further manipulations

(intestines, air passages, urinary and sexual passages) the diseased mucous membranes are removed. That local inflammations may be the starting-point of infectious processes is known and, therefore, when suspicious of such cases it is advisable to be careful in the disposal of the meat.

Those general affections which manifest accompanying symptoms of inflammation are usually of an infectious nature (principally the more severe hemorrhagic, croupous-diphtheritic and parenchymatous inflammations). The judgment of such carcasses depends on the original disease.

Retrogressive Nutritive Disturbances and Infiltration of the Tissues.

—**Atrophy.**—In meat inspection the condition known as atrophy is of no special importance, and comes only into consideration when fat muscular tissues, and certain glands, especially the liver, are affected. While the atrophy of the glandular organs is easily recognized by the decrease in size and the firmer consistence, nevertheless the atrophy of the muscles and of the fat tissues is, as a rule, only noticed in an advanced state. As a result of atrophy of parenchymal cells, the connective-tissue elements stand out more prominently in the atrophied organ; this condition is sometimes wrongly considered an increase of connective tissue (induration).

Judgment.—See page 221.

Cloudy Swelling.—Cloudy swelling (parenchymatous degeneration, granular infiltration) is of very great diagnostic importance in meat inspection. It occurs in large glandular organs and in muscles, and is characterized by slight enlargement of the organ, with a cloudy, dull, lusterless appearance, especially of the cut surface, together with the projection and diffused appearance of the latter. The normal color is changed into grayish color tints, the lightness of which corresponds with the severity of the changes. The consistence of the organ is friable, which as a result of a diminution of blood and moisture may increase to a brittleness. In a pronounced case the organs appear as if they were boiled. Cloudy swelling is to be considered as a disorganization of the protoplasm, which ensues under the absorption of fluids and leads to a partial separation of the solid and fluid parts (Ziegler).

Microscopic examination reveals an accumulation of fine, slightly refractile granules in the protoplasm of the swollen cells, the connection of which appears somewhat loosened. The albuminous granules, which are insoluble in alkalis and ether but are soluble in acetic acid, give the cells a cloudy appearance, as if they had been covered with dust (Fig. 76). The nucleus may also be swollen and its structure degenerated.

Cloudy swelling is frequently the precursor of fatty degeneration (see next page).

Judgment.—See page 221.

Fatty infiltration.—Fatty infiltration, which frequently occurs in various organs of fattened food animals, does not represent an abnor-

mal condition in meat inspection, and is only mentioned in contradistinction to the fatty degeneration described below.

By physiological infiltration is understood a deposit of fat globules in the cells, the normal structure of which remains otherwise intact. The fat enters the cells, according to Rievel, in dissolved form, is split up and is then again synthetically built up within the cells (granular fat synthesis of Arnold). This condition appears principally in the tissues which normally serve for storing fat (connective tissue).

It also occurs to a great extent in primitive muscular fibers, in various epithelial cells and especially in liver cells. To this form of infiltration belongs the so-called fatty liver of highly fattened animals as well as the liver in cases of advanced pregnancy, in sucking animals, and in diseased conditions where there is an insufficient oxidation of blood.

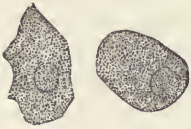

FIG. 76.—Cloudy swelling of liver cells as a result of septicemia. $\times 350$ diameters. (After Ziegler.)

Fatty liver is characterized by its lighter yellowish-brown color, slight swelling, rounded edges, cloudiness, fatty luster of the cut surface but by no structural abnormalities, and the lobules are not obliterated. The consistence is soft. Microscopically, a rich accumulation of fat is found in the interlobular tissue, and the swollen fat globules have a tendency to run together, to form large droplets in the cell protoplasm (Fig. 77, *a, b*).

Judgment.—See page 221.

Fatty Degeneration.—Fatty degeneration, which, according to Rievel, would be more correctly designated as pathological or degenerative fatty infiltration, represents occasionally an advanced development of cloudy swelling; but it may also occur without this preliminary process. It affects both epithelial cells (liver and kidney), connective-tissue substances (heart and skeleton muscles, connective-tissue fibers) and consists in an accumulation of fat in the cells, the structure of which is more or less injured. Fat, however, does not originate from breaking up of the cell albumin, as it was formerly supposed, but it is conveyed as such to the cells. The entire procedure might be traced to respiratory causes.

Fatty degenerated organs are characterized by a yellowish color, which may be uniform or spotted, with slight fatty luster of the cut surface, obliterated structural relations and flabby, doughy consistence. A swelling of organs in the majority of cases does not take place. Microscopically, a disintegration of cell connections is found, and sometimes a crumbling and breaking down of the cell into a fatty detritus, which consists of granules and fat globules (Figs. 77 and 78). The latter remain unchanged by the action of acetic acid; while they are dissolved by ether and chloroform.

Judgment.—See page 221.

Various Degenerations.—Mucoid degeneration (mucin metamorphosis) is rarely observed in food animals. It affects fat tissues, which were transformed into a yellow transparent jelly-like mass (Ostertag).

Hyaline or glassy degeneration of the muscles also occurs infrequently and

is always associated with severe general affections. It was observed by Frattner to affect the heart muscles in the malignant form of foot-and-mouth disease.

Amlyoid degenerations have been observed in various organs, especially in fowls.

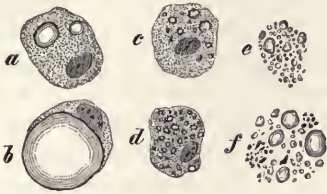

FIG. 77.—Liver cells containing fat: *a* and *b*, fatty infiltration; *c*, *d*, *e*, *f*, fatty degeneration. $\times 400$ diameters. (After Ziegler.)



FIG. 78.—Fatty degeneration of the heart muscle. $\times 350$ diameters. (After Ziegler.)

Necrosis, Caseation, Gangrene.—The easily recognized necrosis, or necrobiosis of the organs or tissues, occurs principally as a local affection, and would accordingly be of little importance in meat inspection if the necrotic parts did not readily become centers for the colonization and multiplication of saprophytic and pathogenic microorganisms. In such cases an inflammation always develops in the tissues surrounding the necrotic parts, and not infrequently a uniformly diseased condition follows in the affected animal.

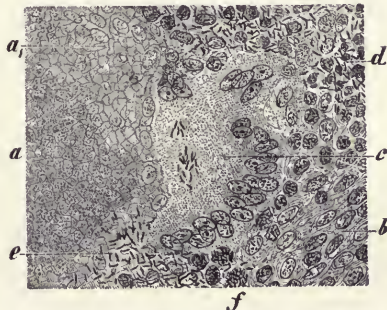

FIG. 79.—Tissue from a partially caseated tuberculous focus with bacilli (alk. fuchsin-aniline blue): *a*, granular; *a*₁, cheesy masses; *b*, fibrous cellular tissue; *c*, partly necrotic giant cell with bacilli; *d*, bacilli in the cellular tissue; *e*, bacilli in necrotic tissue; *f*, bacilli enclosed in cells. $\times 200$ diameters. (After Ziegler.)

Caseation is designated as necrobiotic coagulation necrosis, in which the broken-down tissue has a caseous appearance. Tuberculous change of the tissues is the typical form. In cellular tissue caseation may be frequently observed between the cells as a “fibrinoid mass,” or even as typical thready fibrin (Fig. 79).

Gangrene, which results from necrosis as a result of breaking down of diseased tissues through the influence of saprophytes, is characterized by a softening of those tissues with the formation of gases having an offensive odor. Therefore, everything said about necrosis, and especially concerning the danger of a resulting uniform affection, also

applies to gangrene; as a matter of fact, the development of putrid intoxications or septic infections is quite frequent in connection with gangrene (see Chapter VIII, page 320).

Judgment.—See page 221.

Suppuration.—While suppuration is a product of inflammation and as such has been already mentioned, it deserves special attention as a frequently occurring disintegration of tissues in food animals.

Although suppuration may be produced by chemical substances (mercury, turpentine, petroleum, creolin, digitoxin, bacterial proteins), still, from a practical standpoint, all cases of suppuration must be considered of infectious origin, occasioned by various pus-forming organisms (*Staphylococcus aureus*, *albus* and *citreus*; *Streptococcus pyogenes*; *Streptococcus equi*; *Hemophilus pyogenes*; *Eberthella fætidus*; *Bacillus liquefaciens bovis*; *Corynebacterium bovis*, and others). Various other microorganisms (for instance, *Actinomyces bovis*, *Staphylococcus ascoformans*) may also act as pus-producing agents.

In regard to the origin of suppurations, Kreutzer expresses the following opinion: "Pus-forming bacteria irritate the tissues by their large masses, and through proteins contained in their bodies attract leukocytes (chemotactic action) and produce by this cell-infiltration a true inflammation. Toxins and ferments produced by pus-forming bacteria cause a breaking-down of leukocytes, through a chemical action, which makes their return migration impossible—disturb and prevent fibrin-formation, and peptonize all albumin of the tissues." In the horse, the most frequent pus-producing organisms, according to Kreutzer, is *Staphylococcus aureus* and *albus*; and in cattle *Streptococcus pyogenes* predominates; but in most instances various pus-forming organisms are present at the same time. In the pus of the sheep *Staphylococcus albus* is chiefly present, while in hogs, dogs and cats it is *Staphylococcus aureus*.

Suppuration remains localized, as a rule, in the form of suppurative catarrh (pyorrhæa), ulceration, suppurative exudate (empyema), or suppuration within the tissues (abscess); or it may be generalized throughout the circulation and develop into pyemia (see Chapter VIII, page 318). The local abscesses may become encapsulated and heal by drying up and calcification.

Judgment.—See below.

Calcification.—Deposits of lime salts are found in food animals, either as diffused calcification in various tissues (cartilage, fat tissues) or as circumscribed areas of calcification, which partly appear as end-products of retrogressive tissue metamorphosis (calcified deposits within the muscles, calcified abscesses), and also deposits enclosing dead parasites. Circumscribed calcifications are also designated by the unsuitable name of concrements (page 225).

Concrements proper, which occur as so-called intestinal, urinary, biliary and renal calculi, and which are occasionally found in animals, are of no importance in meat inspection.

Judgment.—See below.

Pathological Pigment Formation.—Abnormal pigmentation occurs principally in cattle and calves, but also in sheep and hogs (Lemke, Feureissen), as melanosis maculosa, or less frequently, as melanosis

diffusa, which may be confined to single organs (lungs, pleura, liver, meninges, various parts of the subcutis, muscular aponeurosis), or may be generalized. In the latter form all connective tissues may be intermixed with black-colored spots. The melano-sarcomata belong to the multiple tumor formations.

The condition described by Virchow as ochronosis—a brown to blackish coloration of the cartilage, tendons and capsules of the joints—is brought on by imbibition of the tissues with coloring similar to that of melanin. It occurs in cattle, calves, and hogs. (Mosselmann, Broubier, Lachmann, Hélroust, Bail and others.)

The condition described by Goltz as xanthosis, which is of comparatively rare occurrence, consists of a liver-brown discoloration of the muscles; according to Roth and Resow, a designation "brown atrophy" would apply more correctly to this condition. It is always associated with changes of the suprarenal capsules.

The hematogenous pigment formations (changing of the blood-coloring matter in extravasations, etc., page 215) and the symptomatic discoloration of tissues (icterus) cannot be considered here.

Judgment.—In judging cases of atrophic degeneration and infiltration of tissues (pages 217 to 221) it should be decided in the first place whether the processes are purely localized or whether they represent symptoms of general affections.

As localized cases are considered, all those conditions of atrophy, fatty infiltration, necrosis, suppuration, calcification and pigment formation in which the affection is slight and the localized diseased parts are removable. The affected organ itself is considered as unwholesome and must be condemned as unfit for human use.

Fatty infiltration, however, gives no cause for condemnation unless at the same time conspicuous changes in the consistence (pulpy softening) of such organs confer upon them the character of a spoiled tissue.

In necrosis and gangrene the meat should be carefully examined for evidence of septicemia; and in fresh suppurations a similar examination regarding pyemic manifestations should be made.

General muscular atrophy should be judged according to the principles of emaciation (page 209).

Pigment formation may appear widespread throughout the entire body (melanosis) and render the animal unfit for human food. In local pigmentations judgment should be made in accordance with the regulations.

The occurrence of cloudy swelling, fatty, mucoid, hyaline and amyloid degenerations points usually to severe generalized affections, and judging should be in accordance with the nature of the disease.

Circumscribed calcifications—so-called lime concretions—must be judged according to their etiology, especially if they appear in multiples and are more or less extensive (see Muscle Concretions, page 225).

Hypertrophy, Hyperplasia, Metaplasia.—The hypertrophy of an organ through enlargement of the elementary constituents (hypertrophy), or through increase of these constituents (hyperplasia), has no importance in meat inspection, as in this condition the macroscopic composition does not appear changed.

The condition designated as metaplasia represents transformation of already

developed tissues into other tissues without intervention of organisms or connective tissue. It occurs in food animals as bone formation in scars (castration scars), belly fat and mesentery of hogs, etc., and is of no importance to meat inspection.

Judgment.—Hypertrophic and hyperplastic organs give no cause for condemnation. Metaplastic tissues, however, should be condemned, inasmuch as they represent foreign bodies in the affected tissues.

Tumors.—Non-malignant tumors appear principally localized, and confined as solitary or isolated new formations in one and the same part of the body.

In malignant tumors (sarcoma and carcinoma) an affection of the corresponding lymph glands is invariably associated, and sometimes there is extensive metastasis, which may result in generalized sarcomatosis and carcinomatosis, without the accompaniment of cachectic conditions in the lower animals.

Epithelioma of the eye, commonly termed "cancer eye," is quite commonly observed in cattle of certain districts. These growths are usually local in character and metastasis is rarely observed.

Judgment.—Non-malignant tumors are usually easily removed, and after their removal they have no influence on the wholesomeness of the part of the body from which they were excised.

In the case of malignant tumors transmissibility of sarcomas and carcinomas to man by the ingestion of meat is probably to be excluded; at any rate it is not yet proved. In most cases the affected organ, together with its lymph glands, is involved by malignant tumors to such an extent that it becomes unfit for human food, and should therefore be condemned.

Where tumors are numerous a decision is made from the extent of the lesions and the nutritive state of the carcass as to whether it should be passed for food or be condemned. The latter action should always be taken if metastasis occurs on numerous parts of the skeleton, body, or in the lymph glands, or if secondary changes (water condition, flabbiness, etc.) are observed in the muscles.

For the so-called granulomata or infectious growths (new formations in tuberculosis, actinomycosis, botryomycosis and glanders), see the Chapter on Infectious Diseases, page 281.

According to B. A. I. Order 211, Regulation 11, Section 7, any organ or part of carcass which is affected by carcinoma or sarcoma shall be condemned. In case the carcinoma or sarcoma involves any internal organ to a marked extent, or affects the muscles, skeleton, or body lymph glands, even primarily, the carcass shall be condemned. In the presence of metastasis to any other organ or part of a carcass, or if metastasis has not occurred but there are present secondary changes in the muscles (serous infiltration, flabbiness, etc.), the carcass should be condemned.

Malformations.—Various malformations which occur in food animals are only of importance in meat inspection should they conspicuously change the appearance or structure of that respective part of the

body. When marked structural changes are present, or if there be a repulsive appearance of the malformed part, it should be declared as unfit for human food; in milder cases only partial condemnation may be necessary.

THE PRINCIPAL AFFECTIONS OF TISSUES AND ORGANS.

In the following section only those pathological-anatomical changes of tissues and organs will be discussed which possess a certain importance in meat inspection, and which have not been sufficiently described in the previous chapters.

In *judging* these tissues and organic diseases in meat inspection it should be understood that they usually cause purely localized changes, which require only removal of the diseased tissues or the respective organs, for only exceptionally do they affect the full value of the entire carcass. Therefore, the judging of the diseases described below, which should be chiefly carried out according to the regulations, will not be further mentioned under the various affections, and will be specified only in such places where they have to be considered from an additional point of view.

Skeletal Muscles.—1. *Hemorrhages* may appear in muscles as local and multiple hemorrhages. The first are due to local traumatic influences which result in a tearing of the muscular fibers and their blood-vessels. Multiple hemorrhages are sometimes due to toxic or infectious causes; more frequently, however, they are of mechanical origin.

Multiple hemorrhages in muscles of fattened hogs are classified among the hemorrhages of mechanical origin (*fragmentatio hæmorrhagica carnis*, Kitt). They result from tearing of the muscle fibers and capillaries in consequence of exertions, to which the fatty infiltrated muscular fibers are not equal on account of not being used to work. They are found as irregular, isolated spots, ranging in size from a pin's head to twice the size of a pea in at least 8 per cent of all the slaughtered hogs. They are situated principally in the muscles of the diaphragm; next in frequency they occur in the abdominal, psoas and pelvic muscles. In rare cases they may also be found in all the skeleton muscles. Occasionally multiple hemorrhages may also occur in other species of food animals; for instance, they were described in cattle by Clausen.

Multiple hemorrhages of toxic and infectious origin accompany phosphorus poisoning, tetanus and anthrax, as well as septic and pyemic diseases. In addition, ecchymoses on the serous membranes and other characteristic lesions of the respective general diseases are always present. The judgment of meat showing these hemorrhages should, therefore, depend on the nature of the condition which produced them.

2. *Inflammatory processes* of the muscle are principally of traumatic origin and are confined locally. Scattered and non-traumatic (poly-myositis) inflammatory changes appear as symptoms of severe general affections and result frequently in muscle degenerations.

Whether the so-called "chicken-meat appearance," which has been occasionally observed in calves and young cattle, represents always an interstitial myositis (Stoss, Bayersdörfer), or whether the condition is due to deficiency of muscle coloring matter, is not yet definitely established. The latter is probably also the case in iridescence of the muscles, which is occasionally observed on the longissimus dorsi muscle of hogs. More frequently, iridescence occurs in boiled, pickled or smoked meat (see Chapter X).

3. *Degenerations, cloudy swelling or granular degeneration* of the muscle fibers occur in severe intoxications and in febrile infectious diseases. The macroscopic appearance of the degenerated muscle shows a flabby, mellow, pale, gray, and cloudy condition; microscopically, the muscle fibers show fine granular, dust-like, albuminous precipitation, which disappears upon addition of acetic acid (see page 217).

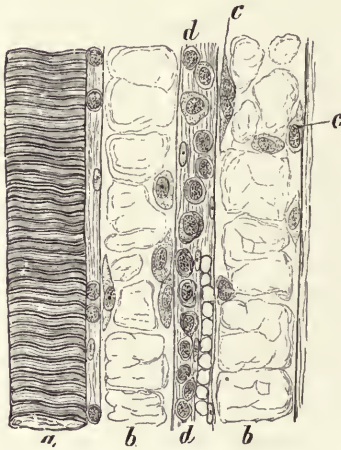

FIG. 80.—Amyloid degeneration: *a*, transversely striated normal fiber; *b*, degenerated fibers; *c*, enlarged muscle nuclei; *d*, connective tissue infiltrated with cells. $\times 250$ diameters. (After Ziegler.)

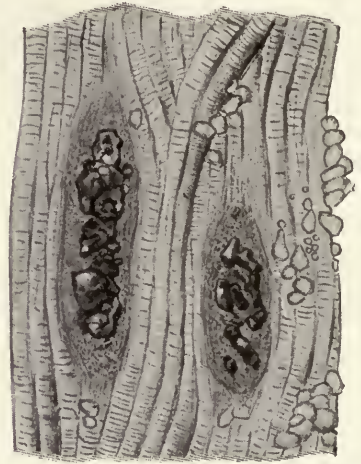

FIG. 81.—Lime concretions in the muscles of the hog. $\times 40$ diameters.

In fatty degeneration the muscles appear still softer, yellowish or mottled, with yellow stripes. Microscopically, strongly refractile bodies (fat globules) are found, which, under certain conditions, may cover the cross-striations, and do not disappear upon addition of acetic acid (Fig. 83).

For fatty infiltration, which should not be confused with fatty degeneration, see page 217.

Hyaline or glassy degeneration is observed in hemoglobinemia, morbus maculosus, acute muscular rheumatism and in parturient paresis (Zschokke).

Macroscopically, hyaline degeneration is only recognizable when it affects numerous muscle fibers. In such cases the muscles appear cloudy, dull, pale, like the meat of fish. Microscopically, the degen-

erated and coagulated contractile substances appear homogeneous, glassy and disintegrated into flakes.

The nature of hyaline degeneration of muscles observed in isolated cases in young cattle and calves, and producing a white or colored appearance, is not yet clear.

The peculiar changes which were recently described as specific muscle degenerations (Ostertag), and which were formerly designated as muscle actinomycosis (Duncker), also appear to be hyaline degeneration (David). This specific degeneration develops also without a general diseased condition (Fig. 82).

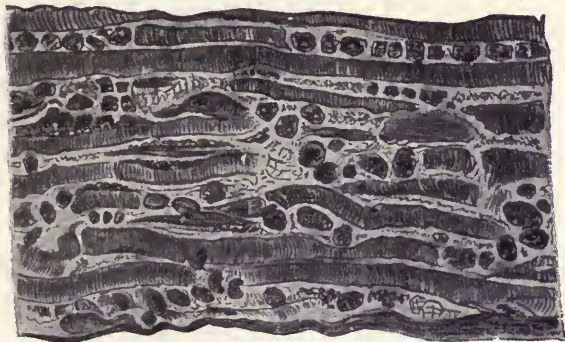

FIG. 82.—Specific degeneration of the muscle of hog. $\times 25$ diameters.
(After Duncker.)

4. *Lime concretions* are often found in the muscles of hogs, and may occur in large numbers. They may be recognized frequently by the naked eye as small, elongated or round, gray or grayish-white points and dots. They are usually met with in muscles of the diaphragm and abdomen. These concretions are indicative of either the end-products of retrogressive metamorphosis of the tissues or calcification of dead parasites. The latter is occasionally confirmed by microscopic examination, which, however, does not disclose the nature of concretions in numerous cases. Glage demonstrated *cysticercus tenuicollis* as the cause of lime concretions occurring in sheep.

Tumors occurring in the muscles, embolic affections, metaplasia and parasites are discussed elsewhere.

Blastomycosis of the muscles of cattle, described by Ostertag, is very rare. All the muscles are studded with fibrinous nodules, ranging in sizes from a lentil to that of a walnut; the centers contain punctiform, yellowish, cloudy colonies.

Judgment.—See page 234.

Connective Tissue.—1. *Hemorrhage.*—What has been said relative to hemorrhages in the muscles applies equally to the etiology and anatomy of hemorrhages in connective tissue. See also page 215, concerning hemorrhages in general.

2. *Imbibition* with blood-coloring matter only occurs in general affections (intoxications and infectious diseases) where the blood becomes wax colored, or where through action of water after death the blood contained in the meat transmits coloring matter to the fluids of the tissue, as, for instance, in meat exposed to the rain. As meat from well-bred animals should contain only traces of blood, only an insignificant local bloody imbibition can develop through the influence of water. Larger bloody imbibitions are always suspicious.

3. *Inflammatory and breaking-down processes* in connective tissue (hyperemia, edema, phlegmon, suppuration, etc.) appear under known pathological-anatomical manifestations. Large and extensive edemas may be the symptoms of severe general affections (hydremia, cachexia). In suppuration and putrefaction of the connective-tissues pyemia and septicemia should be remembered.

4. *Emphysema*.—The presence of air in the subcutaneous tissue and the intermuscular connective tissue may be artificially produced by inflating the carcasses of calves and sheep (page 33) through forcing air into the subcutis. In accordance with the regulations governing Federal meat inspection, such a practice is not permissible in connection with the slaughter of food animals.

Furthermore, emphysema may be due to injuries of the air passages and lungs, as well as to escape of gas from the intestines, in cases where intestinal adhesions to the abdominal wall have caused perforation. In such cases the collection of gas in the connective tissue becomes conspicuous by its disagreeable odor. The latter is also noticeable when emphysema is the result of gangrenous decompositions, blackleg, septicemia, etc. Injuries to the skin, which allow the subcutaneous tissues to come in contact with the external air, also may result in emphysema at places where the skin is easily displaced (extremities).

The other pathological changes in connective tissue, such as parasitic affections, tumors, and embolic processes, are either of no importance in meat inspection or a discussed elsewhere.

Judgment.—(See page 233.) Inflated meat, according to the regulations, is to be declared unfit for human food.

Fat Tissue.—In general, fat tissue is rarely affected by pathological changes; occasionally, however, the following characteristics may be present.

1. *A sclerotic condition* of the fat tissues (lipoma) occurs occasionally in the kidney fat of cattle and in the omentum of hogs (especially in hogs from Bakony, Hungary). The fat tissue appears in larger or smaller nodules, opaque, firm, almost like skin (called fat stones by butchers). Microscopically, a hyperplasia of connective-tissue structures at the expense of the number of fat cells is found.

2. *Black pigmentation* appears occasionally in the belly fat of fat black-haired hogs, very probably the result of hemorrhages (Ostertag). The pigmentation appears as numerous black irregularly formed spots, frequently branched in the shape of trees or like veins. Besides, a deposit of coloring

matter (melanosis diffusa) may be frequently observed on the belly fat of hogs, giving to bacon a bluish-black appearance with fine dotted lines, and at some places a brownish tint (Glage, Feuereissen). A green coloration of fat tissue and muscles near the intestinal tract, on the breast bone, carpal joint, hips, and abdomen was found by Beel in cattle which were constantly pastured. In boiling the discolored meat of these regions a penetrating "grass odor" occurred.

3. *Multiple fat necrosis* has been repeatedly observed in the retroperitoneal fat tissue, on the fat of the mesentery and on the omentum in the form of numerous white, opaque, stearin-like areas varying in size up to a ten cent piece. In bad cases it may affect the entire peritoneal fat. This affection, which is usually of no consequence in meat inspection, may be associated with disease of the pancreas (page 230).



FIG. 83.—Cross-section through the point of the breast of cattle, with presternal calcification: a, lime deposits; b, normal cushion of the sternum; c, sternal bones.

Judgment.—See page 223.

Bone Tissue.—The various diseased conditions involving bones do not require a special discussion at this time, since they mostly occur as purely local changes, are readily intelligible as to their pathological-anatomical nature, and are of little importance in meat inspection. But as diseases of bone tissue and bone-marrow may be associated with general affections, as in rachitis, osteomalacia, osteomyelitis, pyemia, leukemia or from a parasitic cause (tuberculosis, actinomycosis, botryomycosis, glanders, echinococcosis, brucellosis), they are described under these diseases. For pigmentation of bone tissue, see page 220.

Presternal calcification (Ostertag), although not belonging directly to affections of the bones, is best considered at this place. Occasionally, knobby, irregularly shaped formations, with calcified contents ranging in size from a nut to a man's fist, are found in the presternal fat cush-

ion of cattle. These formations sometimes extend into the sternum as a result of pressure. In a superficial examination these calcifications might be mistaken for tuberculous lesions, but they are, without a doubt, of traumatic origin. They can be distinguished from tuberculous processes by their resemblance to masses of plaster of Paris, pure white in color (Fig. 83).

Brucellosis of the Vertebra of Swine.—This occurs most often in the sacro-lumbar region and resembles tuberculosis very closely. The lesion of brucellosis is a grayish-white or pearly white, irregularly outlined abscess which generally starts in the intervertebral spaces and from there extends into the body of the bone, whereas the lesions of tuberculosis usually start in the center of the bone and extend outward. Lesions of brucellosis may also be found in other tissues of the body. In the cervical lymph glands they resemble tuberculosis very closely, but will be noted to show a very regular contour and a marked pearly white color.

Judgment.—See page 223.

Cartilaginous Tissue.—The pathological changes of the cartilaginous tissues have no significance for the inspector of meats.

The Other Meat Components.—Diseases of other components of meat in the narrow sense, namely, those of the nervous system, the lymph and blood-vessels and lymph glands, will be discussed later.

Digestive Apparatus.—1. *Traumatic Inflammation of the Rumen.*—Through the pricking of the rumen by sharp foreign bodies taken up with food, a chronic inflammation of a suppurative or sclerotic nature develops. This results in thickening of the wall of that organ and also, as a rule, in plastic or suppurative inflammation of the serous covering. Adhesion of the rumen to neighboring organs may also develop, generally involving the diaphragm first. By the strong contraction of the muscles of the rumen, sharp foreign bodies are pushed forward, principally in the direction of the diaphragm. In their course around the tissues these foreign bodies form fibrous tissue, fistulous tracts and abscesses, with greenish-yellow pus. The abscess may develop between the stomach, liver and diaphragm and may become the size of a man's head.

After perforation of the diaphragm these foreign bodies not infrequently strike the pericardium, which is only 3 to 4 cm. distant, resulting in pericarditis.

For septic peritonitis or pleuritis developing from perforation of suppurative material into the abdominal and thoracic cavities, see Chapter VIII, page 317.

2. *Peptic Ulcers.*—Round or peptic ulcers are occasionally found in the abomasum of calves in the form of sharply defined erosions in the mucous membrane, with slightly rounded edges. The ulcers are not necessarily always round; they may extend into the muscular coat of the stomach; occasionally only the serous membrane of the thickness of paper is left intact. Similar ulcers may also occur in the duodenum. The inspector's attention is usually called to the presence of these affections in the abomasum, by peritonitis, which

corresponds with the locations of the ulcers; or a perforation of the ulcer may occur shortly before death of the animal, as during transportation for slaughter, etc., and in such cases the contents of the stomach are found in the abdominal cavity.

Should the ulcer, through an early perforation, produce septic peritonitis, the meat should be condemned as unfit for human food. In late perforations care should be taken in the judgment on account of a repulsive sour odor which the meat may possess (boiling test). Otherwise, peptic ulcers are of no importance to the veterinary inspector of meats.

If peritonitis develops in consequence of a peptic ulcer the carcass should be condemned according to B. A. I. Order 211, Regulation 11, Section 10, *a*.

3. *Diffuse lymphadenia* of the mucous membrane of the abomasum is sometimes observed in cattle. The mucous membrane may appear on the rigid stomach wall to the thickness of 5 cm., fatty, grayish-white and glassy in places.

4. The rarely occurring *diphtheritic inflammation* of the abomasum of cattle is, according to Ledschbor, due to a long filamentous bacterium, which closely resembles the *Actinomyces necrophorus*.

5. *Multiple hemorrhages* in the intestinal wall have been occasionally observed in cattle and hogs; in the latter they are usually associated with multiple hemorrhages of the muscles (page 223). The origin of these hemorrhages is not entirely clear. The small hemorrhages may be of purely mechanical origin (severe coughing, asphyxia); larger ones, on the other hand, may have other causes, such as septic and other acute infection, which, however, may be excluded from cases mentioned here. To point out this fact is the only reason for mentioning these larger hemorrhages.

6. For characteristic changes of the intestines in hog cholera, see Chapter VII.

7. *Changes of the liver*, formerly known as angiomas, were recently designated as telangiectasis by Jaeger; this condition commonly occurs in older animals, most frequently in a multiple and spotted form in cows (hemangioma cavernosum hepatis, Kitt).

Externally, deepened, irregularly formed, purple-red to bluish-black spots under the serous membrane of the liver can be seen (Plate II, Fig. 1). They vary greatly in size; sometimes they are confined to single sections of the liver, but they may also involve the entire organ. On the cut surface the spots appear contracted, or a reddish tinge and spongy consistence (blood sponges), and are sharply separated from the otherwise normal liver parenchyma.

According to Jaeger, the anatomical foundation of the telangiectatic degeneration of the liver of cattle results primarily from a breaking-down of liver cells in groups, leaving the bordering capillary endothelium intact. Thus the unaffected capillary blood circulation extends under its own blood-pressure toward the margin of the altered parenchyma, forming sinuses, and finally cavernous spaces. There are no satisfactory explanations concerning the cause of this degeneration.

8. *Chronic interstitial hepatitis* may occur in various stages in all food animals. In the early stages the liver appears greatly enlarged,

grayish-brown in color, firm and dense (hypertrophic cirrhosis), while later it becomes smaller and harder, through the cicatricial contraction of the interstitial newly formed connective tissue. Portions of the parenchyma become obliterated, while intact parts of the latter protrude so that the surface and the section of the liver appear granular (atrophic cirrhosis, cirrhotic granular atrophy, hob-nail liver).

According to Tshauner, cirrhosis of the liver in hogs appears to be produced occasionally by feeding alcoholic foodstuffs which are in the act of fermentation (swill). Cirrhosis of the liver in horses is of importance in the diagnosis of the so-called "Schweinsberger disease." The cirrhotic connective-tissue proliferation in the liver of cattle having distomatosis is, according to Jaeger, due to the irritating toxic products of metabolism from distomas in the bile ducts.

9. *Multiple liver necrosis* is observed principally in cattle (necrosis nodosa, Kitt), but it occurs also in calves, sheep, hogs (hog cholera), horses and dogs. The liver is frequently enlarged, icteric, of an olive-brown to a red-brown color, and through it embolic, pale brown or grayish-yellow sharply circumscribed foci or nodules in large numbers are disseminated. They are without luster, brittle, compact and surrounded in the early stages by a red zone, but later by a connective-tissue capsule. In later stages the necrotic masses are occasionally transformed into a greenish, flaky, pus-like fluid. The causative factor of these changes is the *Actinomyces necrophorus*, which is conveyed to the liver by the portal or umbilical vessels, and obtains lodgment in that organ.

10. *Calcareo-fibrous nodules* are quite frequently found in the liver of the horse (chalicosis nodosa). They are disseminated in all parts of the liver tissue, as sharply circumscribed yellow to yellowish-brown formations, of sizes ranging from a pin's head to that of a milletseed, and are parasitic in origin.

11. A *peculiar nodular formation* in a calf's liver is described by Langer, who found sharply circumscribed foci situated under the capsule of the liver. They were of a grayish-white to an orange-red color, and of varying sizes up to a milletseed. Langer considers the foci as the remains of an infectious disease, which is produced by a bacillus first isolated by Bugge, and which he termed *Bacillus nodulifacius bovis*, a new species of the paratyphoid group. Manifestations of a general disease were not observed in the affected calves.

12. *Fatty necrosis of the pancreas* is observed in old, very fat hogs. The greatly hypertrophied fat tissue enveloping the pancreas shows numerous dull grayish-yellow or grayish nodular areas, which are dry, hard or cheesy. The glandular tissue proper appears intact, and therefore no disturbances in the general condition of the animals can be observed. The nature of the necrosis is still unknown (see also page 227).

13. *Mottled livers* of hogs not infrequently reveal the presence of foreign material. The lesions in such cases are manifested as slightly raised, light brownish areas, which give to the organ a somewhat mottled appearance entirely unlike a parasitic condition. The cut surface of the affected area shows a lighter color than the normal liver tissue, and this condition is more noticeable around the hepatic veins. Investigations as to the cause of these lesions in the liver proved that they result from the foreign materials, such as particles of fat and tissue as well as hair and wash water, which are driven from the sticker's wound into the thorax and thence into the incised heart by the beaters in the dehairing machine. The foreign material gains entrance into the liver through the heart and posterior vena cava. The occurrence of these changes

PLATE II

FIG. 1



Angiomata in a Beef Liver.

FIG. 2

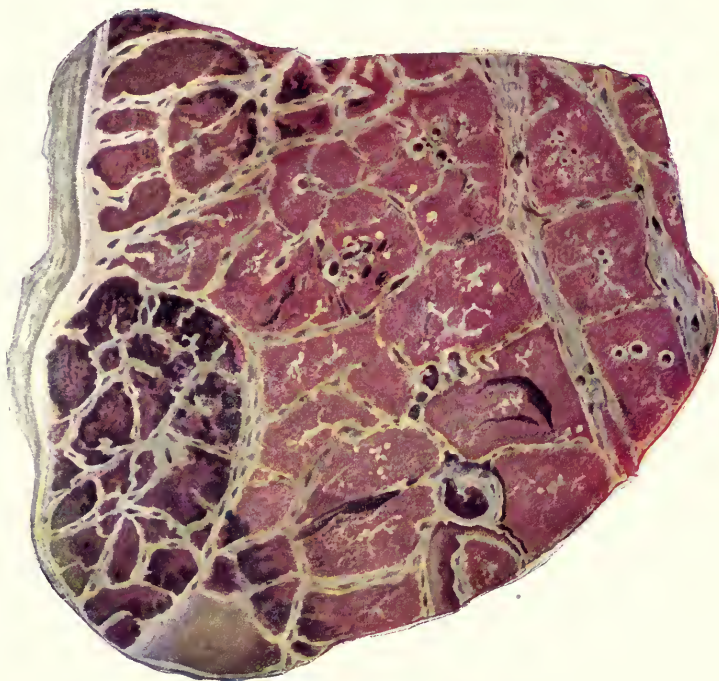

Section of Beef Lung Showing Contagious Pleuropneumonia.

in the liver of swine is associated with a certain type of dehairing machine, and occur only when the carcass passes through the machine head up. Thus the objectionable condition may be overcome by requiring that hogs pass this type of machine head down. All livers which are contaminated in the manner indicated should be condemned.

14. *So-called "saw-dust" livers.* These livers show small yellowish-white areas the size of a small piece of saw dust scattered more or less widely over the entire liver. These circumscribed areas of degeneration and necrosis of liver cells include a lobule only or a group of lobules. Laboratory examinations have failed to show the presence of pathogenic microorganisms in such livers. Livers showing only a limited number of "saw-dust" areas may be passed for food as they have a tendency to disappear on cooling. Where a large number of well distributed areas are found the liver should be condemned, and where only a portion of the liver is affected the unaffected portion should be passed. This condition is seen most frequently in well nourished cattle.

Judgment.—See page 223.

Peritoneum.—1. *Mesenteric Emphysema (Intestinal Emphysema, Jaeger) of the Hog.*—Single or grape-like clusters of air-containing cysts ranging in size from a pin's head to a grape, sometimes hanging on pedicles, are not infrequently found on the small intestines and its mesentery. The walls of the cysts appear transparent, or are colored red by hemorrhages. Sometimes the air cysts accompany the course of the mesenteric vessels in the forms of a rose wreath; occasionally cysts are also found in the muscular coat of the intestines and in the lymph glands. This pneumatosis was investigated by Schmutzer and Heydemann. According to Jaeger, it is due to the *Bacterium coli lymphaticum aërogenes*, which belongs to the coli group and penetrates the intestinal wall, where it produces gas as a result of its great fermenting qualities; it only secondarily extends to the mesentery in severe cases.

Hypophrenic Abscesses.—Abscess formations which may develop at any part of the peritoneum are of the greatest interest in meat inspection, and those suppurations which not infrequently develop between the diaphragm, liver and kidneys of cattle may often reach a considerable size, and are encapsulated. In the process of removing the abdominal viscera, these abscesses are frequently cut open, resulting in a soiling of the viscera and the parietal serous membrane of the body cavities with the contained pus. In such cases the serous membranes should be removed as well as the superficial layer of the meat which has been contaminated. For other results from these abscesses, see page 319.

3. For *peritonitis* as a result of heavy infestation by *Cysticercus tenuicollis*, see page 257.

4. *Multiple calcifications* in the form of flat elevations (Ostertag), ranging in size from a pin's head to that of a lentil, occur comparatively rarely on the peritoneum in cattle, and must not be mistaken for tuberculosis.

Judgment.—See page 223.

Genito-urinary Apparatus.—1. *The white-spotted kidney of calves* (nephritis fibroplastica or maculosa alba) occurs more frequently than is really observed, as the recognition of these changes is frequently obscured by the kidney fat. Slightly projecting whitish-gray spots may be seen on the surface of the kidney. They are distributed over numerous lobules, and vary in size from a milletseed to a bean or

even a hazelnut. On section the white spots appear as wedge-shaped or circular, juicy, shining areas, which extend through the cortex, reaching to the medullary or tubular layer. In the medullary substance the grayish-white extensions appear less frequently. The parenchyma of the kidney is generally unchanged; occasionally a slightly reddened zone is found around the white areas; or less frequently single punctiform hemorrhages are seen in the parenchyma, which, however, are probably coincident.

These spotted changes, according to Rieck, Kitt, Kabitz and others, are infectious emboli, while Vaerst considers the white areas as embryonic nodular remains of the blastemic state.

De Blicck considers the process as an acute, hematogenous, toxic, parenchymatous and interstitial nephritis, a diffused focal nephritis, the cause of which is unknown. Guillebeau, on the contrary, emphasizes the fact that the inflammatory origin of the spotted kidney is neither histologically nor clinically understood, but that even De Blicck's findings speak for the blastemic theory.

At any rate, this change in the kidney is without a noticeable influence on the general condition of the calves; besides, its harmless nature is also confirmed by complete disappearance of the spots during the first year of life.



FIG. 84.—Kidney of calf with fibroplastic nephritis.

The appearance of these changes in a diffused extension over the entire cortical layer of the kidney, which is designated by Kitt as *nephritis alba*, or *fibroplastica diffusa*, is quite rare. These white spots are confluent to such an extent that the entire cortical layer appears to be of a whitish color. In the medullary layer there is always a hyperemia in such cases, with hemorrhages and edematous infiltration of parts adjacent to the pelvis of the kidney.

2. From *purulent nephritis*, which, as a rule, occurs as a hematogenous, embolic, focal nephritis, but which may also develop gradually, should be distinguished the bacterial (diphtheritic) pyelonephritis, which is a special form. It appears occasionally in cattle on one or both sides, and is probably of hematogenous origin (Bollinger, Ernst) and of a cryptogenic nature.

The kidney is prominently enlarged, and its surface is either spotted with gray or totally gray in color. The kidney is enveloped in a fat capsule which has undergone a serous infiltration. On section a collection of slimy pus, with a strongly smelling urinous odor, is noted in

the distended pelvis of the kidney and the dilated calyces, the walls of which are considerably thickened. The papillæ show a diphtheritic deposit, and pin-shaped, radiating, yellowish-gray streaks of various breadths extend from the center toward the cortex. In this location, and also in normally appearing parts of the kidney, small, suppurative, softening foci may be found. As the lesion progresses, the kidney tissue degenerates more and more, until finally the enormously enlarged kidney may only represent a thin-walled cyst filled with pus (pyonephrosis). The ureter on one or both sides also appears dilated and filled with pus in advanced cases.

The *Bacillus renalis bovis* is accepted as the cause of pyelonephritis in cattle, but mixed infections also occur, so that, according to Kitt, Cadéac, Lucret and Ernst, the affection may be considered as polybacterial, similar to other suppurative processes.

In the *judgment* of pyelonephritis the general condition, the nutritive state and the presence or absence of other suppurations in the body must be considered.

Unilateral pyelonephritis appears generally as a purely local affection; if bilateral, retention of urine must be suspected, and the meat should be tested by boiling for odor of urine. The result of the latter, and also other changes which might be present, determine whether the carcass should be condemned as totally unfit for human food.

In cases of bilateral pyelonephritis causing retention of urine the carcass should be condemned according to B. A. I. Order 211, Regulation 11, Section 14.

3. *Cystic and bladder kidneys* not infrequently appear in hogs, cattle and occasionally also in calves. In cystic kidneys the disease is limited to single small or large sections of the kidney from which the flow of the urine is prevented. In bladder kidneys the entire kidney represents a cyst filled with urine (hydronephrosis).

When hydronephrosis is found affecting both sides greater attention is required in the judgment of the meat, as the meat not only in the surrounding parts but also in distant parts of the body may be watery. In addition to this edematous condition, the meat may possess a urinous odor. The boiling test should determine the extent of this condition, and in accordance with the objective finding of the meat it should be passed or declared of inferior quality or condemned.

Frequently only one kidney is found cystic, in which case the carcass is passed for food; while if the affection is bilateral, causing an edematous condition of the meat in various parts of the body, or if the meat possesses a urinous odor, the carcass should be condemned (B. A. I. Order 211, Regulation 11, Section 14).

4. *The inflammations of the uterus* are of considerable interest to the inspector on account of their relations to septicemia (Chapter VIII, page 317). All acute inflammations of the uterus, following parturition, or as a result of fetal and placental decomposition, should be considered suspicious.

5. *Catarrh of the uterus* may result in hydrometra and pyometra, due to accumulations of mucopurulent secretions in that organ. Chronic catarrh (leucorrhœa) may occasionally be followed by great emaciation, thus giving sufficient cause to declare the meat of inferior quality. Otherwise, the suppurative contents of the uterus are of no consequence unless pyemic or septicemic manifestations are present.

In acute cases of diffuse metritis the carcasses should be condemned (B. A. I. Order 211, Regulation 11, Section 10, *d*).

6. *The infectious vaginal catarrh of cattle* (colpitis follicularis infectiosa, vaginitis granularis infectiosa bovis, Raebiger) is probably due to specific streptococci (*Streptococcus vaginitis bovis*, Ostertag). It is accompanied by nodular formation in the inflamed mucous membrane, but is of no importance for the veterinary inspector. According to the investigations of Williams, infectious vaginal catarrh or granular vaginitis occurs quite extensively in the United States, although previously its presence had not been recognized. In the ambulatory clinics of the New York State Veterinary College 201 cases of this affection were treated in 1910, while only 2 were treated in 1931.

Judgment.—For the judgment of the diseases of the urinary and sexual apparatus, see page 223.

Udder.—1. *Catarrh of the udder* is only mentioned as it has been mistaken for tuberculosis of the udder. The enlarged quarters of the udder are harder. From the teats of the diseased quarters a thick ropy secretion, intermixed with pus, may be squeezed out. The mammary lymph glands are uniformly swollen, but they are not lumpy and hard. On the cut surface the milk ducts are dilated and filled with the ropy secretion. Their walls are thickened, and occasionally the mucous membrane shows firm fibrous nodules which, on superficial observation, resemble tuberculous nodules. The interparenchymatous connective tissue is increased; the lobules of the glands are, however, apparently unchanged.

In the course of catarrh of the udder some of the milk ducts may become obstructed and dilated, so that cysts will develop, which on touch are lumpy (milk nodes) and are filled with a curdy content.

2. *Gangrenous and septic mastitis* (Chapter VIII, page 317), alone of the various inflammations of the udder, will be discussed at that place, because of the associated severe general affection, according to which the judgment should be made.

A catarrhal form of mastitis, which leads to agalactia, and which is called in Switzerland "yellow galt," is caused by a particular streptococcus. Dammann and Freese described an infectious inflammation of the udder in sheep which is produced by rod-shaped bacteria.

3. For the characteristic changes in color of cows' udders on boiling, see Chapter IX.

Judgment.—For the judgment of the diseases of the udder, compare with page 223.

According to B. A. I. Order 211, Regulation 11, Section 10, *d*, carcasses which are affected with acute diffuse mammitis should be condemned.

Respiratory Apparatus.—1. *Subpleural hemorrhages of the lung*, which are very frequently seen in food animals, originate at the time of slaughter, and are to be considered as hemorrhages from suffocation. They are punctiform, sharply defined, light red in color and are disseminated over the entire lung. These hemorrhages are absolutely of no importance for the inspector, and should not be mistaken for ecchymoses of septic origin.

2. **Inflammations of the Lungs** are especially important if of a specific character, such as contagious pleuropneumonia in cattle and swine plague (see pages 331 and 325). A rather general rule is that where less than one-third of the lung tissue is affected and there are no other lesions, such as enlarged lymph glands, pleurisy, etc., the carcass is passed for food, while if more than one-third of the lung tissue is involved or other lesions present, indicating septic infection, then the carcass is condemned. In other words, when the inflammation has caused lymphatic involvement or parenchymatous degeneration of organs, or if the lesion is well marked regardless of the lack of evidence of systemic changes of absorption, the carcass should be condemned.

3. *Calcareo-fibrous nodules* in the lungs are very frequently found in horses (chalicosis nodularis). They are scattered irregularly in the parenchyma of the lung, and are usually very numerous, firm and readily peel out. They vary in size from a pin's head to that of a hempseed, and are rarely as large as a pea. Their color is white or whitish-gray, and young nodules appear glassy. There is no red zone surrounding them. The origin of these nodules, which occasionally appear at the same time in the liver (page 230), might be traced back to embolic invasion of animals parasites (Olt, Künnemann, Schütz, Grips).

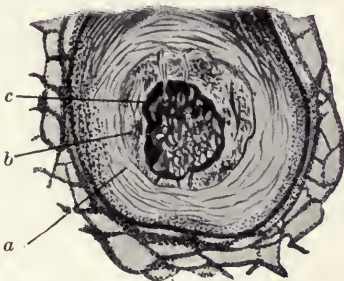

FIG. 85.—Calcareo-fibrous nodule from the lung of a horse: a, connective-tissue capsule; b, slightly, and c, markedly calcified center. (After Kitt.)

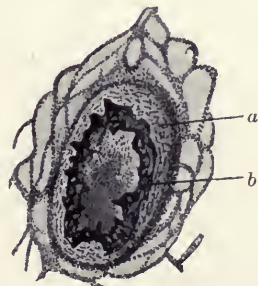

FIG. 86.—Calcareo-fibrous nodule from the lung of a horse: a, connective-tissue capsule; b, calcified zone. (After Kitt.)

In differentiating the calcareo-fibrous nodules from those of glanders, it should be remembered that in the first place the red zone is absent; furthermore, they are of uniform size and consistence, possess pronounced inclination toward calcification, while all manifestations of glanders are absent. Though a normal condition of the bronchial glands might have some weight in differentiating from glanders, there are instances where calcareo-fibrous nodules may also appear in the lymph glands. Besides, the histological structure of the nodules deter-

mines the nature of the affection (Figs. 85 and 86). For comparison with the structure of glanders nodules, see Chapter VIII, page 305.

Judgment.—For the judgment of diseases of the respiratory apparatus, see page 223.

4. *Anthraxis* of the lungs occurs in horses and cattle, as well as in dogs; in the latter about 60 per cent may be affected (Feuereissen).

5. *Pollution of the lungs* with blood and contents of the stomach may follow the slaughter of all food animals, as a result of the inhalation of these substances. Most frequently it occurs in animals which have been "shacted," readily recognized by the irregularly red-colored sections of the lungs. The aspiration of food can be determined only by cutting into the lung in the posterior third of the main lobe. Such a procedure is necessary in examination for the presence of scalding water in the lungs of hogs. To determine the extend of the aspiration of food it is recommended that during the act of cutting the bronchial lymph glands, the principal bronchus of each side be severed at the same time; otherwise the aspirated food, which does not extend into the small bronchi, cannot be seen.

Lungs containing aspirated substances, either solids or liquids, should be condemned.

Pleura.—1. *Petechia of the pleura* may be present in perfectly healthy food animals as suffocation hemorrhages resulting from slaughter (page 235), and should not be confused with hemorrhages of septic origin.

2. *False neuromas* in the course of intercostal nerves are not infrequently observed in cattle. They are new formations of myofibromatous nature, of sizes ranging from that of a pea to a hazelnut—seldom larger—which develop from the nerve sheaths.

3. Relative to *melanotic pigmentation* of the pleura, especially in calves, see page 220.

4. Regarding *secondary inflammation* of the pleura in contagious pleuropneumonia of cattle, swine plague and rinderpest, see these respective diseases.

Judgment.—See page 223.

Circulatory Apparatus.—1. *Petechiæ on the pericardium, epicardium, and endocardium* of food animals are mostly the result of asphyxiation and at the time of slaughter, especially if they are present in connection with hemorrhages of the pleura and with those of the lung (page 235); but they may also result from sepsis or other acute infectious diseases. Hemorrhages occur frequently on the auriculo-ventricular valves.

Reddened patches at the level of the columnæ carneæ are of systolic origin and disappear at diastole; they indicate a systolic pause of the heart.

2. *Pericarditis* is most frequently observed as the result of traumatism in cattle, due to the pressing forward of sharp foreign bodies in the rumen. The degree and the form of such traumatic pericarditis may vary greatly. The judgment, therefore, is influenced by the severity as well as possible complications from disturbances in circulation and from fever. In febrile conditions it must be remembered that traumatic pericarditis may be of septic nature; however, it must also be recognized that pericardial content with offensive odor is not sufficient for the determination of a diagnosis of sepsis (Chapter VIII, page 314).

Besides, pericarditis of serous and serofibrinous form may be observed in hogs as an accompanying symptom of swine plague (Chapter VIII, page 325).

Pericarditis, from which recovery has been made, appears not infrequently as the "villous heart" in cattle and in hogs.

3. *Endocarditis* is observed most frequently in hogs as a verrucose valvular form, and occurs principally as a result of swine erysipelas infection. Ulcerous and diphtheritic endocarditis may be of toxic or pyemic origin.

4. *Cystic formations* (hematoma and lymph cysts on the auriculo-ventricular valves were found frequently by Klaeger and Glage in calves and hogs and not infrequently by Fischer in cattle).

5. *Phlebotaxis* is found in older food animals as nodular dilatations of the veins in parts rich in blood-vessels, principally in the mesenteries.

6. The formation of *multiple infarcts* in the spleen as a result of endocarditis was first indicated by Ostertag. The splenic infarcts appear like wedge-shaped or round growths, at first dark red, later yellowish and white in color. After resorption of the areas of necrotic infarct there usually follows considerable shrinkage of the spleen. The latter also follows rotation of the spleen.

7. *Rotation of the Spleen* is a condition to which Glage has called attention; it occurs rarely. The splenic tumor which develops as a result of the torsion of the blood-vessels is distinguishable by absence of softening of the pulp.

Judgment.—See page 223.

Carcasses affected with acute pericarditis should be condemned, according to B. A. I. Order 211, Regulation 11, Section 10, *a*. For judgment of other lesions of the heart appearing in association with various general affections see these respective diseases.

Skin.—1. *Reddening of the skin* is only important from the standpoint of differential diagnosis in hogs, especially in connection with the presence of infectious diseases of these animals (swine erysipelas, etc.).

2. For *granular eruptions* (Schrotausschlag) of hogs, see page 249.

3. *Pigmented moles*, or *nævi pigmentosi*, are seen most frequently in the skin over the back and thighs of black hogs, and are congenital. They appear as inky-black irregularly round spots from $\frac{1}{8}$ to $\frac{1}{2}$ inch in diameter. The larger moles are elevated and are covered with stiff, coarse hair, which grows straight outward. Usually only a few are present, but occasionally an animal is found where they are quite numerous. If the small moles are incised, a black semi-fluid pigment is found deposited between the layers of the skin, while in the larger moles the pigment may extend into the fat beneath.

4. The term "sooty mange" is applied to a pustular exanthema of young pigs, which leads to the formation of pitch-like scabs (pitch mange), and occurs as an accompanying symptom of general chronic affections. The latter and also the condition of the animal determine the disposal of the meat.

5. Scarlet skin is occasionally seen in hogs where the superficial layer presents a bright scarlet color over the entire body, but nothing abnormal can be found in the lymph glands or organs. The cause is unknown but may result from some defect in bleeding. The discolored skin is only the thickness of tissue paper, but because of the unesthetic appearance of the carcass the affected skin should be removed.

Central Nervous System.—Among the diseases of the central nervous system the only one which need be mentioned is infectious encephalo-myelitis of horses (meningitis cerebrospinalis enzoötica), as it frequently occasions emergency

slaughter. It is generally without influence upon the utilization of the meat, but in cases of delayed slaughter incomplete bleeding may be present. If the disease is of long standing, and is associated with marked decubitus or other injuries, as well as traumatic pneumonia, a certain amount of caution is advisable.

DISEASES OF THE BLOOD AND CONSTITUTIONAL DISEASES.

Anemia (Oligemia).—Anemia appears in food animals as symptomatic or as so-called pernicious anemia.

Symptomatic Anemia.—Symptomatic anemias are expressions of various disturbances in the metabolic functions of the body. Internal parasites, chronic intestinal or pulmonary affections, chronic cachexia, and tuberculosis play the most important part as etiological factors.

Symptoms and Lesions.—During life paleness of the mucous membrane in advanced cases, dulness, loss of appetite and emaciation point to anemia; while in the slaughtered animal it is observed only in advanced cases by emaciation and slight coagulation of the blood, as well as by the pale appearance of the muscles. The presence of certain organic affections indicates the cause of the disease.

Microscopic examination of the blood may show considerable decrease of red blood corpuscles (Shaper).

Judgment.—The judgment depends on the primary affection which may be present and on the nutritive condition of the carcass. As a rule, this meat may be passed for human food, whereas in advanced cases it should be condemned.

According to B. A. I. Order 211, Regulation 11, Section 19, carcasses of animals which are too anemic to produce wholesome meat should be condemned. Advanced cases of anemia are usually associated with pronounced emaciation.

Pernicious Anemia.—The essential primary pernicious or progressive anemia is a disease which has not yet been sufficiently explained. It is of infectious or toxic nature, almost entirely confined to horses, and known as the so-called swamp fever or infectious anemia. The disease runs an acute or chronic course.

Symptoms of Lesions.—Acute cases are marked by intermittent high fever, with greatly increased frequency in pulse, and rapid emaciation without any indications of a local affection. The red blood corpuscles undergo a marked change in form, designated as poikilocytosis; macrocytes and microcytes are present. In chronic diseases the manifestations are the same as in symptomatic anemia. In slaughtered animals, acute show a cloudy swelling and fatty degeneration of the visceral parenchyma and muscles, with hemorrhages in most of the organs, especially under the serous membranes, spleen tumor, cellular infiltration of the bone-marrow, hemoglobin infarcts of the kidneys, without any particular conspicuous affection of the organs. In a more chronic type pathological changes are similar to those of symptomatic anemia; only the bone-marrow is greatly changed, appearing like raspberry jelly or like embryonic bone-marrow.

Judgment.—On account of great emaciation and pronounced changes in the muscles and viscera the meat should be considered badly spoiled, and consequently unfit for human consumption. It has not yet been proved that this meat is injurious to health.

Hydremia.—A watery condition of the blood of food animals occurs most frequently in sheep and cattle. It develops as a result of insufficient assimilation of nutritive substances, or from excessive feeding of food containing a large amount of water, such as swill and sugar beets. In the first instance it produces chronic disturbances of the blood-producing organs as in anemia, with which disease hydremia is usually associated. The symptoms in living animals depend on the extent of the affection. Edema of dependent portions of the body (neck, brisket, abdomen, legs) is usually present even in the earliest stages; at the same time symptoms of anemia are apparent. In slaughtered animals well-pronounced changes of the blood, such as noticeable thinness and slight coagulability, are only found in advanced cases. Furthermore, the subcutaneous and intermuscular connective tissue appears edematous and transudates are in the body cavities. The muscles are relaxed, and rigor mortis is not well marked; they are discolored and grayish-red only in very advanced cases (cachexia). In these cases there are also pronounced atrophy and gelatinous infiltration of the fat tissue.

Judgment.—In advanced hydremia the meat should be condemned as unfit for human food, on account of its repulsive changes and the marked emaciation.

In less severe cases the slaughtered animals may be allowed to hang for twenty-four hours, since experience has shown that a large portion of the transudates and edema of the connective tissue disappears by dripping and evaporation and through its resorption by the muscle substance.

In cutting the carcass it becomes evident whether a distinct watery condition of the muscles is still present in the deeper parts. If this cannot be noticed the carcass is released, while, if visible, the carcass should be condemned. In mild cases deterioration occurs very rarely if the carcasses are allowed to hang.

In case hydremia is associated with emaciation, or if the carcass manifests edema of the muscles and connective tissue, in consequence of that condition, the carcass should be condemned, according to B. A. I. Order 211, Regulation 11, Section 19.

Leukemia.—True leukemia is more infrequent in food animals than pseudoleukemia, which, however, should be distinguished etiologically and anatomically from the former.

To what extent these diseases are of an infectious nature is not definitely known.

True Leukemia.—This disease depends on a marked and continuing increase of white corpuscles (leukocytes and lymphocytes), and originates in hyperplasia of lymphadenoid tissue, *i. e.*, the spleen, lymph glands, bone-marrow and other organs. The blood in this condition may contain a large increase of lymphocytes (leukemia lymphatica). On the other hand, the leukemia may be due to a migration of leukocytes from the bone-marrow resulting in myelogenic leukemia. The clinical and anatomical picture of the disease likewise varies accordingly.

Symptoms and Lesions.—In living animals the presence of leukemia is only suspected, as a rule, in the lymphatic form, owing to enlargement of most of the accessible lymph glands. There is also a dulness of the animal and a paleness of the mucous membranes. Examination of the blood establishes the correct diagnosis. The slaughtered animal shows slightly coagulable pale blood, the serum of which may be of a milky or pus-like consistence; the coagulum in the heart and large blood-vessels is similar in appearance. There is hyperplasia of the spleen and of the lymph glands, which may reach enormous proportions; at the same time the lymph glands are frequently very soft and moist. The bone-marrow has either undergone a lymphadenoid change to a raspberry jelly consistence, or it is like pus. Leukemic infiltrations or tumors may be present in any of the organs; also hemorrhages in the kidneys, serous and mucous membranes, as well as in the muscles. The muscles are considerably paler than normal, gray, flabby, and permeated with hemorrhages. The characteristic microscopical appearance of the blood cannot be discussed here.

Judgment.—On account of the severe and pronounced changes the meat should be condemned as unfit for human food.

Carcasses affected with leukemia, which is invariably associated with a general swelling of the lymphatic glands, should be condemned, according to B. A. I. Order 211, Regulation 11, Section 8.

Pseudoleukemia.—The course of this disease manifests the same clinical aspects as true leukemia. Pseudoleukemia (Hodgkin's disease) is principally distinguished from the former through the fact that the numerical proportion between the leukocytes and erythrocytes of the blood is not disturbed. Pseudoleukemic conditions occur occasionally in cattle and hogs, but rarely to such a degree that the general condition of the animal appears greatly disturbed.

The anatomical lesions do not differ from those of leukemia. Haffner found lymphoid areas in the form of grayish spots throughout the entire muscular system of a sow. Carcasses showing pseudoleukemia should be judged like those with true leukemia.

Rachitis.—Rachitis, which appears most frequently in young hogs, depends upon an insufficient calcification of the periosteal tissues, and on the irregular ossification of the cartilage, causing excessive proliferation of cartilaginous and periosteal tissue (Kitt).

The clinical findings consist of enlargement of the bones, especially on the epiphyses and cartilages of the ribs; bending of the extremities and of the vertebral column; and enlargements of the nose and superior and inferior maxillary bones (snuffle disease), which may be observed in hogs. The manifestations in the slaughtered animal correspond to the clinical findings and to the stage of the disease. In advanced cases lesions of severe nutritive disturbances and of cachexia may be present in the meat.

Judgment.—In the beginning of rachitis, when nutritive conditions are good, there is no ground for condemnation. Condemnation becomes

necessary in very rare cases with cachectic changes of the muscles, and considerable emaciation.

Carcasses affected with rachitis in an advanced degree should be condemned, according to B. A. I. Order 211, Regulation 11, Section 8.

Osteomalacia.—This brittle condition of the bones, called osteopathy, is a softening of the bones of mature animals as a result of a diminution of the lime contents and a partial transformation of the bone into an osteoid mass (Kitt). Klimmer and Schmidt designate this disease, which occurs most frequently in cattle, as a halisteresis ossium, and consider rachitis and osteomalacia as identical in their nature.

Symptoms and Lesions.—The most marked clinical manifestation is the occurrence of bone fractures (fractures of ribs and pelvis) without any corresponding cause being apparent. There are also associated nutritive disturbances, swellings of the joints and painful gait; later emaciation, hardened skin and cachexia. The slaughtered animals show hyperemia of the diseased bones, thinning of the hard outer part, softening of the bone substances, and even its transformation into a fibrous tissue, transformation of the marrow of the bones into a dark yellow to dark red jelly-like mass, bone fractures, peeling off of the periosteum and the wearing away of the joint. Although pronounced changes of the meat appear usually only in cachectic conditions, occasionally they may be observed earlier, according to Klimmer and Schmidt. On account of physical changes of the walls of the blood-vessels, marked serous infiltrations of the bordering tissues develop, the muscles become flabby, watery, and, as a rule, darker and softer; their reaction is generally alkaline. The fat tissue appears atrophied in the later stages. The preservative quality of the meat is poor.

Judgment.—According to Klimmer and Schmidt, animals affected with osteomalacia should only rarely be passed without restriction. They recommend judging meat, finally, twenty-four hours after slaughter. If pronounced changes, and especially cachectic conditions, are noticeable the judgment must be made for total condemnation.

Carcasses showing pronounced changes of osteomalacia should be condemned, according to B. A. I. Order 211, Regulation 11, Section 8.

Sarcomatosis and Carcinomatosis.—These belong here, but have been considered on page 222.

Poisoning In Slaughtered Animals.—Poisoning of slaughtered animals is only of importance from a meat-hygiene standpoint when changes have occurred in the flesh as a result of the toxic action of the poisons, or when the meat itself has been poisoned.

As a rule, poisoning in slaughtered animals is rare. Still, the owners of the animals frequently consider some diseases as such, since the layman is inclined to view all suddenly occurring affections as due to this cause. Poisoning is usually accidental, the poisonous substances being ingested with the food or while searching for food; or it may be the result of improper administration of drugs.

For the clinical symptoms and pathology of various poisonings in living animals, the reader is referred to text-books on toxicology, as only general remarks may be indulged in here with regard to the findings in slaughtered animals. The following groups of intoxications are to be differentiated:

1. Poisons which exert a pronounced local effect and those which primarily affect the parts with which they come in contact are relatively easy of recognition. To these belong, among others, caustics, acids, alkalies and salts; phosphorus, arsenic, cantharidin and also insect and snake venom. Marked inflammation, swelling, hemorrhages and eschars, especially in the digestive tract and on the skin, occur at the points of contact with the poison, but the principal effect of the poison is usually secondary, and is to be sought in disturbances of function of the more important body organs.

2. Some of the blood poisons combine with the hemoglobin of the red cells (carbon monoxide, hydrocyanic acid, sulphuretted hydrogen) and reduce their functional power as carriers of oxygen; while others (nitrites, iodine, potassium chlorate, pyrogallol, picric acid, aniline, carbon bisulphide, etc.) destroy the red cells and form methemoglobin. As a result, the blood will appear light violet to cherry-red and even chocolate-brown in color. These changes may not be marked, however, if the animals have been slaughtered early on account of the serious effect of the poison on the central nervous system. Urine of a red to dark-red color will doubtlessly be present in severe intoxication by poisons of the latter group.

3. With poisons which act on the nerves and heart, anatomical changes, as a rule, are not demonstrable, in spite of extreme nervous irritation or paralysis.

For the purpose of meat inspection, another group might be added to the foregoing:

4. Those which develop marked odor and thereby reveal their presence in the slaughtered animal, such as chloroform, ether, alcohol, petroleum, chloral hydrate, camphor, ethereal oils, phosphorus, carbolic acid, etc. The effect of these drugs would be similar to one of the three classes already mentioned.

As recognition of poisonings and their essential causes may be difficult in certain instances, it is in many cases only possible to establish a probable diagnosis unless an exact chemico-analytical examination is made. Such an examination is rarely practicable for purposes of meat inspection on account of the amount of time required, and even then it may fail in some cases.

Judgment.—The judgment of this class of food animals is dependent upon the separation of the meat proper in its narrow sense from the viscera. Of the viscera, the stomach and intestinal canal will always have to be condemned as dangerous to health. It has been shown that the other viscera are harmless in a number of instances, while in doubtful cases, however, it is necessary to consider the nature of the poison and the probable course it pursues in the organism. In one case the

udder of a cow was found dangerous to health, the animal having been fed large quantities of *veratrum album*. In the subcutaneous administration of poisonous substances, the site of injection and its vicinity, as well as the associated lymphatic vessels up to and including the nearest lymph glands, are to be removed.

Careful observations by Fröhner and Knudsen lead to the assumption that meat in "medicinal treatment of an animal with any drug cannot result in becoming dangerous to health," and what holds good for the medicaments of powerful action as the result of experimental and observational research applies also to other poisonous drugs.

In case of an animal slaughtered on account of having been poisoned, its final disposition depends on the associated conditions or circumstances and the nutrition of the animal. It may be assumed, of course, that consumers will be prejudiced against meat of this class. The value of it is *below par* as soon as odorous poisons have given the meat an abnormal odor. (See boiling test, page 169.)

Meat of poisoned animals is always to be considered unfit for human food whenever a nauseating or loathsome odor is present, when septic infections are observed, or when marked changes in the meat, such as emaciation and edema, occur associated with poisoning.

Auto-intoxications in Slaughtered Animals.—By auto-intoxication is understood the passage of toxic substances developed in the intestines (enterogen), or in the tissues (histogen), into the fluids of the body. The transition of such poisons is caused either by the presence of exciting of toxic metabolic products, by a physiological increase in their production, or as a result of their incomplete destruction. In the same manner the blood may also receive toxic substances in disturbances or suspension of the functions of certain organs.

Cholemia.—The presence of the constituents of bile in the blood is, strictly taken, only a symptomatic condition, a well-marked manifestation of which consists in a yellow coloration of the tissues, called jaundice (icterus). The etiological classification of cholemic affections into catarrhal, hepatoxemic and hematogenic icterus, is also to be considered from the standpoint of meat inspection.

Symptoms and Lesions.—Of the clinical symptoms, the yellow coloration of the mucous membranes is of importance in meat inspection, and also the fact whether a general affection is absent or present. In the latter case there are present severe organic changes or an intoxication (lupinosis, phosphorus poisoning), or an infectious disease (sepsis, anthrax, swine plague, influenza), with its characteristic symptoms. The anatomical lesions are dependent upon the original cause and are associated with yellow discoloration of the tissues. The discoloration is not only noticeable to a high degree on the serous membranes, but also on all tissues and organs, and shows also occasionally distinct greenish-color tints. In animals with normal white fat tissue the slightest degree of yellow coloration is also recognizable on the fat, but this must not be mistaken for the yellow coloration resulting from feeding, and the old age discoloration of the fat in cattle.

Judgment.—The judging of icteric animals should be carried out only in daylight. It is also to be remembered that slight yellow colorations may almost entirely disappear within a certain time after death as a result of the reducing action of the body cells; therefore, slightly icteric carcasses are judged only after twenty-four hours. In severe forms of icterus with parenchymatous degeneration as a result of infections or intoxications this is not necessary. In the latter case the meat is spoiled in a high degree, and is unfit for human consumption. Otherwise, in cases which are pronounced icteric the meat may be passed for sterilization, while it may be passed if in twenty-four hours after slaughter the yellow coloration disappears, or if only a nominal discoloration remains. (See B. A. I. Order 211, Regulation 11, Section 13.)

Uremia.—This term is applied to certain clinical manifestations caused by the retention of toxic substances in the blood which ordinarily are excreted with the urine. The nature of the substances in question remains obscure. The occurrence of uremia in food animals is limited, with a few exceptions, to male individuals, in which the anatomical peculiarities of the urethra (S-shaped bending in ruminants and in hogs) favors its occurrence. The urethra is principally the seat of obstructions with concretions, which as a result produce gangrene of the urethra or a rupture of the bladder. The absorption of the constituents of urine effused into the periurethral connective tissue, or into the peritoneal cavity, results in a uremic poisoning of the blood. Very rarely uremia may also develop as a result of an insufficient excretion of the constituents of urine, as, for instance, in bilateral pyelonephritis of cattle, or in the presence of bilateral cystic kidneys.

Symptoms and Lesions.—The living animals show the known symptoms of *retentio urinæ*, which it is true, in indolent steers, is not very pronounced. After the resorption of urine, febrile symptoms, accelerated pulse, pronounced psychic depression, strong urinary odor of the exspirations, uremic convulsions, and under certain conditions even subnormal temperatures are manifested. On the slaughtered animal and in the immediate vicinity of the carcass pronounced urinary odor may be noted, which, however, is absent in fresh cases. Corresponding with the cause there may be found an infiltration of urine in the scrotal region, rupture of the bladder with peritonitis or severe kidney changes. The muscles have a distinct uriniferous odor, which gradually becomes less marked with the increased cooling of the carcass; intermuscular hemorrhages may also be present.

Therefore, in the examination of a cooled carcass in which uremia is suspected, the meat should be always subjected to a boiling test, during which the presence of a urinary odor becomes recognizable.

Judgment.—The judgment should be made only after the cooling of the meat and the employment of the boiling test. If during the latter no uriniferous odor is perceptible the meat may be passed for human consumption. In advanced uremia the odor of the meat becomes so intensely uremic on account of its highly spoiled condition that it must be condemned as unfit for human food.

The Federal meat-inspection regulations provide that carcasses which give off the odor of urine should be condemned. (B. A. I. Order 211, Regulation 11, Section 14.)

Hemoglobinemia of Horses.—The hemoglobinemia of horses, also designated as hemoglobinuria, azoturia and lumbago, is usually a rheumatic myositis with dissolution of the coloring matter of the muscles. It probably results from an auto-intoxication of myogenic origin, in which the muscular coloring matter and other transformed products of the existing myositis enter the circulation, producing disintegration of the red blood cells and elimination of the hemoglobin with the urine.

Symptoms and Lesions.—Of the clinical symptoms, the well-known dark red to dirty brown and black coloration of the urine, and the paralysis-like weakness of the high-quarters are especially conspicuous. Mucous membranes are highly congested and show a dirty discoloration; the temperature, on the other hand, is usually only very slightly elevated. In the slaughtered animal the blood is of a varnish color and tar-like; edematous swelling and pale coloring of the psoas and croup muscles, as well as of the quadriceps femoris, may be noted as a result of parenchymatous myositis. Secondary lesions are: Swelling of the liver and spleen, infiltration of the red bone-marrow, parenchymatous nephritis and hemorrhages in various organs. In cases of longer duration septic lesions may be present as a result of decubitus gangrene.

Judgment.—The meat of horses slaughtered in the earliest stages of this disease may be passed for food. Later, insufficient bleeding and muscular changes render the meat unfit for human consumption on account of the highly spoiled condition.

According to Schlegel's investigation, another more rarely occurring infectious hemoglobinemia of horses must be mentioned; he designates it as an infectious spinal meningitis, caused by the *Streptococcus melanogenes*. The later stages of this infectious hemoglobinemia pass off under the semblance of septicemia.

Parturient Paresis.—Parturient paresis (parturition fever, calf fever, milk fever) is observed principally in cows; more rarely in goats and hogs. While this affection was formerly considered as an auto-intoxication in which the udder was supposed to be the place for the development of toxins (Sonnenberg), recent publications and especially the beneficial results following the intravenous injection of calcium and phosphate salts indicate that a lowered calcium content of the blood (hypocalcemia) as well as a phosphate deficiency (hypophosphatemia) is concerned in the etiology of this affection. It is possible that both causes must be given consideration. The disease appears, as a rule, in twelve to forty-eight hours after parturition; it, however, has been observed before that time.

Symptoms and Lesions.—The conspicuous symptoms in the living animal are characteristic manifestations of depression and paralysis. If these have advanced to a certain degree the animals will lie with their legs half way bent or stretched out and their heads turned to

the side, resting on the thorax. At the same time there are present somnolence, ptosis, absence of skin reflexes, paralysis of the muscles of the tongue and pharynx and salivation. As a result of the paralysis of the muscles of the stomach, intestines and bladder, flatulency and retention of urine develop. The body temperature is unevenly distributed; the internal temperature is slightly elevated only in the beginning of the disease; later it is normal or subnormal.

On the slaughtered animal the findings are principally negative. The uterus is usually strongly contracted and without abnormal contents; the abdominal viscera are frequently highly injected, while insufficient bleeding will be noted in delayed slaughter.

The recognition of this disease in the living animal is very easy. Nevertheless, a careful examination is necessary in order to determine the possible presence of other puerperal affections (sepsis), special attention being paid to the absence of high fever and to whether there are tenesmus or indications that the animal was given cold-water enemas. On the slaughtered animal the diagnosis must be made by the exclusion of other diseases and by giving consideration to the history of the case. First of all, the attention should be directed to the absence of inflammatory changes in the uterus and the genital organs, as well as to the characteristic lesions of sepsis.

Judgment.—In early slaughter and in well-nourished animals there is sometimes no ground for condemnation. Delayed slaughter renders the carcass unfit for food on account of the greater blood content of the meat. The carcass must be condemned when complications with sepsis are present or when marked substantial changes of the meat or severe internal lesions are present. If an infusion of iodide of potassium or iodide of sodium has been made into the udder, which may transmit a peculiar stale odor and taste to the meat (boiling test), it should be always condemned on account of its repulsiveness. Owing to the repeated administration of strong-smelling remedies (camphor, turpentine, ether and others), their possible absorption by the meat should not be forgotten and the boiling test applied (see page 169).

In accordance with B. A. I. Regulations, carcasses of animals showing symptoms of milk fever at the time of slaughter should be condemned.

PARASITIC DISEASES.

The diseases of food animals caused by animal parasites—the diseases of invasion—are either of purely local nature (diseases of organs) or they appear in various parts of the body, and may, therefore, be designated as general parasitic affections. According to their importance in meat inspection, the animal parasites of food-producing animals may be classified as follows:

(a) *Parasites which are not injurious to man:*¹ To this class belong all parasites represented on pages 247 to 261 (with the exception of *Linguatula serrata*) and those protozoa which excite general parasitic affections.

¹ A number of species in this group have been observed occasionally in man in which host they are usually accidental parasites. These forms are designated by an asterisk (*).

(b) *Parasites which may become injurious to man only indirectly:* Echinococci and pentastomes.

(c) *Parasites which are transmissible to man by the ingestion of meat:* Pork and beef measles and trichinæ.

Parasitic Diseases of Organs.—The parasites of organs may be grouped together in so far as judgment in meat inspection is concerned. As has been stated, they are not transmissible to man. The organs invaded by the parasites should be condemned as unfit for human food in all cases where the parasites are not removed in the commercial preparations of the parts (intestines), or if the organ in all of its portions contains parasites or their presence gives to the organ a repulsive appearance. If the parasites are confined or invade only single sections of an organ only the changed parts need be condemned.

The Federal meat-inspection regulations provide that in the disposal of carcasses, edible organs and parts of carcasses showing evidence of infestation with parasites not transmissible to man the following general rules shall govern: If the lesions are localized in such a manner and are of such a character that the parasites and the lesions caused by them may be radically removed, the non-affected portion of the carcass, organ, or part of the carcass may be passed for food after the removal and condemnation of the affected portions. If an organ or a part of a carcass shows numerous lesions caused by parasites, or if the character of the infestation is such that complete extirpation of the parasites and lesions is difficult and uncertainly accomplished, or if the parasitic infestation or invasion renders the organ or part in any way unfit for food, the affected organ or part shall be condemned. If parasites are found to be distributed in a carcass in such a manner or to be of such a character that their removal and the removal of the lesions caused by them are impracticable, no part of the carcass shall be passed for food. If the infestation is excessive the carcass shall be condemned. If the infestation is moderate the carcass may be passed for sterilization, but in case such carcass is not sterilized as required by the regulations it shall be condemned.

Parasites of the Skin.—HYPODERMA LARVÆ.*—The larvæ of the *Hypoderma bovis* (*Estrus bovis*, gadfly) and of *Hypoderma lineata* develop in the subcutis of cattle.

Development.—The gadfly deposits its sticky eggs on the skin of cattle, where they undergo the first process of development, and hatch in about a week. The young warble crawls to the base of the hair and burrows into the hair follicle. After penetrating the skin the larvæ apparently work upward in the connective tissue and begin to appear in the chest and in the abdominal cavity about two months after penetration. Although numerous larvæ enter the connective tissue of the gullet it appears that many may never enter that organ. During the fall and winter a large portion of the gullets of cattle that are slaughtered are infested with warbles and are known as grubby gullets or weasands, in the packing houses. The distance from the gullet and viscera to the subcutaneous tissues of the back is apparently traversed very rapidly. Soon after the larvæ reach the back they cut a hole through the skin. The full grown larvæ begin to leave the backs early in the year and in northern latitudes the last leave before the middle of July.

Lesions.—"Warbles," or "gad boils," are flat nodular elevations of the skin, especially along the back, from which larvæ covered with pus may be squeezed. After the skin is removed, dirty, greenish-yellow, suppurative areas are found in the subcutis, with edematous infiltration of the surrounding parts, extending even into the muscles, which may also be found invaded by dirty, greenish larval passages.

Judgment.—For the judgment of this and all other parasitic diseases of organs, see above.

SCABIES MITES.—*Psoroptes communis* var. *ovis* (sucking mite, Fig. 87), produces the skin eruption designated as sheep scabies, which affects the woolly parts of the body and begins generally at the sacral region.

Symptoms and Lesions.—At first there is loosening of the wool, which extends over the surface of the body in various places, leaving vesicles and pustules on the skin; later scabs are formed with matting of the wool, thickening of the skin, formation of folds and fissures and itching, especially when warm. In extensive affections, emaciation, anemia and cachexia are present.

The movement of cattle and sheep affected with scabies is restricted by the existing regulations which prohibit the shipment of affected and exposed animals unless they are destined for immediate slaughter.

Sarcoptes scabiei var. *equi*, produces scabies of horses. The disease begins with slight granular elevations and papules on the thickly haired protected portions of the skin, and as it progresses leads to serous exudates, scabs and scab formations. In advanced cases hairless spots, thickened skin, pustules and flat swellings may develop, also emaciation may appear. Itching is generally well marked.

Demodex folliculorum var. *suis* (*Demodex phylloides*)—the hair-follicle mite of hogs—produces nodules and pustules ranging in size from a milletseed to a hazelnut. This not infrequent acne eruption appears on the snout, neck, pectoral region, abdomen, the inner surface of the thighs and flanks and is manifested by grayish or yellowish-gray pustules, as well as by being sharply defined from the neighboring parts (Ostertag).

Demodex folliculorum var. *bovis* causes demodectic or follicular mange in cattle. The lesions, nodules ranging in size from a small pin head to a hazelnut, appear most often in the skin of the neck, shoulders, breast and dewlap, and sometimes in that of other parts of the animal. The nodules are usually firm, although in advanced cases several of them may unite to form small abscesses. Except in advanced cases there are no marked changes in the hair coat. When the larger lesions rupture and discharge their contents over the surrounding hair and skin, the general appearance resembles that of common scab.

Demodex folliculorum var. *ovis* produces demodectic mange in sheep. The favorite location is around the eyelids. The content of the nodule, which resembles that found in follicular mange of cattle, is a thick, cheesy mass.

Demodex folliculorum var. *capræ* produces demodectic mange in goats. The nodules resemble those of the cattle variety, the favorite location

being around the neck and sides. Mature goats appear to be more affected than young ones.

Demodex folliculorum var. *canis* causes the demodex mange, which occurs frequently in dogs, where it invariably appears locally on the face, the pectoral region and on the paws, but it may also extend over the entire skin and result in emaciation. The red and bluish-red papules and pustules, from which a seropurulent bloody fluid may be squeezed, are the characteristic lesions.



FIG. 87.—Male of *Psoroptes communis* var. *ovis*, viewed from the abdominal side. $\times 50$ diameters. (After Ziegler.)

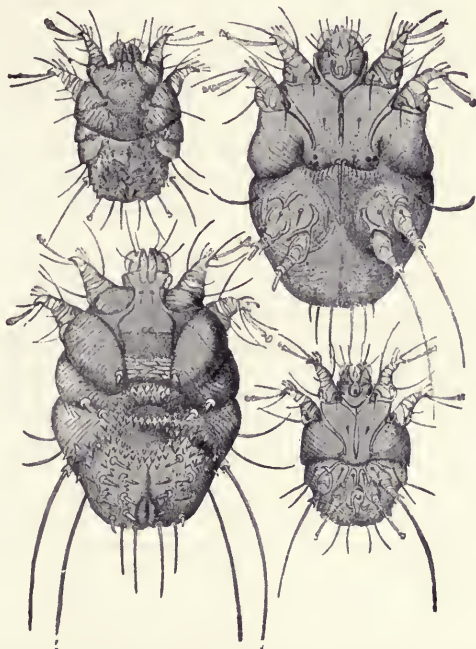

FIG. 88.—*Sarcoptes scabiei* var. *equi*. Above to the left, male; below, dorsal view of female; above to the right, female; below, ventral side of male. $\times 75$ diameters. (After Hutyrá and Marek.)

Sarcoptes scabiei var. *canis** produces sarcoptic mange, frequently affecting dogs. It appears principally on the head, but is found on other parts of the body; it is also manifested as red spots, later by nodules and vesicles, with exudates and scab formations, loss of hair and emaciation in extensive cases.

The other forms of scabies in food animals are: The psoroptic and chorioptic scabies of horses and cattle; the sarcoptic and chorioptic scabies in sheep and goats and the sarcoptic scabies of hogs. With the exception of the psoroptic scabies of the horse, they are of no importance in meat inspection or to veterinary police supervision.

According to B. A. I. Order 211, Regulation 11, Section 15, Paragraph 1, carcasses showing advanced lesions of scabies associated with emaciation, or if the inflammation extends to the flesh, should be condemned. In mild cases the carcasses are passed for food.

Immense numbers of lice (hæmatopines) are occasionally found on calves, and in order to prevent their crawling on the meat, it is advisable to have the skin removed immediately after slaughter.

COCCIDIA.—*Coccidium fuscum*, which was discovered by Olt, is the cause of coccidiosis cutis, spiradenitis coccidiosa, in the granular eruptions of hogs. These protozoa, the classification of which as coccidia is disputed by Lühe, penetrate into the sweat glands and produce chronic inflammation in the glands by a damming up of the secretion.

Lesions.—On various parts of the skin, pale, bluish-gray, lead-gray, or yellowish-brown nodules develop, ranging in size from a pin's head to a bean. They are semisolid, lying very superficially in the skin, and contain a cloudy, watery or bloody, smeary mass, and sometimes rolled-up hair.

No disturbance in the general health is associated with this eruption.

Parasites of the Respiratory Apparatus.—**ÆSTRUS LARVÆ.**—The larvæ of the gadfly of sheep (*Æstrus ovis**) invade the nose and sinuses of the sheep.

Development.—The fly deposits partially developed larvæ on or into the openings of the nose or sheep, from whence they migrate into the nasal, frontal and maxillary sinuses as well as into the cones of the horns. There they develop within a variable period which may extend up to a year into yellowish-brown larvæ, 20 to 30 mm. in length. They are expelled to the outside by sneezing, blowing or shaking (shaking disease), and burrow into the ground, where they change into a pupa stage.

Symptoms and Lesions.—Catarrh of the respective mucous membranes with mucopurulent nasal discharges, shaking of the head, sneezing and indications of brain irritation are observed. Swelling of the mucous membrane occurs with hemorrhages, and there is a loss of weight. Finally, the presence of larvæ enveloped in pus and mucus, which may be fetid, is noted.

PENTASTOMES.—*Linguatula serrata* (*Pentastoma tænioides*), which resembles a tapeworm, infests the nasal cavities and sinuses of dogs, wolves, foxes, horses, mules, sheep, goats and men, and produces only slight catarrhal disturbances. These parasites, which belong to the arachnoidæ, are 15 to 20 mm. long (male), and 80 to 90 mm. long (female).

For the veterinary inspector the only parasite of importance on account of its larval condition is *Linguatula serrata* (*Pentastoma tænioides*). This develops from the eggs which reach the outside with the nasal mucus of infected dogs, and are then taken up by herbivorous animals. There the embryos are set free in the digestive apparatus, and reach either actively or passively the mesenteric glands, liver, lungs, or peritoneum, where they become encapsulated and form cysts.

PARASITES OF THE LUNGS.—*Metastrongylus elongatus*,* *M. salmi* and *Choerostongylus pudendotectus* (*Strongylus paradoxus*).—These lung worms occur very frequently in the lungs of both domesticated and wild hogs. The males are 11 to 25 mm. and the females up to 50 mm. long, and they live in the trachea, the bronchi and the bronchioles, where they usually produce only slight catarrhal disturbances. Lungs affected at the places invaded by a large number of these worms have elevated, flat, dense areas, with a mother-of-pearl luster.

As the latter indications may be absent in spite of the presence of the parasites, it is advisable to cut into every hog lung posteriorly. If worms can be squeezed out of the cut surface another cut is then made a few centimeters anteriorly, and if parasites are also found there the center of the lung may then be considered infested.

Dictyocaulus filaria (*Strongylus filaria*). the thread worm of the lung, lives in the bronchi of sheep, goats, deer and roe, where it produces catarrh and pneumonia. In sheep it occasionally occurs in such immense numbers and extensiveness that entire flocks become infested with it, and a large number of sheep succumb from pneumonia and cachexia (lung-worm plague). The findings resemble those for *Metastrongylus* species. The males are 25 to 80 mm. and the females 50 to 100 mm. long.

Synthetocaulus rufescens (*Strongylus ovis pulmonalis*, lung-hair worm) and other species of this genus, 10 to 30 mm. long, live as reddish-brown parasites in sheep, goats, deer and chamois. They produce, in the lungs, small yellowish or greenish-gray hard nodules or wedge-shaped areas. In cutting into these places, caseous, gray, crumbling masses are found, which contain eggs, embryos and dead parasites.

Dictyocaulus viviparus (*Strongylus micrurus*) is found comparatively seldom in the lungs of cattle and calves. It also occurs in deer and roe. The males are 30 to 40 mm. long and the females 60 to 80 mm. long. They are recognized through the mother-of-pearl luster of the hard lobuli, and occur preferably at the base of the lung, where the parasites are lodged in the dilated bronchi. Occasionally, dead parasites may be found in greenish-colored nodules (Ostertag).

Synthetocaulus commutatus (*Strongylus commutatus*) occurs in the lungs of hares and rabbits. The worm is 30 to 70 mm. long and produces, in the lung tissue proper, inflammatory areas varying in size from a hempseed to a hazelnut. These areas have a yellow caseous content. Occasionally the parasite produces enzoötic losses in rabbits.

According to Schlegel, the *Strongylus commutatus* is comparatively frequent in sheep, and is also the most harmful lung worm of this species. It is supposed to be present always in the dark brown to black or violet-red nodules of the lungs of sheep.

Parasites of Body Cavity.—*Setaria cervi*, also known as *S. labiato-papillosa*, a slender nematode 0.6 to 1.2 cm. long, occurs in the peritoneal cavity of cattle. No pathology is associated with the presence of this worm.

Parasites of the Digestive Apparatus.—GASTRUS LARVÆ.—The larvæ of *Gastrophilus intestinalis*, the stomach bot of the horse, are 18 to 20 mm. long, roll-shaped, yellowish or flesh-colored bodies, which live on the cardiac portion of the mucosa of the horse's stomach. Occasionally they also occur in the dog (Figs. 89 and 90).

The adult fly lays eggs 1 mm. long on the hair of the horse. After about seven days the maggots are ready for emergence from the eggs but they do not hatch until they are rubbed or licked by the horse. The larvæ burrow into the mucosa of the cheeks and tongue, the journey to the stomach requiring about a month. Once in the stomach the larvæ become attached to the mucous membrane and are developed after nine to ten months into full-grown larvæ, which are ejected with the feces.

The larvæ of the *Gastrophilus hæmorrhoidalis* of the horse are more slender than the former, and of a lighter red color.

Larvæ of *Gastrophilus nasalis* occur in the pyloric portion of the stomach of the horse and in the upper part of the duodenum. They are whitish-yellow in color, and measure 13 to 15 mm. in length.

Gongylonema pulchrum, a slender nematode about 1.5 to 4 cm. long, occurs in the mucosa of the tongue, pharynx, and esophagus of swine. The intermediate stage of this parasite occurs in beetles and cockroaches. This species is known to occur also in the gullet of sheep and cattle. In order to remove these parasites from the affected tongues of swine, the only practicable method that has been discovered is to strip off the mucosa in which the worms are embedded. This is readily accomplished by first scalding the tongues with water at a temperature of 145° F. or higher, and then drenching with cold water in a washer provided with baffles similar to that used for scalding hog stomachs. Under federal meat inspection all tongues in which these parasites are found are subjected to this treatment or to some other appropriate treatment that will remove the worms and the affected tissue, namely, the mucosa.



FIG. 89



FIG. 90

FIGS. 89 and 90.—*Gastrophilus intestinalis*. Fig. 89, male fly. Fig. 90, larva. (After Ziegler.)

ROUND WORMS.—*Hæmonchus contortus** (*Strongylus contortus*), the contorted stomach worm, lives in the abomasum of sheep and goats and occasionally in young cattle. The reddish-white worms are 16 to 30 mm. long. The blood-sucking parasites produce anemia and cachexia through heavy infestations. If they appear extensively in a flock of sheep the condition is spoken of as stomach worm epizoötic of sheep.

NEMATODES IN JOINTS.—*Onchocerca bovis* is a slender nematode, 5.75 to 7 cm. long. This worm occurs on both sides of the ligamentum nuchæ, between the first and fifth dorsal vertebræ, frequently between the muscular insertions in carpal and tarsal regions and also about the lateral ligaments of the femoral-patellar (stifle) joints. The worms from large confluent lesions on the ligamentum nuchæ and isolated lesions in the neighborhood of the great trochanter.

Beef bones, particularly stifle joints, sometimes show enlarged joints, the enlargement ranging from slight to extensive. The pathological changes involved have the appearance of tuberculosis, but laboratory examinations of several such samples failed to confirm this diagnosis but established the presence of *Onchocerca*. In performing rail inspection,

inspectors must exercise care that all cases of enlarged stifle joints will be detected and eliminate those which are abnormal.

Ostertagia ostertagi (*Strongylus ostertagi*, *Strongylus convolutus*), conglomerated palisade worm, lives frequently in the abomasum of cattle, and rarely in sheep. They are 7 to 13 mm. long. The presence of these worms, which lie under the epithelia of the mucous membranes, is indicated by round elevated spots the size of lentils, with a central opening. Extensive infestation with these parasites may result in emaciation. The species normally occurring in sheep is *O. circumcincta*.

Ostertagia ostertagi (*Strongylus convolutus*), as well as various other strongylidæ, according to Schnyder, is the cause of a chronic diarrhea in cattle in Switzerland, designated as "Kaltbrandigkeit," because there is no fever but much thirst manifested.

Hyostrongylus rubidus was the cause of a severe affection in hogs, observed by Oppermann, consisting of a diphtheritic or chronic inflammatory affection of the gastric mucous membrane, which resulted in severe anemia to the nursing mother pig.

Hog stomachs are frequently parasitized by the following species of nematodes: *Arduenna strongylina* and *Physacephalus sexalatus*. These parasites are associated with a thick lamellar pseudo-membrane, firmly adherent to the pyloric stomach; under this is a superficial loss of mucous membrane; on this area numerous worms, fastened partly to the stomach wall and partly attached to the pseudo-membrane, are present.

In order that hog stomachs used in the manufacture of edible products may be made entirely clean, inspectors shall require that affected stomachs be cleaned with warm water and a stiff brush, or by some other equally effective method. Thorough methods of cleaning will effect the removal of the parasites named.

Trichuris ovis (*Trichocephalus affinis*), which generally occurs only in cattle, sheep and goats, was found by Meyer in large masses in the large intestines of a hog. The species normally occurring in hogs is *T. suis*. *Trichuris suis* was also found by Haase (Heine). The latter species is the one which normally parasitizes hogs.

Oxyuris curvula and *Oxyuris mastigodes* occur in the large intestines of the horse. Both species are regarded as identical, and are known as *O. equi*.

Strongylus vulgaris, *S. edentatus*, *S. equinus*, formerly known as *Strongylus armatus*, inhabit the large intestines of horses, and embryos of *S. vulgaris* produce aneurysms of the abdominal blood-vessels.

Spirocerca sanguinolenta, blood-sucking, coiled-tail parasite, lives in minute cavities under the mucous membrane of the esophagus and stomach of dogs.

Ascaris equorum (*A. megalcephala*), the large-headed nematode worm, is most frequently found in the small intestines of horses. The larvæ occur in the liver and lungs.

Ascaris suum (*A. lumbricoides*) is frequently found in hogs. Heavy infestations of ascarids in the intestines of calves and sheep cause an abnormally stale, sourish odor and flavor of the meat (Morat, Laubion, Leibender, Vallisneri, Mathis). The sheep ascarid is *A. suum*; the calf ascarid is *Ascaris vitulorum*.

Larvæ of *Æsophagostomum radiatum* and *Æsophagostomum columbianum*, which infest the small intestine and cecum of European cattle and sheep, respectively, are, according to Scheben, the cause of helminthiasis nodularis intestinalis, also called nodular disease of the intestines. In the intestines of American cattle and of American and Australian sheep, the *Æsophagostomum radiatum* and *Æsophagostomum columbianum* are present, respectively, as the cause of the formation of intestinal nodules. The nodular worms of swine in the United States are *O. dentatum*, *O. longicaudum*, and *O. brevicaudum*. These worms produce nodules on the mucosa of the large intestine.

Gnathostoma hispidum (*Cheiracanthus hispidus*), the three-colored stomach worm, lives on the blood from the mucous membrane of the stomach of hogs. This parasite, which is 2 to 3 cm. long, has a spherical head which is separated by a deep furrow from the remainder of the body.

Macrocanthorhynchus hirudinaceus (*Echinorhynchus gigas*), the giant worm, is from 7 to 9 cm. (males) and 30 to 40 cm. (females) long, and inhabits the small intestine of hogs. At the point of attachment it produces a circumscribed inflammatory nodule and small abscesses which may then be easily mistaken for a tuberculous nodule.

For the discussion of trichinæ in the intestines, see page 271.

NEMATODES IN JOINTS.—*Onchocerca bovis* is a slender nematode, 5.75 to 7 cm. long. This worm occurs on both sides of the ligamentum nuchæ, between the first and fifth dorsal vertebræ, frequently between the muscular insertions in carpal and tarsal regions and also about the lateral ligaments of the femoral-patellar (stifle) joint. The worms form large confluent lesions on the ligamentum nuchæ and isolated lesions in the neighborhood of the great trochanter.

Beef bone, particularly stifle joints, sometimes show enlarged joints, the enlargement ranging from slight to extensive. The pathological changes involved have the appearance of tuberculosis, but laboratory examinations of several such samples failed to confirm this diagnosis but established the presence of *Onchocerca*. In performing rail inspection, inspectors must exercise care that all cases of enlarged stifle joints will be detected and eliminate those which are abnormal.

FLAT WORMS.—*Moniezia expansa* produces the most important and frequent tapeworm disease of sheep, and in young animals causes emaciation, diarrhea, cachectic anemia, followed by death. It also occurs in cattle, and is from 2 to 4 m. in length.

Of the other flat worms found in food-producing animals the following may be mentioned:

Cittotænia denticulata of rabbits, cysticercus unknown, 25 to 80 cm., sometimes 150 cm. long.

Anoplocephala perfoliata of horses, 1 to 7.5 cm. long.

Anoplocephala magna of horses, 10 to 25 cm. long.

Anoplocephala mammillana of horses, 2 to 5 cm. long.

In dogs are found:

T. hydatigena (*T. marginata*), 1½ to 2 m. long, which is the adult of *Cysticercus tenuicollis* of sheep, hogs and cattle.

T. pisiformis (*T. serrata*), 1½ to 2 m. long, which is the adult of *Cysticercus pisiformis* of hares.

Multiceps multiceps (*T. cænurus*), 40 to 60 cm. long, which is the adult of *Cænurus cerebralis* of sheep.

*Dipylidium caninum** (*T. cucumerina*), 10 to 40 cm. long. Its cysticercus stage is in the dog louse (*Trichodectes canis latus*) and in the dog flea (*Pulex serraticeps*).

Echinococcus granulosus (*T. echinococcus*), 3 to 4 mm. long, which has its origin from either the *Echinococcus unilocularis* or *E. multilocularis* (page 261) of ruminants and hogs (Fig. 91).

*Diphyllobothrium latum** (*Bothriocephalus latus*), the larval stages of which are found in the muscles of pike, perch, eel, pout, grayling and trout (Fig. 92).

Recent investigations (Vaullegeard) appear to establish the fact that heavy parasitic infestations occasion the production of toxin-like poisonous products in the intestines.

Thysanosoma actinioides. This is the fringed tapeworm of sheep. It occurs in the small intestine, the gall ducts, gall bladder, in the biliary canals of the liver and in the ducts of the pancreas. The affected ducts and glands are usually thickened. These tapeworms are whitish or yellowish and may attain 30 cm.

in length, though they are usually shorter. They are readily recognized by the fringe on the posterior border of the segments. Tapeworms found in the liver or pancreas will be this worm and not *Moniezia*. This parasite occurs in the western part of the United States.

FLUKES.—*Fasciola hepatica** (*Distomum hepaticum*), the large distoma, occurs in the bile ducts of the liver of cattle, sheep, goats, hogs (very rarely), and deer. Distoma or their remains are occasionally found in the lungs, spleen, heart, subcutis, muscles and beneath the serous membranes.

This leaf-shaped worm is 20 to 40 mm. long and 12 to 15 mm. broad at widest portion. Its color is muddy-yellow to greenish-brown. It has an oral and ventral sucker and its cuticula bears scale-like thorns (Fig. 93).

The sexually mature fluke in the bile duct lays eggs which are passed with the bile into the intestine, then with the feces on to the ground. Those eggs dropped into or near water develop into freely moving embryos which swim about until they find their secondary host, a snail. The embryo bores into the snail and there undergoes development. It then leaves the snail and swims



FIG. 91.—Full-grown *Echinococcus granulosus*. $\times 12$ diameters. (After Ziegler.)



FIG. 92.—Head of the *Diphylobothrium latum* (Bremser), enlarged. (After Heller.)

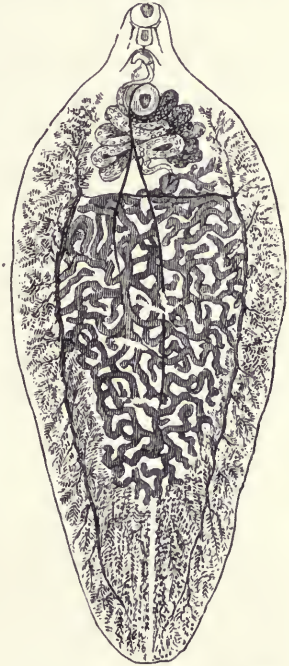

FIG. 93.—*Fasciola hepatica*, with male and female sexual organs. $\times 3.2$ diameters. (After Leuckart.)

on the surface of water or adheres to a blade of wet grass where it encysts. It is then either drunk or eaten by the primary host (sheep, cattle, etc.). After reaching the intestine it soon finds its way to one of the bile ducts where it matures and lays eggs. Recent investigations have established the fact that the young fluke reaches the body cavity, perforates the liver capsule and reaches the bile duct after traversing the hepatic tissue.

The lesions in the liver depend on the intensity and duration of the invasion. If the latter is recent (three weeks) and heavy, symptom of acute inflammation of the liver may be observed. Occasionally

hemorrhages of the liver also occur. Later, changes are found in the bile ducts ranging from simple catarrh of the mucous membrane of the bile ducts to a chronic hyperplastic inflammation of their walls with considerable hypertrophy and calcareous incrustations. Either synchronously or later a chronic interstitial hepatitis with indurations and contractions (hypertrophic cirrhosis of the liver) may develop. In the majority of cases the liver tissue itself remains unchanged. Occasionally suppurative cysts, in which living or dead flukes reside, are found in the parenchyma of the liver communicating with the bile ducts.

Jaeger attributes the action of the distomes on the tissue of the liver to their toxic products of metabolism.

Invasion by the liver fluke does not visibly disturb the general conditions of other animals, but in the sheep, when the disease is severe and extensive (liver-fluke pest or rot), it, as a rule, occasions serious losses by producing digestive disturbances, icterus, anemia and cachexia.

Examination.—These flukes are found by expression of the bile ducts after incisions into the liver, so as to strike the main ducts; for instance, on the stomach surface of the liver of cattle, to the left of the portal canal and at the base of the lobus Spigelii.

Fascioloides magna (*Fasciola magna*).—This is the large liver fluke which may attain a length of 10 cm. It occurs in cysts which contain one to several flukes and a quantity of dark-colored fluid filled with débris. The cysts extend into the tissue, and the fluke is a parasite in the liver substance in cysts and not of the canals and ducts. The livers show characteristic cysts or dark, bluish scars where the flukes have been and where healing has taken place. The cysts take on the character of abscesses and may also be present in the lungs and spleen. This fluke is much more common in cattle than in sheep.

Dicrocoelium lanceatum (*Distomum lanceolatum*), the lancet-shaped fluke, is most common in the liver of sheep, rarer in cattle, hogs, rabbits, hares, and also in man in certain regions.

The worm attains a length of only 4 to 9 mm., and a width of 1 to 2.5 mm. (Fig. 94). Its anterior portion is quite motile and stained black in parts. The mode of invasion resembles that of *Fasciola hepatica*.

This liver fluke may also infest whole herds and produce numerous deaths, as Roemer observed in goats.

Findings and Examination.—The parasite occasions only slight catarrhal changes in the bile ducts, and its presence is frequently not discernible at the surface of the liver. It is, therefore, found only on incision of the bile ducts, where it is frequently present in large numbers.

Judgment.—The judgment of distomatosis depends on the number of flukes and the probable changes in the liver. If the latter are absent, or restricted to the large bile ducts and the distomes are confined to these, they may be entirely removed by careful dissection of the bile ducts and the remaining tissue of the liver utilized. If, however, the flukes are also present in the smaller bile passages, or if severe indura-

tive or suppurative processes are present, the whole organ is confiscated and destroyed.

Such disposition could not be considered under prevailing conditions in the packing-house industry of the United States, and according to B. A. I. Order 211, Regulation 11, Section 18, Paragraph 5, if the liver shows an infestation with flukes it should be condemned.

Paramphistomum cervi is a reddish-white fluke, the shape of a ten-pin (Endloch). It is from 4 to 12 mm. long, 1 to 3 mm. thick, and is found on the mucosa of the first and second stomachs of cattle, sheep, goats, deer and buffalo. It is rare in Germany and of no importance whatever.

PROTOZOA.—*Eimeria zurni* is of interest, as it causes the red diarrhea of cattle (dysenteria hæmorrhagica coccidiosa, Hess). The oval or spherical unicellular coccidia belong to the sporozoa and inhabit the epithelium of the intestinal mucosa, producing severe inflammatory processes.

The symptoms in the living animal may be summarized as a usually acute diarrhea, mixed with blood and accompanied by a general febrile condition. In the slaughtered animal severe inflammation of the intestines is found with blood-red intestinal contents.

Judgment.—In the judgment of such cattle the meat cannot be considered as dangerous to health, yet on account of the existing severe general disturbance its value is impaired. In very severe cases

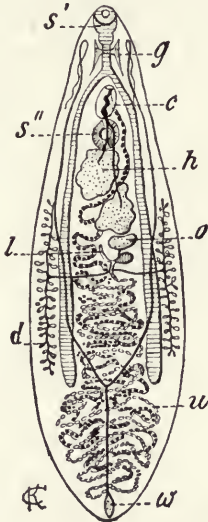

FIG. 94. — *Dicrocoelium lanceatum*: s', oral sucker and entrance to the fork-shaped intestine; s'', ventral sucker; h, testicle with vasa deferentia; c, cirrus; u, uterus; o, ovarium shell; l, canal of Laurer and yolk gland; d, glands; w, excretory vessel; g, ganglion. $\times 8$ diameters. (After Hertwig.)



FIG. 95.—Coccidia in the various stages of development, from the bile duct of a rabbit's liver: a, b, small, granular, young forms; c, d, larger forms with dark-stained border granules; e, f, g, h, oval, encapsulated forms, the protoplasm of which fills up a portion of the capsule. $\times 400$ diameters. (After Ziegler.)

where the animals are greatly emaciated the meat is sometimes unfit for human food.

The *Eimeria stiedæ* (*Coccidium oviforme*), Fig. 95, inhabits the epithelium of the bile ducts of the rabbit liver, and produces abscess-like nodules and cysts.

Eimeria perforans, which is also parasitic in the intestinal epithelia of rabbits, produces diarrhea.

Coccidium fuscum occasions the shot-like skin eruptions (Schrotausschlag) of the hog.

Parasites of the Pleura and Peritoneum.—*Cysticercus tenuicollis*.—The slender-necked bladder worm is a frequent parasite of hogs and rumi-

nants, particularly of sheep. It is often found on and beneath the serous membranes, especially of the omentum, mesentery, and liver in the form of flabby bladders or vesicles filled with serous fluid, ranging in size from a pea to a man's fist. Occasionally the *Cysticercus tenuicollis* has been encountered in the lung tissue of the hog. In a fully grown state the bladders are joined by a long, thin neck to a scolex, from which *Tænia hydatigena* (*Tænia marginata*) of the dog develops, after a change of hosts. The scolex contains four suckers and a double crown of 32 to 40 hooks.

Extensive peritonitis is sometimes produced in hogs in cases of heavy invasion of the parasites beneath the folds of the abdominal serosa, resulting in extensive adhesions of the abdominal organs. The dead cysticerci may be found in large numbers among the peritoneal folds as spherical, nodular or more flattened formations, ranging in size from milletseeds to hazelnuts and composed of whitish to yellowish-brown caseous material with a membranoid envelope (the thickened serosa).

The nature of the nodules, as a rule, is easily ascertained macroscopically by making smears of the contents of the larger and softer caseous nodules, which should contain portions of the cysticercus membrane, and microscopically by the presence of hooks and calcareous bodies.

The calcareous concretions occasionally encountered in the musculature of sheep may be produced by the invasion of slender-necked cysticerci, according to Glage.

Relatively young animals may harbor the parasite, as the development of the thin-necked bladder worm from the tapeworm ova occurs within five to six weeks. At this stage they lie, as a rule, beneath the serous membrane. In further development the bladder worms increase the protrusion of the serosa more and more, but always remain covered by it. In young animals which have recently ingested numerous tapeworm ova, serpentine paths in the liver are occasionally encountered. These are filled with dark red, brownish or greenish masses, and indicate the course traversed by the bladder-worm embryos. Should the parasites remain in the interior of the organs, especially the liver, they barely attain the size of a pea, and rapidly undergo cheesy and calcareous degeneration.

Differential Diagnosis.—The slender-necked bladder worms never occur between the muscle fibers as mature parasites, but they have, nevertheless, been confounded with true measles when found as pea-sized vesicles in places where the serosa lies directly in contact with the musculature (diaphragm, pillars, of the diaphragm, abdominal, intercostal, and sternal muscles). Such errors do not occur when examination is made of—

1. The favorite site of true measles (*C. cellulosa* or *C. bovis*), where the thin-necked measles never occur (tongue, larynx, heart musculature). If no measles are found there it is improbable that the doubtful structure is a true measles.

2. The scolex of the doubtful bladder worms under the microscope, carefully noting the number and shape of the hooks.

To avoid mistaking the caseous or calcified thin-necked bladder worms for tuberculous areas, it is essential to bear in mind the characteristic structure of the latter, and to ascertain the absence of infection of the lymphatic glands of the organ under consideration.

Cysticercus pisiformis.—The pea-shaped bladder worm (the larval stage of *Tænia pisiformis* [*T. serrata*] of the dog) is quite common in the lungs and liver, and especially prevalent in the serous lining of the thoracic and abdominal cavities of rabbits and hares. Sometimes the infestation occurs epizootically, and it is then spoken of as rabbit venery; and in some cases it is at times held to be tuberculosis, as caseation and calcification of the cysts occur within the organs.

On echinococci of serous membranes, see page 261.

OTHER PARASITES.—*Setaria equina*, a round worm 6 to 15 cm. long, has been found free in the abdominal cavity of horses, and *Strongylus* species (Kitt) have been found in the same animal. Migrating liver flukes may also find their way into the serous cavities and become attached to serous membranes.

PARASITES OF THE KIDNEY REGION.—*Stephanurus dentatus*.—These parasites, known as swine kidney worms, are common in swine in tropical and subtropical regions. They are widely prevalent in the southern part of the United States. They are not known from Europe except from southern Spain where they have been found once. They are occasionally encountered in the immature stage in cattle.

The parasites are relatively thick and mottled, the males being from 20 to 40 mm. long and the females from 25 to 54 mm. long. The life history is direct infestation resulting from (1) the swallowing of the infective larvæ with food or water or (2) from the penetration of these larvæ through the broken skin. The larval worms migrate to the liver through the portal vein in which blood-vessel many larvæ become arrested. The agamic worms reach other organs, including the lungs, pancreas, spleen; ultimately the larvæ extricate themselves from the liver by perforating its capsule and, after wandering freely for a time in the abdominal cavity, they penetrate the perirenal fat where they become encapsulated, a single pair of worms usually occurring in each capsule. From the cysts the worms establish fistulous tracks to the ureters which they perforate. Sometimes the worms enter the renal tissue and locate under the capsule of the kidney. They also penetrate the lumbar muscles and sometimes even reach the spinal canal. Sexual maturity is attained by those worms which reach the perirenal fat. Those located elsewhere cannot complete their life cycle.

Judgment.—(See page 247, Parasitic Diseases of Organs.)

Parasites in the Brain.—*Cænurus cerebralis** (*Multiceps multiceps*).—Cerebral bladder-worm cysts, filled with serous fluid, varying in size from a pea to a hen's egg, occur in the brains of sheep, more rarely in cattle, and produce the so-called gid, or staggers.

Large numbers of milletseed-sized whitish granules are situated on the inner wall of the cysts. These are the scolices, from which the *Multiceps multiceps* (*Tænia cænurus*) of the dog is developed.

The development of cænurus cysts occupies two to two and a half months.

The embryos, which have been set free from the ova in the digestive tract, are largely disseminated embolically. As early as eight to fourteen days after invasion bluish-white cysts are found on the surface of the brain. They have a diameter of 1 to 3 mm., and show sulphur-yellow streaks. Similar streaks, indicating the path of the wandering onchosperes, may also be found in other organs, in which there are later observed spherical, encapsulated areas with greenish pus-like contents (cestodal tuberculosis, pseudotuberculosis verminosa). These areas are transformed by calcification into fibrous, calciform nodules (calicosis nodularis).

Occasionally, cœnurus cysts (*C. serialis*) are seen in the abdominal cavity and muscles of hares and rabbits.

Other parasites occurring in the central nervous system, such as *Cysticercus cellulosæ* and *Æstrus larvæ*, are mentioned elsewhere.

For the judgment of parasitic organ affections, see page 247.

Parasitic General Diseases.—*Linguatula serrata* (*Pentastomum denticulatum*). The denticulate pentastome is the larval stage of the tape-worm-like five-month parasite (generally known as *Pentastomum s. Linguatula rhinaria*), considered under parasites of the respiratory system (page 250). It inhabits the intestines, lymphatic glands and the under surface of the serous membranes of cattle, sheep, goats, hogs, deer, rabbit and hare.

Development.—The young larvæ escape from the ova ingested into the intestinal tract with food, pierce the intestinal wall, and enter the various organs actively or embolically. They are most common in the liver, mesenteric, inguinal, and iliac lymphatic glands, but are also found in the lung, spleen, pleura, and peritoneum. They become encysted, undergo various changes and six to seven months after the invasion the mature larva is found. It either dies or wanders actively through the peritoneal or pleural cavities into the intestines or bronchi in order to reach the beginning of the respiratory apparatus and thus escape.

The larval invasion and its results produce milletseed-sized white nodules, which lead to the suspicion of tuberculosis. In the lymphatic glands, especially on the periphery, irregular, milletseed to hazelnut-sized areas of yellowish or greenish-gray color are formed (Plate III, Fig. 1). The parasites occur within this caseous or mortar-like substance as whitish-flat larvæ, 6 to 8 mm. long, an anterior width of 1.2 to 2 mm. and narrower posteriorly. The segmented body, covered with tooth-like thorns, is supplied with two pairs of hooks on either side of the mouth (Fig. 96). The latter are permanent and may be demonstrated

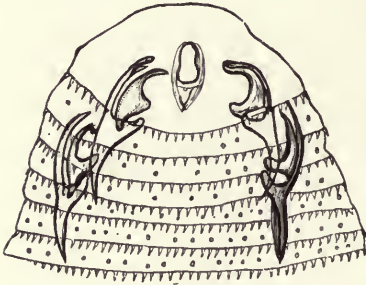

FIG. 96.—Head of *Linguatula serrata*.
× 40 diameters. (According to Ziegler.)

microscopically when the pentastoma larvæ die and decompose.

Recognition or Identification and False Interpretation.—The recognition of the larval site is not difficult if the places in question and the lymphatic glands are cut open. They may be mistaken for tuberculous areas unless it is remembered that:

1. Tuberculous areas do not occur in the peripheral zone of the lymphatic glands only, but also in their interior.
2. Tuberculous areas caseate from the center and are surrounded by a gray peripheral layer, whereas pentastomum areas possess a uniform caseous consistence.
3. Caseous tuberculous areas are yellow, while caseated pentastomum areas give a greenish color (Plate III, Fig. 1).

PLATE III

FIG. 1



Section of a Mesenteric Lymph Gland of a Cow
with Pentastome Foci.

FIG. 2

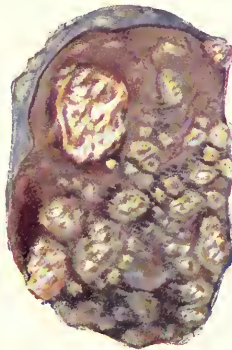

Section of a Tuberculous Bronchial Lymph Gland
from a Cow.

4. In beginning calcification, tuberculous areas retain their yellow color; the pentastomum areas, on the contrary, turn gray.

5. In pentastomum areas the larvæ or their hooks are easily demonstrated.

Judgment.—Direct transmission of the pentastoma larvæ to man through eating meat is most improbable. The portions of meat showing a heavy infestation with *L. serrata* are not to be considered dangerous to health, but at the most are to be designated as greatly impaired in value. Parts or organs extensively invaded are to be removed as unfit for use, while isolated areas in valuable organs (liver) may be excised.

The Federal meat inspection provides for the condemnation of organs infested with *L. serrata*.

The indirect harmfulness of the pentastoma larvæ for man is shown by its relation to *L. serrata* (*P. tænioides*) of man and dog; and for this reason special care should be exercised to prevent dogs from eating organs infested with *L. serrata*.

Particularly careful examination is required in pentastomatosis of body lymph glands to avoid mistaking it for tuberculosis.

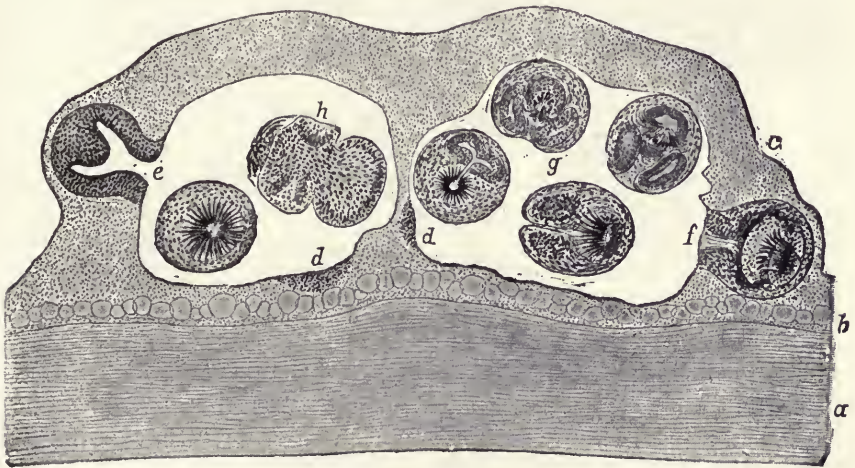

FIG. 97.—Wall of an echinococcus cyst with brood capsules and scolices: *a*, chitin membrane (cuticula); *b*, layer of parenchyma with cystic cells; *c*, daughter cysts; *d*, *e*, *f*, *g*, *h*, scolices in various stages of development. $\times 100$ diameters. (According to Ziegler.)

Echinococci.—Echinococci are bladder worms whose scolices are not situated immediately or directly on the inner surface of the cyst walls, but they are surrounded by separate capsules (proligerous vesicles or daughter cysts) which are attached to the enveloping membrane by a pedicle, or they exist free within the serous fluid which fills the cysts.

Echinococci (*Echinococcus granulosus*) occur in all animals used for slaughter; most commonly, however, in sheep, hogs and cattle. They form the asexual stage of *Echinococcus granulosus* (*Tænia echinococcus*)

the three-segmented tapeworm of the dog (page 254) and occur in two forms as:

- (a) *Echinococcus granulosus s. unilocularis s. simplex*.
 (b) *Echinococcus multilocularis s. alveolaris*.

Echinocci develop from the ova or onchospheres of *Echinococcus* after they reach the alimentary tract. According to the observations of Mangold, Müller, von Linstow, Posselt, this tænia exists in the dog in two varieties, which externally, however, appear very similar. The dissemination of the embryos from the intestines is mainly through the portal circulation. For this reason the liver is the organ most commonly infested with developing echinococcus cysts. According to Leuckart, the development is comparatively slow. White nodules of about 1 mm. in size may be seen four weeks after invasion, and after four more weeks the cystic nodules have only attained a size of 1.5 to 2.5 mm. with a central cavity containing fluid. Only at the age of five months have they attained 15 to 20 mm. in size, and the first proligerous or daughter cysts with scolices are then formed.

The echinococci degenerate easily and undergo caseation or calcification. The initial stage of this degeneration is a softening and fatty change of the parenchyma layer and a transformation of the partly transudated echinococcus fluid into a sticky honey-like mass. In sheep the cyst wall may become cartilaginous, or it may even calcify. The scolices of the echinococci die as a result of the process of degeneration.

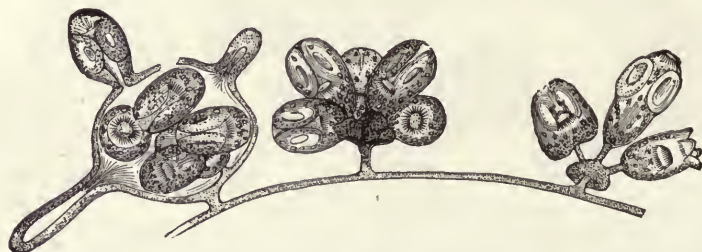

FIG. 98.—Closed and ruptured brood capsules with scolices in connection with the parenchymatous layer of the cystic wall. $\times 40$ diameters. (According to Leuckart.)

Echinococcus granulosus s. unilocularis s. simplex.—The simple echinococcus cysts range in size from a pea to a child's head. They may be transparent or opaque, light gray to pure white and may appear in all animals that are slaughtered, especially in sheep, hogs and cattle. They are principally found in the liver and lung, but they may also be present in all other organs of the body, even in the heart, bones, udder, brain and muscles. Of the organs infested with echinococci, the liver particularly may increase enormously in size and weight.

The unilocular echinococci are always enclosed by a connective-tissue capsule (organic membrane of Ostertag), which results from the reaction of the immediately surrounding structures and separates the parasite from the neighboring tissues of the organs.

The true wall of the echinococci cysts is composed of a laminated cuticula and a parenchymatous layer in which calcareous bodies may be found. Should the parenchymatous layer remain smooth upon its inner surface the echino-

coccus will contain only fluid, and is then called *E. cysticus sterilis*; this is the most common form in slaughter animals. If proligerous vesicles (Fig. 98) develop from the parenchymatous layer, the *E. fertilis* is formed; this form is found most frequently in hogs and sheep. A formation of so-called daughter cysts, having the same structure as the mother cysts, may develop from portions of the parenchymatous layer which have remained between the layers of the cuticula (M. Braun). Originating in the substance of the cuticle, they distend the wall of the mother cyst, either outwardly (*E. granulosus*) or inwardly (*E. hydatidosus*). In the latter case the daughter cysts may rupture the innermost layers of the wall of the mother cyst, be set free, and fall into the mother cyst. The early growing forms of the echinococci, according to Leuckart, appear as whitish bodies the size of sago seed, which, under the microscope, show a structureless enveloping membrane of granular formation within.

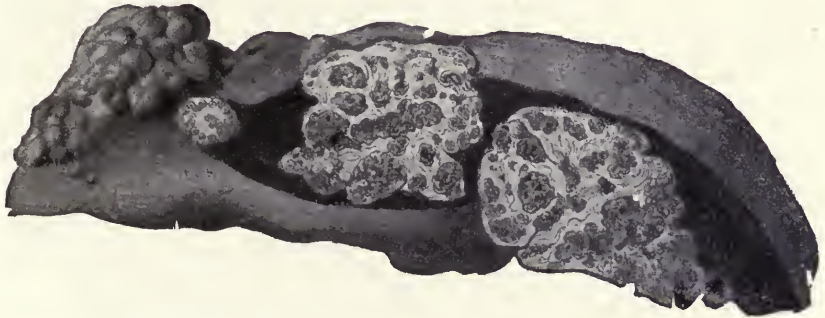

FIG. 99.—Section through liver of cow with *Echinococcus multilocularis*.

Echinococcus multilocularis s. *alveolaris*.—The many-chambered hydatid occurs as a tumor-like growth (Fig. 99) in the liver and lungs, especially in cattle. It has been found occasionally in the spleen and kidneys and other organs in sheep, also in hogs. In hogs it occurs in a form differing from that in cattle and is more like the alveolar echinococcus found in man (Ostertag). The multilocular echinococcus is composed of numerous small cysts or vesicles embedded in a connective-tissue network. The latter is delicate and thin in small echinococcus cysts, but during growth attains considerable thickness in the large forms. According to size and age, the individual vesicles of the multilocular echinococci are either soft and elastic, with thin walls and filled with serous fluid, or gelatinous, caseated and calcified. The centers of larger echinococci are usually of the latter consistence, while the peripheral layers are made of the former. The hydatid grows by the formation of new daughter cysts from the mother cysts. These emerge from within, are freed by the connective tissue, and themselves form mother cysts, which, in their turn, send out daughter cysts toward the periphery.

In other respects the single vesicle of the alveolar echinococcus is similar to the structure of the simple echinococcus; but, according to v. Linstow, *E. alveolaris* has fewer hooks than *E. cysticus* (26 as compared with 36). They are not identical biologically, and two different varieties of echinococcus develop (see page 262).

The alveolar echinococcus found in the pleura of hogs by Ostertag gave the impression of a miliary pearl disease. The numerous milletseed-shaped nodules were grayish-yellow, of firm consistence, and enclosed fresh and caseated hydatids containing scolices.

The recognition of echinococci is easy after they become visible on the surface of the organs and if they have not degenerated. When deeply located within the organs palpation will disclose the large cysts; smaller ones, however, can only be discovered by section. The alveolar echinococcus and caseated or calcified simple echinococci may be mistaken for tuberculosis unless it is noted that in echinococcus disease:

1. The lymph glands belonging to the organ are free of the infection.
2. In the caseous or calcareous masses are contained delicate membranous remnants, the hull or enveloping membrane of the proligerous vesicles or the remnants of the main membrane of the mother cyst.
3. The cuticula of the echinococcus wall shows microscopically a banded or striped structure (Fig. 97).
4. The caseated or calcified contents of unilocular cysts are easily removed from the surrounding smooth-walled connective-tissue capsule.

Judgment.—In the judgment of echinococci it must be remembered that they are not transmissible to man by ingestion. The parasites themselves, however, are objectionable formations, and whenever found in small numbers in any organ they should be carefully excised, while the organ infested is to be cut in layers. When present in great numbers the organ becomes unfit for food and should be condemned.

According to B. A. I. Order, the presence of an organ found infested with echinococcus cysts does not affect the wholesomeness of the meat, and the carcass may be passed for food after condemnation of the infested part or organ.

The importance of the echinococcus cyst to man lies in the easy transmission of the ova of *Echinococcus* of the dog to man. This is proved by the fact that echinococcus disease in man is proportional to that of domestic animals in those localities in which the animal echinococci are not carefully removed, thus allowing dogs to gain access to the tissues containing echinococci. The echinococcus cysts in man, formed from the eggs of *Echinococcus granulosus* of the dog, are developed in the same way as in animals and in almost every case lead to severe disturbance of health and may even prove fatal. For this reason the careful removal of all echinococci through meat inspection is of the greatest sanitary value and importance.

Measles.—The true measles of cattle and swine are the larval stages of two species of tapeworms in man. There are for consideration, therefore, two corresponding forms of measles.

(a) *Cysticercus cellulosæ*, the pork measles.

(b) *Cysticercus bovis*, the beef measles.

The transition stage of a third tapeworm of man, found in the flesh of fish, namely, that of *Diphyllobothrium latum* (*Bothriocephalus latus*), will be considered in Chapter X.

The larval stages of the *Bothriocephalus linguloides*, which occur in man in Japan, according to Miyake, need not be considered here. The same is true of the hydatids of *Tænia krabbei*, which Rusche reported in reindeer meat. The tapeworm in question is parasitic in dogs. The hydatids are somewhat smaller than hog measles, their scolex having 26 to 39 hooks of various sizes.

Generalities and Development.—The measles develop from the tapeworm eggs which have gained access to the stomach of the respective host where they are freed from their covering. Either actively or passively the developing embryos gain access to all parts of the body, and form the so-called measles in the connective tissue of the animal, especially in the striated musculature. They appear as round or oval, transparent, colorless to grayish-white vesicles, ranging in size from a milletseed to a double pea and are filled with a serous fluid. An invagination of the cyst wall, the site of the future tapeworm, shows the scolex as a whitish translucent spot. The measles are separated from the surrounding tissues by the so-called bladder worm capsule, a delicate, connective-tissue membrane formed by the reaction of the cellular tissue. In microscopic examination of a cyst whose scolex has been extruded by gentle pressure between two glass plates, four suckers are observed, and sometimes crowns of hooks on the spherical or pear-shaped head (scoles). In the so-called neck numerous calcareous bodies and a cross-striation pointing to the future segments are found. The development of measles in animals follows ingestion of tapeworm ova, whose onchospheres (embryos), supplied with hooks, are largely carried from the intestines to the widely divergent portions of the body (connective tissue of the body) by the blood stream. The measles, especially those of cattle, may at any stage of their development undergo degeneration—hypertrophy of the sac surround the measles, coagulation necrosis, caseation, suppuration, calcification, and

they usually lose their capacity for further development, which is decided by the intactness of the scolex. If the latter cannot be demonstrated or is easily crushed the measles are no doubt dead. The viability of measles is limited, temperature of 45° to 50° C. causing them to die; a strong salt solution will also kill them in a short time. The measles survive the death of their host for several weeks. The fact that meat is spoiled does not necessarily mean death of the *cysticerci*.

Intrauterine infection of the fetus with embryos of measles, as some observations from practice would indicate, is not yet proved.

Cysticercus cellulosæ.—Measles of pork is the asexual transition or larval stage of the armed tapeworm (*Tænia solium*) of man. The bluish-white cyst of pork measles and the surrounding bladders are very thin; through them the invaginated scolex may be distinctly seen. The latter has four suckers and a rostellum with double crown of 22 to 28 hooks (Fig. 100) which are absent in beef measles.

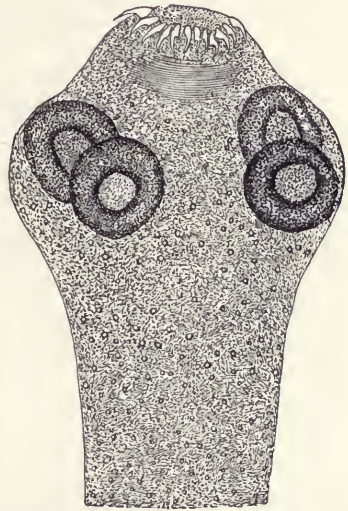

FIG. 100.—Scolex of the hog measles. (*Tænia solium*). Squeeze preparation. $\times 50$ diameters.

Occurrence.—Situation.—Pork measles are found particularly in the connective tissues of domestic and wild hogs; they are rarely observed in the goat, dog, bear, cat, deer, buck, monkey and man. The favorite site is the intermuscular tissue of the heart, tongue, larynx, abdomen, diaphragm, flanks, cheeks, neck, sternum, intercostal muscles, and adductors of the hind legs. When infestation is heavy they may be found in all muscles of the body, in the panniculus adiposus and in the brain; very rarely in the lung and liver. In case of marked invasion the musculature is watery and discolored a grayish-red. When a heavy invasion occurs the measles may be recognized beneath the mucosa of the tongue in the living animal.

Frequency.—This parasite is uncommon in the United States. The Federal meat inspection statistics for 1938 show that 39 hogs were found infested with measles, out of 32,453,905 slaughtered, which would be a little more than 1 infested hog in every 800,000. The number of measly hogs has been decreasing steadily as a result of the inauguration of general meat inspection. The number of measly hogs is in general much larger in East Germany than in the West and South.

According to the government meat-inspection statistics of the year 1904, measles were found in 0.25 per cent of all slaughtered hogs in the German Empire. Infection is much more common in hogs in Russia and southern Europe.

Careful examination of the favorite sites makes the detection of measles easy. The tongue muscles are always to be separated, and the heart should be laid open with a cut exposing both chambers and dividing wall. In doubtful cases microscopic examination should be made. This will determine the presence or absence of the hooks, their number, etc. The hooks remain intact even in caseous or calcified measles.

To avoid error, the thin-necked bladder worm (*Cysticercus tenuicollis*), whose characteristics were described on page 257, must be borne in mind. From a differential diagnostic point of view, the following indications are especially to be observed:

1. The thin-necked bladder worm is never situated intermuscularly; if present it will be found on muscles covered with serous membrane (abdominal, diaphragmatic, intercostal, and sternal muscles).

2. In the isolated specimen of *Cysticercus tenuicollis* attention is called to a thin neck and the presence of more than 28 hooks (32 to 40) on the scolex.

3. The hooks of *Cysticercus tenuicollis* are more sickle-shaped (Fig. 102); those of *Cysticercus cellulosæ* more scythe-like. Some of the smaller hooks of the former possess, in addition, a cleft or bifurcated basal process, which is not found in *Cysticercus cellulosæ* (Schwarz) (Fig. 101).

Even small echinococci may most exceptionally occur in the musculature in cases of unusually heavy infestation, but by bearing the characteristic signs of this parasite in mind no difficulty should be encountered in recognizing it.

In the differentiation of caseous and calcified measles there come into consideration—

1. Embolic suppurations in the muscles.
2. Calcareous areas of degeneration.
3. Calcified parasites (trichinæ, echinococci, thin-necked bladder worms).

These occur very rarely in the musculature and present such definite characteristic appearances in the area affected that a careful examination will prevent mistaking them for measles.



FIG. 101.—Hooks of the *Cysticercus cellulosæ*.



FIG. 102.—Hooks of the *Cysticercus tenuicollis*.

Judgment.—Measly pork in a raw or improperly cooked condition is harmful to man, inasmuch as the armed tapeworm develops in man from the measles. This parasite, 2 to 3.5 mm. in length, is injurious to man.

1. By causing disturbances of digestion and nervous symptoms, which may be present more or less markedly according to the individual susceptibility of the patient.
2. By removal of foodstuffs (nutrition).
3. By the danger of auto-infection with measles.

Auto-infection may be caused by uncleanness in defecation, or through antiperistalsis, in which the ova or mature segments of the tapeworm may gain entrance into the stomach of the affected individual and reproduce in this way the same measles development which occurs in the regular way of change of host in the hog. But the development of the species in the human body is of special gravity and danger, as it frequently appears in the cerebrum, spinal cord, and eyes, producing severe disturbance of health and even death.

According to B. A. I. Order 211, Regulation 11, Section 17, carcasses affected with *Cysticercus cellulosæ* may be passed for sterilization, but if the infestation is excessive the carcass is condemned.

As stated on page 265, measles may be made harmless by high temperature and strong salt solutions. For this reason the meat may be utilized for food, provided the infestation is not too heavy. Meat is considered heavily infested when the measles are found alive or dead in large numbers in areas as large as the palm of the hand, on incising muscles in the favorite location of the measles. This is the case, as a rule, when in the majority of the cut surfaces more than one measles is found in each section.

Heavily infested measly meat possesses characteristics which produce general disgust and make the meat unfit for food. This is also

true when the meat, without being heavily infested with measles, is watery or discolored.

Anent the utility of measly meat, the true musculature is to be considered separate from the fat and the viscera. Measles rarely occur in the fat and in the viscera, nor are either of these used for food in the raw state. Special regulations, therefore, apply to these tissues.

Lightly infested measly meat (*Cysticercus cellulosa*) may be made harmless by the following methods:

1. *Thorough Boiling*.—Inasmuch as a temperature over 49° C. destroys measles, thoroughly boiled pork which assumes a grayish-white color throughout, even in the thickest portions, and in which the juice emanating on section is no longer red, is to be considered harmless.

2. *Pickling—Salting*.—If pork has been thoroughly salted for two to three weeks the measles will be destroyed with certainty.

3. *Freezing—Refrigeration*.—After large pieces of pork have been kept for four days at a temperature of 8° to 10° C. below zero, the measles contained therein will be found dead. This method has, however, not been accepted or incorporated into legal regulations.

The method of killing beef measles (see page 270) by sufficiently long preservation of the meat cannot be employed in pork measles, as they have been found viable forty-two days after the death of the host (Ostertag).

For inspection regulations, see page 270.

Cysticercus bovis s. inermis.—The beef measles is the asexual intermediate or larval stage of the tapeworm *Tænia saginata s. T. medio-canellata s. T. inermis* of man. The usually oval, grayish-white vesicles contain the scolex, which may be seen within the cyst. The scolex contains four suckers, but no crown of hooks. Numerous calcareous (small) bodies may be seen microscopically in the neck of the scolex. The size of the measles varies, according to Kaepfel, from 5 to 19 mm. in length and 3 to 8.5 mm. in width.

Ostertag was the first to establish the fact that numerous measles may become completely disintegrated and be absorbed later. This explains the excess of infestation in younger cattle.

Processes of degeneration are much more common in beef measles than in pork measles, and may appear at any stage of development. Measles of the viscera, masticatory muscle and tongue muscle are most susceptible to degeneration and the processes of caseation are frequently recognized by their green color. If the scolex has also been destroyed in these retrogressive metamorphoses, and is not demonstrable microscopically, the measles are without doubt dead.

Occurrence—Prevalence.—Beef measles occur relatively seldom in suckling calves, more frequently in older calves and heaves in the intermuscular connective tissue, although usually in small numbers. Sites of predilection are the inner (*M. pterygoid. medial. et lateral.*) and outer (*M. masseter*) muscles of mastication, heart and tongue muscles. Next in order are the muscles of the diaphragm, diaphragmatic pillars, esophagus, larynx, thorax, intercostals, and rump muscles; and, in fact,

they are found in all the muscles of the body, but their distribution is very irregular. Nests of measles may be met suddenly in the center of a large uninfested area. In severe or heavy invasion the lungs, liver, brain, lymphatic glands and fatty tissue are also affected, but measles have been found in these organs or regions in isolated numbers, in even very slight manifestations.

Frequency.—Beef measles are not numerous in the United States as only 1 animal in every 10,000 of the cattle slaughtered in 1918 showed this disease. During the four years from 1929 to 1932, out of nearly 33 million cattle slaughtered under Federal supervision, approximately 110,000 were retained for measles, the incidence of infestation during the period being about 0.3 per cent. In 1938 over 15,000,000 cattle (including calves) were slaughtered in the United States under Federal inspection. Of this number 227 (1 out of approximately 60,000) were infested with measles. Out of 332,466 cattle slaughtered during one month in 1915 at 57 establishments under Federal inspection, 2445 or about 0.7 per cent were infested with measles. According to the government meat-inspection statistics for the year 1904, measles occurred in the German Empire in 3.2 of every 1000 head of cattle slaughtered, as follows: 5.13 steers, 6.03 bulls, 1.67 cows, 3.21 young beeves and 0.024 calves. The infestation at the present time is said to be somewhat less than 1 per cent.

C. bovis does not occur in reindeer meat, but the armed measles of *Tænia krabbei* are found there (see page 264).

In order to detect beef measles it is absolutely necessary to make several cuts into the inner and outer muscles of mastication, to inspect carefully the tongue musculature, also to inspect carefully the heart externally and internally after laying open the chambers and cutting through the dividing wall. It is understood that all other surfaces as well as cut surfaces of the remaining muscles should be inspected for beef measles. The diagnosis of doubtful formations and degenerated measles requires a microscopic examination.

In regard to the likelihood of mistaking beef measles for similar structures, reference should be made to the points presented on page 267 in connection with pork measles. The special morphological characteristics of beef measles are always to be borne in mind.

Judgment.—Raw, measly beef must be considered injurious to man, as the 4 to 6 meter long *Tænia saginata* is developed in man from the ingested beef measles. The effect of infestation in man is the same as that of infestation with *Tænia solium* (see page 267), except that the danger of auto-infection has not been observed in the hosts of *Tænia saginata*.



FIG. 103.—Scolex of the *Cysticercus bovis*. $\times 50$ diameters.

As the beef measles is much more easily killed than the pork measles, measly beef may be made fit for human food by boiling thoroughly, salting, freezing, or preserving it for sufficient length of time (cooling it thoroughly), provided that the infestation is not heavy (see page 268). The first three methods have already been discussed under pork measles (page 268). The admission of so-called one-measled beeves (einfinnigen Rinder) as human food, without previous destruction of the measles is a regulation in favor of commercial interest against which weighty sanitary considerations will not prevail.

In regard to thorough cooling of the meat and its effect on the vitality of the measles under proper preservation of the meat, numerous experiments have shown that the beef measles survives its host forty-one days.

According to B. A. I. Order 211, Regulation 11, Section 16, the following provisions govern the disposition of carcasses found affected with beef measles:

Carcasses of cattle (including the viscera) infested with tapeworm cysts known as *Cysticercus bovis* shall be condemned if the infestation is excessive or if the meat is watery or discolored. Carcasses shall be considered excessively infested if incisions in various parts of the musculature expose on most of the cut surfaces two or more cysts within an area the size of the palm of the hand.

A carcass in which infestation is limited to one dead and degenerated cyst may be passed for food after removal and condemnation of the cyst.

Carcasses of cattle showing a slight or moderate infestation, as determined by a careful examination of the heart, muscles of mastication, tongue, diaphragm and its pillars, and of portions of the carcass rendered visible by the process of dressing, may be passed for food after removal and condemnation of the cysts, with the surrounding tissues, provided the carcasses and parts, appropriately identified by retained tags, are held in cold storage for a period of not less than 6 days at a temperature not higher than 15° F. As an alternative to retention in cold storage, such carcasses and parts may be passed for sterilization.

Fats of carcasses passed for food or for sterilization under the above provisions may be passed for food provided they are melted at a temperature of not less than 140° F. The edible viscera, except the lungs and heart, of carcasses passed for food or for sterilization under the provisions of the above paragraphs may be passed for food without refrigeration or other process of sterilization provided they are found to be free from infestation upon final inspection. The intestines, weasands and bladders from beef carcasses affected with *Cysticercus bovis* which have been passed for food or for sterilization may be used for casings after they have been subjected to the usual methods of preparation and may be passed for such purpose upon completion of the final inspection.

The inspection for *Cysticercus bovis* may be omitted in the case of calves under six weeks old. The routine inspection of calves over six weeks old for *Cysticercus bovis* may be limited to a careful examination

of the surface of the heart and such surface of the body musculature as are rendered visible by the process of dressing.

Cysticercus ovis (the larval stage of a dog tapeworm, *Tænia ovis*) produces measles in sheep. The cysticerci, known as sheep measles, occur in the striated muscles, including the heart, and intermuscular connective tissue, and as degenerate cysts in the lungs, walls of the first and fourth stomachs and the kidneys. The cysts are from 3.5 to 9 mm. long by 2 to 4 mm. wide, and are surrounded by a thin external membrane containing a clear fluid. Degenerated cysts appear as cheesy or hard nodules.

Sheep measles was formerly confused with swine measles (*Cysticercus cellulosæ*). Ransom showed conclusively that the former will develop into a strobilate tapeworm, *Tænia ovis*, in the dog, and will not develop in man.

The following regulation covers the disposal of sheep carcasses infested with *Cysticercus ovis* (B. A. I. Order 211, Regulation 11):

In the case of sheep carcasses affected with tapeworm cysts located in the muscles (*Cysticercus ovis*, so-called sheep measles, not transmissible to man) the carcass may be passed after removal and condemnation of affected portions, provided, however, that if upon final inspection of sheep carcasses retained on account of measles the total number of cysts embedded in muscle or in immediate relation with muscular tissue, including the heart, exceeds five, this shall be taken to indicate that the cysts are so generally distributed and so numerous that their removal would be impracticable, and the entire carcass shall be condemned or passed for sterilization, according to the degree of infestation. If not to exceed five cysts are found upon final inspection, the carcass may be passed after removal and condemnation of the affected portions.

Trichinosis.—Trichinosis is due to *Trichinella spiralis* (*Trichina spiralis*), a round worm inhabiting the muscles (muscle trichina), which is, however, not a sexually mature individual, but the asexual larval stage of the intestinal trichina, whose habitat is in the intestines.

Generalities and Development.—The intestinal trichina is a round worm belonging to the family *Trichinellidæ*, according to Schneider, of the Holomyariæ. It exists in both sexes, and is found in the adult stage in the small intestines of man and various mammals. The males attain a length of 1.5 mm., are 0.04 mm. thick and possess two caudal appendages (sexual spicules). The females are 3 to 4 mm. long and 0.06 mm. thick.

The pointed anterior and the blunt posterior extremities of the body, as well as the so-called "cell body," a row of large nucleated cells which lie in the anterior half of the body around the esophagus, are characteristic of the morphology of the trichina.

The trichina occurs in carnivorous and omnivorous animals, of which the following deserve special mention: Domestic and wild hog, dog, rat, fox, badger, marten, polecat, bear, cat. It may be transmitted to a number of other mammals by feeding, but cannot be transmitted to birds or cold-blooded animals. Muscle trichinæ do not develop in birds, but intestinal trichinæ may occur in them.

The most common host of the trichina, no doubt, is the rat; these animals readily transmit the infestation to each other. Animals which prey on, or occasionally eat rats, may become infested from them (hog, dog, cat, bear, marten, polecat), and the trichinæ contained in their meat, can again reinfest the rats. Trichinæ may also be transmitted

through the ingestion of feces of animals which have eaten trichinous meat. The transmission, however, is not directly by way of intestinal trichinæ, but because the feces contained undigested trichinosed meat (Ostertag).

Development of the Trichinæ.—Upon the ingestion of meat containing trichinæ, the latter are freed through digestion of the surrounding capsules and develop to sexually mature worms in the intestinal tract. The males die shortly after impregnating the female and are digested or discharged with the feces, but the females penetrate into the glands of Lieberkühn of the intestinal mucous membrane with their anterior extremity and deposit their young. During the six to seven weeks of life each female gives birth to 1500 to 2000, according to Braun even 8000 to 10,000 larvæ of 0.1 mm. in length, which are carried into the blood by the intestinal lymph stream. The blood carries them to all parts of the body, and in this way they gain access to the striated muscular tissues, in which they locate exclusively, the heart excepted. Trichina larvæ in other tissues and organs of the body die. In the further development of trichina larvæ in the striated muscles they emerge from the capillaries partly by diapodesis, partly by boring through the wall, and enter the sarcolemma sheath. As early as the seventh to eighth day after ingestion of trichinosed meat, the first wandering larvæ may be found in the musculature. The larvæ which wander within the muscle sheath to the bony or tendinous insertions of the muscle fibers destroy the contractile contents of the muscle sheath, which lose their striation and assume first a homogeneous, then a granular appearance. Finally, the larvæ become quiescent and roll up spirally within the sarcolemma. This terminates the migration of the larvæ, which have attained a length of 1 mm., and three weeks after ingestion of trichinosed meat have become muscle trichinæ.

The characteristics of muscle trichina, which has no sexual apparatus, are the anterior pointed and the posterior blunt extremities the cell body and its situation within the muscle sheath. The encystment of the muscle trichina soon begins, forming a capsule of lemon-shaped form, whose longitudinal axis corresponds with that of the muscle fibers. The first signs of the capsules may be observed during the fifth week following infestation; nine to twelve weeks later fully developed capsules will be found everywhere. The capsule itself is structureless, homogeneous, shiny, possesses a double contour, and is transparent in the beginning. Fat cells form at the poles of the capsules within the muscle sheath, and at the end of three months lime salts also appear. The latter gradually encrust the entire capsule and sometimes the trichina itself. The calcification of the capsule may be complete at the ninth month, but it usually takes eighteen months.

Muscle trichinæ may remain active within the capsule for many years (they have been found alive for thirty-one years in man).

Historical.—The trichina was first named by Owen who gave a detailed account, in 1835, of a worm which had been found in the same year by Paget, of London, encysted in the musculature of man. The muscle trichina was found

in hogs by Leidy, of Philadelphia, in 1847. In 1850 Herbst, of Göttingen, made the first experiments in the transmission of trichina. He infected a badger with the encapsulated trichinæ of a dog, and with the meat from the badger, in turn, infected two dogs. The importance of trichina to man was recognized in 1860 by Zenker, of Dresden, who found sexually mature trichinæ in the intestines of a girl who had died from typhoid; he also found recent unencapsulated muscle trichinæ in the musculature. He was enabled to prove that the girl had eaten pork which had been found by him to be heavily infested with trichina. In view of this discovery, some of the best-known investigators studied the trichina, and the life cycle of the worm was established by Leuckart, Virchow, Fiedler, Haubner, etc. The biological study of the trichina received further attention later from Heitzmann, Cerfontaine, Geisse, Askanazy, Chatin, Graham, Stäubli, etc.

The great danger of trichina to man was demonstrated scientifically for the first time in the epidemics of trichinosis at Hettstedt (1863), where 160 persons became infested and 28 died, and at Hederleben (1865), where 337 cases occurred with 101 deaths. In the following years numerous observations of small and large epidemics were made in the most widely divergent portions of Central and North Germany.

The distribution of trichinæ in the musculature is not uniform. They are found in greatest numbers in the diaphragmatic pillars and the diaphragmatic muscles. Heitzmann explains this by the arrest of the embryos at the moment of muscular contraction, which causes a transitory contraction or narrowing of the capillary diameter. In view of the constant activity of the respiratory muscles, this heavy infestation of trichinæ is not surprising. Next in order of frequency of invasion are the tongue, laryngeal muscles, lumbar, masticatory, and abdominal muscles. Specimens for examination should, therefore, be taken from these muscles of the hog. If careful microscopic examination of the diaphragmatic pillar, diaphragmatic, laryngeal, and tongue muscles has failed to reveal trichinæ, it may be assumed that the remaining musculature does not harbor parasites; should isolated specimens occur in the remaining musculature, the ingestion of this meat is never followed by any deleterious results. Trichinæ do not occur in fat; sides of bacon may contain them should muscle tissue be adherent, especially the skin muscles.



FIG. 104.—Adult trichinæ: A, male; B, female. $\times 120$ diameters. (After Leuckart.)

The frequency of trichinosis in hogs is variable and does not give rise to any characteristic symptoms in these animals. By far the greater number of trichinosed hogs of Germany come from the eastern portion of the Empire. In the Kingdom of Prussia, 0.005 per cent of hogs examined in 1904 were found affected. The same ratio was obtained in the Kingdom of Saxony during 1901 to 1905, whereas in 1891 to 1900, 0.01 per cent of all slaughtered and inspected hogs showed trichinous infection. Trichinosis among hogs in Germany is, therefore, gradually decreasing. In Saxony it was found the hogs imported from southern Europe were more frequently infected than those at home. Pork from America has been found trichinous in 4 to 8 per cent of the cases, according to observations made in Germany. In the United States the percentage of trichinous hogs found by the trichina inspectors after examining about 8 million carcasses averaged about 2 per cent yearly. Recent investigations on the incidence of trichinæ in hogs in the United States showed that the frequency of these parasites in garbage-fed hogs is about 5 times that in grain-fed hogs. Thus, only 60 out of 6,622 diaphragms obtained from as many grain-fed hogs showed trichinæ (0.91 per cent), whereas 286 diaphragms out of 6,484 from as many garbage-fed hogs were found to be infested (4.41 per cent). The results

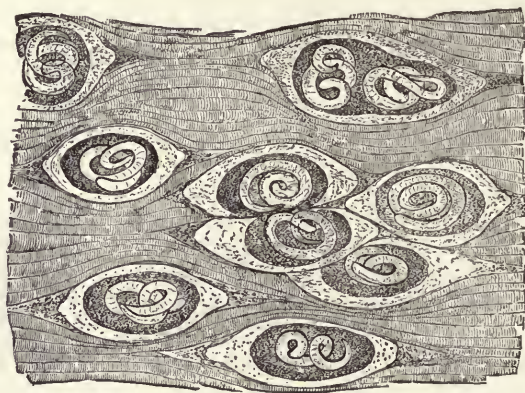

FIG. 105.—Encapsulated muscle trichinæ. $\times 60$ diameters. (After Leuckart.)

obtained showed, moreover, a far higher intensity of infestation in garbage-fed hogs than that in grain-fed hogs. Among 1177 dogs slaughtered in Chemnitz during 1897 to 1900, 13 (1.11 per cent) were found infested with trichinæ. In the entire Kingdom of Saxony, in 1906, among 3603 slaughtered dogs, 8 (0.222 per cent) were infested with trichinæ.

In order to discover the origin of infested hogs, the various states of Germany instituted a compulsory trichina inspection. Every infested animal is traced and reported accordingly to the central office, which in turn notifies the affected sections of the allied states of the presence of trichina in hogs coming from their district.

A careful microscopic examination is necessary in order to recognize trichina in the meat; a magnification of 30 diameters is best.

A careful examination for trichina in suckling pigs, wild hogs, dogs, and bears, according to the direction laid down, is also of importance, owing to the prevalence of trichina in man, of which Opalka has presented interesting tables.

Diluted acetic acid (1 : 30) may be added to preparations of indistinct, not entirely fresh, meat for the purpose of clearing it; diluted potassium hydrate solution may be added to salted meat or ham to aid swelling of the muscle fibers.

In the examination of pork the specimens should always be taken in hams, etc., from near the bones; that is, at the tendinous insertions of the muscles. Examination of sausage is naturally of doubtful value.

The following may be confounded with muscle trichinæ in their various stages of development: Calcareous concretions (see page 225), Miescher's bodies (see page 276), specific muscle degeneration of the hog (see page 223), and crystals of tyrosin (ham); their characteristics on careful examination will, however, prevent mistakes. Vinegar eels may accidentally gain access to the preparation, but these are easily recognized by their active serpentine movements. They are also almost twice as large as muscle trichinæ and will be found in the fluid which has been added, rarely between the muscle fibers. Worms, similar to embryos of *Metastrongylus* species (*Strongylus paradoxus*), have been found in preparations for inspection of trichina (Wallman, Georges, Tiemann). They may gain access as the result of cutting the lungs of the hog, and in this way get into the microscopic preparation.

In addition, trichina-like worms (so-called pseudotrichinæ) have also been found in the musculature of various animals (rat, rabbit, mouse, fowl, fish, mole). Under careful examination, these are unlikely to be mistaken for trichinæ. These round worms *never occur in the muscle sheaths, possess no cell body and taper at both ends*. In the case of capsule formation they will not be found of the peculiar structure of the trichina capsule, but of connective-tissue-like formation.

For details regarding pseudotrichinæ, see Johne's *Der Trichinenschauer*.

Judgment.—Trichinous meat is injurious to health, as its ingestion causes trichinosis, resulting fatally in about 5 per cent of the cases. The disease may occur epidemically when meat heavily infested with trichinæ is dispensed in numerous small portions at one time. It is to be presumed, however, that the trichinous meat has been eaten in the raw state, in an imperfectly cooked condition, or in the form of slightly smoked ham or sausages. The muscle trichinæ are not very resistant to the usual methods of preparation of meats. Temperatures of over 62° to 70° C. kill the parasites by coagulation of the albumen. Careful investigations have shown that trichinæ encysted in pork and other meat are killed when the meat is heated gradually to a temperature of 137° F. Salting or pickling of the meat will not kill the trichinæ in the surface layers in less than fourteen days, and those in the deeper tissues will require four to six weeks for their extermination. Hot smoke is effective, partly through the heat, partly through the cresols of the smoke, thus destroying the trichinæ; but the process is rather a slow one in large pieces of meat.

In decaying meat and under the influence of low temperatures (5° F.) the muscle trichinæ lose their vitality in twenty days. Wandering larvæ are harmless, and muscle trichinæ continue their development in another host only after they develop sexual parts and have attained a body length of 0.5 to 0.75 mm.

Trichinous meat of wild hogs, dogs, and bear is to be judged like that of domestic hogs, examination for trichinæ is absolutely essential before the meat is to be used for food.

As infested meat can easily be rendered harmless by the action of high degrees of temperature, there is no reason why trichinous meat should be withdrawn from the food supply of man. The judgment of the fat, in which trichinæ do not occur, will be more favorable even than that of the muscles. For reasons similar to those given under measles, it will be necessary to distinguish between slightly and heavily infested meat. Meat is considered heavily infested when microscopic examination of 6 preparations taken from the pillars of the diaphragm, the costal portion of the diaphragm, the laryngeal and tongue muscles (24 specimens in all) discloses trichinæ in 9 or more of the preparations. While the strongly trichinous muscle meat is to be considered unfit for use in every case, slightly trichinous meat, inclusive of the fat of the strongly trichinous hogs, may be considered fit, with certain restrictions.

Instructions have been issued in connection with Federal meat inspection for the purpose of avoiding any possible danger from the ingestion of trichinous meat (see page 181).

General Diseases Produced by Protozoa.—**SARCOSPORIDIOSIS.**—Of the sarcosporidia, which cause sarcosporidiosis, one genus inhabits the muscle fibers (*Miescheria*) and another is found in the connective tissue (*Balbiana*). Both are considered identical and are known as *Sarcocystis*.

1. **MIESCHER'S BODIES.**—Miescher's or psorospermial bodies, which, according to Blanchard, may be subdivided into the genera *Miescheria* and *Sarcocystis*, are found in the musculature of hogs, sheep, horses, cattle, goats, dogs, deer, antelope, rabbits, and chickens. They are composed of straight, faintly spindle-shaped structures 3 mm. long and 0.006 to 0.4 mm. wide, and lie within the contractile contents of the striated muscle fibers.

General Development.—Miescher's bodies are composed of a delicate enveloping membrane, sending delicate fasciculi into the interior. The latter is filled with spherical kidney- or sickle-shaped bodies (sporozoites, Rainey's bodies), which are probably without a surrounding sheath, but nucleated. The sporozoites may decompose and form a granular detritus; quite commonly calcification of the psorosperms occurs. In what manner and in what form these parasites gain access to the animal body is as little known as is their development in the animal body, which probably is of an embolic nature.

Lesions.—The sacs of Miescher (*Sarcocystis miescheriana*) occur in the striated muscles of the hog, but are found most frequently in the abdominal and diaphragmatic muscles. The large sacs, especially when calcified, may be seen macroscopically as light gray, pointed or tapering oblong dots in the dark musculature, but the smaller ones cannot be found without the aid of the microscope. They are peculiarly granulated structures within otherwise unchanged muscle fiber (Fig. 106). In the smaller sacs, and with a high magnification, the thoroughly preserved striation of the muscle fibers may be made out alongside of the parasite. After calcification has occurred the sac will appear as a more or less opaque, almost black structure macroscopic-

ally. Of the muscles of sheep, the abdominal and skin muscles are most frequently inhabited, and here very large Miescher's bodies (*Sarcocystis tenella*) obtain. Small microscopic sacs may occur in other muscles also. Not infrequently macroscopic Miescher's sacs (*Sarcocystis betrami*) are found in the neck and esophageal muscles of the horse. Miescher's bodies (*Sarcocystis blanchardi*) are uncommon in cattle in this country, and may be recognized by their milletseed to barley-seed size and yellowish-green appearance.

Miescher's bodies, when in the calcified state, may be confounded with the so-called calcareous concretions (lime deposits) (see page 225), and in the hog with calcified trichinæ (see page 275). In both cases the addition of acetic acid will remove the calcification, and the microscopic examination will reveal the substratum of the calcification.

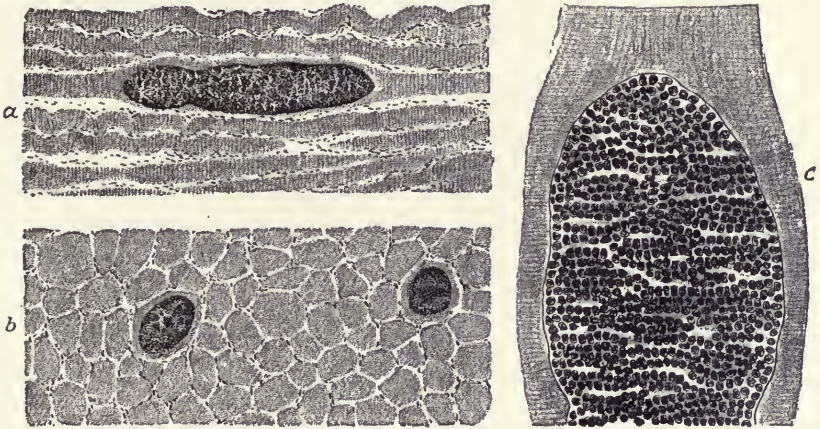

FIG. 106.—Sacs of Miescher from hog muscles: *a*, *b*, longitudinal and transverse sections of muscle. $\times 60$ diameters. *c*, longitudinal section of muscle. $\times 380$ diameters. (After Ziegler.)

Judgment.—The very fact that the presence of Miescher's sacs in the muscles does not irritate the latter, nor produce any symptoms of disease in the animals, would lead to the conclusion that they are harmless parasites. In a few instances sarcocystes (*S. hominis*) have been found in man, but their transmission through ingestion of meat has not been observed.

The report by Beel of a disagreeable sweetish odor of the meat in the case of a hog heavily infested with sarcosporidia has not been verified by other authors.

Regulations.—The utility of the meat infested with Miescher's bodies depends on the appearance of the meat and the intensity of the infestation.

If the meat does not show infestation macroscopically it may be used with impunity. If the calcified sacs are visible macroscopically and if they are present in large numbers in all the muscles, or if the meat (musculature) shows greenish or yellowish spots, or if it is edema-

tous, the entire carcass is to be condemned. If the changes are confined to certain muscles, as in sheep and cattle, these muscles are to be condemned.

2. BALBIANIDÆ.—The balbianidæ are designated as psorospermial pouches as compared with the psorospermic bodies of Miescher. They occur in the esophagus of sheep, goats, horses, cattle, buffaloes, and deer, often in large numbers. They are found more rarely in the tongue, laryngeal, thoracic, abdominal, and eye muscles and in the heart. On account of their size, Railliet named them *Balbiania gigantea* (*Sarcocystis gigantea*). They are not considered identical with *Sarcocystis*.

Lesions.—The intermuscular connective tissue of the esophagus contains milletseed to hazelnut-sized yellowish-white cysts, with suppurative contents, composed mainly of sporozoites (Fig. 107).

Judgment.—On account of their objectionable consistence all muscles inhabited by Balbianidæ are to be condemned.

HEMOSPORIDIOSIS.—1. PIROPLASMOSIS.—Piroplasmoses are diseases of the blood occasioned by protozoa of the genus *Piroplasma* or *Pyrosoma*. The transmission of these parasites is effected through the medium of ticks (in Europe, *Ixodes reduvius* [*I. ricinus*], in other places, *Boöphilus* [*Margaropus*] species).

Piroplasmosis of Cattle.—This epizootic or isolated, sometimes acute, but more often chronic, disease is produced by the *Piroplasma bigeminum* (*Pyrosoma bigeminum*, Smith and Kilborne; *Apiosoma bigeminum*, Wandolleck Peron; *Ixidioplasma bigeminum*, Schmidt; *Babesia bovis*).

Pathogenesis.—The parasites on gaining access to the blood by transmission through ticks, occasion destruction of the red blood corpuscles of cattle.

This results in hemoglobinemia and in severe cases in hemoglobinuria and icterus. The cell detritus causes emboli, hemorrhages and parenchymatous nephritis. After considerable increase in the number of parasites fever sets in. In some cases death from asthenia occurs as the result of the disturbances of nutrition and rapid decrease of the erythrocytes.

Symptoms—Lesions.—In the living animals there may be present symptoms of fatigue, emaciation, fever of 40° to 42° C., disturbed rumination, and in the beginning irritation and even attacks of madness may be observed. There is retention of fecal matter and colic; later thin stools, with mixture of mucus and blood. The milk secretion is diminished. Afterward there follow muscular tremors, uncertain gait, swelling of superficial lymph glands, lacrimation, reddening of the mucous membranes, which subsequently become pale and icteric. The urine at first is reddish and later turns darker and darker. The



FIG. 107.—Esophagus of sheep with balbianidæ (*Sarcocystis*).

disease is fatal in four or five days in unfavorable cases. In the lighter forms improvement occurs about the middle of the first week, the fever diminishes, but convalescence is, as a rule, very slow.

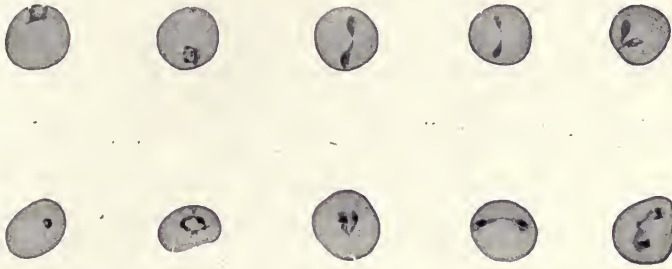

FIG. 108.—*Piroplasma bigeminum*. Typical ring and pear-shaped forms. The upper row stained with alkaline methylene blue; the lower according to Romanowsky. (After Kossel and Weber, from Hutyra and Marek.)

In the slaughtered animal are found, according to the stage of the disease, catarrhal inflammation of the stomach and intestines with small hemorrhages and erosions; hypertrophy of the liver, the latter being flabby, lusterless, faintly reddish-brown and permeated by yellowish bands and spots; the spleen is considerably enlarged, the pulp highly injected and softened; urinary bladder is filled with light to dark red urine, and the mucous membrane shows numerous hemorrhages; there is cloudy swelling of the kidneys; hemorrhages in the serous membranes; the blood is light red and thin; icterus is present in some cases.

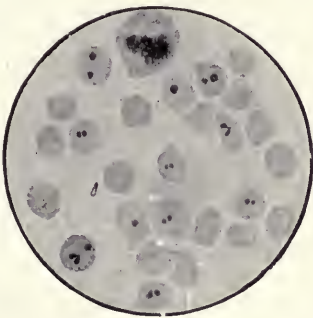

FIG. 109. — *Piroplasma bigeminum*. Round and pear-shaped forms. Cattle blood. Stained with methylene blue. (After Hutyra and Marek.)

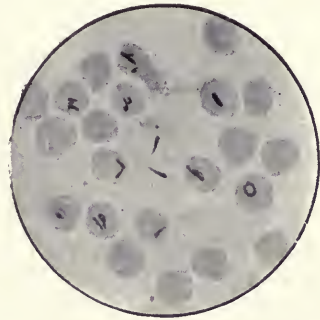

FIG. 110. — *Piroplasma bigeminum*. Rod-shaped forms. Cattle blood. Stained according to Laveran. (After Hutyra and Marek.)

The recognition of the disease is facilitated during life by finding the parasites on microscopic examination of the blood.

Dried cover-glass preparations are fixed in absolute alcohol, or in a mixture of equal parts of alcohol and ether, and stained with a 1 per cent aqueous solution of methylene blue. The preparations may be fixed in absolute methyl alcohol and then stained with Giemsa's stain.

In the differential diagnosis anthrax, hemorrhagic septicemia and hematuria must be considered; the symptoms in these disease, as well as their bacteriological findings, differ in important features from those of piroplasmosis.

Judgment.—Carcasses affected with this disease should be condemned, according to B. A. I. Order 211, Regulation 11, Section 6. In Germany the judgment depends on the grade of the disease and on the fact that this affection is not transmissible to man by ingestion of the meat. In severe cases the meat is to be condemned; in lighter forms the question of inferior value is considered.

Of the more important piroplasmoses should be mentioned:

Splenetic fever of cattle, which formerly occasioned heavy losses in the United States, but is gradually being controlled by tick eradication.

Diseases of cattle similar in their intensity and rate of mortality to splenetic fever occur in German East Africa, Hungary (forest disease), Roumania (epizoötic hemoglobinuria), Italy (malaria of cattle), Sardinia (hematuria), Finland, Turkey, Argentine Republic (tristeza), Australia (tick fever), South Africa (red water or coast fever).

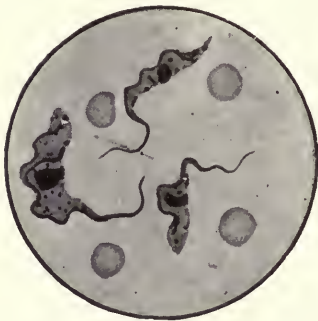

FIG. 111.—*Trypanosoma equinum* s. *elmassiani*. Guinea-pig blood. (After Hutyra and Marek.)

Infectious hemoglobinuria of cattle (enzoötic bloody urine) occurs sporadically in Germany as well as enzoöticly. It differs from splenetic fever by a longer period of incubation and a milder course.

The South African *horse malaria* (Geglielmi, Rickmann), which is frequently

associated with a separate and distinct enzoötic disease of horses described by Theiler.

Carceag or *parasitic icterohematuria* of sheep in Roumania, which also occurs in other countries (malarial catarrhal fever).

Malignant jaundice of dogs in France, Hungary, Italy, Africa and India (malignant malarial fever, malignant protozoan jaundice).

2. TRYPANOSOMIASIS.—(a) Surra and tsetse-fly disease, or nagana of cattle, camels, horses, and elephants in Africa and India, and mal de caderas of horses in South America, are caused by flagellate infusoria (trypanosomes), and are without importance in meat inspection.

(b) The investigations of Schneider and Buffard proved that dourine of horses must also be classified as a protozoan (trypanosoma) disease and the results of these investigators were confirmed by Nocard. At the present time this disease is of importance only from a sanitary police standpoint.

PLATE IV

FIG. 1

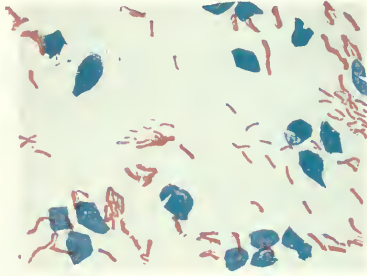

Tubercle Bacilli. Fuchsin and Methylene Blue Staining.
× 400. (After Ziegler.)

FIG. 2

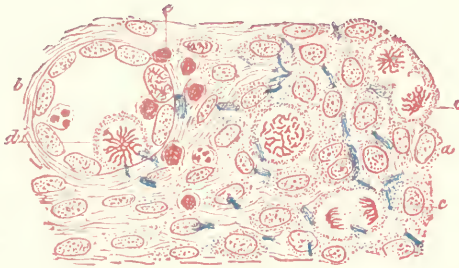

Changes in the Tissue Produced by a Fresh Invasion of
Tubercle Bacilli. (After Baumgarten.)

a, proliferating connective tissue; *b*, cross-section of bloodvessel, *c*, karyomitosis in connective tissue; *d*, karyomitosis of an endothelial cell of a vessel; *e*, migrated leukocytes. × 350.

FIG. 3

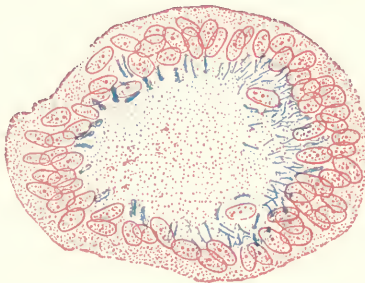

Giant Cell Containing Bacilli from a Tubercle with Necrotic
Centre. × 350. (After Ziegler.)

CHAPTER VIII.

INFECTIOUS DISEASES IN FOOD-PRODUCING ANIMALS.

INFECTIOUS DISEASES OF FOOD ANIMALS TRANSMISSIBLE TO MAN.

TUBERCULOSIS.

TUBERCULOSIS occurs among all food-producing animals, and is the disease with which the veterinary inspector is most occupied. Etiologically, it is identical with tuberculosis of man, and is caused by the tubercle bacillus discovered by Koch in 1882. The disease in animals runs a chronic course.

Pathogenesis.—The development of the disease requires a certain predisposition in the body, which affords favorable colonizing conditions for the entering tubercle bacilli. The disease may, according to the mode of infection, become established in the following manner:

1. Through the respiratory tract (inhalation tuberculosis).
2. Through the digestive tract (ingestion tuberculosis).
3. Through the female genital organs (genital infection, generative tuberculosis).
4. Through the skin (cutaneous tuberculosis).
5. From the umbilical vein during intra-uterine development of the fetus (fetal tuberculosis, congenital tuberculosis).

Although in accordance with these modes of infection the primary lesion of the disease is expected to be present in the respective organs, nevertheless, it frequently happens that the tubercle bacilli will not produce an affection at the seat of entrance, but will be disseminated throughout the body and only cause lesions remote from the place of entry.

The fact that lymph glands offer especially favorable conditions for the colonization and development of tubercle bacilli is of importance in meat inspection, and they must therefore be regarded as favorite locations for tuberculosis.

As soon as tubercle bacilli find conditions favorable for development in any tissue of the body, they multiply and cause a reaction of that tissue. This is manifested as a round-cell proliferation, which appears either in the form of an isolated tubercle or as a tuberculous infiltration. The isolated tubercle in its developed condition forms a gray, transparent, non-vascular cellular nodule of the size of a milletseed, which encloses tubercle bacilli. Among these cells there develop, as a rule, multinuclear giant cells, which are centrally located. In the case of tuberculous infiltration, principally exudative processes of a

fibrous nature appear. Retrogressive processes soon take place from the center of the tubercle, as a result of which the latter becomes clouded and changes to a grayish or yellowish-white color; the tubercle becomes caseous (coagulation necrosis with secondary granular disintegration). In the tuberculous infiltration the retrogressive processes consist of a more purely coagulation necrosis, *e. g.*, hyaline degeneration. If the periphery of the tubercle does not disintegrate it will gradually become fibrous, and a caseo-fibrous tubercle develops. The formation of entirely fibrous tubercles in food animals, except in the horse, is rare. These processes are followed by a further retrogressive metamorphosis, that of calcification of the tubercle, which is of special importance in food animals. Suppuration of the tubercle and the formation of abscesses or cavities may result from a simultaneous infection with pus-forming organisms, or, as Bongert has proved in case of cattle, it may result when tubercle bacilli die gradually in great numbers. Abscesses and cavities occur comparatively rarely in food animals. Ulcers, however, may be formed as a result of the caseation of tubercles located on the surface of mucous membranes.

Notwithstanding the degenerative processes within the tubercle, the latter may increase continually in size on the outside and thus develop into larger nodules and tubercles. The confluence of small nodules may lead to the formation of conglomerates or to new formations of a fibrous character.

Methods of Dissemination.—The methods of dissemination of tuberculosis and its metastatic formations are of special importance in the judgment of tuberculous animals.

1. **Dissemination by the Lymphatic System.**—Lymphatic miliary tubercles are formed in the neighborhood of the primary tubercle and the lymph glands involved become diseased. By means of the further dissemination of the tubercle bacilli by the lymphatic fluid, other lymphatic glands lying nearer the heart and finally the lymph of the thoracic duct and the blood itself may become infected.

As the lymphatic fluid flows from the inside of the organs toward their surface (*e. g.*, toward the corresponding lymphatic glands), it becomes self-evident that an infection of the organ cannot be in an inward direction from the surface. Should the bacilli enter the lymph of the thoracic or abdominal cavities, then not only the serous membrane may become infected (serous tuberculosis), but the bacilli may also enter the adjoining cavity through the lymph spaces of the diaphragm.

2. **Dissemination by the Blood.**—This may take place after the entry of tubercle bacilli into the blood in the way described, or also after a direct penetration of tubercle bacilli into the blood stream, when the walls of the veins become diseased or destroyed by caseation of tuberculous foci. As a result of the dissemination of the tubercle bacilli by means of the blood a hematogenous miliary tuberculosis (embolic tuberculosis) develops at the point where the bacilli are deposited and multiply. The bacilli which have come into the venous blood may be

PLATE V



Section of a Tuberculous Udder of a Cow with
Adjacent Lymph Glands.

retained in the lungs, and if their penetration occurred at the basic region of the portal vein they may be retained in the liver, which is by no means unusual in a mild infection of the blood. When the venous blood is flooded with greater numbers of tubercle bacilli, or when the latter enter the veins of the lungs, they pass into the arterial blood of the large circulatory system and thereby into the whole body. This process of dissemination is known as "generalized tuberculosis."

In the dissemination of tubercle bacilli through the large circulatory system the placenta may also become infected, and from there infection may spread to the fetus.

3. Dissemination of Tubercle Bacilli on the Surface of Mucous Membrane by Means of Secretions.—This process may not only transmit a further infection of the organs belonging to the affected apparatus (larynx, trachea, bronchi, and other parts of the lungs; lymph glands of the palate, small and large intestines), but it may also lead to the infection of another organ or tract. Thus infection of the digestive apparatus may result in consequence of pulmonary tuberculosis if the tuberculous excretions of the respiratory mucous membranes are swallowed. To the first-mentioned form of dissemination belongs the spreading of tubercle bacilli from the kidneys by means of the urine to the pelvis of the kidneys, ureters, bladder or to the urethra.

Forms of Tuberculosis.—Meat inspection must distinguish between two forms of tuberculosis in accordance with the aforesaid methods of dissemination.

Localized Tuberculosis.—This term designates the following conditions: (a) The infection of a single part of the body with the corresponding lymph glands. This form of tuberculosis is most frequent in food-producing animals on account of the small number of bacilli in the tuberculous processes.

(b) Infection of several parts of the body without the concurrence of the large circulatory system. In this case the tuberculous processes have originated from a primary infection by continuous development through dissemination of the bacilli by means of the lymphatic or secretive juices, and, as far as the blood enters into consideration, through the portal circulation.

Generalized Tuberculosis.—This form exists when a part of the body is affected to which the tubercle bacilli can be carried by the arterial blood only (*e. g.*, spleen, kidneys, suprarenal glands, testicles, ovaries, udder (Plate V), bones, muscles, lymph glands, central nervous system, eyes, etc.). The number and consistence of tuberculous processes which develop in generalized cases depend upon the degree of prevalence of bacilli in the blood and upon the filterable action of the liver and lungs. When this action is very marked many bacilli are retained by these organs, and both lungs and liver are found to be everywhere uniformly permeated with tuberculous nodules of a similar stage of development (hematogenous miliary tuberculosis). Acute miliary tuberculosis may be defined as the dissemination of tubercle bacilli by means of blood shortly preceding the death, which results

in the production in most of the organs of a countless number of eruptions of only slightly degenerated tubercles of uniform size. When venous blood is poor in bacilli only a few single tubercles will develop in the liver and lungs. The presence of numerous embolic tubercles in the lungs is of marked diagnostic significance, as it positively indicates infection of the blood with numerous tubercle bacilli, and points to the suspicion of generalized tuberculosis.

Generalized tuberculosis is infrequent among food animals, and does not lead to uniform development of tubercles in all parts of the body. The arrangement of the blood-vessels in the various organs and the extent of circulation of blood in the organs are essentially decisive. Generalized tuberculosis, in addition to the lesions of the lungs and liver, is usually found in the spleen and kidneys, in the various body lymph glands, in the bones and joints and in the udder and uterus. Tuberculosis of the uterus, however, does not indicate a generalized condition in every instance, *e. g.*, passing of tubercle bacilli from the abdominal cavity through the Fallopian tubes into the uterus. The muscles proper are so very rarely affected that by many they are considered as almost immune to tuberculosis. Tubercle bacilli which enter the circulatory system but are not deposited in any of the organs die in from four to six days, as was established by Nocard and others.

Prevalence of Tuberculosis in Food Animals.—From the figures and estimates that are available it seems fair to conclude that not more than 0.4 per cent of the dairy cows in the United States are tuberculous and that tuberculosis exists in about 0.05 per cent of the beef cattle. Tuberculosis among hogs varies considerably, being most prevalent in the north-central states and is largely of the avian type. It has been estimated that the disease exists in about 9 per cent of the hogs in the United States. Sheep, on the other hand, are almost immune as only 18 carcasses were found infected in 1938 out of almost 18,000,000 sheep inspected by the Federal Meat Inspection Service. All the counties in the United States are now modified-accredited except 5 counties in California.

The statement made by Ostertag, that at least 25 per cent of the older cattle in Germany are tuberculous, is conservative.

According to meat-inspection statistics of the German Empire, the percentage of tuberculosis in animals slaughtered in 1918 was as follows:

Cattle, 15.01 per cent; calves, 0.42; sheep, 0.2; goats, 0.69; hogs, 1.58; horses, 0.15; dogs, 0.85.

Tuberculosis in cattle was most prevalent in the Kingdom of Saxony with 34.48 per cent, Schaumburg-Lippe being lowest, with 5.73 per cent.

Tuberculosis in calves was most prevalent in Pomerania (Prussia), with 0.79 per cent, while Alsace-Lorraine was lowest, with 0.02 per cent.

The Kingdom of Saxony also had the highest percentage of tuberculosis in hogs, with 5.13 per cent, Hohenzollern being lowest, with 0.3 per cent.

Symptoms and Lesions.—The clinical appearance of tuberculosis can be only briefly described here. The symptoms become of diagnostic importance only when they are conspicuous, when it may be assumed that the affection has reached an advanced stage. Even then they are not trustworthy. Highly suspicious symptoms in all food animals are hard, nodular swellings of the lymph glands, udder or testicles, painless exostoses and swellings of joints, which cannot be attributed to other causes, coughing and difficulty in breathing, with very apparent

loss of flesh. Hard, tight skin and a rough coat of hair, chronic bloating, hardening of the udder and dry rattling may be additional indications in cattle. The symptoms which arouse suspicion in hogs—among which nutritive disturbances are rare—are principally exostosis and curvature of the spine without rachitic symptoms.

Other methods for diagnosing tuberculosis in the live animal (antemortem inspection) cannot be given in detail here. The lesions present in the slaughtered animal differ in the various species.

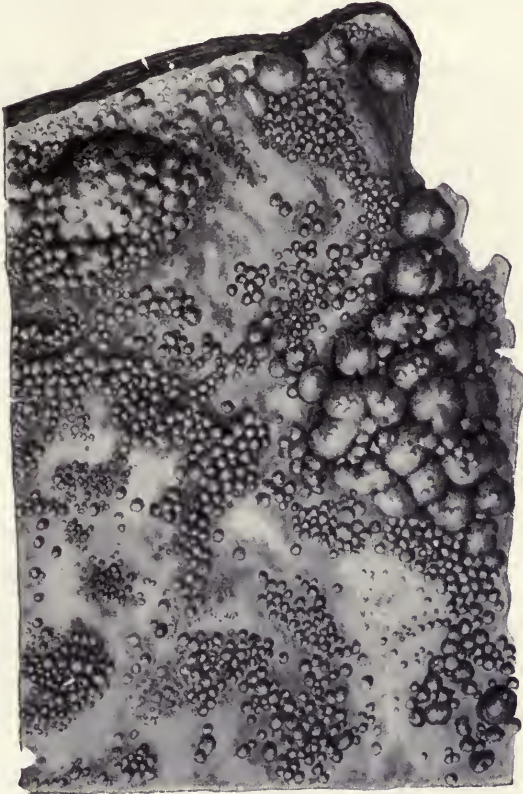

FIG. 112.—Small nodular tubercles from the pleura of a cow.

In cattle tuberculosis occurs principally in two different forms, which, however, are often combined—namely, tuberculosis of the serous membranes (pearly disease) and tuberculosis of the organs. The former begins with reddish, soft, granulation-like proliferations, from which large nodules of various sizes are developed (Figs. 112 and 113), and which, either when isolated or confluent, show a tendency to become calcified early. Occasionally, enormous thick fibrous or calcified tuberculous deposits are formed on the commonly diseased pleura and pericardium. Peritoneal tuberculosis is somewhat less common.

Concerning tuberculosis of the organs and mucous membranes, the respiratory apparatus is most often the primary seat of the affection (tuberculous bronchial pneumonia); next comes the digestive tract, while the female genital organs are very seldom affected. In the lungs there are now and then cavities.

All parts of the body may be secondarily infected. The manifestation of the disease is influenced by the nature and the mode of infection as well as by the anatomical structure of the various organs. Lymph gland tuberculosis (Plate III, Fig. 2) is often conspicuous for its enormous development. For tuberculosis of the udder, compare Plate V.

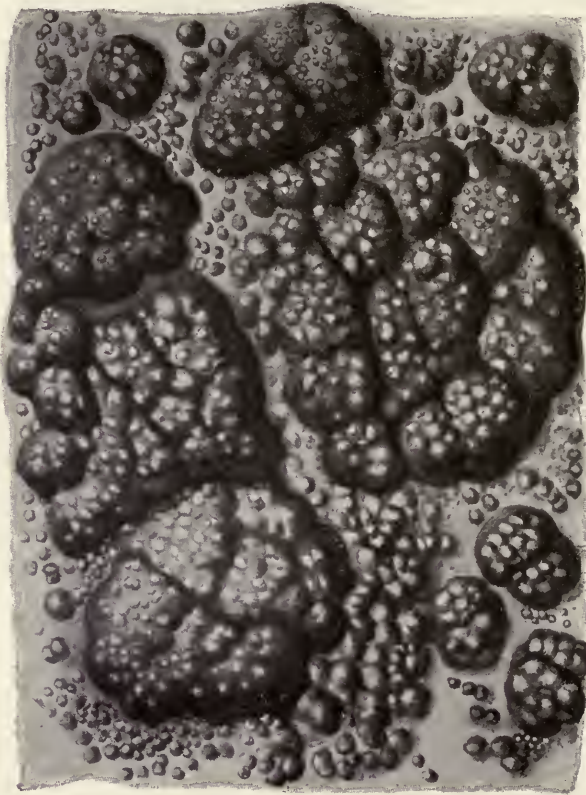

FIG. 113.—Large nodular tubercles from the pleura of a cow.

Tuberculous processes in cattle tend generally toward dry caseation and calcification. Tuberculosis of any organ in which the lesions are softened may develop into generalized tuberculosis; the latter is characterized in young animals in the first place by an affection of the spleen; in older animals by involvement of the kidneys. Tuberculosis of the bones is not very common; on the other hands, it is not uncommon for the body lymph glands to become diseased without accompaniment of a similar affection in the spleen and kidneys.

Corresponding to the transmission of the disease by the placenta, calves not infrequently manifest embolic tuberculosis of the various organs; first of all, in the liver, portal glands, lungs, posterior mediastinum, spleen, and kidneys, but the disease may also result and spread by infection from the digestive tract. Generalization occurs in a majority of cases.

Tuberculosis, although comparatively seldom found in sheep, presents in a general way the conditions and appearance of tuberculosis in cattle. Lesions of the serous membranes occur also, although they are not so common as in cattle. Calcification takes place at a comparatively early period.

This disease appears also in a similar form in goats, in which pearly disease and lesions in the lungs of a nature similar to those found in human phthisis (cavity formation) have been observed. Generalized tuberculosis is not uncommon among sheep and goats in Germany, but is extremely rare among these species in the United States.

In hogs, tuberculous affections occur most frequently in the digestive tract from which secondary infection of the various organs takes place, especially in the liver and lungs. Very often a generalized tuberculosis results, which is characterized by tuberculosis of the spleen in the majority of cases. Primary respiratory tuberculosis is less common than in cattle, while lesions of the serous membranes are even more rare. Calcification in the tuberculous foci begins at an early period. In generalized tuberculosis the lymph glands of the muscles and bones are often affected. Junack has described "tuberculosis without retrogressive alterations in swine." In one case in which a hog became so diseased, the condition resembled sarcomatosis.

Tuberculosis in the horse, while very infrequently observed, resembles tuberculosis in cattle, but does not possess a tendency to calcify; it does, however, tend to soften at the center. The formation of small fibrous tubercles is not uncommon. The lymph glands of the affected organs become considerably hyperplastic. Infection spreads principally from the lungs.

The general appearance of tuberculosis in the dog suggests the conditions found in the goat, but the tuberculous lesions in the lungs and lymph glands are of a more grayish-white color, similar in consistence to bone-marrow. Instead of caseation there is generation into grayish-white decomposing masses which resemble whey.

Postmortem Examination.—In carrying out the general method of examination at the postmortem inspection for tuberculosis, the following directions should be observed:

1. All lymph glands located at the portal of entry of the infection must be carefully incised; first of all the submaxillary and retropharyngeal lymph glands, tonsils, bronchial, mediastinal, mesenteric, and portal lymph glands.

2. On cutting into plainly visible seats of tuberculous infection, cavities should be avoided, if possible, owing to the dissemination of tuberculous material. Contamination of the meat with tuberculous

material must also be carefully guarded against. Soiled knives must be used only after boiling in a 2 per cent solution of soda.

3. In an animal which is found to be tuberculous the parts which are least often affected (lymph glands of the muscle, spleen, kidneys, udder, bones) should be examined first. Von Stroh records some interesting studies concerning the prevalence of tuberculosis of the lymph glands of the muscles.

Identification of the common forms of tuberculosis is not difficult for the inspector when once he is familiar with the manifold variations in the form of development of tuberculous processes and their metamorphosis. The lymph glands, as has repeatedly been emphasized, form a point of predilection for the development of tubercle bacilli, and the specific condition of the lymph glands is, therefore, of special importance for diagnosis (Plate III, Fig. 2). The condition of the lymphatic glands also verifies the diagnosis of doubtful affections of organs, since it may generally be considered that at least one of the corresponding glands will be typically affected in tuberculosis of the organs.

It need not be emphasized that the characteristic conditions of development and structure of tuberculous granulations from the most diminutive transparent grayish nodules, which at first become clouded at the center, after which they degenerate, together with the tendency to spread to the surrounding tissues by the formation of secondary nodules, are also indications worthy of cognizance. Ostertag recommends a microscopic examination (at about 40 diameters) of a crushed sample in order to determine with certainty the character of doubtful nodules. By this method the round or elongated giant cells can be plainly seen; these, as it is well known, are especially well developed in the tubercles of domestic animals. This method is also said to be well adapted for the examination of lymph glands for tuberculous foci, which cannot be determined macroscopically; they appear conspicuous from the surrounding normal lymph-gland tissue by disclosing round, colony-like, cloudy spots, with giant cells in the center and epithelioid cells around the outside.

It is self-evident that the demonstration of the presence of tubercle bacilli also serves to make the diagnosis positive, although an effort to determine their presence may result in failure even in genuine tuberculosis. It has been experimentally determined that in strongly caseated or calcified foci attempts to find bacilli often fail, especially in tuberculosis of swine. Such foci are, however, infectious, which can be proved by animal experiment. This, however, cannot be utilized for practical meat inspection on account of the delay in the decision which it would cause.

Differential Diagnosis.—The following-named conditions may be mistaken for tuberculous lesions:

1. Degenerated echinococci and measles (pp. 262 and 265).
2. Actinomycotic processes (p. 296).
3. Pentastome colonies in the lymph glands (p. 260).

4. Strongyle nodules in the lung of sheep (p. 250).
5. Lesions of hog cholera (p. 327).
6. Brucellosis (p. 228).

The characteristic indications of these diseases are sufficiently discussed under their respective heads, and when compared with the characteristic pathological peculiarities of tuberculosis they assure definite results in diagnosis, particularly as the latter is, in addition, based on the appearance of the lymph glands and the result of a microscopic examination.

Virulence of the Tissues of Tuberculous Animals.—In testing the question as to the extent to which tuberculous changes in food animals may become dangerous to human health as a result of their utilization as a food, it is impossible to avoid the premise that the tubercle bacillus of animals is identical with the bacillus which causes human tuberculosis. As tubercle bacilli entering the digestive tract of man are apt to produce tuberculosis, and also since virulent tubercle bacilli are found in the tuberculous part of food animals, it follows that all organs and parts of carcasses which are tuberculous must be regarded as infectious and dangerous to human health. Animals in which only the lymph glands are diseased belong in this category, as it is very possible that small, virulent tuberculous foci in the earliest stage of development have been overlooked at the macroscopic examination of the parenchyma of the organs. This fact makes it self-evident that tuberculous organs must be considered as totally unwholesome, even when only a few scattered lesions may apparently occur therein.

In regard to the virulence of the meat, *e. g.*, the striated muscles, it must be remembered that the musculature is very infrequently the seat of tuberculous processes that, as a rule, tubercle bacilli are carried to the muscles by the blood only, that they occur in the blood rarely, and then they remain in the circulation only for a short period of time.

Numerous experiments in feeding and inoculation have been conducted on animals to test the virulence of tuberculous meat, but, as has already been pointed out by Ostertag, the dissemination or extent and special character of the tuberculous affection in the animal, from which the sample of muscle was taken were entirely disregarded. Ostertag summarizes the results of these experiments by saying that "muscle or juice of muscle from tuberculous animals does not, as a rule, contain any or not sufficient bacilli to produce tuberculosis in experimental animals." The meat is infectious only in the most advanced stage of tuberculosis, and when suppurative softening of the tuberculous lesions is present. In connection with this it must also be recognized that, although the susceptibility of man to tuberculosis is assumed to be the same as that of experimental animals, yet the number of bacilli which will produce tuberculosis on intraperitoneal inoculation is not sufficient to produce it by their introduction into the digestive tract, and that, therefore, a positive result from inoculation does not imply that the meat is unwholesome for food. Even the investigations along this line by Hoefnagel, Westenhoeffer and Swierstra, in which

the condition of the tuberculous animal, the extent of the affection and the nature of the tuberculous processes were carefully taken into consideration, have corroborated Ostertag's view.

The results of the experiments regarding the blood and the muscle juice from tuberculous animals should be considered from the same standpoint.

Notwithstanding all this, it must be remembered that, from a meat-inspection standpoint muscle is not the only form of meat which must be considered, and that the term "meat" does not include the striated musculature only. It also includes other constituents of meat, such as the lymph glands and bones which are not uncommonly affected by tuberculosis when the disease has become generalized in the body. Precaution is therefore necessary in judging generalized tuberculosis.

In the utilization of meat from tuberculous animals, the fact that the tubercle bacilli possess only a small degree of resistance to high temperature is of great importance to national economy. According to Bang, 85° C. for a period of ten minutes will suffice to kill tubercle bacilli, while Yersin and Forster give 70° to 75° C. for ten minutes as sufficient. On this is based the utilization of the meat of tuberculous animals after cooking. Tubercle bacilli are very resistant to pickling and to smoking and pickling.

Judgment.—In the judgment of tuberculous lesions of food animals by the veterinary inspector in connection with their harmfulness to man, the points to be considered are the extent of the affection and stage of development, the age and nature of the tuberculous changes and the nutritive condition of the animal.

In general a poor nutritive condition, especially extreme emaciation, will influence the judgment unfavorably.

The same is also true regarding the age of the tuberculous lesions when fresh disease processes exist, and especially when the latter are contiguous to the old infections. A fresh "blood infection" (fresh generalized condition, acute miliary tuberculosis in the most restricted sense) is present only when the spleen or the lymph glands are swollen or when very small tubercles, not over the size of a milletseed, which have been disseminated through the large circulatory system, are present. Fresh blood infection, which, as a rule, is seldom found in food animals, demands careful examination and consideration.

Precaution is recommended owing to the nature of tuberculous materials in the soft tuberculous processes (cavities and purulent cheesy abscesses), as a generalized condition is frequently associated with them. In regard to the extension of tuberculosis, the forms mentioned on page 283 should be clearly distinguished.

An organ must be regarded as tuberculous even when only the corresponding lymph glands of that organ show tuberculous changes; a similar position must be taken with regard to pieces of meat which have not been shown to be free from tuberculosis by careful inspection.

In regard to tuberculosis of individual organs, the rule is that the whole organ should be always condemned when its corresponding glands show tuberculous changes.

When the mesenteric lymph glands are affected a distinction must be made between those of the small and large intestines and the respective intestines to which the affected group of lymph glands belong must be condemned. The mesentery with the diseased glands may be permitted to be utilized for technical purposes after it has been thoroughly denatured.

When the submaxillary or retropharyngeal lymph glands are diseased they must be removed, together with the surrounding affected parts, if any. Frequently the lesions are localized in these lymph glands, which become infected almost exclusively from the mucous membranes of the mouth, nose, and pharyngeal orifice.

Relative to the judgment of a tuberculous "quarter," that part of the body is considered infected which corresponds to the region drained by the diseased body lymph glands. In case of tuberculosis of the hock or stifle of old cattle where the bone lesions are a direct extension from adjacent infected tissue or from a local infection which has taken place through the skin from infected feces, the altered bones, glands and surrounding tissues only need be condemned. The judgment of the remaining parts of the carcass should naturally depend on the presence of other lesions. When tuberculosis of the bones is suspected, especially in hogs, it becomes necessary to split the bones before final judgment is made.

In removing tuberculous parts, especially serous membranes, attention is called to the necessity of removing the associated lymph glands and the other parts adjoining them. In order to remove satisfactorily the small lymph glands to which access is difficult, it is advisable to remove the surrounding parts of meat and bone with them. The veterinary inspector must do this himself or see that it is done under his immediate supervision. In all this work care must be taken not to contaminate sound meat with tuberculous material; also, special attention should be given to changing knives, saws, etc., which are soiled with tuberculous material.

Veal from calves which have been vaccinated with protective tuberculosis vaccine (for example, Bovovaccine and Tauruman) contains virulent tubercle bacilli for several months after the inoculation; owing to this fact, the use of such meat should be permitted only after sterilization.

In comparing the regulations governing the Federal meat inspection of the United States with those of other countries, it appears that in the disposition of tuberculous carcasses the regulations are stricter in this country in the condemnation of carcasses from the extent of the lesions. The difference of judgment, however, is largely due to the fact that the Freibank system has not been developed here as it has been in Europe and consequently the disposition for sterilization is greatly limited by the prevailing conditions. The term "conditionally passed meat" or "second grade" meat does not appeal strongly to the American public, and considerable educational work will be required before a reasonable demand can be created for such meats.

The following principles are declared for guidance in passing on carcasses affected with tuberculosis.

Principle A.—No meat should be used for food if it contains tubercle bacilli, of if there is a reasonable possibility that it may contain tubercle bacilli, or if it is impregnated with toxic substance of tuberculosis or associated septic infections.

Principle B.—Meat should not be destroyed if the lesions are localized and not numerous, if there is no evidence of distribution of tubercle bacilli through the blood or by other means to the muscles or to parts that may be eaten with the muscles, and if the animal is well nourished and in good condition, since in this case there is no proof, or even reason to suspect, that the flesh is unwholesome.

Principle C.—Evidences of generalized tuberculosis are to be sought in such distribution and number of tuberculous lesions as can be explained only upon the supposition of the entrance of tubercle bacilli in considerable number into the systemic circulation. Significant of such generalization is the presence of numerous uniformly distributed tubercles throughout both lungs, also tubercles in the spleen, kidneys, bones, joints, and sexual glands, and in the lymph glands connected with these organs and parts, or in the splenic, renal prescapular, popliteal, and inguinal glands, when several of these organs and parts are coincidentally affected.

Principle D.—Localized tuberculosis is tuberculosis limited to a single or several parts or organs of the body without evidence of recent invasion of numerous bacilli into the systemic circulation.

The meat of animals affected with tuberculosis shall be disposed of as follows:

Rule A.—The entire carcass shall be condemned if any of the following conditions occur:

(a) When it was observed before the animal was killed that it was suffering with fever.

(b) When there is a tuberculous or other cachexia, as shown by anemia and emaciation.

(c) When the lesions of tuberculosis are generalized, as shown by their presence not only at the usual seats of primary infection but also in parts of the carcass or in the organs that may be reached by the bacilli of tuberculosis only when they are carried in the systemic circulation. Tuberculous lesions in any two of the following mentioned organs are to be accepted as evidence of generalization when they occur in addition to local tuberculous lesions in the digestive or respiratory tracts, including the lymph glands connected therewith: Spleen, kidney, uterus, udder, ovary, testicle, adrenal gland, and brain or spinal cord or their membranes. Numerous tubercles uniformly distributed throughout both lungs also afford evidence of generalization.

(d) When the lesions of tuberculosis are found in the muscles or intermuscular tissue or bones or joints, or in the body lymph glands as a result of draining the muscles, bones or joints.

(e) When the lesions are extensive in one or both body cavities.

(f) When the lesions are multiple, acute and actively progressive. (Evidence of active progress consists in signs of acute inflammation about the lesions, or liquefaction necrosis, or the presence of young tubercles.)

Rule B.—An organ or a part of a carcass shall be condemned under any of the following conditions:

(a) When it contains lesions of tuberculosis.

(b) When the lesion is localized but immediately adjacent to the flesh, as in the case of tuberculosis of the parietal pleura or peritoneum. In this case not only the membrane or part affected but also the adjacent thoracic or abdominal wall is to be condemned.

(c) When it has been contaminated by tuberculous material through contact with the floor or a soiled knife or otherwise.

(d) Heads showing lesions of tuberculosis shall be condemned, except that when a head is from a carcass passed for food or for sterilization and the lesions

are slight, or calcified or encapsulated, and are confined to lymph glands in which not more than two glands are involved, the head may be passed for sterilization after the diseased tissues have been removed and condemned.

(e) An organ shall be condemned when the corresponding lymph gland is tuberculous.

Rule C.—Carcasses showing lesions of tuberculosis should be passed for food when the lesions are slight, localized and calcified or encapsulated, or are limited to a single or several parts or organs of the body (except as noted in Rule A), and there is no evidence of recent invasion of tubercle bacilli into the systemic circulation. Under this rule carcasses showing such lesions as the following may be passed after the parts containing the lesions are removed and condemned in accordance with Rule B:

(a) In the cervical lymph glands and two groups of visceral lymph glands in a single body cavity, such as the cervical, bronchial, and mediastinal glands of the cervical, hepatic, and mesenteric glands.

(b) In the cervical lymph glands and one group of visceral lymph glands and one organ in a single body cavity, such as the cervical and bronchial glands and the lungs, or the cervical and hepatic glands and the liver.

(c) In two groups of visceral lymph glands and one organ in a single body cavity, such as the bronchial and mediastinal glands and the lungs, or the hepatic and mesenteric glands and the liver.

(b) In two groups of visceral lymph glands in the thoracic cavity and one group in the abdominal cavity, or in one group of visceral lymph glands in the thoracic cavity and two groups in the abdominal cavity, such as the bronchial, mediastinal, and hepatic glands or the bronchial, and mesenteric glands.

(e) In the cervical lymph glands and one group of visceral lymph glands in each body cavity, such as the cervical, bronchial and hepatic glands.

(f) In the cervical lymph glands and one group of visceral lymph glands in each body cavity, together with the liver when the latter contains but few localized foci. In this class of carcasses, which will be chiefly those of hogs, the lesions of the liver are considered to be primary, as the disease is practically always of alimentary origin.

Rule D.—Carcasses which reveal lesions more severe or more numerous than those described for carcasses to be passed (Rule C), but not so severe nor so numerous as the lesions described for carcasses to be condemned (Rule A), may be rendered into lard or tallow, or otherwise sterilized in accordance with Regulation 15 if the distribution of the lesions is such that all parts containing tuberculous lesions can be removed.

As a rule the term "slight" is used in connection with tuberculous lymph glands when there is less than one-half of the gland involved and it is not enlarged. "Well-marked" is applied where more than one-half of the gland is involved, or when there is edema or slight enlargement of the gland. "Extensive" is used where the entire gland is involved and visibly enlarged.

In the liver or lungs it is a rather general practice to consider lesions "slight" when not over twelve foci, the size of a milletseed, are found or five nodules about 1 inch in diameter. Lesions are considered extensive in an organ (lungs or liver) if one-third or more of the area of the organ is affected. Well-marked lesions are those lying between these two extremes. The above interpretations are intended only as a rough working guide for beginners, as there are usually other associated factors which must be given consideration.

PARATUBERCULOSIS.

Paratuberculosis or chronic bacterial dysentery is a chronic infectious disease of bovines caused by an acid-fast bacillus simulating the tubercle bacillus. It is characterized by a thickening and corrugation of the intestinal mucous membranes, resulting in a marked diarrhea, anemia

and emaciation. It has also been termed by various European investigators Johne's disease, chronic bacterial enteritis, chronic hypertrophic enteritis and chronic bovine pseudotuberculous enteritis.

This disease was observed in the United States for the first time by Pearson in Pennsylvania cattle, and later by Beebe in Minnesota and by Mohler in Virginia cattle and in an imported heifer from the Island of Jersey at the Athenia, N. J., quarantine station of the Bureau of Animal Industry.

The disease was first studied in 1895 by Johne and Frothingham, in Dresden, but they were inclined to attribute the cause of the peculiar lesions of enteritis which they observed to the avian tubercle bacillus. In 1904 Markus reported the disease in Holland, and subsequently it was observed in Belgium, Switzerland, Denmark and Great Britain. Cattle of all ages are susceptible, but the disease occurs most frequently in cattle from three to six years old. Other species of animals and birds are not susceptible to the infection.

Bacteriology.—The bacillus which has been invariably demonstrated in the intestinal lesions and mesenteric lymph glands in this disease is a rod about 2 to 3 microns long and 0.5 micron wide. It stains more or less irregularly, like the tubercle bacillus, and, moreover, the similarity goes farther in that the organism is also strongly acid-fast, which facts lead Johne and Frothingham to surmise that the disease was caused by avian tubercle bacilli. However, it has now been plainly demonstrated that the bacillus of paratuberculosis is readily distinguished from those organisms, although it resembles the tubercle bacillus in form and staining qualities.

Symptoms and Lesions.—The disease develops slowly and months may pass before it may be detected by clinical manifestations. Probably the first symptom noticed is that the animal is losing condition despite the fact that its appetite is good and the feed nourishing. This is soon followed by a diarrhea which is moderate at first, but soon becomes excessive and may be either irregular or persistent, the feces being watery, fetid and frequently containing mucus. In the meantime the hair becomes dry and harsh and the animal falls off considerably in weight. The temperature, however, remains about normal. The appetite does not seem to be greatly impaired until the last few weeks of life, but nevertheless emaciation continues, the animal becomes more and more anemic, great muscular weakness and exhaustion are manifested and death follows, apparently as the result of the persistent diarrhea and great emaciation. The disease may continue for four or five weeks or may last for a year or even longer before death intervenes.

The lesions observed on postmortem are remarkably slight and out of all proportion to the severity of the symptoms manifested. The disease appears to start in the small intestines, especially in the lower portion, where the lesions are usually the most marked, but it also involves the large intestines, including the rectum. The mucous membrane may alone be affected, although usually in the long-stand-

ing cases the submucosa is also invaded, and the entire intestinal wall is then much thicker than normal and the tissue infiltrated with an inflammatory exudate. The mucous membrane is markedly wrinkled or corrugated, showing large coarse folds with more or less reddening or hemorrhagic patches or spots on the summits of the ridges, especially noticeable in the large intestines. The mesenteric lymph glands are usually somewhat enlarged and appear watery on section, or may contain caseous foci. The other organs do not appear to be affected except from the anemia present in the later stages of the disease.

Judgment.—Paratuberculosis is usually associated with emaciation and anemia, and therefore in the disposition of a carcass affected with the disease its condition must be taken into consideration. Evidently the pathogenicity of the bacillus of paratuberculosis is limited to the bovine species, and its pathogenic action is confined to the intestinal tract and the corresponding lymph glands. Therefore, in the early stages of the disease the carcass may be passed for food, while in the later stages, when anemia and emaciation are in evidence, the carcass should be condemned.

PSEUDOTUBERCULOSIS.

As pseudotuberculosis, are designated the affections which run their course by producing nodules similar to those in tuberculosis, and which, as a rule, also caseate, but which are not caused by Koch's tubercle bacillus. Foreign bodies, cocci, bacteria, bacilli, and hyphomycetes may be etiologically involved. However, only those names which are etiologically correct are at present used in connection with the tuberculous-like process caused by animal parasites, which were formerly also designated as tuberculosis.

Frequency.—Among food animals pseudotuberculous processes with conspicuous caseation or premature calcification occur most frequently in sheep. They have, however, been found in cattle, calves, guinea-pigs, rabbits, and chickens.

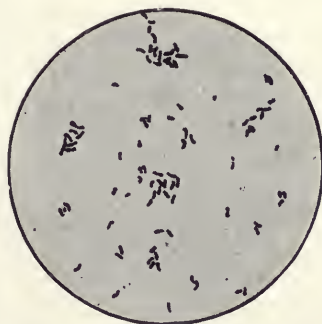

FIG. 114.—*Corynebacterium pseudotuberculosis*. Agar culture. Gram's staining. (After Hutyra and Marek.)

In sheep the disease is known as caseous lymphadenitis and is caused by the *Corynebacterium pseudotuberculosis*, Preisz (Fig. 114). The bacillus appears as a very thin immotile rod, and stains readily with aqueous aniline dyes and by Gram's method; the bacilli in cultures are both thicker and longer, developing also club and pear-shaped forms (Hutyra and Marek).¹

The absence of giant cells and epithelioid cells, according to Ostertag, is of importance in identifying pseudotuberculous alterations. The dry, caseated pseudotuberculous lesions in the lymph glands are character-

¹ The disease is fully described by Nørgaard and Mohler in the Seventeenth Annual Report of the United States Bureau of Animal Industry.

ized by onion-like layers (Noack). An attempt should also be made to establish the cause of the processes. It may be confused with tuberculosis only, but this may be avoided by carefully observing the aforementioned characteristics, together with those changes which are characteristic of genuine tuberculosis.

Judgment.—All parts of carcasses permeated with pseudotuberculous processes should be treated as unfit for food, regardless of the form of infection, whether it is of primary, secondary or embolic nature. Whether or not the whole carcass shall be condemned or passed for food depends upon the condition of the animal and the character of the meat. Noack recommends that similar action be taken as in genuine tuberculosis until it has been proved that man is not susceptible to the bacillus of pseudotuberculosis.

Regulation 11, Section 12 of B. A. I. Order 211, provides that when extensive lesions of caseous lymphadenitis occur in any part or when well-marked lesions are found in viscera and skeletal lymph glands and the carcass is thin, the carcass shall be condemned. When the lesions of caseous lymphadenitis are limited to the superficial glands or to a few nodules in an organ, involving also the adjacent lymph glands, the meat may be passed after the affected parts are removed and condemned. Carcasses showing intermediary lesions not covered by the above paragraphs may be passed for sterilization.

ACTINOMYCOSIS (ACTINOBACILLOSIS).

Actinomycosis is a chronic infectious disease which occurs in cattle, swine, sheep, and horses, as well as in man. It is characterized by the formation of tumors, connective-tissue infiltrations and abscesses. It is caused by several different forms of bacteria and is therefore said by Hutyra, Marek and Manninger to be polybacterial in origin. The *Corynebacterium israeli* is the principal cause of bone actinomycosis of cattle and udder actinomycosis of swine. The *Actinobacillus lignieresii* is the principal causal agent of actinomycosis (actinobacillosis) of the skin and viscera. Another school of workers continues to support the ray fungus, *Actinomyces bovis*, as the cause.

Pathogenesis.—The infective agents can enter the body through wounds of digestive or respiratory tracts or the outer skin. After entering the tissues they develop a nodule, in the neighborhood of which an inflammatory area and a granulation zone soon arise. Around this center changes will then occur, which consist either in the formation of connective-tissue neoformations, which lead to induration and hardening, or destruction of tissue and abscess formation. The latter condition occurs especially among swine. The actinomycotic growth in domestic animals shows chiefly fibrous characters, but occasionally a myxofibromatous consistence may also appear. Both enclose the above-mentioned granulation center, in which the causal factors may be recognized macroscopically as fine-grained, sulphur-yellow or grayish granules (Fig. 115).

Microscopically, these bodies appear to be greenish and of a characteristically radiated structure, but when calcified they are somewhat darker in color.

Metastatic extensions of the infection from the primary lesion may occur, causing generalization in other parts of the body; but this is exceptionally infrequent, as is also any affection of the lymphatic glands, where neither purulence nor calcification is often found to occur.

Symptoms and Lesions.—In cattle the chief symptoms are hard, tumor-like distention of the jaw bones, at which points red, sarcomatous-like proliferations may break out through the skin (lumpy jaw). Such tumors may also occur in the region of the parotid glands, on the cheeks, the lips, and more rarely on other parts of the body. The tongue changes to be described later, while occurring much more frequently than the affection of the jaw, are noticed only in the most severe cases during the life of the animal, or when the animal is noticeably troubled in taking up its food. The latter condition will gradually lead to the emaciation of the animal, although its general health is undisturbed. In swine the most common indication of actinomycosis consists in nodular growths and cold abscesses within the mammæ. The first may also be accompanied by ulcerations or fistulous formations. Larger tumors are

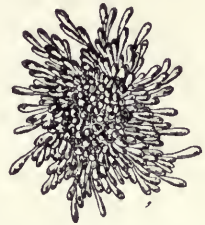

FIG. 115.—Granules in actinomycosis.



FIG. 116.—Actinomycotic ulcer on the dorsum of the tongue of cattle. (After Hutyra and Marek.)

comparatively rare. Small actinomycotic nodules may be observed at the seat of castration, both in male and female hogs. In other food animals actinomycotic affections are very rarely recognized during life.

In slaughtered cattle the most frequent seat of the disease is the tongue, the actinomycotic affection starting, as a rule, in the transverse groove (Fig. 116). In and around this location little nodules may arise, scattered about in the mucous membrane. Whenever these growths permeate the lingual muscles inflammation results, which

affects chronically the intermuscular connective tissues and leads to enlargement and hardening of the organ (wooden tongue). On the surface of the tongue actinomycotic erosions and fungiform prominences may develop. Similar alterations may also occur upon the cheeks and gums.

The changes in the jaw bones usually result from the entrance of the infection alongside the teeth, and often lead to considerable swelling and deformities (Fig. 117). The infrequently occurring actinomycotic changes in other mucous membranes and viscera appear as pedunculated tumors (in the buccal cavity, esophagus, and stomachs), or as nodular tumors, which through myxomatous infiltrations may reach great dimensions, especially in the lungs.

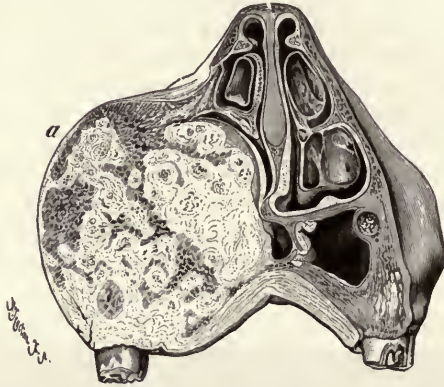

FIG. 117.—Frontal section through the nose and superior maxilla of cattle with an actinomycotic growth: *a*, nodules consisting of connective tissue, bone, and small suppurative foci. One quarter of the natural size. (After Ziegler.)

In the udder the changes occur as nodular growths or as diffuse indurative inflammations in conjunction with the growths. Actinomycosis of the skin is seen principally on the head and neck in the form of tumors, or as diffused bacon-like infiltrations. Pieroni found actinomycotic changes in the dura mater and the occipital bone.

As previously mentioned, actinomycosis of swine appears most frequently as a disease of the mammæ, manifested either by nodules with skin erosions, or by cold abscesses with or without fistulous formations. Extensive infiltrations are comparatively rare in these parts. The lesions at the places of castration are mostly nodular. Actinomycotic changes in the fauces are relatively rare (Johne); likewise abscesses in the region of the throat and on the other parts of the skin.

Actinomycosis has been found in the lungs, muscles, and on the lips and tongues of slaughtered sheep.

The cases of actinomycosis of the horse are limited to a few observations of the disease in the spermatic cord, lymph glands, bones, tongue, and generalized affections.

Diagnosis is not difficult if attention is given to the pathological characteristics mentioned above. The scattered yellowish granules are

to be especially noted in the growths, the microscopic examination of which assures a diagnosis.

Actinomycotic tumors may be mistaken for various other growths, especially for tuberculous nodules, when the characteristic structure of the actinomycotic tumors is not considered, and besides when insufficient attention is paid to the condition of the lymph glands.

Judgment.—Although actinomycosis may at times affect man dangerously, no instance has been observed of a direct transmission of the disease to people, either from living or slaughtered animals. Actinomycotic tissues should be condemned as unfit for human food on account of their decidedly abnormal consistence. This disposition should be made of the entire organ wherever multiple local infection has occurred. In cases of generalized actinomycosis the entire carcass should be carefully examined on account of the atypical course of such generalization, and the parts showing actinomycotic changes should be condemned.

In accordance with B. A. I. Order 211, Regulation 11, Section 5, Paragraphs 1 to 3, carcasses affected with generalized actinomycosis should be condemned. Carcasses of animals in a well-nourished condition showing uncomplicated localized actinomycotic lesions may be passed after the infected organs or parts have been removed and condemned, except as provided in the following paragraph.

Heads affected with actinomycosis (lumpy jaw), including the tongue, shall be condemned, except that when the disease of the jaw is slight, strictly localized, and without suppuration, fistulous tracts or lymph-gland involvement, the tongue, if free from disease, may be passed, or when the disease is slight and confined to the lymph glands, the head, including the tongue, may be passed after the affected glands have been removed and condemned.

BOTRYOMYCOSIS.

Botryomycosis is a chronic, tumor-like, connective-tissue proliferation, caused by the *Staphylococcus ascoformans*, Kitt. It grows in the form of spherical or grape-like colonies (Fig. 118), which soon are surrounded by hyaline capsules. These clumps of round microorganisms were called *Botryomyces* by Bollinger; *Biscomyces equi* by Vivolta; *Micrococcus ascoformans* by Johne, and *Micrococcus botryogenus* by Rabe. This disease occurs almost exclusively in horses, but it has also been observed in cattle and hogs in isolated cases.

Symptoms and Lesions.—The characteristic lesions are fibrous nodules and tumors, with softened yellowish-brown areas in the center, in which small sand-like granules of a yellowish-white color are found. The latter are composed of grape-shaped, conglomerate, closely adherent clumps of staphylococci. The most common site of these nodules in the

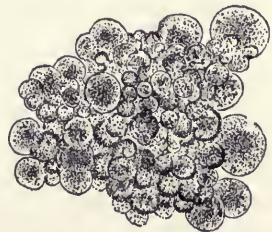

FIG. 118.—Colony of staphylococci. (After Rabe.)

horse is the subcutis and spermatic cord, but they may also occur in the udder, ribs, muscles, and on the pleura. Guenther, Czokor, Immelmann and Reali have also reported botryomycosis in cattle, while Wilbrandt and Schneidemuhl have found it in the hog. A generalization of the disease has been variously observed.

The disease is recognized by microscopic examination of the granules, which stain with all the basic aniline stains, thereby avoiding confusion with other infectious granulomata, such as actinomycosis and glanders.

Judgment.—All parts affected with botryomycotic processes are to be condemned as unfit for food and destroyed.

ANTHRAX.

Anthrax, which occurs in all food-producing animals, in game and in fowls, is caused by the *Bacillus anthracis*. The hog and dog are somewhat resistant to infection, but anthrax infection has been definitely demonstrated in them.



FIG. 119.—Anthrax bacilli with stained capsules.



FIG. 120.—Anthrax bacilli containing spores. Agar culture eight hours old. Stained by fuchsin. (After Hutyra and Marek.)

Bacteriology.—The anthrax bacilli (Figs. 119 and 120) measure 1.5 to 3 microns in length, 1 to 1.5 microns in width, with slightly convex or perfectly square ends. They form obtusely angular chains, reaching a maximum of 10 microns in length. The anthrax bacilli are immotile, and those taken from the blood are surrounded by a characteristic, capsular or gelatinous membrane, by which they are distinguished from other similarly formed bacteria. The anthrax bacillus grows only in the presence of oxygen and forms spores (Fig. 120); the latter, however, never form in the live animal body or in the intact cadaver. The best way to prepare suspected material (spleen pulp) for shipment and bacteriological examination is by careful slow drying of thick smears on glass slides or on the inner surface of test-tubes (Bongert and Hosang); or, perhaps better still, by the Forster plaster-of-Paris rod method (Marxer, Jacobsthal and Pfersdorff, Eberle, Dausel).

Staining of the Anthrax Bacilli with Their Capsules.—After Luepke: Slightly boil the cover-glass preparation with a 0.2 per cent gentian violet solution; rinse thoroughly with water. After Johne: Stain in hot 2 per cent gentian violet solution; wash in water; decolorize for ten to twenty seconds in 2 per

cent acetic acid; wash in water. After Klett: Boil in alcoholic methylene blue solution (1 to 10 alcohol to 100 water); wash in water; stain in alcoholic solution of fuchsin (1 to 10 alcohol to 100 water); wash. After Olt: Heat the cover-glass over a flame after applying a 3 per cent aqueous safranin solution; wash in water. After Raebiger: Air-dried cover-glass preparations are stained cold with formalin-gentian violet (150 Gm., 40 per cent formalin, with 15 to 20 Gm. gentian violet) for twenty seconds; wash in water.

Pathogenesis.—The anthrax bacilli, or their spores, enter either through injuries of the skin or through the digestive apparatus into the body. Only the spores are effective by the latter method. Infection by way of the air passage, which occurs in man, is exceedingly rare in animals. From the point of inoculation the bacilli enter the blood, where they multiply rapidly, and through their toxins produce a severe febrile affection.

Symptoms and Lesions.—The clinical symptoms vary considerably according to the point of infection, species of animals and individuals, and they may be entirely overlooked in peracute cases (apoplectiform anthrax). Otherwise, characteristic symptoms are the sudden appearance of the disease, the rapid course, high fever, general severe constitutional symptoms, hemorrhages into the mucous membranes, bloody discharges, cerebral or pulmonary congestions, colic, and drying up of milk secretion in lactating animals. In some cases there may be present invisible localizations, such as carbuncle and edema of the skin (especially in cattle and horses) and mucous membranes (especially of the tongue, termed gloss anthrax); also edema of the neck in hogs.

The most important pathological finding is the swollen spleen, whose pulp is blackish-red and of a fluid consistence. In the hog and horse, exceptionally also in emergency slaughtered cattle, enlargement of the spleen may be slight or absent. Further, there occurs cloudy swelling of the heart, liver and kidneys with venous stasis or formation of hemorrhagic infarcts and petechial hemorrhages. The latter may occur on any part of the body, especially beneath the pericardium and pleura. Marked stasis in the mesenteric, intestinal, and hepatic veins is present, with brownish-red discoloration of the mucous membrane of the abomasum and intestinal walls, in which hemorrhages may occur; bloody infiltration of the mucous membranes of the small intestines, and to a less degree of the colon mucosa is observed. Pulmonary edema and marked cervical edema, especially in hogs, may be noted, and also yellowish gelatinous and bloody infiltrations of the subcutis, with engorged veins of the skin and muscles. The majority of the lymphatic glands are strikingly edematous, hyperemic and show bloody extravasations. Rigor mortis is absent. The blood is not coagulated, and is, as a rule, dark to black-red (tar-like). There occur cases, however, which run a rapid course in which the color of the blood is not materially changed.

The unopened cadaver rapidly becomes distended, and discharges mixed with blood will flow from the natural body openings; in the body cavities a blood-stained serous fluid will be found.

The recognition of anthrax is based on careful consideration of the pathological findings and the microscopic examination of stained cover-glass preparations made from the splenic pulp, the lymph of the mesenteric glands, the blood of the veins of the skin, or from the edematously infiltrated portions of the subcutis. In doubtful cases test inoculations and culture growths for the demonstration of the bacilli will be effective; but these cannot be considered at this point. It might be emphasized, however, that the plate method (Fig. 121) is the best and safest for the bacteriological diagnosis of anthrax (Kitt, Bongert, Hosang, Kaesewurm).

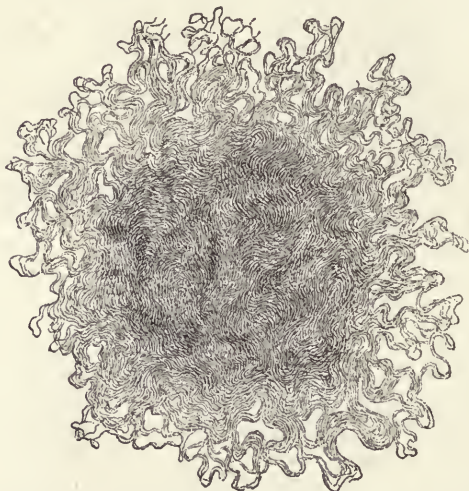

FIG. 121.—Superficial colony of the *Bacillus anthracis* in a twenty-four-hour-old agar plate culture. $\times 50$ diameters.

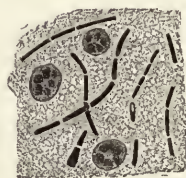

FIG. 122.—Cadaver bacilli. $\times 500$ diameters.

For differential diagnosis must be considered: Blackleg, malignant edema, hemorrhagic septicemia, septic disease, petechial fever, certain intoxications, overfeeding of cattle after long transportation, and erysipelas in hogs. For a description of the particular characteristics of these disease as compared with the symptoms of anthrax, as well as the differentiating characteristics of some of the microorganisms of these diseases, the reader is referred elsewhere.

Partial splenic enlargement (infarcts) resulting from emboli is characterized by firm consistency of the swollen parts. A very large splenic tumor, involving the entire organ, has been observed in the hog as a result of torsion. A confusion of cadaver bacilli with anthrax bacilli is excluded in the light of our recent staining technic, and upon careful study of the two species (Figs. 119 and 122). Kaesewurm has called attention to a pseudoanthrax bacillus which also forms colonies composed of bundles of wavy, tangled filaments.

McFadyean has described a peculiar staining reaction of anthrax bacilli which is specific. Smear preparations are stained for a few seconds

with a 1 per cent aqueous solution of methylene blue; the amorphous material around and between the bacilli appears violet or reddish-purple, while the bacilli and cell nuclei are blue.

Judgment.—The meat of animals affected with anthrax should be considered injurious as food, and is to be condemned and destroyed.

If on antemortem inspection an animal is suspected of having anthrax, slaughtering is to be forbidden, and the necessary measure should be taken to prevent its spread to man or to animals and to arrest further dissemination of the infectious material.

If a slaughtered animal be found diseased all parts thereof are to be condemned and disposed of by the veterinary authorities. Persons engaged in the slaughter of the animals or in handling it in any way should be carefully examined for probable infection wounds on hands or arms.

The fact that much anthrax meat has been eaten without any harm to man is explained by the loss of vitality of the bacilli (not of the spores, however) in the intestinal tract, where, as a rule, they are destroyed by the gastric juice. This meat, nevertheless, remains dangerous to man on account of the liability of inoculation by handling or by ingestion through the injured mucous membrane of the digestive tract.

In accordance with B. A. I. Order 211, Regulation 11, Section 2, all parts, including hides, hoofs, horns, viscera, intestinal contents, fat and blood, of animals, the carcasses of which show lesions of anthrax, regardless of the extent of the disease, shall be condemned and immediately incinerated or otherwise completely destroyed. The killing bed upon which the animal was slaughtered shall be disinfected with a 1 to 1000 solution of bichloride of mercury, and all knives, saws, cleavers and other instruments which have come in contact with the carcass shall be thoroughly cleansed in boiling water or in a prescribed disinfectant followed by rinsing in clean water.

RABIES.

On account of its rarity and the exceedingly difficult recognition of rabies (lyssa) in slaughtered animals, it will be but slightly touched upon. This disease may occur in all food animals and is usually occasioned through the bite of a rabid dog.

Etiologically rabies requires further research, although it is quite generally accepted that the nerve-cell inclusions discovered by Negri in 1903, and termed Negri bodies, are the causative agents.

Symptoms and Lesions.—In view of the multiplicity of variation of the clinical symptoms of rabies in the different animal species and the uselessness of an extensive description, the reader is referred to the special text-books of veterinary medicine. The anatomical changes are not characteristic.

The recognition of a well-developed case of rabies in the living animal is not very difficult, especially if it can be observed for several days. In the slaughtered animal, however, only a probable diagnosis of rabies

can be established, which may be verified by the determination of a bite from a dog at some previous time, and a comparison of the clinical symptoms reported. In the dog suspicion is further incited by the presence of indigestible material (wood, straw, hair, cloth, etc.) in the otherwise usually empty stomach; the intestinal tract is also generally free from normal food stuffs. The absence of any other distinct organic disease which might be the cause of the symptoms also supports the diagnosis of rabies.

Absolutely certain diagnosis is obtained by subdural, intraocular, or intramuscular inoculation of the substance of the central nervous system into experiment animals. Histologically the diagnosis may be made by the demonstration of Negri bodies. Negri bodies are round, oval, or pear-shaped structures situated in the interior of the large ganglion cells of the central nervous system. They assume a dark red color on staining with eosin-methylene blue solution, while the cells and cell nuclei appear blue. In the section for the treatment of rabies at the Royal Institute for Infectious Diseases in Berlin the diagnosis of rabies is accepted on the finding of the Negri bodies without recourse to animal inoculation.

Judgment.—As the meat of rabid animals is dangerous to health and unfit for food, it should be condemned. Although transmission of rabies has not been observed to result from ingestion of meat from rabid animals, the disease is nevertheless possible if inoculation occurs while handling the meat. According to v. Ratz, the virus of rabies remains active for thirteen to twenty-four days after the death of the animal.

In the incubation stage of the disease slaughtering of domestic animals, with the exception of cats and dogs, is not prohibited, and the meat may also be utilized after removal of the bitten area.

In accordance with B. A. I. Order 211, Regulation 9, Section 2, Paragraph 4, all animals showing on antemortem inspection symptoms of rabies shall be marked "U. S. condemned" and tanked for fertilizer.

GLANDERS.

Glanders or farcy is an exceedingly infectious disease of solipedes, but may be transmitted to sheep, goats, dogs, cats and various other animals, especially man. Of the food animals, cattle are immune, while hogs are nearly so. The disease is produced by the glanders bacillus discovered by Löffler and Schütz.

Bacteriology.—The *Pfeifferella mallei* is immotile, 2 microns long, 0.3 microns wide and frequently arranged in pairs. Sporulation does not take place. The staining is best accomplished, according to Löffler, by using aniline aqueous gentian violet for five minutes, to which has been added the same quantity of potassium hydrate solution (1 to 10,000). Next dip in acetic acid solution (1 to 100), to which a few drops of tropeolin solution have been added, and then wash in water.

Potato culture is characteristic; at a temperature of 37.5° C. for two days it shows a yellow homogeneous growth, which later turns dark brownish-red and assumes a honey-like appearance.

Pathogenesis.—The glanders bacillus gains entrance in solipeds in most cases by way of the digestive apparatus, next in order through the abraded skin. Infection occurs rarely by way of the air passages. Only in very severe infections do the bacilli produce changes or lesions at the point of entrance (intestinal mucosa). As a rule, they are disseminated by the lymphatic or blood stream and produce disease processes embolically in the most remote organs. There will form either millet- or pea-sized subepithelial nodules (nodular glanders), or diffuse cellular infiltration of the nodules of the mucous membranes causes ulcers, with a yellowish infiltrated base, which rapidly enlarge. Healing of the ulcers with radiating cicatrices may also occur (Fig. 123). The nodules, nodes and diffuse glanderous growths in the interior of the organs are partly light gray and abundant in cells, partly opaque, yellowish-white, caseated or approaching suppuration and partly grayish-white with a firm consistence.

In infection of the skin (farcy, cutaneous glanders) there form, partly in the papillary portion, partly in the subcutis, rapidly disintegrating nodes, which give rise to abscesses. From these abscesses a glanderous lymphangitis develops.

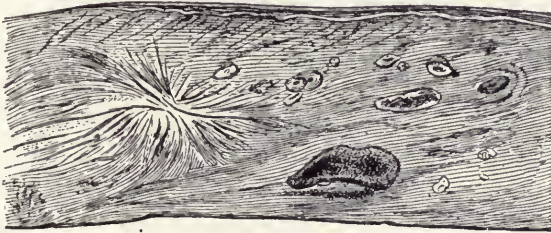

FIG. 123.—Nasal septum of a horse, showing ulcers and a scar of glanders. (After Ostertag.)

All glanderous processes are associated with a specific inflammation of the lymphatic glands, which is characterized by inflammatory swelling, formation of nodules, areas of degeneration and chronic inflammatory proliferation of connective tissue, which extends to the neighboring tissues, resulting in coalition of the glands with the surrounding tissues.

Symptoms and Lesions.—Of the various symptoms of chronic glanders, which is frequently recognized with difficulty in the living animal—acute glanders not coming into consideration in inspection—the following are of particular importance on antemortem examination: Nasal discharge, which is irregular; adhesive mucus, which is gray or greenish-yellow, may be mixed with a clear catarrhal secretion; nodules or ulcers or cicatrices on the mucous membranes of the nose; diffuse enlargement of the submaxillary lymphatic glands, which later appear painless, nodular, hard and attached to the maxilla; nodes, ulcers, corded lymphatics and glanderous phlegmons of the skin.

The anatomical changes correspond to the clinical symptoms from the very beginning of the disease. Aside from the changes in the skin

and the nasal and accessory cavities, special attention should be directed to changes in the lungs where embolic glanderous nodules (Fig. 124), sometimes of considerable magnitude, form. Furthermore, emboli occur particularly in the liver, spleen, kidneys, testes, muscles, heart, brain, and bones. The above-described lesions will also be found in the lymph glands.

The anatomical recognition of glanders is of special importance. The glassy-gray, transparent or translucent appearance of the glanders nodules, their red area and involvement of the corresponding lymph glands (swollen and nodular on section), have been emphasized by Ostertag. Schütz has also called attention to chromatotaxis of the pus

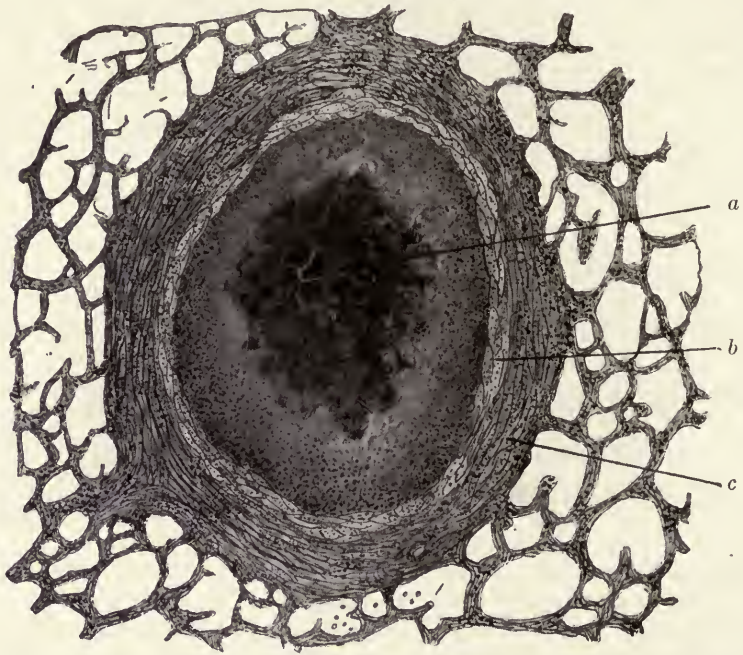

FIG. 124.—Old glanders nodule from the lung: *a*, central necrosed portion; *b*, innermost cellular capsule; *c*, connective-tissue capsular layer. $\times 30$ diameters. (After Ostertag.)

cells in glanders, in which, during progressive cell necrosis, the chromatin of the nuclei is broken up into fine granules. A bacteriological and cultural test is indicated in all suspected cases, which are to be immediately turned over to the veterinary police authorities. The work of practical meat inspection does not permit of animal experiments as a rule.

Keyser obtained very good results from the complement-fixation test for the diagnosis of glanders in carcasses of horses, and the application of this test in doubtful cases would therefore appear advisable.

In order to avoid confusion with other diseases there must be considered parasitic lung nodules (calcareous and fibrous nodules); small

multiple areas or processes in traumatic pneumonia; embolic lung nodules in pyemia, strangles, tuberculosis, actinomycosis and botryomycosis of the lungs, leukemia and nasal catarrh. In all of these diseases the characteristic glanderous lesion will be absent or similar findings will be found to differ on comparison.

Judgment.—Upon the recognition of glanders in the living animal, its slaughter is to be prohibited and the necessary sanitary precautions left to the authorities. The meat of glanderous animals is to be declared unfit for food as it is dangerous to health.

From a veterinary police standpoint the compulsory reporting and killing of the diseased animals must be considered. The killing should be done under the direction of a veterinarian; this also applies to the removal of the cadaver which is not to be skinned.

Great care in handling glanderous or suspected animals is urgently advised.

Horses are at present being slaughtered as food animals in the United States, and it is only natural that animals showing lesions of glanders should be condemned.

FOOT AND MOUTH DISEASE.

This peculiar affection of cloven-footed animals, also called aphthous fever, is a febrile disease starting with vesicles or blisters on the mucous membranes of the digestive apparatus and outer skin. The affection more frequently occurs in swine and cattle. Sheep, goats and wild cloven-footed animals are seldom affected. It may be transmitted to cats, fowls and human beings.

The exact cause of this disease is not known, but the virus is filterable and is exceedingly contagious.

Pathogenesis.—The initial symptom of the infection is a slight internal fever, followed by rapidly forming vesicles. In cattle the latter appear on the lips, muzzle, all parts of the buccal mucous membrane, between the claws, on the pads of the hoofs, and around the coronary band. Exceptionally these erosions are also found at the base of the horn, udder, vulva, perineum, and on the scrotum of the male. In sheep and goats there appear most frequently very small vesicles between the claws; lesions are very seldom found in the mouth of these animals. Swine are first affected in the interdigital space and around the supernumerary digits; later, small vesicles are noticed on the muzzle and snout.

These rapidly appearing blisters soon burst, leaving a red, moist erosion. These erosions, as a rule, heal very rapidly, and are covered by shreds of epithelium growing in from the edges. In very severe cases the claws may drop off and the tendons of the digits may become affected by extensive suppuration, or suppurative arthritis may develop with accompanying septicemia or pyemia.

The disease usually takes a malignant course in suckling animals, which generally die from inflammation of the stomach and intestines.

A malignant type of disease is also observed in older animals during certain periods of the plague, when the animals die of apoplexy or with manifestations of an intoxication in connection with a violent type of diarrhea.

Symptoms and Lesions.—Beside the appearance of vesicles, the most striking symptoms are lameness, an affection of the buccal mucous membranes and dribbling of the saliva. In cattle the latter appears thick and tenacious, containing large bubbles. This salivation may be absent in cases where the eruption and formation of vesicles are



FIG. 125.—Vesicles and ulcers on the gums and ulcers on the muzzle of a cow affected with foot and mouth disease. (After Hutyra and Marek.)

on the posterior parts of the buccal mucous membrane, in which cases the animals swallow the saliva. Besides inappetence, there is a characteristic “smacking” noise of the lips, which is caused by a fast in and out motion of the lips. The other symptoms of this disease appear according to the previously mentioned development of the disease.

The anatomical changes are in accord with the development of the disease, and include moist erosions, which may be followed by complications, such as suppuration and ulceration of the joints and feet.

In the virulent form of this disease the lesions present themselves very differently, according to the clinical manifestations. Severe gastroenteritis, multiple embolic myocarditis, parenchymatous or amyloid degeneration of the heart and other indications of blood poisoning are, however, seldom absent.

The recognition of typical cases of foot and mouth diseases is not difficult. In the late stages it may not be easily recognized, and in certain conditions the disease may only be diagnosed in the slaughtered animal. The slaughtering of "suspects" should preferably be carried out in abattoirs so that an accurate diagnosis can be established and the rapid eradication of the disease accomplished. In the formation of vesicles on the dorsum of the tongue it should be noted that the fungiform papillæ remain standing apparently intact in the eroded places (Leutsch).

Other lesions of the oral cavity which may be confused with foot and mouth disease are

- I. Traumatic injuries of the epithelium of the mouth.
- II. Chemical and thermic injuries.
- III. Superficial actinomycotic lesions.
- IV. Pseudo-aphtha (Leutsch) or erosive stomatitis (M. Müller).
- V. Benign stomatitis; mycotic stomatitis; stomatitis bovis specifica (Ostertag and Bugge, Hess, Peters, Hajnal [Stomatitis oidica]).
- VI. Vesicular stomatitis of cattle and horses.

The first two, as a rule, show irregular destruction of the mucous membrane or deeper tissues. The actinomycotic erosions, which are characterized clinically by very slight sensitiveness, appear as sharply circumscribed, mostly rounded defects of the mucous membrane with brownish-red base, from which flat, reddish, button-like proliferations gradually protrude like mushrooms.

In pseudo-aphtha or erosive stomatitis the lesions range in size from a pea to a penny, and begin as flat elevations on the mucous membrane of the mouth. Small amounts of saliva dribble from the mouth, but the appetite is not destroyed; later, these elevations change into superficial ulcerations. Occasionally fever and depression accompany this disease. The origin of this affection is not known.

Erosive stomatitis ononidea, according to Müller, is produced only by eating *Ononis spinosa*, or *O. repens*, and, as a rule, is accompanied by some inappetence.

The benign stomatitis or mycotic stomatitis cannot be transmitted to calves, and otherwise corresponds to pseudo-aphtha. In the benign buccal eruptions, described by Hess, papules form on the mucous membrane and border of the lips in sizes ranging from a hempseed to a pea, in the center of which appears a quickly bursting vesicle. After this bursting occurs superficial ulcers are observed. The general health of the animal is not disturbed and the disease is not transmissible.

Vesicular stomatitis more closely resembles foot and mouth disease than any of the above affections. A reliable differential diagnosis can be made only after inoculation experiments, including horses, have been

made. (For more detailed information on this disease the reader is referred to Department Bulletin No. 662 by J. R. Mohler.)

The following diseases of the feet enter into consideration in differential diagnosis.

1. Animals transported over hard and stony roads are, as a rule, affected with hardening of the pad of the hoof, which occurs uniformly on all four feet.

2. Contusions of the feet in hogs are not infrequently seen, mostly in but one foot, which shows infiltration of blood without vesicles, or a small blood blister on the coronary band.

3. Swelling of the coronary band and pad, due to long standing on wet ground.

4. Inflammation of the interdigital space, especially foot rot in sheep, but there are no vesicles present.

Judgment.—In a country like the United States, where foot and mouth disease is not indigenous but only occurs at irregular and more or less lengthy intervals, the meat of animals affected with this disease should be condemned on account of the great danger of spreading the disease to animals and man.

From the standpoint of veterinary police, compulsory notification of the disease should be observed. The hide should not be permitted to be moved from the premises until properly disinfected under supervision. Only the veterinary inspector is to decide on this question as well as on the disposal of the affected parts. In consideration of the easy dissemination of the disease by the inspectors themselves, the greatest care is advised.

Outbreaks of foot and mouth disease are eradicated in this country by compulsory slaughter and burial of all infected and exposed animals. In instances where it is desirable to salvage exposed animals before the symptoms of the disease have had an opportunity to appear, they are slaughtered under rigid inspection following the taking of their temperatures.

VARIOLA.

Of the pock-like diseases which occur in all animals that are slaughtered for their meat, the pox of sheep and the vaccination pox of calves are of importance.

Sheep Variola.—Sheep pox, after absence for a number of years from Germany, reappeared in 1915. It is produced by an easily disseminated, filterable virus, whose pathogenicity varies. It is probable that it is taken into the system through the air passages.

Pathogenesis.—After a period of six or eight days' incubation the clinical symptoms of sheep variola appear, beginning with fever, debility, loss of appetite, suppurative conjunctivitis with swelling of the lids, severe muco-purulent, nasal and pharyngeal catarrh, and foul odor from mouth and nose. After a day or two, red, round, or oblong, nettle-rash-like excrescences (roseola variolosa according to Hutyra and Marek) appear on the skin of those portions of body which are devoid of wool or only slightly woolly, such as the vicinity of the eyes, cheeks, lips, *alæ nasi*, inner part of thighs, under surface of tail, lower chest and posterior part of the abdomen.

In the normal course of the disease pimples develop in these spotted areas, which may increase at their base to the size of a penny (*Stadium papulosum*). From under the surface of the papules exudes a tenacious fluid, which soon forms vesicles (*S. vesiculosum*), containing a yellowish or slightly reddish fluid. By the sixth or seventh day this becomes cloudy and purulent (*S. pustulosum*, *S. suppurationis*). A crust or scab (*S. crustosum*) follows desiccation of the pustule, which dries and later falls off.

As the skin and subcutis become edematously infiltrated at the diseased areas, there occurs swelling of these portions of the body, which may be especially marked at the head and extremities.

In some epizootics the pustular stage is absent at first and during the further course of the disease develops slowly.

Although the constitutional condition of the sheep improves with the decrease of the eruption, severe catarrh of the mucous membranes will remain in some cases, followed by catarrhal pneumonia. A sweetish, nauseating odor emanates from these animals; they cease to feed, and finally succumb to the disease.

Among other complications of special significance are the appearance of extensive hemorrhages (*variola hæmorrhagica*), the confluence of the pox, and the development of gangrenous pox, in which septicemia or pyemia leads to fatal results.

Symptoms and Lesions.—The symptoms and lesions in the live animal are as above described. In the slaughtered animal corresponding lesions are found in the skin, subcutis and the mucous membranes, where pock vesicles may also appear and give the appearance of only slight or of severe general constitutional involvement (pyemia or septicemia).

Judgment.—If sheep are slaughtered while suffering from variola, which rarely occurs, the meat may under most favorable circumstances be passed for food. In complications, especially extensive suppurations and gangrenous or putrid pox, the meat is to be condemned as unfit for food. If the pox are healing and the nutrition of the sheep is good the meat is serviceable for food.

The disposition of the hides should be in accordance with the instruction applying to hides from animals affected with foot and mouth disease, great care being necessary on account of the easy manner in which pox contagion is spread.

Cowpox.—While the spontaneous appearance of cowpox from a meat-inspection standpoint is insignificant, the vaccination pox of calves, which is artificially produced in special institutions for the purpose of preparing vaccine lymph for protective vaccination of mankind against smallpox, deserves special mention. Following the slaughter of calves from which lymph of vaccine vesicles is taken as above mentioned, the carcasses are inspected, but they do not offer any ground usually for condemnation. By way of exception a febrile intercurrent, intestinal catarrh, with ensuing deterioration of the flesh, causes this class of meat to be considered of inferior quality.

Imperfect scarification on the lower abdomen leads occasionally to gelatinous infiltration of the subcutaneous tissue and of the superficial muscular layer, in which case the altered portions, with the adjacent lymph glands, must be rejected as unfit for human food.

According to B. A. I. Order 211, Regulation 11, Section 6, carcasses

of vaccine animals showing unhealed vaccine lesions should be condemned. If the antemortem inspection reveals vaccine animals with unhealed lesions, accompanied by fever, they are not required to be slaughtered, but may be released, provided they are promptly removed from the stockyards or premises of the establishment where inspected (B. A. I. Order 211, Regulation 9, Section 7).

TETANUS.

By tetanus is understood a specific infectious disease, the exciting cause of which produces in the body tonic contractions of the transversely striated muscles, through the formation of toxic substances acting on the nervous system. Tetanus appears in all food animals and especially in horses and lambs.

Etiology and Pathogenesis.—The tetanus bacilli or other spores penetrate a wound of the skin or mucous membrane of the body, multiply in the coagulated blood or in the necrotic tissue of the wound without passing through the blood, form spores and produce toxins, tetanotoxin, tetanolysin (Ehrlich), which are carried through the blood and lymph, causing an increased reflex excitability of the spinal cord and nerves, with consecutive tetanic muscular contraction.

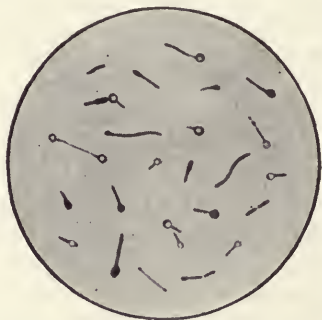

FIG. 126.—Tetanus bacilli with spores in various stage of development; four days' old agar culture. Carbol-fuchsin solution. (After Hutyra and Marek.)

The tetanus bacilli (Fig. 126) are 3 to 5 microns long and 0.3 to 0.5 microns wide, motile, anaërobic and as soon as their terminal spores are formed appear as stickpins in shape. They stain by the ordinary stains and also by Gram's method.

Symptoms and Lesions.—Among the clinical appearances the only one to be mentioned is the progressive stiffening of the muscles, which, following tetanic contractions, appear as hard as boards. The condition begins to prevail in the head as trismus, and spreads out more or less rapidly to the muscles of the limbs. Accompanying this are excitability, great fear, frequent sweatings and increased respiration.

The postmortem findings are generally negative. In advanced cases there may appear evidences of imperfect bleeding; the blood is blackish-red and improperly coagulated, ecchymoses appear on the serous and mucous membranes and also on the heart. There is also parenchymatous degeneration of the liver, heart, kidneys and muscles, certain groups of which show a diffused dirty red, bluish-brown, soft or cooked appearance. Hypostatic pneumonia may be present. The recognition of tetanus is as difficult and even impossible after slaughter as it is easy during life.

In animals slaughtered in advanced cases it may be mistaken for

septicemia, hemoglobinemia, suffocation, certain cases of morbus maculosus and encephalomyelitis, but each of the diseases mentioned may be differentiated from tetanus by one or more of their specific symptoms.

Judgment.—Although the tetanus bacilli do not pass through the blood, the meat of animals suffering from tetanus when slaughtered should be condemned. In such cases there is, as a rule, evidence of improper bleeding or other changes (fetid odor and taste, deviation in color, consistency and keeping quality).

According to Kitasato, the tetanus toxin is broken up and destroyed by cooking at 65° C.

According to B. A. I. Order 211, Regulation 9, Section 2, Paragraph 4, animals showing symptoms of tetanus on antemortem inspection shall be condemned.

MALIGNANT EDEMA.

Malignant edema is an acute febrile wound infection which appears spontaneously in horses, cattle and sheep, and less often in other food-producing animals.

A particularly prominent form of malignant edema is the so-called parturient symptomatic anthrax, the careful study of which, by Albert and Carl, has demonstrated with great certainty that genuine symptomatic anthrax cannot develop in this form (Hutyra and Marek).



FIG. 127.—Bacilli of malignant edema, showing flagella.

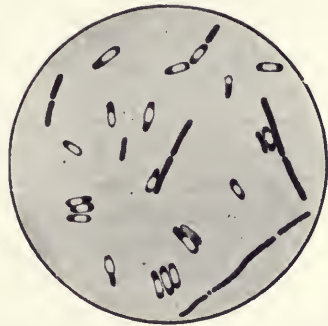

FIG. 128.—Bacilli of malignant edema. Peritoneal exudate from a guinea-pig. Cover-glass preparation stained with fuchsin. $\times 1000$ diameters. (After Hutyra and Marek.)

Pathogenesis.—The causative microorganisms of malignant edema are ubiquitous and appear normally in the intestines. They are slender bacilli 3 to 5 microns long, 0.8 to 1 micron wide (Figs. 127 and 128), with rounded ends (thus differing from anthrax bacilli), and possess slight motility. They form chains and flagella, are anaërobic, and therefore do not appear in circulating blood. After death they wander out of the intestines into the portal blood in case the carcass chills very slowly. On that account they may be found in the spleen after twenty-four hours, and, under such conditions they form centrally located spores in the blood, which are easily stained, but not by Gram's method.

After entrance of the bacilli into the connective tissue, there develops an edema infiltrated with gas bubbles together with toxins, the absorption of which causes fatal constitutional disease.

The clinical symptoms are manifested by quickly progressive, dough-like, hot swellings, which afterward show crepitation. A strong febrile reaction is also present.

Lesions.—Yellow gelatinous infiltrations of the affected connective tissue and of the surrounding muscles, together with infiltration of these areas with fetid-smelling gas bubbles, are observed; the parenchyma is occasionally unaffected; sometimes, however, it is degenerated; by way of exception, there is a spleen tumor or swollen spleen. In cases where the disease originates in the uterus, the latter is slightly contracted; its walls are edematous, and mucous membrane is swollen with the destruction of the affected cotyledons. The connective tissue of the pelvis is edematously infiltrated.

Diagnosis.—For recognition of malignant edema it is necessary to take into consideration all the morphological and biological characteristics of the bacilli of malignant edema; nevertheless their presence is not decisive, because they can spread easily into the body of an animal from the intestines after death.

The disease may be mistaken for:

1. **Symptomatic Anthrax.**—Here the foul odor of the edematous swellings is absent. The bacilli of symptomatic anthrax form only end spores and do not grow in filaments. The appearance of symptomatic anthrax (blackleg) in certain sections of the country is to be considered, and also the fact that the muscles are only occasionally attacked by malignant edema.

2. **Anthrax.**—In malignant edema there are the above-mentioned morphological characteristics of the bacilli, their absence in blood, and failure in inoculating rats. They do not grow on potato and gelatin media. Besides these differential characteristics, there is no crepitation in the edematous swellings of anthrax.

3. **Inflammatory Edema.**—This does not present crepitation.

4. **Subcutaneous Emphysema.**—In this case fever is absent.

Judgment.—Although the meat is not injurious to health, it should be declared unfit for food, principally on account of objectionable alterations in the meat.

In accordance with the meat-inspection regulations of the United States, carcasses affected with malignant edema should be condemned, not alone on account of the possibility of dissemination of the bacilli throughout the carcass by the blood, but also on account of the changes in the meat produced by the high febrile condition of the animals in the course of the disease.

SEPTICEMIA.

By the collective term "sepsis"¹ is designated, from a purely scientific point of view, a severe hemolysis produced by the entrance of infective material (microorganisms or ultravisible contagions) into the blood. (Sepsis in a narrow sense.)

¹ The designation "ichorus" or "putrid blood poisoning," for sepsis, should not be used any longer in view of the etiology of the latter.

For practical meat inspection those hemolytic diseases of sepsis which are caused by the entrance of products of pathogenic bacteria (toxins and toxalbumins) into the blood or by the combination of both the infectious material and toxins, are to be considered under the term septicemia. (Sepsis in a broad sense.)

The term can also refer to a bacteriemia or a toxinemia, and also to mixed cases as toxemic bacteriemia.

The presence of toxins, produced in the blood through the activity of saprophytic bacteria, causes toxinemia which is called putrid intoxication or sapremia in contradistinction to septicemia.

The term sepsis includes the entrance of all pathogenic bacteria and their toxins into the blood channels; and it includes also the spreading of purulent matter through the blood, though the disease of the blood termed pyemia constitutes a special affection when metastatic suppurative foci develop in consequence of bacterial dissemination.

The combination of septicemia and pyemia is called septicopyemia.

It is evident that the other microparasitic blood infections which develop under the manifestation of sepsis and which bear distinct names, such as anthrax, erysipelas, etc., belong in the broadest sense to septic diseases on account of well-defined characteristics of their causative factors as specific agents of blood infections.

Pathogenesis.—Although there are still no definite results in fundamental investigations for exciting causes of all the septic diseases of food-producing animals, yet certain forms of the streptococci and staphylococci should be etiologically considered here. Doubtless other bacteria (for instance, certain forms of coli and Gärtner's enteritidis bacillus) also cause septic conditions, and it is probable that such conditions are also favored by other bacteria (proteus) under certain symbiotic relations.

The point of entrance for the exciting causes of sepsis can, in many cases, be recognized as a local disease (wounds, inflammations and disintegrating foci), while obscure infections do occur, however, without any noticeable place of inoculation. The further effects of the deleterious microbes result from the facts already explained, the principal factor being the formation of toxic substances, which almost invariably cause a fatal termination.

Symptoms and Lesions.—The clinical as well as the anatomical appearance of septic diseases are frequently so little apparent that an especially thorough examination and careful estimate of every single symptom are absolutely necessary.

Of the clinical phenomena the following are of special importance:

1. High fever (in cattle 41° to 42° C.) beginning with rigor, which is absent only in very exceptional cases. During the last stage of the disease normal and subnormal temperatures appear.

2. Cardiac weakness and greatly accelerated, wiry pulse.

3. Severe psychical depression, muscular weakness, tremors and paralysis of certain nerve regions, which, however, in most cases are difficult to establish.

4. Dirty red, blurred coloring of the visible mucous membranes, showing petechia and ecchymosis.

5. Drying up of the milk during lactation.

6. The presence of an injury or of a suppurating wound upon the surface of the body where the septic disease originated, or discharge of an ichorous nature through a natural orifice of the body, especially from the vagina; but these lesions may be absent.

In postmortem examination there are especially to be observed:

1. Cloudy swelling of the heart, liver and kidneys, which is sometimes accompanied by fatty degeneration. The latter should not be mistaken for normal fatty livers of animals which are in an advanced stage of pregnancy or have recently given birth to young.

2. Swelling and serous infiltration of most lymphatic glands. These may also be permeated by isolated hemorrhages or hemorrhagic foci. Lymph stasis, following obstruction in the circulation (as for instance in traumatic pericarditis), should not be mistaken for marked saturation of the lymph glands in the dependent portions of meat that is hanging up.

3. Petechiæ—ecchymoses and suggillations—under the serous membranes and in the mucous membranes, for which the so-called asphyxiation hemorrhages should not be mistaken (page 235).

4. Bloody imbibition of the intima of the great blood-vessels.

5. Blood-stained serous exudates in the thoracic and abdominal cavities.

6. Imperfect coagulation of the blood.

7. Insufficient rigor mortis and imperfect bleeding.

8. Soft, withered, watery character of the meat, which has a singular, generally dark color, and sometimes develops a peculiar sweetish repugnant odor, which, as a rule, appears only during the cooking test.

9. Alkaline reaction of the meat, which is permanent (compare page 43).

10. The existence of a center of origin for the septic disease, which in many instances may be present only as an insignificant lesion, and sometimes it cannot even be detected.

11. The duration of the course of the disease must be in certain relation to the intensity of the infection.

The recognition of sepsis, from the pronounced features of the disease, is not difficult, especially if a point of origin can be demonstrated, but in new cases, and where infection is obscure, the diagnosis may be difficult. In such instances all changes, even insignificant ones, must be observed and their relative importance carefully weighed. There should always be taken into consideration the fact, correctly pointed out by Ostertag, that the more prominent pathological changes in the internal organs, by which the marked symptoms may be explained, are very often absent, and that sepsis, nevertheless, may be present regardless of the absence of these lesions. In doubtful cases, and especially where immediate slaughter becomes necessary, a second examination must be made after twenty-four hours. In some instances

the method proposed by Basenau (page 167) may be of aid in reaching a diagnosis.

The septicemic diseases of cattle appear chiefly in the following forms, the most important characteristic symptoms of which alone are here given:

1. *Septic Polyarthritits of Calves*, following septic infection of the navel (septic omphalophlebitis in calves).—Flaccid inflammation of the navel, with dirty red, offensive secretions, very often accompanied by ichorous disintegration of the umbilical vessels, serous arthritis with gelatinous infiltration of the peri-articular portions, especially of the tarsal and carpal joints, as well as of the radio-ulnar, hock, and hip-joints, tumefaction and marked saturation of the muscular lymph glands and sometimes icterus are present.

2. *Hemorrhagic Enteritis of Calves*, which runs a rapid course; so that in some cases no cloudy swelling of the parenchyma is observed. Bloody diarrhea, blood-stained intestinal contents, and acute hemorrhagic enteritis, especially of the small intestines, with swelling and bloody saturation of the mesenteric lymph glands, are observed. The disease is probably a form of scour of calves (p. 339).

3. *Septic Enteritis of Cattle*, similar to the foregoing, but incomplete with regard to symptomatology. Every inflammation of the intestines of cattle, accompanied by severe febrile and general disturbances, must be looked upon as suspicious of sepsis.

4. *Septic Metritis of Cows*, which follows retention of fetal membranes, or injury to the genital passages. In the latter there are mostly diphtheritic patches and ulcers. Septic metritis is accompanied by pelvic peritonitis, saturation of the pelvic connective tissue, and marked infiltration of the sacral and iliac lymph glands. It has been emphatically stated by Albrecht that not all febrile diseases of cattle caused by metritis are of septic nature from the beginning, and with timely slaughter and good bleeding the meat may not be injurious to health. Perhaps Albrecht's case was one of general sapremic intoxication caused by secondary retention (page 320). On the other hand, great precaution is necessary when cattle are slaughtered in an advanced stage of the disease, and when there is incomplete bleeding or extensive gangrenous alteration of the genital passages.

5. *Septic Pleuritis and Peritonitis* are caused by external injuries, or by perforation of the intestines, respectively, as a result of ulcerations or necrotic processes.

6. *Septic or Traumatic Pericarditis*.—This affection appears only in cattle, and is caused by penetration of foreign bodies through the stomach into the pericardium. Cases of pericarditis, however, are not always accompanied by offensive secretions of a septic nature.

7. *Septic Mastitis of Cows*.—This is distinguished from other inflammatory conditions of the udder by its rapid progress, accompanied by severe general symptoms. It may affect at least one-half of the udder or the entire udder, which is considerably swollen, dark red and hot, with corresponding swelling and infiltration of its lymph glands. Extension of the inflammation to the abdominal wall and to the surface of the inner thigh may follow.

8. *Septic Wounds and Injuries* of any kind and origin may lead to septicemia. Wounds of the joints, deep puncture wounds, with improper drainage and wounds on the digits, with extensive destruction of tissue, predispose to septicemia.

9. In classifying *morbus maculosus* (petechial fever, purpura hæmorrhagica) of horses and cattle under septicemic forms, the author agrees with Ostertag, Hutyra, Marek and others to the effect that the most striking symptoms of the disease, *i. e.*, hemorrhages and marked changes in the parenchyma indicate that *morbus maculosus* is a septic intoxication.

Judgment.—From experience gained in cases of meat poisoning it is essential that carcasses of all food animals affected with sepsis should be considered unfit for human food on account of their danger to health, and such disposal should be made of them as would cause no harm. As the toxalbumins of septicemia bacteria are not positively destroyed by heat, the use of this meat even in a cooked condition is not permitted.

The practice proposed by Basenau, namely, the feeding of fresh and cooked meat to mice to prove that it is poisonous, cannot be recommended universally on account of the circumstances frequently accompanying suspected cases of septicemia.

In accordance with B. A. I. Order 211, Regulation 11, Sections 10 *b* and 18 *a*, carcasses showing lesions of septicemia should be condemned.

PYEMIA.

Pyemia is a disease of the blood caused by microorganisms entering into the circulation and resulting in the development of metastatic abscesses or suppurative osteomyelitis (osteomyelitis suppurativa). It is described as a purulent blood poisoning.

Pathogenesis.—The pus-forming microorganisms, which are the exciting causes of pyemia, are principally *Staphylococcus aureus* (*Micrococcus pyogenes*, Fig. 129), and *Streptococcus pyogenes* (Fig. 130). They usually enter the blood directly through a local suppurative focus or indirectly through the lymph channels; the disease may also develop from an obscure origin.

As long as bacteria circulate in the blood they will produce fever. Elimination from the circulation may follow if they become deposited in the various organs, the lungs and liver coming first into consideration, then the kidneys, spleen, bone-marrow, joints, muscles, brain, etc. The results of suppurative emboli differ according to the character of the pyogenic bacteria. In cases where the beginning of embolic suppurative foci is characterized by the appearance of grayish-yellow areas, that are surrounded at first by a red zone, the emboli may be considered as principally streptococcic. From these foci, abscesses develop in the interior of the organs, their growth being arrested by encapsulation, and later the abscesses become consolidated by drying and calcification. Accordingly, recovery from pyemia is possible and is not infrequent in food animals. The disseminated pus-forming organisms, however, may also produce suppurative inflammation of the serous membranes.

When, on the other hand, the changes described below occur in the marrow they should be considered as due to staphylococcic emboli (Ostertag).

Symptoms and Lesions.—Clinically, the disease can only be diagnosed as pyemia by the presence of local suppurations, accompanied by intermittent high fever and depression. If, in addition, there is inflammation of the joints and of the bones, or if affections of the lungs or

kidneys are manifested, then the seat of the metastatic abscesses is indicated. The pathological lesions are the result of the pathogenic effect of the bacteria. It is to be especially observed, however, that as long as actual pyemia exists there are always manifest appearances of severe infection of the blood, and particularly cloudy swelling of the parenchyma, punctiform hemorrhages in the kidneys, lymph glands and under the serous membranes; these are present in addition to the above-mentioned punctiform, puriform foci, or suppurative inflammation and changes in the bone-marrow.

The recognition of pyemia in slaughtered animals is not difficult when the disease is well developed. In the first stages the diagnosis must be established even without the presence of the metastatic suppurative foci, by means of the other symptoms of a general blood



FIG. 129. — *Staphylococcus aureus*. Stained preparation from a pure culture. $\times 1000$ diameters. (After Weichselbaum.)



FIG. 130.—*Streptococcus pyogenes*. Stained preparation from a pure culture. $\times 1000$. (After Weichselbaum.)

infection, especially if local suppuration or local osteomyelitis be present; when doubtful, it would be advisable to protect the consumer by condemning the carcass.

Although pyemia may develop as a consequence of any local suppurative process, the following forms, whose symptomatology deserves only slight mention, may be particularly noted:

1. *Pyemic Polyarthritis*, occurring especially in calves (pyosepticemia in calves, suppurative inflammation of umbilical vein). It may also exist without a conspicuous affection of the umbilicus as a disease of the carpal, tarsal, radio-ulnar, hock, and femoro-tibial joints with corresponding general symptoms. Attention is also called to the fact that numerous instances of recovered cases of pyemia in calves have been noted.

2. *Hemorrhagic and Purulent Osteomyelitis* is often of obscure origin. At first there is hyperemia of the bone-marrow with hemorrhages therein, but later, puriform softening of the bone-marrow occurs with suppurative ulcerations in the joints.

3. *The Pyemias Following Swine Plague and Caseous Pneumonia*, especially in sheep, goats, and calves, present no special characteristics.

4. *The Pyobacillosis of Pigs*, under certain conditions, may run the course of pyemic cachexia; but symptoms of acute intoxication are not prominent.

Judgment.—The causes of suppuration in animals and man are identical, and the meat of pyemic animals contains pus-producing bacteria with their metabolic products (toxalbumins). Such meat has been shown to be injurious to the health of mankind by the numerous poisonings which have occurred through infection, and must be designated as unfit for human food, for even boiling does not remove its injurious properties.

It is not yet established whether the toxicity of the meat from pyemic animals is due to the pus-producing organisms alone, or to the introduction of other microorganisms (enteritidis and colon bacilli) from the intestines into the tissues of the body as a result of severe constitutional disease.

When metastatic abscesses occur in the animal body, without any constitutional symptoms—processes which therefore do not belong to pyemia as such, and can be viewed only as possibly healed pyemia—the portions of the carcass not infected are always to be considered harmless. A distinct encapsulation of the abscesses is not always necessary; but in no case should any signs of blood poisoning be present. In certain cases (for instance, suppuration of the body lymph glands and joints, muscular abscesses) it may be necessary to consider the meat as unfit for food on account of its deteriorated or spoiled condition.

For hypophrenic abscesses, see page 231.

Contamination of meat with pus from the heart of vena cava, in which pus enters after death from rupture of hypophrenic and hepatic abscesses, has been described by Lohbeck, Reimers, Haffner.

According to B. A. I. Order 211, Regulation 11, Section 10 *b*, carcasses showing lesions of pyemia should be condemned.

PUTRID INTOXICATION.

Putrid intoxication or sapremia (Ostertag) recently separated from the clinical diagnosis of septicemia, is more rarely observed in meat inspection since septic processes are frequently associated with it. Sapremia is an intoxication of the blood produced by resorption of the products of metabolism of saprophytes (saprophytic bacteria) which are situated in a portion of the organism not engaged in nutrition (necrotic areas, thrombi, hematoma, retained secretions and excretions) and produce decomposition. The bacteria, it is true, produce constitutional disturbances, but this, however, is not marked, as the toxins present in the blood are destroyed by active, healthy cells. Parenchymatous affections are absent or are insignificant on postmortem examination of sapremic animals, but they invariably show a putrefactive process of bad odor.

In traumatic pericarditis of cattle pure clinical examples of sapremia may be occasionally observed. In these cases marked changes will frequently be found in the heart and pericardium with very malodorous masses of exudates, showing no signs of fever during life, nor presence of any other pathological lesions. Occasionally the meat will be found

edematous, or organic diseases of other organs may be present and for this reason it will be necessary to declare the meat unfit for food.

On account of the possibility of transmission of the putrid odor from the exudative masses in the pericardial sac to the rest of the meat, the boiling test should always be applied.

In retained placenta of cattle there may develop at the beginning a purely sapremic constitutional disease, which may lead to recovery under proper treatment in spite of slight or moderate fever. In these cases the meat of animals slaughtered early and showing no signs of sepsis is harmless. However, on account of complications with inflammatory lesions of the uterus (septic metritis), care should be exercised.

Carcasses showing putrid intoxications are judged in the Meat-inspection Service of the United States on the same lines as infection with septicemia or pyemia, and therefore should be condemned.

ERYSIPELAS OF HOGS.

Observations made from time to time have established the fact conclusively that the erysipelas of hogs may be transmitted to man under certain conditions, occurring particularly as localized lesions, and that the organism isolated from such lesions in man is identical with the *Erysipelothrix rhusiopathiæ* causing the disease in swine. However, on account of its relation to other swine diseases, this infection will be considered in the following section.

INFECTIOUS DISEASES CHARACTERISTIC OF FOOD ANIMALS BUT NOT TRANSMISSIBLE TO MAN.

Swine Erysipelas.—Erysipelas of swine, also called rotlauf and bacillary erysipelas, is a frequently occurring epizootic disease, produced by a specific bacillus (*Erysipelothrix rhusiopathiæ*), discovered by Löffler.

The disease may be divided into an acute septicemic erysipelas and a chronic urticarial erysipelas, but for practical meat inspection purposes the former should be differentiated from the latter.

Pathogenesis.—The erysipelas bacilli, which may also develop ectogenously, gain admission to the organism through the digestive tract or through wounds of the skin. Perhaps they are normally present in the body of the hog (intestines, tonsils), but under certain conditions they may become pathogenic, according to the observations of Olt, Bauremeister and Jensen.

The erysipelas bacilli are about 0.8 to 1.5 microns long, 0.1 to 0.2 micron wide, and stain with basic aniline stains; also by Gram's method (Fig. 131). In nutrient gelatin media at room temperature stab cultures assume the characteristic bottlebrush shape after three or four days (Fig. 132). The bacilli are not particularly resistant to atmospheric influences. While Petri's observations, which have been practically verified by Stadie, showed that the usual preparation and conservation methods of handling meat are not sufficient to kill the organisms; heating in a steam kettle destroys them.

After passing through mice, the erysipelas bacilli lose their virulence for hogs (Prettner).

The bacilli, after gaining entrance into the blood, multiply rapidly, producing toxins whose action extends particularly to the blood, the larger organs of the body and the nervous system. In the majority of cases the disease runs a fatal course, and on account of its dangerous character frequently leads to the emergency slaughter of the animal.

Symptoms and Lesions.—In the living animal, redness of the skin is particularly noticeable, occurring in spots on the inferior part of the abdomen, inner thigh surfaces, breast, neck and ears. The red spots spread rapidly, turn blue or brownish-red, and are evenly discolored. At the same time there exist severe general disturbances, such as fever, debility, anorexia, constipation followed by diarrhea, accelerated breathing, etc.

The pathological lesions vary with the stage of the disease during which the animal was slaughtered. It frequently happens that when the hog is scalded the redness of the skin becomes even more intensified, and may extend deep into the subcutaneous fatty layer (Speckschicht). In addition there is but slight "bleeding out," insufficient rigor mortis, enlargement of the spleen, parenchymatous degeneration of the liver, heart and kidneys, which latter usually show hemorrhagic inflammation, hemorrhages beneath the serosa and in the cortical layer of the kidneys, hemorrhagic gastroenteritis,



FIG. 131.—Bacilli of swine erysipelas. Dried blood preparation.
× 500 diameters.



FIG. 132.—Erysipelas bacilli, stab culture in gelatin; five days old at room temperature.

swelling of the intestinal lymph follicles, enlargement and marked transudation of the mesenteric glands and other lymph glands, which may also show punctiform hemorrhages. In severe cases, and especially in animals slaughtered when approaching death, the musculature appears serosanguinolent, grayish-red and has a tendency to decompose rapidly. Endocarditis valvularis verrucosa may be observed as a sequel. The chronic form is frequently associated with arthritis, accompanied by lameness and enlargement of one or several of the joints.

The symptoms furnish sufficient basis for the recognition of the disease, the demonstration of the erysipelas bacillus being best effected through specimens taken from the splenic pulp. Inoculated mice or pigeons succumb after three or four days, and a culture will develop the characteristic properties within the same period of time.

The difficulties experienced at times in differentiating between acute swine erysipelas and acute hog cholera, both clinically and on postmortem examination, has necessitated the working out of certain blood tests as aids in making definite diagnosis in such cases.

Two such tests have been worked out by the Federal Bureau of Animal Industry, one of which is a rapid agglutination tube test, for laboratory diagnosis, and the other a rapid whole blood or plate test, for use by veterinarians in the field. The technic of the latter is very similar to the rapid blood test for pullorum disease. The antigen used for these tests is made from broth cultures of the swine erysipelas organism which are killed during the process of preparation of the antigen.

These tests, while new and subject to further improvement, have been found of considerable aid in diagnosing outbreaks of swine erysipelas, but of course they will not in themselves eliminate the possibility of hog cholera also being present coincidentally.

Differential Diagnosis.—In order to avoid confusion in the recognition of septicemic erysipelas there must be considered:

1. *Swine Plague and Hog Cholera.*

—The symptoms of both these diseases resemble in the acute stage those of erysipelas; in the slaughtered animal, however, the anatomical findings will differ decidedly.

2. *Urticarial Erysipelas.*—This disease during life produces characteristic skin macules, while on postmortem examination there is an absence of the lesions in the viscera. At most there may be present enlargement of the spleen or liver if the animals are slaughtered at the height of the disease.

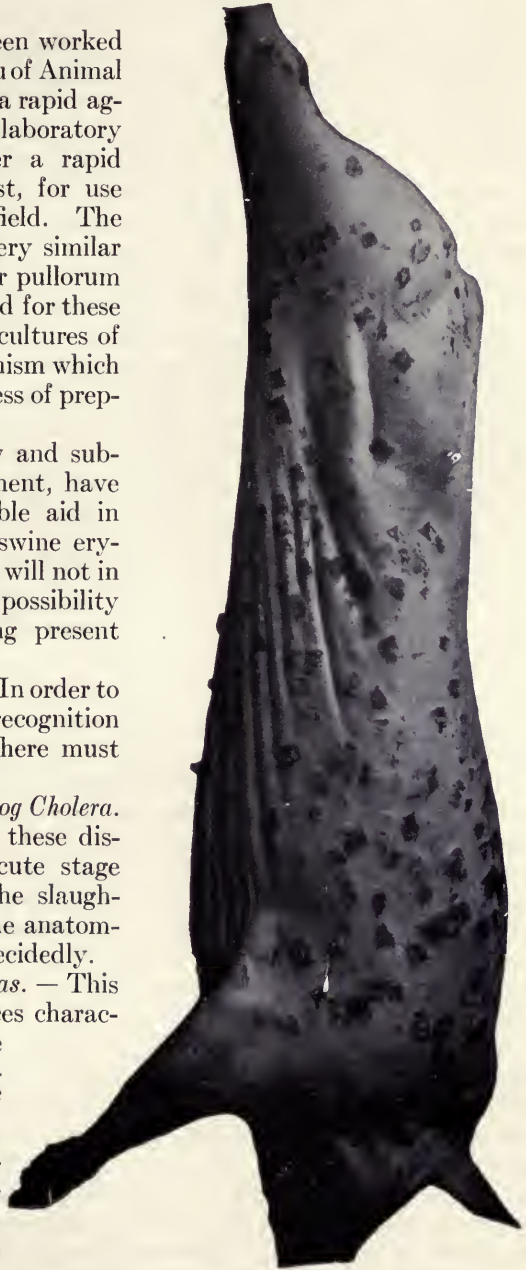

FIG. 133.—Side of a hog with urticarial erysipelas.

3. *Erythema of Thermic or Mechanical Nature*.—These changes are confined to the skin of certain portions of the body only, and in mechanical injuries hemorrhages occur; internal lesions are absent.

4. *Heat Stroke*.—This frequently occurs in summer transportation of hogs, and is accompanied by bluish-red discolorations of the skin, the latter, however, being mostly hypostatic; on postmortem examination indications of suffocation will be found.

5. *Wound Erysipelas*.—This condition, being almost always restricted to the head, is usually unilateral and characterized by severe infiltration of the subcutis of the parts affected. Kleinert has observed two cases in hogs of more extensive erysipelas of the head, breast, abdomen, outer surface of the thighs, back and ears, associated with putrid metritis (suppurative metritis).

6. *Anthrax*.—This disease is not frequent in hogs, occurring generally as gloss anthrax. Demonstration of the bacilli confirms the diagnosis.

Judgment.—For judgment of erysipelas in hogs, see page 329.

Urticarial Erysipelas.—Nettle fever, or diamond-skin disease, of hogs is a macular hemorrhagic dermatitis, accompanied by febrile constitutional symptoms, and runs a mild course. Since Lorenz, Jensen, Schütz, Luepke, etc., have demonstrated erysipelas bacilli in the skin, the disease is classed with erysipelas, although the other symptoms differ from it.

In this country Creech (1921) reported the finding of the swine erysipelas bacillus in 5 different cases of urticarial lesions in swine. Therefore, the disease of urticaria or diamond-skin disease now existing in the United States should in the future be classed as a chronic form of swine erysipelas, just as it has been considered heretofore in European countries.

It has also been definitely established that acute swine erysipelas likewise prevails in the United States. For some time only isolated cases of the disease were encountered occasionally, but during the last eight years the disease in certain localities has become more prevalent and has assumed the proportions of distinct outbreaks in which considerable losses have been sustained in the herds affected. Cases of the disease in man have also been reported more frequently in the last few years, especially as wound infections in veterinarians and butchers.

Field observations indicate that the swine in this country have either the acute, subacute or chronic form. Hogs surviving acute swine erysipelas either make a complete recovery or pass to the subacute or chronic form of the disease. In the latter form arthritis is frequently noted, with marked enlargement of the joints, which may affect 50 per cent of the pigs in the herd. Sloughing of the skin is also observed in some of these chronic cases. However, as a rule, in chronic cases the clinical findings are characterized by flat, red, round, or rhombic skin plaques, which rapidly increase in size and number. In the slaughtered animal the plaques usually present a rhombic shape (Fig. 133), and extend deep into the cutis and even into the subcutis. Diseases of internal organs are absent in slight cases, but severe cases may be associated with enlarged spleen and hyperemia of the liver.

The recognition of urticarial erysipelas is easy; to avoid confusion, it will be necessary to consider the diseases mentioned in the discussion on differential diagnosis of erysipelas.

Judgment.—The diseased skin areas should be removed and no further restriction placed on the meat if the carcass is otherwise fit for food.

(B. A. I. Order 211, Regulation 11, Section 15, Paragraph 2.)

Swine Plague.—Swine plague or swine septicemia (Löffler, Preisz) is a subacute or chronic contagious disease of hogs, frequently occurring associated with hog cholera in the same animal. The pure forms of swine plague are characterized by severe pneumonia, accompanied by pleuritis and pericarditis and their complications and sequelæ.

According to Ostertag, every inflammation of the lungs in hogs which cannot be proved to be caused by foreign bodies, parasites, tubercle bacilli or pus bacteria is to be suspected as being swine plague.

Pathogenesis.—Swine plague is caused by bacteria which are usually oval in shape, but occasionally bacillus-like (*Pasteurella suisepitica*.) They belong to the group of bacteria causing hemorrhagic septicemia (Hueppe), *i. e.*, rabbit septicemia (Koch).

The bacteria (Fig. 134) are about 1 micron long, 0.5 micron wide, oval, immotile and take a bipolar stain with gentian violet. According to Priesz, this is best accomplished when stained with aqueous fuchsin, and then decolorized with alcohol or weak acetic acid. These bacteria are found in the blood as well as in the diseased tissues.

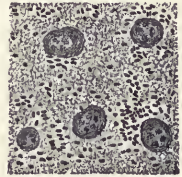

FIG. 134. — Swine plague bacteria. Dried blood preparation. \times 500 diameters.

The bacteria of swine plague enter the body through the respiratory organs or by the digestive tract and from there to the blood, producing a rapid or gradual general infection similar to septicemia. The lungs are the sites of predilection for their destructive action. In accordance with the virulence of the swine plague bacteria, various "types" are noted, but they do not differ morphologically.

The course of the disease may be peracute, simulating hemorrhagic septicemia; acute, as a multiple caseous pneumonia; chronic, with the symptoms of a catarrhal pneumonia, the latter being the most common form. Recovery may occur, leaving more or less extensive pathological lesions, such as adhesions between the pleuræ and between the lungs and pericardium, fibrosis of the lung tissue, and caseous, sequestered areas. When swine plague and hog cholera occur in the same animal, Preisz holds that in acute cases the latter infection is primary, while the former is only secondary.

Symptoms and Lesions.—The clinical symptoms depend on the course of the disease; for at one time they are of general septic infection, while at others those of pneumonia will predominate. The special pathological conditions are severe pneumonia in various stages of hepatization with multiple necrosed areas, hemorrhagic, fibrinous pleuritis and pericarditis, and occasionally peritonitis may be associated. During the height of the disease there are also marked enlarge-

ment and redness of the lymph glands with hemorrhages in them as well as in the kidneys, degeneration of the large organs, and occasionally icterus.

It may prove difficult to recognize swine plague in the living animal; therefore, diagnosis in some cases cannot be made with any degree of certainty except when marked pneumonic symptoms (cough) are present. In slaughtered animals diagnosis is verified by the conditions described, by bacteriological examination, and through inoculation of white mice, which die in from one to three days' time. Only in acute forms of swine plague are bacteria found in the blood, while in chronic cases they are only present in parts affected, though according to Junack it is impossible to find bacteria in about one-third of all the cases diagnosed as chronic swine plague. Certain types of the *Pasteurella suis-septica* develop long forms in addition to short forms, but they do not occur in the animal body.

According to the most recent investigation swine plague as an independent infection occurs only rarely. The cases which have been considered as pure forms of swine plague are now in most instances known to be hog cholera infection caused by the filterable virus. The pulmonary lesions of hog cholera previously thought to be characteristic of swine plague develop as a result of secondary invasion of the *P. suis-septica* in the same manner as the intestinal lesions are produced by the *Salmonella suis-pestifer* and other secondary invaders.

Differential Diagnosis.—In differential diagnosis the following diseases come into consideration.

1. *Swine Erysipelas.*—In acute cases of swine plague red coloration of the skin also occurs, but it is present only in those parts of the body involved by the disease. In swine erysipelas there are no characteristic pulmonary changes of swine plague; finally, the bacteriological and bacterioscopic findings will establish the nature of the infection.

2. *Hog cholera* in its initial stages, when the intestinal changes are not yet well developed or when mixed infection exists, which rapidly terminates the life of the animal.

3. *Tuberculosis* after the inflammatory changes have run their course. In swine plague there are not characteristic multiple infections of the lymphatic glands as in tuberculosis, the areas of caseation or necrotic areas of the lungs being without new formation of granulation tissue at the periphery; not are those peculiar secondary nodules of tuberculosis present in the vicinity.

4. *Verminous pneumonias* which occur *en masse* and may be readily recognized by the presence of parasites.

5. *Traumatic pneumonias* lead to gangrene, as a rule, and are found in the main lobes of the lung.

Judgment.—For the judgment of swine plague carcasses, see page 329.

Pyobacillosis of Pigs.—Pyobacillosis, pyemic cachexia of pigs, occurs in young hogs quite frequently as a non-acute disease, and is caused by the *Hemophilus pyogenes*, which is erroneously viewed by Grips, Nieberle and Glagè as belonging to swine plague. The disease is characterized by catarrhal changes or

suppurative catarrh of the intestines and air passages, associated with sero-fibrinous inflammation of the pleura, pericardium and peritoneum, as well as by suppurative or caseated changes in the lungs, with hepatization and atelectasis in their vicinity. A generalization of the pyobacillus and suppurations in the joints, bones, tendon sheaths, muscles, body lymph glands, mammae, etc., are also observed.

In the judgment of pyobacillosis, its form of appearance and the nutritive condition of the animal must be taken into consideration. As the latter is often greatly impaired, the entire carcass usually must be condemned and this is also the case where suppurative changes are generalized.

As pigs are rarely slaughtered while affected with pyobacillosis, but, as a rule, die of the disease, the importance of meat inspection is not significant in this disease.

The Federal Meat Inspection provides that carcasses of pigs affected with pyobacillosis should be judged on the same principles as pyemia, and, therefore, should be condemned.

Hog Cholera.—Hog cholera, or swine fever, is an infectious disease of hogs which runs partly an acute and partly a chronic course; it is characterized by marked lesion in the digestive apparatus and an infiltration of the lymph apparatus, especially of the lymphatic glands. In many instances the disease occurs complicated by swine plague.

Pathogenesis.—Formerly the *Salmonella suispestifer*, whose portal of entry is the digestive tract, has been accepted as the cause of hog cholera; but investigations have proved that the disease is due to an ultramicroscopic filterable virus, and that the hog cholera bacilli bring about changes only secondary to the condition produced as a result of the presence of the invisible virus. This is the view of de Schweinitz and Dorset, McFadyean, Hutyra, Ostertag and Stadie.

Hutyra and others believe that the invisible filterable virus is responsible not only for so-called hog cholera, but for swine plague as well, and that the respective bacilli of these previously considered separate diseases are merely secondary invaders.

The *Salmonella suispestifer* (Fig. 135) is a short, motile, typhoid-like bacillus with rounded ends, 1.2 to 1.5 microns long, and 0.6 micron wide. The bacilli lie singly or arranged in pairs and possess flagella. The latter may be indistinctly visible if the specimens are stained with Löffler's flagella stain. The bacilli stain best with Löffler's alkaline methylene blue solution and are most readily found in the mesenteric lymph glands. In more advanced necrotic changes resulting from hog cholera the necrosis bacilli also come into consideration (Bang, Preisz, Karlinski, Ostertag, Kitt).

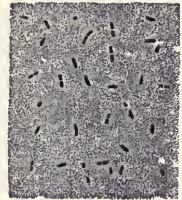

FIG. 135. — *Salmonella suispestifer*. Pure culture. $\times 500$ diameters.

As a result of the invasion of the organism by the filterable virus of hog cholera there occur, according to the virulence of the virus and the resistance of the tissues, either hemorrhagic intestinal inflammations with infection of the blood and a rapidly lethal course, or chronic forms with marked destruction of the intestinal canal and mesenteric lymph glands.

Symptoms and Lesions.—The clinical symptoms in the development of hog cholera vary. In acute cases there are fever, diarrhea, red petechia

of the skin, with exanthemata on the ears, nose (snout), the inner surfaces of the thighs and around the anus, suppurative conjunctivitis, great weakness and debility. In the less rapid course variable symptoms arise (constipation and malodorous, green diarrhea), those of the intestinal canal predominating; also emaciation, weakness, chronic skin exanthemata with crust formation. When complicated with swine plague, symptoms of chronic lung disease with dyspnea, cough, etc., may be observed.



FIG. 136.—Portion of large intestine with lesions of hog cholera.

The pathological lesions in the peracute cases correspond to those of hemorrhagic septicemia with croupous and necrotic changes of the intestinal mucosa. In less acute types there is a specific affection of the colon, the mucosa of which present croupous-diphtheritic changes. Corresponding to the solitary and multiple lymph follicles of the intestinal mucous membrane, there are millet to hazelnut-sized, definitely circumscribed or confluent caseous, yellow, button-like projecting ulcerations covered with a crust-like dirty coat (Fig. 136). On removal of the latter the irregular ulcers are exposed. The ileocecal valve especially is, as a rule, pathognomically enlarged and caseated (Ostertag). These changes are in some cases recognizable on the exterior of the intestine as prominent yellowish-gray spots. In addition to this, it is by no means uncommon to find certain portions of the intestinal wall quite rigid, hypertrophic, or even the entire large intestines may be grown together into tough, thick rolls. If such is the case there will, as a rule, be found fibrous adhesions to the peritoneum also. Similar characteristic areas and ulcers develop also in the small intestines. The mesenteric glands are always swollen, of a dark bluish-red or

pale color, and partially or entirely caseated. Similar changes are also usually observed in the cervical, and occasionally in the pelvic lymph glands. Croupous diphtheritic membranes may also be found on the mucosa of the tongue, cheeks, gums, tonsils, pharynx and epiglottis. The spleen may be enlarged and injected, and the kidneys present petechial hemorrhages in the cortex.

If a multiple caseous pneumonia is present it is an indication of a complication with swine plague. Whether the metastatic bone and joint caseations and suppurations in the chronic cases are a part of the

descriptive symptoms of hog cholera or of pyobacillosis still remains to be proved.

Differential Diagnosis.—Recognition of the developed chronic forms of hog cholera is not difficult, but the following diseases must be considered in differential diagnosis:

1. *Swine erysipelas* in acute and peracute cases of hog cholera. In addition of the absence of the swine erysipelas bacilli there is the absence of the intense hemorrhagic nephritis and the presence of intestinal lesions.

2. *Tuberculosis of the Digestive Apparatus.*—Differentiation from this disease is indicated by the extensive destruction of the intestinal mucous membrane, the total caseation of the lymph glands, the absence of the characteristic tuberculous nodules in the vicinity of the lesions, the absence of calcification in the affected lymph glands and the absence of tuberculous changes in other organs.

Judgment of the Meat in Swine Erysipelas, Swine Plague and Hog Cholera.—In view of the fact that the meat of these diseased animals has frequently been used for food without ever having incurred any impairment or injury to man, it can hardly be classed as injurious to health; in individual cases, however, the following should be considered:

1. The entire carcass is unfit for food as soon as marked substantial changes (congestion of blood, serous infiltration, degeneration, yellow discoloration) of the musculature or fatty tissue are observed, or when marked emaciation has occurred.

2. In all other cases, with the exception of the chronic forms of swine plague and the sequelæ of this disease and those of hog cholera, the carcass in all three of these diseases is to be considered fit for food, but subject to certain conditions. For veterinary sanitary reasons and partly in consideration of the presence of the causative agents in the blood of cases of swine erysipelas, swine plague, and the acute forms of hog cholera, the meat and fat are to be boiled, steamed (rendered into lard) or pickled. The portions affected by the disease should be condemned.

3. In case of slow chronic forms of swine plague, without disturbance of the general condition, or sequelæ of this disease (adhesions, cicatrices, capsulated caseated areas, etc.), or of hog cholera (caseation of the mesenteric lymphatic glands, adhesions of intestines, formation of cicatrices in the intestinal mucosa), only the affected portions of the meat are to be condemned and destroyed. The remainder of the carcass is fit for food without any restriction.

The Federal Meat-inspection Regulations (B. A. I. Order 211, Regulation 9, Section 2, Paragraphs 2 and 3) provide that all hogs plainly showing on antemortem inspection that they are affected with either hog cholera or swine plague shall be marked "U. S. condemned" and disposed of in accordance with Section 8 of this regulation.

If a hog has a temperature of 106° F. or higher, and is of a lot in which there are symptoms of either hog cholera or swine plague, in case of doubt as to the cause of the high temperature, after being marked

for identification, it may be held for a reasonable time, under the supervision of an inspector, for further observation and taking of temperature. Any hog so held shall be reinspected on the day it is slaughtered. If upon such reinspection, or, when not held for further observation and taking of temperature, then on the original inspection the hog has a temperature of 106° F. or higher, it shall be condemned and disposed of in accordance with Section 8 of this regulation.

And it is further provided that the carcasses of all hogs marked as suspects on antemortem inspection shall be given careful postmortem inspection, and if it appears that they are affected with either acute hog cholera or swine plague, they shall be disposed of as follows:

Carcasses of hogs which show acute and characteristic lesions of either hog cholera or swine plague in any organ or tissue, other than the kidneys or lymph glands, shall be condemned. Inasmuch as lesions resembling lesions of hog cholera or swine plague occur in the kidneys and lymph glands of hogs not affected with either hog cholera or swine plague, carcasses of hogs in the kidneys or lymph glands of which appear any lesions resembling lesions of either hog cholera or swine plague shall be carefully further inspected for corroborative lesions. On such further inspection—

(a) If the carcass shows such lesions in the kidneys or in the lymph glands or in both, accompanied by characteristic lesions in some other organ or tissue, then all lesions shall be regarded as those of hog cholera or swine plague, and the carcass shall be condemned.

(b) If the carcass shows any organ or tissue, other than the kidneys or lymph glands, lesions of either hog cholera or swine plague, which are slight and limited in extent, it shall be passed for sterilization in accordance with Regulation 15.

(c) If the carcass shows no indication of either hog cholera or swine plague in any organ or tissue other than the kidneys or lymph glands it shall be passed for food, unless some other provision of these regulations requires a different disposal.

In disposing of certain carcasses on account of hog cholera, the following additional instructions shall be observed:

In conclusive but suspicious symptoms of hog cholera observed during the antemortem inspection shall be duly considered in connection with postmortem findings, and when the carcass of such a "suspect" shows lesions in the kidneys and the lymph glands which resemble lesions of hog cholera, they shall be regarded as those of hog cholera and the carcass shall be passed for sterilization.

When a hog which on antemortem inspection showed no symptoms of hog cholera, but on postmortem shows lesions in the kidneys and lymph glands which resemble lesions of hog cholera and in addition shows slight and limited lesions of hog cholera in one other organ or tissue, the carcass shall be passed for sterilization.

A careful antemortem inspection shall be made of all lots of hogs in which animals are observed showing positive or suspicious symptoms of hog cholera. The symptoms of each animal marked as a "suspect"

shall be recorded descriptively on M. I. Form 119-A for appropriate evaluation by the veterinarian making final disposition of the carcass.

Swine which have been injected with hog cholera virus within ten days immediately preceding the date they are offered for slaughter shall be condemned on antemortem inspection.

Swine which have been injected with hog cholera virus within twenty-one days, but not less than ten days, immediately preceding the date they are offered for slaughter if otherwise in fit condition shall be marked and handled as United States suspects and if slaughtered within the period specified, the carcasses shall be passed for sterilization provided the autopsy reveals no cause for condemnation.

Swine which have been injected with hog cholera virus not less than twenty-one days immediately preceding the date of slaughter shall be given antemortem and postmortem inspection in accordance with the regulations without reference to the injected virus.

Influenza of Swine.—Swine influenza has been more recently recognized as a definite disease, the first cases having been observed by Koen in Iowa, who also termed the infection swine "flu." Shope established a specific virus as the cause of the infection; its relation however to influenza of men and horses has not been definitely proved. The disease is highly contagious and the initial infection is of a benign character, but may become serious as a result of supervening complications, especially when appropriate prophylactic measures are not inaugurated. Devitalized animals are especially susceptible, more so during and following shipment. They manifest severe thumping, high temperature, listlessness and inappetence. In most instances when the affected animals are placed in dry quarters, free from draughts, they usually recover within a few days. The mortality rarely exceeds 5 per cent unless followed by other infections. The postmortem usually reveals pneumonic areas in the lungs which, even after the recovery of the animals, may reveal atelectasis. The disposition of the carcasses depends on the nature and extent of the involvement of the lungs and should be governed by the regulations prescribed for pneumonia.

CONTAGIOUS PLEUROPNEUMONIA OF CATTLE.

This epizootic disease of the lungs is a chronic, contagious pleuropneumonia peculiar to cattle. It was eradicated from the United States in 1892.

Pathogenesis.—The cause of the disease, according to Nocard and Roux, seems to be minute, motile microorganisms of indefinite morphology, which enter the lungs by the air passages and gradually produce progressive pleuropneumonia, beginning in the connective tissue of the lungs.

Symptoms and Lesions.—Since the clinical symptoms of this disease, when occurring in isolated cases, can never be diagnosed on antemortem inspection, they will not be discussed here.

The anatomical lesions, however, are quite characteristic (Plate II, Fig. 2). The unilateral inflammation of the lungs is superficially recognized by a varying grade of pleuritis and the coarse condition of the changed portion of the lung, which contains no air. Section of the diseased area will reveal marked proliferation of the interlobular connective tissue, which will be found thick, gelatinous, intermixed with fibrinous, grayish-yellow bands, about 2 cm. wide, separating the compressed lung lobules and the lobules of the adjoining lung sections. The diseased lobules may appear singly or in groups with varying degrees of inflammation, while fresh inflammatory lobules will be seen lying beside older forms. Hyperemic, edematous and bright red hepaticized lobules alternate with dark red, liver-like lobules and with some which show a grayish-yellow to grayish-brown color. The latter are cloudy, dry and point to an early stage of necrosis, which may lead to sequestration of smaller or larger lung areas. As a result of the condition just described, the lung presents a marbled appearance on section (Plate II, Fig. 2). The inflammation of the pulmonary pleura extends also to the other pleural surfaces, in advanced cases of the disease and leads to extensive fibrin deposits, adhesions and collections of exudate within the pleural sac.

Differential Diagnosis.—Pleuropneumonia is recognized quite readily when the above-mentioned pathological lesions are present. Only in quite recently formed cases will any difficulty of diagnosis be met, and in these great care should be exercised on account of the grave consequences which might follow an error in diagnosis.

Pleuropneumonia may be mistaken for—

1. *Foreign body (traumatic) pneumonia*, which occurs either at one particular point only or in multiple places, and may also present a marbled appearance. Here the foreign body may be demonstrated, however; and in the latter case the widely distributed areas will not suggest pleuropneumonia.

2. *Genuine croupous pneumonia*, which, however, is rare, usually occurs on the right side and presents uniform processes throughout.

3. *Hemorrhagic septicemia* of cattle in the pectoral form. Here the rapid clinical course and the anatomically uniform acute pulmonary inflammation differentiates it from pleuropneumonia. Mice and rabbits die of hemorrhagic septicemia within twelve to thirty-six hours after inoculation.

4. *Contagious bronchopneumonia of calves*, which occurs as a lobular catarrhal inflammation of the lung without involving the interlobular tissue.

5. *Pneumonocystis*, which is readily recognized microscopically.

Judgment.—As the meat of animals suffering from pleuropneumonia is not harmful to man as food, it may be declared serviceable after removal of the diseased portions, provided emaciation, fever, serous infiltration and other conditions of the meat do not impair its value. It would be necessary to condemn the carcass only exceptionally in cases of pronounced emaciation with serosity.

Contagious pleuropneumonia of cattle does not exist at the present time in the United States and as the regulations governing the importation of cattle prescribe a quarantine of thirty days, counting from the date of arrival at the quarantine station, which constitutes the longest period for the incubation of this contagion, it is not likely that the disease will reappear in this country, and accordingly it is not of any great interest in meat inspection.

BLACKLEG.

Symptomatic anthrax or blackleg may attack cattle, sheep, goats, very rarely horses and also hogs, but this infectious disease is usually restricted to certain localities. Blackleg is characterized by the formation of gas-containing swellings in the subcutis which rapidly spread.

Pathogenesis.—Blackleg is caused by anaërobic bacilli, *Clostridium chauvei*, which enter the organism through abrasions of the skin or mucous membrane.

The bacilli measure 3 to 6 microns in length and 0.5 to 0.7 micron in width, are motile as long as they have not developed spores, and stain readily; they do not stain by Gram's method however. They are never found in the circulating blood, but always in the subcutaneous and intermuscular connective tissue (Fig. 137).



FIG. 137.—Blackleg bacilli with spores. Muscle juice from guinea-pig. Cover-glass preparation. \times 1000 diameters. (After Hutyra and Marek.)

After the bacilli have gained entrance into the body there develop crepitating, rapidly spreading swellings in the connective tissue, especially of the neck, shoulders, beneath the breast, thigh, flanks, and more rarely at the gums, base of tongue and wall of the pharynx, accompanied by severe general febrile symptoms.

Symptoms and Lesions.—The symptoms in the living animal correspond to the preceding description. Anatomically the subcutis and the intermuscular connective tissue beneath the partly necrosed skin appear of a yellowish color, bloody, permeated by air bubbles and of an offensive odor, which in many instances is similar to that of rancid butter. At these points the musculature is a muddy brownish-red, crepitating and very juicy; the corresponding lymphatic glands contain a bloody serous infiltration, are swollen and contain hemorrhagic areas. The latter are also found under the serosa. Serosanguinolent extravasations or exudates in the body cavities and occasionally perirenal and mesenteric bloody gelatinous infiltrations are noted. Degenerations of the heart, liver and kidneys occur, while the spleen and blood remain unchanged.

Differential Diagnosis.—Blackleg is easily recognized in differential diagnosis. The following diseases must be considered:

1. *Malignant edema*, which need rarely be differentiated clinically from blackleg. Anatomically, attention should be directed to the foul

necrotic odor of the edematous swellings, the more plump morphology of the edema bacillus (page 313), which in addition possesses spores in the center of the organism and not at the end, as is the case with the blackleg bacillus. The latter do not develop into threads in the cadaver like edema bacilli.

2. *Anthrax*.—The clinical course of this disease differs considerably from that of blackleg, and in the slaughtered animal the blood and spleen alterations, as well as the demonstration of the bacillus of anthrax, serve to differentiate it from blackleg.

3. *Mechanical subcutaneous emphysema*, which clinically and anatomically differs entirely, particularly in that it produces no necrosis of the skin.

4. *Phlegmons* of the subcutis as a result of pyogenic wound infection run a much slower course than blackleg and remain localized.

Judgment.—If blackleg is found on antemortem inspection, or if it is even suspected, slaughtering of the animal is to be forbidden. The meat of animals suffering from blackleg, although not injurious to man, must be condemned on account of the marked substantial changes therein, and is not to be considered fit for human food. (B. A. I. Order 211, Regulation 11, Section 6 a.)

That the so-called "parturient blackleg" is not true blackleg, but a form of malignant edema, has already been stated on page 313.

Reindeer pest is quite similar to blackleg, and this is mentioned on account of the fact that no inconsiderable quantities of reindeer meat are imported into Germany. In reindeer pest there is found gas formation in the subcutis, the intramuscular, subpleural and subperitoneal tissues, and especially abundant beneath the renal capsule. As compared with blackleg it is found the reindeer pest differs also in the presence of abundant gas formation in the internal organs. The cause of reindeer pest, according to Lundgren and Bergman, are aerobic rods, thinner than those of blackleg or anthrax bacilli, forming spores either in the middle or at the end, and staining by Gram's method. On account of the great similarity to blackleg, the meat of animals affected with reindeer pest is to be judged like that of blackleg.

BRADSOT.

The disease called bradsot (rapid plague), or braxy, is an acute infectious disease of sheep, which originated in Iceland, Norway, Scotland, and occurs in Germany, according to Peters, in Mecklenburg, Pomerania, and also in Middle Germany (Dammann and Opermann, R. Fröhner). It occurs almost exclusively during the winter months, particularly in young animals, and in its nature it is a gastro-mycosis.

Pathogenesis.—Bradsot is produced by the *Clostridium gastromycosis* (*Bacillus gastromycosis ovis*) (Neilsen), an anaerobic, slender, motile schizomycete, which stains by Gram's method. It forms central or polar spores, and is frequently found arranged end to end.

The entrance of the bacillus into the digestive tract produces a hemorrhagic, abomaso-duodenal inflammation followed by general infection or intoxication.

Pathology.—On account of the frequent peracute course of the disease clinical conditions, such as debility, gnashing of teeth, difficulties

of respiration, coma and tympanitis, are rarely observed. The anatomical changes have been described in the pathogenesis. In addition to these, there occur occasionally fibrinous infiltrations of the subcutaneous connective tissues, with gas formation and serosanguinolent exudates in the abdominal cavity. Decomposition sets in quickly.

Judgment.—Although injury to human health is unlikely as the result of ingestion of meat from sheep affected with “bradsot” as has been noted by certain observers, it is necessary to condemn it on account of the severe general infection or intoxication which is present.

In view of the rapid course of the disease, it is not likely that many sheep affected with this disease will be brought to abattoirs for slaughter.

However, the occurrence of the disease would naturally require a condemnation of the affected carcasses on account of the severe infection and intoxication.

RINDERPEST (CATTLE PLAGUE).

Cattle plague is an acute infectious disease peculiar to cattle, which may be transmitted to other ruminants, and occurs as a severe febrile general infection associated with inflammation of all mucous membranes, especially those of the digestive tract. The plague has disappeared from all but the eastern part of Europe and has never occurred in the United States. Little is known in regard to the nature of the infectious material.

Symptoms and Lesions.—Clinical symptoms: Chills (rigor), high fever, marked depression, constipation, and after a few days catarrh of all visible mucous membranes, which are stained scarlet red, either diffusely or in spots (petechiæ). Difficulty in respiration and dysenteric feces, occasionally mixed with blood, occur later. The visible mucous membranes show erosions, upon which grayish-white crusts appear, and when these are cast off ulcers become visible. As the animals rapidly emaciate, the secretions of the mucous membranes become discolored, pus-like, malodorous and the temperature sinks to sub-normal.

The anatomical lesions, according to Kitt are: In the primary stages hyperemia and catarrhal condition of the mucous membranes, then croupous diphtheritic exudates, with marked hyperemia, particularly along the entire digestive tract, and at the orifice of the female genitals; occasionally simultaneously croupous exudate in the bronchi occurs. To these are added ecchymosis of the heart and exanthema of the skin. The third stomach is frequently filled with very dry, powdered fodder; the gall-bladder is usually full and distended; parenchyma degenerated; musculature wasted, soft and filled with small blood extravasations.

Diagnosis.—In order to recognize cattle plague, which is exceedingly difficult in isolated cases, all of the diagnostic factors must be most carefully considered, such as the symptom-complex, autopsy findings, the course of the plague and its history.

Differential Diagnosis.—It may be mistaken for:

1. *Malignant catarrhal fever*, in which, however, the mucous membranes of the head, the respiratory apparatus and the eyes are particularly involved, and in which the viscera are intact. It usually occurs only enzoötically.

2. *Dysentery and Mycotic Enteritis*.—Here the intestinal symptoms predominate and the other pest symptoms are absent.

3. *Poisoning, Especially Mercurial and Caustic Poisons*.—Here the contagion is absent, and the generalized croupous diphtheritic inflammation of the mucous membranes is also lacking.

4. *Infectious hemoglobinuria of cattle* (page 281), when on postmortem examination of cattle which have died from this disease, ulcers and lamellar deposits are found in the abomasum and duodenum (Hutyra, Marek). There is, however, an absence of the changes in the oral mucous membranes, the air passages and genitals, while the hemoglobin-containing urine will attract attention.

Judgment.—The killing or slaughtering of animals affected with cattle plague or those suspected of having this disease is to be prohibited. Although the meat of cattle-plague animals has been proved to be harmless to man when used for food, it must, nevertheless, be destroyed or declared unfit for food on account of the great danger in spreading the disease.

As the disease does not exist in the United States, there are no provisions made in the regulations for the judgment of animals affected with rinderpest; it is, however, self-evident that the occurrence of the disease would require condemnation of the affected carcasses with strict veterinary police regulations to prevent its spread.

VESICULAR EXANTHEMA OF HORSES AND CATTLE.

This contagious disease of the genital organs, which occasionally produces a constitutional disturbance, is mentioned here only on account of its veterinary police (sanitary) importance.

Symptoms and Lesions.—Marked redness and swelling of the mucous membrane of the vagina, prepuce and penis, itching, slight discharge and strangury, development of delicately covered vesicles of sizes from a milletseed to a dime, which burst and change into superficial ulcers. They form brownish crusts and heal, leaving white cicatrices. It is sometimes difficult to observe the symptoms in bulls, since only fine erosions and small vesicles appear on the mucous membrane of the prepuce. In severe cases there occur confluent, deeper penetrating ulcers, with suppuration and foul pus, more marked discharge, and swelling of the surrounding parts as well as grave febrile general disturbance.

Judgment.—The meat of animals afflicted with vesicular exanthema is generally fit for food; in severe cases, which, however, are rarely brought for slaughter, the grade of the disease and complications present decide whether the meat is to be entirely condemned.

The Federal meat inspection provides that carcasses of cattle affected with vesicular exanthema may be passed for food, provided the disease has not caused general systemic disturbances and the lesions are confined to the genital organs, which should be condemned.

For contagious vaginal catarrh or granular vaginitis, see page 234.

HEMORRHAGIC SEPTICEMIA (GAME AND CATTLE PLAGUE).

This disease, belonging to the group of septicemia hæmorrhagica (Hueppe), occasionally occurs epizootically in cattle, deer and black game, and in isolated cases may be transmitted to the horse, goat and hog. It appears in pectoral and exanthematous forms, though both may occur together.

Pathogenesis.—The cause of this disease (*Pasteurella bovisseptica*), which simulates that of swine plague, may gain entrance to the organism in various ways, corresponding to the above-mentioned forms of the disease. According to Dammann and Oppermann, a species of gnat (*Simulia ornata*) is the intermediate host in the transmission of this affection. The bacilli produce local inflammations, and passing into the blood create various changes resembling the course of sepsis.

Symptoms and Lesions.—In cattle the exanthematous form is the most frequent. The clinical symptoms are the rapidly developing warm swellings of the subcutis of the head and neck, with high fever and difficult respiration. Anatomically there are sanguino-gelatinous exudations on the head and neck, marked swelling of the retropharyngeal and cervical lymphatic glands, cloudy swelling of the large viscera, and hemorrhages into most organs.

The pectoral form, which predominates in game, runs the clinical and anatomical course of severe croupous pleuropneumonia, with marked dyspnea. The above-mentioned hemorrhages are never absent.

In both forms there also exists marked hemorrhagic enteritis, which is noticeable clinically by bloody discharges in addition to the severe general constitutional condition. These intestinal forms or symptoms were formerly described as a special intestinal form of *game and cattle plague*.

The positive recognition of the plague *intra vitam* is oftentimes impossible, though *per postmortem* it is quite easy. The presence of the bacteria, inoculation of rabbits and mice, and feeding infectious material to birds, causing death to all within twelve to thirty-six hours, confirm the diagnosis.

Differential Diagnosis.—It may be mistaken for:

1. *Anthrax*.—In hemorrhagic septicemia the marked splenic changes are absent, and the blood alterations and anthrax bacilli as well.

2. *Pleuropneumonia*.—From this disease the uniform age and synchronism of all the diffuse pneumonic areas in game and cattle plague differ considerably.

3. *Malignant edema, blackleg and rinderpest*, whose differential diagnostic features have already been cited.

Judgment.—The slaughter of animals affected with hemorrhagic septicemia should be prohibited, and they are to be treated like those affected with anthrax.

In view of the danger in spreading contagion, the entire carcass is to be condemned, although the ingestion of the meat by man is not dangerous to health. (B. A. I. Order 211, Regulation 11, Section 6 *b*.)

MALIGNANT CATARRHAL FEVER OF CATTLE.

This miasmatic infectious disease peculiar to cattle is characterized by marked inflammation of all mucous membranes of the head and eyes, accompanied by severe constitutional and cerebral disturbances. It is also called malignant epizoötic catarrh.

Pathogenesis.—The still unknown infectious principle sometimes causes, in addition to the above-mentioned symptoms, a more extensive affection of the respiratory apparatus as well as croupous diphtheritic inflammation of the digestive tract, and occasionally vesicular or nodule-like skin exanthemata (skin eruptions), while nephritis, cystitis, and colpitis may also occur.

Symptoms and Lesions.—The most prominent clinical symptoms are rapidly increasing fever, marked fatigue, impairment of sensation, muscular tremors, inflammation of the mucous membranes of the head, particularly those of the eyes, difficulty of respiration, diarrhea, which may be mixed with blood, and rapid emaciation. Predominating anatomical lesions are catarrhal or hemorrhagic, later croupous and diphtheritic inflammations of the mucous membranes of the entire respiratory apparatus, and occasionally also involving the digestive apparatus; great congestion of blood in the cranial cavity; marked swelling of the lids, conjunctivitis, keratitis, and even iritis; enlargement of the spleen and cloudy swelling of the liver and kidneys, which are usually not marked; at times nephritis, cystitis, colpitis, and the above-mentioned skin changes may occur.

Differential Diagnosis.—The recognition of the well-developed cases of malignant catarrhal fever is not difficult. For differential diagnosis should be considered:

1. *Rinderpest*, in which the affection of the eyes is conspicuously absent and in which the rapid course is characterized by the predominating gastric symptoms, while in catarrhal fever the affection of the respiratory apparatus is most marked. In catarrhal fever the organs are only slightly involved, whereas in animals suffering with rinderpest they are greatly degenerated.

2. *Mycotic enteritis*, when the intestinal infection of catarrhal fever predominates. Here are noted, however, the absence of marked depression symptoms and changes in the mucous membranes of the head.

Judgment.—The meat is not injurious to man as food. It may, however, have to be condemned in advanced cases on account of the occurring emaciation and the objective changes in the meat (increased blood contents, etc.).

According to B. A. I. Regulations carcasses of animals affected with malignant catarrhal fever or malignant epizoötic catarrh and showing generalized inflammation of mucous membranes shall be condemned.

NECROTIC STOMATITIS (DIPHTHERIA) OF CALVES.

Diphtheria of calves is not related to diphtheria in man, and occurs comparatively infrequently as an infectious disease with rapid course of

development, characterized by the appearance of croupous diphtheritic patches on the mucous membranes of the oral cavity.

Pathogenesis.—The exciting cause of the disease is the necrosis bacillus (Bang), which appears as short rods (1.8 to 2.4 microns long and 0.6 micron wide), and also as filaments (Fig. 138). Without doubt the bacillus, also termed *Actinomyces necrophorus*, gains admission through wounds or abrasions, whereupon it effects its further action by way of the blood. Sepsis may be associated with the course of this affection.

Symptoms and Lesions.—The clinical symptoms are similar to those of foot and mouth disease, but in addition, cough, difficulty of respiration, and diarrhea occur. Pathologically there are noted in advanced cases croupous-diphtheritic ulcers on the mucous membrane of the mouth, pharynx, larynx, trachea, stomach and intestinal canal, pneumonic areas, and also cloudy swelling of the internal organs.

Recognition of necrotic stomatitis of calves is based on the above-mentioned findings, which are not likely to be mistaken for anything else, unless it be foot and mouth disease.

Judgment.—If the animals are slaughtered in the early stages the meat may be passed for food; later it becomes unfit for food on account of rapid emaciation and general constitutional symptoms, which produce such changes as to render it unfit for food. This is also the case when sepsis has occurred.

From the standpoint of Federal meat inspection, necrobacillosis may be regarded as a local affection at the beginning, and carcasses in which the lesions are so localized may be passed for food if in a good state of nutrition, after removing and condemning those portions affected with necrotic lesions. On the other hand, when emaciation, cloudy swelling of the glandular organs, or enlargement and discoloration of the lymph glands are associated with the affection it is evident that the disease has progressed beyond the condition of localization to a state of toxemia, and the entire carcass should therefore be condemned as both innutritious and noxious. Septicemia or pyemia may intervene as a complication of the local necrosis, and when present the carcass shall be condemned.



FIG. 138.—*Actinomyces necrophorus*, showing coccoid, bacillary and filamentous forms.

DIARRHEA OR DYSENTERY OF CALVES (WHITE SCOUR).

White scour of calves is an infectious intestinal inflammation, which may occur also in other sucklings and sometimes appears enzootically.

Pathogenesis.—The exciting agents of dysentery, according to Jensen, Poels and Joest, are bacteria belonging to the colon group, which are facultatively

pathogenic and enter the blood from the intestinal tract, producing general infection with special localization in the intestinal canal. According to other investigators, the *Pasteurella bovisseptica* may also be a factor in the etiology of this disease.

Symptoms and Lesions.—The clinical symptoms possess no definite characteristics. Pathologically there is emaciation, anemia, reddish, blurred injection of the mucous membrane of the abomasum, and the entire intestinal tube, swelling of the mesenteric glands, and subserous hemorrhages, the musculature being flabby, lusterless and of a muddy red color.

With the aid of a microscope recognition of this disease is readily accomplished.

Differential Diagnosis.—It is apt to be mistaken for:

1. *Acute gastric and intestinal catarrhs*, in which, however, the course is milder, and in which the signs of blood infection are lacking.
2. *Diarrhea of septicemia and pyemia*, whose other symptoms, however, are usually easy of recognition.

Judgment.—When the calves are slaughtered after a general infection has set in the meat will have to be declared unfit for food, on account of the possibility of its being dangerous to health. As the bacteria are found in the blood and rapidly multiply in the carcass (Ostertag), caution is imperative from the well-known fact that certain varieties of the colon bacillus may assume marked pathogenic properties.

As white scour in calves represents a general infection, and since the disease is usually associated with general debility and emaciation, therefore, carcasses thus affected are condemned in the Federal Inspection Service.

DISTEMPER AND INFLUENZA OF HORSES.

Diseases of horses coming under this classification require no special notice here since they do not necessitate slaughter of the animals, because the diseases in question either run a mild course or cause death in severe cases, not bringing into question the possibility of emergency slaughter. If such an exceptional case should arise, however, judgment of the meat will not be difficult, when it is borne in mind that septic or pyemic infections may complicate the course of distemper, influenza and pneumonia of horses.

CHAPTER IX.

POSTMORTEM CHANGES OF MEAT.

THE first changes of the animal tissues after death are of a physico-chemical nature, such as the appearance of coagulation, changes of color, changes in reaction. The appearance of coagulation is most distinctly marked in the stiffening of fat in fat cells, and in the coagulation of myosin in striated muscles. The latter is probably brought on by acid formation in the muscles, and rigor mortis is the result. The muscles thus obtain an acid reaction, a condition which is designated as a simple souring of meat by W. Eber, who was the first to systematize the decomposition processes of meat. To this is added the sour fermentation which may occur in two forms:

FERMENTATION PROCESSES IN MEAT.

Simple sour fermentation begins with rigor mortis and produces the so-called "ripening" of the meat. The latter becomes more tender, appears more juicy and gradually loses the quality to take up a bright scarlet-red color on the cut surface. The cut surface then becomes light brown to yellow. The odor of the ripening meat is sourish—aromatic. Later, traces of formation of hydrogen sulphide (*haut goût*) may develop (W. Eber, Glage) as a result of the sulphur compounds present in the meat.

Beef, especially ribs and loins, are ripened commercially for special trade by holding them for about thirty days at a uniform temperature of 33° F. The dry white mould which forms during this process should be removed with a stiff brush and the meat faced up with a knife. Variation of temperature should be avoided in order to prevent spoiling of the meat.

The nature of ripening of meat consists, according to the investigations of Salkowski, Jacoby, M. Müller, Vogel, in fermentation processes, which may be designated as an autodigestion (Salkowski); or autolysis (Jacoby, M. Müller); also as a physiological destruction of the meat (Glage).

Stinking sour fermentation occurs in meat which could not cool out. Thus it appears in game which is tightly packed while still containing body heat, or in meat of slaughtered animals if it is piled up without being sufficiently chilled. The condition is designated in game as "over heated;" in meat, as "suffocated."

This condition is termed "sour side" in the United States, and is produced by hanging the sides too close to each other in the cooler, thus preventing the proper circulation of cooled air between them; and also by too sudden chilling of the carcass, whereby insufficient time is given for gradual disappearance of body heat.

In game the hair can be pulled out by the handful from the skin, the subcutis is colored green, and the cut surfaces of the copper-red colored muscles change in the same way; gas bubbles may appear. The last two changes are also observed in pieces of meat of food animals.

The stinking products contain large quantities of H_2S . The detection of fermentation processes is not difficult because of these described changes. The presence of an acid reaction is necessary, and the absence of ammonia.

The investigations of McBryde show that *ham souring* as encountered in the wet cure, where the hams are entirely submerged in pickling fluids, is due to the growth of the *Clostridium putrefaciens* within the bodies of the hams. (See Fig. 139.)

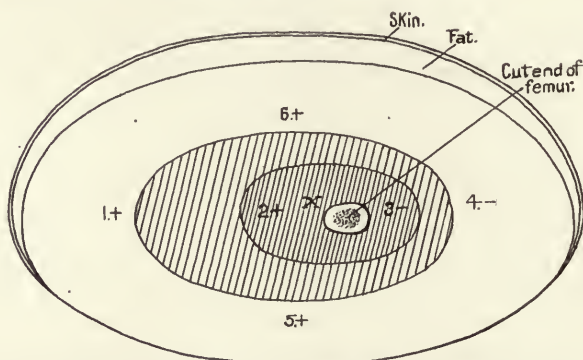

FIG. 139.—Cross-section through body of artificially soured ham, showing sour areas and points at which cultures were taken. Darker shading indicates sour area in hams pumped in body and shank; light shading indicates sour area in hams pumped in shank only; figures indicate points at which cultures were taken; plus signs indicate presence of bacillus; minus signs indicate absence of bacillus; X indicates point of inoculation. (After McBryde.)

Judgment.—While meat in a state of simple sour fermentation is suitable for human consumption, as a matter of fact it is designated in that condition as “table ripe;” on the other hand, meat showing the slightest trace of stinking sour fermentation should be considered highly spoiled and be condemned as injurious to health.

PUTREFACTION OF MEAT.

Putrefaction of meat is a highly complicated bacterial and chemical decomposition, which by adequate treatment, curing or preserving, may be checked. On the other hand, it is above all superinduced by heat and moisture. The last two factors facilitate the growth of putrefactive microorganisms.

Nature and Development.—Obligatory anaerobic bacteria come into consideration as agents of putrefaction, especially the *Clostridium putrificum* (Bienstock), *Clostridium œdematis maligni* (page 313), *Clostridium sporogenes*, *Bacillus gangrænæ emphysematosæ*, for whose existence and development satisfactory conditions are produced on the surface of the meat through abstraction of

oxygen by the aërobic bacteria. Of the aërobic bacteria in putrefactive meat, there may be found *staphylococci*, *Escherichia coli*, species of proteus (Figs. 140 and 141) and particularly the *Salmonella enteritidis*, Gärtner. The *Bacillus paraputrificus* (Beinstock) retards putrefaction.

The action of putrefactive microorganisms consists in the decomposition of albuminous bodies and gelatinous substances, which are broken up into fatty acids and bases, amino-acids, CO₂, NH₃, H₂S, and other gases which produce a disagreeable odor. The freer the access of oxygen to the putrefactive meat, the quicker and more completely decomposition progresses (rotting). With an insufficient supply of air a stinking putrefaction develops. As end-products of putrefactive decomposition there develop, according to Gotschlich:

1. Gases (CO₂, CH₄, H₂, N₂, NH₃, H₂S).
2. Fatty acids (formic, acetic, butyric, valerianic, palmitic acid).
3. Oxy- and polybasic acids (lactic, succinic, oxalic acid).
4. Various other substances (amines, amides, amino-acids, leucin, tyrosin, aromatic acids, indol, skatol, peptone, ptomains, toxins).

Toxins appear to assume the properties of strong poisons only in the presence of a free supply of air (Neilson).



FIG. 140.—*Proteus vulgaris*. From a pure culture. × 730 diameters. (After Weichselbaum.)



FIG. 141.—Colony of the *Proteus vulgaris* with swarming processes. Gelatin plate. × 70 diameters. (After Weichselbaum.)

Proteolytic enzymes are formed with produce liquefaction. From the hydrolysis of protein material amino-acids and polypeptides result, the former decomposing into leucin, tyrosin, histidin, etc., known as ptomains, which were formerly incriminated as the agents of food-poisoning.

Kühl has shown the influence of sugar upon decomposition. Putrefaction occurs the quickest in non-sugar containing media, while it is much slower in the presence of lactose because when the sugar is fermented acids are produced which inhibit the growth of putrefactive bacteria. The putrefaction of meat occurs in a very similar manner.

Salus, Rettger and others believe that true putrefaction with decomposition of protein and the formation of putrid-smelling products such as mercaptan and aromatic oxyacids occur only through the action of obligate anaërobes, while Lange, Poppe and others incriminate only aërobes or facultative anaërobes, in the decomposition of meat.

Lesions.—Putrefaction, as a rule, begins on the surface of meat and penetrates the deep parts, following the course of the connective tissue. The muscle fibers proper resist putrefaction for some time. Meat of animals which had febrile affection, or that of insufficiently bled animals,

putrefies more quickly than flesh of healthy animals. In dead animals which have not been deviscerated, both superficial and deep putrefaction occur simultaneously and in a short time, due to the blood content of the flesh and to the migration of putrefactive bacteria from the intestines into the neighboring veins. Carcasses of large animals decompose more quickly than those of smaller animals because they cool out more slowly.

Stinking, putrefactive, malodorous substances do not necessarily appear, as has been stated already, in all putrefactions; besides, they vary considerably in accordance with the kind of meat. In putrid meat sausages and salted meat, stinking odors are sometimes entirely absent. Some of the putrefactive odors appear more pronounced in treating meat with acids or alkalis; some again are uninfluenced by such treatment. Marked changes of color (turning dirty gray, gray-red, gray-green) are not always characteristic. Changes in the consistence appear noticeable only in advanced stages of putrefaction, and then the meat appears soft, friable, smeary and porous. The reaction is at first amphoteric and then alkaline through the formation of ammonia. Alkalinity alone, however, is no criterion of putrefaction, inasmuch as fresh organs, blood and muscles of many animals, as well as pickled and smoked meats, give an alkaline reaction. On the other hand, spoiled meat may give an acid reaction which occurs in that stage of decomposition where the oxyacids take the ascendancy. Putrefactive toxins are very resistant to the customary methods of preparing meats, and cannot be completely destroyed by ordinary boiling; they lose their poisonous effects after heating for one and a half hours at 100° C., according to Scholl.

For proof of putrefaction the changes of meat in relation to color, consistence, odor, taste, resistance, should be taken into consideration, but as they may vary greatly their detection must depend to a large extent on subjective perception by the inspector. For testing deeper putrefaction the use of a thin, steel "tryer" is recommended. It is thrust into the meat, particularly near the bone, and upon withdrawal is scented for the detection of any odor on the steel (see Fig. 149). Besides, the bacterioscopic and bacteriological examination shows very large numbers of anaërobic and aërobic bacteria. The agglutination test of Schönberg offers splendid advantages for the preliminary test of meat samples submitted for bacteriological examination. (See page 373.) The muscle fibers under the microscope appear cloudy, but not enlarged as in cloudy swelling. They are infected with numerous bacteria; triple phosphate crystals may be present.

According to Marxer, meat should be considered as putrefactive if 1 Gm. contains over 1,000,000 organisms of any kind, or proteus bacteria in large numbers. W. Eber recommends proving the presence of free ammonia, which develops in meat in all putrefaction; and his putrefactive test is based upon this fact. In opposition to this, however, Glage claims that it cannot by itself be decisive for the demonstration of putrefaction, as the presence of ammonia is not an exclusively

specific sign of putrefaction, and its development does not occur sufficiently early with the formation of toxins in the meat. While Eber's test for putrefaction has been found ineffective, no modern test has yet been discovered which is entirely satisfactory. Glage demands a bacteriological examination of meat which is in the act of decomposition by making smear preparations, cultures and animal experiments. However this requirement, which may be justified from a scientific standpoint, could be carried out in practice only with the greatest difficulty. In large pieces of meat examination should extend particularly to the deeper layers of muscles, as putrefaction of the surface may be present without involving deeper parts.

The putrefactive toxins need a thorough study with regard to the bacteria which form them and their resistance to higher degrees of temperature according to the species of bacteria producing them. It is well known that after the culturing of decomposed meat and the feeding of pure cultures of some of these putrefactive bacteria of small experimental animals, symptoms of sickness may occur. To obtain putrefaction toxins from decomposing meat Scholl recommends pressing the putrid fluid and soaking the residue with water at 40° C. for twenty minutes. He produced paralysis in the guinea-pig by injecting a small quantity of this fluid intraabdominally. Inasmuch as such toxins may disappear again through further decomposition, it has been recommended that material for examination should be placed in absolute alcohol, as the poison will thereby remain unchanged for a long time. The alcohol extract may then be evaporated and the residue dissolved with water. Subcutaneous injections of 1 to 2 cc. of this solution kills guinea-pigs and rabbits if strong putrefactive toxins are present.

For determining the bacterial content of meat and sausage products Bickert recommends grinding a sample in a sterile grinding machine, then in a ball mill for one hour and mixing with equal parts of sterile sand and four times the quantity of physiological saline culture. The bacterial content may then be determined bacteriologically according to the usual methods or more readily by the plate method.

The accepted signs of putrefaction are not present in all cases. Hydrogen sulphide may not be present in extensive superficial putrefaction, even with marked putrid odor. In the case of salt and smoked meats this odor may occur only at cooking.

In the determination of putrefaction Glassman and Rochwarger recommend the permutable method for the determination of combined ammonia. Scala and Bonamartini advocate the titring of reducing substances with 1 to 100 normal iodine solution. They assert that fresh meat does not contain more volatile reducing substances than suffice for the saturation of a definite amount of this iodine solution. If these reducing substances are so plentiful that more than double the normal amount of iodine solution is required for saturation, then the meat is designated as putrid. However, this entire subject needs further research in order to reach more decisive results. While these test methods may be used as an aid in the diagnosis of putrefaction in the presence of the usual signs of spoilage, they are not in themselves decisive.

Judgment.—The judgment of putrefactive meat which shows considerable perceptible changes is not difficult, as such would at once be considered highly spoiled and unfit for human food. In general, it may be considered injurious to health, but this is not in direct relation to the intensity of the putrefaction. The nature of the causative agents of putrefaction enters into this question; also numerous unknown

additional circumstances, and besides the symbiotic association of the bacteria present.

With reference to this condition, and in consideration of the significant poisonous properties of putrefactive toxins under various conditions (see Chapter XI), precaution should be taken to withhold even slightly putrid meat from the market; however, from the standpoint of law its injuriousness to health cannot be positively asserted. Therefore, in making a decision it should be with consideration of the forensic results.

In accordance with the regulations governing the Federal Meat Inspection, meats which on reinspection show evidence of putrefaction should be considered unhealthful and therefore unfit for human food.

MIXED PROCESSES IN THE DECOMPOSITION OF MEAT.

Various kinds of fermentative and putrefactive processes may naturally develop simultaneously in the meat, and it is not always possible to characterize their nature exactly. Especially difficult is the demonstration of the presence of the exceptionally dangerous *Clostridium botulinum* (page 377) in the meat either microscopically or bacteriologically. The judging in such cases has to depend principally upon the objective characteristics of the meat and the unfavorable conditions should be considered always as decisive.

MICROPHYTIC CHANGES OF MEAT.

Characteristics.—*Moulds.*—Mould formation on meat is usually the result of keeping meat in damp, poorly ventilated rooms. Of the known mould fungi, the penicillium, aspergillus and mucor species are especially apt to establish themselves on meat, the surface of which they cover with their white, gray or grayish-green tufts, which may also proliferate into the slits, gaps, vessels, and cuts of the meat (Figs. 142, 143 and 144).

For the chemical changes in mouldy meat, see results of Butjagin's investigations which contain the desired information.

Phosphorescence.—The phosphorescence of meat in the dark is the result of an infection of its surface with phosphorescent bacteria. The organism which comes principally into consideration in this connection is *Pseudomonas phosphorescens*, which, according to Molisch, is the most widely distributed phosphorescent bacterium.

Matzuschita classifies the phosphorescent bacteria into two groups, one of which liquefies gelatin, while the other leaves it unliquefied. To the first belong four species of the *Pseudomonas phosphorescens*, the *Achromobacter luminosus* and the *Achromobacter cyaneophosphorescens*; to the second, six additional species of the *Pseudomonas phosphorescens*.

According to Sacksland the phosphorescent bacteria are very resistant to extreme degrees of cold.

Red and Blue Colorations of Meat.—A spotted reddening of the surface of meat may be produced by an infection with various species

of the *Bacillus prodigiosus*, which under Bergey's classification is now called *Serratia marcescens*.

This condition should not be confused with the diffused reddening of boiled meat which has already been referred to on page 81, and which is produced by the action of nitrites and sulphites.

Superficial blue coloration of meat is produced by the *Pseudomonas syncyanea*.

Diverse Changes of Meat.—Besides the microorganisms already described, many other varieties thrive on meat. Their development is greatly favored by the suitable nutritive substance and by improper storing of the meat.

At this point there come into consideration the aroma bacteria (Glage), which belong to the ice bacteria, and which develop only on meat kept in cool places. They produce, besides ammonia, a fruit-like odor.

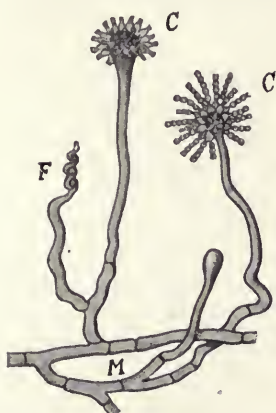

FIG. 142.—*Aspergillus glaucus*: C, conidia chains; F, young Eurotium perithecium; M, mycelium. $\times 300$ diameters.

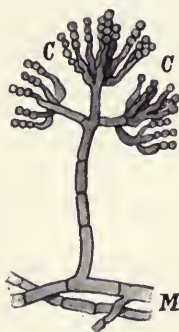

FIG. 143.—*Penicillium glaucum*: C, conidia; M, mycelium. $\times 300$ diameters.

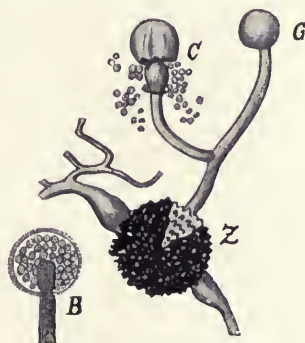

FIG. 144.—*Mucor mucedo*: C, burst sporangium with conidia; G, closed sporangium; Z, germinating zygosporangium; B, carrier of conidia with sporangium in a schematic longitudinal section. $\times 300$ diameters.

Since the causes of some of the infectious diseases of man (typhoid, cholera, scarlet fever, and others) thrive on meat, it should not be kept in the vicinity of a place where any such contagion exists.

Judgment.—In judging the changes of meat described in this section, it should be remembered that they are principally of a superficial nature, and do not otherwise affect the meat to a disadvantage. If, therefore, no decomposition (putrefaction, stinking fermentation) accompany these conditions, mouldy or phosphorescent meat or meat showing colored spots is, as a rule, neither injurious to health nor spoiled; and after removal of the fungoid vegetation or washing with vinegar it should be passed for food.

In the presence of moulds it should be remembered that meat might assume a mouldy taste and odor, which should be determined by the boiling test.

A highly spoiled condition, and with it an unfitness for food, occurs in the presence of marked mouldy taste and odor.

INSECT LARVÆ ON MEAT.

In warm weather we frequently find insect larvæ on meat to which flies have access. The offending flies, which are of several kinds, may deposit the eggs on the meat, or in other cases may deposit the living larvæ, so that in either case we have the living larvæ or maggots developing rapidly.

The following species may be mentioned:

Sarcophaga carnaria (flesh fly, meat fly).—This is quite a large fly ($\frac{1}{2}$ inch), rather slender body, gray, rear of body checkered, in fact the markings resemble those of the house fly, and its size is about the size of the "blow fly."

Living larvæ are deposited by the females upon fresh meat, or in the wounds of animals. They develop rapidly, consuming large quantities of flesh and, upon attaining their growth, crawl away and secrete themselves where they remain a few days in the pupa stage and issue forth as adults (Fig. 147).

Calliphora vomitoria (blow fly) is a widely distributed fly about four times the size of the ordinary house fly. It is familiar to us as the large fly which so noisily frequents the window or seeks entrance to cellars and store rooms.

This form differs from the preceding in that it lays eggs instead of living larva; otherwise it is very similar. The eggs which are laid on meat or in wounds, hatch out very rapidly, often in a few hours producing the larva of maggots so commonly seen on decomposed meat (Fig. 145).

Cynomyia cadaverina (or blue-bottle fly).—The history and habits of this species is quite similar to the preceding species. Its eggs are deposited upon any available fleshy material. The larvæ mature rapidly, developing into flies which are among the first to appear in the spring.

Musca domestica, or ordinary house fly, and the **Stomoxys calcitrans**, or ordinary stable fly, which so closely resembles the house fly are of no particular importance to us, except that they should be excluded from meat rooms and prevented from getting on meat on account of the danger of infection and filth being thus carried to food (Fig. 146).

Their breeding place is principally stable manure and filth.

Piophilha casei, or ham skipper.—This fly is small, glistening, black in color and lays its eggs on smoked ham, dried beef, cheese, etc. The eggs hatch into small, white, cylindrical maggots which feed upon the meat or cheese and when fully grown are $\frac{1}{8}$ inch long.

This maggot is commonly called a "skipper" from its wonderful leaping power, which it possesses in common with certain other fly larvæ, all of which are devoid of legs.

The skipper makes this leap or jump by bringing the two ends of the body together and then suddenly releasing them like a spring, by which means it will jump several inches.

The skipper is longer and more slender than the ordinary maggot and is a dreaded pest about meat plants during warm weather on account of the great difficulty in getting rid of it during the balance of the season after it has once gained a foothold there.

The skipper fly deposits eggs in more or less compact clusters of 5 and 15, and the average number of eggs appears to be about 30 to each female. These hatch in thirty-six hours, producing a white, cylindrical larva, tapering gradually toward the anterior end, and



FIG. 145.—*Calliphora vomitoria*. × 2 diameters.



FIG. 146.—*Stomoxys calcitrans*.
× 3 diameters.

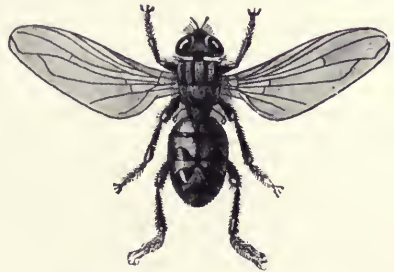

FIG. 147.—*Sarcophaga carnaria*.
× 2 diameters.

truncated posteriorly. They are furnished at the latter end with two horny projecting stigmata and a pair of fleshy filaments.

The larva completes its growth in seven or eight days (7 to 9 mm. long), and if food is abundant it does not move about much, but remains with others in groups in or near the same crevice where the eggs were deposited.

When it is mature, however, it moves to some dry spot, contracts in length, assumes a yellowish color and gradually forms into a golden-brown puparium (4 to 5 mm. in length) from which in ten days the adult fly emerges.

The entire life cycle may be concluded in three weeks, but some

authorities claim this often requires four to five weeks, with two or three generations during the summer.

In handling "skipped meat" precautions must be taken to prevent further infection of the rooms in which the meat is handled, as the skippers are very active and will jump or spring considerable distances. Many firms burn or tank this kind of meat on sight in order to destroy effectually all of the larvæ, as the packers have a dread of the parasite.

If only a few skippers are present the affected parts may be completely trimmed out and the balance saved, but steps must be taken to kill the larvæ either by immersing the meat in boiling water, or to render them inactive by placing the meat in ice-water so that the skippers will not spring from the infected parts to the free portions and thus render all of the meat unfit for use.

OTHER INSECTS ON MEAT.

Necrobia rufipes (red-legged ham beetle).—Two or three species of small beetles of the family Cleridæ, which are normally scavengers, feed occasionally upon dried meats. The most abundant of these in the United States is the one mentioned above.

It is a small (less than $\frac{1}{4}$ inch), rather slender beetle, of a dark bluish color and having red legs. Its larva is a slender white worm with a brown head and two small hooks at the end of the body, but as it becomes older it turns darker and when mature is of a grayish-white color with a series of brown patches above.

The larva is about $\frac{1}{2}$ inch long and when mature transforms itself into a paper-like cocoon, which has been called the "paper worm" by ham dealers. It is quite common in some sections of the South and West and occasionally becomes very abundant, causing heavy losses.

Whenever the canvas covering of the ham is broken in a storeroom where the fly is present the eggs are laid on the exposed meat (most frequently in May or June) and in a few days they hatch and the young grubs burrow into the fatty tissue near the rind, where they grow rapidly. They seem to congregate by preference in the hollow of the bone at the butt of the ham.

This may be prevented by careful canvassing of the hams early in the season.

Dermestes lardarius (larder beetle).—This is a dark-brown beetle with a pale yellowish-brown band containing six black dots across the upper part of the wing covers. It is about $\frac{3}{10}$ inch in length.

The larva is brown, hairy and tapering, being over $\frac{1}{2}$ inch long, and besides being a common museum pest, it is found in many kinds of animal products, such as hams, bacon, cheese, horns, hoofs, hair, feathers, etc.

This insect is a rapid breeder and may produce four or five generations annually. The larva seems to prefer food that contains fat and

connective tissue, seldom attacking muscle. When feeding upon dried and smoked meat it is usually seen creeping on the surface of the meat as it does not bury itself in its food until about time to assume the pupa stage.

Tyroglyphus longior, and **T. siro** (ham, cheese and flour mites).—These are very minute, more or less colorless, eight-legged creatures, which swarm in great numbers in old cheese and various stored products, such as dried meats, flour, etc.

The two species mentioned above are the most common and may be found feeding in common. They increase under favorable conditions with almost incredible rapidity and cause the entire destruction of such articles as cheese, etc., which become infested with them.

Under certain conditions, such as lack of food, etc., the soft mite has the power of changing form, acquiring a hard, brown protective covering into which all of the legs can be drawn in repose. In this condition they can prolong their existence almost indefinitely and are extremely tenacious of life, so that it is very hard to disinfect a room where they have gained a foothold.

Periplanæ americana et al. (cockroaches).—These are very common about meat rooms as well as dwelling houses, especially where there is heat and moisture. There are many varieties, but most of them do not interest us.

The common roaches are rather uniformly dark brown or dark colored. They are smooth and slippery insects and in shape are broad and flattened. The head is flexed under the body so that the mouth is directed backward and the eyes downward. The males usually have two pairs of wings, but in some species the females are almost wingless.

The legs are strong and powerful and armed with numerous strong bristles. The mouth parts are well developed and have strong biting jaws, enabling them to eat all sorts of substances.

(For the life history, see Farmer's Bulletin No. 658, U. S. Dept. of Agriculture, 1928.)

Roaches are especially abundant around cooking rooms and in dressing rooms; in fact wherever there is heat and moisture. They feed on almost any dead animal matter, cereals and food materials of all sorts, and the damage they do is not only in the products actually consumed, but in the soiling of everything with which they come in contact, as food supplies having this fetid, nauseous, roachy odor are tainted beyond redemption.

Judgment of Meat Contaminated with Insects and Insect Larva.—It is necessary to use discrimination and judgment in this matter, as the surface of otherwise good meat is quite often affected with insect larvæ, and in this case it is only necessary in many cases to trim away the infected and the surrounding meat; whereas if the larvæ penetrate into the meat to any extent it will be necessary to condemn it entirely.

In all cases we should, of course, take into consideration any changes which had occurred in the meat in question and be guided accordingly.

OTHER CHANGES IN MEAT.

Soiling.—In the soiling of meat during slaughter with urine, bile, intestinal contents, pus or ichor, it frequently happens that simple washing of the meat is not sufficient for their removal, and in such cases, especially in soiling with pus and ichor, the superficial layers of the meat should be removed.

For contamination of meat with anthrax bacilli, see page 303, and for contamination with pus-producing organisms, page 320. Decker's investigations show the possibility of the transmission of tubercle bacilli to the meat by contaminated tools of butchers.

Absorption of Odors.—Absorption of odors may occur through unsuitable storage of meat. Odors from the following substances are especially readily absorbed and retained: Carbolic acid, chlorine, turpentine, tar vapors, tobacco and carrion. The corresponding odor and taste appear, as a rule, only after the meat is prepared; therefore, a boiling test should be made in all suspected cases.

Sulphurous acid, according to Kieckton may occur in meat if it is kept in sulphurated rooms.

Carbolic acid can be demonstrated in meat by bromine water, which forms with a watery carbolic solution a yellowish-white precipitation of tribromide of phenol (Glage).

Metallic Poisons.—Metallic poisons may be transmitted to meat through unsuitably prepared storage containers (tin boxes, lead solder), or by machines for working up meat.

Judgment.—Judgment in these cases is in accordance with the cause.

Changes in Color.—Peculiar changes in color, the nature of which is yet to be determined, occasionally appear on boiling apparently normal udders of cows. The entire substance of the udder, after boiling is completed, appears of a bluish, dark blackish-blue or an ink-like color.

These changes are observed only after a certain time following slaughter, in the working up or during the culinary preparation of the tissue, and they are supposed to occur only in udders of older cows during lactation. Such changes cannot be predicted even after thorough examination of the organ in an unprepared condition.

While no injurious results to health, so far as known, have been observed from their ingestion, yet such changed udders should be condemned.

SOURING AND RANCIDITY OF FATS.

Fatty acids in large quantities develop in unrendered fats and in meats rich in fat when unsuitably stored, and may produce a souring of the product. The causes for this lie principally in the presence of fat-splitting enzymes, which split the fats into fatty acids and glycerin, and also to some extent to the action of fat-splitting microorganisms.

Souring takes place in unrendered fats through decomposition of the nitrogenous tissues, and in rendered fats, which are not free from moisture and scrap, through the action of microorganisms on the moist and dissolved nitrogenous material. Souring of unrendered fats is accompanied by

rapid splitting of the fat. In the souring of rendered fat which are mixed with moisture and scrap, the changes is at first confined to the suspended material, the fat remaining unaltered until considerable decomposition of nitrogenous matter has taken place. In the preparation of lard by steam rendering, and in the preparation of oleo oil, it is important to effectively separate moisture and scrap, as otherwise the conditions known as "tank water souring" and "sour bottoms" are apt to develop.

Rancidity is a chemical change taking place in fat, due to oxidation. Development of rancidity is promoted by exposure to air, light, elevated temperatures, and contact with metals. The odor and taste of rancid fats are due to the formation of aldehydes and ketones resulting from the breaking down of the fats.

Rancid odor may also be produced without any marked changes in the meat though infection with the *Clostridium botulinum*. However, in those cases souring of meat is absent, as the *Clostridium botulinum* grows only on alkaline soil.

Souring and rancidity in meat containing fat are recognized by the characteristic changes in odor and taste, both of which may be designated as stinking and repulsive. The degree of acidity, *i. e.*, the quantity of acid in fat, and its rancidity should be established by the chemist.

Judgment.—Rancid and sour meat products and fats should be condemned as unsound, although no injurious effect to health from the ingestion of rancid meat or free fatty acids has as yet been proved.

If *Clostridium botulinum* is the cause of the rancid changes then the meat is always injurious to health (page 377).

There is no single standard adopted in the United States by which the rancidity of meat and fat is judged. The condition, taste and odor are the guides by which the disposal is made.

The presence of more than 1.5 per cent of free acid in fat is ground for suspicion. When such a percentage of free acid is associated with a rancid, sour, or offensive taste or odor, condemnation is indicated. When the fat is sweet and clean, a higher percentage of free acid, possibly up to 5 per cent, may be tolerated. (See Chapter XV.)

CHAPTER X.

EXAMINATION AND JUDGMENT OF PREPARED AND PRESERVED MEATS, CHICKENS, GAME, FISH, AMPHIBIA AND CRUSTACEANS.

PRESERVED AND PREPARED MEAT.

THE properties of the preserved meat to be discussed in this section as well as the manner of obtaining it, have been amply discussed in Chapters I and III. For examination and judgment of such meat in general all the principles apply which have already been described in the previous chapters. Therefore, only those essential characteristics will be mentioned in the following discussion, which are of special significance for the kind of meat belonging here.

Ground Meat, Sausages and Meats Prepared by Culinary Methods.

—The composition and ingredients of ground meat and sausage, also of culinary prepared meat preparations when they consist of small pieces, are difficult to determine.

The addition of starch flour may be quite easily established by treatment with tincture of iodine or Lygol's solution. It is best to boil a small piece of the sausage, etc., in water, and then to the cooled decoction add Lugol's solution. Smearing the cut surface of sausage with iodine solution also discloses the blue coloration developing from the presence of starch flour; but in these cases the occurrence of single blue dots (starch from spices) should not be considered as intentional addition of starch. As is well known, the starch granules can also be easily recognized microscopically. The quantitative determination of the addition of starch should be entrusted to professional chemists.

Testing for mixtures of egg albumen and gum tragacanth ("albumina") (page 79) should also be left for the chemist.

For the tests for horse meat, see pages 71 and 75.

Trichina and measles are the principal parasites which should be given consideration. While microscopic examination of what are presumably pieces of pork might disclose the presence of trichina, such an examination will always remain incomplete for easily understood reasons, taking into consideration the comminuted masses of meat. This also should be considered in delivering an opinion.

Recent investigations have shown that trichinae may be detected in pork by the digestion of meat in cases of light infestations. The digestive fluid is made up as follows: to 1000 cc. of water add, scale pepsin, 2.5 gms.; hydrochloric acid, 10 cc.; common table salt, 3 gms.; 600 cc. of this solution will digest thoroughly in about eighteen hours in an incubator 50 gms. of meat. The fluid is decanted, the sediment centrifuged

and examined for trichinæ under a low magnification. By this method living and dead larvæ are readily recovered. The examination for measles is very circumstantial and uncertain.

In the matter of coloring materials, a striking red color of the ground (chopped) meat indicates mixture with sulphurous acid salts. When a superficial red coloration of boiled or roasted meat is present the nitrite action on the muscle-coloring matter mentioned on page 81 should be remembered.

Coloring of sausages with artificial materials (page 79) is suspected when the fat pieces present show a red coloration on their peripheries.

Examination for Spoiling and Decomposition.—Examination for spoiled conditions and decompositions should be made according to the instruction given on page 342. Spoiled sausages usually have a smeary appearance and show a cyst formation under the covering, which is brittle and separates readily from the sausage filling. Blood sausage, after it is spoiled, shows on its cut surface a pale red color; the odor is sour and the fat areas appear yellowish-green. The cut surface of liver sausage reddens after being spoiled, and very soon emits a sour odor. Jelly sausages turn soft, friable, smeary, sour and stinking. Meat sausages appear, according to the water contents, a uniform gray, grayish-green or reddish-yellow color, with a discoloration of the fat.

All sausages which are rich in carbohydrates putrefy under certain conditions very rapidly and strongly. Furthermore, all other manifestations of putrefaction, taste, mould formation, etc., should be considered.

Shilling undertook investigations in regard to the contents of dirt in sausage casings by examining fresh intestines which had been cleaned in the usual way. He found that each meter of hogs' small intestines weighing 2.16 Gm. contained 0.33 Gm. dry substance; hogs' large intestines weighing 4.98 Gm. contained 0.53 Gm. dry substance; cattle's small intestines weighing 2.47 Gm. contained 0.275 Gm. dry substance; cattle's large intestines weighing 5 Gm. contained 0.666 Gm. dry substance.

The considerable amount of dirt in the large intestines is caused by the number of deep folds.

Meat sausages, the filling in which has a gray border, or which has entirely turned gray (page 79) should not be considered as spoiled without further thought, but they should be examined for characteristic signs of fermentation and putrefaction.

Rancidity (page 352) should be determined by the sharp, harsh and consequently disagreeable taste. The quantitative test for rancidity should be made by a chemist, who should also establish the degree of acidity.

Judgment.—The judging of deviations mentioned here is made according to previously developed principles with regard to the spoiled condition and the presence of parasites.

In regard to the admissibility of starch flour in making sausages and the addition of so-called albumina, see pages 78 and 79.

Von Raumer demands punishment for adulteration when binding substances are used. Sausage prepared with 1 per cent of binding substance contained 63.075 per cent water; with 4 per cent of binding substance it contained 58.08 per cent of water, compared with 43.33 per cent of water in sausage without binding substances.

No meat or product shall contain any substance which impairs its wholesomeness, nor contain any dye, preservative or added chemical except as stated below.

There may be added to meat and products common salt, sugar, wood smoke, cider vinegar, wine vinegar, malt vinegar, sugar vinegar, glucose vinegar, spirit vinegar, pure spices, saltpeter, nitrite and nitrate of soda. Benzoate of soda may be added to meat and products only when declared on the label.

Only harmless coloring matters may be used, and these only with the approval of and in such manner as may be designated by the department. Dyes may be used in or upon the products only in the manner and under the conditions following:

(a) The dyes may be mixed with prepared fats, such as lard and lard compounds.

(b) The dyes may be used for coloring sausage casings or other casings, by dipping or application, provided the character of the casings is such that the dye does not penetrate into the meat-food product contained in the casing. If cloth casings are used they shall be coated with uncolored paraffin before the application of the color.

(c) When artificial coloring matter is used the product shall be marked or labeled. (B. A. I. Order 211, Regulation 18, Section 6.)

In regard to the consistence of sausage filling, the methods characteristic of the various localities and described on pages 77 to 80 are decisive. The working up into sausages of testicles, uteri, fetuses and cattle skins is to be judged as an adulteration, and should not be permitted.

Meat Preserved by Physical Methods.—In canned meats (page 84) examination should at first determine whether they are spoiled. Spoiling may be regarded as established when the contents of the container can be shaken. Bulging of the otherwise concave bottoms of the cans also indicates accumulation of gases within the can, as a result of putrefaction. If gases have been present, but have been removed, double soldering places will be found on the bottom of the can, and also a movableness of the contents.

If a can with shakable contents has been exposed to heat, it should be allowed to cool, as the jelly in the cans liquefies at 26° C.

According to Pfuhl and Wintzen, the cause of bulging in canned meats may be also due to an insufficient soldering of the containers. The formation of hydrogen and the separation of ferrous phosphate are in direct relation to each other, and are traceable to the action of the organic acid contained in the bouillon on the iron of the walls of the container, and to the ensuing secondary reactions.

As soon as decomposition sets in it is found on opening the can that the jelly is liquefied, of a disagreeable odor, and that corresponding changes have occurred in the pieces of meat. But even without decom-

position the liquefying of canned jelly is a suspicious sign and makes a more careful examination necessary (bacteriological, boiling test, etc.). It should also be examined for adulterations, prohibited additions of chemicals and a content of inferior quality in the cans (gelatinous admixtures).

When the presence of lead salts is suspected in canned material as a result of a considerable content of lead in the pewter used for soldering, chemical examination is required.

The examination of frozen meat, to be done accurately, should be undertaken only after thawing it out in the usual way. Such meat appears softer and more moist; also the red blood corpuscles on microscopic examination can be distinguished from those of meat not frozen, since they are discolored, deformed and swim in a greenish serum.

This serum contains the hemoglobin in the form of irregular, yellowish-brown crystals.

Judgment.—The judging of frozen meat and also of canned meat is carried out in accordance with the general principles. In spoiled canned meats there is always a suspicion of harmfulness to health, and for this reason they should be declared unfit for consumption (see Meat Poisonings, Chapter XI). Adulterations, to which also should be added the gelatin containing admixtures, render the canned products of inferior quality.

In accordance with B. A. I. Regulations, any canned meat or product which requires sterilization to preserve it shall be sterilized on the same day that the cans are filled. Defective or leaky cans discovered after the process of sterilization has been completed shall not be repaired or repacked unless (a) the repairing or repacking be completed within six hours after the process of sterilization has been completed, or (b) if their defective or leaky condition be discovered during afternoon run, they be held in coolers at a temperature not exceeding 34° F. until the following day, when they may be repaired or repacked. Sterilization will be deemed completed within the meaning of this paragraph when the cans have sufficiently cooled for inspection and handling. The contents of all defective or leaky cans not repaired nor repacked in compliance with this paragraph shall be condemned.

Meat Preserved with Chemical Substances.—Pickled Meat.—In regard to the occurrence of decomposition of pickled meat, attention should be directed to the consistence and the surface of the meat, especially near the bones, as well as to the condition of the brine. Nothing further need be said here in reference to the examination for measles, trichina and other diseased changes.

The iridescence of cooked, pickled or smoked meat on the cut surfaces is the result of deficiency in muscular coloring matter (Legge) and is otherwise unimportant.

Test for Salt.—For testing of common salt, see Chapter XV.

Test for Saltpeter.—For determining the presence of saltpeter, see Chapter XV.

Test for Boracic Acid.—If the presence of boracic acid is suspected the test described in Chapter XV will prove satisfactory for the demonstration of the acid and its salts.

Test for Sulphurous Acid.—If meat is treated with sulphurous acid, hyposulphurous acid or their salts their presence may be best determined by the test described in Chapter XV.

Test for Salicylic Acid.—While salicylic acid is not employed in the preservation of canned meat, it is used occasionally, however, for the preservation of fresh meat. The test will be found in Chapter XV.

Test for Formaldehyde.—Although formaldehyde is not adapted to the preservation of meat on account of its disagreeable odor and taste, the method for its determination is indicated in Chapter XV.



FIG. 148.—Inspection and wrapping of smoked meat. (Note insertion of the tryer.)

Tyrosin deposits may form on barreled livers, which are preserved in brine (Gröning). The surface of such livers, and the intima of the vessels of the liver, are covered with small roundish, millet-sized granules, which show a yellowish center, surrounded by a narrow, whitish-gray zone. On section such a liver appears mottled and sprinkled with white dots. Microscopically, under large magnification and after clearing with glycerin, fine, light needles lying closely together in bundles may be seen radiating from the opaque yellowish granules toward the periphery. A yellowish-green solution of the granules in nitric acid turns red on heating.

Smoked Products.—In the examination of smoked products for spoiled conditions the parts lying around the bones should be especially observed, as well as the larger connective-tissue tracts and the consistence of the skin, if such is present. Since meat is more apt to decompose along the the bones, it is a custom to introduce a thin steel “tryer” into hams

in order to be convinced by the odor test of the good or poor condition of the respective meat layers. (Fig. 148.)

The meat is examined with this so-called "tester"—a sharp-pointed steel rod with a handle, which is introduced toward the ham bone. (Fig. 149.)

As a result of gas formation within the ham during pickling, small vacuoles may result in the muscles (*caro porosa*).

In regard to the iridescence of smoked meat on the cut surface (salmon, ham), see page 357.



FIG. 149.—Inspecting and wrapping of smoked meat. (Note smelling of tryer.)

Judgment.—No special features are offered in the judgment of meat products belonging to this section. As the use of boracic acid, sulphurous acid salts and formaldehyde is prohibited, all meat found on the market to be treated with these substances should be confiscated as unfit for consumption. For penal prosecutions of such offenders, the preliminary tests mentioned in Chapter XV should be supplemented by exact chemical examinations.

The iridescence and vacuole formation in meat are of no importance when other processes of decomposition can be excluded.

Various Conserve Preparations.—Meat Extract (pages 47 and 96).—Decomposition and mould formation, which are easily recognizable, spoil meat extract and render it unfit for food.

Wilhelmy made investigations regarding the bacterial flora of meat extracts. The number of organisms, which principally occur as spores, is not very large. Adulterations are recognizable only by a careful chemical examination.

The presence of horse meat may be suspected when the extract is of a thick, slimy consistence, has a fatty taste and does not dissolve clearly in water. Broth made from such extract forms films on the surface like cream or milk, which repeatedly reappear after removal.

Examination of Fats.—In the examination of fats the following principles should be observed:

1. In the presence of moulds, fungi or colonies of bacteria, it should be determined whether these represent: (a) An insignificant localized pollution from the outside, for instance, as a result of slight defects in the packing; (b) a significant outside covering of the fat; or (c) proliferations in the inside of the fat. (Fig. 150.)



FIG. 150.—Inspection for cleanliness and soundness of fresh fats which are to be rendered into lard.

2. In the judgment of the color, care should be taken to see whether the fat manifests a color which is not characteristic of that particular kind of fat, or whether it shows any perceptible foreign ingredient.

3. In the test for odor it should be examined for a rancid, tallowish, oily, sour, musty, mouldy as well as for a putrid repulsive odor.

4. In testing for the taste it should be established whether there is a bitter or a repulsive taste. Care should also be taken to detect foreign ingredients by the taste.

5. If a musty odor or taste is established the fat should be examined to learn if this originates from insignificant outside pollution of the fat or of the package.

Of the chemical examination of fats it is deemed advisable to describe only the tests for foreign colorings and for adulteration with cottonseed oil, which will be found in Chapter XV.

EXAMINATION AND JUDGING OF FOWLS, GAME, FISH, AMPHIBIA, CRUSTACEANS AND MOLLUSKS.

The meat included under this section has already been discussed in Chapters I and II, with reference to its origin and characteristics. As the conditions to be observed in the examination and judgment

of such meat correspond in general with those which were established for food animals in the narrow sense (page 35), only a few characteristics need be given here.

Fowl.—Domestic fowl should be examined in life, and also when slaughtered, after plucking. The slaughter wound should be noted in fowls which are brought to the market after being plucked.

The skin should not be discolored (bluish or bluish-gray, faded or shriveled), and should not disclose cadaver spots.

Light, poorly nourished geese are occasionally inflated, according to Ostertag.

Age.—In regard to the age, a distinction is made, as a rule, only between young and old; that is, whether it is under one year old or over. Niebel points out the following signs of age:

The domestic pigeon is considered young until the attainment of sexual maturity; but most unfledged animals (five to six weeks) are usually sold as young. In very young squabs the breast appears white. Very soon it changes to a bluish-red, until it finally becomes blue-red. In very young pigeons the entire breast-bone is flexible; in young ones only the posterior end, while in old pigeons it cannot be flexed at all. A young pigeon possesses long, yellowish down, and the tail feathers appear stemmed; that is, the shaft of the same on the lower end does not contain any feathers. An older, full-fledged pigeon has red-colored feet and no down. According to Cornevin, the bill for the first six to eight months is soft, later becoming hard.

In very young domestic fowl the back portion of the breast bone can be easily bent outward; in young fowls it breaks easily, and in old fowls only when considerable force is applied. The breast bone keel bends sideways readily in young birds; in old ones it remains stable. The ischium and the os pubis can be pressed forward without breaking in young birds, while in old ones the latter occurs with a cracking sound. An old cock has a spur over 1 cm. in length, which in the young is correspondingly smaller. Occasionally spurs may be also found in hens. Older hens have hard spurs and rough scales on the legs; the lower half of the bill cannot be bent at all with the fingers, as in the case with young hens.

In young guinea fowls the feather flag of the outside quill feather is pointed; in the old birds it is more or less rounded.

In turkeys the age is determined by the spur and also by the appearance of the first quill feather already described. This is also decisive in turkey hens, in which the rectum of old animals is surrounded by a red ring. In a young domestic goose or domestic duck the trachea at the entrance of the thorax can be easily indented; in the old it resists pressure. If a goose still possess yellow down it is then at the most but ten weeks old.

External Diseases.—Of the external diseases of fowl may be mentioned chickenpox (epithelioma contagiosum), which usually occurs in chickens, turkeys and pigeons on the combs, wattles, corners of the bill and also on the mucous membranes of the head and neck. According to Marx and Sticker, it is produced by an ultramicroscopical filterable virus.

The comb scab (*Lophophyton gallinæ*, chicken favus) and the leg scab (*Cnemidocoptes mutans*), which leads to the development of the so-called lime feet (scaly leg), should be considered.

Internal Diseases.—The numerous animal parasites occurring internally in fowls are, as a rule, of no importance to the veterinary inspector, except in severe infestations and cachectic conditions, thereby effecting changes in the meat. The connective-tissue mite (*Laminosioptes cysticola*), however, deserves special mention. It frequently produces dull white or yellowish spots and nodules up to the size of 1 mm., often in very large numbers in the subcutaneous and muscular connective tissue of chickens. The contents of these formations are

otherwise granular, fatty of chalky. In severe infestations with this parasite the meat becomes unfit for human food; milder cases make it a spoiled (deficient) food. The air-sac mite (*Cytoleichus nudus*) lives in the neck, breast and abdominal air sacs in chickens and pheasants, where they may cause inflammatory changes and necrosis. In invasions of the lungs and trachea, inflammation and dyspnea are observed. As a result of the presence of numerous tapeworms, *Davainea echinobothrida* in the intestines of chickens, cachectic conditions may develop (Ruther).

Of the specific infectious diseases of fowl, the following come under consideration:

CHICKEN CHOLERA.—Chicken cholera is a septicemic affection which occurs in all domestic fowl, and spreads rapidly in an epizootic form.

The cause is the *Pasteurella avicida*, which belongs to the group of hemorrhagic septicemia bacilli (page 337).

Symptoms and Lesions.—In the living bird the symptoms are not characteristic: Fever, dulness, difficulty in respiration, feathering bristled and livid coloring of the comb in chickens.

Occasionally there is a sudden death without showing pronounced signs of illness. The anatomical findings consist principally in a hemorrhagic enteritis; hemorrhages under the serous membranes, epicardium, on the heart and in the lungs; infarcts of the muscles which in prolonged sickness may also degenerate.

The recognition of chicken cholera depends on the demonstration of the bacteria, which may be found in the blood of larger veins. In doubtful cases Kitt recommends the inoculation of blood into pigeons with the aid of lance prickings of the chest muscles. In case of chicken cholera death occurs in twelve to forty-eight hours. Chickens slaughtered in the last stage of the disease, which is indicated by the cadaver spots on the inside of the legs and on the lower portion of the abdomen, are, as a rule, not offered for sale.

Judgment.—As there is no danger to human health from eating these fowl, the degree of the disease and the condition of the bird decide whether it should be considered as highly spoiled and accordingly condemned or whether after previous boiling it should be admitted for consumption. The latter precaution is necessary for preventing the spread of bacteria.

FOWL PEST.—Fowl pest is an acute contagious infectious disease which almost exclusively occurs in chickens, very rarely in pigeons and water fowl, and terminates fatally within two to four days. The cause is an ultramicroscopic filterable virus.

Symptoms and Lesions.—In the living animal there are noted dulness, lethargy, dark red coloration of the comb and wattles, slimy discharges from the opening of the mouth and occasionally profuse diarrhea. The anatomical findings in quickly terminating cases may be limited to several punctiform hemorrhages on the proventriculus, pericardium, breast bone or peritoneum. Otherwise there is a collection of mucus in the nasal and buccal cavities, pulmonary hyperemia, pericarditis, hemorrhages on the mucous membranes and under the serous membranes, intestinal catarrh, fibrinous exudate in the abdom-

inal cavity, salpingitis, cloudy swelling of the liver, edema on chest and neck.

For the recognition of fowl pest it is always advisable to inoculate a pigeon and a chicken; if fowl pest is present death occurs in from twelve to forty-eight hours. Besides, the absence of the causative bacillus of chicken cholera and absence of a marked intestinal inflammation are decisive.

Judgment.—The same principles should be applied as in chicken cholera.

CHICKENPOX (DIPHThERIA).—This is an infectious disease of chickens and pigeons running an acute or chronic course and produced by a filterable virus.

Lesions.—While originally considered to be separate diseases, it was later proved that the virus which causes the pox nodules on the head, typical of chickenpox, also causes the yellow-white membranous deposits in the mouth and eyes which are characteristic of diphtheria. In advanced affections croupous diphtheritic inflammation of the deeper air passages and intestinal canal occurs. In the latter cases it is generally accompanied by anemia, cloudy swellings of the parenchyma and hemorrhages on the pericardium.

Judgment.—There have been no observations recorded of transmission of the disease from chicken to man. In fact, the general opinion prevails among scientists that there is no relation between diphtheria of chickens and that of man. Whether the meat should be considered spoiled depends on its objective changes.

TUBERCULOSIS OF FOWL.—There has been found some pathogenicity of the bacilli of fowl tuberculosis for man and for certain domestic animals, by investigations which have demonstrated the presence of the avian tubercle bacillus in human beings, hogs, horses and other mammals. In recent years due to extension of poultry inspection, tuberculosis of fowl has received greater attention. Fowls affected with tuberculosis are judged along somewhat different aspects than in mammalia because primary lesions occur in organs not subject to primary manifestations in mammalia. Lesions that are primary in poultry would be systemic in other animals and cause condemnation of the carcass. Most common seat of lesions is the liver, spleen, intestines and lungs in the order named.

Many cases of generalized or extensive tuberculosis are found in birds of excellent flesh. Nodules in the lungs may not always be tuberculosis as they are often associated with chronic pullorum disease. No lymph glands are demonstrable in poultry. Intestinal lesions of tuberculosis are found in the wall of the intestines instead of lymph glands. Poultry with slight tuberculous lesions in the spleen or liver are passed for food.

Cases with numerous lesions in either liver or spleen should be condemned and also all carcasses in which lesions are found in both liver and spleen.

FOWL ARTHRITIS.—Finally there should be mentioned fowl arthritis or gout with changes of the joints, and calcareous incrustations in the skin, kidneys, and serous membranes. For the test of uric acid deposits

the murexid reaction is applied as follows: The concrements are mixed with a small quantity of nitric acid, evaporated by drying to an onion-red mass, which, on the addition of a drop of ammonia, gives a beautiful purple-red color. The meat of animals severely affected with arthritis must be considered as spoiled food. Egg concrements in the body cavity, which are occasionally observed in hens, are of no importance.

The general judging of fowl meat does not deviate from the general principles described for other flesh.

Postmortem Changes of Fowl Meat.—Borchmann called attention to the unfavorable influence on goose meat of long storing of undrawn geese in refrigerators and cold storage houses (ice geese, Russian geese). The objective deterioration of the appearance of such geese consists in a whitish-yellow to a whitish-green discoloration of the skin ("cadaver color"), which after thawing out becomes oily, yellow, leather-like and tightly attached. Besides, there may be present hypostasis of the skin of the lower abdomen and rump. The muscles of cold-storage geese are red-violet or deep dark red, and when roasted appear dark brown to brownish-black and tough. The fat of a cold-storage goose is oily, does not stiffen and deposits a gray, gritty sediment; its taste is rancid or musty. Due to these characteristics, cold-storage geese are, under all conditions, of inferior quality, and besides they may also be in a highly spoiled condition and consequently unfit for consumption.

Bacon also pointed out the dangers of long storing of undrawn fowl in cold-storage houses.

Game.—The meat of game is characterized in general by its high blood content, which favors its decomposition when unsuitably kept, notwithstanding the fact that the meat of game resists putrefaction for a comparatively long time.

Although game should, as a rule, disclose shot wounds, nevertheless wild fowl can be seen occasionally which were caught in traps or nets, and only display traces of strangulation. The shot wounds which are produced post-mortem have no bloody infiltrated borders.

Age.—In reference to the age which sometimes comes into consideration in haired game, principally in rabbits, deer, fallow deer, roe, and boars, Niebel established the following fixed points:

In young rabbits the thorax can be easily pressed in; and in compressing the posterior branches of the maxillæ the two middle incisors spread apart as wide as the thickness of a finger. The hair of a young rabbit, especially on the abdomen, is softer than that of an old animal. The aponeuroses of the lumbar region are, in the young rabbit, grayish-white, thin, transparent; in the old, yellowish-white and not transparent. The ribs of young animals break easily; those of the old do not. The pelvic symphysis is cartilaginous in young animals; in old rabbits it is ossified. The meat of old rabbits is dark red, while in young rabbits it is pale and grayish-red.

In deer the question occasionally arises whether it is a calf or a full-grown deer. According to Whering, an alleged deer which possesses less than six molar teeth in each row, and accordingly is less than sixteen to eighteen months

old, must be considered a calf. Whering indicates the changes of teeth in the roe, common stag and fallow deer in the following exhibit:

	Roe. Months.	Common stag. Months.	Fallow deer. Months.
The center incisors appear after . . .	6 to 8	10	15
The inside laterals appear after . . .	10 to 11	13	17
The outside laterals appear after . . .	12	15	20
The corners appear after	13	22	18
The premolars appear after	14 to 15	24	30

The young of the wild boar have at three to four months 3 pairs of temporary incisors, 3 temporary molars in each row and temporary tusks. When eight to nine months they have besides 1 permanent molar in each row and the tusks. A shoat of twenty months has 3 pairs of permanent incisors, the wolf teeth, 5 permanent molars in each row, and the temporary tusks are replaced by permanent ones. In boars and sows two and a half years old the last permanent molar is also present.

For wild fowl Niebel gives the following signs of age:

An old partridge is distinguished from a young one by its more strongly developed structure, gray to grayish-blue legs, which in the young are more yellow, and by yellowish-brown feathers on the head, which in the young are gray. But after four months the young partridge also has yellowish-brown head feathers, and therefore after that age only the outside quill feathers show indications by which to decide, their ends being pointed in young partridges, while in the old they are rounded.

In the mountain partridge the age is determined by the extreme outside quill feather.

In the woodcock, heathcock, heathpout and white grouse the extreme outside quill decides, together with the breast bone and spurs.

The spur of a young pheasant cock is short and stubby; that of an old bird is 10 mm. long and 7 mm. wide; in a cock about ten months old the spur is only 6 mm. long.

The breast bone is flexible in earliest youth; it can be broken in young birds; in old ones, however, it is broken only with great difficulty. The feathers until the second year are of a dark color, which remains permanently in the hen, while in the cock at two years the variegated feathering and long tail feathers develop.

In wild geese and ducks the firmness of the trachea is decisive.

In young bustards the end of the breast bone is flexible. In snipe, quail and others the age is of no importance.

Sex.—The establishment of sex is occasionally of some importance in the eviscerated deer.

When the sexual organs are removed and the cranial covering sawed off the pelvis is decisive, as indicated by Whering and Schaff in the following: The pelvis of the doe (Fig. 151) when viewed from above appears broader, more spacious, less slender than the pelvis of the buck (Fig. 152); the distance of the outside angles of the ilium from each other is as 50 to 40. On the pubic symphysis the pelvis of the buck is thick and like a protuberance; that of the doe is thin, flat in front and slightly hollowed. It is emphasized by Whering that the appearance of the symphysis can only be utilized with a degree of certainty in older deer, as all the young individuals have a thickened protuberant symphysis; accordingly, Malkmus recommends cutting out the halves of the pelvic bones and boiling them.

The common stag and fallow deer show also similar sexual differences in the pelvis.

In regard to the value of the meat of both sexes in haired and feathered game, the meat of male animals is preferred in general on account of its stronger taste of game. During estrum, venison is supposed to have a repulsive taste similar to that of the male goat.

Diseases.—*Tularemia.*—Tularemia is a specific, infectious, bacterial disease caused by *Pastuerella tularensis* (*Bacterium tularensis*). While this disease has been reported only in wild rabbits, it has been proved experimentally that domesticated rabbits are also susceptible to the disease. Tularemia assumes importance from the fact that it can readily be transmitted to man, and while it has not been reported in domesticated stock, the proved susceptibility of such stock and the transmissibility of the disease to man warrant its discussion with other diseases of rabbits.

The disease is carried from infected rabbits to healthy stock by the wood tick (*Dermacentor andersoni*), the rabbit tick (*Hæmaphysalis leporis palustris*), the deer fly (*Chrysops discalis*), and the rabbit louse (*Hæmodipsus ventricosus*).

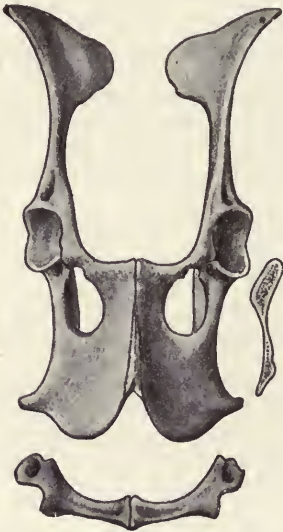

FIG. 151.—Pelvis of a doe with a front view of the os pubis and a section through the symphysis.



FIG. 152.—Pelvis of a buck with a front view of the os pubis and a section through the symphysis.

The disease is transmitted to man by the deer fly, the wood tick, or by the handling and dressing of infected rabbit carcasses.

Postmortem: An animal dead of the disease usually shows numerous necrotic spots in the liver and spleen, while besides these lesions, in laboratory animals infected by inoculation, the lymph glands, especially in certain parts of the body, as the abdomen and groin, are swollen and inflamed and sometimes contain pus.

As a safeguard to those handling wild rabbits during the hunting season or otherwise, it is very important to use rubber gloves when dressing rabbits. This is especially advised when the disease is known to exist in a particular locality.

Other important diseases which occur in game have already been mentioned in Chapter VIII. Anthrax, hemorrhagic septicemia and animal

parasites, measles, trichina in bear and wild boar, as well as the so-called rabbit measles (*Cysticercus pisiformis*) should be especially considered. For measles of deer and reindeer, see pages 264 and 269. Strongyloides in the lungs and intestines of rabbits may produce severe affections and may result in numerous fatalities.

Postmortem Changes.—In the matter of postmortem changes (page 341), no concessions should be made by the sanitary police to the current conception of "land flavor." In animals not eviscerated the intestinal putrefaction soon passes over to the abdominal walls and discolors them green or bluish-green. The appearance of the eyes is also an indication of the freshness of game; if they are markedly sunken it is then quite certain the game was shot several days previously.

Regarding the judging of meat of game there is nothing to be added to what has already been described regarding other flesh.

Fish.—The killing of fish should be preceded by stunning with a blow on the head.

Although in the water of moderate climates there occur no fish the meat of which in itself would be poisonous,¹ yet it should be remembered that the roe of perch and occasionally also that from pike, herring, carp, tench and breem may contain during the spawning time cholera-like acting poisons (barbel cholera, signatera).

The raw meat and blood of the river eel and sea eel, as well as of the lamprey, contain a toxalbumin (ichthyotoxicon) which is destroyed by cooking. In the lamprey there may also appear a poison in the skin, which remains active even when the fish are boiled to a soup. Some of the fish also possess poison glands in the mouth and skin; in the latter class are included the so-called "poison stingers" (dragon fish, sea scorpion). For distinguishing fresh fish from stale and decomposed fish, the following fixed points are of service:

Condition.	Scales.	Eyes.	Gills.	Body in general and meat.	Specific gravity.
Fresh	Glittering, free from slime, firmly adherent	Standing out	Gills, lids, and mouth closed	Solid; placing fish horizontally on the hand, it does not bend. Meat firm, elastic, tight on bones	Sink in water
Not fresh, stale for some time	More or less easily removable, slightly slimy or smeary	Red bordered, sunken; cornea cloudy	Lids open or can be easily opened; gills pale, yellow, dirty, or grayish-red, covered with the same kind of fluid; odor disagreeable	Bony, bends easily, especially at the tail end; occasionally bloating of the abdomen, which may be bluish discolored. Finger impressions are easily made, and remain; meat is soft, can be easily removed from the bone	Swim on water.
Putrefied	Very loose, covered with a smeary slime-like mass of disagreeable odor	Breaking down; are frequently removed	Very off-colored; extremely offensive odor	Withered, flabby, soft pale, bloated. The meat is sloppy	Swim on water.

With the possible exception of carp, the age of fish is not regarded. To establish it a scale from the side should be cleaned in alcohol and held against

¹ For further particulars, see Kobert on Poisonous Fish and Fish Poisons, Lecture, Stuttgart, 1905.

the light. If in the center of this scale a light point is noticed the carp is then of one summer. In a two-summer carp the central point is noticed, surrounded by a ring; that of three summers has two rings, and so forth.

Deceptions in Commerce with Fish Meat.—Occasionally a species of codfish (*Merluccius vulgaris*) is used for sea salmon (Raebiger). According to Gilage, perch (*Carax vulgaris*) should not be sold for genuine sprats. *Gadus pollachius* goes as Spanish salmon. The meat of the thorn hound (*Acanthias vulgaris*) is often offered as sea eel or sea salmon, as well as that of the common nose fish (*Chondrostoma nasus*), a cheap fresh-water fish which is sold as mackerel, according to Rehmet.

The substitutions of sprats for sardines or anchovies in box conserves is determined, according to Henseval, by a spiny comb on the abdominal side of the sprats, which is characteristic of these fish, and which can be perceived by passing the finger over the body in the direction of the head.

Diseases of Fish.—Of the diseases of fish, the following should be referred to:

(a) *Nodular disease* (morbus nodulosus, fishpox) commonly occurs in barbs, carp, tench, perch, pike and red eye. It is produced by myxosporidiæ (myxobolus. The latter are located in the epithelia of the skin, muscles, gills and in the internal organs, and produce cyst-like tumors, swellings and abscesses. In the rump muscles of various species of salmon cysts may appear the size of hazelnuts produced by myxosporidiæ (*Henneguya zschokkei*) which displace the muscle and become visible externally in the form of boils. The meat has a yellowish color, becomes soft, jelly-like and tastes bitter.



FIG. 153.—Plerocercoid of *Diphylobothrium latum*, from the musculature of the pike: a, head extended; b, head drawn in.

(b) *Fish Measles.*—The plerocercoid or larva of the *Diphylobothrium latum* (broad tapeworm of man) lives in the muscles and the various viscera of the pike, turbot, perch, trout, grayling, salmon and their varieties. In Germany these measles occur principally in fish from the Baltic Sea, and from the East Prussian Seas, but may be also observed in those from the Starnberger Sea.

These worm-like plerocercoid are 8 to 30 mm. long, not encapsulated, and lie slightly curved with their grayish-white indistinctly annulated bodies. They are easily found on the pyloric appendices of the turbot; they may also occur in the caviar of pike.

Cysts of 3.5 mm. long and 1.5 mm. broad, containing the larva of a species of Tetrahynchidæ (= *Tænia tetrahynchus*), were found in the meat of codfish and halibut, but they are harmless for man (Bergmann).

(c) The young form of the *Agamonema capsularia*, described by Leuckart as *Filaria piscium*, lives as a 2- to 5-cm. long encapsulated round worm in the meat of various salt-water fish, and especially of the *Gadus callarias* (a species of codfish). Cooking the meat facilitates their detection, as in the process worms turn red-brown in color.

(d) Muscle distomes of various kinds are not infrequent in fish.

(e) The young stage of the *Opisthorchis felineus*, which produces cancer-like affection of the bile passages in the liver of man, is supposed to live, according to Askanazy, in the red eye (*Leuciscus rutilus*); however, thus far only the eggs of the parasite have been found in this fish.

(f) The various infectious diseases of fish can be left unconsidered, as the fish with such affections spoil rapidly and are seldom placed on the market. For details, see Hofer's *Handbook of the Diseases of Fish* and Ostertag's *Handbook of Meat Inspection*.

According to Kobert, the *Bacillus piscicidus agilis* (Sieber) produces a septicemic affection in carp, which may also become injurious to man.

Judgment of Diseased Fish.—Fish with *Diphyllbothrium* measles are injurious to health. In all other diseases the meat is, as a rule, to be considered as highly spoiled.

Postmortem changes in fish meat appear rapidly, and in putrid fish poisons develop which act more intensely than the putrefactive toxins in meat of warm-blooded animals. The fish poison, according to van Ermengem, is similar to sausage poison, and appears to be strongest at the beginning of putrefaction.

Crustaceans, Mollusks and Amphibians.—Crabs and lobsters should only be offered for sale alive, as they spoil quickly when boiled. Crabs boiled after they have died have distended bodies, and the caudal fin is not rolled in. A lobster which has been boiled shortly before death has the caudal end turned toward the abdominal side, and can be readily moved up and down ("Wippen"). If the lobster is boiled some time after death the meat of the caudal portion cannot be taken out intact; it crumbles between the fingers.

Of diseases there should be mentioned the "spotted disease" which produces black spots on the shell, and is caused by *Oidium astaci*, and the crab plague, found by Hofer to be produced by the *Bacterium pestis astaci* in the muscles, is also pathogenic for fish. Mycosis *astacina* is accompanied by milky discoloration of the under side and mortification of single limbs of crabs.

Canned lobster is always alkaline, even in an objectionable fresh state. Adulterations occur with the *Palimivurus vulgaris*. As these shell crabs have no claws, the canned products are often sold as "lobsters without claws."

Occasionally the inferior quality North Sea crab is boiled in fuschin water and sold as Baltic Sea crab. The coloring is then spotted and the eggs under the abdomen are bright red; by boiling crabs in alcohol the artificial coloring matter may be extracted. Furthermore, the zoölogical signs should be considered.

Dead oysters show open shells, and at the beginning of decomposition a black ring appears on their inner surface. They very soon develop a disagreeable odor. According to Bardet, all oysters are diseased during summer. They show a milky appearance, and their liver is greatly enlarged, gray and white. To obtain a green color oysters are placed in a copper acetate solution, whereby they turn gray-green but not dark green. If vinegar is poured over such oysters an inserted iron needle will show a metallic copper luster, while with the addition of ammonia the oysters turn a dark blue (Springfield).

That oysters may be carriers of typhoid bacilli has been repeatedly established.

The common mussel is dead when the shells do not close after they are taken out of the water. Certain mussels, especially those from stagnant water, may contain poisons, the development and nature of which are still obscure. An alkaloidal-like substance, mytilotoxin, was isolated by Brieger and Salkowski and occurs principally in the liver of the mussel. In man it produces the poisoning called mytilotoxism, or mussel poisoning, which belongs to the ichthyotoxism group of poisoning (page 377). Poisonous mussels are supposed to produce a sweetish, nauseating, bouillon odor; they are also less pigmented, and their shells are more easily broken and are broader than those which are not poisonous. The liver is larger and more tender. Water in which poisonous mussels are boiled appears bluish; that of healthy mussels is light. The meat of poisonous mussels is yellow, that of the non-poisonous is whitish. Placed in alcohol, poisonous mussels color it a strong golden-yellow; the non-poisonous scarcely make any noticeable change.

According to Salkowski, if this solution is heated with a few drops of nitric acid in a reagent glass the poisonous solution turns a grayish-green, while the non-poisonous remains almost colorless.

In snails, turtles and frogs' legs special changes and injurious effects were not observed.

Judgment.—On account of the great danger which diseased, poisonous or decomposing crustaceans and shell fish produce to human health (mytilotoxism) such food should be positively withheld from human consumption.

CHAPTER XI.

FOOD POISONING.

IN this chapter special diseases of animals are not treated, but only the diseases of man which appear as a result of meat consumption, and which on account of the symptomatic picture are designated food poisoning.

While nothing could be added here regarding meat inspection proper, these food poisonings cannot be left undiscussed, as they are of great importance to meat hygiene, and their etiological relations are noted partly in important diseases of animals and partly in particular changes of the meat. In the past it has been customary to classify food poisoning according to the food producing it, as meat poisoning, fish poisoning, cheese poisoning, etc. However, all the latter are really forms of food poisoning produced, as a rule, by bacterial infection.

Poisonings which are to be traced to consumption of meat can be arranged into three groups with reference to their etiology—namely, meat poisoning as a result of microorganisms which belong to the group of the *Salmonella enteritidis*; meat poisoning through the *Escherichia coli*, staphylococcus and the proteus group; and meat poisoning or botulism produced by the *Clostridium botulinum*.

FOOD POISONING AS A RESULT OF SALMONELLA ENTERITIDIS.

Food poisoning outbreaks due to the salmonella group of bacteria have been reported in many parts of the world. It is evident from the literature available that various species of animals furnish a reservoir for the salmonella group which may furnish the source of infection of various foods. In 121 food poisoning outbreaks in Great Britain from 1919 to 1931, Savage isolated *Salmonella artrycke* in 76 cases, *Salmonella enteritidis* in 14 and *Salmonella suipestifer* in 7. While Rosenau states that *Salmonella artrycke* is known to be the same as *Salmonella suipestifer*, Gaiger and Davies claim it is distinguishable by the agglutination-absorption test.

The nature of food poisonings which are produced by the group of *Salmonella enteritidis* consists either in an intoxication of the human body with chemical poisons (bacterial toxins, toxalbumins, toxigenic substances), developed by the microorganisms in the animal body, or else in an infection with the bacteria themselves, the latter view more generally accepted.

In so-called paratyphoid meat poisoning there enters into consideration the action of the metabolic products of bacteria which in themselves are not poisonous, but at the same time increase the action and aggressiveness of the bacilli.

The character of the diseases developed in this manner in man varies extraordinarily. The symptoms in general show an acute course and develop as an attack of cholera, cholera nostras or an inflammatory gastro-enteritis (febris gastrica), sometimes accompanied by muscular weakness or ataxy. The symptoms may, therefore, act delusively in a typhoid condition. Frequently, however, they can be hardly distinguished from a gastro-intestinal catarrh.

Convalescence is always slow; relapses and even fever of two months' duration (Netter) may occur. Mortality hardly exceeds 2 to 5 per cent.

Without doubt the various forms of the disease are greatly influenced by the nature and intensity of the causative agents in consumed meat, by their quantity, preparation, etc.

Since there is no uniform typical clinical picture in food poisoning, a diagnosis of poisoning by meat can only be established by connecting a concrete affection with corresponding complex symptoms, with the history of consumption of certain meat foods, and with the absence of other kinds of disease-producing influences. That suspicion of meat poisoning is justifiable if symptoms occur soon after the ingestion of meat appears self-evident, but the time of incubation may also extend over several days.

Etiology.—Extensive statistics show that septic and pyemic affections and their various forms in food animals (page 315) are the principal causes of meat poisoning proper. Since these affections frequently induce emergency slaughter, it is not surprising that by far the greatest number of meat-poisoning cases may be traced ultimately to emergency slaughtered animals.

To what extent the bacteria of the enteritidis group play a part in the development of septic and pyemic affections has not yet been explained. The injurious properties in a diseased food animal may be distributed throughout the entire meat or they may be confined only to single parts of the viscera. In both instances the virulence of the meat or viscera may be widely different, and accordingly the degree of the poisoning may vary greatly. The virulence of the meat depends on the severity and nature of the malady of the food animal at the time of slaughter and the bleeding of the animal as well as on the nature of the storage and preparation of the meat.

With reference to storage, it must be accepted that under certain conditions of heat and dampness the postmortem poisonous properties of meat are further increased by continuing the activities of the causal agents of the infection. Thus, Basenau, Poels and Dhont have proved that species of bacteria closely related to the *Salmonella enteritidis* develop luxuriantly in the muscular tissues, even at a low temperature (10° C.). The preparation of the meat plays an important part. Experience has shown that the consumption of raw meat, as a rule, produces more severe disturbances than boiled and roasted preparations. In the latter the exciters of infection which exist in the meat proper are to a great extent destroyed, and thus the danger which threatens human beings through the multiplication of these causal factors is averted.

That the chemical poisonous substances (toxins of the *Salmonella enteritidis*) which are present in the meat are not destroyed by culinary boiling or roasting has been frequently established by experience (see below), and this serves as proof that the nature of a number of poisonings by meat is an intoxication. It is readily apparent that these toxic substances may be weakened through the preparation of the meat by soaking or through the formation of chemical combinations, which at the same time cause an attenuation of the poison in the meat. It has been shown by careful observation that in certain cases the meat broth contained pronounced toxic properties.

As individual organs, especially the liver and kidneys, were found to be poisonous while the meat proper and the muscular structure of the same animal proved to be harmless, it must be accepted that these organs were either exclusively the seats of the infective elements, or that by virtue of their physical functions they absorbed larger quantities of the poisonous substances.

Finally, the instances in which the meat became virulent only on postmortem can be readily understood by the above-mentioned observations of Basenau, Poels and Dhont, as well as by the fact that the *Salmonella enteritidis* is extensively distributed in putrefying organic material and also in many carcasses (Gärtner).

According to recorded observations, cases of poisoning resulting from the ingestion of fish, meat and oysters (Netter, Herdmann and Boyce, Vivaldi and Rodella), as well as cases of so-called paratyphus of unknown cause, belong within the sphere of action of the *Salmonella enteritidis*.

Etiology.—The bacteria of the group of *Salmonella enteritidis*, which produce the poisonous qualities of the meat, possess the following characteristics:

1. Short bacteria, very frequently of ovoid form (coccus bacilli) of 0.2 to 0.4 μ usually arranged in pairs; sometimes they stain irregularly, especially in somewhat older gelatin cultures, as well as in peritoneal and pleuritic exudates, in the liver, etc., so that they resemble the bacteria of hemorrhagic septicemia.

2. They do not stain by Gram's method.

3. They are quite motile, resembling the typhoid bacillus, and possess peripherally arranged flagella, 4 to 8 μ long, but sometimes they are more than 10 to 12 μ long.

4. The superficial colonies on gelatin are quite polymorphous; frequently they are only slightly distinguished from those of the *Escherichia coli*, and while they are in general more transparent, they are less lobate and show usually a transparent border.

5. They do not form indol, or at the most they produce it only in extremely small quantities.

6. They do not coagulate milk, but after about ten days reduce its opaqueness somewhat. In fact, it renders the milk slightly transparent, and causes it, at the same time, to take up a yellowish color similar to coffee and milk and become markedly alkaline.

7. They always ferment dextrose with abundant gas formation, and also generally decompose the other kinds of sugars—lactose, galactose, maltose, cane-sugar, etc.—and even glycerin with gas formation, excepting certain varieties of the organisms, as for instance those described by Fischer and Durham, which do not affect lactose.

8. They cloud bouillon very quickly, and a membrane forms on the surface which tears readily, but no distinguishing odor is communicated to the nutritive media.

9. On potatoes the growth is frequently barely visible; in other cases it is quite thick, dirty yellowish or of a brownish development.

10. The quite luxuriant growth in Petruschki's litmus milk effects no change in the color, nor is there an acid production.

11. A more or less pronounced formation of fluorescence takes place in the neutral-red agar of Rothberger with 0.3 per cent addition of dextrose; the nutritive substance is discolored after eighteen to twenty-four hours and gas is produced.

12. On the nutritive media of Drigalski-Conradi, bluish colonies develop after sixteen to eighteen hours, which are somewhat larger and less transparent than those of the typhoid bacilli.

These microorganisms are further distinguished from the more or less related species with which they might at first be confused, as for instance with certain varieties of the *Escherichia coli*, by their great virulence and by their characteristic production of toxins, which are resistant to high temperatures. These poisons penetrate the nutritive media and may be demonstrated in the filtrate which is free from the organisms.

The mode of infection by the *Salmonella enteritidis* and its dissemination through the body of a food animal cannot be taken up here. It should be remembered, however, the contamination of the latter may occur through contact with the bacilli without the presence of an infection in the animal itself; the latter, however, does occur in certain instances.

De Nobele convinced himself that the muscle juice of animals infected with microorganisms of the *Salmonella enteritidis* group possesses pronounced agglutinative properties toward the latter. According to this investigation, it would be sufficient to test the muscle plasma in quite high concentrations (1 to 10 to 1 to 20) with each of the representatives of this group of microorganisms. As the expressed muscle juice of healthy animals does not agglutinate the microorganisms in question, even in a concentration of 1 to 1, a definite result could be obtained by this test within two hours. It would be necessary to resort to the cultural method only in case the agglutination gave negative results. It would be advantageous to keep the meat to be examined for twenty-four hours after slaughter at a temperature of 18° to 20° C., and to make the culture inoculations only after that time. By this procedure a marked increase of the microorganisms is obtained, which are not numerous immediately after slaughter. On the other hand, through this method the results of examination are unfortunately much longer delayed.

For facilitating bacteriological inspection of meats, Schönberg, of Berlin, developed a preliminary agglutination test which should prove of great value in all instances where bacteriological examinations are indicated. The test is especially suitable in institutions engaged in testing for the presence of abortion organisms and food poisoning bacteria.

In order to obtain the best results from the agglutination test, the illumination employed in the execution of the test is of great value. During dull daylight and also with artificial illumination the greatest care and closest attention are necessary to determine definitely whether a suspected colony on a Petri dish should be considered suspicious or not.

For this purpose the application of the test on a mirror offers great advantages. By mixing the colony under suspicion in a drop of agglutinating serum on a straight or concave mirror, the agglutination phenomenon appears much clearer, lighter, and more distinct than on a slide. This becomes very apparent if we apply on a dull winter day the agglutination test on a mirror and the

control test on an ordinary glass slide, as has been the usual practice heretofore. Plain or concave mirrors may be used for that purpose. The concave mirror has the advantage of enlargement, depending on the concavity of the mirror. The agglutination test on a mirror is especially adapted for the rapid demonstration of the abortion organism which clumps markedly when mixed with agglutinating serum.

In comparative tests with various types of mirrors it has been proved that a thin slide with mirror coating, the mirror coating of which is protected by a surface of shellac, is most suitable. This enables disinfection and cleaning of the slide. The mirror slides may then be repeatedly employed.

In scientific or forensic examinations regarding the poisonous qualities of meat, the serodiagnosis method also possesses a great importance for the distinction of the suspicious bacilli found thereby.

Also for the diagnosis of poisoning in men and animals by meat, the agglutination test of the blood of affected individuals is of value.

Occurrences of Poisonings.—The first critical enumeration of cases before 1880 is found in the work of Siedamgrotzky. The review of similar poisonings by Bollinger in the same year gives an account of 17 endemic poisonings by meat, which probably belonged principally to the enteritidis group, affecting almost 2400 cases, with 35 deaths. Ostertag, in his *Handbook of Meat Inspection* (1932), gives the number of cases of poisoning by meat in Germany from 1913 to 1927 as 12,327, with 96 deaths.

Outbreaks of food poisoning occur more frequently on the Continent than in Great Britain, and more frequently in the latter country than in the United States, according to Rosenau.

For the recognition of poisonous qualities in meat the examination for bacteria could be carried out by Basenau's method (page 167); however such a bacteriological examination could be used in practice only in emergencies.

This would also be the case with the agglutination examination suggested by De Nabele and Schönberg. Stress should be laid on the prevention of poisonings by meat through a conscientious examination of food animals before and after slaughter by the veterinary inspector. As has been already emphasized, the postmortem examination should be especially carried out with the greatest care and conscientiousness in emergency slaughter, and should be executed with the application of all technical methods available (page 165).

Although there will be certain doubtful cases for the practised expert in which the rendering of a decision will not be easy, at the same time it will be possible for him, by considering and valuing all clinical and pathological characteristics of septic and pyemic affections to prevent the occurrences of poisonings by meat almost completely, or at any rate to the greatest extent possible, according to the present standpoint of scientific meat inspection.

FOOD POISONING WITH ESCHERICHIA, PROTEUS, STAPHYLOCOCCUS, ETC.

This form of food poisoning relates to a poisonous action of meat, originating in infection of entirely healthy animals, sometimes only

after slaughter, with pathogenic or saprophytic organisms which produce toxins, although it is generally recognized that only slight evidence is available to incriminate toxins. Sometimes such disease-producing meat is visibly changed, decomposed or affected with slight putrefaction by the action of bacteria, but in numerous cases absolutely no changes are noticeable in poisonous meat. The latter was principally observed in so-called shopped-meat poisonings (see below).

Nature and Manifestations.—The cases belonging here represent principally pure intoxication by the toxins produced by microorganisms in the injurious meat. This is especially true of the early manifestations of the disease which appear soon after ingestion of the meat (three to four hours). Of course, intoxication may be combined with a pathogenic infection where severe symptoms of poisonings and a protracted course of the sickness develop after some time has elapsed as a result of the increase of injurious microorganisms in the digestive apparatus of affected persons. The manifestations of these food poisonings vary considerably, and are similar to those which are observed in genuine poisonings by meat. Nausea, vomiting, diarrhea, giddiness, headache, dizziness and debility occur, which may increase to fainting; while in children and weak persons cholera-like symptoms have also been observed. Recovery is the rule, but deaths have been observed, especially in children. According to van Ermengem, two saprophytes come into consideration in the etiology of this group of meat poisonings. Both are common inhabitants of putrid animal substance. They are the *Escherichia coli* and the *Proteus vulgaris* with its numerous varieties—for instances, *Proteus radians* (Gutzeit); also the microbe named by Hamburger as *Bacillus celluliformis*, which differs somewhat from the *Escherichia coli*, but appears also to be of etiological importance. As bacteria play an important part in the putrefaction of meat, the injurious properties of such meat may be traced to them.

The injurious action of these bacteria consists also in the formation of toxins which are not destroyed by ordinary boiling and roasting of meat, although they are somewhat attenuated. Experience, it is true, has shown that boiled and roasted meat foods have produced a great number of poisonings, but they were mostly milder than when the meat was consumed without previous heating, or was insufficiently boiled or roasted.

The intensity of the decomposition of meat bear no relation to its presumed poisonous character; and in this, experience also has taught that frequently only slight manifestations of decomposition were associated with severe poisonous actions.

A statistical arrangement of poisonings is not possible, since the affections belonging here, with the exception of the chopped-meat poisonings, are not, as a rule, of epidemic character, but are limited to individual cases, the scientific investigations of which are made very difficult for obvious reasons.

The recognition of the poisonous quality of meat belonging to this group is practically impossible, as has been mentioned, since objective

changes may be entirely absent, notwithstanding the presence of the poison. In decomposing meat the signs described on page 342 are sufficient to demonstrate putrefaction of the meat and to judge the same, according to the views given on page 345.

For the prevention of the group of food poisonings it is necessary to exclude all such meat from traffic in which putrefaction has been demonstrated, or which shows manifestations of decomposition. Otherwise, these food poisonings must be prevented by the care of the housewife or servants in selecting for use only unobjectionable meat. When suspected meat cannot be unconditionally excluded from human consumption, it should be utilized only after a thorough boiling or roasting.

The so-called chopped-meat poisonings have been observed only in the warmer seasons. This alone indicates that the poisoning depends upon a pollution of the easily decomposing meat with bacteria (see bacterial content, page 77), which grow well on the meat.

More extensive chopped-meat poisonings were almost exclusively observed at places where a large amount of slightly smoked sausage or raw meat or partially roasted meat had been consumed. Epidemic chopped-meat poisonings were observed in Chemnitz, Dresden, Gerbstadt, Gera, Halle a. S., Sulken, Velbert, Hamberg, Berlin and elsewhere, affecting over 600 people, with several deaths. However, isolated cases occur every summer.

Chopped-meat poisonings have been observed in which paratyphus bacilli were supposed to be the cause. These should not be grouped with the chopped-meat poisonings proper, but with the food poisonings of the enteritidis group.

To prevent poisoning by chopped meat, it is advisable not to keep it at a summer temperature for any length of time; wherefore, the prohibition of the use of preserving substances should be of assistance; and the meat should not be consumed in a raw state or insufficiently prepared.

Jordan (1931) has described several cases of staphylococcus food poisoning in which the vehicles of infection were layer cake, chicken gravy, Christmas cake and cheese. Both albus and aures varieties were isolated from these foodstuffs. Sterile broth filtrates of cultures of these organisms produced, when ingested by human volunteers, symptoms of vomiting and diarrhea, within two hours after partaking of from 2 cc. to 10 cc. of the filtrate. Staphylococcus food poisoning differs in several respects from salmonella food poisoning. The incubation period is very short, from two to four hours; symptoms are very severe, accompanied by great prostration, but recovery occurs, there being no recorded deaths.

Lovell (1932) thinks that the reason people become infected through decomposing food is due to the fact that the food has enormous numbers of some organisms which, if present in small numbers, would produce no pathological results.

BOTULISM.

Certain affections in man produced by the consumption of meat, but which deviate by characteristic symptoms from both of the previous groups, are designated as botulism (allantiasis, sausage poisoning).

The name "sausage poisoning" originates from the fact that the first critically observed cases by Justinus Kerner in the year 1820 were connected with the ingestion of injurious sausages, and also later many severe affections of this kind could be traced to this source.

Here, too, most of the poisonings known as ichthyotoxismus and mytilotoxismus, which are produced by the meat of fish, mussels and other shell food, should be classified.

Nature and Manifestations.—Botulism consists in an intoxication of the human organism by poisonous substances, which are produced by the *Clostridium botulinum*, discovered by van Ermengem.

This microorganism is a normal inhabitant of the surface layers of the soil and may, therefore, easily gain access to vegetables, fruit and even meat. Four types of *Clostridium botulinum* have been recorded. Type A produces exceedingly poisonous toxins and has proved responsible for most of the outbreaks especially in the western part of the United States. Type B appears to be less frequent, and in this country it is responsible for cases appearing along the Atlantic border. Type C also occurs in the United States, especially as a poultry disease, but has not yet been connected with poisoning in man. Type D is regarded by some as a fourth type producing lamziekte in South Africa (Theiler). There is also the related organism *Clostridium parabolulinum* which produces parabolulinism of livestock in Australia, but not recognized as yet in man in the United States. It is considered by Jordan and Meyer to be a member of the Type C group. The products responsible for botulism in man have been home preserved vegetables, fruits, fish, poultry, and meats, which as a rule were not found to be altered in appearance, taste or smell.

The symptoms especially characteristic are disturbances in the sight, such as paralysis in the region of the opticus, oculomotorius (mydriasis), trochlearis, abducens, facialis (ptosis), as well as of the lachrymalis and trigeminus nerves; they may occur singly or in association. Striking manifestations originating in the digestive apparatus are frequently absent or only slightly pronounced and passing. On the other hand, there exists a persistent constipation retention of urine and marked debility.

Fever and disturbances in consciousness and sensibility are absent. The symptoms of the disease appear twenty-four to thirty-six hours after the meal; occasionally, however, even later. There are great differences in the severity and duration of the disease. The mortality is about 25 to 30 per cent, much higher than in other forms of food poisonings.

Etiology.—As is already indicated by the name, botulism is at times caused by the ingestion of sausages which are infected with the *Clostridium botulinum*, producing toxins. But as this organism thrives also in other meat foods (see below), the most varied meat may enter into the question of botulinus poisoning.

Among the sausages which frequently cause poisoning, the liver sausage, as well as other visceral and jelly sausages, takes the first

place. In certain localities these varieties are extensively prepared, and are made into cured sausages by smoking. The sausage content itself does not resist putrefaction to any extent. Since the sausages usually appear in large sizes when prepared in so-called home slaughter for domestic consumption, it may readily occur that insufficient boiling will leave the bacteria contained within the sausages undestroyed. The bactericidal action of the smoking is also only slight in very large sausages, because the smoke penetrates with difficulty. This is especially the case when smoking is carried on for only a few hours) during the day), as frequently happens in the households of the country.

Proof that the poisonous effect of sausages can be traced to bacteria lies in the fact that other meat foods in the state of putrefaction produce affections entirely analogous to those of sausage poisoning. Thus, poisonous properties were observed in partially decomposed hams, in slightly putrid meat and in their broth; also in fermenting pickled meat; in roasted geese, which were allowed to hang undrawn for a day in the cellar; in old roast-mutton gravy; sausage meat; liver; liver pâté; spoiled canned preserves, etc. At the same time the respective foods did not display any striking changes, and showed principally only musty, slightly rancid, sour odors and taste.

The *Clostridium botulinum* has some similarity to the edema bacillus; it is 4 to 6 μ long and 0.9 to 1.2 μ broad; straight, with slightly rounded ends. It is an anaërobie; forms oval spores at the end of the rod; grows luxuriantly on alkaline media at 18° to 25° C., and develops a sharp odor of butyric acid. At higher degrees of temperature (35° to 37° C.) it grows only sparingly and without the formation of toxins. By heating half an hour at 80° C. the bacillus becomes inactive, the same as when exposed for one hour at 10° C. As the bacillus does not grow on pork containing 6 per cent salt, well-pickled foods, which always contain a large quantity of salt, should not be infected with it. But as pickling is frequently quickly and superficially accomplished, pickled and smoked products may contain botulinus bacilli and their toxins.

Van Ermengem classifies the *Clostridium botulinum* in a group of microorganisms established by himself, the toxigenic saprophytes, which do not multiply in the living body, but act only through their toxins. The enormous poisoning action of their toxins appears evident, when it is considered that for instance 1 to 2 drops of a gelatin culture, or 0.001 cm. of dextrose bouillon culture administered *per os* to monkeys and guinea-pigs, constitute a fatal dose in from twenty-four to thirty-six hours.

Occurrences of Poisonings.—Most of the botulinus poisonings, both epidemic and endemic cases, which have occurred in Würtemberg, according to Ostertag, can be accredited to the lack of intelligence by which formerly certain kinds of sausages, as liver and blood sausages, were prepared. Botulinus poisonings have also been observed in Bavaria, Baden and North Germany, although less frequently; single cases are reported in the literature from everywhere. In the Loch Maree tragedy in Scotland in 1922, 8 persons died of botulism from eating a single glass of potted wild duck paste. In England this disease is very rare in man. Jordan states that possibly as many as 2000 cases of botulism have been reported throughout the world, mostly among the people in Germany, Russia and the United States.

Prevention of Botulism.—For prevention of botulism, the following instructions to the public on the proper preparation of sausages are worthy of consideration:

1. Preserved food substances, which are exposed to anaërobic bacteria, must never be consumed in a raw state, but should be properly cooked.

2. Preserved food substances which by a rancid or butyric acid-like odor arouse suspicion should be excluded from consumption.

3. For pickling, only such brine containing at least 10 per cent common salt should be employed, as the *Clostridium botulinum* cannot multiply in this solution.

From a therapeutic standpoint the antitoxin serum first prepared by Kempner from goats for treatment of botulism has been found efficacious if given early. It is now made by injecting horses, and experimentally has been found to have both protective and curative properties.

CHAPTER XII.

HISTORY OF MEAT HYGIENE.

THE history of meat hygiene, and especially of meat inspection, which is inseparably connected with the history of food of man, need only be briefly discussed here,¹ to indicate its general development.

There is no doubt that man at all times, at least as far as his appearance can be traced paleontologically, has consumed meat food. For Europe especially it may be considered as proved that the paleolithic cave dwellers has already utilized the meat of various living animals and fish. The meat consumption of man during later epochs may with certainty be established from the oldest historical traditions.

The oldest data in the history of meat inspection are the food edicts of the Egyptians which designated certain animals, the hog above all, as unclean, and excluded their meat as food for man. The Egyptian priests held to this with great strictness, and may therefore be considered as the first representatives of a method of meat inspection.

The Egyptian food laws, whose prohibition of hog meat was accepted by all the Semitic races of those times, were without doubt prefigurative for the Mosaic food laws of the Israelites. Among the Israelites the priests were also the judges of the meats; this is accounted for by their connection with the extensive religious animal offerings and the share of the priests in the meat of the sacrificed animal. It was required that these sacrificed animals, and in a broader sense all the food animals, should be healthy and without a blemish.

Otherwise, animals fit for food were divided into clean (ruminants, domestic fowls and birds other than birds of prey, as well as fish having fins and scales) and unclean (solipeds, hogs, etc.). The consumption of young animals was interdicted, and the prohibition against consuming fat, blood and meat of hogs was especially strict. These edicts were amplified from time to time, particularly during the so-called Talmudic period, which extended through the first century, A. D., by specific instructions regarding the slaughter and examination of food animals (page 29). The method of slaughter was especially considered by the Jews (page 33).

Mohammedan food regulations, even of today, are similar to the Israelite and Egyptian food laws. The Koran considers both the hog and the dog as unclean.

In contrast to the views regarding the meat foods of the Semitic races stand those of the old Greeks and Romans. Pork was not inter-

¹ For details, see Ostertag's *Handbuch der Fleischbeschau*, Baranski (*Anleitung zur Vieh und Fleischbeschau*) and Goltz (*Geschichte der Fleischnahrung und Fleischnahrungsmittel*).

dicted, but was greatly favored by the Romans; and the Greeks likewise favored the meat of young castrated dogs. On the other hand, the consumption of meat of lambs which were not shorn at one time was forbidden to the Athenians, and the Romans disdained the meat of goats as unhealthy. Police were stationed at the Athens market from the earliest times. In Rome, since 388, following the foundation of the city, two state Aedils provided for order and supervision of the stock and meat markets, where also an official inspection of meat was conducted.

The salting of meat, which is mentioned by Homer, was known to the Romans, as was also the preparation of various kinds of sausages (botuli fry, incisia slice, circelli ring, temacina chopped sausages) and smoked products. Well-equipped abattoirs (lamenæ) and meat markets (macelli) existed, according to Ostertag, in ancient Rome. The old Roman meat control, however, was not further developed, for it ceased with the downfall of the western Roman Empire.

In northern Europe and among the ancient Gauls and Germans there are no traditions regarding a supervision of meat foods or on any other special customs. Not until after the spread of Christianity were Old Testament food laws inaugurated, which were strictly supervised by the Church. The prohibition of the consumption of horse meat, issued by Apostle Bonifacius, under the direction of Pope Gregory III, at the beginning of the eighth century, may be regarded as the earliest special food edict in old Germany. It, however, was adopted not so much from a hygienic standpoint as out of consideration for the horse offerings of the heathen Germans. Bonifacius, under the direction of Pope Zacharias, later prescribed that bacon and pork should not be eaten otherwise than cooked. The consumption of diseased meat from dead and torn animals was also prohibited.

In the course of time the civil authorities of Germany gradually paid more attention to meat, which formed the principal food of the people in the Middle Ages, and the meat industry developed into a particular business, which was later highly respected. The earliest German records in which meat traffic received consideration go back to the year 1120 (documents of the foundation of the city of Freiburg); butchers, however, are mentioned for the first time in 1156, in the "Iustitia cavitatis Augsburg" as "carnifices." As the trade developed the individual control of the meat industry in relation to the orderly traffic of meats not only progressed more and more, but the ecclesiastical and civil authorities concerned themselves about it. Thus, marketable and non-marketable meat are distinguished for the first time in a record which was imparted by Bishop Lutold in the year 1248 to the butcher's guild at Basel.

The decrees issued in the thirteenth and fourteenth centuries relative to meat traffic were principally of local significance for individual cities, but they contain important meat-inspection regulations. Thus are especially mentioned the measles of hogs, the bloating of meat, immaturity of calves, meat of emaciated and diseased animals, pearly

disease, etc., and in the year 1276 compulsory slaughter as well as compulsory inspection and declaration of sick animals was ordered for the public abattoir in Augsburg.

That state regulations were also found necessary in certain states becomes evident from a decree of the state of Mecklenburg for the year of 1572, according to which the butchers were to be controlled by the city bailiff and two competent persons.

After the 'Thirty Years' War little of the former fraternal and official supervising regulations in the domain of meat traffic remained, and only toward the end of the seventeenth century and the beginning of the eighteenth did the administration again direct some attention to meat and the slaughter of food animals. Without regarding local regulations, the decrees which existed at these times for Mecklenburg, Hanover, Braunschweig-Lüneburg, and the electorate of Saxony, as well as the general decrees of Baden, are worthy of mention. The importation of pickled and smoked meats was even then prohibited by certain States (Hanover, Saxony) and cities (Leipzig), without doubt on account of the fear of rinderpest. To a large extent, this led to a decree in Baden in the year 1772, requiring the professional opinion of the district physician on cattle which were effected with an infectious disease; in other disease the stock examiner had to pass upon the fitness of meat for consumption in order that meat, which at that time was very expensive, should not be unnecessarily withheld as human food. Even somewhat earlier, in the year 1761, the government of Bavaria prescribed a renewal of the inspection of food animals by official meat inspectors. At that time a change was also effected in the judging of pearly disease. Until then it was accepted as identical with a venereal affection, and, therefore, the meat of all such affected cattle was destroyed without further consideration. But after Graumann, in 1784, explained that the nodules of pearly disease were not injurious to human health the meat and milk of cattle affected with this pearly disease were not longer considered as unfit for food.

Until the end of the eighteenth century there was little scientific system in food regulations which gradually appeared with the establishment of veterinary schools, on a basis of the medical views of those days. These, however, were not favorable to meat inspection, since the teachings in regard to the injurious effects of meat in certain diseased animals led to the view that no danger threatened human health from consumption of meat of diseased animals. With this not only was a supervision of the meat traffic declared superfluous, but also the formerly recognized hygienic importance of the public abattoirs was ignored to such an extent that in 1826 a Prussian Ministerial script even declared the introduction of compulsory slaughter on the part of the local authorities as inadmissible. As a result, the number of public abattoirs in Prussia not only decreased but even abattoirs existing already were abandoned.

The conditions of meat inspection in South Germany were not

quite as unfavorable. In Baden and Kurpfaltz the institution of animal inspection was continued, and in the year 1802 a Ministerial decree was issued in Würtemberg for the prevention of very frequent poisonings by sausage. In the Kingdom of Bavaria the necessity of recognized meat inspection was soon seen, and first expressed in a meat-inspection ordinance for southern Bavaria, October 21, 1836, and for Schwaben and Neuburg, January 10, 1857. Further meat-inspection regulations followed for Würtemberg, March 14, 1860, northern Bavaria, June, 2, 1862, and Baden, August 17, 1865. The further development of meat inspection, which in North Germany was based on the Prussian abattoir laws of March 18, 1868, belongs to modern times. For the development of meat hygiene in other European states, handbooks on meat inspection as well as special historical works should be referred to.

The history of meat inspection in the United States is practically the history of the U. S. Bureau of Animal Industry. While there were forms of municipal meat inspection carried out in several cities previous to the organization of this bureau the inspection was not established on a scientific basis until the inauguration of the Federal Meat-inspection Service. The reasons for commencing this work were as follows:

The foreign sales of the meat-packing industry from the first included numerous varieties of meats and meat-products, and by 1879 the export trade in American bacon alone, without mentioning other foodstuffs, had become well established, when the continental countries became alarmed, seemingly on account of the presence of trichina in American hog products, and accordingly prohibitive measures against these meats were instituted. Italy was the first to promulgate these restrictions, and by 1881 Austria, Germany and France had likewise prohibited the importation of American pork or its products. American cattle met a similar rebuff at the instance of Great Britain, in 1882, when regulations, commonly called the "Slaughter Order," were instituted by the Order-in-Council of the Board of Agriculture, which compelled American cattle to be slaughtered at the port of entry. This prohibition of store cattle was caused, presumably, by the presence of contagious pleuropneumonia among the cattle in a few of the Eastern States and Illinois. Although this disease was effectually eradicated from this country in 1892, and although not a single case has been found either in cattle imported into Great Britain from the United States or among our herds since that date, the restrictive measures continue to be enforced, and the stigma constituting the assumed reason for this embargo remains. It is plainly evident to anyone who has given this subject the least consideration that these two alleged sanitary procedures of foreign governments were directly pointed at the meat and livestock industry of this country. Although they caused a vast falling off in the value of exports in these lines, and were to those variously engaged a hardship which continued for a decade, nevertheless, these interdictions must be considered as the potent and

exciting factors in securing legislation for the scientific inspection of meats for foreign and domestic use, and incidentally in advancing the cause of veterinary science in the United States.

The exclusion of American pork products finally became intolerable, and in order to relieve the situation and regain an export market for these foodstuffs, Congress passed the Act of August 30, 1890, providing for the inspection of salted pork and bacon. It was but natural to presume that with the passage of such a law providing for the certification of the pure and healthful character of American meats all restrictive measures against our export trades would be revoked. However, this initial act was not sufficiently comprehensive, referring chiefly to the manner in which the products were packed and their appearance immediately before shipment, without taking into consideration the condition of the animals producing these meats at the time of slaughter. For this reason the European countries failed to abolish their restriction against American pork. The relief expected in consequence of this Act was not, therefore, realized, and on March 3, 1891, Congress, recognizing the importance of protecting and fostering this export industry, the value of which had reached the sum of \$104,660,000 in 1881, and of acquiring and maintaining a pure and wholesome meat supply for our own people, passed a more effective act. This legislation authorized the issuance of regulations providing for the antemortem and postmortem examination of all cattle, sheep and hogs intended for export and interstate commerce, especially providing for postmortem inspection of cattle the meat of which is designated for export; for a microscopic examination of all hogs for export in order that certificates could be issued setting forth their freedom from trichinosis; the condemnation of all diseased animals; the marking or stamping of all inspected carcasses and the labeling of food products made from such carcasses intended for export or interstate traffic.

The work connected with the endorsement of this Act was placed under the care of the Bureau of Animal Industry, which had been established in 1884 for the purpose of collecting information concerning the nature, cause, treatment and prevention of diseases of animals and the publication of the best measures for the prevention and eradication of such diseases. These increased duties rendered it desirable that the various lines of work be divided, and accordingly, on April 1, 1891, the Bureau was organized into several divisions, one of which was designated the Meat Inspection Division, and, as its name implies, had, among other duties, special supervision of the inspection of meats for export and interstate commerce. Regulations were immediately adopted for the purpose of carrying into effect this Act of Congress. A system of inspection was devised, a force of veterinarians and their assistants organized, and the inspection of meats inaugurated within ten weeks after the passage of the Act, or on May 12, 1891, at the abattoir of Eastman & Co., of New York City. Other abattoirs made application for inspection, and by the end of the first complete fiscal

year (1892) inspection had been granted to twenty-eight abattoirs in twelve different cities.

It will thus be observed that Federal Meat Inspection has only a very recent history, but one of which our people and our profession can justly be proud.

The microscopic examination of pork for trichina was first established in Chicago, June 22, 1891, and likewise begun in other cities before the end of that year. At first there was some hesitancy and skepticism among the packers as to the practical application of this microscopic examination without seriously retarding the business of the firms and causing vexatious and unnecessary delays, but all doubts were shortly dispelled by the satisfactory performance of the work, and the problem was efficiently solved by the persistence and skill of the Chief of the Bureau of Animal Industry and the growing perception and ripening knowledge of his assistants. As a direct result of these microscopic examinations of pork products, which were subjected to the keenest scrutiny of the attaches of European countries and favorably reported upon by them, the decree of September 3, 1891, was made by the German Government after the Saratoga Convention which readmitted American pork that was officially certified as having been microscopically examined before shipment from the United States.

Subsequently similar interdictions were removed by Italy, France, Denmark and Austria, and in consequence of this reestablished confidence relative to the healthfulness and purity of the pork products of this country, the export trade began at once to show decided and gratifying increase, and gradually to expand and regain its former importance and value.

The beneficial and desirable results that would necessarily accrue in consequence of having the supervision and inspection of the Government meat inspectors to certify to the purity and soundness of the products of their abattoirs, soon appealed to and was quickly acted upon not only by the packers who sought to compete in foreign markets, but those doing a strictly local and interstate business. The proprietors of those abattoirs desiring inspection for their meat products are required to make written applications to the Secretary of Agriculture stating the kind and number of animals slaughtered and the destination of the products thereof, and to agree to such supervision of their business as may be demanded by the regulations of the bureau. On conforming to such requirements the packing house is given a serial number by which it and the products thereof are thereafter known, and an inspector is placed in charge of the plant and furnished with a sufficient number of veterinary inspectors and inspector assistants to carry out the required inspection.

The extension of the work caused by the enforcement of the Act of Congress cannot be fully appreciated or comprehended without a knowledge of the importance and magnitude of the subject. The successful and speedy elaboration of many details which necessarily required much labor and consideration and the care and efficiency with which they

were immediately enforced exceeded all expectations when the difficulties and obstacles—the inherent perplexities of the question—were considered. Moreover, this inspection was an innovation in sanitation in this country, and was of necessity carried out principally by inexperienced men who were chosen chiefly on the strength of their political influence rather than by the breadth of their veterinary knowledge.

The next epoch in the history of meat inspection is marked by the placing of all employees of the Bureau into the classified service by Presidential order. This took effect July 1, 1894, since which time all appointments to the force have been made only after the applicant has passed a rigid and highly satisfactory examination. By this means only the intelligent, competent and superior candidates are chosen from the eligible list by certification from the U. S. Civil Service Commission. Now that the merit system is in vogue, not only the personnel of the Bureau has been improved, as would be expected, but the harmony and discipline resulting therefrom is vastly better than is possible where political intrigue forms a basis of appointment, promotions and retention. The first requisite to be met by those aspiring to the position of veterinary inspector is to be a graduate of a recognized and reputable veterinary college, and then to pass a rigid examination that destroys the ambition of a large percentage of applicants. After successfully meeting these requirements and receiving an appointment, his future service depends entirely upon the personal equation, and would include the ability, integrity, and discretion with which his onerous and multiple duties are performed.

Previous to 1894 the inspection consisted principally in the examination of beef for export and the microscopic examination of pork destined for continental Europe; but at this time, owing to an increased demand for official inspection of meats, a similar antemortem and postmortem examination was extended to hogs, as has already been in operation from the beginning with cattle. In the following year calves and sheep were likewise subjected to inspection both before and after slaughter. As the inspection gradually increased and covered a large number of animals, it became more and more important to obtain sufficient authority from Congress to dispose of the condemned carcasses, as the original act failed to grant power for the proper disposal of such products. The danger of allowing condemned meats to remain undestroyed is palpable when taken into consideration with the limited authority of the Federal Government regarding the use of such carcasses within the State. That it was highly unsatisfactory to the Bureau, as well as to the health of our people, to permit the packer to have absolute control over the final disposal of unwholesome meats, was readily appreciated, especially in view of the dearth of State and municipal sanitary authorities vested with the power for properly disposing of those products. Consequently, Congress, by the enactment of March 2, 1895, granted full power to the Secretary of Agriculture to adopt such rules and regulations as would be necessary to prevent the use of condemned carcasses for export or interstate traffic,

making it a misdemeanor punishable by a fine not exceeding \$1000 or imprisonment, at the discretion of the court. The work was rapidly advancing as the inspectors became more thoroughly trained and experienced. New problems and duties were taken up as fast as the previous ones had been elucidated and controlled, and the progress was made highly gratifying. In keeping with this policy of steady conservative progress, the service was extended in 1895 by new legislation to include the interstate cattle inspection, and by 1897 not only all the beef and the greater part of pork and other meat products exported to Europe, but a large amount of the meat intended for interstate commerce was inspected in accordance with the law.

Although the legislation of neither 1891 nor 1895 mentioned sanitation, the Department in February, 1906, issued a sanitary regulation demanding the installation of toilet rooms of the employees of the various packing houses and insisting on cleanliness in all official abattoirs. Considerable progress was being made along these lines when the agitation of 1906 drew attention to the unsatisfactory conditions relating principally to canned and prepared meats, the use of preservatives and the unsanitary condition and methods of the packing establishments, although the Department at that time had no control over such matters under the law. These defects of the law under which inspection was being conducted had been realized and unsuccessful efforts had been made by the Department to improve the efficiency of the service by new legislation and increased appropriations, but it required the agitation of a sensational press to direct public attention to the inadequacy and defects of the law, which finally resulted in the adoption of the Meat Inspection Act of June 30, 1906.¹

This act provides that all cattle, sheep, goats, and hogs shall be subject to antemortem examinations when the meat thereof is to be used in interstate or foreign commerce, and such animals as are rejected must be slaughtered subject to postmortem inspection. In further provides for the postmortem inspection of all cattle, sheep, swine and goats, the products of which are intended for interstate and foreign trade. Those found fit for human food are marked "U. S. Inspected and Passed," and those carcasses found diseased or otherwise unfit for food are marked "U. S. Inspected and Condemned," and all such condemned meats are destroyed in the presence of a Government inspector. All meats which are marked "U. S. Inspected and Passed" may be reinspected at any subsequent time, and if they have become tainted, unclean or otherwise unfit for food they must be destroyed. In order that the slaughtering establishments may be under the supervision of the Government at all times, it is provided that the employees of the Bureau of Animal Industry shall have access to all portions of the plant day and night, whether it is in operation or not. Furthermore, power is granted the Secretary of Agriculture to destroy all food products containing dyes, chemicals or ingredients which render

¹ This law is reproduced on page 154.

the meat unfit for food. All food products handled in any official establishment must be under the supervision of an inspector during their preparation for preserving in cans, tins, pots, or other receptacles. These containers shall then bear a label that the contents have been inspected and passed. Nor are these food products allowed to be sold under any false or deceptive name. The Government is also empowered to have experts in sanitation to make inspection of all establishments, and to prescribe regulations of sanitation to be maintained, and when the sanitary conditions are not satisfactory the meat of such an establishment cannot enter interstate commerce. This Act further provides that on and after October 1, 1906, no carrier shall transport or receive for transportation any carcasses, meat or meat-food products, which have not been inspected and marked "U. S. Inspected and Passed," and any person or firm violating any of its provisions may be punished by a fine not exceeding \$10,000 or imprisonment not longer than two years, or by both such fine and imprisonment. For the enforcement of this law a yearly appropriation of about \$5,400,000 is made. When it is considered that previously the yearly appropriations for meat inspection had always been less than requested by the Secretary of Agriculture, and that in the years of the largest appropriations they averaged a little over \$800,000, it will be readily appreciated that a great advance has been made, not only in securing a rational and eminently satisfactory law on meat inspection, but also an appropriation which will permit of its efficient and continued enforcement. It can no longer be said, as it has been in the past, that we are more particular in protecting the people of Europe than our own citizens.

Meat inspection in Canada was begun twenty-five years ago. There was no government control maintained in Canada in connection with meat-food products until the necessity for such action was brought to the attention of the people through the meat-inspection agitation in the United States. Then the Parliamentary authorities passed a meat-inspection bill in September, 1907, which provides for a competent meat-inspection service, not alone for the increasing export of meat and meat-food products, but likewise for the control of the meat supply destined for home consumption.

Accordingly, in order to provide a sufficient number of well-trained veterinary inspectors for this work, arrangements were made through the Veterinary Director General for a special course of instruction in meat inspection in one of the veterinary colleges of the United States, located near a large packing center. Thus the Canadian veterinarians were admitted daily to the large abattoirs and were paired with the inspectors of the Bureau of Animal Industry in order to acquire a most valuable practical knowledge of the duties required by the Canadian Government. At the same time a full course of lectures was given to the students on the scientific aspect of meat inspection.

The requirements for the appointment as veterinary inspector in Canada are practically the same as in the United States. Graduates of recognized veterinary colleges are required to pass a special examination on veterinary branches.

The regulations governing meat inspection in Canada follow the same lines as those in force at the present time in the United States. They provide for an antemortem and postmortem inspection of all food animals slaughtered in an establishment where government inspection is maintained as well as strict sanitation of those establishments. The principles in the judgment of carcasses are also similar to those adopted in the United States Meat Inspection Regulations.

CHAPTER XIII.

ABATTOIRS AND STOCKYARDS.

THE supply of meat constitutes for all communities, especially for large cities, a factor of pronounced economic and hygienic importance. This meat supply is being obtained in greater and greater abundance from certain central places, in which the largest quantity of meat, the so-called dressed meat, is sold. Such central places are the public abattoirs (slaughter houses), which at the same time form the principal and central points for antemortem and postmortem inspection described in this book. For a more accurate study of the questions and conditions to be considered in the building and equipment of public abattoirs, the reader is referred to special literature on that subject.¹

As the larger abattoirs are frequently connected with stockyards, these stockyards must also be mentioned.

ABATTOIRS.

Abattoirs are establishments which serve for slaughter of such animals whose meat is utilized as food for human beings. Further, the meat is roughly prepared there for the market, is stored in the various departments, and frequently the so-called offal is worked up or is given preliminary treatment and removed, if further utilization cannot be accomplished. As most of the abattoirs in Europe are open to everyone, they are designated in general as public abattoirs, in which the slaughter of all animals is compulsory. The inhabitants of a locality are compelled to carry out the contemplated slaughter of animals of certain species exclusively in public abattoirs, provided accidental or emergency cases do not exceptionally require immediate emergency slaughter of an animal at some other place. With the introduction of compulsory slaughter further use of all private slaughtering places which may exist in the locality is accordingly prohibited.

The construction and use of public abattoirs is regulated by law in many municipalities of Europe.

Thus, for instance, the law applying to abattoirs in the Kingdom of Saxony has the following wording:

Law Concerning the Public Abattoirs, of July 11, 1876.

1. In localities in which public abattoirs are present in sufficient numbers, or such that are to be established by local statutes, there may be prohibited—

(a) The establishment of new private slaughtering places as well as

¹ Among others, Schwarz (Building Equipment and Operation for Public Abattoirs and Stockyards, Berlin, 1898), Schwarz (Machine Technic for the Operation of Abattoirs, Berlin, 1901), Osthoff (Abattoirs and Stockyards, revised by Dr. M. Fischer, Professor of the University of Halle, a. S., 2d edition, Leipzig, 1903.

(b) A further use of existing private slaughtering places. All such statutory provisions to be made effective, require the approval of the Minister of the Interior.

2. Inasmuch as the owners of private slaughtering places are entitled to indemnities in cases of certain diseases, the latter should be granted by the community.

3. The Department of the Interior is authorized to suspend in whole or in part the statutory provisions enacted in accordance with law if the provisions given in the introductory remarks are no longer present, and if the community does not remedy the existing deficiency within a given time; if such conditions apply to city community with city regulations a hearing should be given before the District Commissioners; in all other cases a hearing before the County Commissioners should be taken.

Location of the Abattoir.—In selecting a location for an abattoir it should be considered that the building should: (1) Be located outside the city, and that there should be no indication of it being soon surrounded by other buildings; (2) be easy of access from all points of the city by good roads; (3) be easily connected by a side track with the existing railroad line; (4) have underground drainage for the waste water without coming in contact with the built-up section of the city, and this drainage should be executed in such a way that it empties below the city into a water drain, or into a constructed waste-water cleaning plant; (5) have a sufficient water supply to cover the great demand of wash water which is required in abattoirs; (6) be of such sufficient size that an extension of the plant at that location should be assured for at least thirty years.

Entire Establishment.—The location of the various buildings and rooms of an abattoir is, in general, according to one of three systems.

German System.—The German arrangement of the buildings (Fig. 154) aims to make the plant appear as closed as possible. Therefore, the most important operating rooms are either united in a single building under one roof, or most of the buildings are connected by roofed connecting passages, in such a way that larger open courts are not present between the various buildings.

The advantages of the German arrangement of buildings lie in the smaller requirement of space, lower buildings and operating expenses; good facilities for surveying and supervising, convenient connections of the working establishments, and consequent saving of time in slaughter and an easy control of the butcher helpers by the foremen, as well as protection against draught, rain, snow, and cold, which such a closed plant affords to a greater advantage than an open establishment. A prominent disadvantage of the German system is the difficulty of extension, which, however, may be avoided by correct measurement of the requirements of space and commodious arrangements of the principal operating rooms. On account of the latter conditions, the German arrangement of buildings is not adapted to abattoirs of larger cities; while, on the other hand, it possesses great advantages without doubt for abattoirs of small or medium size, as compared with the French system; and above all, it is also more suitable for climatic conditions for most parts of Germany.

French System.—In the French arrangement of buildings there are open courts or streets between the various buildings, the grouping of which is arranged according to their operation; thus the closed appearance of the German system is absent.

The advantages of the French system lie, above all, in the easy possibility of extension of every part of the plant; its disadvantages are brought out by the advantages of the German arrangements. Large abattoir plants can be practically constructed only after the French system, or by the combination system next to be described.

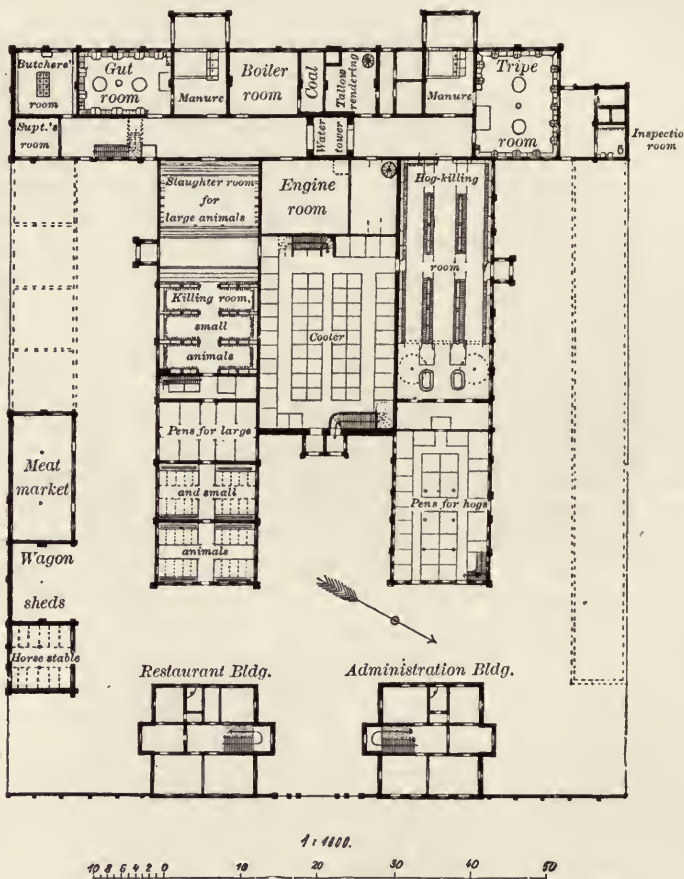

FIG. 154.—Ground plan of an abattoir (Tilsit) with German arrangement of the buildings.

The original characteristic slaughter-cell arrangement of the French system, into which every abattoir was divided, must now be considered as a condition that belongs to the past.

Combination System.—By a combination system for abattoir plants (Fig. 155) is meant a system of building in which the principal operating

buildings are arranged according to the French system, and connected by roofed passages or connecting halls. This system has been adopted more and more extensively during the last few years. The connecting halls between the various killing houses on one side and the cooling house on the other make possible not only the transportation of meat without exposure to the changes of weather, but they also serve as a place for keeping the utensils of the butchers, for whom the roofing serves to an advantage, just the same as to the butchers, dealers,

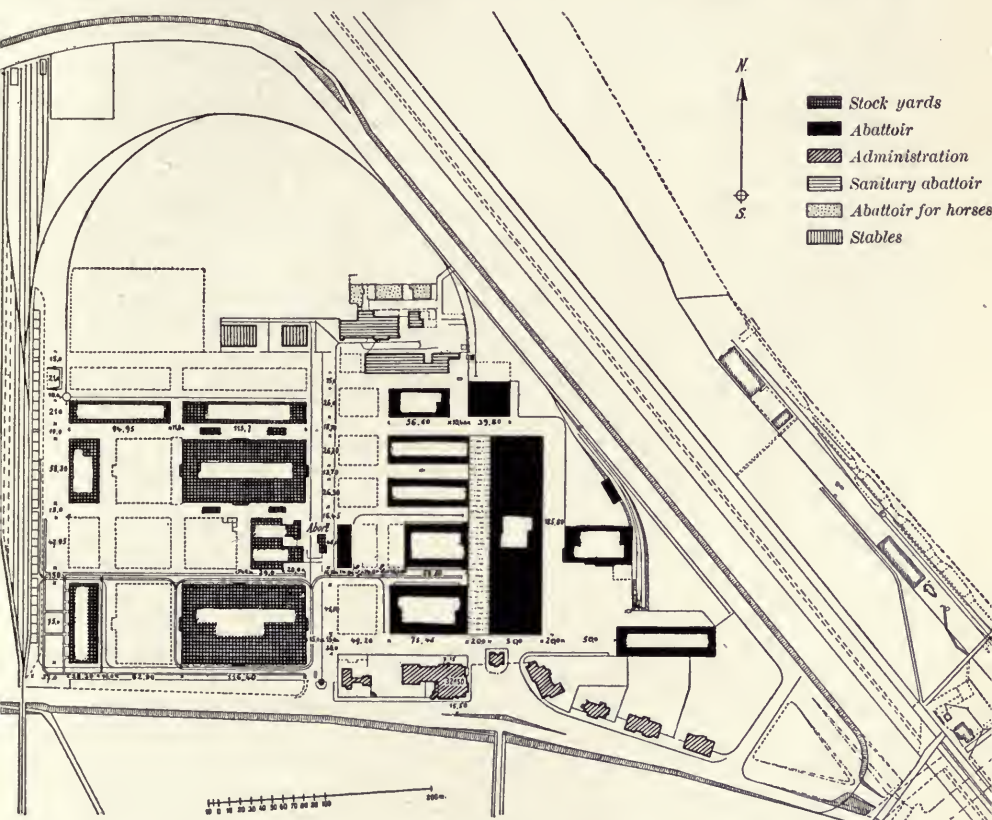

FIG. 155.—Ground plan of an abattoir and stockyards, in which the first is arranged in accordance with the combination system.

officials and other visitors to the abattoir, who frequent the corresponding buildings. Similarly roofed connecting passages are also established between the killing halls on one side and the tripe-house and manure house on the other.

The advantage of such building arrangements become apparent from the description. Disadvantages may be present when the corresponding buildings do not front the connecting passageway, but border the same with long walls, thereby interfering with the lighting and ventilation of slaughter halls, etc.

In the central plant of a large abattoir which is connected with stockyards, the following principal parts should be considered: (a) Stockyards with special quarantine pens; (b) abattoir with accessory buildings; (c) official and plague abattoir; (d) horse and dog abattoir; (e) office building; (f) living quarters; (g) vaccine establishment (for preparing lymph against smallpox); (h) railroad tracks and station for disinfection of railroad cars; (i) provision for sewers and clarification plant for waste water; (k) water-supplying plant; (l) lighting plant, and (m) streets and places with roofed wagon stands.

There is no special system followed in the construction of abattoirs in the United States. However, in accordance with the provisions of the requirements of the United States Department of Agriculture all abattoirs where meat inspection is maintained must be arranged and constructed in accordance with the sanitary requirements. The plans for construction of new buildings or any contemplated changes must be submitted to the Department for approval.

Buildings and Rooms.—The necessary buildings and rooms of every abattoir, with their purposes and principal equipments, are indicated in the following:

Killing Houses.—In the killing houses the animals are slaughtered, skinned, or the hair is removed, eviscerated and inspected; also frequently they remain there hanging to cool out. While in small abattoirs a single room may serve for slaughtering all species of food animals, in medium-sized abattoirs cattle and small stock are slaughtered together, while only hogs are butchered in a special room. In large abattoirs, special slaughtering rooms must be provided for cattle, small stock and hogs.

The slaughtering of horses requires an individual killing house, separated from the others. In the same way a special killing house must be provided for the slaughter of sick animals.

The general equipment of the abattoirs should meet the following requirements: As much light as possible; hard, impenetrable floors; good drainage for the water used in washing; smooth walls which must be easily washed to a height of 2 meters from the floor; a plentiful supply of cold and hot water; abundant ventilation, and according to judgment, also slight heating in winter.

In killing houses for large stock windlasses are found particularly necessary for hoisting both cattle and horses. These hoisters are termed stationary when the slaughtered animals is left to hang on them until cool, and movable when special equipments are provided for cooling the carcass, and the windlass serves only for hoisting and transporting the slaughtered animal to the hanging floor. The latter, as a rule, is connected with coolers by rails and a proper transporting equipment in such a way that the divided hanging sides of large stock may be conveyed to the coolers without much exertion.

Killing houses for small stock contain hook frames built into them for hanging thereon skinned calves and sheep and their viscera. These animals are slaughtered on trestles.

Lately, special slaughter trestles have also come into use. They are fastened to the floor and may be raised in such a way that they also serve at the same time for hanging arrangements. Hook frames are thus made superfluous.

The killing houses for hogs are distinguished by the sticking and scalding rooms, as well as by the dressing room. In the former are present the striking and sticking sheds; also hot-water vats, in which the stuck hogs are scalded to facilitate removal of the hair. Sometimes the hair is removed on special tables in this room; however, the scraping is frequently executed in the room in which the carcass is dressed. The dressing room contains hooks on frames or rails for hanging and eviscerating hogs after the hair has been removed; also hanging arrangements and tables for the viscera and other parts.

For the conveyance of hogs from the scalding vat to the scraping table and from there to the hanging floor and chill room, very ingenious arrangements are frequently installed, which save human strength as much as possible. One of the latest of these devices, which has widely attracted the attention of abattoir constructors, is a patented gliding-rail system, with traversable spreaders.

In connection with hog-killing houses of large abattoirs, trichina-inspection rooms are usually established.

Tripe Room.—The tripe room (gut room) is used for emptying and cleaning of the gastro-intestinal canal. In small abattoirs there is only one common room; in large abattoirs, however, there are separate tripe rooms for every slaughter house. The tripe rooms of cattle slaughter houses are usually connected with a special manure house for the reception of the contents of the stomach. The tripe rooms are supplied with troughs for cleaning stomachs and intestines in warm and cold water, with vats for scalding certain parts, and with tables.

Cooling Room.—The equipment and operation of the cooling rooms and coolers, which are today inseparable even in small abattoirs, have been fully described on page 89.

Stables.—Stables must be present for all species of food animals, as well as for horses which are employed in the industrial traffic of abattoirs. For the sick or suspicious stock, stables are equipped apart from the others, and they must also be used for stabling foreign food stock.

In the equipment of stables the omission of woodwork, non-percolating and easily cleaned floors and wall surfaces, good lighting and ventilation, sufficient water supply and good drainage for the filthy water are indispensable.

Manure Houses.—The manure houses which have given the best satisfaction for the disposal of manure are so equipped that they possess elevated platforms, with openings through which the manure is poured or thrown into closed iron manure cars, which are switched there. The most important factors are good ventilation and quickness in carrying off the manure. In large abattoirs useful devices have been installed for the disposal of the manure and for its further utilization.

Tallow Factories for Rendering Fat and Tallow Obtained in the Abattoir.—Blood-utilizing plants, casing plants, hide-salting establishments and hide houses, and plants for the industrial utilization of condemned

products are only found in larger abattoirs. An odorless plant, which may vary greatly, should be required as absolutely necessary.

Boiler and Engine Houses.—Boiler and engine houses are required in order to obtain steam for heating and operating purposes, as well as for working the engines for operating the refrigerating machines, electric dynamos, pumps, etc. The latter convey the water into special tanks placed at some elevation in order to obtain a ready flow for the water supply.

Disposal of Condemned Meat.—The establishments which are present in medium-sized and larger abattoirs, for the separate stabling, slaughtering and sanitary and veterinary police disposal of diseased food stock and those suspected of diseases or plagues are designated as sanitary institutions or police slaughter houses. They represent to a certain extent a small abattoir within a larger establishment, and are correspondingly equipped. There also are placed, as a rule, the contrivances for harmless disposition of condemned meat (page 200) required by the meat-inspection regulations, for rendering and steaming meat (page 203), for rendering fat (page 199), pickling (page 199) and for curing meat, as well as the apparatus and plants mentioned under tallow factories.

Offices.—In the official building are quarters for the general and financial management of the abattoir and for the meat and trichina inspection should they not be located in the slaughter houses proper; wardrobes for the foremen and assistants; the restaurant, unless there is a special restaurant building; and living quarters for officials.

An inspection office for meat brought from the outside, as well as a Freibank salesroom, may be located in the office building if they are not placed in other buildings.

Scale Houses.—Scale houses and special quarters for gatekeepers are only necessary in medium-sized and large abattoirs.

Waste-water Cleaning Plants.—Waste-water cleaning plants, for which the most varied systems are in existence, must be provided for all abattoirs in view of the great pollution of the waste water of abattoirs. Their construction is principally underground.

Management of the Abbatoirs.—The experience of many years has demonstrated that the management of abattoirs must be positively effected by the community itself; it is desired to avoid all numerous unpleasant conditions and incidents, which were observed in the management of such establishments at first, by receiving hearty coöperation from private individuals, corporations and butchers' coöperative associations. Competent veterinarians have always given the best satisfaction as managers of abattoirs.

The same state of affairs exists in the erection of public abattoirs which are to be managed entirely by local administration. Aside from the noteworthy fact that in public abattoirs the police rights of the community are exercised to a very great extent, it should be especially recognized that the public abattoirs are not only very good investments of capital, but that they are continually proving to be a

profitable source of income. They should, however, principally benefit the community, and not the private individual or corporation.

When an abattoir is privately owned and managed, the experts assigned to the execution of the antemortem and postmortem inspection should be permanently appointed city officials, and there should be a general official supervision of employees.

What is said on page 400 will apply also to the supervision of abattoirs.

STOCKYARDS.

Stockyards which serve for commercial traffic in food animals in specially constructed buildings are appropriately equipped. They are very necessary in all cities in which the supply of food animals from the immediate neighborhood is insufficient and in which the supply comes from larger stock-raising localities. Stockyards which are favorably situated and well attended frequently become centers for the animal commerce of large territories, and, consequently, a considerable amount of shipping takes place from such stockyards.

As a rule, a large proportion of the stock sold at the stock markets is slaughtered at the same place. Therefore, it is advantageous to connect the stockyards directly with the abattoirs. The advantage of this is especially great when an outbreak of contagion in the stock markets calls for the immediate slaughter of affected stock.

Location of Stockyards.—The same factors come into consideration in the selection of a location for the erection of stockyards as in the establishment of an abattoir. An immediate track connection with a railroad is a natural necessity, and for these reasons the advantage of its connection with an abattoir becomes apparent. Accordingly, stockyards and abattoirs represent usually a complete establishment, composed of two elements which are dependent upon each other. A distinct separation of the abattoir from the stockyard in such a way that the one may be closed against the other is indispensable from a veterinary police standpoint, and also on the grounds of technical management.

There are not special systems for grouping stockyard buildings. This is rather influenced by the location of the various buildings of the abattoir, and especially by the practical points of view. Parts of stockyards separated for special purposes are: Yards for animals left over from the market; quarantine and plague yards, which, however, in smaller stockyards are mostly represented by isolated stables.

The Union Stockyards at Chicago, Ill. (Fig. 156), in which antemortem inspection of livestock is conducted by the employees of the Bureau of Animal Industry, contain 500 acres, about 50 of which are either covered by buildings or used for storage of manure, lumber, etc. This latter portions is the only area which is not paved or covered with flooring. Of the remaining 450 acres, an area comprising a few acres—which includes the pens that are scarcely ever in use—is floored with planking and drained by box sewers. The remainder of the cattle



FIG. 156.—Union stockyards, Chicago, Illinois.

pens, roadways and alleys comprising the vast area in daily use are paved throughout with vitrified brick having a low degree of water absorption. The drainage is good and the pens are kept as clean as the character of their use will permit.

Buildings and Plants.—The buildings and plants which belong to a well-equipped stockyard will be briefly described. When a public traffic is maintained, or food animals are bought, the equipment in general should, in the first place, satisfy the veterinary police and sanitary requirements in relation to cleanliness and possibility for disinfection (hard, impenetrable floors; these should be smooth, easily washed walls; omission of woodwork; good arrangements for ventilation; good light; abundant water supply and good drainage for filthy water).

Stock which is transported to the stockyards is put up for sale in special market pens, as a rule, only on certain market days. Whether a special pen is provided for every species of food animal depends on the size of the stockyards and the existing trade activity.

At some places calves are also put up for sale in the market pens used for cattle, while in others they are sheltered in the market pens used for hogs; and in still other stockyards there are special small stock-market pens for calves.

In the equipment of these market yards railings should be provided in those used for cattle for tying the animals; and in the yards for smaller stock divisions into smaller and larger pens are required for placing the animals. Equipment for feeding stock in the market yards (mangers, troughs, racks) is not necessary in case there is ample stable room present, in which stabling and feeding may take place before and after market.

Special emphasis should be laid, from the standpoint of veterinary police, upon good and sufficient stables. Large attached stable rooms, however, are unsatisfactory, and small stable divisions should be favored.

Special stables are required for the horses employed in the business of the stockyards. The stable loft serves, as a rule, as a storage room for feed and straw.

An exchange building with restaurant is necessary only in large stockyards. In this building offices and business rooms are also provided for traders, stock commission men, animal insurance companies, stockyard banks, etc.

A special office building for the officials and the management of the abattoir is necessary in those instances where the required rooms cannot be obtained in the other buildings (exchange halls).

The location of railroad platforms for loading and unloading stock is influenced on the one hand by track connections, but on the other hand, the traffic with market stock is considerably facilitated by the suitable relation of the stables to the platform. A special platform, or a separated part of the general platform, must be provided for the traffic of quarantined stock or animals infected with a contagious dis-

ease. On the platforms are holding and counting pens necessary for temporary quarantine of the stock. Small platforms for unloading and loading stock carried by motor trucks are suitably erected at various practical places in the stockyards. This method of conveying all kinds of livestock has increased greatly during the last few years.

A dung yard must be provided when the stable manure is not immediately loaded into cars from special manure houses (page 395). The attempt has been made to compost the manure. By this method the vegetable and animal organisms which produce disease are rendered harmless through the development of self-heating as a consequence of the process.

Equipment for washing hogs (wash pens, vats) and for the preparation of scalded feed and gruels (gruel kitchens) are usually established in connection with the respective stables.

The water supply (cold and warm water) of the stockyard is obtained, as a rule, from the corresponding plant of the abattoir.

A disinfection plant for railroad cars, with necessary tracks, steam and hot-water boilers, hydrants, etc., is found only in larger stockyards.

The part of the stockyard used for animals left over from the market is indispensable for large stockyards at a time of danger from plague. It represents a closed portion of the stockyard with stables for all species of animals which were not sold, for the time being, on the market.

The quarantine or closed yards are somewhat similar to those previously mentioned, and are used for the accommodation of market stock from foreign countries which is not allowed to come in contact with native stock. It is more correct to connect the quarantine yard directly with the abattoir, or to provide an equipment in the yards for slaughtering animals placed in the quarantine pens.

The yards for animals with infectious diseases are, as a rule, connected with the sanitary establishment mentioned on page 394, in order that the infected stock may be slaughtered there.

Management of Stockyards.—The management of stockyards is the same as that of abattoirs (see page 396).

Veterinary supervision of the stockyards, as a rule, devolves upon Government veterinarians, unless special State veterinarians are employed for this purpose; or the director of the stockyards is authorized by the Government to maintain this supervision, assigning an official veterinarian to attend to the duties.

In the United States the stockyards with are located in the larger live-stock centers are, as a rule, controlled by private corporations. However, all conditions pertaining to their sanitation and operations are under the direct control and supervision of the Bureau of Animal Industry.

CHAPTER XIV.

PREPARATION AND CONTROL OF MEAT-FOOD PRODUCTS.

It is not considered good policy, as a rule, to slaughter hogs while they are in a heated or exhausted condition, so the usual rule is to allow them to cool off and rest for several hours in the pens previous to the time of killing, as this renders the meat less liable to sour in cure. Sows in heat should not be slaughtered, as this meat is hard to cure, especially the hams, which in many cases spoil in pickle.

In the larger packing houses the hogs are hung up by the leg, by means of a shackle attached to an endless chain or a so-called "Ferris wheel," which automatically drops them off on to the rail in the sticking pen. They are then stuck and allowed to bleed out well before being dropped into the scalding vat. In some of the smaller plants the hogs are first stunned with the knocking hammer in the pen and stuck while in the horizontal position. This does not give as thorough bleeding as when the hogs are bled in the hanging position and is objectionable from the inspection point of view, as the lungs are full of blood due to hypostatic congestion so that diseased conditions, such as pneumonia, are not so readily distinguished.

After the hogs have bled out they are dropped into the scalding vat for a few minutes to loosen the bristles. The temperature of the water in the scalding vat is usually 140° to 150° F., depending on the length of the vat, the time of the year, and the rapidity with which the carcasses pass through.

If the water in the scalding vat is too hot or if the hogs remain in too long, they become "burnt" and the bristles and scurf become set, so that it is almost impossible to scrape and clean the hog properly.

When scalding is completed the hogs are scraped by hand or, in the modern plant, they are passed through a dehairing machine which, by means of rapidly revolving paddles, removes nearly all the hair and massages the skin free from dirt. The hogs are then successively singed with a gas flame, shaved, washed in a water spray bath, eviscerated, split, the leaf fat pulled loose, the hams faced, then given a final washing to remove blood from neck region, after which the carcasses are weighed and chilled for cutting up.

The method of chilling dressed hogs is to run them into coolers refrigerated by either brine coils or the open brine-spray system. At the start these coolers are slightly below the freezing point, and as they are filled with hogs the temperature will rise to 45° or 48° F., after which it should be gradually reduced (about 0.5° per hour), so

that after twenty-four hours it will be 36° F. During the next twelve hours it should be reduced to 32° F. and held there or a degree or two lower for eight hours, after which it is raised to 33° F. until the hogs are cut at forty-eight hours' chilling. This is known as the forty-eight hour chill, and the meat at the center of the hams at the bone should be about 36° F.

In many of the smaller and medium-sized plants, hog carcasses are only chilled for twenty-four hours.

After chilling completed the hogs are cut up into various cuts, as hams, shoulders, bellies, loins, etc., which should be neatly trimmed ready for delivery to the curing cellar. These cuts may be placed in cure on the same day as cut, in which case it is better to have the cutting room under refrigeration at about 36° to 38° F., but in other plants the hams, shoulders and sometimes the bellies are still further chilled by holding them spread out on racks in a cooler at 32° to 34° F. for twenty-four to thirty-six hours longer before placing them in pickle.

It is claimed that there is a smaller percentage of "sours" by this method, but many believe the difference is not sufficient to pay for the cost of the extra handling thus incurred.

The average shrink from wet dressed weight after twenty-four hours' chilling is 2 per cent; after forty-eight hours 3 to 4 per cent; and after ninety-four hours about 5 per cent.

Various firms have entirely different methods, and there are several plants where hogs are cut up and cured after only a twelve-to sixteen-hour chill, but it is only by care and close personal supervision that this method is successful.

Many packers do not like to chill hogs too fast, as they believe the inside of the heavy parts does not thus chill properly, but actual tests appear to have disproved that idea. The hogs should not be frozen, as in that case the pickle will not penetrate the meat properly.

Experience has shown that frozen meat must be thoroughly thawed out before being placed in cure; otherwise it will almost invariably spoil in pickle.

A meat thermometer should be used for accurate work to determine the temperature of the meat at the bone before hams, etc., are placed in cure, and the one giving the best results is the kind that can be read while the bulb remains imbedded in the meat.

Occasionally the shank bones are sawed through on the killing beds, which allows the hams to cool out more quickly and more thoroughly, thereby preventing many cases of marrow-sour hams.

Curing Pork.—After the pork has been cut up it is sorted for various cuts, weights, etc., and then sent to the curing cellar where it is placed in curing vats, tierces or other curing containers and covered with a pickling solution which consists of salt, saltpeter and a sweetening substance, such as sugar, syrup, molasses or occasionally honey. (For composition of pickles, see pages 92 and 357.)

In many plants some of the curing pickle is pumped into the interior of hams, shoulders and sometimes bellies, by means of an apparatus

consisting of a force pump, hose and hollow needle. The latter is run into the body of the meat, usually along the bone, and various amounts of pickle injected according to the size of the piece of meat being pumped. The ordinary pump throws 3 ounces of pickle to each stroke of the handle, and each firm has definite instructions for their employees as to the number of strokes, which varies from two to six for hams and two to four for shoulders. Sometimes when overhauling the meat the pumping is repeated with a smaller amount of pickle.

The pumping conveys the pickle directly into the deeper parts of the meat, thereby reducing the time of curing, since the penetration of the pickle from the outside through soaking consumes a considerably longer time, and besides it also lessens the danger of the meat souring in pickle.

To obtain the best results and a minimum percentage of sour meat strict sanitary methods must be employed throughout the entire process. Receptacles used in the manufacture of pickle, also the pumping paraphernalia, should be sterilized, and the vats or other containers should be thoroughly washed and steamed out. Above all, the overhauling instructions should be carried out to the letter.

Pickle should be strained or filtered before it is placed on the meat, and if used more than once it is sometimes boiled and should always be filtered before being used the second time.

The curing process may be conducted in open vats made either of wood or concrete, or in closed tierces. The concrete vats are very satisfactory, as they utilize the entire available space and are easily kept clean, for there are no holes or corners underneath and in back of them to hold or collect dirt. If used, they should be of oil-finished concrete, trowelled down to a very smooth surface, with the bottom so sloped as to properly drain to an outlet at one side of the bottom.

Every firm has its own separate pickle formula or, frequently, several different formulas for various kinds of meat or for certain classes of trade, and, as a rule, these formulas are considered trade secrets, although they differ chiefly in the amounts and proportions of the ingredients used. The pickle used for pumping purposes is, as a rule, very similar to ordinary pickle.

In preparing *regular pickle* many firms make the solution in bulk in large tanks or vats and run the required amount on to the meat to be cured, after it has been placed in the curing vats or tierces.

Other firms make up a plain brine solution of the required strength in bulk; then weigh out the desired amount of saltpeter and sugar to each tierce or vat of meat to be cured, and rub or sprinkle this on the meat as it is being packed, after which the plain brine solution is added.

Another method often used is to weigh out all of the pickle ingredients, salt, saltpeter and sugar, needed for each tierce or vat of meat, and then rub each piece of meat with it, or sprinkle it on the meat while it is being packed, after which sufficient cold brine is run in to submerge the meat or to fill the tierce.

When the latter method is used it is customary to weigh out 285

pounds of hams, bellies, etc., rub each piece with the cure and pack in a tierce, head it up and fill with clear cold brine. About 15 gallons is the usual amount required for the above quantity of meat in a tierce.

The meat should be first sorted for small, medium and large sizes and each size cured in separate vats, so that the result will be a uniform cure.

When curing in open vats the meat should be pressed down by means of weights, so as to keep it thoroughly immersed in the pickle.

The temperature of the curing cellar should be about 36° to 38° F., and the curing pickle should be the same temperature or, better, 2° to 4° F. lower when put on the meat, which should be thoroughly chilled and not higher than 36° F. at the bone when placed in cure. The temperature of the curing cellar should not be allowed to go over 40° F.

Do not attempt to place meat in cure when it is frozen, as it will not take the pickle and will almost invariably spoil, unless thoroughly thawed out first.

Overhauling.—The meat should be overhauled during the curing process twice, or, better, three times; hams, picnics and shoulders, at about the fifth, fifteenth and thirtieth days. If cured in tierces the piles should be broken and the tierces rolled about 100 to 150 yards at the above periods, and if the curing is done in vats the meat should be overhauled by transferring it to other vats and the same pickle pumped on to it.

Time Required for Curing.—The time required to cure sweet pickled meats, as hams, shoulders and picnics, is about four days to the pound average, if not pumped, and three and a half days to the pound if pumped once, while if pumped twice about ten days may be deducted from the time in cure for large-sized hams.

Meat in cure will gain about 8 to 10 per cent. Thus, when products are put down at 285 pounds green they will weight 310 pounds, or sometimes more, cured. This gain is usually all lost during the smoking process.

An exception to the above is beef tongues which lose 0.5 of 1 per cent in cure, and also pork in dry cure.

Saltpeter.—Saltpeter (potassium nitrate or India saltpeter) is used in curing preparations mainly because it brings out the red color of the meat as it is only to a slight extent a curative agent. If no saltpeter is used the meat turns gray in pickle, but with its use the nitrate is changed to nitrite, which acts on the hemoglobin, producing a bright red derivative (nitrosohemoglobin).

Chile Saltpeter.—If sodium nitrate (Chile saltpeter) is used a less quantity is required, as 80 parts of Chile saltpeter equal 100 parts of the ordinary saltpeter; so in figuring quantities of this substance for pickle, formulas containing 20 per cent or one-fifth less of the Chile saltpeter are used.

Sodium Nitrite.—The use of sodium nitrite is permitted in curing meats but only under careful supervision, so that the finished product will contain not over 200 parts per million. This has an advantage in

hastening the color fixing process and somewhat shortens the time in cure. The maximum amounts permitted are as follows: $\frac{1}{4}$ ounce to each 100 pounds of sausage meat, 1 ounce to each 100 pounds of dry salt meat, or 2 pounds to each 100 gallons of curing pickle.

Pickle Solution.—In making pickle solution the sugar and saltpeter are usually figured at about 3° ; thus if the plain brine is 75° strength, the sugar and saltpeter added would raise it 3° to 78° .

STRENGTH OF PICKLE. PLAIN BRINE SOLUTIONS.

Salt, amount.	Strength salometer.	Baumés degree at 60° F.	Specific gravity at 60° F.	Freezing point, Fahr.
0.00	0°	0°	1.000	32.00
0.50	20°	5°	1.037	25.40
0.75	30°	22.00
1.00	40°	10°	1.073	18.60
1.25	50°	15.00
1.50	60°	15°	1.115	12.20
1.75	70°	9.00
2.00	80°	19°	1.150	6.86
2.25	90°	3.00
2.50	100°	23°	1.191	1.00

Amount of Pickle Required.—The amount of pickle required is about 5 gallons to each 100 pounds of meat, or 14 to 15 gallons to each tierce, which is put down usually with 285 pounds of meat. Some firms use more pickle as follows:

Use $5\frac{1}{2}$ to $5\frac{3}{4}$ gallons of pickle to each 100 pounds hams or shoulders.

Use 6 to $6\frac{1}{2}$ gallons of pickle to each 100 pounds bellies.

Use $6\frac{1}{2}$ to 7 gallons of pickle to each 100 pounds boneless shoulder butts.

Pickle becomes reduced in strength during the curing process on account of the meat taking up some of the salt, saltpeter and sugar, and in turn giving up some of its water content.

If pickle is to be used again for curing a second batch of meat, it must be sweet and clean. It is usually filtered and often sterilized by boiling and then strengthened up to the required degree.

When meat is to be held for storage after curing is finished, keep it at a temperature of 26° to 28° F., which prohibits further curing, as meat will not take up any more pickle at this low temperature, or better still, run off the pickle and hold the meat in air-tight tierces at the above temperature until used.

GENERAL SWEET PICKLE FORMULA.

Cane sugar	20 to 25 pounds
Saltpeter	5 pounds
70° brine	100 gallons

This makes a mild cure for hams, etc., but more of each ingredient may be added if a stronger pickle is desired.

Reduced to amounts for a tierce holding 285 pounds of meat and 15 gallons of pickle, the above contains:

Sugar	4 pounds
Saltpeter	12 ounces
Salt	26 pounds

Special Formula.—In addition to a general formula for pickle some firms use different pickle for various parts and cuts.

SWEET PICKLE FORMULA FOR PICNICS.

Cane sugar	22 pounds
Salt peter	3½ "
78° brine	100 gallons

SWEET PICKLE FORMULA FOR HOG AND BEEF TONGUES.

Cane sugar	12 pounds
Salt peter	5 "
80° brine	100 gallons

Curing Bellies.—Bacon may be cured in open vats, in closed tierces, in dry salt, or for the best results, in dry salt in water-tight boxes.

These boxes are made to hold either 300 or 600 pounds of bellies, and the following makes a good cure for each 100 pounds of bellies:

Fine salt	4 to 6 pounds
Salt peter	3 to 6 ounces
Granulated sugar	1½ to 2 pounds

Rub the green chilled bellies well with this cure and then pack them into the water-tight boxes. Have the bellies packed in tight and the lid pressed down firmly and secured with proper clasps.

No water or brine need be added as the meat makes its own brine. The only reason for adding any liquid in this method is to reduce the shrink, but this detracts from the quality of the product.

No overhauling is required and the bacon will be cured ready to smoke in twenty to twenty-five days. Soak for fifteen to thirty minutes and then smoke for about eighteen hours.

If bellies are cured in open vats lay them in layer upon layer, rib side up, sprinkle each layer with its share of the cure and when the vat is filled run in sufficient mild brine to submerge the bellies.

For each 100 pounds of bellies use the curing materials given in above formula.

Instead of the above method the bellies may be placed in vats, rib side up, and submerged in the following pickle, which gives a good mild cure:

60° brine	100 gallons
Salt peter	4 pounds
Cane sugar	20 to 25 pounds

Bellies frequently are given a three-day per pound cure, but often only two days per pound is allowed or even less, especially if for immediate sale and delivery to consumer. They should be overhauled once or more, but the oftener this is done, the sooner they can be taken out, although these short cures require expert handling, with little or no soaking, or often simply washing in luke-warm water, followed by a light cool smoke at 110° to 115° F. for about fourteen to eighteen hours.

For the regular or longer cures, bellies are soaked three to four hours before smoking.

Dry Salt Meat.—Pork is often cured by the dry salt method instead of in a pickling solution. In this system the curing preparation is rubbed well into the meat, after which it is piled up layer upon layer in the curing cellar to cure.

Cure.—Use 14 pounds of fine salt to each 100 pounds of pork, but no saltpeter is ordinarily used on dry salt meat cured in piles, except that when bellies are first cleared (ribs removed) a small shake of saltpeter is sprinkled on the meat beneath the ribs to bring out the red color of the meat when it is smoked. About 4 ounces of saltpeter to 100 pounds of meat is used for this.

Salt-peter is also used on some special cure dry salt meats, such as Proscuitto hams, etc.

Dry salt meats are all pumped with 100° F. plain brine, and dry salt bellies are overhauled twice, first at ten to twelve days and again about twelve days later.

Rough ribs are overhauled three times, on the seventh, the twenty-seventh and on the eighty-seventh days after being put down.

Meat comes out of dry salt at about its original green weight; no soaking is required, only wash it before placing in the smoke house, unless it is to be substituted for sweet-pickled meat when it should be soaked about eight minutes for each day it was in cure.

Soaking and Smoking.—When the meat is taken out of cure it should be soaked in clean water at about 80° F. to remove the excess of salt and thus make the meat more palatable. The period of soaking is usually three minutes for each day in cure for sweet pickle meats, although if they are left in cure a longer time than required, then the soaking period should be increased accordingly.

Beef hams require a little longer time to soak out than pork as the curing solution is usually stronger, and the water should be changed at least once.

The meat is next washed and strung, then hung up on meat “trees” to drain until almost dry and then branded with the ink brand. When the hot iron brand is used instead of ink it is not so necessary to allow meat to dry as the brand is applied before hanging.

The “trees” are now run into the smoke house for twenty-four to thirty hours, but in local plants where the meat is sold for quick consumption the period of smoke is reduced to twelve or sixteen hours or even less, thus making what is called a “light” smoke.

The temperature of smoking varies at different plants, but is often started at 125° to 130° F. for the first three hours, so as to dry the meat and allow it to take the smoke rapidly, then finished with a cold smoke at 110° F., but other firms keep the temperature at 120° F., although it is not advisable to have the temperature above this, for if the smoke house is too hot it will cause a heavier shrinkage from the dripping of the melted fat.

After smoking the meat is removed to a well ventilated provision hanging room to cool off. This should be a darkened, screened room to keep out the flies in the summer, as skipper flies have a special liking

for smoked meat and their larvæ cause heavy losses. If a room becomes infested with these pests it is almost impossible to eliminate them that season.

Smoke houses are often heated with steam coils to hasten the drying of the meat and to economize on fuel; and in some cases gas flames are used. Other houses are equipped with a fan arrangement to draw the smoke from the top and pass it again over the meat.

In providing the smoke a fire of hard wood smothered with saw-dust gives the best results, both as to color and resultant flavor.

The smoking shrink varies with the length of time and the degree of heat used.

In mild smoke it will be about 8 to 10 per cent in hams, and the packer aims to have them come out of smoke at about their green weight, although often it will run as low as 97 per cent of the green weight.

The altitude must be considered in deciding on the temperature of the smoke house; thus if we take 125 as the maximum it should be:

Sea level to 1500 feet above	125° F.
1500 feet to 2500 feet above	115° F.
2500 feet to 4000 feet above	100° F.
4000 feet and over	90° F.

The great secret of having high-class hams, bacon, etc., is to dispose of them for consumption as soon as they are properly cured and not to hold them any longer, as holding will cause them to lose quality.

Tenderized Hams.—A radically different method of curing and smoking hams and shoulders has recently been developed. The freshly chilled hams are pumped with a 70 degree brine directly into the large arteries of the hind quarter, the amount of pickle being equal to 10 per cent of the green weight of the ham. The needle is so directed that 5 per cent is injected into the femoral artery and the balance directed backward into the prepubic artery, with a stroke or two into the meat of the butt of the ham. The face of the ham is then rubbed freely with a dry curing mixture composed of salt, saltpeter, sodium nitrite and sugar. The hams are then placed face upward in the vat, layer upon layer. Do not add any pickling solution and leave the bung open at the bottom of the vat for drainage. Allow the hams to cure for seven or eight days, for all weights. Then soak in warm water (120° F.) for about twenty-five minutes, wash in warm water, string and hang in the smoke house. Smoke for eighteen hours with hot smoke using steam and gas to maintain the temperature at 140° to 150° F. for the first five hours to dry the meat, and then to 150° to 170° F. for eight hours using wood or saw-dust for smoke and live steam for heat. Finally dry heat is used at 195° to 200° F. for five hours. The inside temperature of these hams when finished is 140° to 145° F. Hams thus prepared may be safely eaten without further cooking as a temperature of 137° F. will kill any trichina that may be present. This high temperature causes a heavy shrinkage so the hams come out of smoke at from 3 to 5 per cent under green weight.

Hams so handled are tender and the bones protrude like in a boiled

ham. The advantage to the packer is a much quicker turn-over of capital and a tremendous saving in curing cellar space.

Inspection for soundness of sweetpickle meat is often made at the time of first overhauling, as this is the critical period, and if then sound it is likely to remain so during the entire process; but mostly the meat is tried out after the curing is finished. If it is for shipment it is tried in the sweet pickle state, or if smoked in the plant then it is tried off after smoking is completed, as this gives the surest results, for if there is any taint there the heat of the smoke house will bring it out so it can be readily detected on the "trier."

Testing is done by means of an ordinary steel "trier" as follows:

Hams.—1. Try in the shank for shank sours.

2. Try under the pelvis or "aitch" bone near the coxo-femoral joint.

3. Try alongside of and under the femur (or long bone) from the inner side.

4. Try in the marrow of the tibia, if this is cut short enough to expose the marrow, but as a rule the marrow cavity is closed in the present method of cutting long shank hams.

5. Also try the fat in skin back hams, especially if they are old stock, as sometimes this is the only part affected; also the pelvic or "gut" fat is sometimes tainted and the balance of the ham good.

Trying the body of the ham would only show results in a "stinker," where another part is also bad.

Picnics and Shoulders.—Run trier under and alongside the scapula (blade) from the butt end so as to reach the joint and go under it with trier. Also try directly at joint, especially in large pieces.

Bacon or Bellies.—Run trier from inside under about second or third rib to reach space where the large vascular trunks are found. Also try it the same way farther back toward the last ribs near the center behind the skirt. We frequently find bacon tainted in spots only, just under the rib.

In molasses-cured meat there is normally a peculiar sweetish odor, which is at first hard to distinguish from a slightly sour taint.

When a tainted piece is found the sour or tainted portion, if small and localized, may be trimmed out and the sound part saved.

Sour marrows should be burned out or the bone entirely removed.

"Puffed" ham is where there is decomposition and gas formation present, giving a puffed appearance, a peculiar gassy feel and a gassy smell different from an ordinary taint. It is usually due to the ham being placed in smoke before it is fully cured, when the heat causes rapid decomposition, and it mostly results from a mistake or mixing of date tags on the vats of meat in the cellar.

Electric Curing of Meat.—There have been numerous attempts made to hasten the cure of meat by the aid of an electric current. In the adaptation of this idea the hams or bellies were placed in wooden curing vats where they were laid on wooden racks, each layer of meat being separated by a rack from the next layer, thus insuring a free circulation of brine around the meat.

An electric current was then run through the vat from electrodes located at each end immersed in the pickle, and the pickle solution was kept in constant circulation in the vats by means of an automatic electric pump, which forced the brine from a central storage tank to the several curing vats from which it was returned to the storage tank by gravity.

The aim was to materially hasten the curing process and this was accomplished, although it is probable that the constant circulation of the pickle was a large factor in bringing this about. But the objectionable feature was the chemical changes which took place in the pickle whereby objectionable substances were produced in the pickle and gases, such as chlorine, liberated into the curing room, so that the process has now been discontinued under a Bureau ruling to that effect.

Curing Beef.—The process of curing beef is very similar to pork, only a stronger solution of pickle is generally used, as in curing briskets, plates, rumps and flanks for mess beef where 100° pickle is used with saltpeter added, but as a rule no sugar is included.

For curing rounds for dried beef a weaker pickle is used.

PICKLE FORMULA FOR MESS BEEF.

Salt to make 100° brine at 38° to 40° F.
35 pounds saltpeter per 1000 gallons of pickle.

CURING MATERIALS FOR 1000 POUNDS MESS BEEF.

Capping salt	34 pounds per 1000 pounds meat
Fine salt	163 pounds per 1000 pounds meat
100° pickle	55 to 60 gallons per 1000 pounds meat

Packing for Curing.—Rub the fine salt thoroughly over the meat and into the seams and wrinkles. Sprinkle the capping salt evenly over each layer of meat in the vat to prevent sticking together. Put into vats rib side up. Flanks must have special care in rubbing and sprinkling with salt as they lie close together and are more likely to stick together than other cuts. Then run in above pickle to completely submerge the meat.

Packing for Shipment.—In packing mess beef for shipment, repickle in the barrel with new 100° F. pickle and put in the capping salt, working in well down the sides of the barrels or tierces prior to heading up, so as to insure quick distribution throughout the contents.

Curing Beef Plates.—Plate beef is cured in barrels, tierces and vats; preferably secondhand, but of course sweet and sound. When curing in barrels pack 180 pounds green; in tierces 270 pounds green, and in vats pack to capacity.

In barrels and tierces curing pickle should be 90° to 100° F.; in vats 70° to 90° F. It takes approximately 3 pounds of salt to make 1 gallon of 100° F. Saltpeter, 2 to 4 ounces to each 100 pounds of meat, should be put in curing pickle to bring out the proper color. For heavy and fat plates use the maximum and for lean and light plates use the minimum quantity of saltpeter.

Temperature of curing pickle and curing room should be 38° to 39° F., but not over 40° F.

Overhaul twice: first on the seventh day after packing, and again on the seventeenth day.

Overhauling in barrels and tierces consists of rolling them about 100 to 150 yards, and in vats of transferring the contents from one to another.

Plate beef cures in thirty-five to forty-five days according to weight, the maximum time being allowed for the heaviest plates.

It is best to *repack* the beef into barrels as soon as possible after it is cured and never leave it more than ninety days in the curing vats as this may cause *rust*.

Repack the beef into barrels at 200 to 202 pounds according to age; 200 pounds is enough when beef is just cured, the weight to be increased if the beef is older.

Cap each barrel with 25 to 30 pounds of rock salt, then fill with 100° clear pickle, either all new or one-half to two-thirds new and balance old. A portion of old pickle is desirable, but do not use it unless it can be made clear by straining.

After the barrels are properly branded and tested to see that they do not leak they are ready for shipment.

Net weight of commercial packages are: Tierces, 300 pounds; barrels, 200 pounds; half barrels, 100 pounds; quarter barrels, 40 pounds.

Curing Beef Hams.—Beef hams are chilled forty-eight hours after being cut and before being put into cure.

Cure.—Pack 285 pounds green weight to a tierce and, while packing it in the tierce, sprinkle with the following:

Brown sugar	6 pounds
Saltpeter	8 to 12 ounces
Fine salt	5 pounds

Then fill up the tierce with cool brine, 70° to 80° strength, and carry at a temperature of 37° to 40° F.

Pickle.—Eighty-degree plain pickle. Tierces are filled with pickle, headed up and are carried at a temperature of 37° to 40° F.

If practicable insides, outsides and knuckles should be packed separately on account of curing at different ages.

Overhaul.—Three times: First at five days after putting down; second at ten days after the first overhauling; third at fifteen days after the second overhauling.

By overhauling is meant the piles of tierces should be broken down and the tierces rolled around. The distance rolled should be about the length of a good city block or a little more.

They are cured for shipment in fifty days. Hams are repacked in iron-hooped (galvanized) barrels at 228 pounds for gross shipment. This is equivalent to 220 pounds net.

Second pickle should be used in repickling young cured hams for shipment.

Carrying for Storage.—When hams have reached cure and are to be carried in storage they should be kept at a temperature around 28° F.

When repacking hams to carry in storage, 2 gallons of second pickle to 9 gallons of new pickle are used.

New pickle should be 60° strength.

Hams can be carried indefinitely in storage at the above temperature without further handling.

Curing Dried Beef.—Dried beef is made from beef rounds, which are first boned, except the knee cap, and then cut up as follows:

Knuckle or Veiny Piece.—The portion anterior to the femur contains the knee-cap.

Outside or Flat.—Outside half or round posterior to the femur.

Inside or "Tender."—Inside half of round posterior to the femur. This is the choicest part, as it furnishes the wide slices.

The three pieces above mentioned, cut from one round, constitute what is known to the trade as a *set*.

They are usually cured in barrels or tierces for forty-five to ninety days, depending on the size, etc.; outsides, forty-five days; knuckles, sixty days; insides, ninety days.

After the curing is completed, soak well, trim off the loose fat and tissue, string and dry. It may be smoked or air-dried, but the latter is much preferred.

Excellent results are obtained by handling the beef in a dry room which is heated by steam coils, or by a hot-air coal furnace, and provided with a good air circulation to remove the moist air. By this method the drying can be completed in from five to nine days.

A good method is to heat the drying room to 135° F. for the first two or three days, then drop the temperature several degrees for the next five days, when the beef is, as a rule, sufficiently dry to slice nicely, although in moist, damp weather it will dry slower. Some firms dry beef at a considerably higher temperature than above stated.

If the meat is dried too hard at the beginning the outside becomes hard while the inside remains moist, so it is difficult to slice and also is liable to mould quickly when sliced and put up in cartons.

Beef can be sliced best if it is of an even hardness; but when the out-side is hard and the inside is soft the slice breaks up and crumbles in the center.

Beef gains 10 per cent or more in pickle and in drying shrinks 35 to 40 percent. The loss after drying in trimming and slicing will average 5 to 12 per cent, but varies considerably according to how much of the string end is left on and on the condition of the outside of the meat.

Sausage Making.—Sausage is understood to be a mixture of meat placed in a sausage covering or casing.

Casings may be artificial, such as the muslin bags used for pork roll, luncheon roll, etc., or a transparent artificial casing made of cellulose; or they may be natural casings for which the intestines are mostly used after being properly cleaned and cured. They are of various shapes and sizes depending upon the part from which they are obtained and are classed as follows:

Beef Weasands.—Esophagus of cattle after the muscular layer has been removed, $2\frac{1}{2}$ to 3 inches in diameter, 18 to 24 inches long. Used for Bologna style sausage, Salami, etc.

Hog Stomachs.—Seven by 5 inches in medium hogs; used for head cheese and blood head cheese.

Rounds.—Small intestine of either cattle, hogs or sheep. Beef rounds, $1\frac{1}{2}$ to 2 inches in diameter, stuff 16 pounds of meat to a pound of casings; used for summer sausage, Bologna, liver pudding, blood pudding, mettwurst, etc.

Hog Rounds.—Three-quarters to $1\frac{1}{2}$ inches in diameter, stuff 60 to 62 pounds of meat to the round; used for Polish style sausage; Frankfurt style sausage; bockwurst, pork sausage, liver pudding, etc.

Bungs.—Cecum and part of folded colon of cattle and sheep; the rectum and part of lower colon of hogs.

Beef bungs, 3 to 6 inches in diameter, sued for large Bologna, minced sausage, head cheese, blood head cheese, blood and tongue sausage.

Hog bungs, 2 to 4 inches in diameter and tapering. Used for summer sausages and liver pudding.

Middles.—*Large Intestines.*—Beef middles, 1 to $2\frac{1}{2}$ inches in diameter, stuff 30 pounds of meat to the pound. Used for Bologna and summer sausages. Hog middles or “black” guts differ from other casings in that they have a decided bosselated appearance instead of being smooth like other casings. They are $1\frac{1}{2}$ to 3 inches in diameter, stuff 5 pounds to the pound and are used for liver pudding and sometimes for summer sausage.

Bladders of Cattle.—Eight to 12 inches long, used for Mortadella, minced sausage, etc.

Casings should be thoroughly cleaned and free from an excessive amount of fat, and what fat remains should be sweet. They should be free from the so-called “Knots,” which are small nodules about the size of a pea and filled with a greenish pus or calcareous material caused by parasitic invasion (*Esophagostoma columbianum*). Hog and sheep rounds are the only casings which are stuffed without being turned, as their small caliber makes turning impracticable.

Casings are received in a cured, salted state and just before being used they should be soaked in luke-warm water at about 90° F. until soft and pliable, then washed out with clean warm water. Care must be taken that the soaking water is not too hot, as in that case it will scald the casings, making them liable to burst in stuffing and to tear in the smoke house. This bursting of casings may also occur where the sausage is cooked at too high a temperature.

Preparations of Sausages.—Sausages and their preparation vary considerably in different countries, and the ingredients and their proportions vary even more widely in various communities. Even the same firm will vary the formulas of its sausage to a great extent, depending upon the relative price of the different ingredients, so we will not attempt to give the various formulas, but rather to furnish a formula for a good grade of sausage of each kind.

The principal ingredients of sausage are always muscle meat and fat, besides blood, heart, tongue, connective tissue, liver, hog skin, and various other parts of the viscera. In order to make the sausage tasty, spices, such as pepper, paprika, caraway, marjoram, sage, garlic, onions, coriander, cinnamon, cloves, truffle, sardella, sugar, saltpeter and salt, are used; the latter being invariably used of the dual purpose of improving the taste and for its preserving effect.

Most sausages are prepared for early or immediate consumption, while others, known as "dry sausages," are made to keep for a long time. In order to improve their keeping qualities, all of them, except fresh pork sausage and fresh pork and beef sausage, are either smoked or cooked or both.

Classification of Sausages.—Sausages may be classed as (1) meat sausages, (2) blood sausages, (3) white sausages or puddings, and (4) jelly sausages.

CLASS I.—Meat Sausages.—May be again classed as fresh sausage, as pork sausage; smoked sausage, as Frankfurters, Bologna, etc.; dry or summer sausage, as cervelat, Salami, etc.

Fresh Sausage.—Fresh sausage is divided into an all-pork sausage and the ordinary fresh sausage which is usually made of pork with some beef trimmings or beef products added to decrease the cost of production.

Pork sausage is made of all pork and in the highest grade the meat from nearly the entire carcass is used, but usually it consists of pork trimmings and hog fat. These are run through the Enterprise grinder and sometimes ice or water, not to exceed 3 per cent, is added to facilitate grinding, mixing and stuffing; then the ground pork is thoroughly mixed with from 2 to 2.5 per cent of salt and spices, as white pepper, sage, marjoram, mace, or nutmeg and sometimes sugar, to suit the trade, and then stuffed into hog or sheep casings and sold fresh without smoking or cooking.

No saltpeter or sodium nitrate is added to sausage marked or sold as "Fresh."

Occasionally a light smoke is given to improve the taste, when it is often known as smoked country-style sausage. The pork in this sausage is usually given a mild cure to increase its keeping qualities.

Pork and beef sausage, or, as it is usually called, "Fresh sausage," is made in the same manner as pork sausage, only some beef trimmings or beef products are added on account of their lower price.

Smoked Sausage.—This class has better keeping qualities than fresh sausage as the meat ingredient is partly cured in preparation and is smoked and cooked.

Water is added, preferably in the form of ice, to the meat prepared for all or this class of sausage and is really essential when the mass is to be filled into small casings.

The absorption power of sausage for water depends on the binding quality of the meat, and for this reason bull meat is by far the best since when it is chopped up fine in the sausage machine (Silent Cutter) it is sticky and binds together well. It also absorbs and holds a large percentage of water, especially if it is chopped fresh before rigor mortis sets in and while the animal heat remains. This method, used by many good sausage makers, produces a delicious juicy sausage.

The amount of water which this hot meat takes up in chopping varies greatly during different seasons of the year. In winter when cattle are on dry feed it is highest and may go to 40 or 60 per cent or more, while in summer when grass cattle are killed it is much lower as the meat is more moist and watery. The amount is determined entirely

by the feel of the chopped meat, and herein lies much of the success of a good sausage maker in being able to tell when the meat is just right. Only experience can teach this, as set rules or formulas are of little value here.

By the term binder or binding quality of meat is meant the power to take up and hold water, so as to make the mass more adhesive and thus cause the finished product to hold together better.

Bull meat, especially the chucks or fore-quarters, makes the best binder, as it contains more gelatin than either cow or steer meat and takes up more water in chopping.

Cereal is also used for this purpose, but its use is entirely prohibited by some States, and not over $3\frac{1}{2}$ per cent is permitted by the Federal regulations, and if so used its presence must be plainly shown by branding the casings and marking the labels to that effect. If more than $3\frac{1}{2}$ per cent of cereal, milk powder, etc., is added, the product is not considered as sausage but must be branded and labeled as "Imitation."

The idea that added cereal causes the absorption of large quantities of water is unfounded as starch flour only absorbs water in boiling, but boiling water or prepared paste is not used in the preparations of sausage.

Egg albumen and tragacanth, the so-called "albumina," absorb immense quantities of water and their use in sausage should be considered an adulteration.

The use of artificial colors in the preparation of sausage is prohibited in the United States, although it is permissible to color the casings after stuffing, provided the color used is officially approved as being harmless, and the color does not pass through the casing into the meat. Such sausage must be legibly branded and labeled "Artificially colored."

Formerly, before official supervision was in force, there were many questionable practices employed. Sausage was loaded with cereal and with preservatives to prevent its souring, then given a very light or almost no smoke to eliminate the shrinkage, or instead it was dipped in such solutions and combinations as artificial dye, oil of smoke and sausage varnish containing shellac, so by this means it was given a fine color, the smoke flavor and a gloss from the shellac to resemble the shiny surface caused by smoking.

In addition to bull meat, already mentioned, cow meat is much used for sausage, especially the thin canner cows, as they are comparatively free from fat and produce a large percentage of lean meat at a less expense than fat cattle.

TRIMMING-OUT TESTS.

Five cows.	Pounds.
Dressed weight	1590
Meat trimmed out, or 65.79 per cent	1035
One bull.	Pounds.
Live weight (hide, 102 pounds)	1350
Dressed weight (52.96 per cent)	715
Meat trimmed out (73.06 per cent of dressed weight)	523
Bones	150
Fat, etc.	39
	712

Some sausage firms use hot beef and in this system the beef is chopped immediately after the animals are slaughtered, before rigor mortis sets in, but while this makes a very fine product it is more perishable and must be handled with extreme care in every part of the process, and the sausage thus made should be sold promptly and used without delay. Most firms make sausage from beef which has been thoroughly chilled before being boned out, using either the meat from the entire carcass or mostly regular trimmings taken from the fore quarters.

Process of Making Sausage.—The beef to be used as a basis for sausage is run through an Enterprise meat grinder, then placed in a meat chopper or “Silent Cutter,” which consists of a revolving circular iron bowl, equipped with several rapidly revolving knives which strike and cut the meat as it is brought to them by the revolving bowl. The Silent Cutter holds about 300 pounds of meat and during the chopping process there is added about 9 pounds of salt, 6 to 10 ounces of saltpeter and sometimes 8 to 10 ounces of sugar, along with a variable amount of cracked ice. The salt is used as a curing agent, while the saltpeter is used to give the meat a bright red color through its action on the hemoglobin in muscles.

The ice keeps down the temperature of the meat as the rapid striking of the cutting knives generates considerable heat, and the more ice that can be worked into the beef while it is being chopped, the more juicy and palatable will be the finished sausage.

The quantity of ice and water added is of no special importance, since the hot smoking to which these smoked, cooked sausages are subjected, as a rule, causes the loss of much of the added water. The Federal regulations prohibit the use of excessive amounts of water and require that not over 10 per cent of added water shall remain in the finished product after smoking and cooking have been completed. If too small an amount of water is present in the sausage it becomes dry and unpalatable.

Frozen meat is less desirable for sausage making, as the product from this meat does not have the good quality and flavor of sausage made from chilled meat.

TEST ON FRANKFURT STYLE SAUSAGE.

Warm beef before chopping	220 pounds
Ice added in chopping	60 “
<hr/>	
Beef after chopping	280 “
Pork added	210 “
Salt added	6 “
Saltpeter added	$\frac{1}{2}$ “
Mixed spices added	$5\frac{1}{2}$ “
Casings used	$4\frac{1}{2}$ “
<hr/>	
Total weight when stuffed	506 “
Total weight after smoking	445 “
<hr/>	
Original meat, spices and casings	446 “
Loss of weight in processing	1 pound

This will, of course, vary considerably, and *usually* there will be a gain of 3 or 4 per cent, or even more.

When the beef for sausage has been chopped by the Silent Cutter into a doughy mass it is placed in large trucks and run into a cooler of 38° to 40° F., where it is allowed to remain for from two to six days to cure. Sometimes large shallow pans are used for this purpose instead of trucks to allow the meat to cool out quicker and better.

When cured it is taken out and run through a Silent Cutter again or through a "mixer," which is a machine similar to that used by bakers to knead dough, where it is mixed with various proportions of other meats, as pork, veal, etc., other materials and spices to prepare it for stuffing into casings.

When thoroughly mixed the mass is placed in the "stuffer," a hollow cylinder provided at one end with a piston head worked by air, water, or by hand power, and at the other end with a movable head on a pivot and having one or two openings through funnel-shaped projections or "nozzles," through which the sausage mass is forced into casings by the upward pressure of the piston.

The sausage, after stuffing, is linked, or tied, or cut into proper lengths as the case may be, and then places on "smoke sticks," which in turn are hung on "smoke trees" to be run into the smoke-house after hanging a few minutes to dry off.

Smoking.—The smoke-house is similar to the ordinary meat smoke-house, except the fire is placed closer to the sausage. Hickory wood and sawdust, often from cedar wood, is used to make the smoke.

The sausage is smoked from one to four hours at a temperature of 100° to 180° F. or over, depending upon the size and kind, after which it is removed from the smoke-house and placed in the cooking vats in water for fifteen minutes to three or four hours at a temperature of 160° to 180° F., depending on its size, after which it is taken out and again hung on trees or racks and freely sprayed or washed with hot water to remove the grease which adheres to it from the cooking vat. Then it is sprayed well with cold water to shrink the casing and thus prevent the sausage from shrinking and becoming wrinkled. Small sausage such as Frankfurt style sausage is often cooked in a steam cabinet instead of a cooking vat. This method saves considerable labor in handling.

The sausage should now be run into the cooler and when chilled it is branded and the smaller sausage is tied off into bundles ready to send out to the trade.

A sausage cooler should be kept at about 55° F., because if it is too cold the sausage will sweat freely when taken out into the air, which tends to make the casing slimy and spoil rapidly.

Dry sausage is often smoked at a lower temperature and for a longer period of time, after which it is held in a dry room for a variable period.

The process of smoking sausage should be started at a low temperature until the casing has dried off, then raise it and finish off the smoking at the higher temperature.

The temperatures at which sausage is smoked vary widely in different cities and for various classes of trade, and while some are satisfied with a cool smoke, which suits the manufacturer as it gives a low shrinkage, there are other localities which require sausage smoked at quite high temperatures, so that it is almost thoroughly cooked in the smoke-house, where temperatures at 200° and even 220° F. are used in finishing off Frankfurt style sausage. The inside temperature of these sausages that are intended to be eaten without further cooking must be over 137° F. in order to kill any trichina present in the pork content.

FRANKFURT STYLE SAUSAGE.

Beef (chopped and cured)	} this proportion will } vary more or less	. . .	40 pounds
Pork (usually fresh)			60 "
Salt			1½ "
Saltpeter			4 ounces
Spices (as pepper, nutmeg, coriander, paprika and sugar)			1 to 1½ pounds

Run the fresh beef through the Enterprise, then the Silent Cutter at which time the salt, saltpeter, and most of the ice are added; cure two to five days in trucks in cooler; then through Silent Cutter again where it is mixed with proper proportions of pork and spices.

Stuff in sheep casings or small hog casings.

Smoke two to three hours, starting at 100° F. and finishing at 170° F.

Cook five to ten minutes at 160° to 180° F. The inside temperature of Frankfurt style sausage after cooking varies from 155° to 170° F.

Hang on trees and spray with hot water first and then with cold water, then after a few minutes run into cooler at 45° F., until packed for shipment. If intended for wagon delivery sausage should be held in coolers at 50° to 55° F.

Bologna Style Sausage.—This is made of beef and pork in about the same proportions and in the same manner as Frankfurt style sausage, except for some difference in proportions of spices. Stuff in beef middles; smoke two to three and a half hours at 160° to 180° F.; cook sixty to ninety minutes at 160° F.; then handle in the same manner as described above for Frankfurts.

Some use in these two classes of sausage numerous other meat products as giblet meat, cheek meat, hearts, weasand meat, and tripe, although the latter two kinds make a much poorer quality of sausage. The highest quality product is made from beef taken from the entire carcass, or boneless beef chuck meat, or beef shank meat along with good pork trimmings.

When cured meat is used, it will, of course, require much less salt and saltpeter in the mixing than when fresh meat is used.

LUNCHEON ROLL, BREAKFAST ROLL, ETC.

Fresh pork, usually from shoulders, with sinews and fat removed		100 pounds
Beef	10 to 15	"
Salt	4 to 5	"
Saltpeter		4 ounces
Sugar and pepper to taste and other spices if desired.		

Cut the pork with a knife into pieces about $\frac{1}{4}$ pound each and sprinkle evenly with salt and saltpeter, or run through a mixer to thoroughly mix the curing materials, then place the meat in trucks and allow to cure in a cooler for three or four days.

When cured run through the mixer and add spices and the fine-chopped beef as a binder for the pork.

Stuff into cloth containers holding usually 5 or 6 pounds.

Cook for five hours at 160° F.

It is not smoked, as a rule, although some firms give a very light smoke.

POLISH STYLE SAUSAGE.

Beef (chopped and cured three days)	50 pounds
Lean pork trimmings	75 "
Regular pork trimmings	75 "

Run the pork trimmings through a $\frac{1}{4}$ inch plate of the Enterprise grinder and mix with 8 ounces of saltpeter, 8 ounces of sugar and 5 pounds of salt and allow to cure three days.

Mix the pork and beef in the mixer, adding spices such as white pepper, paprika, nutmeg and coriander to suit the taste, also 2 to 3 ounces of finely chopped garlic.

Stuff in wide hog casings and smoke two to three hours, starting at 100° F. and finishing at about 170° F. Cook for twenty minutes at 160° F.

Dry Sausage or Summer Sausage.—Summer sausage is a meat sausage so prepared that it will keep for months at ordinary temperatures, and the finished product requires no cooking or preparation of any kind, as it is ready to eat in its purchased form. In order to avoid any danger of trichinosis from eating this sausage containing uncooked pork, the Government requires the pork used for this or any other pork product sent out to be eaten without cooking, to be first frozen for twenty days at 5° F. to kill any trichina that may be present. In lieu of freezing, the ground pork may be mixed with at least $3\frac{1}{2}$ pounds of salt to 100 pounds of pork, cured five days and then, after stuffing, be held in a drying room not lower than 45° F. for not less than twenty days, as this has been found to kill any trichina that may be present.

Cervelat and Salami.—These are the most common kinds of dry sausage on the market, and are made of pork (lean) with from 10 to 30 per cent of beef.

The meat used for making dry sausage should be of good quality, carefully trimmed, free of sinews, and instead of grinding, as in making ordinary sausage, it is chopped under large "rockers," which consist of a number of large semicircular knife blades moving with a rocking motion on a revolving wooden block.

The salt, saltpeter, and seasoning are added while the chopping is in progress, after which the meat is taken to a cooler having a temperature of 38° to 40° F., where it is spread on boards or in pans to a thickness of 10 to 12 inches for about three or four days to cure.

When it is cured it is stuffed in casings of various kinds according

to the brand, usually hog bungs or beef middles, after which it is hung in the dry room at a temperature of 48° to 50° F., for from five to eight days. This room in which the sausage is dried should be free from drafts and dampness, the air should be as nearly pure as possible, and the temperature must not vary.

Too much dampness will often cause sour sausage, which is at first characterized by a soft, slimy condition in the center. This condition requires an expert to detect and only long experience will qualify one for that work. By grasping the sausage in the hand and slightly squeezing it the center will appear to have wasted away or become hollow or soft, while properly cured dry sausage should be firm and solid. A "trier" may also be used to detect this sour sausage.

After drying it is smoked with a cold smoke, from 50° to 75° F., for twenty-four to seventy-two hours, depending on the size and kind, when it is hung in a dry room again at 60° F. for thirty days, after which it is packed ready for shipment.

If this sausage becomes mouldy it may be washed off by hand or machine, but three washings is about the limit, as after that it becomes soft and spoils. Or it may be wiped off with edible lard oil or oleo stock to remove the mould, and this does not soften it.

LEBANON BOLOGNA.		
Fresh beef		100 pounds
Salt		3 "
Sugar		2½ "
Saltpeter	2½ to 3	ounces
Black pepper	5	"
Red pepper	1	ounce
Cloves	1	"
Nutmeg	2	ounces
Allspice	2	"
Cinnamon	1	ounce

Chop through a medium plate of the Enterprise, add spices, etc., and allow to cure for about ten days in shallow pans (6 inches deep). Then mix again thoroughly by hand, without any water, and stuff into casings, usually beef bung guts. It may now be placed in pickle to cure, but this practice is not now followed, as a rule.

Smoke from twelve to fifteen days in a very cold, wet smoke. This process requires expert handling, and the exact details of the smoking are held as a trade secret by those who know.

The shrink is 25 per cent or over.

There are a great many other varieties of meat sausages, which have a more restricted distribution to certain classes of trade: Holsteiner sausage, Swedish sausage, Mettwurst and Bockwurst, which is a Lent specialty made of veal and some pork and occasionally beef along with salt, spices, eggs and milk, mixed with a higher percentage of water (often 50 to 60), stuffed into sheep casings and cooked but not smoked.

CLASS II.—*Blood Sausages*.—Blood sausages or blood puddings are prepared from blood mixed with small cubes of cooked fats, lean pork meat, heart, tongue, hog skin, spices, etc. Hog blood was formerly used as it was thought to make a finer grained sausage than beef blood, but

hog blood is so difficult to obtain free from contamination with dirt, urine, etc., that its use has been discontinued, and beef blood substituted.

BLOOD PUDDING.

Hog fat; back, shoulder or cheeks, fresh	100 pounds
Hog head meat or tongues, cured	20 "
Hog skins	25 "
Blood	30 "
Salt	2½ "
Spices, as pepper, cloves, marjoram, nutmeg, etc.	2 "

Cook the fat one hour and then cut it into small cubes in a fat-cutting machine. Cook the meat and skins separately about three hours, then chop the skins in a Silent Cutter until of a thick, creamy consistency. Cut the meat into small pieces or through a coarse plate of the Enterprise. Then mix thoroughly with the blood and spices in a vat or truck and stuff into beef bungs.

Cook for two to three hours at 185° to 195° F., and cool in ice-water. Then lay out on board or table in cooler until shipped.

No smoking required.

Blood and Tongue Sausage.—This is made the same as blood sausage, except that more tongues are used. The hog tongues are always cured first, then thoroughly cooked, and may be put into the sausage whole or cut into several pieces.

Smoked Blood Pudding.—This is made the same as ordinary blood pudding except that it is smoked. It is usually stuffed into smaller casings.

Blonzen Sausage.—This is a blood pudding stuffed into hog middles. After being cooked it is smoked for two to two and a half hours at 130° to 140° F.

CLASS III.—*White Sausages.*—This class of sausage is often known as "Puddings," and is prepared from cooked and chopped visceral parts, especially from the liver, along with hog skin, tripe, brains, finely-cut pork or veal, sometimes hog fat and various spices.

These sausages are cooked but not usually smoked and have a light-gray to whitish color.

LIVER PUDDING.

Hog skins	25 pounds
Hog livers	25 "
Hog head meat	50 "
Salt	1½ "
Spices, as pepper, marjoram, mace, allspice, sometimes onions	1 pound

Scald the livers well. Cook the meat and skins thoroughly and then run all through the fine plate of the Enterprise cutter. Sometimes it is then run through the Silent Cutter, especially for the finer grades. Mix well in a metal truck and stuff through the stuffer into beef round or hog middles.

Cook about fifteen to twenty minutes at 185° to 195° F., then cool in a vat of ice-water.

Braunschweiger Sausage or Smoked Liver Pudding.—This is a liver pudding made very similar to the above, but differing somewhat in

the proportions, and has the addition of scalded hog fat, while fresh pork trimmings are used instead of the head meat. Chop it all very fine in the Silent Cutter, and then add the scalded hog fat which has previously been cut into small cubes in a fat-cutting machine.

Cook about forty minutes at 145° to 150° F., and then smoke for two to two and a half hours at about 120° F.

CLASS IV.—*Jelly Sausages*.—These are prepared from parts of the carcass rich in connective tissue, such as the skin and heads of hogs, head and feet of calves, etc. Fat and lean meat may also be added along with spices. The cooked meat and other ingredients are cut or chopped and filled loosely into large casings as beef bungs, hog stomachs or bladders and then thoroughly cooked. During this cooking the jelly forms inside of the sausage, which hardens on cooling and binds the other ingredients together. No smoking is required.

HEAD CHEESE.

Hog head meat	60 pounds
Hog skins	60 "
Liquor in which above is cooked	15 "
Salt	2 "
Spices, as pepper, marjoram, onions, etc.	$\frac{1}{2}$ pound

Snouts, ears, hearts, etc., may also be used.

Thoroughly cook the heads until the meat falls off the bones, remove the bones and cut the meat into small pieces. Cook the skins thoroughly and chop very fine in a Silent Cutter until of a thick, creamy consistency, and then add the head meat, spices, etc., and mix in a metal truck.

Fill loosely into hog stomachs or beef bungs by pouring from a dipper.

Cook for one to one and a half hours at 180° to 190° F., and then cool in a vat of iced-water, after which they are laid out on a table until stiff and firm. Often during this hardening they are laid under boards which are pressed down by means of weights.

Blood Head Cheese.—This is made the same as head cheese, except the blood is used instead of the liquor in which the meat was cooked.

We might also mention under the class of jelly sausages such products as souse, jellied tongues, etc., although they are not exactly sausages, but are somewhat of that nature.

Souse.—This is made of pigs' feet, snouts, hocks, skins, hog cheeks, etc., thoroughly cooked, spiced, and later placed in pans and covered with a mixture of gelatin, vinegar and lemon juice.

Hog snouts	50 pounds
Hog cheeks or knuckles	50 "
Gelatin solution made with 10 pounds of dry gelatin	85 "
Vinegar	2 $\frac{1}{2}$ gallons
Spices, as pepper, whole allspice, whole cloves, etc.	$\frac{1}{2}$ pound
Lemon juice	8 ounces

Cook the meat three hours at a simmer (190° to 200° F.) until it falls from the bones; remove the bones and cut the meat into small

pieces by hand and mix in the spices. Put into pans, usually about 6 pounds and pour over it the mixture of gelatin, vinegar and lemon juice. Then allow to cool and harden when it is ready for the trade and is eaten without further processing or cooking.

In some cases the jelly is made by cooking thoroughly cleaned hog skins, but the great difficulty in this is to get a clear product.

Jellied Tongues.—This is made very similar to souse. The sweet pickled hog tongues are cooked about two and a half hours at 190° to 200° F., the skin removed and the gullet trimmed off. They are then placed evenly in pans and a solution of gelatin, vinegar and lemon, similar to that used in souse, is poured over them until they are well covered. Press the tongues down and hold them there by means of weighted boards.

Place in a cooler to harden, when the product is ready for sale and consumption.

No spices are used, except a few whole cloves, whole allspice and bay leaves to give a more attractive appearance.

CLASS V.—*Sausage with Larger Quantities of Vegetable Matter.*—The basic substances of these sausages are usually blood with fat or lean pork meat, or a white sausage filling. To these are added, besides various spices, larger quantities of vegetable substances, which are rich in carbohydrates, as groats, bread, boiled rice, rolls, boiled potatoes, currants, raisins, sugar, etc. The filled sausages, for which the stomachs or bladders of hogs are frequently used as containers, are cooked and may be consumed when fresh, or they may be preserved by smoking.

This kind of sausage is principally prepared for the household and, therefore, almost every locality has its own characteristic sausage belonging to this group.

The Government regulations in this country do not permit more than 3½ per cent of cereal to be added to sausage, and this only when the casings and containers are properly branded to show its presence.

Scrapple is a product which might be classed under the above heading, although it is not put in a sausage form in a casing. It is primarily a winter product, as little or none of it is made in warm weather.

SCRAPPLE.

Edible parts of hog heads including meat (boneless) . . .	430 pounds
Hog skins	25 "
Hog livers	25 "
Cornmeal	100 "
Rye flour	5 "
Salt	12½ "
Spices—pepper, sage, etc. (approximately)	2½ "
Liquor in which meat was cooked (approximately)	350 "

Above will make a batch of about 950 pounds.

Sometimes hog snouts, hog faces, pork trimmings, etc., are used instead of hog heads and often some beef head meat or beef plates are used.

Clean the hog heads thoroughly, remove the eyes, ear tubes, etc.; split the heads and cut out the teeth and turbinated and ethmoid

bones to eliminate the nasal mucous discharge; wash heads and then cook them until the meat falls off the bones; remove the bones and run the cooked meat through the Enterprise grinder. Return the meat to the cooking kettle along with the liquor in which it was cooked, and boil again and, while boiling, add the meal, stirring it constantly until thick, added the spices and salt and cook until finished, then put into pans, usually about 15 pounds and allow to cool. Ordinarily it is made in a steam-jacketed, cast-iron kettle with a double action stirring paddle.

Boiled Hams.—Hams may be boiled with the bone in, but the far more common method is to prepare them as boneless boiled hams, in which case the sweet-pickled ham is boned, trimmed of surplus fat and skin, tied, roped and placed in a canvas cover, or pressed into a square or cylindrical metal mould, when it is ready for cooking.

Place the hams in the vat, submerge in water and bring the water rapidly up to 160° to 170° F., where it is allowed to remain during the entire cooking process, or in other cases it is dropped 10° F. after the first hour.

Time of cooking hams is estimated at twenty-five to thirty minutes per pound of ham; for instance, a 12-pound average lot would require five or six hours.

Hams after cooking should remain in cold water until they are fairly well cooled and the fat firm, which aids in reducing the shrink. During this cooling they also absorb some of the albumins lost during the cooking process. The metal moulds are repressed after cooking to secure a firm ham that will hold together in slicing. Place the hams in the moulds in a cooler for about twelve hours to chill them thoroughly.

It is desirable to have all of the hams in the vat as near a uniform weight as possible, or if large and small hams are cooked in the same vat the small hams should be placed in the vat last, so they can be taken out first.

Shrinkage.—The higher the temperature of the water and the longer the period of cooking, the greater will be the total shrinkage of the hams, sometimes running as high as 38 to 45 per cent in well-cooked hams; but the cooking shrink in ordinary cooking will run about 18 to 22 per cent, the balance of the loss being bones, fat and skin.

In the larger plants the hams for cooking are often trimmed of fat in the fresh state, as the fat can thus be utilized to better advantage for lard than if removed after the hams come out of sweet pickle.

Tripe.—Method of Handling.—Tripe is the large stomach or paunch or cattle prepared as follows:

When the paunch is taken from the animal the fat on the external surface is trimmed off to be used in the manufacture of oleo oil. The paunch contents are then emptied out and the paunch is inverted over a cone-shaped contrivance, thus presenting the internal surface outermost, which is thoroughly washed under a spray and scrubbed with a stiff brush.

Place the clean paunches in a tripe scalding containing water at 145° F.

until the lining mucous membrane loosens, or scald in water at about 150° F. for a few minutes to loosen mucous membrane, after which it is removed by thorough scraping and beating until perfectly clean, then wash thoroughly and place in a cooking vat, where it is cooked at the boiling-point, 212° F., until tender, which takes from two to four hours, then cool thoroughly in cold water, preferably with ice added, for several hours. If it is to be shipped fresh it should be mildly salted and well iced in transit as it spoils easily.

For curing place in containers in a good 45-gram white vinegar. This will lose strength rapidly and should be brought up to the original 45-grain strength before final packing for shipment. A good temperature for curing tripe is about 48° F.

MANUFACTURE OF LARD.

Steam Lard is the basis from which refined lards are prepared, and the Chicago Board of Trade rules describe it as follows:

“Standard prime steam lard should be solely the product of the trimmings and other fat parts of hogs, rendered in tanks by the direct application of steam, and without subsequent change in grain or character by the use of agitators or other machinery, except as such change may unavoidably come from transportation. It must have proper color, flavor and soundness for keeping and no material which has been salted must be included.”

The tanks used are of iron or steel, round with cone bottoms, and the usual size is as follows: 6½ feet in diameter; shell, 14 feet long; bottom cone, 30 inches long. The head is dish- or cone-shaped and provided with a manhole for charging. A gate valve is located at the bottom of cone for emptying, a slush valve a short distance from the bottom of cone, and two lard draw-off valves on the side of the shell about 10 inches apart and the lower one 5 feet from the bottom of shell.

There should be live steam connection to the inside of tank near the bottom, and pipe connection at the top to take off the condensable gases to the water condenser, and the non-condensable gases to the boiler furnace to be burned in order to eliminate objectionable odors in the escaping gases.

Charging.—Have the tank washed out clean, then close bottom and the draw-off valves, after which it is ready to charge. Fill the tank with the fats to be rendered and run in water at the same time. Close up the top and turn in the live steam at 40 pounds' pressure. The vent cock should be opened to allow escape of gases from the tank when they form on heating.

The sides of the tank should be watched and felt for cold spots, which will make sour lard if not properly attended to. They can be removed by shutting off the steam and drawing off the water. The same remedy is to be employed if the tank gets to foaming, which fact can be determined by occasionally opening the pet cock.

Cook for eight to ten hours at 287° F. at 40 to 45 pounds steam pressure and when completed allow to settle four to five hours. Be careful that all steam pressure is off the tank before opening the man-hole in the head of tank. Try this by opening pet cocks for vent but too much vent or opening up too soon may cause the tank to start "rolling."

After the tank has settled the lard is drawn off through the side valve to a receiving tank. The lard in the tank may be lowered to the level of this valve by letting water out of the bottom through the slush valve, or it may be raised if necessary by running water into the bottom of the tank. The flow of lard must be carefully watched so that it will not be mixed with water.

Hold the lard in the receiving tank until it settles well and cools off sufficiently to allow it to be tierced. The draw-off valve should be at least 1 inch above the bottom of the tank so as not to allow settlings and water to contaminate it, and it is better to draw off a pail full for inspection, before running off into tierces, as the presence of water is liable to cause the lard to sour.

The contents of the tank after the lard is drawn off are dumped into the slush box, when any remaining lard can be skimmed off after settling. The residue or tankage is then run to the fertilizer department, is pressed, dried and made into fertilizer and the liquid part drained to the catch-basin to collect any remaining fat which would be utilized for inedible grease, and the water known as "stick water" may be further processed and dried to make fertilizer or glue.

Refined Pure Lard.—Refined pure lard is made by refining prime steam lard, and is carried out by adding to the warm lard at 175° F., or lower, from 1 to 1.5 or in exceptional cases even 2 per cent of fullers' earth, according to the quality of the lard. Mix the earth well and keep the lard agitated by mechanical means from the bottom of the tank.

Do not have the lard over 175° F. or it will acquire from the earth a strong flavor, which is objectionable, and will often cause complaints of "scorched" lard to be received. This also occurs if too much earth is used, or if it remains in contact with the lard too long, so not over fifteen minutes' contact should be allowed and only enough earth used to bleach the lard, which may be determined for each run by a test on a small sample.

Providing the lard is dry the bleaching takes place almost immediately and, after agitating, the lard should be forced through the filter press until it is clear, then passed to a receiving tank to cool, and then chilled in a lard agitator or over the lard "rolls."

The *agitator* is a water or brine-jacketed cooling tank, provided with revolving paddles run by overhead gearing. The lard is agitated here until it is of a thick creamy consistency suitable for running off into containers, this method is too slow for the large refiners, so they use the lard-chilling rolls.

The *cooling roll* or *lard roll* consists of a revolving metal cylinder, cooled internally by running cold water or brine. The lard, as it is

chilled on the outer surface of this cylinder, is scraped off as it revolves against a long steel bar or scraper and is dropped into a trough where a revolving worm picks it up and carries it to a second roll of the same kind and from there it is run to an agitator or is directly filled off into tubs, cans, etc.

If two rolls are used the first cools the lard to 70° or 80° F. and the second roll cools it to about 60° F.

If only one roll is used it should be brine cooled and the lard delivered to it at 105° F. or under, and if the brine is 12° F. or under the lard will be chilled sufficiently to run off directly into the shipping containers.

Formerly such refining agents as caustic soda, borax, lime, alum, soda crystals, and sodium bicarbonate were largely used, but they are not now permitted, except sodium bicarbonate, 1 or 2 pounds to each 1000 pounds of fat rendered, and caustic soda in moderate amount.

Lard should be chilled quickly on the rolls, or else agitated during cooling so that the stearin and oil will harden together, as otherwise the stearin will crystallize and the oil will separate out, thus making the lard oily instead of being hard and firm.

Kettle-rendered Lard.—This lard is rendered by dry steam in a steam-jacketed kettle, or by fire, but rendering by cooking over a fire is only done in very small plants.

The steam-jacketed kettle often used is made of cast iron and sits above the floor on legs, but this entails much loss of labor in filling and removing the lard and cracklings. A better kettle is of cylindrical shape, suspended in the floor, and projecting into the room below, so set that the top is low enough to allow the fat to fall directly into it from the hasher. It is provided with double action rotating paddles to keep the fat agitated while rendering, and at the bottom is a large valve or gate-cock through which is unloaded the rendered lard and cracklings.

Procedure.—The skin should be removed from the fat to make good lard and the fat should be thoroughly sweet and clean, because if the fat gets heated or is smeary the lard will contain a high percentage of fatty acid which makes it unfit for food. The fat is run through a hasher to break up the fiber and allow the oil to separate out better and more completely in rendering.

Run the chilled or the fresh hot fat through the hasher directly into the kettle, turn on the steam at 40 to 65 pounds' pressure and start the agitator, so that the fat may be heated and agitated during the time the kettle is being filled.

Cook the fat about two to two and a half hours after it commences to boil, during which the temperature will be about 240° to 260° F., or over.

If it is desired to whiten the lard, sodium bicarbonate, from $\frac{1}{2}$ to 2 pounds for each 1000 pounds of fat, may be added. This will cause it to foam and it will be necessary to agitate it briskly with a paddle at the surface to keep it from foaming over.

After this the heat may be increased by raising the steam pressure

to 65 pounds, then turn off the steam, and draw off the lard through a screen box and two or more thicknesses of cheese-cloth to hold back the cracklings. In some large plants a small filter press is used to clear the lard.

Run the lard from the screen box to a receiving tank to settle and partially cool, and then convey it to a water- or brine-jacketed cooling tank or agitator, where it is agitated and cooled until it is of a thick, creamy consistency, when it can be run off into a container.

In some plants lard is run off at a higher temperature, *viz.*: 160° F. for small pails; 120° to 140° F. for large pails and wooden tubs, and 100° to 120° F. for tierces. The containers are then held in a cooler at 35° to 45° F. to chill and while cooling a current of air from fans is directed to sweep over the surface of the hot lard in the pails, which produces the rough, ruffled tops sometimes desired for appearance sake and known as "Boston tops."

Instead of cooling by an agitator the lard may be cooled on the lard rolls, as in the case of refined lards, but this is not customary except in a few of the largest plants, and the same may be said in regard to clarifying it with fullers' earth, as the latter may impart its odor and flavor, which more than offsets its bleaching and drying effects.

In small plants without cooling apparatus the hot lard can be run into 50-pound cans and these set in a tank of cold water to cool, and the lard stirred frequently until it cools.

Kettle-rendered lard has a peculiar, pleasant flavor, which is really the desirable flavor for all lards, and is different from tank or refined lard. The color is slightly darker, although if properly made at not too high a temperature it has an almost perfectly white color. Lard should be practically free from water, as otherwise it is liable to become sour, especially in hot weather.

When the rendering is completed the cracklings are placed in a press and the remaining lard pressed out, after which the pressed cracklings may be used for chicken food or sent to the fertilizer department, where the remaining fat is recovered in the extractor by a gasoline or benzine process and sold for inedible grease.

The cracklings may be rendered in a pressure tank, and the fat recovered as steam lard.

Kettle-rendered Leaf Lard is handled the same as above, but only leaf fat is used, and it is rendered at a somewhat lower temperature.

Neutral Lard.—Neutral lard is rendered very similar to open kettle-rendered lard only at a lower temperature so as to avoid the peculiar taste and odor of hog fat which occurs when it is rendered at a high temperature. It is quite largely used in the manufacture of oleo-margarine.

There are two recognized grades of neutral lard: No. 1, made entirely from leaf fat, yields about 91 per cent and 2 per cent prime steam lard from the scraps. No. 2, made entirely from back fat, yields about 65 per cent and 18 per cent prime steam lard from the scraps.

The fats for both these grades should be thoroughly chilled before

rendering. Hash the fat the same as for kettle-rendered lard only finer, heat the hashed fat carefully and keep the temperature at 100° F. or under while filling the kettle, then increase the steam and melt at a temperature of about 125° F. for about forty minutes; then run it up to 127° F., and drop the lard and scraps quickly into the settling tank and salt with 77 pounds of salt to each 1000 pounds of original fat.

Settle for twenty to thirty minutes and siphon off through a strainer and several thicknesses of cheese-cloth to a storage tank, where it should stand thirty minutes, skim and heat to 128° F.

Then allow it to stand until it drops to 120° F., when it is ready to draw off into tierces which should be held at 56° to 60° F. for ten to twelve days to grain. During this time the bungs are left out of the tierces, as it helps the lard to grain and vents the tierces.

Never roll a tierce of neutral lard after the first three days, as it spoils the grain; instead use a truck. Good neutral lard is grainy and has a taste like hickory nuts.

Inspection.—Sour lard is caused by excess of moisture and can be easily detected by the sour odor.

Rancid lard is due to advanced age and improper storage at too high a temperature. It may be detected by the taste, odor and by chemical test. To test, heat it by rubbing a small portion vigorously in the palm of the hand, then smell quickly; or place some in a small glass and immerse in a vessel of hot water, when, if rancid, the fumes given off from the hot lard will readily reveal that condition. It may also be determined by the taste, but this method is useless if more than one sample is to be tested, as the rancid taste will remain in the mouth and render the tasting of other samples useless or even deceptive.

Neats' Foot Oil.—The best neats' foot oil comes from cattle feet without the addition of any other material, such as bones, as they produce too high a percentage of stearin, which is objectionable.

The cattle feet, after the shins are cut off, are scalded and the hoof pinched off, and then washed and cleaned thoroughly. Cook the feet in an open kettle at a temperature of 185° to 200° F. for nine to ten hours, and then allow to stand for about an hour when the oil will appear on the surface and may be skimmed or drawn off through a strainer to a steam-jacketed kettle, where it is warmed up to 210° F. for eight to ten hours.

It is now allowed to settle and the water and impurities are drawn off from the bottom of the kettle, after which the steam is again turned on and the temperature raised to about 250° F. for one and a half to two hours to evaporate the moisture and dry the oil, which is an essential part of the process.

The oil is now allowed to cool down to about 85° F., at which temperature it is filled into tierces or other containers for the market.

Neats' foot oil may be pressed for cold test oil and will stand a temperature of 30° F. for twenty-four hours without freezing.

There are other grades of neats' foot oil which are made from the feet of horses, sheep, calves, etc., but the essential features of the

manufacture of all this oil is to have the raw material fresh and clean, free from blood, dirt, etc., to cook below the boiling-point and to properly dry the finished oil.

The color of the oil should be a golden-yellow resembling prime summer yellow cottonseed oil, and the amount of free fatty acid should not exceed 0.75 per cent, but even less is preferable.

Oleo Oil and Oleo Stearin.—Oleo oil and oleo stearin are made from beef fat processes as follows with minor variations at different establishments:

No. 1. Oleo oil and oleo stearin made from caul fat, ruffle fat, No. 1 suet.

No. 2. Oleo oil and oleo stearin made from gut fat, paunch fat, pluck fat.

The fat for No. 1 oil is obtained from various parts of the carcass, caul fat (omental fat), ruffle fat (mesenteric fat) and No. 1 suet (kidney capsule fat). The caul and ruffle fats should be well washed and then conveyed to the chilling vats. The suet is ready to be hashed as it comes from the beef-cutting department.

The fat for No. 2 oleo is gut, paunch and pluck fat. The gut fat is derived from the bung (cecum) and middle guts (large colon) in the process of trimming and fattying them for use as sausage containers. The paunch fat is trimmed from the external surface of the paunch, and the pluck fat is trimmed principally from the heart and a small per cent from around the trachea (windpipe).

When the fat has been thoroughly washed and cleaned in the offal department it is conveyed to the chilling vats and submerged in clean cold water at a temperature of about 36° to 38° F. for from four to five hours or until the animal heat has been entirely removed.

When "shop" fat (kidney, cod and breast fat) collected from butcher shops is used it is soaked in the chilling vats overnight in water chilled by ice, brine pipes, or sometimes in cool artesian well water. The chilling of fat is a very important feature in the manufacture of oils and oil-house products.

When thoroughly chilled the fat is pulled from the chilling vats and run through a hasher which feeds directly into the melting kettles. The melting kettle used is provided with an open jacket containing water which is heated by a perforated steam pipe running from the top to the bottom. Have the kettle heated up before the fat is hashed into it and start the agitator, which should make about 12 or 13 revolutions per minute.

About one hour is required to fill a kettle which ordinarily holds from 5500 to 6000 pounds of fat, and care should be taken during the filling to keep the kettle well heated and to have the oil to mix freely with the fat. Feed in about 16 shovels or 320 pounds of Michigan fine, or 10 shovels (200 pounds) or crushed rock salt to each kettle; the same being divided into four parts and scattered in the kettle when it is about one-fourth, one-half, three-fourths and entirely full, then after

rendering is completed and the agitation has ceased use 6 to 8 skimmers of salt (25 to 30 pounds) to settle the kettle.

The rendering is completed at the end of the second hour and the temperature reaches 150° F. on No. 1 oil, 160° F. on No. 2 oil and on mutton oil and not higher than 170° F. on No. 3 oil. During the melting period it should be heated slowly and well agitated. The third hour is allowed for settling, all steam being turned off and the oil frequently skimmed, as scum will constantly form from the salt, etc.

When the kettles are filled too fast or are heated too slowly the fat does not melt properly and "chillers" result on account of the oil not freeing itself from the water and scrap as it should. In such cases it must be well heated and well stirred and allowed to settle well or sour bottoms and a poor grade of oil will result.

After the oil has settled it is drawn off from the kettle by means of a swinging pipe that is introduced into the body of the oil from the top so as not to disturb the settlings in the bottom, and from there it is run into the settling kettles or clarifiers on the floor below.

The bottoms or settlings are next skimmed of oil, and then dumped into the next kettle of fat or sent to the tank house.

The oil is allowed to stand in the clarifiers for two to three hours at a temperature of 140° F or over, during which time it is frequently skimmed, and the bottoms are drawn off from them before the oil is run off.

The oil is run into large trucks, known as "seeding" trucks, where it is allowed to remain without the least disturbance for seventy-two to ninety-six hours at a temperature of 87° to 96° F. It is here that the stearin separates out in crystals, while the olein and palmitin, which together are called oleo oil, remain fluid. This process is called "seeding."

On the fourth day the contents of the seeding trucks are mixed up into a soft grainy mush, without disturbing the bottoms, as the bottoms are not fit to press on account of moisture contained in them. Bottoms are classed as good and poor, and if sweet and wholesome are remelted with the next rendering, but sometimes they are sour from the water, in which case they should go to the tank house for inedible product.

The seeding room should be well ventilated and heated to insure a uniform temperature. A subdued light is preferred to prevent the bleaching out of the yellow color of the oil.

The mixed fat or mush is not ready to be pressed and is prepared for this by placing the oleo stock in canvas cloths or wrappers (No. 10 duck, 18 by 28 inches), 4 to 6 pounds each, neatly folded to inclose it, then placed in the press side by side with others to make a complete layer of ten cakes. These are placed layer upon layer, usually 60 in number, each separated by a steel plate until the press is full, after which the power is turned on and the pressing begins, thus squeezing the oleo oil out through the canvas covers. The press-room should be about 88° to 90° F. It requires a half hour for a gang of ten men

to fill a press; two hours to press the stock and twenty minutes to lift the press (Fig. 157).

The press should drain thoroughly and the oil run to a receiving tank, where it is held at 105° to 114° F. to settle, when it is tierced at the same temperature, then allowed to seed or grain for four to seven days at 55° to 60° F. without being disturbed, after which it is ready for shipment.

Stearin.—The wax or residue remaining in the canvas wrappers after the oleo oil has been pressed out is known as oleo stearin. It is shaken out of the cloths into a bin or receptacle, where it should stand for twenty-four hours before being packed into slack barrels or tierces. It is graded as Nos. 1, 2 or 3 to correspond with the same grades of oil.

The hardness of stearin varies with the length of time, the degree and the temperature of the pressing, thus Extra Hard Stearin is pressed to give a titer or melting temperature of 160° to 165° F.



FIG. 157.—Pressing oleo stock.

Soft stearin has a titer of 120° to 124° F. This is about the average hardness of stearin.

Extra soft stearin has a titer of 90° to 95° F., and in making it the press is only run about twenty minutes, or just long enough to press out the overabundance of free oil, and to leave the stearin rather thick and pasty.

Stearin is used as a constituent of "Compound" and other commercial products, but the recently perfected process of the hydrogenation of vegetable oils, whereby they can be made of almost any desired hardness by the use of hydrogen gas, has very largely reduced the demand for stearin.

Lard Oil and Lard Stearin.—Lard oil and lard stearin are made from prime steam lard in a manner very similar to the one above described

for the making of oleo stearin and oleo oil, except that the seeding takes place in a cooler at 45° F. and it is pressed cold.

Lard Oil Tests.—1. Temperature of stock, 45° F.; that of the press-room, 60° F.; the stock yielded 46 per cent of lard stearin and 54 per cent of lard oil, which latter stood a cold test of 47° F.

To make colder degree oils the temperature of the stock or seeding-room and the press-room must be lowered accordingly. This oil is much used for locomotive head-lights and a low cold test is desirable, especially in cold weather.

Compound and Lard Compound.—These are made of various ingredients, being a combination of vegetable and animal fats to make a product resembling and used for the same purpose as lard. Lard compound differs from compound or lard substitutes only in the fact that it must contain, in order to be so labeled, as much or more lard as the combined weight of all the other ingredients. Both products must be labeled to show the ingredients in the order of their percentages and preceded by the words "composed of."

The ingredients entering into these products vary according to the prices and the market conditions generally, as it is the aim usually to use as much of the less expensive ingredients as is consistent with hardness and structure of the finished mixture. A titer test of 37° C. gives the proper consistency for compound, but if it is to be used in warm climates this must be increased to 38° C.

In making these products the ingredients are melted and then thoroughly mixed together, after which they are cooled in very much the same manner as described for lard by using the chilling rolls or the properly cooled agitator.

The different materials used for lard compound are prime steam lard, oleo stearin, edible tallow, and cottonseed oil; and in order to arrive at definite titers for the finished product it is necessary to test each ingredient separately with regard to its titer.

The ingredients used have ordinarily the following titers:

Prime steam lard	36° to 37° F.
Lard stearin	40° to 44° C.
Cottonseed oil	30° to 33° C.
Oleo stearin	49° to 51° C.
Edible tallow	42° to 44° C.

With these as a basis there will be shown the method of calculating the titer of the finished product on some well-known and excellent formulas:

No. 1

80 per cent cottonseed oil at 33 titer—80 multiplied by 33 equals	26.40
20 per cent oleo stearin at 51 titer—20 multiplied by 51 equals	10.20
Titer of finished product	36.60

No. 2

75 per cent cottonseed oil at 33 titer—75 multiplied by 33 equals	24.75
10 per cent oleo stearin at 51 titer—10 multiplied by 51 equals	5.10
15 per cent edible tallow at 43 titer—15 multiplied by 43 equals	6.45
Titer of finished product	36.30

These are a trifle less than 37° titer, but are fine for winter use. For warm climates or hot weather the following are good formulas:

No. 3

70 per cent cottonseed oil at 33 titer—70 multiplied by 33 equals	. . .	23.10
20 per cent oleo stearin at 51 titer—20 multiplied by 51 equals	. . .	10.20
10 per cent steam lard at 37 titer—10 multiplied by 37 equals	. . .	3.70
Titer of finished product		37.00

Or if the stearin is high in price and steam lard cheap then No. 3 is supplanted by No. 4, which is a lard compound:

No. 4

75 per cent prime steam lard at 37 titer—75 multiplied by 37 equals	. . .	27.75
15 per cent edible tallow at 43 titer—15 multiplied by 43 equals	. . .	6.45
10 per cent cottonseed oil at 33 titer—10 multiplied by 33 equals	. . .	3.30
Titer of finished product		37.50

This is a very good lard compound and the following No. 5 is a good compound:

No 5.

70 per cent cottonseed oil at 33 titer—70 multiplied by 33 equals	. . .	23.10
10 per cent edible tallow at 43 titer—10 multiplied by 43 equals	. . .	4.30
20 per cent oleo stearin at 51 titer—20 multiplied by 51 equals	. . .	10.20
Titer of finished product		37.60

Thus it will be seen that a variety of mixtures can be made, and should it be desired to use corn oil its titer will have to be observed. Remember the titer varies in different lots, so test often.

The ingredients often require bleaching before using, and the method employed is the same as already explained for bleaching lard, viz., by the use of fullers' earth, combined with air and heat and the subsequent removal of the bleaching agent by filtering.

The amount of earth required must be determined by testing each batch of ingredients; and each ingredient must be bleached before mixing, but never try to bleach the mixture.

Oleo stearin bleaches very easily, and if the cakes are exposed to the sunlight it will bleach in a short time, but if fullers' earth bleach is desired use about 0.5 or 1 per cent at a temperature of 140° to 150° F.

Cottonseed oil is usually bought refined, but needs bleaching, which requires more earth, often as high as 6 per cent and some oils cannot be bleached, so test before buying.

Compounds are now largely made entirely of vegetable oils since the method of hardening them by the use of hydrogen gas has been perfected. These vegetable compounds do not come within the scope of the Meat-inspection Law.

Manufacture of Butterine (Oleomargarin or Margarin).—To make a fairly high grade of butterine use the following:

No. 1 oleo oil, melted at 110° F.	400 pounds
No. 1 neutral oil, melted at 128° F.	400 "

Cool both slowly to 100° F. and then run both into a churn and add 30 per cent of cream at 72° F. and churn for twenty minutes. Then run into chill vat with water at 40° F., and after it is thoroughly chilled run into trucks and hold it in tempering room, at 78° to 80° F., overnight, with the top covered with salt. Then put through the butter-worker; salt to taste to suit trade when it is ready to pack into tubs or prints.

MEDIUM HIGH-GRADE BUTTERINE.

No. 2 oleo oil	500 pounds
No. 1 neutral	250 "
Cottonseed oil	250 "
Milk	400 "

LOW-GRADE BUTTERINE.

No. 3 oleo stock	350 pounds
Cottonseed oil	650 "
Skimmed milk	200 "

SOME OTHER FORMULAS.

Temperature of water.	Oleo oil.	Neutral oil.	Cottonseed oil.	Milk.	Cream.	Creamery butter.	Salt.	Total.	Yield.	Shrinkage, pounds.	Shrinkage, per cent.	Quality of product.
38° F.	350	450	250	450	60	1560	1210	350	22.43	Low grade
40° F.	525	475	300	..	60	1360	1294	66	4.85	Medium high grade
40° F.	525	475	225	300	50	1575	1497	78	4.95	High grade

CHAPTER XV.

CHEMICAL ANALYSIS OF MEAT-FOOD PRODUCTS.

MEAT inspection in a broader sense must also provide for laboratory examination of meat and meat-food products. Such laboratory examination are essential for the purpose of determining the presence of harmful preservatives and adulterants which may be added for fraudulent purposes. This applies especially to the addition of harmful preservatives in order to disguise the spoiled condition of meat, the detection of beef fats in lard, the utilization of cottonseed oil in the various fats, the addition of artificial coloring to meat products and the use of excessive amounts of starchy substances, especially in connection with the preparation of sausage. In the following pages the most important methods of analysis are described which have proved satisfactory for making reliable and rapid routine tests for various preservatives and adulterants in meat products.

These methods have been adopted by the more important meat-inspection laboratories of the country, after being thoroughly tested for their applicability and have been found to meet the necessary requirements. All the methods here described may be carried out with the apparatus usually found in any chemical laboratory, and can be manipulated by anyone who has had the average college course in chemistry.

ESTIMATION OF SALT (SODIUM CHLORIDE).

Moisten $2\frac{1}{2}$ to 3 grams of the finely comminuted and thoroughly mixed sample in a platinum dish with 20 cc. of 5 per cent sodium carbonate solution, evaporate to dryness and ignite at a temperature not exceeding a dull redness. Extract with hot water, filter and wash. Return the residue to the platinum dish and ignite to an ash, dissolve in dilute nitric acid (1 plus 4), filter to free from any insoluble residue, wash thoroughly and add this solution to the water-extract. Add to this solution a slight excess of tenth-normal silver nitrate solution. Filter to remove the precipitated silver chloride and wash the precipitate thoroughly. To the combined filtrate and washings add 2 cc. of a saturated solution of ferric ammonium sulphate and determine the excess of silver nitrate by titration with tenth-normal ammonium thiocyanate. Calculate percentage of salt from the number of cubic centimeters of tenth-normal silver nitrate required.

Determine chlorine in the combined filtrate and washings in accordance with the A. O. A. C. Method for Chlorine in Plants, Official and Tentative Methods, 4th ed., 1935, Sec. XII, paragraphs 34 and 35.

DETECTION OF NITRATES.

A small portion of the finely divided material is treated in a porcelain dish with a little 0.1 per cent solution of diphenylamin in concentrated sulphuric acid. Presence of a blue color indicates nitrate.

Quantitative Estimation of Nitrates.—Weigh 1 Gm. of the sample into a 100-cc. flask, add from 20 to 30 cc. of water and heat on the water-bath for fifteen minutes, shaking occasionally. Add 3 cc. of a saturated solution of silver sulphate for each per cent of sodium chloride present, then add 10 cc. of lead subacetate and 5 cc. of alumina cream, shaking after each addition. Make up to mark with water and filter through a folded filter, returning the filtrate to the filter until it runs clear. Evaporate to dryness 25 cc. of the filtrate, add 1 cc. of phenol-sulphonic acid,¹ mix thoroughly with a glass rod, add 1 cc. of water and 3 or 4 drops of concentrated sulphuric acid, and heat on a steam-bath for two or three minutes, being careful not to raise the temperature sufficiently to char the material. Add about 25 cc. of water and an excess of ammonium hydroxide. Transfer to a 100-cc. flask, add 1 or 2 cc. of alumina cream if not perfectly clear, dilute to the mark with water and filter if necessary.

Prepare a number of 50-cc. Nessler tubes, preferably the long, narrow tubes, placing in the first 1 cc. of the standard nitrate solution, containing 0.01 mg. of nitrogen as potassium nitrate in each cc. in the second 2 cc., and so on to 10 cc., then 12 cc., 15 cc., 18 cc., and 20 cc. Compare with the standards the solution prepared as directed above. If dilution is necessary to bring within this range, calculate to original concentration, and calculate the percentage of potassium nitrate in the original sample, 1 cc. standard nitrate solution being equal to 0.07 mg. KNO_3 .

Standard Potassium Nitrate Solution.—0.722 Gm. of pure dry potassium nitrate is weighed out and dissolved in 1 liter of distilled water. Ten cc. of this solution are evaporated to dryness, 2 cc. of the phenol-sulphonic acid added, and quickly and thoroughly mixed with the residue by means of a glass rod. The mixture is dissolved in distilled water and the solution diluted to 100 cc. One cc. equals 0.07 mg. KNO_3 .

Estimation of Nitrites.—*Preparation of Nitrite Reagent*,—(1) 0.5 Gm. of sulphanilic acid is dissolved in 150 cc. of 15 per cent acetic acid. (2) 0.1 Gm. of solid alpha-naphthalamine is boiled with 20 cc. of water, the colorless solution is poured off from the bluish-violet residue and 150 cc. of 15 per cent acetic acid added.

The two solutions are now mixed. Resulting solution may be used as long as it remains colorless. When solution becomes red, due to contact with nitrous acid which is often present in the air, it should be discarded and new solution made or decolorized by shaking with zinc dust.

¹ Prepared by mixing 37 cc. of concentrated sulphuric acid, 3 cc. of distilled water and 6 Gm. of phenol.

Preparation of Standard Nitrite Solution.—To a cold solution of commercial sodium or potassium nitrite add a solution of silver nitrate as long as a precipitate appears. Decant the liquid and thoroughly wash the precipitate with cold water. Dissolve in boiling water. Concentrate and crystallize the silver nitrite from the hot solution. Suck dry on filter plates, using suction and finally dry over calcium chloride (anhydrous) in the dark and in a vacuum to constant weight.

Weigh out 0.22 Gm. of the dry silver nitrite. Dissolve in hot water. Decompose with slight excess of sodium chloride, cool if necessary and dilute to 1 liter. Allow the precipitate of silver chloride to settle, remove 5 cc. of the clear solution and dilute to 1 liter. This second solution, which is the standard, will contain nitrite per cc. equivalent to 0.0001 mg. of nitrogen. This dilute solution should be made up fresh each day.

Nitrites in Meat.—The sample is finely chopped and well mixed by passing through a sausage cutter several times, mixing by hand each time after passing through the cutter. Of this well-mixed sample 5 Gm. is weighed out into a 500-cc. graduated flask, about 250 cc. distilled water free from nitrites added and allowed to stand thirty minutes, during which time the flask should be well shaken about every five minutes. Next about 25 cc. alumina cream are added, the mixture well shaken, made up to mark with distilled water and well shaken again. After filtering through a dry filter paper an aliquot is placed in a 50-cc. Nessler tube (diluting if necessary) and after addition of 2 cc. of nitrite reagent comparison made with known standards.

BORIC ACID.

1. **Qualitatively.**—Place approximately 10 gm. of meat, cut in small pieces, in a nickel dish, add a few cc. of 10 per cent NaOH solution, heat on hot plate until dry or partly charred, ignite over Bunsen flame until organic matter is destroyed, cool, add about 10 cc. water bring to boil, allow to settle a few minutes, decant into small beaker or graduated cylinder, acidify with about 1 cc. concentrated HCl, dip strip of yellow turmeric paper into the solution and hang in air or place on glass plate over steam-bath until dry. Development of a pink coloration on the yellow turmeric paper indicates the presence of boric acid. An uneven, spotted coloration or a brownish coloration indicates contamination from outside sources, or an excessive amount of HCl used in acidifying.

Preparation of Turmeric Paper.—Dissolve 0.05 Gm. of curcumin in 100 cc. absolute alcohol, and immerse in this solution heavy white filter paper of coarse texture and highly absorbent character (such as S. and S. No. 598, size 23 by 23, extra heavy). These sheets are dried in a dark place, and after a period of time varying from a half-hour to an hour, are ready for use. They should be cut into strips of the proper size and kept in the dark in tightly stoppered bottles.

2. **Quantitatively.**—(a) A roughly quantitative determination of boric acid may be made by the use of turmeric paper in the manner described under the heading "Qualitatively;" solutions containing known amounts of boric acid should be used for comparison with the samples which are to be tested. If by this method more than 0.01 of 1 per cent of boric acid is indicated a quantitative determination by the method given below should be made.

(b) Render 25 Gm. of the sample decidedly alkaline with 10 per cent solution of sodium hydroxide and evaporate to dryness in a platinum dish. Ignite the residue cautiously until thoroughly carbonized and then burn off the carbon deposit from the side of the dish. Add 20 cc. of water, mix thoroughly and bring to a boil; allow to cool and add hydrochloric acid by drop until acid. Transfer the entire contents of the dish to a 100 cc.- graduated flask, not allowing the volume to exceed 60 cc. Add 1 Gm.¹ of powdered CaCl_2 and a few drops of phenolphthalein, then add a 10 per cent solution of sodium hydroxide until a permanent, slightly pink color is produced; after this is reached add 25 cc. of lime water and make the volume up to 100 cc. Mix well by shaking for at least two minutes and filter through a dry filter. To 25 cc. of the filtrate add normal H_2SO_4 drop by drop until the pink color disappears. Now add a drop of methyl orange solution and $\frac{N}{10}$ NaOH very carefully until the liquid assumes a slightly orange tinge.² Boil about one minute to expel carbon dioxide. Cool the solution, add a little phenolphthalein and 2 Gm. of mannite. Titrate with $\frac{N}{10}$ NaOH until a permanent pink color is produced. One cc. of $\frac{N}{10}$ 0.0062 Gm. $\text{B}(\text{OH})_3$. When the end-point is reached more mannite should be added; if this causes a disappearance of the pink, the titration should be continued until the pink color remains permanent after the addition of mannite.

FLUORIDES.

Qualitative Estimation.—Take the residue from the qualitative determination of boric acid described above, make alkaline, evaporate and ignite in a platinum crucible. The ash will contain any calcium silicate and fluoride present in the sample.

Mix the ash with a little precipitated silica known to be free from fluorides, and add 1 cc. of concentrated sulphuric acid. Cover the crucible with a watch-glass from the underside of which a drop of water is suspended, and heat an hour on the steam-bath. The silicon fluoride which is formed is decomposed by coming in contact with the drop of water, leaving a gelatinous deposit of silicic acid in the water, and etching a ring at the periphery of the drop.

¹ In the case of meat extracts or other substances which contain unusually large amounts of phosphates it may be necessary to add more calcium chloride; in all cases sufficient calcium chloride should be added to completely precipitate the phosphates.

² It is very important to avoid an excess of alkali at this point.

SULPHUROUS ACID AND SULPHITES.

Qualitatively and Quantitatively.—To 50 Gm. of the samples add 150 cc. of water and place in a distilling flask. Now add approximately 1 Gm. of sodium bicarbonate and mix thoroughly, then add 20 cc. of a 20 per cent solution of glacial phosphoric acid, attaching the flask to the condenser as quickly as possible. The end of the condenser tube should be made to extend below the surface of 20 cc. of an approximately $\frac{N}{10}$ iodine solution and the distillation conducted with a steady flame. Small pieces of pumice stone aid in the boiling. Distil until at least 100 cc. of distillate have been collected in the iodine solution. To this distillate add 5 cc. concentrated HCl and boil until the solution is practically colorless. Add BaCl₂ solution and allow the solution to which the BaCl₂ is added to stand on the steam-bath for thirty minutes. If a precipitation occurs allow the solution to stand twelve hours, then filter, ignite and weigh the BaSO₃ precipitate and calculate to sulphurous acid.

BENZOATES, SALICYLATES AND SACCHARIN.

Qualitatively.—If the material be a solid or semisolid, macerate from 200 to 300 Gm. in a mortar with about 400 cc. of 25 per cent alcohol and strain through a cotton bag. Make alkaline and remove alcohol by evaporation on the water-bath. Dilute with water, acidify and extract with ether. Separate if necessary by means of a centrifuge. The ether solution is allowed to evaporate at room temperature in a glass dish. The residue is examined for crystals of salicylic acid and benzoic acid and then tested in the manner described below.

If the substance to be examined is a liquid the addition of alcohol and subsequent evaporation will be unnecessary as the sample may be simply acidified and extracted with ether as described above.

Test for Saccharin.—Note the taste of the residue from the extract described above. The presence of saccharin to the amount of 20 mg. per liter is indicated by an intense sweetness.

Test for Salicylic Acid.—To a portion of the dry residue described above add a drop of ferric chloride solution. A deep purple or violet color indicates salicylic acid. This color is sometimes made more distinct by dilution with water. In case the material under examination contains sufficient extractive matter to interfere with this color test, or if it is not possible to separate the solid matter by straining, satisfactory results may be obtained by distillation with steam, using a short exit tube of large diameter through which the steam and volatilized acids pass directly from the flask to the condenser. The following method of conduction the distillation is very satisfactory: Macerate a portion of the sample with water and render acid with phosphoric acid; transfer to a 600-cc. Erlenmyer flask with an inside diameter at the mouth of about $1\frac{1}{4}$ inches; a short tube with an inside diameter of not less than $\frac{3}{8}$ inch should connect the flask with the condenser,

and should turn into the condenser immediately above the stopper in the flask. Conduct steam through a small tube passing through the stopper and dipping deeply into the material in the flask. Continue the distillation with steam until 500 cc. have passed over, care being taken not to let the contents of the flask get too low, then acidify and extract with ether as described above.

Test for Benzoic Acid.—The remaining residue from the extraction, described above, is taken up with a small amount of ether, filtered and placed in a porcelain crucible, allowed to evaporate and then rendered completely dry by placing in vacuum over sulphuric acid. When thoroughly dry, sublime the residue, covering the crucible with a watch-glass or glass evaporating dish kept cold by a mixture of ice and salt. The sublimate should be examined for crystals of benzoic acid. After the microscopic examination the sublimate should be dissolved in hot water, made alkaline with ammonium hydroxide, all the NH_3 driven off but not heated too much; the solution must not be evaporated to dryness. Take up with a few cc. of water and add a few drops of a neutral 0.5 per cent solution of ferric chloride. The presence of benzoic acid will be indicated by the formation of a flesh-colored precipitate of ferric benzoate. (Confirm by Mohler test, Official and Tentative Methods A. O. A. C., 4th ed., 1935, XXXII, page 8.)

DETERMINATION OF FORMALDEHYDE IN MEAT

To 100 Gm. of finely chopped meat in a 1000-cc. round-bottom distilling flask add 300 cc. of water and 25 cc. of a 20 per cent phosphoric acid solution, distill with the aid of a Hopkins bulb and collect the filtrate in a 50-cc. Nessler tube. Add to the 50 cc. collected 2 cc. of a freshly prepared 1 per cent solution of phenylhydrazine hydrochloride, mix well, allow to stand three minutes, add 1 cc. of freshly prepared 5 per cent potassium ferricyanide solution, mix well, allow to stand three minutes, add 4 cc. of concentrated hydrochloric acid, mix well and allow to stand three minutes.

A decided reddish-pink coloration indicates formaldehyde which can be made quantitative by matching this tube and succeeding tubes similarly prepared against tubes of known formaldehyde content prepared by adding 0.25 cc., 0.5 cc., 1 cc., 2 cc., 3 cc., and 5 cc., of a solution containing 0.00005 Gm. of formaldehyde¹ in each cc., dilute to mark of 50 cc. with water, followed by phenylhydrazine hydrochloride, potassium ferricyanide and hydrochloric acid as above. In cases where it becomes necessary to distill several tubes the distillation may be temporarily stopped, more water added to the flask and then the distillation continued. The sum of the formaldehyde in the tubes collected will be equal to the formaldehyde in the original 100 Gm. of sample.

¹ The standard formaldehyde solution is prepared by measuring 1.37 cc. of a 38 per cent by volume solution of formaldehyde and making up to 1000 cc.; 50 cc. of this solution made up to 500 cc. will give a solution, 1 cc. of which contains 0.00005 Gm. of formaldehyde and is the solution referred to for the preparation of standard tubes.

THE DETECTION OF FOREIGN COLORING MATTER IN MEATS.

To not less than 50 Gm. of the finely divided sample sufficient 50 per cent alcohol is added to completely cover the sample; it is then heated on the steam-bath for at least twenty minutes, filtered and the filtrate placed in the ice-box until the fat is congealed which is then separated by filtration. Any yellow or red color retained by the fat is probably due to the presence of spices of the capsicum variety, or possibly to added annatto. If the filtrate is colored, acidify with acetic acid, add a small piece of clean, white wool and boil for twenty minutes, adding sufficient water to maintain approximately the original volume. Now make the solution alkaline with sodium carbonate or caustic soda, add a fresh piece of wool, and repeat the dyeing procedure. In this way both acid and basic dyes may be detected. Any definite coloration of the wool thus obtained indicates the presence of foreign coloring matter.

DETECTION OF STARCH IN MEAT PRODUCTS.

A small portion of the sample is boiled with water, cooled and a drop of iodine solution is added to the liquid. The characteristic blue color is produced if starch be present in notable quantity. Traces of starch may be due to spices used in the seasoning. A microscopic examination will usually reveal the character of the starch, whether it is from cereals or from spices. In some preparations, however, the starch is thoroughly cooked and its structure destroyed.

Rapid Method for Estimation of Starch.—Digest 10 Gm. of the sample on the steam-bath for thirty minutes with 50 cc. of alcoholic potash solution (80 Gm. chemically pure stick KOH in 1 liter of 95 per cent alcohol) with occasional stirring to facilitate digestion.

Transfer to a 100-cc. graduated oil tube (A. S. T. M. long form), washing the sediment from the beaker with a stream of 95 per cent alcohol from a wash bottle. Bring the solution in the tube up to the 100-cc. mark. Mix and allow the tube to stand for one hour, giving it a gentle rotation from time to time to assist sedimentation. At the end of one hour's standing, read volume of solids.

A volume of solids exceeding 1 cc. indicates a cereal-added product, or a product to which a non-starchy vegetable matter has been added.

Estimation of Starch by Price Method.—In a 200-cc. beaker treat 10 Gm. of finely divided meat with 75 cc. of an 8 per cent solution of potassium hydrate in 95 per cent alcohol, and heat on the steam-bath until all the meat is dissolved. This will require from thirty to forty-five minutes. Add an equal volume of 95 per cent alcohol, cool and allow to stand at least one hour. Filter by suction through a thin layer of asbestos in a Gooch crucible. Wash twice with warm 4 per cent potassium hydrate in 50 per cent alcohol and then twice with warm 50 per cent alcohol. Discard the washing. Retain as much of the precipitate in the beaker as possible until the last washing. Place the crucible with contents in the original beaker, add 40 cc. of water

and then 25 cc. of concentrated sulphuric acid. Stir during the addition of the acid and see that the acid comes in contact with all the precipitate. Allow to stand about five minutes, add 40 cc. of water and heat just to boiling, stirring constantly. Transfer the solution to a 250-cc. graduated flask, add 2 cc. of a 20 per cent aqueous solution of phosphotungstic acid, allow to cool to room temperature and make up to mark with distilled water. Filter through a starch-free filter paper, and determine the dextrose present in a 50 cc. portion of the filtrate with Fehling's solution after neutralizing the acid, using Low's method, as given in Official and Tentative Methods of the A.O.A.C., 4th ed., 1935, XXXIV, pp. 38, 41, for the determination of the copper in cuprous oxide precipitate. The amount of dextrose multiplied by 0.9 gives the equivalent in starch.

WATER IN ADDED STARCH.

Pass the sample through a sausage cutter of the Enterprise or Universal type three times at least. Casing should be removed from stuffed sausage before grinding. Weigh a 2" by 2" glass weighing bottle containing a short glass rod. Place approximately 10 Gm. of well-mixed sample in this weighing bottle. Weigh accurately. By means of the short glass rod remove about 5 Gm. of sample to a 7-cm. filter paper. Wrap this paper around the sample and drop in a 500-cc. Kjeldahl flask. Weigh the weighing bottle plus remainder of sample, then spread over bottom and sides of bottle. Dry sixteen hours at 100° C., cool and weigh; calculate percentage of water from loss in weight. To Kjeldahl flask add 10 Gm. K_2SO_4 plus 50 cc. H_2SO_4 plus 2 cc. saturated $CuSO_4$ solution. Digest until colorless, which takes about three to four hours. Dilute, make alkaline with concentrated NaOH solution, distill into 15 cc. or more if necessary $\frac{N}{2} H_2SO_4$. Titrate excess acid with $\frac{N}{2} NaOH$, using P. nitro phenol as indicator. Nitrogen $\times 6.25$ equals amount of protein. The amount of protein $\times 4$ equals normal amount of water present in pure fresh sausage. Water in excess of this shows added water.

DETECTION OF BEEF IN PORK PRODUCTS.

Shake a large portion of the finely divided sample in a corked flask with petroleum ether (boiling below 60° C.), and digest for some hours. Pour off the solvent; remove most of the petroleum ether by distillation, and the last traces by allowing to stand in a vacuum desiccator over freshly ignited calcium chloride. Examine fat by the method given for detecting adulteration of lard with beef fat.

METHODS FOR FAT ANALYSIS.

Detection of Artificial Colors.—*Vegetable Colors.*—One hundred Gm. of the fat should be dissolved in a separatory funnel in 300 cc. of petroleum ether. The water, etc., are drawn off and the ethereal solution

of the fat and coloring matters washed several times by agitation with water. The ethereal solution poured off from any stearin which may have separated on standing is then shaken with 50 cc. of a decinormal solution of caustic potash (5.61 Gm. of KOH per liter) which is usually sufficient to affect the solution of all coloring matters capable of being dissolved by dilute alkali. Alkaline solution is separated from the ethereal layer, placed on the steam-bath until all the petroleum ether is driven off, cooled and then cautiously treated with dilute hydrochloric acid until faintly acid to litmus paper. The precipitate consists of coloring matter mixed with a little fatty acid; it is filtered off and washed with cold water. It should then be dissolved in alcohol and the color identified by the reactions outlined in Schultz and Julius' "A Systematic Survey of the Organic Coloring Matter," by A. J. Green.

Coal-tar Colors.—Take approximately 100 Gm. of the fat which is to be tested, saponify some with alcoholic potash, dilute with water until of a liquid consistency. Drive off the alcohol, cool and shake in a separatory funnel with ether. The ether will take up the coal-tar color and when evaporated may be indentified by the reactions outlined in Schultz and Julius (*loc. cit.*).

Detection of Beef Fat in Lard.—Weigh out 5 Gm. of the filtered fat into a glass-stoppered cylinder graduated to 25 cc. add warm acetone until the 25-cc. mark is reached. The cylinder is shaken until the contents are thoroughly mixed, and the cylinder and its contents are then allowed to stand in a suitable place in which a temperature of 30° C. is maintained. After eighteen hours the cylinder is removed and the supernatant acetone solution carefully decanted from the cystallized glycerides, which are usually found in a firm mass at the bottom of the cylinder. Warm acetone is then added in three portions of 5 cc. each from a small wash bottle, care being taken not to break up the deposit while washing and decanting the first two portions. The third portion is, however, actively agitated in the cylinder, and by a quick movement transferred with the crystals to a small filter paper. The crystals are then washed with five successive small portions of the warm acetone with the use of the wash bottle and the excess acetone removed from them by suction. The paper with its contents is then transferred to a suitable place, where it should be spread out and any large lumps of the glycerides broken up by gentle pressure. When dry, the mass is thoroughly comminuted and the melting-point of the crystals determined. The melting-point of the crystals is determined as follows:

"A large test-tube approximately 150 by 25 mm., containing water (free from air) into which the bulb of a thermometer with the melting-point tube attached is immersed is placed in a beaker of water and so adjusted that the surface of the liquid contained in the two vessels is at the same level. The water in the beaker should be heated rapidly to about 55° C. and that temperature maintained until the thermometer carrying the melting-point tube registers between 50° and 55° C., then heat is again applied and the temperature of the outer bath carried somewhat rapidly to 67° C., when the lamp is removed. The melting-

point of the crystals is regarded as the point when the fused substance becomes perfectly clear and transparent. The use of a dark background placed about 4 inches from the apparatus will prove of advantage.

"The melting-point tube should be of about 1 mm. internal diameter, sealed at one end and with a slight flare at the other extremity, in order that the loading may be expedited. The amount of the substance taken for each determination should be approximately the same and should occupy a space about 9 mm. in length, being somewhat firmly packed in the lower end of the tube by tapping it sharply on a hard surface. The water in the outer bath should be agitated frequently during the determination."

A melting-point below 63° C. is regarded as evidence of adulteration and a melting-point below 63.4°C. is regarded as suspicious.

After the melting-point of the crystallized glycerides has been determined, transfer them to a 50-cc. beaker, add 25 cc. of approximately $\frac{N}{2}$ alcoholic NOH and heat on the steam-bath until saponification is complete. Pour the solution into a separatory funnel containing 200 cc. of distilled water, acidify, add 75 cc. ether and shake. Draw off the acid layer and wash at least three times with distilled water. Transfer the ether solution to a clean, dry, 50-cc. beaker, drive off the ether on the steam-bath and finally dry the acids at 100° C. After the acids have stood for at least two hours, after drying, determine the melting-point in the same manner in which the melting-point of the crystals was determined. If the melting-point of the glycerides plus twice the difference between the melting-point of the glycerides and the melting-point of the fatty acids is less than 73° C. the lard is regarded as adulterated.

Detection of Cottonseed Oil (Halophen Reaction).—Mix 100 cc. of carbon bisulphide containing 3 Gm. of sulphur in solution with an equal volume of amyl alcohol. Mix equal volumes of this reagent and the fat under examination and heat in a bath of boiling calcium chloride brine from one to two hours. In the presence of as little as 1 per cent of cottonseed oil a characteristic red or orange-red color is produced.

Fat from animals which have been fed on cottonseed products will give a positive reaction with this test. Presence of a vegetable oil must then be proved by the finding of (1) phytosterol before it can be proved that cottonseed oil is present.

(1) *Phytosterol Acetate Test.*—(a) Follow method given in Circular 212, Bureau of Animal Industry. (b) Digitonin method.

Fifty Gm. of the fat oil or fat to be tested are shaken vigorously for fifteen minutes in a separatory funnel with 20 cc. of a 1 per cent solution of digitonin in 95 per cent alcohol. The mixture is allowed to stand for a time until the emulsion separates. The lower or fat layer should be quite clear, while the alcohol layer is full of a bulky, flocculent precipitate. The fat is drawn off as much as possible, care being taken not to lose any of the precipitate. One hundred cc. of ether is then added to the alcohol layer and the mixture filtered. The

precipitate is next washed with ether until free from fat. After drying in the air it is transferred to a tall 50-cc. beaker. Two to 3 cc. of acetic anhydride are added that the beaker covered with a watch-glass. It is then boiled slowly over a low flame for half an hour. After cooling 30 to 35 cc. of 60 per cent alcohol are added and the contents of the beaker thoroughly mixed. The alcohol solution is then filtered off and the precipitate washed with 60 per cent alcohol. It is next dissolved on the filter with a stream of hot 80 per cent alcohol from a wash bottle and the filtrate set away in a cool place (10° C. or below). After the acetates have crystallized out of this solution they are filtered off, recrystallized from absolute alcohol, dried and the melting-point determined. The melting-point is determined as directed in Bureau of Animal Industry, Circular 212.

If the final acetate crystals melt below 115° C. no phytosterol is present. If the melting-point is above 115.5° C. the presence of phytosterol may be regarded as proven. The finding of phytosterol is positive proof of the presence of a vegetable fat.

As the phytosterol acetate from cottonseed oil melts at 124° C., and the acetate of corn oil and soy bean oil at 131° to 132° C., adulteration of cottonseed oil with the two last named oils may be detected by this method.

Tests for Rancidity in Fats.—*Reagents.*—A 0.1 per cent solution of phloroglucin in U. S. P. ether. HCl, specific gravity, 1.19. Liquid petrolatum U. S. P.

Pour 10 cc. of the melted fat into a large 8 by 1 inch test-tube. Add 10 cc. of HCl; then close with a rubber stopper and shake vigorously for fifteen seconds. Add 10 cc. of the phloroglucin reagent, replace the stopper and shake again for fifteen seconds. A red color in the acid layer after it has settled out indicates rancidity. An orange or yellow tint should be regarded as negative. If a positive reaction is obtained make two mixtures of the fat with liquid petrolatum, one containing 1 part of fat in 10 parts of the mixture, the other containing 1 part of fat in 20 parts of the mixture. Test these mixtures in the same manner as before. By this method fats may be divided into four classes, as follows:

1. Fats giving no reaction.
2. Fats giving the reaction when undiluted but not when diluted 1 to 10.
3. Fats giving the reaction when undiluted in dilution 1 to 10, but not in dilution 1 to 20.
4. Fats giving the reaction in dilution 1 to 20.

Fats found to be in either of the first two classes should be regarded as fit for food unless, of course, there are adverse factors other than the test which render their fitness for food doubtful. Fats giving a reaction in the 1 to 20 dilution should be regarded as unfit for food. The class of fats giving a reaction in dilution 1 to 10 but not in dilution 1 to 20 should be left open for judgment in each particular case.

Detection and Determination of Nickel in Fats.—Ten grams of the fat to be tested are heated on the steam-bath with 10 cc. of hydrochloric acid

(specific gravity, 1.12), with frequent shaking for two to three hours. The fat is then removed by filtering through a wet filter paper, the filtrate being received in a white porcelain dish. The filtrate is evaporated to dryness on the steam-bath, 2 to 3 cc. of concentrated nitric acid being added, after it has been partly evaporated, to insure the destruction of all organic matter. After the evaporation is complete the residue is dissolved in a few cc. of distilled water and a few drops of a 1 per cent solution of dimethylglyoxime in alcohol added. A few drops of dilute ammonia are then added. The presence of nickel is shown by the appearance of the red colored nickel dimethylglyoxime. The amount of nickel present may be estimated by comparing the color developed with that developed in a standard solution of nickel salt. A larger sample of the fat may be taken if desired. If this is done the amount of hydrochloric acid used for extraction as well as the amount of nitric acid added to the filtrate should be correspondingly increased. Samples as large as 200 Gm. have been handled with satisfactory results.

TITER TEST OF FATS.

Apparatus.—The standard thermometer used must have a zero mark, 0.1° graduation between 10° and 60° C., and auxiliary reservoirs at the upper end and between the 0° and the 10° marks. The cavity in the capillary tube between the 0° and 10° marks must be at least 1 cm. below the 10° mark, which must be about 3 to 4 cm. above the bulb, the total length of the thermometer being about 38 cm. The bulb should be 3 cm. long and 6 mm. in diameter. The stem of the thermometer should be 6 mm. in diameter, made of the best thermometer tubing, with scale etched on the stem, the graduation to be clear cut and distinct. The thermometer should have been annealed for seventy-five hours at 450° C., and the bulb should be of Jena normal 16^{mm} glass, moderately thin, so that the thermometer will be quick-acting.

Method.—Heat 75 cc. of glycerol-potassium hydroxide solution (25 Gm. of potassium hydroxide in 100 cc. of high-test glycerol) to 150° C. in an 800-cc. beaker; then add 50 cc. of the oil or melted fat, previously filtered, if necessary, to remove foreign substances. Saponification often takes place almost immediately, but heating, with frequent stirring, should be continued for fifteen minutes, avoiding a temperature much above 150° C. When the saponification is complete, as indicated by the perfectly homogeneous solution, pour the soap into an 800-cc. casserole containing about 500 cc. of nearly boiling water, add carefully 50 cc. of 30 per cent sulphuric acid and heat the solution, with frequent stirring, until the layer of fatty acids separates out perfectly clear. Transfer the fatty acids to a tall separatory funnel, wash three to four times with boiling water to remove all mineral acids, draw the fatty acids off into a small beaker and allow to stand on a steam-bath until the water has settled out and the acids are clear. Filter into a dry beaker and heat to 150° C. on a thin asbestos plate, stirring continually with the thermometer.

When dried, cool the fatty acids to 15° to 20° C. above the expected

titer and transfer to the titer tube, 25 by 100 mm. (1 by 4 inches), and made of glass about 1 mm. in thickness. Place in a 16-ounce wide-mouthed bottle of clear glass, 70 by 150 mm. (2.8 by 6 inches), fitted with a perforated cork, so as to hold the tube rigidly when in position. Suspend the standard thermometer so that it can be used as a stirrer, and stir the mass slowly until the mercury remains stationary for thirty seconds. Then allow the thermometer to hang quietly, with the bulb in the center of the mass, and observe the rise of the mercury column. The highest point to which it rises is regarded as the titer of the fatty acids.

ANALYSIS OF GELATIN.

Determination of Arsenic.—Weigh out 10 Gm. of gelatin into a 150-cc. beaker. Add 50 cc. dilute hydrochloric acid and place on steam bath. As soon as gelatin is dissolved add 20 cc. bromine water (saturated). After digesting for one hour remove from the steam bath and cool. Make up to 100 cc., mix and filter. To 20 cc. of the filtered solution add 1 cc. potassium iodide solution (600 Gm. per liter) and 0.3 cc. stannous chloride solution (250 Gm. per liter). Heat on steam bath for five minutes, cool, and transfer to a previously prepared Gutzeit apparatus. Prepared this apparatus as follows: Add to the generator 3 Gm. 30-mesh, arsenic-free zinc and 20 cc. dilute hydrochloric acid (1 plus 3), connect and allow to run for five minutes. Place a small amount of loosely drawn lead acetate cotton, prepared by moistening the cotton with lead acetate solution and drying in the barrel before connecting the apparatus and a strip of mercuric bromide paper (prepared by wetting a sheet of hard surface drawing paper in an alcohol solution of mercuric bromide and drying) in the tube just before adding the solution. Add 0.8 cc. amyl alcohol, rinse out beaker with 3 to 5 cc. water, and add to the generator. The liberated gases pass through the lead acetate cotton and over the strip of mercuric bromide paper. Allow generator to run for one hour, or longer if necessary, protecting paper from strong light. Compare with standards prepared in the same manner from arsenic-free gelatin to which known amounts of arsenic have been added. Standards should show the action of from 1 to 7 micromilligrams (0.001 to 0.007 mg.) of arsenious acid (As_2O_3).

Determination of Ash.—Weigh out 20 to 40 Gm. of gelatin in a tared platinum or porcelain dish of approximately 150 cc. capacity and ash at a temperature of from 500° to 550° C. This is approximately the temperature at which the furnace presents a barely visible red when viewed through the small vent hole in the door. Samples will usually be satisfactorily ashed in from four to five hours, but no error is involved in allowing them to remain in the muffle for a longer period. It has been found convenient and economical of time to use an electric muffle furnace, placing the samples in the muffle, previously regulated so as to remain at the correct temperature, near the close of the day and allowing them to remain overnight. After ashing is complete, remove to a desiccator, cool and weigh.

Determination of Copper.—Moisten the ash with a small amount of water, add approximately 5 cc. concentrated hydrochloric acid, evapo-

rate to dryness, add 8 cc. dilute hydrochloric acid, heat to boiling, and transfer to a 50-cc. Erlenmeyer flask, using enough wash water to make the volume approximately 40 cc. Heat nearly to boiling, saturate with hydrogen sulphide, stopper tightly, and allow to stand in a warm place for one-half hour or more. Filter into a 150-cc. Erlenmeyer flask and wash promptly and thoroughly with warm 1 plus 20 hydrochloric acid saturated with hydrogen sulphide. Transfer paper and precipitate to a 50-cc. porcelain crucible and ignite in a muffle furnace at a temperature not exceeding that at which the gelatin was ashed. After ignition, cool, moisten ash with 1 to 2 cc. nitric acid, and evaporate to dryness on steam-bath. Take up copper salts with 1 to 2 cc. nitric acid, add approximately 5 cc. of water and warm on steam-bath to facilitate solution. Dilute to approximately 30 cc. and make alkaline with ammonia. Heat on steam-bath, away from any hydrogen sulphide fumes, until all ammonia is expelled, occasionally diluting with water to maintain approximately the original volume. Do not evaporate to dryness. Filter into a 50-cc. graduated flask, wash out crucible with warm water, make up to mark and mix. Measure out 25 cc. into a 50-cc. Nessler tube, add 5 cc. ammonium nitrate solution (100 Gm. per liter), and make up to 50 cc. Add 0.2 cc. potassium ferrocyanide solution (40 Gm. per liter) and mix. Match the color against tubes prepared in the same way from a standard copper solution, 1 cc. of which is equivalent to 0.1 mg. of copper. Make up standards containing 2, 3, 4, 5 and 6 cc. of standard solution equivalent to 20, 30, 40, 50 and 60 parts per million of copper if a 20 Gm. sample is used and one-half of solution taken. Solutions giving a stronger reaction than 6 cc. of the standard cannot be accurately compared. If a reaction stronger than that given by 6 cc. of the standard is obtained, an aliquot smaller than 25 cc. must be taken and the determination repeated.

Determination of Zinc.—Boil the filtrate and washings from the hydrogen sulphide precipitation of copper until all hydrogen sulphide is removed. Add 1 cc. concentrated nitric acid and continue the boiling until the volume is reduced to approximately 25 cc. Add 10 cc. ammonium chloride (200 Gm. per liter), make definitely alkaline with ammonium hydrate, heat nearly to boiling, and filter into a 100-cc. Erlenmeyer flask. Wash with warm, alkaline, ammonium chloride solution containing 50 Gm. ammonium chloride and 25 cc. ammonium hydrate (sp. gr. 0.9) per liter. Neutralize filtrate and washings with acetic acid, add 0.5 Gm. sodium acetate and sufficient glacial acetic acid to make an excess of 2 cc. for each 50 cc. of solution. Warm on steam-bath and saturate with hydrogen sulphide. Allow to stand in a warm place for approximately one-half hour. Filter through a small paper and wash thoroughly with warm 1 to 100 acetic acid saturated with hydrogen sulphide. If filtrate is turbid, return to flask, add a few drops of saturated mercuric chloride solution, shake, and filter again. Ignite in a tared platinum crucible at a dull red heat until completely ashed, then a few minutes at bright red heat. Weigh as ZnO. Weight of ZnO \times 40,000 equals parts per million of zinc if a 20 Gm. sample has been taken.



INDEX.

A

- ABBATOIRS, 390
law concerning, 390
performance of meat inspection in,
189-190
public, 390
in Rome, 381
- Abdominal cavity, lymph glands of, 49
- Abomasum, diffused lymphadenia of, 229
diphtheritic inflammation of, 229
- Abscess, 220
hypophrenic, 231, 320
metastatic, 318
- Accidents, emergency slaughter in, 33
- Acetic acid, conserving with, 84, 95
- Acidity of fat, degree of, 353
- Actinobacillosis of cattle, 296
- Actinomyces bovis, 296
necrophorus, 230, 339
- Actinomycosis, 296
- Adrenal glands, 62
- Advanced pregnancy, animals in, 211
- Agamonema capsularia, 368
- Age of slaughter of animals, 21, 207
- Agglutination test in meat poisoning, 373
of Schönberg, 373
- Air-sac mite, 362
- Albuminoids of muscles, 44
- Albumin, 39
- Albumina, 79, 354, 355
- Albumose in meat peptone, 96
- Aldehydes in fat, 353
- Allantiasis, 376
- Ambulatory antemortem and postmortem
inspection, 190
- Ammonia in putrefaction of meat, test for,
344
- Amphibians, examination of, 369
peculiarities of meat of, 71
- Amyloid degeneration, 219
- Anatomy of most important viscera, 64
- Anco Laabs pressure steam apparatus,
196, 203-305
- Anemia, 214, 238
- Angiomatosis of liver, 229
- Animals, transportation of, regulation on,
17
- Anoplocephala, 254
- Antemortem and postmortem inspection,
186, 192
ambulatory, 190
extraordinary, 190-191
fees for, 186-187
organization of, 162
performance of, 163
procedure of, 164
statistics of, 186
supervision of, 187

- Anthracosis of lungs, 236
- Anthrax, 300, 314
- Aphthous fever, 307
- Apiosoma bigeminum, 278
- Appert's conserving method, 84
- Aroma bacteria, 347
- Arsenic, test for, 448
- Artificial colors, test for, 443
- Ascariides, 253
- Ash, test for, 448
- Aspergillus, 346
- Atrophy, 217
brown, 221
- Autodigestion of meat, 341
- Auto-infection with measles, 267
- Auto-intoxications, 243
- Autolysis of muscles, 341
- Azoturia, 245

B

- BABESIA BOVIS, 278
- Bacillary erysipelas, 321
- Bacillus anthracis, 300
cellulæformis, 375
coli, 372, 375
gangrænæ emphysematosæ, 342
gastromycosis ovis, 324
nodulifacius bovis, 230
cedematis maligni, 318, 342
paraputrificus, 343
piscicidus agilis, 368
prodigiosus, 347
proteus as cause of meat poisonings,
374, 375
pseudotuberculosis ovis, 295
renalis bovis, 233
supestifer, 326
pestis, 325
tetanus, 312
tuberculosis, 281
- Bacon, definition of, 45
- Bacterial content of chopped meat, 77,
345
- Bacteriemia, 315
- Bacteriological meat inspection, 167-169
- Bacterium, cause of sepsis, 314-315
coli lymphaticum aérogenes, 231
pestis astaci, 369
- Barbel cholera, 367
- Balbaniidae, 278
- Beef, detection of, in pork products, 443
differentiated from horse meat, 75-76
measles, 268
peculiarities of meat, 68
sides showing marked cuts, 36
- Benzoic acid, test for, 440, 441
- Bile, utilization of, 41
- Billy-goats, odor of meat of, 210

- Binding quality of meat, 78
 substances in sausage, 78
 Biological method for distinguishing various kinds of meats, 71
 Blackleg, 333
 parturient, 334
 Bladder worm, 258, 266
 Blastomycosis of muscles, 225
 Bleeding, 30
 incomplete, 213
 thorough, indications of, 30
 Blood, 39, 48
 aspiration of, 236
 chemical composition of, 48
 diseases of, 238
 poisoning, ichorous, 314, 316
 purulent, 314-315
 pudding, 420-421
 quantity of, in slaughtered animals, 30-31
 sausage, 79, 420-421
 watery conditions of, 239
 Bloodvessels, 48
 Bloody urine, enzoötic, 280
 Blow fly, 348
 Blue coloration of meat, 346-347
 of udder, 352
 Boars, odor of meat of, 210
 Boat, transportation of food animals by, 17
 Body lymph glands, 48-49, 57
 Boiler house, 396
 Boiling of meat, 81, 84-85, 196
 test, 169
 Bolt apparatuses, 26-29
 hammer, 28, 29
 pistol, 27, 28
 Bone, 47
 as offal, 40
 marrow, 47
 of calf, 68
 of cattle, 68
 of goat, 69
 of hog, 69
 of sheep, 69
 tissue, diseases of, 227
 Boöphilus species, 278
 Boracic acid, conserving with, 94
 test for, 358, 438
 Bothriocephalus latus, 264
 liguloides, 264
 Botryomycosis, 299
 Botulism, 376
 Bradsot, 334
 Brain, parasites of, 259
 Branding stamp, 19, 194, 195
 Breaking down processes in connective tissue, 226
 Brine, 92
 Bromatological fauna, 19
 Bronchopneumonia of calves, 332
 Brucellosis of swine, 228
 Brucin reaction (test for saltpeter), 357
 Buffalo meat distinguished from beef, 76
 Bulging of cans, 356
 Bull, characteristics of meat of, 68
 Bull, meat, odor of, 210
 Bullet-shooting apparatus, 27
 Burning of small parts of carcasses, 201
 Burying of meat, 201
 Butt, 38
 Butterine, 97, 434
 Buying of food animals, 11, 12
- C**
- CADAVER, bacilli, 302
 Calcareo-fibrous nodules in liver, 230
 in lungs, 235, 306
 Calcification, 220
 presteral, 227-228
 Calf, age and maturity, 22, 23
 definition of, 10
 diarrhea, 339
 diphtheria, 338
 dysentery, 339
 fever, 245
 meat, inflation of, 33
 necrotic stomatitis, 338-339
 peculiarities of, 68
 pyemic polyarthritis, 319
 ruffles of, 39
 septic polyarthritis, 317
 Canned meat, 84-87
 inspection of, 356-357
 poisonous, 378
 Carbolic odor of meat, 352
 Carceag of sheep (parasitic icterohematuria), 280
 Carcinomatosis, 222
 Carne pura, 84
 Carnifices, 381
 Caro porosa, 359
 Cartilage, 48
 diseases of, 228
 Caseation, 219
 Caseous lymphadenitis, 116, 295
 Casings, 177
 Cat, distinguishing of meat from rabbit, 73
 Catarrhal fever of cattle, malignant, 338
 Cattle plague, 335, 337
 Caul fat, 41
 Central nervous system, diseases of, 237
 Cereal, addition of, to sausage, 78, 415
 Cerebral bladder-worm cyst, 259
 Cerebrospinal meningitis of horses, 237
 Chalicosis nodosa of liver, 230
 nodularis of lungs, 235
 Chargue dulce, 84
 Cheiracanthus hispidus, 254
 Chemical analysis of meat-food products, 436
 conserving methods, 92
 destruction of meat, 201
 Chemistry of tissues and organs, 42-44
 Chicken, arthritis, 363
 cholera, 362
 diphtheria, 363
 favus, 361
 meat, appearance of, 224

- Chicken, pest, 362
 pox, 363
 tuberculosis, 363
 Chlorine odor of meat, 352
 Cholemia, 243
 Cholera, dissemination of, by meat,
 347
 hog, 327
 of fowls, 362
 Chopped meat, 77
 bacterial content of, 77
 examination of, 354-355
 poisoning, 376
 Circulatory apparatus, 236
 disturbances, 236
 Cirrhosis of liver, 230
 Clams, poisonous, 369
 Classification of food animals for market
 quotations, 14, 15
 Clostridium botulinum, 346, 377
 gastromycosis, 334
 putrificum, 342
 Cloudy swelling, 217, 224
 Cnemidocoptes mutans, 361
 Coal-tar colors, test for, 444
 Coccidia of intestinal mucosa, 257
 of skin, 250
 Coccidium fuscum, 250, 257
 oviforme, 257
 Cœnurus cerebralis, 259
 Cold, preserving meat by, 87
 slaughter, 34, 214
 storage geese, 364
 Coli bacilli as producers of sepsis, 315
 in pyemia, 320
 Color changes of udder in boiling, 352
 Coloring of meat, 79
 substances, test for, 442, 444
 Colpitis follicularis infectiosa, 234
 Comb scab in fowl, 361
 Comparative anatomy of viscera, 64
 Composition of meats and meat-food
 products, 45-47
 Compression machine, 89
 Compressor for trichina inspection, 180
 Compulsory slaughter in public abattoirs,
 390
 Concrements, 220
 lime, 225
 Condemnations, 195
 Condemned meats, 200
 disposal of, 201
 room for, 170-171
 truck for, 200
 utilizing plants for, 396
 Conditionally passed meat, 196
 confiscated, utilizing plants
 for, 396
 Connective tissue, 44
 diseases of, 225
 mite, 361
 Conserves, examination of, 359
 preparations of, 83
 Conserving by closing out of air, 84
 of meat, 77, 83, 85
 methods of, 83
 Contagious pleuropneumonia of cattle,
 331
 Cooking of meat, 81, 84, 196
 Cooling rooms, 89, 395
 Copper test for, 448-449
 Corned beef, 86
 Corynebacterium pseudotuberculosis, 295
 Cottonseed oil, adulteration of fat with,
 97
 test for, 360, 445
 Cow, age of, 23
 definition of, 10
 peculiarities of meat of, 68
 pox, 311
 udder of, blue coloration of, 352
 Crabs, diseases of, 369
 examination of, 369
 fraudulent substitution for, 369
 Cracklings, 97
 Crustaceans, examination of, 369
 peculiarities of meat of, 71
 Cryptorchid boars, sexual odor of, 210
 Culinary preparation of meat, 80-81
 Curing beef, 410
 dry beef, 412
 salt meat, 407
 electric, 409
 methods, 181
 for trichina, 181
 pork, 402
 tenderized hams, 408
 Cutting of throat for bleeding, 29, 30
 Cystic formation of heart valves, 237
 kidney, 233
 Cysticerci as cause of lime concrements,
 225
 of peritonitis, 231
 Cysticercus cellulosa, 264, 265
 inermis s. bovis, 268
 pisiformis, 259, 367
 tenuicollis, 258, 266
 Cystoleichus nudus, 362

D

- DAVAINEA echinobothrida, 362
 Dead animals, 213
 -born animals, 207
 Decomposition of meat, 354, 355
 Deer, age of, 364-365
 distinguishing meat of, from beef, 76
 from sheep and goat, 72-73
 sex of, 365
 Degenerations, 218-219
 of muscles, 224
 Demodex scabies, 248
 Diamond skin disease, 324
 Diarrhea of calves, 339
 Differentiating signs of various meats, 71
 Diffuse lymphadenia of mucous mem-
 brane of abomasum, 229
 Digestibility of meat, 80
 Digestive apparatus, diseases of, 228
 lymph glands, 49
 parasites of, 251

- Digestive apparatus, weight of, 12
 Diphtheritic inflammation of abomasum, 229
 of calves, 338
 of fowls, 363
 Dipylidium caninum, 254
 Diseased meat, influence of cooking on, 81
 of pickling on, 94
 of smoking on, 95-96
 Diseases of blood, 238
 constitutional, 238
 Disinfection plant for railroad care, 400
 Disposal of condemned meat, 195, 200
 Distemper of horses, 340
 Distillation, dry, for destruction of meat, 201
 Distomatosis, 256
 Dog, distinguishing meat from pork, 73
 as food animal, 10
 peculiarities of meat of, 69
 Dourine, 280
 Dressed weight, 12
 Dressing of carcasses, 31
 Dry distillation for disposal of meat, 201
 rendering, 202-203
 Drying of meat, 84
 Duck, age of, determination of, 361
 Dysentery, hemorrhagic, of cattle, 257
 of calves, 339
- E**
- EAR tags, 19, 20
 Echinococci, 261
 Echinorhynchus gigas, 254
 Edema, malignant, 313
 Eel blood, poisonous qualities of, 367
 Egg concretions, 364
 Eimeria perforans, 257
 stiedæ, 257
 zurni, 257
 Elastic tissues, 44
 Emaciated animals, 208
 Emaciation, 208
 Embolism, 215-216
 Emergency slaughter, 33
 inspection in, 173
 meat poisoning from, 371
 Emmerich's slaughtering methods, 84
 Emphysema mesenteric, 231
 of connective tissue, 226
 Empyema, 220
 Encephalomyelitis, 237
 Endocarditis, 237
 valvularis verrucosa, 322
 Endocrine glands, 61
 Engine houses, 396
 Enteritidis bacilli as producers of sepsis, 315
 in pyemia, 320
 Enteritis, hemorrhagic, 317
 mycotic, of cattle, 338
 septic, 317
 Enzoötic hemoglobinuria, 280
 Enzymes of muscles, 44
 Epithelioma contagiosum, 361
 Epizoötic hemoglobinuria, 280
 Eruptions of teeth, 22
 Erysipelas of hogs, 321, 329
 wound, 324
 Erythema, 324
 Escherichia coli, 374-375
 Examination of inspectors, 162-163
 Exhausted animals, 213
 Extractive bodies in muscles, 113
 Extraordinary meat inspection, 190-191
- F**
- FALLOW deer, 365
 Farcy, 305
 Fasciola hepatica, 255
 Fasting calf, 207
 Fat, 35, 96
 abnormal coloration of, 212
 analysis, 443
 chemical constituents of, 47
 color of, 45
 nickel in, test for, 446-447
 prepared, 96-97
 rancidity in, test for, 446
 rendering, 199
 stones, 226
 test for, 360, 447
 tissue, 45, 226
 diseases of, 226-227
 structure and consistence of, 45
 titer test for, 447
 Fattened calves, 68
 steers, 68
 Fatty acids, 353
 degeneration, 218
 infiltration, 217-218
 necrosis of pancreas, 230
 Fauna, bromatological, 9
 Fees for inspection, 186
 Fermentation in meat, 341
 Ferments of musculature, 43
 Fetal meat, 207
 Filaria piscium, 368
 Fish, diseases of, 368
 examination of, 360
 measles, 368
 meat, characteristics of, 70
 deceptions with, 368
 poisonous, 367
 ripening process in, 81
 poisonings, 367
 pox, 368
 roe, poisonous, 367
 Flat worms, 254
 Flour, addition of, to sausage, 127, 354, 417
 mite, 351
 Flukes, 255
 Fluorides, 439
 qualitative estimation of, 439
 Food animals, 9
 abnormal conditions and diseases of, 207
 age of, 21-23

- Food animals, anatomy of viscera, 64
 classification of, for market quotations, 14
 dressing of, 31
 guarantee for, 20
 importation of, 17, 18
 insurance of, 18, 19
 slaughtering of, 23
 traffic in, 11
 transportation of, 15
 utilization of, 34, 35
 aspiration of, 236
 poisoning, 370
 preparations derived from animals, 96
- Foot and mouth disease, 307
 rot in sheep, 310
- Forest disease, 280
- Formaldehyde, test for, 358, 441
- Fowl, age of, 361
 arthritis, 363
 pest, 362
 tuberculosis, 363
- Fraudulent substitutions of meat, 71
- Freezing, conserving meat by, 92
 quick, 92
- Freibank, 187
- Fringed tapeworm, 254
- Frog, 369
- Frontal blow, 26
- Frozen meat, inspection of, 357
- G**
- GAD boils, 248
 fly, 247
 of sheep, 250
- Game, age of, determination of, 364-365
 and cattle plague, 337
 diseases of, 366
 peculiarities of meat of, 70
 postmortem changes of, 367
- Gangrene, 219
- Gastro-intestinal canal, weight of, 13
- Gastrophilus intestinalis, 251
- Gastros larvæ, 251
- Gauls, meat food of, 381
- Gelatin, analysis of, 448
 determination of arsenic in, 448
 of ash, 448
 of copper, 448-449
 of zinc in, 449
- Genito-urinary apparatus, diseases of, 231
 lymph glands of, 56
- Germans, meat food of, 381
- Gid of sheep, 259
- Glanders, 304
 nodules of, in lungs, 235, 306
- Glassy degeneration, 224
- Glycogen in muscles, 75-76
- Glucose, 76
- Gnathostoma hispidium, 254
- Goat, distinguishing meat of, from deer, 72-73
 from mutton, 72
- Goat as food animal, 10
 peculiarities of meat of, 69
- Goldbeater skins, 39
- Goose, age of, determination of, 361
 meat from cold storage, 364
- Graafian follicles, 64
- Granular atrophy of liver, 230
 degeneration, 224
 eruptions of hogs, 237
- Granulomata, 222
- Grape fungus disease, 299
- Grass-fed cattle, 212
- Green discoloration of fat, 227
- Ground meat, 77
 bacterial content of, 77
 examination of, 254-255
 poisonings by, 376
- Gruel kitchens, 400
- Guarantee in trading with food animals, 20
- Gutting, 31
- H**
- HADDOCK, conserving of, 84
- Halisteresis ossium, 241
- Halphen reaction, 445
- Ham, souring of, 342
- Hanging arrangement in abattoirs, 394
- Hare, age of, determination of, 364
 distinguishing of meat from cat meat, 73
- Haut-gout, 341
- Heart, 66
 weight of, in cattle, 67
- Heat conduction of meat, 82
 stroke, 324
- Heated products, 184
- Heathcock, determining age of, 365
- Hemangioma of liver, 229
- Hematoidin, 215
- Hæmatopines, 250
- Hemoglobin in hemorrhages, 215
- Hemoglobinemia of cattle, 224, 280
 of horses, 245
- Hemoglobinuria of cattle, 280
 of horses, 245
- Hemophylus pyogenes, 326
- Hemorrhages, 215
 multiple, of muscle, 223
 of lungs, 235
 time of occurrence of, 215
- Hemorrhagic septicemia, 337
- Hemorrhodin, 93
- Hemosiderin, 215
- Hemosporidiosis, 278
- Henneguya zschokkei, 368
- Hepatitis, chronic interstitial, 229
- Hide houses, 395
 salting establishment, 395
- History of meat hygiene, 380
 in Canada, 388
 in United States, 383
- Hodgkin's disease, 240
- Hog bristles, utilization of, 40
 as food animal, 10

Hog cholera, 327
 dehairing, new method, 32-33
 distinguishing meat from dog meat, 73
 emergency slaughter of, 34
 influence of feeding on meat of, 69
 peculiarities of meat of, 69
 Hoofs and claws of offal, 41
 Hook-frames in abattoirs for small stock, 394
 Horns, development of, determining age by, 23
 rings of, in cows, 23
 Horse abattoir, 394
 as food animal, 10
 distinguishing from beef, 75-76
 salted intestines of, from cattle intestines, 178
 malaria, 280
 mange, 248
 meat act, 160-161
 test for, 75-76
 peculiarities of meat of, 69
 House fly, 348
 Hyaline degeneration, 224
 Hydremia, 215, 239
 Hydrometra, 234
 Hydronephrosis, 233
 Hygrometer, 91
 Hyperemia, 214
 Hyperplasia, 221
 Hypertrophy, 221
 Hypoderma larvæ, 247
 Hypophrenic abscesses, 231
 Hyposarca, 215
 Hypostasis, 214

I

ICE-BOX, 87
 houses, 87
 production, artificial, 88, 90
 Ichthyotoxicon, 367
 Ichthyotoxismus, 377
 Icterus, 243
 Imbibition, hemorrhagic, 214, 226
 Immature animals, 207
 Importation of food animals and meat, 17-18, 205-206
 Incising of lymph glands, 165, 167
 Incompletely bled animals, 213
 Indigestions of food animals, influence of, on weight, 14
 Induration, 217
 Infarct, hemorrhagic, 215-216
 in spleen, 237
 Infectious diseases, 281
 growths, 223
 vaginal catarrh of cattle, 234
 Inferior quality meat, 200
 Infiltration of tissues, 217
 Inflammations, 216
 Inflammatory disease of head in cattle, 338
 processes of connective tissue, 226
 Inflation of carcasses, 33, 226

Influences of feeding on food animals, 211
 Influenza of horses, 340
 swine, 331
 Injection pickling, 92
 Ink stamps, 193, 198
 Insect larvæ on meat, 348
 Inspection of imported meat, 177, 205-206
 office, 396
 of slaughtered animals, 165, 192
 disposal of, as result of, 192
 reports, 186
 Inspector's assistant, 163
 Insurance of food animals, 18-19
 Intestinal emphysema, 231
 Intestines, 65
 multiple hemorrhages of, 229
 Intoxication in food animals, 243
 putrid, 321
 Invasion, diseases of, 247
 Iridescence of muscles, 224
 of pickled meat, 357
 Ischemia, 214
 Ixidioplasma bigeminum, 278
 Ixodes reduvius, 278

J

JAUNDICE, 243
 malignant, of dogs, 280
 Jelly sausage, 80
 Jerked beef, 84
 Jewish meat laws, 380
 John's disease, 293

K

KETONES in fat, 353
 Kettle-rendered lard, 427
 Kidneys, 66
 weight of, in cattle, 67
 Killing methods, 26
 houses, 394
 Knocking hammer, 28

L

LAABS, Anco, pressure steam apparatus, 196, 203, 205
 Laboratory inspectors, 162
 Laminosioptes cysticola, 361
 Land flavor, 367
 Lard, 97, 422
 artificial, 97
 beef fat in, test for, 444
 compound, 433
 examination of, 360
 manufacture of, 425
 oil, 432
 stearin, 432
 Large stock, dressing of, 31
 as food animals, 9
 "Leaker" (defective can), 86

- Legal means of redress in meat inspection, 185-186
- Leg-scab of fowl, 361
- Leucorrhœa, 234
- Leukemia, 239
- Lice, 250
- Lime concrements from *Cysticercus tenuicollis*, 258
in muscles, 225
- Lipoma, 226
- Live weight of food animals, 13
- Liver, 65
fluke, 255
migration of, 255
mottled, 230
necrosis of, multiple, 230
telangiectasis of, 229
weight of, in cattle, 67
- Livid areas, 214
- Lobster conserves, 369
examination of, 369
- Lophophyton gallinæ, 361
- Loin back, 38
- Long clear, 38
- Losses in meat in preparation for food, 83
- Lumbago of horses, 245
- Lungs, 66
diseases of, 235
nodules in, calcareo-fibrous, 235, 307
parasites of, 250
weight of, in cattle, 67
- Lymph glands, 48
incising of, 165, 167
regional, 60
visceral, 49
nodes, incising of, 167
size, numbers and location of, 48
vessels, 48
- Lymphadenia, diffused, of abomasum, 229
- Lymphadenitis, caseous, 116
- Lyssa, 303
- M**
- MACHINES, refrigeration, 89
- Macular hemorrhagic dermatitis in hogs, 324
- Maggots on meat, 348
- Mal de caderas, 280
- Malaria of cattle, 280
of horses, 280
- Malformations, 222-223
- Malignant catarrhal fever of cattle, 338
edema, 313, 333
- Malleus, 304
- Mammæ, 67
- Management of abattoirs, 396
of stockyards, 400
- Manure houses (dung yards), 395, 400
- Margaropus species, 278
- Margarin, 434
law, 97
- Market halls in stockyards, 399
quotations for food animals, 14
- Marking of inspected meat, 194
foreign, 205-206
- Marking of inspected meat of insured animals, 19
- Mastitis, 234
septic, 234, 317
- Maturity of calves for slaughter, 21, 22
- Measles, 264
auto-infection with, 267
in fish, 368
in game, 266, 367
in sheep, 271
relation for judgment of, 264-271
- Meat, benzoates in, test for, 440, 441
changes in, postmortem, 341
coloring matter in, test for, 442
conserving of, 83
constituents of, 42
of crustaceans and mollusks, 71
cuts, 37
decomposition of, 345
disposal of condemned, 195-196
distinguishing various kinds of, 71
extracts, 47, 96
examination of, 360
fetal, 207
of fish, 70
flies, 348
flour, American, 96
preparation of, 84
of food animals, 9, 35, 67
foods, chemical analysis of, 436
composition of, 42
obtaining of, 9
packing for curing, 410
for shipment, 410
poisoning with, 370
products, preparation and control, 401
formaldehyde in, test for, 441
fraudulent substitutions of, 71
of game, 70
inspection supervision, 187
ambulatory, 190
designation of animals in, 9
extraordinary, 190-191
history of, 380
law, 154
performance of, 163, 189
regulations for, 99-161
statistics of, 186
inspectors (practical), 163
kosher, 33
market cuts of, 35, 38-39
markings of, 194-195
nitrites in, 438
passed conditionally, 196
paste, 80
peculiarities of, 67
poisonings, 370
from *Bacillus botulinus*, 377
Clostridium botulinum, 378
Escherichia, 374
enteritidis, 370
postmortem changes in, 341
of poultry, 70
preparation of, 77
production of, 77

- Meat, prohibition from importing, 18
 of reptiles, etc., 71
 ripening of, 43
 salicylates in, test for, 440
 sausage, 78-79
 starch in, test for, 442
 technic of inspection of, 165
 turning gray in cooking, 81
- Melanosis, 221
- Meningitis, cerebrospinal, 237
- Mesenteric emphysema, 231
- Mess pork, 38
- Metallic poisons in meat, 352
- Metaplasia, 221
- Method of procedure in meat inspection, 169
- Metritis, septic, 317
- Microorganisms, action of pickling on, 94
 of smoking on, 95-96
- Microphytic changes of meat, 346
- Miescher's sacs, 276, 277
- Milk fever, 245
 nodes, 234
- Mohammedan food laws, 380
- Moles, pigmented, 237
- Mollusks, meat of, peculiarities, 71
- Moniezia, 254
- Morbus maculosus, 317
 nodulosus of fish, 368
- Morphology of tissues and organs, 42
- Mould formation on meat, 346
- Mucin metamorphosis, 218
- Mucoid degeneration, 218
- Mucor, 346
- Multiple fat necrosis, 227
 hemorrhages of muscles, 223
- Muca domestica, 348
- Muscle, actinomycosis of, 224
 coloring matter, retaining of, 76
 degeneration of, 224
 distomes in fish, 368
 lymph glands of, 48, 57
 samples for trichina examination, 181
 turning gray in cooking, 81
 in pickling, 93
- Muscular hemorrhages, 223
- Musculature, 42
- Mussel poisoning, 369
- Mutton, peculiarities of meat of, 69
- Muzzle prepared as food, 40
- Mycosis astacina, 369
- Mytilotoxismus, 369, 377
- Myxobolus, 368
- Myxosporidias, 368
- N**
- NAGANA of cattle, 280
- Navel, infection of, pyemic, 319
 septic, 317
- Neats' foot oil, 41, 429
- Neck stretcher for Schachten, 30
- Necrophorus bacilli, cause of calf diphtheria, 339
 in liver, 230
- Necrotic stomatitis of calves, 338-339
- Necrosis, 219
 of fat, 227
- Negri bodies, 304
- Nephritis, 231, 232
- Nervous system, diseases of, 237
- Nettle fever, 324
- Neuroma of intercostal nerves, 236
- Neutral lard, 428
- Nickel, detection of, in fat, 446-447
- Nitrate of potassium, test for, 437
 quantitative, 437
- Nitric oxyhemochromogen, 81
- Nitrites, estimation of, 437
 in meat, 438
 reagent, preparation of, 437
 solution, preparation of, 438
- Nodular disease of fish, 368
- Nutritive value of meat, 83
- O**
- OBLIGATIONS, conditions of, 20
- Ochronosis, 221
- Odor of meat, 68
 abnormal, 210
 absorption, 211, 352
 examination of, 169
- Oestrus larvæ, 247, 250
 ovis, 250
- Offal, 40-41
- Oidium astaci, 369
- Oil, conserving with, 87
 sardines, 87
- Olein, 97
- Oleo oil, preparation of, 97, 430
 stearin, 430
- Oleomargarin, 97, 434
- Oligemia, 238
- Omphalophlebitis, septic, 317
- Opisthorchis felineus, 368
- Organs, diseases of, 223
 lymph glands of, 48
 parasites of, 247
 used for preparation of therapeutic remedies, 39-40
- Osteomalacia, 241
- Osteomyelitis, hemorrhagic, 319
 purulent, 319
- Osteopsathyrosis, 241
- Ovaries, comparative anatomy of, 67
 poisonous, from fish, 367
 utilization of, 39-40
- Overhauling of meat, 404
- Overheated meat, 341
- Oversticking, 30
- Oxyuris, 253
- Oysters, diseases of, 369
- P**
- PALISADE WORMS, 253
- Palpating animals in trading, 11
- Pancreas, 64, 65

- Pancreas, necrosis of, 230
 Pancreatic peptone, 96
 Paprika bacon, 84
 Paramphistomum cervi, 257
 Paratuberculosis, 293
 Parasites of brain, 259
 of digestive apparatus, 251
 of lungs, 250
 of pleura and peritoneum, 257-258
 of skin, 247
 Parasitic diseases of organs, 247
 infestations, 250, 251
 Parathyroid glands, 62
 Paratuberculosis, 293
 Paratyphoid meat poisonings, 370
 Parenchymatous degeneration, 217
 Parturient paresis, 245
 symptomatic anthrax, 313, 347
 Parturition fever, 245
 Pasteurella avicida, 362
 bovisepctica, 337
 suisepctica, 325
 tularensis, 366
 Pasture stock, 9
 Paunch truck, for condemned meat, 200
 Pearly disease, 285
 virulence of meat of, 289
 Pelvic cavity, lymph glands of, 49
 Penetration of meat by high temperature, 82
 Penicillium, 346
 Pentastomes, 250
 Pentastomum denticulatum, 260
 tænoides, 250
 Pepsin peptone, 96
 Peptic ulcers, 228-229
 Peptones, 96
 Pericarditis, 236, 317, 320
 traumatic, 320
 Peritoneum, diseases of, 231
 parasites of, 257
 Peritonitis, 231, 258, 317
 Pernicious anemia, 238
 Petechiæ of pleura, 236
 Petechial fever, 317
 Pfeifferella mallei, 304
 Pheasant, age of, 365
 Phlebotaxis, 237
 Phosphorescence of meat, 346
 Phytosterol acetate test, 445
 Pickle, special formula for, 406
 Pickled meat, examination of, 357
 Pickling fluid, concentration, 93, 199, 405
 of meat, 92, 199
 Picnic ham, 38
 Pigeon, age of, determination of, 361
 Pigment formation, 220-221
 Pigmentation, black, of fat, 226-227
 of pleura, 236
 Pigmented moles, 237
 Pineal body, 62
 Piophila casei, 348
 Piroplasmosis, 278
 Pitch mangle, 237
 Pithing, 29
 Pituitary gland, 63
 Placenta, retained, 321
 Pleuritis, 235, 236
 septic, 317
 Pleuropneumonia, contagious, 331
 Pneumonia, caseous, 319
 Pneumotosis of mesentery, 231
 Poisoning, 241-242
 Poisonous fish, 367
 Poisons in meat, analysis for, 437
 in fat, analysis for, 447
 Pollution of lungs, 236
 Polyarthritis, pyemic, 319
 septic, 317
 Polymyositis, 223
 Pork, 69
 curing, 402
 measles, 265
 peculiarities of, 69
 products, detection of beef in, 443
 Porschen of kosher meat, 33
 Postmortem changes of meat, 341
 hypostasis, 214
 spots, 214
 Potassium nitrate solution, 437
 Poultry, age of, determination of, 361
 diseases of, 361
 meat of, characteristics of, 70
 influences of feeding on, 211
 postmortem changes of meat, 341
 Pox, 311
 of chicken, 363
 of fish, 368
 Precipitation method for distinguishing meat, 71
 Pregnancy in animals, claims on seller, 212
 Premier jus, 97
 Preparation of meats, 77
 sausages, 413
 Prepared meat, examination of, 354
 Preservative salts, 92
 Pressure steam apparatus for disposal of meat, 196-197, 201
 Price method, estimation of starch by, 442
 Pricking stamp, 19, 21
 Private slaughter houses, 390
 Procedure of inspection, 169
 Production of meat, 77
 Projection trichina microscopes, 180, 181
 Proteus radians, 375
 vulgaris, 375
 in meat poisoning, 375
 Protozoa of digestive apparatus, 257
 general affections due to, 276
 Pseudoanthrax bacilli, 302
 Pseudoaphtha, 309
 Pseudoleukemia, 240
 Pseudomonas phosphorescens, 346
 sycyanea, 347
 Pseudotrachina, 275
 Pseudotuberculosis, 295
 Psorospermial bodies, 278
 Pudding, blood, 421
 Purpura hemorrhagica, 317
 Pus, contamination of meat with, 321
 forming organisms, 220
 Putrefaction bacteria in sapremia, 220

- Putrefaction of meat, 342
 test for, 345
- Putrid intoxication, 320
- Pyelonephritis, 232, 233
- Pyemia, 220, 318
 cause of meat poisoning, 371
- Pyobacillosis, 319, 326
- Pyonephrosis, 233
- Pyorrhoea, 220
- Q**
- QUALITY classes of food animals, 11, 14
- Quantity of blood in animals, 30-31
- Quarantine abattoirs, 394
 yards, 400
- Quick freezing, 92
- R**
- RABBIT, age of, determination of, 364
 distinguishing the meat of, from cat
 meat, 73
 as food animal, 10
 measles, 367
 meat of, peculiarities of, 69
 production of, 10-11
- Rabies, 303
- Rachitis, 240
- Railroad platforms, 399
 sickness, 17
 transportation of food animals, 16-17
- Rainey's bodies, 276
- Ram, odor of meat of, 210
- Rancidity of fats, 352
 tests for, 446
- Ray fungus disease, 296
- Reaction of musculature, 43
 test for, 167
- Red diarrhea of cattle, 257
- Reddening of meat, 79, 81, 346
- Reductive properties of musculature, 44
- Refrigerating railroad car, 88
- Refrigeration method, 184
 plant machines, 89-91
- Regional lymph glands, 60
- Regulations for meat inspection, 99
- Reindeer as meat, 9
 pest, 334
- Reinspection of meat, 178
- Rendering, dry, 202-205
- Rennet fermenti, 39
- Replacement of teeth, 22, 24, 25
- Reptiles, peculiarities of meat of, 71
- Respiratory apparatus, diseases of, 235
 lymph glands of, 53
- Rest for transported animals, 15, 17
- Retained placenta, 321
- Retaining room, 170
- Rigor mortis, 43
 ferment, 43
- Rinderpest, 335, 338
- Ripening of meat, 43, 81, 134
- Roasting of meat, 82
- Roe, poisonous qualities of, 367
- Romans, meat foods of, 380, 381
- Rotation of spleen, 237
- Rotting of meat, 342
- Rough rib, 38
- Round worms of digestive apparatus, 252
- Rumen, traumatic inflammation of, 228
- S**
- SACCHARIN, test for, 440
- Salicylates, 440
- Salicylic acid, 440
 test for, 358, 440
- Salmonella enteritidis, 343, 370
 cause of meat poisoning, 372
 suipestifer, 327
- Salt, conserving of meat with, 92
 estimation of, 436
 test for, 357
- Saltpeter, test for, 357
- Sample taking for trichina inspection, 179
- Sanitary establishment, 394, 395
 slaughter house, 394, 395
- Sapremia, 315, 320
- Saprophytes, 320
- Sarcocystis miesheriana, 276
- Sarcomatosis, 222
- Sarcophage carnaria, 348, 349
- Sarcoptic mange, 249
- Sarcosporidiosis, 276
- Sausage, 77
 blood, 79, 420
 casings, coloring of, 79
 classification of, 414
 dirt in, 355
 dry, 419
 examination of, 354-355
 fat, 97
 filling, 78, 423
 fresh water in, 443
 jelly, 80, 422
 making, 412
 fresh, 412-418
 poisonings from, 316
 summer, 419
 turning gray of, 79, 355
 white, 79, 421
- Scabies mites, 248
- Scalding of slaughtered hogs, 31
 vat, 395
- Scaly leg of fowl, 361
- Scarlet fever, dissemination by meat, 347
- Schachten of food animals, 29
- Schönberg agglutination test, 373-374
- Schweinsberger disease, 230
- Sclerotic condition of fat tissue, 226
- Scrapie, 423
- Sea eel, 367
 salmon, 368
- Semetic food laws, 28, 29, 30, 33, 380
- Sepsis, 314-315
 cause of meat poisonings, 371
- Septicemia, 314
 hæmorrhagica, 337
- Septico-pyemia, 315
- Serratia marcescens, 347

- Serum diagnosis for distinguishing meat, 71
- Sex, determination of, 174
- Sexual organs as offal, 41
peculiarities of meat, 210
- Shaking disease of sheep, 250
- Sheep, distinguishing of meat of, from
deer, 72-73
from goat, 72
as food animals, 10
measles, 271
pox, 310
scabies, 248
variola, 310
- Shooting of food animals, 27
bolt apparatus for, 26, 27
- Short clear, 38
rib, 45
- Signatera, 367
- Simulia ornata, 337
- Singeing of hogs, 31
- Skeletal muscles, diseases of, 223
- Skin, diseases of, 237
of food animals, 40
parasites of, 247
- Slaughter ax, 26
houses, public, 390
in Rome, 381
mask, 26
- Slaughtering of animals, 23
for Jews, 28, 29, 30, 33
machine for hogs, 30
methods with stunning, 26
without stunning, 29
regulation for, 34
- Small stock as food animals, 9
- Smoked products, examination of, 358
- Smoking, conserving by, 95, 407
- Snuffle disease of hogs, 240
- Soaking and smoking meat, 407
- Sodium chloride, estimation of, 436
- Soiled meat, with anthrax bacilli, 302-303
with pus, 320
- Soiling of meat, 352
- Sooty mange, 237
- Sour side, 341
- Souring of fats, 352
of meat, 341
- Spinal meningitis, infectious, of horses, 237
- Spiradenitis coccidiosa, 250
- Splenic fever, 280
- Spleen, 65-66
rotation of, 237
weight of, in cattle, 67
- Spotted disease of lobsters and crabs, 369
kidney of calves, white, 231
- Spring-bolt apparatus, 27
- Squeezing out passages or cavities of
slaughtered animals, 167
- Stables at abattoirs, 395
in stockyards, 399
- Stamping ink, 198
- Stamps for meat, 193, 194
- Staphylococci as producers of sepsis, 315
suppuration, 220, 318
- Starch flour addition to sausage fillings, 354
from spices in sausage, 354
test for, 442
- Steam lard, 425
- Sterilizing of meat, 81-82
passed conditionally, 196
- Stearin, 430, 432
- Steer, definition for, 10
- Sterilizers for meat, 196
- Sterilizing of meat by boiling, 84
- Stockyards, 390, 397
- Stomach, 65
contents, utilization of, 41
worm, epizootic of sheep, 252
- Stomatitis bovin, 309
- Stomoxys calcitrans, 348, 349
- Streptococci as producers of sepsis, 315
suppuration, 318
- Streptococcus melanogenes, 245
vaginitis bovis, 234
- Strongylides of intestines, 253
of lungs, 250
- Stunning of food animals, 26, 27
by blow on base of head, 26
- Sturgeon calves, 68
- Sucking mite, 248
- Suffocated meat, 341
- Sulphate of hydrogen, test for, 345
- Sulphites, test for, 358, 440
- Sulphurous acid, conserving by, 94
test for, 358, 440
- Summer sausage, 419
- Supervision of antemortem and post-mortem inspection, 187
- Suppuration, 220
- Suppurative osteomyelitis, 318
- Surra of cattle, 280
- Swamp fever, 238
- Sweetbread, 39, 66
- "Sweller" (defective can), 86
- Swelling, cloudy, 217
- Swine, brucellosis, 228
erysipelas, 321
fever, 327
influenza, 331
plague, 323, 325
pyemia, 319
- Symptomatic anthrax, 314
parturient, 314

T

- TÆNIA saginata, 268
solium, 265
- Tallow, 96
examination of, 360
factories, 395
- Tanking of condemned meat, 201
- Tapeworm disease of sheep, 254
of man, 264-265, 270
- Tasajo, 84
- Taste, abnormalities of, in meat, 210
- Technic of meat inspection, 165
- Teeth, determining age by, 24, 25

- Telangiectasis of liver, 229
 Temperature, penetration into meat, 82
 Tenderized hams, 408
 Tester, 359
 Tetanolysin, 312
 Tetanotoxin, 312
 Tetanus, 312
 Tetrarhynchus larvæ, 368
 Therapeutic remedies prepared from organs, 39, 40
 Thoracic wall, lymph glands of, 56
 Thrombosis, 215-216
 Thymus gland, 63, 66
 Thyroid glands, comparative anatomy of, 61-62, 66
 utilization of, 39, 40
 Tick fever of cattle, 280
 Ticks, 278
 Tissues, diseases of, 223
 Titer test on fats, 447
 Tobacco odor of meat, 352
 Tongue, 64
 Toxinemia, 315
 Toxins of putrefaction, 345
 Traffic in food animals, 11
 Tragacanth in sausage, 354
 Transportation by boat, 17
 by driving, 15
 of food animals, 15
 losses in food animals from, 12
 by railroad, 16, 17
 by truck, 15
 regulations on, 17-28
 wagon for cattle, 15
 Transudates, 215
 Traumatic inflammation of rumen, 228
 pericarditis, 236, 317
 pneumonia, 326
 Trepha, 33
 Trichina, 271
 inspection, 179, 274
 microscopes, 180
 Trichinosis, 271
 Trichocephalus affinis, 253
 Trieberrn of kosher meat, 33
 Tripe, 424
 room, 395
 Tristeza of cattle, 280
 Truck for condemned meat, 200
 Trypanosomes, 280
 Trypanosomiasis, 280
 Tsetse-fly disease, 280
 Tuberculosis, 281
 dissemination of, 282
 examination for, 287
 forms of, 283
 of fowls, 363
 outline showing forms of tuberculosis and disposal of meat, 291-293
 postmortem examination for, 287
 prevalence of, 284
 vaccination, influence of, on meat, 291
 virulence of meat in, 289
 Tularemia of rabbits, 366
 Tumeric paper, preparation of, 438
 Tumors, 222
 Turpentine odor of meat, 352
 Typhoid, dissemination of, by meat, 347, 370
 Tyroglyphus longior, 351
 siro, 351
 Tyrosin deposits in barrelled livers, 358
- U**
- UDDER, 67
 diseases of, 234
 United States inspected and condemned, 170
 and passed, 170
 retained, 170
 suspect, 164
 Uremia, 244
 Uric acid deposits in poultry, 376
 Urinary apparatus, diseases of, 244, 256
 lymph glands of, 56
 bladder, 66
 Urticarial erysipelas, 324
 Uterus, comparative anatomy of, 67
 diseases of, 233
 Utilization of food animals, 34, 35
- V**
- VACCINATION pox of calves, 310
 Vacuoles in meat, 358-359
 Vaginal catarrh of cattle, infectious, 234
 Vaginitis, 234
 Variola, 310
 Veal, 68
 Vegetable colors, test for, 443
 Verminous pneumonia, 326
 Vesicular exanthema of horses and cattle, 336
 stomatitis, 309
 Veterinary inspectors, responsibility of, 163
 police in abattoirs, 396-397
 supervision of abattoirs, 396, 400
 of meat inspection, 192
 of stockyards, 400
 Villous heart, 237
 Viscera, 39
 of cattle, weight of, absolute and relative, 12, 67
 comparative anatomy of, 64
 lymph glands, 49
- W**
- WARBLER, 248
 Waste water clearing plants, 396
 Water absorption of sausage filling, 78
 addition to sausage, 78, 443
 supply of abattoirs, 396
 of stockyards, 400
 test for, in sausages, 443

- | | |
|---|--|
| Weight of viscera, absolute and relative,
12, 67
losses in culinary preparation of
meat, 83
White sausage, 79
scour of calves, 339
spotted kidney, 231
Wild duck, 361
goose, 361
Woodcock, age of, determination of, 365
Wooden tongue, 298
Wound erysipelas, 324
septic, 317 | <p style="text-align: center;">X</p> XANTHOSIS, 221
<p style="text-align: center;">Y</p> YELLOW coloration of fat, 45
as result of feeding, 212
galt, 234
Young cattle, definition for, 10
peculiarities of meat, 68
<p style="text-align: center;">Z</p> ZINC, test for, in gelatin, 449 |
|---|--|



