

Marine Biological Laboratory Library
Woods Hole, Massachusetts



Gift of F. R. Lillie estate - 1977

Biological Dept.
Univ. of Toronto

MBL/WHOI



0 0301 0019357 9

Frank K. Zillie

A TEXT BOOK
OF
PHYSIOLOGY



A TEXT BOOK
OF
PHYSIOLOGY



BY

M. FOSTER, M.A., M.D., LL.D., F.R.S.,

PROFESSOR OF PHYSIOLOGY IN THE UNIVERSITY OF CAMBRIDGE,
AND FELLOW OF TRINITY COLLEGE, CAMBRIDGE.

WITH ILLUSTRATIONS.

FIFTH EDITION, LARGELY REVISED.

PART I., COMPRISING BOOK I.

Blood. The Tissues of Movement. The Vascular Mechanism.

London:
MACMILLAN AND CO.
AND NEW YORK.

1888

[*The Right of Translation is reserved.*]

Cambridge:

PRINTED BY C. J. CLAY, M.A. & SONS,
AT THE UNIVERSITY PRESS.

First Edition 1876. *Second Edition* 1877.
Third Edition 1879. *Fourth Edition* 1883.
Reprinted 1884, 1886. *Fifth Edition* 1888.

PREFACE.

IN the present edition I have made considerable changes and additions; but in the changes I have tried to maintain the character of the book as presented in previous editions; and the additions, with the exception of the histological paragraphs, are caused not by any attempt to add new matter or to enlarge the general scope of the work, but by an effort to explain more fully and at greater length what seem to me to be the most fundamental and most important topics. I have been led to introduce some histological statements, not with the view of in any way relieving the student from the necessity of studying distinct histological treatises, but in order to bring him to the physiological problem with the histological data fresh in his mind. I have therefore dealt very briefly with the several histological points and confined myself to matters having a physiological bearing. My friends Dr Gaskell, Mr Langley and Dr Lea have given me great assistance throughout, and their names might fitly appear on the title page, were it not that the present arrangement makes me alone responsible for all shortcomings. I have also to thank my senior demonstrator Mr L. E. Shore, M.B. and my junior demonstrator Mr Wingfield, M.A. for much valuable aid. The second and third parts will follow this first part as soon as possible.

CONTENTS OF PART I.

INTRODUCTION.

	PAGE
§§ 1—3. Distinctive characters of living and dead bodies	1
§ 4. Living substance, food and waste	3
§ 5. Protoplasm and the physiological unit	4
§ 6. Histological differentiation and physiological division of labour. Tissues and functions	6
§ 7. The two chief classes of tissues	6
§ 8. Muscular and nervous tissues	7
§ 9. Tissues of digestion and excretion	7
§ 10. Organs.—Muscles and nerves of the organs of nutrition	8
§ 11. The blood and the vascular system	8
§ 12. The main problem of physiology	9

BOOK I.

BLOOD. THE TISSUES OF MOVEMENT.

THE VASCULAR MECHANISM.

CHAPTER I.

BLOOD.

§ 13. The general work of the Blood	13
---	----

SECTION I.

THE CLOTTING OF BLOOD.

§ 14. The phenomena of clotting	15
§ 15. The characters of fibrin	17
§ 16. Serum-paraglobulin; its characters	18

	PAGE
§ 17. Serum-albumin; its characters	19
§ 18. The circumstances which affect the rapidity of clotting	20
§ 19. The preparation of plasmin and fibrinogen	22
§ 20. Fibrin-ferment; its action. Nature of the process of clotting	23
§ 21. Why blood clots when shed	26
§ 22. The influence on clotting exerted by the living blood vessels	27
§ 23. The nature of this influence; the action of the white corpuscles	29

SECTION II.

THE CORPUSCLES OF THE BLOOD.

The Red Corpuscles.

§ 24. The structure of the red corpuscles; laky blood; stroma, and hæmoglobin	31
§ 25. The number of red corpuscles in human blood; method of enumeration	34
§ 26. The destruction of red corpuscles	35
§ 27. The formation of red corpuscles, in the embryo and in the adult; hæmatoblasts	36

The White Corpuscles.

§ 28. The structure of the white corpuscles; characters of the cell-substance	38
§ 29. The chemical bodies present in white corpuscles	40
§ 30. The white corpuscles as a type of living matter; metabolism, katabolic and anabolic changes. The nature and relations of the 'granules'; living substance, food and waste	41
§ 31. The origin of the white corpuscles. Leucocytes	44
§ 32. The disappearance of the white corpuscles. Their influence on the plasma. Different kinds of white corpuscles	45

Blood Platelets.

§ 33. The characters of blood platelets	47
---	----

SECTION III.

THE CHEMICAL COMPOSITION OF BLOOD.

§ 34. General chemical characters	49
§ 35. Chemical composition of serum	49
§ 36. Chemical composition of red corpuscles	50
§ 37. Chemical composition of white corpuscles	51

SECTION IV.

THE QUANTITY OF BLOOD AND ITS DISTRIBUTION IN THE BODY.

§ 38. The determination of the quantity of blood in the body, and the main facts of its distribution	52
--	----

CHAPTER II.

THE CONTRACTILE TISSUES.

	PAGE
§ 39. The movements of the body carried out by means of various kinds of contractile tissues	54

SECTION I.

THE PHENOMENA OF MUSCLE AND NERVE.

Muscular and Nervous Irritability.

§ 40. Irritability; contractility; stimuli	56
§ 41. Independent muscular irritability; action of urari	57
§ 42. Simple and tetanic contractions	58
§ 43. The muscle-nerve preparation	58
§ 44. Various forms of stimuli. Induction Coil. Key. Magnetic Interruptor. Electrodes. Method of graphic record	59

The Phenomena of a Simple Muscular Contraction.

§ 45. The muscle curve. Myographs. Time measurements. Signals	68
§ 46. Analysis of a simple muscle curve	74
§ 47. Variations of the muscle curve. The shortening accompanied by thickening	77
§ 48. Simple muscular contractions rare in the living body	78
§ 49. Tetanic contractions. Analysis of the curve of tetanus	78
§ 50. Various degrees of tetanic contractions	82
§ 51. Diminution and disappearance of irritability after death	83

SECTION II.

ON THE CHANGES WHICH TAKE PLACE IN A MUSCLE DURING A CONTRACTION.

The Change in Form.

§ 52. Gross structure of muscle, arrangement of muscular fibres, blood vessels and nerves	84
§ 53. The wave of contraction; its length, velocity and other characters	86
§ 54. Minute structure of muscular fibre; nature of striation	88
§ 55. The visible changes which take place in a muscular fibre during a contraction	91
§ 56. The appearances presented when the fibre is examined with polarized light	93
§ 57. Nature of the act of contraction	94

The Chemistry of Muscle.

	PAGE
§ 58. Contrast of living and dead muscle; rigor mortis	95
§ 59. Chemical bodies present in dead muscle; myosin, syntonin	96
§ 60. Chemistry of living muscle; muscle-plasma, muscle-clot and muscle-serum, myoglobulin, histo-hæmatin	98
§ 61. Acid reaction of rigid muscle; development of carbonic acid in rigor mortis	99
§ 62. Other constituents of muscle	101
§ 63. Chemical changes during contraction; development of carbonic acid and acid reaction	102
§ 64. Summary of the chemistry of muscle	104

Thermal Changes.

§ 65. Heat given out during a contraction. Comparison of muscle with a steam engine	104
---	-----

Electrical Changes.

§ 66. Non-polarisable electrodes. Muscle currents; their distribution and nature	106
§ 67. Negative variation of the muscle current; currents of action. The rheoscopic frog	111

The Changes in a Nerve during the passage of a Nervous Impulse.

§ 68. Structure of a nerve. Primitive sheath or neurilemma, medulla, axis cylinder, nodes of Ranvier. The axis cylinder the essential part	113
§ 69. Nerve endings in striated muscular fibres. Henle's sheath. End-plates	118
§ 70. Non-medullated nerve fibres	120
§ 71. The chemistry of a nerve; cholesterin, lecithin, cerebrin, protagon	121
§ 72. The nervous impulse; the electrical changes accompanying it. These changes travel in both directions along the nerve	123
§ 73. Summary of the changes occurring in a muscle and nerve as the result of stimulation	125

SECTION III.

THE NATURE OF THE CHANGES THROUGH WHICH AN ELECTRIC CURRENT IS ABLE TO GENERATE A NERVOUS IMPULSE.

Action of the Constant Current.

§ 74. Action of the constant current; making and breaking contractions	126
§ 75. Electrotonus. Effect of the constant current on the irritability of the nerve. Katelectrotonus. Anelectrotonus	128
§ 76. Electrotonic currents	130
§ 77. Relation of electrotonus to nervous impulses, and to the effects of the constant current	132
§ 78. Action of the constant current on muscle	134

SECTION IV.

THE MUSCLE-NERVE PREPARATION AS A MACHINE.

	PAGE
§ 79. The influence of the nature and mode of application of the stimulus on the magnitude of the contraction. Maximal and minimal stimuli. Influence of abruptness and duration of stimulus. Some parts of a nerve more irritable than others	136
§ 80. Frequency of repetition necessary to produce tetanus; pale and red muscles. The muscular sound	139
§ 81. The influence of the load; effect of resistance. The work done	141
§ 82. The influence of the size and form of the muscle	142

SECTION V.

THE CIRCUMSTANCES WHICH DETERMINE THE DEGREE OF IRRITABILITY OF MUSCLES AND NERVES.

§ 83. Diminution and disappearance of irritability after severance from the body. Effect of division of nerves; degeneration of nerve fibres. Regeneration	143
§ 84. The influence of temperature	145
§ 85. The influence of blood-supply	146
§ 86. The influence of functional activity. Exercise. Fatigue. The causes of exhaustion	148

SECTION VI.

THE ENERGY OF MUSCLE AND NERVE AND THE NATURE OF MUSCULAR AND NERVOUS ACTION.

§ 87. Nature of the act of contraction and the act of relaxation. The relation of the energy of work to the energy of heat. The relation of nitrogenous metabolism to the energy of contraction	151
§ 88. The nature of a nervous impulse	154

SECTION VII.

ON SOME OTHER FORMS OF CONTRACTILE TISSUE.

Plain, smooth or unstriated Muscular Tissue.

§ 89. Structure of plain muscular tissue; characters of the fibre-cell	157
§ 90. Arrangement and termination of nerves in unstriated muscle	158
§ 91. The chemistry of unstriated muscle	159
§ 92. The characters of the contraction of unstriated muscle. Peristaltic contractions. 'Spontaneous' contractions. Tonic contractions	159

Ciliary Movement.

		PAGE
§ 93.	Structure of a ciliated epithelium cell	162
§ 94.	Nature of ciliary movement. Circumstances affecting ciliary movements	163

Amœboid Movements.

§ 95.	Nature of an amœboid movement; its relation to a muscular contraction	166
-------	---	-----

CHAPTER III.

ON THE MORE GENERAL FEATURES OF NERVOUS TISSUES.

§ 96.	The general arrangement of the nervous system. Cerebro-spinal and splanchnic or sympathetic system; somatic and splanchnic nerves	169
§ 97.	The structure of spinal ganglia. The ganglionic nerve cell. Bipolar, unipolar and apolar nerve cells	173
§ 98.	The structure of ganglia of the splanchnic or sympathetic system. Multipolar cells. Spiral cells	176
§ 99.	Grey matter and white matter of the central nervous system. Structure of a nerve cell of the spinal cord; axis cylinder process	177
§ 100.	Functions of nerve cells	178
§ 101.	Reflex actions; the machinery required. The circumstances determining the nature of a reflex action. Reflex actions often purposeful	179
§ 102.	Automatic actions	183
§ 103.	Inhibitory nerves	184

CHAPTER IV.

THE VASCULAR MECHANISM.

SECTION I.

THE STRUCTURE AND MAIN FEATURES OF THE VASCULAR APPARATUS.

§ 104.	The chief work of the blood carried on in the capillaries and other minute vessels	186
--------	--	-----

The Structure of Arteries, Veins and Capillaries.

§ 105.	On some features of connective tissue. Gelatiniferous fibrillæ. Connective-tissue corpuscles	187
§ 106.	Elastic fibres	189

	PAGE
§ 107. The structure of capillaries; epithelioid cells. The size of capillaries and variations in their calibre	190
§ 108. The structure of minute arteries	193
§ 109. The structure of larger arteries	194
§ 110. The structure of the veins	196
§ 111. Some points in the structure of the heart	197
§ 112. The main features of the vascular apparatus	198

SECTION II.

THE MAIN FACTS OF THE CIRCULATION.

§ 113. Behaviour of arteries contrasted with that of veins	201
§ 114. Blood-pressure in an artery and in a vein.	202
§ 115. Methods of registering blood-pressure; mercurial manometer. Kymograph. The blood-pressure curve	204
§ 116. Characters of the blood-pressure in various arteries and veins. Blood-pressure in the capillaries. Fall of blood-pressure in the minute vessels	207
§ 117. The circulation through the capillaries, and small vessels. Peripheral resistance	209

Hydraulic Principles of the Circulation.

§ 118. The three main physical facts of the circulation; the central pump, the peripheral resistance and the elastic tubing	211
§ 119. The conversion of the intermittent into a continuous flow by means of the elastic reaction of the arteries	212
§ 120. Artificial Model. Arterial and venous pressure with great and with little peripheral resistance	214
§ 121. Additional aids to the circulation in the living body	219

Circumstances determining the Rate of the Flow.

§ 122. Methods of determining the rate of the flow. Hæmadromometer, Rheometer, Hæmatachometer. The rate of flow in arteries, veins and capillaries	220
§ 123. The rate of flow dependent on the width of the bed	223
§ 124. The time of the entire circuit	225
§ 125. Summary of the main physical facts of the circulation	226

SECTION III.

THE HEART.

The Phenomena of the Normal Beat.

§ 126. The visible movements	228
§ 127. The cardiac cycle; the series of events constituting a beat	229
§ 128. The change of form	232

		PAGE
§ 129.	The cardiac impulse	234
§ 130.	The sounds of the heart	235
<i>Endocardiac Pressure.</i>		
§ 131.	Methods of determining endocardiac pressure. Minimum and maximum manometer. The negative pressure in the cardiac cavities	238
§ 132.	Cardiac sound and tambour	240
§ 133.	Discussion of cardiac curves	243
§ 134.	The main events occurring in the ventricle during a beat	246
§ 135.	The nature and causes of the negative pressure	247
§ 136.	The duration of the several phases of the cardiac cycle	249
§ 137.	Summary of the events constituting a beat	251
§ 138.	The work done	253

SECTION IV.

THE PULSE.

§ 139.	Methods of recording the pulse. The sphygmograph. The pulse curve	255
§ 140.	Pulse tracing from an artificial model; the features of the pulse wave	257
§ 141.	Characters of the pulse curve; influence of pressure exerted by lever	260
§ 142.	The changes undergone by the pulse wave along the arterial tract	261
§ 143.	The velocity of the pulse wave	262
§ 144.	The length of the pulse wave	263
§ 145.	<i>Dicrotism.</i> Secondary elevations. Kataerotic and anaerotic tracings	264
§ 146.	The causes of the dicrotic wave	266
§ 147.	The predicrotic wave	270
§ 148.	Causes of anaerotic waves	271
§ 149.	Venous pulse	271

SECTION V.

THE REGULATION AND ADAPTATION OF THE VASCULAR MECHANISM.

The Regulation of the Beat of the Heart.

§ 150.	The two great regulators; changes in the heart-beat and changes in the peripheral mechanism	273
--------	---	-----

The Histology of the Heart.

§ 151.	Cardiac muscular tissue. The structure of the frog's heart	274
§ 152.	The structure of the mammalian heart	276
§ 153.	The nerves of the heart. The ganglia of the heart	277

The Development of the Normal Beat.

§ 154.	Graphic record of the heart-beat. The beat of the frog's heart. The sequence of events, and the descending scale of rhythmic power	280
--------	--	-----

CONTENTS.

XV

	PAGE
§ 155. The causes of the spontaneous rhythmic beat; the relations of the ganglia; the features of the cardiac tissue	284
§ 156. The cardiac tissue and not the ganglia chiefly concerned in the maintenance of the sequence of events	288
<i>The Government of the Heart-Beat by the Nervous System.</i>	
§ 157. Inhibition in the frog by stimulation of vagus nerves. Features of inhibition	290
§ 158. Augmentation of the heart-beat. Antagonism of augmentation and inhibition. Course of augmentor fibres in the frog	292
§ 159. Reflex inhibition. Cardio-inhibitory centre	295
§ 160. Inhibition in the mammal; effect on blood-pressure. Course of augmentor fibres in the dog	296
§ 161. Nature of augmentor and inhibitory effects. Action of atropin and muscarin	300
<i>Other Influences regulating or modifying the Beat of the Heart.</i>	
§ 162. Influences of blood, and substances contained in the blood. Influence of the distension of the cavities. Relation of heart-beat to blood-pressure	303

SECTION VI.

CHANGES IN THE CALIBRE OF THE MINUTE ARTERIES. VASO-MOTOR ACTIONS.

§ 163. Changes of calibre in arteries as seen in the web of a frog's foot and elsewhere. Vaso-motor nerves	306
§ 164. The vascular phenomena in a rabbit's ear	307
§ 165. The effects on the vessels of the ear of dividing and stimulating the cervical sympathetic nerve	308
§ 166. Course of vaso-motor fibres of the ear	309
§ 167. The effects on the vessels of the submaxillary gland of stimulating the chorda tympani nerve; vaso-constrictor and vaso-dilator fibres	310
§ 168. Vaso-motor nerves of other parts of the body. Constrictor and dilator fibres in the sciatic and brachial nerves	313
<i>The Course of Vaso-constrictor and Vaso-dilator fibres.</i>	
§ 169. Course of vaso-constrictor fibres	317
§ 170. Course of vaso-dilator fibres	318
<i>The Effects of Vaso-motor actions.</i>	
§ 171. Local and general effects of the constriction and dilation of an artery or set of arteries	319
<i>Vaso-motor Functions of the Central Nervous System.</i>	
§ 172. Vaso-dilator fibres usually employed as part of a reflex action	321
§ 173. Loss of tone resulting from the division of the spinal cord at various levels. Vaso-motor centre in the medulla oblongata	322

	PAGE
§ 174. The Depressor nerve	
§ 175. Rise of blood-pressure from stimulation of afferent nerves; pressor effects	323 325
§ 176. The limits of the medullary vaso-motor centre	326
§ 177. The relation of the medullary vaso-motor centre to other spinal vaso-motor centres. Nature of dilation, tone, and constriction of blood vessels	327
§ 178. Summary of vaso-motor actions	330
§ 179. Instances of vaso-motor actions. Blushing. Effect of warmth on skin	331
§ 180. Vaso-motor nerves of the veins	333

SECTION VII.

THE CAPILLARY CIRCULATION.

§ 181. The normal capillary circulation. The axial core and the plasmatic layer	334
§ 182. Changes in the capillary circulation induced by irritants. The phenomena of inflammation	336
§ 183. The migration of the white corpuscles	337
§ 184. Stagnation or stasis. The diapedesis of the red corpuscles. Nature of the inflammatory changes	338
§ 185. Changes in the peripheral resistance due to changes in the blood . .	339

SECTION VIII.

CHANGES IN THE QUANTITY OF BLOOD.

§ 186. Effects of increasing and of diminishing the total quantity of blood	341
---	-----

SECTION IX.

A REVIEW OF SOME OF THE FEATURES OF THE CIRCULATION.

§ 187. The constant and variable factors	343
§ 188. Variations in the circulation due to variations in the distension of the cavities	344
§ 189. Influence on the heart-beat of the supply of blood, and other nutritive conditions	344
§ 190. Causes of an irregular heart-beat	345
§ 191. Causes of the sudden cessation of the heart-beat, and sudden death	346
§ 192. Blushing and the effects of warmth on the skin. Effects of alcohol on the vascular mechanism	347
§ 193. The influence of exercise on the vascular mechanism	349
§ 194. The effects of food on the vascular mechanism	351
§ 195. Relations and mutual actions of heart-beat and vaso-motor system .	351

LIST OF FIGURES IN PART I.

FIG.	PAGE
1. A muscle-nerve preparation	59
2. Diagram of du Bois-Reymond key	61
3. Diagram illustrating apparatus arranged for experiments with muscle and nerve	63
4. Diagram of an Induction Coil	65
5. The Magnetic Interruptor	66
6. The Magnetic Interruptor with Helmholtz's arrangement for equalizing the make and break shocks	67
7. A muscle curve from the gastrocnemius of a frog	69
8. The same, with the recording surface moving slowly	69
9. The same, with the recording surface travelling very rapidly	70
10. The Pendulum Myograph	71
11. Diagram of an arrangement of a vibrating tuning fork with a Despretz signal	73
12. Curves illustrating the measurement of the velocity of a nervous impulse	75
13. Tracing of a double muscular contraction	79
14. Muscle curve. Single induction shocks repeated slowly	79
15. The same, repeated more rapidly	79
16. The same, repeated still more rapidly	80
17. Tetanus produced with the ordinary magnetic interruptor	81
18. Non-polarisable electrodes	107
19. Diagram illustrating the electric currents of nerve and muscle	108
20. Diagram illustration of the progression of electric changes	112
21. Diagram of ascending and descending constant current	128
22. Diagram of the electrotonic changes in irritability	130
23. Diagram illustrating electrotonic currents	131
24. Scheme of the nerves of a segment of spinal cord	170
25. Apparatus for investigating blood-pressure	205
26. Tracing of arterial pressure in dog	206
27. Tracing of arterial pressure in rabbit	207
28. Ludwig's Kymograph	208
29. Diagram of fall of blood-pressure in arteries, capillaries and veins	209
30. Arterial model	215
31. Tracing from arterial model with little peripheral resistance	216
31*. The same with increased peripheral resistance	217

FIG.	PAGE
32. Ludwig's Stromuhr	221
33. Chauveau and Lortet's Hæmatachometer	223
34. Diagram illustrating causes determining the velocity of the flow	224
35. Tracing from heart of cat	233
36. Minimum and maximum Manometer	239
37. Marey's Tambour, and cardiac sound	241
38. Tracing from right auricle and ventricle	242
39. Curve of endocardiac pressure	243
40. Tracing from heart of cat	244
41. Cardiogram from man	244
42. Fick's spring Manometer	255
43. Diagram of a Sphygmograph	256
44. Pulse tracing from radial artery	257
45. Diagram of artificial pulse tracings	258
46. Diagram of progression of pulse wave	259
47. Pulse tracing with different pressures	260
48. Pulse tracing from dorsalis pedis artery	261
49. Pulse tracing from carotid artery	264
50. Anacrotic pulse tracing	265
51. Dicrotic pulse tracing	265
52. A perfusion cannula	281
53. Diagram of apparatus for registering the beat of a frog's heart	281
54. Inhibition of heart-beat in the frog	291
55. Diagram of the course of cardiac augmentor fibres in the frog	292
56. Cardiac inhibition in the mammal	296
57. The course of cardiac inhibitory and augmentor fibres in the dog	298
58. Diagram of the course of vaso-constrictor fibres	310
59. Diagram of the nerves of the submaxillary gland	311
60. The depressor nerve	324
61. Rise of pressure due to stimulation of the sciatic nerve	325

ERRATUM.

P. 215, l. 18, *for* sphygmographs *read* sphygmographs.

INTRODUCTION.

§ 1. DISSECTION, aided by microscopical examination, teaches us that the body of man is made up of certain kinds of material, so differing from each other in optical and other physical characters and so built up together as to give the body certain structural features. Chemical examination further teaches us that these kinds of material are composed of various chemical substances, a large number of which have this characteristic that they possess a considerable amount of potential energy capable of being set free, rendered actual, by oxidation or some other chemical change. Thus the body as a whole may, from a chemical point of view, be considered as a mass of various chemical substances, representing altogether a considerable capital of potential energy.

§ 2. This body may exist either as a living body or (for a certain time at least) as a dead body, and the living body may at any time become a dead body. At what is generally called the moment of death (but artificially so, for as we shall see the processes of death are numerous and gradual) the dead body so far as structure and chemical composition are concerned is exceedingly like the living body; indeed the differences between the two are such as can be determined only by very careful examination, and are still to a large extent estimated by drawing inferences rather than actually observed. At any rate the dead body at the moment of death resembles the living body in so far as it represents a capital of potential energy. From that moment onwards however the capital is expended; by processes which are largely those of oxidation, the energy is gradually dissipated, leaving the body chiefly in the form of heat. While these chemical processes are going on the structural features disappear, and the body, with the loss of nearly all its energy, is at last resolved into "dust and ashes."

The characteristic of the dead body then is that, being a mass of substances of considerable potential energy, it is always more or less slowly losing energy, never gaining energy; the capital of energy present at the moment of death is more or less slowly diminished, is never increased or replaced.

§ 3. When on the other hand we study a living body we are struck with the following salient facts.

1. The living body moves of itself, either moving one part of the body on another or moving the whole body from place to place. These movements are active; the body is not simply pulled or pushed by external forces, but the motive power is in the body itself, the energy of each movement is supplied by the body itself.

2. These movements are determined and influenced, indeed often seem to be started, by changes in the surroundings of the body. Sudden contact between the surface of the body and some foreign object will often call forth a movement. The body is sensitive to changes in its surroundings, and this sensitiveness is manifested not only by movements but by other changes in the body.

3. It is continually generating heat and giving out heat to surrounding things, the production and loss of heat, in the case of man and certain other animals, being so adjusted that the whole body is warm, that is of a temperature higher than that of surrounding things.

4. From time to time it eats, that is to say takes into itself supplies of certain substances known as food, these substances being in the main similar to those which compose the body and being like them chemical bodies of considerable potential energy, capable through oxidation or other chemical changes of setting free a considerable quantity of energy.

5. It is continually breathing, that is, taking in from the surrounding air supplies of oxygen.

6. It is continually, or from time to time, discharging from itself into its surroundings so-called waste matters, which waste matters may be broadly described as products of oxidation of the substances taken in as food, or of the substances composing the body.

Hence the living body may be said to be distinguished from the dead body by three main features.

The living body like the dead is continually losing energy (and losing it more rapidly than the dead body, the special breathing arrangements permitting a more rapid oxidation of its substance), but unlike the dead body is by means of food continually restoring its substance and replenishing its store of energy.

The energy set free in the dead body by the oxidation and other chemical changes of its substance leaves the body almost exclusively in the form of heat, whereas a great deal of energy leaves the living body as mechanical work, the result of various movements of the body, and as we shall see a great deal of the energy

which ultimately leaves the body as heat, exists for a while within the living body in other forms than heat, though eventually transformed into heat.

The changes in the surroundings affect the dead body at a slow rate and in a general way only, simply lessening or increasing the amount or rate of chemical change and the quantity of heat thereby set free, but never diverting the energy into some other form such as that of movement; whereas changes in the surroundings may in the case of the living body rapidly, profoundly and in special ways affect not only the amount but also the kind of energy set free. The dead body left to itself slowly falls to pieces, slowly dissipates its store of energy, and slowly gives out heat; a higher or lower temperature, more or less moisture, a free or scanty supply of oxygen, the advent of many or few putrefactive organisms, these may quicken or slacken the rate at which energy is being dissipated but do not divert that energy from heat into motion; whereas in the living body so slight a change of surroundings as the mere touch by a hair of some particular surface, may so affect the setting free of energy as to lead to such a discharge of energy in the form of movement that the previously apparently quiescent body may be suddenly thrown into the most violent convulsions.

The differences therefore between living substance and dead substance though recondite are very great, and the ultimate object of physiology is to ascertain how it is that living substance can do what dead substance cannot, can renew its substance, and replenish the energy which it is continually losing, and can according to the nature of its surroundings vary not only the amount but also the kind of energy which it sets free. Thus there are two great divisions of physiology: one having to do with the renewal of substance and the replenishment of energy, the other having to do with the setting free of energy.

§ 4. Now the body of man (or one of the higher animals) is a very complicated structure consisting of different kinds of material which we call *tissues*, such as muscular, nervous, connective, and the like, variously arranged in organs such as heart, lungs, muscles, skin &c., all built up to form the body according to certain morphological laws. But all this complication, though advantageous and indeed necessary for the fuller life of man, is not essential to the existence of life. The amoeba is a living being; it renews its substance, replenishes its store of energy, and sets free energy now in one form, now in another; and yet the amoeba may be said to have no tissues and no organs; at all events this is true of closely allied but not so well known simple beings. Using the more familiar amoeba as a type, and therefore leaving on one side the nucleus, and any distinction between endosarc and ectosarc, we may say that its body is homogeneous in the sense that if we divided it into small pieces, each piece would be like all

the others. In another sense it is not homogeneous. For we know that the amoeba receives into its substance material as food, and that this food or part of it remains lodged in the body, until it is made use of and built up into the living substance of the body, and each piece of the living substance of the body must have in or near it some of the material which it is about to build up into itself. Further we know that the amoeba gives out waste matters such as carbonic acid and other substances, and each piece of the amoeba must contain some of these waste matters about to be, but not yet, discharged from the piece. Each piece of the amoeba will therefore contain these three things, the actual living substance, the food about to become living substance and the waste matters which have ceased to be living substance.

Moreover we have reasons to think that the living substance does not break down into the waste matters which leave the body at a single bound, but that there are stages in the downward progress between the one and the other. Similarly, though our knowledge on this point is less sure, we have reason to think that the food is not incorporated into the living substance at a single step, but that there are stages in the upward progress from the dead food to the living substance. Each piece of the body of the amoeba will therefore contain substances representing various stages of becoming living, and of ceasing to be living, as well as the living substance itself. And we may safely make this statement though we are quite unable to draw the line where the dead food on its way up becomes living, or the living substance on its way down becomes dead.

§ 5. Nor is it necessary for our present purpose to be able to point out under the microscope, or to describe from a histological point of view, the parts which are living and the parts which are dead food or dead waste. The body of the amoeba is frequently spoken of as consisting of 'protoplasm.' The name was originally given to the matter forming the primordial utricle of the vegetable cell as distinguished from the cell wall on the one hand, and from the fluid contents of the cell or cell sap on the other, and also we may add from the nucleus. It has since been applied very generally to such parts of animal bodies as resemble, in their general features, the primordial utricle. Thus the body of a white blood corpuscle, or of a gland cell, or of a nerve cell, is said to consist of protoplasm. Such parts of animal bodies as do not in their general features resemble the matter of the primordial utricle are not called protoplasm or, if they at some earlier stage did bear such resemblance, but no longer do so, are sometimes, as in the case of the substance of a muscular fibre, called 'differentiated protoplasm.' Protoplasm in this sense sometimes appears, as in the outer part of most amoebae, as a mass of glassy-looking material, either continuous or interrupted by more or less spherical spaces or vacuoles filled with fluid, sometimes as in a gland cell as a more refrac-

tive, cloudy-looking, or finely granular material arranged in a more or less irregular network, or spongework, the interstices of which are occupied either by fluid or by some material different from itself. We shall return however to the features of this 'protoplasm' when we come to treat of white blood corpuscles and other 'protoplasmic' structures. Meanwhile it is sufficient for our present purpose to note that lodged in the protoplasm, discontinuous with it, and forming no part of it, are in the first place collections of fluid, of watery solutions of various substances, occupying the more regular vacuoles or the more irregular spaces of the network, and in the second place discrete granules of one kind or another, also forming no part of the protoplasm itself, but lodged either in the bars or substance of the protoplasm or in the vacuoles or meshes.

Now there can be little doubt that the fluids and the discrete granules are dead food or dead waste, but the present state of our knowledge will not permit us to make any very definite statement about the protoplasm itself. We may probably conclude, indeed we may be almost sure that protoplasm in the above sense is not all living substance, that it is made up partly of the real living substance, and partly of material which is becoming living or has ceased to be living; and in the case where protoplasm is described as forming a network, it is possible that some of the material occupying the meshes of the network may be, like part of the network itself, really alive. 'Protoplasm' in fact, as in the sense in which we are now using it, and shall continue to use it, is a *morphological* term; but it must be borne in mind that the same word 'protoplasm' is also frequently used to denote what we have just now called 'the real living substance.' The word then embodies a *physiological* idea; so used it may be applied to the living substance of all living structures, whatever the microscopical features of those structures; in this sense it cannot at present, and possibly never will be recognised by the microscope, and our knowledge of its nature must be based on inferences.

Keeping then to the phrase 'living substance' we may say that each piece of the body of the amoeba consists of living substance, in which are lodged, or with which are built up in some way or other, food and waste in various stages.

Now an amoeba may divide itself into two, each half exhibiting all the phenomena of the whole; and we can easily imagine the process to be repeated, until the amoeba was divided into a multitude of exceedingly minute amoebae, each having all the properties of the original. But it is obvious, as in the like division of a mass of a chemical substance, that the division could not be repeated indefinitely. Just as in division of the chemical mass we come to the chemical molecule, further division of which changes the properties of the substance, so in the continued division of the amoeba we should come to a stage in which further division interfered with the physiological actions, we should come

to a physiological unit, corresponding to but greatly more complex than the chemical molecule¹. This unit to remain a physiological unit and to continue to live must contain not only a portion of the living substance but also the food for that living substance, in several at least of the stages, from the initial raw food up to the final 'living' stages, and must similarly contain various stages of waste.

§ 6. Now the great characteristic of the typical amoeba (leaving out the nucleus) is that, as far as we can ascertain, all the physiological units are alike; they all do the same things. Each and every part of the body receives food more or less raw and builds it up into its own living substance; each and every part of the body may be at one time quiescent and at another in motion; each and every part is sensitive and responds by movement or otherwise to various changes in its surroundings.

The body of man, in its first stage, while it is as yet an ovum, if we leave aside the nucleus and neglect differences caused by the unequal distribution of food material or yolk, may also be said to be composed of like parts or like physiological units.

By the act of segmentation however the ovum is divided into parts or cells which early shew differences from each other; and these differences rapidly increase as development proceeds. Some cells put on certain characters and others other characters; that is to say the cells undergo *histological differentiation*. And this takes place in such a way that a number of cells lying together in a group become eventually converted into a *tissue*, and the whole body becomes a collection of such tissues arranged together according to morphological laws, each tissue having a definite structure, its cellular nature being sometimes preserved, sometimes obscured or even lost.

This histological differentiation is accompanied by a *physiological division of labour*. Each tissue may be supposed to be composed of physiological units, the units of the same tissue being alike but differing from the units of other tissues; and corresponding to this difference of structure, the units of different tissues behave or act differently. Instead of all the units as in the amoeba doing the same things equally well, the units of one tissue are told off as it were to do one thing especially well, or especially fully, and thus the whole labour of the body is divided among the several tissues.

§ 7. The several tissues may thus be classified according to the work which they have to do; and the first great distinction is into (1) the tissues which are concerned in the setting free of energy in special ways, and (2) the tissues which are concerned in replenishing the substance and so renewing the energy of the body.

Each physiological unit of the amoeba while it is engaged in

¹ Such a physiological unit might be called a *somacule*.

setting free energy so as to move itself, and by reason of its sensitiveness so directing that energy as to produce a movement suitable to the conditions of its surroundings, has at the same time to bear the labour of taking in raw food, of selecting that part of the raw food which is useful and rejecting that which is useless, and of working up the accepted part through a variety of stages into its own living substance; that is to say it has at the same time that it is feeling and moving to carry on the work of digesting and assimilating. It has moreover at the same time to throw out the waste matters arising from the changes taking place in its own substance, having first brought these waste matters into a condition suitable for being thrown out.

§ 8. In the body of man movements as we shall see are broadly speaking carried out by means of muscular tissue, and the changes in muscular tissue which lead to the setting free of energy in the form of movement are directed, governed, and adapted to the surroundings of man, by means of nervous tissue. Rays of light fall on the nervous substance of the eye called the retina, and set up in the retina changes which induce in the optic nerve other changes, which in turn are propagated to the brain as *nervous impulses*, both the excitation and the propagation involving an expenditure of energy. These nervous impulses reaching the brain may induce other nervous impulses which travelling down certain nerves to certain muscles may lead to changes in those muscles by which they suddenly grow short and pull upon the bones or other structures to which they are attached, in which case we say the man starts; or the nervous impulses reaching the brain may produce some other effects. Similarly sound falling on the ear, or contact between the skin and some foreign body, or some change in the air or other surroundings of the body, or some change within the body itself may so affect the nervous tissue of the body that nervous impulses are started and travel to this point or to that, to the brain or elsewhere and eventually may either reach some muscular tissue and so give rise to movements, or may reach other tissues and produce some other effect.

The muscular tissue then may be considered as given up to the production of movement, and the nervous tissue as given up to the generation, transformation and propagation of nervous impulses. In each case there is an expenditure of energy, which in the case of the muscle, as we shall see, leaves the body partly as heat, and partly as work done, but in the case of nervous tissue is wholly or almost wholly transformed into heat before it leaves the body; and this expenditure necessitates a replenishment of energy and a renewal of substance.

§ 9. In order that these master tissues, the nervous and muscular tissues, may carry on their important works to the best advantage, they are relieved of much of the labour that falls upon each physiological unit of the amoeba. They are not presented

with raw food, they are not required to carry out the necessary transformations of their immediate waste matters. The whole of the rest of the body is engaged (1) in so preparing the raw food, and so bringing it to the nervous and muscular tissues that these may build it up into their own substance with the least trouble, and (2) in receiving the waste matters which arise in muscular and nervous tissues, and preparing them for rapid and easy ejection from the body.

Thus to certain tissues, which we may speak of broadly as 'tissues of digestion,' is allotted the duty of acting on the food and preparing it for the use of the muscular and nervous tissues; and to other tissues, which we may speak of as "tissues of excretion," is allotted the duty of clearing the body from the waste matters generated by the muscular and nervous tissues.

§ 10. These tissues are for the most part arranged in machines or mechanisms called organs, and the working of these organs involves movement. The movements of these organs are carried out, like the other movements of the body, chiefly by means of muscular tissue governed by nervous tissue. Hence we may make a distinction between the muscles which are concerned in producing an effect on the world outside man's body, the muscles by which man does his work in the world, and the muscles which are concerned in carrying out the movements of the internal organs. And we may similarly make a distinction between the nervous tissue concerned in carrying out the external work of the body and that concerned in regulating the movements and, as we shall see, the general conduct of the internal organs. But these two classes of muscular and nervous tissue though distinct in work, and as we shall see often different in structure, are not separated or isolated. On the contrary while it is the main duty of the nervous tissue as a whole, the nervous system as we may call it, to carry out, by means of nervous impulses passing hither and thither, what may be spoken of as the work of man, and in this sense is the master tissue, it also serves as a bond of union between itself and the muscles doing external work on the one hand, and the organs of digestion or excretion on the other, so that the activity and conduct of the latter may be adequately adapted to the needs of the former.

§ 11. Lastly the food prepared and elaborated by the digestive organs is carried and presented to the muscular and nervous tissues in the form of a complex fluid known as blood, which, driven by means of a complicated mechanism known as the vascular system, circulates all over the body, visiting in turn all the tissues of the body, and by a special arrangement known as the respiratory mechanism, carrying in itself to the several tissues a supply of oxygen as well as of food more properly so called.

The motive power of this vascular system is supplied as in the case of the digestive system by means of muscular tissue, the

activity of which is similarly governed by the nervous system, and hence the flow of blood to this part or that part is regulated according to the needs of the part.

§ 12. The above slight sketch will perhaps suffice to shew not only how numerous but how varied are the problems with which Physiology has to deal.

In the first place there are what may be called general problems, such as How the food after its preparation and elaboration into blood is built up into the living substance of the several tissues? How the living substance breaks down into the dead waste? How the building up and breaking down differ in the different tissues in such a way that energy is set free in different modes, the muscular tissue contracting, the nervous tissue thrilling with a nervous impulse, the secreting tissue doing chemical work, and the like? To these general questions the answers which we can at present give can hardly be called answers at all.

In the second place there are what may be called special problems, such as What are the various steps by which the blood is kept replenished with food and oxygen, and kept free from an accumulation of waste, and how is the activity of the digestive, respiratory and excretory organs, which effect this, regulated and adapted to the stress of circumstances? What are the details of the working of the vascular mechanism by which each and every tissue is for ever bathed with fresh blood, and how is that working delicately adapted to all the varied changes of the body? And, compared with which all other special problems are insignificant and preparatory only, How do nervous impulses so flit to and fro within the nervous system as to issue in the movements which make up what we sometimes call the life of man? It is to these special problems that we must chiefly confine our attention, and we may fitly begin with a study of the blood.

BOOK I.

BLOOD. THE TISSUES OF MOVEMENT. THE
VASCULAR MECHANISM.

CHAPTER I.

BLOOD.

§ 13. THE several tissues are traversed by minute tubes, the capillary blood vessels, to which blood is brought by the arteries, and from which blood is carried away by the veins. These capillaries form networks the meshes of which, differing in form and size in the different tissues, are occupied by the elements of the tissue which consequently lie *outside* the capillaries.

The blood flowing through the capillaries consists, under normal conditions, of an almost colourless fluid, the *plasma*, in which are carried a number of bodies, the *red*, and the *white corpuscles*. Outside the capillary walls, filling up such spaces as exist between the capillary walls and the cells or fibres of the tissue, or between the elements of the tissue themselves, is found a colourless fluid, resembling in many respects the plasma of blood and called *lymph*. Thus all the elements of the tissue and the outsides of all the capillaries are bathed with lymph, which, as we shall see hereafter, is continually flowing away from the tissue along special channels to pass into lymphatic vessels and thence into the blood.

As the blood flows through the capillaries certain constituents of the plasma (together with, at times, white corpuscles, and under exceptional circumstances red corpuscles) pass through the capillary wall into the lymph, and certain constituents of the lymph pass through the capillary wall into the blood within the capillary. There is thus an interchange of material between the blood within the capillary and the lymph outside. A similar interchange of material is at the same time going on between the lymph and the tissue itself. Hence, by means of the lymph acting as middleman, a double interchange of material takes place between the blood within the capillary and the tissue outside the capillary. In every tissue, so long as life lasts and the blood flows through the blood vessels, a double stream, now rapid now slow, is passing from the blood to the tissue and from the tissue to the blood. The stream from the blood to the tissue carries to the tissue the material which the tissue needs for building itself up and for doing its work, including the all important oxygen. The

stream from the tissue to the blood carries into the blood certain of the products of the chemical changes which have been taking place in the tissue, products which may be simple waste, to be cast out of the body as soon as possible, or which may be bodies capable of being made use of by some other tissue.

A third stream, that from the lymph lying in the chinks and crannies of the tissue along the lymph channels to the larger lymph vessels, carries away from the tissue such parts of the material coming from the blood as are not taken up by the tissue itself and such parts of the material coming from the tissue as do not find their way into the blood vessel.

In most tissues, as in muscle for instance, the capillary network is so close set and the muscular fibre lies so near to the blood vessel that the lymph between the two exists only as a very thin sheet; but in some tissues as in cartilage the blood vessels lie on the outside of a large mass of tissue, the interchange between the central parts of which and the nearest capillary blood vessel is carried on through a long stretch of lymph passages. But in each case the principle is the same; the tissue, by the help of lymph, *lives on the blood*; and when in succeeding pages we speak of changes between the blood and the tissues, it will be understood, whether expressly stated so or no, that the changes are effected by means of the lymph. The blood may thus be regarded as *an internal medium* bearing the same relations to the constituent tissues that the external medium, the world, does to the whole individual. Just as the whole organism lives on the things around it, its air and its food, so the several tissues live on the complex fluid by which they are all bathed and which is to them their immediate air and food.

All the tissues take up oxygen from the blood and give up carbonic acid to the blood, but not always at the same rate or at the same time. Moreover the several tissues take up from the blood and give up to the blood either different things or the same things at different rates or at different times.

From this it follows, on the one hand, that the composition and characters of the blood must be for ever varying in different parts of the body and at different times; and on the other hand, that the united action of all the tissues must tend to establish and maintain an average uniform composition of the whole mass of blood. The special changes which blood is known to undergo while it passes through the several tissues will best be dealt with when the individual tissues and organs come under our consideration. At present it will be sufficient to study the main features which are presented by blood, brought so to speak, into a state of equilibrium by the common action of all the tissues.

Of all these main features of blood, the most striking if not the most important is the property it possesses of clotting when shed.

SECT. I. THE CLOTTING OF BLOOD.

§ 14. Blood, when shed from the blood vessels of a living body, is perfectly fluid. In a short time it becomes viscid: it flows less readily from vessel to vessel. The viscosity increases rapidly until the whole mass of blood under observation becomes a complete jelly. The vessel into which it has been shed can at this stage be inverted without a drop of the blood being spilt. The jelly is of the same bulk as the previously fluid blood, and if carefully shaken out will present a complete mould of the interior of the vessel. If the blood in this jelly stage be left untouched in a glass vessel, a few drops of an almost colourless fluid soon make their appearance on the surface of the jelly. Increasing in number, and running together, the drops after a while form a superficial layer of pale straw-coloured fluid. Later on, similar layers of the same fluid are seen at the sides and finally at the bottom of the jelly, which, shrunk to a smaller size and of firmer consistency, now forms a clot or *crassamentum*, floating in a perfectly fluid *serum*. The shrinking and condensation of the clot, and the corresponding increase of the serum, continue for some time. The upper surface of the clot is generally slightly concave. A portion of the clot examined under the microscope is seen to consist of a feltwork of fine granular fibrils, in the meshes of which are entangled the red and white corpuscles of the blood. In the serum nothing can be seen but a few stray corpuscles chiefly white. The fibrils are composed of a substance called *fibrin*. Hence we may speak of the clot as consisting of fibrin and corpuscles; and the act of clotting is obviously a substitution for the plasma of fibrin and serum, followed by a separation of the fibrin and corpuscles from the serum.

In man, blood when shed becomes viscid in about two or three minutes, and enters the jelly stage in about five or ten minutes. After the lapse of another few minutes the first drops of serum are seen, and clotting is generally complete in from one

to several hours. The times however will be found to vary according to circumstances. Among animals the rapidity of clotting varies exceedingly in different species. The blood of the horse clots with remarkable slowness; so slowly indeed that many of the red and also some of the white corpuscles (both these being specifically heavier than the plasma) have time to sink before viscosity sets in. In consequence there appears on the surface of the blood an upper layer of colourless plasma, containing in its deeper portions many colourless corpuscles (which are lighter than the red). This layer clots like the other parts of the blood, forming the so-called 'buffy coat.' A similar buffy coat is sometimes seen in the blood of man, in certain abnormal conditions of the body.

If a portion of horse's blood be surrounded by a cooling mixture of ice and salt, and thus kept at about 0° C., clotting may be almost indefinitely postponed. Under these circumstances a more complete descent of the corpuscles takes place, and a considerable quantity of colourless transparent plasma free from blood-corpuscles may be obtained. A portion of this plasma removed from the freezing mixture clots in the same manner as does the entire blood. It first becomes viscid and then forms a jelly, which subsequently separates into a colourless shrunken clot and serum. This shews that the corpuscles are not an essential part of the clot.

If a few cubic centimetres of this colourless plasma, or of a similar plasma which may be obtained from almost any blood by means which we will presently describe, be diluted with many times its bulk of a 0.6 p.c. solution of sodium chloride¹ clotting is much retarded, and the various stages may be more easily watched. As the fluid is becoming viscid, fine fibrils of fibrin will be seen to be developed in it, especially at the sides of the containing vessel. As these fibrils multiply in number, the fluid becomes more and more of the consistence of a jelly and at the same time somewhat opaque. Stirred or pulled about with a needle, the fibrils shrink up into a small opaque stringy mass; and a very considerable bulk of the jelly may by agitation be resolved into a minute fragment of shrunken fibrin floating in a quantity of what is really diluted serum. If a specimen of such diluted plasma be stirred from time to time, as soon as clotting begins, with a needle or glass rod, the fibrin may be removed piecemeal as it forms, and the jelly stage may be altogether done away with. When fresh blood which has not yet had time to clot is stirred or whipped with a bundle of rods (or anything presenting a large amount of rough surface), no jelly-like clotting takes place, but the rods become covered with a mass of shrunken fibrin. Blood thus whipped until fibrin ceases to be deposited, is found to have entirely lost its power of clotting.

¹ A solution of sodium chloride of this strength will hereafter be spoken of as 'normal saline solution.'

Putting these facts together, it is very clear that the phenomena of the clotting of blood are caused by the appearance in the plasma of fine fibrils of fibrin. So long as these are scanty, the blood is simply viscid. When they become sufficiently numerous, they give the blood the firmness of a jelly. Soon after their formation they begin to shrink, and while shrinking enclose in their meshes the corpuscles but squeeze out the fluid parts of the blood. Hence the appearance of the shrunken coloured clot and the colourless serum.

§ 15. Fibrin, whether obtained by whipping freshly-shed blood, or by washing either a normal clot, or a clot obtained from colourless plasma, exhibits the same general characters. It belongs to that class of complex unstable nitrogenous bodies called *proteids* which form a large portion of all living bodies and an essential part of all living structures.

Our knowledge of proteids is at present too imperfect, and probably none of them have yet been prepared in adequate purity, to justify us in attempting to assign to them any definite formula; but it is important to remember their general composition. 100 parts of a proteid contain rather more than 50 parts of carbon, rather more than 15 of nitrogen, about 7 of hydrogen, and rather more than 20 of oxygen; that is to say they contain about half their weight of carbon, and only about $\frac{1}{6}$ th their weight of nitrogen; and yet as we shall see they are eminently the nitrogenous substances of the body. They usually contain a small quantity (1 or 2 p.c.) of sulphur, and many also have some phosphorus attached to them in some way or other. When burnt they leave a variable quantity of ash, consisting of inorganic salts of which the bases are chiefly sodium and potassium and the acids chiefly hydrochloric, sulphuric, phosphoric and carbonic.

They all give certain reactions, by which their presence may be recognised: of these the most characteristic are the following. Boiled with nitric acid they give a yellow colour, which deepens into orange upon the addition of ammonia. This is called the *xanthoproteic* test; the colour is due to a product of decomposition. Boiled with the mixture of mercuric and mercurous nitrates known as *Millon's reagent* they give a pink colour. Mixed with a strong solution of sodic hydrate they give on the addition of a drop or two of a very weak solution of cupric sulphate a violet colour which deepens on heating. These are artificial reactions, not throwing much if any light on the constitution of proteids; but they are useful as practical tests enabling us to detect the presence of proteids.

The several members of the proteid group are at present distinguished from each other chiefly by their respective solubilities, especially in various saline solutions. Fibrin is one of the least soluble; it is insoluble in water, almost insoluble in dilute neutral saline solutions, and very sparingly soluble in more concentrated

neutral saline solutions and in dilute acids and alkalis. In strong acids and alkalis it dissolves, but in the process becomes completely changed into something which is no longer fibrin. In dilute acids it swells up and becomes transparent, but when the acid is neutralized returns to its previous condition. When suspended in water and heated to 100° C. or even to 75° C., it becomes changed, and still less soluble than before; it is said in this case to be *coagulated* by the heat, and as we shall see nearly all proteids have the property of being changed in nature, of undergoing coagulation and so becoming less soluble than before, by being exposed to a certain high temperature.

Fibrin then is a proteid distinguished from other proteids by its smaller solubility; it is further distinguished by its peculiar filamentous structure, the other proteids when obtained in a solid form appearing either in amorphous granules or at most in viscid masses.

§ 16. We may now return to the *serum*.

This is perfectly fluid, and remains fluid until it decomposes. It is of a faint straw colour, due to the presence of a special pigment substance, differing from the red matter which gives redness to the red corpuscles.

Tested by the xanthoproteic and other tests it obviously contains a large quantity of proteid matter, and upon examination we find that at least two distinct proteid substances are present in it.

If crystals of magnesium sulphate be added to serum and gently stirred until they dissolve, it will be seen that the serum as it approaches saturation with the salt becomes turbid instead of remaining clear, and eventually a white amorphous granular or flocculent precipitate makes its appearance. This precipitate may be separated by decantation or filtration, washed with saturated solutions of magnesium sulphate, in which it is insoluble, until it is freed from all other constituents of the serum, and thus obtained fairly pure. It is then found to be a proteid body, distinguished by the following characters among others:

1. It is (when freed from any adherent magnesium sulphate) insoluble in distilled water; it is insoluble in concentrated solutions of neutral saline bodies, such as magnesium sulphate, sodium chloride, &c., but readily soluble in dilute (e.g. 1 p.c.) solutions of the same neutral saline bodies. Hence from its solutions in the latter it may be precipitated either by adding more neutral saline substance or by removing by dialysis the small quantity of saline substance present. When obtained in a precipitated form, and suspended in distilled water, it readily dissolves into a clear solution upon the addition of a small quantity of some neutral saline body. By these various solutions and precipitations it is not really changed in nature.

2. It readily dissolves in very dilute acids (e.g. in hydro-

chloric acid even when diluted to far less than 1 p.c.), and it is similarly soluble in dilute alkalis, but in being thus dissolved it is wholly changed in nature, and the solutions of it in dilute acid and dilute alkalis give reactions quite different from those of the solution of the substance in dilute neutral saline solutions. By the acid it is converted into what is called *acid-albumin*, by the alkali into *alkali-albumin*, both of which bodies we shall have to study later on.

3. When it is suspended in water and heated it becomes altered in character, *coagulated*, and all its reactions are changed. It is no longer soluble in dilute neutral saline solutions, not even in dilute acids and alkalis; it has become *coagulated proteid*, and is now even less soluble than fresh fibrin. When a solution of it in dilute neutral saline solution is similarly heated, a similar change takes place, a precipitate falls down which on examination is found to be coagulated proteid. The temperature at which this change takes place is somewhere about 75° C., though shifting slightly according to the quantity of saline substance present in the solution.

The above three reactions are given by a number of proteid bodies forming a group called *globulins*, and the particular globulin present in blood-serum is called *paraglobulin*.

One of the proteids present in blood-serum is then paraglobulin, characterised by its solubility in dilute neutral saline solutions, its insolubility in distilled water and concentrated saline solutions, its ready solubility, and at the same time conversion into other bodies, in dilute acids and alkalis, and in its becoming converted into coagulated proteid, and so being precipitated from its solutions at 75° C.

The amount of it present in blood-serum varies in various animals, and apparently in the same animal at different times. In 100 parts by weight of serum there are generally present about 8 or 9 parts of proteids altogether, and of these some 3 or 4, more or less, may be taken as paraglobulin.

§ 17. If the serum from which the paraglobulin has been precipitated by the addition of neutral salt, and removed by filtration, be subjected to dialysis, the salt added may be removed, and a clear, somewhat diluted serum free from paraglobulin may be obtained.

This still gives abundant proteid reactions, so that the serum still contains a proteid, or some proteids still more soluble than the globulins, since they will remain in solution, and are not precipitated, even when dialysis is continued until the serum is practically freed from both the neutral salt added to it and the diffusible salts previously present in the natural serum.

When this serum is heated to 75° C. a precipitate makes its appearance, the proteids still present are coagulated at this temperature.

We have some reasons for thinking that more than one proteid is present, but they are all closely allied to each other, and we may for the present speak of them as if they were one, and call the proteid left in serum, after removal of the paraglobulin, by the name of *albumin*, or, to distinguish it from other albumins found elsewhere, *serum-albumin*. Serum-albumin is distinguished by being more soluble than the globulins, since it is soluble in distilled water, even in the absence of all neutral salts. Like the globulins, though with much less ease, it is converted by dilute acids and dilute alkalis into acid- or into alkali-albumin.

The percentage amount of serum-albumin in serum may be put down as 4 or 5, more or less, but it varies and sometimes is less abundant than paraglobulin. In some animals (snakes) it is said to disappear during starvation.

The more important characters of the three proteids which we have just studied may be stated as follows:

Soluble in water and in saline solutions of all strengths	<i>serum-albumin</i> .
Insoluble in water, readily soluble in dilute saline solutions, insoluble in concentrated saline solutions	<i>paraglobulin</i> .
Insoluble in water, hardly soluble at all in dilute saline solutions, and very little soluble in more concentrated saline solutions.....	<i>fibrin</i> .

Besides paraglobulin and serum-albumin, serum contains a very large number of substances, generally in small quantity, which, since they have to be extracted by special methods, are called *extractives*; of these some are nitrogenous, some non-nitrogenous. Serum contains besides important inorganic saline substances; but to these we shall return.

§ 18. With the knowledge which we have gained of the proteids of clotted blood we may go back to the question:—Clotting being due to the appearance in blood plasma of a proteid substance, fibrin, which previously did not exist in it as such, what are the causes which lead to the appearance of fibrin?

We learn something by studying the most important external circumstances which affect the rapidity with which the blood of the same individual clots when shed. These are as follows:

A temperature of about 40° C., which is about or slightly above the temperature of the blood of warm-blooded animals, is perhaps the most favourable to clotting. A further rise of a few degrees is apparently also beneficial, or at least not injurious; but upon a still further rise the effect changes, and when blood is rapidly heated to 56° C. no clotting at all may take place. At this temperature certain proteids of the blood are coagulated and precipitated before clotting can take place, and with this change the power of the blood to clot is wholly lost. If however the heating be not very rapid,

the blood may clot before this change has time to come on. When the temperature instead of being raised is lowered below 40° C. the clotting becomes delayed and prolonged; and at the temperature of 0° or 1° C. the blood will remain fluid, and yet capable of clotting when withdrawn from the adverse circumstances, for a very long, it might almost be said, for an indefinite time.

A small quantity of blood shed into a small vessel clots sooner than a large quantity shed into a larger one; and in general the greater the amount of foreign surface with which the blood comes in contact the more rapid the clotting. When shed blood is stirred or "whipped" the fibrin makes its appearance sooner than when the blood is left to clot in the ordinary way; so that here too the accelerating influence of contact with foreign bodies makes itself felt. Similarly, movement of shed blood hastens clotting, since it increases the amount of contact with foreign bodies. So also the addition of spongy platinum or of powdered charcoal, or of other inert powders, to tardily clotting blood, will by influence of surface, hasten clotting. Conversely, blood brought into contact with pure oil does not clot so rapidly as when in contact with glass or metal; and blood will continue to flow for a longer time without clotting through a tube smeared inside with oil than through a tube not so smeared. The influence of the oil in such cases is a physical not a chemical one; any pure neutral inert oil will do. As far as we know these influences affect only the rapidity with which the clotting takes place, that is, the rapidity with which the fibrin makes its appearance, not the amount of clot, not the quantity of fibrin formed, though when clotting is very much retarded by cold changes may ensue whereby the amount of clotting which eventually takes place is indirectly affected.

Mere exposure to air exerts apparently little influence on the process of clotting. Blood collected direct from a blood-vessel over mercury so as wholly to exclude the air, clots, in a general way, as readily as blood freely exposed to the air. It is only when blood is much laden with carbonic acid, the presence of which is antagonistic to clotting, that exclusion of air, by hindering the escape of the excess of carbonic acid, delays clotting.

These facts teach us that fibrin does not as was once thought make its appearance in shed blood because the blood when shed ceases to share in the movement of the circulation, or because the blood is cooled on leaving the warm body, or because the blood is then more freely exposed to the air; they further suggest the view that the fibrin is the result of some chemical change, the conversion into fibrin of something which is not fibrin, the change like other chemical changes being most active at an *optimum* temperature, and like so many other chemical changes being assisted by the influences exerted by the presence of inert bodies.

And we have direct experimental evidence that plasma does contain an antecedent of fibrin which by chemical change is converted into fibrin.

§ 19. If blood be received direct from the blood-vessels into one-third its bulk of a saturated solution of some neutral salt such as magnesium sulphate, and the two gently but thoroughly mixed, clotting, especially at a moderately low temperature, will be deferred for a very long time. If the mixture be allowed to stand, the corpuscles will sink, and a colourless plasma will be obtained similar to the plasma gained from horse's blood by cold, except that it contains an excess of the neutral salt. The presence of the neutral salt has acted in the same direction as cold: it has prevented the occurrence of clotting. It has not destroyed the fibrin; for if some of the plasma be diluted with from five to ten times its bulk of water, it will clot speedily in quite a normal fashion, with the production of quite normal fibrin.

The separation of the fluid plasma from the corpuscles and from other bodies heavier than the plasma is much facilitated by the use of the centrifugal machine. This consists essentially of a tireless wheel with several spokes, placed in a horizontal position and made to revolve with great velocity (1000 revolutions per minute for instance) round its axis. Tubes of metal or very strong glass are suspended at the ends of the spokes by carefully adjusted joints. As the wheel rotates with increasing velocity, each tube gradually assumes a horizontal position, bottom outwards, without spilling any of its contents. As the rapid rotation continues the corpuscles and heavier particles are driven to the bottom of the tube, and if a very rapid movement be continued for a long time will form a compact cake at the bottom of the tube. When the rotation is stopped the tubes gradually return to their upright position again without anything being spilt, and the clear plasma in each tube can then be decanted off.

If some of the colourless transparent plasma, obtained either by the action of neutral salts from any blood, or by the help of cold from horse's blood, be treated with some solid neutral salt, such as sodium chloride, to saturation, a white flaky, somewhat sticky precipitate will make its appearance. If this precipitate be removed, the fluid no longer possesses the power of clotting (or very slightly so), even though the neutral salt present be removed by dialysis, or its influence lessened by dilution. With the removal of the substance precipitated, the plasma has lost its power of clotting.

If the precipitate itself, after being washed with a saturated solution of the neutral salt (in which it is insoluble) so as to get rid of all serum and other constituents of the plasma, be treated with a small quantity of water, it readily dissolves¹, and the solution rapidly filtered gives a clear colourless filtrate, which is at first perfectly fluid. Soon however the fluidity gives way to viscosity,

¹ The substance itself is not soluble in distilled water, but a quantity of the neutral salts always clings to the precipitate, and thus the addition of water virtually gives rise to a dilute saline solution, in which the substance is readily soluble.

and this in turn to a jelly condition, and finally the jelly shrinks into a clot floating in a clear fluid; in other words, the filtrate clots like plasma. Thus there is present in cooled plasma, and in plasma kept from clotting by the presence of neutral salts, a something, precipitable by saturation with neutral salts, a something which, since it is soluble in very dilute saline solutions, cannot be fibrin itself, but which in solution speedily gives rise to the appearance of fibrin. To this substance its discoverer, Denis, gave the name of *plasmine*.

The substance thus precipitated is not however a single body but a mixture of at least two bodies. If sodium chloride be carefully added to plasma to an extent of about 13 per cent. a white flaky viscid precipitate is thrown down very much like *plasmine*. If after the removal of the first precipitate more sodium chloride and especially if magnesium sulphate be added, a second precipitate is thrown down, less viscid and more granular than the first.

The second precipitate when examined is found to be identical with the *paraglobulin*, coagulating at 75° C., which we have already seen to be a constituent of serum.

The first precipitate is also a proteid belonging to the globulin group, but differs from *paraglobulin* not only in being more readily precipitated by sodium chloride, and in being when precipitated more viscid, but also in other respects, and especially in being coagulated at a far lower temperature than *paraglobulin*, viz. at 56° C. Now while isolated *paraglobulin* cannot by any means known to us be converted into fibrin, and its presence in the so-called *plasmine* does not seem to be essential to the formation of fibrin out of *plasmine*, the presence in *plasmine* of the body coagulating at 56° C. does seem essential to the conversion of *plasmine* into fibrin, and we have reason for thinking that it is itself converted, in part at least, into fibrin. Hence it has received the name of *fibrinogen*.

§ 20. The reasons for this view are as follows.

Besides blood which clots naturally when shed, there are certain fluids in the body which do not clot naturally, either in the body or when shed, but which by certain artificial means may be made to clot, and in clotting to yield quite normal fibrin.

Thus the so-called serous fluid taken some hours after death¹ from the pericardial, pleural or peritoneal cavities, the fluid found in the enlarged serous sac of the testis, known as hydrocele fluid, and other similar fluids, will in the majority of cases, when obtained free from blood or other admixtures, remain fluid almost indefinitely, shewing no disposition whatever to clot². Yet in most cases at

¹ If it be removed immediately after death it generally clots readily and firmly, giving a colourless clot consisting of fibrin and white corpuscles.

² In some specimens, however, a spontaneous coagulation, generally slight, but in exceptional cases massive, may be observed.

all events, these fluids, when a little blood, or a piece of blood clot, or a little serum is added to them, will clot rapidly and firmly¹, giving rise to an unmistakable clot of normal fibrin, differing only from the clot of blood in that, when serum is used, it is colourless, being free from red corpuscles.

Now blood (or blood clot, or serum) contains many things, to any one of which the clotting power thus seen might be attributed. But it is found that in many cases clotting may be induced in the fluids of which we are speaking by the mere addition, and that even in exceedingly small quantity, of a substance which can be extracted from blood, or from serum, or from blood clot, or even from washed fibrin, or indeed from other sources, a substance whose exact nature is uncertain, it being doubtful whether it is a proteid at all, and whose action is peculiar.

If serum, or whipped blood or a broken-up clot be mixed with a large quantity of alcohol and allowed to stand some days, the proteids present are in time so changed by the alcohol as to become insoluble in water. Hence if the copious precipitate caused by the alcohol, after long standing, be separated by filtration from the alcohol, dried at a low temperature, not exceeding 40° C., and extracted with distilled water, the aqueous extract contains very little proteid matter, indeed very little organic matter at all. Nevertheless even a small quantity of this aqueous extract added alone to certain specimens of hydrocele fluid or other of the fluids spoken of above, will bring about a speedy clotting. The same aqueous extract has also a remarkable effect in hastening the clotting of fluids which, though they will eventually clot, do so very slowly. Thus plasma may, by the careful addition of a certain quantity of neutral salt and water, be reduced to such a condition that it clots very slowly indeed, taking perhaps days to complete the process. The addition of a small quantity of the aqueous extract we are describing will however bring about a clotting which is at once rapid and complete.

The active substance, whatever it be, in this aqueous extract exists in small quantity only, and its clotting virtues are at once and for ever lost when the solution is boiled. Further, there is no reason to think that the active substance actually enters into the formation of the fibrin to which it gives rise. It appears to belong to a class of bodies playing an important part in physiological processes and called *ferments*, of which we shall have more to say hereafter. We may therefore speak of it as the *fibrin ferment*, the name given to it by its discoverer Alexander Schmidt.

This fibrin ferment is present in and may be extracted from clotted or whipped blood, and from both the clot² and the serum of clotted blood; and since in most if not all cases where blood or

¹ In a few cases no coagulation can thus be induced.

² A powerful solution of fibrin ferment may be readily prepared by simply extracting a washed blood clot with a 10 p.c. solution of sodium chloride.

blood clot or serum produces clotting in hydrocele or pericardial fluid, an exactly similar clotting may be induced by the mere addition of fibrin ferment, we seem justified in concluding that the clotting virtues of the former are due to the ferment which they contain.

Now when fibrinogen is precipitated from plasma as above described by sodium chloride, redissolved, and reprecipitated, more than once, it may be obtained in solution, by help of a dilute neutral saline solution, in an approximately pure condition, at all events free from other proteids. Such a solution will not clot spontaneously; it may remain fluid indefinitely; and yet on the addition of a little fibrin ferment it will clot readily and firmly, yielding quite normal fibrin.

This body fibrinogen is also present and may be separated out from the specimens of hydrocele, pericardial, and other fluids which clot on the addition of fibrin ferment, and when the fibrinogen has been wholly removed from these fluids they refuse to clot on the addition of fibrin ferment.

Paraglobulin, on the other hand, whether prepared from plasmine by separation of the fibrinogen, or from serum, or from other fluids in which it is found, cannot be converted by fibrin ferment or indeed by any other means into fibrin. And fibrinogen isolated as described above, or serous fluids which contain fibrinogen, can be made, by means of fibrin ferment, to yield quite normal fibrin in the complete absence of paraglobulin. A solution of paraglobulin obtained from serum or blood clot will it is true clot pericardial or hydrocele fluids containing fibrinogen, or indeed a solution of fibrinogen, but this is apparently due to the fact that the paraglobulin has in these cases some fibrin ferment mixed with it; it is also possible that under certain conditions the presence of paraglobulin may be favourable to the action of the ferment.

When the so-called plasmine is precipitated as directed in § 19 fibrin ferment is carried down with the fibrinogen and paraglobulin, and when the plasmine is re-dissolved the ferment is present in the solution and ready to act on the fibrinogen. Hence the re-dissolved plasmine clots spontaneously. When fibrinogen is isolated from plasma by repeated precipitation and solution, the ferment is washed away from it, and the pure ferment-free fibrinogen, ultimately obtained, does not clot spontaneously.

So far it seems clear that there does exist a proteid body, fibrinogen, which may by the action of fibrin ferment be directly, without the intervention of other proteids, converted into the less soluble fibrin. Our knowledge of the constitution of proteid bodies is too imperfect to enable us to make any very definite statement as to the exact nature of the change thus effected; but we may say this much. Fibrinogen and fibrin have about the same elementary composition, fibrin containing a trifle more nitrogen. When fibrinogen is converted into fibrin by means of fibrin ferment, the weight of

the fibrin produced is always less than that of the fibrinogen which is consumed, and there is always produced at the same time a certain quantity of another proteid, belonging to the globulin family. There are reasons however why we cannot speak of the ferment as *splitting up* fibrinogen into fibrin and a globulin; it seems more probable that the ferment converts the fibrinogen first into a body which we might call *soluble fibrin*, and then turns this body into veritable fibrin; but further inquiries on the subject are needed.

It may be added that among the conditions necessary for the due action of fibrin ferment on fibrinogen, the presence of a certain quantity of some neutral salt seems to be one. In the total absence of all neutral salts the ferment cannot convert the fibrinogen into fibrin. There are some reasons also for thinking that the presence of a lime salt such as calcium sulphate, though it may be in minute quantity only, is essential.

§ 21. We may conclude then that the plasma of blood when shed, or at all events soon after it has been shed, contains fibrinogen; and it also seems probable that the clotting comes about because the fibrinogen is converted into fibrin by the action of fibrin ferment; but we are still far from a definite answer to the question, why blood remains fluid in the body and yet clots when shed?

We have already said that blood, or blood plasma, brought up to a temperature of 56° C. as soon as possible after its removal from the living blood vessels, gives a proteid precipitate and loses its power of clotting. This may be taken to shew that blood, as it circulates in the living blood vessels, contains fibrinogen as such, and that when the blood is heated to 56° C., which is the coagulating point of fibrinogen, the fibrinogen present is coagulated and precipitated, and consequently no fibrin can be formed.

Further, while clotted blood undoubtedly contains an abundance of fibrin ferment, no ferment, or a minimal quantity only, is present in blood as it leaves the blood vessels. If blood be received directly from the blood vessels into alcohol, the aqueous extract prepared as directed above contains no ferment or merely a trace. Apparently the ferment makes its appearance in the blood as the result of changes taking place in the blood after it has been shed.

We might from this be inclined to conclude that blood clots when shed but not before, because, fibrinogen being always present, the shedding brings about changes which produce fibrin ferment, not previously existing, and this acting on the fibrinogen gives rise to fibrin. But we meet with the following difficulty. A very considerable quantity of very active ferment may be injected into the blood current of a living animal without necessarily producing any clotting at all. Obviously either blood within the blood vessels does not contain fibrinogen as such, and the fibrinogen detected by heating the blood to 56° C. is the result of changes

which have already ensued before that temperature is reached; or in the living circulation there are agencies at work which prevent any ferment which may be introduced into the circulation from producing its usual effects on fibrinogen; or there are agencies at work which destroy or do away with the fibrin, little by little, as it is formed.

§ 22. And indeed when we reflect how complex blood is, and of what many and great changes it is susceptible, we shall not wonder that the question we are putting cannot be answered off hand.

The corpuscles with which blood is crowded are living structures and consequently are continually acting upon and being acted upon by the plasma. The red corpuscles it is true are, as we shall see, peculiar bodies, with a restricted life and a very specialized work, and possibly their influence on the plasma is not very great; but we have reason to think that the relations between the white corpuscles and the plasma are close and important.

Then again the blood is not only acting upon and being acted upon by the several tissues as it flows through the various capillaries, but along the whole of its course, through the heart, arteries, capillaries and veins, is acting upon and being acted upon by the vascular walls, which like the rest of the body are alive, and being alive are continually undergoing and promoting change.

That relations of some kind, having a direct influence on the clotting of blood, do exist between the blood and the vascular walls is shewn by the following facts.

After death, when all motion of the blood has ceased, the blood remains for a long time fluid. It is not till some time afterwards, at an epoch when post-mortem changes in the blood and in the blood vessels have had time to develop themselves, that clotting begins. Thus some hours after death the blood in the great veins may be found still perfectly fluid. Yet such blood has not lost its power of clotting; it still clots when removed from the body, and clots too when received over mercury without exposure to air, shewing that, though the blood, being highly venous, is rich in carbonic acid and contains little or no oxygen, its fluidity is not due to any excess of carbonic acid or absence of oxygen. Eventually it does clot even within the vessels, but perhaps never so firmly and completely as when shed. It clots first in the larger vessels, but remains fluid in the smaller vessels for a very long time, for many hours in fact, since in these the same bulk of blood is exposed to the influence of, and reciprocally exerts an influence on, a larger surface of the vascular walls than in the larger vessels. And if it be urged that the result is here due to influences exerted by the body at large, by the tissues as well as by the vascular walls, this objection will not hold good against the following experiment.

If the jugular vein of a large animal, such as an ox or horse, be carefully ligatured when full of blood, and the ligatured portion

excised, the blood in many cases remains perfectly fluid, along the greater part of the length of the piece, for twenty-four or even forty-eight hours. The piece so ligatured may be suspended in a framework and opened at the top so as to imitate a living test-tube, and yet the blood will often remain long fluid, though a portion removed at any time into a glass or other vessel will clot in a few minutes. If two such living test-tubes be prepared, the blood may be poured from one to the other without clotting taking place.

A similar relation of the fluid to its containing living wall is seen in the case of those serous fluids which clot spontaneously. If, as soon after death as the body is cold and the fat is solidified, the pericardium be carefully removed from a sheep by an incision round the base of the heart, the pericardial fluid (which, as we have already seen, during life, and some little time after death, possesses the power of clotting) may be kept in the pericardial bag as in a living cup for many hours without clotting, and yet a small portion removed with a pipette clots at once.

This relation between the blood and the vascular wall may be disturbed or overridden: clotting may take place or may be induced within the living blood vessel. When the lining membrane is injured, as when an artery or vein is sharply ligatured, or when it is diseased, as for instance in aneurism, a clot is apt to be formed at the injured or diseased spot; and in certain morbid conditions of the body clots are formed in various vascular tracts. Absence of motion, which in shed blood, as we have seen, is unfavourable to clotting, is apt within the body to lead to clotting. Thus when an artery is ligatured, the blood in the tract of artery on the cardiac side of the ligature, between the ligature and the branch last given off by the artery, ceasing to share in the circulation, remains motionless or nearly so, and along this tract a clot forms, firmest next to the ligature and ending near where the branch is given off; this perhaps may be explained by the fact that the walls of the tract suffer in their nutrition by the stagnation of the blood, and that consequently the normal relation between them and the contained blood is disturbed.

That the blood within the living blood vessels, though not actually clotting under normal circumstances, may easily be made to clot, that the blood is in fact so to speak always on the point of clotting, is shewn by the fact that a foreign body, such as a needle thrust into the interior of a blood vessel or a thread drawn through and left in a blood vessel, is apt to become covered with fibrin. Some influence exerted by the needle or thread, whatever may be the character of that influence, is sufficient to determine a clotting, which otherwise would not have taken place.

The same instability of the blood as regards clotting is strikingly shewn, in the case of the rabbit at least, by the result of injecting into the blood vessels a small quantity of a solution of a peculiar proteid prepared from certain structures such as the thymus body.

Massive clotting of the blood in almost all the blood vessels, small and large, takes place with great rapidity, leading to the sudden death of the animal. In contrast to this effect may be mentioned the result of injecting into the blood vessels of a dog a quantity of a solution of a body called *albumose*, of which we shall hereafter have to treat as a product of the digestion of proteid substances, to the extent of .3 gm. per kilo of body weight. So far from producing clotting, the injected albumose has such an effect on the blood that for several hours after the injection shed blood will refuse to clot of itself and remain quite fluid, though it can be made to clot by special treatment.

§ 23. All the foregoing facts tend to shew that the blood as it is flowing through the healthy blood vessels is, as far as clotting is concerned, in a state of unstable equilibrium, which may at any moment be upset, even within the blood vessels, and which is upset directly the blood is shed, with clotting as a result. Our present knowledge does not permit us to make an authoritative statement as to the exact nature of this equilibrium. There are reasons however for thinking that the white corpuscles play an important part in the matter. Wherever clotting occurs naturally, white corpuscles are present; and this is true not only of blood but also of such specimens of pericardial or other serous fluids as clot naturally. When horse's blood is kept fluid by being retained within the jugular vein, as mentioned a little while back, and the vein is hung upright, the corpuscles both red and white sink, leaving an upper layer of plasma almost free from corpuscles. This upper layer will be found to have lost largely its power of clotting spontaneously, though the power is at once regained if the white corpuscles from the layers beneath be returned to it. And many other arguments, which we cannot enter upon here, may be adduced all pointing to the same conclusion, that the white corpuscles play an important part in the process of clotting. But it would lead us too far into controversial matters to attempt to define what that part is, or to explain the exact nature of the equilibrium of which we have spoken, or to discuss such questions as—Whether the ordinary white corpuscles, or corpuscles of a special kind are concerned in the matter? Whether the corpuscles, when clotting takes place, give out something, e.g. fibrinogen or ferment or both or something else, or whether the corpuscles simply in some way or other assist in the transformation of some previously existing constituents of the plasma? Whether the influence exerted by the condition of the vascular wall is exerted directly on the plasma or indirectly on the corpuscles? Whether, as some have thought, the peculiar bodies of which we shall presently speak under the name of *blood platelets* have any share in the matter, and if so what? These questions are too involved and the discussion of them too long to be entered upon here.

What we do know is that in blood soon after it has been shed,

the body which we have called fibrinogen is present as also the body which we have called fibrin ferment, that the latter acting on the former will produce fibrin, and that the appearance of fibrin is undoubtedly the cause of what is called clotting. We seem justified in concluding that the clotting of shed blood is due to the conversion by ferment of fibrinogen into fibrin. The further inference that clotting within the body is the same thing as clotting outside the body and similarly due to the transformation of fibrinogen by ferment into fibrin, though probable, is not proved. We do not yet know the exact nature and condition of the blood within the living blood vessels, and until we know that we cannot satisfactorily explain why blood in the living blood vessels is usually fluid but can at times clot.

SEC. 2. THE CORPUSCLES OF THE BLOOD.

The Red Corpuscles.

§ 24. The redness of blood is due exclusively to the red corpuscles. The plasma as seen in thin layers within the living blood vessels appears colourless, as does also a thin layer of serum; but a thick layer of serum (and probably of plasma) has a faint yellowish tinge due as we have said to the presence of a small quantity of a special pigment.

The corpuscles appear under the microscope as fairly homogeneous, imperfectly translucent biconcave discs with a diameter of 7 to 8 μ and a thickness of 1 to 2 μ . Being discs they are circular in outline when seen on the flat, but rod-shaped when seen in profile as they are turning over. Being biconcave, with a thicker rounded rim surrounding a thinner centre, the rays of light in passing through them, when they are examined by transmitted light, are more refracted at the rim than in the centre. The effect of this is that, when viewed at what may be considered the proper focus, the centre of a corpuscle appears clear, while a slight opacity marks out indistinctly the inner margin of the thicker rim, whereas, when the focus is shifted either up or down, the centre becomes dark and the rest of the corpuscle clear. Any body of the same shape, and composed of substance of the same refractive power, would produce the same optical effects. Otherwise the corpuscle appears homogeneous without distinction of parts and without a nucleus. A single corpuscle seen by itself has a very faint colour, looking yellow rather than red, but when several corpuscles lie one upon the top of the other the mass is distinctly red.

The red corpuscle is elastic, in the sense that it may be deformed by pressure or traction, but when the pressure or traction is removed regains its previous form. Its shape is also much influenced by the physical conditions of the plasma, serum, or fluid in which for the time being it is. If the plasma or serum be diluted with water, the disc, absorbing water, swells up into a sphere, becoming

a disc again on the removal of the dilution. If the serum be concentrated, the disc, giving out water, shrinks irregularly and assumes various forms; one of these forms is that of a number of blunted protuberances projecting all over the surface of the corpuscle, which is then said to be crenate; in a drop of blood examined under the microscope, crenate corpuscles are often seen at the edge of the cover slip where evaporation is leading to concentration of the plasma, or, as it should then perhaps rather be called, serum. In blood just shed the red corpuscles are apt to adhere to each other by their flat surfaces, much more than to the glass or other surface with which the blood is in contact, and hence arrange themselves in rolls. This tendency however to form rolls very soon diminishes after the blood is shed.

Though a single corpuscle is somewhat translucent, a comparatively thin layer of blood is opaque; type for instance cannot be read through even a thin layer of blood.

When a quantity of whipped blood (or blood otherwise deprived of fibrin) is frozen and thawed several times it changes colour, becoming of a darker hue, and is then found to be much more transparent, so that type can now be easily read through a moderately thin layer. It is then spoken of as *laky blood*. The same change may be effected by shaking the blood with ether, or by adding a small quantity of bile salts, and in other ways. Upon examination of laky blood it is found that the red corpuscles are "broken up" or at least altered, and that the redness which previously was confined to them is now diffused through the serum. Normal blood is opaque because each corpuscle while permitting some rays of light (chiefly red) to pass through, reflects many others, and the brightness of the hue of normal blood is due to this reflection of light from the surfaces of the several corpuscles. Laky blood is transparent because there are no longer intact corpuscles to present surfaces for the reflection of light, and the darker hue of laky blood is similarly due to the absence of reflection from the several corpuscles.

When laky blood is allowed to stand a sediment is formed (and may be separated by the centrifugal machine) which on examination is found to consist of discs, or fragments of discs, of a colourless substance exhibiting under high powers an obscurely spongy or reticular structure. These colourless thin discs seen flat-wise often appear as mere rings. The substance composing them stains with various reagents and may thus be made more evident.

The red corpuscle then consists obviously of a colourless framework, with which in normal conditions a red colouring matter is associated; but by various means the colouring matter may be driven from the framework and dissolved in the serum.

The framework is spoken of as *stroma*; it is a modified or differentiated protoplasm, and upon chemical analysis yields proteid substances, some of them at least belonging to the *globulin*

group, and other matters, among which is the peculiar complex fat called *lecithin* of which we shall have to speak in treating of nervous tissue. In the nucleated red corpuscles of the lower vertebrata this differentiated stroma, though forming the chief part of the cell body around the nucleus, is accompanied by a variable amount of undifferentiated protoplasm, but the latter in the mammalian red corpuscle is either absent altogether or reduced to a minimum. Whether any part of this stroma is living, in the sense of being capable of carrying on a continual double chemical change, of continually building itself up as it breaks down, is a question too difficult to be discussed here.

The red colouring matter which in normal conditions is associated with this stroma may by appropriate means be isolated, and, in the case of the blood of many animals, obtained in a crystalline form. It is called *Hæmoglobin*, and may by proper methods be split up into a proteid belonging to the globulin group, and into a coloured pigment, containing iron, called *Hæmatin*. Hæmoglobin is therefore a very complex body. It is found to have remarkable relations to oxygen, and indeed as we shall see the red corpuscles by virtue of their hæmoglobin have a special work in respiration; they carry oxygen from the lungs to the several tissues. We shall therefore defer the further study of hæmoglobin until we have to deal with respiration.

The red corpuscle then consists of a disc of colourless stroma with which is associated in a peculiar way the complex coloured body hæmoglobin. Though the hæmoglobin, as is seen in laky blood, is readily soluble in serum (and it is also soluble in plasma), in the intact normal blood it remains confined to the corpuscle; obviously there is some special connection between the stroma and the hæmoglobin; it is not until the stroma is altered, we may perhaps say killed (as by repeated freezing and thawing), that it loses its hold on the hæmoglobin, which thus set free passes into solution in the serum. The disc of stroma when separated from the hæmoglobin has as we have just said an obscurely spongy texture; but we do not know accurately the exact condition of the stroma in the intact corpuscle or how it holds the hæmoglobin. There is certainly no definite membrane or envelope to the corpuscle, for by exposing blood to a high temperature, 60° C., the corpuscle will break up into more or less spherical pieces, each still consisting of stroma and hæmoglobin.

The quantity of stroma necessary to hold a quantity of hæmoglobin is exceedingly small. Of the total solid matter of a corpuscle more than 90 p.c. is hæmoglobin. A red corpuscle in fact is a quantity of hæmoglobin held together in the form of a disc by a minimal amount of stroma. Hence whatever effect the stroma *per se* may have upon the plasma, this, in the case of mammals at all events, must be insignificant: the red corpuscle is practically simply a carrier of hæmoglobin.

§ 25. The average number of red corpuscles in human blood may be probably put down at about 5 millions in a cubic millimetre (the range in different mammals is said to be from 3 to 18 millions), but the relation of corpuscle to plasma varies a good deal even in health, and very much in disease. Obviously the relation may be affected (1) by an increase or decrease of the plasma, (2) by an actual decrease or increase of red corpuscles. Now the former must frequently take place. The blood as we have already urged is always being acted upon by changes in the tissues and indeed is an index of those changes; hence the plasma must be continually changing, though always striving to return to the normal condition. Thus when a large quantity of water is discharged by the kidney, the skin or the bowels, that water comes really from the blood, and the drain of water must tend to diminish the bulk of the plasma, and so to increase the *relative* number of red corpuscles, though the effect is probably soon remedied by the passage of water from the tissues into the blood. So again when a large quantity of water is drunk, this passes into the blood and tends temporarily to dilute the plasma (and so to diminish the relative number of red corpuscles) though this condition is in turn soon remedied by the passage of the superfluous fluid to the tissues and excretory organs. The greater or less number of red corpuscles then in a given bulk of blood may be simply due to less or more plasma, but we have reason to think that the actual number of the corpuscles in the blood does vary from time to time. This is especially seen in certain forms of disease, which may be spoken of under the general term of anæmia (there being several kinds of anæmia) in which the number of red corpuscles is distinctly diminished.

The redness of blood may however be influenced not only by the number of red corpuscles in each cubic millimetre of blood but also by the amount of hæmoglobin in each corpuscle, and to a less degree by the size of the corpuscles. If we compare, with a common standard, the redness of two specimens of blood unequally red, and then determine the relative number of corpuscles in each, we may find that the less red specimen has as many corpuscles as the redder one, or at least the deficiency in redness is greater than can be accounted for by the paucity of red corpuscles. Obviously in such a case the red corpuscles have too little hæmoglobin. In some cases of anæmia the deficiency of hæmoglobin in each corpuscle is more striking than the scantiness of red corpuscles.

The number of corpuscles in a specimen of blood is determined by mixing a small but carefully measured quantity of the blood with a large quantity of some indifferent fluid, e.g. a 5 p.c. solution of sodium sulphate, and then actually counting the corpuscles in a known minimal bulk of the mixture.

This perhaps may be most conveniently done by the method generally known as that of Gowers (Hæmacytometer) improved by Malassez. A

glass slide, in a metal frame, is ruled into minute rectangles, e.g. $\frac{1}{4}$ mm. by $\frac{1}{5}$ mm., so as to give a convenient area of $\frac{1}{20}$ th of a square mm. Three small screws in the frame permit a coverslip to be brought to a fixed distance, e.g. $\frac{1}{5}$ mm., from the surface of the slide. The blood having been diluted, e.g. to 100 times its volume, a small quantity of the diluted (and thoroughly mixed) blood, sufficient to occupy fully the space between the coverslip and the glass slide when the former is brought to its proper position, is placed on the slide, and the coverslip brought down. The volume of diluted blood now lying over each of the rectangles will be $\frac{1}{100}$ th ($\frac{1}{20} \times \frac{1}{5}$) of a cubic mm.; and if, when the corpuscles have subsided, the number of corpuscles lying within a rectangle be counted, the result will give the number of corpuscles previously distributed through $\frac{1}{100}$ th of a cubic mm. of the diluted blood. This multiplied by 100 will give the number of corpuscles in 1 cubic mm. of the diluted blood, and again multiplied by 100 the number in 1 cubic mm. of the entire blood. It is advisable to count the number of corpuscles in several of the rectangles, and to take the average. For the convenience of counting, each rectangle is subdivided into a number of very small squares, e.g. into 20, each with a side of $\frac{1}{20}$ th mm., and so an area of $\frac{1}{400}$ th of a square mm.

Since the actual number of red corpuscles in a specimen of blood (which may be taken as a sample of the whole blood) is sometimes more, sometimes less, it is obvious that either red corpuscles may be temporarily withdrawn from and returned to the general blood current, or that certain red corpuscles are after a while made away with, and that new ones take their place. We have no satisfactory evidence of the former being the case in normal conditions, whereas we have evidence that old corpuscles do die and that new ones are born.

§ 26. The red corpuscles, we have already said, are continually engaged in carrying oxygen, by means of their hæmoglobin, from the lungs to the tissues; they load themselves with oxygen at the lungs and unload at the tissues. It is extremely unlikely that this act should be repeated indefinitely without leading to changes which may be familiarly described as wear and tear, and which would ultimately lead to the death of the corpuscles.

We shall have to state later on that the liver discharges into the alimentary canal, as a constituent of bile, a considerable quantity of a pigment known as *bilirubin*, and that this substance has remarkable relations with, and indeed may be regarded as a derivative of *hæmatin*, which as we have seen (§ 24) is a product of the decomposition of hæmoglobin. It appears probable in fact that the bilirubin of bile (and this as we shall see is the chief biliary pigment and the source of the other biliary pigments) is not formed wholly anew in the body but is manufactured in some way or other out of hæmatin derived from hæmoglobin. This must entail a daily consumption of a considerable quantity of hæmoglobin, and, since we know no other source of hæmoglobin besides the red corpuscles, and have no evidence of red corpuscles continuing to exist after

having lost their hæmoglobin, must therefore entail a daily destruction of many red corpuscles.

Even in health then a number of red corpuscles must be continually disappearing; and in disease the rapid and great diminution which may take place in the number of red corpuscles shews that large destruction may occur.

We cannot at present accurately trace out the steps of this disappearance of red corpuscles. In the spleen pulp, red corpuscles have been seen in various stages of disorganisation, some of them lying within the substance of large colourless corpuscles, and as it were being eaten by them. There is also evidence that destruction takes place in the liver itself, and indeed elsewhere. But the subject has not yet been adequately worked out.

§ 27. This destruction of red corpuscles necessitates the birth of new corpuscles, to keep up the normal supply of hæmoglobin; and indeed the cases in which after even great loss of blood by hæmorrhage a healthy ruddiness returns, and that often rapidly, shewing that the lost corpuscles have been replaced, as well as the cases of recovery from the disease anæmia, prove that red corpuscles are, even in adult life, born somewhere in the body.

In the developing embryo of the mammal the red corpuscles of the blood are not hæmoglobin-holding non-nucleated discs of stroma, but coloured nucleated cells which have arisen in the following way.

In certain regions of the embryo there are formed nests of nuclei imbedded in that kind of material of which we have already (§ 5) spoken, and of which we shall have again to speak as undifferentiated protoplasm. The special features of this undifferentiated protoplasm are due to the manner in which its living basis (§ 5), in carrying on its continued building up and breaking down, disposes of itself, its food, and its products. These are for a while so arranged as to form a colourless mass with minute colourless solid particles or colourless vacuoles imbedded in it, the whole having a granular appearance. After a while this granular looking protoplasm is in large measure gradually replaced by material of different optical and chemical characters, being for instance more homogeneous and less "granular" in appearance; this new material is stroma, and as it is formed, there is formed with it and in some way or other held by it a colouring matter, hæmoglobin. We cannot at present say anything definite as to the way in which and the steps by which the original protoplasm is thus to a large extent differentiated into stroma and hæmoglobin. All we know is that the existence of what we have called living substance is necessary to the formation of stroma and hæmoglobin. We therefore seem justified in speaking of this living substance as manufacturing these substances, but we do not know whether the living substance turns itself so to speak into stroma or hæmoglobin or both, or whether by some agency, the nature of which is at present unknown to us, it converts some of the material which is present in

the protoplasm and which we may regard as food for itself, into one or other or both of these bodies.

When this differentiation has taken place or while it is still going on, the material in which the nuclei are imbedded divides into separate cell-bodies for the several nuclei; and thus the nest of nuclei is transformed into a group of nucleated red corpuscles, each corpuscle consisting of a nucleus imbedded in a hæmoglobin-holding stroma to which is still attached more or less of the original undifferentiated protoplasm.

Still later on in the life of the embryo the nucleated red corpuscles are replaced by ordinary red corpuscles, by non-nucleated discs composed almost exclusively of hæmoglobin-holding stroma. How the transformation takes place, and especially how the nucleus comes to be absent is at present a matter of considerable dispute; there is much however to be said for the view that the normal red corpuscle is a portion only of a cell, that it is a fragment of cell substance which has been budded off and so has left the nucleus behind.

In the adult as in the embryo the red corpuscles appear to be formed out of preceding coloured nucleated cells.

In the interior of bones is a peculiar tissue called marrow, which in most parts, being very full of blood-vessels, is called *red marrow*. In this red marrow the capillaries and minute veins form an intricate labyrinth of relatively wide passages with very thin walls, and through this labyrinth the flow of blood is comparatively slow. In the passages of this labyrinth are found coloured nucleated cells, that is to say, cells the cell substance of which has undergone more or less differentiation into hæmoglobin and stroma. And there seems to be going on in red marrow a multiplication of such coloured nucleated cells, some of which transformed, in some way or other, into red non-nucleated discs, that is into ordinary red corpuscles, pass away into the general blood current. In other words, a formation of red corpuscles, not wholly unlike that which takes place in the embryo, is in the adult continually going on in the red marrow of the bones.

According to some observers the coloured nucleated cells arise by division, in the marrow, from colourless cells, not unlike but probably distinct in kind from ordinary white corpuscles, the formation of hæmoglobin taking place subsequent to cell-division. Other observers, apparently with reason, urge that, whatever their primal origin, these coloured nucleated cells arise, during post-embryonic life, by the division of previous similar coloured cells, which thus form, in the marrow, a distinct class of cells continually undergoing division and thus giving rise to cells, some of which become red corpuscles and pass into the blood stream, while others remain in the marrow to undergo further division and so to keep up the supply. Such repeatedly dividing cells may fitly be called *hematoblasts*.

A similar formation of red corpuscles has also been described,

though with less evidence, as taking place in the spleen, especially under particular circumstances, such as after great loss of blood.

The formation of red corpuscles is therefore a special process taking place in special regions; we have no satisfactory evidence that the ordinary white corpuscles of the blood are, as they travel in the current of the circulation, transformed into red corpuscles.

The red corpuscles then, to sum up, are useful to the body on account of the hæmoglobin which constitutes so nearly the whole of their solid matter. What functions the stroma may have besides the mere so to speak mechanical one of holding the hæmoglobin in the form of a corpuscle, we do not know. The primary use of the hæmoglobin is to carry oxygen from the lungs to the tissues, and it would appear that it is advantageous to the economy that the hæmoglobin should be as it were bottled up in corpuscles rather than simply diffused through the plasma. How long a corpuscle may live, fetching and carrying oxygen, we do not exactly know; the red corpuscles of one animal, *e.g.* a bird, injected into the vessels of another, *e.g.* a mammal, disappear within a few days; but this affords no measure of the life of a corpuscle in its own home. Eventually however the red corpuscle dies, its place being supplied by a new one. The hæmoglobin set free from the dead corpuscles appears to have a secondary use in forming the pigment of the bile and possibly other pigments.

The White or Colourless Corpuscles.

§ 28. The white corpuscles are far less numerous than the red; a specimen of ordinary healthy blood will contain several hundred red corpuscles to each white corpuscle, though the proportion, even in health, varies considerably under different circumstances, ranging from 1 in 300 to 1 in 700. But though less numerous, the white corpuscles are probably of greater importance to the blood itself than are the red corpuscles; the latter are chiefly limited to the special work of carrying oxygen from the lungs to the tissues, while the former probably exert a considerable influence on the blood plasma itself, and help to maintain it in a proper condition.

When seen in a normal condition, and 'at rest' the white corpuscle is a small spherical colourless mass, varying in size, but with an average diameter of about 10μ , and presenting generally a finely but sometimes a coarsely granular appearance. The surface even when the corpuscle is perfectly at rest, is not absolutely smooth and even but somewhat irregular, thereby contributing to the granular appearance; and at times these irregularities are exaggerated into protuberances or 'pseudopodia' of varying size or form, the corpuscle in this way assuming various forms without changing its bulk, and by the assumption of a series of forms shifting its place. Of these 'amœboid movements' as they are called we shall have to speak later on.

In carrying on these amoeboid movements the corpuscle may transform itself from a spherical mass into a thin flat irregular plate; and when this occurs there may be seen at times in the midst of the extended finely granular mass or *cell body*, a smaller body of different aspect and refractive power, the *nucleus*. The normal presence of a nucleus in the white corpuscle may also be shewn by treating the corpuscle with dilute acetic acid which swells up and renders more transparent the cell body but makes the nucleus more refractive and more sharply defined, and so more conspicuous, or by the use of staining reagents, the majority of which stain the nucleus more readily and more deeply than the cell body. In what perhaps may be considered a typical white corpuscle, the nucleus is a spherical mass about 2—3 μ in diameter, but it varies in size in different corpuscles, and not unfrequently is irregular in form, at least after the action of reagents. It occasionally appears as if about to divide into fragments, and sometimes a corpuscle may contain two or even more (then generally small) nuclei. Though staining readily with staining reagents, the nucleus of an ordinary white corpuscle does not shew the nuclear network which is so characteristic, as we shall see, of the nuclei of many cells, and which in these is the part of the nucleus which especially stains; in the closely allied lymph corpuscles, to which we shall have immediately to refer, a nuclear network is present.

The cell body of the white corpuscle may be taken as a good example of what we have called undifferentiated protoplasm. Optically it consists of a uniformly transparent but somewhat refractive material or basis, in which are imbedded minute particles, generally spherical in form, and in which sometimes occur minute vacuoles filled with fluid; it is rarely if ever that any distinct network, like that which is sometimes observed in other cells, can be seen in the cell body of a white corpuscle whether stained or no. The imbedded particles are generally very small, and for the most part distributed uniformly over the cell body giving it the finely granular aspect spoken of above; sometimes however the particles are relatively large, making the corpuscle coarsely granular, the coarse granules being frequently confined to one or another part of the cell body. These particles or granules whether coarse or fine vary in nature; some of them, as shewn by their greater refractive power, their staining with osmic acid, and their solution by solvents of fat, are fatty in nature; others may similarly be shewn by their reactions to be proteid in nature.

The material in which these granules are imbedded, and which forms the greater part of the cell body, has no special optical features; so far as can be ascertained it appears under the microscope to be homogeneous, no definite structure can be detected in it. It must be borne in mind that the whole corpuscle consists largely of water, the total solid matter amounting to not much more than 10 per cent. The transparent material of the cell body

must therefore be in a condition which we may call semi-fluid, or semi-solid, without being called upon to define what we exactly mean by these terms. This approach to fluidity appears to be connected with the great mobility of the cell body as shewn in its amœboid movements.

§ 29. When we submit to chemical examination a sufficient mass of white corpuscles separated out from the blood by special means and obtained tolerably free from red corpuscles and plasma (or apply to the white blood corpuscles the chemical results obtained from the more easily procured lymph corpuscles which as we shall see are very similar to and indeed in many ways closely related to the white corpuscles of the blood), we find that this small solid matter of the corpuscle consists largely of certain proteids.

One of these proteids is a body either identical with or closely allied to the proteid called *myosin*, which we shall have to study more fully in connection with muscular tissue. At present we may simply say that myosin is a body intermediate between fibrin and globulin, being less soluble than the latter and more soluble than the former; thus while it is hardly at all soluble in a 1 p.c. solution of sodium chloride or other neutral salt it is, unlike fibrin, speedily and wholly dissolved by a 10 p.c. solution. Myosin is further interesting because, as we shall see, just as fibrin is formed in the clotting of blood from fibrinogen, so myosin is formed out of a preceding myosinogen, during a kind of clotting, which takes place in muscular fibre and which is spoken of as *rigor mortis*. And we have reasons for thinking that in the living white blood corpuscle there does exist a body identical with or allied to myosinogen, a body which we may speak of as being in a fluid condition; and that on the death of the corpuscle this body is converted, by a kind of clotting, into myosin, or into an allied body, which being solid, gives the body of the corpuscle a stiffness and rigidity which it did not possess during life.

Besides this myosin or myosin-like proteid, the white corpuscles also contain either paraglobulin itself or some other member of the globulin group, as well as a body or bodies like to or identical with serum-albumin.

In addition there is present, in somewhat considerable quantity, a substance of a peculiar nature, which since it is confined to the nuclei of the corpuscles and further seems to be present in all nuclei, has been called *nuclein*. This nuclein, which though a complex nitrogenous body is very different in composition and nature from proteids, is remarkable on the one hand for being a very stable inert body, and on the other for containing a large quantity (according to some observers nearly 10 p.c.) of phosphorus, which appears to enter more closely into the structure of the molecule than it does in the case of proteids.

Next in importance to the proteids, as constant constituents of

the white corpuscles, come certain fats. Among these the most conspicuous is the complex fatty body *lecithin*.

In the case of many corpuscles at all events we have evidence of the presence of a member of the large group of carbohydrates, comprising starches and sugar, viz. the starch-like body *glycogen*, which we shall have to study more fully hereafter. This glycogen may exist in the living corpuscle as glycogen, but it is very apt after the death of the corpuscle to become changed by hydration into some form of sugar, such as maltose or dextrose.

Lastly the ash of the white corpuscles is characterised by containing a relatively large quantity of potassium and of phosphates and by being relatively poor in chlorides and in sodium. But in this respect the corpuscle is merely an example of what seems to be a general rule (to which however there may be exceptions) that while the elements of the tissues themselves are rich in potassium and phosphates, the blood plasma or lymph on which they live abounds in chlorides and sodium salts.

§ 30. In the broad features above mentioned, the white blood corpuscle may be taken as a picture and example of all living tissues. If we examine the histological elements of any tissue, whether we take an epithelium cell, or a nerve cell, or a cartilage cell, or a muscular fibre, we meet with very similar features. Studying the element morphologically, we find a nucleus¹ and a cell body, the nucleus having the general characters described above with frequently other characters introduced, and the cell body consisting of at least more than one kind of material, the materials being sometimes so disposed as to produce the optical effect simply of a transparent mass in which granules are imbedded, in which case we speak of the cell body as protoplasmic, but at other times so arranged that the cell body possesses differentiated structure. Studying the element from a chemical point of view we find proteids always present, and among these bodies identical with or more or less closely allied to myosin, we generally have evidence of the presence also of fat of some kind and of some member or members of the carbohydrate group, and the ash always contains potassium and phosphates, with sulphates, chlorides, sodium and calcium, to which may be added magnesium and iron.

We stated in the Introduction that living matter is always undergoing chemical change; this continued chemical change we may denote by the term *metabolism*. We further urged that so long as living matter is alive, the chemical change or metabolism is of a double kind. On the one hand, the living substance is continually breaking down into simpler bodies, with a setting free of energy; this part of the metabolism we may speak of as made up of *katabolic* changes. On the other hand the living substance is continually building itself up, embodying energy into itself and so replenishing its store of energy; this part of the metabolism

¹ The existence of multinuclear structures does not affect the present argument.

we may speak of as made up of *anabolic* changes. We also urged that in every piece of living tissue there might be (1) the actual living substance itself, (2) material which is present for the purpose of becoming, and is on the way to become, living substance, that is to say, food undergoing or about to undergo anabolic changes, and (3) material which has resulted from, or is resulting from, the breaking down of the living substance, that is to say, material which has undergone or is undergoing *katabolic* changes, and which we speak of as waste. In using the word "living substance," however, though we may for convenience sake speak of it as a substance, we must remember that in reality it is not a substance in the chemical sense of the word, but material undergoing a series of changes.

If, now, we ask the question, which part of the body of the white corpuscle (or of a similar element of another tissue) is the real living substance, and which part is food or waste, we ask a question which we cannot as yet definitely answer. We have at present no adequate morphological criteria to enable us to judge, by optical characters, what is really living and what is not.

One thing we may perhaps say; the material which appears in the cell body in the form of distinct granules, merely lodged in the more transparent material, cannot be part of the real living substance; it must be either food or waste. Many of these granules are fat, and we have at times an opportunity of observing that they have been introduced into the corpuscle from the surrounding plasma. The white corpuscle as we have said has the power of executing amœboid movements; it can creep round objects, envelope them with its own substance, and so put them inside itself. The granules of fat thus introduced may be subsequently extruded or may disappear within the corpuscle; in the latter case they are obviously changed, and apparently made use of by the corpuscle. In other words, these fatty granules are apparently food material, on their way to be worked up into the living substance of the corpuscle.

But we have also evidence that similar granules of fat may make their appearance wholly within the corpuscle; they are products of the activity of the corpuscle. We have further reason to think that in some cases, at all events, they arise from the breaking down of the living substance of the corpuscle, that they are what we have called waste products.

But all the granules visible in a corpuscle are not necessarily fatty in nature; some of them may undoubtedly be proteid granules, and it is possible that some of them may at times be of carbohydrate or other nature. In all cases however they are either food material or waste products. And what is true of the easily distinguished granules is also true of other substances, in solution or in a solid form, but so disposed as not to be optically recognised.

Hence a part, and it may be no inconsiderable part, of the body of a white corpuscle may be not living substance at all, but either food or waste. Further it does not necessarily follow that the whole of any quantity of material, fatty or otherwise, introduced into the corpuscle from without, should actually be built up into and so become part of the living substance; the changes from raw food to living substance are as we have already said probably many, and it may be that after a certain number of changes, few or many, part only of the material is accepted as worthy of being made alive, and the rest, being rejected, becomes at once waste matter; or the material may, even after it has undergone this or that change, never actually enter into the living substance but all become waste matter. We say waste matter, but this does not mean useless matter. The matter so formed may without entering into the living substance be of some subsidiary use to the corpuscle, or as probably more often happens, being discharged from the corpuscle, may be of use to some other part of the body. We do not know how the living substance builds itself up, but we seem compelled to admit that, in certain cases at all events, it is able in some way or other to produce changes on material while that material is still outside the living substance as it were, before it enters into and indeed without its ever actually entering into the composition of the living substance. On the other hand we must equally admit that some of the waste substances are the direct products of the katabolic changes of the living substance itself, were actually once part of the living substance. Hence we ought perhaps to distinguish the products of the activity of living matter into waste products proper, the direct results of katabolic changes, and into bye products which are the results of changes effected by the living matter outside itself and which cannot therefore be considered as necessarily either anabolic or katabolic.

Concerning the chemical characters of the living matter itself we cannot at present make any very definite statement. We may say that the proteid myosin, or rather the proteid antecedent or antecedents of myosin, enter in some way into its structure, but we are not justified in saying that the living substance consists only of proteid matter in a peculiar condition. And indeed the persistency with which some representative of fatty bodies, and some representative of carbohydrates always appear in living tissue would perhaps rather lead us to suppose that these equally with proteid material were essential to its structure. Again though the behaviour of the nucleus as contrasted with that of the cell body leads us to suppose that the living substance of the former is a different kind of living substance from that of the latter, we do not know exactly in what the difference consists. The nucleus as we have seen contains *nuclein* which perhaps we may regard as a largely modified proteid; but a body which is remarkable for its stability, for the difficulty with which it is changed by chemical

reagents, cannot be regarded as an integral part of the essentially mobile living substance of the nucleus.

In this connection it may be worth while to call again attention to the fact that the corpuscle contains a very large quantity indeed of water, viz. about 90 p.c. Part of this, we do not know how much, probably exists in a more or less definite combination with the protoplasm, somewhat after the manner of, to use what is a mere illustration, the water of crystallization of salts. If we imagine a whole group of different complex salts continually occupied in turn in being crystallized and being decrystallized, the water thus engaged by the salts will give us a rough image of the water which passes in and out of the substance of the corpuscle as the result of its metabolic activity. We might call this "water of metabolism." Another part of the water, carrying in this case substances in solution, probably exists in spaces or interstices too small to be seen with even the highest powers of the microscope. Still another part of the water similarly holding substances in solution exists at times in definite spaces visible under the microscope, more or less regularly spherical, and called vacuoles.

We have dwelt thus at length on the white corpuscle in the first place because as we have already said what takes place in it is in a sense a picture of what takes place in all living structures, and in the second place because the facts which we have mentioned help us to understand how the white corpuscle may carry on in the blood a work of no unimportant kind; for from what has been said it is obvious that the white corpuscle is continually acting upon and being acted upon by the plasma.

§ 31. To understand however the work of these white corpuscles we must learn what is known of their history.

In successive drops of blood taken at different times from the same individual, the number of colourless corpuscles will be found to vary very much, not only relatively to the red corpuscles, but also absolutely. They must therefore 'come and go.'

In treating of the lymphatic system we shall have to point out that a very large quantity of fluid called lymph, containing a very considerable number of bodies very similar in their general characters to the white corpuscles of the blood, is being continually poured into the vascular system at the point where the thoracic duct joins the great veins on the left side of the neck, and to a less extent where the other large lymphatics join the venous system on the right side of the neck. These corpuscles of lymph, which, as we have just said, closely resemble, and indeed are with difficulty distinguished from the white corpuscles of the blood, but of which, when they exist outside the vascular system, it will be convenient to speak of as *leucocytes*, are found along the whole length of the lymphatic system, but are more numerous in the lymphatic vessels after these have passed through the lymphatic glands. These lymphatic glands are partly composed of

what is known as *adenoid tissue*, a special kind of connective tissue arranged as a delicate network. The meshes of this are crowded with colourless nucleated cells, which though varying in size, are for the most part small, the nucleus being surrounded by a relatively small quantity of cell substance. Many of these cells shew signs that they are undergoing cell-division, and we have reason to think that cells so formed, acquiring a larger amount of cell substance, become veritable leucocytes. In other words, leucocytes multiply in the lymphatic glands, and leaving the glands by the lymphatic vessels, make their way to the blood. Patches and tracts of similar adenoid tissue, not arranged however as distinct glands but similarly occupied by developing leucocytes and similarly connected with lymphatic vessels, are found in various parts of the body, especially in the mucous membranes. Hence we may conclude that from various parts of the body, the lymphatics are continually bringing to the blood an abundant supply of leucocytes, and that these in the blood become ordinary white corpuscles. This is probably the chief source of the white corpuscles, for though the white corpuscles have been seen dividing in the blood itself, no large increase takes place in that way.

§ 32. It follows that since white corpuscles are thus continually being added to the blood, white corpuscles must as continually either be destroyed, or be transformed, or escape from the interior of the blood vessels; otherwise the blood would soon be blocked with white corpuscles.

Some do leave the blood vessels. In treating of the circulation we shall have to point out that white corpuscles are able to pierce the walls of the capillaries and minute veins and thus to make their way from the interior of the blood vessels into spaces filled with lymph, the "lymph spaces," as they are called, of the tissue lying outside the blood vessels. This is spoken of as the "migration of the white corpuscles." In an "inflamed area" large numbers of white corpuscles are thus drained away from the blood into the lymph spaces of the tissue; and it is probable that a similar loss takes place, more or less, under normal conditions. These migrating corpuscles may, by following the devious tracts of the lymph, find their way back into the blood; some of them however may remain, and undergo various changes. Thus, in inflamed areas, when suppuration follows inflammation, the white corpuscles which have migrated may become 'pus corpuscles,' or, where thickening and growth follow upon inflammation, may, according to many authorities, become transformed into temporary or permanent tissue, especially connective tissue; but this transformation into tissue is disputed. When an inflammation subsides without leaving any effect a few corpuscles only will be found in the tissue; those which had previously migrated must therefore have been disposed of in some way or another.

In speaking of the formation of red corpuscles (§ 27) we saw

that not only it is not proved that the nucleated corpuscles which give rise to red corpuscles are ordinary white corpuscles, but that in all probability the real hæmatoblasts, the parents of red corpuscles, are special corpuscles developed in the situations where the manufacture of red corpuscles takes place. So far therefore from assuming, as is sometimes done, that the white corpuscles of the blood are all of them on their way to become red corpuscles, it may be doubted whether any of them are. In any case however, even making allowance for those which migrate, a very considerable number of the white corpuscles must 'disappear' in some way or other from the blood stream, and we may perhaps speak of their disappearance as being a 'destruction' or 'dissolution.' We have as yet no exact knowledge to guide us in this matter, but we can readily imagine that, upon the death of the corpuscle, the substances composing it, after undergoing changes, are dissolved by and become part of the plasma. If so, the corpuscles as they die must repeatedly influence the composition and nature of the plasma.

But if they thus affect the plasma in their death, it is even more probable that they influence it during their life. Being alive they must be continually taking in and giving out. As we have already said they are known to ingest, after the fashion of an amœba, solid particles of various kinds such as fat or carmine, present in the plasma, and probably digest such of these particles as are nutritious. But if they ingest these solid matters they probably also carry out the easier task of ingesting dissolved matters. If however they thus take in, they must also give out; and thus by the removal on the one hand of various substances from the plasma, and by the addition on the other hand of other substances to the plasma, they must be continually influencing the plasma. We have already said that the white corpuscles in shed blood as they die are supposed to play an important part in the clotting of blood; similarly they may during their whole life be engaged in carrying out changes in the proteids of the plasma which do not lead to clotting, but which prepare the proteids for their various uses in the body.

Pathological facts afford support to this view. The disease called leucocythæmia (or leukæmia) is characterised by an increase of the white corpuscles, both absolute and relative to the red corpuscles, the increase due to an augmented production or possibly to a retarded destruction, being at times so great as to give the blood a pinkish grey appearance, like that of blood mixed with pus. We accordingly find that in this disease the plasma is in many ways profoundly affected and fails to nourish the tissues. As a further illustration of the possible action of the white corpuscles we may state that, according to some observers in certain diseases in which minute organisms, such as bacteria, make their appearance in the blood, the white corpuscles 'take up' these

bacteria into their substance, and thus probably, by exerting an influence on them, modify the course of the disease of which these bacteria are the essential cause.

If the white corpuscles are thus engaged during their life in carrying on important labours, we may expect them to differ in appearance according to their condition. Some of the corpuscles are spoken of as 'faintly' or 'finely' granular. Other corpuscles are spoken of as 'coarsely' granular, their cell substance being loaded with conspicuously discrete granules. It may be of course that there are two distinct kinds of corpuscles, having different functions and possibly different origins and histories; but since intermediate forms are met with containing a few coarse granules only, it is more probable that the one form is a phase of the other, that a faintly granular corpuscle by taking in granules from without or by producing granules within itself as products of its metabolism, may become a coarsely granular corpuscle.

Whether however the white corpuscles are really all of one kind, or whether they are different kinds performing different functions, must at present be left an open question.

Blood Platelets.

§ 33. In a drop of blood examined with care immediately after removal, may be seen a number of exceedingly small bodies ($2\ \mu$ to $3\ \mu$ in diameter) frequently disc-shaped but sometimes of a rounded or irregular form, homogeneous in appearance when quite fresh but apt to assume a faintly granular aspect. They are called *blood platelets*. They have been supposed by some to become developed into and indeed to be early stages of the red corpuscles, and hence have been called hæmatoblasts; but this view has not been confirmed, indeed, as we have seen (§ 27), the real hæmatoblasts or developing red corpuscles are of quite a different nature.

They speedily undergo change after removal from the body, apparently dissolving in the plasma; they break up, part of their substance disappearing, while the rest becomes granular. Their granular remains are apt to run together forming in the plasma the shapeless masses which have long been known and described as "lumps of protoplasm." By appropriate reagents, however, these platelets may be fixed and stained in the condition in which they appear after leaving the body.

The substance composing them is peculiar, and though we may perhaps speak of them as consisting of living material, their nature is at present obscure. They may be seen within the living blood vessels, and therefore must be regarded as real parts of the blood and not as products of the changes taking place in blood after it has been shed.

When a needle or thread or other foreign body is introduced into the interior of a blood vessel, they are apt to collect upon, and indeed are the precursors of the clot which in most cases forms around the needle or thread. They are also found in the *thrombi* or plugs which sometimes form in the blood vessels as the result of disease or injury. Indeed it has been maintained that what are called *white thrombi* (to distinguish them from red thrombi which are plugs of corpuscles and fibrin) are in reality aggregations of blood platelets; and for various reasons blood platelets have been supposed to play an important part in the clotting of blood, carrying out the work which in this respect is by others attributed to the white corpuscles. But no very definite statement can at present be made about this; and indeed the origin and whole nature of these blood platelets is at present obscure.

SEC. 3. THE CHEMICAL COMPOSITION OF BLOOD.

§ 34. We may now pass briefly in review the chief chemical characters of blood, remembering always that, as we have already urged, the chief chemical interests of blood are attached to the changes which it undergoes in the several tissues; these will be considered in connection with each tissue at the appropriate place.

The average specific gravity of human blood is 1055, varying from 1045 to 1075 within the limits of health.

The reaction of blood as it flows from the blood vessels is found to be distinctly though feebly alkaline. If a drop be placed on a piece of faintly red highly glazed litmus paper, and then wiped off, a blue stain will be left.

The whole blood contains a certain quantity of gases, viz. oxygen, carbonic acid and nitrogen, which are held in the blood in a peculiar way, which vary in different kinds of blood, and so serve especially to distinguish arterial from venous blood, and which may be given off from blood when exposed to an atmosphere, according to the composition of that atmosphere. These gases of blood we shall study in connection with respiration.

The normal blood consists of *corpuscles* and *plasma*.

If the corpuscles be supposed to retain the amount of water proper to them, blood may, in general terms, be considered as consisting by weight of from about one-third to somewhat less than one-half of corpuscles, the rest being plasma. As we have already seen, the number of corpuscles in a specimen of blood is found to vary considerably, not only in different animals and in different individuals, but in the same individual at different times.

The *plasma*, is resolved by the clotting of the blood into *serum* and *fibrin*.

§ 35. The *serum* contains in 100 parts

Proteid substances	about 8 or 9 parts.
Fats, various extractives, and saline matters	„ 2 or 1 „
Water	„ 90 „

The proteids are *paraglobulin* and *serum-albumin* (there being probably more than one kind of serum-albumin) in varying proportion. We may perhaps, roughly speaking, say that they occur in about equal quantities.

Conspicuous and striking as are the results of clotting, massive as appears to be the clot which is formed, it must be remembered that by far the greater part of the clot consists of corpuscles. The amount by weight of fibrin required to bind together a number of corpuscles in order to form even a large firm clot is exceedingly small. Thus the average quantity by weight of fibrin in human blood is said to be .2 p.c.; the amount however which can be obtained from a given quantity of plasma varies extremely, the variation being due not only to circumstances affecting the blood, but also to the method employed.

The fats, which are scanty, except after a meal or in certain pathological conditions, consist of the neutral fats, stearin, palmitin, and olein, with a certain quantity of their respective alkaline soaps. The peculiar complex fat lecithin occurs in very small quantities only; the amount present of the peculiar alcohol cholesterol which has so fatty an appearance is also small. Among the extractives present in serum may be put down nearly all the nitrogenous and other substances which form the extractives of the body and of food, such as urea, kreatin, sugar, lactic acid, &c. A very large number of these have been discovered in the blood under various circumstances, the consideration of which must be left for the present. The peculiar odour of blood or of serum is probably due to the presence of volatile bodies of the fatty acid series. The faint yellow colour of serum is due to a special yellow pigment. The most characteristic and important chemical feature of the saline constitution of the serum is the preponderance, at least in man and most animals, of sodium salts over those of potassium. In this respect the serum offers a marked contrast to the corpuscles. Less marked, but still striking, is the abundance of chlorides and the poverty of phosphates in the serum as compared with the corpuscles. The salts may in fact briefly be described as consisting chiefly of sodium chloride, with some amount of sodium carbonate, or more correctly sodium bicarbonate, and potassium chloride, with small quantities of sodium sulphate, sodium phosphate, calcium phosphate, and magnesium phosphate. And of even the small quantity of phosphates found in the ash, part of the phosphorus exists in the serum itself not as a phosphate but as phosphorus in some organic body.

§ 36. The *red corpuscles* contain less water than the serum, the amount of solid matter being variously estimated at from 30 to 40 or more p.c. The solids are almost entirely organic matter, the inorganic salts amounting to less than 1 p.c. Of the organic matter again by far the larger part consists of hæmoglobin. In 100 parts of the dried organic matter of the corpuscles of human blood, about

90 parts are hæmoglobin, about 8 parts are proteid substances, and about 2 parts are other substances. Of these other substances one of the most important, forming about a quarter of them and apparently being always present, is lecithin. Cholesterin appears also to be normally present. The proteid substances which form the stroma of the red corpuscles appear to belong chiefly to the globulin family. As regards the inorganic constituents, the corpuscles are distinguished by the relative abundance of the salts of potassium and of phosphates. This at least is the case in man; the relative quantities of sodium and potassium in the corpuscles and serum respectively appear however to vary in different animals; in some the sodium salts are in excess even in the corpuscles.

§ 37. The proteid matrix of the *white corpuscles*, we have stated to be composed of myosin (or an allied body) paraglobulin, and possibly other proteids. The nuclei contain nuclein. The white corpuscles are found to contain in addition to proteid material, lecithin and other fats, glycogen, extractives and inorganic salts, there being in the ash as in that of the red corpuscles a preponderance of potassium salts and of phosphates.

The main facts of interest then in the chemical composition of the blood are as follows. The red corpuscles consist chiefly of hæmoglobin. The organic solids of serum consist partly of serum-albumin, and partly of paraglobulin. The serum or plasma contrasts in man at least, with the corpuscles, inasmuch as the former contains chiefly chlorides and sodium salts while the latter are richer in phosphates and potassium salts. The extractives of the blood are remarkable rather for their number and variability than for their abundance, the most constant and important being perhaps urea, kreatin, sugar, and lactic acid.

SEC. 4. THE QUANTITY OF BLOOD, AND ITS DISTRIBUTION IN THE BODY.

§ 38. The quantity of blood contained in the whole vascular system is a balance struck between the tissues which give to, and those which take away from the blood. Thus the tissues of the alimentary canal largely add to the blood water and the material derived from food, while the excretory organs largely take away water and the other substances constituting the excretions. Other tissues both give and take; and the considerable drain from the blood to the lymph spaces which takes place in the capillaries is met by the flow of lymph into the great veins.

From the result of a few observations on executed criminals it has been concluded that the total quantity of blood in the human body is about $\frac{1}{13}$ th of the body weight. But in various animals, the proportion of the weight of the blood to that of the body has been found to vary very considerably in different individuals; and probably this holds good for man also, at all events within certain limits.

In the same individual the quantity probably does not vary largely. A sudden drain upon the water of the blood by great activity of the excretory organs, as by profuse sweating, or a sudden addition to the water of the blood, as by drinking large quantities of water or by injecting fluid into the blood vessels, is rapidly compensated by the passage of water from the tissues to the blood or from the blood to the tissues. As we have already said the tissues are continually striving to keep up an average composition of the blood, and in so doing keep up an average quantity. In starvation the quantity (and quality) of the blood is maintained for a long time at the expense of the tissues, so that after some days deprivation of food and drink, while the fat, the muscles, and other tissues have been largely diminished, the quantity of blood remains nearly the same.

The total quantity of blood present in an animal body is estimated in the following way. As much blood as possible is allowed to escape from the vessels; this is measured directly. The vessels are then washed out with water or normal saline solution, and the washings carefully collected, mixed and measured. A known quantity of blood is diluted with water or normal saline solution until it possesses the same tint as a measured specimen of the washings. This gives the amount of blood (or rather of hæmoglobin) in the measured specimen, from which the total quantity in the whole washings is calculated. Lastly, the whole body is carefully minced and washed free from blood. The washings are collected and filtered, and the amount of blood in them is estimated as before by comparison with a specimen of diluted blood. The quantity of blood, as calculated from the two washings, together with the escaped and directly measured blood, gives the total quantity of blood in the body.

The method is not free from objections, but other methods are open to still graver objections.

The blood is in round numbers distributed as follows :

About one-fourth in the heart, lungs, large arteries and veins,

” ” ” ” liver,

” ” ” ” skeletal muscles,

” ” ” ” other organs.

Since in the heart and great blood-vessels the blood is simply in transit, without undergoing any great changes (and in the lungs, as far as we know, the changes are limited to respiratory changes), it follows that the changes which take place in the blood passing through the liver and skeletal muscles far exceed those which take place in the rest of the body.

CHAPTER II.

THE CONTRACTILE TISSUES.

§ 39. IN order that the blood may nourish the several tissues it is carried to and from them by the vascular mechanism; and this carriage entails active movements. In order that the blood may adequately nourish the tissues, it must be replenished by food from the alimentary canal, and purified from waste by the excretory organs; and both these processes entail movements. Hence before we proceed further we must study some of the general characters of the movements of the body.

Most of the movements of the body are carried out by means of the muscles of the trunk and limbs, which being connected with the skeleton are frequently called skeletal muscles. A skeletal muscle when subjected to certain influences suddenly shortens, bringing its two ends nearer together; and it is the shortening, acting upon various bony levers or by help of other mechanical arrangements, which produces the movement. Such a temporary shortening, called forth by certain influences and due as we shall see to changes taking place in the muscular tissue forming the chief part of the muscle, is technically called a *contraction* of the muscle; and the muscular tissue is spoken of as a contractile tissue. The heart is chiefly composed of muscular tissue, differing in certain minor features from the muscular tissue of the skeletal muscles, and the beat of the heart is essentially a contraction of the muscular tissue composing it, a shortening of the peculiar muscular fibres of which the heart is chiefly made up. The movements of the alimentary canal and of many other organs are similarly the results of the contraction of the muscular tissue entering into the composition of those organs, of the shortening of certain muscular fibres built up into those organs. In fact almost all the movements of the body are the results of the contraction of muscular fibres, of various nature and variously disposed.

Some few movements however are carried out by structures which cannot be called muscular. Thus in the pulmonary passages and elsewhere movement is effected by means of cilia attached to epithelium cells; and elsewhere, as in the case of the migrating white corpuscles of the blood, transference from place to place in the body is brought about by amœboid movements. But, as we shall see, the changes in the epithelium cell or white corpuscle which are at the bottom of ciliary or amœboid movements are in all probability fundamentally the same as those which take place in a muscular fibre when it contracts: they are of the nature of a contraction, and hence we may speak of all these as different forms of contractile tissue.

Of all these various forms of contractile tissue the skeletal muscles, on account of the more complete development of their functions, will be better studied first; the others, on account of their very simplicity, are in many respects less satisfactorily understood.

All the ordinary skeletal muscles are connected with nerves. We have no reason for thinking that they are thrown into contraction, under normal conditions, otherwise than by the agency of nerves.

Muscles and nerves being thus so closely allied, and having besides so many properties in common, it will conduce to clearness and brevity if we treat them together.

SEC. 1. THE PHENOMENA OF MUSCLE AND NERVE.

Muscular and Nervous Irritability.

§ 40. The skeletal muscles of a frog, the brain and spinal cord of which have been destroyed, do not exhibit any spontaneous movements or contractions, even though the nerves be otherwise quite intact. Left undisturbed the whole body may decompose without any contraction of any of the skeletal muscles having been witnessed. Neither the skeletal muscles nor the nerves distributed to them possess any power of automatic action.

If however a muscle be laid bare and be more or less violently disturbed, if for instance it be pinched, or touched with a hot wire, or brought into contact with certain chemical substances, or subjected to the action of galvanic currents, it will move, that is contract, whenever it is thus disturbed. Though not exhibiting any spontaneous activity, the muscle is (and continues for some time after the general death of the animal to be) *irritable*. Though it remains quite quiescent when left untouched, its powers are then dormant only, not absent. These require to be roused or 'stimulated' by some change or disturbance in order that they may manifest themselves. The substances or agents which are thus able to evoke the activity of an irritable muscle are spoken of as *stimuli*.

But to produce a contraction in a muscle the stimulus need not be applied directly to the muscle; it may be applied indirectly by means of the nerve. Thus, if the trunk of a nerve be pinched, or subjected to sudden heat, or dipped in certain chemical substances, or acted upon by various galvanic currents, contractions are seen in the muscles to which branches of the nerve are distributed.

The nerve like the muscle is irritable, it is thrown into a state of activity by a stimulus; but unlike the muscle it does not itself contract. The stimulus does not give rise in the nerve to any visible change of form; but that changes of some kind or other

are set up and propagated along the nerve down to the muscle is shewn by the fact that the muscle contracts when a part of the nerve at some distance from itself is stimulated. Both nerve and muscle are irritable, but only the muscle is contractile, *i.e.* manifests its irritability by a contraction. The nerve manifests its irritability by transmitting along itself, without any visible alteration of form, certain molecular changes set up by the stimulus. We shall call these changes thus propagated along a nerve, 'nervous impulses.'

§ 41. We have stated above that the muscle may be thrown into contractions by stimuli applied directly to itself. But it might fairly be urged that the contractions so produced are in reality due to the fact that the stimulus, although apparently applied directly to the muscle, is, after all, brought to bear on some or other of the many fine nerve-branches, which as we shall see are abundant in the muscle, passing among and between the muscular fibres in which they finally end. The following facts however go far to prove that the muscular fibres themselves are capable of being directly stimulated without the intervention of any nerves. When a frog (or other animal) is poisoned with urari, the nerves may be subjected to the strongest stimuli without causing any contractions in the muscles to which they are distributed; yet even ordinary stimuli applied directly to the muscle readily cause contractions. If before introducing the urari into the system, + a ligature be passed underneath the sciatic nerve in one leg, for instance the right, and drawn tightly round the whole leg to the exclusion of the nerve, it is evident that the urari when injected into the back of the animal, will gain access to the right sciatic nerve above the ligature, but not below, while it will have free access to the rest of the body, including the whole left sciatic. If, as soon as the urari has taken effect, the two sciatic nerves be stimulated, no movement of the left leg will be produced by stimulating the left sciatic, whereas strong contractions of the muscles of the right leg below the ligature will follow stimulation of the right sciatic, whether the nerve be stimulated above or below the ligature. Now since the upper parts of both sciatics are equally exposed to the action of the poison, it is clear that the failure of the left nerve to cause contraction is not attributable to any change having taken place in the upper portion of the nerve, else why should not the right, which has in its upper portion been equally exposed to the action of the poison, also fail? Evidently the poison acts on some parts of the nerve lower down. If a single muscle be removed from the circulation (by ligaturing its blood vessels), previous to the poisoning with urari, that muscle will contract when any part of the nerve going to it is stimulated, though no other muscle in the body will contract when its nerve is stimulated. Here the whole nerve right down to the muscle has been exposed to the action of the poison; and yet it has lost none of its power over the muscle. On

the other hand, if the muscle be allowed to remain in the body, and so be exposed to the action of the poison, but the nerve be divided high up and the part connected with the muscle gently lifted up before the urari is introduced into the system, so that no blood flows to it and so that it is protected from the influence of the poison, stimulation of the nerve will be found to produce no contractions in the muscle, though stimuli applied directly to the muscle at once cause it to contract. From these facts it is clear that urari poisons the ends of the nerve within the muscle long before it affects the trunk; and it is exceedingly probable that it is the very extreme ends of the nerves (possibly the end-plates, or peculiar structures in which the nerve fibres end in the muscular fibres, for urari poisoning, at least when profound, causes a slight but yet distinctly recognisable effect in the microscopic appearance of these structures) which are affected. The phenomena of urari poisoning therefore go far to prove that muscles are capable of being made to contract by stimuli applied directly to the muscular fibres themselves; and there are other facts which support this view.

§ 42. When in a recently killed frog we stimulate by various means and in various ways the muscles and nerves, it will be observed that the movements thus produced, though very various, may be distinguished to be of two kinds. On the one hand the result may be a mere twitch, as it were, of this or that muscle; on the other hand, one or more muscles may remain shortened or contracted for a considerable time, a limb for instance being raised up or stretched out, and kept raised up or stretched out for many seconds. And we find upon examination that a stimulus may be applied either in such a way as to produce a mere twitch, a passing rapid contraction which is over and gone in a fraction of a second, or in such a way as to keep the muscle shortened or contracted for as long time as, up to certain limits, we may choose. The mere twitch is called a *single or simple muscular contraction*; the sustained contraction, which as we shall see is really the result of rapidly repeated simple contractions, is called a *tetanic contraction*.

§ 43. In order to study these contractions adequately, we must have recourse to the 'graphic method' as it is called, and obtain a tracing or other record of the change of form of the muscle. To do this conveniently, it is best to operate with a muscle isolated from the rest of the body of a recently killed animal, and carefully prepared in such a way as to remain irritable for some time. The muscles of cold blooded animals remain irritable after removal from the body far longer than those of warm blooded animals, and hence those of the frog are generally made use of. We shall study presently the conditions which determine this maintenance of the irritability of muscles and nerves after removal from the body.

A muscle thus isolated, with its nerve left attached to it, is

called a *muscle-nerve preparation*. The most convenient muscle for this purpose in the frog is perhaps the gastrocnemius, which should be dissected out so as to leave carefully preserved the attachment to the femur above, some portion of the tendon (*tendo achillis*) below, and a considerable length of the sciatic nerve with its branches going to the muscle. Fig. 1.

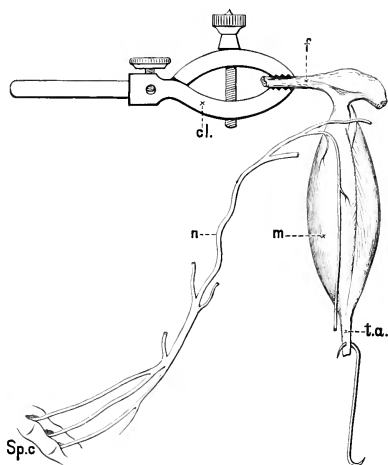

FIG. 1. A MUSCLE-NERVE PREPARATION.

m, the muscle, gastrocnemius of frog; *n*, the sciatic nerve, all the branches being cut away except that supplying the muscle; *f*, femur; *cl.* clamp; *t. a.* tendo achillis; *sp. c.* end of spinal canal.

§ 44. We may apply to such a muscle-nerve preparation the various kinds of stimuli spoken of above, mechanical, such as pricking or pinching, thermal, such as sudden heating, chemical, such as acids or other active chemical substances, or electrical; and these we may apply either to the muscle directly, or to the nerve, thus affecting the muscle indirectly. Of all these stimuli by far the most convenient for general purposes are electrical stimuli of various kinds; and these, except for special purposes, are best applied to the nerve, and not directly to the muscle.

Of electrical stimuli again, the currents, as they are called, generated by a voltaic cell are most convenient, though the electricity generated by a rotating magnet, or that produced by friction may be employed. Making use of a cell or battery of cells, Daniell's, Grove's, Leclanché or any other, we must distinguish between the current produced by the cell itself, the *constant*

current as we shall call it, and the *induced current* obtained from the constant current by means of an induction coil, as it is called; for the physiological effects of the two kinds of current are in many ways different.

It may perhaps be worth while to remind the reader of the following facts.

In a galvanic battery, the substance (plate of zinc for instance) which is acted upon and used up by the liquid is called the *positive* element, and the substance which is not so acted upon and used up (plate &c. of copper, platinum, or carbon, &c.) is called the *negative* element. A galvanic action is set up when the positive (zinc) and the negative (copper) elements are connected outside the battery by some conducting material, such as a wire, and the current is said to flow in a circuit or circle from the zinc or positive element to the copper or negative element *inside the battery*, and then from the copper or negative element back to the zinc or positive element through the wire *outside the battery*. If the conducting wire be cut through, the current ceases to flow; but if the cut ends be brought into contact, the current is re-established and continues to flow so long as the contact is good. The ends of the wires are called 'poles,' or when used for physiological purposes, in which case they may be fashioned in various ways, are spoken of as *electrodes*. When the poles are brought into contact or are connected by some conducting material, galvanic action is set up, and the current flows through the battery and wires; this is spoken of as "making the current" or "completing or closing the circuit." When the poles are drawn apart from each other, or when some non-conducting material is interposed between them, the galvanic action is arrested; this is spoken of as "breaking the current" or "opening the circuit." The current passes from the wire connected with the negative (copper) element in the battery to the wire connected with the positive (zinc) element in the battery; hence the pole connected with the copper (negative) element is called the *positive* pole, and that connected with the zinc (positive) element is called the *negative* pole. When used for physiological purposes the positive pole becomes the positive electrode, and the negative pole the negative electrode. The positive electrode is often spoken of as the *anode* (ana, up), and the negative electrode as the *kathode* (kata, down).

A piece of nerve of ordinary length, though not a good conductor, is still a conductor, and when placed on the electrodes, completes the circuit, permitting the current to pass through it; in order to remove the nerve from the influence of the current it must be lifted off from the electrodes. This is obviously inconvenient; and hence it is usual to arrange a means of opening or closing the circuit at some point along one of the two wires. This may be done in various ways: by fastening one part of the wire into a cup of mercury and so by dipping the other part of the wire into the cup to close the circuit and make the current, and by lifting it out of the mercury to open the circuit and break the current; or by arranging, between the two parts of the wires, a moveable bridge of good conducting material such as brass, which can be put down to close the circuit or raised up to open the circuit; or in

other ways. Such a means of closing and opening a circuit and so of making or breaking a current is called a *key*.

A key which is frequently used by physiologists goes by the name of du Bois-Reymond's key; though undesirable in many respects it has the advantage that it can be used in two different ways. When arranged as in A. Fig. 2, the brass bridge of K, the key, being down, and forming a means of good conduction between the brass plates to which the wires are screwed, the circuit is closed and the current passes from the positive pole (end of the negative (copper) element) to the positive electrode or anode, *An.* through the nerve, to the negative electrode or kathode *Kat.* and thence back to the negative pole (end of the positive (zinc) element) in the battery; on raising the

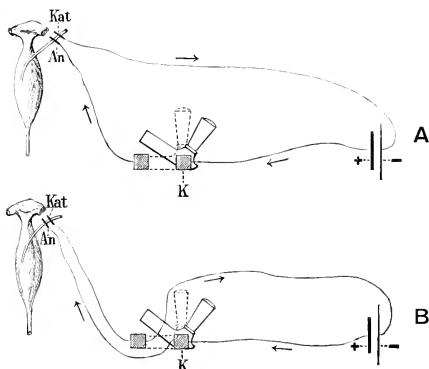

FIG. 2. DIAGRAM OF DU BOIS-REYMOND KEY USED, A, FOR MAKING AND BREAKING, B, FOR SHORT CIRCUITING.

brass bridge the circuit is opened, the current broken, and no current passes through the electrodes. When arranged as in B, if the brass bridge be 'putting down,' the resistance offered by it is so small compared with the resistance offered by the nerve between the electrodes, that the whole current from the battery passes through the bridge, back to the battery, and none, or only an infinitesimal portion, passes into the nerve. When on the other hand the bridge is raised, and so the conduction between the two sides suspended, the current is not able to pass directly from one side to the other, but can and does pass along the wire through the nerve back to the battery. Hence in arrangement A, 'putting down the key' as it is called makes a current in the nerve, and 'raising' or 'opening the key' breaks the current. In arrangement B, however, putting down the key diverts the current from the nerve by sending it through the bridge, and so back to the battery; the current instead of making the longer circuit through the electrodes makes the shorter circuit through the key; hence this is called 'short circuiting.' When the bridge is raised the current passes through the nerve on the electrodes. Thus 'putting down' and 'raising' or 'opening'

the key have contrary effects in A and B. In B, it will be observed, the battery is always at work, the current is always flowing either through the electrodes (key up) or through the key (key down); in A, the battery is not at work until the circuit is made by putting down the key. And in many cases it is desirable to take so to speak a sample of the current while the battery is in full swing rather than just as it begins to work. Moreover in B the electrodes are, when the key is down, wholly shut off from the current, whereas in A, when the key is up, one electrode is still in direct connection with the battery and this connection, leading to what is known as unipolar action, may give rise to stimulation of the nerve. Hence the use of the key in the form B.

Other forms of key may be used. Thus in the Morse key (F. Fig. 3) contact is made by pressing down a lever handle (*ha*); when the pressure is removed, the handle, driven up by a spring, breaks contact. In the arrangement shewn in the figure one wire from the battery being brought to the binding screw *b*, while the binding screw *a* is connected with the other wire, putting down the handle makes connection between *a* and *b*, and thus makes a current. By arranging the wires in the several binding screws in a different way, the making contact by depressing the handle may be used to short circuit.

In an "induction coil" Figs. 3 and 4, the wire connecting the two elements of a battery is twisted at some part of its course into a close spiral, called the *primary coil*. Thus in Fig. 3 the wire *x''* connected with the copper or negative plate *c.p.* of the battery, *E*, joins the primary coil *pr. c.*, and then passes on as *y'''*, through the "key" *F*, to the positive (zinc) plate *z.p.* of the battery. Over this primary coil, but quite unconnected with it, slides another coil, the *secondary coil, s.c.*; the ends of the wire forming this coil, *y''* and *x''*, are continued on in the arrangement illustrated in the figure as *y'* and *y*, and as *x'* and *x* and terminate in electrodes. If these electrodes are in contact or connected with conducting material, the circuit of the secondary coil is said to be closed; otherwise it is open.

In such an arrangement it is found that at the moment when the primary circuit is closed, i.e. when the primary current is "made" a secondary "induced" current is, for an exceedingly brief period of time, set up in the secondary coil. Thus in Fig. 3 when by moving the "key" *F*, *y'''* and *x'''* previously not in connection with each other, are put into connection and the primary current thus made, at that instant a current appears in the wires *y'' x''* &c., but almost immediately disappears. A similar almost instantaneous current is also developed when the primary current is "broken," but not till then. So long as the primary current flows with uniform intensity, no current is induced in the secondary coil. It is only when the primary current is either made or broken, or suddenly varies in intensity, that a current appears in the secondary coil. In each case the current is of very brief duration, gone in an instant almost, and may therefore be spoken of as "a shock," an induction shock; being called a "making shock" when it is caused by the making, and a "breaking shock" when it is caused by the breaking, of the primary circuit. The direction of the current in the making shock is opposed to that of the primary current; thus in

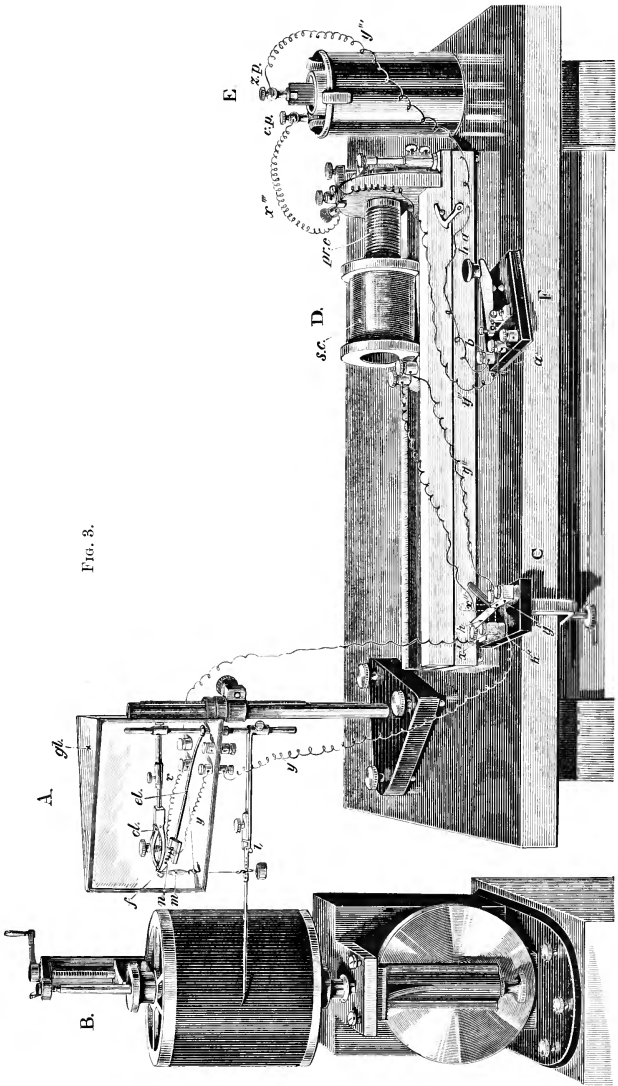

FIG. 3.

FIG. 3. DIAGRAM ILLUSTRATING APPARATUS ARRANGED FOR EXPERIMENTS WITH MUSCLE AND NERVE.

- A. The moist chamber containing the muscle-nerve preparation. The muscle *m*, supported by the clamp *cl.*, which firmly grasps the end of the femur *f*, is connected by means of the S hook *s* and a thread with the lever *l*, placed below the moist chamber. The nerve *n*, with the portion of the spinal column *n'* still attached to it, is placed on the electrode-holder *el.* in contact with the wires *x, y*. The whole of the interior of the glass case *gl.* is kept saturated with moisture, and the electrode-holder is so constructed that a piece of moistened blotting-paper may be placed on it without coming into contact with the nerve.
- B. The revolving cylinder bearing the smoked paper on which the lever writes.
- C. du Bois-Reymond's key arranged for short-circuiting. The wires *x* and *y* of the electrode-holder are connected through binding screws in the floor of the moist chamber with the wires *x', y'*, and these are secured in the key, one on either side. To the same key are attached the wires *x'' y''* coming from the secondary coils *s. c.* of the induction-coil *D*. This secondary coil can be made to slide up and down over the primary coil *pr. c.*, with which are connected the two wires *x'''* and *y'''*. *x'''* is connected directly with one pole, for instance the copper pole *c. p.* of the battery *E*. *y'''* is carried to a binding screw *a* of the Morse key *F*, and is continued as *y^{iv}* from another binding screw *b* of the key to the zinc pole *z. p.* of the battery.

Supposing everything to be arranged, and the battery charged, on depressing the handle *ha*, of the Morse key *F*, a current will be made in the primary coil *pr. c.*, passing from *c. p.* through *x'''* to *pr. c.*, and thence through *y'''* to *a*, thence to *b*, and so through *y^{iv}* to *z. p.* On removing the finger from the handle of *F*, a spring thrusts up the handle, and the primary circuit is in consequence immediately broken.

At the instant that the primary current is either made or broken, an induced current is for the instant developed in the secondary coil *s. c.* If the cross bar *h* in the du Bois-Reymond's key be raised (as shewn in the thick line in the figure), the wires *x'', x', x*, the nerve between the electrodes and the wires *y, y', y''* form the complete secondary circuit, and the nerve consequently experiences a making or breaking induction-shock whenever the primary current is made or broken. If the cross bar of the du Bois-Reymond key be shut down, as in the dotted line *h'* in the figure, the resistance of the cross bar is so slight compared with that of the nerve and of the wires going from the key to the nerve, that the whole secondary (induced) current passes from *x''* to *y''* (or from *y''* to *x''*), along the cross bar, and practically none passes into the nerve. The nerve being thus "short-circuited," is not affected by any changes in the current.

The figure is intended merely to illustrate the general method of studying muscular contraction; it is not to be supposed that the details here given are universally adopted or indeed the best for all purposes.

the figure while the primary current flows from *x'''* to *y'''*, the induced making shock flows from *y* to *x*. The current of the breaking shock on the other hand flows in the same direction as the primary current from *x* to *y*, and is therefore in direction the reverse of the making shock. Compare Fig. 4, where arrangement is shewn in a diagrammatic manner.

The current from the battery, upon its first entrance into the primary coil, as it passes along each twist of that coil, gives rise in the neighbouring twists of the same coil to a momentary induced current having a direction opposite to its own, and therefore tending to weaken itself. It is not until this 'self-induction' has passed off that the current in the primary coil is established in its full strength. Owing

to this delay in the full establishment of the current in the primary coil, the induced current in the secondary coil is developed more slowly

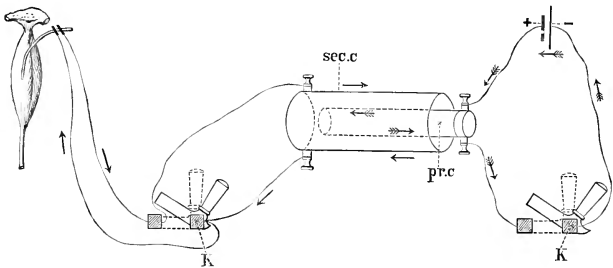

FIG. 4. DIAGRAM OF AN INDUCTION COIL.

+ positive pole, end of negative element, - negative pole, end of positive element of battery, K, du Bois-Reymond's key, *pr. c.* primary coil, current shewn by feathered arrow, *sc. c.* secondary coil, current shewn by unfeathered arrow.

than it would be were no such 'self-induction' present. On the other hand when the current from the battery is 'broken,' or 'shut off' from the primary coil, no such delay is offered to its disappearance, and consequently the induced current in the secondary coil is developed with unimpeded rapidity. We shall see later on that a rapidly developed current is more effective as a stimulus than is a more slowly developed current. Hence the making shock, where rapidity of production is interfered with by the self-induction of the primary coil, is less effective as a stimulus than the breaking shock whose development is not thus interfered with.

The strength of the induced current depends, on the one hand, on the strength of the current passing through the primary coil, that is, on the strength of the battery. It also depends on the relative position of the two coils. Thus a secondary coil is brought nearer and nearer to the primary coil and made to overlap it more and more; the induced current becomes stronger and stronger, though the current from the battery remains the same. With an ordinary battery, the secondary coil may be pushed to some distance away from the primary coil, and yet shocks sufficient to stimulate a muscle will be obtained. For this purpose however the two coils should be in the same line; when the secondary coil is placed cross-wise, at right angles to the primary, no induced current is developed, and at intermediate angles the induced current has intermediate strengths.

When the primary current is repeatedly and rapidly made and broken, the secondary current being developed with each make and with each break, a rapidly recurring series of alternating currents is developed in the secondary coil and passes through its electrodes. We shall frequently speak of this as the *interrupted* induction current, or more briefly the interrupted current; it is sometimes spoken of as the

faradaic current, and the application of it to any tissue is spoken of as *faradization*.

Such a repeated breaking and making of the primary current may be effected in many various ways. In the instrument commonly used for the purpose, the primary current is made and broken by means of a vibrating steel slip working against a magnet; hence the instrument is called a magnetic interruptor. See Fig. 5.

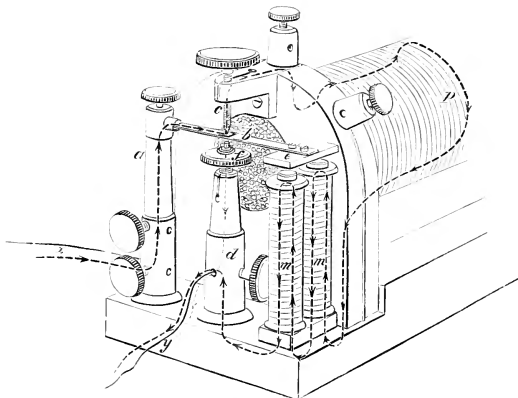

FIG. 5. THE MAGNETIC INTERRUPTOR.

The two wires *x* and *y* from the battery are connected with the two brass pillars *a* and *d* by means of screws. Directly contact is thus made the current, indicated in the figure by the *thick* interrupted line, passes in the direction of the arrows, up the pillar *a*, along the steel spring *b*, as far as the screw *c*, the point of which, armed with platinum, is in contact with a small platinum plate on *b*. The current passes from *b* through *c* and a connecting wire into the primary coil *p*. Upon its entering into the primary coil, an induced (making) current is for the instant developed in the secondary coil (not shewn in the figure). From the primary coil *p* the current passes, by a connecting wire, through the double spiral, *m*, and, did nothing happen, would continue to pass from *m* by a connecting wire to the pillar *d*, and so by the wire *y* to the battery. The whole of this course is indicated by the thick interrupted line with its arrows.

As the current however passes through the spirals *m*, the iron cores of these are made magnetic. They in consequence draw down the iron bar *e*, fixed at the end of the spring *b*, the flexibility of the spring allowing this. But when *e* is drawn down, the platinum plate on the upper surface of *b* is also drawn away from the screw *c*, and thus the current is "broken" at *b*. (Sometimes the screw *f* is so arranged that when *e* is drawn down a platinum plate on the *under* surface of *b* is brought into contact with the platinum-armed point of the screw *f*.)

The current then passes from *b* not to *c* but to *f*, and so down the pillar *d*, in the direction indicated by the *thin* interrupted line, and out to the battery by the wire *y*, and is thus cut off from the primary coil. But this arrangement is unnecessary.) At the instant that the current is thus broken and so cut off from the primary coil, an induced (breaking) current is for the moment developed in the secondary coil. But the current is cut off not only from the primary coil, but also from the spirals *m*; in consequence their cores cease to be magnetised, the bar *e* ceases to be attracted by them, and the spring *b*, by virtue of its elasticity, resumes its former position in contact with the screw *c*. This return of the spring however re-establishes the current in the primary coil and in the spirals, and the spring is drawn down, to be released once more in the same manner as before. Thus as long as the current is passing along *x*, the contact of *b* with *c* is alternately being made and broken, and the current is constantly passing into and being shut off from *p*, the periods of alternation being determined by the periods of vibration of the spring *b*. With each passage of the current into, or withdrawal from the primary coil, an induced (making and, respectively, breaking) current is developed in a secondary coil.

As thus used, each 'making shock,' as explained above, is less powerful than the corresponding 'breaking shock;' and indeed it sometimes happens that instead of each make as well as each break acting as a stimulus, giving rise to a contraction, the 'breaks' only are effective, the several 'makes' giving rise to no contractions.

By what is known as Helmholtz's arrangement, Fig. 6, however

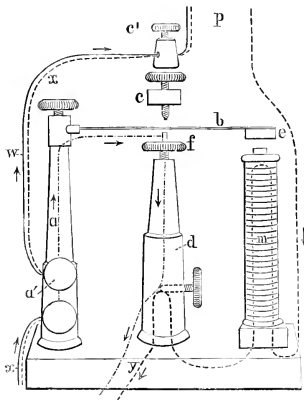

FIG. 6. THE MAGNETIC INTERRUPTER WITH HELMHOLTZ ARRANGEMENT FOR EQUALIZING THE MAKE AND BREAK SHOCKS.

the making and breaking shocks may be equalized. For this purpose the screw *c* is raised out of reach of the excursions of the spring *b*, and

a moderately thick wire w , offering a certain amount only of resistance, is interposed between the upper binding screw a' on the pillar a , and the binding screw c' leading to the primary coil. Under these arrangements the current from the battery passes through a' , along the interposed wire to c' , through the primary coil and thus as before to m . As before, by the magnetisation of m , e is drawn down and b brought in contact with f . As the result of this contact, the current from the battery can now pass by a, f , and d (shewn by the thin interrupted line) back to the battery; but not the whole of the current, some of it can still pass along the wire w to the primary coil, the relative amount being determined by the relative resistances offered by the two courses. Hence at each successive magnetisation of m , the current in the primary coil does not entirely disappear when b is brought in contact with f ; it is only so far diminished that m ceases to attract e , and hence by the release of b from f the whole current once more passes along w . Since, at what corresponds to the 'break' the current in the primary coil is diminished only, not absolutely done away with, self-induction makes its appearance at the 'break' as well as at the 'make'; thus the 'breaking' and 'making' induced currents or shocks in the secondary coil are equalized. They are both reduced to the lower efficiency of the 'making' shock in the old arrangement; hence to produce the same strength of stimulus with this arrangement a stronger current must be applied or the secondary coil pushed over the primary coil to a greater extent than with the other arrangement.

The Phenomena of a simple Muscular Contraction.

§ 45. If the far end of the nerve of a muscle-nerve preparation, Figs. 1 and 3, be laid on electrodes connected with the secondary coil of an induction-machine, the passage of a single induction-shock, which may be taken as a convenient form of an almost momentary stimulus, will produce no visible change in the nerve, but the muscle will give a twitch, a short sharp contraction, *i.e.* will for an instant shorten itself, becoming thicker the while, and then return to its previous condition. If one end of the muscle be attached to a lever, while the other is fixed, the lever will by its movements indicate the extent and duration of the shortening. If the point of the lever be brought to bear on some rapidly travelling surface, on which it leaves a mark (being for this purpose armed with a pen and ink if the surface be plain paper, or with a bristle or finely pointed piece of platinum foil if the surface be smoked glass or paper), so long as the muscle remains at rest the lever will describe an even line, which we may call the base line. If however the muscle shortens the lever will rise above the base line and thus describe some sort of curve above the base line. Now

it is found that when a single induction-shock is sent through the nerve the twitch which the muscle gives causes the lever to describe some such curve as that shewn in Fig. 7; the lever (after a brief interval immediately succeeding the opening or shutting the key, of which we shall speak presently,) rises at first rapidly but afterwards more slowly, shewing that the muscle is correspondingly shortening, then ceases to rise, shewing that the muscle is ceasing

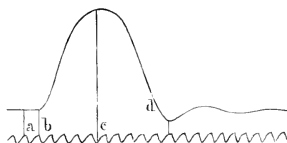

FIG. 7. A MUSCLE-CURVE FROM THE GASTROCNEMIUS OF THE FROG.

This curve, like all succeeding ones, unless otherwise indicated, is to be read from left to right, that is to say, while the lever and tuning-fork were stationary the recording surface was travelling from right to left.

a indicates the moment at which the induction-shock is sent into the nerve. *b* the commencement, *c* the maximum, and *d* the close of the contraction.

Below the muscle-curve is the curve drawn by a tuning-fork making 100 double vibrations a second, each complete curve representing therefore one hundredth of a second.

to grow shorter, then descends, shewing that the muscle is lengthening again, and finally, sooner or later, reaches and joins the base line, shewing that the muscle after the shortening has regained its previous natural length. Such a curve described by a muscle during a twitch or simple muscular contraction, caused by a single induction-shock or by any other stimulus producing the same effect, is called a curve of a simple muscular contraction or, more shortly, a "muscle-curve." It is obvious that the exact form of the curve described by identical contractions of a muscle will depend on the rapidity with which the recording surface is travelling. Thus if the surface be travelling slowly the up-stroke corresponding to the shortening will be very abrupt and the down-stroke also very steep, as in Fig. 8, which is a curve from a gastrocnemius muscle of a frog, taken with a slowly moving drum, the tuning-fork being the same as that used in Fig. 7; indeed with a very slow movement, the two may be hardly separable from each other. On the other hand if the surface travel very rapidly the curve may be immensely long drawn out, as in Fig. 9, which is a curve from a gastrocnemius muscle of a frog, taken with a very rapidly moving pendulum myograph, the tuning-fork marking about 500 vibrations a second. On examination, however, it will be

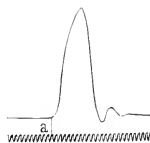

FIG. 8.

found that both these extreme curves are fundamentally the same as the medium one, when account is taken of the different rapidities of the travelling surface in the several cases.

In order to make the 'muscle-curve' complete, it is necessary to mark on the recording surface the exact time at which the induction-shock is sent into the nerve, and also to note the speed at which the recording surface is travelling.

In the pendulum myograph the rate of movement can be calculated from the length of the pendulum; but even in this it is convenient, and in the case of the spring myograph and revolving cylinder is necessary, to measure the rate of movement directly by means of a vibrating tuning-fork or of some body vibrating regularly. Indeed it is best to make such a direct measurement with each curve that is taken.

A tuning-fork, as is known, vibrates so many times a second according to its pitch. If a tuning-fork, armed with a light marker on one of its prongs and vibrating say 100 a second, *i.e.* executing a double vibration, moving forwards and backwards, 100 times a second, be brought while vibrating to make a tracing on the recording surface immediately below the lever belonging to the muscle, we can use the curve or rather curves described by the tuning-fork to measure the duration of any part or of the whole of the muscle-curve. It is essential that at starting the point of the marker of the tuning-fork should be exactly underneath the marker of the lever, or rather, since the point of the lever as it moves up and down describes not a straight line but an arc of a circle of which its fulcrum is the centre and itself (from the fulcrum to the tip of the marker) the radius, that the point of the marker of the tuning-fork should be exactly on the arc described by the marker of the lever, either above or below it, as may prove most convenient. If then at starting the tuning-fork marker be thus on the arc of the lever marker, and we note on the curve of the tuning-fork the place where the arc of the lever cuts it at the beginning and at the end of the muscle-curve as at Fig. 7, we can count the number of vibrations of the tuning-fork which have taken place between the two marks, and so ascertain the whole time of the muscle curve; if for instance there have been 10 double vibrations, each



FIG. 9.

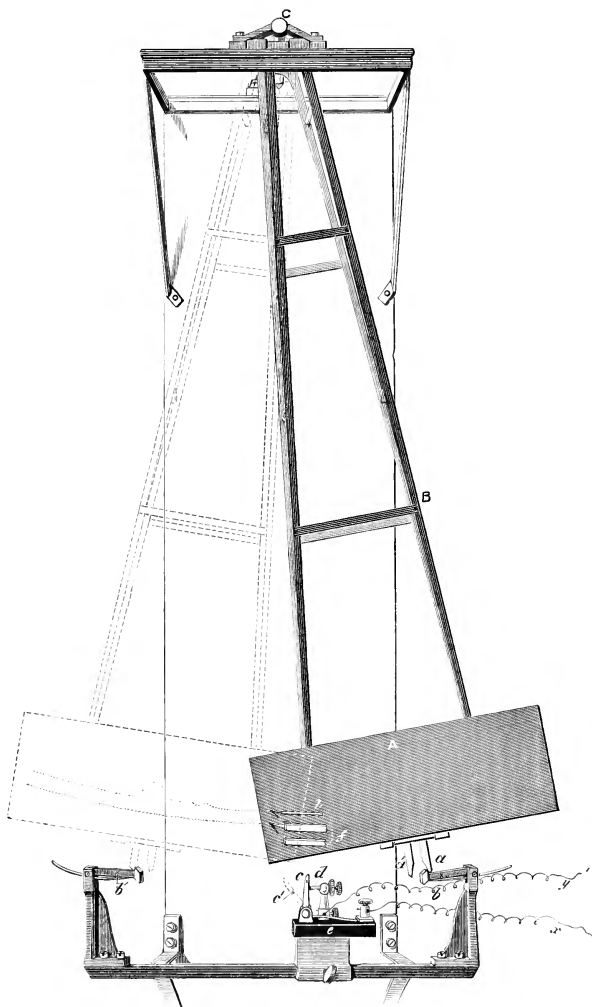

FIG. 10. THE PENDULUM MYOGRAPH.

The figure is diagrammatic, the essentials only of the instrument being shewn. The smoked glass plate *A* swings with the pendulum *B* on carefully adjusted

bearings at *C*. The contrivances by which the glass plate can be removed and replaced at pleasure are not shewn. A second glass plate so arranged that the first glass plate may be moved up and down without altering the swing of the pendulum is also omitted. Before commencing an experiment the pendulum is raised up (in the figure to the right), and is kept in that position by the tooth *a* catching on the spring-catch *b*. On depressing the catch *b* the glass plate is set free, swings into the new position indicated by the dotted lines, and is held in that position by the tooth *a'* catching on the catch *b'*. In the course of its swing the tooth *a'* coming into contact with the projecting steel rod *c*, knocks it on one side into the position indicated by the dotted line *c'*. The rod *c* is in electric continuity with the wire *x* of the primary coil of an induction-machine. The screw *d* is similarly in electric continuity with the wire *y* of the same primary coil. The screw *d* and the rod *c* are armed with platinum at the points in which they are in contact, and both are insulated by means of the ebonite block *e*. As long as *c* and *d* are in contact the circuit of the primary coil to which *x* and *y* belong is closed. When in its swing the tooth *a'* knocks *c* away from *d*, at that instant the circuit is broken, and a 'breaking' shock is sent through the electrodes connected with the secondary coil of the machine, and so through the nerve. The lever *l*, the end only of which is shewn in the figure, is brought to bear on the glass plate, and when at rest describes a straight line, or more exactly an arc of a circle of large radius. The tuning-fork *f*, the ends only of the two limbs of which are shewn in the figure placed immediately below the lever, serves to mark the time.

occupying $\frac{1}{100}$ sec., the whole curve has taken $\frac{1}{10}$ sec. to make. In the same way we can measure the duration of the rise of the curve or of the fall or of any part of it.

Though the tuning-fork may, by simply striking it, be set going long enough for the purposes of an observation, it is convenient to keep it going by means of an electric current and a magnet, very much as the spring in the magnetic interruptor (Fig. 5) is kept going.

It is not necessary to use an actual tuning-fork; any rod, armed with a marker, which can be made to vibrate regularly, and whose time of vibration is known, may be used for the purpose; thus a reed, made to vibrate by a blast of air, is sometimes employed.

The exact moment at which the induction-shock is thrown into the nerve may be recorded on the muscle-curve by means of a 'signal,' which may be applied in various ways.

A light steel lever armed with a marker is arranged over a small coil by means of a light spring in such a way that when the coil by the passage of a current through it becomes a magnet it pulls the lever down to itself; on the current being broken, and the magnetisation of the coil ceasing, the lever by help of the spring flies up. The marker of such a lever is placed immediately under (i.e. at some point on the arc described by) the marker of the muscle (or other) lever. Hence by making a current in the coil and putting the signal lever down, or by breaking an already existing current, and letting the signal lever fly up, we can make at pleasure a mark corresponding to any part we please of the muscle (or other) curve.

If in order to magnetise the coil of the signal, we use, as we may do, the primary current which generates the induction-shock, the breaking or making of the primary current, whichever we use to produce the

induction-shock, will make the signal lever fly up or come down. Hence we shall have on the recording surface, under the muscle, a mark indicating the exact moment at which the primary current was broken or made. Now the time taken up by the generation of the induced current and its passage into the nerve between the electrodes is so infinitesimally small, that we may, without appreciable error, take the moment of the breaking or making of the primary current as the moment of the entrance of the induction-shock into the nerve. Thus we can mark below the muscle-curve, or, by describing the arc of the muscle lever, on the muscle-curve itself, the exact moment at which the induction-shock falls into the nerve between the electrodes, as is done at *a* in Figs. 7, 8, 9.

In the pendulum myograph a separate signal is not needed. If, having placed the muscle lever in the position in which we intend to make it record, we allow the glass plate to descend until the tooth *a'* just touches the rod *c* (so that the rod is just about to be knocked down, and so break the primary circuit) and make on the base line, which is meanwhile being described by the lever marker, a mark to indicate where the point of the marker is under these circumstances, and then bring back the plate to its proper position, the mark which we have made will mark the moment of the breaking of the primary circuit and so of the entrance of the induction-shock into the nerve. For it is just when, as the glass plate swings down, the marker of the lever comes to the mark which we have made that the rod *c* is knocked back and the primary current is broken.

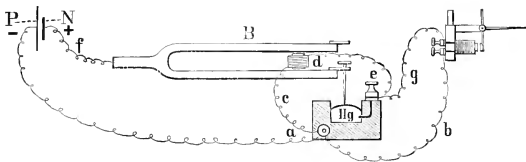

FIG. 11. DIAGRAM OF AN ARRANGEMENT OF A VIBRATING TUNING-FORK WITH A DESPRETZ SIGNAL.

The current flows along the wire *f* connected with the positive (+) pole or end of the negative plate (*N*) of the battery, through the tuning-fork, down the pin connected with the end of the lower prong, to the mercury in the cup *Hg*, and so by a wire (shewn in figure) to the binding screw *e*. From this binding screw part of the current flows through the coil *d* between the prongs of the tuning-fork, and thence by the wire *c* to the binding screw *a*, while another part flows through the wire *g*, through the coil of the Despretz signal back by the wire *b*, to the binding screw *a*. From the binding screw *a* the current passes back to the negative (-) pole or end of the positive element (*P*) of the battery. As the current flows through the coil of the Despretz signal from *g* to *b*, the core of coil becoming magnetized draws down the marker of the signal. As the current flows through the coil *d*, the core of that coil, also becoming magnetized, draws up the lower prong of the fork. But the pin is so adjusted that the drawing up of the prong lifts the point of the pin out of the mercury. In consequence the current being thus broken at *Hg*, flows neither through *d* nor through the Despretz signal. In consequence, the core of the Despretz thus ceasing to be magnetized, the marker flies back, being usually assisted by a spring (not shown in the figure). But in consequence of the current ceasing to flow through *d*, the core of *d* ceases to lift up the prong, and the pin, in the descent of

the prong, makes contact once more with the mercury. The re-establishment of the current however once more acting on the two coils, again pulls down the marker of the signal, and again by magnetizing the core of d pulls up the prong and once more breaks the current. Thus the current is continually made and broken, the rapidity of the interruptions being determined by the vibration periods of the tuning-fork, and the lever of the signal rising and falling synchronously with the movements of the tuning-fork.

A 'signal' like the above, in an improved form known as Despretz's, may be used also to record time, and thus the awkwardness of bringing a large tuning-fork up to the recording surface obviated. For this purpose the signal is introduced into a circuit the current of which is continually being made and broken by a tuning-fork (Fig. 11). The tuning-fork once set vibrating continues to make and break the current at each of its vibrations, and as stated above is kept vibrating by the current. But each make or break caused by the tuning-fork affects also the small coil of the signal, causing the lever of the signal to fall down or fly up. Thus the signal describes vibration curves synchronous with those of the tuning-fork driving it. The signal may similarly be worked by means of vibrating agents other than a tuning-fork.

Various recording surfaces may be used. The form most generally useful is a cylinder covered with smoked paper and made to revolve by clockwork or otherwise; such a cylinder driven by clockwork is shewn in Fig. 3. B. By using a cylinder of large radius with adequate gear, a high speed, for instance in a second, can be obtained. In the *spring myograph* a smoked glass plate is thrust rapidly forward along a groove by means of a spring suddenly thrown into action. In the *pendulum myograph*, Fig. 10, a smoked glass plate attached to the lower end of a long frame swinging like a pendulum, is suddenly let go at a certain height, and so swings rapidly through an arc of a circle. The disadvantage of the last two methods is that the surface travels at a continually changing rate, whereas, in the revolving cylinder, careful construction and adjustment will secure a very uniform rate.

§ 46. Having thus obtained a time record, and an indication of the exact moment at which the induction-shock falls into the nerve, we may for present purposes consider the muscle-curve complete. The study of such a curve, as for instance that shewn in Fig. 7, taken from the gastrocnemius of a frog, teaches us the following facts:

1. That although the passage of the induced current from electrode to electrode is practically instantaneous, its effect, measured from the entrance of the shock into the nerve to the return of the muscle to its natural length after the shortening, takes an appreciable time. In the figure, the whole curve from a to d takes up about the same time as eleven double vibrations of the tuning-fork. Since each double vibration here represents 100th of a second, the duration of the whole curve is rather more than $\frac{1}{10}$ sec.

2. In the first portion of this period, from a to b , there is no visible change, no raising of the lever, no shortening of the muscle.

3. It is not until b , that is to say after the lapse of about 100th sec., that the shortening begins. The shortening as shewn

by the curve is at first slow, but soon becomes more rapid, and then slackens again until it reaches a maximum at c ; the whole shortening occupying rather more than $\frac{4}{100}$ sec.

4. Arrived at the maximum of shortening, the muscle at once begins to relax, the lever descending at first slowly, then more rapidly, and at last more slowly again, until at d the muscle has regained its natural length; the whole return from the maximum of contraction to the natural length occupying rather more than $\frac{5}{100}$ sec.

Thus a simple muscular contraction, a simple spasm or twitch, produced by a momentary stimulus, such as a single induction-shock, consists of three main phases:

1. A phase antecedent to any visible alteration in the muscle. This phase, during which invisible preparatory changes are taking place in the nerve and muscle, is called the '*latent period*.'

2. A phase of shortening or, in the more strict meaning of the word, contraction.

3. A phase of relaxation or return to the original length.

In the case we are considering, the electrodes are supposed to be applied to the nerve at some distance from the muscle. Consequently the latent period of the curve comprises not only the preparatory actions going on in the muscle itself, but also the changes necessary to conduct the immediate effect of the induction-shock from the part of the nerve between the electrodes along a considerable length of nerve down to the muscle. It is obvious that these latter changes might be eliminated by placing the electrodes on the muscle itself or on the nerve close to the muscle. If this were done, the muscle and lever being exactly as before, and care were taken that the induction-shock entered into the nerve at the new

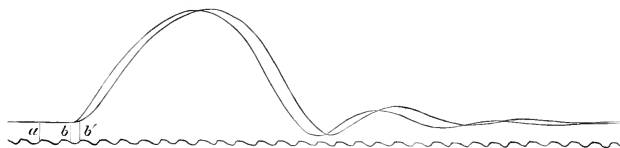

FIG. 12. CURVES ILLUSTRATING THE MEASUREMENT OF THE VELOCITY OF A NERVOUS IMPULSE.

The same muscle-nerve preparation is stimulated (1) as far as possible from the muscle, (2) as near as possible to the muscle; both contractions are registered in exactly the same way.

In (1) the stimulus enters the nerve at the time indicated by the line a , the contraction begins at b' ; the whole latent period therefore is indicated by the distance from a to b' .

In (2) the stimulus enters the nerve at exactly the same time a ; the contraction begins at b ; the latent period therefore is indicated by the distance between a and b .

The time taken up by the nervous impulse in passing along the length of nerve between 1 and 2 is therefore indicated by the distance between b and b' , which may be measured by the tuning-fork curve below; each double vibration of the tuning-fork corresponds to $\frac{1}{125}$ or '0083 sec.

spot, at the moment when the point of the lever had reached exactly the same point of the travelling surface as before, two curves would be gained having the relations shewn in Fig. 12. The two curves resemble each other in almost all points, except that in the curve taken with the shorter piece of nerve, the latent period, the distance a to b as compared with the distance a to b' is shortened: the contraction begins rather earlier. A study of the two curves teaches us the following two facts:

1. Shifting the electrodes from a point of the nerve at some distance from the muscle to a point of the nerve close to the muscle has only shortened the latent period a very little. Even when a very long piece of nerve is taken the difference in the two curves is very small, and indeed in order that it may be clearly recognized or measured, the travelling surface must be made to travel very rapidly. It is obvious therefore that by far the greater part of the latent period is taken up by changes in the muscle itself, changes preparatory to the actual visible shortening. Of course, even when the electrodes are placed close to the muscle, the latent period includes the changes going on in the short piece of nerve still lying between the electrodes and the muscular fibres. To eliminate this with a view of determining the latent period in the muscle itself, the electrodes might be placed directly on the muscle poisoned with urari. If this were done, it would be found that the latent period remained about the same, that is to say, that in all cases the latent period is chiefly taken up by changes in the muscular as distinguished from the nervous elements.

2. Such difference as does exist between the two curves in the figure, indicates the time taken up by the propagation, along the piece of nerve, of the changes set up at the far end of the nerve by the induction-shock. These changes we have already spoken of as constituting a nervous impulse; and the above experiment shews that it takes a small but yet distinctly appreciable time for a nervous impulse to travel along a nerve. In the figure the difference between the two latent periods, the distance between b and b' , seems almost too small to measure accurately; but if a long piece of nerve be used for the experiment, and the recording surface be made to travel very fast, the difference between the duration of the latent period when the induction-shock is sent in at a point close to the muscle, and that when it is sent in at a point as far away as possible from the muscle, may be satisfactorily measured in fractions of a second. If the length of nerve between the two points be accurately measured, the rate at which a nervous impulse travels along the nerve to a muscle can thus be easily calculated. This has been found to be in the frog about 28, and in man about 33 metres per second, but varies considerably especially in warm-blooded animals.

Thus when a momentary stimulus, such as a single induction-shock, is sent into a nerve connected with a muscle, the following

events take place: a nervous impulse is started in the nerve and this travelling down to the muscle produces in the muscle first the invisible changes which constitute the latent period, secondly the changes which bring about the shortening or contraction proper, and thirdly the changes which bring about the relaxation and return to the original length. The changes taking place in each of these three phases are changes of living matter; they vary with the condition of the living substance of the muscle, and only take place so long as the muscle is alive. Though the relaxation which brings back the muscle to its original length is assisted by the muscle being loaded with a weight or otherwise stretched, this is not essential to the actual relaxation, and with the same load the return will vary according to the condition of the muscle; the relaxation must be considered as an essential part of the whole contraction no less than the shortening itself.

§ 47. Not only, as we shall see later on, does the whole contraction vary in extent and character according to the condition of the muscle, the strength of the induction-shock, the load which the muscle is bearing, and various attendant circumstances, but the three phases may vary independently. The latent period may be longer or shorter, the shortening may take a longer or shorter time to reach the same height, and especially the relaxation may be slow or rapid, complete or imperfect. Even when the same strength of induction-shock is used the contraction may be short and sharp or very long drawn out, so that the curves described on a recording surface travelling at the same rate in the two cases appear very different; and under certain circumstances, as when a muscle is fatigued, the relaxation, more particularly the last part of it, may be so slow, that it may be several seconds before the muscle really regains its original length.

Hence, if we say that the duration of a simple muscular contraction of the gastrocnemius of a frog, under ordinary circumstances is about $\frac{1}{10}$ sec., of which $\frac{1}{100}$ is taken up by the latent period, $\frac{4}{100}$ by the contraction, and $\frac{5}{100}$ by the relaxation, these must be taken as 'round numbers' stated so as to be easily remembered. The duration of each phase as well as of the whole contraction varies in different animals, in different muscles of the same animal, and in the same muscle under different conditions.

The muscle curve which we have been discussing is a curve of changes in the length only of the muscle; but if the muscle, instead of being suspended, were laid flat on a glass plate and a lever laid over its belly, we should find, upon sending an induction-shock into the nerve, that the lever was raised, shewing that the muscle during the contraction became thicker. And if we took a graphic record of the movements of the lever we should obtain a curve very similar to the one just discussed; after a latent period the lever would rise, shewing that the muscle was getting thicker, and afterwards would fall, shewing that the muscle was becoming thin again.

In other words, in contraction the lessening of the muscle lengthwise is accompanied by an increase crosswise; indeed, as we shall see later on, the muscle in contracting is not diminished in bulk at all (or only to an exceedingly small extent, about $\frac{1}{10000}$ of its total bulk), but makes up for its diminution in length by increasing in its other diameters.

§ 48. A single induction-shock is, as we have said, the most convenient form of stimulus for producing a simple muscular contraction, but this may also be obtained by other stimuli provided that these are sufficiently sudden and short in their action, as for instance by a prick of, or sharp blow on, the nerve or muscle. For the production of a single simple muscular contraction the changes in the nerve leading to the muscle must be of such a kind as to constitute what may be called a single nervous impulse, and any stimulus which will evoke a single nervous impulse only may be used to produce a simple muscular contraction.

As a rule however most stimuli other than single induction shocks tend to produce in a nerve several nervous impulses, and as we shall see the nervous impulses which issue from the central nervous system and so pass along nerves to muscles, are as a rule not single and simple but complex. Hence, as a matter of fact, a simple muscular contraction is within the living body a comparatively rare event (at least as far as the skeletal muscles are concerned), and cannot easily be produced outside the body otherwise than by a single induction-shock. The ordinary form of muscular contraction is not a simple muscular contraction but the more complex form known as a tetanic contraction, to the study of which we must now turn.

Tetanic Contractions.

§ 49. If a single induction-shock be followed at a certain interval by a second shock of the same strength, the first simple contraction will be followed by a second simple contraction, both contractions being separate and distinct; and if the shocks be repeated a series of rhythmically recurring separate simple contractions may be obtained. If however the interval between two shocks made short, if for instance it be made only just long enough to allow the first contraction to have passed its maximum before the latent period of the second is over, the curves of the two contractions will bear some such relation to each other as that shewn in Fig. 13. It will be observed that the second curve is almost in all respects like the first except that it starts, so to speak, from the first curve instead of from the base-line. The second nervous impulse has acted on the already contracted muscle, and made it contract again just as it would have done if there had been no first impulse and the muscle had been at rest. The two contractions are added together and the lever is raised

nearly double the height it would have been by either alone. If in the same way a third shock follows the second at a sufficiently

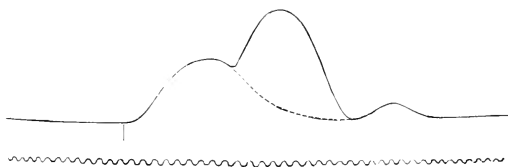

FIG. 13. TRACING OF A DOUBLE MUSCLE-CURVE.

While the muscle (gastrocnemius of frog) was engaged in the first contraction (whose complete course, had nothing intervened, is indicated by the dotted line), a second induction-shock was thrown in, at such a time that the second contraction began just as the first was beginning to decline. The second curve is seen to start from the first, as does the first from the base-line.

short interval, a third curve is piled on the top of the second; the same with a fourth, and so on. A more or less similar result would occur if the second contraction began at another phase of the first. The combined effect is, of course, greatest when the second contraction begins at the maximum of the first, being less both before and afterwards.

Hence the result of a repetition of shocks will depend largely on the rate of repetition. If, as in Fig. 14, the shocks follow each other so slowly that one contraction is over, or almost over, before the next begins, each contraction will be distinct, or nearly distinct, and there will be little or no combined effect.



FIG. 14. MUSCLE-CURVE. SINGLE INDUCTION SHOCKS REPEATED SLOWLY.

If however the shocks be repeated more rapidly, as in Fig. 15, each succeeding contraction will start from some part of the preceding one, and the lever will be raised to a greater height at each contraction.

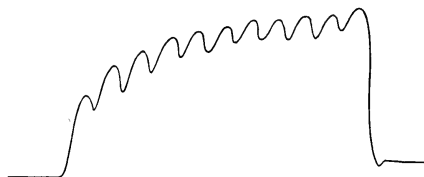

FIG. 15. MUSCLE-CURVE. SINGLE INDUCTION SHOCK REPEATED MORE RAPIDLY.

If the frequency of the shocks be still further increased, as in Fig. 16, the rise due to the combination of contraction will be still more rapid, and a smaller part of each contraction will be visible on the curve.



FIG. 16. MUSCLE-CURVE. SINGLE INDUCTION SHOCK REPEATED STILL MORE RAPIDLY.

In each of these three curves it will be noticed that the character of the curve changes somewhat during its development. The change is the result of commencing fatigue, caused by the repetition of the contractions, the fatigue manifesting itself by an increasing prolongation of each contraction, shewn especially in a delay of relaxation, and by an increasing diminution in the height of the contraction. Thus in Fig. 14 the contractions quite distinct at first, become fused later; the fifth contraction for instance is prolonged so that the sixth begins before the lever has reached the base line; yet the summit of the sixth is hardly higher than the summit of the fifth, since the sixth though starting at a higher level is a somewhat weaker contraction. So also in Fig. 15, the lever rises rapidly at first but more slowly afterwards, owing to an increasing diminution in the height of the single contractions. In Fig. 16 the increment of rise of the curve due to each contraction diminishes very rapidly, and though the lever does continue to rise during the whole series, the ascent after about the sixth contraction is very gradual indeed, and the indications of the individual contractions are much less marked than at first.

Hence when shocks are repeated with sufficient rapidity, it results that after a certain number of shocks, the succeeding impulses do not cause any further shortening of the muscle, any further raising of the lever, but merely keep up the contraction already existing. The curve thus reaches a maximum, which it maintains, subject to the depressing effects of exhaustion, so long as the shocks are repeated. When these cease to be given, the muscle returns to its natural length.

When the shocks succeed each other still more rapidly than in Fig. 16 the individual contractions, visible at first, may become fused together and wholly lost to view in the latter part of the curve. When the shocks succeed each other still more rapidly

(the second contraction beginning in the ascending portion of the first), it becomes difficult or impossible to trace out any of the single contractions¹. The curve then described by the lever is of the kind shewn in Fig. 17, where the primary current of an

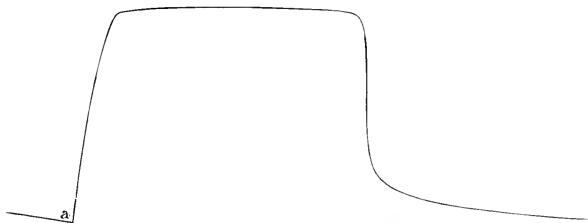

FIG. 17. TETANUS PRODUCED WITH THE ORDINARY MAGNETIC INTERRUPTOR OF AN INDUCTION-MACHINE. (Recording surface travelling slowly.)

The interrupted current is thrown in at *a*.

induction-machine was rapidly made and broken by the magnetic interruptor, Fig. 5. The lever, it will be observed, rises at *a* (the recording surface is travelling too slowly to allow the latent period to be distinguished), at first very rapidly, in fact in an unbroken and almost a vertical line, and so very speedily reaches the maximum, which is maintained so long as the shocks continue to be given; when these cease to be given, the curve descends at first very rapidly and then more and more gradually towards the base line, which it reaches just at the end of the figure.

This condition of muscle, brought about by rapidly repeated shocks, this fusion of a number of simple twitches into an apparently smooth continuous effort, is known as *tetanus*, or *tetanic contraction*. The above facts are most clearly shewn when induction-shocks, or at least galvanic currents in some form or other, are employed. They are seen, however, whatever be the form of stimulus employed. Thus in the case of mechanical stimuli, while a single quick blow may cause a single twitch, a pronounced tetanus may be obtained by rapidly striking successively fresh portions of a nerve. With chemical stimulation, as when a nerve is dipped in acid, it is impossible to secure a momentary application; hence tetanus, generally irregular in character, is the normal result of this mode of stimulation. In the living body, the contractions of the skeletal muscles, brought about either by the will or otherwise, are generally tetanic in character. Even very short sharp movements, such as a sudden jerk of a limb or a wink of the eyelid, are in reality examples of tetanus of short duration.

¹ The ease with which the individual contractions can be made out depends in part, it need hardly be said, on the rapidity with which the recording surface travels.

If the lever, instead of being fastened to the tendon of a muscle hung vertically, be laid across the belly of a muscle placed in a horizontal position and the muscle be thrown into tetanus by a repetition of induction-shocks, it will be seen that each shortening of the muscle is accompanied by a corresponding thickening, and that the total shortening of the tetanus is accompanied by a corresponding total thickening. And indeed in tetanus we can observe more easily than in a single contraction that the muscle in contracting changes in form only, not in bulk. If a living muscle or group of muscles be placed in a glass jar or chamber, the closed top of which is prolonged into a narrow glass tube, and the chamber be filled with water (or preferably with a solution of sodium chloride, .6 p. c. in strength, usually called "normal saline solution," which is less injurious to the tissue than simple water) until the water rises into the narrow tube, it is obvious that any change in the bulk of the muscle will be easily shewn by a rising or falling of the column of fluid in the narrow tube. It is found that when the muscle is made to contract, even in the most forcible manner, the change of level in the height of the column which can be observed is practically insignificant: there appears to be a fall indicating a diminution of bulk to the extent of about one ten-thousandth of the total bulk of the muscle. So that we may fairly say that in a tetanus, and hence in a simple contraction, the lessening of the length of the muscle causes a corresponding increase in the other directions: the substance of the muscle is displaced not diminished.

§ 50. So far we have spoken simply of an induction-shock or of induction-shocks without any reference to their strength, and of a living or irritable muscle without any reference to the degree or extent of its irritability. But induction-shocks may vary in strength, and the irritability of the muscle may vary.

If we slide the secondary coil a long way from the primary coil, and thus make use of extremely feeble induction-shocks, we shall probably find that these shocks, applied even to a quite fresh muscle-nerve preparation, produce no contraction. If we then gradually slide the secondary coil nearer and nearer the primary coil, and keep on trying the effects of the shocks, we shall find that after a while, in a certain position of the coils, a very feeble contraction makes its appearance. As the secondary coil comes still nearer to the primary coil the contractions grow greater and greater. After a while however, and that indeed in ordinary circumstances very speedily, increasing the strength of the shock no longer increases the height of the contraction; the maximum contraction of which the muscle is capable with such shocks however strong has been reached.

If we use a tetanizing or interrupted current we shall obtain the same general results; we may, according to the strength of the current, get no contraction at all, or contractions of various extent up to a maximum, which cannot be exceeded. Under favourable

conditions the maximum contraction may be very considerable: the shortening in tetanus may amount to three-fifths of the total length of the muscle.

The amount of contraction then depends on the strength of the stimulus, whatever be the stimulus; but this holds good within certain limits only; to this point however we shall return later on.

§ 51. If, having ascertained in a perfectly fresh muscle-nerve preparation the amount of contraction produced by this and that strength of stimulus, we leave the preparation by itself for some time, say for a few hours, and then repeat the observations, we shall find that stronger stimuli, stronger shocks for instance, are required to produce the same amount of contraction as before; that is to say, the irritability of the preparation, the power to respond to stimuli, has in the meanwhile diminished. After a further interval we should find the irritability still further diminished: even very strong shocks would be unable to evoke contractions as large as those previously caused by weak shocks. At last we should find that no shocks, no stimuli, however strong, were able to produce any visible contraction whatever. The amount of contraction in fact evoked by a stimulus depends not only on the strength of the stimulus but also on the degree of irritability of the muscle-nerve preparation.

Immediately upon removal from the body, the preparation possesses a certain amount of irritability, not differing very materially from that which the muscle and nerve possess while within and forming an integral part of the body; but after removal from the body the preparation loses irritability, the rate of loss being dependent on a variety of circumstances; and this goes on until, since no stimulus which we can apply will give rise to a contraction, we say the irritability has wholly disappeared.

We might take this disappearance of irritability as marking the death of the preparation, but it is followed sooner or later by a curious change in the muscle, which is called rigor mortis, and which we shall study presently; and it is convenient to regard this rigor mortis as marking the death of the muscle.

The irritable muscle then, when stimulated either directly, the stimulus being applied to itself, or indirectly, the stimulus being applied to its nerve, responds to the stimulus by a change of form which is essentially a shortening and thickening. By the shortening (and thickening) the muscle in contracting is able to do work, to move the parts to which it is attached; it thus sets free energy. We have now to study more in detail how this energy is set free and the laws which regulate its expenditure.

SEC. 2. ON THE CHANGES WHICH TAKE PLACE IN A MUSCLE DURING A CONTRACTION.

The Change in Form.

§ 52. *Gross structure of muscle.* An ordinary skeletal muscle consists of *elementary muscle fibres*, bound together in variously arranged bundles by connective tissue which carries blood vessels, nerves and lymphatics. The same connective tissue besides supplying a more or less distinct wrapping for the whole muscle forms the two ends of the muscle, being here sometimes scanty, as where the muscle appears to be directly attached to a bone, and a small amount only of connective tissue joins the muscular fibres to the periosteum, sometimes abundant, as when the connective tissue in which the muscular fibres immediately end is prolonged into a tendon.

Each elementary fibre, which varies even in the mammal in length and breadth (in the frog the dimensions vary very widely) but may be said on an average to be 30 or 40 mm. in length and 20μ to 30μ in breadth, consists of an elastic homogeneous or faintly fibrillated sheath of peculiar nature, the *sarcolemma*, which embraces and forms an envelope for the *striated muscular substance* within. Each fibre, cylindrical in form, giving a more or less circular outline in transverse section, generally tapers off at each end in a conical form.

At each end of the fibre the sarcolemma, to which in life the muscular substance is adherent, becomes continuous with fibrillæ of connective tissue. When the end of the fibre lies at the end of the muscle, these connective tissue fibrillæ pass directly into the tendon (or into the periosteum, &c.), and in some cases of small muscles which are no longer than their constituent fibres, each fibre may thus join at each end of itself, by means of its sarcolemma, the tendon or other ending of the muscle. In a very large number of muscles however the muscle is far longer than any of its fibres, and there may even be whole bundles of fibres in

the middle of the muscle which do not reach to either end. In such case the connective tissue in which the sarcolemma ends is continuous with the connective tissue which, running between the fibres and between the bundles, binds the fibres into small bundles, and the smaller bundles into larger bundles.

The contraction of a muscle is the contraction of all or some of its elementary fibres, the connective tissue being passive; hence while those fibres of the muscle which end directly in the tendon, in contracting pull directly on the tendon, those which do not so end pull indirectly on the tendon by means of the connective tissue between the bundles, which connective tissue is continuous with the tendon.

The blood vessels run in the connective tissue between the bundles and between the fibres, and the capillaries form more or less rectangular networks immediately outside the sarcolemma. Lymphatic vessels also run in the connective tissue, in the lymph spaces of which they begin. Each muscular fibre is thus surrounded by lymph spaces and capillary blood vessels, but the active muscular substance of the fibre is separated from these by the sarcolemma; hence the interchange between the blood and the muscular substance is carried on backwards and forwards through the capillary wall, through some of the lymph spaces, and through the sarcolemma.

Each muscle is supplied by one or more branches of nerves composed of medullated fibres, with a certain proportion of non-medullated fibres. These branches running in the connective tissue divide into smaller branches and twigs between the bundles and fibres. Some of the nerve fibres are distributed to the blood vessels, and others end in a manner of which we shall speak later on in treating of muscular sensations; but by far the greater part of the medullated fibres end in the muscular fibres, the arrangement being such that every muscular fibre is supplied with at least one medullated nerve fibre, which joins the muscular fibre somewhere about the middle between its two ends or sometimes nearer one end, in a special nerve ending, of which we shall presently have to speak, called an *end plate*. The nerve fibres thus destined to end in the muscular fibres divide as they enter the muscle, so that what, as it enters the muscle is a single nerve fibre, may, by dividing, end as several nerve fibres in several muscular fibres. Sometimes two nerve fibres join one muscular fibre, but in this case the end plate of each nerve fibre is still at some distance from the end of the muscular fibre. It follows that when a muscular fibre is stimulated by means of a nerve fibre, the nervous impulse travelling down the nerve fibre falls into the muscular fibre not at one end but at about its middle; it is the middle of the fibre which is affected first by the nervous impulse, and the changes in the muscular substance started in the middle of the muscular fibre travel thence to the two ends of the fibre.

In an ordinary skeletal muscle however, as we have said, the fibres and bundles of fibres begin and end at different distances from the ends of the muscle, and the nerve or nerves going to the muscle divide and spread out in the muscle in such a way that the end plates, in which the individual fibres of the nerve end, are distributed widely over the muscle at very different distances from the ends of the muscle. Hence, if we suppose a single nervous impulse, such as that generated by a single induction shock, or a series of such impulses to be started at the same time at some part of the trunk of the nerve in each of the fibres of the nerve going to the muscle, these impulses will reach very different parts of the muscle at about the same time and the contractions which they set going will begin, so to speak, nearly all over the whole muscle at the same time, and will not all start in any particular zone or area of the muscle.

§ 53. *The wave of contraction.* We have seen, however, that under the influence of urari the nerve fibre, is unable to excite contractions in a muscular fibre, although the irritability of the muscular fibre itself is retained. Hence, in a muscle poisoned by urari the contraction begins at that part of the muscular substance which is first affected by the stimulus, and we may start a contraction in what part of the muscle we please by properly placing the electrodes.

Some muscles, such for instance as the *sartorius* of the frog, though of some length are composed of fibres which run parallel to each other from one end of the muscle to the other. If such a muscle be poisoned with urari so as to eliminate the action of the nerves and stimulated at one end (an induction-shock sent through a pair of electrodes placed at some little distance apart from each other at the end of the muscle may be employed, but better results are obtained if a mode of stimulation, of which we shall have to speak presently, viz. the application of the "constant current," be adopted), the contraction which ensues starts from the end stimulated, and travels thence along the muscle. If two levers be made to rest on, or be suspended from, two parts of such a muscle placed horizontally, the parts being at a known distance from each other and from the part stimulated, the progress of the contraction may be studied.

The movements of the levers indicate in this case the thickening of the fibres which is taking place at the parts on which the levers rest or to which they are attached; and if we take a graphic record of these movements, bringing the two levers to mark, one immediately below the other, we shall find that the lever nearer the part stimulated begins to move earlier, reaches its maximum earlier, and returns to rest earlier than does the farther lever. The contraction, started by the stimulus, in travelling along the muscle from the part stimulated reaches the nearer lever some little time before it reaches the farther lever, and has passed by

the nearer lever some little time before it has passed by the farther lever; and the farther apart the two levers are the greater will be the difference in time between their movements. In other words the contraction travels along the muscle in the form of a wave, each part of the muscle in succession from the end stimulated swelling out and shortening as the contraction reaches it, and then returning to its original state. And what is true of the collection of parallel fibres which we call the muscle is also true of each fibre, for the swelling at any part of the muscle is only the sum of the swelling of the individual fibres; and if we were able to take a single long fibre and stimulate it at one end, we should be able under the microscope to see a swelling or bulging accompanied by a corresponding shortening, *i.e.* to see a contraction, sweep along the fibre from end to end.

If in the graphic record of the two levers just mentioned we count the number of vibrations of the tuning-fork which intervene between the mark on the record which indicates the beginning of the rise of the near lever (that is the arrival of the contraction wave at this lever) and the mark which indicates the beginning of the rise of the far lever, this will give us the time which it has taken the contraction wave to travel from the near to the far lever. Let us suppose this to be $\cdot 005$ sec. Let us suppose the distance between the two levers to be 15 mm. The contraction wave then has taken $\cdot 005$ sec. to travel 15 mm., that is to say it has travelled at the rate of 3 meters per sec. And indeed we find by this, or by other methods, that in the frog's muscles the contraction wave does travel at a rate which may be put down as from 3 to 4 meters a second, though it varies under different conditions. In the warm-blooded mammal the rate is somewhat greater, and may probably be put down at 5 meters a second in the excised muscle, rising possibly to 10 meters in a muscle within the living body.

If again in the graphic record of the two levers we count, in the case of either lever, the number of vibrations of the tuning-fork which intervene between the mark where the lever begins to rise and the mark where it has finished its fall and returned to the base line, we can measure the time intervening between the contraction wave reaching the lever, and leaving the lever on its way onward, that is to say we can measure the time which it has taken the contraction wave to pass over the part of the muscle on which the lever is resting. Let us suppose this time to be say $\cdot 1$ sec. But a wave which is travelling at the rate of 3 m. a second and takes $\cdot 1$ sec. to pass over any point must be 300 mm. long. And indeed we find that in the frog the length of the contraction wave may be put down as varying from 200 to 400 mm., and in the mammal it is not very different.

Now, as we have said, the very longest muscular fibre is stated to be at most only about 40 mm. in length; hence, in an ordinary

contraction, during the greater part of the duration of the contraction the whole length of the fibre will be occupied by the contraction wave. Just at the beginning of the contraction there will be a time when the front of the contraction wave has reached for instance only half way down the fibre (supposing the stimulus to be applied, as in the case we have been discussing, at one end only), and just at the end of the contraction there will be a time for instance when the contraction has left the half of the fibre next to the stimulus, but has not yet cleared away from the other half. But nearly all the rest of the time every part of the fibre will be in some phase or other of contraction, though the parts nearer the stimulus will be in more advanced phases than the parts farther from the stimulus.

This is true when a muscle of parallel fibres is stimulated artificially at one end of the muscles, and when therefore each fibre is stimulated at one end. It is of course all the more true when a muscle of ordinary construction is stimulated by means of its nerve. The stimulus of the nervous impulse impinges, in this case, on the muscle fibre at the end plate which, as we have said, is placed towards the middle of the fibre, and the contraction wave travels from the end plate in opposite directions toward each end, and has accordingly only about half the length of the fibre to run in. All the more therefore must the whole fibre be in a state of contraction at the same time.

It will be observed that in what has just been said the contraction wave has been taken to include not only the contraction proper, the thickening and shortening, but also the relaxation and return to the natural form; the first part of the wave up to the summit of the crest corresponds to the shortening and thickening, the decline from the summit onwards corresponds to the relaxation. But we have already insisted that the relaxation is an essential part of the whole act, indeed in a certain sense as essential as the shortening itself.

§ 54. *Minute structure of muscular fibre.* So far we have been dealing with the muscle as a whole and as observed with the naked eye, though we have incidentally spoken of fibres. We have now, confining our attention exclusively to skeletal muscles, to consider what microscopic changes take place during a contraction, what are the relations of the histological features of the muscle fibre to the act of contraction.

The long cylindrical sheath of sarcolemma is occupied by muscle substance. After death the muscle substance may separate from the sarcolemma, leaving the latter as a distinct sheath, but during life the muscle substance is adherent to the sarcolemma, so that no line of separation between the two can be made out; the movements of the one follow exactly all the movements of the other.

Scattered in the muscle substance but, in the mammal, lying

for the most part close under the sarcolemma are a number of nuclei, oval in shape with their long axes parallel to the length of the fibre. Around each nucleus is a thin layer of granular looking substance, very similar in appearance to that forming the body of a white blood corpuscle, and like that often spoken of as undifferentiated protoplasm. A small quantity of the same granular substance is prolonged for some distance, as a narrow conical streak from each end of the nucleus, along the length of the fibre.

With the exception of these nuclei with their granular looking bed and the end plate or end plates, to be presently described, all the rest of the space enclosed by the sarcolemma from one end of the fibre to the other appears to be occupied by a peculiar material, *striated muscle-substance*.

It is called *striated* because it is marked out, and that along the whole length of the fibre, by transverse bands, stretching right across the fibre, of substance which is very transparent, *bright substance*, alternating with similar bands of substance which has a dim cloudy appearance, *dim substance*; that is to say the fibre is marked out along its whole length by alternate *bright bands* and *dim bands*. The bright bands are on an average about $1\ \mu$ or $1.5\ \mu$ m. and the dim bands about $2.5\ \mu$ or $3\ \mu$ m. thick. By careful focussing, both bright bands and dim bands may be traced through the whole thickness of the fibre, so that the whole fibre appears to be composed of bright discs and dim discs placed alternately one upon the other along the whole length of the fibre, the arrangement being broken by the end plate and here and there by the nuclei.

When a muscular fibre is treated with dilute mineral acids it is very apt to break up transversely into discs, the sarcolemma being dissolved, or so altered as easily to divide into fragments corresponding to the discs; and a disc may thus be obtained so thin as to comprise only a single dim or bright band, or a dim band with a thin layer of bright substance above and below it, the cleavage having taken place along the middle of the bright bands.

When treated with certain reagents, alcohol, chromic acid, &c., the fibre is very apt to split up (and the splitting up may be assisted by "teasing") longitudinally into columns of variable thickness, some of which however may be exceedingly thin, and are then sometimes spoken of as 'fibrillæ.' Both these discs and fibrillæ are artificial products, the results of a transverse or longitudinal cleavage of the dead, hardened or otherwise prepared muscle substance. They may moreover be obtained in almost any thickness or thinness, and these discs and fibrillæ do not by themselves prove much beyond the fact that the fibre tends to cleave in the two directions.

The living fibre however, though at times quite glassy looking, the bright bands appearing like transparent glass and the dim bands like ground glass, is at other times marked with longitudinal

lines giving rise to a longitudinal striation, sometimes conspicuous and occasionally obscuring the transverse striation. In the muscles of some insects each dim band has a distinct palisade appearance as if made up of a number of 'fibrillæ' or 'rods' placed side by side and imbedded in some material of a different nature; moreover these fibrillæ or rods may, with greater difficulty, be traced through the bright bands, and that at times along the whole length of the fibre. And there is a great deal of evidence, into which we cannot enter here, which goes to prove that in all striated muscle, mammalian muscle included, the muscle substance is really composed of longitudinally placed natural *fibrillæ* of a certain nature, imbedded in an *interfibrillar* substance of a different nature. In mammalian muscle and vertebrate muscle generally these fibrillæ are exceedingly thin and in most cases are not sharply defined by optical characters from their interfibrillar bed; in insect muscles and some other muscles, they are relatively large, well defined and conspicuous. The artificial fibrillæ obtained by teasing may perhaps in some cases where they are exceedingly thin correspond to these natural fibrillæ, but in the majority of cases they certainly do not.

In certain insect muscles each bright band has in it two (or sometimes more) dark lines which are granular in appearance and may be resolved by adequate magnifying power into rows of granules. Since they may by focussing be traced through the whole thickness of the fibre the lines are the expression of discs. Frequently the lines in the bright bands are so conspicuous as to contribute a greater share to the transverse striation of the fibre than do the dim bands. Similar granular lines (rows or rather discs of granules), may also be seen though less distinctly, in vertebrate, including mammalian, muscle.

Besides these granular lines whose position in the bright band is near to the dim bands, often appearing to form, as it were, the upper edge of the dim band below and the lower edge of the dim band above, there may be also sometimes traced another transverse thin line in the very middle of the bright band. This line, like the other lines (or bands) is the expression of a disc and has been held by some observers to represent a membrane stretched across the whole thickness of the fibre and adherent at the circumference with the sarcolemma; in this sense it is spoken of as *Krause's membrane*. The reasons for believing that the line really represents a definite membrane do not however appear to be adequate. It may be spoken of as the "intermediate line."

When a thin transverse section of frozen muscle is examined quite fresh under a high power, the muscle substance within the sarcolemma is seen to be marked out into a number of small more or less polygonal areas, and a similar arrangement into areas may also be seen in transverse sections of prepared muscle, though the features of the areas are somewhat different from those seen in the

fresh living fibre. These areas are spoken of as "Cohnheim's areas"; they are very much larger than the diameter of a fibrilla as indicated by the longitudinal striation, and indeed correspond to a whole bundle of such fibrillæ. Their existence seems to indicate that the fibrillæ are arranged in longitudinal prisms separated from each other by a larger amount of interfibrillar substance than that uniting together the individual fibrillæ forming each prism.

Lastly it may be mentioned that not only are the various granular lines at times visible with difficulty or quite invisible, but that even the distinction between dim and bright bands is on occasion very faint or obscure, the whole muscle substance, apart from the nuclei, appearing almost homogeneous.

Without attempting to discuss the many and various interpretations of the above and other details concerning the minute structure of striated muscular fibre, we may here content ourselves with the following general conclusions.

(1) That the muscle substance is composed of longitudinally disposed *fibrillæ* (probably cylindrical in general form and probably arranged in longitudinal prisms) imbedded in an *interfibrillar substance*, which appears to be less differentiated than the fibrillæ themselves and which is probably continuous with the undifferentiated protoplasm round the nuclei. The interfibrillar substance stains more readily with gold chloride than do the fibrillæ, and hence in gold chloride specimens appears as a sort of meshwork, with longitudinal spaces corresponding to the fibrillæ.

(2) That the interfibrillar substance is, relatively to the fibrillæ, more abundant in the muscles of some animals than in those of others, being for instance very conspicuous in the muscles of insects, in which animals we should naturally expect the less differentiated material to be more plentiful than in the muscles of the more highly developed mammal.

(3) That, the fibrillæ and interfibrillar substance having different refractive powers, some of the optical features of muscle may be due, on the one hand to the relative proportion of fibrillæ to interfibrillar substance, and on the other hand to the fibrillæ not being cylindrical throughout the length of the fibre but constricted at intervals, and thus becoming beaded or moniliform; for instance the rows of granules spoken of above are by some regarded as corresponding to aggregations of interfibrillar material filling up the spaces where the fibrillæ are most constricted. But it does not seem possible at the present time to make any statement which will satisfactorily explain all the various appearances met with.

§ 55. We may now return to the question, What happens when a contraction wave sweeps over the fibre?

Muscular fibres may be examined even under high powers of the microscope while they are yet living and contractile; the contraction itself may be seen, but the rate at which the wave travels is too

rapid to permit satisfactory observations being made as to the minute changes which accompany the contraction. It frequently happens however that when living muscle has been treated with certain reagents, as for instance with osmic acid vapour, and subsequently prepared for examination, fibres are found in which a bulging, a thickening and shortening, over a greater or less part of the length of the fibre, has been fixed by the osmic acid or other reagent. Such a bulging obviously differs from a normal contraction in being confined to a part of the length of the fibre, whereas, as we have said, a normal wave of contraction, being very much longer than any fibre, occupies the whole length of the fibre at once. We may however regard this bulging as a very short, a very abbreviated wave of contraction, and assume that the changes visible in such a short bulging also take place in a normal contraction.

Admitting this assumption, we learn from such preparations that in the contracting region of the fibre, while both dim and bright bands become broader across the fibre, and correspondingly thinner along the length of the fibre, a remarkable change takes place between the dim bands, bright bands, and granular lines. We have seen that in the fibre at rest the intermediate line in the bright band is in most cases inconspicuous; in the contracting fibre, on the contrary, a dark line in the middle of the bright band in the position of the intermediate line becomes very distinct. As we pass along the fibre from the beginning of the contraction wave, to the summit of the wave, where the thickening is greatest, this line becomes more and more striking, until at the height of the contraction, it becomes a very marked dark line or thin dark band. *Pari passu* with this change, the distinction between the dim and bright bands becomes less and less marked; these appear to become confused together, until at the height of the contraction, the whole space between each two now conspicuous dark lines is occupied by a substance which can be called neither dim nor bright, but which in contrast to the dark line appears more or less bright and transparent. So that in the contracting part there is, at the height of the contraction, a reversal of the state of things proper to the part at rest. The place occupied by the bright band, in the state of rest, is now largely filled by a conspicuous dark line which previously was represented by the inconspicuous intermediate line, and the place occupied by the conspicuous dim band of the fibre at rest now seems by comparison with the dark line the brighter part of the fibre. The contracting fibre is like the fibre at rest striated, but its striation is different in its nature from the natural striation of the resting fibre; and it is held by some that in the earlier phases of the contraction, while the old natural striation is being replaced by the new striation, there is a stage in which all striation is lost.

We may add that the outline of the sarcolemma, which in the fibre at rest is quite even, becomes during the contraction indented

opposite the intermediate line, and bulges out in the interval between each two intermediate lines, the bulging and indentation becoming more marked the greater the contraction.

§ 56. We can learn something further about this remarkable change by examining the fibre under polarized light.

When ordinary light is sent through a Nicol prism (which is a rhomb of Iceland spar divided into two in a certain direction, the halves being subsequently cemented together in a special way) it undergoes a change in passing through the prism and is said to be *polarized*. One effect of this polarization is that a ray of light which has passed through one Nicol prism will or will not pass through a second Nicol according to the relative position of the two prisms. Thus if the second Nicol be so placed that what is called its "optic axis" be in a line with or parallel to the optic axis of the first Nicol the light passing through the first Nicol will also pass through the second. But if the second Nicol be rotated until its optic axis is at right angles with the optic axis of the first Nicol none of the light passing through the former will pass through the latter; the prisms in this position are said to be 'crossed.' In intermediate positions more or less light passes through the second Nicol according to the angle between the two optic axes.

Hence when one Nicol is placed beneath the stage of a microscope so that the light from the mirror is sent through it, and another Nicol is placed in the eye-piece, the field of the microscope will appear dark when the eye-piece Nicol is rotated so that its optic axis is at right angles to the optic axis of the lower Nicol, and consequently the light passing through the lower Nicol is stopped by it. If however the optic axis of the eye-piece Nicol be parallel to that of the lower Nicol, the light from the latter will pass through the former and the field will be bright; and as the eye-piece is gradually rotated from one position to the other the brightness of the field will diminish or increase.

Both the Nicols are composed of doubly refractive material. If now a third doubly refractive material be placed on the stage and therefore between the two Nicols, the light passing through the lower Nicol will (in a certain position of the doubly refractive material on the stage, that is to say when its optic axes have a certain position) pass through it and also through the *crossed* Nicol in the eye-piece. Hence the doubly refractive material on the stage (or such parts of it as are in the proper position in respect to their optic axes) will, when the eye-piece Nicol is crossed, appear illuminated and bright on a dark field. In this way the existence of doubly refractive material in a preparation may be detected.

When muscle prepared and mounted in Canada balsam is examined in the microscope between Nicol prisms, one on the stage below the object, and the other in the eye-piece, the fibres stand out as bright objects on the dark ground of the field when the axes of the prisms are crossed. On closer examination it is seen that the parts which are bright are chiefly the dim bands.

This indicates that it is the dim bands which are doubly refractive, *anisotropic*, or are chiefly made up of anisotropic substance; there seems however to be some slight amount of anisotropic substance in the bright bands though these as a whole appear single refractive or *isotropic*. The fibre accordingly appears banded or striated with alternate bands of anisotropic and isotropic material. According to most authors such an alternation of anisotropic and (chiefly) isotropic bands which is obvious in a dead and prepared fibre exists also in the living fibre; but some maintain that the living fibre is uniformly anisotropic.

Now when a fibre contracts, in spite of the confusion previously mentioned between dim and bright bands, there is no confusion between the anisotropic and isotropic material. The anisotropic, doubly refractive bands, bright under crossed Nicols, occupying the position of the dim band in the resting fibre, remain doubly refractive, bright under crossed Nicols, even at the very height of the contraction. The isotropic, singly refractive, bands, dark under crossed Nicols, occupying the position of the bright bands in the fibre at rest, remain isotropic and dark under crossed Nicols at the very height of the contraction. All that can be seen is that the singly refractive isotropic bands become very thin indeed during the contraction, while the anisotropic bands, though of course becoming thinner and broader in the contraction, do not become so thin as do the isotropic bands; in other words, while both bands become thinner and broader, the doubly refractive anisotropic band seems to increase at the expense of the singly refractive isotropic band.

§ 57. We call attention to these facts because they shew how complex is the act of contraction. The mere broadening and shortening of each section of the fibre is at bottom, a translocation of the molecules of the muscle substance. If we imagine a company of 100 soldiers ten ranks deep, with ten men in each rank, rapidly, but by a series of gradations, to extend out into a double line with 50 men in each line, we shall have a rough image of the movement of the molecules during a muscular contraction. But from what has been said it is obvious that the movement, in striated muscle at least, is a very complicated one; in other forms of contractile tissue it may be, as we shall see, more simple. Why the movement is so complicated in striated muscle, what purposes it serves, why the skeletal muscles are striated we do not at present know. Apparently where swift and rapid contraction is required the contractile tissue is striated muscle; but how the striation helps so to speak the contraction we do not know. We cannot say what share in the act of contraction is to be allotted to the several parts. Since during a contraction, the fibre bulges out more opposite to each dim disc and is indented opposite to each bright disc, since the dim disc is more largely composed of anisotropic material than the rest of the fibre, and since the anisotropic material in the position of the dim disc increases during a contraction, we might

perhaps infer that the dim disc rather than the bright disc is the essentially active part. Assuming that the fibrillar substance is more abundant in the dim discs, while the interfibrillar substance is more abundant in the bright discs, and that the fibrillar substance is anisotropic (and hence the dim discs largely anisotropic) while the interfibrillar substance is isotropic, we might also be inclined to infer it is the fibrillar and not the interfibrillar substance which really carries out the contraction; but even this much is not yet definitely proved.

One thing must be remembered. The muscle substance though it possesses the complicated structure, and goes through the remarkable changes which we have described, is while it is living and intact in a condition which we are driven to speak of as semi-fluid. The whole of it is essentially *mobile*. The very act of contraction indeed shews this; but it is mobile in the sense that no part of it, except of course the nuclei and sarcolemma, neither dim nor bright substance, neither fibrillar nor interfibrillar substance can be regarded as a hard and fast structure. A minute nematoid worm has been seen wandering in the midst of the substance of a living contractile fibre; as it moved along, the muscle substance gave way before it, and closed up again behind it, dim bands and bright bands all falling back into their proper places. We may suppose that in this case the worm threaded its way in a fluid interfibrillar substance between and among highly extensible and elastic fibrillæ. But even on such a view, and still more on the view that the fibrillar substance also was broken and closed up again, the maintenance of such definite histological features as those which we have described in material so mobile can only be effected, even in the fibre at rest, at some considerable expenditure of energy; which energy it may be expected has a chemical source. During the contraction there is a still further expenditure of energy, some of which, as we have seen, may leave the muscle as 'work done;' this energy likewise may be expected to have a chemical source. We must therefore now turn to the chemistry of muscle.

The Chemistry of Muscle.

§ 58. We said, in the Introduction, that it was difficult to make out with certainty the exact chemical differences between dead and living substance. Muscle however in dying undergoes a remarkable chemical change, which may be studied with comparative ease. We have already said that all muscles, within a certain time after removal from the body, or, if still remaining part of the body, within a certain time after 'general' death of the body, lose their irritability, and that the loss of irritability, which even when rapid, is gradual, is succeeded by an event which is somewhat more sudden, viz. the entrance into the condition known

as *rigor mortis*. The occurrence of rigor mortis, or cadaveric rigidity, as it is sometimes called, which may be considered as the token of the death of the muscle, is marked by the following features. The living muscle possesses a certain translucency, the rigid muscle is distinctly more opaque. The living muscle is very extensible and elastic, it stretches readily and to a considerable extent when a weight is hung upon it or when any traction is applied to it, but speedily and, under normal circumstances, completely returns to its original length when the weight or traction is removed; as we shall see however the rapidity and completeness of the return depends on the condition of the muscle, a well nourished active muscle regaining its normal length much more rapidly and completely than a tired and exhausted muscle. A dead rigid muscle is much less extensible and at the same time much less elastic; the muscle now requires considerable force to stretch it, and when the force is removed, does not, as before, return to its former length. To the touch the rigid muscle has lost much of its former softness, and has become firmer and more resistant. The entrance into rigor mortis is moreover accompanied by a shortening or contraction, which may, under certain circumstances, be considerable. The energy of this contraction is not great, so that any actual shortening is easily prevented by the presence of even a slight opposing force.

Now the chemical features of the dead rigid muscle are also strikingly different from those of the living muscle.

§ 59. If a *dead muscle*, from which all fat, tendon, fascia, and connective tissue have been as much as possible removed, and which has been freed from blood by the injection of 'normal' saline solution, be minced and repeatedly washed with water, the washings will contain certain forms of albumin and certain extractive bodies, of which we shall speak directly. When the washing has been continued until the wash-water gives no proteid reaction, a large portion of muscle will still remain undissolved. If this be treated with a 10 p. c. solution of a neutral salt, ammonium chloride being the best, a large portion of it will become dissolved; the solution however is more or less imperfect and filters with difficulty. If the filtrate be allowed to fall drop by drop into a large quantity of distilled water, a white flocculent matter will be precipitated. This flocculent precipitate is *myosin*. Myosin is a proteid, giving the ordinary proteid reactions, and having the same general elementary composition as other proteids. It is soluble in dilute saline solutions, especially those of ammonium chloride, and may be classed in the globulin family, though it is not so soluble as paraglobulin, requiring a stronger solution of a neutral salt to dissolve it; thus while soluble in a 5 or 10 p. c. solution of such a salt, it is far less soluble in a 1 p. c. solution, which as we have seen readily dissolves paraglobulin. From its solutions in neutral saline solution it is precipitated by saturation with a neutral

salt, preferably sodium chloride, and may be purified by being washed with a saturated solution, dissolved again in a weaker solution, and reprecipitated by saturation. Dissolved in saline solutions it readily coagulates when heated, *i.e.* is converted into coagulated proteid, and it is worthy of notice that it coagulates at a comparatively low temperature, *viz.* about 56° C.; this it will be remembered is the temperature at which fibrinogen is coagulated, whereas paraglobulin, serum-albumin, and many other proteids do not coagulate until a higher temperature, 75° C. is reached. Solutions of myosin are precipitated by alcohol, and the precipitate, as in the case of other proteids, becomes by continued action of the alcohol, altered into coagulated insoluble proteid.

We have seen that paraglobulin, and indeed any member of the globulin group, is very readily changed by the action of dilute acids into a body called *acid-albumin*, characterised by not being soluble either in water or in dilute saline solutions but readily soluble in dilute acids and alkalis, from its solutions in either of which it is precipitated by neutralisation, and by the fact that the solutions in dilute acids and alkalis are not coagulated by heat. When therefore a globulin is dissolved in dilute acid, what takes place is not a mere solution but a chemical change; the globulin cannot be got back from the solution, it has been changed into acid-albumin. Similarly when globulin is dissolved in dilute alkalis it is changed into *alkali-albumin*; and broadly speaking alkali-albumin precipitated by neutralisation can be changed by solution with dilute acids into acid-albumin, and acid-albumin by dilute alkalis into alkali-albumin.

Now myosin is similarly, and even more readily than is globulin, converted into acid-albumin, and by treating a muscle either washed or not, directly with dilute hydrochloric acid, the myosin may be converted into acid-albumin and dissolved out. Acid-albumin obtained by dissolving muscle in dilute acid used to be called *syntonin*, and it used to be said that a muscle contained syntonin; the muscle however contains myosin, not syntonin, but it may be useful to retain the word syntonin to denote acid-albumin obtained by the action of dilute acid on myosin. By the action of dilute alkalis, myosin may similarly be converted into alkali-albumin.

From what has been above stated it is obvious that myosin has many analogies with fibrin, and we have yet to mention some striking analogies; it is however much more soluble than fibrin, and speaking generally it may be said to be intermediate in its character between fibrin and globulin. On keeping, and especially on drying, its solubility is much diminished.

Of the substances which are left in washed muscle, from which all the myosin has been extracted by ammonium chloride solution, little is known. If washed muscle be treated directly with dilute hydrochloric acid, a large part of the material of the muscle passes,

as we have said, at once into syntonin. The quantity of syntonin thus obtained may be taken as roughly representing the quantity of myosin previously existing in the muscle. A more prolonged action of the acid may dissolve out other proteids, besides myosin, left after the washing. The portion insoluble in dilute hydrochloric acid consists in part of the gelatine yielding and other substances of the sarcolemma and of the connective and other tissues between the bundles, of the nuclei of these tissues and of the fibres themselves, and in part, possibly, of some portions of the muscle substance itself. We are not however at present in a position to make any very definite statement as to the relation of the myosin to the structural features of muscle. Since the dim bands are rendered very indistinct by the action of 10 p.c. sodium chloride solution, we may perhaps infer that myosin enters largely into the composition of the dim bands, and therefore of the fibrillæ; but it would be hazardous to say much more than this.

§ 60. Living muscle may be frozen, and yet, after certain precautions will, on being thawed, regain its irritability, or at all events will for a time be found to be still living in the sense that it has not yet passed into rigor mortis. We may therefore take living muscle which has been frozen as still living.

If *living contractile muscle*, freed as much as possible from blood, be frozen, and while frozen, minced, and rubbed up in a mortar with four times its weight of snow containing 1 p.c. of sodium chloride, a mixture is obtained which at a temperature just below 0°C. is sufficiently fluid to be filtered, though with difficulty. The slightly opalescent filtrate, or *muscle-plasma* as it is called, is at first quite fluid, but will when exposed to the ordinary temperature become a solid jelly, and afterwards separate into a *clot* and *serum*. It will in fact coagulate like blood-plasma, with this difference, that the clot is not firm and fibrillar, but loose, granular and flocculent. During the coagulation the fluid, which before was neutral or slightly alkaline, becomes distinctly acid.

The clot is myosin. It gives all the reactions of myosin obtained from dead muscle.

The serum contains an albumin very similar to, if not identical with, serum-albumin, a globulin differing somewhat from, and coagulating at a lower temperature than paraglobulin, and which to distinguish it from the globulin of blood has been called *myoglobulin*, some other proteids which need not be described here, and various 'extractives' of which we shall speak directly. Such muscles as are red also contain a small quantity of hæmoglobin, and of another allied pigment called *histohæmatin*, to which pigments indeed their redness is due.

Thus while dead muscle contains myosin, albumin, and other proteids, extractives, and certain insoluble matters, together with gelatinous and other substances not referable to the muscle

substance itself, living muscle contains no myosin, but some substance or substances which bear somewhat the same relation to myosin that the antecedents of fibrin do to fibrin, and which give rise to myosin upon the death of the muscle. There are indeed reasons for thinking that the myosin arises from the conversion of a previously existing body which may be called *myosinogen*, and that the conversion takes place, or may take place, by the action of a special ferment, the conversion of myosinogen into myosin being very analogous to the conversion of fibrinogen into fibrin.

We may in fact speak of rigor mortis as characterised by a coagulation of the muscle-plasma, comparable to the coagulation of blood-plasma, but differing from it inasmuch as the product is not fibrin but myosin. The rigidity, the loss of suppleness, and the diminished translucency appear to be at all events largely, though probably not wholly, due to the change from the fluid plasma to the solid myosin. We might compare a living muscle to a number of fine transparent membranous tubes containing blood-plasma. When this blood-plasma entered into the 'jelly' stage of coagulation, the system of tubes would present many of the phenomena of rigor mortis. They would lose much of their suppleness and translucency, and acquire a certain amount of rigidity.

§ 61. There is however one very marked and important difference between the rigor mortis of muscle and the coagulation of blood. Blood during its coagulation undergoes a slight change only in its reaction; but muscle during the onset of rigor mortis becomes distinctly acid.

A living muscle at rest is in reaction neutral, or, possibly from some remains of lymph adhering to it, faintly alkaline. If on the other hand the reaction of a thoroughly rigid muscle be tested, it will be found to be most distinctly acid. This development of an acid reaction is witnessed not only in the solid untouched fibre but also in expressed muscle-plasma; it seems to be associated in some way with the appearance of the myosin.

The exact causation of this acid reaction has not at present been clearly worked out. Since the coloration of the litmus produced is permanent, carbonic acid, which as we shall immediately state, is set free at the same time, cannot be regarded as the active acid, for the reddening of litmus produced by carbonic acid speedily disappears on exposure. On the other hand it is possible to extract from rigid muscle a certain quantity of lactic acid, or rather of a variety of lactic acid known as sarcolactic acid¹; and it has been thought that the appearance of the acid reaction of rigid muscle is due to a new formation or to an increased formation of this sarcolactic acid. There is much to be said in favour of this

¹ There are many varieties of lactic acid, which are isomeric, having the same composition $C_3H_6O_3$, but differ in their reactions and especially in the solubility of their zinc salts. The variety present in muscle is distinguished as sarcolactic acid.

view, but it cannot at present be regarded as established beyond dispute.

Coincident with the appearance of this acid reaction, though as we have said, not the direct cause of it, a large development of carbonic acid takes place when muscle becomes rigid. Irritable living muscular substance like all living substance is continually respiring, that is to say, is continually consuming oxygen and giving out carbonic acid. In the body, the arterial blood going to the muscle gives up some of its oxygen, and gains a quantity of carbonic acid, thus becoming venous as it passes through the muscle capillaries. Even after removal from the body, the living muscle continues to take up from the surrounding atmosphere a certain quantity of oxygen and to give out a certain quantity of carbonic acid.

At the onset of rigor mortis there is a very large and sudden increase in this production of carbonic acid, in fact an outburst as it were of that gas. This is a phenomenon deserving special attention. Knowing that the carbonic acid which is the outcome of the respiration of the whole body is the result of the oxidation of carbon-holding substances, we might very naturally suppose that the increased production of carbonic acid attendant on the development of rigor mortis is due to the fact that during that event a certain quantity of the carbon-holding constituents of the muscle are suddenly oxidized. But such a view is negatived by the following facts. In the first place, the increased production of carbonic acid during rigor mortis is not accompanied by a corresponding increase in the consumption of oxygen. In the second place, a muscle (of a frog for instance) contains in itself no free or loosely attached oxygen; when subjected to the action of a mercurial air-pump it gives off no oxygen to a vacuum, offering in this respect a marked contrast to blood; and yet, when placed in an atmosphere free from oxygen, it will not only continue to give off carbonic acid while it remains alive, but will also exhibit at the onset of rigor mortis, the same increased production of carbonic acid that is shewn by a muscle placed in an atmosphere containing oxygen. It is obvious that in such a case the carbonic acid does not arise from the direct oxidation of the muscle substance, for there is no oxygen present *at the time* to carry on that oxidation. We are driven to suppose that during rigor mortis, some complex body, containing in itself ready formed carbonic acid so to speak, is split up, and thus carbonic acid is set free, the process of oxidation by which that carbonic acid was formed out of the carbon-holding constituents of the muscle having taken place at some anterior date.

Living resting muscle, then, is alkaline or neutral in reaction, and the substance of its fibres contains a coagulable plasma. Dead rigid muscle on the other hand is acid in reaction, and no longer contains a coagulable plasma, but is laden with the solid myosin.

Further, the change from the living irritable condition to that of rigor mortis is accompanied by a large and sudden development of carbonic acid.

It is found moreover that there is a certain amount of parallelism between the intensity of the rigor mortis, the degree of acid reaction and the quantity of carbonic acid given out. If we suppose, as we fairly may do, that the intensity of the rigidity is dependent on the quantity of myosin deposited in the fibres, and the acid reaction to the development if not of lactic acid, at least of some other substance, the parallelism between the three products, myosin, acid-producing substance, and carbonic acid, would suggest the idea that all three are the results of the splitting-up of the same highly complex substance. No one has at present however succeeded in isolating or in otherwise definitely proving the existence of such a body, and though the idea seems tempting, it may in the end prove totally erroneous.

§ 62. As to the other proteids of muscle, such as the albumin and the globulin, we know as yet nothing concerning the parts which they play and the changes which they undergo in the living muscle or in rigor mortis.

Besides the *fat* which is found, and that not unfrequently in abundance, in the connective tissue between the fibres, there is also present in the muscular substance within the sarcolemma, always some, and at times a great deal, of fat, chiefly ordinary fat, viz. stearin, palmitin, and olein in variable proportion, but also the more complex fat lecithin. As to the function of these several fats in the life of the muscle we know little or nothing.

Carbohydrates, the third of the three great classes in which we may group the energy holding substances of which the animal body and its food are alike composed, viz. proteids, fat and carbohydrates, are represented in muscle by a peculiar body, *glycogen*, which we shall have to study in detail later on. We must here merely say that glycogen is a body closely allied to starch, having a formula, which may be included under the general formula for starches x ($C_6H_{10}O_5$), and may like it be converted by the action of acids, or by the action of particular ferments known as anylyolytic ferments, into some form of sugar, dextrose ($C_6H_{12}O_6$) or some allied sugar. Many, if not all, living muscles contain a certain amount, and some, under certain circumstances, a considerable amount of glycogen. During or after rigor mortis this glycogen is very apt to be converted into dextrose, or an allied sugar. The muscles of the embryo at an early stage contain a relatively enormous quantity of glycogen, a fact which suggests that the glycogen of muscle is carbohydrate food of the muscle about to be wrought up into the living muscular substance.

The bodies which we have called *extractives* are numerous and varied. They are especially interesting since it seems probable that they are waste products of the metabolism of the muscular

substance, and the study of them may be expected to throw light on the chemical change which muscular substance undergoes during life. Since, as we shall see, muscular substance forms by far the greater part of the nitrogenous, that is proteid portion of the body, the nitrogenous extractives of muscle demand peculiar attention. Now the body *urea*, which we shall have to study in detail later on, far exceeds in importance all the other nitrogenous extractives of the body as a whole, since it is practically the one form in which nitrogenous waste leaves the body; if we include with urea, the closely allied uric acid (which for present purposes may simply be regarded as a variety of urea), we may say that all the nitrogen taken in as food sooner or later leaves the body as urea; compared with this all other nitrogenous waste thrown out from the body is insignificant. Of the urea which thus leaves the body, a considerable portion must at some time or other have existed, or to speak more exactly its nitrogen must have existed as the nitrogen of the proteids of muscular substance. Nevertheless no urea at all is, in normal conditions, present in muscular substance either living and irritable, or dead and rigid; urea does not arise in muscular substance itself as one of the immediate waste products of muscular substance.

There is however always present, in relatively considerable amount, on an average about .25 p. c. of wet muscle, a remarkable body, *kreatin*. This is in one sense a compound of urea: it may be split up into urea and sarcosin. This latter body is a methyl glycin, that is to say, a glycin in which methyl has been substituted for hydrogen, and glycin itself is amido-acetic acid, a compound of amidogen, that is a representative of ammonia, and acetic acid. Hence kreatin contains urea, which has close relations with ammonia, together with another representative of ammonia, and a surplus of carbon and hydrogen arranged as a body belonging to the fatty acid series. We shall have to return to this kreatin and to consider its relations to urea and to muscle when we come to deal with urine.

The other nitrogenous extractives, such as karnin, hypoxanthin (or sarkin), xanthin, taurin, &c., occur in small quantity, and need not be dwelt on here.

Among non-nitrogenous extractives the most important is the sarcolactic acid, of which we have already spoken; to this may be added sugar in some form or other either coming from glycogen or from some other source.

The ash of muscle, like the ash of the blood corpuscles and indeed the ash of the tissues in general as distinguished from the blood or plasma or lymph on which the tissues live, is characterised by the preponderance of potassium salts and of phosphates; these form in fact nearly 80 p. c. of the whole ash.

§ 63. We may now pass on to the question, What are the chemical changes which take place when a living resting muscle

enters into a contraction? These changes are most evident after the muscle has been subjected to a prolonged tetanus; but there can be no doubt that the chemical events of a tetanus are, like the physical events, simply the sum of the results of the constituent single contractions.

In the first place, the muscle becomes acid, not so acid as in rigor mortis, but still sufficiently so, after a vigorous tetanus, to turn blue litmus distinctly red. The cause of the acid reaction like that of rigor mortis is doubtful, but is in all probability the same in both cases.

In the second place, a considerable quantity of carbonic acid is set free; and the production of carbonic acid in muscular contraction is altogether similar to the production of carbonic acid during rigor mortis: it is not accompanied by any corresponding increase in the consumption of oxygen. This is evident even in a muscle through which the circulation of blood is still going on; for though the blood passing through a contracting muscle gives up more oxygen than the blood passing through a resting muscle, the increase in the amount of oxygen taken up falls below the increase in the carbonic acid given out. But it is still more markedly shewn in a muscle removed from the body; for in such a muscle both the contraction and the increase in the production of carbonic acid will go on in the absence of oxygen. A frog's muscle suspended in an atmosphere of nitrogen will remain irritable for some considerable time, and at each vigorous tetanus an increase in the production of carbonic acid may be readily ascertained.

Moreover there seems to be a correspondence between the energy of the contraction and the amount of carbonic acid and the degree of acid reaction produced, so that, though we are now treading on somewhat uncertain ground, we are naturally led to the view that the essential chemical process lying at the bottom of a muscular contraction as of rigor mortis is the splitting up of some highly complex substance. But here the resemblance between rigor mortis and contraction ends. We have no satisfactory evidence of the formation during a contraction of any body like myosin. And this difference in chemical results tallies with an important difference between rigid muscle and contracting muscle. The rigid muscle as we have seen becomes less extensible, less elastic, less translucent; the contracting muscle remains no less translucent, elastic, and extensible than the resting muscle, indeed there are reasons for thinking that the muscle in contracting becomes actually more extensible for the time being.

But if during a contraction myosin is not formed, what changes of proteid or nitrogenous matter do take place? We do not know. We have no evidence that kreatin, or any other nitrogenous extractive is increased by the contraction of muscle, we have no evidence of any nitrogen waste at all as the result of a contraction; and indeed, as we shall see later on, the study of the waste

products of the body as a whole lead us to believe that the energy of the work done by the muscles of the body comes from the potential energy of carbon compounds, and not of nitrogen compounds at all. But to this point we shall have to return.

§ 64. We may sum up the chemistry of muscle somewhat as follows.

During life the muscular substance is continually taking up from the blood, that is from the lymph, proteid, fatty and carbohydrate material, saline matters and oxygen; these it builds up into itself, how we do not know, and so forms the peculiar complex living muscular substance. The exact nature of this living substance is unknown to us. What we do know is that it is largely composed of proteid material, and that such bodies as myosinogen, myoglobin, and albumin have something to do with the building of it up.

During rest this muscular substance, while taking in and building itself up out of or by means of the above mentioned materials is continually giving off carbonic acid and continually forming nitrogenous waste such as kreatin. It also probably gives off some amount of sarcolactic acid, and possibly other non-nitrogenous waste matters.

During a contraction there is a great increase of carbonic acid given off, of either lactic acid, or some other substance giving rise to an acid reaction, a greater consumption of oxygen, though the increase is not equal to the increase of carbonic acid, but, as far as we can learn, no increase of nitrogenous waste.

During rigor mortis, there is a similar increased production of carbonic acid and of some other acid producing substance, accompanied by a remarkable conversion of myosinogen into myosin, by which the rigidity of the dead fibre is brought about.

Thermal Changes.

§ 65. The chemical changes during a contraction set free a quantity of energy, but only a portion of this energy appears in the 'work done,' a considerable portion takes on the form of heat. Though we shall have hereafter to treat this subject more fully, the leading facts may be given here.

Whenever a muscle contracts, its temperature rises, indicating that heat is given out. When a mercury thermometer is plunged into a mass of muscles, such as those of the thigh of the dog, a rise of the mercury is observed upon the muscles being thrown into a prolonged contraction. More exact results however are obtained by means of a thermopile, by the help of which the rise of temperature caused by a few repeated single contractions, or indeed by a single contraction, may be observed, and the amount of heat given out approximatively measured.

The thermopile may consist either of a single junction in the form of a needle plunged into the substance of the muscle; or of several junctions either in the shape of a flat surface carefully opposed to the surface of muscle (the pile being balanced so as to move with the contracting muscle, and thus to keep the contact exact), or in the shape of a thin wedge, the edge of which comprising the actual junctions is thrust into a mass of muscles and held in position by them. In all cases the fellow junction or junctions must be kept at a constant temperature.

Another delicate method of determining the changes of temperature of a tissue is based upon the measurement of alterations in electric resistance which a fine wire, in contact with or plunged into the tissue, undergoes as the temperature of the tissue changes.

It has been calculated that the heat given out by the muscles of the thigh of a frog in a single contraction amounts to 3.1 micro-units of heat¹ for each gramme of muscle, the result being obtained by dividing by five the total amount of heat given out in five successive single contractions. It will however be safer to regard these figures as illustrative of the fact that the heat given out is considerable rather than as data for elaborate calculations. Moreover we have no satisfactory quantitative determinations of the heat given out by the muscles of warm-blooded animals, though there can be no doubt that it is much greater than that given out by the muscles of the frog.

There can hardly be any doubt that the heat thus set free is the product of chemical changes within the muscle, changes, which though they cannot for the reasons given above (§ 63) be regarded as simple and direct oxidations, yet, since they are processes dependent on the antecedent entrance of oxygen into the muscle, may be spoken of in general terms as a combustion. So that the muscle may be likened to a steam-engine, in which the combustion of a certain amount of material gives rise to the development of energy in two forms, as heat and as movement, there being certain quantitative relations between the amount of energy set free as heat and that giving rise to movement. We must however carefully guard ourselves against pressing this analogy too closely. In the steam-engine, we can distinguish clearly between the fuel which through its combustion is the sole source of energy, and the machinery, which is not consumed to provide energy and only suffers wear and tear. In the muscle we cannot with certainty at present make such a distinction. It may be that the chemical changes at the bottom of a contraction do not involve the real living material of the fibre but only some substance, manufactured by the living material and lodged in some way, we do not know how, in the living material; it may be that when a fibre contracts it is this substance within the fibre which explodes and not the fibre itself. If we further suppose that this substance is some complex

¹ The micro-unit being a milligramme of water raised one degree centigrade.

compound of carbon and hydrogen into which no nitrogen enters, we shall have an explanation of the difficulty referred to above (§ 63), namely, that nitrogenous waste is not increased by a contraction. The special contractile, carbon-hydrogen substance may then be compared to the charge of a gun, the products of its explosion being carbonic and sarcolactic acids, while the real living material of the fibre may be compared to the gun itself, but to a gun which itself is continually undergoing change, far beyond mere wear and tear, among the products of which change nitrogenous bodies like kreatin are conspicuous. This view will certainly explain why kreatin is not increased during the contraction while the carbonic and lactic acids are. But it must be remembered that such a view is not yet proved; it may be the living material of the fibre as a whole which is continually breaking down in an explosive decomposition and as continually building itself up again out of the material supplied by the blood.

In a steam-engine only a certain amount of the total potential energy of the fuel issues as work, the rest being lost as heat, the proportion varying, but the work rarely, if ever, exceeding one-tenth of the total energy and generally being less. In the case of the muscle we are not at present in a position to draw up an exact equation between the latent energy on the one hand and the two forms of actual energy on the other. We have reason to think that the proportion between heat and work varies considerably under different circumstances, the work sometimes rising as high as one-fifth, sometimes possibly sinking as low as one twenty-fourth of the total energy; and observations seem to shew that the greater the resistance which the muscle has to overcome, the larger the proportion of the total energy expended which goes out as work done. The muscle in fact seems to be so far self-regulating, that the more work it has to do, the greater, within certain limits, is the economy with which it works.

Lastly it must be remembered that the giving out of heat by the muscle is not confined to the occasions when it is actually contracting. When, at a later period, we treat of the heat of the body generally, evidence will be brought forward that the muscles even when at rest are giving rise to heat, so that the heat given out at a contraction is not some wholly new phenomenon, but a temporary exaggeration of what is continually going on at a more feeble rate.

Electrical Changes.

§ 66. Besides chemical and thermal changes a remarkable electric change takes place whenever a muscle contracts.

Muscle-currents. If a muscle be removed in an ordinary

manner from the body, and two non-polarisable electrodes¹, connected with a delicate galvanometer of many convolutions and

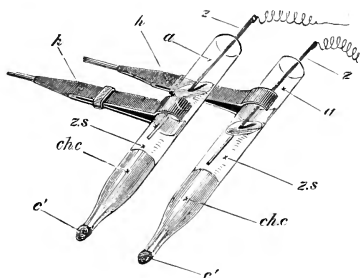

FIG. 18. NON-POLARISABLE ELECTRODES.

a, the glass tube; *z*, the amalgamated zinc slips connected with their respective wires; *z. s.*, the zinc sulphate solution; *ch. c.*, the plug of china clay; *c'*, the portion of the china-clay plug projecting from the end of the tube; this can be moulded into any required form.

high resistance, be placed on two points of the surface of the muscle, a deflection of the galvanometer will take place indicating the existence of a current passing through the galvanometer from the one point of the muscle to the other, the direction and amount of the deflection varying according to the position of the points. The 'muscle-currents' thus revealed are seen to the best advantage when the muscle chosen is a cylindrical or prismatic one with parallel fibres, and when the two tendinous ends are cut off by clean incisions at right angles to the long axis of the muscle. The muscle then presents a transverse section (artificial) at each end and a longitudinal surface. We may speak of the latter as being divided into two equal parts by an imaginary transverse line on its surface called the 'equator,' containing all the points of the surface midway between the two ends. Fig. 19 is a diagrammatic representation of such a muscle, the line *ab* being the equator. In such a muscle the development of the muscle-currents is found to be as follows.

The greatest deflection is observed when one electrode is placed

¹ These (Fig. 18) consist essentially of a slip of *thoroughly amalgamated* zinc dipping into a *saturated* solution of zinc sulphate, which in turn is brought into connection with the nerve or muscle by means of a plug or bridge of china-clay moistened with normal sodium chloride solution; it is important that the zinc should be thoroughly amalgamated. This form of electrodes gives rise to less polarisation than do simple platinum or copper electrodes. The clay affords a connection between the zinc and the tissue which neither acts on the tissue nor is acted on by the tissue. Contact of any tissue with copper or platinum is in itself sufficient to develop a current.

at the mid-point or equator of the muscle, and the other at either cut end; and the deflection is of such a kind as to shew that positive currents are continually passing from the equator through the galvanometer to the cut end; that is to say, the cut end is negative relatively to the equator. The currents outside the muscle may be considered as completed by currents *in the muscle* from the cut end to the equator. In the diagram Fig. 19, the arrows indicate the

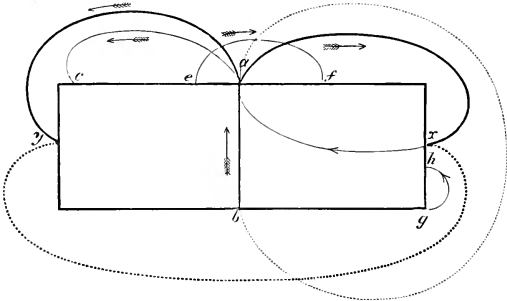

FIG. 19. DIAGRAM ILLUSTRATING THE ELECTRIC CURRENTS OF NERVE AND MUSCLE.

Being purely diagrammatic, it may serve for a piece either of nerve or of muscle, except that the currents at the transverse section cannot be shewn in a nerve. The arrows shew the direction of the current through the galvanometer.

ab the equator. The strongest currents are those shewn by the dark lines, as from *a*, at equator, to *x* or to *y* at the cut ends. The current from *a* to *c* is weaker than from *a* to *y*, though both, as shewn by the arrows, have the same direction. A current is shewn from *e*, which is near the equator, to *f*, which is farther from the equator. The current (in muscle) from a point in the circumference to a point nearer the centre of the transverse section is shewn at *gh*. From *a* to *b* or from *x* to *y* there is no current, as indicated by the dotted lines.

direction of the currents. If the one electrode be placed at the equator *ab*, the effect is the same at whichever of the two cut ends *x* or *y* the other is placed. If, one electrode remaining at the equator, the other be shifted from the cut end to a spot *c* nearer to the equator, the current continues to have the same direction, but is of less intensity in proportion to the nearness of the electrodes to each other. If the two electrodes be placed at unequal distances *e* and *f*, one on either side of the equator, there will be a feeble current from the one nearer the equator to the one farther off, and the current will be the feebler, the more nearly they are equidistant from the equator. If they are quite equidistant, as for instance when one is placed on one cut end *x*, and the other on the other cut end *y*, there will be no current at all.

If one electrode be placed at the circumference of the transverse section and the other at the centre of the transverse section, there

will be a current through the galvanometer from the former to the latter; there will be a current of similar direction but of less intensity when one electrode is at the circumference g of the transverse section and the other at some point h nearer the centre of the transverse section. In fact, the points which are relatively most positive and most negative to each other are points on the equator and the two centres of the transverse sections; and the intensity of the current between any two points will depend on the respective distances of those points from the equator and from the centre of the transverse section.

Similar currents may be observed when the longitudinal surface is not the natural but an artificial one; indeed they may be witnessed in even a piece of muscle provided it be of cylindrical shape and composed of parallel fibres.

These 'muscle-currents' are not mere transitory currents disappearing as soon as the circuit is closed; on the contrary they last a very considerable time. They must therefore be maintained by some changes going on in the muscle, by continued chemical action in fact. They disappear as the irritability of the muscle vanishes, and are connected with those nutritive, so-called vital changes which maintain the irritability of the muscle.

Muscle-currents such as have just been described, may, we repeat, be observed in any cylindrical muscle suitably prepared, and similar currents, with variations which need not be discussed here, may be seen in muscles of irregular shape with obliquely or otherwise arranged fibres. And du Bois-Reymond, to whom chiefly we are indebted for our knowledge of these currents, has been led to regard them as essential and important properties of living muscle. He has moreover advanced the theory that muscle may be considered as composed of electro-motive particles or molecules, each of which like the muscle at large has a positive equator and negative ends, the whole muscle being made up of these molecules in somewhat the same way, (to use an illustration which must not however be strained or considered as an exact one) as a magnet may be supposed to be made up of magnetic particles each with its north and south pole.

There are reasons however for thinking that these muscle-currents have no such fundamental origin, that they are in fact of surface and indeed of artificial origin. Without entering into the controversy on this question, the following important facts may be mentioned.

1. When a muscle is examined while it still retains uninjured its natural tendinous terminations, the currents are much weaker than when artificial transverse sections have been made; the natural tendinous end is less negative than the cut surface. But the tendinous end becomes at once negative when it is dipped in water or acid, indeed when it is in any way injured. *The less roughly in fact a muscle is treated the less evident are the muscle-

currents; and it is maintained that if adequate care be taken to maintain a muscle in an absolutely natural condition no such currents as those we have been describing exist at all, that natural living muscle is *isoelectric* as it is called.

2. The surface of the uninjured inactive¹ ventricle of the frog's heart, which is practically a mass of muscle, is isoelectric, no current is obtained when the electrodes are placed on any two points of the surface. If however any part of the surface be injured, or if the ventricle be cut across so as to expose a cut surface, the injured spot or the cut surface becomes at once most powerfully negative towards the uninjured surface, a strong current being developed which passes through the galvanometer from the uninjured surface to the cut surface or to the injured spot. The negativity thus developed in a cut surface passes off in the course of some hours, but may be restored by making a fresh cut and exposing a fresh surface.

The temporary duration of the negativity after injury, and its renewal upon fresh injury, in the case of the ventricle, in contrast to the more permanent negativity of injured skeletal muscle, is explained by the different structure of the two kinds of muscle. The cardiac muscle as we shall hereafter see is composed of short fibre-cells; when a cut is made a certain number of these fibre-cells are injured, giving rise to negativity, but the injury done to them stops with them and is not propagated to the cells with which they are in contact; hence upon their death the negativity and the current disappear. A fresh cut involving new cells, produces fresh negativity and a new current. In the long fibres of the skeletal muscle, on the other hand, the effects of the injury are slowly propagated along the fibre from the spot injured.

Now, when a muscle is cut or injured the substance of the fibres dies at the cut or injured surface. And many physiologists, among whom the most prominent is Hermann, have been led by the above and other facts to the conclusion that muscle-currents do not exist naturally in untouched, uninjured muscles, that the muscular substance is naturally, when living, isoelectric, but that whenever a portion of the muscular substance dies, it becomes *while dying* negative to the living substance, and thus gives rise to currents. They explain the typical currents (as they might be called) manifested by a muscle with a natural longitudinal surface and artificial transverse sections, by the fact that the dying cut ends are negative relatively to the rest of the muscle.

Du Bois-Reymond and those with him offer special explanations of the above facts and of other objections which have been urged against the theory of naturally existing electro-motive molecules. Into these we cannot enter here. We must rest content with the statement that in an ordinary muscle currents such as have been described may be witnessed, but that strong arguments may be

¹ The necessity of its being inactive will be seen subsequently.

adduced in favour of the view that these currents are not 'natural' phenomena but essentially of artificial origin. It will therefore be best to speak of them as *currents of rest*.

§ 67. *Currents of action. Negative variation of the Muscle-current.* The controversy whether the "currents of rest" observable in a muscle be of natural origin or not, does not affect the truth or the importance of the fact that an electrical change takes place and a current is developed in a muscle whenever it enters into a contraction. When currents of rest are observable in a muscle these are found to undergo a diminution upon the occurrence of a contraction, and this diminution is spoken of as 'the negative variation' of the currents of rest. The negative variation may be seen when a muscle is thrown into a single contraction, but is most readily shewn when the muscle is tetanized. Thus if a pair of electrodes be placed on a muscle, one at the equator, and the other at or near the transverse section, so that a considerable deflection of the galvanometer needle, indicating a considerable current of rest, be gained, the needle of the galvanometer will, when the muscle is tetanized by an interrupted current sent through its nerve (at a point too far from the muscle to allow of any escape of the current into the electrodes connected with the galvanometer), swing back towards zero; it returns to its original deflection when the tetanizing current is shut off.

Not only may this negative variation be shewn by the galvanometer, but it, as well as the current of rest, may be used as a galvanic shock and so employed to stimulate a muscle, as in the experiment known as 'the rheoscopic frog.' For this purpose the muscles and nerves need to be very irritable and in thoroughly good condition. Two muscle-nerve preparations *A* and *B* having been made, and each placed on a glass plate for the sake of insulation, the nerve of the one *B* is allowed to fall on the muscle of the other *A* in such a way that one point of the nerve comes in contact with the equator of the muscle, and another point with one end of the muscle or with a point at some distance from the equator. At the moment the nerve is let fall and contact made, a current, viz. the 'current of rest' of the muscle *A*, passes through the nerve; this acts as a stimulus to the nerve, and so causes a contraction in the muscle connected with a nerve. Thus the muscle *A* acts as a battery, the completion of the circuit of which by means of the nerve of *B* serves as a stimulus, causing the muscle *B* to contract.

If while the nerve of *B* is still in contact with the muscle of *A*, the nerve of the latter is tetanized with an interrupted current, not only is the muscle of *A* thrown into tetanus but also that of *B*; the reason being as follows. At each spasm of which the tetanus of *A* is made up, there is a negative variation of the muscle-current of *A*. Each negative variation of the muscle-current of *A* serves as a stimulus to the nerve of *B*, and is hence

the cause of a spasm in the muscle of *B*; and the stimuli following each other rapidly, as being produced by the tetanus of *A* they must do, the spasms in *B* to which they give rise are also fused into a tetanus in *B*. *B* in fact contracts in harmony with *A*. This experiment shews that the negative variation accompanying the tetanus of a muscle, though it causes only a single swing of the galvanometer, is really made up of a series of negative variations, each single negative variation corresponding to the single spasms of which the tetanus is made up.

But an electrical change may be manifested even in cases when no currents of rest exist. We have stated (§ 66) that the surface of the uninjured inactive ventricle of the frog's heart is isoelectric, no currents being observed when the electrodes of a galvanometer are placed on two points of the surface. Nevertheless a most distinct current is developed whenever the ventricle contracts. This may be shewn either by the galvanometer or by the rheoscopic frog. If the nerve of an irritable muscle-nerve preparation be laid over a pulsating ventricle, each beat is responded to by a twitch of the muscle of the preparation. In the case of ordinary muscles too instances occur in which it seems impossible to regard the electrical change manifested during the contraction as the mere diminution of a preexisting current.

Accordingly those who deny the existence of 'natural' muscle-currents speak of a muscle as developing during a contraction a 'current of action,' occasioned as they believe by the muscular substance as it is entering into the state of contraction becoming negative towards the muscular substance which is still at rest, or has returned to a state of rest. In fact, they regard the negativity of muscular substance as characteristic alike of beginning death and of a beginning contraction. So that in a muscular contraction a wave of negativity, starting from the end-plate when indirect, or from the point stimulated when direct stimulation is used, passes along the muscular substance to the ends or end of the fibre.

If for instance we suppose two electrodes placed on two points (Fig. 20) *A* and *B* of a fibre about to be stimulated by a single induction-shock at one end. Before the stimulation the fibre is isoelectric, and the needle of the galvanometer stands at zero. At a certain time after the shock has been sent through the stimulating electrodes (*x*), as the wave of contraction is travelling down the fibre, the section of the fibre beneath *A* will become negative towards the rest of the fibre and so negative towards the portion of the fibre under *B*,

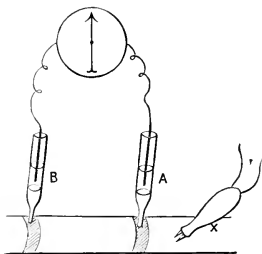

FIG. 20.

i.e. *A* will be negative relatively to *B*, and this will be shewn by a deflection of the needle. A little later *B* will be entering into contraction, and will be becoming negative towards the rest of the fibre including the part under *A*, whose negativity by this time is passing off, that is to say *B* will now be negative towards *A*, and this will be shewn by a deflection of the needle in a direction opposite to that of the deflection which has just previously taken place. Hence between two electrodes placed along a fibre a single wave of contraction will give rise to two currents of different phases, to a diphasic change; and this indeed is found to be the case.

This being so it is obvious that the electrical result of tetanizing a muscle when wave after wave follows along each fibre is a complex matter; but it is maintained that the apparent negative variation of tetanus can be explained as the net result of a series of currents of action due to the individual contractions, the second phase of the current in each contraction being less marked than the first phase. We cannot however enter more fully here into a discussion of this difficult subject.

Whichever view be taken of the nature of these muscle-currents, and of the electric change during contraction, whether we regard that change as a 'negative variation' or as a 'current of action,' it is important to remember that it takes place entirely during the latent period. It is not in any way the result of the change of form, it is the forerunner of that change of form. Just as a nervous impulse passes down the nerve to the muscle without any visible changes, so a molecular change of some kind, attended by no visible events known to us at present, but only by an electrical change, runs along the muscular fibre from the end-plate to the ends of the fibre, preparing the way for the visible change of form which is to follow. This molecular invisible change is the work of the latent period, and careful observations have shewn that it, like the visible contraction which follows at its heels, travels along the fibre from a spot stimulated towards the ends of the fibres, in the form of a wave having about the same velocity as the contraction, *viz.* about 3 metres a second¹.

The Changes in a Nerve during the passage of a Nervous Impulse.

§ 68. The change in the form of a muscle during its contraction is a thing which can be seen and felt; but the changes in a nerve during its activity are invisible and impalpable. We stimulate one end of a nerve going to a muscle, and we see this followed

¹ In the muscles of the frog; but as we have seen having probably a higher velocity in the intact mammalian muscles, within the living body, and varying according to circumstances.

by a contraction of the muscle attached to the other end; or we stimulate a nerve still connected with the central nervous system, and we see this followed by certain movements, or by other tokens which shew that disturbances have been set up in the central nervous system. We know therefore that some changes or other, constituting what we have called a nervous impulse, have been propagated along the nerve; but the changes are such as we cannot see. It is possible however to learn something about them.

Structure of a Nerve. An ordinary nerve going to a muscle is composed of elementary nerve fibres, analogous to the elementary muscle fibres, running lengthwise along the nerve and bound together by connective tissues carrying blood vessels and lymphatics. Each fibre is a long rod or cylinder, varying in diameter from less than 2μ to 20μ or even more, and the several fibres are arranged by the connective tissue into bundles or cords running along the length of the nerve. A large nerve such as the sciatic contains many cords of various sizes; in such a case the connective tissue between the fibres in each cord is more delicate than that which binds the cords together; each cord has a more or less distinct sheath of connective tissue, and a similar but stouter sheath protects the whole nerve. In smaller nerves the cords are less in number, and a very small nerve may consist, so to speak, of one cord only, that is to say it has one sheath for the whole nerve and fine connective tissue binding together all the fibres within the sheath. When a large nerve divides or sends off branches, one or more cords leave the trunk to form the branch; when nerves are joined to form a plexus, one or more cords leaving one nerve join another nerve; it is, as a rule, only when a very small nerve is dividing near its end into delicate twigs that division or branching of the nerve is effected or assisted by division of the nerve fibres themselves.

Nearly all the nerve fibres composing an ordinary nerve, such as that going to a muscle, though varying very much in thickness, have the same features, which are as follows. Seen under the microscope in a perfectly fresh condition, without the use of any reagents, each fibre appears as a transparent but somewhat refractive, and therefore bright-looking, rod, with a sharply defined outline, which is characteristically double, that is to say, the sharp line which marks the outside of the fibre is on each side of the fibre accompanied by a second line parallel to itself and following such gentle curves as it shews, but rather nearer the axis of the fibre. This is spoken of as the *double contour*, and is naturally more conspicuous and more easily seen in the thicker than in the thinner fibres. The substance of the fibre between the two inner contour lines appears, in the perfectly fresh fibre, homogeneous. If the fibre be traced along its course for some little distance there will be seen at intervals an appearance as if the fibre had been

strangled by a ligature tied tightly round it; its transverse diameter is suddenly narrowed, and the double contour lost, the fibre above and below being united by a narrow short isthmus only. This is called a *node*, a node of Ranvier, and upon examination it will be found that each fibre is marked regularly along its length by nodes at intervals of about a millimeter. If the fibre be examined with further care there will be seen or may be seen, about midway between every two nodes, an oval nucleus lying embedded as it were in the outline of the fibre, with its long axis parallel or nearly so to the axis of the fibre.

If some of the fibres be torn across it may sometimes be seen that at the torn end of a fibre, though the double contour ceases, the outline of the fibre is continued as a delicate transparent membranous tubular sheath; this is the *primitive sheath* or *neurilemma*¹. Lying in the axis of this sheath and sometimes projecting for some distance from the torn end of a fibre, whether the sheath be displayed or no, may, in some cases be seen a dim or very faintly granular band or thread, about one-third or half the diameter of the fibre; this is the *axis cylinder*; it becomes lost to view as we trace it back to where the fibre assumes a double contour. This axis cylinder stains readily with ordinary staining reagents, and being in this and in other respects allied in nature to the cell-substance of a leucocyte or to the muscle-substance of a muscular fibre, has often been spoken of as protoplasmic.

Lying about the torn ends of the fibres may be seen drops or minute irregular masses, remarkable for exhibiting a double contour like that of the nerve fibre itself; and indeed drops of this double contoured substance may be seen issuing from the torn ends of the fibres. Treated with osmic acid these drops and masses are stained black; they act as powerful reducing reagents, and the reduced osmium gives the black colour. Treated with ether or other solvents of fat they moreover more or less readily dissolve. Obviously they are largely composed of fat and we shall see that the fat composing them is of a very complex nature. Now a nerve fibre shewing a double contour stains black with osmic acid; but the staining is absent or very slight where the double contour ceases as at a torn end or at the nodes of Ranvier; the axis cylinder stains very slightly indeed with osmic acid and the sheath hardly at all. So also when a transverse section is made through a nerve or a nerve cord, each fibre appears in section as a dark black ring surrounding a much more faintly stained central area. Further, when a double contoured nerve fibre is treated with ether, or other solvents of fat, the double contour vanishes, and the

¹ This word was formerly used to denote the connective tissue sheath wrapping round the whole nerve. It seemed undesirable however to use two such analogous terms as sarcolemma and neurilemma for two things obviously without analogy, and hence neurilemma is now used for that part of the nerve which is obviously analogous to the sarcolemma in muscle, viz. the sheath of the fibre.

whole fibre becomes more transparent; and if such a fibre, either before or after the treatment with ether, be stained with carmine or other dye, the axis cylinder will be seen as a stained band or thread lying in the axis of a tubular space defined by the neurilemma which stains only slightly except at and around the nuclei which, as we have seen, are embedded in it at intervals. In the entire fibre the tubular space between the axis cylinder and the sheath is filled with a fatty material, the *medulla*, which from its fatty nature has such a refractive power as to exhibit a double contour when seen with transmitted light, on which account the fibre itself has a double contour. It is this refractive power of the medulla which gives to a nerve fibre and still more so to a bundle of nerve fibres or to a whole nerve a characteristic opaque white colour when viewed by reflected light.

As we shall see, all nerve fibres do not possess a medulla, and hence such a fibre as we are describing is called a *medullated fibre*.

A typical medullated fibre consists then of the following parts.

1. The *axis cylinder*, a central cylindrical core of so called 'protoplasmic' material, delicate in nature and readily undergoing change, sometimes swelling out, sometimes shrinking, and hence in various specimens appearing now as a thick band, now as a thin streak in the axis of the tubular sheath, and giving in cross section sometimes a circular, sometimes an oval, and not unfrequently a quite irregular outline. Probably in a perfectly natural condition it occupies about one half the diameter of the nerve, but even its natural size varies in different nerve fibres. When seen quite fresh it has simply a dim cloudy or at most a faintly granular appearance; under the influence of reagents it is apt to become fibrillated longitudinally, and has been supposed to be in reality composed of a number of delicate longitudinal fibrillæ united by an interfibrillar substance, but this is not certain. It is further said to be protected on its outside by a transparent sheath, the axis cylinder sheath, but this also is disputed.

The axis cylinder passes unbroken through successive nodes of Ranvier, the constriction of the node not affecting it otherwise than perhaps to narrow it. Now the fibres of a spinal nerve (omitting for the present the fibres coming from the sympathetic nerves) may be traced back either to the spinal ganglion on the posterior root, or along the anterior root to the anterior cornua of the spinal cord; and as we shall see the axis cylinders of the fibres are, in both cases, prolongations of processes of nerve cells, in the former case of cells of the ganglion, in the latter case of cells of the anterior cornua. In each case a process of a cell becoming the axis cylinder of a nerve fibre runs an unbroken course, passes as a continuous band of peculiar living matter, through node after node right down to the termination of the fibre in the tissue in which the fibre ends; the only obvious change which

it undergoes is that, in many if not all cases, it divides near its termination in the tissue, and in some cases the divisions are numerous and join or anastomose freely. Obviously the axis cylinder is the essential part of the nerve fibre.

2. The *primitive sheath* or *neurilemma*, a tubular sheath of transparent apparently homogeneous material, not unlike that of a sarcolemma in nature. At each node the neurilemma is constricted so as to embrace the axis cylinder closely, but is at the same time thickened by some kind of cement material. Staining reagents, especially silver nitrate, appear to enter the nerve fibre from without more readily at a node than elsewhere, staining the fibre most at the node, and creeping upwards and downwards from the node along the axis cylinder; hence it has been supposed that the nutritive fluid, the lymph, enters into the fibre and so gets access to the axis cylinder more readily at the nodes than elsewhere. About midway between every two nodes is placed a long oval nucleus, on the inside of the neurilemma, pushing the medulla, as it were, inwards, and so lying in a shallow bay of that substance. Immediately surrounding the nucleus is a thin layer of granular substance of the kind which we have spoken of as undifferentiated protoplasm; in young newly formed fibres at all events and possibly in all fibres a very thin layer of this same substance is continued all over the segment between the nodes, on the inner surface of the neurilemma between it and the medulla.

3. *The medulla*. This is a hollow cylinder of fatty material of a peculiar nature filling all the space between the neurilemma on the outside and the axis cylinder within, and suddenly ceasing at each node. It thus forms a close fitting hollow jacket for the axis cylinder between every two nodes. The fatty material is fluid, at least at the temperature of the body, but appears to be held in its place as it were by a network of a substance called *neurokeratin*, allied to the substance *keratin*, which is the basis of the horny scales of the epidermis and of other horny structures; this network is most marked towards the outside of the medulla.

So long as the nerve is in a fresh living, perfectly normal condition, the medulla appears smooth and continuous, shewing no marks beyond the double contour; but in nerves removed from the body for examination (and according to some observers, at times in nerves still within the body) clefts make their appearance in the medulla running obliquely inwards from the neurilemma to the axis cylinder, and frequently splitting up the medulla in such a way that it appears to be composed of a number of hollow cones partially slid one over the other along the axis cylinder. These clefts are spoken of as *indentations*. At a later stage of alteration the medulla may divide into a number of small irregular masses separated by fluid; and since each small piece thus separated has a double contour, like a drop of medulla exuded from the end of a fibre, the whole fibre has an irregular 'curdy' appearance.

The essential part then of a medullated nerve fibre (of a spinal nerve) is the axis cylinder, which is really a prolongation of a process from a nerve cell in a spinal ganglion or in the spinal cord, running an unbroken course through node after node, never in its course, as far as we know, joining another axis cylinder and very rarely dividing until it approaches its end, where it may divide freely, the divisions in some cases anastomosing freely. We may conclude, and all we know supports the conclusion, that the changes, making up what we have called a nervous impulse, take place, primarily and chiefly at all events, in this essential part of the nerve fibre, the axis cylinder. The neurilemma and medulla together form a wrapping for the nourishment and protection of the axis cylinder, the fatty medulla probably serving partly as prepared food for the axis cylinder, partly as a mechanical support; possibly it may also play a part as an insulator in the electric phenomena.

It is easy moreover to see that while the axis cylinder along its whole length is practically (whatever be the exact manner of its formation in the embryo) a part of the cell of which it is an elongated process, each segment between every two nodes represents a cell wrapping round the axis cylinder process, of which cell the nucleus between the nodes is the nucleus, the neurilemma the envelope or cell wall, and (though this is perhaps not quite so clear) the medulla the cell substance largely converted into fatty material, a cell in fact which is really outside the axis cylinder or nerve fibre proper. It is along the axis cylinder that the nervous impulses sweep, and each wrapping cell only serves to nourish and protect the segment of the axis cylinder between its two nodes. And we accordingly find that both at the beginning of the nerve fibre in the ganglion cell or spinal cord and at its end in the tissue, both neurilemma and medulla disappear, the axis cylinder only being left.

A nerve going to a muscle is chiefly composed of medullated fibres as just described, the majority of which, ending in end-plates in the muscular fibres, are the fibres which conduct the nervous impulses to the muscle, causing it to contract, and may hence be spoken of as *motor* nerve fibres. Some of the fibres however end in other parts, such as the tendon, or the connective tissue between the bundles, and some in the blood vessels. There are reasons for thinking that some of these convey impulses from the muscle to the central nervous system and are consequently spoken of as sensory or *afferent* fibres; concerning those connected with the blood vessels we shall speak in dealing with the vascular system.

§ 69. *Nerve-endings in striated muscular fibres.* A nerve on entering a muscle divides into a number of branches which, running in the connective tissue of the muscle, form a plexus round the bundles of muscle fibres, the smaller branches forming a plexus

round the muscle fibres themselves. From this plexus are given off a number of nerve fibres, running singly, each of which joining a muscle fibre ends in an end-plate. In forming these plexuses the individual nerve fibres divide repeatedly, the division always taking place at a node of Ranvier, so that what is a single nerve fibre as the nerve enters the muscle may give rise to several nerve fibres ending in several muscle fibres. The nerve fibre joins the muscle fibre at about its middle or somewhat nearer one end, and occasionally two nerve fibres may join one muscle fibre and form two end-plates. The general distribution of the bundles of nerve fibres and single nerve fibres is such that some portion of the muscle is left free from nerve fibres; thus at the lower and at the upper end of the sartorius of the frog there is a portion of muscle quite free from nerve fibres.

A single nerve fibre, running by itself, has, outside the neurilemma an additional delicate sheath of fine connective tissue known as *Henle's sheath*, which appears to be a continuation of the connective tissue forming the sheath of the nerve branch from which the fibre sprang, or uniting the fibres together in the branch.

The actual ending of the nerve fibre in the muscle fibre differs in different classes of animals.

In mammals and some other animals the single nerve fibre joins the muscle fibre in a swelling or projection having a more or less oval base, and appearing when seen sideways as a low conical or rounded eminence. At the summit of this eminence the nerve fibre loses both its sheath of Henle and its neurilemma, one or other or both (for on this point observers do not agree) becoming continuous with the sarcolemma of the muscle fibre. At the summit of the eminence, where the sheaths fuse, the fibre, now consisting only of axis cylinder and medulla, loses its medulla abruptly, (in the muscles of the tongue the nerve fibre in many cases loses its medulla at some considerable distance before it joins the muscle fibre to form the end-plate) while the axis cylinder branches out in all directions, the somewhat varicose branches, which sometimes anastomose, forming a low conical mass, which when viewed from above has an arborescent or labyrinthine appearance. On the branches of this arborescence may lie one or more somewhat granular oval nuclei. The arborescence itself has, like the axis cylinder of which it is a development, a very faintly granular or cloudy appearance, but lying between it and the actual muscle substance is a disc or bed of somewhat coarsely granular material, called *the sole* of the end-plate, on which the ramified arborescent axis cylinder rests, more or less overlapping it at the edge, but with which it appears not to be actually continuous. Lying in the midst of this 'sole' are a number of clear oval transparent nuclei.

The end-plate then beneath the sarcolemma consists of two

parts, the ramified axis cylinder, and the granular nucleated sole, the two apparently, though in juxtaposition, not being continuous. According to some observers the sole is continuous with and indeed is a specialized part of that substance pervading the whole muscular fibre which we spoke of as interfibrillar substance. We cannot enter here into a discussion of the probable meaning and use of these structures or how they effect what seems obviously their function, the transformation of the changes constituting a nervous impulse into the changes, which running along the muscle fibre in the latent period as forerunners of the changes entailing actual contraction, may be spoken of as constituting a muscle impulse. It is of interest to observe that certain analogies may be drawn between an end plate and the histological elements of the so-called electrical organs of certain animals. The element of the electric organ of the torpedo, for instance, may be regarded as a muscle fibre in which the nerve ending has become highly developed, while the muscle substance has been arrested in its development and has not become striated.

In amphibia (e.g. in frogs) the ending of a nerve fibre in a muscle fibre is somewhat different. A nerve fibre about to end in a muscle fibre divides into a brush of several nerve fibres, each of which, losing its sheath of Henle and sarcolemma, enters the same muscle fibre, and then losing its medulla runs longitudinally along the fibre for some distance, it and its branches dividing several times in a characteristically forked manner, and bearing at intervals oval nuclei. In other animals forms of nerve ending are met with more or less intermediate between that seen in the mammal and that seen in the frog.

§ 70. Besides the medullated nerve fibres described in § 68, there are in most nerves going to muscles a few and in some nerves, going to other parts, a large number of nerve fibres which do not possess a medulla, and hence are called *non-medullated fibres*; these are especially abundant in the so-called sympathetic nerves.

A non-medullated fibre which, like a medullated fibre, may have any diameter from 2μ or less to 20μ or more, is practically a naked axis cylinder, not covered with medulla, but bearing on its outside at intervals oval nuclei disposed longitudinally. These nuclei appear wholly analogous to the nuclei of the neurilemma of a medullated fibre, and probably belong to a sheath enclosing each fibre, though it is not easy to demonstrate the independent existence of such a sheath in the case of most non-medullated fibres. In the similar fibres constituting the olfactory nerve a sheath is quite conspicuous. Unlike the medullated fibres these non-medullated divide and also join freely; like them each may be regarded as a process of a nerve cell.

Of such non-medullated fibres a scanty number are found in nerves going to muscles scattered among the medullated fibres

and bound up with them by connective tissue. They appear to have no connection with the muscular fibres, but to be distributed chiefly to the blood vessels; and the function of non-medullated fibres had better be considered in connection with nerves of which they form a large part, such as certain nerves going to blood vessels and to secreting organs. But it may be stated that though they possess no medulla they are capable of propagating nervous impulses in the same way as medullated nerves; and this fact may be taken as indicating that the medulla cannot serve any very important function as an electric insulator.

§ 71. *The chemistry of a nerve.* We have spoken of the medulla as fatty, and yet it is in reality very largely composed of a substance which is not (in the strict sense of the word) a fat. When we examine chemically a quantity of nerve (or what is practically the same thing a quantity of that part of the central nervous system which is called *white matter*, and which as we shall see is chiefly composed, like a nerve, of medullated nerves, and is to be preferred for chemical examination because it contains a relatively small quantity of connective tissue), we find that a very large proportion, according to some observers about half, of the dried matter consists of the peculiar body *cholesterin*. Now cholesterin is not a fat but an alcohol; like glycerin however, which is also an alcohol, it forms compounds with fatty acids; and though we do not know definitely the chemical condition in which cholesterin exists during life in the medulla, it is more than probable that it exists in some combination with some of the really fatty bodies also present in the medulla, and not in a free isolated state. It is singular that besides being present in such large quantities in nervous tissue, and to a small extent in other tissues and in blood, cholesterin is a normal constituent of bile, and forms the greater part of gall stones when these are present; in gall stones it is undoubtedly present in a free state. Besides cholesterin 'white' nervous matter contains a less but still considerable quantity of a complex fat, whose nature is disputed. According to some authorities rather less than half this complex fat consists of the peculiar body *lecithin*, which we have already seen to be present also in blood corpuscles and in muscle. Lecithin contains the radicle of stearic acid (or of oleic, or of palmitic acid) associated not, as in ordinary fats, with simple glycerin, but with the more complex glycerin-phosphoric acid, and further combined with a nitrogenous body, *neurin*, an ammonia compound of some considerable complexity; it is therefore of remarkable nature since, though a fat, it contains both nitrogen and phosphorus. According to the same authorities the remainder of the complex fat consists of another fatty body, also apparently containing nitrogen but no phosphorus, called *cerebrin*. Other authorities regard both these bodies, lecithin and cerebrin, as products of decomposition of a still more complex fat, called

protagon. Obviously the fat of the white matter of the central nervous system and of spinal nerves (of which fat by far the greater part must exist in the medulla, and form nearly the whole of the medulla) is a very complex body indeed, especially so if the cholesterin exists in combination with the lecithin, or cerebrin (or protagon). Being so complex it is naturally very unstable, and indeed, in its instability resembles proteid matter. Hence probably the reason why the medulla changes so rapidly and so profoundly after the death of the nerve. It seems moreover that a certain though small quantity of proteid matter forms part of the medulla, and it is possible that this exists in some kind of combination with the complex fat; but our knowledge on this point is imperfect.

The presence in such large quantity of this complex fatty medulla renders the chemical examination of the other constituents of a nerve very difficult, and our knowledge of the chemical nature of, and of the chemical changes going on in the axis cylinder, is very limited. Examined under the microscope the axis cylinder gives the xanthoproteic reaction and other indications that it is proteid in nature; beyond this we are largely confined to inferences. We infer that its chemical nature is in a general way similar to that of the cell substance of the nerve cell of which it is a process. We infer that the chemical nature of the cell substance of a nerve cell, being of the kind which is frequently called 'protoplasmic,' is, in a general way, similar to that of other 'protoplasmic' cells, for instance of a leucocyte. Now where we can examine conveniently such cells we find, as we have said § 30, the proteids present in them to be some form of albumin, some form of globulin, and either myosin itself, or antecedents of myosin, or some allied body. In other words, the proteid basis of the kind of cell substance which is frequently spoken of as "undifferentiated protoplasm," does not, in its broad features, differ materially from the proteid basis of that "differentiated protoplasm," which we have called muscle substance. Hence we infer that in their broad chemical features the axis cylinder of a nerve fibre and the cell body of a nerve cell resemble the substance of a muscle fibre; and this view is supported by the fact that both kreatin and lactic acid are present as 'extractives,' certainly in the central nervous system, and probably in nerves. The resemblance is of course only a general one; there must be differences in chemical nature between the axis cylinder which propagates a nervous impulse without change of outward form and the muscle fibre which contracts; but we cannot at present state exactly what these differences really are.

After the fats of the medulla (and the much smaller quantity of fat present in the axis cylinder), the proteids of the axis cylinder, and the other soluble substances present in one or the other, or gathered round the nuclei of the neurilemma, have by various means been dissolved out of a nerve fibre, certain substances still

remain. One of these in small quantity is the nuclein of the nuclei; another in larger quantity is the substance *neurokeratin* which forms as we have seen a supporting framework for the medulla, and whose most marked characteristic is perhaps its resistance to solution.

In the ash of nerves there is a preponderance of potassium salts and phosphates but not so marked as in the case of muscle.

§ 72. *The nervous impulse.* The chemical analogy between the substance of the muscle and that of the axis cylinder would naturally lead us to suppose that the progress of a nervous impulse along a nerve fibre was accompanied by chemical changes similar to those taking place in a muscle fibre. Whatever changes however do or may take place are too slight to be recognized by the means at our disposal. We have no satisfactory evidence that in a nerve even repeated nervous impulses can give rise to an acid reaction or that the death of a nerve fibre leads to such a reaction. The grey matter of the central nervous system it is true is said to be slightly acid during life and to become more acid after death; but in this grey matter nerve cells are relatively abundant; the white matter, composed chiefly of nerve fibres, is and remains, during action as well as rest, and even after death, neutral or slightly alkaline.

Nor have we satisfactory evidence that the progress of a nervous impulse is accompanied by any setting free of energy in the form of heat.

In fact, beyond the terminal results, such as a muscular contraction in the case of a nerve going to a muscle, or some affection of the central nervous system in the case of a nerve still in connection with its nervous centre, there is one event and one event only which we are able to recognize as the objective token of a nervous impulse, and that is an electric change. For a piece of nerve removed from the body exhibits nearly the same electric phenomena as a piece of muscle. It has an equator which is electrically positive relatively to the two cut ends. In fact the diagram Fig. 19, and the description which was given in § 66 of the electric changes in muscle may be applied almost as well to a nerve, except that the currents are in all cases much more feeble in the case of nerves than of muscles, and the special currents from the circumference to the centre of the transverse sections cannot well be shewn in a slender nerve; indeed it is doubtful if they exist at all.

During the passage of a nervous impulse the 'natural nerve-current' undergoes a negative variation, just as the 'natural muscle current' undergoes a negative variation during a contraction. There are moreover reasons in the case of the nerve, as in the case of the muscle, which lead us to doubt the pre-existence of any such 'natural' currents. A nerve in an absolutely natural condition appears to be, like a muscle, isoelectric; hence we may

say that in a nerve during the passage of a nervous impulse, as in a muscle during a muscular contraction, a 'current of action' is developed.

This 'current of action' or 'negative variation' may be shewn either by the galvanometer or by the rheoscopic frog. If the nerve of the 'muscle nerve preparation' *B* (see § 67) be placed in an appropriate manner on a thoroughly irritable nerve *A* (to which of course no muscle need be attached), touching for instance the equator and one end of the nerve, then single induction-shocks sent into the far end of *A* will cause single spasms in the muscle of *B*, while tetanization of *A*, *i.e.* rapidly repeated shocks sent into *A*, will cause tetanus of the muscle of *B*.

That this current, whether it be regarded as an independent 'current of action' or as a negative variation of a 'pre-existing' current, is an essential feature of a nervous impulse is shewn by the fact that the degree or intensity of the one varies with that of the other. They both travel too at the same rate. In describing the muscle-curve, and the method of measuring the muscular latent period, we have incidentally shewn (§ 46) how at the same time the velocity of the nervous impulse may be measured, and stated that the rate in the nerves of a frog is about 28 metres a second. By means of a special and somewhat complicated apparatus it is ascertained that the current of action travels along an isolated piece of nerve at the same rate. It also, like the molecular change in a muscle preceding the contraction, and indeed like the contraction itself, travels in the form of a wave, rising rapidly to a maximum at each point of the nerve and then more gradually declining again. The length of the wave may by special means be measured, and is found to be about 18 mm.

When an isolated piece of nerve is stimulated in the middle, the current of action is propagated equally well in both directions, and that whether the nerve be a chiefly sensory or a chiefly motor nerve, or indeed if it be a nerve-root composed exclusively of motor or of sensory fibres. Taking the current of action as the token of a nervous impulse, we infer from this that when a nerve fibre is stimulated artificially at any part of its course, the nervous impulse set going travels in both directions.

We used just now the phrase 'tetanization of a nerve,' meaning the application to a nerve of rapidly repeated shocks such as would produce tetanus in the muscle to which the nerve was attached, and we shall have frequent occasion to employ the phrase. It must however be understood that there is in the nerve, in an ordinary way, no summation of nervous impulses comparable to the summation of muscular contractions. Putting aside certain cases which we cannot discuss here we may say that the series of shocks sent in at the far end of the nerve start a series of impulses; these travel down the nerve and reach the muscle as a series of distinct impulses; and the first changes in the muscle, the molecular

latent-period changes, also form a series the members of which are distinct. It is not until these molecular changes become transformed into visible changes of form that any fusion or summation takes place.

§ 73. Putting together the facts contained in this and the preceding sections, the following may be taken as a brief approximate history of what takes place in a muscle and nerve when the latter is subjected to a single induction-shock. At the instant that the induced current passes into the nerve, changes occur, of whose nature we know nothing certain except that they cause a 'current of action' or 'negative variation' of the 'natural' nerve-current. These changes propagate themselves along the nerve in both directions as a nervous impulse in the form of a wave, having a wave-length of about 18 mm., and a velocity (in frog's nerve) of about 28 m. per sec. Passing down the nerve fibres to the muscle, flowing along the branching and narrowing tracts, the wave at last breaks on the end-plates of the fibres of the muscle. Here it is transmuted into what we may call a muscle impulse, with a shorter steeper wave, and a greatly diminished velocity (about 3 m. per sec.). This muscle impulse, of which we know hardly more than that it is marked by a current of action, travels from each end-plate in both directions to the end of the fibre, where it appears to be lost, at all events we do not know what becomes of it. As this impulse wave, whose development takes place entirely within the latent period, leaves the end-plate it is followed by an explosive decomposition of material, leading to a discharge of carbonic acid, to the appearance of some substance or substances with an acid reaction, and probably of other unknown things, with a considerable development of heat. This explosive decomposition gives rise to the visible contraction wave, which travels behind the invisible muscle impulse at about the same rate, but with a vastly increased wave-length. The fibre, as the wave passes over it, swells and shortens and thus brings its two ends nearer together.

When repeated shocks are given, wave follows wave of nervous impulse, muscle impulse, and visible contraction; but the last do not keep distinct, they are fused into the continued shortening which we call tetanus.

SEC. 3. THE NATURE OF THE CHANGES THROUGH WHICH AN ELECTRIC CURRENT IS ABLE TO GENERATE A NERVOUS IMPULSE.

Action of the Constant Current.

§ 74. In the preceding account, the stimulus applied in order to give rise to a nervous impulse has always been supposed to be an induction-shock, single or repeated. This choice of stimulus has been made on account of the almost momentary duration of the induced current. Had we used a current lasting for some considerable time the problems before us would have become more complex, in consequence of our having to distinguish between the events taking place while the current was passing through the nerve from those which occurred at the moment when the current was thrown into the nerve or at the moment when it was shut off from the nerve. These complications do arise when instead of employing the induced current as a stimulus, we use *a constant current, i.e.* when we pass through the nerve (or muscle) a current direct from the battery without the intervention of any induction-coil.

Before making the actual experiment, we might perhaps naturally suppose that the constant current would act as a stimulus throughout the whole time during which it was applied, that, so long as the current passed along the nerve, nervous impulses would be generated, and that these would throw the muscle into something at all events like tetanus. And under certain conditions this does take place; occasionally it does happen that at the moment the current is thrown into the nerve the muscle of the muscle-nerve preparation falls into a tetanus which is continued until the current is shut off; but such a result is exceptional. In the vast majority of cases what happens is as follows. At the moment that the circuit is made, the moment that the current is thrown into the nerve, a single twitch, a simple contraction, the so-called *making contraction*, is witnessed; but after this has passed away

the muscle remains absolutely quiescent in spite of the current continuing to pass through the nerve, and this quiescence is maintained until the circuit is broken, until the current is shut off from the nerve, when another simple contraction, the so-called *breaking contraction*, is observed. The mere passage of a constant current of uniform intensity through a nerve does not under ordinary circumstances act as a stimulus generating a nervous impulse; such an impulse is only set up when the current either falls into or is shut off from the nerve. It is the entrance or the exit of the current, and not the continuance of the current, which is the stimulus. The quiescence of the nerve and muscle during the passage of the current is however dependent on the current remaining uniform in intensity or at least not being suddenly increased or diminished. Any sufficiently sudden and large increase or diminution of the intensity of the current will act like the entrance or exit of a current, and by generating a nervous impulse give rise to a contraction. If the intensity of the current however be very slowly and gradually increased or diminished, a very wide range of intensity may be passed through without any contraction being seen. ✕ It is the sudden change from one condition to another, and not the condition itself, which causes the nervous impulse.

In many cases, both a 'making' and a 'breaking' contraction, each a simple twitch, are observed, and this is perhaps the commonest event; but when the current is very weak, and again when the current is very strong, either the breaking or the making contraction may be absent, *i. e.* there may be a contraction only when the current is thrown into the nerve or only when it is shut off from the nerve.

Under ordinary circumstances the contractions witnessed with the constant current either at the make or at the break, are of the nature of a 'simple' contraction, but, as has already been said, the application of the current may give rise to a very pronounced tetanus. Such a tetanus is seen sometimes when the current is made, lasting during the application of the current, sometimes when the current is broken, lasting some time after the current has been wholly removed from the nerve. The former is spoken of as a 'making,' the latter as a 'breaking' tetanus. But these exceptional results of the application of the constant current need not detain us now.

The great interest attached to the action of the constant current lies in the fact, that *during* the passage of the current, in spite of the absence of all nervous impulses and therefore of all muscular contractions, the nerve is for the time both between and on each side of the electrodes profoundly modified in a most peculiar manner. This modification, important both for the light it throws on the generation of nervous impulses and for its practical applications, is known under the name of *electrotonus*.

§ 75. *Electrotonus*. The marked feature of the electrotonic condition is that the nerve though apparently quiescent is changed in respect to its irritability; and that in a different way in the neighbourhood of the two electrodes respectively.

Suppose that on the nerve of a muscle-nerve preparation are placed two (non-polarizable) electrodes (Fig. 21, *a*, *k*) connected with a battery and arranged with a key so that a constant current can at pleasure be thrown into or shut off from the nerve. This constant current, whose effects we are about to study, may be called the 'polarizing current.' Let *a* be the positive electrode or anode, and *k* the negative electrode or kathode, both placed at some distance from the muscle, and also with a certain interval between each other. At the point *x* let there be applied a pair of electrodes connected with an induction-coil. Let the muscle further be connected with a lever, so that its contractions can be recorded, and their amount measured. Before the polarizing current is thrown into the nerve, let a single induction-shock of known intensity (a weak one being chosen, or at least not one which would cause in the muscle a maximum contraction) be thrown in at *x*. A contraction of a certain amount will follow.

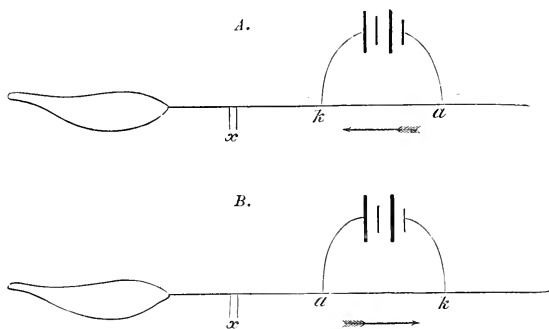

FIG. 21. MUSCLE-NERVE PREPARATIONS, with the nerve exposed in *A* to a *descending* and in *B* to an *ascending* constant current.

In each *a* is the anode, *k* the kathode of the constant current. *x* represents the spot where the induction-shocks used to test the irritability of the nerve are sent in.

That contraction may be taken as a measure of the irritability of the nerve at the point *x*. Now let the polarizing current be thrown in, and let the kathode or negative pole be nearest the muscle, as in Fig. 21 *A*, so that the current passes along the nerve in a direction from the central nervous system towards the muscle; such a current is spoken of as a *descending* one. The entrance of the polarizing current into the nerve will produce

a 'making' contraction; this we may neglect. If while the current is passing, the same induction-shock as before be sent through *x*, the contraction which results will be found to be greater than on the former occasion. If the polarizing current be now shut off, a 'breaking' contraction will probably be produced; this also we may neglect. If now the point *x* after a short interval be again tested with the same induction-shock as before, the contraction will be no longer greater, but of the same amount, or perhaps not so great, as at first. During the passage of the polarizing current, therefore, the irritability of the nerve at the point *x* has been temporarily *increased*, since the same shock applied to it causes a greater contraction during the presence than in the absence of the current. But this is only true so long as the polarizing current is a descending one, so long as the point *x* lies on the side of the kathode. On the other hand, if the polarizing current had been an *ascending* one, with the anode or positive pole nearest the muscle, as in Fig. 21 *B*, the irritability of the nerve at *x* would have been found to be *diminished* instead of increased by the polarizing current; the contraction obtained during the passage of the constant current would be less than before the passage of the current or might be absent altogether, and the contraction after the current had been shut off would be as great or perhaps greater than before. That is to say, when a constant current is applied to a nerve, the irritability of the nerve between the polarizing electrodes and the muscle is, during the passage of the current, increased when the kathode is nearest the muscle (and the polarizing current descending) and diminished when the anode is nearest the muscle (and the polarizing current ascending). The same result, *mutatis mutandis*, and with some qualifications which we need not discuss, would be gained if *x* were placed not between the muscle and the polarizing current, but on the far side of the latter. Hence it may be stated generally that during the passage of a constant current through a nerve the irritability of the nerve is increased in the region of the kathode, and diminished in the region of the anode. The changes in the nerve which give rise to this increase of irritability in the region of the kathode are spoken of as *katelectrotonus*, and the nerve is said to be in a *katelectrotonic* condition. Similarly the changes in the region of the anode are spoken of as *anelectrotonus*, and the nerve is said to be in an *anelectrotonic* condition. It is also often usual to speak of the *katelectrotonic* increase, and *anelectrotonic* decrease of irritability.

This law remains true whatever be the mode adopted for determining the irritability. The result holds good not only with a single induction-shock, but also with a tetanizing interrupted current, with chemical and with mechanical stimuli. It further appears to hold good not only in a dissected nerve-muscle preparation but also in the intact nerves of the living body. The

increase and decrease of irritability are most marked in the immediate neighbourhood of the electrodes, but spread for a considerable distance in each direction in the extrapolar regions. The same modification is not confined to the extrapolar region, but exists also in the intrapolar region. In the intrapolar region there must be of course a neutral or indifferent point, where the katelectrotonic increase merges into the anelectrotonic decrease, and where therefore the irritability is unchanged. When the polarizing current is a weak one, this indifferent point is nearer the anode than the kathode, but as the polarizing current increases in intensity, draws nearer and nearer the kathode (see Fig. 22).

The amount of increase and decrease is dependent: (1) On the strength of the current, the stronger current up to a certain limit producing the greater effect. (2) On the irritability of the nerve, the more irritable, better conditioned nerve being the more affected by a current of the same intensity.

In the experiments just described the increase or decrease of irritability is taken to mean that the same stimulus starts in the one case a larger or more powerful and in the other case a smaller or less energetic impulse; but we have reason to think that the mere propagation or conduction of impulses started elsewhere is also affected by the electrotonic condition. At all events anelectrotonus appears to offer an obstacle to the passage of a nervous impulse.

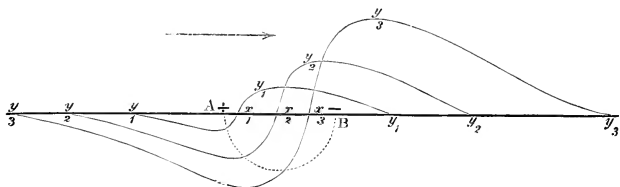

FIG. 22. DIAGRAM ILLUSTRATING THE VARIATIONS OF IRRITABILITY DURING ELECTROTONUS, WITH POLARIZING CURRENTS OF INCREASING INTENSITY (from Pflüger).

The anode is supposed to be placed at A, the kathode at B; AB is consequently the intrapolar district. In each of the three curves, the portion of the curve below the base line represents diminished irritability, that above, increased irritability. y_1 represents the effect of a weak current; the indifferent point x_1 is near the anode A. In y_2 , a stronger current, the indifferent point x_2 is nearer the kathode B, the diminution of irritability in anelectrotonus and the increase in katelectrotonus being greater than in y_1 ; the effect also spreads for a greater distance along the extrapolar regions in both directions. In y_3 the same events are seen to be still more marked.

§ 76. *Electrotonic Currents.* During the passage of a constant current through a nerve, variations in the electric currents belonging to the nerve itself may be observed; and these variations have certain relations to the variations of the irritability of the nerve. Thus if a constant current supplied by the battery P (Fig. 23) be applied

to a piece of nerve by means of two non-polarizable electrodes p , p' , the "currents of rest" obtainable from various points of the nerve will be different during the passage of the polarizing current from those which were manifest before or after the current was applied; and, moreover, the changes in the nerve-currents produced by the polarizing current will not be the same in the neighbourhood of the anode (p) as those in the neighbourhood of the kathode (p'). Thus let G and H be two galvanometers so connected with the two ends of the nerve as to afford good and clear evidence of the "currents of rest." Before the polarizing current is thrown into the nerve, the needle of H will occupy a position indicating the passage of a current of a certain intensity from h to h' through the galvanometer (from the positive longitudinal surface to the negative cut end of the nerve), the circuit being completed by a current *in* the nerve from h' to h , *i.e.* the current

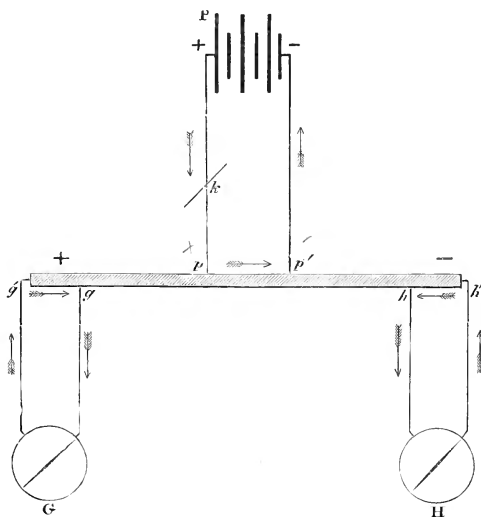

FIG. 23. DIAGRAM ILLUSTRATING ELECTROTONIC CURRENTS.

P the polarizing battery, with k a key, p the anode, and p' the kathode. At the left end of the piece of nerve the natural current flows through the galvanometer G from g to g' , in the direction of the arrows; its direction therefore is the same as that of the polarizing current; consequently it appears increased, as indicated by the sign $+$. The current at the other end of the piece of nerve, from h to h' , through the galvanometer H , flows in a contrary direction to the polarizing current; it consequently appears to be diminished, as indicated by the sign $-$.

N.B. For simplicity's sake, the polarizing current is here supposed to be thrown in at the middle of a piece of nerve, and the galvanometer placed at the two ends. Of course it will be understood that the former may be thrown in anywhere, and the latter connected with any two pairs of points which will give currents.

will flow in the direction of the arrow. Similarly the needle of G will by its deflection indicate the existence of a current flowing from g to g' through the galvanometer, and from g' to g through the nerve, in the direction of the arrow.

At the instant that the polarizing current is thrown into the nerve at pp' , the currents at gg' , hh' will undergo a "negative variation," that is, the nerve at each point will exhibit a "current of action" corresponding to the nervous impulse, which, at the making of the polarizing current, passes in both directions along the nerve, and may cause a contraction in the attached muscle. The current of action is, as we have seen, of extremely short duration, it is over and gone in a small fraction of a second. It therefore must not be confounded with a permanent effect which, in the case we are dealing with, is observed in both galvanometers. This effect, which is dependent on the direction of the polarizing current, is as follows: Supposing that the polarizing current is flowing in the direction of the arrow in the figure, that is, passes in the nerve from the positive electrode or anode p to the negative electrode or kathode p' , it is found that the current through the galvanometer G is increased, while that through H is diminished. The polarizing current has caused the appearance in the nerve outside the electrodes of a current, having the same direction as itself, called the 'electrotonic' current; and this electrotonic current adds to, or takes away from, the natural nerve-current or "current of rest" according as it is flowing in the same direction as that or in an opposite direction.

The strength of the electrotonic current is dependent on the strength of the polarizing current, and on the length of the intrapolar region which is exposed to the polarizing current. When a strong polarizing current is used, the electromotive force of the electrotonic current may be much greater than that of the natural nerve-current.

The strength of the electrotonic current varies with the irritability, or vital condition of the nerve, being greater with the more irritable nerve; and a dead nerve will not manifest electrotonic currents. Moreover, the propagation of the current is stopped by a ligature, or by crushing the nerve.

We may speak of the conditions which give rise to this electrotonic current as a *physical* electrotonus analogous to that *physiological* electrotonus which is made known by variations in irritability. The physical electrotonic current is probably due to the escape of the polarizing current along the nerve under the peculiar conditions of the living nerve; but we must not attempt to enter here into this difficult subject or into the allied question as to the exact connection between the physical and the physiological electrotonus, though there can be little doubt that the latter is dependent on the former.

§ 77. These variations of irritability at the kathode and anode respectively thus brought about by the action of the constant current are interesting theoretically, because we may trace a connection between them and the nervous impulse which is the result of the making or breaking of a constant current.

For we have evidence that a nervous impulse is generated when a portion of the nerve passes suddenly from a normal

condition to a state of katelectrotonus or from a state of anelectrotonus back to a normal condition, but that the passage from a normal condition to anelectrotonus or from katelectrotonus back to a normal condition is unable to generate an impulse. Hence when a constant current is 'made' the impulse is generated only at the kathode where the nerve passes suddenly into katelectrotonus; when the current on the other hand is 'broken' the impulse is generated only at the anode where the nerve passes suddenly back from anelectrotonus into a normal condition. We have an indirect proof of this in the facts to which we drew attention a little while back, viz. that a contraction sometimes occurs at the 'breaking' only, sometimes at the 'making' only of the constant current, sometimes at both. For it is found that this depends partly on the strength of the current in relation to the irritability of the nerve, partly on the direction of the current, whether ascending or descending; and the results obtained with strong, medium and weak descending and ascending currents have been stated in the form of a 'law of contraction.' We need not enter into the details of this 'law' but will merely say that the results which it formulates are best explained by the hypothesis just stated. We may add that when the constant current is applied to certain structures composed of plain muscular fibres, whose rate of contraction we have seen to be slow, the making contraction may be actually seen to begin at the kathode and travel towards the anode, and the breaking contraction to begin at the anode and travel thence towards the kathode.

Since in katelectrotonus the irritability is increased, and in anelectrotonus decreased, both the entrance from the normal condition into katelectrotonus and the return from anelectrotonus to the normal condition are instances of a passage from a lower stage of irritability to a higher stage of irritability. Hence the phenomena of electrotonus would lead us to the conception that a stimulus in provoking a nervous impulse produces its effect by, in some way or other, suddenly raising the irritability to a higher pitch. But what we are exactly to understand by raising the irritability, what molecular change is the cause of the rise, and how either electric or other stimuli can produce this change are matters which we cannot discuss here.

Besides their theoretical importance the phenomena of electrotonus have also a practical interest. When an ascending current is passed along a nerve going to a muscle or group of muscles the region between the electrodes and the muscle is thrown into anelectrotonus and its irritability is diminished. If the current be of adequate strength the irritability may be so much lessened that nervous impulses cannot be generated in that part of the nerve or cannot pass along it. Hence by this means the irregular contractions of muscles known as 'cramp' may be abolished. Similarly, by bringing into a condition of anelectrotonus a portion

of a sensory nerve in which violent impulses are being generated, giving rise in the central nervous system to sensations of pain, the impulses are toned down or wholly abolished, and the pain ceases. So on the other hand we may at pleasure heighten the irritability of a part by throwing it into katelectrotonus. In this way the constant current, properly applied, becomes a powerful remedial means.

We said just now that probably every stimulus produces its effect on a nerve by doing what the constant current does when it acts as a stimulus, viz. suddenly raising the irritability of the nerve to a higher pitch. At any rate the stimulus so often employed in experiments, the induction-shock, acts exactly in the same way as the constant current. The induction-shock is a current of short duration, developed very suddenly but disappearing more gradually, and this is true both of a making induction-shock, a shock due to the making of the primary current, and of a breaking shock, a shock due to the breaking of the primary current. The two differ in direction (hence if the making shock be ascending, the breaking shock will be descending and vice versa) and in the fact that the breaking shock is more suddenly developed and hence more potent than the making shock; but otherwise they act in the same way. In each case, since the induced current is developed rapidly but disappears more slowly, there is a sudden development of electrotonus, of katelectrotonus at the kathode and of anelectrotonus at the anode, and a more gradual return to the normal condition. Now there are many reasons for thinking that in all cases the passing from the normal condition to katelectrotonus at the kathode is a more potent stimulus than the return from anelectrotonus to the normal condition at the anode, and this will be still more so if the return to the normal condition be much slower than the entrance into electrotonus, as is the case in an induction-shock. And it would appear that in an induction-shock, which as we have said disappears much more slowly than it is developed, we have to deal not with two stimuli, one at the shock passing into a nerve and one at the shock leaving the nerve, but with one only, that produced at the shock passing into the nerve. Hence when an induction-shock is sent into a nerve, one stimulus only is developed and that at the kathode only, the establishment of katelectrotonus. This is true whether the shock be a making or a breaking shock, *i.e.* due to the making or breaking of the primary current, though of course owing to the change of direction in the induced current what was the kathode at the making shock becomes the anode at the breaking shock.

Lastly, though we are dealing now with nerves going to muscles, that is to say with motor nerves only, we may add that what we have said about electrotonus and the development of nervous impulses by it appears to apply equally well to sensory nerves.

§ 78. In a general way muscular fibres behave towards an

electric current very much as do nerve fibres; but there are certain important differences.

In the first place muscular fibres, devoid of nerve fibres, are much more readily thrown into contractions by the breaking and making of a constant current than by the more transient induction-shock; the muscular substance seems to be more sluggish than the nervous substance and requires to be acted upon for a longer time. This fact may be made use of, and indeed is in medical practice made use of, to determine the condition of the nerves supplying a muscle. If the intramuscular nerves be still in good condition, the muscle as a whole responds readily to single induction-shocks because these can act upon the intramuscular nerves. If these nerves on the other hand have lost their irritability, the muscle does not respond readily to single induction-shocks, or to the interrupted current, but can still easily be thrown into contractions by the constant current.

In the second place while in a nerve no impulses are as a rule generated during the passage of a constant current, between the break and the make, provided that it is not too strong, and that it remains uniform in strength, in an unarized muscle on the other hand, even with moderate and perfectly uniform currents, a kind of tetanus or apparently a series of rhythmically repeated contractions is very frequently witnessed during the passage of the current. The exact nature and cause of these phenomena in muscle, we must not however discuss here.

SEC. 4. THE MUSCLE-NERVE PREPARATION AS A MACHINE.

§ 79. The facts described in the foregoing sections shew that a muscle with its nerve may be justly regarded as a machine which, when stimulated, will do a certain amount of work. But the actual amount of work which a muscle-nerve preparation will do is found to depend on a large number of circumstances, and consequently to vary within very wide limits. These variations will be largely determined by the condition of the muscle and nerve in respect to their nutrition; in other words, by the degree of irritability manifested by the muscle or by the nerve or by both. But quite apart from the general influences affecting its nutrition and thus its irritability, a muscle-nerve preparation is affected as regards the amount of its work by a variety of other circumstances, which we may briefly consider here, reserving to a succeeding section the study of variations in irritability.

The influence of the nature and mode of application of the stimulus. When we apply a weak stimulus, a weak induction-shock, to a nerve we get a small contraction, a slight shortening of the muscle; when we apply a stronger stimulus, a stronger induction-shock, we get a larger contraction, a greater shortening of the muscle. We take, other things being equal, the amount of contraction of the muscle as a measure of the nervous impulse, and say that in the former case a weak or slight, in the latter case a stronger or larger nervous impulse has been generated. Now the muscle of the muscle-nerve preparation consists of many muscular fibres and the nerve of many nerve fibres; and we may fairly suppose that in two experiments we may in the one experiment bring the induction-shock or other stimulus to bear on a few nerve fibres only, and in the other experiment on many or even all the fibres of the nerve. In the former case only those muscular fibres in which the few nerve fibres stimulated end will be thrown into contraction, the others remaining quiet, and the shortening of the muscle as a whole, since only a few fibres take part in it, will necessarily be less than when all the fibres of the nerve

are stimulated and all the fibres of the muscle contract. That is to say, the amount of contraction will depend on the number of fibres stimulated. For simplicity's sake however we will in what follows, except when otherwise indicated, suppose that when a nerve is stimulated, all the fibres are stimulated and all the muscular fibres contract.

In such a case the stronger or larger nervous impulse leading to the greater contraction will mean the greater disturbance in each of the nerve fibres. What we exactly mean by the greater disturbance we must not discuss here; we must be content with regarding the greater or more powerful or more intense nervous impulse as that in which, by some mode or other, more energy is set free.

So far as we know at present this difference in amount or intensity, of the energy set free, is the chief difference between various nervous impulses. Nervous impulses may differ in the velocity which they travel, in the length and possibly in the form of the impulse wave, but the chief difference is in strength, in, so to speak the height, of the wave. And our present knowledge will not permit us to point out any other differences, any differences in fundamental nature for instance, between nervous impulses generated by different stimuli, between for example the nervous impulses generated by electric currents and those generated by chemical or mechanical stimuli, or by those changes in the central nervous system which give rise to what may be called natural motor nervous impulses as distinguished from those produced by artificial stimulation of motor nerves¹.

This being premised, we may say that, other things being equal, the magnitude of a nervous impulse, and so the magnitude of the ensuing contraction, is directly dependent on what we may call the strength of the stimulus. Thus taking a single induction-shock as the most manageable stimulus, we find that if, before we begin, we place the secondary coil (Fig. 4, *sc.*) a long way off the primary coil *pr. c.*, no visible effect at all follows upon the discharge of the induction-shock. The passage of the momentary weak current is either unable to produce any nervous impulse at all, or the weak nervous impulse to which it gives rise is unable to stir the sluggish muscular substance to a visible contraction. As we slide the secondary coil towards the primary, sending in an induction-shock at each new position, we find that at a certain distance between the secondary and primary coils, the muscle responds to each induction-shock² with a contraction which makes

¹ It will be observed that we are speaking now exclusively of the nerve of a muscle-nerve preparation, *i.e.* of what we shall hereafter term a motor nerve. Whether sensory impulses differ essentially from motor impulses will be considered later on.

² In these experiments either the breaking or making shock must be used, not sometimes one and sometimes the other, for, as we have stated, the two kinds of shock differ in efficiency, the breaking being the most potent.

itself visible by the slightest possible rise of the attached lever. This position of the coils, the battery remaining the same and other things being equal, marks the *minimal* stimulus giving rise to the minimal contraction. As the secondary coil is brought nearer to the primary, the contractions increase in height corresponding to the increase in the intensity of the stimulus. Very soon however an increase in the stimulus caused by further sliding the secondary coil over the primary fails to cause any increase in the contraction. This indicates that the *maximal* stimulus giving rise to the maximal contraction has been reached; though the shocks increase in intensity as the secondary coil is pushed further and further over the primary, the contractions remain of the same height, until fatigue lowers them.

With single induction-shocks then the muscular contraction, and by inference the nervous impulse, increases with an increase in the intensity of the stimulus, between the limits of the minimal and maximal stimuli; and this dependence of the nervous impulse, and so of the contraction, on the strength of the stimulus may be observed not only in electric but in all kinds of stimuli.

It may here be remarked that in order for a stimulus to be effective, a certain abruptness in its action is necessary. Thus as we have seen the constant current when it is passing through a nerve with uniform intensity does not give rise to a nervous impulse, and indeed it may be increased or diminished to almost any extent without generating nervous impulses, provided that the change be made gradually enough; it is only when there is a sudden change that the current becomes effective as a stimulus. And the reason why the breaking induction-shock is more potent as a stimulus than the making shock is because as we have seen (§ 44) the current which is induced in the secondary coil of an induction-machine at the breaking of the primary circuit, is more rapidly developed, and has a sharper rise than the current which appears when the primary circuit is made. Similarly a sharp tap on a nerve will produce a contraction, when a gradually increasing pressure will fail to do so; and in general the efficiency of a stimulus of any kind will depend in part on the suddenness or abruptness of its action.

A stimulus, in order that it may be effective, must have an action of a certain duration, the time necessary to produce an effect varying according to the strength of the stimulus and being different in the case of a nerve from what it is in the case of a muscle. It would appear that an electric current applied to a nerve must have a duration of at least about $\cdot 0015$ sec. to cause any contraction at all, and needs a longer time than this to produce its full effect. A muscle fibre apart from its nerve fibre requires a still longer duration of the stimulus, and hence, as we have already stated, a muscle poisoned by urari, or which has otherwise lost the action of its nerves, will not respond as readily to induction-shocks as to

the more slowly acting, breaking and making of a constant current.

In the case of electric stimuli, the same current will produce a stronger contraction when it is sent along the nerve than when it is sent across the nerve; indeed it is maintained that a current which passes through a nerve in an absolutely transverse direction is powerless to generate impulses.

It would also appear, at all events up to certain limits, that the longer the piece of nerve through which the current passes, the greater is the effect of the stimulus.

When two pairs of electrodes are placed on the nerve of a long and perfectly fresh and successful nerve-preparation, one near to the cut end, and the other nearer the muscle, it is found that the same stimulus produces a greater contraction when applied through the former pair of electrodes than through the latter. This has been interpreted as meaning that the impulse started at the farther electrodes gathers strength, like an avalanche, in its progress to the muscle. It is more probable, however, that the larger contraction produced by stimulation of the part of the nerve near the cut end is due to the stimulus setting free a larger impulse, *i.e.* to this part of the nerve being more irritable. The mere section, possibly by developing nerve currents, increases for a time the irritability at the cut end. A similar greater irritability may however also be observed in the part of the nerve nearer the spinal cord while it is still in connection with the spinal cord; and it is possible that the irritability of a nerve may vary considerably at different points of its course.

§ 80. We have seen that when single stimuli are repeated with sufficient frequency, the individual contractions are fused into tetanus; as the frequency of the repetition is increased, the individual contractions are less obvious on the curve, until at last we get a curve on which they seem to be entirely lost and which we may speak of as a complete tetanus. By such a tetanus a much greater contraction, a much greater shortening of the muscle is of course obtained than by single contractions.

The exact frequency of repetition required to produce complete tetanus will depend chiefly on the length of the individual contractions, and this varies in different animals, in different muscles of the same animal, and in the same muscle under different conditions. In a cold-blooded animal a single contraction is as a rule more prolonged than in a warm-blooded animal, and tetanus is consequently produced in the former by a less frequent repetition of the stimulus. A tired muscle has a longer contraction than a fresh muscle, and hence in many tetanus curves the individual contractions, easily recognised at first, disappear later on, owing to the individual contractions being lengthened out by the exhaustion caused by the tetanus itself. In many animals,

e.g. the rabbit, some muscles (such as the adductor magnus femoris) are pale, while others (such as the semitendinosus) are red. The red muscles are not only more richly supplied with blood vessels, but the muscle substance of the fibres contains more hæmoglobin than the pale, and there are other structural differences. Now the single contraction of one of these red muscles is more prolonged than a single contraction of one of the pale muscles produced by the same stimulus. Hence the red muscles are thrown into complete tetanus with a repetition of much less frequency than that required for the pale muscles. Thus, ten stimuli in a second are quite sufficient to throw the red muscles of the rabbit into complete tetanus, while the pale muscles require at least twenty stimuli in a second.

So long as signs of the individual contractions are visible on the curve of tetanus it is easy to recognise that each stimulation produces one of the constituent single contractions, and that the number so to speak of the vibrations of the muscle making up the tetanus corresponds to the number of stimulations; but the question whether, when we increase the number of stimulations beyond that necessary to produce a complete tetanus, we still increase the number of constituent single contractions is one not so easy to answer. And connected with this question is another difficult one. What is the rate of repetition of single contractions making up those tetanic contractions which as we have said are the kind of contractions by which the voluntary, and indeed other natural, movements of the body are carried out? What is the evidence that these are really tetanic in character?

When a muscle is thrown into tetanus, a more or less musical sound is produced. This may be heard by applying a stethoscope directly over a contracting muscle, and a similar sound but of a more mixed origin and less trustworthy may be heard when the masseter muscles are forcibly contracted or when a finger is placed in the ear, and the muscles of the same arm are contracted.

When the stethoscope is placed over a muscle, the nerve of which is stimulated by induction-shocks repeated with varying frequency, the note heard will vary with the frequency of the shocks, being of higher pitch with the more frequent shocks. Now it has been thought that the vibrations of the muscle giving rise to the "muscle sound" are identical with the single contractions making up the tetanus of the muscle. And since, in the human body, when a muscle is thrown into contraction in a voluntary effort, or indeed in any of the ordinary natural movements of the body, the fundamental tone of the sound corresponds to about 19 or 20 vibrations a second, it has been concluded that the contraction taking place in such cases is a tetanus of which the individual contractions follow each other about 19 or 20 times a second. But investigations seem to shew that the vibrations

giving rise to the muscle sound do not really correspond to the shortenings and relaxations of the individual contractions, and that the pitch of the note cannot therefore be taken as an indication of the number of single contractions making up the tetanus; indeed, as we shall see in speaking of the sounds of the heart, a single muscular contraction may produce a sound which though differing from the sound given out during tetanus has to a certain extent musical characters. Nevertheless the special characters of the muscle sound given out by muscles in the natural movements of the body may be taken as shewing at least that the contractions of the muscle in these movements are tetanic in nature, and the similarity of the note in all the voluntary efforts of the body and indeed in all movements carried out by the central nervous system is at least consonant with the view that the repetition of single contractions is of about the same frequency in all these movements. What that frequency is, and whether it is exactly identical in all these movements, is not at present perhaps absolutely determined; but certain markings on the myographic tracings of these movements and other facts seem to indicate that it is about 12 a second.

§ 81. *The Influence of the Load.* It might be imagined that a muscle, which, when loaded with a given weight, and stimulated by a current of a given intensity, had contracted to a certain extent, would only contract to half that extent when loaded with twice the weight and stimulated with the same stimulus. Such however is not necessarily the case; the height to which the weight is raised may be in the second instance as great, or even greater, than in the first. That is to say, the resistance offered to the contraction actually augments the contraction, the tension of the muscular fibre increases the facility with which the explosive changes resulting in a contraction take place. And we have other evidence that anything which tends to stretch the muscular fibres, that any tension of the muscular fibres, whether during rest or during contraction, increases the metabolism of the muscle. There is, of course, a limit to this favourable action of the resistance. As the load continues to be increased, the height of the contraction is diminished, and at last a point is reached at which the muscle is unable (even when the stimulus chosen is the strongest possible) to lift the load at all.

In a muscle viewed as a machine we have to deal not merely with the height of the contraction, that is with the amount of shortening, but with the work done. And this is measured by multiplying the number of units of height to which the load is raised into the number of units of weight of the load. Hence it is obvious from the foregoing observations that the work done must be largely dependent on the weight itself. Thus there is a certain weight of load with which in any given muscle, stimu-

lated by a given stimulus, the most work will be done ; as may be seen from the following example :

Load, in grammes	0	50	100	150	200	250
Height of contractions in millimeters	14	9	7	5	2	0
Work done, in gram-millimeters ...	0	450	700	750	400	0

§ 82. *The Influence of the Size and Form of the Muscle.* Since all known muscular fibres are much shorter than the wave-length of a contraction, it is obvious that the longer the fibre, the greater will be the shortening caused by the same contraction wave, the greater will be the height of the contraction with the same stimulus. Hence in a muscle of parallel fibres, the height to which the load is raised as the result of a given stimulus applied to its nerve, will depend on the length of the fibres, while the maximum weight of load capable of being lifted will depend on the number of the fibres, since the load is distributed among them. Of two muscles therefore of equal length (and of the same quality) the most work will be done by that which has the larger number of fibres, that is to say, the fibres being of equal width, which has the greater sectional area ; and of two muscles with equal sectional areas, the most work will be done by that which is the longer. If the two muscles are unequal both in length and sectional area, the work done will be the greater in the one which has the larger bulk, which contains the greater number of cubic units. In speaking therefore of the work which can be done by a muscle, we may use as a standard a cubic unit of bulk, or, the specific gravity of the muscle being the same, a unit of weight.

We learn then from the foregoing paragraphs that the work done, by a muscle-nerve preparation, will depend, not only on the activity of the nerve and muscle as determined by their own irritability, but also on the character and mode of application of the stimulus, on the kind of contraction (whether a single spasm, or a slowly repeated tetanus or a rapidly repeated tetanus) on the load itself, and on the size and form of the muscle. Taking the most favourable circumstances, viz. a well nourished, lively preparation, a maximum stimulus causing a rapid tetanus and an appropriate load, we may determine the maximum work done by a given weight of muscle, say one gramme. This in the case of the muscles of the frog has been estimated at about four gram-metres for one gramme of muscle.

SEC. 5. THE CIRCUMSTANCES WHICH DETERMINE THE DEGREE OF IRRITABILITY OF MUSCLES AND NERVES.

§ 83. A muscle-nerve preparation, at the time that it is removed from the body, possesses a certain degree of irritability, it responds by a contraction of a certain amount to a stimulus of a certain strength, applied to the nerve or to the muscle. After a while, the exact period depending on a variety of circumstances, the same stimulus produces a smaller contraction, *i.e.* the irritability of the preparation has diminished. In other words, the muscle or nerve or both have become partially 'exhausted'; and the exhaustion subsequently increases, the same stimulus producing smaller contractions, until at last all irritability is lost, no stimulus however strong producing any contraction whether applied to the nerve or directly to the muscle; and eventually the muscle, as we have seen, becomes rigid. The progress of this exhaustion is more rapid in the nerves than in the muscles; for some time after the nerve-trunk has ceased to respond to even the strongest stimulus, contractions may be obtained by applying the stimulus directly to the muscle. It is much more rapid in the warm-blooded than in the cold-blooded animals. The muscles and nerves of the former lose their irritability, when removed from the body, after a period varying according to circumstances from a few minutes to two or three hours; those of cold-blooded animals (or at least of an amphibian or a reptile) may under favourable conditions remain irritable for two, three, or even more days. The duration of irritability in warm-blooded animals may however be considerably prolonged by reducing the temperature of the body before death.

If with some thin body a sharp blow be struck across a muscle which has entered into the later stages of exhaustion, a wheal lasting for several seconds is developed. This wheal appears to be a contraction wave limited to the part struck, and disappearing very slowly, without extending to the neighbouring muscular substance. It has been called

an *'idio-muscular'* contraction, because it may be brought out even when ordinary stimuli have ceased to produce any effect. It may however be accompanied at its beginning by an ordinary contraction. It is readily produced in the living body on the pectoral and other muscles of persons suffering from phthisis and other exhausting diseases.

This natural exhaustion and diminution of irritability in muscles and nerves removed from the body may be modified both in the case of the muscle and of the nerve, by a variety of circumstances. Similarly, while the nerve and muscle still remain in the body, the irritability of the one or of the other may be modified either in the way of increase or of decrease by certain general influences, of which the most important are, severance from the central nervous system, and variations in temperature, in blood-supply, and in functional activity.

The Effects of Severance from the Central Nervous System. When a nerve, such for instance as the sciatic, is divided *in situ*, in the living body, there is first of all observed a slight increase of irritability, noticeable especially near the cut end; but after a while the irritability diminishes, and gradually disappears. Both the slight initial increase and the subsequent decrease begin at the cut end and advance centrifugally towards the peripheral terminations. This centrifugal feature of the loss of irritability is often spoken of as the Ritter-Valli law. In a mammal it may be two or three days, in a frog, as many, or even more weeks, before irritability has disappeared from the nerve-trunk. It is maintained in the small (and especially in the intramuscular) branches for still longer periods.

This centrifugal loss of irritability is the forerunner in the peripheral portion of the divided nerve of structural changes which proceed in a similar centrifugal manner. The medulla suffers changes similar to those seen in nerve fibres after removal from the body; its double contour and its characteristic indentations become more marked, it breaks up into small irregular fragments, or drops. Mingled with the fat particles of the medulla are seen small masses of proteid material which appear to be derived from the protoplasm around the nuclei. Meanwhile the axis cylinder also breaks up into fragments, and the nuclei of the neurilemma divide and multiply. The fatty constituents subsequently decrease in amount, the proteid material increasing or not diminishing, and thus the contents of the neurilemma between each two nodes is reduced to a mass of proteid material, in which the fragments of the axis cylinder can no longer be recognised. This mass which still retains some fat globules, is studded with nuclei. If no regeneration takes place these nuclei with their proteid bed eventually disappear.

In the central portion of the divided nerve similar changes may be traced as far only as the next node of Ranvier. Beyond this the nerve usually remains in a normal condition.

Regeneration, when it occurs, is apparently carried out by the peripheral growth of the axis-cylinders of the intact central portion. When the cut ends of the nerve are close together the axis-cylinders growing out from the central portion run into and between the shrunken neurilemmas of the peripheral portion; but much uncertainty still exists as to the exact parts which the proliferated nuclei and the proteid material referred to above, and the old axis-cylinders of the peripheral portion respectively play in giving rise to the new structures of the regenerated fibre.

Such a degeneration may be observed to extend down to the very endings of the nerve in the muscle, including the end-plates, but does not at first affect the muscular substance itself. The muscle, though it has lost all its nervous elements, still remains irritable towards stimuli applied directly to itself: an additional proof of the existence of an independent muscular irritability.

For some time the irritability of the muscle, as well towards stimuli applied directly to itself as towards those applied through the impaired nerve, seems to be diminished; but after a while a peculiar condition (to which we have already alluded § 78) sets in, in which the muscle is found to be not easily stimulated by single induction-shocks but to respond readily to the make or break of a constant current. In fact it is said to become even more sensitive to the latter mode of stimulation than it was when its nerve was intact and functionally active. At the same time it also becomes more irritable towards direct mechanical stimuli, and very frequently fibrillar contractions, more or less rhythmic and apparently of spontaneous origin, though their causation is obscure, make their appearance. This phase of heightened sensitiveness of a muscle, especially to the constant current, appears to reach its maximum, in man at about the seventh week after nervous impulses have ceased, owing to injury to the nerves or nervous centre, to reach the muscle.

If the muscle thus deprived of its nervous elements be left to itself its irritability, however tested, sooner or later diminishes; but if the muscle be periodically thrown into contractions by artificial stimulation with the constant current, the decline of irritability and attendant loss of nutritive power may be postponed for some considerable time. But as far as our experience goes at present the artificial stimulation cannot fully replace the natural one, and sooner or later the muscle like the nerve suffers degeneration, loses all irritability and ultimately its place is taken by connective tissue.

§ 84. *The influence of temperature.* We have already seen that sudden heat, (and the same might be said of cold when sufficiently intense), applied to a limited part of a nerve or muscle, as when the nerve or muscle is touched with a hot wire, will act as a stimulus. It is however much more difficult to generate nervous or muscular impulses by exposing a whole nerve or muscle to a gradual rise of temperature. Thus according to most

observers a nerve belonging to a muscle¹ may be either cooled to 0° C. or below, or heated to 50° or even 100° C., without discharging any nervous impulses, as shewn by the absence of contraction in the attached muscle. The contractions moreover may be absent even when the heating has not been very gradual.

A muscle may be gradually cooled to 0° C. or below without any contraction being caused; but when it is heated to a limit, which in the case of frog's muscles is about 45°, of mammalian muscles about 50°, a sudden change takes place: the muscle falls, at the limiting temperature, into a rigor mortis, which is initiated by a forcible contraction or at least shortening.

Moderate warmth, *e. g.* in the frog an increase of temperature up to somewhat below 45° C., favours both muscular and nervous irritability. All the molecular processes are hastened and facilitated: the contraction is for a given stimulus greater and more rapid, *i. e.* of shorter duration, and nervous impulses are generated more readily by slight stimuli. Owing to the quickening of the chemical changes, the supply of new material may prove insufficient; hence muscles and nerves removed from the body lose their irritability more rapidly at a high than at a low temperature.

The gradual application of cold to a nerve, especially when the temperature is thus brought near to 0°, slackens all the molecular processes, so that the wave of nervous impulse is lessened and prolonged, the velocity of its passage being much diminished, *e. g.* from 28 metres to 1 metre per sec. At about 0° the irritability of the nerve disappears altogether.

When a muscle is exposed to similar cold, *e. g.* to a temperature very little above zero, the contractions are remarkably prolonged; they are diminished in height at the same time, but not in proportion to the increase of their duration. Exposed to a temperature of zero or below, muscles soon lose their irritability, without however undergoing rigor mortis. After an exposure of not more than a few seconds to a temperature not much below zero, they may be restored, by gradual warmth, to an irritable condition, even though they may appear to have been frozen. When kept frozen however for some few minutes, or when exposed for a less time to temperatures of several degrees below zero, their irritability is permanently destroyed. When after this they are thawed, they are at first supple and as we have seen may be made to yield muscle plasma; but they very speedily enter into rigor mortis of a most pronounced character.

§ 85. *The influence of blood-supply.* When a muscle still within the body is deprived by any means of its proper blood-supply, as when the blood vessels going to it are ligatured, the same gradual loss of irritability and final appearance of rigor mortis are observed as in muscles removed from the body. Thus

¹ The action of cold and heat on sensory nerves will be considered in the later portion of the work.

if the abdominal aorta be ligatured, the muscles of the lower limbs lose their irritability and finally become rigid. So also in systemic death, when the blood-supply to the muscles is cut off by the cessation of the circulation, loss of irritability ensues, and rigor mortis eventually follows. In a human corpse the muscles of the body enter into rigor mortis in a fixed order: first those of the jaw and neck, then those of the trunk, next those of the arms, and lastly those of the legs. The rapidity with which rigor mortis comes on after death varies considerably, being determined both by external circumstances and by the internal conditions of the body. Thus external warmth hastens and cold retards the onset. After great muscular exertion, as in hunted animals, and when death closes wasting diseases, rigor mortis in most cases comes on rapidly. As a general rule it may be said that the later it is in making its appearance, the more pronounced it is, and the longer it lasts; but there are many exceptions, and when the state is recognized as being fundamentally due to a clotting of myosin, it is easy to understand that the amount of rigidity, *i.e.* the amount of the clot, and the rapidity of the onset, *i.e.* the quickness with which coagulation takes place, may vary independently. The rapidity of onset after muscular exercise and wasting disease may perhaps be, in part, dependent on an increase of acid reaction, which is produced under those circumstances in the muscle, for this seems to be favourable to the coagulation of the muscle plasma. When rigor mortis has once become thoroughly established in a muscle through deprivation of blood, it cannot be removed by any subsequent supply of blood. Thus where the abdominal aorta has remained ligatured until the lower limbs have become completely rigid, untying the ligature will not restore the muscles to an irritable condition; it simply hastens the decomposition of the dead tissues by supplying them with oxygen and, in the case of the mammal, with warmth also. A muscle however may acquire as a whole a certain amount of rigidity on account of some of the fibres becoming rigid, while the remainder, though they have lost their irritability, have not yet advanced into rigor mortis. At such a juncture a renewal of the blood-stream may restore the irritability of those fibres which were not yet rigid, and thus appear to do away with rigor mortis; yet it appears that in such cases the fibres which have actually become rigid never regain their irritability, but undergo degeneration.

Mere loss of irritability, even though complete, if stopping short of the actual coagulation of the muscle substance, may be with care removed. Thus if a stream of blood be sent artificially through the vessels of a separated (mammalian) muscle, the irritability may be maintained for a very considerable time. On stopping the artificial circulation, the irritability diminishes and in time entirely disappears; if however the stream be at once resumed, the irritability will be recovered. By regulating the flow, the

irritability may be lowered and (up to a certain limit) raised at pleasure. From the epoch however of interference with the normal blood-stream there is a gradual diminution in the responses to stimuli, and ultimately the muscle loses all its irritability and becomes rigid, however well the artificial circulation be kept up. This failure is probably in great part due to the blood sent through the tissues not being in a perfectly normal condition; but we have at present very little information on this point. Indeed with respect to the *quality* of blood thus essential to the maintenance or restoration of irritability, our knowledge is definite with regard to one factor only, viz. the oxygen. If blood deprived of its oxygen be sent through a muscle removed from the body, irritability, so far from being maintained, seems rather to have its disappearance hastened. In fact, if venous blood continues to be driven through a muscle, the irritability of the muscle is lost even more rapidly than in the entire absence of blood. It would seem that venous blood is more injurious than none at all. If exhaustion be not carried too far, the muscle may however be revived by a proper supply of oxygenated blood.

The influence of blood-supply cannot be so satisfactorily studied in the case of nerves as in the case of muscles; there can however be little doubt that the effects are analogous.

§ 86. *The influence of functional activity.* This too is more easily studied in the case of muscles than of nerves.

When a muscle within the body is unused, it wastes; when used, it (within certain limits) grows. Both these facts shew that the nutrition of a muscle is favourably affected by its functional activity. Part of this may be an indirect effect of the increased blood-supply which occurs when a muscle contracts. When a nerve going to a muscle is stimulated, the blood vessels of the muscle dilate. Hence at the time of the contraction more blood flows through the muscle, and this increased flow continues for some little while after the contraction of the muscle has ceased. But, apart from the blood-supply, it is probable that the exhaustion caused by a contraction is immediately followed by a reaction favourable to the nutrition of the muscle; and this is a reason, possibly the chief reason, why a muscle is increased by use, that is to say, the loss of substance and energy caused by the contraction is subsequently more than made up for by increased metabolism during the following period of rest.

Whether there be a third factor, whether muscles for instance are governed by so-called trophic nerves which affect their nutrition directly in some other way than by influencing either their blood-supply or their activity, must at present be left undecided.

A muscle, even within the body, after prolonged action is fatigued, *i.e.* a stronger stimulus is required to produce the same contraction; in other words, its irritability may be lessened by

functional activity. Whether functional activity therefore is injurious or beneficial depends on its amount in relation to the condition of the muscle. It may be here remarked that as a muscle becomes more and more fatigued, stimuli of short duration, such as induction-shocks, sooner lose their efficacy than do stimuli of longer duration, such as the break and make of the constant current.

The sense of fatigue of which, after prolonged or unusual exertion, we are conscious in our own bodies, is probably of complex origin, and its nature, like that of the normal muscular sense of which we shall have to speak hereafter, is at present not thoroughly understood. It seems to be in the first place the result of changes in the muscles themselves, but is possibly also caused by changes in the nervous apparatus concerned in muscular action, and especially in those parts of the central nervous system which are concerned in the production of voluntary impulses. In any case it cannot be taken as an adequate measure of the actual fatigue of the muscles; for a man who says he is absolutely exhausted may under excitement perform a very large amount of work with his already weary muscles. The will in fact rarely if ever calls forth the greatest contractions of which the muscles are capable.

Absolute (temporary) exhaustion of the muscles, so that the strongest stimuli produce no contraction, may be produced even within the body by artificial stimulation: recovery takes place on rest. Out of the body absolute exhaustion takes place readily. Here also recovery may take place. Whether in any given case it does occur or not, is determined by the amount of contraction causing the exhaustion, and by the previous condition of the muscle. In all cases recovery is hastened by renewal (natural or artificial) of the blood-stream.

The more rapidly the contractions follow each other, the less the interval between any two contractions, the more rapid the exhaustion. A certain number of single induction-shocks repeated rapidly, say every second or oftener, bring about exhaustive loss of irritability more rapidly than the same number of shocks repeated less rapidly, for instance every 5 or 10 seconds. Hence tetanus is a ready means of producing exhaustion.

In exhausted muscles the elasticity is much diminished; the tired muscle returns less readily to its natural length than does the fresh one.

The exhaustion due to contraction may be the result:—Either of the consumption of the store of really contractile material present in the muscle. Or of the accumulation in the tissue of the products of the act of contraction. Or of both of these causes.

The restorative influence of rest, in the case of a muscle removed from the circulation, may be explained by supposing that during the repose, either the internal changes of the tissue

manufacture new explosive material out of the comparatively raw material already present in the fibres, or the directly hurtful products of the act of contraction undergo changes by which they are converted into comparatively inert bodies. A stream of fresh blood may exert its restorative influence not only by quickening the above two events, but also by carrying off the immediate waste products while at the same time it brings new raw material. It is not known to what extent each of these parts is played. That the products of contraction are exhausting in their effects, is shewn by the facts that the injection of a solution of the muscle-extractives into the vessels of a muscle produces exhaustion, and that exhausted muscles are recovered by the simple injection of inert saline solutions into their blood vessels. But the matter has not yet been fully worked out.

One important element brought by fresh blood is oxygen. This, as we have seen, is not necessary for the carrying out of the actual contraction, and yet is essential to the maintenance of irritability. The oxygen absorbed by the muscle apparently enters in some peculiar way into the formation of that complex explosive material the decomposition of which in the act of contraction, though it gives rise to carbonic acid and other products of oxidation, is not in itself a process of direct oxidation.

SEC. 6. THE ENERGY OF MUSCLE AND NERVE, AND THE NATURE OF MUSCULAR AND NERVOUS ACTION.

§ 87. We may briefly recapitulate some of the chief results arrived at in the preceding pages as follows.

A muscular contraction itself is essentially a translocation of molecules, a change of form not of bulk. We cannot say however anything definite as to the nature of this translocation or as to the way in which it is brought about. For instance we cannot satisfactorily explain the connection between the striation of a muscular fibre and a muscular contraction. Nearly all rapidly contracting muscles are striated, and we must suppose that the striation is of some use; but it is not essential to the carrying out of a contraction, for as we shall see the contraction of a non-striated muscle is fundamentally the same as that of a striated muscle. But whatever be the exact way in which the translocation is effected, it is in some way or other the result of a chemical change, of an explosive decomposition of certain parts of the muscle substance. The energy which is expended in the mechanical work done by the muscle has its source in the energy latent in the muscle substance and set free by that explosion. Concerning the nature of that explosion we only know at present that it results in the production of carbonic acid and in an increase of the acid reaction, and that heat is set free as well as the specific muscular energy. There is a general parallelism between the extent of metabolism taking place and the amount of energy set free; the greater the development of carbonic acid, the larger is the contraction and the higher the temperature.

It is important to remember that, as we have already urged, relaxation, the return to the original length, is an essential part of the whole contraction no less than the shortening itself. It is true that the return to the original length is assisted by the stretching exerted by the load, and in the case of muscles within the living body is secured by the action of antagonistic muscles or

by various anatomical relations; but the fact that the completeness and rapidity of the return are dependent on the condition of the muscle, that is on the complex changes within the muscle making up what we call its nutrition, the tired muscle relaxing much more slowly than the untired muscle, shews that the relaxation is due in the main to intrinsic processes going on in the muscle itself, processes which we might characterize as the reverse of those of contraction. In fact, to put the matter forcibly, adopting the illustration used in § 57, and regarding relaxation as a change of molecules from a 'formation' of one hundred in two lines of fifty each to a formation of ten columns each ten deep, it would be possible to support the thesis that the really active forces in muscle are those striving to maintain the latter formation in columns and that the falling into double lines, that is to say the contraction, is the result of these forces ceasing to act; in other words that the contracted state of the muscular fibre is what may be called the natural state, that the relaxed condition is only brought about at the expense of changes counteracting the natural tendencies of the fibre. Without going so far as this however we may still recognize that both contraction and relaxation are the result of changes which, since they seem to be of a chemical nature in the one case, are probably so in the other also. And though in the absence of exact knowledge it is dangerous to speculate, we may imagine that these chemical events leading to relaxation or elongation are of an opposite or antagonistic character to those whose issue is contraction.

It has not been possible hitherto to draw up a complete equation between the latent energy of the material and the two forms of actual energy set free, heat and movement. The proportion of energy given out as heat to that taking on the form of work varies under different circumstances; and it would appear that on the whole a muscle would not be much more efficient than a steam-engine in respect to the conversion of chemical action into mechanical work, were it not that in warm-blooded animals the heat given out is not, as in the steam-engine, mere loss, but by keeping up the animal temperature serves many subsidiary purposes. It might be supposed that in a contraction by which work is actually done, as compared with the same contraction when no work is done, there is a diminution of the increase of temperature corresponding to the amount of work done, that is to say, that the mechanical work is done at the expense of energy which otherwise would go out as heat. Probable as this may seem it has not yet been experimentally verified.

Of the exact nature of the chemical changes which underlie a muscular contraction we know very little, the most important fact being, that the contraction is not the outcome of a direct oxidation, but the splitting up or explosive decomposition of some complex substance or substances. The muscle does consume oxygen, and

the products of muscular metabolism are in the end products of oxidation, but the oxygen appears to be introduced not at the moment of explosion but at some earlier date. As to the real nature of this explosive material we are as yet in the dark; we do not know for certain whether we ought to regard it as a single substance (in the chemical sense) or as a mixture of more substances than one. We may however perhaps be allowed provisionally to speak of it at all events as a single substance and to call it 'contractile material' or we may adopt a term which has been suggested and call it *inogen*.

We shall have occasion to point out later on, that the living substance of certain cells is able to manufacture and to lodge in the substance of the cell relatively considerable quantities of fat whereby the cell becomes a fat cell, the fat so formed and lodged being subsequently by some means or other discharged from the cell. We shall also have occasion to point out that in a somewhat similar way the living material of certain gland cells manufactures and lodges in itself certain substances which when the cell 'secretes' undergo more or less change and are ejected from the cell. These substances appear to be products of the activity of the living substance of the cell, and to be so related to that living substance that, though discontinuous with it and merely lodged in it they are still capable of being so influenced by it as to undergo change more or less sudden, more or less profound. And we may, resting on the analogy of these fat cells and gland cells, suppose that the living substance of the muscle manufactures and lodges in itself this contractile material or inogen which is capable of being so influenced by the living substance as to undergo an explosive decomposition. But we here meet with a difficulty.

The muscular fibre as a whole is eminently a nitrogenous proteid body; the muscular fibres of the body form the greater part of the whole proteid mass of the body. Moreover the ordinary continued metabolism of the muscular fibre as a whole is essentially a nitrogenous metabolism; as we shall have to point out later on the muscles undoubtedly supply a great part of that large nitrogenous waste which appears in the urine as *urea*; the nitrogenous metabolism of the muscle during the twenty-four hours must therefore be considerable, and under certain circumstances, as for instance during fever, this nitrogenous metabolism may be still further largely increased.

On the other hand, as we have already shewn, there can be no doubt that the act of contraction, the explosive decomposition of the inogen, does not increase the nitrogenous metabolism of the muscle. Shall we conclude then that the inogen is essentially a non-nitrogenous body lodged in the nitrogenous muscle substance? Not only have we no positive evidence of this, but the analogy between contraction and rigor mortis is directly opposed to such a view: for it is almost impossible to resist the conclusion that the stuff which

gives rise to the myosin clot, the carbonic acid, and lactic acid or other acid-producing substances of rigor mortis, is the same stuff which gives rise to the carbonic acid and lactic acid or other acid-producing substances of a contraction. The difference between the two seems to be that in the contraction the nitrogenous product of the decomposition of the inogen does not appear as solid myosin but assumes the form of some soluble proteid. The important fact concerning the two acts, rigor mortis and contraction, is that, while the great non-nitrogenous product of the decomposition of the inogen, viz. carbonic acid, is simple waste matter containing no energy, fit only to be cast out of the body at once (and the same is nearly true of the other non-nitrogenous product, lactic acid), the nitrogenous product being a proteid is still a body containing much energy, which in the case of the living muscle may after the contraction be utilized by the muscle itself or, being carried away into the blood-stream, by some other parts of the body.

But if this view be correct the ordinary metabolism going on while the muscle is at rest must differ in kind as well as, and perhaps more than, in degree from the metabolism of contraction; for the former as we have just said is essentially a nitrogenous metabolism largely contributing to the nitrogenous waste of the body at large.

Whether in the muscle at rest this nitrogenous metabolism is confined to that part of the muscle in which the inogen is lodged and does not involve the inogen itself, or whether the inogen as well as the rest of the fibre undergoes metabolism when the muscle is at rest, going off in puffs, so to speak, instead of in a large explosion, its nitrogenous factors being at the same time involved in the change, are questions which we cannot at present settle.

§ 88. While in muscle the chemical events are so prominent that we cannot help considering a muscular contraction to be essentially a chemical process, with electrical changes as attendant phenomena only, the case is different with nerves. Here the electrical phenomena completely overshadow the chemical. Our knowledge of the chemistry of nerves is at present of the scantiest, and the little we know as to the chemical changes of nervous substance is gained by the study of the central nervous organs rather than of the nerves. We find that the irritability of the former is closely dependent on an adequate supply of oxygen, and we may infer from this that in nervous as in muscular substance a metabolism, of in the main an oxidative character, is the real cause of the development of energy; and the axis-cylinder, which as we have seen is most probably the active element of a nerve-fibre, undoubtedly resembles in many of its chemical features the substance of a muscular fibre. But we have as yet no satisfactory experimental evidence that the passage of a nervous impulse along a nerve is the result, like the contraction of a muscular fibre, of chemical changes, and like it accompanied by an evolution of heat. On the other hand, the electric phenomena are so

prominent that some have been tempted to regard a nervous impulse as essentially an electrical change. But it must be remembered that the actual energy set free in a nervous impulse is, so to speak, insignificant, so that chemical changes too slight to be recognized by the means at present at our disposal would amply suffice to provide all the energy set free. On the other hand, the rate of transmission of a nervous impulse, putting aside other features, is alone sufficient to prove that it is something quite different from an ordinary electric current.

The curious disposition of the end-plates, and their remarkable analogy with the electric organs which are found in certain animals, has suggested the view that the passage of a nervous impulse from the nerve fibre into the muscular substance is of the nature of an electric discharge. But these matters are too difficult and too abstruse to be discussed here.

It may however be worth while to remind the reader that in every contraction of a muscular fibre, the actual change of form is preceded by invisible changes propagated all over the fibre and occupying the latent period, and that these changes resemble in their features the nervous impulse of which they are, so to speak, the continuation rather than the contraction of which they are the forerunners and to which they give rise. So that a muscle, even putting aside the visible terminations of the nerve, is fundamentally a muscle and a nerve besides.

SEC. 7. ON SOME OTHER FORMS OF CONTRACTILE TISSUE.

Plain, Smooth or Unstriated Muscular Tissue.

§ 89. This, in vertebrates at all events, rarely occurs in isolated masses or muscles, as does striated muscular tissue, but is usually found taking part in the structure of complex organs, such for instance as the intestines; hence the investigation of its properties is beset with many difficulties.

It is usually arranged in sheets, composed of flattened bundles or bands bound together by connective tissue carrying blood vessels, lymphatics and nerves. Some of these bundles or bands may be split up into smaller bands similarly united to each other by connective tissue, but in many cases the whole sheet being thin is made up directly of small bands. Each small band is composed of a number of elementary fibres or fibre cells, which in a certain sense are analogous to the striated elementary fibres, but in many respects differ widely from them.

Each unstriated elementary fibre is a minute object, from 50μ to 200μ in length and from 5μ to 10μ in breadth; it is therefore, in size, of a wholly different order from a striated fibre. It is fusiform or spindle-shaped, somewhat flattened in the middle and tapering to a point at the ends, which in some cases are branched; but the exact form of the fibre will differ according as the muscle is in a state of contraction or relaxation.

Midway between the two ends and in the centre of the fusiform body lies a nucleus, which in a normal condition is elliptical in outline, with its long axis lying lengthwise, but which under the influence of reagents is very apt to become rod-shaped; hence in prepared specimens the presence of these rod-shaped nuclei is very characteristic of plain muscular tissue.

The nucleus has the ordinary characters of a nucleus, and very frequently two nucleoli are conspicuous. Around the nucleus is

gathered a small quantity of granular protoplasm, like that around the nuclei of a striated fibre, and this is continued along the axis of the fibre for some distance from each pole of the nucleus, gradually tapering away, and so forming a slender granular core in the median portion of the fibre.

The rest of the fibre, forming its chief part, is composed of a transparent but somewhat refractive substance, which is either homogeneous or exhibits a delicate longitudinal fibrillation; this is the muscle substance of the fibre and corresponds to the muscle substance of the striated fibre, but is not striated. Sometimes the whole fibre is thrown into a series of transverse wrinkles, which give it a striated appearance, but this is a very different striation from that produced by an alternation of dim and bright bands. No such alternation of bands is to be seen in the plain muscular fibre; the whole of the substance of the fibre around the nucleus and core is homogeneous, or at least exhibits no differentiation beyond that into fibrillæ and interfibrillar substance, and even this distinction is doubtful.

The fibre has a sharp clear outline but is not limited by any distinct sheath corresponding to the sarcolemma, at least according to most observers.

It is obvious that the plain muscular fibre is a nucleated cell, the cell substance of which has become differentiated into contractile substance, the cell otherwise being but slightly changed; whereas the much larger striated fibre is either a number of cells fused together or a cell which has undergone multiplication in so far that its nucleus has given rise to several nuclei, but in which no division of cell substance has taken place.

A number of such fusiform nucleated cells or fibres or fibre cells are united together, not by connective tissue but by a peculiar proteid cement substance into a flat band or bundle, the tapering end of one fibre dovetailing in between the bodies of other fibres. So long as this cement substance is intact it is very difficult to isolate an individual fibre, but various reagents will dissolve or lessen this cement, and then the fibres separate.

Small flat bands thus formed of fibres cemented together are variously arranged by means of connective tissue, sometimes into a plexus, sometimes into thicker larger bands, which in turn may be bound up as we have said into sheets of varying thickness.

In the plexus of course the bands run in various directions, but in the sheets or membranes they follow for the most part the same direction, and a thin transverse section of a somewhat thick sheet presents a number of smaller or larger areas, corresponding to the smaller or larger bands which are cut across. The limits of each area are more or less clearly defined by the connective tissue in which blood vessels may be seen, the area itself being composed of a number of oval outlines, the sections of the flattened individual fibres; in hardened specimens the outlines may from

mutual pressure appear polygonal. In the centre of some of these sections of fibres the nucleus may be seen, but it will of course be absent from those fibres in the which plane of section has passed either above or below the nucleus. When a thin sheet of plain muscle is spread out or teased out under the microscope, the bands may also be recognized, and at the torn ends of some of the bands the individual fibres may be seen projecting after the fashion of a palisade.

Blood vessels and lymphatics are carried by the connective tissue, and form capillary networks and lymphatic plexuses round the smaller bands.

§ 90. The arrangement of the nerves in unstriated muscle differs from that in striated muscle. Whereas in striated muscle medullated fibres coming direct from the anterior roots of spinal nerves predominate, in plain muscle non-medullated fibres are most abundant; in fact the nerves going to plain muscles are not only small but are almost exclusively composed of non-medullated fibres and come to the muscles from the so-called sympathetic system. Passing into the connective tissue between the bundles the nerves divide and, joining again, form a plexus around the bundles; that is to say, a small twig consisting of a few, or perhaps only one axis-cylinder, coming from one branch will run alongside of or join a similar small twig coming from another branch; the individual axis-cylinders however do not themselves coalesce. From such primary plexuses, in which a few medullated fibres are present among the non-medullated fibres, are given off still finer, "intermediate" plexuses consisting exclusively of non-medullated fibres; these embrace the smaller bundles of muscular fibres. The branches of these plexuses may consist of a single axis-cylinder, or may even be filaments corresponding to several or to a few only of the fibrillæ of which an axis-cylinder is supposed to be composed. From these intermediate plexuses are given off single fibrillæ or very small bundles of fibrillæ, which running in the cement substance between the individual fibres form a fine network around the individual fibres, which network differs from the plexuses just spoken of inasmuch as some of the filaments composing it appear to coalesce. The ultimate ending of this network has not yet been conclusively traced; but it seems probable that fibrils from the network terminate in small knobs or swellings lying on the substance of the muscular fibres, somewhat after the fashion of minute end-plates.

A similar termination of nerves in a plexus or network is met with in other tissues, and is not confined to non-medullated fibres. A medullated fibre may end in a plexus, and when it does so loses first its medulla and subsequently its neurilemma, the plexus becoming ultimately like that formed by a non-medullated fibre and consisting of attenuated axis-cylinders with thickenings, and sometimes with nuclei, at the nodal points.

§ 91. As far as we know plain muscular tissue in its chemical features resembles striated muscular tissue. It contains albumin, some forms of globulin, and antecedents of myosin which upon the death of the fibres become myosin; for plain muscular tissue after death becomes rigid, losing its extensibility and probably becoming acid, though the acidity is not so marked as in striated muscle. Kreatin has also been found, as well as glycogen, and indeed it seems probable that the whole metabolism of plain muscular tissue is fundamentally the same as that of the striated muscles.

§ 92. In their general physical features plain muscular fibres also resemble striated fibres, and like them they are irritable and contractile; when stimulated they contract. The fibres vary in natural length in different situations, those of the blood vessels for instance being shorter and stouter than those of the intestine; but in the same situation the fibres may also be found in one of two different conditions. In the one case the fibres are long and thin, in the other case they are reduced in length, it may be to one half or even to one third, and are correspondingly thicker, broader and less pointed at the ends, their total bulk remaining unaltered. In the former case they are relaxed or elongated, in the latter case they are contracted.

The facts of the contraction of plain muscular tissue may be studied in the intestine, the muscular coat of which consists of an outer thin sheet composed of fibres and bundles of fibres disposed longitudinally and of an inner much thicker sheet of fibres disposed circularly; in the ureter a similar arrangement of two coats obtains.

If a mechanical or electrical (or indeed any other) stimulus be brought to bear on a part of a fresh living still warm intestine (the small intestine is the best to work with) a circular contraction is seen to take place at the spot stimulated; the intestine seems nipped in ringwise, as if tied round with an invisible cord; and the part so constricted, previously vascular and red, becomes pale and bloodless. The individual fibres of the circular coat in the region stimulated have each become shorter, and the total effect of the shortening of the multitude of fibres all having the same circular disposition is to constrict or narrow the lumen or tube of the intestine. The longitudinally disposed fibres of the outer longitudinal coat will at the same time similarly contract or shorten in a longitudinal direction, but this coat being relatively much thinner than the circular coat, the longitudinal contraction is altogether overshadowed by the circular contraction. A similar mode of contraction is also seen when the ureter is similarly stimulated.

The contraction thus induced is preceded by a very long latent period and lasts a very considerable time, in fact several seconds, after which relaxation slowly takes place. We may say then that over the circularly dispersed fibres of the intestine (or ureter) at the spot in question there has passed a contraction-wave remarkable for its long latent period and for the slowness of its development,

the wave being propagated from fibre to fibre. From the spot so directly stimulated, the contraction may pass also as a wave (with a length of 1 cm. and a velocity of from 20 to 30 millimetres a second in the ureter). along the circular coat both upwards and downwards. The longitudinal fibres at the spot stimulated are as we have said also thrown into contractions of altogether similar character, and a wave of contraction may thus also travel longitudinally along the longitudinal coat both upwards and downwards. It is evident however that the wave of contraction of which we are now speaking is in one respect different from the wave of contraction treated of in dealing with striated muscle. In the latter case the contraction-wave is a simple wave propagated along the individual fibre and starting from the end-plate or, in the case of direct stimulation, from the part of the fibre first affected by the stimulus; we have no evidence that the contraction of one fibre can communicate contraction to neighbouring fibres or indeed in any way influence neighbouring fibres. In the case of the intestine or ureter, the wave is complex, being the sum of the contraction-waves of several fibres engaged in different phases and is propagated from fibre to fibre, both in the direction of the fibres, as when the whole circumference of the intestine is engaged in the contraction, or when the wave travels longitudinally along the longitudinal coat, and also in a direction at right angles to the axes of the fibres, as when the contraction-wave travels lengthways along the circular coat of the intestine, or when it passes across a breadth of the longitudinal coat; that is to say, the changes leading to contraction are communicated not only in a direct manner across the cement substance uniting the fibres of a bundle but also in an indirect manner, probably by means of nerve fibres, from bundle to bundle across the connective tissue between them. Moreover, it is obvious that even the contraction-wave which passes along a single unstriated fibre differs from that passing along a striated fibre, in the very great length both of its latent period and of the duration of its contraction. Hence, much more even than in the case of a striated muscle, the whole of each fibre must be occupied by the contraction-wave, and indeed be in nearly the same phase of the contraction at the same time.

Waves of contraction thus passing along the circular and longitudinal coats of the intestine constitute what is called peristaltic action.

Like the contractions of striated muscle the contractions of plain muscles may be started by stimulation of nerves going to the part, the nerves supplying plain muscular tissue, running for the most part as we have said in the so-called sympathetic system, but being as we shall see ultimately connected with the spinal cord or brain. Here however we come upon an important distinction between the striated skeletal muscles, and the plain muscles of the viscera. As a general rule the skeletal

muscles are thrown into contraction only by nervous impulses reaching them along their nerves; spontaneous movements of the skeletal muscles, that is contractions arising out of changes in the muscles themselves are extremely rare, and when they occur are abnormal; so-called 'cramps' for instance, which are prolonged tetanic contractions of skeletal muscles independent of the will, though their occurrence is largely due to the condition of the muscle itself, generally the result of overwork, are probably actually started by nervous impulses reaching them from without. On the other hand the plain muscles of the viscera, of the intestine, uterus and ureter, for instance, and of the blood vessels very frequently fall into contractions and so carry out movements of the organs to which they belong quite independently of the central nervous system. These organs exhibit 'spontaneous' movements quite apart from the will, quite apart from the central nervous system, and under favourable circumstances continue to do this for some time after they have been entirely isolated and removed from the body. So slight indeed is the connection between the movements of organs and parts supplied with plain muscular fibres, and the will, that these muscular fibres have sometimes been called involuntary muscles; but this name is undesirable since some muscles consisting entirely of plain muscular fibres (*e.g.* the ciliary muscles by which the eye is accommodated for viewing objects at different distances) are directly under the influence of the will, and, some muscles composed of striated fibres, (*e.g.* those of the heart) are wholly removed from the influence of the will.

We shall best study however the facts relating to the movements of parts provided with plain muscular fibres when we come to consider the parts themselves.

Like the skeletal muscles, whose nervous elements have been rendered functionally incapable (§ 78), plain muscles are much more sensitive to the making and breaking of a constant current than to induction-shocks; a current, when very brief, like that of an induction-shock, produces little or no effect.

The plain muscles seem to be remarkably susceptible to the influences of temperature. When exposed to low temperatures they readily lose the power of contracting; thus the movements of the intestine are said to cease at a temperature below 19° C. Variations in temperature have also very marked effect on the duration and extent of the contractions. Associated probably with this susceptibility is the rapidity with which plain muscular fibres, even in cold-blooded vertebrates, lose their irritability after removal from the body and severance from their blood-supply. Thus while, as we have seen, the skeletal muscles of a frog can be experimented upon for many hours, (or even for two or three days) after removal from the body, and the skeletal muscles of a mammal for a much less but still considerable time, it is matter of very great difficulty to secure the continuance of movements of the

intestine or of other organs supplied with plain muscular fibres, even in the case of the frog, for any long period after removal from the body.

The contraction of plain muscular fibres is as we said very slow in its development and very long in its duration, even when started by a momentary stimulus, such as a single induction-shock. The contraction after a stimulation often lasts so long as to raise the question, whether what has been produced is not a single contraction but a tetanus. Tetanus, however, that is the fusion of a series of contractions seems to be of rare occurrence, though probably it may be induced, in plain muscular tissue; but the ends of tetanus are gained by a kind of contraction which, rare or at least not prominent in skeletal muscle, becomes of great importance in plain muscular tissue, by a kind of contraction called a *tonic* contraction. The subject is one not without difficulties, but it would appear that a plain muscular fibre may remain for a very considerable time in a state of contraction, the amount of shortening thus maintained being either small or great: it is then said to be in a state of tonic contraction. This is especially seen in the case of the plain muscular tissue of the arteries, and we shall have to return to this matter in dealing with the circulation.

The muscular tissue which enters into the construction of the heart is of a peculiar nature, being on the one hand striated, and on the other in some respects similar to plain muscular tissue, but this we shall consider in dealing with the heart itself.

Ciliary Movement.

§ 93. Nearly all the movements of the body which are not due to physical causes, such as gravity, the diffusion of liquids &c., are carried out by muscles, either striated or plain; but some small and yet important effects in the way of movement are produced by the action of cilia, and by those changes of protoplasm which are called amoeboid.

Cilia are generally appendages of epithelial cells. An *epithelium* consists of a number of cells, arranged in a layer, one, two or more cells deep, the cell bodies of the constituent cells being in contact with each other or united merely by a minimal amount of cement substance, not separated by an appreciable quantity of intercellular material. As a rule no connective tissue or blood vessel passes between the cells, but the layer of cells rests on a basis of vascular connective tissue, from which it is usually separated by a more or less definite basement membrane, and from the blood vessels of which its cells draw their nourishment. The cells vary in form, and the cell body round the nucleus may be protoplasmic in appearance or may be differentiated in various ways. An epithelium bearing cilia is called a ciliated epithelium. Various passages of the body, such as, in the mammal, parts of the nasal chambers

and of the respiratory and generative passages, are lined with ciliated epithelium, and by the action of cilia, fluid containing various particles and generally more or less viscid is driven outwards along the passages towards the exterior of the body.

A typical epithelium cell, such as may be found in the trachea, is generally somewhat wedge-shaped with its broad end circular or, rather, polygonal in outline, forming part of the free surface of the epithelium, and with its narrow end, which may be a blunt point or may be somewhat branched and irregular, plunged among smaller subjacent cells of the epithelium, or reaching to the connective tissue below.

The cell body is, over the greater part of its extent, composed of protoplasm with the usual granular appearance. At about the lower third of the cell is placed, with its long axis vertical, an oval nucleus, having the ordinary characters of a nucleus. So far the ciliated cell resembles an ordinary epithelium cell; but the free surface of the cell is formed by a layer of hyaline transparent somewhat refractive substance which when the cell is seen, as usual, in profile appears as a hyaline refractive band or border. From this border there project outward a variable number, 10 to 30, delicate tapering hair-like filaments, varying in length, but generally about a quarter or a third as long as the cell itself; these are the cilia. Immediately below this hyaline border the cell substance often exhibits more or less distinctly a longitudinal striation, fine lines passing down from the hyaline border towards the lower part of the cell substance round the nucleus. The hyaline border itself usually exhibits a striation as if it were split up into blocks, each block corresponding to one of the cilia, and careful examination leads to the conclusion that the hyaline border is really composed of the fused thicker basal parts of the cilia.

The cell body has no distinct external membrane or envelope and its substance is in close contact with that of its neighbours, being united to them either by a thin layer of some cement substance, or by the simple cohesion of their respective surfaces. At all events the cells do cohere largely together, and it is difficult to obtain an isolated living cell, though the cells may be easily separated from each other when dead by the help of dissociating fluids. When a cell is obtained isolated in a living state, it is very frequently found to have lost its wedge shape and to have become more or less hemispherical or even spherical; under the unusual conditions, and freed from the support of its neighbours, the cell body changes its form.

The general characters just described are common to all ciliated epithelium cells, but the cells in different situations vary in certain particulars, such as the exact form of the cell body, the number and length of the cilia &c.

§ 94. Ciliary action, in the form in which it is most common

in mammals and indeed vertebrates, consists in the cilium (*i.e.* the tapering filament spoken of above) being at one moment straight or vertical, at the next moment being bent down suddenly into a hook or sickle form, and then more slowly returning to the straight erect position. When the cilia are vigorous, this double movement is repeated with very great rapidity, so rapidly that the individual movements cannot be seen; it is only when, by reason of fatigue, the action becomes slow that the movement itself can be seen; what is seen otherwise is simply the effect of the movement. The movements when slow have been counted at about eight (double movements) in a second; probably when vigorous they are repeated from twelve to twenty times a second.

The flexion takes place in one direction only, and all the cilia of each cell, and indeed of all the cells of the same epithelium move in the same direction. Moreover the same direction is maintained during the whole life of the epithelium; thus the cilia of the epithelium of the trachea and bronchial passages move during the whole of life in such a way as to drive the fluid lying upon them upwards towards the mouth; as far as we know in vertebrates, or at least in mammals, the direction is not and cannot by any means be reversed.

The flexion is very rapid but the return to the erect position is much slower; hence the total effect of the blow, supposing the cilium and the cell to be fixed, is to drive the thin layer of fluid in which the cilium is working, and which always exists over the epithelium, and any particles which may be floating in that fluid in the same direction as that in which the blow is given. If the cell be not attached but floating free the effect of the blow may be to drive the cell itself backward; and when perfectly fresh ciliated epithelium is teased out and examined in an inert fluid such as normal saline solution, isolated cells or small groups of cells may be seen rowing themselves about as it were by the action of their cilia.

All the cilia of a cell move, as we have just said, in the same direction, but not quite at the same time. If we call the side of the cell towards which the cilia bend the front of the cell and the opposite side the back, the cilia at the back move a trifle before those at the front so that the movement runs over the cell in the direction of the movement itself. Similarly, taking any one cell, the cilia of the cells behind it move slightly before, and the cilia of the cells in front of it slightly after, its own cilia move. Hence in this way along a whole stretch of epithelium the movement or bending of the cilia sweeps over the surface in ripples or waves, very much as, when the wind blows, similar waves of bending sweep over a field of corn or tall grass. By this arrangement the efficacy of the movement is secured, and a steady stream of fluid carrying particles is driven over the surface in a uniform continued direction; if the cilia of separate cells, and still more if the

separate cilia of each cell, moved independently of the others, all that would be produced would be a series of minute 'wobbles,' of as little use for driving the fluid definitely onwards as the efforts of a boat's crew all rowing out of time are for propelling the boat.

Swift bending and slower straightening is the form of ciliary movement generally met with in the ciliated epithelium of mammals and indeed of vertebrates; but among the invertebrates we find other kinds of movement, such as a to and fro movement, equally rapid in both directions, a cork-screw movement, a simple undulatory movement, and many others. In each case the kind of movement seems adapted to secure a special end. Thus even in the mammal while the one-sided blow of the cilia of the epithelial cells secures a flow of fluid over the epithelium, the tail of the spermatozoon, which is practically a single cilium, by moving to and fro in an undulatory fashion drives the head of the spermatozoon onwards in a straight line, like a boat driven by a single oar worked at the stern.

Why and exactly how the cilium of the epithelial cells bends swiftly and straightens slowly, always acting in the same direction, is a problem difficult at present to answer fully. Some have thought that the body of the cell is contractile, or contains contractile mechanisms pulling upon the cilia, which are thus simple passive puppets in the hands of the cells. But there is no satisfactory evidence for such a view. On the whole the evidence is in favour of the view that the action is carried out by the cilium itself, that the bending is a contraction of the cilium, and that the straightening corresponds to the relaxation of a muscular fibre. But even then the exact manner in which the contraction bends and the relaxation straightens the filament is not fully explained. We have no positive evidence that a longitudinal half, the inside we might say, of the filament is contractile, and the other half, the outside, elastic, a supposition which has been made to explain the bending and straightening. In fact no adequate explanation of the matter has as yet been given, and it is really only on general grounds we conclude that the action is an effect of contractility.

In the vertebrate animal, cilia are, as far as we know, wholly independent of the nervous system, and their movement is probably ceaseless. In such animals however as Infusoria, Hydrozoa, &c. the movements in a ciliary tract may often be seen to stop and to go on again, to be now fast now slow, according to the needs of the economy, and, as it almost seems, according to the will of the creature; indeed in some of these animals the ciliary movements are clearly under the influence of the nervous system.

Observations with galvanic currents, constant and interrupted, have not led to any satisfactory results, and, as far as we know at present, ciliary action is most affected by changes of temperature and chemical media. Moderate heat quickens the movements, but a rise of temperature beyond a certain limit (about 40°C. in the case

of the pharyngeal membrane of the frog) becomes injurious; cold retards. Very dilute alkalis are favourable, acids are injurious. An excess of carbonic acid or an absence of oxygen diminishes or arrests the movements, either temporarily or permanently, according to the length of the exposure. Chloroform or ether in slight doses diminishes or suspends the action temporarily, in excess kills and disorganises the cells.

Amœboid Movements.

§ 95. The white blood corpuscles, as we have said (§ 28), are able of themselves to change their form and by repeated changes of form to move from place to place. Such movements of the substance of the corpuscles are called amœboid, since they closely resemble and appear to be identical in nature with the movements executed by the amœba and similar organisms. The movement of the endoplasm of the vegetable cell seems also to be of the same kind.

The amœba changes its form (and shifts its place) by throwing out projections of its substance, called pseudopodia, which may be blunt and short, broad bulgings as it were, or may be so long and thin as to be mere filaments, or may be of an intermediate character. As we watch the outline of the hyaline ectosarc we may see a pseudopodium beginning by a slight bulging of the outline; the bulging increases by the neighbouring portions of the ectosarc moving into it, the movement under the microscope reminding one of the flowing of melted glass. As the pseudopodium grows larger and engages the whole thickness of the ectosarc at the spot, the granules of the endosarc may be seen streaming into it forming a core of endosarc in the middle of the bulging of ectosarc. The pseudopodium may continue to grow larger and larger at the expense of the rest of the body, and eventually the whole of the amœba including the nucleus may as it were have passed into the pseudopodium; the body of the amœba will now occupy the place of the pseudopodium instead of its old place; in other words it will in changing its form have also changed its place.

During all these movements, and during all similar amœboid movements, the bulk of the organism will, as far as can be ascertained, have remained unchanged; the throwing out a pseudopodium in one direction is accompanied by a corresponding retraction of the body in other directions. If as sometimes happens the organism throws out pseudopodia in various directions at the same time, the main body from which the pseudopodia project is reduced in thickness; from being a spherical lump for instance it becomes a branched film. The movement is brought about not by increase or decrease of substance but by mere translocation of particles; a particle which at one moment was in one position

moves into a new position, several particles thus moving towards the same point cause a bulging at that point, and several particles moving away from the same point cause a retraction at that point; but no two particles get nearer to each other so as to occupy together less space and thus lead to condensation of substance, or get farther from each other so as to occupy more space and thus lead to increase of bulk.

In this respect, in that there is no change of bulk, but only a shifting of particles in their relative position to each other, the amœboid movement resembles a muscular contraction; but in other respects the two kinds of movement seem different, and the question arises, have we the right to speak of the substance which can only execute amœboid movements as being *contractile*?

We may, if we admit that contractility is at bottom simply the power of shifting the relative position of particles, and that muscular contraction is a specialized form of contraction. In a plain muscular fibre (which we may take as simpler than the striated muscle) the shifting of particles is specialized in the sense that it has always a definite relation to the long axis of the fibre; when the fibre contracts a certain number of particles assume a new position by moving at right angles to the long axis of the fibre, and the fibre in consequence becomes shorter and broader. In a white blood corpuscle, amœba, or other organism executing amœboid movements, the shifting of the particles is not limited to any axis of the body of the organism; at the same moment one particle or one set of particles may be moving in one direction, and another particle or another set of particles in another direction. A pseudopodium, short and broad, or long thin and filamentous, may be thrust out from any part of the surface of the body and in any direction; and a previously existing pseudopodium may be shortened, or be wholly drawn back into the substance of the body.

In the plain muscle fibre the fact that the shifting is specialized in relation to the long axis of the fibre, necessitates that in a contraction the shortening, due to the particles moving at right angles to the long axis of the fibre, should be followed by what we have called relaxation due to the particles moving back to take up a position in the long axis; and we have several times insisted on relaxation being an essential part of the total act of contraction. If no such movement in the direction of relaxation took place, the fibre would by repeated contractions be flattened out into a broad thin film at right angles to its original long axis, and would thus become useless. A spherical white blood corpuscle may, by repeated contractions, *i.e.* amœboid movements, transform itself into such a broad thin film; but in such a condition it is not useless. It may remain in that condition for some time, and by further contractions, *i.e.* amœboid movements, may assume other shapes or revert to the spherical form.

So long as we narrow our idea of contractility to what we see in a muscular fibre, and understand by contraction a movement of particles in relation to a definite axis, necessarily followed by a reversal of the movement in the form of relaxation, we shall find a difficulty in speaking of the substance of the amœba or of the white blood corpuscle as being contractile. If however we conceive of contractility as being essentially the power of shifting the position of particles in any direction, without change of bulk (the shifting being due to intrinsic molecular changes about which we know little save that chemical decompositions are concerned in the matter), we may speak of the substance of the amœba and white blood corpuscle as being contractile, and of muscular contraction as being a specialized kind of contraction.

The protoplasm of the amœba or of a white corpuscle is, as we have said, of a consistency which we for want of better terms call semi-solid or semi-fluid. Consequently when no internal changes are prompting its particles to move in this or that direction, the influences of the surroundings will tend to give the body, as they will other fluid or semi-fluid drops, a spherical form. Hence the natural form of the white corpuscle is more or less spherical. If under the influence of some stimulus internal or external, some of the particles are stirred to shift their place, amœboid movements follow, and the spherical form is lost. If however all the particles were stirred to move with equal energy, they would neutralize each other's action, no protrusion or retraction would take place at any point of the surface and the body would remain a sphere. Hence in extreme stimulation, in what in the muscle corresponds to complete tetanus, the form of the body is the same as in rest; and the tetanized sphere would not be appreciably smaller than the sphere at rest, for that would imply change of bulk, but this as we have seen does not take place. This result shews strikingly the difference between the general contractility of the amœba, and the special contractility of the muscle.

CHAPTER III.

ON THE MORE GENERAL FEATURES OF NERVOUS TISSUES.

§ 96. IN the preceding chapter we have dealt with the properties of nerves going to muscles, the nerves which we called *motor*, and have incidentally spoken of other nerves which we called *sensory*. Both these kinds of nerves are connected with the brain and spinal cord and form part of the General Nervous System. We shall have to study hereafter in detail the brain and spinal cord; but the nervous system intervenes so repeatedly in the processes carried out by other tissues that it will be desirable, before proceeding further, to discuss some of its more general features.

The Nervous System consists (1) of the *Brain and Spinal Cord* forming together the *cerebrospinal axis* or *central nervous system*, (2) of the *nerves* passing from that axis to nearly all parts of the body, those which are connected with the spinal cord being called *spinal* and those which are connected with the brain, within the cranium, being called *cranial*, and (3) of *ganglia* distributed along the nerves in various parts of the body.

The spinal cord obviously consists of a number of segments or metameres, following in succession along its axis, each metamere giving off on each side a pair of spinal nerves; and a similar division into metameres may be traced in the brain, though less distinctly, since the cranial nerves are arranged in manner somewhat different from that of the spinal nerves. We may take a single spinal metamere, represented diagrammatically in Fig. 24, as illustrating the general features of the nervous system; and since the half on one side of the median line resembles the half on the other side we may deal with one lateral half only.

nection with the spinal nerve, to supply vasomotor (constrictor) fibres to the muscles (m') of blood vessels in certain parts, for example, in the limbs.

Sy, the sympathetic chain uniting the ganglia of the series Σ . The terminations of the other nerves arising from Σ , σ , σ' are not shewn.

Each spinal nerve arises by two roots. The metamere of the central nervous system C consists, as we shall hereafter see, of grey matter Gr in the interior and white matter W on the outside. From the anterior part of grey matter is given off the anterior nerve root A and from the posterior part the posterior nerve root P . The latter passes into a swelling or ganglion G , "the ganglion of the posterior root," or more shortly "the spinal ganglion"; the anterior root does not pass into this ganglion. Beyond the ganglion the roots join to form the nerve trunk N . We shall later on give the evidence that the nerve fibres composing the posterior root P are, as far as we know at present, exclusively occupied in carrying nervous impulses from the tissues of the body to the central nervous system, and that the fibres composing the anterior root A are similarly occupied in carrying impulses from the central nervous system to the several tissues; that is to say the former is made up of *sensory* fibres, or, (since the impulses passing along them to the central system may give rise to effects other than sensations) *afferent* fibres, while the latter is made up of *motor*, or, (since the impulses passing along them from the central nervous system may produce effects other than movements) *efferent* fibres. The nerve trunk N is consequently a *mixed* nerve composed of afferent and efferent fibres.

By far the greater part of this mixed nerve, dividing into various branches, is distributed (N') to the skin and the skeletal muscles, some of the fibres (motor) ending in muscular fibres (M), others (sensory) ending in epithelial cells (S) connected with the skin, which we shall consider hereafter under the name of sensory epithelial cells, while others, X , after dividing into minute branches and forming plexuses end, in ways not yet definitely determined, in tissues associated with the skin or skeletal muscles. Morphologists distinguish the parts which go to form the skin, skeletal muscles, &c. as *somatic*, from the *splanchnic* parts which go to form the viscera. We may accordingly call this main part of the spinal nerve the *somatic* division of the nerve.

Soon after the mixed nerve N leaves the spinal canal it gives off a small branch V , which under the name of (white) *ramus communicans*, joins one of a longitudinal series of *ganglia* (Σ) conspicuous in the thorax as the main *sympathetic* chain. This branch is destined to supply the viscera, and might therefore be called the *splanchnic* division of the spinal nerve. We may say at once, without entering into details, that the whole of the sympathetic system with its ganglia, plexuses and nerves is to be regarded as a development or expansion of the visceral or splanchnic divisions of certain spinal nerves. By means of

this system splanchnic fibres from the central nervous system are distributed to the tissues of the viscera, some of them on their way passing through secondary ganglia σ , and, it may be, tertiary ganglia. There are however, as we shall see, certain nerves or fibres which do not run in the sympathetic system, and yet are distributed to the viscera and are 'splanchnic' in nature. We cannot therefore use the word sympathetic to denote all the fibres which are splanchnic in nature. On the other hand the "splanchnic nerves" of the anatomist form a part only of the splanchnic system in the above sense, the term thus used is limited to particular nerves of the splanchnic system distributed to the abdomen; and the double use of the term splanchnic might lead to confusion. The difficulty may perhaps be avoided by calling the splanchnic nerves of the anatomist "abdominal splanchnic." The majority of these splanchnic fibres seem to be efferent in nature, carrying impulses from the central nervous system to the tissues, some ending in plain muscular fibres (m) others in other ways (x); but some of the fibres are afferent and convey impulses from the viscera to the central nervous system, and it is probable that some of these begin or end in epithelial cells of the viscera (s).

We shall have occasion in the next chapter to speak of nerves which govern the blood vessels of the body, the so-called *vaso-motor* nerves. A certain class of these, namely the *vaso-constrictor* nerves or fibres are branches of the splanchnic divisions of the cerebrospinal nerves, and as we shall see the vaso-constrictor nerves of the skeletal muscles, skin, and other parts supplied by somatic nerves, after running for some distance in the splanchnic division (V), turn aside ($v.v$ and $v.m$) and join the somatic division, the fibres of which they accompany on their way to the tissues whose blood vessels (m') they supply.

We have seen (§ 68) that a nerve going to a muscle is composed of nerve-fibres, chiefly medullated, some however being non-medullated, bound together by connective tissue. The same description holds good for the whole somatic division of each of the spinal nerves. The splanchnic division also consists of medullated and non-medullated fibres bound together by connective tissue, but in it the non-medullated fibres preponderate, some branches appearing to contain hardly any medullated fibres at all. The non-medullated fibres which are found in the somatic division appear to be fibres which have joined that division from the splanchnic division. So prominent are non-medullated fibres in splanchnic nerves and hence in the sympathetic system that they are sometimes called sympathetic fibres.

We have said that the axis-cylinder, whether of a medullated or non-medullated fibre, is to be considered as a long drawn out process of a nerve cell. Nerve cells are found in three main situations.

1. In the central nervous system, the brain and spinal cord.

2. In the several ganglia placed along the course of the nerves, both the spinal ganglia, and the ganglia of the splanchnic or sympathetic system. 3. At the terminations of nerves in certain tissues. Some of these latter are to be regarded as small, more or less terminal, ganglia, and similar minute ganglia consisting of two or three cells only are found frequently along the course of splanchnic nerves and occasionally along the course of spinal nerves; such cells really therefore belong to the second group. But besides this, in certain situations, as for instance in certain organs of the skin, and in the organs of special sense, nerves, generally afferent or sensory in nature, either actually end in, or at their termination are connected with, cells which appear to be of a nervous nature; such cells form a distinct category by themselves.

Hence along its whole course a nerve consists exclusively of nerve fibres (and the connective tissue supporting them), except in the central nervous system from which it springs, in the ganglia, great and small, through which it passes or which are attached to it at one part or another of its course, in both of which situations nerve cells are found, and at its termination where its fibres may end in nerve cells.

The features of these nerve cells differ in these several situations. The characters of the terminal cells which, as we have said, are chiefly sensory, and the structure of the brain and spinal cord we shall study in detail later on. We may here confine our attention to the nerve cells of the ganglia, and to some of the broad features of the nerve cells of the spinal cord.

§ 97. *Spinal ganglia.* When a longitudinal section of a spinal ganglion is examined under a low power, the fibres of the posterior root as they enter the ganglion are observed to spread out and pass between relatively large and conspicuous nucleated cells which are to a large extent arranged in groups, somewhat after the fashion of a bunch of grapes. These are the nerve cells; they have frequently a diameter of about 100μ but may be still larger or may be much smaller. In a transverse section it will be observed that a large compact mass of these cells lies on the outer side of the ganglion, and that the racemose groups on the inner side are smaller. A quantity of connective tissue carrying blood vessels and lymphatics runs between the groups and passing into each group runs between the cells and fibres; and a thick wrapping of connective tissue continuous with the sheath of the nerve surrounds and forms a sheath for the whole ganglion.

Each of the nerve cells, ganglionic cells as they are called, examined under a higher power, either after having been isolated or in an adequately thin and prepared section, will present the following features.

The cell consists of a *cell body* which is, normally, pear-shaped, having a broad end in which is placed the nucleus and a narrow end which thins out into a stalk and is eventually continued

on as a nerve fibre. The substance of the cell body is of the kind which we call finely granular protoplasm; sometimes there is an appearance of fibrillation, the fibrillæ passing in various directions in the body of the cell and being gathered together in a longitudinal direction in the stalk. Sometimes the cell body immediately around the nucleus appears of a different grain from that nearer the stalk, and not unfrequently near the nucleus is an aggregation of discrete pigment granules imbedded in the protoplasm.

The *nucleus*, like the nuclei of nearly all nerve cells, is large and conspicuous, and when in a normal condition is remarkably clear and refractive, though it appears to consist like other nuclei of a nuclear membrane and network and nuclear interstitial material. Even more conspicuous perhaps is a very large spherical highly refractive *nucleolus*; occasionally more than one nucleolus is present.

Surrounding the cell body is a distinct *sheath* or *capsule* consisting of a transparent, hyaline, or faintly fibrillated membrane, lined on the inside by one layer or by two layers of flat, polygonal, nucleated epithelioid cells or plates; that is to say, cells which resemble epithelium cells, but differ not only in being extremely flattened, but also in the cell body being transformed from ordinary granular protoplasm into a more transparent differentiated material. In stained specimens the nuclei of these plates are very conspicuous. Under normal conditions this sheath is in close contact with the whole body of the cell, but in hardened and prepared specimens the cell body is sometimes seen shrunk away from the sheath, leaving a space between them. Occasionally the cell body while remaining attached to the sheath at three or four or more points is retracted elsewhere, and accordingly assumes a more or less stellate form; but this artificial condition must not be confounded with the natural branched form which as we shall see other kinds of nerve cells possess.

When a section is made through a hardened ganglion the plane of the section passes through the stalks of few only of the cells, and that rarely for any great distance along the stalk, since in the case of many of the cells the stalk is more or less curved and consequently runs out of the plane of section; but in properly isolated cells we can see that in many cases, and we have reasons to believe that in all cases, the stalk of the cell is as we have said continued on into a nerve fibre. As the cell body narrows into the stalk several nuclei make their appearance, lodged on it; these are small granular nuclei, wholly unlike the nucleus of the cell body itself, and more like, though not quite like, the nuclei of the neurilemma of a nerve. They are probably of the same nature as the latter; and indeed as we trace the narrowing stalk downwards a fine delicate sheath which, if present, is at least not obvious over the cell body, makes its appearance, and a little farther on between this

sheath, which is now clearly a neurilemma, and the stalk of the cell body, which has by this time become a cylinder of uniform width and is now obviously an axis-cylinder, a layer of medulla, very fine at first but rapidly thickening, is established. The stalk of the nerve cell thus becomes an ordinary medullated nerve fibre. The sheath of the cell is continued also on to the nerve fibre, not as was once thought as the neurilemma, but as that special sheath of connective tissue, of which we have already spoken (§ 69) as Henle's sheath, and which ultimately becomes fused with the connective tissue of the nerve.

At some variable distance from the cell the nerve fibre bears the first node, and either at this or some early succeeding node the fibre divides into two; as we have seen, division of a medullated nerve fibre always takes place at a node. The two divisions thus arising run in opposite directions forming in this way a \perp piece; and while one division runs in one direction towards the posterior root, the other runs in an opposite direction towards the nerve trunk. The nerve cell is thus as it were a side piece attached to a fibre passing through the ganglion on its way from the posterior root to the nerve trunk. It cannot be said that in any one ganglion this connection has been traced in the case of every nerve cell of the ganglion; but the more care is taken, and the more successful the preparation, the greater is the number of cells which may be isolated with their respective \perp pieces; so that we may conclude that, normally, every cell of a ganglion is connected on the one hand with a fibre of the posterior root, and on the other hand with a fibre of the nerve trunk. We have reasons further to believe that every fibre of the posterior root in passing through the ganglion on its way to the mixed nerve trunk is thus connected with a nerve cell; but this has been called in question. In certain animals, for instance certain fishes, the cells of the spinal ganglia are not pear-shaped but oval or fusiform, and each narrow end is prolonged into a nerve fibre, one end thus being connected with the posterior root and the other with the nerve trunk. In such a case the nerve cell is simply a direct enlargement of the axis-cylinder, with a nucleus placed in the enlargement. The nerve cells above described are similar enlargements, also bearing nuclei, placed not directly in the course of the axis-cylinder, but on one side and connected with the axis-cylinder by the cross piece of the \perp piece. Hence the ordinary ganglion cell is spoken of as being *unipolar*, those of fishes being called *bipolar*.

In examining spinal ganglia cells are sometimes found which bear no trace of any process connecting them with a nerve fibre. Such cells are spoken of as *apolar*. It is possible that such a cell may be a young cell which has not yet developed its nerve process or an old cell which has by degeneration lost the process which it formerly possessed.

§ 98. The ganglia of the *splanchnic* system, like the spinal ganglia, consist of nerve cells and fibres imbedded in connective tissue, which however is of a looser and less compact nature in them than in the spinal ganglia. As far as the characters of their nuclei, the nature of their cell substance, and the possession of a sheath are concerned what has been said concerning the nerve cells of spinal ganglia holds, in general, good for those of splanchnic ganglia; and indeed, in certain ganglia of the splanchnic system connected with the cranial nerves, the nerve cells appear to be wholly like those of spinal ganglia. In most splanchnic ganglia however, in those which are generally called *sympathetic* ganglia, two important differences may be observed between what we may call the characteristic nerve cell of the splanchnic ganglion and the cell of the spinal ganglion.

In the first place while the nerve cell of the spinal ganglia has one process only, the nerve cell of the splanchnic ganglia may have and frequently has two, three or even four or five processes; it is a *multipolar* cell.

In the second place while these processes of the splanchnic ganglion cell are continued on as nerve fibres as is the single process of the spinal ganglion cell, the nerve fibres so formed are, in the case of most of the processes of a cell, and sometimes in the case of all the processes, non-medullated fibres, and remain non-medullated as far as they can be traced. In some instances one process becomes at a little distance from the cell a medullated fibre, while the other processes become non-medullated fibres; and we are led to believe that in this case the medullated fibre is proceeding *to* the cell on its way from the central nervous system, and that the non-medullated fibres are proceeding *from* the cell on their way to more peripherally placed parts; the nerve cell seems to serve as a centre for the division of nerve fibres, and also for the change from medullated to non-medullated fibres.

In consequence of its thus possessing several processes the splanchnic ganglion cell is more or less irregular and often star-like in form, in contrast to the pear shape of the spinal ganglion cell. But in certain situations in certain animals, for instance in the frog, in many of the ganglia of the abdomen, and in the small ganglia in the heart, pear-shaped splanchnic ganglion cells are met with. In such cases the nucleated sheath is distinctly pear-shaped or balloon-shaped, and the large conspicuous nucleus is placed, as in the spinal ganglion cell, near the broad end, but the cell substance of the cell is gathered at the stalk not into a single fibre but into two fibres one of which is straight and the other twisted spirally round the straight one. The two fibres run for some distance together in the same funnel-shaped prolongation of the nucleated sheath of the cell but eventually separate, each fibre acquiring a sheath (sheath of Henle) of its own. Generally, if not always, one fibre, usually the straight one, becomes a medullated fibre, while

the other, usually the twisted or spiral one, is continued as a non-medullated fibre. While within the common nucleated sheath both fibres, especially the spiral one, bear nuclei of the same character as those seen in a corresponding situation in the spinal ganglion cell. It has been maintained that the straight and spiral fibres take origin from different parts of the nerve cell, but this has not been definitely proved.

In the walls of the intestine, in connection with splanchnic nerves, are found peculiar nerve cells forming what are known as the plexuses of Meissner and Auerbach, but we shall postpone for the present any description of these or of other peculiar splanchnic cells.

§ 99. In the *central nervous system* nerve cells are found in the so-called *grey matter* only, they are absent from the *white matter*. In the grey matter of the spinal cord, in the parts spoken of as the anterior cornua, we meet with remarkable nerve cells of the following characters. The cells are large, varying in diameter from 50μ to 140μ , and each consists of a cell body surrounding a large conspicuous refractive nucleus, in which is placed an even still more conspicuous nucleolus. The nucleus resembles the nuclei of the ganglion cells already described, and the cell body, like the cell body of the ganglion cells, is composed of finely granular protoplasm, often fibrillated, though generally obscurely so; frequently a yellowish brown pigment is deposited in a part of the cell body not far from the nucleus. The cell body is prolonged sometimes into two or three only but generally into several processes, which appear more distinctly fibrillated than the more central parts of the cell body. These processes are of two kinds. One process and, apparently, one only, but in the case of the cells of the anterior cornu, always one, is prolonged as a thin unbranched band, which retains a fairly uniform diameter for a considerable distance from the cell, and when successfully traced is found sooner or later to acquire a medulla and to become the axis-cylinder of a nerve fibre; the processes which thus pass out from the grey matter of the anterior cornu through the white matter form the anterior roots of the spinal nerve. Such a process is accordingly called the *axis cylinder process*. The other processes of the cell rapidly branch, and so divide into very delicate filaments which are soon lost to view in the substance of the grey matter. Indeed the grey matter is partly made up of a plexus of delicate filaments arising on the one hand from the division of processes of the nerve cells, and on the other from the division of the axis-cylinders of fibres running in the grey matter.

The cell is not surrounded like the ganglion cell by a distinct sheath. As we shall see later on while treating in detail of the central nervous system, all the nervous elements of the spinal cord are supported by a network or spongework of delicate peculiar tissue

called *neuroglia*, analogous to and serving much the same function as but different in origin and nature from connective tissue. This neuroglia forms a sheath to the nerve cell and to its processes, as well as to the nerve fibres running both in the white and the grey matter; hence within the central nervous system the fibres, whether medullated or no, possess no separate neurilemma; tubular sheaths of the neuroglia give the axis-cylinder and medulla all the support they need.

All the nerve cells of the anterior cornu probably possess an axis-cylinder process, and other cells similarly provided with an axis-cylinder process are found in other parts of the grey matter. But in certain parts, as for instance in the posterior cornu, many of the cells appear to possess no axis-cylinder process; in such cases all the processes appear to branch out rapidly into fine filaments. Except for this absence, apparent or real, of an axis-cylinder process, such cells resemble in their general features the cells of the anterior cornu, though they are generally somewhat smaller. Speaking generally the great feature of the nerve cells of the central nervous system as distinguished from the ganglion cells is the remarkable way in which their processes branch off into a number of delicate filaments, corresponding to the delicate filaments or fibrillæ in which at its termination in the tissues the axis-cylinder of a nerve often ends.

§ 100. From the above descriptions it is obvious that in the spinal cord (to which as representing the central nervous system we may at present confine ourselves, leaving the brain for later study) afferent fibres (fibres of the posterior root) are in some way by means of the grey matter brought into connection with efferent fibres (fibres of the anterior root); in other words the spinal cord is a centre uniting afferent and efferent fibres. The spinal ganglia are not centres in this sense; the nerve cells composing the ganglia are simply relays on the afferent fibres of the posterior root, they have no connection whatever with efferent fibres, they are connected with fibres of one kind only. Concerning the ganglia of the splanchnic system we cannot in all cases make at present a positive statement, but the evidence so far at our disposal points to the conclusion that in them as in the spinal ganglia each nerve cell belongs to fibres of one function only, that where several processes of a cell are prolonged into nerve fibres, these fibres have all the same function, the nerve cell being as in the spinal ganglia a mere relay. We have no satisfactory evidence that in a ganglion the fibres springing from or connected with one cell join another cell so as to convert the ganglion into a centre joining together cells, whose nerve fibres have different functions.

We shall have later on to bring forward evidence that the nucleated cell body of a nerve cell in a ganglion or elsewhere is in some way or other connected with the nutrition, the growth and repair of the nerve fibres springing from it. Besides this nutritive

function the multipolar cells of the splanchnic ganglia appear to serve the purpose of multiplying the tracts along which nervous impulses may pass. An impulse for instance reaching a multipolar cell in one of the proximal (sympathetic) ganglia along one fibre or process (the fibre in very many cases being a medullated fibre) can pass out of the cell in various directions along several processes or fibres, which in the majority of cases if not always are non-medullated fibres. Thus these nerve cells are organs of distribution for impulses of the same kind. What further modifications of the impulses thus passing through them these ganglia may bring about we do not know.

It is only in some few instances that we have any indications, and those of a very doubtful character, that the ganglia of the splanchnic system can carry out either of the two great functions belonging to what is physiologically called a *nerve centre*, namely the function of starting nervous impulses anew from within itself, the function of an *automatic centre* so-called, and the function of being so affected by the advent of afferent impulses as to send forth in response efferent impulses, of converting as it were afferent into efferent impulses, the function of a *reflex centre* so-called.

It is the central nervous system, the brain with the spinal cord, which supplies the nervous centres for automatic actions and for reflex actions; indeed all the processes taking place in the central nervous system (at least all such as come within the province of physiology) fall into or may be considered as forming part of one or the other of these two categories.

§ 101. *Reflex actions.* In a reflex action afferent impulses reaching the nervous centre give rise to the discharge of efferent impulses, the discharge following so rapidly and in such a way as to leave no doubt that it is caused by the advent at the centre of the afferent impulses. Thus a frog from which the brain has been removed while the rest of the body has been left intact will frequently remain quite motionless (as far at least as the skeletal muscles are concerned) for an almost indefinite time; but if its skin be pricked, or if in other ways afferent impulses be generated in afferent fibres by adequate stimulation, movements of the limbs or body will immediately follow. Obviously in this instance the stimulation of afferent fibres has been the cause of the discharge of impulses along efferent fibres.

The machinery involved in such a reflex act consists of three parts: (1) the afferent fibres, (2) the nerve centre, in this case the spinal cord, and (3) the efferent fibres. If any one of these three parts be missing the reflex act cannot take place; if for instance the afferent nerves or the efferent nerves be cut across in their course, or if the centre, the spinal cord, be destroyed, the reflex action cannot take place.

Reflex actions can be carried out by means of the brain, as we

shall see while studying that organ in detail, but the best and clearest examples of reflex action are manifested by the spinal cord; in fact, reflex action is one of the most important functions of the spinal cord. We shall have to study the various reflex actions of the spinal cord in detail hereafter, but it will be desirable to point out here some of their general features.

When we stimulate the nerve of a muscle nerve preparation the result, though modified in part by the condition of the muscle and nerve, whether fresh and irritable or exhausted for instance, is directly dependent on the nature and strength of the stimulus. If we use a single induction-shock we get a simple contraction, if the interrupted current we get a tetanus, if we use a weak shock we get a slight contraction, if a strong shock a large contraction and so on; and throughout our study of muscular contractions we assumed that the amount of contraction might be taken as a measure of the magnitude of the nervous impulses generated by the stimulus. And it need hardly be said that when we stimulate certain fibres only of a motor nerve, it is only the muscular fibres in which those nerve fibres end, which are thrown into contraction.

In a reflex action on the other hand the movements called forth by the same stimulus may be in one case insignificant, and in another violent and excessive, the result depending on the arrangements and condition of the reflex mechanism. Thus the mere contact of a hair with the mucous membrane lining the larynx, a contact which can originate only the very slightest afferent impulses, may call forth a convulsive fit of coughing, in which a very large number of muscles are thrown into violent contractions; whereas the same contact of the hair with other surfaces of the body may produce no obvious effect at all. Similarly, while in the brainless but otherwise normal frog, a slight touch on the skin of the flank will produce nothing but a faint flicker of the underlying muscles, the same touch on the same part of a frog poisoned with strychnia will produce violent lasting tetanic contractions of nearly all the muscles of the body. Motor impulses as we have seen travel along motor nerves without any great expenditure of energy and probably without increasing that expenditure as they proceed; and the same is apparently the case with afferent impulses passing along afferent nerves. When however in a reflex action afferent impulses reach the nerve centre, a change in the nature and magnitude of the impulses takes place. It is not that in the nerve centre the afferent impulses are simply turned aside or reflected into efferent impulses; and hence the name "reflex" action is a bad one. It is rather that the afferent impulses act afresh as it were as a stimulus to the nerve centre, producing according to circumstances and conditions either a few weak efferent impulses or a multitude of strong ones. The nerve centre may be regarded as a collection of explosive charges ready to be discharged and so to start efferent

impulses along certain efferent nerves, and these charges are so arranged and so related to certain afferent nerves, that afferent impulses reaching the centre along those nerves may in one case discharge a few only of the charges and so give rise to feeble movements, and in another case discharge a very large number and so give rise to large and violent movements. In a reflex action then the number, intensity, character and distribution of the efferent impulses, and so the kind and amount of movement, will depend chiefly on what takes place in the centre, and this will in turn depend on the one hand on the condition of the centre and, on the other, on the special relations of the centre to the afferent impulses.

At the same time we are able to recognize in most reflex actions a certain relation between the strength of the stimulus, or the magnitude of the afferent impulses and the extent of the movement or the magnitude of the efferent impulses. The nerve-centre remaining in the same condition, the stronger or more numerous afferent impulses will give rise to the more forcible or more comprehensive movements. Thus if a flank of a brainless frog be very lightly touched, the only reflex movement which is visible is a slight twitching of the muscles lying immediately underneath the spot of skin stimulated. If the stimulus be increased, the movements will spread to the hind-leg of the same side, which frequently will execute a movement calculated to push or wipe away the stimulus. By forcibly pinching the same spot of skin, or otherwise increasing the stimulus, the resulting movements may be led to embrace the fore-leg of the same side, then the opposite side, and finally, almost all the muscles of the body. In other words, the disturbance set going in the centre, confined when the stimulus is slight to a small part of the centre, overflows, so to speak, when the stimulus is increased, to other parts of the centre, and thus throws impulses into a larger and larger number of efferent nerves.

We may add, without going more fully into the subject here, that in most reflex actions a special relation may be observed between the part stimulated and the resulting movement. In the simplest cases of reflex action this relation is merely of such a kind that the muscles thrown into action are those governed by a motor nerve which is the fellow of the sensory nerve, the stimulation of which calls forth the movement. In the more complex reflex actions of the brainless frog, and in other cases, the relation is of such a kind that the resulting movement bears an *adaptation* to the stimulus: the foot is withdrawn from the stimulus, or the movement is calculated to push or wipe away the stimulus. In other words, a certain *purpose* is evident in the reflex action.

Thus in all cases, except perhaps the very simplest, the movements called forth by a reflex action are exceedingly complex compared with those which result from the direct stimulation of a

motor trunk. When the peripheral stump of a divided sciatic nerve is stimulated with the interrupted current, the muscles of the leg are at once thrown into tetanus, continue in the same rigid condition during the passage of the current, and relax immediately on the current being shut off. When the same current is applied for a second only, to the skin of the flank of a brainless frog, the leg is drawn up and the foot rapidly swept over the spot irritated, as if to wipe away the irritation; but this movement is a complex one, requiring the contraction of particular muscles in a definite sequence, with a carefully adjusted proportion between the amounts of contraction of the individual muscles. And this complex movement, this balanced and arranged series of contractions, may be repeated more than once as the result of a single stimulation of the skin. When a deep breath is caused by a dash of cold water, the same co-ordinated and carefully arranged series of contractions is also seen to result, as part of a reflex action, from a simple stimulus. And many more examples might be given.

In such cases as these, the complexity may be in part due to the fact that the stimulus is applied to terminal sensory organs and not directly to a nerve-trunk. As we shall see in speaking of the senses, the impulses which are generated by the application of a stimulus to a sensory organ are more complex than those which result from the direct stimulation of a sensory nerve-trunk. Nevertheless, reflex actions of great if not of equal complexity may be induced by stimuli applied directly to a nerve-trunk. We are therefore obliged to conclude that in a reflex action, the processes which are originated in the centre by the arrival of even simple impulses along afferent nerves may be highly complex; and that it is the constitution and condition of the centre which determines the complexity and character of the movements which are effected. In other words, a centre concerned in a reflex action is to be regarded as constituting a sort of molecular machinery, the character of the resulting movements being determined by the nature of the machinery set going and its condition at the time being, the character and amount of the afferent impulses determining exactly what parts of and how far the central machinery is thrown into action.

Throughout the above we have purposely used the word centre, avoiding the mention of nerve cells. But undoubtedly the part of the spinal cord acting as centres of reflex action is situated in the grey matter, which grey matter is characterised by the presence of nerve cells; undoubtedly also the efferent fibres are connected with the afferent fibres by means of cells, certainly by the cells of the anterior cornu described in § 99 and probably also by other cells in the posterior cornu or elsewhere. So that a reflex action is carried on undoubtedly *through* cells. But it does not follow that a cellular mechanism is essential in the sense at all events that the nuclei of the cells have anything to do with the

matter, or even that the most important of the molecular processes constituting the changes taking place in a centre during a reflex action are carried out only by the cell substance immediately surrounding the nuclei. The power of carrying out a reflex action is probably contingent on the nature and arrangement of axis-cylinders, and of the branching material by which in a nerve centre the afferent and efferent axis-cylinders are joined together, the nuclei intervening only so far as they have to do with the growth and repair of the nervous material.

§ 102. *Automatic actions.* Efferent impulses frequently issue from the brain and spinal cord and so give rise to movements without being obviously preceded by any stimulation. Such movements are spoken of as automatic or spontaneous. The efferent impulses in such cases are started by changes in the nerve centre which are not the immediate result of the arrival at the nerve centre of afferent impulses from without, but which appear to arise in the nerve centre itself. Changes of this kind may recur rhythmically; thus, as we shall see, we have reason to think that in a certain part of the medulla oblongata changes of the nervous material, recurring rhythmically, lead to the rhythmic discharge along certain nerves of efferent impulses whereby muscles connected with the chest are rhythmically thrown into action and a rhythmically repeated breathing is brought about. And other similar rhythmic automatic movements may be carried out by other parts of the spinal cord.

From the brain itself a much more varied and apparently irregular discharge of efferent impulses, not the obvious result of any immediately foregoing afferent impulses, and therefore not forming part of reflex actions, is very common, constituting what we speak of as volition, efferent impulses thus arising being called volitional or voluntary impulses. The spinal cord apart from the brain does not appear capable of executing these voluntary movements; but to this subject we shall return when we come to speak of the central nervous system in detail.

We said just now that there is no satisfactory evidence that the ganglia of the splanchnic system ever act as centres of reflex action. The evidence however that these ganglia may serve as centres of rhythmic automatic action seems at first sight of some strength. Several organs of the body containing muscular tissue, the most notable being the heart, are during life engaged in rhythmic automatic movements, and in many cases continue these movements after removal from the body. In nearly all these cases ganglia are present in connection with the muscular tissue; and the presence and intact condition of these ganglia seem at all events in many cases in some way essential to the due performance of the rhythmic automatic movements. Indeed it has been thought that the movements in question are really due to the rhythmic automatic generation in the cells of these ganglia

of efferent impulses which passing down to the appropriate muscular fibres call forth the rhythmic movement. When we come to study these movements in detail, we shall find reasons for coming to the conclusion that this view is not supported by adequate evidence; and indeed, though it is perhaps immature to make a dogmatic statement, all the evidence goes, as we have already said, to shew that the great use of the ganglia of the splanchnic system, like that of the spinal ganglia, is connected with the nutrition of the nerves, and that these structures do not like the central nervous system act as centres either automatic or reflex.

§ 103. *Inhibitory nerves.* We have said that the fibres of the anterior root should be called efferent rather than motor because though they all carry impulses outward from the central nervous system to the tissues, the impulses which they carry do not in all cases lead to the contraction of muscular fibres. Some of these efferent fibres are distributed to glandular structures, for instance to the salivary glands, and impulses passing along these lead to changes in epithelial cells and their surroundings whereby, without any muscular contraction necessarily intervening, secretion is brought about: the action of these fibres of secretion we shall study in connection with digestion.

Besides this there are efferent fibres going to muscular tissue or at all events to muscular organs, the impulses passing along which, so far from bringing about muscular contraction, diminish, hinder or stop movements already in progress. Thus if when the heart is beating regularly, that is to say, when the muscular fibres which make up the greater part of the heart are rhythmically contracting, the branches of the pneumogastric nerve going to the heart be adequately stimulated, for instance with the interrupted current, the heart will stop beating; and that not because the muscles of the heart are thrown into a continued tetanus, the rhythmic alternation of contraction and relaxation being replaced by sustained contraction, but because contraction disappears altogether, all the muscular fibres of the heart remaining for a considerable time in complete relaxation and the whole heart being quite flaccid. If a weaker stimulus be employed the beat may not be actually stopped but slowed or weakened. And, as we shall see, there are many other cases where the stimulation of efferent fibres hinders, weakens, or altogether stops a movement already in progress. Such an effect is called an *inhibition*, and the fibres stimulation of which produces the effect are called 'inhibitory' fibres.

The phenomena of inhibition are not however confined to such cases as the heart, where the efferent nerves are connected with muscular tissues. Thus the activity of a secreting gland may be inhibited, as for instance when emotion stops the secretion of saliva, and the mouth becomes dry from fear. In this instance

however, it is probable that inhibition is brought about not by inhibitory impulses passing to the gland and arresting secretion in the gland itself, but rather by an arrest, in the central nervous system, of the nervous impulses which, normally, passing down to the gland, excite it as we shall see to action. And indeed, as we shall see later on, there are many illustrations of the fact that afferent impulses reaching a nervous centre, instead of stimulating it to activity, may stop or inhibit an activity previously going on. In fact it is probable, though not actually proved in every case, that wherever in any tissue, energy is being set free, nervous impulses brought to bear on the tissue may affect the rate or amount of the energy set free in two different ways; on the one hand, they may increase or quicken the setting free of energy, and on the other hand they may slacken, hinder, or inhibit the setting free of energy. And in at all events a large number of cases it is possible to produce the one effect by means of one set of nerve fibres, and the other effect by another set of nerve fibres. We shall have occasion however to study the several instances of this double action in the appropriate places. It is sufficient for us at the present to recognize that a nervous impulse passing along a nerve fibre need not always set free energy when it reaches its goal, it may hinder or stop the setting free of energy and is then called an inhibitory impulse.

CHAPTER IV.

THE VASCULAR MECHANISM.

SEC. 1. THE STRUCTURE AND MAIN FEATURES OF THE VASCULAR APPARATUS.

§ 104. THE blood, as we have said, is the internal medium on which the tissues live; from it these draw their food and oxygen, to it they give up the products or waste matters which they form. The tissues, with some few exceptions, are traversed by, and thus the elements of the tissues surrounded by, networks of minute thin-walled tubes, the *capillary blood vessels*. The elementary striated muscle fibre, for instance, is surrounded by capillaries, running in the connective tissue outside but close to the sarcolemma, arranged in a network with more or less rectangular meshes. These capillaries are closed tubes with continuous walls, and the blood, which, as we shall see, is continually streaming through them, is as a whole confined to their channels and does not escape from them. The elements of the tissues lie outside the capillaries and form *extra-vascular islets*, of different form and size in the different tissues, surrounded by capillary networks. But the walls of the capillaries are so thin and of such a nature that certain of the constituents of the blood pass from the interior of the capillary through the capillary wall to the elements of the tissue outside the capillary, and similarly certain of the constituents of the tissue, to wit, certain substances the result of the metabolism continually going on in the tissue, pass from the tissue outside the capillary through the capillary wall into the blood flowing through the capillary. Thus as we have already said, § 13, there

is a continual interchange of material between the blood in the capillary, and the elements of the tissue outside the capillary, the lymph acting as middle man. By this interchange the tissue lives on the blood and the blood is affected by its passage through the tissue. In the small arteries which end in, and in the small veins which begin in the capillaries, a similar interchange takes place; but the amount of interchange diminishes as, passing in each direction from the capillaries, the walls of the arteries and veins become thicker; and indeed, in all but the minute veins and arteries the interchange is so small that it may practically be neglected. It is in the capillaries (and minute arteries and veins) that the business of the blood is done; it is in these that the interchange takes place; and the object of the vascular mechanism is to cause the blood to flow through these in a manner best adapted for carrying on this interchange under varying circumstances. The use of the arteries is in the main simply to carry the blood in a suitable manner from the heart to the capillaries, the use of the veins is in the main simply to carry the blood from the capillaries back to the heart, and the use of the heart is in the main simply to drive the blood in a suitable manner through the arteries into the capillaries and from the capillaries back along the veins to itself again. The structure of these several parts is adapted to these several uses.

The structure of arteries, capillaries and veins.

§ 105. *On some features of connective tissue.* The heart and blood vessels are, broadly speaking, made up partly of muscular tissue with its appropriate nervous elements, and partly of certain varieties of the tissue known as connective tissue. We shall have to speak of some of the features of connective tissue of physiological importance when we come to deal with the lymphatic system, for this system is intimately associated with connective tissue. But an association only less close exists between the blood vessels and connective tissue; for connective tissue not only enters largely, in one or other of its forms, into the structure of the blood vessels, but also forms a sort of bed both for the larger vessels on their way to and from the several tissues and organs and for the smaller vessels, including the capillaries, within each tissue and organ; indeed a capillary may be regarded as a minute tubular passage hollowed out in the connective tissue which binds together the elements of a tissue. It will be desirable therefore to point out at once a few of the characters of connective tissue.

The connective tissue of the adult body is derived from certain mesoblastic cells of the embryo and consists essentially of certain cells, which do not lie in close contact with each other as do the cells of epithelium, but are separated by more or less intercellular material which may in certain cases be fluid or semi-fluid but

which is generally solid, and is commonly spoken of as *matrix*. In most forms of connective tissue the matrix is relatively so abundant and prominent, that the cells, or *connective tissue corpuscles* as they are called, become inconspicuous; and, speaking generally, the value of connective tissue to the body depends much more on the qualities of the matrix than on the activity of the connective tissue corpuscles.

The kind of connective tissue, sometimes called "loose connective tissue," which wraps round and forms a bed for the blood vessels, consists of an irregular meshwork formed by interlacing bundles of various sizes which leave between them spaces of very variable form and size, some being mere chinks or clefts, others being larger but generally flattened passages, all containing lymph and having as we shall see special connections with the lymphatic vessels. The larger spaces are sometimes called "areolæ," and this kind of connective tissue is sometimes spoken of as "areolar tissue." When a small portion of this tissue is teased out carefully under the microscope, the larger bundles may be separated into finer bundles, and each bundle, which generally pursues a wavy course, has a fibrillated appearance as if made up of exceedingly fine fibrillæ; treated with lime water or baryta water the bundles do actually split up into fine wavy fibrillæ of less than $1\ \mu$ in diameter, a substance of a peculiar nature which previously cemented the fibrillæ together being dissolved out from between them. When a mass of such fibrillæ is boiled with water, they become converted into *gelatine*, a substance containing, like proteid material, carbon, nitrogen, hydrogen and oxygen with a small quantity of sulphur, but differing from proteid material both in its percentage composition and in its properties. A remarkable and well known feature of gelatine is that its solutions while fluid at a temperature of boiling water or less, become solid or a 'jelly' at lower temperatures. The untouched fibrillæ, in their natural condition, behave as we shall see in speaking of the digestion of connective tissue, somewhat differently from prepared gelatine; the natural fibrilla therefore, does not consist of gelatine but of a substance which by boiling is readily converted into gelatine. The substance soluble in lime or baryta water, which cements a number of fibrillæ into a bundle, appears to be allied to a body, of which we shall speak later on, called mucin. Since the fibrillæ form by far the greater part of the matrix of connective tissue, a quantity of this tissue when boiled seems almost entirely converted into gelatine.

In connective tissue then a number of exceedingly fine gelatiniferous fibrillæ are cemented together into a fine microscopic bundle, and a number of these finer bundles may be similarly cemented together or simply apposed together to form larger bundles; some of the bundles at least appear moreover to be defined by a delicate transparent sheath of a somewhat peculiar nature. A number of these bundles, small and large, are arranged as a

meshwork the irregular spaces of which are occupied by lymph. On the sides of the bundles towards the spaces or between the bundles where these are in apposition, often lying in minute spaces hollowed out in the cement or ground substance uniting the bundles, are found the connective tissue corpuscles. Each of these is a cell consisting of a nucleus, generally oval or elongate, surrounded by a protoplasmic cell body usually irregular in form, being sometimes merely spindle shaped but more frequently distinctly branched or stellate, and nearly always much flattened in a plane corresponding to the direction of the fibres, or bundles of the matrix. Although as we have said the fibrillæ are cemented together into a bundle, each fibrilla remains sufficiently distinct to have a marked refractive effect on rays of light falling upon or transmitted through the tissue, so that the bundles appear white and opaque; hence this tissue, and especially a more dense form of it, is sometimes spoken of as white fibrous tissue. Owing to this opacity the more delicate connective tissue corpuscles are not readily visible in the natural condition of the tissue. They may however be brought to view by the action of dilute acid such as acetic acid. Under the influence of this acid each fibrilla swells out, and the swollen fibrillæ pressing upon each other cease to refract light so much as before, and thus become more transparent, very much as an opaque mass of strips of isinglass becomes transparent when the strips are swollen by boiling; this increase of transparency allows the corpuscles, which are not swollen but rather shrunken and made more opaque by the action of the acid, to become visible. The presence of these corpuscles may also be revealed by the use of such staining reagents as while not staining the fibrillated matrix stain the nuclei and the protoplasmic bodies of the corpuscles.

◀ Besides these branched irregular flattened connective tissue corpuscles, which do not naturally exhibit any amœboid movements, leucocytes, exhibiting more or less active movements, are found in the spaces of the tissue, together with corpuscles of a third kind remarkable from the large coarse granules with which the cell substance is studded, and known as "plasma-corpuscles."

§ 106. When connective tissue is rendered transparent by the action of dilute acetic acid, there come into view besides the corpuscles, a number of fibres, different from the gelatiniferous fibres not only in not being swollen and rendered transparent by the action of the acid, but also by their size, relatively scanty number, clear bold outline and sharply curved course. The fibres vary much in size, some being very fine so as to appear mere lines, while others are very large with a distinct double outline. Whether small or large each fibre is a single fibre, not a bundle, and cannot be split up, like a fibre or small bundle of the ordinary matrix, into fibrillæ. Not only is their course sharply curved unlike the gently sweeping outlines of the gelatiniferous fibres,

but they divide and anastomose freely, thus forming networks of varying shape; the gelatiniferous fibrillæ on the other hand never divide, and the bundles interlace into a network rather than anastomose.

The number of these fibres occurring in connective tissue varies much in different situations, and in some places, as for instance in the *ligamentum nuchæ* of certain animals, nearly the whole tissue is composed of large fibres of this kind, having in the mass a yellow colour, the ordinary gelatiniferous fibres being reduced to a minimum. In such a situation a remarkable physical character of these fibres is easily recognized; they are in a high degree extensible and elastic; hence they are frequently called *elastic fibres*; from their yellowish colour they are sometimes called yellow elastic fibres. The white gelatiniferous fibrillæ on the contrary possess very little extensibility or elasticity.

When a portion of *ligamentum nuchæ* is freed by prolonged boiling from the remnant of gelatiniferous fibres mixed up with the yellow elastic material, the latter is found on chemical treatment to yield a substance called *elastin*, which very closely resembles proteid matter in elementary composition except that it contains no sulphur, and which yet probably differs widely from it in nature.

Connective tissue then consists of a matrix of inextensible inelastic white wavy gelatiniferous fibrillæ, cemented into bundles, (the bundles being arranged, in loose connective tissue, in irregular meshworks) with which are associated in varying abundance anastomosing curled yellow elastic fibres, and among which are embedded branched connective tissue corpuscles. Leucocytes and plasma cells are also found in the meshes or areolæ of the meshwork. We may now return to the structure of the blood vessels.

§ 107. *Capillaries.* A capillary is, as we said above, a tubular passage hollowed out in connective tissue. Without special preparation all that can be seen under the microscope is the outline of the wall of the capillary, shewing under high powers a double contour, and marked with oval nuclei which are lodged in the wall at intervals and which project somewhat into the lumen or canal of the vessel. When however the tissue containing the capillaries is treated with a weak solution of silver nitrate, and after being thoroughly washed is exposed to light, the wall of the capillary is seen to be marked out by thin black lines into spindle shaped areas, dovetailing into each other, and so related to the nuclei in the wall, that each nucleus occupies about the centre of an area. From this and from other facts we conclude that the capillary wall is built of flat fusiform nucleated plates cemented together at their edges by some cement substance, which more readily absorbs and retains silver nitrate than do the plates themselves, and hence after treatment with the silver salt shews in the form of black lines the silver which has been absorbed and subsequently reduced. Each plate is a flattened nucleated cell, the cell body of

which, except for a remnant of undifferentiated protoplasm round the nucleus, has become converted into transparent, differentiated material. Since the cells, except for the minimum of cement substance between them, are in close contact with each other, we might speak of them as forming an epithelium; but on account of their cell body being reduced to a mere plate, and on account of their connection both by origin and nature, with mesoblastic connective tissue corpuscles, it is convenient to speak of them as *epithelioid* cells or plates. They are sometimes spoken of as *endothelial* cells or plates. In a small capillary the width of one of these epithelioid plates at its widest part, where the nucleus lies, may be of nearly the same size as the circumference of the even distended capillary; the cells consequently are placed not side by side, but more or less alternate with each other, and their nuclei project alternately into the lumen of the vessel. The larger capillaries may, however, be so wide that two or even more cells lie more or less abreast. Outside the capillary, which is thus a thin and delicate membrane, a mere patchwork of thin epithelioid cells cemented together, is always found a certain amount of connective tissue, the wall of the capillary forming at places part of the walls of the lymph-holding connective tissue spaces, and at other places being united by cement material to the bundles, bands or sheets of the same connective tissue. Not unfrequently, in young tissues, branched connective tissue corpuscles lie upon and embrace a capillary, some of the processes of the cell being attached to the outside of the epithelioid plates of the capillary. Even in the capillaries of such a tissue as muscle, the network of capillaries embracing a muscular fibre is always surrounded by a certain, though sometimes a small amount only, of connective tissue; indeed wherever capillaries run they are accompanied as we have said by connective tissue, so that everywhere all over the body, the blood in the capillary is separated from the lymph in the spaces of the connective tissue by nothing more than the exceedingly thin bodies of the cemented epithelioid plates. It must be added, however, that the spaces in the connective tissue are themselves sometimes lined by similar epithelioid plates, of which we shall have to treat in speaking of the lymphatics, so that in places the partition between the blood and these lymph spaces may be a double one, and consist of two layers of thin plates.

In any case, however, the partition is an exceedingly thin one, and so permeable that it allows an adequately rapid interchange of material between the blood and the lymph. As we shall presently see, not only fluids, that is, matters in solution, are able to pass through the partition into the lymph, but intact corpuscles both red and white, especially the latter, may, in certain circumstances, make their way through, and so pass from the interior of the capillary into the lymph spaces outside. It is probable, however, that these make their way chiefly, if not exclusively,

through the cement lines, and especially at the point where the cement lines of three or more cells meet together and where the cement substance exists in larger amount than elsewhere.

The size of the capillaries is variable. In some regions of the body, for instance in the lungs, the capillaries are on the whole wider than in other regions, for instance, the skin; and all the minute vessels joining arteries to veins and possessing the structural features just described, that is, being true capillaries, will not always have the same size even in the same region of the body; the artery may give rise to large capillaries which branch into small capillaries, and these again may join into large capillaries before uniting to form veins. Thus one capillary may be so narrow that a single (mammalian) red corpuscle passes through it with difficulty, whereas another capillary may be wide enough to afford room for two or three such corpuscles to travel abreast. Besides this, the same capillary, may, in the living body, vary in width from time to time. At one moment, as when the entrance on the arterial side is blocked, or when blood for some reason or another ceases to flow into it, the capillary may be empty and collapsed, its walls in contact, and its lumen abolished or nearly so; and, in tissues taken from the dead body and prepared for microscopical examination, the capillaries are generally thus empty of blood and collapsed, so that they can be seen with difficulty, appearing as they then do as almost mere lines with swellings at intervals corresponding to the nuclei of the constituent cells. At another time, as when blood is flowing into it at high pressure, the capillary may be widely distended. In the variations in calibre, the walls of the capillary play a passive part; the material of the epithelioid plates is extensible and the pressure of the blood within the capillary distends the walls, and the material being also elastic, the walls shrink and collapse when the pressure is removed, being assisted in this by the pressure of the lymph in the spaces outside the capillary.* But besides this, in a young animal, at all events, the capillary wall is to a certain extent contractile; the epithelioid cells, which then appear to contain a large amount of undifferentiated protoplasm, seem able, under the influence of stimuli, to change their form, passing from a longer and narrower shape to a shorter and broader one, and thus influencing the calibre of the tube of which they form the walls. How far such an active change of form takes place in the capillaries of the adult body has not yet been definitely determined.

The structure of the capillary then seems adapted to two ends. In the first place, its walls being permeable are adapted for carrying out that important interchange between the blood and tissue, which, as we have more than once said, takes place almost exclusively in the capillary regions. In the second place, the extensibility and elasticity of its walls permit it to adapt its calibre to the amount and force with which the blood is flowing into it.

§ 108. *Arteries.* The wall of a *minute artery*, i.e. of one which is soon about to break up into capillaries, and which is sometimes spoken of as an *arteriole*, consists of the following parts.

There is within a lining of fusiform epithelioid cells, very similar to those of a capillary and similarly cemented together into a membrane. The long diameter of these fusiform cells, which are sometimes very narrow, is placed parallel to the axis of the artery.

Outside this epithelioid lining comes a thin transparent structureless or finely fibrillated membrane, seen in an optical or other section of the artery as a mere line, which serves as a supporting membrane, basement membrane, or *membrana propria*, for the epithelioid cells. This membrane is similar in chemical nature and in properties to the elastic fibres found in connective tissue, and hence is spoken of as the *elastic membrane*. The epithelioid cells and the elastic membrane together are often spoken of as forming the *inner coat (tunica intima)* of the artery.

Wrapped transversely in a more or less distinctly spiral manner round this inner coat, and imbedded in a small quantity of connective tissue, lie a number of plain muscular fibres, arranged in the smallest arteries in a single layer, in the larger but still small arteries in more than one layer. This forms in these arteries the *middle* or muscular coat (*tunica media*). Outside this muscular coat comes the external coat (*tunica externa*) consisting of connective tissue the bundles of which are disposed for the most part longitudinally and contain a number of connective tissue corpuscles and a relatively large number of elastic fibres. This outer coat is continuous with the connective tissue bed in which the artery lies.

A minute artery then differs from a capillary, in the thickness of its walls whereby the permeability so characteristic of the capillary is to a great extent lost, in the distinct development of elastic elements, the elastic membrane of the inner coat, and the elastic fibres of the outer coat, whereby elastic qualities are definitely assured to the walls of the vessel, and lastly and chiefly by the presence of distinct muscular elements. It is obvious, that while by the development of elastic elements, passive changes of calibre have a greater scope than in the capillary, active changes in calibre, which in the capillary are at best doubtful, are assured to the artery by the muscular elements. When these transversely disposed muscular fibres contract, they must narrow the calibre of the artery and may do that against even very considerable internal pressure; when they relax, they allow the internal pressure which may exist, to distend the vessel and temporarily to increase the calibre.

When such a small artery breaks up into capillaries the muscular fibres and elastic membrane disappear, the remnant of the muscular coat being sometimes continued for a short distance

in the form of a single fibre straggling in a spiral fashion round the artery towards the capillary, and all that is left is the epithelioid lining of the inner coat with a little connective tissue to represent the outer coat.

§ 109. The *larger arteries* resemble the minute arteries in so far that their walls may be considered as composed of three coats, but each of these coats is of a more or less complex nature, and the minor details of their structure differ in different arteries.

In such an artery as the carotid or radial, the three coats have the following general characters.

The inner coat is composed of a lining of epithelioid cells resting not on a single delicate basement membrane, but on an elastic layer of some thickness, consisting chiefly of a so-called "fenestrated" elastic membrane or of more than one such membrane, together with some amount of fine elastic fibres and in some cases at all events a small quantity of white connective tissue. A "fenestrated" membrane is a membrane composed of the same substance as the elastic fibres, perforated irregularly with holes, and more or less marked with indications of fibres; it may be regarded as a feltwork of elastic fibres, fused or beaten out, as it were, in a more or less complete membrane, some of the meshes of the feltwork remaining as 'fenestræ' and traces of the fibres being still left. Such fenestrated membranes, some thick, some thin, occur both in the inner and middle coats of the larger arteries; and in the inner coat, usually immediately under the epithelioid lining, there is in most large arteries a conspicuous membrane of this kind, sometimes so thick as to give a very distinct double outline in sections of the artery even under moderate powers. Beneath this there may be other similar fenestrated membranes, or a felt of fine elastic fibres held together by a very small quantity of white connective tissue. In the aorta, and in some other arteries, the epithelioid cells rest immediately not on an elastic membrane but on a thin layer of so-called "sub-epithelioid" tissue, which consists of connective tissue corpuscles imbedded in a homogeneous or very faintly fibrillated matrix or ground substance.

The epithelioid cells are disposed longitudinally, that is, with their long diameters parallel to the axis of the artery, and a similar longitudinal arrangement obtains to a greater or less extent in the underlying elastic elements. When after death the arteries, emptied of blood, become narrowed or constricted by the contraction of the muscular elements of the middle coat, the inner coat is thrown into longitudinal wrinkles or folds, so that in transverse sections of an artery in this condition the inner coat has a characteristic puckered appearance.

The inner coat is somewhat delicate, and easily torn, so that in injuries to arteries, as when an artery is forcibly ligatured, it is apt to be broken.

The middle coat, which is generally many times thicker than the inner coat, consists of elastic layers and muscular layers placed in more or less regular alternation. The muscular layers consist of bands of plain muscular fibres placed transversely and united together by a very small amount of white connective tissue. The elastic layers consist of somewhat thick fenestrated membranes or of feltworks of elastic fibres running on the whole longitudinally, but not unfrequently more or less obliquely; these are also bound together by a small quantity of white connective tissue.

The outer coat consists of feltworks of elastic fibres, or in some instances of fenestrated membranes, disposed chiefly longitudinally, and separated by bundles of ordinary white connective tissue, which become more and more predominant in the outer portions of the coat. In many arteries bands of plain muscular fibres are present in this coat also, and then run for the most part but not exclusively in a longitudinal direction.

Blood vessels for the nourishment of the tissue of the walls (*vasa vasorum*) are present in the larger arteries, being most abundant in the outer coat, but penetrating for some distance into the middle coat. Nerves, consisting chiefly of non-medullated fibres, may be traced through the outer coat into the middle coat where they appear to end in connection with the muscular fibres.

Lastly, in the case of most large arteries, the bed of connective tissue in which the artery runs, is formed into a more or less distinct sheath. In this sheath, the white connective tissue is much more abundant than are the yellow elastic elements, so that the sheath is far less elastic than the artery. Hence, when an artery and its sheath are completely cut across, the artery is, by elastic shrinking, retracted within its sheath.

The most important structural features of a large artery may then be summed up, by saying that the artery consists of a thin inner coat consisting of an epithelioid lining resting on an elastic basis of no conspicuous thickness, of a thick middle coat consisting partly of muscular fibres disposed for the most part transversely, and partly of stout elastic elements, this coat being the thickest and most important of all three coats, and of an outer coat of variable thickness consisting chiefly of elastic elements intermixed with an increasing amount of white connective tissue.

All arteries possess the above features. It may further be said, that as a general rule the muscular element bears a larger proportion to the elastic element in the smaller than in the larger arteries, that is to say, the smaller arteries are more conspicuously muscular, and the larger arteries more conspicuously elastic. It must be remembered however that the several arteries of the body differ considerably in minor features, such as the relative disposition and amount of muscular and elastic elements in the middle coat, the amount of muscular tissue in the outer coat, and the proportion of white connective tissue present and the like; in the aorta for

instance, a considerable quantity of white connective tissue is present in the middle and indeed in the inner coat, as well as in the outer coat. Leaving these smaller differences on one side we may say, that while all three coats, but especially the important middle coat, contribute to give an artery its characteristic elastic qualities, by virtue of which it expands readily under internal pressure, and shrinks again when the pressure is removed, it is the middle coat which by means of the abundant circularly disposed muscular fibres, now through the contraction of those fibres narrows and constricts, now through their relaxation permits the widening of the vessel. The importance of the inner coat is probably centred in the epithelioid lining; in treating of blood (§ 22) we saw reason to think that the blood vessels exerted a marked, though obscure influence on the blood streaming through them; that influence in all probability is effected by the epithelioid cells. The elastic elements of the inner coat are probably chiefly of value in permitting this coat to follow the changes of the more important middle coat. The outer coat, while increasing the elastic power of the whole vessel, is especially useful, by means of its small blood vessels, in conveying nourishment to the middle coat.

§ 110. *The Veins.* These vary in different parts of the body so very widely, that it is difficult to give a general description of structure suitable to all veins. It may be said however that they differ from arteries in having much thinner walls, and in those walls containing relatively much more white connective tissue, and much less yellow elastic tissue.

A large vein possesses like an artery an inner coat consisting of an epithelioid lining, the cells of which are shorter and broader than in the corresponding artery, resting on an elastic basis, which is less conspicuous than in the corresponding artery, and consists of a fine feltwork of fibres rather than a fenestrated membrane, and contains more white connective tissue.

In a medium sized vein such as the saphena vein it is possible to distinguish outside the inner coat, a middle and an outer coat. The former consists of white connective tissue, with a scanty supply of elastic fibres; it contains, sometimes in considerable quantity, plain muscular fibres, the bundles of which form a meshwork, with the meshes disposed for the most part transversely. The latter consists also of white connective tissue with some elastic fibres running longitudinally and obliquely, plain muscular fibres being sometimes present and when present disposed chiefly in a longitudinal direction. Small vasa vasorum are present in the outer coat and extend into the middle coat. In many large veins there is no sharp distinction between a middle and outer coat; the whole wrapping round the inner coat consists of white connective with a variable quantity of elastic tissue, and of muscular fibres which run chiefly longitudinally or obliquely and which may be very scanty, or which as in the vena porta: may be abundant. The

structure of the veins in fact varies very widely; on the whole they may be said to be channels, the walls of which are elastic enough to adapt themselves to considerable variations in the quantity of blood passing through them, without possessing, as do the arteries, a great store of elastic power to meet great variations in pressure, and which are not so uniformly muscular and contractile as are the arteries. And we shall see that this general character of passive channels is adapted to the work which the veins have to do. This general character however is modified in certain situations to meet particular wants; thus while the veins of the bones and of the brain are devoid of muscular fibres, others such as the vena portæ may be very muscular; and in some veins such as those of the extremities a considerable quantity of elastic tissue is present.

A *minute vein* just emerging from capillaries differs very little from an artery of corresponding size; it is of rather wider bore, has decidedly less muscular and elastic tissue, and the epithelioid cells are shorter and broader.

Many veins, especially those of the limbs, are provided with valves, which are pouch-like folds of the inner coat, the mouth of the pouch looking away from the capillaries towards the heart. The wall of each valve consists of a lining of epithelioid cells on the inside and on the outside, and between the two, a layer of white connective tissue strengthened with a few elastic fibres and somewhat thicker than the connective tissue basis of the epithelioid lining of the veins generally. The valves may occur singly or may lie two or even three abreast. The veins of the viscera, those of the central nervous system and its membranes, and of the bones, do not possess valves.

§ 111. The details of the structure of the peculiar muscular tissue forming the greater part of the heart we shall reserve to a later section; but we may here say that the interior of the heart is lined with a membrane (*endocardium*) corresponding to the inner coat of the blood vessels, and consisting of a layer of epithelioid cells, which however are shorter and broader than in the blood vessels, being polygonal rather than fusiform, resting on a connective tissue basis in which are present elastic fibres and in places plain muscular fibres.

The valves of the heart, like those of the veins, are folds of this lining membrane, strengthened by a considerable development of connective tissue. In the middle of the thin free border of each of the semilunar valves of the aorta and pulmonary artery bundles of this connective tissue, meeting together, are mixed with cartilage cells to form a small nodule of fibro-cartilage called the *Corpus Arantii*.

In the auriculo-ventricular valves muscular fibres pass in among the connective tissue for some little distance from the attached border.

In one respect, the endocardium differs from the inner coat of

the blood vessels; the connective tissue in it bears blood vessels and lymphatics. In the case of the auriculo-ventricular valves these blood vessels of the endocardium traverse the whole valve, but in the case of the semilunar valves stop short near the attached border so that the greater part of the valve is bloodless.

Main Features of the Apparatus.

§ 112. We may now pass briefly in review some of the main features of the several parts of the vascular apparatus, heart, arteries, veins and capillaries.

The heart is a muscular pump, that is a pump the force of whose strokes is supplied by the contraction of muscular fibres, working intermittently, the strokes being repeated so many times (in man about 72 times) a minute. It is so constructed and furnished with valves in such a way that at each stroke it drives a certain quantity of blood with a certain force and a certain rapidity from the left ventricle into the aorta and so into the arteries, receiving during the stroke and the interval between that stroke and the next, the same quantity of blood from the veins into the right auricle. We omit for simplicity's sake the pulmonary circulation by which the same quantity of blood is driven at the stroke from the right ventricle into the lungs and received into the left auricle. The rhythm of the beat, that is the frequency of repetition of the strokes, and the characters of each beat or stroke, are determined by changes taking place in the tissues of the heart itself, though they are also influenced by causes working from without.

The arteries are tubes, with relatively stout walls, branching from the aorta all over the body. The constitution of their walls, as we have seen, especially of the middle coat, gives the arteries two salient properties. In the first place they are *very elastic*, in the sense that they will stretch readily, both lengthways and crosswise, when pulled, and return readily to their former size and shape when the pull is taken off. If fluid be driven into one end of a piece of artery, the other end of which is tied, the artery will swell out to a very great extent, but return immediately to its former calibre when the fluid is let out. This elasticity is as we have seen chiefly due to the elastic elements in the coats, elastic membranes and feltworks, but the muscular fibres being themselves also elastic contribute to the result. By reason of their possessing such stout elastic walls the arteries when empty do not collapse but remain as open tubes. In the second place the arteries by virtue of their muscular elements are *contractile*; when stimulated either directly as by applying an electric or mechanical stimulus to the arterial walls or indirectly by means of the so-called vaso-motor nerves, which we shall have to study

presently, the arteries shrink in calibre, the circularly disposed muscular fibres contracting and so, in proportion to the amount of their contraction, narrowing the lumen or bore of the vessel. The contraction of these arterial muscular fibres, like that of all plain non-striated muscular fibres, is slow and long continued, with a long latent period, as compared with the contraction of skeletal striated muscular fibres. Owing to this muscular element in the arterial walls, the calibre of an artery may be very narrow, or very wide, or in an intermediate condition between the two, neither very narrow nor very wide, according as the muscular fibres are very much contracted, or not contracted at all, or only moderately contracted. We have further seen that, while the relative proportion of elastic and muscular elements differs in different arteries, as a general rule the elastic elements predominate in the larger arteries and the muscular elements in the smaller arteries, so that the larger arteries may be spoken of as eminently elastic, or as especially useful on account of their elastic properties, and the smaller arteries as eminently muscular, or as especially useful on account of their muscular properties. Thus in the minute arteries which are just passing into capillaries the muscular coat, though composed often of a single layer, and that sometimes an imperfect one, of muscular fibres, is a much more conspicuous and important part of the arterial wall than that furnished by the elastic elements.

The arteries branching out from a single aorta down to multi-
tudinous capillaries in nearly every part of the body, diminish in *
bore as they divide. Where an artery divides into two or gives off a branch, though the bore of each division is less than that of the artery before the division or branching, the two together are greater; that is to say the united sectional area of the branches is greater than the sectional area of the trunk. Hence the sectional area of the arterial bed through which the blood flows goes on increasing from the aorta to the capillaries. If all the arterial branches were thrown together into one channel, this would form a hollow cone with its apex at the aorta and its base at the capillaries. The united sectional area of the capillaries may be taken as several hundred times that of the sectional area of the aorta, so greatly does the arterial bed widen out.

The capillaries are channels of variable but exceedingly small size. The thin sheet of cemented epithelioid plates which forms the only wall of a capillary is elastic, permitting the channel offered by the same capillary to differ much in width at different times, to widen when blood and blood corpuscles are being pressed through it and to narrow again when the pressure is lessened or cut off. The same thin sheet permits water and substances, including gases, in solution to pass through itself from the blood to the tissue outside the capillary and from the tissue to the blood, and thus carries on the interchange of material between the

blood and the tissue. In certain circumstances at all events white and even red corpuscles may also pass through the wall to the tissue outside.

The minute arteries and veins with which the capillaries are continuous allow of a similar interchange of material, the more so the smaller they are.

The walls of the veins are thinner, weaker and less elastic than those of the arteries, and possess a very variable amount of muscular tissue; they collapse when the veins are empty. Though all veins are more or less elastic and some veins are distinctly muscular, the veins as a whole cannot, like the arteries, be characterized as eminently elastic and contractile tubes; they are rather to be regarded as simple channels for conveying the blood from the capillaries to the heart, having just so much elasticity as will enable them to accommodate themselves to the quantity of blood passing through them, the same vein being at one time full and distended and at another time empty and shrunk, and only gifted with any great amount of muscular contractility in special cases for special reasons. The united sectional area of the veins, like that of the arteries, diminishes from the capillaries to the heart; but the united sectional area of the *venæ cavæ* at their junction with the right auricle is greater than, nearly twice as great as, that of the aorta at its origin. The total capacity also of the veins is much greater than that of the arteries. The veins alone can hold the total mass of blood which in life is distributed over both arteries and veins. Indeed nearly the whole blood is capable of being received by what is merely a part of the venous system, viz. the *vena portæ* and its branches.

SEC. 2. THE MAIN FACTS OF THE CIRCULATION.

§ 113. Before we attempt to study in detail the working of these several parts of the mechanism it will be well, even at the risk of some future repetition, to take a brief survey of some of the salient features.

At each beat of the heart, which in man is repeated about 72 times a minute, the contraction or systole of the ventricles drives a certain quantity of blood, probably amounting to about 180 c.c. (4 to 6 oz.), with very great force into the aorta (and the same quantity of blood with less force into the pulmonary artery). The discharge of blood from the ventricle into the aorta is very rapid and the time taken up by it is, as we shall see, much less than the time which intervenes between it and the next discharge of the next beat. So that the flow from the heart into the arteries is most distinctly intermittent, sudden rapid discharges alternating with relatively long intervals during which the arteries receive no blood from the heart.

At each beat of the heart just as much blood flows, as we shall see, from the veins into the right auricle as escapes from the left ventricle into the aorta; but, as we shall also see, this inflow is much slower, takes a longer time, than the discharge from the ventricle.

When the finger is placed on an artery in the living body, a sense of resistance is felt, and this resistance seems to be increased at intervals, corresponding to the heart-beats, the artery at each heart-beat being felt to rise up or expand under the finger, constituting what we shall study hereafter as *the pulse*. In certain arteries this pulse may be seen by the eye. When the finger is similarly placed on a corresponding vein very little resistance is felt, and, under ordinary circumstances no pulse can be perceived by the touch or by the eye.

When an artery is severed, the flow of blood from the proximal

cut end, that on the heart side, is not equable, but comes in jets, corresponding to the heart-beats, though the flow does not cease between the jets. The blood is ejected with considerable force, and may in a large artery of a large animal be spurted out to the distance of some feet. The larger the artery and the nearer to the heart, the greater the force with which the blood issues, and the more marked the intermittence of the flow. The flow from the distal cut end, that away from the heart, may be very slight, or may take place with considerable force and marked intermittence, according to the amount of collateral communication.

When a corresponding vein is severed, the flow of blood, which is chiefly from the distal cut end, that in connection with the capillaries, is not jerked but continuous; the blood comes out with comparatively little force, and 'wells up' rather than 'spurts out'. The flow from the proximal cut end, that on the heart side, may amount to nothing at all, or may be slight, or may be considerable, depending on the presence or absence of valves and the amount of collateral communication.

When an artery is ligatured the vessel swells on the proximal side, towards the heart, and the throbbing of the pulse may be felt right up to the ligature. On the distal side the vessel is empty and shrunk and no pulse can be felt in it unless there be free collateral communication.

When a vein is ligatured the vessel swells on the distal side, away from the heart, but no pulse is felt; while on the proximal side, towards the heart, it is empty and collapsed unless there be too free collateral communication.

§ 114. When the interior of an artery, for instance the carotid, is placed in communication with a long glass tube of not too great a bore, held vertically, the blood, immediately upon the communication being effected, may be seen to rush into and to fill the tube for a certain distance, forming in it a column of blood of a certain height. The column rises not steadily but by leaps, each leap corresponding to a heart-beat, and each leap being less than its predecessor; and this goes on, the increase in the height of the column at each heart-beat each time diminishing, until at last the column ceases to rise and remains for a while at a mean level, above and below which it oscillates with slight excursions at each heart-beat.

To introduce such a tube an artery, say the carotid of a rabbit, is laid bare, ligatured at a convenient spot, *l'* Fig. 25, and further temporarily closed a little distance lower down nearer the heart by a small pair of 'bull dog' forceps, *bd*, or by a ligature which can be easily slipped. A longitudinal incision is now made in the artery between the forceps, *bd*, and the ligature *l'* (only the drop or two of blood which happens to remain enclosed between the two being lost): the end of the tube, represented by *c* in the figure, is introduced into the artery and secured by the ligature *l*. The interior of the tube is

now in free communication with the interior of the artery, but the latter is by means of the forceps at present shut off from the heart. On removing the forceps a direct communication is at once established between the tube and the artery below; in consequence the blood from the heart flows through the artery into the tube.

This experiment shews that the blood as it is flowing into the carotid is exerting a considerable pressure on the walls of the artery. At the moment when the forceps are removed there is nothing but the ordinary pressure of the atmosphere to counter-balance this pressure within the artery, and consequently a quantity of blood is pressed out into the tube; and this goes on until the column of blood in the tube reaches such a height that its weight is equal to the pressure within the artery, whereupon no more blood escapes. The whole column continues to be raised a little at each heart-beat but sinks as much during the interval between each two beats, and thus oscillates, as we have said, above and below a mean level. In a rabbit this column of blood will generally have the height of about 90 cm. (3 feet); that is to say the pressure which the blood exerts on the walls of the carotid of a rabbit is equal to the pressure exerted by a column of rabbit's blood 90 cm. high. This is equal to the pressure of a column of water about 95 cm. high and to the pressure of a column of mercury about 70 mm. high.

If a like tube be similarly introduced into a corresponding vein, say the jugular vein, it will be found that the column of blood, similarly formed in the tube, will be a very low one, not more than a very few centimeters high, and that while the level of the column may vary a good deal, owing as we shall see later to the influence of the respiratory movements, there will not, as in the artery, be oscillations corresponding to the heart-beats.

We learn then from this simple experiment that in the carotid of the rabbit the blood while it flows through that vessel is exerting a considerable mean pressure on the arterial walls, equivalent to that of a column of mercury about 70 mm. high, but that in the jugular vein the blood exerts on the venous walls a very slight mean pressure, equivalent to that of a column of mercury three or four mm. high. We speak of this mean pressure exerted by the blood on the walls of the blood vessels as *blood-pressure*, and we say that the blood-pressure in the carotid of the rabbit is very high (70 mm. Hg.), while that in the jugular vein is very low (only 3 or 4 mm. Hg.).

In the normal state of things the blood flows through the carotid to the arterial branches beyond, and through the jugular vein towards the heart; the pressure exerted by the blood on the artery or on the vein is a *lateral* pressure on the walls of the artery and vein respectively. In the above experiment the pressure measured is not exactly this, but the pressure exerted at the end of the artery (or of the vein) where the tube is attached. We

might directly measure the lateral pressure in the carotid by somewhat modifying the procedure described above. We might connect the carotid with a tube the end of which was not straight but made in the form of a \perp piece, and might introduce the \perp piece in such a way that the blood should flow along one limb (the vertical limb) of the \perp piece from the proximal to the distal part of the carotid, and at the same time by the other (horizontal) limb of the \perp piece into the main upright part of the glass tube. The column of blood in the tube would then be a measure of the pressure which the blood as it is flowing along the carotid is exerting on a portion of its walls corresponding to the mouth of the horizontal limb of the \perp piece. If we were to introduce into the aorta, at the place of origin of the carotid, a similar (larger) \perp piece and to connect the glass tube with the horizontal limb of the \perp piece by a piece of elastic tubing of the same length and bore as the carotid, the column of blood rising up in the tube would be the measure of the lateral pressure exerted by the blood on the walls of the aorta at the origin of the carotid artery and transmitted to the rigid glass tube through a certain length of elastic tubing. And indeed what is measured in the experiment previously described is not the lateral pressure in the carotid itself at the spot where the glass tube is introduced, but the lateral pressure of the aorta at the origin of the carotid modified by the influences exerted by the length of the carotid between its origin and the spot where the tube is introduced.

§ 115. Such an experiment as the one described has the disadvantages that the animal is weakened by the loss of the blood which goes to form the column in the tube, and that the blood in the tube soon clots and so brings the experiment to an end. Blood-pressure may be more conveniently studied by connecting the interior of the artery (or vein) with a mercury gauge or manometer, Fig. 25, the proximal, descending limb of which, m , is filled above the mercury with some innocuous fluid, as is also the tube connecting the manometer with the artery. Using such an instrument we should observe very much the same facts as in the more simple experiment.

Immediately that communication is established between the interior of the artery and the manometer, blood rushes from the former into the latter, driving some of the mercury from the descending limb, m , into the ascending limb, m' , and thus causing the level of the mercury in the ascending limb to rise rapidly. This rise is marked by jerks corresponding with the heart-beats. Having reached a certain level, the mercury ceases to rise any more. It does not, however, remain absolutely at rest, but undergoes oscillations; it keeps rising and falling. Each rise, which is very slight compared with the total height to which the mercury has risen, has the same rhythm as the systole of the ventricle. Similarly, each fall corresponds with the diastole.

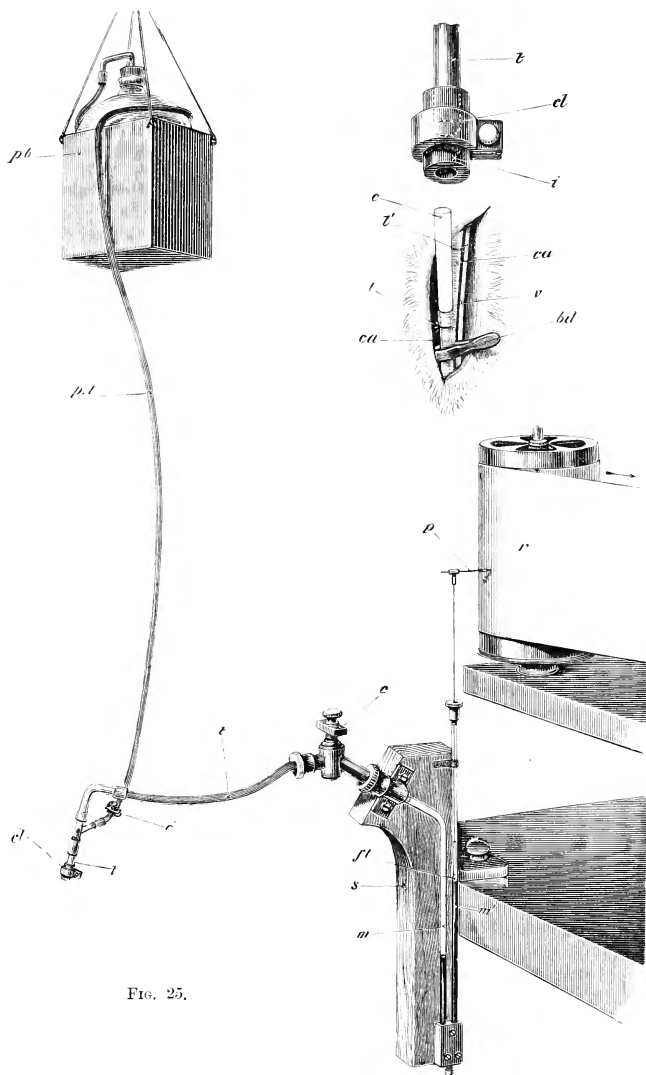

FIG. 25.

FIG. 25. APPARATUS FOR INVESTIGATING BLOOD-PRESSURE.

At the upper right-hand corner is seen, on an enlarged scale, the carotid artery, clamped by the forceps *bd*, with the vagus nerve *v* lying by its side. The artery has been ligatured at *l'* and the glass cannula *c* has been introduced into the artery between the ligature *l'* and the forceps *bd*, and secured in position by the ligature *l*. The shrunken artery on the distal side of the cannula is seen at *ca'*.

p.b. is a box containing a bottle holding a saturated solution of sodium carbonate or a solution of sodium bicarbonate of sp. gr. 1083, and capable of being raised or lowered at pleasure. The solution flows by the tube *p.t.* regulated by the clamp *c''* into the tube *t*. A syringe, with a stopcock, may be substituted for the bottle, and attached at *c''*. This indeed is in many respects a more convenient plan. The tube *t* is connected with the leaden tube *t*, and the stopcock *c* with the manometer, of which *m* is the descending and *m'* the ascending limb, and *s* the support. The mercury in the ascending limb bears on its surface the float *fl*, a long rod attached to which is fitted with the pen *p*, writing on the recording surface *r*. The clamp *cl* at the end of the tube *t* has an arrangement shewn on a larger scale at the right hand upper corner.

The descending tube *m* of the manometer and the tube *t* being completely filled along its whole length with fluid to the exclusion of all air, the cannula *c* is filled with fluid, slipped into the open end of the thick-walled india-rubber tube *i*, until it meets the tube *t* (whose position within the india-rubber tube is shewn by the dotted lines), and is then securely fixed in this position by the clamp *cl*.

The stopcocks *c* and *c''* are now opened, and the pressure-bottle raised or fluid driven in by the syringe until the mercury in the manometer is raised to the required height. The clamp *c''* is then closed and the forceps *bd* removed from the artery. The pressure of the blood in the carotid *ca*. is in consequence brought to bear through *t* upon the mercury in the manometer.

If a float, swimming on the top of the mercury in the ascending limb of the manometer, and bearing a brush or other marker, be brought to bear on a travelling surface, some such tracing as that represented in Fig. 26 will be described. Each of the smaller

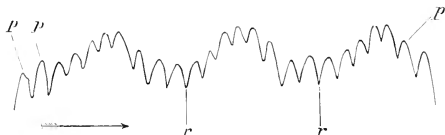

FIG. 26. TRACING OF ARTERIAL PRESSURE WITH A MERCURY MANOMETER.

The smaller curves *p p* are the pulse-curves. The space from *r* to *r* embraces a respiratory undulation. The tracing is taken from a dog, and the irregularities visible in it are those frequently met with in this animal.

curves (*p, p*) corresponds to a heart-beat, the rise corresponding to the systole and the fall to the diastole of the ventricle. The larger undulations (*r, r*) in the tracing, which are respiratory in origin, will be discussed hereafter. In Fig. 27 are given two tracings taken from the carotid of a rabbit; in the lower curve the recording surface is travelling more rapidly than in the upper curve; otherwise the curves are alike and repeat the general features of the curve from the dog.

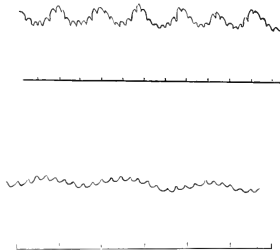

FIG. 27. BLOOD-PRESSURE CURVES FROM THE CAROTID OF RABBIT, THE TIME MARKER IN EACH CASE MARKING SECONDS.

Description of Experiment. Into a carotid, or other blood vessel, prepared as explained, a small glass tube, of suitable bore, called a *cannula*, is introduced by the method described above, and is subsequently connected, by means of a short piece of india-rubber tubing (Fig. 25 *i*), and a leaden or other tube *t* which is at once flexible and yet not extensible, with the descending limb, *m*, of the manometer or mercury gauge. The cannula, tube and descending limb of the manometer are all filled with some fluid, which tends to prevent clotting of the blood, the one chosen being generally a strong solution (sp. gr. 1083) of sodium bicarbonate, but other fluids may be chosen. In order to avoid loss of blood, a quantity of fluid is injected into the flexible tube sufficient to raise the mercury in the ascending limb of the manometer to a level a very little below what may be beforehand guessed at as the probable mean pressure. When the forceps *bd* are removed, the pressure of the blood in the carotid is transmitted through the flexible tube to the manometer, the level of the mercury in the ascending limb of which falls a little, or sinks a little at first, or may do neither, according to the success with which the probable mean pressure has been guessed, and continues to exhibit the characteristic oscillations until the experiment is brought to an end by the blood clotting or otherwise.

Tracings of the movements of the column of mercury in the manometer may be taken either on a smoked surface of a revolving cylinder (Fig. 1), or by means of a brush and ink on a continuous roll of paper, as in the more complex kymograph (Fig. 28).

§ 116. By the help of the manometer applied to various arteries and veins we learn the following facts.

(1) The mean blood pressure is high in all the arteries, but is greater in the larger arteries nearer the heart than in the smaller arteries farther from the heart; it diminishes in fact along the arterial tract from the heart towards the capillaries.

(2) The mean blood pressure is low in the veins but is greater in the smaller veins nearer the capillaries than in the larger veins nearer the heart, diminishing in fact from the capillaries towards the heart. In the large veins near the heart it may be *negative*,

that is to say the pressure of blood in the vein bearing on the proximal descending limb of the manometer may be less than

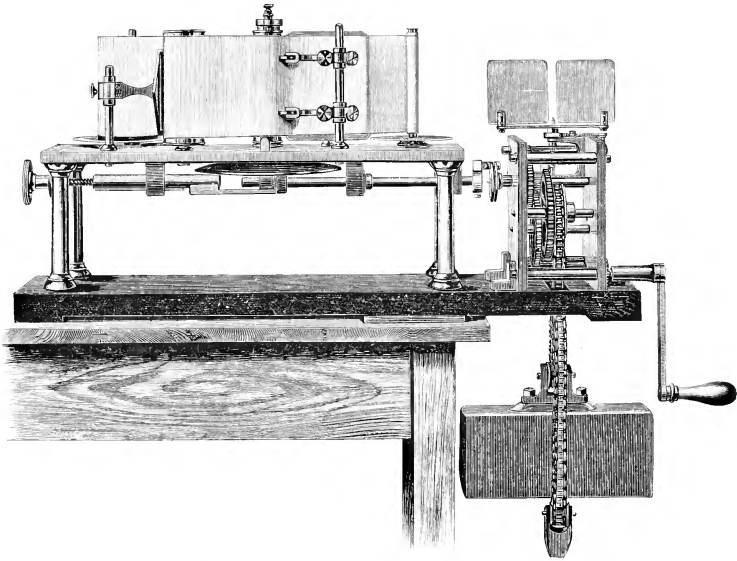

FIG. 28. LUDWIG'S KYMOGRAPH FOR RECORDING ON A CONTINUOUS ROLL OF PAPER.

the pressure of the atmosphere on the ascending distal limb, so that when communication is made between the interior of the vein and the manometer, the mercury sinks in the distal and rises in the proximal limb, being sucked up towards the vein.

The manometer cannot well be applied to the capillaries, but we may measure the blood-pressure in the capillaries in an indirect way. It is well known that when any portion of the skin is pressed upon, it becomes pale and bloodless; this is due to the pressure driving the blood out of the capillaries and minute vessels and preventing any fresh blood entering into them. By carefully investigating the amount of pressure necessary to prevent the blood entering the capillaries and minute arteries of the web of the frog's foot, or of the skin beneath the nail or elsewhere in man, the internal pressure which the blood is exercising on the walls of the capillaries and minute arteries and veins may be approximately determined. In the frog's web this has been found to be equal to about 7 or 11 mm. mercury. In the mammal the capillary blood-pressure is naturally higher than this and may be put down at

from 20 to 30 mm. It is therefore considerable, being greater than that in the veins though less than that in the arteries.

(3) There is thus a continued decline of blood-pressure from the root of the aorta, through the arteries, capillaries and veins to the right auricle. We find, however, on examination that the most marked fall of pressure takes place between the small arteries on the one side of the capillaries and the small veins on the other, the curve of pressure being somewhat of the form given in Fig. 29, which is simply intended to shew this fact graphically and has not been constructed by exact measurements.

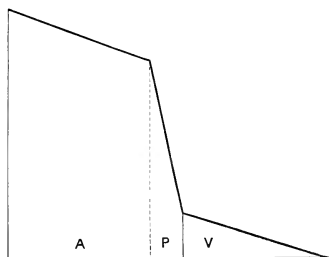

FIG. 29. DIAGRAM OF BLOOD-PRESSURE.

A, Arteries. *P*, Peripheral Region (minute arteries, capillaries and veins).
V, Veins.

(4) In the arteries this mean pressure is marked by oscillations corresponding to the heart-beats, each oscillation consisting of a rise (increase of pressure above the mean) corresponding to the systole of the ventricle, followed by a fall (decrease of pressure below the mean) corresponding to the diastole of the ventricle.

(5) These oscillations, which we may speak of as the pulse, are largest and most conspicuous in the large arteries near the heart, diminish from the heart towards the capillaries, and are, under ordinary circumstances, wholly absent from the veins along their whole extent from the capillaries to the heart.

Obviously a great change takes place in that portion of the circulation which comprises the capillaries, the minute arteries leading to and the minute veins leading away from the capillaries, and which we may speak of as the "peripheral region." It is here that a great drop of pressure takes place; it is here also that the pulse disappears.

§ 117. If the web of a frog's foot be examined with a microscope, the blood, as judged of by the movements of the corpuscles, is seen to be passing in a continuous stream from the small arteries through the capillaries to the veins. The velocity is greater in the arteries than in the veins, and greater in both than in the capillaries. In the arteries faint pulsations, synchronous

with the heart's beat, are frequently visible; but these disappear in the capillaries, in which the flow is even, that is, not broken by pulsations, and this evenness of flow is continued on along the veins as far as we can trace them. Not infrequently variations in velocity and in the distribution of the blood, due to causes which will be hereafter discussed, are witnessed from time to time.

The character of the flow through the smaller capillaries is very variable. Sometimes the corpuscles are seen passing through the channel in single file with great regularity; at other times they may be few and far between. Some of the capillaries, as we have said § 107, are wide enough to permit two or more corpuscles abreast. In all cases the blood as it passes through the capillary stretches and expands the walls. Sometimes a corpuscle may remain stationary at the entrance into a capillary, the channel itself being for some little distance entirely free from corpuscles. Sometimes many corpuscles will appear to remain stationary in one or more capillaries for a brief period and then to move on again. Any one of these conditions readily passes into another; and, especially with a somewhat feeble circulation, instances of all of them may be seen in the same field of the microscope. It is only when the vessels of the web are unusually full of blood that all the capillaries can be seen equally filled with corpuscles. The long oval red corpuscle moves with its long axis parallel to the stream, occasionally rotating on its long axis, and sometimes, in the larger channels, on its short axis. The flexibility and elasticity of a corpuscle are well seen when it is being driven into a capillary narrower than itself, or when it becomes temporarily lodged at the angle between two diverging channels.

These and other phenomena, on which we shall dwell later on, may be readily seen in the web of the frog's foot or in the stretched-out tongue or in the mesentery of the frog; and essentially similar phenomena may be observed in the mesentery or other transparent tissue of a mammal. All over the body, wherever capillaries are present, the corpuscles and the plasma are being driven in a continuous, and though somewhat irregular, yet on the whole steady flow through channels so minute that the passage is manifestly attended with considerable difficulties.

It is obvious that the peculiar characters of the flow through the minute arteries, capillaries and veins affords an explanation of the great change, taking place in the peripheral region, between the arterial flow and the venous flow. The united sectional area of the capillaries is, as we have seen, some hundreds of times greater than the sectional area of the aorta; but this united sectional area is made up of thousands of minute passages, varying in man from 5 to 20 μ , some of them, therefore, being in an undistended condition, smaller than the diameter of a red corpuscle. Even were the blood a simple liquid free from all

corpuscles, these extremely minute passages would occasion an enormous amount of friction, and thus present a considerable obstacle or resistance to the flow of blood through them. Still greater must be the friction and resistance occasioned by the actual blood with its red and white corpuscles. The blood in fact meets with great difficulties in its passage through the peripheral region, and sometimes, as we shall see, the friction and resistance are so great in the peripheral vessels of this or that area that no blood passes through them at all, and an arrest of the flow takes place in the area.

The resistance to the flow of blood thus caused by the friction generated in so many minute passages is one of the most important physical facts in the circulation. In the large arteries the friction is small; it increases gradually as they divide, but receives its chief and most important addition in the minute arteries and capillaries, it is relatively greater in the minute arteries than in the capillaries on account of the flow being more rapid in the former, for friction diminishes rapidly with a diminution in the rate of flow. We may speak of it as the 'peripheral friction,' and the resistance which it offers as the 'peripheral resistance.' It need perhaps hardly be said that this peripheral resistance not only opposes the flow of blood through the capillaries and minute arteries themselves where it is generated, but, working backwards along the whole arterial system, has to be overcome by the heart at each systole of the ventricle.

Hydraulic Principles of the Circulation.

§ 118. In the circulation then the following three facts of fundamental importance are met with:

1. The systole of the ventricle, driving at intervals a certain quantity of blood, with a certain force, into the aorta.
2. The peripheral resistance just described.
3. A long stretch of elastic tubing (the arteries), reaching from the ventricle to the region of peripheral resistance.

From these facts we may explain the main phenomena of the circulation, which we have previously sketched, on purely physical principles without any appeal to the special properties of living tissues, beyond the provision that the ventricle remains capable of good rhythmical contractions, that the arterial walls retain their elasticity, and that the friction between the blood and the lining of the peripheral vessels remains the same; we may thus explain the high pressure and pulsatile flow in the arteries, the steady stream through the capillaries, the low pressure and the uniform pulseless flow in the veins, and finally the continued flow of the blood from the aorta to the mouths of the venæ cavæ.

All the above phenomena in fact are the simple results of an

intermittent force (like that of the systole of the ventricle) working in a closed circuit of branching tubes, so arranged that while the individual tubes first diminish in calibre (from the heart to the capillaries) and then increase (from the capillaries to the heart), the area of the bed first increases and then diminishes, the tubes together thus forming two cones placed base to base at the capillaries, with their apices converging to the heart, and presenting at their conjoined bases a conspicuous peripheral resistance, the tubing on one side, the arterial, being eminently elastic, and on the other, the venous, affording a free and easy passage for the blood. It is the peripheral resistance (for the resistance offered by the friction in the larger vessels may, when compared with this, be practically neglected), reacting through the elastic walls of the arteries upon the intermittent force of the heart, which gives the circulation of the blood its peculiar features.

§ 119. *Circumstances determining the character of the flow.* When fluid is driven by an intermittent force, as by a pump, through a perfectly rigid tube, such as a glass one (or a system of such tubes), there escapes at each stroke of the pump from the distal end of the tube (or system of tubes) just as much fluid as enters it at the proximal end. What happens is very like what would happen if, with a wide glass tube completely filled with billiard balls lying in a row, an additional ball were pushed in at one end; each ball would be pushed on in turn a stage further and the last ball at the further end would tumble out. The escape moreover takes place at the same time as the entrance.

This result remains the same when any resistance to the flow is introduced into the tube, as for instance when the end of the tube is narrowed. The force of the pump remaining the same, the introduction of the resistance undoubtedly lessens the quantity of fluid issuing at the distal end at each stroke, but it at the same time lessens the quantity entering at the proximal end; the inflow and outflow remain equal to each other, and still occur at the same time.

In an elastic tube, such as an indiarubber one (or in a system of such tubes), whose sectional area is sufficiently great to offer but little resistance to the progress of the fluid, the flow caused by an intermittent force is also intermittent. The outflow being nearly as easy as the inflow, the elasticity of the walls of the tube is scarcely at all called into play. The tube behaves practically like a rigid tube. When, however, sufficient resistance is introduced into any part of the course, the fluid, being unable to pass by the resistance as rapidly as it enters the tube from the pump, tends to accumulate on the proximal side of the resistance. This it is able to do by expanding the elastic walls of the tube. At each stroke of the pump a certain quantity of fluid enters the tube at the proximal end. Of this only a fraction can pass through the resistance during the stroke. At the moment when

the stroke ceases, the rest still remains on the proximal side of the resistance, the elastic tube having expanded to receive it. During the interval between this and the next stroke, the distended elastic tube, striving to return to its natural undistended condition, presses on this extra quantity of fluid which it contains and tends to drive it past the resistance.

Thus in the rigid tube (and in the elastic tube without the resistance) there issues, from the distal end of the tube, at each stroke, just as much fluid as enters it at the proximal end, while between the strokes there is perfect quiet. In the elastic tube with resistance, on the contrary, the quantity which passes the resistance is only a fraction of that which enters the tube from the pump at any one stroke, the remainder or a portion of the remainder continuing to pass during the interval between the strokes. In the former case, the tube is no fuller at the end of the stroke than at the beginning; in the latter case there is an accumulation of fluid between the pump and the resistance, and a corresponding distension of that part of the tube, at the close of each stroke—an accumulation and distension, however, which go on diminishing during the interval between that stroke and the next. The amount of fluid thus remaining after the stroke will depend on the amount of resistance in relation to the force of the stroke, and on the distensibility of the tube; and the amount which passes the resistance before the next stroke will depend on the degree of elastic reaction of which the tube is capable. Thus, if the resistance be very considerable in relation to the force of the stroke, and the tube very distensible, only a small portion of the fluid will pass the resistance, the greater part remaining lodged between the pump and the resistance. If the elastic reaction be great, a large portion of this will be passed on through the resistance before the next stroke comes. In other words, the greater the resistance (in relation to the force of the stroke), and the more the elastic force is brought into play, the less intermittent, the more nearly continuous, will be the flow on the far side of the resistance.

If the first stroke be succeeded by a second stroke before its quantity of fluid has all passed by the resistance, there will be an additional accumulation of fluid on the near side of the resistance, an additional distension of the tube, an additional strain on its elastic powers, and, in consequence, the flow between this second stroke and the third will be even more marked than that between the first and the second, though all three strokes were of the same force, the addition being due to the extra amount of elastic force called into play. In fact, it is evident that, if there be a sufficient store of elastic power to fall back upon, by continually repeating the strokes a state of things will be at last arrived at, in which the elastic force, called into play by the continually increasing distension of the tube on the near side of the resistance, will be sufficient to drive through the resistance, between each two strokes,

just as much fluid as enters the near end of the system at each stroke. In other words, the elastic reaction of the walls of the tube will have converted the intermittent into a continuous flow. The flow on the far side of the resistance is in this case not the *direct* result of the strokes of the pump. All the force of the pump is spent, first in getting up, and afterwards in keeping up, the distension of the tube on the near side of the resistance; the immediate cause of the continuous flow lies in the distension of the tube which leads it to empty itself into the far side of the resistance, at such a rate, that it discharges through the resistance during a stroke and in the succeeding interval just as much as it receives from the pump by the stroke itself.

This is exactly what takes place in the vascular system. The friction in the minute arteries and capillaries presents a considerable resistance to the flow of blood through them into the small veins. In consequence of this resistance, the force of the heart's beat is spent in maintaining the whole of the arterial system in a state of great distension; the arterial walls are put greatly on the stretch by the pressure of the blood thrust into them by the repeated strokes of the heart; this is the pressure which we spoke of above as blood-pressure. The greatly distended arterial system is, by the elastic reaction of its elastic walls, continually tending to empty itself by overflowing through the capillaries into the venous system; and it overflows at such a rate, that just as much blood passes from the arteries to the veins during each systole and its succeeding diastole as enters the aorta at each systole.

§ 120. Indeed the important facts of the circulation which we have as yet studied may be roughly but successfully imitated on an artificial model, Fig. 30, in which an elastic syringe represents the heart, a long piece of elastic indiarubber tubing the arteries, another piece of tubing the veins, and a number of smaller connecting pieces the minute arteries and capillaries. If these connecting pieces be made at first somewhat wide, so as to offer no great resistance to the flow from the artificial arteries to the artificial veins, but be so arranged that they may be made narrow, by the screwing-up of clamps or otherwise, it is possible to illustrate the behaviour of the vascular mechanism when the peripheral resistance is less than usual (and as we shall see later on, it is possible in the living organism either to reduce or to increase what may be considered as the normal peripheral resistance) and to compare that behaviour with the behaviour of the mechanism when the peripheral resistance is increased.

The whole apparatus being placed flat on a table, so as to avoid differences in level in different parts of it, and filled with water, but so as not to distend the tubing, the two manometers attached, one, *A*, to the arterial side of the tubing and the other, *V*, to the venous side, ought to shew the mercury standing at equal heights in both limbs of both instruments, since nothing but the pressure of the atmo-

sphere is bearing on the fluid in the tubes, and that equally all over.

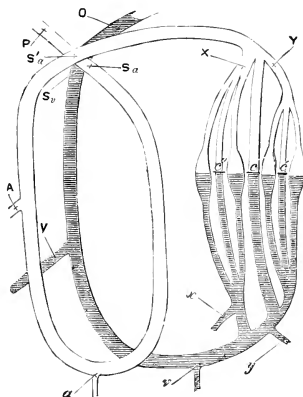

FIG. 30. ARTERIAL SCHEME.

P, unshaded, is an elastic tube to represent the arterial system branching at *X* and *Y*, and ending in the region of peripheral resistance, including the capillaries, which are imitated by filling loosely with small pieces of sponge the parts shewn as dilated in the figure. The capillaries are gathered up into the venous system, shaded, which terminates at *O*. Water is driven into the arterial system at *P* by means of an elastic bag-syringe or any other form of pump. Clamps are placed on the undilated tubes *c*, *c'*, *c''*. When these clamps are tightened the only access for the water from the arterial to the venous side is through the dilated parts filled with sponge, which offer a considerable resistance to the flow of fluid through them. When the clamps are unloosed the fluid passes, with much less resistance, through the undilated tubes. Thus by tightening or loosening the clamps the "peripheral" resistance may be increased or diminished at pleasure.

At *A*, on the arterial side, and at *V*, on the venous side, manometers can be attached. At *a* and *v* (and also at *x* and *y*) by means of clamps, the flow of fluid from an artery and from a vein, under various conditions, may be observed. At *Sa*, *S'a*, and *Sv*. sphygmographs may be applied.

If now, the connecting pieces being freely open, that is to say the peripheral resistance being very little, we imitate a ventricular beat by the stroke of the pump, we shall observe the following. Almost immediately after the stroke the mercury in the arterial manometer will rise, but will at once fall again, and very shortly afterwards the mercury in the venous tube will in a similar manner rise and fall. If we repeat the strokes with a not too rapid rhythm, each stroke having the same force, and make, as may be effected, the two manometers write on the same recording surface, we shall obtain curves like those of Fig. 31, *A* and *V*. At each stroke of the pump the mercury in the arterial manometers rises, but forthwith falls again to or nearly to

the base line; no mean arterial pressure, or very little, is established. The contents of the ventricle (syringe) thrown into the

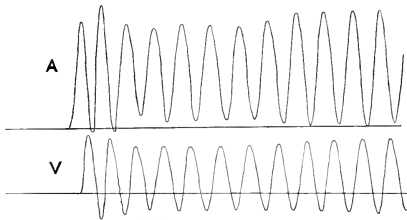

FIG. 31. TRACINGS TAKEN FROM AN ARTIFICIAL SCHEME WITH THE PERIPHERAL RESISTANCE SLIGHT.

A, Arterial, V, Venous Manometer. This figure, to save space, is on a smaller scale than the corresponding Fig. 31*.

arterial system distend it, but the passage through the peripheral region is so free that an equal quantity of fluid passes through to the veins immediately, and hence the mercury at once falls. But the fluid thus passing easily into the veins distends these too, and the mercury in their manometer rises too, but only to fall again, as a corresponding quantity issues from the ends of the veins into the basin, which serves as an artificial auricle. Now introduce 'peripheral resistance' by screwing up the clamps on the connecting tubes, and set the pump to work again as before. With the first stroke the mercury in the arterial manometer, Fig. 31* A', rises as before, but instead of falling rapidly it falls slowly, because it now takes a longer time for a quantity of fluid equal to that which has been thrust into the arterial system by the ventricular stroke to pass through the narrowed peripheral region. Before the curve has fallen to the base line, before the arterial system has had time to discharge through the narrowed peripheral region as much fluid as it received from the ventricle, a second stroke drives more fluid into the arteries, distending them this time more than it did before and raising the mercury to a still higher level. A third, a fourth and succeeding strokes produce the same effect, except that the *additional* height to which the mercury is raised at each stroke becomes at each stroke less and less, until a state of things is reached in which the mercury being on the fall when the stroke takes place is by the stroke raised just as high as it was before, and then beginning to fall again is again raised just as high, and so on. With each succeeding stroke the arterial system has become more and more distended; but the more distended it is the greater is the elastic reaction brought into play; this greater elastic reaction more and more overcomes the obstacle presented by the peripheral

resistance and drives the fluid more and more rapidly through the peripheral region. At last the arterial system is so distended,

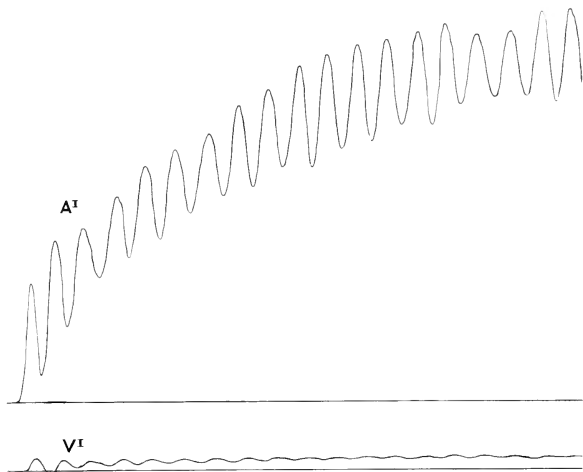

FIG. 31*. TRACINGS TAKEN FROM AN ARTIFICIAL SCHEME WITH THE PERIPHERAL RESISTANCE CONSIDERABLE.

A', Arterial, V', Venous Manometer.

and the force of the elastic reaction so great, that during the stroke and the succeeding interval just as much fluid passes through the peripheral region as enters the arteries at the stroke. In other words, the repeated strokes have established a mean arterial pressure which at the point where the manometer is affixed is raised slightly at each ventricular stroke and falls slightly between the strokes.

Turning now to the venous manometer, Fig. 31* V', we observe that each stroke of the pump produces on this much less effect than it did before the introduction of the increased peripheral resistance. The mercury, instead of distinctly rising and falling at each stroke, now shews nothing more than very gentle undulations; it feels to a very slight degree only the *direct* effect of the ventricular stroke; it is simply raised slightly above the base line and remains fairly steady at this level. The slight rise marks the mean pressure exerted by the fluid at the place of attachment of the manometer. This mean 'venous' pressure is a continuation of the mean arterial pressure so obvious in the arterial manometer, but is much less than that because a large part of the arterial mean pressure has been expended in driving the fluid past

the peripheral resistance. What remains is however sufficient to drive the fluid along the wide venous tubing right to the open end.

Thus this artificial model may be made to illustrate how it comes about that the blood flows in the arteries at a relatively high pressure, which at each ventricular systole is raised slightly above, and at each diastole falls slightly below, a certain mean level, and flows in the veins at a much lower pressure, which does not shew the immediate effects of each heart-beat.

If two manometers, instead of one, were attached to the arterial system, one near the pump and the other farther off, close to the peripheral resistance, the pressure shewn by the near manometer would be found to be greater than that shewn by the far one. The pressure at the far point is less because some of the pressure exerted at the near point has been used to drive the fluid from the near point to the far one. Similarly on the venous side, a manometer placed close to the peripheral region would shew a higher pressure than that shewn by one farther off, because it is the pressure still remaining in the veins near the capillaries which, assisted as we shall see by other events, drives the blood onward to the larger veins. The blood-pressure is at its highest at the root of the aorta, and at its lowest at the mouths of the venæ cavæ, and is falling all the way from one point to the other, because all the way it is being used up to move the blood from one point to the other. The great drop of pressure is, as we have said, in the peripheral region, because more work has to be done in driving the blood through this region than in driving the blood from the heart to this region or from this region to the heart.

The manometer on the arterial side of the model shews, as we have seen, an oscillation of pressure, a pulse due to each heart-beat, and the same pulse may be felt by placing a finger or rendered visible by placing a light lever on the arterial tube. It may further be seen that this pulse is most marked nearest the pump and becomes fainter as we pass to the periphery; but we must reserve the features of the pulse for a special study. On the venous side of the model no pulse can be detected by the manometer or by the finger, provided that the peripheral resistance be adequate. If the peripheral resistance be diminished, as by unscrewing the clamps, then, as necessarily follows from what has gone before, the pulse passes over on to the venous side; and, as we shall have occasion to point out later on, in the living organism the peripheral resistance in particular areas may be at times so much lessened that a distinct pulsation appears in the veins.

If in the model, when the pump is in full swing, and arterial pressure well established, the arterial tube be pricked or cut or the small side tube *a* be opened, the water will gush out in jets, as does blood from a cut artery in the living body, whereas if the

venous tube be similarly pricked or cut, or the small tube *v* be opened, the water will simply ooze out or well up, as does blood from a vein in the living body. If the arterial tube be ligatured, it will swell on the pump side and shrink on the peripheral side; if the venous tube be ligatured, it will swell on the side nearest the capillaries and shrink on the other side. In short, the dead model will shew all the main facts of the circulation which we have as yet described.

§ 121. In the living body, however, there are certain helps to the circulation which cannot be imitated by such a model without introducing great and undesirable complications; but these chiefly affect the flow along the veins.

The veins are in many places provided with valves so constructed as to offer little or no resistance to the flow from the capillaries to the heart, but effectually to block a return towards the capillaries. Hence any external pressure brought to bear upon a vein tends to help the blood to move forward towards the heart. In the various movements carried out by the skeletal muscles, such an external pressure is brought to bear on many of the veins, and hence these movements assist the circulation. Even passive movements of the limbs have a similar effect. So also the movements of the alimentary canal, carried out by means of plain muscular tissue, promote the flow along the veins coming from that canal, and when we come to deal with the spleen we shall see that the plain muscular fibres which are so abundant in that organ in some animals, serve by rhythmical contractions to pump the blood regularly away from the spleen along the splenic veins.

When we come to deal with respiration we shall see that each enlargement of the chest constituting an inspiration tends to draw the blood towards the chest, and each return or retraction of the chest walls in expiration tends to drive the blood away from the chest. The arrangement of the valves of the heart causes this action of the respiratory pump to promote the flow of blood in the direction of the normal circulation; and indeed were the heart perfectly motionless the working of this respiratory pump alone would tend to drive the blood from the *venæ cavæ* through the heart into the aorta, and so to keep up the circulation; the force so exerted however would, without the aid of the heart, be able to overcome a very small part only of the resistance in the capillaries and small vessels of the lungs and so would prove actually ineffectual.

There are then several helps to the flow along the veins, but it must be remembered that however useful, they are helps only and not the real cause of the circulation. The real cause of the flow is the ventricular stroke, and this is sufficient to drive the blood from the left ventricle to the right auricle, even when every muscle of the body is at rest and breathing is for a while stopped, when therefore all the helps we are speaking of are wanting.

Circumstances determining the Rate of the Flow.

§ 122. We may now pass on to consider briefly the rate at which the blood flows through the vessels, and first the rate of flow *in the arteries*.

When even a small artery is severed a considerable quantity of blood escapes from the proximal cut end in a very short space of time. That is to say, the blood moves in the arteries from the heart to the capillaries with a very considerable velocity. By various methods, this velocity of the blood-current has been measured at different parts of the arterial system; the results, owing to imperfections in the methods employed, cannot be regarded as satisfactorily exact, but may be accepted as approximately true. They shew that the velocity of the arterial stream is greatest in the largest arteries near the heart, and diminishes from the heart towards the capillaries. Thus in a large artery of a large animal, such as the carotid of a dog or horse, and probably in the carotid of a man, the blood flows at the rate of 300 or 500 mm. a second. In the very small arteries the rate is probably only a few mm. a second.

Methods. The Hæmadromometer of Volkmann. An artery, *e.g.* a carotid, is clamped in two places, and divided between the clamps. Two cannulæ, of a bore as nearly equal as possible to that of the artery, or of a known bore, are inserted in the two ends. The two cannulæ are connected by means of two stopcocks, which work together, with the two ends of a long glass tube, bent in the shape of a U, and filled with normal saline solution, or with a coloured innocuous fluid. The clamps on the artery being released, a turn of the stopcocks permits the blood to enter the proximal end of the long U tube, along which it courses, driving the fluid out into the artery through the distal end. Attached to the tube is a graduated scale, by means of which the velocity with which the blood flows *along the tube* may be read off. Even supposing the cannulæ to be of the same bore as the artery, it is evident that the conditions of the flow through the tube are such as will only admit of the result thus gained being considered as an approximative estimation of the real velocity in the artery itself.

The Rheometer (Stromuhr) of Ludwig. This consists of two glass bulbs, *A* and *B*, Fig. 32, communicating above with each other and with the common tube *C* by which they can be filled. Their lower ends are fixed in the metal disc *D*, which can be made to rotate, through two right angles, round the lower disc *E*. In the upper disc are two holes, *a* and *b*, continuous with *A* and *B* respectively, and in the lower disc are two similar holes, *a'* and *b'*, similarly continuous with the tubes *G* and *H*. Hence, in the position of the discs shewn in the figure, the tube *G* is continuous through the two discs with the bulb *A* and the tube *H* with the bulb *B*. On turning the disc *D* through two right angles the tube *G* becomes continuous with *B* instead of *A*, and the tube *H* with *A* instead of *B*. There is a further arrangement, omitted from the figure for the

sake of simplicity, by which when the disc *D* is turned through one instead of two right angles from either of the above positions, *G* becomes directly continuous with *H*, both being completely shut off from the bulbs.

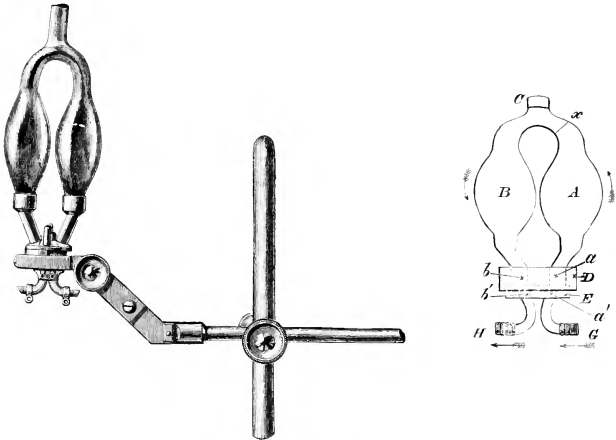

FIG. 32. LUDWIG'S STROMUHR AND A DIAGRAMMATIC REPRESENTATION OF THE SAME.

The ends of the tubes *H* and *G* are made to fit exactly into two cannulae inserted into the two cut ends of the artery about to be experimented upon, and having a bore as nearly equal as possible to that of the artery.

The method of experimenting is as follows. The disc *D*, being placed in the intermediate position, so that *a* and *b* are both cut off from *a'* and *b'*, the bulb *A* is filled with pure olive oil up to the mark *x*, and the bulb *B*, the rest of *A*, and the junction *C*, with defibrinated blood; and *C* is then clamped. The tubes *H* and *G* are also filled with defibrinated blood, and *G* is inserted into the cannula of the central, *H* into that of the peripheral, end of the artery. On removing the clamps from the artery the blood flows through *G* to *H*, and so back into the artery. The observation now begins by turning the disc *D* into the position shewn in the figure; the blood then flows into *A*, driving the oil there contained out before it into the bulb *B*, in the direction of the arrow, the defibrinated blood previously present in *B* passing by *H* into the artery, and so into the system. At the moment that the blood is seen to rise to the mark *x*, the disc *D* is with all possible rapidity turned through two right angles; and thus the bulb *B*, now largely filled with oil, placed in communication with *G*. The blood-stream now drives the oil back into *A*, and the new blood in *A* through *H* into the artery. As soon as the oil has wholly returned to its original position, the disc is again turned round, and *A* once more placed in communication with *G*,

and the oil once more driven from *A* to *B*. And this is repeated several times, indeed generally until the clotting of the blood or the admixture of the oil with the blood puts an end to the experiment. Thus the flow of blood is used to fill alternately with blood or oil the space of the bulb *A*, whose cavity as far as the mark *x* has been exactly measured; hence if the number of times in any given time the disc *D* has to be turned round be known, the number of times *A* has been filled is also known, and thus the quantity of blood which has passed in that time through the cannula connected with the tube *G* is directly measured. For instance, supposing that the quantity held by the bulb *A* when filled up to the mark *x* is 5 c.c., and supposing that from the moment of allowing the first 5 c.c. of blood to begin to enter the tube to the moment when the escape of the last 5 c.c. from the artery into the tube was complete, 100 seconds had elapsed, during which time 5 c.c. had been received 10 times into the tube from the artery (all but the last 5 c.c. being returned into the distal portion of the artery), obviously .5 c.c. of blood had flowed from the proximal section of the artery in one second. Hence supposing that the diameter of the cannula (and of the artery, they being the same) were 2 mm., with a sectional area therefore of 3.14 square mm., an outflow through the section of .5 c.c. or 500 c.mm. in a second would give ($\frac{500}{3.14}$), a velocity of about 159 mm. in a second.

The *Hæmatometer* of Vierordt is constructed on the principle of measuring the velocity of the current by observing the amount of deviation undergone by a pendulum, the free end of which hangs loosely in the stream. A square or rectangular chamber, one side of which is of glass and marked with a graduated scale in the form of an arc of a circle, is connected by means of two short tubes with the two cut ends of an artery; the blood consequently flows from the proximal (central) portion of the artery through the chamber into the distal portion of the artery. Within the chamber and suspended from its roof is a short pendulum, which when the blood-stream is cut off from the chamber hangs motionless in a vertical position, but when the blood is allowed to flow through the chamber, is driven by the force of the current out of its position of rest. The pendulum is so placed that a marker attached to its free end travels close to the inner surface of the glass side along the arc of the graduated side. Hence the amount of deviation from a vertical position may easily be read off on the scale from the outside. The graduation of the scale having been carried out by experimenting with streams of known velocity, the velocity can at once be calculated from the amount of deviation.

An instrument based on the same principle has been invented by Chauveau and improved by Lortet, Fig. 33. In this the part which corresponds to the pendulum in Vierordt's instrument is prolonged outside the chamber, and thus the portion within the chamber is made to form the short arm of a lever, the fulcrum of which is at the point where the wall of the chamber is traversed and the long arm of which projects outside. A somewhat wide tube, the wall of which is at one point composed of an indiarubber membrane, is introduced between the two cut ends of an artery. A long light lever pierces the indiarubber membrane. The short expanded arm of this lever projecting within the tube is moved on its fulcrum in the indiarubber ring by the current of blood passing through the tube, the greater the velocity of the current, the larger being

the excursion of the lever. The movements of the short arm give rise to corresponding movements in the opposite direction of the long arm outside the tube, and these, by means of a marker attached to the end

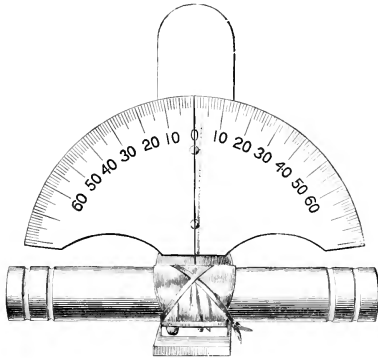

FIG. 33. HÆMATACHOMETER OF CHAUEAU AND LORTET.

of the long arm, may be directly inscribed on a recording surface. This instrument is very well adapted for observing changes in the velocity of the flow. In determining actual velocities, for which purpose it has to be experimentally graduated, it is not so useful.

In *the capillaries*, the rate is slowest of all. In the web of the frog the flow as judged by the movement of the red corpuscles may be directly measured under the microscope by means of a micrometer, and is found to be about half a millimetre in a second; but this is probably a low estimate, since it is only when the circulation is somewhat slow, slower perhaps than what ought to be considered the normal rate, that the red corpuscles can be distinctly seen. In the mammal the rate has been estimated at about $\cdot 75$ millimetres a second but is probably quicker even than this.

As regards *the veins*, the flow is very slow in the small veins emerging from the capillaries but increases as these join into larger trunks, until in a large vein, such as the jugular of the dog, the rate is about 200 mm. a second.

§ 123. It will be seen then that the velocity of the flow is in inverse proportion to the width of the bed, to the united sectional areas of the vessels. It is greatest at the aorta, it diminishes along the arterial system to the capillaries, to the united bases of the cones spoken of in § 112, where it is least, and from thence increases again along the venous system.

And indeed it is this width of the bed and this alone which

determines the *general* velocity of the flow at various parts of the system. The slowness of the flow in the capillaries is not due to there being so much more friction in their narrow channels than in the wider canals of the larger arteries. For the peripheral resistance caused by the friction in the capillaries and small arteries is an obstacle not only to the flow of blood through these small vessels where the resistance is actually generated, but also to the escape of the blood from the large into the small arteries, and indeed from the heart into the large arteries. It exerts its influence along the whole arterial tract. *And it is obvious that if it were this peripheral resistance which checked the flow in the capillaries, there could be no recovery of velocity along the venous tract.

The blood is flowing through a closed system of tubes, the blood vessels, under the influence of one propelling force, the systole of the ventricle, for this is the force which drives the blood from ventricle to auricle, though as we have seen its action is modified in the several parts of the system. In such a system the same quantity of fluid must pass each section of the system at the same time, otherwise there would be a block at one place, and a deficiency at another. If, for instance,

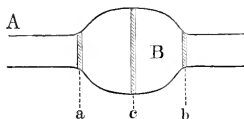

FIG. 34.

a fluid is made to flow by some one force, pressure or gravity, through a tube *A* (Fig. 34) with an enlargement *B*, it is obvious that the same quantity of fluid must pass through the section *b* as passes through the section *a* in the same time, for instance a second.

Otherwise, if less passes through *b* than *a*, the fluid would accumulate in *B*, or if more, *B* would be emptied. In the same way just as much must pass in the same time through the section *c* as passes through *a* or *b*. But if just as many particles of water have to get through the narrow section *a* in the same time as they have to get through the broader section *c*, they must move quicker through *a* than through *c*, or more slowly through *c* than through *a*. For the same reason water flowing along a river impelled by one force, viz. that of gravity, rushes rapidly through a 'narrow' and flows sluggishly when the river widens out into a 'broad.' The flow through *B* will be similarly slackened if *B* instead of being simply a single enlargement of the tube *A* consists of a number of small tubes branching out from *A*, with a united sectional area greater than the sectional area of *A*. In each of such small tubes, at the line *c* for instance, the flow will be slower than at *a*, where the small tubes branch out from *A*, or at *b*, where they join again to form a single tube. Hence it is that the blood rushes swiftly through the arteries, tarries slowly through the capillaries, but quickens its pace again in the veins.

An apparent contradiction to this principle that the rate of

flow is dependent on the width of the bed is seen in the case where, the fluid having alternative routes, one of the routes is temporarily widened. Suppose a tube A dividing into two branches of equal length x and y which unite again to form the tube V . Suppose, to start with, that x and y are of equal diameter; then the resistance offered by each being equal, the flow will be equally rapid through the two, being just so rapid that as much fluid passes in a given time through x and y together as passes through A or through V . But now suppose y to be widened; the widening will diminish the resistance offered by y , and in consequence, supposing that no material change takes place in the pressure or force which is driving the fluid along, more fluid will now pass along y in a given time than did before, that is to say the rapidity of the flow in y will be increased. It will be increased at the expense of the flow through x , since it will still hold good that the flow through x and y together is equal to the flow through A and through V . We shall have occasion later on to point out that a small artery, or a set of small arteries, may be more or less suddenly widened, without materially affecting the general blood-pressure which is driving the blood through the artery or set of arteries. In such cases the flow of blood through the widened artery or arteries is for the time being increased in rapidity, not only in spite of but actually in consequence of the artery being widened.

It must be understood in fact that this dependence of the rapidity of the flow on the width of the bed applies to the general rate of flow of the whole circulation, and that, besides the above instance, other special and temporary variations occur due to particular circumstances. Thus changes of pressure may alter the rapidity of flow. The cause of the flow through the whole system is the pressure of the ventricular systole manifested as what we have called blood-pressure. At each point along the system nearer the left ventricle, and therefore further from the right auricle, the pressure is greater than at a point further from the left ventricle and so nearer the right auricle; it is this difference of pressure which is the real cause of the flow from the one point to the other; and other things being equal the rapidity of the flow will depend on the amount of the difference of pressure. Hence temporary or local variations in rapidity of flow may be caused by the establishment of temporary or local differences of pressure. For example at any point along the arterial system the flow is increased in rapidity during the temporary increase of pressure due to the ventricular systole, *i.e.* the pulse, and diminished during the subsequent temporary decrease, the increase and decrease being the more marked the nearer the point to the heart. And we shall probably meet later on with other instances.

§ 124. *Time of the entire circuit.* It is obvious from the foregoing that a red corpuscle in performing the whole circuit, in

travelling from the left ventricle back to the left ventricle, would spend a large portion of its time in the capillaries, minute arteries and veins. The entire time taken up in the whole circuit has been approximately estimated by measuring the time it takes for an easily recognized chemical substance after injection into the jugular vein of one side to appear in the blood of the jugular vein of the other side.

While small quantities of blood are being drawn at frequently repeated intervals from the jugular vein of one side, or while the blood from the vein is being allowed to fall in a minute stream on an absorbent paper covering some travelling surface, an iron salt such as potassium ferrocyanide (or preferably sodium ferrocyanide as being more innocuous) is injected into the jugular vein of the other side. If the time of the injection be noted, and the time after the injection into one side at which evidence of the presence of the iron salt can be detected in the sample of blood from the vein of the other side be noted, this gives the time it has taken the salt to perform the circuit; and on the supposition that mere diffusion does not materially affect the result, the time which it takes the blood to perform the same circuit is thereby given.

In the horse this time has been experimentally determined at about 30 secs. and in the dog at about 15 secs. In man it is probably from 20 to 25 secs.

Taking the rate of flow through the capillaries at about 1 mm. a sec. it would take a corpuscle as long a time to get through about 20 mm. of capillaries as to perform the whole circuit. Hence, if any corpuscle had in its circuit to pass through 10 mm. of capillaries, half the whole time of its journey would be spent in the narrow channels of the capillaries. Inasmuch as the purposes served by the blood are chiefly carried out in the capillaries, it is obviously of advantage that its stay in them should be prolonged. Since, however, the average length of a capillary is about .5 mm., about half a second is spent in the capillaries of the tissues and another half second in the capillaries of the lungs.

§ 125. We may now briefly summarise the broad features of the circulation, which we have seen may be explained on purely physical principles, it being assumed that the ventricle delivers a certain quantity of blood with a certain force into the aorta at regular intervals, and that the physical properties of the blood vessels remain the same.

We have seen that owing to the peripheral resistance offered by the capillaries and small vessels the *direct* effect of the ventricular stroke is to establish in the arteries a mean arterial pressure which is greatest at the root of the aorta and diminishes towards the small arteries, some of it being used up to drive the blood from the aorta to the small arteries, but which retains at the region of the small arteries sufficient power to drive through the

small arteries, capillaries and veins just as much blood as is being thrown into the aorta by the ventricular stroke. We have seen further that in the large arteries at each stroke the pressure rises and falls a little above and below the mean, thus constituting the pulse, but that this extra distension with its subsequent recoil diminishes along the arterial tract and finally vanishes; it diminishes and vanishes because it too, like the whole force of the ventricular stroke, of a fraction of which it is the expression, is used up in establishing the mean pressure; we shall however consider again later on the special features of this pulse. We have seen further that the task of driving the blood through the peripheral resistance of the small arteries and capillaries consumes much of this mean pressure, which consequently is much less in the small veins than in the corresponding small arteries, but that sufficient remains to drive the blood, even without the help of the auxiliary agents which are generally in action, from the small veins right back to the auricle. Lastly we have seen that while the above is the cause of the flow from ventricle to auricle, the changing rate of the flow, the diminishing swiftness in the arteries, the sluggish crawl through the capillaries, the increasing quickness through the veins are determined by the changing width of the vascular 'bed.'

Before we proceed to consider any further details as to the phenomena of the flow through the vessels, we must turn aside to study the heart.

SEC. 3. THE HEART.

§ 126. The heart is a valvular pump which works on mechanical principles, but the motive power of which is supplied by the contraction of its muscular fibres. Its action consequently presents problems which are partly mechanical, and partly vital. Regarded as a pump, its effects are determined by the frequency of the beats, by the force of each beat, by the character of each beat—whether, for instance, slow and lingering, or sudden and sharp—and by the quantity of fluid ejected at each beat. Hence, with a given frequency, force, and character of beat, and a given quantity ejected at each beat, the problems which have to be dealt with are for the most part mechanical. The vital problems are chiefly connected with the causes which determine the frequency, force, and character of the beat. The quantity ejected at each beat is governed more by the state of the rest of the body, than by that of the heart itself.

The Phenomena of the Normal Beat.

The visible movements. When the chest of a mammal is opened and artificial respiration kept up the heart may be watched beating. Owing to the removal of the chest-wall, what is seen is not absolutely identical with what takes place within the intact chest, but the main events are the same in both cases. A complete beat of the whole heart, or cardiac cycle, may be observed to take place as follows.

The great veins, inferior and superior venæ cavæ and pulmonary veins, are seen, while full of blood, to contract in the neighbourhood of the heart: the contraction runs in a peristaltic wave towards the auricles, increasing in intensity as it goes. Arrived at the auricles, which are then full of blood, the wave suddenly spreads, at a rate too rapid to be fairly judged by the eye, over the whole of those

organs, which accordingly contract with a sudden sharp systole. In the systole, the walls of the auricles press towards the auriculo-ventricular orifices, and the auricular appendages are drawn inwards, becoming smaller and paler. During the auricular systole, the ventricles may be seen to become turgid. Then follows, as it were immediately, the ventricular systole, during which the ventricles become more conical. Held between the fingers they are felt to become tense and hard. As the systole progresses, the aorta and pulmonary arteries expand and elongate, the apex is tilted slightly upwards, and the heart twists somewhat on its long axis, moving from the left and behind towards the front and right so that more of the left ventricle becomes displayed. As the systole gives way to the succeeding diastole, the ventricles resume their previous form and position, the aorta and pulmonary artery shrink and shorten, the heart turns back towards the left, and thus the cycle is completed.

In the normal beat, the two ventricles are perfectly synchronous in action, they contract at the same time and relax at the same time, and the two auricles are similarly synchronous in action. It has been maintained however that the synchronism may at times not be perfect.

Before we attempt to study in detail the several parts of this complicated series of events, it will be convenient to take a rapid survey of what is taking place within the heart during such a cycle.

§ 127. *The cardiac cycle.* We may take as the end of the cycle the moment at which the ventricles having emptied their contents have relaxed and returned to the diastolic or resting position and form. At this moment the blood is flowing freely with a fair rapidity but as we have seen at a very low pressure through the venæ cavæ into the right auricle (we may confine ourselves at first to the right side), and since there is now nothing to keep the tricuspid valve shut, some of this blood probably finds its way into the ventricle also. This goes on for some little time, and then comes the sharp short systole of the auricle, which, since it begins as we have seen as a wave of contraction running forwards along the ends of the venæ cavæ, drives the blood not backwards into the veins but forwards into the ventricle; this end is further secured by the fact that the systole has behind it on the venous side the pressure of the blood in the veins, increasing as we have seen backwards towards the capillaries, and before it the relatively empty cavity of the ventricle in which the pressure is at first very low. By the complete contraction of the auricular walls the complete or nearly complete emptying of the cavity is ensured. No valves are present in the mouth of the superior vena cava, for they are not needed; and the imperfect Eustachian valve at the mouth of the inferior vena cava cannot be of any great use in the adult, though in its more developed state in

the fœtus it had an important function in directing the blood of the inferior vena cava through the foramen ovale into the left auricle. The valves in the coronary vein are however probably of some use in preventing a reflux into that vessel.

As the blood is being driven by the auricular systole into the ventricle, a reflux current is probably set up, by which the blood, passing along the sides of the ventricle, gets between them and the flaps of the tricuspid valve and so tends to float these up. It is further probable that the same reflux current, continuing somewhat later than the flow into the ventricle, is sufficient to bring the flaps into apposition, without any regurgitation into the auricle, at the close of the auricular systole, before the ventricular systole has begun. According to some authors however the closure of the valve is effected, at the very beginning of the ventricular systole, by the contraction of the papillary muscles; the chordæ tendineæ of a papillary muscle are attached to the adjacent edges of two flaps, so that the shortening of the muscle tends to bring these edges into apposition.

The auricular systole is as we have said immediately followed by that of the ventricle. Whether the contraction of the ventricular walls (which as we shall see is a simple though prolonged contraction and not a tetanus) begins at one point and swiftly travels over the rest of the fibres, or begins all over the ventricle at once, is a question not at present definitely settled; but in any case the walls exert on the contents a pressure which is soon brought to bear on the whole contents and very rapidly rises to a maximum. The only effect of this increasing intra-ventricular pressure upon the valve is to render the valve more and more tense, and in consequence more secure, the chordæ tendineæ (the slackening of which through the change of form of the ventricle is probably obviated by a regulative contraction of the papillary muscles) at the same time preventing the valve from being inverted or even bulging largely into the auricle, and indeed, according to some observers, keeping the valvular sheet actually convex to the ventricular cavity, by which means the complete emptying of the ventricle is more fully effected. The connection, to which we have just referred, of the chordæ of the same papillary muscle with the adjacent edges of two flaps, also assists in keeping the flaps in more complete apposition. Moreover the extreme borders of the valves, outside the attachments of the chordæ, are excessively thin, so that when the valve is closed, these thin portions are pressed flat together back to back; hence while the tougher central parts of the valves bear the force of the ventricular systole, the opposed thin membranous edges, pressed together by the blood, more completely secure the closure of the orifice.

At the commencement of the ventricular systole the semilunar valves of the pulmonary artery are closed, and are kept closed by the high pressure of the blood in the artery. As however the

ventricle continues to press with greater and greater force on its contents, making the ventricle hard and tense to the touch, the pressure within the ventricle becomes greater than that in the pulmonary artery and this greater pressure forces open the semilunar valves and allows the escape of the contents into the artery. The ventricular systole may be seen and felt in the exposed heart to be of some duration, it is strong enough and long enough to empty the ventricle completely; indeed, as we shall see, it probably lasts longer than the discharge of blood, so that there is a brief period during which the ventricle is empty but yet contracted.

During the ventricular systole the semilunar valves are pressed outwards towards but not close to the arterial walls, reflux currents probably keeping them in an intermediate position, so that their orifice forms an equilateral triangle with curved sides; they thus offer little obstacle to the escape of blood from the cavity of the ventricle. The ventricle as we have seen propels the blood with great force and rapidity into the pulmonary artery and the whole contents are speedily ejected. Now, when a force which is driving a fluid with great rapidity along a closed channel suddenly ceases to act, the fluid, by its momentum, continues to move onward after the force has ceased; in consequence of this a negative pressure makes its appearance in the rear of the fluid, and, sucking the fluid back again, sets up a reflux current. So when the last portions of blood leave the ventricle a negative pressure makes its appearance behind them, and leads to a reflux current from the artery towards the ventricle. This alone would be sufficient to bring the valves together; and, in the opinion of some, is the real cause of the closure of the valves; others however, as we shall see later on, maintain that subsequent to this reflux due to mere negative pressure a somewhat later reflux, in which the elastic reaction of the arterial walls is concerned, more completely fills and renders tense the pockets, causing their free margins to come into close and firm contact, and thus entirely blocks the way. The corpora Arantii meet in the centre, and the thin membranous festoons or lunulae are brought into exact apposition. As in the tricuspid valves, so here, while the pressure of the blood is borne by the tougher bodies of the several valves, each two thin adjacent lunulae, pressed together by the blood acting on both sides of them, are kept in complete contact, without any strain being put upon them; in this way the orifice is closed in a most efficient manner.

There is no adequate foundation for the view put forward by Brücke that during the ventricular systole the flaps are pressed back flat against the arterial walls, and in the case of the aorta completely cover up the orifices of the coronary arteries, so that the flow of blood from the aorta into the coronary arteries can take place only during the ventricular diastole or at the very beginning of the systole, and not at all during the systole itself.

The ventricular systole now passes off, the muscular walls relax, the ventricle returns to its previous form and position, and the cycle is once more ended.

What thus takes place in the right side takes place in the left side also. There is the same sudden sharp auricular systole beginning at the roots of the pulmonary veins, the same systole of the ventricle but, as we shall see, one much more powerful and exerting much more force; the mitral valve with its two flaps acts exactly like the tricuspid valve, and the action of the semilunar valves of the aorta simply repeats that of the valves of the pulmonary artery.

We may now proceed to study some of the cardiac events in detail.

§ 128. *The change of form.* The exact determination of the changes in form and position of the heart, especially of the ventricles, during a cardiac cycle is attended with difficulties.

The ventricles for instance are continually changing their form; they change while their cavities are being filled from the auricles, they change while the contraction of their walls is getting up the pressure on their contents, they change while under the influence of that pressure their contents are being discharged into the arteries, and they change when, their cavities having been emptied, their muscular walls relax.

We may take it for granted that the internal cavities are obliterated by the systole, for it is probable that practically the whole contents are driven out at each stroke, and probably also each cavity is emptied from its apex towards the mouth of the artery.

With regard to changes in external form, there seems no doubt that the side-to-side diameter is much lessened. It seems also clear that the front-to-back diameter is greater during the whole time of the systole than during the diastole, the increase taking place during the first part of the systole. If a light lever be placed on the surface of the heart of a mammal, the chest having been opened and artificial respiration being kept up, some such curve as that represented in Fig. 35 is obtained. The rise of the lever in describing such a curve is due to the elevation of the part of the front surface of the heart on which the lever is resting. Such an elevation might be caused, especially if the lever were placed near the apex, by the heart being "tilted" upwards during the systole, but only a small portion at most of the rise can be attributed to this cause; the rise is perhaps best seen when the lever is placed in the middle portion of the ventricle, and must be chiefly due to an increase in the front-to-back diameter of the ventricle during the beat. We shall discuss this curve later on in connection with other curves and may here simply say that the part of the curve from *b'* to *d* probably corresponds to the actual systole of the ventricle, that is to the time

during which the fibres of the ventricle are undergoing contraction, the sudden fall from *d* onwards representing the relaxation

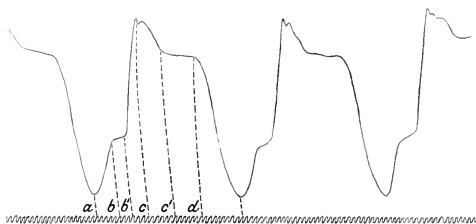

FIG. 35¹. TRACING FROM HEART OF CAT, OBTAINED BY PLACING A LIGHT LEVER ON THE VENTRICLE, THE CHEST HAVING BEEN OPENED. THE TUNING-FORK CURVE MARKS 50 VIBRATIONS PER SEC.

which forms the first part of the diastole. If this interpretation of the curve be correct, it is obvious that the front-to-back diameter is greater during the whole of the systole than it is during diastole, since the lever is raised up all this time.

This increase of the front-to-back diameter combined with a decrease of the side-to-side diameter has for a result a change in the form of the section of the base of the ventricles. During the diastole this has somewhat the form of an ellipse with the

¹ The vertical or rather curved lines (segments of circles) introduced into this and many other curves are of use for the purpose of measuring parts of the curve. A complete curve should exhibit an 'abscissa' line. This may be drawn by allowing the lever, arranged for the experiment but remaining at rest, to mark with its point on the recording surface set in motion; a straight line, the abscissa line, is thus described, and may be drawn before or after the curve itself is made, and may be placed above or preferably below the curve. When a tuning-fork or other time marker is used, the line of the time marker or a line drawn through the curves of the tuning-fork will serve as an abscissa line. After a tracing has been made, the recording surface should be brought back to such a position that the point of the lever coincides with some point of the curve which it is desired to mark; if the lever be then gently moved up and down, the point of the lever will describe a segment of a circle (the centre of which lies at the axis of the lever), which segment should be made long enough to cut both the curve and the abscissa line (the tuning-fork curves or other time marking line) where this is drawn. By moving the recording surface backwards and forwards similar segments of circles may be drawn through other points of the curve. The lines *a*, *b*, *c* in Fig. 35 were thus drawn. The distance between any two of these points may thus be measured on the tuning-fork curve or other time curve, or on the abscissa line. Similar lines may be drawn on the tracing after its removal from the recording instrument in the following way. Take a pair of compasses, the two points of which are fixed just as far apart as the length of the lever used in the experiment, measured from its axis to its writing point. By means of the compasses find the position on the tracing of the centre of the circle of which any one of the previously drawn curved lines forms a segment. Through this centre draw a line parallel to the abscissa. By keeping one point of the compass on this line but moving it along the line backwards or forwards a segment of a circle may be drawn so as to cut any point of the curve that may be desired, and also the abscissa line or the time line. Such a segment of a circle may be used for the same purposes as the original one and any number of such segments may be drawn.

long axis from side to side, but with the front part of the ellipse much more convex than the back, since the back surface of the ventricles is somewhat flattened. During the systole this ellipse is by the shortening of the side-to-side diameter and the increase of the front-to-back diameter converted into a figure much more nearly resembling a circle. It is urged moreover that the whole of the base is constricted and that the greater efficiency of the auriculo-ventricular valves is thereby secured.

As to the behaviour of the long diameter from base to apex observers are not agreed. Some maintain that it is shortened, and others that it is practically unchanged. If any shortening does take place it must be largely compensated by the elongation of the great vessels, which, as stated above, may be seen in an inspection of the beating heart. For there is evidence that the apex, though as we have seen it is during the systole somewhat twisted round, and at the same time brought closer to the chest-wall, does not change its position up or down, *i.e.* in the long axis of the body. If in a rabbit or dog a needle be thrust through the chest-wall so that its point plunges into the apex of the heart, though the needle quivers, its head moves neither up nor down as it would do if its point in the apex moved down or up.

Broadly speaking then during systole the ventricles undergo a diminution of total volume, equal to the volume of contents discharged into the great vessels (for the walls themselves like all muscular structures retain their volume during contraction save for changes which may take place in the quantity of blood contained in their blood vessels, or of lymph in the intermuscular spaces), while they undergo a change of form which may be described as that from a roughly hemispherical figure with an irregularly elliptical section to a more regular cone with a circular base.

§ 129. *Cardiac Impulse.* If the hand be placed on the chest, a shock or impulse will be felt at each beat, and on examination this impulse, 'cardiac impulse,' will be found to be synchronous with the systole of the ventricle. In man, the cardiac impulse may be most distinctly felt in the fifth costal interspace, about an inch below and a little to the median side of the left nipple. In an animal the same impulse may also be felt in another way, *viz.* by making an incision through the diaphragm from the abdomen, and placing the finger between the chest-wall and the apex. It then can be distinctly recognized as the result of the hardening of the ventricle during the systole. And the impulse which is felt on the outside of the chest is chiefly the effect of the same hardening of the stationary portion of the ventricle in contact with the chest-wall, transmitted through the chest-wall to the finger. In its flaccid state, during diastole, the apex is (in a standing position at least) at this point in contact

with the chest-wall, lying between it and the tolerably resistant diaphragm. During the systole, while being brought even closer to the chest-wall, by the tilting of the ventricle and by the movement to the front and to the right of which we have already spoken, it suddenly grows tense and hard. The ventricles, in executing their systole, have to contract against resistance. They have to produce within their cavities, pressures greater than those in the aorta and pulmonary arteries, respectively. This is, in fact, the object of the systole. Hence, during the swift systole, the ventricular portion of the heart becomes suddenly tense, somewhat in the same way as a bladder full of fluid would become tense and hard when forcibly squeezed. The sudden pressure exerted by the ventricle thus become suddenly tense and hard, aided by the closer contact of the apex with the chest-wall (which however by itself without the hardening of contraction would be insufficient to produce the effect), gives an impulse or shock both to the chest-wall and to the diaphragm, which may be felt readily both on the chest-wall, and also through the diaphragm when the abdomen is opened and the finger inserted. If the modification of the sphygmograph (of which we shall speak in dealing, later on, with the pulse), called the cardiograph, be placed on the spot where the impulse is felt most strongly, the lever is seen to be raised during the systole of the ventricles, and to fall again as the systole passes away, very much as if it were placed on the heart directly. A tracing may thus be obtained, see Fig. 41, of which we shall have to speak more fully immediately, see § 133. If the button of the lever be placed, not on the exact spot of the impulse, but at a little distance from it, the lever will be *depressed* during the systole. While at the spot of impulse itself the contact of the ventricle is increased during systole, away from the spot the ventricle retires from the chest-wall (by the diminution of its right-to-left diameter), and hence, by the mediastinal attachments of the pericardium, draws the chest-wall after it.

§ 130. *The Sounds of the Heart.* When the ear is applied to the chest, either directly or by means of a stethoscope, two sounds are heard, the first a comparatively long dull booming sound, the second a short sharp sudden one. Between the first and second sounds, the interval of time is very short, too short to be measurable, but between the second and the succeeding first sound there is a distinct pause. The sounds have been likened to the pronunciation of the syllables *lūbb dūp*, so that the cardiac cycle, as far as the sounds are concerned, might be represented by:—*lūbb, dūp, pause.*

The second sound which is short and sharp presents no difficulties. *It is coincident in point of time with the closure of the semilunar valves, and is heard to the best advantage over the second right costal cartilage close to its junction with the sternum,

i.e. at the point where the aortic arch comes nearest to the surface, and to which sounds generated at the aortic orifice would be best conducted. Its characters are such as would belong to a sound generated by membranes like the semilunar valves being suddenly made tense and so thrown into vibrations. It is obscured and altered, or replaced by 'a murmur,' when the semilunar valves are affected by disease, and may be artificially obliterated, a murmur taking its place, by passing a wire down the arteries and hooking up the aortic valves. There can be no doubt in fact that the second sound is due to the semilunar valves being thrown into vibrations at their sudden closure. The sound heard at the second right costal cartilage is chiefly that generated by the aortic valves, and murmurs or other alterations in the sound caused by changes in the aortic valves are heard most clearly at this spot. But even here the sound is not exclusively of aortic origin, for in certain cases in which the semilunar valves on the two sides of the heart are not wholly synchronous in action, the sound heard here is double ("reduplicated second sound"), one being due to the aorta, and one to the pulmonary artery. When the sound is listened to on the left side of the sternum at the same level, the pulmonary artery is supposed to have the chief share in producing what is heard, and changes in the sound heard more clearly here than on the right side are taken as indications of mischief in the pulmonary valves.

The first sound, longer, duller, and of a more 'booming' character than the second, heard with greatest distinctness at the spot where the cardiac impulse is felt, presents many difficulties in the way of a complete explanation. * It is heard distinctly when the chest-walls are removed. The cardiac impulse therefore can have little or nothing to do with it. In point of time it is coincident with the systole of the ventricles, and may be heard to the greatest advantage at the spot of the cardiac impulse, that is to say, at the place where the ventricles come nearest to the surface, and to which sounds generated in the ventricle would be best conducted.

It is more closely coincident with the closure and consequent vibrations of the auriculo-ventricular valves than with the entire systole: for on the one hand it dies away before the second sound begins, whereas, as we shall see, the actual systole lasts up to if not beyond the closure of the semilunar valves, and on the other hand the auriculo-ventricular valves cease to be tense and to vibrate as soon as the contents of the ventricle are driven out. This suggests that the sound is caused by the sudden tension of the auriculo-ventricular valves, and this view is supported by the facts that the sound is obscured, altered or replaced by murmurs when the tricuspid or mitral valves are diseased, and that the sound is also altered or, according to some observers, wholly done away with when blood is prevented

from entering the ventricles by ligature of the *venæ cavæ*. On the other hand the sound has not that sharp character which one would expect in a sound generated by the vibration of membranes such as the valves in question, but in its booming qualities rather suggests a muscular sound. Further, according to some observers, the sound, though somewhat modified, may still be heard when the large veins are clamped so that no blood enters the ventricle, and indeed may be recognized in the few beats given by a mammalian ventricle rapidly cut out of the living body by an incision carried below the auriculo-ventricular ring. Hence the view has been adopted that this first sound is a muscular sound. In discussing the muscular sound of skeletal muscle (see § 80), we saw reasons to distrust the view that this sound was generated by the repeated individual simple contractions which made up the tetanus and hence corresponded in tone to the number of those simple contractions repeated in a second, and to adopt the view that the sound was really due to a repetition of unequal tensions occurring in a muscle during the contraction. Now the ventricular systole is undoubtedly a simple contraction, a prolonged simple contraction, not a tetanus, and therefore under the old view of the nature of a muscular sound, could not produce such a sound; but accepting the other view and reflecting how complex must be the course of the systolic wave of contraction over the twisted fibres of the ventricle we shall not find great difficulty in supposing that that wave is capable in its progress of producing such repetitions of unequal tensions as might give rise to a 'muscular sound,' and consequently in regarding the first sound as mainly so caused. Accepting such a view of the origin of the sound we should expect to find the tension of the muscular fibres and so the nature of sound dependent on the quantity of fluid present in the ventricular cavities and hence modified by ligature of the great veins, and still more by the total removal of the auricles with the auriculo-ventricular valves. We may add that we should expect to find it modified by the escape of blood from the ventricles into the arteries during the systole itself, and might regard this as explaining why it dies away before the ventricle has ceased to contract.

Moreover seeing that the auriculo-ventricular valves must be thrown into sudden tension at the onset of the ventricular systole, which as we have seen is developed with considerable rapidity, not far removed at all events from the rapidity with which the semilunar valves are closed, a rapidity therefore capable of giving rise to vibrations of the valves adequate to produce a sound, it is difficult to escape the conclusion that the closure of these valves must also generate a sound, which in a normally beating heart is mingled in some way with the sound of muscular origin, although the ear cannot detect the mixture.

If we accept this view that the sound is of double origin,

partly 'muscular,' partly 'valvular,' both causes being dependent on the tension of the ventricular cavities, we can perhaps more easily understand how it is that the normal first sound is at times so largely, indeed we may say so completely, altered and obscured in diseases of the auriculo-ventricular valves.

Since the left ventricle forms the entire left apex of the heart, the murmurs or other changes of the first sound heard most distinctly at the spot of cardiac impulse belong to the mitral valve of the left ventricle. Murmurs generated in the tricuspid valve of the right ventricle are heard more distinctly in the median line below the end of the sternum.

Endocardiac Pressure.

§ 131. Since the heart exists for the purpose of exerting pressure on the blood within its cavities, by which pressure the circulation of the blood is effected, the study of the characters of this endocardiac pressure possesses great interest. Unfortunately the observation of this pressure is attended with great difficulties. The ordinary mercury manometer which is so useful in studying the pressure in the arteries fails us when applied to the heart. It is true that a long cannula, or tube open at the end, filled with sodium carbonate solution, may be introduced into the jugular vein and so slipped down into either the right auricle or the right ventricle, or may be similarly introduced into the carotid artery and with care slipped down through the aorta, past the semilunar valves, into the left ventricle, and having been thus introduced may, like the ordinary cannula used in studying arterial pressure (§ 115), be brought into connection with a mercury manometer. In this way, as in the case of an artery, a graphic record may be obtained of the changes of pressure taking place in either of the above three cavities. But the changes in the ventricular cavities are so great and rapid, that the inertia of the mercury, an evil even in the case of an artery, comes so largely into play that the curve described by the float on the mercury is far from being an accurate record of the changes of pressure in the cavity.

The mercury manometer may however be made to yield valuable results by adopting the ingenious contrivance of converting the ordinary manometer into a maximum or a minimum instrument.

The principle of the maximum manometer, Fig. 36, consists in the introduction into the tube leading from the heart to the mercury column, of a (modified cup-and-ball) valve, opening, like the aortic semilunar valves, easily from the heart, but closing firmly when fluid attempts to return to the heart. The highest pressure is that which drives the longest column of fluid past the valve, raising the mercury

column to a corresponding height. Since this column, once past the valve, cannot return, the mercury remains at the height to which it was raised by it and thus records the maximum pressure. By reversing the direction of the valve, the manometer is converted from a maximum into a minimum instrument.

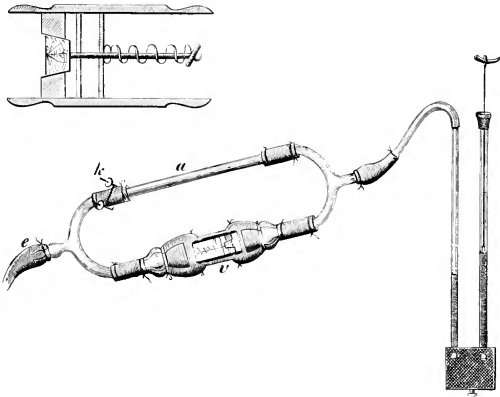

FIG. 36. THE MAXIMUM MANOMETER OF GOLTZ AND GAULE.

At *e* a connection is made with the tube leading to the heart. When the screw clamp *k* is closed, the valve *v* comes into action, and the instrument, in the position of the valve shown in the figure, is a maximum manometer. By reversing the direction of *v* it is converted into a minimum manometer. When *k* is opened, the variations of pressure are conveyed along *a*, and the instrument then acts like an ordinary manometer.

The maximum manometer applied to the cavity of either ventricle or of the right auricle, gives a record of the highest pressure reached within that cavity, and the minimum manometer similarly applied shews the lowest pressure reached, during the time that the instrument is applied.

The maximum manometer thus employed shews that the maximum pressure in the left ventricle is distinctly greater than the mean pressure in the aorta (the ordinary mercury manometer having previously given the paradoxical result, due to the inertia of the mercury, that the mean pressure in the left ventricle might be less than in the aorta), that the maximum pressure in the right ventricle is less than in the left, and in the right auricle is still less. In the dog for example the pressure in the left ventricle reaches a maximum of about 140 mm. (mercury), in the right ventricle of about 60 mm. and in the right auricle of about 20 mm.

But the chief interest attaches to the minimum pressure observed; for the minimum manometer records a *negative* pressure *

in the cavities of the heart, *i.e.* shews that the pressure in them may fall below that of the atmosphere. Thus in the left ventricle (of the dog) a minimum pressure varying from -52 to -20 mm. may be reached, the minimum of the right ventricle being from -17 to -16 mm., and of the right auricle from -12 to -7 mm.¹ Part of this diminution of pressure in the cardiac cavities may be due, as will be explained in a later part of this work, to the aspiration of the thorax in the respiratory movements. But even when the thorax is opened, and artificial respiration kept up, under which circumstances no such aspiration takes place, a negative pressure is still observed, the pressure in the left ventricle still sinking as low as -24 mm. Now, what the instrument actually shews is that at some time or other during the number of beats which took place while the instrument was applied (and these may have been very few) the pressure in the ventricle sank so many mm. below that of the atmosphere. Since the negative pressure is observed when the heart is beating quite regularly, each beat being exactly like the others, we may infer that a negative pressure occurs at some period or other of each cardiac cycle. But the instrument obviously gives us no information as to the exact phase of the beat in which the negative pressure occurs; to this point as well as to the importance of this negative pressure we shall return presently.

§ 132. The difficulties due to the inertia of the mercury may be obviated by adopting the method of Chauveau and Marey which consists in introducing, in a large animal such as a horse, through a blood vessel into a cavity of the heart, a tube ending in an elastic bag, Fig. 37 A, fashioned something like a sound, both tube and bag being filled with air, and the tube being connected with a recording 'tambour.'

A tube of appropriate curvature, A. *b.* Fig. 37, is furnished at its end with an elastic bag or 'ampulla' *a*. When it is desired to explore simultaneously both auricle and ventricle, the sound is furnished with two ampullæ with two small elastic bags, one at the extreme end and the other at such a distance that when the former is within the cavity of the ventricle the latter is in the cavity of the auricle. Such an instrument is spoken of as a 'cardiac sound.' Each 'ampulla' communicates by a separate air-tight tube with an air-tight tambour (Fig. 37 B) on which a lever rests, so that any pressure on the ampulla is communicated to the cavity of its respective tambour, the lever of which is raised in proportion. When two ampullæ are used the writing points of both levers are brought to bear on the same recording surface exactly underneath each other. The tube is carefully introduced through the right jugular vein into the right side of the heart until the lower (ventricular) ampulla is fairly in the cavity of the right ventricle, and consequently the upper (auricular) ampulla in the cavity of the right auricle. Changes of pressure on either

¹ These numbers are to be considered merely as instances which have been observed, and not as averages drawn from a large number of cases.

ampulla then cause movements of the corresponding lever. When the pressure, for instance, on the ampulla in the auricle is increased, the auricular lever is raised and describes on the recording surface an

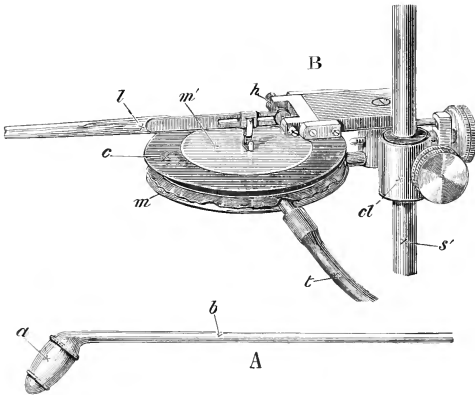

FIG. 37. MAREY'S TAMBOUR, WITH CARDIAC SOUND.

A. A simple cardiac sound such as may be used for exploration of the left ventricle. The portion *a* of the ampulla at the end is of thin indiarubber, stretched over an open framework with metallic supports above and below. The long tube *b* serves to introduce it into the cavity which it is desired to explore.

B. The Tambour. The metal chamber *m* is covered in an air-tight manner with the indiarubber *c*, bearing a thin metal plate *m'* to which is attached the lever *l* moving on the hinge *h*. The whole tambour can be placed by means of the clamp *cl* at any height on the upright *s'*. The indiarubber tube *t* serves to connect the interior of the tambour either with the cavity of the ampulla of A or with any other cavity. Supposing that the tube *t* were connected with *b*, any pressure exerted on *a* would cause the roof of the tambour to rise and the point of the lever would be proportionately raised.

ascending curve; when the pressure is taken off the curve descends; and so also with the ventricle.

The 'sound' may in a similar manner be readily introduced through the carotid artery into the *left ventricle* and the changes taking place in that chamber also explored.

When this instrument is applied to the right auricle and ventricle some such record is obtained as that shewn in Fig. 38 where the upper curve is a tracing taken from the right auricle, and the lower curve from the right ventricle of the horse, both curves being taken simultaneously on the same recording surface.

In these curves the rise of the lever indicates pressure exerted

upon the corresponding ampulla, and the upper curve, from the right auricle, shews the sudden brief pressure *b* exerted by the sudden and brief auricular systole. The lower curve, from the right ventricle, shews that the pressure exerted by the ventricular systole begins almost immediately after the auricular systole, increases very rapidly indeed, so that the lever rises in almost a

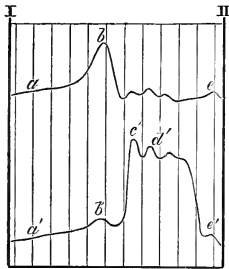

FIG. 38. SIMULTANEOUS TRACINGS FROM THE RIGHT AURICLE, AND VENTRICLE, OF THE HORSE. (AFTER CHAUVEAU AND MAREY.)

straight line up to *c'*, is continued for some considerable time, and then falls very rapidly to reach the base line. But it may be doubted whether the instrument can be trusted to tell much more than this. The pressure recorded by each lever is the pressure exerted on the ampulla and this may continue to be exerted after all blood has been discharged from the cavity, the walls of the emptied cavity closing round and pressing on the ampulla. But as we shall presently see, it is of great interest to determine, not only the force and duration of the pressure exerted by the ventricular systole, but also whether or no the fibres continue contracted and exerting pressure for an appreciable

time after the blood has been forced out of the cavity. The figure moreover, it need hardly be said, does not, by itself, give any information as to the relative amounts of pressure exerted by the auricle and ventricle respectively. In the curve the auricular lever rises about half as high as the ventricular lever; but we must not infer from this that the auricular stroke is half as strong as the ventricular stroke; the former is arranged so as to move much more readily, to be much more sensitive than the latter. The instrument it is true may be experimentally graduated, and may then be used to determine the actual amount of pressure; but for this purpose is not wholly satisfactory. We may add that the irregularities seen on the ventricular curve during the ventricular systole and on the auricular curve at the same time have given rise to much debate and need not be discussed here. On the whole the method, though useful for giving a graphic view of the series of events within the cardiac cavities during a cardiac cycle, the short auricular pressure, the long continued ventricular pressure, lasting nearly half the whole period, and the subsequent pause when both parts are at rest or in diastole, cannot with safety be used for drawing more detailed conclusions.

Perhaps the least untrustworthy method of recording the changes of endo-cardiac pressure is that recently introduced by Roy and Rolleston, though difficulties present themselves in the interpretation of the curves obtained by it.

By means of a short cannula introduced through a large vessel, or directly, as a trocar, through the walls of the ventricle (or auricle), the blood in the cavity is brought to bear on an easily moving piston. The movements of the piston are recorded by a lever, and the evils of inertia are met by making the piston and lever work against the torsion of a steel ribbon, the length of which, and consequently the resistance offered by which, and hence the excursions of the piston can be varied at pleasure.

The curves obtained by this method vary according to circumstances. We may take as fair examples two curves from the left ventricle, one (Fig. 39 A) of a rapidly beating, and the other (Fig. 39 B) of a slowly beating heart.

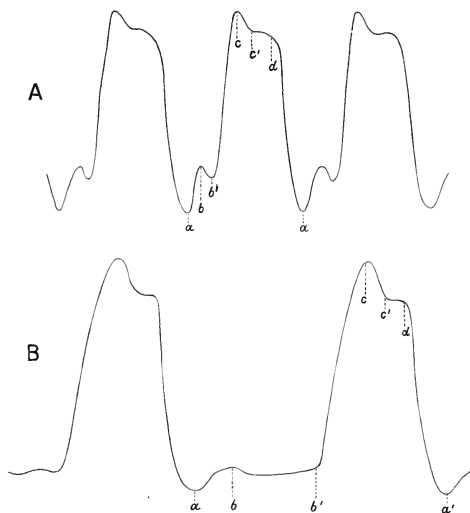

FIG. 39. CURVES OF ENDOCARDIAC PRESSURE. FROM LEFT VENTRICLE OF DOG.

A. a quickly beating, B. a more slowly beating heart.

The letters in this, and the succeeding Figs. 40, 41 are explained in the text.

§ 133. In attempting to interpret these curves with the view of learning the changes of pressure taking place in the heart, it is desirable to study them in connection with the tracing of which we have already spoken, Fig. 40, taken by means of a light lever placed on the exposed ventricle and which as we have seen is a curve of the changes taking place in the front-to-back diameter

of the ventricle; or we may use what is very nearly the same thing, viz. a cardiographic tracing (Fig. 41), that is to say a tracing of the cardiac impulse, which is a curve of changes in the pressure exerted by the apex of the heart on the chest-wall.

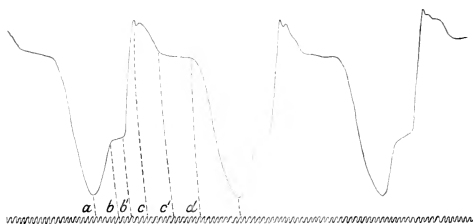

FIG. 40. (See Fig. 35.)

Various forms of cardiograph have been used to record the cardiac impulse. In some the pressure of the impulse, as in the sphygmograph, is transmitted directly to a lever which writes upon a travelling surface. In others the impulse is, by means of an ivory button, brought to bear on an air-chamber, connected by a tube with a tambour as in Fig. 37; the pressure of the cardiac impulse compresses the air in the air-chamber, and through this the air in the chamber of the tambour by which the lever is raised. In such delicate and complicated movements, as those of the heart however, the use of long tubes filled with air is liable to introduce various errors.

We may begin our study of these curves at any point in the cycle; let it be the point b' in Fig. 39. From this point the curve rises very abruptly, almost in the vertical line, to a maximum at c ; and the same sudden large rise to a maximum occurs in the front-to-back diameter of the ventricles (Fig. 40) and in the pressure of the apex against the chest-wall (Fig. 41). There can be no doubt that

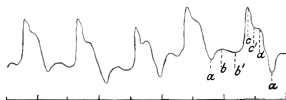

FIG. 41. CARDIOGRAM FROM MAN.

this corresponds to the first part of the systole of the ventricles. By the sudden onset of the contraction of the ventricular fibres pressure is brought to bear on the contents of the ventricle, and there being as yet no escape for the blood, by the increasing contraction of the

fibres, the pressure becomes greater and greater. At the point *c* a change takes place in all three curves, the rise is converted into a fall, which however is very gradual as far as *d*. In the case of the front-to-back diameter curve (Fig. 40) we may interpret this as meaning that while the continued contraction of the muscular fibres still maintains that change in the form of the ventricle by which the front-to-back diameter is increased, that same diameter is somewhat lessened by a diminution of the volume of the ventricles due to the escape of blood into the great arteries, and the cardiographic tracing admits of a similar interpretation, the apex relaxes its pressure on the chest-wall. We may extend the same interpretation to the pressure curve (Fig. 39). Somewhere about *c* the pressure in the (left) ventricle has become higher than the pressure in the aorta, and in consequence blood escapes from the former into the latter. Whether the exact moment of the opening of the valves is absolutely identical with the turn of the curve at *c*, the curve beginning to fall at the moment when the area of high pressure in the ventricle is made continuous with the area of lower pressure in the aorta, or whether it occurs a little before *c*, the still increasing contraction of the ventricular fibres still increasing the pressure on the column of blood as it begins to move from the cavity of the ventricle into the aorta, may be left for the present undecided. The sudden fall from *d* to *a* admits of only one interpretation and that in all the curves; this can only be due to the sudden relaxation of the muscular fibres of the ventricle, whereby the front-to-back diameter suddenly diminishes, the apex suddenly ceases to press on the chest-wall, and the pressure which the ventricular walls were previously exerting on the fluid in the cannula introduced into its cavity also suddenly ceases. From *b'* to *d* then the ventricular walls are still contracting; during the whole of this time the real systole is being continued, but gives place at *d* to a rapid relaxation which ushers in or forms the first part of the sequent diastole. Some little time after the beginning of this systole, somewhere about *c*, as we have seen, blood begins to escape from the ventricle into the aorta; this escape is certainly completed by the time *d* is reached and we have reason to think that it is really completed some little time before. The entrance into the aorta of the column of blood ejected by the ventricle distends that vessel, and the distension passes on, as we have seen, along the arterial track as the pulse. If now we measure the time during which the aorta, even near the heart, is being distended by the injection of the ventricular contents, we find this to be appreciably less than the time from *c* to *d*, during which the systole of the ventricle is still going on, though the contents have already begun to escape at about *c*. This means that the ventricle, though empty, remains contracted for some little time after its contents have left the cavity. It is possible

that the point c' in the three figures under discussion, where the descent of the lever changes in rate, becoming less rapid, corresponds to the end of the outflow from the ventricle; but this is not certain, and indeed the exact interpretation of this part of the curve is especially difficult.

The escape from the ventricle is rapid and forcible; the flow ceases suddenly. Hence, as we have already stated § 127, owing to the column of blood tending to move on by virtue of its inertia after the propelling force has ceased to act, a negative pressure makes its appearance behind the column of blood discharged from the ventricle, and as soon as the column is lodged in the aorta leads to a reflux towards the ventricle. This reflux would of itself have the effect of closing the valves even were the aorta a rigid tube. But the aorta is extensible and elastic and the effects of the movement of the column of fluid are combined with the effects of the movement of the arterial walls: the elastic action of the arterial walls, in a manner which we shall discuss later on in dealing with the pulse, also leads to a reflux. It has been urged that the reflux due to the negative pressure of the mere movement of the column of blood being more rapid, occurs independently of and earlier than the reflux due to the elastic recoil, the former closing the valves, the latter securing their complete closure. Be this so or no the valves are probably closed almost immediately after the escape of the ventricular contents, though observers are not agreed on this point, some urging that the valves are not closed until so late a period as the point d , just as relaxation is about to begin. In the curves we are now considering, a notch, followed by a rise, or at least a more or less abrupt change in the course of the curve at c' , is sometimes observed in that part of the curve which intervenes between the first large rise and the final sudden fall; and this secondary rise has been taken to indicate the closure of the semilunar valves. Sometimes two such notches and peaks are seen, and the occurrence of the two has been attributed to a want of synchronism in the closure of the pulmonary and aortic semilunar valves, the latter closing some little time before the former. But it is by no means clear that these notches and peaks are thus due to the closure of the valves; they may possibly have another origin, they are not always present, and indeed it does not seem certain that the closing of the valves should necessarily make an impress on the ventricular curve.

§ 134. In the performance of the ventricle then (and what has been said of the left ventricle applies also to the right ventricle) there appear to be four stages:

1. A rapid "getting up" of pressure within the ventricle, all the valves being as yet closed; this continues until the pressure within the ventricle, becoming greater than that in the aorta, throws open the aortic valves.

2. The escape of the contents of the ventricle into the aorta, the contractions of the ventricular walls still continuing.

3. Further maintenance of the contraction for some little time after the main body, at all events, of the contents have passed the aortic valves; by this the complete emptying of the ventricle seems assured.

4. Sudden and rapid relaxation of the ventricular walls.

These four events together make up a large portion, and in a quickly beating heart the greater portion, of the whole cardiac cycle.

Meanwhile, that is during the time from b' to a , blood has been flowing from the great veins into the auricle; during the interval from b' to d none of this can pass into the ventricle since this is still contracted, but with the commencement of relaxation from d onwards there is no longer any obstacle, on the contrary, as we shall see an inducement for the blood to pass from the auricle into the ventricle.

For a brief time, as we have seen, there is probably an unbroken flow from the great veins (pulmonary or *venæ cavæ*) through the auricle into the ventricle, leading to a steady but slight increase of the front-to-back diameter, to a slight pressure of the apex on the chest-wall, and to a slight increase of intraventricular pressure, especially shewn in the curve of the slowly beating heart of the horse (Fig. 38). In Fig. 40, the sudden rise due to the ventricular systole is preceded by a rise b followed by a fall, forming thus, as it were, a shoulder on the curve. This has been interpreted as indicating the sharp transient auricular systole; the sudden injection of the auricular contents into the ventricle increases the front-to-back diameter of the ventricle, and the momentum of the rapid stroke being considerable, the lever is in each case carried too far forward, so that the rise is followed by a fall, producing a notch. A similar though somewhat different shoulder is also seen in the cardiogram Fig. 41. In the curve of ventricular pressure taken by means of the cardiac sound (Fig. 38) there is a similar temporary increase b' in the ventricular pressure coincident with the auricular stroke b , and in the "piston" pressure curve of the rapidly beating heart (Fig. 39 A) there is a similar shoulder b just preceding the rise of the ventricular systole. The meaning of the last curve is however doubtful, for in the similar curve of the more slowly beating heart (Fig. 39 B) it occurs immediately after the relaxation of the ventricle, some time before the occurrence of the auricular systole, and in many curves taken by the same method is absent altogether. The exact meaning therefore of the shoulder b in the other curves must be left at present undecided.

§ 135. We have still to consider the negative pressure shewn by the minimum manometer. This instrument, as we have said,

merely shews that the pressure in the ventricle (or auricle) becomes negative at some phase or other of the cardiac cycle, but does not tell us in which phase it occurs.

Now there are two ways in which such a negative pressure might originate. In the first place, as we have just seen, a negative pressure makes its appearance in the rear of the column of blood driven from the ventricle into the aorta with great suddenness and rapidity. But this negative pressure, as we have also seen, follows the column into the aorta past the semilunar valves, and in part at all events determines the closure of the semilunar valves. Hence if this is the negative pressure which the minimum manometer records, it ought to be shewn not only when the end of the tube connected with the manometer is in the cavity of the ventricle, but also when the tube is slipped out of the ventricle just past the semilunar valves. When the tube however is in the latter situation the manometer does not shew the same marked negative pressure that it does when the tube is in the ventricle; the negative pressure which occurs in the aorta at each beat is insufficient to produce such an effect on the minimum manometer as is produced when the instrument is in the ventricle. Hence we infer that the negative pressure shewn by the minimum manometer is not produced in this way. We may moreover conclude that the semilunar valves are closed before this negative pressure makes its appearance in the ventricle; otherwise, however produced, it would be transmitted from the interior of the ventricle through the open valves to the root of the aorta beyond.

But there is another event which might give rise to a negative pressure. The relaxation of the ventricular walls is, as the curves (Figs. 39, 40, 41) shew, a rapid process, something quite distinct from the mere filling of the ventricular cavities with blood from the auricles; and, though some have objected to the view, it may be urged that this return of the ventricle from its contracted (and emptied) condition to its normal form would develop a negative pressure. This return is probably simply the total result of the return of each fibre or fibre cell to its natural condition, though some have urged that the extra quantity of blood thrown into the coronary arteries at the systole helps to unfold the ventricles somewhat in the way that fluid driven between the two walls of a double-walled collapsed ball or cup will unfold it.

Accepting the return of the ventricles to their normal form as the cause of the negative pressure (and it may be remarked that the return of the thick-walled left ventricle naturally exerts a greater negative pressure than the thin-walled right ventricle), it is obvious that the negative pressure will assist the circulation by sucking the blood which has meanwhile been accumulated in the auricle from that cavity into the ventricle, the auriculo-ven-

tricular valves easily giving way. At the same time this very flow from the auricle will at once put an end to the negative pressure, which obviously can be of brief duration only. It may further be urged, in support of this view, that even when the thorax is opened, so that the respiratory movements can no longer act towards producing a negative pressure in the auricle and great veins (§ 131), a minimum manometer placed in the right auricle shews frequently no pressure at all (that is a pressure equal to that of the atmosphere) and sometimes a decidedly negative pressure. Seeing that the blood under these circumstances is being driven along the great veins by a pressure which though low is always above that of the atmosphere, we may conclude that the negative pressure produced in the ventricle is the cause of this lowering of the pressure in the auricle, though it is unable to make itself felt along the great veins.

§ 136. *The duration of the several phases.* We may first of all distinguish certain main phases: (1) The systole of the auricles. (2) The systole, proper, of the ventricles, during which their fibres are in a state of contraction, lasting to d in Figs. 39, 40, 41. (3) The diastole of the ventricles, that is to say the time intervening between their fibres ceasing to contract, and commencing to contract again. To these we may perhaps add (4) The pause or rest of the whole heart, comprising the period from the end of the relaxation of the ventricles to the beginning of the systole of the auricles; during this time the walls are undergoing no active changes, neither contracting nor relaxing, their cavities being simply passively filled by the influx of blood.

The mere inspection of almost any series of cardiac curves however taken, those for instance which we have just discussed, will shew, apart from any accurate measurements, that the systole of the auricles is always very brief, that the systole of the ventricles is always very prolonged, always occupying a considerable portion of the whole cycle, and that the diastole of the whole heart, reckoned from the end either of the systole, or of the relaxation of the ventricle, is very various, being in quickly beating hearts very short and in slowly beating hearts decidedly longer.

When we desire to arrive at more complete measurements, we are obliged to make use of calculations based on various data; and these give only approximate results. Naturally the most interest is attached to the duration of events in the human heart.

The datum which perhaps has been most largely used is the interval between the beginning of the first and the occurrence of the second sound. This may be determined with approximative correctness, and is found to vary from $\cdot 301$ to $\cdot 327$ sec., occupying from 40 to 46 p. c. of the whole period, and being fairly constant for different rates of heart-beat. That is to say in a rapidly beating heart it is the pauses which are shortened and not the duration of the actual beats.

The observer, listening to the sounds of the heart, makes a signal at each event on a recording surface, the difference in time between the marks being measured by means of the vibrations of a tuning-fork recorded on the same surface. By practice it is found possible to reduce the errors of observation within very small limits.

Now whatever be the exact causation of the first sound, it is undoubtedly coincident with the systole of the ventricles, though possibly the actual commencement of its becoming audible may be slightly behind the actual beginning of the muscular contractions. Similarly the occurrence of the second sound, which, as we have seen, is certainly due to the closure of the semilunar valves, has been taken to mark the close of the ventricular systole. And on this supposition the interval between the beginning of the first and the occurrence of the second sound has been regarded as indicating approximatively the duration of the ventricular systole, *i.e.* the period during which the ventricular fibres are contracting. We have however urged above that the ventricles still remain contracted for a brief period after the valves are shut; if this view be correct then the second sound does not mark the end of the systole, and the duration of the systole is rather longer than the time given above.

The determination of the separate duration of each of the three periods of the ventricular systole, *viz.* the getting up the pressure, the discharge of the contents, and the remaining emptied but contracted, is subject to so much uncertainty that it need not be insisted on here; it may however be said that, roughly speaking, each phase occupies probably about $\cdot 1$ sec.

In a heart beating 72 times a minute, which may be taken as the normal rate, each entire cardiac cycle would last about $0\cdot 8$ sec., and taking $0\cdot 3$ sec. as the duration of the ventricular systole, the deduction of this would leave $0\cdot 5$ sec. for the whole diastole of the ventricle including its relaxation, the latter occupying about or somewhat less than $\cdot 1$ sec. In the latter part of this period there occurs the systole of the auricles, the exact duration of which it is difficult to determine, it being hard to say when it really begins, but which, if the contraction of the great veins be included, may perhaps be taken as lasting on an average $0\cdot 1$ sec. The 'passive interval' therefore, during which neither auricle nor ventricle are undergoing contractions, lasts about $\cdot 4$ sec. and the absolute pause or rest during which neither auricle nor ventricle are contracting or relaxing about $\cdot 3$ sec.; if however a longer period be allotted to the ventricular systole, these periods must be proportionately shortened. The systole of the ventricle follows so immediately upon that of the auricles, that practically no interval exists between the two events.

The duration of the several phases may for convenience sake be arranged in a tabular form as follows; but in reading the table

the foregoing remarks as to the approximate or even uncertain character of some of the data must be borne in mind.

	secs.	secs.
Systole of ventricle before the opening of the semilunar valves, while pressure is still getting up (probably rather less than)	·1	}
Escape of blood into aorta (about)	·1	
Continued contraction of the emptied ventricle (possibly rather more than)	·1	
Total systole of the ventricle (probably rather more than)		·3
Diastole of both auricle and ventricle, neither contracting, or "passive interval" (probably rather less than)	·4	}
Systole of auricle (about or less than)	·1	
Diastole of ventricle, including relaxation and filling, up to the beginning of the ventricular systole (probably rather less than)		·5
Total Cardiac Cycle		<u>·8</u>

Summary.

§ 137. We may now briefly recapitulate the main facts connected with the passage of blood through the heart. The right auricle during its diastole, by the relaxation of its muscular fibres, and by the fact that all backward pressure from the ventricle is removed by the closing of the tricuspid valves, offers but little resistance to the ingress of blood from the veins. On the other hand, the blood in the trunks of both the superior and inferior vena cava is under a pressure, which though diminishing towards the heart remains higher than the pressure obtaining in the interior of the auricle; the blood in consequence flows into the empty auricle, its progress in the case of the superior vena cava being assisted by gravity. At each inspiration this flow (as we shall see in speaking of respiration) is favoured by the diminution of pressure in the heart and great vessels caused by the respiratory movements. Before this flow has gone on very long, the diastole of the ventricle begins, its cavity dilates, the flaps of the tricuspid valve fall back, and blood for some little time flows in an unbroken stream from the venæ cavæ into the ventricle. In a short time, however, probably before very much blood has had time to enter the ventricle, the auricle is full; and forthwith its sharp sudden systole takes place. Partly by reason of the backward pressure in the veins, which increases

rapidly from the heart towards the capillaries, and which, at some distance from the heart is assisted by the presence of valves in the venous trunks, but still more from the fact that the systole begins at the great veins themselves and spreads thence over the auricle, the force of the auricular contraction is spent in driving the blood, not back into the veins, but into the ventricle, where the pressure is still exceedingly low. Whether there is any backward flow at all into the great veins or whether by the progressive character of the systole the flow of blood continues, so to speak, to follow up the systole without break so that the stream from the veins into the auricle is really continuous, is at present doubtful; though a slight positive wave of pressure synchronous with the auricular systole, travelling backward along the great veins, has been observed at least in cases where the heart is beating vigorously.

The ventricle thus being filled by the auricular systole, the play of the tricuspid valves described above comes into action, the auricular systole is followed by that of the ventricle, and the pressure within the ventricle, cut off from the auricle by the tricuspid valves, is brought to bear on the pulmonary semilunar valves and the column of blood on the other side of those valves. As soon as by the rapidly increasing shortening of the ventricular fibres the pressure within the ventricle becomes greater than that in the pulmonary artery, the semilunar valves open and the still continuing systole discharges the contents of the ventricle into that vessel.

As the ventricle thus rapidly and forcibly empties itself, either the transient negative pressure which makes its appearance in the rear of the ejected column of blood or the elastic action of the aortic walls leads to a reflux of blood towards the ventricle, the effect of which however is to close the semilunar valves, and thus to shut off the blood in the distended arteries from the emptied ventricle. Either immediately at or more probably some little time after this closing of the valves, the ventricular systole ends and relaxation begins; then once more the cavity of the ventricle becomes unfolded and finally distended by the influx of blood, a negative pressure developed by the relaxation probably aiding the flow from the auricle and great veins.

During the whole of this time the left side has with still greater energy been executing the same manœuvre. At the same time that the venæ cavæ are filling the right auricle, the pulmonary veins are filling the left auricle. At the same time that the right auricle is contracting, the left auricle is contracting too. The systole of the left ventricle is synchronous with that of the right ventricle, but executed with greater force; and the flow of blood is guided on the left side by the mitral and aortic valves in the same way that it is on the right by the tricuspid valves and the valves of the pulmonary artery.

The Work done.

§ 138. We can measure with approximative exactness the intraventricular pressure, the length of each systole, and the number of times the systole is repeated in a given period, but perhaps the most important factor of all in the determination of the work of the vascular mechanism, the quantity ejected from the ventricle into the aorta at each systole, cannot as yet be said to have been accurately determined; we are largely obliged to fall back on calculations having many sources of error. The general result of some of these calculations gives about 180 grms. (6 oz.) as the quantity of blood which is driven from each ventricle at each systole in a full-grown man of average size and weight, but this estimate is probably too high.

In the dog the quantity has been experimentally determined, by allowing the heart to deliver its contents through one branch of the aorta, all others being ligatured or blocked, into a receiver, the contents of which are at intervals, by an ingenious contrivance, returned to the right auricle. The time taken to fill the receiver and the number of beats executed during that time being noted, the average quantity ejected at a beat is thus given. It is found to vary very widely.

Various methods have been adopted for calculating the average amount of blood ejected at each ventricular systole. The simplest method is to measure the capacity of the recently removed and as yet not rigid ventricle, filled with blood under a pressure equal to the calculated average pressure in the ventricle. On the supposition that the whole contents of the ventricle are ejected at each systole this would give the quantity driven into the aorta at each stroke. The other methods are very indirect.

It is evident that exactly the same quantity must issue at a beat from each ventricle; for if the right ventricle at each beat gave out rather less than the left, after a certain number of beats the whole of the blood would be gathered in the systemic circulation. Similarly, if the left ventricle gave out less than the right, all the blood would soon be crowded into the lungs. The fact that the pressure in the right ventricle is so much less than that in the left (probably 30 or 40 mm. as compared with 200 mm. of mercury), is due, not to differences in the quantity of blood in the cavities, but to the fact that the peripheral resistance which has to be overcome in the lungs is so much less than that in the rest of the body.

It must be remembered that though it is of advantage to speak of an average quantity ejected at each stroke, it is more than probable that that quantity may vary within very wide limits. Taking, however, 180 grms. as the quantity, in man, ejected at

each stroke at a pressure of 250 mm.¹ of mercury, which is equivalent to 3·21 metres of blood, this means that the left ventricle is capable at its systole of lifting 180 grms. 3·21 m. high, *i.e.* it does 578 gram-meters of work at each beat. Supposing the heart to beat 72 times a minute, this would give for the day's work of the left ventricle nearly 60,000 kilogram-meters. Calculating the work of the right ventricle at one-fourth that of the left, the work of the whole heart would amount to 75,000 kilogram-meters, which is just about the amount of work done in the ascent of Snowdon by a tolerably heavy man.

A calculation of more practical value is the following. Taking the quantity of blood as $\frac{1}{13}$ of the body weight, the blood of a man weighing 75 kilos would be about 5,760 grms. If 180 grms. left the ventricle at each beat, a quantity equivalent to the whole blood would pass through the heart in 32 beats, *i.e.* in less than half a minute.

¹ A high estimate is purposely taken here.

SEC. 4. THE PULSE.

§ 139. We have seen that the arteries, though always distended, undergo at each systole of the ventricle a temporary additional distension, a temporary additional expansion so that when the finger is placed on an artery, such as the radial, an intermittent pressure on the finger, coming and going with the

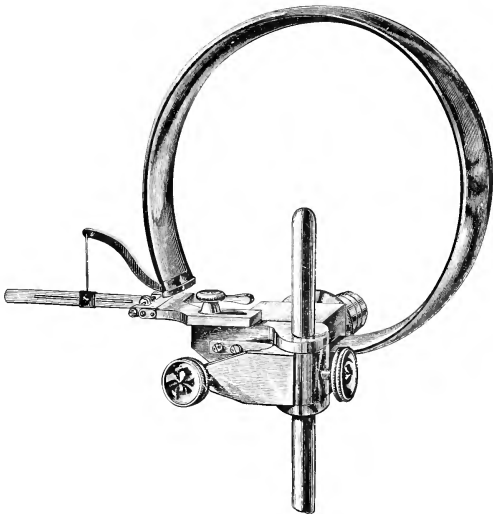

FIG. 42. FICK'S SPRING MANOMETER.

The flattened tube in the form of a hoop is firmly fixed at one end, while the other free end is attached to a lever. The interior of the tube, filled with spirit, is brought, by means of a tube containing sodium carbonate solution, into connection with an artery, in much the same way as in the case of the mercury manometer. The increase of pressure in the artery being transmitted to the hollow hoop, tends to straighten it, and correspondingly moves the attached lever.

beat of the heart, is felt, and when a light lever is placed on the artery, the lever is raised at each beat, falling between.

This intermittent expansion which we call the pulse, corresponding to the jerking outflow of blood from a severed artery, is present in the arteries only, being, except under particular circumstances, absent from the veins and capillaries. The expansion is frequently visible to the eye, and in some cases, as where an artery has a bend, may cause a certain amount of locomotion of the vessel.

The temporary increase of pressure which is the cause of the temporary increase of expansion makes itself felt, as we have seen, in the curve of arterial pressure taken by the mercury manometer; but the inertia of the mercury prevents the special characters of each increase becoming visible. In Fick's spring manometer (Fig. 42), in which the increase of pressure unfolds a curved spring and so moves a lever, the inertia is much less, and satisfactory tracings may be taken by this instrument. Other instruments have also been devised for recording the special characters of each increase of pressure or of the expansion of the artery which is the result of that increase. The easiest and most common method

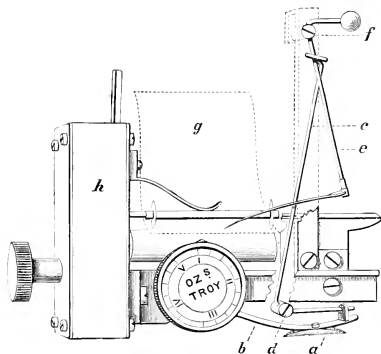

FIG. 43. DIAGRAM OF A SPHYGMOGRAPH (Dudgeon's).

Certain supporting parts are omitted so that the multiplying levers may be displayed.

a is a small metal plate which is kept pressed on the artery by the spring *b*. The vertical movements of *a* cause to and fro movements of the lever *c* about the fixed point *d*. These are communicated to and magnified by the lever *e* which moves round the fixed point *f*. The free end of this lever carries a light steel marker which rests on a strip of smoked paper *g*. The paper is placed beneath two small wheels and rests on a roller which can be rotated by means of clock-work contained in the box *h*. The paper is thus caused to travel at a uniform rate. The screw graduated in ounces Troy is brought to bear on the spring *b* by means of a cam and by this the pressure put on the artery can be regulated. The levers magnify the pulse movements fifty times.

of registering the expansion of an artery is that of simply bringing a light lever to bear on the outside of the artery.

A lever specially adapted to record a pulse tracing is called a sphygmograph, the instrument generally comprising a small travelling recording surface on which the lever writes. There are many different forms of sphygmograph but the general plan of structure is the same. Fig. 43 represents in a diagrammatic form the essential parts of the sphygmograph, known as Dudgeon's. The instrument is generally applied to the radial artery because the arm affords a convenient support to the fulcrum of the lever, and because the position of the artery, near to the surface and with the support of the radius below so that adequate pressure can be brought to bear by the lever on the artery, is favourable for making observations. It can of course be applied to other arteries. When applied to the radial artery some such tracing as that shewn in Fig. 44 is obtained. At each heart-beat the lever

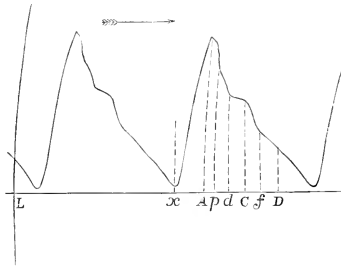

FIG. 44. PULSE TRACING FROM THE RADIAL ARTERY OF MAN.

The vertical curved line, L, gives the tracing which the recording lever made when the blackened paper was motionless. The curved interrupted lines shew the distance from one another in time of the chief phases of the pulse-wave, viz. x =commencement and A end of expansion of artery. p , predicrotic notch. d , dicrotic crest. C, dicrotic notch. D, post-dicrotic crest. f , the post-dicrotic notch. These are explained in the text later on.

rises rapidly and then falls more gradually in a line which is more or less uneven.

§ 140. We have now to study the nature and characters of the pulse in greater detail.

We may say at once, and indeed have already incidentally seen, that the pulse is essentially due to the action of physical causes; it is the physical result of the sudden injection of the contents of the ventricle into the elastic tubes called arteries; its more important features may be explained on physical principles and may be illustrated by means of an artificial model.

If two levers be placed on the arterial tubes of an artificial model Fig. 30 *S. a.*, *S'. a.*, one near to the pump, and the other

near to the peripheral resistance, with a considerable length of tubing between them, and both levers be made to write on a recording surface, one immediately below the other, so that their curves can be more easily compared, the following facts may be observed, when the pump is set to work regularly. They are perhaps still better seen if a number of levers be similarly arranged at different distances from the pump as in Fig. 45.

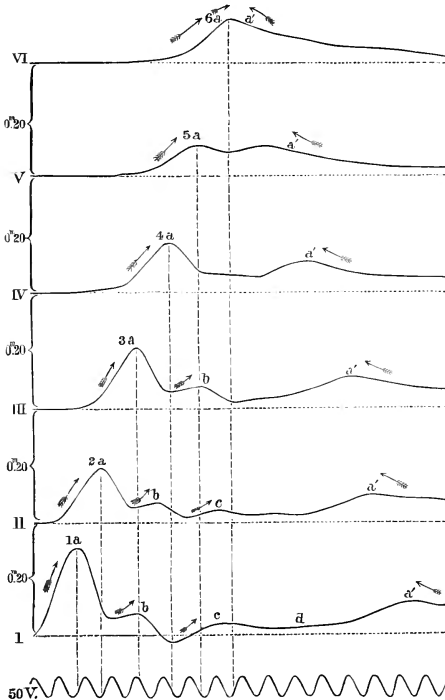

FIG. 45. Pulse-curves described by a series of sphygmographic levers placed at intervals of 20 cm. from each other along an elastic tube into which fluid is forced by the sudden stroke of a pump. The pulse-wave is travelling from left to right, as indicated by the arrows over the primary (*a*) and secondary (*b*, *c*) pulse-waves. The dotted vertical lines drawn from the summit of the several primary waves to the tuning-fork curve below, each complete vibration of which occupies $\frac{1}{50}$ sec., allow the time to be measured which is taken up by the wave in passing along 20 cm. of the tubing. The waves *a'* are waves reflected from the closed distal end of the tubing; this is indicated by the direction of the arrows. It will be observed that in the more distant lever VI. the reflected wave, having but a slight distance to travel, becomes fused with the primary wave. (From Marey.)

At each stroke of the pump, each lever rises until it reaches a maximum (Fig. 45 1a, 2a, &c.) and then falls again, thus describing a curve. The rise is due to the expansion of the part of the tube under the lever, and the fall is due to that part of the tube returning after the expansion to its previous calibre. The curve is therefore the curve of the expansion (and return) of the tube at the point on which the lever rests. We may call it the pulse-curve. It is obvious that the expansion passes by the lever in the form of a wave. At one moment the lever is at rest: the tube beneath it is simply distended to the normal amount indicative of the mean pressure which at the time obtains in the arterial tubes of the model; at the next moment the pulse expansion reaches the lever, and the lever begins to rise; it continues to rise until the top of the wave reaches it, after which it falls again until finally it comes to rest, the wave having completely passed by.

It may perhaps be as well at once to warn the reader that the figure which we call the pulse-curve is not a representation of the pulse-wave itself; it is simply a representation of the movements, up and down, of the piece of the wall of the tubing at the spot on which the lever rests *during the time* that the wave is passing over that spot. We may roughly represent the wave in the diagram Fig. 46 in which the wave shewn by the dotted line is

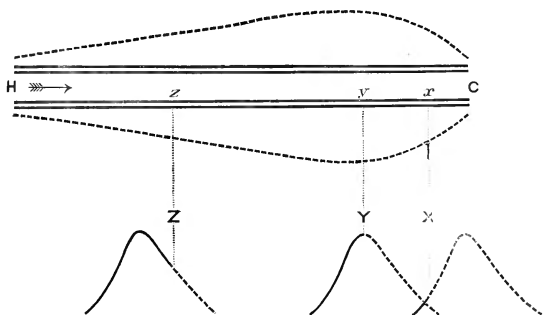

FIG. 46. A ROUGH DIAGRAMMATIC REPRESENTATION OF A PULSE WAVE PASSING OVER AN ARTERY.

passing over the tube (shewn in a condition of rest by the thick double line) in the direction from *H* to *C*. It must however be remembered that the wave thus figured is a much shorter wave than is the pulse-wave in reality (that being, as we shall see, about 6 meters long), *i.e.* occupies a smaller length of the arterial system from the heart *H* towards the capillaries *C*.

The curves below *X*, *Y*, *Z* represent, in a similarly diagrammatic fashion, the curves described, during the passage of the wave, by levers placed on the points *x*, *y*, *z*. At *Z* the greater part of the wave has already passed under the lever, which during its passage has already described the greater part of its curve, shewn by the thick line, and has only now to describe the small part, shewn by the dotted line, corresponding to the remainder of the wave from *Z* to *H*. At *Y* the lever is at the summit of the wave. At *X* the lever has only described a small part of the beginning of the wave, viz. from *C* to *x*, the rest of the curve, as shewn by the dotted line, having yet to be described.

But to return to the consideration of Fig. 45.

§ 141. The rise of each lever is somewhat sudden, but the fall is more gradual, and is generally marked with some irregularities which we shall study presently. The rise is sudden because the sharp stroke of the pump suddenly drives a quantity of fluid into the tubing and so suddenly expands the tube; the fall is more gradual because the elastic reaction of the walls of the tube, which brings about the return of the tube to its former calibre after the expanding power of the pump has ceased, is more gradual in its action.

These features, the suddenness of the rise or up-stroke, and the more gradual slope of the fall or down-stroke, are seen also in natural pulse-curves taken from living arteries (Figs. 44, 47, &c.).

Indeed the difference between the up-stroke and the down-stroke is even more marked in the latter than in the former, the delivery of blood from the ventricle being more rapid than the issue of water from a pump as ordinarily worked.

It may here be noted that the actual size of the curve, that is the amount of excursion of the lever, depends in part (as does also to a great extent the form of the curve) on the amount of pressure exerted by the lever on the tube. If the lever only just touches the tube in its expanded state, the rise will be insignificant. If on the other hand the lever be pressed down too firmly, the tube beneath will not be able to expand as it otherwise would, and the rise of the lever will be proportionately diminished. There is a certain pressure which must be exerted by the lever on the tube, the exact amount depending on the expansive power of the tubing and on the

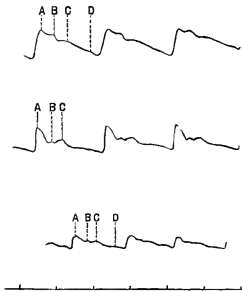

FIG. 47. PULSE TRACINGS FROM THE SAME RADIAL ARTERY UNDER DIFFERENT PRESSURES OF THE LEVER.

The letters are explained in a later part of the text.

proportionately diminished. There is a certain pressure which must be exerted by the lever on the tube, the exact amount depending on the expansive power of the tubing and on the

pressure exerted by the fluid in the tube, in order that the tracing may be best marked. This is shewn in Fig. 47 in which are given three tracings taken from the same radial artery with the same instrument; in the lower curve the pressure of the lever is too great, in the upper curve too small, to bring out the characters seen most distinctly in the middle curve with a medium pressure.

§ 142. It will be observed that in Fig. 45 curve I., which is nearer the pump, rises higher, and rises more rapidly than curve II., which is farther away from the pump; that is to say, at the lever farther away from the pump, the expansion is less and takes place more slowly than at the lever nearer the pump. Similarly in curve IV. the rise is still less, and takes place still less rapidly than in II., and the same change is seen still more marked in V. as compared with IV. In fact if a number of levers were placed at equal distances along the arterial tubing of the model and the model were working properly, with an adequate peripheral resistance, we might trace out step by step how the expansion, as it travelled along the tube, got less and less in amount and at the same time became more gradual in its development, the curve becoming lower and more flattened out, until in the neighbourhood of the artificial capillaries there was hardly any trace of it left. In other words we might trace out step by step the gradual disappearance of the pulse.

The same changes, the same gradual lowering and flattening of the curve may be seen in natural pulse tracings, as for instance in Fig. 48 which is a tracing from the dorsalis pedis artery, compared with the tracing from the radial artery Fig. 47, taken from the same individual with the same instrument on the same occasion.

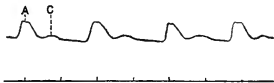

FIG. 48. PULSE TRACING FROM DORSALIS PEDIS TAKEN FROM THE SAME INDIVIDUAL AS FIG. 47.

This feature is of course not obvious in all pulse-curves taken from different individuals with different instruments and under varied circumstances; but if a series of curves from different arteries were carefully taken under the same conditions it would be found that the aortic tracing is higher and more sudden than the carotid tracing which again is higher and more sudden than the radial tracing, the tibial tracing being in turn still lower and more flattened. The pulse-curve dies out by becoming lower and lower and more and more flattened out.

And a little consideration will shew us that this must be so. The systole of the ventricle drives a quantity of blood into the already full aorta. The sudden injection of this quantity of blood expands the portion of the aorta next to the heart, the part immediately adjacent to the semilunar valves beginning to expand

first, and the expansion travelling thence on to the end of this portion. In the same way the expansion travels on from this portion through all the succeeding portions of the arterial system. For the total expansion required to make room for the new quantity of blood is not provided by that portion alone of the aorta into which the blood is actually received; it is supplied by the whole arterial system: the old quantity of blood which is replaced by the new in this first portion has to find room for itself in the rest of the arterial space. As the expansion travels onward, however, the *increase* of pressure which each portion transmits to the succeeding portion will be less than that which it received from the preceding portion. For the whole increase of pressure due to the systole of the ventricle has to be distributed over the whole of the arterial system; the general mean arterial pressure is, as we have seen, maintained by repeated systoles, and any one systole has to make its contribution to that mean pressure; the increase of pressure which starts from the ventricle must therefore leave behind at each stage of its progress a fraction of itself; that is to say, the expansion is continually growing less, as the pulse travels from the heart to the capillaries. Moreover, while the expansion of the aorta next to the heart is so to speak the direct effect of the systole of the ventricle, the expansion of the more distant artery is the effect of the systole transmitted by the help of the elastic reaction of the arterial tract between the heart and the distant artery; and since this elastic reaction is slower in development than the actual systole, the expansion of the more distant artery is slower than that of the aorta, the up-stroke of the pulse-curve is less sudden, and the whole pulse-curve is more flattened.

The object of the systole is to supply a contribution to the mean pressure, and the pulse is an oscillation above and below that mean pressure, an oscillation which diminishes from the heart onwards, being damped by the elastic walls of the arteries, and so, little by little, converted into mean pressure until in the capillaries the mean pressure alone remains, the oscillations having disappeared.

§ 143. If in the model the points of the two levers at different distances from the pump be placed exactly one under the other on the recording surface, it is obvious that, the levers being alike except for their position on the tube, any difference in time between the movements of the two levers will be shewn by an interval between the beginnings of the curves they describe, the recording surface being made to travel sufficiently rapidly.

If the movements of the two levers be thus compared, it will be seen that the far lever (Fig. 45, II.) commences later than the near one (Fig. 45, I.); the farther apart the two levers are, the greater is the interval in time between their curves. Compare the series I. to VI. (Fig. 45). This means that the wave of expansion, the

pulse-wave, takes some time to travel along the tube. In the same way it would be found that the rise of the near lever began some fraction of a second after the stroke of the pump.

The velocity with which the pulse-wave travels depends chiefly on the amount of rigidity possessed by the tubing. The more extensible (with corresponding elastic reaction) the tube, the slower is the wave; the more rigid the tube becomes, the faster the wave travels; in a perfectly rigid tube, what in the elastic tube would be the pulse, becomes a mere shock travelling with very great rapidity. The width of the tube is of much less influence, though according to some observers the wave travels more slowly in the wider tubes.

The rate at which the normal pulse-wave travels in the human body has been variously estimated at from 10 to 5 meters per second. In all probability the lower estimate is the more correct one; but it must be remembered that the rate may vary very considerably under different conditions. According to all observers the velocity of the wave in passing from the groin to the foot is greater than that in passing from the axilla to the wrist (6 m. against 5 m.). This is probably due to the fact that the femoral artery with its branches is more rigid than the axillary and its branches. So also in the arteries of children, the wave travels more slowly than in the more rigid arteries of the adult. The velocity is also increased by circumstances which heighten and decreased by those which lessen the mean arterial pressure, since with increasing pressure the arterial walls become more and with diminishing pressure less rigid. Probably also the velocity of the pulse-wave depends on conditions of the arterial walls, which we cannot adequately describe as mere differences in rigidity. In experimenting with artificial tubes it is found that different qualities of indiarubber give rise to very different results.

Care must be taken not to confound the progress of the pulse-wave, i.e. of the expansion of the arterial walls, with the actual onward movement of the blood itself. The pulse-wave travels over the moving blood somewhat as a rapidly moving natural wave travels along a sluggishly flowing river. Thus while the velocity of the pulse-wave is 6 or possibly even 10 meters per sec., that of the current of blood is not more than half a meter per sec. even in the large arteries, and is still less in the smaller ones.

§ 144. Referring to the caution given above not to regard the pulse-curve as a picture of the pulse-wave, we may now add that the pulse-wave is of very considerable length. If we know how long it takes for the pulse-wave to pass over any point in the arteries and how fast it is travelling, we can easily calculate the length of the wave. In an ordinary pulse-curve the artery, owing to the slow return, is seen not to regain the calibre which it had before the expansion, until just as the next expansion begins, that is to say, the pulse-wave takes the whole time of a cardiac cycle, viz. $\frac{8}{10}$ ths

sec. to pass by the lever. Taking the velocity of the pulse-wave as 6 meters per sec. the length of the wave will be $\frac{8}{10}$ ths of 6 m., that is nearly 5 meters. And even if we took a smaller estimate, by supposing that the real expansion and return of the artery at any point took much less time, say $\frac{4}{10}$ ths sec., the length of the pulse-wave would still be more than 2 meters. But even in the tallest man the capillaries farthest from the heart, those in the tips of the toes, are not 2 m. distant from the heart. In other words, the length of the pulse-wave is much greater than the whole length of the arterial system, so that the beginning of each wave has become lost in the small arteries and capillaries some time before the end of it has finally passed away from the beginning of the aorta.

We must now return to the consideration of certain special features in the pulse, which from the indications they give or suggest of the condition of the vascular system are often of great interest.

§ 145. *Dicrotism*. In nearly all pulse tracings, the curve of the expansion and recoil of the artery is broken by two, three, or several smaller elevations and depressions: secondary waves are imposed upon the fundamental or primary wave. In the sphygmographic tracing from the carotid Fig. 49 and in many of the other tracings

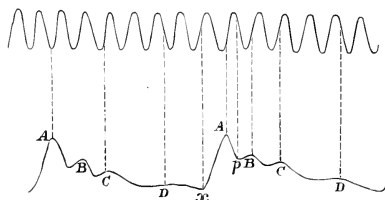

Fig. 49. PULSE-TRACING FROM CAROTID ARTERY OF HEALTHY MAN (from Moens).

x, commencement of expansion of the artery. A, summit of the first rise. C, dicrotic secondary wave. B, predicrotic secondary wave; p, notch preceding this. D, succeeding secondary wave. The curve above is that of a tuning-fork with ten double vibrations in a second.

given, these secondary elevations are marked as B, C, D. When one such secondary elevation only is conspicuous, so that the pulse-curve presents two notable crests only, the primary crest and a secondary one, the pulse is said to be "dicrotic"; when two secondary crests are prominent, the pulse is often called "tricrotic"; where several "polycretic." As a general rule, the secondary elevations appear only on the descending limb of the primary wave as in most of the curves given, and the curve is then spoken of as "katacretic." Sometimes, however, the first elevation or crest is not the highest but appears on the ascending

portion of the main curve: such a curve is spoken of as "anacrotic" Fig. 50.

Of these secondary elevations, the most frequent, conspicuous and important is the one which appears some way down on the descending limb and is marked C on Fig. 49 and on most of the curves here given. It is more or less distinctly visible on all sphygmograms, and may be seen in those of the aorta as well as of other arteries. Sometimes it is so slight as to be hardly discernible; at other times it may be so marked as to give rise to a really double pulse (Fig. 51), *i.e.* a pulse which can be felt as double by the finger; hence it has been called the *dicrotic* elevation or the dicrotic wave, the notch preceding the elevation being spoken of as the "dicrotic notch."



FIG. 50. ANACROTIC SPHYGMOGRAPH TRACING FROM THE ASCENDING AORTA (Aneurism).



FIG. 51. TWO GRADES OF MARKED DICROTISM IN RADIAL PULSE OF MAN. (Typhoid Fever.)

Neither it nor any other secondary elevations can be recognised in the tracings of blood-pressure taken with a manometer. This may be explained, as we have said § 139, by the fact that the movements of the mercury column are too sluggish to reproduce these finer variations; but dicrotism is also conspicuous by its absence in the tracings given by more delicately responsive instruments. Moreover, when the normal pulse is felt by the finger, most persons find themselves unable to detect any dicrotism. But that it does really exist in the normal pulse is shewn by the fact that it appears in a most unmistakeable manner in the tracing obtained by allowing the blood to spirt directly from an opened small artery, such as the dorsalis pedis, upon a recording surface.

Less constant and conspicuous than the dicrotic wave but yet appearing in most sphygmograms is an elevation which appears higher up on the descending limb of the main wave; it is marked B in Fig. 49, and on several of the other curves, and is frequently called the *predicrotic* wave; it may become very prominent. Sometimes other secondary waves, often called 'post-dicrotic', are seen following the dicrotic wave, as at D in Fig. 49, and some other curves; but these are not often present and usually even when present inconspicuous.

When tracings are taken from several arteries or from the same

artery under different conditions of the body, these secondary waves are found to vary very considerably, giving rise to many characteristic forms of pulse-curve. Were we able with certainty to trace back the several features of the curves to their respective causes, an adequate examination of sphygmographic tracings would undoubtedly disclose much valuable information concerning the condition of the body presenting them. Unfortunately the problem of the origin of these secondary waves is a most difficult and complex one; so much so that the detailed interpretation of a sphygmographic tracing is still in most cases extremely uncertain.

§ 146. The chief interest attaches to the nature and meaning of the dicrotic wave. In general the main conditions favouring dicrotism are (1) a highly extensible and elastic arterial wall, (2) a comparatively low mean pressure, leaving the extensible and elastic reaction of the arterial wall free scope to act, and (3) a sufficiently vigorous and sufficiently rapid stroke of the ventricle. The development of the dicrotic wave may probably be explained as follows.

At each beat the time during which the contents of the left ventricle are injected into the aorta is as we have seen (§ 136) very brief. The expansion of the aorta is very sudden, and the cessation of that expansion is also very sudden.

Now when fluid is being driven with even a steady pressure through an elastic tube or a system of elastic tubes, levers placed on the tube will describe curves indicating variations in the diameter of the tube, if the inflow into the tube be suddenly stopped, as by sharply turning a stop-cock; and a comparison of levers placed at different distances from the stop-cock will shew that these variations of diameter travel down the tube from the stop-cock in the form of waves. The lever near the stop-cock will first of all fall, but speedily begin to rise again, and this subsequent rise will be followed by another fall, after which there may be one or more succeeding rises and falls, that is oscillations, with decreasing amplitudes, until the fluid comes to rest. The levers farther from the stop-cock will describe curves, similar to the above in form but of less amplitude, and it will be found that these occur somewhat later in time, the more so the farther the lever is from the stop-cock. Obviously these waves are generated at or near the stop-cock and travel thence along the tubing.

We may infer that at each beat of the heart similar waves would be generated at the root of the aorta, upon the sudden cessation of the flow from the ventricle, and would travel thence along the elastic arteries. The facts that each beat is rapidly succeeded by another, and that the flow which suddenly ceases is also, by the nature of the ventricular stroke, suddenly generated, may render the waves more complicated, but will not change their essential nature.

The exact interpretation of the generation of these waves is perhaps not without difficulty, but two factors seem of especial importance. In the first place, as we have already more than once said, when a rapid flow is suddenly stopped a negative pressure makes its appearance behind the column of fluid. In a rigid tube this simply leads to a reflux of fluid. In an elastic tube its effects are complicated by the second factor, the elastic action and inertia of the walls of the tube. Upon the sudden cessation of the flow, the expansion of the tube, or as we may at once say, of the aorta, ceases, the vessel begins to shrink, and the lever placed on it falls, as from *A* onward in the pulse-curve. This shrinking is in part due to the elastic reaction of the walls of the aorta, but is increased by the "suction" action of the negative pressure spoken of above. In thus shrinking however under these combined causes, the aorta, through the inertia of its walls, overshoots the mark, it is carried beyond its natural calibre, *i.e.* the diameter it would possess if left to itself with the pressure inside and outside equal; it shrinks too much, and consequently begins again to expand. This secondary expansion (taking for simplicity sake a pulse-curve in which the so-called predicrotic wave, *B*, is absent or inconspicuous) causes the secondary rise of the lever up to *C*, that is the dicrotic rise. In thus expanding again the aorta tends to draw back towards the heart the column of blood which by loss of momentum had come to rest, or indeed under the influence of the negative pressure spoken of above was already undergoing a reflux. In this secondary expansion moreover the aorta is by the inertia of its walls, aided by that of the blood, again carried, so to speak, beyond its mark, so that no sooner has it become expanded and filled with fluid to a certain extent than it again begins to shrink as from *C* onward. And this shrinking may in a similar manner to the first be followed by a further expansion and shrinking, giving rise to a post-dicrotic wave, or it may be to post-dicrotic waves. And the successive changes thus inaugurated at the root of the aorta travel as so many waves along the arterial system, diminishing as they go. It will be observed that for the development of these waves, a certain quality in the walls of the tubing is necessary. The tube must be such as possesses when at rest an open lumen; the walls must be of such a kind that the tube remains open when empty, *i.e.* when the atmospheric pressure is equal inside and outside, so that when it shrinks too much, it expands again in striving to regain its natural calibre. This we have seen to be a characteristic of the arteries. A collapsible tube of thin membrane will not shew the phenomena; such a tube when the stop-cock is turned collapses and empties itself, continuing to be collapsed without any effort to expand again.

In the above explanation no mention has been made of the closing of the semilunar valves; we shall have to speak of these

a little later on in referring to the predicrotic wave and shall see that, under the view we have just given, the closing of the semilunar valves is to be regarded rather as the effect than the cause of the dicrotic wave. Many authors however give an interpretation of the dicrotic wave different from that detailed above. Thus it is held that the primary shrinking, from *A* onwards, being brought to bear on the column of blood already come to rest, in face of the great pressure in front, drives the blood back against the semilunar valves, thus closing them, and that the impact of the column of blood against the valves starts a new wave of expansion, which reinforcing the natural tendency of the elastic walls to expand again after their primary shrinking produces the dicrotic wave *C*. On this view it is the blood driven back from the valves which expands the artery; on the view given above it is the expanding artery which draws the blood back towards the valves.

Moreover, quite other views have been or are held concerning this dicrotic wave. According to many authors it is what is called a 'reflected' wave. Thus, when the tube of the artificial model bearing two levers is blocked just beyond the far lever, the primary wave is seen to be accompanied by a second wave, which at the far lever is seen close to, and often fused into, the primary wave (Fig. 45, VI. *a'*), but at the near lever is at some distance from it (Fig. 45, I. *a'*), being the farther from it the longer the interval between the lever and the block in the tube. The second wave is evidently the primary wave reflected at the block and travelling backwards towards the pump. It thus of course passes the far lever before the near one. And it has been argued that the dicrotic wave of the pulse is really such a reflected wave, started either at the minute arteries and capillaries, or at the points of bifurcation of the larger arteries, and travelling backwards to the aorta. But if this were the case the distance between the primary crest and the dicrotic crest ought to be less in arteries more distant from than in those nearer to the heart, just as in the artificial scheme the reflected wave is fused with a primary wave near the block (Fig. 45, VI. 6 *a. a'*), but becomes more and more separated from it the farther back towards the pump we trace it (Fig. 45, I. 1 *a. a'*). Now this is not the case with the dicrotic wave. Careful measurements shew that the distance between the primary and dicrotic crests is either greater or certainly not less in the smaller or more distant arteries than in the larger or nearer ones. This feature indeed proves that the dicrotic wave cannot be due to reflection at the periphery or indeed in any way a retrograde wave. Besides the multitudinous peripheral division would render one large peripherically reflected wave impossible. Again, the more rapidly the primary wave is obliterated or at least diminished on its way to the periphery the less conspicuous should be the dicrotic wave. Hence increased extensi-

bility and increased elastic reaction of the arterial walls which tend to use up rapidly the primary wave, should also lessen the dicrotic wave. But as a matter of fact these conditions, as we have said, are favourable to the prominence of the dicrotic wave.

On the other hand these, and the other conditions which favour dicrotism in the pulse, are exactly those which would favour such a development of secondary waves as has been described above, and their absence would be unfavourable to the occurrence of such waves. Thus dicrotism is less marked in rigid arteries (such as those of old people) than in healthy elastic ones; the rigid wall neither expands so readily nor shrinks so readily, and hence does not so readily give rise to such secondary waves. Again dicrotism is more marked when the mean arterial pressure is low than when it is high; indeed dicrotism may be induced when absent, or increased when slightly marked, by diminishing, in one way or another, the mean pressure. Now when the pressure is high, the arteries are kept continually much expanded, and are therefore the less capable of further expansion, that is to say, are, so far, more rigid. Hence the additional expansion due to the systole is not very great; there is a less tendency for the arterial walls to swing backwards and forwards, so to speak, and hence a less tendency to the development of secondary waves. When the mean pressure is low, the opposite state of things exists; supposing of course that the ventricular stroke is adequately vigorous (the low pressure being due, not to diminished cardiac force but to diminished peripheral resistance) the relatively empty but highly distensible artery is rapidly expanded, and falling rapidly back enters upon a secondary (dicrotic) expansion and even a third.

Moreover the same principles may be applied to explain why sometimes dicrotism will appear marked in a particular artery while it remains little marked in the rest of the system. In experimenting with an artificial tubing such as the arterial model, the physical characters of which remain the same throughout, both the primary and the secondary waves retain the same characters as they travel along the tubing save only that both gradually diminish towards the periphery; and in the natural circulation, when the vascular conditions are fairly uniform throughout, the pulse curve, as a rule, possesses the same general characters throughout, save that it is gradually 'damped off.' But suppose we were to substitute for the first section of the tubing a piece of perfectly rigid tubing; this at the stroke of the pump on account of its being rigid would shew neither primary nor secondary expansion, but the expanding force of the pump's stroke would be transmitted through it to the second, elastic section, and here the primary and secondary waves would at once become evident. This is an extreme case, but the same thing would be seen to a less degree in passing from a more rigid,

that is less extensible and elastic section, to a less rigid, more extensible and elastic section; the primary and secondary expansions, in spite of the general damping effect, would suddenly increase. Similarly in the living body a pulse-curve which so long as it is travelling along arteries in which the mean pressure is high, and which are therefore practically somewhat rigid, is not markedly dicrotic, may become very markedly dicrotic when it comes to a particular artery, in which the mean pressure is low (and we shall see presently that such a case may occur), and the walls of which are therefore for the time being relatively more distensible than the rest.

Lastly we may recall the observation made above § 141 that the curve of expansion of an elastic tube is modified by the pressure exerted by the lever employed to record it, and that hence, in the same artery, and with the same instrument, the size, form, and even the special features of the curve vary according to the amount of pressure with which the lever is pressed upon the artery. Accordingly the amount of dicrotism apparent in a pulse may be modified by the pressure exerted by the lever. In Fig. 47 for instance the dicrotic wave is more evident in the middle than in the upper tracing.

§ 147. The predicrotic wave, (marked *B* on Fig. 49, and on several other of the pulse curves), which precedes the dicrotic wave and is still more variable than that wave, being sometimes slight or even invisible and sometimes conspicuous, has given rise to much controversy. In the interpretation of the dicrotic wave given in the preceding paragraph it was stated that the negative pressure developed on the cessation of the flow in the rear of the column of blood, led by itself to a reflux towards the ventricle; and it has been suggested that this reflux meeting and closing the semilunar valves starts a small wave of expansion before the larger dicrotic wave has had time to develop itself. On this view the semilunar valves would be actually closed before the occurrence of the secondary dicrotic expansion of the arterial walls, though the larger more powerful reflux of this later event must render the closure more complete and in doing so possibly gives rise to the second sound. According however to the second view given in the same paragraph, which regards the reflux due to the shrinking of the artery in face of the great pressure in front as firmly closing the semilunar valves, and as thus starting the secondary dicrotic wave of expansion, the firm closing of the semilunar valves must take place before the beginning, not during the development of the dicrotic wave; it is still possible however, even on this view as on the other, to suppose that an antecedent reflux due to the negative pressure succeeding the cessation of flow from the ventricle closes the valves and starts the predicrotic wave. But the matter is one not yet beyond the stage of controversy.

§ 148. In an anacrotic pulse the first rise is not the highest, but a second rise B, Fig. 50, which follows and is separated from it by a notch is higher than or at least as high as itself. Such an anacrotic wave, though it may sometimes be produced temporarily in healthy persons, is generally associated with diseased conditions, usually such in which the arteries are abnormally rigid. In describing the ventricular systole we spoke of the pressure within the ventricle as reaching its maximum just before the opening of the semilunar valves; and this is apparently the normal event; but there are curves which seem to shew that after the first sudden rise of pressure which opens the valves, followed by a brief lessening of pressure, which appears on the curve as a notch, the pressure may again rise and that to a point higher than before. And a similar curve is sometimes described by the front-to-back diameter of the ventricle. The systole opens the valves as it were with a burst; this is followed by a slight relapse, and then the systole, strengthening again, discharges the whole of the ventricular contents into the aorta and so brings about a tardy maximum expansion. And what is thus started in the aorta travels onward over the arterial system. It is difficult to see how these anacrotic events can be produced except by a certain irregularity in the ventricular systole, and indeed the anacrotic pulse is frequently associated with some disease or defect of the ventricle.

§ 149. *Venous Pulse.* Under certain circumstances the pulse may be carried on from the arteries through the capillaries into the veins. Thus, as we shall see later on, when the salivary gland is actively secreting, the blood may issue from the gland through the veins in a rapid pulsating stream. The nervous events which give rise to the secretion of saliva, lead at the same time, by the agency of vaso-motor nerves, of which we shall presently speak, to a dilatation of the small arteries of the gland. When the gland is at rest, the minute arteries are, as we shall see, somewhat constricted and narrowed, and thus contribute largely to the peripheral resistance in the part; this peripheral resistance throws into action the elastic properties of the small arteries leading to the gland, and the remnant of the pulse reaching these arteries is, as we before explained, finally destroyed. When the minute arteries are dilated, their widened channels allow the blood to flow more easily through them and with less friction; the peripheral resistance which they normally offer is thus lessened. In consequence of this the elasticity of the walls of the small arteries is brought into play to a less extent than before, and these small arteries cease to do their share in destroying the pulse which comes down to them from the larger arteries. As in the case of the artificial model, where the 'peripheral' tubing is kept open, not enough elasticity is brought into play to convert the intermittent arterial flow into a continuous one, and the pulse which reaches the arteries of the gland

passes on through them and through the capillaries, and is continued on into the veins. A similar venous pulse is also sometimes seen in other organs.

Careful tracings of the great veins in the neighbourhood of the heart shew elevations and depressions, which appear due to the variations of intracardiac (auricular) pressure, and which may perhaps be spoken of as constituting a "venous pulse", though they have a quite different origin from the venous pulse just described in the salivary gland; but at present they need further elucidation. ✕ In cases however of insufficiency of the tricuspid valves, the systole of the ventricle makes itself distinctly felt in the great veins; and a distension travelling backwards from the heart becomes very visible in the veins of the neck. This is sometimes spoken of as a venous pulse.

Variations of pressure in the great veins due to the respiratory movements are also sometimes spoken of as a venous pulse; the nature of these variations will be explained in treating of respiration.

SEC. 5. THE REGULATION AND ADAPTATION OF THE VASCULAR MECHANISM.

The Regulation of the Beat of the Heart.

§ 150. So far the facts with which we have had to deal, with the exception of the heart's beat itself, have been simply physical facts. All the essential phenomena which we have studied may be reproduced on a dead model. Such an unvarying mechanical vascular system would however be useless to a living body whose actions were at all complicated. The prominent feature of a living mechanism is the power of adapting itself to changes in its internal and external circumstances. In such a system as we have sketched above there would be but scanty power of adaptation. The well-constructed machine might work with beautiful regularity; but its regularity would be its destruction. The same quantity of blood would always flow in the same steady stream through each and every tissue and organ, irrespective of local and general wants. The brain and the stomach, whether at work and needing much, or at rest and needing little, would receive their ration of blood, allotted with a pernicious monotony. Just the same amount of blood would pass through the skin on the hottest as on the coldest day. The canon of the life of every part for the whole period of its existence would be furnished by the inborn diameter of its blood vessels, and by the unvarying motive power of the heart.

Such a rigid system however does not exist in actual living beings. The vascular mechanism in all animals in which it is present is capable of local and general modifications, adapting it to local and general changes of circumstance. These modifications fall into two great classes:

1. Changes in the heart's beat. These, being central, have of course a general effect; they influence or may influence the whole body.

2. Changes in the peripheral resistance, due to variations in the calibre of the minute arteries, brought about by the agency of their contractile muscular coats. These changes may be either local, affecting a particular vascular area only, or general, affecting all or nearly all the blood vessels of the body.

These two classes of events are chiefly governed by the nervous system. It is by means of the nervous system that the heart's beat and the calibre of the minute arteries are brought into relation with each other, and with almost every part of the body. It is by means of the nervous system acting either on the heart, or on the small arteries, or on both, that a change of circumstances affecting either the whole or a part of the body is met by compensating or regulative changes in the flow of blood. It is by means of the nervous system that an organ has a more full supply of blood when at work than when at rest, that the tide of blood through the skin rises and ebbs with the rise and fall of the temperature of the air, that the work of the heart is tempered to meet the strain of overfull arteries, and that the arterial gates open and shut as the force of the central pump waxes and wanes. The study of these changes becomes therefore to a large extent a study of nervous actions.

The circulation may also be modified by events not belonging to either of the above two classes. Thus, in this or that peripheral area, changes in the capillary walls and the walls of the minute arteries and veins may lead to an increase of the tendency of the blood corpuscles to adhere to the vascular walls, and so, quite apart from any change in the calibre of the blood vessels, may lead to increase of the peripheral resistance. This is seen in an extreme case in inflammation, but may possibly intervene to a less extent in the ordinary condition of the circulation, and may also be under the influence of the nervous system. Further, any decided change in the quantity of blood actually in circulation must also influence the working of the vascular mechanism. But both these changes are unimportant compared with the other two kinds of changes. Hence, the two most important problems for us to study are, 1, how the nervous system regulates the beat of the heart, and 2, how the nervous system regulates the calibre of the blood vessels. We will first consider the former problem.

The Histology of the Heart.

§ 151. It will be necessary now to take up certain points concerning the minute structure of the heart, which we had previously postponed; and since much of our knowledge of the nervous mechanism of the beat of the heart is derived from experiments on the hearts of cold-blooded animals, more particularly of the frog, it will be desirable to consider these as well as the mammalian heart.

Cardiac Muscular Tissue. The ventricle of the frog's heart is composed of minute spindle-shaped fibres or fibre cells, each containing a nucleus in its middle, and tapering to a point at each end; sometimes however the end is forked or even branched. These fibres or fibre cells, in fact, resemble plain muscular fibres save that they are somewhat larger and that their substance is striated. The striation is due, like the striation of a striated muscle fibre, to alternate dim and bright bands, but is rarely so distinct as in a skeletal fibre; it is very apt to be obscured by the presence of dispersed distinct granules, which, in many cases at all events, are of a fatty nature. Like the plain muscular fibre, the cardiac muscular fibre has no distinct sarcolemma.

A number of these fibres are joined by cement substance into small bundles, and these bundles are, by help of connective tissue which carries no blood vessels, woven into an intricate network or sponge work, which forms the greater part of the wall of the ventricle. Immediately under the pericardial coating, consisting of a layer of epithelioid plates resting on a connective tissue basis, the muscular tissue forms a thin continuous sheet, but within this it spreads out into a sponge work, the meshes of which present a labyrinth of passages continuous with the cavity of the ventricle. The bars of this sponge work, varying in thickness and, though apparently irregular, arranged on a definite system, consist of bundles of muscular fibres united by connective tissue, and are coated with the same endocardial membrane (flat epithelioid plates resting on a connective tissue basis) that lines the cavity of the ventricle and indeed the whole interior of the heart. The cavity of the ventricle, in other words, opens out into a labyrinth of passages reaching nearly to the surface of the ventricle. When the ventricle is dilated or relaxed, blood flows freely into and fills this labyrinth, bathing the bars of the sponge work, which, in the absence of capillaries, depend on this blood for their nourishment. When the ventricle contracts, the blood is driven out of this labyrinth as well as out of the central cavity. Hence the ventricle when dilated and full of blood is of a deep red colour, when contracted and empty is extremely pale, having little more than the colour of the muscular fibres themselves, which, like striated fibres, possess in their own substance a certain amount of hæmoglobin or of myohæmatin.

The much thinner walls of the auricle consist of a much thinner network of similar fibres united by a relatively larger quantity of connective tissue into a thin sheet, with the pericardial membrane on the outside and the endocardial membrane on the inside. The fibres have in the auricle a much greater tendency to be branched, and many, ceasing to be spindle-shaped, become almost stellate. Among the obscurely striated, but still striated fibres are found ordinary plain muscular fibres which increase in relative number along the roots of the veins, *venæ cavæ* and *pulmonales*,

until at some little distance from the heart plain muscular fibres only are found. Blood vessels are absent from the walls of the auricles also.

In the *bulbus arteriosus*, mixed up with much connective and elastic tissue, are found fusiform fibres which close to the ventricle are striated and form a thick layer, but at a certain distance from the ventricle lose their striation, or rather become mixed with plain muscular fibres, and form a thinner layer.

§ 152. In the mammal, both the ventricles and the auricles are formed of bundles of muscular tissue, bound together by connective tissue, and arranged more especially in the ventricles in a very complex system of sheets or bands disposed as spirals, and in other ways, the details of which need not detain us. In the auricular appendices and elsewhere, the bundles form irregular networks projecting into the cavities.

The connective tissue binding the muscular fibres together, unlike the corresponding connective tissue in the frog's heart, is well supplied with blood vessels belonging to the coronary system. This connective tissue forms on the inner surface of the cavities a continuous sheet, the connective tissue basis of the flat epithelioid cells of the endocardium, and on the outside of the heart the visceral layer of the pericardium.

The histological unit of these muscular bundles is neither a fibre nor a fusiform fibre cell, but a more or less columnar or prismatic nucleated cell generally provided with one or more short broad processes. The nucleus, which is oval and in general resembles one of the nuclei of a striated fibre, is placed in about the middle of the cell with its long axis in the line of the long diameter of the cell. The cell body, which is not bounded by any definite sarcolemma, is striated, though obscurely so, across the long diameter of the cell, the striations as in a skeletal muscle fibre being due to the alternation of dim and bright bands. As in the frog's heart granules are frequently abundant, obscuring the striation, which indeed even in the absence of granules is never so distinct as in the fibres of skeletal muscles. Such a cell is at each end joined by cement substance to similar cells, and a row of such cells constitutes a cardiac elementary fibre. Hence a cardiac fibre is a fibre striated, but without sarcolemma, and divided by partitions of cement substance into somewhat elongated divisions or cells, each containing a nucleus. Many of the cells in a fibre have a short broad lateral process. Such a process is united by cement substance to a similar process of a cell belonging to an adjoining fibre; and by the union of a number of these processes, a number of parallel fibres are formed into a somewhat close network. Each bundle of the cardiac muscular tissue is thus itself a network. These bundles are further woven into networks by connective tissue in which run capillaries and larger blood vessels; and sheets or bundles composed of such networks are arranged as we have

said in a complex manner both in the auricle and ventricle. Hence the muscular substance of the mammalian heart is, at bottom, an exceedingly complex network, the element of which is a somewhat branched nucleated striated cell. It may be remarked that the 'musculi pectinati' of the auricle and the 'columnæ carneæ' of the ventricle suggest the origin of the mammalian heart from a muscular labyrinth like that of the frog's ventricle.

At the commencement of the great arteries this peculiar cardiac muscular tissue ceases abruptly, being replaced by the ordinary structures of an artery, but the striated muscular fibres of the auricle may be traced for some distance along both the venæ cavæ and venæ pulmonales.

Under the endocardium are frequently present ordinary plain muscular fibres, and in some cases peculiar cells are found in this situation, the cells of Purkinjé, which are interesting morphologically because the body of the cell round the nucleus is ordinary clear protoplasm while the outside is striated substance. Plain muscular fibres are said also to spread from the endocardium for a certain distance into the auriculo-ventricular valves.

§ 153. *The Nerves of the Heart.* The distribution of nerves in the heart varies a good deal in different vertebrate animals, but nevertheless a general plan is more or less evident. The vertebrate heart may be regarded as a muscular tube (a single tube, if for the moment we disregard the complexity of a double circulation occurring in the higher animals) divided into a series of chambers, sinus venosus (or junction of great veins), auricle, ventricle and bulbus (or conus) arteriosus. The nerves (with the exception of a small nerve which in some animals reaches the heart by the aorta) enter the heart at the venous end of this tube, at the sinus venosus, and pass on towards the arterial end, diminishing in amount as they proceed, and disappearing at the aorta. Connected with the nerve fibres thus passing to the heart are groups, smaller or greater, of nerve cells. These like the nerve fibres are most abundant at the venous end (appearing on the nerve branches before these actually reach the heart), as a rule become fewer towards the arterial end, and finally disappear, so that (according to most observers) at the bulbus (conus) arteriosus they are entirely absent.

These collections of nerve cells or ganglia may be arranged in groups according to their position. In many lower vertebrates there is a distinct ring or collar of ganglia at the junction of the sinus venosus with the auricle, where the primitive circular disposition of muscular fibres is maintained; and there is a similar ganglionic collar at the junction of the auricle with the ventricle, where also there is similarly retained a circular disposition of the muscular fibres forming the so-called *canalis auricularis*. And indeed in all vertebrates two similar collections of ganglia are more or less distinctly present. There are ganglia

at the junction of the sinus with the auricle and along the entering nerve branches; these may be called the sinus ganglia. There are other ganglia at the junction of the auricle and ventricle; these may be called the auriculo-ventricular ganglia. Besides these two groups there are also ganglia over the auricle in connection with nerves passing from the sinus to the ventricle.

Lastly, as a general rule the main nerve branches and the ganglia are not plunged deep in the substance of the heart, but are placed superficially, immediately under the pericardial layer. From the cells and nerves so situated finer branches and fibres pass to the substance of the heart.

In the frog (and other amphibia) the arrangement differs somewhat from the above plan and therefore needs a special description.

The only nerves going to the heart of the frog are the two vagi, right and left, which may be seen running along the two superior venæ cavæ, and becoming lost to view at the sinus where they pass from the surface to deeper parts. Each vagus is not however simply a vagus nerve, but as we shall see contains fibres derived from the splanchnic or sympathetic system. As the nerves approach the sinus, groups of nerve cells become abundant in connection with the fibres, and as the fibres spread out at the sinus many ganglia are scattered among them, forming what is called as a whole the *sinus ganglion* or the *ganglion of Remak*.

From the sinus the two vagi, leaving their position under the pericardium plunge into the heart and run along the septum between the auricles, on the left side of the septum, one, the anterior nerve, passing nearer the front of the heart than the other, the posterior. Several groups of cells, or small ganglia, are connected with the two 'septal' nerves thus passing along the septum.

The nerves reaching the auriculo-ventricular ring on the anterior side of the heart end in two ganglia lying at the base of the two large auriculo-ventricular valves.

From these two ganglia, *Bidder's ganglia* or the *auriculo-ventricular ganglia*, nerve fibres pass into the substance of the ventricle. Nerve cells may be traced on the fibres going to the ventricle for some little distance, but for a little distance only; over the greater part of the ventricle, the lower two-thirds for instance, the nerve fibres are free from nerve cells.

Thus in the frog there are two main ganglia, sinus or Remak's ganglion, auriculo-ventricular or Bidder's ganglia. From the former there pass on the one hand scattered fibres, in connection with which are small groups of cells, to the auricular walls, and to the sinus walls, and on the other hand the two main nerves running along the septum, in connection with which are small ganglia which may be called 'septal' ganglia. From the latter, Bidder's ganglia, fibres unaccompanied except for a short distance by nerve

cells pass to the substance of the ventricle, and possibly to the *bulbus arteriosus*.

In the mammal, the arrangement appears to conform more closely to the general plan described above. The several cardiac nerves from the sympathetic chain together with branches from the *vagus*, including fibres from the recurrent laryngeal, form the superficial and deep cardiac plexuses below and beneath the arch of the aorta. From these plexuses fibres are distributed to the superior vena cava and to the pulmonary veins and thence to the various parts of the heart. Ganglia are abundant on the superior vena cava and are also found on the pulmonary veins, in the walls of the auricles, in the auriculo-ventricular groove and in the basal portion of the ventricles; further, according to some observers, in contrast to the frog's heart, a number of small ganglia may be observed over a large part of the ventricle far down towards the apex. The auricular septum, at least in its central parts, is free from ganglia. The nerves and ganglia lie for the most part superficially immediately under the pericardium.

In the frog, the fibres forming the *vagus* nerves as they run along the superior venæ cavæ are composed of medullated and non-medullated fibres, the latter being chiefly if not wholly derived from the splanchnic or sympathetic system. Medullated fibres, with a larger proportion of non-medullated fibres are found in the septal nerves, running to Bidder's ganglia, but the fine fibres which pass from Bidder's ganglia to the substance of the ventricle are exclusively non-medullated fibres. The nerve cells in the sinus ganglia and along the ends of the *vagus* nerves, as well as some of the cells of the ganglia scattered over the septum, are of the kind previously (§ 98) described as spiral cells. The cells composing Bidder's ganglia, as well as many of the cells in the septum, are said to be bipolar and fusiform.

In the mammal, the fibres passing to the heart are also medullated and non-medullated. Some of the medullated fibres are of fine calibre, may be traced back to the *vagus*, and appear to be fibres of which we shall speak presently as *inhibitory*. Others of the medullated fibres are of larger calibre, and some of these at all events appear to be sensory or at least *afferent* in function. Of the non-medullated fibres, some may be traced back along the cardiac nerves to the inferior cervical ganglion and are of the kind we shall speak of as *augmenting*. In contrast to the frog many of the fibres in the ventricle (where they lie close under the pericardium), are medullated, and it is probable that these are afferent fibres.

The cells forming the various ganglia scattered over the mammalian heart may perhaps be classed as unipolar, and multipolar, the former being especially connected with medullated fibres, the one class being prominent in one situation, the other in another.

The Development of the Normal Beat.

§ 154. The heart of a mammal or of a warm-blooded animal generally ceases to beat within a few minutes after being removed from the body in the ordinary way, the hearts of newly born animals continuing however to beat for a longer time than those of adults. Hence, though by special precautions and by means of an artificial circulation of blood, an isolated mammalian heart may be preserved in a pulsating condition for a much longer time, our knowledge of the exact nature and of the causes of the cardiac beat is as yet very largely based on the study of the hearts of cold-blooded animals, which will continue to beat for hours, or under favourable circumstances even for days, after they have been removed from the body with only ordinary care. We have reason to think that the mechanism by which the beat is carried on varies in some of its secondary features in different kinds of animals: that the hearts, for instance, of the eel, the snake, the tortoise and the frog, differ in some minor details of behaviour, both from each other and from the bird and the mammal; but we may, at first at all events, take the heart of the frog as illustrating the main and important truths concerning the causes and mechanism of the beat.

In studying closely the phenomena of the beat of the heart it becomes necessary to obtain a graphic record of various movements.

1. In the frog or other cold-blooded animal, a light lever may be placed directly on the ventricle (or on an auricle, &c.) and changes of form, due either to distension by the influx of blood, or to the systole, will cause movements of the lever, which may be recorded on a travelling surface. The same method as we have seen may be applied to the mammalian heart.

2. Or, as in Gaskell's method, the heart may be fixed by a clamp carefully adjusted round the auriculo-ventricular groove while the apex of the ventricle and some portion of one auricle are attached by threads to horizontal levers placed respectively above and below the heart. The auricle and the ventricle each in its systole pulls at the lever attached to it; and the times and extent of the contractions may thus be recorded.

3. A record of endo-cardiac pressure may be taken in the frog or tortoise, as in the mammal, by means of an appropriate manometer. And in these animals at all events it is easy to keep up an artificial circulation. A cannula is introduced into the sinus venosus and another into the ventricle through the aorta. Serum or dilute blood (or any other fluid which it may be desired to employ) is driven by moderate pressure through the former; to the latter is attached a tube connected by means of a side piece with a small mercury manometer. So long as the exit-tube is open at the end, fluid flows freely through the heart and apparatus. Upon closing the exit-tube at its far end, the

force of the ventricular systole is brought to bear on the manometer, the index of which registers in the usual way the movements of the mercury column. Newell Martin has succeeded in applying a modification of this method to the mammalian heart.

4. The movements of the ventricle may be registered by introducing into it through the auriculo-ventricular orifice a so-called 'perfusion' cannula, Figs. 52 and 53 I., with a double tube, one inside the other, and tying the ventricle on to the cannula at the auriculo-ventricular groove, or at any level below that which may be desired. The blood or other fluid is driven at an adequate pressure through the tube *a*, enters the ventricle, and returns by the tube *b*. If *b* be connected with a manometer as in method 3, the movements of the ventricle may be registered.

5. In the apparatus of Roy, Fig. 53 II., the exit-tube is free, but the ventricle (the same method may be adopted for the whole heart) is placed in an air-tight chamber filled with oil or partly with normal saline solution and partly with oil. By means of the tube



FIG. 52. A PERFUSSION CANNULA.

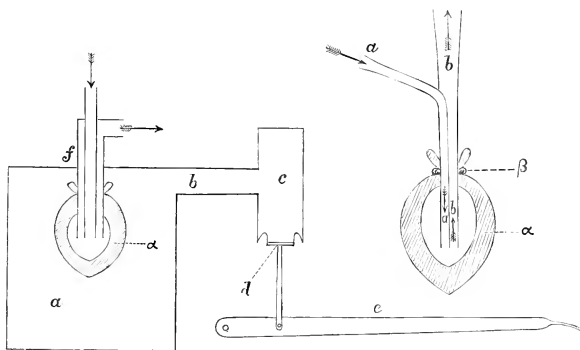

FIG. 53. PURELY DIAGRAMMATIC FIGURES OF

I. Perfusion cannula tied into frog's ventricle. *a*, entrance, *b*, exit-tube; α , wall of ventricle; β , ligature.

II. Roy's apparatus modified by Gaskell. *a*, chamber filled with saline solution and oil, containing the ventricle *a* tied on to perfusion cannula *f*. *b*, tube leading to cylinder *c*, in which moves piston *d*, working the lever *e*.

b the interior of the chamber *a* is continuous with that of a small cylinder *c* in which a piston *d* secured by thin flexible animal membrane works up and down. The piston again bears on a lever *e* by means of which its movements may be registered. When the ventricle contracts, and by contracting diminishes in volume, there is a lessening of pressure in the interior of the chamber, this is transmitted to the cylinder, and the piston correspondingly rises, carrying with it the lever. As the

ventricle subsequently becomes distended the pressure in the chamber is increased, and the piston and lever sink. In this way variations in the volume of the ventricle may be recorded, without any great interference with the flow of blood or fluid through it.

The heart of the frog, as we have just said, will continue to beat for hours after removal from the body even after the cavities have been cleared of blood, and indeed when they are almost empty of all fluid. The beats thus carried out are in all important respects identical with the beats executed by the heart in its normal condition within the living body. Hence we may infer that the beat of the heart is an automatic action: the muscular contractions which constitute the beat are due to causes which arise spontaneously in the heart itself.

In the frog's heart, as in that of the mammal, § 126, there is a distinct sequence of events which is the same whether the heart be removed from, or be still in its normal condition within, the body. First comes the beat of the sinus venosus, preceded by a more or less peristaltic contraction of the large veins leading into it, next follows the sharp beat of the two auricles together, then comes the longer beat of the ventricle, and lastly the cycle is completed by the beat of the bulbus arteriosus, which does not, like the mammalian aorta, simply recoil by elastic reaction after distension by the ventricular stroke but carries out a distinct muscular contraction passing in a wave from the ventricle outwards.

When the heart in dying ceases to beat, the several movements cease, as a rule, in an order the inverse of the above. Omitting the bulbus arteriosus, which sometimes exhibits great rhythmical power, we may say that first the ventricle fails, then the auricles fail, and lastly the sinus venosus fails.

The heart after it has ceased to beat spontaneously remains for some time irritable, that is capable of executing a beat, or a short series of beats, when stimulated either mechanically as by touching it with a blunt needle or electrically by an induction shock or in other ways. The artificial beat so called forth may be in its main features identical with the natural beat, all the divisions of the heart taking part in the beat, and the sequence of events being the same as in the natural beat. Thus when the sinus is pricked the beat of the sinus may be followed by a beat of the auricles and of the ventricle; and even when the ventricle is stimulated, the directly following beat of the ventricle may be succeeded by a complete beat of the whole heart.

Under certain circumstances however the division directly stimulated is the only one to beat; when the ventricle is pricked for instance it alone beats, or when the sinus is pricked it alone beats. The results of stimulation moreover may differ according to the condition of the heart and according to the particular spot to which the stimulus is applied.

With an increasing loss of irritability, the response to stimula-

tion ceases in the several divisions in the same order as that of the failure of the natural beat, the ventricle ceases to respond first, then the auricles and lastly the sinus venosus, which frequently responds to stimulation long after the other divisions have ceased to make any sign.

It would appear as if the sinus venosus, auricles, and ventricle formed a descending series in respect to their irritability and to the power they possess of carrying on spontaneous rhythmic beats, the sinus being the most potent. This is also seen in the following experiments.

In order that the frog's heart may beat after removal from the body with the nearest approach in rapidity, regularity and endurance to the normal condition, the removal must be carried out so that the excised heart still retains the sinus venosus intact.

When the incision is carried through the auricles so as to leave the sinus venosus behind in the body, the result is different. The sinus venosus beats forcibly and regularly, having suffered hardly any interruption from the operation. The excised heart, however, remains, in the majority of cases, for some time motionless. Stimulated by a prick or an induction shock, it will give perhaps one, two or several beats, and then comes to rest. In the majority of cases, however, the animal having previously been in a vigorous condition, it will after a while recommence its spontaneous beating, the systole of the ventricle following that of the auricles; but the rhythm of beat will not be the same as that of the sinus venosus left in the body, but will be slower, and the beats will not continue to go on for so long a time as will those of a heart still retaining the sinus venosus.

When the incision is carried through the auriculo-ventricular groove, so as to leave the auricles and sinus venosus within the body, and to isolate the ventricle only, the results are similar but more marked. The sinus and auricles beat regularly and vigorously, with their proper sequence, but the ventricle, after a few rapid contractions due to the incision acting as a stimulus, generally remains for a long time quiescent. When stimulated however the ventricle will give one, two or several beats, and after a while, in many cases at least, will eventually set up a spontaneous pulsation with an independent rhythm; and this may last for some considerable time, but the beats are not so regular and will not go on for so long a time as will those of a ventricle to which the auricles are still attached.

If a transverse incision be carried through the ventricle at about its upper third, leaving the base of the ventricle still attached to the auricles, the portion of the heart left in the body will go on pulsating regularly, with the ordinary sequence of sinus, auricles, ventricle, but the isolated lower two-thirds of the ventricle will not beat spontaneously at all however long it be left. Moreover in response to a single stimulus such as an in-

duction shock or a gentle prick it gives, not as in the case of the entire ventricle when stimulated at the base or of the ventricle to which the auricles are attached, a series of beats, but a single beat.

Lastly, to complete the story we may add, that when the heart is bisected longitudinally, each half continues to beat spontaneously, with an independent rhythm, so that the beats of the two halves are not necessarily synchronous, and this continuance of spontaneous pulsations after longitudinal bisection may be seen in the conjoined auricles and ventricle, or in the isolated auricles, or in the isolated but entire ventricle. Moreover the auricles may be divided in many ways and yet many of the segments will continue beating; small pieces even may be seen under the microscope pulsating, feebly it is true but distinctly and rhythmically.

In these experiments then the various parts of the frog's heart also form, as regards the power of spontaneous pulsation, a descending series: sinus venosus, auricles, entire ventricle, lower portions of ventricle, the last exhibiting under ordinary circumstances no spontaneous pulsations at all.

§ 155. Now we have seen (§ 153) that these parts form to a certain extent a similar descending series as regards the presence of ganglia; at least so far that the ganglia are very numerous in the sinus venosus, that they occur in the auricles, and that while Bidder's ganglia are present at the junction of the ventricle with the auricles, ganglia are wholly absent from the rest of the ventricle. Hence on the assumption (which we have already, § 100, seen reason to doubt) that the nerve cells of ganglia are similar in general functions to the nerve cells of the central nervous system, the view very naturally presents itself that the rhythmic spontaneous beat of the heart of the frog is due to the spontaneous generation in the ganglionic nerve cells of rhythmic motor impulses which passing down to the muscular fibres of the several parts causes rhythmic contractions of these fibres, the sequence and coordination of the beating of the several divisions of the heart being the result of a coordination between the several ganglia in regard to the generation of impulses. Under this view the cardiac muscular fibre simply responds to the motor impulses reaching it along its motor nerve fibre in the same way as the skeletal muscular fibre responds to the motor impulses reaching it along its motor nerve fibre; in both cases the muscular fibre is as it were a passive instrument in the hands of the motor nerve, or rather of the nervous centre (ganglion or spinal cord) from which the motor nerve proceeds. And the view, thus based on the fact of the frog's heart, has been extended to the hearts of (vertebrate) animals generally.

There are reasons however which shew that this view is not tenable.

For instance the lower two-thirds, or lower third or even the

mere tip of the frog's ventricle, that is to say parts which are admitted not to contain nerve cells, may, by special means, be induced to carry on for a considerable time a rhythmic beat, which in its main features is identical with the spontaneous beat of the ventricle of the intact heart. If such a part of the frog's ventricle be tied on to the end of a perfusion cannula (Fig. 52), the portion of the ventricular cavity belonging to the part may be adequately distended and at the same time be 'fed' with a suitable fluid, such as blood, made to flow through the cannula; it will then be found that the portion of ventricle so treated will, after a preliminary period of quiescence, commence to beat, apparently spontaneously, and will continue so beating for a long period of time. It may be said that in this case the distension of the cavity and the supply of blood or other fluid acts as a stimulus; but if so the stimulus is a continuous one, or at least not a rhythmic one, and yet the beat is most regularly rhythmic.

Then again the reluctance of the ventricle to execute spontaneous rhythmic beats is to a certain extent peculiar to the frog. The ventricle of the tortoise for instance, the greater part of the substance of which is as free from nerve cells as is that of the frog, will beat spontaneously when isolated from the auricles with great ease and for a long time. Further a mere strip of this ventricular muscle tissue if kept gently extended, and continually moistened with blood or other suitable fluid, will continue to beat spontaneously with very great regularity for hours or even days, especially if the series be started by the preliminary application of induction shocks rhythmically repeated.

In connection with this question we may call attention to the fact that the cardiac muscular fibre is not wholly like the skeletal muscular fibre; in many respects the contraction or beat of the former is in its very nature different from the contraction of the latter; the former cannot be considered like the latter a mere instrument in the hands of the motor nerve fibre. The features of the beat or contraction of cardiac muscle may be studied on the isolated and quiescent ventricle, or part of the ventricle of the frog. When such a ventricle is stimulated by a single stimulus, such as a single induction shock or a single touch with a blunt needle, a beat may or may not result. If it follows it resembles, in all its general features at least, a spontaneous beat. Between the application of the stimulus and the first appearance of any contraction is a very long latent period, varying according to circumstances, but in a vigorous fresh frog's ventricle being about .3 sec. The beat itself lasts a variable but considerable time, rising slowly to a maximum and declining slowly again. Of course when the beat is recorded by means of a light lever placed on the ventricle, what the tracing shews is really the increase in the front-to-back diameter of the ventricle during the beat, that is to say one of the results of the contraction of the

cardiac fibres, and gives, in an indirect manner only, the extent of the contraction of the fibres themselves; and the same is the case with the other methods of recording the movements of the whole ventricle. We may however study in a more direct way the contraction of a few fibres by taking a slip of the ventricle (and for this purpose the tortoise is preferable to the frog) and suspending it to a lever after the fashion of a muscle nerve preparation. We then get a curve of contraction, characterised by a long latent period, a slow long-continued rise, and a slow long-continued fall, a contraction in fact more like that of a plain muscular fibre than of a skeletal muscular fibre. In the tortoise the contraction is particularly long, the contraction of even the skeletal muscles being long in that animal; it is less long but still long in the frog, shorter still, but yet long as compared with the skeletal muscles, in the mammal.

The beat of the ventricle then is a single but relatively slow prolonged contraction wave sweeping over the peculiar cardiac muscle-cell, passing through the cement substance from cell to cell along the fibre, from fibre to fibre along the bundle and from bundle to bundle over the labyrinth of the ventricular walls.

Like the case of the skeletal muscle, this single contraction is accompanied by an electric change, a current of action. The intact ventricle at rest is as we have already said (§ 66) isoelectric, but each part just as it is about to enter into a state of contraction becomes negative towards the rest. Hence when the electrodes of a galvanometer are placed on two points *A*, *B* of the surface of the ventricle a diphasic variation of the galvanometer needle is seen just as a beat, natural or excited, is about to occur. Supposing that the wave of contraction reaches *A* first, this will become negative towards the rest of the ventricle, including *B*, but when the wave sometime afterwards reaches *B*, *B* will become negative towards the rest of the ventricle, including *A*. Compare § 67.

The beat of the auricles, that of the sinus venosus, and that of the bulbus arteriosus are similar in their main features to that of the ventricle, so that the whole beat may be considered to be a wave of contraction sweeping through the heart from sinus to bulbus; but the arrangement of fibres is such that this beat is cut up into sections in such a way that the sinus, the auricles, the ventricle, and the bulbus have each a beat so to speak to themselves. In a normal state of things these several parts of the whole beat follow each other in the sequence we have described, but under abnormal conditions the sequence may be reversed, or one section may beat while the others are at rest, or the several sections may beat out of time with each other.

So far the description of the contraction which is the foundation of the beat differs from that of a skeletal muscle in degree only; but now comes an important difference. When we stimulate a skeletal muscle with a strong stimulus we get a large contraction,

when we apply a weak stimulus we get a small contraction; within certain limits (see § 79) the contraction is proportional to the stimulus. This is not the case with the quiescent ventricle or heart. When we apply a strong induction-shock we get a beat of a certain strength; if we now apply a weak shock we get either no beat at all or quite as strong a beat as with the stronger stimulus. That is to say the magnitude of the beat depends on the condition of the ventricle (or heart) and not on the magnitude of the stimulus. If the stimulus can stir the ventricle up to beat at all, the beat is the best which the ventricle at the time can accomplish; the stimulus either produces its maximum effect or none at all. It would seem as if the stimulus does not produce a contraction in the same way that it does when it is brought to bear on a skeletal muscle, but rather stirs up the heart in such a way as to enable it to execute a spontaneous beat which, without the extra stimulus, it could not bring about. And this is further illustrated by the fact that when a ventricle is beating rhythmically either spontaneously, or as the result of rhythmic stimulation, the kind of effect produced by a new stimulus thrown in will depend upon the exact phase of the cycle of the beat at which it is thrown in. If it is thrown in just as a relaxation is taking place, a beat follows prematurely, before the next beat would naturally follow, this premature beat being obviously produced by the stimulus. But if it be thrown in just as a contraction is beginning, no premature beat follows: the ventricle does not seem to feel the stimulus at all. There is a period during which the ventricle is insensible to stimuli, and that however strong; this period is called the "refractory" period. (There is it may be mentioned a similar refractory period in skeletal muscle, but it is of exceedingly short duration.) From this it results that, when a succession of stimuli repeated at a certain rate are sent into the ventricle, the number of beats does not correspond to the number of stimuli, some of the stimuli falling in refractory periods are ineffective and produce no beat. Hence also it is difficult if not impossible to produce a real tetanus of the ventricle, to fuse a number of beats into one. And there are other facts tending to shew that the contraction of a cardiac muscular fibre, even when induced by artificial stimulation, is of a peculiar nature, and that the analogy with the contraction of a skeletal muscular fibre, induced by motor impulses reaching it along its nerve, does not hold good.

These and other considerations, taken together with the facts already mentioned that portions of cardiac muscular tissue in which ganglionic cells are certainly not present can, in various animals be induced, either easily or with difficulty, to execute rhythmic beats, which have all the appearance of being spontaneous in nature, lead us to conclude that the beat of the heart is not the result of rhythmic impulses proceeding from the cells of the ganglia to passive muscular fibres, but is mainly the result of changes taking

place in the muscular tissue itself. And here we may call attention to the peculiar histological features of cardiac muscular tissue; though so far differentiated as to be striated, its cellular constitution and its 'protoplasmic' features, including the obscurity of the striation, shew that the differentiation is incomplete. Now one attribute of undifferentiated primordial protoplasm is the power of spontaneous movement.

§ 156. We have moreover evidence that it is the muscular tissue and not the arrangement of ganglia and nerves which is primarily concerned in maintaining the remarkable sequence of sinus beat, auricle beat and ventricle beat. This is perhaps better seen in the heart of the tortoise than in that of the frog.

In this animal the nerves passing from the sinus to the ventricle may be divided, or the several ganglia may be respectively removed, and yet the normal sequence is maintained. On the other hand we find that interference with the muscular substance of the auricle, when carried to a certain extent, prevents the beat of the auricle passing over to the ventricle so that the sequence is broken after the auricle beat. If for instance the auricle be cut through until only a narrow bridge of muscle be left connecting the part of the auricle adjoining the sinus with the part adjoining the auriculo-ventricular ring, or if this part be compressed with a clamp, a state of things may be brought about in which every second beat only, or every third beat only of the sinus and auricle is followed by a beat of the ventricle; and then, if the bridge be still further narrowed or the clamp screwed tighter, the ventricle does not at all follow in its beat the sequence of sinus and auricle, though it may after a while set up an independent rhythm of its own. This experiment suggests, and other facts support the view, that the normal sequence is maintained as follows. The beat begins in the sinus (including the ends of the veins); the contraction wave beginning at the ends of the veins travels over the muscular tissue of the sinus and reaching the auricle starts a contraction in that segment of the heart; similarly the contraction wave of the auricular beat reaching the ventricle starts the ventricular beat, which in turn in like fashion starts the beat of the bulbus. And in hearts in a certain condition it is possible by stimulation to reverse this sequence, or to produce, by alternate stimulation, an alternation of a normal and a reversed sequence; thus in the heart of the skate, in a certain condition, mechanical stimulation of the bulbus by inducing a beat of the bulbus will start a sequence of bulbus, ventricle, auricle and sinus, and similar stimulation of the sinus will produce a normal sequence of sinus, auricle, ventricle and bulbus.

It would perhaps be premature to insist that the nervous elements do not intervene in any way in the maintenance of this sequence; but the evidence shews that they are not the main factors,

and we have at present no satisfactory indications of the way in which they do or may intervene.

Two questions naturally suggest themselves here. The first is, Why does the cardiac cycle begin with the sinus beat? We have previously, § 154, given the evidence that the sinus has a greater potentiality of beating than the other parts; in and by itself it beats more readily and with a quicker rhythm than the other parts. When we ask the further question, why has it this greater potentiality? the only answer we can at present give is that it is inborn in the substance of the sinus. The problem is somewhat of the same kind as why the heart of one animal beats so much quicker than that of another. All we can say at present is that the rate is the outcome of the molecular constitution of tissue, without being able to define that molecular constitution.

The second question is, Why does not the contraction wave starting at the sinus spread as a continuous wave over the whole heart? why is it broken up into sinus beat, auricle beat, ventricle beat? We may here call to mind the fact mentioned in § 153, of the existence, more or less marked in all hearts, and well seen in the heart of the tortoise, of a muscular ring or collar between the sinus and the auricle, and of a similar ring between the auricle and ventricle. The muscular tissue in these rings seems to be of a somewhat different nature from the muscular tissue forming the body of the sinus, or of the auricle or of the ventricle. If we suppose that this tissue has a low conducting power, it may offer sufficient resistance to the progress of the contraction to permit the sinus for example to carry out or to be far on in the development of its beat, before the auricle begins its beat (and thus bisect so to speak the beat which otherwise would be common to the two), and yet not offer so much resistance as to prevent the contraction wave passing ultimately on from the sinus to the auricle. We may in the tortoise by careful clamping or section of the auricle in its middle, by which an obstacle to the contraction wave is introduced, bisect the single auricular beat into two beats, one of the part between the sinus and the obstacle, and another between the obstacle and the ventricular. We may thus consider the breaking up the primitive unbroken peristaltic wave of contraction from sinus to bulbus to be due to the introduction of tissue of lower conducting power at the junctions of the several parts.

We do not say that this is the complete solution of the problem, but it at least offers an approximate solution; and here as elsewhere we have no satisfactory evidence of nervous elements being main factors in the matter.

In the above we have dealt chiefly with the heart of the cold-blooded animal, but as far as we know the same conclusions hold good for the mammalian heart also.

The question now arises, If the ganglia are not the prime cause of the heart's rhythmic beat, or of the maintenance of the normal

sequence, what purposes do they serve? But before we even attempt to answer this question we must deal with the nervous mechanisms by which the beat of the heart, thus arising spontaneously within the tissues of the heart itself, is modified and regulated to meet the requirements of the rest of the body.

The Government of the Heart-Beat by the Nervous System.

§ 157. It will be convenient to begin with the heart of the frog, which as we have seen is connected with the central nervous system through and therefore governed by the two vagi nerves, each of which though apparently a single nerve contains, as we shall see, fibres of different origin and nature.

If while the beats of the heart of a frog are being carefully registered an interrupted current of moderate strength be sent through one of the vagi, the heart is seen to stop beating. It remains for a time in diastole, perfectly motionless and flaccid; all the muscular fibres of the several chambers are for the time being in a state of relaxation. The heart has been *inhibited* by the impulses descending down the vagus from the part of the nerve stimulated.

If the duration of the stimulation be short and the strength of the current great, the standstill may continue after the current has been shut off; the beats when they reappear are generally at first feeble and infrequent, but soon reach or even go beyond their previous vigour and frequency. If the duration of the current be very long, the heart may recommence beating while the stimulation is still going on, but the beats are feeble and infrequent though gradually increasing in strength and frequency. The effect of the stimulation is at its maximum at or soon after the commencement of the application of the stimulus, gradually declining afterwards; but even at the end of a very prolonged stimulation the beats may still be less in force or in frequency, or in both, than they were before the nerve was stimulated, and on the removal of the current may shew signs of recovery by an increase in force and frequency. The effect is not produced instantaneously; if on the curve the point be exactly marked when the current is thrown in, as at *on* Fig. 54, it will frequently be found that one beat at least occurs after the current has passed into the nerve; the development of that beat has taken place before the impulses descending the vagus have had time to affect the heart.

The stimulus need not necessarily be the interrupted current; mechanical, chemical or thermal stimulation of the vagus will also produce inhibition; but in order to get a marked effect it is desirable to make use of not a single nervous impulse but a series of nervous impulses; thus it is difficult to obtain any recognisable result by employing a single induction shock of moderate intensity only. As we shall see later on 'natural' nervous impulses descend-

ing the vagus from the central nervous system, and started there, by afferent impulses or otherwise, as parts of a reflex act, may produce inhibition.

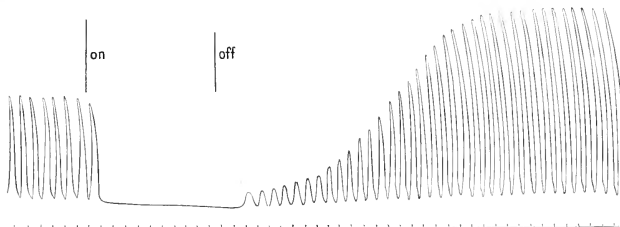

FIG. 54. INHIBITION OF FROG'S HEART BY STIMULATION OF VAGUS NERVE.

on marks the time at which the interrupted current was thrown into the vagus, *off* when it was shut off. The time marker below marks seconds. The beats were registered by suspending the ventricle from a clamp attached to the aorta and attaching a light lever to the tip of the ventricle.

The stimulus may be applied to any part of the course of the vagus from high up in the neck right down to the sinus; indeed very marked results are obtained by applying the electrodes directly to the sinus where as we have seen the two nerves plunge into the substance of the heart. The stimulus may also be applied to either vagus, though in the frog, and some other animals, one vagus is sometimes more powerful than the other. Thus, it not infrequently happens that even strong stimulation of the vagus on one side produces no change of the rhythm, while even moderate stimulation of the nerve on the other side of the neck brings the heart to a standstill at once.

If during the inhibition the ventricle or other part of the heart be stimulated directly, for instance mechanically by the prick of a needle, a beat may follow; that is to say the impulses descending the vagus, while inhibiting the spontaneous beats, have not wholly abolished the actual irritability of the cardiac tissues.

With a current of even moderate intensity, such a current for instance as would produce a marked tetanus of a muscle-nerve preparation, the standstill is complete, that is to say a certain number of beats are entirely dropped; but with a weak current the inhibition is partial only, the heart does not stand absolutely still but the beats are slowed, the intervals between them being prolonged, or weakened only without much slowing, or both slowed and weakened. Sometimes the slowing and sometimes the weakening is the more conspicuous result.

It sometimes happens that, when in the frog the vagus is stimulated in the neck, the effect is very different from that just described; for the beats are increased in frequency, though they

may be at first diminished in force. And, occasionally, the beats are increased both in force and in frequency: the result is augmentation, not inhibition. But this is due to the fact that in the frog the vagus along the greater part of its course is a mixed nerve and contains fibres other than those of the vagus proper.

§ 158. If we examine the vagus nerve closely, tracing it up to

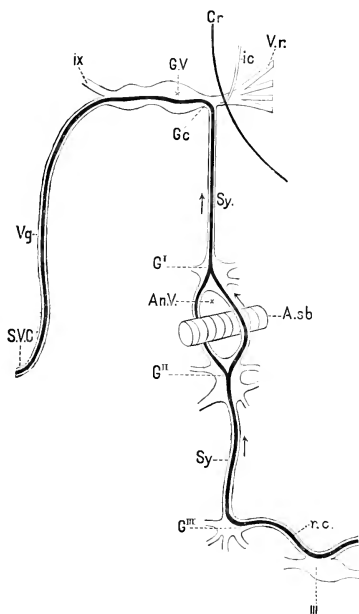

FIG. 55. DIAGRAMMATIC REPRESENTATION OF THE COURSE OF CARDIAC AUGMENTOR FIBRES IN THE FROG.

V.r. roots of vagus (and ixth) nerve. *G.V.* ganglion of same. *Cr.* line of cranial wall. *Vg.* vagus trunk. *ix.* ninth, glosso-pharyngeal nerve. *S.V.C.* superior vena cava. *Sy.* sympathetic nerve in neck. *G.C.* junction of sympathetic ganglion with vagus ganglion sending *i.c.* intracranial fibres passing to Gasserian ganglion. The rest of the fibres pass along the vagus trunk. *G'* splanchnic ganglion connected with the first spinal nerve. *G''* splanchnic ganglion of the second spinal nerve. *An.V.* annulus of Vieussens. *A.sb.* subclavian artery. *G'''* splanchnic ganglion of the third spinal nerve. *III.* third spinal nerve. *r.c.* ramus communicans.

The course of the augmentor fibres is shewn by the thick black line. They may be traced from the spinal cord by the anterior root of the 3rd spinal nerve, through the ramus communicans to the corresponding splanchnic ganglion *G'''* and thence by the second ganglion *G''*, the annulus of Vieussens, and the first ganglion *G'* to the cervical sympathetic *Sy* and so by the vagus trunk to the superior vena cava *S.V.C.*

the brain, we find that just as the nerve has pierced the cranium, just where it passes through the ganglion (*GV*, Fig. 55), certain fibres pass into it from the sympathetic nerve of the neck, *Sy*, of the further connections of which we shall speak presently.

This being the case we may expect that we should get different results according as we stimulated (1) the vagus in the cranium, before it was joined by the sympathetic, (2) the sympathetic fibres before they join the vagus and (3) the vagus trunk, containing the real vagus and the sympathetic fibres added. What we have previously described are the ordinary results of stimulating the mixed trunk, and these as we have said are not wholly constant, though, usually and in the main, most distinct inhibitory results follow.

If we stimulate the sympathetic in the neck as at *Sy*, Fig. 54, cutting the nerve below so as to block all impulses from passing downwards, and only allow impulses to pass up to the vagus and thence down the mixed vagus trunk to the heart, we get very remarkable results. The beat of the heart instead of being inhibited is augmented, the beats are increased either in frequency or in force, or most generally both in frequency and in force. The effect is perhaps best seen when the heart before stimulation is beating slowly and feebly; upon stimulation of the cervical sympathetic the beats at once improve in vigour and frequency; indeed a heart which for one reason or another has almost ceased to beat may, by proper stimulation of the sympathetic, be called back into vigorous activity.

If on the other hand we stimulate the vagus before it has been joined by the sympathetic fibres (and to ensure the result not being marred by any escape of the stimulating current on to the sympathetic fibres it is necessary to stimulate the vagus within the cranium) we get pure and constant inhibitory results, the beats are for a time wholly abolished, or are slowed, or are weakened, or are both slowed and weakened.

Obviously then the heart of the frog is supplied through the vagus by two sets of fibres coming from the central nervous system, the one by the vagus proper and the other by the cervical sympathetic nerve, and these two sets have opposite and antagonistic effects upon the heart. We find upon examination that we can make the following statements concerning them.

The one set, those belonging to the vagus proper, are inhibitory; they weaken the systole and prolong the diastole, the effect with a strong stimulation being complete, so that the heart is for a time brought to a standstill. Sometimes the slowing, sometimes the weakening is the more prominent. When the nerve and the heart are in good condition, it needs only a slight stimulus, a weak current, to produce a marked effect, and it may be mentioned that the more vigorous the heart, the more rapidly it is beating, the easier is it to bring about inhibition. Although as we have said the effect is at its maximum soon after the beginning of stimulation, a very

prolonged inhibition may be produced by prolonged stimulation; indeed by rythmical stimulation of the vagus the heart may be kept perfectly quiescent for a very long time and yet beat vigorously upon the cessation of the stimulus. In other words, the mechanism of inhibition, that is the fibres of the vagus and the part or substance of the heart upon which these act to produce inhibition, whatever that part or substance may be, are not readily exhausted. Further the inhibition when it ceases is, frequently at all events, followed by a period of reaction, during which the heart for a while beats more vigorously and rapidly than before. Indeed the total effect of stimulating the vagus fibres is not to exhaust the heart but rather to strengthen it; and by repeated inhibitions carefully administered, a feebly beating heart may be nursed into vigorous activity.

The other set, those joining the vagus from the sympathetic, are 'augmentor' or 'accelerating' fibres; the latter name is the more common but the former is more accurate since the effect of stimulating these fibres is to increase not only the rapidity but the force of the beat; not only is the diastole shortened but the systole is strengthened, sometimes the one result and sometimes the other being the more prominent. In contrast with the case of the vagus fibres, a somewhat strong stimulation is required to produce an effect; the time required for the maximum effect to be produced is also remarkably long. Moreover, at all events in the case of a heart in which the circulation is not maintained and which is therefore cut off from its normal nutritive supply, the augmentor fibres are far less easily exhausted than are the inhibitory fibres. Hence when, in such a heart, both sets of fibres are stimulated together, as when the vagus trunk in the neck is stimulated, the first effects produced are those of inhibition, but these on continued stimulation may become mixed with those of augmentation and finally the latter alone remain. Lastly the contrast is completed by the fact that the augmentation resulting from the stimulation of the sympathetic is followed by a period of reaction in which the beats are feebler; in other words augmentation is followed by exhaustion; and indeed by repeated stimulation of these sympathetic fibres a fairly vigorous bloodless heart may be reduced to a very feeble condition.

By watching the effects of stimulating the sympathetic nerve at various points of its course we may trace these augmentor fibres from their junction with the vagus down the short sympathetic of the neck through the first splanchnic or sympathetic ganglion connected with the first spinal nerve, G^I , Fig. 55, through one or both the loops of the annulus of Vieussens, $An. V$, through the second ganglion, connected with the second spinal nerve, G^{II} , to the third ganglion connected with the third spinal nerve, G^{III} , and thence through the ramus communicans or visceral branch of that ganglion, *v. c.*, to the third spinal

nerve, *III*, by the anterior root of which they reach the spinal cord.

§ 159. Both sets of fibres then may be traced to the central nervous system; and we find accordingly that the heart may be inhibited or augmented by nervous impulses which are started in the nervous system either by afferent impulses as part of a reflex act or otherwise, and which pass to the heart by the inhibitory or by the augmenting tract.

Thus if the medulla oblongata or a particular part of the medulla oblongata which is specially connected with the vagus nerve be stimulated, the heart is inhibited; if for instance a needle be thrust into this part the heart stands still. This region in question may be stirred to action, in a 'reflex' manner, by afferent impulses reaching it from various parts of the body. Thus if the abdomen of a frog be laid bare, and the intestine be struck sharply with the handle of a scalpel, the heart will stand still in diastole with all the phenomena of vagus inhibition. If the *nervi mesenterici* or the connections of these nerves with the spinal cord be stimulated with the interrupted current, cardiac inhibition is similarly produced. If in these two experiments both vagi are divided, or the medulla oblongata is destroyed, inhibition is not produced, however much either the intestine or the mesenteric nerves be stimulated. This shews that the phenomena are caused by impulses ascending along the mesenteric nerves to the medulla, and so affecting a portion of that organ as to give rise by reflex action to impulses which descend the vagi as inhibitory impulses. The portion of the medulla thus mediating between the afferent and efferent impulses may be spoken of as the *cardio-inhibitory centre*.

Reflex inhibition through one vagus may be brought about by stimulation of the central end of the other. In general the alimentary tract seems in closer connection with the cardio-inhibitory centre than other parts of the body; and if the peritoneal surface of the intestine be inflamed, very gentle stimulation of the inflamed surface will produce marked inhibition. But apparently stimuli if sufficiently powerful will through reflex action produce inhibition whatever be the part of the body to which they are applied. Thus crushing a frog's foot will stop the heart, and adequate stimulation of most afferent nerves will produce some amount of inhibition.

The details of the reflex chain and the portion of the centre concerned in the development of augmenting impulses have not been worked out so fully as in the case of inhibitory impulses, but there can be little doubt that the former like the latter are governed by the central nervous system.

§ 160. So far we have been dealing with the heart of the frog, but the main facts which we have stated regarding inhibition and augmentation of the heart-beat apply also to other

vertebrate animals including mammals, and indeed we meet similar phenomena in the hearts of invertebrate animals.

If in a mammal the heart be exposed to view by opening the thorax, and the vagus nerve be stimulated in the neck, the heart may be seen to stand still in diastole, with all the parts flaccid and at rest. If the current employed be too weak, the result as in the frog is not an actual arrest but a slowing or weakening of the beats. If a light lever be placed on the heart a graphic record of the standstill, or of the slowing, of the complete or incomplete inhibition may be obtained. The result of stimulating the vagus is also well shewn on the blood-pressure curve, the effect of complete cardiac inhibition on blood-pressure being most striking. If, while a tracing of arterial pressure is being taken, the beat of the heart be suddenly arrested, some such curve as that represented in Fig. 56 will be obtained. It will be observed that two beats follow

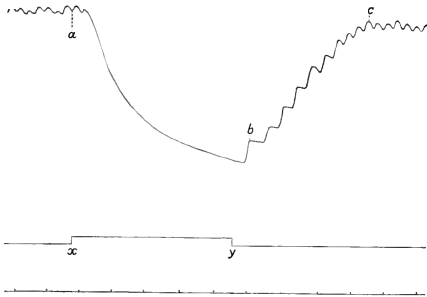

FIG. 56. TRACING, SHEWING THE INFLUENCE OF CARDIAC INHIBITION ON BLOOD-PRESSURE. FROM A RABBIT.

x the marks on the signal line when the current is thrown into, and y shut off from the vagus. The time marker below marks seconds, the heart, as is frequently the case in the rabbit, beating very rapidly.

the application of the current marked by the point a , which corresponds to the signal x on the line below. Then for a space of time no beats at all are seen, the next beat b taking place almost immediately after the shutting off the current at y . Immediately after the last beat following a , there is a sudden fall of the blood-pressure. At the pulse due to the last systole, the arterial system is at its maximum of distention; forthwith the elastic reaction of the arterial walls propels the blood forward into the veins, and, there being no fresh fluid injected from the heart, the fall of the mercury is unbroken, being rapid at first, but slower afterwards, as the elastic force of the arterial walls is more and more used up. With the returning beats the pressure corre-

spondingly rises in successive leaps until the normal mean pressure is regained. The size of these returning leaps of the mercury may seem disproportionately large, but it must be remembered that by far the greater part of the force of the first few strokes of the heart is expended in distending the arterial system, a small portion only of the blood which is ejected into the arteries passing on into the veins. As the arterial pressure rises, more and more blood passes at each beat through the capillaries, and the rise of the pressure at each beat becomes less and less, until at last the whole contents of the ventricle pass at each stroke into the veins, and the mean arterial pressure is established. To this it may be added, that, as we have seen, the force of the individual beats may be somewhat greater after than before inhibition. Besides, when the mercury manometer is used, the inertia of the mercury tends to magnify the effects of the initial beats.

In the mammal inhibition may be brought about by impulses passing along fibres which, starting in the medulla oblongata, run down over the vagus nerve and reach the heart by the cardiac nerves. It would appear however that the inhibitory fibres do not belong to the vagus proper, but leave the central nervous system by the spinal accessory nerve. Thus if the roots of the spinal accessory be divided, those of the vagus proper being left intact, the spinal accessory fibres in the vagus trunk degenerate, and when this takes place stimulation of the vagus trunk fails to produce the ordinary inhibitory effects. In the mammal as in the frog inhibition may be brought about not only by artificial stimulation of the vagus trunk, but by stimulation in a reflex manner or otherwise of the cardio-inhibitory centre. Thus the fainting which often follows upon a blow on the stomach is a repetition of the result just mentioned as obtained on the frog by striking the stomach or stimulating the *nervi mesenterici*. So also the fainting, complete or partial, which accompanies severe pain or mental emotion is an illustration of cardiac inhibition by the vagus. In fact cardiac inhibition so far from being a mere laboratory experiment enters repeatedly into the every day working of our own organism as well as that of other living beings.

Indeed there is some reason for thinking that the central nervous system by means of the cardiac inhibitory fibres keeps as it were a continual rein on the heart, for, in the dog at least, section of both vagi causes a quickening of the heart's beat.

In the dog the augmentor fibres (Fig. 57) leave the spinal cord by the anterior roots of the second and third dorsal nerves, possibly also to some extent by the fourth and fifth, pass along the rami communicantes of those nerves to the ganglion stellatum, first thoracic ganglion, or respectively to one or other of the ganglia forming part of the thoracic splanchnic or sympathetic chain immediately below, and thence upwards through the annulus of Vieussens, passing along one or other or both loops, to the inferior

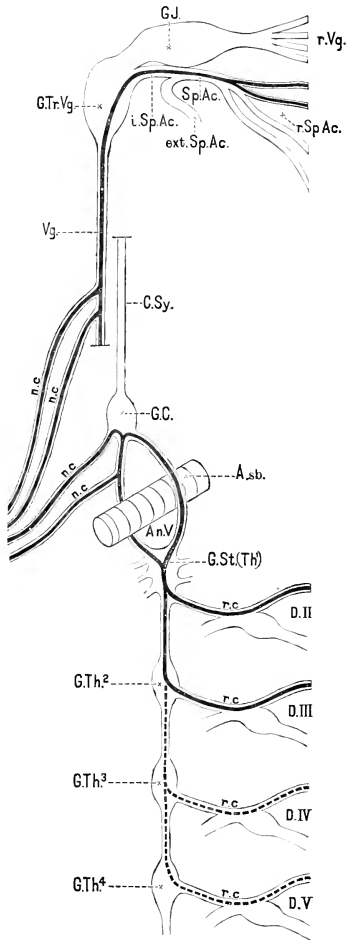

FIG. 57. DIAGRAMMATIC REPRESENTATION OF THE CARDIAL INHIBITORY AND AUGMENTOR FIBRES IN THE DOG.

The upper portion of the figure represents the inhibitory, the lower the augmentor fibres.

r. Vg., roots of the vagus; *r. Sp. Ac.*, roots of the spinal accessory: both drawn very diagrammatically. *G. J.*, ganglion jugulare. *G. Tr. Vg.*, ganglion trunci vagi. *Sp. Ac.*, spinal accessory trunk. *Ext. Sp. Ac.*, external spinal accessory. *i. Sp. Ac.*, internal spinal accessory. *Vg.*, trunk of vagus nerve. *n. c.*, branches going to heart. *C. Sy.*, cervical sympathetic. *G. C.*, lower cervical ganglion. *A. sb.*, subclavian artery. *An. V.*, Annulus of Vieussens. *G. St. (Th.¹)*, ganglion stellatum or 1st thoracic ganglion. *G. Th.²*, *G. Th.³*, *G. Th.⁴*, second, third and fourth thoracic ganglia. *D. II.*, *D. III.*, *D. IV.*, *D. V.*, second, third, fourth and fifth thoracic spinal nerves. *r. c.*, ramus communicans. *n. c.*, nerves (cardiac) passing to heart (superior vena cava) from cervical ganglion and from the annulus of Vieussens.

The inhibitory fibres, shewn by black line, run in the upper (medullary) roots of the spinal accessory, by the internal branch of the spinal accessory, past the ganglion trunci vagi, along the trunk of the vagus, and so by branches to the superior vena cava and the heart.

The augmentor fibres, also shewn by black line, pass from the spinal cord by the anterior roots of the second and third thoracic nerves (possibly also from fourth and fifth as indicated by broken black line), pass the second and first (stellate) thoracic ganglia by the annulus of Vieussens to the lower cervical ganglion, from whence, as also from the annulus itself, they pass along the cardiac nerves to the superior vena cava.

cervical ganglion. Their further course to the heart is along the nerves springing either from the inferior cervical ganglion or from the loop of Vieussens directly. Their exact path from the ganglia in fact seems to vary in different individuals.

The path of the augmentor fibres has not been worked out so fully in other mammals as in the dog, but it is most probable that in all cases they leave the spinal cord by the anterior roots of the second and third dorsal nerves (possibly also by the fourth and fifth) and, passing up the sympathetic chain to the ganglion stellatum and annulus of Vieussens, proceed to the heart by nerves branching off from some part or other of the annulus or from the lower and middle cervical ganglia.

The effects of stimulating these augmentor fibres in the mammal are, in general, the same as those witnessed in the frog. In the mammal as in the frog impulses along these augmentor fibres may be originated in the central nervous system, and that probably in various ways. That palpitation of the heart which is so conspicuous an effect of certain emotions is probably due to the sudden positive action of augmenting impulses, though it may possibly be due in part at least to sudden withdrawal of normal, continuous, tonic, inhibitory impulses.

In the mammal then as in the frog, the heart is governed by two sets of nerves, the one antagonistic to the other. In the dog the roots of the spinal accessory nerve, by which inhibitory fibres leave the central nervous system, consist entirely of medullated fibres. Among these are fibres of fine calibre, 2μ — 3μ in diameter, which may be traced down the trunk of the vagus, along the branches going to the heart, right down to the heart itself. There can be little doubt that these medullated fibres of fine calibre are the inhibitory fibres of the vagus, and indeed there is evidence, which renders it probable that the inhibitory fibres of the heart

are always medullated fibres of fine calibre, which continue as medullated fibres right down to the heart but eventually lose their medulla in the heart itself.

The anterior roots of the second and third dorsal nerves, and the (white) rami communicantes belonging to them, which, as we have just seen, contain in the dog augmentor fibres, also consist exclusively of medullated fibres. But the nerves which convey the augmenting impulses from the lower cervical ganglion or from the annulus of Vieussens to the heart consist of non-medullated fibres. Hence the augmentor fibres must have lost their medulla and become continuous with non-medullated fibres somewhere in their course along the sympathetic chain. It is probable that the change occurs in the ganglion stellatum and lower cervical ganglion, and it is further probable that the change is effected by the medullated fibre passing into one of the ganglion cells, and so losing its medulla, the impulses which it conveys passing out of the nerve cell by one or more of the other processes of the cell which are continued on as non-medullated fibres. Cf. § 98.

In the dog then these two sets of nerve fibres, antagonistic to each other in function, differ in structure, the augmentor fibres early losing their medulla and hence being over a large part of their course non-medullated fibres, whereas the inhibitory fibres are medullated fibres, which though they may pass by or through ganglia (as the ganglion jugulare and ganglion trunci vagi) do not lose their medulla in these ganglia but remain as medullated fibres right down to the heart. And this difference in structure appears to hold good for all mammals, and is possibly true for vertebrates generally.

§ 161. The question, What is the exact nature of the change brought about by the inhibitory and augmenting impulses respectively on their arrival at the heart? or, in other words, By virtue of what events produced in the heart itself do the impulses of one kind bring about inhibition, of the other kind augmentation? is a very difficult one, which we cannot attempt to discuss fully here. We may if we please speak of an "inhibitory mechanism" placed in the heart itself, but we have no exact knowledge of the nature of such a mechanism. Still less do we possess any satisfactory information as to an augmenting mechanism. It has been suggested that some of the ganglia in the heart serve as such an inhibitory (or augmenting) mechanism; but there is evidence that the inhibitory impulses produce their effect by acting directly on the muscular fibres, or at all events do not produce their effect by acting exclusively on any ganglia. †One evidence of this kind is supplied by the action of the drug atropin.

If, either in a frog or a mammal, or other animal, after the vagus fibres have been proved, by trial, to produce, upon stimulation, the usual inhibitory effects, a small quantity of atropin

be introduced into the circulation (when the experiment is conducted on a living animal, or be applied in a weak solution to the heart itself when the experiment is conducted, as in the case of a frog, on an excised heart or after the circulation has ceased). It will after a short time be found, not only that the stimulation, the application of a current for instance, which previously when applied to the vagus produced marked inhibition, now produces no inhibition, but even that the strongest stimulus, the strongest current applied to the vagus will wholly fail to affect the heart, provided that there be no escape of current on to the cardiac tissues themselves; under the influence of even a small dose of atropin, the strongest stimulation of the vagus will not produce standstill or appreciable slowing or weakening of the beat.

Now it might be supposed that the atropin produces this remarkable effect by acting on some ganglionic or other mechanism intervening between the vagus fibres and the cardiac muscular tissue; but we have evidence that the atropin acts either on the muscular tissue itself or on the very endings of the nerves in the muscular fibres. We have said, § 155, that a properly prepared strip of the ventricle of the tortoise will execute for a long time spontaneous rhythmic contractions, it will go on "beating" for a long time. A strip of the auricle will exhibit the same phenomena even still more readily. If now while such a strip from the auricle is satisfactorily beating a gentle interrupted current be passed through it, it will stop beating: the current inhibits the spontaneous beats; a very gentle interrupted current must be used, otherwise the effect is obscured by the more direct stimulating action of the current. If now the strip be gently bathed with a weak solution of atropin no such inhibitory effect is produced by the interrupted current; the beats go on regardless of the action of the current. The interpretation of this experiment is that in the first case the interrupted current stimulated the fine termination of the inhibitory fibres in the muscular strip, and that in the second case the atropin produced some effect either on these fine fibres, or on their connections with the muscular substance or on the actual muscular substance itself by virtue of which they ceased to act. But if this be so, if the same inhibitory effects are produced alike by stimulating the vagus trunk, and stimulating the very endings of the nerves in the muscles of the heart, if not the actual muscular tissue itself, then there is no need to suppose the existence of any special inhibitory mechanism placed between the fibres in the vagus branches and the cardiac muscular tissue.

The action of atropin on the heart is so to speak complemented by the action of muscarin, the active principle of many poisonous mushrooms. If a small quantity of muscarin be introduced into the circulation, or applied directly to the heart, the beats become slow and feeble, and if the dose be adequate the

heart is brought to a complete standstill. The effect is in some respects like that of powerful stimulation of the vagus, but the standstill is much more complete, the effect is much more profound. Now if, in a frog, the heart be brought to a standstill by a dose of muscarin, the application of an adequate quantity of atropin will bring back the beats to quite their normal strength. The one drug is as far as the heart is concerned (and indeed in many other respects) the antidote of the other. And, as in the case of atropin, so in the case of muscarin, there is evidence that the drug acts not on any ganglionic mechanisms but on the cardiac tissue itself.

The conclusion that inhibition is the result of changes in the cardiac tissue itself may serve to explain why in inhibition sometimes the slowing sometimes the weakening is the more prominent. When the inhibitory impulses, by reason of particular fibres being affected or otherwise, are brought to bear chiefly on those parts of the heart, such as the sinus, which possessing higher rhythmic potentiality (see § 156) determine the sequence and set the rate of rhythm, it is the rate which is most markedly affected. When on the other hand the inhibitory impulses fall chiefly on the parts possessing lower rhythmic potentiality, the most marked effect is a diminution in the force of the contractions.

There is no adequate evidence then that the cardiac ganglia act as an inhibitory mechanism in the sense that they produce important changes in the nature of the impulses reaching them along vagus inhibitory fibres before those impulses pass on to the muscular tissue. We may add that there is similarly no adequate evidence that any of the ganglia act as an 'augmenting' mechanism. We have previously seen, §§ 155, 156, reasons for thinking the ganglia are not centres for the origination or regulation of the spontaneous beats. The question then arises, What are their functions? To this question we cannot at present give a wholly satisfactory answer.

The inhibitory fibres remain as we have seen medullated fibres until they reach the heart, but it would appear that they lose their medulla, somewhere, in the heart before they actually reach the muscular tissue, and it is probable that the loss takes place in connection with some of the cardiac ganglia much in the same way that the augmenting fibres lose their medulla in the ganglia of the sympathetic chain; but we do not know what is the physiological effect or the purpose of this loss of the medulla, and we cannot suppose that this is the sole or even chief use of the ganglia. Coincident with the loss of the medulla an increase of fibres frequently takes place, more than one non-medullated fibre leaving a nerve cell into which one medullated fibre enters; and we may suppose that this mode of branching has purposes not fulfilled by the mere division of a fibre. Then again bearing in mind the nutritive or "trophic"

function of the spinal ganglia alluded to in § 100, we may suppose that the cardiac ganglia are in some way concerned in the nutrition of the cardiac nerve fibres. But our knowledge is not yet sufficiently ripe to allow exact statements to be made.

Other Influences regulating or modifying the Beat of the Heart.

§ 162. Important as is the regulation of the heart by the nervous system, it must be borne in mind that other influences are or may be at work. The beat of the heart may for instance be modified by influences bearing directly on the nutrition of the heart. The tissues of the heart, like all other tissues, need an adequate supply of blood of a proper quality; if the blood vary in quality or quantity the beat of the heart is correspondingly affected. The excised frog's heart, as we have seen, continues to beat for some considerable time, though apparently empty of blood. After a while however the beats diminish and disappear; and their disappearance is greatly hastened by washing out the heart with a normal saline solution, which when allowed to flow through the cavities of the heart readily permeates the tissues on account of the peculiar construction (§ 151) of the ventricular walls. If such a 'washed out' quiescent heart be fed with a perfusion cannula, in the manner described (§ 155), with diluted blood (of the rabbit, sheep, &c.), it may be restored to functional activity. A similar but less complete restoration may be witnessed if serum be used instead of blood; and a heart fed regularly with fresh-supplies of blood or even of serum may be kept beating for a very great length of time. In treating of the skeletal muscles we saw that in their case the exhaustion following upon withdrawal of the blood-stream might be attributed either to an inadequate supply of new nutritive material and oxygen, or to an accumulation in the muscular substance of the products of muscular metabolism, or to both causes combined. And the same considerations hold good for the nervous and muscular structures of the heart, though the subject has not yet been sufficiently well worked out to permit any very definite statements to be made. It seems probable however that an important factor in the matter is the accumulation in the muscular fibres and in the surrounding lymph of carbonic acid, and especially of the substances which give rise to the acid reaction.

When the frog's heart is thus 'fed' with various substances the interesting fact is brought to light that some substances, such for instance as very dilute lactic acid, lead to increased expansion, and others, such for instance as very dilute solutions of sodium hydrate, to diminished expansion, that is to continued contraction, of the quiescent ventricle. It would appear that the muscular fibres of the ventricle over and above their rhythmic contractions are capable of varying in length, so that at one time they are longer, and the ventricle when pressure is applied to it

internally dilates beyond the normal, while at another time they are shorter, and the ventricle, with the same internal pressure, is contracted beyond the normal. Further, in the frog at least, when the pause between two beats is lengthened the relaxation of the ventricle goes on increasing, so that apparently the ventricle when beating normally is already somewhat contracted when a new beat begins. In other words, the ventricle possesses what we shall speak of in reference to arteries as tonicity or tonic contraction, and the amount of this tonic contraction, and in consequence the capacity of the ventricle, varies according to circumstances. We have, moreover, evidence that inhibitory impulses diminish and augmenting impulses increase this tonic contraction.

When the frog's ventricle is thus artificially fed with serum or even with blood, the beats, whether spontaneous or provoked by stimulation, are apt to become intermittent and to arrange themselves into groups. This intermittence is possibly due to the serum or blood being unable to carry on nutrition in a completely normal manner, and to the consequent production of abnormal chemical substances; and it is probable that cardiac intermittences seen during life have often a similar causation. Various chemical substances in the blood, natural or morbid, may thus affect the heart's beat by acting on its muscular fibres, or its nervous elements, or both, and that probably in various ways, modifying in different directions the rhythm, or the individual contractions, or both.

The physical or mechanical circumstances of the heart also affect its beat; of these perhaps the most important is the amount of the distension of its cavities. The contractions of cardiac muscle, like those of ordinary muscle (see § 81), are increased up to a certain limit by the resistance which they have to overcome; a full ventricle will, other things being equal, contract more vigorously than one less full; though, as in ordinary muscle, the limit at which resistance is beneficial may be passed, and an overfull ventricle will fail to beat at all.

Under normal conditions the ventricle probably empties itself completely at each systole. Hence an increase in the quantity of blood in the ventricle would augment the work done in two ways; the quantity thrown out would be greater, and the increased quantity would be ejected with greater force. Further, since the distension of the ventricle is (at the commencement of the systole at all events) dependent on the auricular systole, the work of the ventricle (and so of the heart as a whole) is in a measure governed by the auricle.

An interesting combination of direct mechanical effects and indirect nervous effects is seen in the relation of the heart's beat to blood-pressure. When the blood-pressure is high, not only is the resistance to the ventricular systole increased, but, other things being equal, more blood flows (in the mammalian

heart) through the coronary artery. Both these events would increase the activity of the heart, and we might expect that the increase would be manifest in the rate of the rhythm as well as in the force of the individual beats. As a matter of fact, however, we do not find this. On the contrary the relation of heart-beat to pressure may be put almost in the form of a law, that "the rate of the beat is in inverse ratio to the arterial pressure;" a rise of pressure being accompanied by a diminution, and fall of pressure with an increase of the pulse-rate. This however only holds good if the vagi be intact. If these be previously divided, then in whatever way the blood-pressure be raised—whether by injecting blood or clamping the aorta, or increasing the peripheral resistance, through that action of the vaso-motor nerves which we shall have to describe directly—or in whatever way it be lowered, no such clear and decided inverse relation between blood-pressure and pulse-rate is observed. It is inferred therefore that increased blood-pressure causes a slowing of the pulse, when the vagi are intact, because the cardio-inhibitory centre in the medulla is stimulated by the high pressure, either directly by the pressure obtaining in the blood vessels of the medulla, or in some indirect manner, and the heart in consequence to a certain extent inhibited.

SEC. 6. CHANGES IN THE CALIBRE OF THE MINUTE ARTERIES. VASO-MOTOR ACTIONS.

§ 163. We have seen (§ 108) that all arteries contain plain muscular fibres, for the most part circularly disposed, and most abundant in, or sometimes almost entirely confined to, the middle coat. We have further seen that as the arteries become smaller, the muscular element as a rule becomes more and more prominent as compared with the other elements, until, in the minute arteries, the middle coat consists almost entirely of a series of plain muscular fibres wrapped round the internal coat. Nerve fibres, of whose nature and course we shall presently speak, are distributed largely to the arteries, and appear to end chiefly in fine plexuses round the muscular fibres, but their exact terminations have not as yet been clearly made out. By mechanical, electrical, or other stimulation, this muscular coat may, in the living artery, be made to contract. During this contraction, which has the slow character belonging to the contractions of all plain muscle, the calibre of the vessel is diminished. The veins also as we have seen possess muscular elements, but these vary in amount and distribution very much more in the veins than in the arteries. Most veins however are contractile, and may vary in calibre according to the condition of their muscular elements. Veins are also supplied with nerves. It will be of advantage however to consider separately the little we know concerning the changes in the veins and to confine ourselves at present to the changes in the arteries.

If the web of a frog's foot be watched under the microscope, any individual small artery will be found to vary considerably in calibre from time to time, being sometimes narrowed and sometimes dilated; and these changes may take place without any obvious changes either in the heart-beat or in the general circulation; they are clearly changes of the artery itself. During the narrowing, which is obviously due to a contraction of the muscular coat of the artery, the capillaries fed by the artery and the veins into which these lead become less filled with blood, and paler. During

the widening, which corresponds to the relaxation of the muscular coat, the same parts are fuller of blood and redder. It is obvious that, the pressure at the entrance into any given artery remaining the same, more blood will enter the artery when relaxation takes place and consequently the resistance offered by the artery is diminished, and less when contraction occurs and the resistance is consequently increased; the blood flows in the direction of least resistance.

The extent and intensity of the narrowing or widening, the constriction or dilation which may thus be observed in the frog's web, vary very largely. Variations of slight extent, either more or less regular and rhythmic or irregular, occur even when the animal is apparently subjected to no disturbing causes, and may be spoken of as spontaneous; larger changes may follow events occurring in various parts of the body; while as the result of experimental interference the arteries may become either constricted, in some cases almost to obliteration, or dilated until they acquire double or more than double their normal diameter. This constriction or dilation may be brought about not only by treatment applied directly to the web, but also by changes affecting the nerve of the leg or other parts of the body. Thus section of the sciatic nerve is generally followed by a widening which may be slight or which may be very marked, and which is sometimes preceded by a passing constriction; while stimulation of the peripheral stump of the divided nerve by an interrupted current of moderate intensity generally gives rise to constriction, often so great as almost to obliterate some of the minute arteries.

Obviously then the contractile muscular elements of the minute arteries of the web of the frog's foot are capable by contraction or relaxation of causing decrease or increase of the calibre of the arteries; and this condition of constriction or dilation may be brought about through the agency of nerves. Indeed not only in the frog, but also, and still more so, in warm-blooded animals have we evidence that in the case of nearly all, if not all, the arteries of the body, the condition of the muscular coat, and so the calibre of the artery is governed by means of nerves; these nerves have received the general name of *vaso-motor nerves*.

§ 164. If the ear of a rabbit, preferably a light coloured one, be held up before the light, a fairly conspicuous artery will be seen running up the middle line of the ear accompanied by its broader and more obvious veins. If this artery be carefully watched it will be found, in most instances, to be undergoing rhythmic changes of calibre, constriction alternating with dilation. At one moment the artery appears as a delicate hardly visible pale streak, the whole ear being at the same time pallid. After a while the artery slowly widens out, becomes broad and red, the whole ear blushing, and many small vessels previously invisible coming into view. Again the artery narrows and the blush fades away; and this may be

repeated at somewhat irregular intervals of a minute more or less. The extent and regularity of the rhythm are usually markedly increased if the rabbit be held up by the ears for a short time previous to the observation. Similar rhythmic variations in the calibre of the arteries have been observed in several places, *ex. gr.* in the vessels of the mesentery and elsewhere; probably they are widely spread.

Sometimes no such variations are seen, the artery remains constant in a condition intermediate between the more extreme widening and extreme narrowing just described. In fact we may speak of an artery as being at any given time in one of three phases. It may be very constricted, in which case its muscular fibres are very much contracted; or it may be very dilated, in which case its muscular fibres are relaxed; or it may be moderately constricted, the muscular fibres being contracted to a certain extent, and remaining in such a condition that they may on the one hand pass into stronger contraction, leading to marked constriction, or on the other hand into distinct relaxation, leading to dilation. We have reason to think, as we shall see, that many arteries of the body are kept habitually, or at least for long periods together, in this intermediate condition, which is frequently spoken of as *tonic contraction* or *tonus*, or *arterial tone*.

§ 165. If now in a vigorous rabbit, in which the heart is beating with adequate strength and the whole circulation is in a satisfactory condition, the cervical sympathetic nerve be divided on one side of the neck, remarkable changes may be observed in the blood vessels of the ear of the same side. The arteries and veins widen, they together with the small veins and the capillaries become full of blood, many vessels previously invisible come into view, the whole ear blushes, and if the rhythmic changes described above were previously going on, these now cease: and in consequence of the extra supply of warm blood the whole ear becomes distinctly warmer. Now these changes take place, or may take place, without any alteration in the heart-beat or in the general circulation. Obviously the arteries of the ear have, in consequence of the section of the nerve, lost the tonic contraction which previously existed: their muscular coats previously somewhat contracted have become quite relaxed, and whatever rhythmic contractions were previously going on have ceased. The more marked the previous tonic contraction, and the more vigorous the heart-beats, so that there is an adequate supply of blood to fill the widened channels, the more striking the results. Sometimes, as when the heart is feeble, or the pre-existing tonic contraction is slight, the section of the nerve produces no very obvious change.

If now the upper segment of the divided cervical sympathetic nerve, that is the portion of the nerve passing upwards to the head and ear, be laid upon the electrodes of an induction machine, and a gentle interrupted current be sent through the nerve, new changes

take place in the blood vessels of the ear. A short time after the application of the current, for in this effect there is a latent period of very appreciable duration, the ear grows paler and cooler, many small vessels previously conspicuous become again invisible, the main artery shrinks to the thinnest thread, and the main veins become correspondingly small. When the current is shut off from the nerve, these effects still last some time but eventually pass off; the ear reddens, blushes once more, and indeed may become even redder and hotter, with the vessels more filled with blood than before. Obviously the current has generated in the cervical sympathetic nerve impulses which, passing upward to the ear and finding their way to the muscular coats of the arteries of the ear, have thrown the muscles of those coats into forcible contractions, and have thus brought about a forcible narrowing of the calibre of the arteries, a forcible constriction. Through the narrowed constricted arteries less blood finds its way, and hence the paleness and coldness of the ear. If the impulses thus generated be very strong the constriction of the arteries may be so great that the smallest quantity only of blood can make its way through them and the ear may become almost bloodless. If the impulses be weak the constriction induced may be slight only; and indeed by careful manipulation the nerve may be induced to send up to the ear impulses only just sufficiently strong to restore the moderate tonic constriction which existed before the nerve was divided.

We infer from these experiments that among the various nerve fibres making up the cervical sympathetic, there are certain fibres which passing upwards to the head become connected with the arteries of the ear, and that these fibres are of such a kind that, impulses generated in them and passing upwards to the ear, lead to marked contraction of the muscular fibres of the arteries, and thus produce constriction. These fibres are vaso-motor fibres for the blood vessels of the ear. From the loss of tone, so frequently following section of the cervical sympathetic, we may further infer, that, normally during life, impulses of a gentle kind are continually passing along these fibres, upwards through the cervical sympathetic, which impulses, reaching the arteries of the ear, maintain the normal tone of those arteries. But, as we said, the existence of this tone is not so constant, and these tonic impulses are not so conspicuous as the artificial constrictor impulses generated by stimulation of the nerve.

§ 166. The above results are obtained whatever be the region of the cervical sympathetic which we divide or stimulate from the upper cervical ganglion to the lower. We may therefore describe these vaso-motor impulses as passing upwards from the lower cervical ganglion along the cervical sympathetic, to the upper cervical ganglion, from which they issue by branches which ultimately find their way to the ear. But these impulses do not start from the lower cervical ganglion; on the contrary, by repeating the experi-

ments of division and stimulation in a series of animals, we may trace the path of these impulses from the lower cervical ganglion,

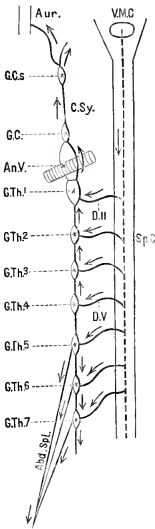

Fig. 58, through the annulus of Vieussens to the ganglion stellatum or first thoracic ganglion, and thence either along the ramus communicans (visceral branch) to the anterior root of the second dorsal nerve, and thus to the spinal cord, or lower down along the thoracic sympathetic chain, and thence by other rami communicantes to some other of the upper dorsal nerves, and thus to the spinal cord. The path taken by these vaso-motor impulses for the ear is in fact very similar to that of the augmentor fibres for the heart (cf. Fig. 57) from the spinal cord up to the annulus of Vieussens and to the lower cervical ganglion; but there they part company. We can thus trace these impulses along the cervical sympathetic to the anterior roots of certain dorsal nerves, and through these to a particular part of the spinal cord, where we will for the present leave them. We may accordingly speak of vaso-motor fibres for the ear as passing from the dorsal spinal cord to the ear along the track just marked out; stimulation of these fibres at their origin in the spinal cord or at any

FIG. 58. DIAGRAM ILLUSTRATING THE PATHS OF VASO-CONSTRICTOR FIBRES ALONG THE CERVICAL SYMPATHETIC AND (PART OF) THE ABDOMINAL SPLANCHNIC.

Aur. artery of ear. *G.C.S.* superior cervical ganglion. *Abd. Spl.* upper roots of and part of abdominal splanchnic nerve. *V.M.C.* vaso-motor centre in medulla. The other references are the same as in Fig. 57, § 160. The paths of the constrictor fibres are shewn by the arrows. The dotted line in the spinal cord, *Sp.C.*, is to indicate the passage of constrictor impulses down the cord from the vaso-motor centre in the medulla.

part of their course (along the anterior roots of the second, third or other upper dorsal nerves, visceral branches of those nerves, ganglion stellatum or upper part of thoracic sympathetic chain, annulus of Vieussens, &c. &c.) leads to constriction in the blood vessels of the ear of that side; and section of these fibres at any part of the same course tends to abolish any previously existing tonic constriction of the blood vessels of the ear, though this effect is not so constant or striking as that of stimulation.

§ 167. We must now turn to another case. In dealing with digestion we shall have to study the sub-maxillary salivary gland. We may for the present simply say that this is a glandular mass well supplied with blood vessels, and possessing a double nervous supply. On the one hand it receives fibres from the cervical

sympathetic, Fig. 59 *v. sym.* (in the dog, in which the effects which we are about to describe are best seen, the vagus and cervical

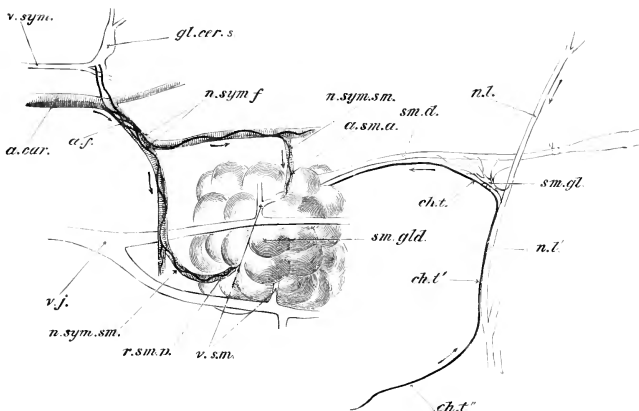

FIG. 59. DIAGRAMMATIC REPRESENTATION OF THE SUBMAXILLARY GLAND OF THE DOG WITH ITS NERVES AND BLOOD VESSELS.

(The dissection has been made on an animal lying on its back, but since all the parts shewn in the figure cannot be seen from any one point of view, the figure does not give the exact anatomical relations of the several structures.)

sm. gland. The submaxillary gland, into the duct (*sm. d.*) of which a cannula has been tied. The sublingual gland and duct are not shewn. *n. l., n. l'.* The lingual branch of the fifth nerve, the part *n. l.* is going to the tongue. *ch. t., ch. t', ch. t''.* The chorda tympani. The part *ch. t'* is proceeding from the facial nerve; at *ch. t'* it becomes conjoined with the lingual *n. l'* and afterwards diverging passes as *ch. t.* to the gland along the duct; the continuation of the nerve in company with the lingual *n. l.* is not shewn. *sm. gl.* The submaxillary ganglion with its several roots. *a. car.* The carotid artery, two small branches of which, *a. sm. a.* and *r. sm. p.*, pass to the anterior and posterior parts of the gland. *v. s. m.* The anterior and posterior veins from the gland, falling into *v. j.* the jugular vein. *v. sym.* The conjoined vagus and sympathetic trunks. *g. cer. s.* The upper cervical ganglion, two branches of which forming a plexus (*a. f.*) over the facial artery, are distributed (*n. sym. sm.*) along the two glandular arteries to the anterior and posterior portions of the gland.

The arrows indicate the direction taken by the nervous impulses during reflex stimulation of the gland. They ascend to the brain by the lingual and descend by the chorda tympani.

sympathetic are enclosed in a common sheath so as to form what appears to be a single trunk), which reach the gland in company with the arteries supplying the gland (*n. sym. sm.*). On the other hand it receives fibres from a small nerve called the *chorda tympani* (*ch. t.*), which, springing from the 7th cranial (facial) nerve, crosses the tympanum of the ear (hence the name) and, joining the lingual branch of the 5th nerve, runs for some distance in

company with that nerve, and then ends partly on the tongue, and partly in a small nerve which, leaving the lingual nerve before reaching the tongue, runs along the duct of the sub-maxillary gland, and is lost in the substance of the gland; a small branch is also given off to the sublingual gland.

Now when the chorda tympani is simply divided no very remarkable changes take place in the blood vessels of the gland, but if the peripheral segment of the divided nerve, that still in connection with the gland, be stimulated very marked results follow. The small arteries of the gland become very much dilated and the whole gland becomes flushed. (As we shall see later on the gland at the same time secretes saliva copiously, but this does not concern us just now.) Changes in the calibre of the blood vessels are of course not so readily seen in a compact gland as in a thin extended ear; but if a fine tube be placed in one of the small veins by which the blood returns from the gland, the effects on the blood vessels of stimulating the chorda tympani become very obvious. Before stimulation the blood trickles out in a thin slow stream of a dark venous colour; during stimulation the blood rushes out in a rapid full stream, often with a distinct pulsation and frequently of a colour which is still scarlet and arterial in spite of the blood having traversed the capillaries of the gland; the blood rushes so rapidly through the widened blood vessels that it has not time to undergo completely that change from arterial to venous which normally occurs while the blood is traversing the capillaries of the gland. This state of things may continue for some time after the stimulation has ceased, but before long the flow from the veins slackens, the issuing blood becomes darker and venous, and eventually the circulation becomes normal.

Obviously the chorda tympani contains fibres which we may speak of as 'vaso-motor' since stimulation of them produces a change in, brings about a movement in the blood vessels; but the change produced is of a character the very opposite to that produced in the blood vessels of the ear by stimulation of the cervical sympathetic. There stimulation of the nerve caused contraction of the muscular fibres, constriction of the small arteries; here stimulation of the nerve causes a widening of the arteries, which widening is undoubtedly due to relaxation of the muscular fibres. Hence we must distinguish between two kinds of vaso-motor fibres, fibres the stimulation of which produces constriction, *vaso-constrictor* fibres, and fibres the stimulation of which causes the arteries to dilate, *vaso-dilator* fibres, the one kind being the antagonist of the other.

The reader can hardly fail to be struck with the analogy between these two kinds of vaso-motor fibres on the one hand, and the inhibitory and augmentor fibres of the heart on the other hand. The augmentor cardiac fibres increase the rhythm and the force of the heart beats; the vaso-constrictor fibres increase

the contractions of the muscular fibres of the arteries; the one works upon a rhythmically active tissue, the other upon a tissue whose work is more or less continuous, but the effect is in each case similar, an increase of the work. The inhibitory cardiac fibres slacken or stop the rhythm of the heart and diminish the beats; the vaso-dilator fibres diminish the previously existing contraction of the muscular fibres of the arteries so that these expand under the pressure of the blood.

We must not attempt here to discuss what is the exact nature of the process by which the nervous impulses passing down the fibres thus stop contraction and induce relaxation; but we may say that in all probability the process, whatever be its nature, is one which takes place in the muscular fibre itself on the arrival of the nervous impulse, and that there is no need to pre-suppose the existence of any special terminal inhibitory or dilating nervous mechanism. We have repeatedly insisted that the relaxation of a muscular fibre is as much a complex vital process, is as truly the result of the metabolism of the muscular substance, as the contraction itself; and there is *à priori* no reason why a nervous impulse should not govern the former as it does the latter. We may perhaps go further and say that relaxation need not be considered as the mere undoing of a contraction, that the action of dilator fibres is not necessarily limited to the removal of a previously existing constriction. We may imagine a muscular fibre as subject to the action of two opposing forces, the one elongating, relaxing, or dilating, the other shortening, contracting, or constricting; when neither are in action, or when the two are equipollent, the fibre is at rest, neither relaxing nor contracting; when one acts alone, or when one acts more powerfully than the other, then either relaxation, elongation, dilation, or contraction, shortening, constriction is the result; we have probably as much right to suppose relaxation to be a necessary antecedent of contraction as to suppose contraction to be a necessary antecedent of relaxation.

§ 168. But we must return to the vaso-motor nerves. The cervical sympathetic contains vaso-constrictor fibres for the ear, and we may now add for other regions also of the head and face. Thus the branches of the cervical sympathetic going to the sub-maxillary gland of which we just spoke, (Fig. 59 *n. sym. sm.*), contain vaso-constrictor fibres for the vessels of the gland; stimulation of these fibres produces, on the vessels of the gland, an effect exactly the opposite of that produced by stimulation of the chorda tympani. But to this particular point we shall have to return when we deal with the gland in connection with digestion. A more important fact for our present purpose is that the cervical sympathetic appears to contain only vaso-constrictor fibres; if we put aside as exceptional and doubtful the result of certain observers who obtained vaso-dilator effects in the mouth and face,

we may say that in no region to which the fibres of the cervical sympathetic are distributed can any vaso-dilator action be observed as the result of stimulation of the nerve at any part of its course. In the chorda tympani, on the other hand, the vaso-motor fibres are exclusively vaso-dilator fibres, and this is true both of the part of the nerve ending in the submaxillary and sublingual glands, and the rest of the ending of the nerve in the tongue. Stimulation of the chorda tympani, (as far as the vaso-motor functions of the nerve are concerned, for it has, as we shall see, other functions), at any part of its course from its leaving the facial nerve to its endings in the tongue or gland, produces only vaso-dilator effects, never vaso-constrictor effects.

With many other nerves of the body the case is different. In the frog, division of the sciatic nerve leads to a widening of the arteries of the web of the foot of the same side, and stimulation of the peripheral end of the nerve causes a constriction of the vessels, which, if the stimulation be strong, may be so great that the web appears for the time being to be devoid of blood. Also in a mammal division of the sciatic nerve causes a similar widening of the small arteries of the skin of the leg. Where the condition of the circulation can be readily examined, as for instance in the hairless balls of the toes, especially when these are not pigmented, the vessels are seen to be dilated and injected; and a thermometer placed between the toes shews a rise of temperature amounting, it may be, to several degrees. If moreover the peripheral end of the divided nerve be stimulated, the vessels of the skin become constricted, the skin grows pale, and the temperature of the foot falls. And very similar results are obtained in the forelimb by division and subsequent stimulation of the nerves of the brachial plexus.

The quantity of blood present in the blood vessels of the mammal though it may sometimes be observed directly, has frequently to be determined indirectly. The temperature of passive structures subject to cooling influences, such as the skin, is largely dependent on the supply of blood: the more abundant the supply, the warmer the part. Hence in these parts variations in the quantity of blood may be inferred from variations of temperature; but in dealing with more active structures there are obviously sources of error in the possibility of the treatment adopted, such as the stimulation of a nerve, giving rise to an increase of temperature due to increased metabolism, independent of variations in blood supply.

The quantity of blood may also be determined by the *plethysmograph*. In this instrument, a part of the body, such as the arm, is introduced into a closed chamber filled with fluid, *ex. gr.* a large glass tube, the opening by which the arm is introduced being secured with a stout caoutchouc membrane. An increase or decrease of blood sent into the arm will lead to an increase or decrease of the volume of the arm, and this will make itself felt by an increase or diminution of

pressure in the fluid of the closed chamber, which may be registered and measured in the usual way. We shall have to speak again of a modification of this instrument when we are dealing with the kidney.

So far the results are quite like those obtained by division and stimulation of the cervical sympathetic, and we might infer that the sciatic nerve and brachial plexus contain vaso-constrictor fibres for the vessels of the skin of the hind limb and fore limb, vaso-dilator fibres being absent. But sometimes a different result is obtained; on stimulating the divided sciatic nerve the vessels of the foot are not constricted but dilated, perhaps widely dilated. And this vaso-dilator action is almost sure to be manifested when the nerve is divided, and the peripheral stump stimulated some days after division, by which time commencing degeneration has begun to interfere with the irritability of the nerve. For example if the sciatic be divided, and some days afterwards, by which time the flushing and increased temperature of the foot, following upon the section, has wholly or largely passed away, the peripheral stump be stimulated with an interrupted current a renewed flushing and rise of temperature is the result. We are led to conclude that the sciatic nerve (and the same holds good for the brachial plexus) contains both vaso-constrictor and vaso-dilator fibres, and to interpret the varying result as due to variations in the relative irritability of the two sets of fibres. The constrictor fibres appear to predominate in these nerves, and hence constriction is the more common result of stimulation; the constrictor fibres also appear to be more readily affected by a tetanizing current than the dilator fibres. When the nerve after division commences to degenerate the constrictor fibres lose their irritability earlier than the dilator fibres, so that at a certain stage a stimulus, such as the interrupted current, while it fails to affect the constrictor fibres, readily throws into action the dilator fibres. The latter indeed, in contrast to ordinary motor nerves, (§ 83), retain their irritability after section of the nerve for very many days. The result is perhaps even still more striking if a mechanical stimulus, such as that of "crimping" the nerve by repeated snips with the scissors, be employed. Exposure to a low temperature again seems to depress the constrictors more than the dilators; hence when the leg is placed in ice-cold water stimulation of the sciatic, even when the nerve has been but recently divided, throws the dilator only into action and produces flushing of the skin with blood. Rhythmical stimulation moreover of even a freshly divided nerve produces dilation. And there are other facts which support the same view that the sciatic nerve (and brachial plexus) contains both vaso-constrictor and vaso-dilator fibres which are differently affected by different circumstances. We may point out that the case of the vagus of the frog is a very analogous one; in it are both cardiac inhibitory (true vagus) and cardiac augmentor (sym-

pathetic) fibres, but the former, like the vaso-constrictor fibres in the sciatic, are predominant, and special means are required to shew the presence of the latter.

In the splanchnic nerve (abdominal splanchnic) which supplies fibres to the blood vessels of so large a part of the abdominal viscera, there is abundant evidence of the presence of vaso-constrictor fibres, but the presence of vaso-dilator fibres has not yet been shewn. Division of this nerve leads to a widening of the blood vessels of the abdominal viscera, stimulation of the nerve to a constriction; and as we shall see, since the amount of blood vessels thus governed by this nerve is very large indeed, interference either in the one direction or the other with its vaso-motor functions produces very marked results, not only on the circulation in the abdomen but on the whole vascular system.

In nerves going to muscles vaso-dilator fibres predominate, indeed in these the presence of any vaso-constrictor fibres at all has not at present been satisfactorily established. When a muscle contracts there is always an increased flow of blood through the muscle; this may be in part a mere mechanical result of the change of form, the shortening and thickening of the fibres opening out the minute blood vessels, but is not wholly, and probably not even largely, thus produced. A notable feature of vaso-motor fibres is that, in very many cases at all events, their action is not affected by small or moderate doses of urari such as render the motor nerves of striated muscle powerless. Thus in a frog placed under the influence of a moderate amount of urari, stimulation of a nerve going to a muscle will produce vaso-motor effects unaccompanied and unobscured by any contraction of the striated fibres. By placing a thin muscle of a frog, such as the mylo-hyoid, under the microscope, and watching the calibre of the small arteries and the circulation of the blood through them while the nerve is being stimulated, the widening of the blood vessels, as the result of the stimulation, may be actually observed. This experiment appears not to succeed in a mammal; and it has been suggested that when a muscle contracts, some of the chemical products of the metabolism of the muscle may, by direct action on the minute blood vessels apart from any nervous agency, lead to a widening of those blood vessels; this however is doubtful. With regard to vaso-constrictor fibres the only evidence that they exist in muscles is that when the nerve of a muscle is divided the blood vessels of the muscle widen, somewhat like the blood vessels of the ear after division of the cervical sympathetic. This suggests the presence of vaso-constrictor fibres carrying the kind of influence which we called tonic, leading to an habitual moderate constriction; it cannot however be regarded, by itself, as conclusive evidence; but we must not discuss the matter here.

Speaking generally then, most, if not all the arteries of the body are supplied with vaso-motor fibres running in this or that

nerve, the fibres being either vaso-constrictor or vaso-dilator, and some nerves containing one kind of fibres only, some both in varying proportion. Almost every nerve in the body therefore may be looked upon as influencing a certain set of blood vessels, as governing a vascular area, the area being large or small, and the government being exclusively constrictor or exclusively dilator or mixed.

The Course of Vaso-constrictor and Vaso-dilator Fibres.

§ 169. Both the vaso-constrictor and the vaso-dilator fibres have their origin in the central nervous system, the spinal cord or the brain, but the course of the two sets appears to be very different.

In the mammal, as far as we know at present, all the vaso-constrictor fibres for the whole body take their origin in the middle region of the spinal cord, or rather, leave the spinal cord by the nerves belonging to this middle region. Thus in the dog the vaso-constrictor fibres, not only for the trunk but for the limbs, head, face and tail, leave the spinal cord by the anterior roots of the spinal nerves reaching from about the second dorsal to the second lumbar nerve, both inclusive. Running in the case of each nerve root to the mixed nerve trunk they pass along the visceral branch, white ramus communicans, to the chain of splanchnic ganglia lying in the thorax and abdomen, the so-called thoracic and abdominal sympathetic chain (Fig. 58). From these ganglia they reach their destination in various ways. Thus, those going to the head and neck pass upward through the annulus of Vieussens to the lower cervical ganglion and thence, as we have seen, up the cervical sympathetic. Those for the abdominal viscera pass off in a similar way to the abdominal splanchnic nerves, Fig. 58, *abd. spl.* Those destined for the arm take their way by the recurrent fibres (grey rami communicantes), (Fig. 24 *r. v.*), and so reach the nerves of the brachial plexus; while those for the hind leg pass in a similar way through some portion of the abdominal sympathetic before they join the nerves of the sciatic plexus. And the constrictor fibres of the skin of the trunk probably reach the spinal nerves in which they ultimately run in a similar manner. All the vaso-constrictor fibres, whatever their destination, leave the spinal cord by the anterior roots of spinal nerves, and then passing through the appropriate visceral branches, join the thoracic or abdominal chain of splanchnic ganglia. In these ganglia the fibres undergo a remarkable change. Along the anterior root and along the visceral branch they are medullated fibres, but long before they reach the blood vessels for which they are destined they become non-medullated fibres; they appear to lose their medulla in the system of splanchnic ganglia. We may add that in the anterior roots and along the visceral branches,

white rami communicantes, these fibres are invariably of small diameter, not more than 1.8μ to 3.6μ .

§ 170. The course of the vaso-dilator fibres appears to be a wholly different one, though the details have as yet been fully worked out in the case of few of the fibres only. It is chiefly in the nerves belonging to the cranial and sacral regions of the central nervous system whence, as we have seen, no vaso-constrictor fibres are known to issue, that the course of the vaso-dilator fibres has been successfully traced. Thus the vaso-dilator fibres for the sub-maxillary gland running in the chorda tympani may be traced as we have seen back to the facial or seventh nerve; and the continuation of the chorda tympani along the lingual nerve to the tongue contains vaso-dilator fibres for that organ; when the lingual is stimulated, the blood vessels of the tongue dilate owing to the stimulation of the conjoined chorda tympani fibres. The ramus tympanicus of the glossopharyngeal nerve contains vaso-dilator fibres for the parotid gland, and it appears probable that the trigeminal nerve contains vaso-dilator fibres for the eye and nose and possibly for other parts. In the anterior roots of the second and third sacral nerves run vaso-dilator fibres which pass into the so-called *nerri erigentes*, the nerves, stimulation of which, by leading to a widening of the arteries of the penis brings about the erection of that organ, the effect being assisted by a simultaneous hindrance to the venous outflow. Though vaso-dilator fibres are, as we have seen, present in the nerves of the limbs, and probably also in those of the trunk, the investigation of their several paths is rendered very difficult by the concomitant presence of vaso-constrictor fibres. There are some reasons for thinking that the vaso-dilator fibres in these nerves pursue a direct course from the spinal cord through the anterior spinal roots, and thus afford a contrast with the constrictor fibres of the same nerves which, as we have seen, take a roundabout course, passing into the splanchnic system, before they join the nerve trunk. Our information however is too imperfect to allow any very positive statement to be made. Accepting this view however we may say that while all the vaso-constrictor fibres, as far as we know, come from a particular, though considerable, part of the spinal cord and pass into the splanchnic system on their way to their several destinations, the vaso-dilator fibres arise from all parts of the spinal cord as well as from the medulla oblongata and pursue a more or less direct course to their destination.

Further, while the vaso-dilator fibres, as they leave the central nervous system, are, like the vaso-constrictor fibres, fine medullated fibres, unlike the vaso-constrictors they retain their medulla for the greater part of their course and only lose it near their termination in the tissue whose blood vessels they supply.

Lastly, while the vaso-constrictor fibres, as in the case of the cervical sympathetic, of the abdominal splanchnic, and of the

nerves of the skin, and probably in all cases, are normally in a state of moderate activity (so long as they remain in connection with the central nervous system), the moderate activity maintaining that moderate constriction which we spoke of above as 'tone,' the vaso-dilators appear to possess no such continued activity. Section of vaso-constrictor fibres leads to loss of tone, diminution of constriction, lasting, as we shall see, for some considerable time; but section of vaso-dilators, according at all events to most observers, does not lead to analogous constriction, or diminution of dilation; all that is observed is a transient increase of dilation due probably to the section acting as a transient stimulus to the nerve at the place of section. But before we study the use made by the central nervous system of vaso-motor nerves it will be best to consider briefly some features of

The Effects of Vaso-motor Actions.

§ 171. A very little consideration will shew that vaso-motor action is a most important factor in the circulation. In the first place the whole flow of blood in the body is adapted to and governed by what we may call the *general tone* of the arteries of the body at large. In a normal condition of the body, a very large number of the minute arteries of the body are in a state of tonic, *i.e.* of moderate, contraction, and it is the narrowing due to this contraction which forms a large item of that peripheral resistance which we have seen to be one of the great factors of blood-pressure. The normal general blood-pressure, and therefore the normal flow of blood, is in fact dependent on the 'general tone' of the minute arteries.

In the second place local vaso-motor changes in the condition of the minute arteries, changes, *i.e.* of any particular vascular area, have very decided effects on the circulation. These changes, though local themselves, may have effects which are both local and general, as the following considerations will shew.

Let us suppose that the artery *A* is in a condition of normal tone, is midway between extreme constriction and dilation. The flow through *A* is determined by the resistance in *A*, and in the vascular tract which it supplies, in relation to the mean arterial pressure, which again is dependent on the way in which the heart is beating and on the peripheral resistance of all the small arteries and capillaries, *A* included. If, while the heart and the rest of the arteries remain unchanged, *A* be constricted, the peripheral resistance in *A* will increase, and this increase of resistance will lead to an increase of the general arterial pressure. Since, as we have seen, § 119, it is arterial pressure which is the immediate cause of the flow from the arteries to the veins, this increase of arterial pressure will tend to drive more blood from the arteries

into the veins. The constriction of *A* however, by increasing the resistance, opposes any increase of the flow through *A* itself, in fact will make the flow through *A* less than before. The whole increase of discharge from the arterial into the venous system will take place through the arteries in which the resistance remains unchanged, that is, through channels other than *A*. Thus, as the result of the constriction of any artery there occur, (1) diminished flow through the artery itself, (2) increased general arterial pressure, leading to (3) increased flow through the other arteries. If, on the other hand, *A* be dilated, while the heart and other arteries remain unchanged, the peripheral resistance in *A* is diminished. This leads to a lowering of the general arterial pressure, which in turn tends to drive less blood from the arteries into the veins. The dilation of *A* however, by diminishing the resistance, permits, even with the lowered pressure, more blood to pass through *A* itself than before. Hence the diminished flow tells all the more on the rest of the arteries in which the resistance remains unchanged. Thus, as the result of the dilation of any artery, there occur (1) increased flow of blood through the artery itself, (2) diminished general pressure, and (3) diminished flow through the other arteries. Where the artery thus constricted or dilated is small, the local effect, the diminution or increase of flow through itself, is much more marked than the general effects, the change in blood-pressure and the flow through other arteries. When, however, the area the arteries of which are affected is large, the general effects are very striking. Thus if while a tracing of the blood-pressure is being taken by means of a manometer connected with the carotid artery, the abdominal splanchnic nerves be divided, a conspicuous but steady fall of pressure is observed, very similar to but more marked than that which is seen in Fig. 60. The section of the abdominal splanchnic nerves causes the mesenteric and other abdominal arteries to dilate, and these being very numerous, a large amount of peripheral resistance is taken away, and the blood-pressure falls accordingly; a large increase of flow into the portal veins takes place, and the supply of blood to the face, arms, and legs is proportionally diminished. It will be observed that the dilation of the arteries is not instantaneous but somewhat gradual, as shewn by the pressure sinking not abruptly but with a gentle curve.

The general effects on blood-pressure by vaso-motor changes are so marked that the manometer may be used to detect vaso-motor actions. Thus, if the stimulation of a particular nerve or any other operation leads to a marked rise of the mean blood-pressure, unaccompanied by any changes in the heart-beat, we may infer that constriction has taken place in the arteries of some considerable vascular area; and similarly, if the effect be a fall of blood-pressure, we may infer that constriction has given way to dilation.

Vaso-motor Functions of the Central Nervous System.

§ 172. The central nervous system, to which we have traced the vaso-motor nerves, makes use of these nerves to regulate the flow of blood through the various organs and parts of the body; by the local effects thus produced it assists or otherwise influences the functional activity of this or that tissue; by the general effects it secures the well being of the body.

The use of the vaso-dilator nerves, which is more simple than that of the vaso-constrictors since it appears not to be complicated by the presence of habitual tonic influences, is frequently conspicuous as part of a reflex act. Thus, when food is placed in the mouth afferent impulses, generated in the nerves of taste, give rise in the central nervous system to efferent impulses, which descend the chorda tympani and other nerves to the salivary glands and, by dilating the blood vessels, secure a copious flow of blood through the glands while, as we shall see later on, they excite them to secrete. The centre of this reflex action appears to lie in the medulla oblongata and may be thrown into activity not only by impulses reaching it along the specific nerves of taste, but also by impulses passing along other channels; thus, emotions started in the brain by the sight of food or other things may give rise to impulses passing down along the central nervous system itself to the medulla oblongata, or events in the stomach may send impulses up the vagus nerve, or stimulation of one kind or another may send impulses up almost any sentient nerve, and these various impulses reaching the medulla may, by reflex action, throw into activity the vaso-dilator fibres of the chorda tympani and other analogous nerves, and bring about a flushing of the salivary glands, while at the same time they cause the glands to secrete.

The vaso-dilator fibres of the *nervi erigentes* may be thrown into activity in a similar reflex way, the centre in this case being placed in the lumbar or lower dorsal portion of the spinal cord, though it is easily thrown into activity by impulses descending down the spinal cord from the brain; that such a centre does exist is shewn by the fact that, when in a dog the spinal cord is completely divided in the dorsal region, erection of the penis may readily be brought about by stimulation of sentient surfaces. And other instances might be quoted in which vaso-dilator fibres appear to be connected with a 'centre' soon after their entrance into the nervous system.

If, as seems probable, § 167, the blood vessels of a muscle dilate by vaso-motor action whenever the muscle is thrown into contraction, either in a reflex or voluntary movement, the vaso-dilator fibres of the muscle would seem to be thrown into action by impulses arising in the spinal cord not far from the origin of

the ordinary motor impulses, and accompanying those motor impulses along the motor nerve.

§ 173. The case of the vaso-constrictor fibres is somewhat more complicated on account of the existence of tonic influences; since the same fibres may, on the one hand, by an increase in the impulses passing along them, be the means of constriction, and on the other hand, by the removal or diminution of the tonic influences passing along them, be the means of dilation. We have already traced all the vaso-constrictor fibres from the middle region of the spinal cord to the splanchnic system in the thorax and abdomen, from whence they pass (1) by the abdominal splanchnic and by the hypogastric nerves to the viscera of the abdomen and pelvis, (concerning the vaso-motor nerves of the thoracic viscera we know at present very little), (2) by the cervical sympathetic or cervical splanchnic, as it might be called, to the skin of the head and neck, the salivary glands and mouth, the eyes and other parts, and probably the brain including its membranes, (3) by the brachial and sciatic plexuses to the skin of the fore- and hind-limbs and by various other nerves to the skin of the trunk. The chief parts of the body supplied by vaso-constrictor fibres appear to be the skin with its appendages, and the alimentary canal with its appendages, glandular and other; the great mass of skeletal muscles appears to receive an insignificant supply of vaso-constrictor fibres, if any at all.

If now in an animal the spinal cord be divided in the lower dorsal region, the skin of the legs becomes flushed, their temperature frequently rises and there is a certain amount of fall in the general blood-pressure as measured, for instance, in the carotid; and this state of things may last for some considerable time. Obviously the section of the spinal cord has cut off the usual tonic influences descending to the lower limbs; in consequence the blood vessels have become dilated, in consequence the general peripheral resistance has become proportionately diminished, and in consequence the general blood-pressure has fallen. The tonic vaso-constrictor impulses for the lower limbs, therefore, have their origin in the central nervous system higher up than the lower dorsal region of the spinal cord.

If the spinal cord be divided between the roots of the 5th and 6th dorsal nerves, (that is to say, at the level where the path of the splanchnic fibres from the cord seems to divide, see Fig. 58, those issuing above passing upwards to the fore-limbs and head, and those issuing below passing to the abdomen and lower limbs), the cutaneous blood vessels of the lower limbs dilate, as in the former case, and on examination it will be found that the blood vessels of the abdomen are also largely dilated; at the same time the blood-pressure undergoes a very marked fall, it may indeed be reduced to a very few millimetres of mercury. Obviously the tonic vaso-constrictor impulses passing to the abdomen and to

the lower limbs take origin in the central nervous system higher up than the level of the 5th dorsal nerve.

If the section of the spinal cord be made above the level of the 2nd dorsal nerve, in addition to the above mentioned results, the vessels of the head and face also become dilated; but in consequence of the fall of general blood-pressure just mentioned, these vessels never become so full of blood, the loss of tone is not so obvious in them as after simple division of the cervical sympathetic, since the latter operation produces little or no effect on the general blood-pressure.

Obviously then the tonic vaso-constrictor impulses, which passing to the skin and viscera of the body maintain that tonic narrowing of so many small arteries by which the general peripheral resistance, and so the general blood-pressure, is maintained, proceed from some part of the central nervous system higher up than the upper dorsal region of the spinal cord. And, since exactly the same results follow upon section of the spinal cord in the cervical region right up to the lower limit of the medulla oblongata, we infer that these tonic impulses proceed from the medulla oblongata.

On the other hand we may remove the whole of the brain right down to the upper parts of the medulla, and yet produce no flushing, or only a slight transient flushing, of any part of the body and no fall at all, or only a slight transient fall, of the general blood-pressure. We therefore seem justified in assuming the existence in the medulla oblongata of a nervous centre, which we may speak of as a *vaso-motor centre*, or the *medullary vaso-motor centre*, from which proceed tonic vaso-constrictor impulses, or which regulates the emission and distribution of such tonic vaso-constrictor impulses or influences over various parts of the body.

§ 174. The existence of this vaso-motor centre may moreover be shewn in another way. The extent or amount of the tonic constrictor impulses proceeding from it may be increased or diminished, the activity of the centre may be augmented or inhibited, by impulses reaching it along various afferent nerves; and provided no marked changes in the heart-beat take place at the same time, a rise or fall of general blood-pressure may be taken as a token of an increase or decrease of the activity of the centre.

In the rabbit there is found in the neck, lying side by side with the cervical sympathetic nerve and running for some distance in company with it, a slender nerve which may be ultimately traced down to the heart, and which if traced upwards is found to come off somewhat high up from the vagus, by two or more roots, one of which is generally a branch of the superior laryngeal nerve. This nerve (the fibres constituting which are in the dog bound up with the vagus, and do not form an independent nerve) appears to be exclusively an afferent nerve; when after division of the nerve the peripheral end, the end still in connection with the

heart, is stimulated no marked results follow. The beginnings of the nerve in the heart are therefore quite different from the endings of the inhibitory fibres of the vagus, or of the augmentor fibres of the splanchnic (sympathetic) system; the nerve has nothing to do with the nervous regulation of the heart treated of in Sec. 5. If now while the pressure in an artery such as the carotid is being registered, the central end of the nerve (*i.e.* the one connected with the brain) be stimulated with the interrupted current, a gradual but marked fall of pressure (Fig. 60)

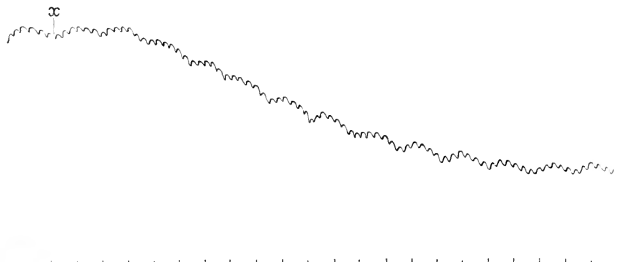

FIG. 60. TRACING, SHEWING THE EFFECT ON BLOOD-PRESSURE OF STIMULATING THE CENTRAL END OF THE DEPRESSOR NERVE IN THE RABBIT.

On the time marker below the intervals correspond to seconds. At *x* an interrupted current was thrown into the nerve.

in the carotid is observed, lasting, when the period of stimulation is short, some time after the removal of the stimulus. Since the beat of the heart is not markedly changed, the fall of pressure must be due to the diminution of peripheral resistance occasioned by the dilation of some arteries. And it is probable that the arteries thus dilated are chiefly if not exclusively those arteries of the abdominal viscera which are governed by the abdominal splanchnic nerves; for if these nerves are divided on both sides previous to the experiment, the fall of pressure when the nerve is stimulated is very small, in fact almost insignificant. The inference we draw is as follows. The afferent impulses passing upwards along the nerve in question have so affected some part of the central nervous system that the influences which, in a normal condition of things, passing along the abdominal splanchnic nerves keep the minute arteries of the abdominal viscera in a state of moderate tonic constriction, fail altogether, and those arteries in consequence dilate just as they do when the abdominal splanchnic nerves are divided, the effect being possibly increased by the similar dilation of other vascular areas. Since stimulation of the nerve of which we are speaking always produces a fall, never a rise of blood-pressure, the amount of fall of course being dependent on circumstances, such as the condition of the nervous system, state of

blood-pressure &c., the nerve is known by the name of the depressor nerve. As we shall point out later on, by means of this afferent nerve from the heart the peripheral resistance is, in the living body, lowered to suit the weakened powers of a labouring heart.

This gradual lowering of blood-pressure by diminution of peripheral resistance affords a marked contrast to the sudden lowering of blood-pressure by cardiac inhibition; compare Fig. 60 with Fig. 56.

§ 175. But the general blood-pressure may be modified by afferent impulses passing along other nerves than the depressor, the modification taking on, according to circumstances, the form either of decrease or of increase.

Thus, if in an animal placed under the influence of urari (some anesthetic other than chloral &c. being used) the central stump of the divided sciatic nerve be stimulated, an increase of blood-pressure (Fig. 61) almost exactly the reverse of the

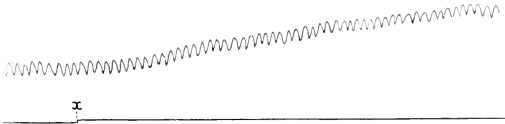

FIG. 61. EFFECT ON BLOOD-PRESSURE CURVE OF STIMULATING SCIATIC NERVE UNDER URARI (Cat).

x marks the moment in which the current was thrown into the nerve. Artificial respiration was carried on, and the usual respiratory undulations are absent.

decrease brought about by stimulating the depressor, is observed. The curve of the blood-pressure, after a latent period during which no changes are visible, rises steadily without any corresponding change in the heart's beat, reaches a maximum and after a while slowly falls again, the fall sometimes beginning to appear before the stimulus has been removed. There can be no doubt that the rise of pressure is due to the constriction of certain arteries; the arteries in question being those of the abdominal splanchnic area certainly, and possibly those of other vascular areas as well. The effect is not confined to the sciatic; stimulation of any nerve containing afferent fibres may produce the same rise of pressure, and so constant is the result that the experiment has been made use of as a method for determining the existence of afferent fibres in any given nerve and even the paths of centripetal impulses through the spinal cord.

If, on the other hand, the animal be under the influence not of urari but of a large dose of chloral, instead of a rise of blood-pressure a fall, quite similar to that caused by stimulating the depressor, is observed when an afferent nerve is stimulated.

The condition of the central nervous system seems to determine whether the effect of afferent impulses on the central nervous system is one leading to an augmentation of vaso-constrictor impulses and so to a rise, or one leading to a diminution of vaso-constrictor impulses and so to a fall of blood-pressure.

§ 176. We have used the words 'central nervous system' in speaking of the above; we have evidence however that the part of the central nervous system acted on by the afferent impulses is the vaso-motor centre in the medulla oblongata, and that the effects in the way of diminution (depressor) or of augmentation (pressor) are the results of afferent impulses inhibiting or augmenting the tonic activity of this centre or of a part of this centre especially connected with the abdominal splanchnic nerves. The whole brain may be removed right down to the medulla oblongata, and yet the effects of stimulation in the direction either of diminution or of augmentation may still be brought about. If the medulla oblongata be removed, these effects vanish too, though all the rest of the nervous system be left intact. Nay, more, by partially interfering with the medulla oblongata, we may partially diminish these effects and thus mark out, so to speak, the limits of the centre in question within the medulla itself. Thus, in an intact animal under urari, stimulation of the sciatic nerve with a stimulus of a certain strength will produce a rise of blood-pressure up to a certain extent. After removal of the whole brain right down to the medulla oblongata, the same stimulation will produce the same rise as before; the vaso-motor centre has not been interfered with. Directly, however, in proceeding downwards, the region of the centre in question is reached, stimulation of the sciatic produces less and less rise, until at last when the lower limit of the centre is arrived at no effect at all on blood-pressure can be produced by even strong stimulation of the sciatic or other afferent nerve. In this way the lower limit of the medullary vaso-motor centre has been determined in the rabbit at a horizontal line drawn about 4 or 5 mm. above the point of the calamus scriptorius, and the upper limit at about 4 mm. higher up, *i.e.* about 1 or 2 mm. below the corpora quadrigemina. When transverse sections of the brain are carried successively lower and lower down, an effect on blood-pressure in the way of lowering it and also of diminishing the rise of blood-pressure resulting from stimulation of the sciatic, is first observed when the upper limit is reached. On carrying the sections still lower, the effect of stimulating the sciatic become less and less, until when the lower limit is reached no effects at all are observed. The centre appears to be bilateral, the halves being placed not in the middle line but more sideways and rather nearer the anterior than the posterior surface. It may perhaps be more closely defined as a small prismatic space in the forward prolongation of the lateral columns after they have given off their fibres to the decussating

pyramids. This space is largely occupied by a mass of grey matter, called by Clarke the antero-lateral nucleus, and containing large multipolar cells; but it is by no means certain that this group of nerve cells really acts as the centre in question.

§ 177. The above experiments appear to afford adequate evidence that, in a normal state of the body, the integrity of the medullary vaso-motor centre is essential to the production and distribution of those continued constrictor impulses by which the general arterial tone of the body is maintained, and that an increase or decrease of vaso-constrictor action in particular arteries, or in the arteries generally, is brought about by means of the same medullary vaso-motor centre. But we must not therefore conclude that this small portion of the medulla oblongata is the only part of the central nervous system which can act as a centre for vaso-constrictor fibres; and, as we have seen, there is no evidence at present that the vaso-dilator fibres are connected with either this or any other one centre. In the frog reflex vaso-motor effects may be obtained by stimulating various afferent nerves after the whole medulla has been removed, and indeed even when only a comparatively small portion of the spinal cord has been left intact and connected, on the one hand, with the afferent nerve which is being stimulated and, on the other, with the efferent nerves in which run the vaso-motor fibres whose action is being studied. In the mammal such effects do not so readily appear, but may with care and under special conditions be obtained. Thus in the dog, when the spinal cord is divided in the dorsal region, the arteries of the hind limbs and hinder part of the body, as we have already said, § 172, become dilated. This one would naturally expect as the result of their severance from the medullary vaso-motor centre. But if the animal be kept in good condition for some time, a normal or nearly normal arterial tone is after a while re-established; and the tone thus regained may, by afferent impulses reaching the cord below the section, be modified in the direction certainly of diminution, *i.e.* dilation, and possibly, but this is by no means so certain, of increase, *i.e.* constriction; dilation of various cutaneous vessels of the limbs may be readily produced by stimulation of the central stump of one or another nerve.

These remarkable results, which though they are most striking in connection with the lower part of the spinal cord hold good apparently for other parts also of the spinal cord, naturally suggest a doubt whether the explanation just given above of the effects of section of the medulla oblongata is a valid one. When we come to study the central nervous system, we shall again and again see that the immediate effect of operative interference with these delicate structures is a temporary suspension of nearly all their functions. This is often spoken of as 'shock' and may be regarded as an extreme form of inhibition. An example of it occurs in the above experiment of section of the dorsal cord. For some

time after the operation the vaso-dilator nervi erigentes (which as far as we know have no special connection with the medullary vaso-motor centre) cannot be thrown into activity as part of a reflex action; their centre remains for some time inactive. After a while however it recovers, and erection of the penis through the nervi erigentes may then still be brought about by suitable stimulation of sensory surfaces. Hence the question may fairly be put whether the effects of cutting and injuring the structures which we have spoken of as the medullary vaso-motor centre, are not in reality simply those of shock, whether the vascular dilation which follows upon sections of the so-called medullary vaso-motor centre, does not come about because section of or injury to this region exercises a strong inhibitory influence on all the vaso-motor centres situated in the spinal cord below. Owing to the special function of the medulla oblongata in carrying on the all-important work of respiration, a mammal whose medulla has been divided cannot be kept alive for any length of time. We cannot therefore put the matter to the simple experimental test of extirpating the supposed medullary vaso-motor centre and seeing what happens when the animal has completely recovered from the effects of the operation: we have to be guided in our decision by more or less indirect arguments. And against the argument that the effects are those of shock, we may put the argument, evidence for which we shall meet with in dealing with the central nervous system, that when one part of the central nervous system is removed or in any way placed *hors de combat*, another part may vicariously take on its function; in the absence of the medullary vaso-motor centre, its function may be performed by other parts of the spinal cord which in its presence do no such work.

And we may, in connection with this, call attention to the fact that the dilation or loss of tone which follows upon section of the cervical sympathetic (and the same is true of the abdominal splanchnic) is not always, though it may be sometimes, permanent; in a certain number of cases it has been found that after a while, it may be not until after several days, the dilation disappears and the arteries regain their usual calibre; on the other hand in some cases no such return has been observed after months or even years. This recovery when it occurs cannot always be attributed to any regeneration of vaso-motor fibres in the sympathetic, for it is stated to have been observed when the whole length of the nerve including the superior cervical ganglion had been removed. When recovery of tone has thus taken place, dilation or increased constriction may be occasioned by local treatment: the ear may be made to blush or to pale by the application of heat or cold, by gentle stroking or rough handling and the like; but neither the one nor the other condition can be brought about by the intervention of the central nervous system. So also the spontaneous rhythmic variations in the calibre of the arteries of

the ear of which we spoke, though they cease for a time after division of the cervical sympathetic, may in some cases eventually reappear and that even if the superior cervical ganglion be removed; in other cases they do not. And the analogous rhythmic variations of the veins of the bat's wing have been proved experimentally to go on vigorously when all connection with the central nervous system has been severed; they may continue in fact in isolated pieces of the wing provided that the vessels are adequately filled and distended with blood or fluid. From these and other facts, even after making allowance for the negative cases, we may conclude that what we have spoken of as the tone of the vessels of the face, though influenced by and in a measure dependent on the central nervous system, is not simply the result of an effort of that system. The muscular walls of the arteries are not mere passive instruments worked by the central nervous system through the vaso-motor fibres; they appear to have an intrinsic tone of their own, and it seems natural to suppose that when the central nervous system causes dilation or constriction of the vessels of the face, it makes use, in so doing, of this intrinsic local tone. It has been supposed that this intrinsic tone is dependent on some local nervous mechanism; in the ear at least no such mechanism has yet been found; and indeed, as we said above, § 167, no such peripheral nervous mechanism is really necessary. In the case both of a vessel governed by vaso-dilator fibres and one governed by vaso-constrictor fibres, we may suppose a certain natural condition of the muscular fibres which we may call a condition of equilibrium. In a vessel governed only by vaso-dilator fibres, if there be such, this condition of equilibrium is the permanent condition of the muscular fibre, from which it is disturbed by vaso-dilator impulses, but to which it speedily returns. In a vessel governed by vaso-constrictor fibres, and subject to tone, the muscular fibre is habitually kept on the constrictor side of this equilibrium, and, as in the cases quoted above, may strive of itself towards some amount of active constriction even when separated from the central nervous system.

But to return to the medullary vaso-motor centre. Without attempting to discuss the matter fully we may say that, after all due weight has been attached to the play of inhibitory impulses or 'shock' as the result of operative interference, there still remains a balance of evidence in favour of the view that the region of the medulla of which we are speaking does really act as a general vaso-motor centre in the manner previously explained, and plays an important part in the vaso-motor regulation of the living body.

It is not however to be regarded as the single vaso-motor centre, whence alone can issue tonic constrictor impulses or whither afferent impulses from all parts of the body must always travel before they can affect the vaso-motor impulses

passing along this or that nerve. We are rather to suppose that the spinal cord along its whole length contains, interlaced with the reflex and other mechanisms by which the skeletal muscles are governed, vaso-motor centres and mechanisms of varied complexity, the details of whose functions and topography have yet largely to be worked out; and though as we have seen the medullary centre is essentially a centre of impulses issuing along vaso-constrictor fibres, it is possible that there are ties between it and vaso-dilator fibres also. As in the absence of the sinus venosus the auricles and ventricle of the frog's heart may still continue to beat, so in the absence of the medulla oblongata these spinal vaso-motor centres provide for the vascular emergencies which arise. As however in the normal entire frog's heart, the sinus, so to speak, gives the word and governs the work of the whole organ, so the medullary vaso-motor centre rules and co-ordinates the lesser centres of the cord, and through them presides over the chief vascular areas of the body. By means of these vaso-motor central mechanisms, by means of the head centre in the medulla, and the subsidiary centres in the spinal cord, the delicate machinery of the circulation, which determines the blood supply, and so the activity of each tissue and organ, is able to respond by narrowing or widening arteries to the ever-varying demands and to meet by compensating changes the shocks and strains of daily life.

§ 178. We may sum up the history of vaso-motor actions somewhat as follows.

All, or nearly all, or as far as we know all the arteries of the body are connected with the central nervous system by nerve fibres, called vaso-motor fibres, the action of which varies the amount of contraction of the muscular coats of the arteries and so leads to changes in calibre. The action of these vaso-motor fibres is more manifest, and probably more important in the case of small and minute arteries than in the case of large ones.

These vaso-motor fibres are of two kinds. The one kind, vaso-constrictor fibres, are of such a nature or have such connections at their central origin or peripheral endings that stimulation of them produces narrowing, constriction of the arteries; and during life these fibres appear to be the means by which the central nervous system exerts a continued tonic influence on the arteries and maintains an arterial 'tone.' The other kind, vaso-dilator fibres, are of such a kind, or have such connections, that stimulation of them produces widening, dilation of the arteries. There is no adequate evidence that these vaso-dilator fibres serve as channels for tonic dilating impulses or influences.

The vaso-constrictor fibres leave the spinal cord by the anterior roots of the nerves coming from middle regions of the spinal cord only (in the dog, and probably in other mammals, from about the second dorsal to the second lumbar nerve), pass into the splanchnic

ganglia connected with those nerves (thoracic and abdominal chain of sympathetic ganglia), where the fibres lose their medulla, and proceed to their destination as non-medullated fibres either still in so-called sympathetic nerves, such as splanchnic, cervical sympathetic, hypogastric &c., or along recurrent branches of the splanchnic system to join the spinal nerves of the arm, leg and trunk.

In the intact organism the emission and distribution along these vaso-constrictor fibres of tonic constrictor impulses, by which general and local arterial tone is maintained and regulated, is governed by a limited portion of the medulla oblongata known as the medullary vaso-motor centre; and when some change of conditions or other natural stimulus brings about a change in the activity of the vaso-constrictor fibres of one or more vascular areas, or of all the arteries supplied with vaso-constrictor fibres, this same medullary vaso-motor centre appears in such cases to play the part of a centre of reflex action. Nevertheless, in cases where the nervous connections of this medullary vaso-motor centre with a vascular area are cut off by an operation, as by section of the cord, other parts of the spinal cord may act as centres for the vaso-constrictor fibres of the area, and possibly these subordinate centres may be to a certain extent in action in the intact organism.

The vaso-dilator fibres appear to take origin in various parts of the central nervous system and to proceed in a direct course to their destination along the (anterior) roots and as part of the trunks and branches of various cerebro-spinal nerves; they do not lose their medulla until they approach their termination. They do not appear to serve as channels of tonic dilating influences; they are thrown into action generally as part of a reflex action, and their centre, in the reflex act, appears in each case to lie in the central nervous system not far from the centre of the ordinary motor fibres which they accompany.

The effects of the activity of the vaso-dilator fibres appear to be essentially local in nature; when any set of them come into action the vascular area which these govern is dilated. And the vascular areas so governed are relatively so small that changes in them produce little or no effect on the vascular system in general.

The effects of changes in the activity of the vaso-constrictor fibres are both local and general, and may be also double in nature. By an inhibition of tonic constrictor impulses a certain amount of dilation may be effected; by an augmentation of constrictor impulses, constriction, it may be of considerable extent, may be brought about. When the vascular area so affected is small the effects are local, more or less blood is distributed through the area; when the vascular area affected is large, the inhibition of constriction may lead to a marked fall, and an augmentation of constriction to a marked rise of general blood-pressure.

§ 179. We shall have occasion later on again and again to point out instances of the effects of vaso-motor action both local and

general, but we may here quote one or two characteristic ones. "Blushing" is one. Nervous impulses started in some parts of the brain by an emotion produce a powerful inhibition of that part of the medullary vaso-motor centre which governs the vascular areas of the head supplied by the cervical sympathetic, and hence has an effect on the vaso-motor fibres of the cervical sympathetic almost exactly the same as that produced by section of the nerve. In consequence the muscular walls of the arteries of the head and face relax, the arteries dilate and the whole region becomes suffused. Sometimes an emotion gives rise not to blushing, but to the opposite effect, viz. to pallor. In a great number of cases this has quite a different cause, being due to a sudden diminution or even temporary arrest of the heart's beats; but in some cases it may occur without any change in the beat of the heart, and is then due to a condition the very converse of that of blushing, that is, to an increased arterial constriction; and this increased constriction, like the dilation of blushing, is effected through the agency of the central nervous system and the cervical sympathetic.

The vascular condition of the skin at large affords another instance. When the temperature of the air is low, the vessels of the skin are constricted, and the skin is pale; when the temperature of the air is high the vessels of the skin are dilated and the skin is red and flushed. In both these cases the effect is mainly a reflex one, it being the central nervous system which brings about augmentation of constriction in the one case and inhibition in the other; though possibly some slight effect is produced by the direct action of the cold or heat on the vessels of the skin simply. Moreover the vascular changes in the skin are accompanied by corresponding vascular changes in the viscera (chiefly abdominal) of a reverse kind. When the vessels of the skin are dilated those of the viscera are constricted, and vice versa; so that a considerable portion of the whole blood ebbs and flows, so to speak, according to circumstances from skin to viscera and from viscera to skin. By these changes, as we shall see later on, the maintenance of the normal temperature of the body is in large measure secured.

When food is placed in the mouth the blood vessels of the salivary glands as we have seen are flushed with blood as an adjuvant to the secretion of digestive fluid; and as the food passes along the alimentary canal each section in turn, with the glandular appendages belonging to it, welcomes its advent by flushing with blood, the dilation being sometimes, as in the case of the salivary gland, the result of the activity chiefly of vaso-dilator fibres, but sometimes the result of the cessation of constrictor impulses and sometimes the result of the two combined. So also when the kidney secretes urine, its vessels become dilated, and in general, wherever functional activity comes into play, the metabolism of tissue which is the basis of that activity is assisted by a more generous flow of blood through the tissue.

§ 180. *Vaso-motor nerves of the Veins.* Although the veins are provided with muscular fibres and are distinctly contractile, and although rhythmic variations of calibre due to contractions may be seen in the great veins opening into the heart, in the veins of the bat's wing, and elsewhere, and similar rhythmic variations, also possibly due to active rhythmic contractions, but possibly also of an entirely passive nature, have been observed in the portal veins, very little is known of any nervous arrangements governing the veins. When in the frog the brain and spinal cord are destroyed, very little blood comes back to the heart as compared with the normal supply, and the heart in consequence appears almost bloodless and beats feebly. This has been by some regarded as more than can be accounted for by mere loss of arterial tone, and accordingly interpreted as indicating the existence of a normal tone in the veins dependent on the central nervous system. When the latter is destroyed, the veins become abnormally distended and a large quantity of blood becomes lodged and hidden as it were in them.

SEC. 7. THE CAPILLARY CIRCULATION.

§ 181. We have already some time back (§ 117) mentioned some of the salient features of the circulation through the capillaries, viz., the difficult passage of the corpuscles (generally in single file, though sometimes in the larger channels two or more abreast) and plasma through the narrow channels, in a stream which though more or less irregular is steady and even, not broken by pulsations, and slower than that in either the arteries or the veins. We have further seen (§ 106) that the capillaries vary very much in width from time to time; and there can be no doubt that the changes in their calibre are chiefly of a passive nature. They are expanded when a large supply of blood reaches them through the supplying arteries, and, by virtue of their elasticity, shrink again when the supply is lessened or withdrawn; they may also become expanded by an obstacle to the venous outflow.

On the other hand, as we have also stated, there is a certain amount of evidence that, in young animals at all events, the calibre of a capillary canal may vary, quite independently of the arterial supply or the venous outflow, in consequence of changes in the form of the epithelioid cells, allied to the changes which in a muscle-fibre or muscle-cell constitute a contraction; and though the matter requires further investigation, it is possible that these active changes play an important part in determining the quantity of blood passing through a capillary area; but there is as yet no satisfactory evidence that they, like the corresponding changes in the arteries, are governed by the nervous system.

Over and above these changes of form, the capillaries and minute vessels are subject to changes and exert influences by virtue of which they play an important part in the work of the circulation. Their condition determines the amount of resistance offered by their channels to the flow of blood through those channels, and determines the amount and character of that inter-

change between the blood and the tissues which is the main fact of the circulation.

If the web of the frog's foot, or better still if some transparent tissue of a mammal be watched under the microscope, it will be observed that, while in the small capillaries the corpuscles are pressed through the channel in single file, one after the other, each corpuscle as it passes occupying the whole bore of the capillary, in the larger capillaries (of the mammal), and especially in the small arteries and veins which permit the passage of more than one corpuscle abreast, the red corpuscles run in the middle of the channel, forming a coloured core, between which and the sides of the vessels all round is a colourless layer, containing no red corpuscles, called the 'plasmatic layer' or 'peripheral zone.' This division into a peripheral zone and an axial stream is due to the fact that in any stream passing through a closed channel the friction is greatest at the sides, and diminishes towards the axis. The corpuscles pass where the friction is least, in the axis. A quite similar axial core is seen when any fine particles are driven with a sufficient velocity in a stream of fluid through a narrow tube. As the velocity is diminished the axial core becomes less marked and disappears.

In the peripheral zone, especially in that of the veins, are frequently seen white corpuscles, sometimes clinging to the sides of the vessel, sometimes rolling slowly along, and in general moving irregularly, stopping for a while and then suddenly moving on. The greater the velocity of the flow of blood, the fewer the white corpuscles in the peripheral zone, and with a very rapid flow they, as well as the red corpuscles, may be all confined to the axial stream. The presence of the white corpuscles in the peripheral zone has been attributed to their being specifically lighter than the red corpuscles, since when fine particles of two kinds, one lighter than the other, are driven through a narrow tube, the heavier particles flow in the axis and the lighter in the more peripheral portions of the stream. But, besides this, the white corpuscles have a greater tendency to adhere to surfaces than have the red, as is seen by the manner in which the former become fixed to the glass slide and cover-slip when a drop of blood is mounted for microscopical examination. They probably thus adhere by virtue of the amœboid movements of their protoplasm, so that the adhesion is to be considered not so much a mere physical as a physiological process, and hence may be expected to vary with the varying nutritive conditions of the corpuscles and of the blood vessels. Thus while the appearance of the white corpuscles in the peripheral zone may be due to their lightness, their temporary attachment to the sides of the vessels and characteristic progression is the result of their power to adhere; and as we shall presently see their amœboid movements may carry them on beyond mere adhesion.

§ 182. These are the phenomena of the normal circulation, and may be regarded as indicating a state of equilibrium between the blood on the one hand and the blood vessels with the tissues on the other; but a different state of things sets in when that equilibrium is overthrown by causes leading to what is called inflammation or to allied conditions.

If an irritant, such as a drop of chloroform or a little diluted oil of mustard, be applied to a small portion of a frog's web, tongue, mesentery, or some other transparent tissue, the following changes may be observed under the microscope; they may also be seen in the mesentery or other transparent tissue of a mammal. The first effect that is noticed is a dilation of the arteries, accompanied by a quickening of the stream. The irritant, probably by a direct action on the muscular fibres of the arteries, has led to a relaxation of the muscular coat and hence to a widening; and we have already, § 123, explained how such a widening in a small artery may lead to a temporary quickening of the stream. In consequence of the greater flow through the arteries, the capillaries become filled with corpuscles, and many passages, previously invisible or nearly so on account of their containing no corpuscles, now come into view. The veins at the same time appear enlarged and full. If the stimulus be very slight, this may all pass away, the arteries gaining their normal constriction, and the capillaries and veins returning to their normal condition; in other words, the effect of the stimulus in such a case is simply a temporary blush. Unless however the chloroform or mustard be applied with especial care the effects are much more profound, and a series of remarkable changes sets in.

In the normal circulation, as we have just said, white corpuscles may be seen in the peripheral, plasmatic zone, but they are scanty in number, and each one after staying for a little time in one spot suddenly gets free, sometimes almost by a jerk as it were, and then rolls on for a greater or less distance. In the area now under consideration a large number of white corpuscles soon gather in the peripheral zones, especially of the veins and venous capillaries, (that is of the larger capillaries which are joining to form veins), but also, to a less extent, of the arteries; and this takes place although the vessels still remain dilated and the stream still continues rapid though not so rapid as at first. Each white corpuscle appears to exhibit a greater tendency to stick to the sides of the vessels, and though driven away from the arteries by the stronger arterial stream, becomes lodged so to speak in the veins. Since new white corpuscles are continually being brought by the blood stream on to the scene, the number of them in the peripheral zones of the veins increases more and more, and this may go on until the inner surface of the veins and venous capillaries appears to be lined with a layer of white corpuscles. The small capillaries too contain more white corpuscles than

usual, and even in the arteries these are abundant, though not forming the distinct layer seen in the veins. The white corpuscles however are not the only bodies present in the peripheral zone. Though in the normal circulation blood-platelets (see § 33) cannot be seen in the peripheral zone, and hence must be confined (on the view, which has the greater support, that these bodies are really present in quite normal blood) to the axial stream, they make their appearance in that zone with the changes which we are now describing. Indeed in many cases they are far more abundant than the white corpuscles, the latter appearing imbedded at intervals in masses of the former. Soon after their appearance the individual platelets lose their outline and run together into formless masses.

§ 183. This much, the appearance of numerous white corpuscles and platelets in the peripheral zones, may take place while the stream, though less rapid than at the very first, still remains rapid; so rapid at all events that, owing to the increased width of the passages, in spite of the obstruction offered by the adherent white corpuscles, the total quantity of blood flowing in a given time through the inflamed area is greater than normal. But soon, though the vessels still remain dilated, the stream is observed most distinctly to slacken and then a remarkable phenomenon makes its appearance. The white corpuscles lying in contact with the walls of the veins or of the capillaries are seen to thrust processes through the walls; and, the process of a corpuscle increasing at the expense of the rest of the body of the corpuscle, the whole corpuscle, by what appears to be an example of amoeboid movement, makes its way through the wall of the vessel into the lymph space outside; the perforation appears to take place either in the cement substance joining the epithelioid plates together, or, possibly, by an actual breach through the substance of a plate, the breach being repaired immediately after the passage of the corpuscle. This is the migration of the white corpuscles to which we alluded in § 32, and takes place chiefly in the veins and capillaries, not at all or to a very slight extent in the arteries. Through this migration the lymph spaces around the vessels in the inflamed area become crowded with white corpuscles. At the same time the lymph in the same spaces not only increases in amount but changes somewhat in its chemical characters; it becomes more distinctly and readily coagulable, and is sometimes spoken of as "exudation fluid" or by the older writers as "coagulable lymph." This turgescence of the lymph spaces, together with the dilated crowded condition of the blood vessels, gives rise to the swelling which is one of the features of inflammation.

If the inflammation now passes off the white corpuscles cease to emigrate, cease to stick for any length of time to the sides of the vessels, the stream of blood through the vessels quickens again, and the vessels themselves, though they may remain for a long time

dilated, eventually regain their calibre, and a normal circulation is re-established. The migrated corpuscles move away from the region, along the labyrinth of lymph spaces, and the surplus lymph also passes away along the lymph spaces and lymphatic vessels.

§ 184. The condition of things however instead of passing off may go on to a further stage. More and more white corpuscles, arrested in their passage, crowd the channels and block the way, so that though the vessels remain dilated the stream becomes slower and slower, until at last it stops altogether and "stagnation" or "stasis" sets in. The red corpuscles are driven in, often in masses, among the white corpuscles and platelets, the distinction between axial stream and peripheral zone becoming lost; and arteries, veins and capillaries, all distended, sometimes enormously so, are filled with a mass of mingled red and white corpuscles and platelets. When actual stagnation occurs the red corpuscles run together so that their outlines are no longer distinguishable; they appear to become fused into a homogeneous red mass. And it may now be observed that, not only white corpuscles but also red corpuscles, make their way through the distended and altered walls of the capillaries, chiefly, at all events, at the junctions of the epithelioid plates, into the lymph spaces beyond. This is spoken of as the *diapedesis* of the red corpuscles.

This latter 'stagnation' stage of inflammation may be the prelude to further mischief and indeed to the death of the inflamed tissue, but it too like the earlier stages may pass away. As it passes away the outlines of the corpuscles become once more distinct, those on the venous side of the block gradually drop away into the neighbouring currents, little by little the whole obstruction is removed, and the current through the area is re-established.

The slowing and final arrest of the blood current described above is not due to any lessening of the heart's beat; the arterial pulsations, or at least the arterial flow, may be seen to be continued in full force down to the affected area, and there to cease very suddenly. It is not due to any constriction of the small arteries increasing the peripheral resistance, for these continue dilated, sometimes exceedingly so. It must therefore be due to some new and unusual resistance occurring in the area itself, and there can be no doubt that this is to be found in an increased tendency of the corpuscles, especially of the white corpuscles, to stick to the sides of the vessels. The increase of adhesiveness is not caused by any change confined to the corpuscles themselves; for if after a temporary delay one set of corpuscles has managed to pass away from the affected area, the next set of corpuscles brought to the area in the blood stream is subjected to the same delay and the same apparent fusion. The cause of the increased adhesiveness must therefore lie in the walls of the blood vessels or in the tissue of which these form a part. That the increased adhesion is due to the vascular walls and not primarily to the corpuscles themselves

is further shewn by the fact that if in the frog, an artificial blood of normal saline solution to which milk has been added be substituted for normal blood, a stasis may by irritants be induced in which oil-globules play the part of corpuscles, and by their aggregation bring about an arrest of the flow.

We are driven to conclude that there exist in health certain relations between the blood on the one hand and the walls of the vessels on the other, by which the tendency of the corpuscles to adhere to the blood vessels is kept within certain limits; these relations consequently determine the normal flow, with its axial stream and peripheral zone, and the normal amount of peripheral resistance; in inflammation, these relations, in a manner we cannot as yet fully explain, are disturbed so that the tendency of the corpuscles to adhere to the sides of the vessels is largely and progressively increased. Hence the tarrying of the corpuscles in spite of the widening of their path, and finally their agglomeration and fusion in the distended channels.

We may add that the changes occurring in the vascular walls also at least facilitate the migration of the corpuscles, and modify the passage from the blood to the tissue of the fluid parts of the blood, the lymph of inflamed areas being richer in proteids than normal lymph.

We must not however pursue this subject of inflammation any further. We have said enough to shew that the peripheral resistance (and consequently all that depends on that peripheral resistance) is not wholly determined by the varying width of the minute passages but is also dependent on the vital condition of the tissue of which the walls of the passages form a part. When the tissue is in health, a certain resistance is offered to the passage of blood through the capillaries and other minute vessels, and the whole vascular mechanism is adapted to overcome this resistance to such an extent that a normal circulation can take place. When the tissue becomes affected, the disturbance of the relations between the tissue and the blood may, as in the later stages of inflammation, so augment the resistance that the passage of the blood becomes at first difficult and ultimately impossible. And it is quite open to us to suppose that under certain circumstances the reverse of the above may occur in this or that area, conditions in which the resistance may be lowered below the normal, and the circulation in the area quickened. Thus the vital condition of the tissue becomes a factor in the maintenance of the circulation; and it is possible, though not yet proved, that these vital conditions are directly under the dominion of the nervous system.

§ 185. Changes in the peripheral resistance may also be brought about by changes in the character of the blood, especially by changes in the relative amount of gases present. When a stream of defibrinated blood is artificially driven through a

perfectly fresh excised organ such as the kidney, it is found that the resistance to the flow of blood through the organ, measured for instance by the amount of outflow in relation to the pressure exerted, varies considerably owing to changes taking place in the organ, and may be increased by increasing the venous character and diminished by increasing the arterial character of the blood. Remarkable changes in the resistance are also brought about by the addition of small quantities of certain drugs such as chloral, atropin &c. to the blood.

These changes have been attributed to the altered blood acting on the walls of the vessels, inducing for instance constriction or widening of the small arteries, or it may be affecting the capillaries, for it has been asserted that the epithelioid plates of the capillaries vary in form according to the relative quantities of carbonic acid and oxygen present in the blood. But this is not the whole explanation of the matter, since similar variations in resistance are met with when blood is driven through fine capillary tubes of inert matter. In such experiments it is found that the resistance to the flow increases with a diminution of the oxygen carried by the red corpuscles, and is modified by the addition to the blood of even small quantities of certain drugs.

It is obvious then that in the living body the peripheral resistance, being the outcome of complex conditions, may be modified in many ways. Experiment teaches us that, even in dealing with non-living inert matter, the flow of fluid through capillary tubes may be modified on the one hand by changes in the substance of which the tubes are composed, and on the other hand by changes in the chemical nature (even independent of the specific gravity) of the fluid which is used. In the living body both the fluid, the blood, and the walls of the minute vessels, being both alive, are incessantly subject to change; the changes in the one moreover are capable of reacting upon and inducing changes in the other; and, lastly, the changes both of the one and of the other may be primarily set going by events taking place in some part of the body far away from the region in which these changes are modifying the resistance to the flow.

SEC. 8. CHANGES IN THE QUANTITY OF BLOOD.

§ 186. In an artificial scheme, changes in the total quantity of fluid in circulation will have an immediate and direct effect on the arterial pressure, increase of the quantity heightening and decrease diminishing it. This effect will be produced partly by the pump being more or less filled at each stroke, and partly by the peripheral resistance being increased or diminished by the greater or less fulness of the small peripheral channels. The venous pressure will under all circumstances be raised with the increase of fluid, but the arterial pressure will be raised in proportion only so long as the elastic walls of the arterial tubes are able to exert their elasticity.

In the natural circulation, the direct results of change of quantity are modified by compensatory arrangements. Thus experiment shews that when an animal with normal blood-pressure is bled from one carotid, the pressure in the other carotid sinks so long as the bleeding is going on¹, and remains depressed for a brief period after the bleeding has ceased. In a short time however it regains or nearly regains the normal height. This recovery of blood-pressure, after hæmorrhage, is witnessed so long as the loss of blood does not amount to more than about 3 per cent. of the body-weight. Beyond that, a large and frequently a sudden dangerous permanent depression is observed.

The restoration of the pressure after the cessation of the bleeding is too rapid to permit us to suppose that the quantity of fluid in the blood-vessels is repaired by the withdrawal of lymph from the extra-vascular elements of the tissues. In all probability the result is gained by an increased action of the vaso-motor nerves, increasing the peripheral resistance, the vaso-motor centres being thrown into increased action by the diminution of their

¹ Chiefly in consequence of the free opening in the vessel, from which the bleeding is going on, cutting off a great deal of the peripheral resistance, and so leading to a general lowering of the blood-pressure.

blood-supply. When the loss of blood has gone beyond a certain limit, this vaso-motor action is insufficient to compensate the diminished quantity (possibly the vaso-motor centres in part become exhausted), and a considerable depression takes place; but at this epoch the loss of blood frequently causes anæmic convulsions.

Similarly when an additional quantity of blood is injected into the vessels, no marked increase of blood-pressure is observed so long as the vaso-motor centre in the medulla oblongata is intact. If however the cervical spinal cord be divided previous to the injection, the pressure, which on account of the removal of the medullary vaso-motor centre is very low, is permanently raised by the injection of blood. At each injection the pressure rises, falls somewhat afterwards, but eventually remains at a higher level than before. This rise is stated to continue until the amount of blood in the vessels above the normal quantity reaches from 2 to 3 per cent. of the body-weight, beyond which point it is said no further rise of pressure occurs.

These facts seem to shew, in the first place, that when the volume of the blood is increased, compensation is effected by a lessening of the peripheral resistance by means of a vaso-dilator action of the vaso-motor centres, so that the normal blood-pressure remains constant. They further shew that a much greater quantity of blood can be lodged in the blood vessels than is normally present in them. That the additional quantity injected does remain in the vessels is proved by the absence of extravasations, and of any considerable increase of the extra-vascular lymphatic fluids. It has already been insisted that, in health, the veins and capillaries must be regarded as being far from filled, for were they to receive all the blood which they can, even at a low pressure, hold, the whole quantity of blood in the body would be lodged in them alone. In these cases of large addition of blood, the extra quantity appears to be lodged in the small veins and capillaries (especially of the internal organs), which are abnormally distended to contain the surplus.

We learn from these facts the two practical lessons, first, that blood-pressure cannot be lowered directly by bleeding, unless the quantity removed be dangerously large, and secondly, that there is no necessary connection between a high blood-pressure and fulness of blood or plethora, since an enormous quantity of blood may be driven into the vessels without any marked rise of pressure.

SEC. 9. A REVIEW OF SOME OF THE FEATURES OF THE CIRCULATION.

§ 187. The facts dwelt on in the foregoing sections have shewn us that the factors of the vascular mechanism may be regarded as of two kinds: one constant, or approximately constant, the other variable.

The constant factors are supplied by the length, natural bore, and distribution of the blood vessels, by the extensibility and elastic reaction of their walls, and by such mechanical contrivances as the valves. By the natural bore of the various blood vessels is meant the diameter which each would assume, if the muscular fibres were wholly at rest, and the pressure of fluid within the vessel were equal to the pressure outside. It is obvious however that even these factors are only approximately constant for the life of an individual. The length and distribution of the vessels change with the growth of the whole body or parts of the body, and the physical qualities of the walls, especially of the arterial walls, their extensibility and elastic reaction change continually with the age of the individual. As the body grows older the once supple and elastic arteries become more and more stiff and rigid, and often in middle life, or it may be earlier, a lessening of arterial resilience which proportionately impairs the value of the vascular mechanism as an agent of nutrition, marks a step towards the grave. The valvular mechanisms too also shew signs of age, as years advance, and more or less marked and increasing imperfections diminish the usefulness of the machine.

The chief variable factors are on the one hand the beat of the heart, and on the other the peripheral resistance, the variations in the latter being chiefly brought about by muscular contraction or relaxation in the minute arteries, but also, though to what extent has not yet been accurately determined, by the condition of the walls of the minute vessels according to which the blood can pass

through them with less or with greater ease, as well as by the character of the circulating blood.

§ 188. These two chief variables, the beat of the heart and the width of the minute arteries, are known to be governed and regulated by the central nervous system, which adapts each to the circumstances of the moment, and at the same time brings the two into mutual independence; but the central nervous system is not the only means of government; there are other modes of regulation, and so other safeguards.

Thus while undoubtedly the two prominent governors of the heart are the inhibitory fibres of the vagus, and the augmentor fibres from the splanchnic system, the one slowing the rhythm and weakening the stroke, the other quickening the rhythm and strengthening the stroke, other causes may vary the beat, in the absence of any action of either of these two nerves. Mere distension of the ventricle, by increasing the tension of the ventricular fibres, and so increasing the force of the contraction of each fibre (see § 162), brings about a more forcible beat. As we shall see in dealing with respiration, a powerful inspiration leads to a larger flow of blood into the heart, and forthwith the ventricle, out of its very fulness, gives stronger beats for the time. So also when by valvular disease or otherwise an unusual obstacle is presented to the outflow from the ventricle, increased vigour in the strokes of the distended organ strives to compensate the mischief. As however in the case of the skeletal muscle, the tension, if too great, may be injurious. In a similar manner the auricle, by a stronger or a weaker contraction, may distend the ventricle to a greater or to a less extent, and so produce a stronger or weaker ventricular systole.

§ 189. Still more efficient perhaps as a direct governor of the heart's beat is the quality and quantity of blood passing in the mammal through the coronary arteries and regulating the nutrition of the cardiac substance. In the absence of all interference by inhibitory or augmentor fibres the heart will continue beating with a certain rhythm and force, determined by the metabolism going on certainly in its muscular, and possibly to a certain extent also in its nervous elements. We have seen that the energy set free in an ordinary skeletal muscle, in response to a stimulus, may vary from nothing to a maximum according to the metabolism going on, according to the nutritive vigour of the muscular fibres. The spontaneous rhythmic beat of the cardiac substance may be regarded as the outcome of a metabolism more highly pitched, more elaborate, of a higher order than that which simply furnishes the ordinary skeletal fibre with mere irritability towards stimuli. All the more therefore may the beat be expected to be influenced by any change in the metabolism of the cardiac substance, and so by any change in the blood which furnishes the basis for that metabolism. Hence the beat of the heart, quite apart from

extrinsic nervous influences, may vary largely in consequence of changes in its own metabolism, which in turn may result from alterations in the blood-supply, or may have a deeper origin, and be due to the fact that the cardiac substance, owing to failure in its molecular organisation (a failure which may be temporary or permanent), is unable to avail itself properly of the nutritive opportunities afforded by a normal quantity of normal blood.

§ 190. As is well known, the beat of the heart may become temporarily or permanently irregular; that many hearts go on beating day after day, year after year, without any such irregularity is a striking proof of the complete balance which usually obtains between the several factors of which we are speaking. Sometimes such cardiac irregularities, those of a transient nature and brief duration, are the results of extrinsic nervous influences. Some events taking place in the stomach, for instance, give rise to afferent impulses which ascending from the mucous membrane of the stomach along certain afferent fibres of the vagus to the medulla oblongata, so augment the action of the cardio-inhibitory centre as to stop the heart for a beat or two, the stoppage being frequently followed by a temporary increase in the rapidity and force of the beat. Such a passing failure of the heart-beat, in its sudden onset, in its brief duration, and in the reaction which follows, very closely resembles the temporary inhibition brought about by artificial stimulation of the vagus. But these characters are not essential to cardiac inhibition. For it must be remembered that the central nervous system possesses, in the form of natural nervous impulses of various origin, a means of stimulation far finer, more delicate and more varied than anything we can effect by our rough means of induction coils and electrodes. Thus in many cases of fainting, the heart-beats, instead of stopping abruptly, gradually die away or fade away it may be to an absolute brief arrest, but more frequently merely down to a feebleness which is insufficient to supply the brain with a quantity of blood adequate to maintain consciousness, and then, in many cases, at all events, are resumed, or recover strength gradually and quietly without any boisterous reaction. In all probability all cases of simple fainting, from emotion, pain, digestive troubles, &c., as distinguished from the syncope of actual heart disease, are instances of vagus inhibition, and though we cannot accurately reproduce their varied phases by direct stimulation of the vagus trunk, we may approach them more nearly by producing reflex inhibition, as by mechanical irritation of the abdomen, see § 159.

Whether definite temporary irregularity is ever brought about by means of the augmentor fibres, we have at present no clear evidence; but cases do occur of palpitation without previous stoppage, cases in which a few hurried strong beats come on, pass off, and are followed by feebler beats; and these may possibly be due to some transient influence of augmentor fibres thrown into

activity as part of a reflex act or otherwise. And though we have no direct experimental evidence, it is very probable that the acceleration or augmentation of the beat, or a combination of the two, which so often follows emotion, is carried out by augmentor fibres.

In all probability, however, irregularity in the heart-beat is much more frequently the result of intrinsic events, or the product of a disordered nutrition of the cardiac substance. The normal nutrition sets the pace of the normal rhythm. We cannot explain how this is affected; nor can we explain why in one individual the normal pace is set as low as 50, or even 30 beats a minute, and in another as high as 90 a minute, or even more, while in most persons it is about 70 a minute. The slower or the quicker pace, though not normal to the species, must be considered as normal to the individual, for it may be kept up through long years in an organism capable of carrying on a normal man's duties and work. So long as we cannot explain these differences we cannot hope to explain how it is that a disordered nutrition brings about an irregular heart-beat, either the more regular irregularity of a "dropping" pulse, that is a failure of sequence rather than an irregularity, or a more actively irregular rhythm, such as that often accompanying a dilated ventricle. We may, however, distinguish two kinds of irregularity; one, in which, in spite of all favourable nutritive conditions, the cardiac substance cannot secure, even perhaps for a minute, a steady rhythm; and another in which the rhythm, though normal under ordinary circumstances, is, so to speak, in a condition of unstable equilibrium, so that a very slight change in conditions, too much or too little blood, or some small alteration in the composition of the blood, or the advent of some, it may be slight, nervous impulse, augmentor or inhibitory, develops a temporary irregularity.

§ 191. No one thing, perhaps, concerning the heart is more striking than the fact that a heart which has gone on beating for many years, with only temporary irregularities, and those few and far between, a heart which must therefore have executed with long-continued regularity, many millions of beats, should suddenly, apparently without warning, after a brief flickering struggle, cease to beat any more. But we must remember that each beat is an effort, an effort moreover, which, as we have seen (§ 155), is the best which the heart can make at the moment, the accomplishment of each beat is, so to speak, a hurdle which has to be leapt, one of the long series of hurdles which make up the steeplechase of life. At any one leap failure may occur; so long as failure does not occur, so long as the beat is made, and a fair proportion of the ventricular contents are discharged into the great vessels, the chief end is gained, and whether the leap is made clumsily or well is, relatively considered, of secondary importance. But if the beat be not made, everything almost (provided

that the miss be due not to vagus inhibition but to intrinsic events) is unfavourable for a succeeding beat: the mysterious molecular changes, by which the actual occurrence of one beat prepares the way for the next, are missing, the favourable influences of the extra rush of blood through the coronary arteries due to a preceding beat are missing also, and even the distension of the cardiac cavities, at first favourable, speedily passes the limit and becomes unfavourable. And these untoward influences accumulate rapidly as the first miss is followed by a second, and by a third. In this way a heart, which has been brought into a state of unstable equilibrium by disordered nutrition, (as for instance by imperfect coronary circulation, such as seems to accompany diseases of the aortic valves leading to regurgitation from the aorta into the ventricle, in which cases sudden death is not uncommon), which is able just to accomplish each beat, but no more, which has but a scanty saving store of energy, under some strain or other untoward influence, misses a leap, falls, and is no more able to rise. Doubtless in such cases could adequate artificial aid be promptly applied in time, could the fallen heart be stirred even to a single good beat, the favourable reaction of that beat might bring a successor, and so once more start the series; but such a period of grace, of potential recovery, is a brief one. Even a coarse skeletal muscle, when cut off from the circulation, soon loses its irritability beyond all recovery, and the heart cut off from its own influence on itself runs down so rapidly, that the period of possible recovery is measured chiefly by seconds.

§ 192. Turning now to the minute arteries and the peripheral resistance which they regulate, we may call to mind the existence of the two kinds of mechanism, the vaso-constrictor mechanism, which, owing to the maintenance by the central nervous system of a tonic influence, can be worked both in a positive constrictor, and in a negative dilator direction, and the vaso-dilator mechanism, which, as far as we know, exerts its influence in one direction only, viz. to dilate the blood vessels. The latter dilator mechanism seems, as we have seen, to be used in special instances only, as seen in the cases of the chorda tympani and *nervi erigentes*; the use of the former constrictor mechanism appears to be more general. Thus the relaxation of the cutaneous arteries of the head and neck, which is the essential feature in blushing, seems due to mere loss of tone, to the removal of constrictor influences previously exerted through the vaso-constrictor fibres of the cervical sympathetic. Though probably dilator fibres pass directly along the roots of the cervical and of certain cranial nerves to the nerves of the head and neck, we have no evidence that these come into play in blushing; as we have seen, blushing may be imitated by mere section of the cervical sympathetic. So also the "glow" and redness of the skin of the whole body, *i.e.* dilation generally of the cutaneous

arteries, which is produced by external warmth, is probably another instance of diminished activity of tonic constrictor influences; though the result, that the dilation produced by warming an animal in an oven is greater than that produced by section of nerves, seems to point to the dilator fibres for the cutaneous vessels which, as we have seen, probably exist in the sciatic and brachial plexuses and possibly in all the spinal nerves, also taking part in the action. A similar loss of constrictor action in the cutaneous vessels may be the result of certain emotions, whether going so far as actual blushing of the body, or merely producing a 'glow.' The effect of cold on the other hand, and of certain emotions, or of emotions under certain conditions, is to increase the constrictor action on the cutaneous vessels, and the skin grows pale. It may be worth while to point out, that in both the above cases, while both the cold and warmth produce their effect, chiefly at all events through the central nervous system, and very slightly, if at all, by direct action on the skin, their action on the central nervous system is not simply a general augmentation or inhibition of the whole vaso-motor centre. On the contrary, the cold, while it constricts the cutaneous vessels, so acts on the vaso-motor centre as to inhibit that portion of the vaso-motor centre which governs the abdominal splanchnic area; while less blood is carried to the colder skin, by the opening up of the splanchnic area more blood is turned on to the warmer regions of the body, and the rise of blood-pressure which the constriction of the cutaneous vessels tended to produce, and which might be undesirable, is thereby prevented. Conversely when warmth dilates the cutaneous vessels, it at the same time constricts the abdominal splanchnic area, and prevents an undesirable fall of pressure.

The warm and flushed condition of the skin, which follows the drinking of alcoholic fluids, is probably, in a similar manner the result of an inhibition of that part of the vaso-motor centre which governs the cutaneous arteries; and it is probable also, that except for the local effect of the fluid on the gastric mucous membrane, whereby some amount of blushing of the gastric blood vessels takes place as a reflex act, this effect on the vessels of the skin is accompanied by an inverse constrictor action in the splanchnic area. This last point however has not been proved experimentally and may not occur, since the influence of the alcohol is at the same time to increase the heart's action, and thus to obviate the fall of pressure which would certainly occur were the cutaneous and splanchnic vascular areas to be dilated at the same time. This effect of the alcohol on the heart may be a direct action of the alcohol on the cardiac substance, being carried thither by the blood; but the effect, in being an augmentation of the force and acceleration of the pace of the heart-beat of a temporary character, followed by a reaction in the direction

of feebleness and slowness, so strikingly resemble the effects of artificially stimulating the cardiac augmentor fibres, that it is at least probable that the alcohol does act upon the cardiac augmentor mechanism.

§ 193. The influence on the body of exercise illustrates both the manner in which the two vascular factors, the heart-beat and the peripheral resistance, are modified by circumstances, and the mutual action of these on each other.

When the body passes from a condition of comparative rest and quiet to one of exertion and movement, the metabolism of the skeletal muscles (and of the nervous system) is increased and more heat is generated in them. We know for certain that the increased metabolism throws into the blood of the veins coming from the muscles an increased amount of carbonic acid, and it is probable but not so certain, that it also loads the blood with lactic acid and other metabolic products; at the same time there is an increased consumption of oxygen; the blood of the body tends to become less arterial and more venous. In dealing with respiration we shall see that the influence thus exerted on the blood leads to an increase in the respiratory movements, and we shall further see that the more vigorous working of the respiratory pump since it promotes the flow of blood to and through the heart and lungs quickens and strengthens the heart beats. Possibly this mere mechanical effect of the more vigorous breathing is sufficient by itself to account for the increase in the frequency and vigour of the heart's action, but it is more than probable that it is the changed condition of the blood which, while it hurries on the respiratory pump, also stimulates the vascular pump, either by a direct action on the cardiac substance, or through the medium of the central nervous system and the augmentor fibres. If, as experiments seem to shew, the increased vigour of the respiratory movements compensates or even over-compensates the tendency of the whole blood to become more venous, so that during exercise the blood, which is distributed by the aorta, actually does not contain more carbonic acid and less oxygen than at rest but even the reverse, then these effects must be due to some of the products of muscular metabolism other than carbonic acid.

The same changed condition of blood while it thus excites the heart dilates the cutaneous vessels, as is clearly shewn by the warm flushed skin, and at the same time throws into activity the perspiratory mechanism with which we shall hereafter have to deal. There can be no doubt, as we shall see later on, that the perspiration which accompanies muscular exercise is brought about by means of the central nervous system, and we may almost with certainty conclude that the dilation of the cutaneous arteries is also brought about by means of the central nervous system and most probably by means of an inhibition of that part of the vaso-motor centre which maintains under ordinary circumstances a greater or

less tonic constriction of the cutaneous arteries; how far this may be assisted by the special action of vaso-dilator fibres we do not know.

This widening of the cutaneous arteries diminishes largely the peripheral resistance and so tends to lower the blood-pressure. Moreover, with each effort of each skeletal muscle the minute arteries of that muscle are dilated, so that during exercise, and especially during vigorous exercise calling into action many skeletal muscles, there must be in the body at large a very considerable widening of the minute arteries distributed to the various muscles, and in consequence a very considerable diminution of the peripheral resistance. These two diminutions of peripheral resistance, cutaneous and muscular, would tend to lower the blood-pressure; a result which would be most injurious, since the increased metabolism of the muscles demands a more rapid circulation in order to get rid of the products of metabolism, and for a rapid circulation a high blood-pressure is in most cases necessary, and in all cases advantageous. The evil is in part at all events met by the increased force and frequency of the heart's beats, for as we have said again and again the mean blood-pressure is the product of the heart-beat working against the peripheral resistance, and may remain constant when one factor is increased or diminished, provided that the other factor be proportionately diminished or increased. It is possible then that the mere increase in the heart's beats are, during exercise, sufficient to neutralize the diminution of peripheral resistance, or even to raise the blood-pressure above the normal; and indeed, we find, as a matter of fact, that during exercise there is such an increase of the mean blood-pressure. But it is more than probable that much valuable labour of the heart is economised by neutralizing the imminent fall of blood-pressure in another manner. It would appear that while that part of the vaso-motor centre which governs the cutaneous vascular area is being inhibited, that part which governs the abdominal splanchnic area is on the contrary being augmented. And in this way a double end is gained. On the one hand the mean blood-pressure is maintained or increased in a more economical manner than by increasing the heart-beats, and on the other hand the blood during the exercise is turned away from the digestive organs which at the time are or ought to be at rest and therefore requiring comparatively little blood. These organs certainly at all events ought not during exercise to be engaged in the task of digesting and absorbing food, and the old saying, "after dinner sit awhile," may serve as an illustration of the working of the vascular mechanism with which we are dealing. The duty which some of the digestive organs have to carry out in the way of excretion of metabolic waste products is during exercise probably taken on by the flushed and perspiring skin. It is true that at the beginning of a period of exercise, before the skin so to speak has settled down to its work, an increased flow of urine, dependent on or accompanied by an

increased flow of blood through the kidney, may make its appearance; but in this case, as we shall see later on in dealing with the kidney, the flow of blood through the kidney may be increased in spite of constriction of the rest of the splanchnic area, and, besides, such an initial increase of urine speedily gives way to a decrease.

§ 194. The effect of food on the vascular mechanism affords a marked contrast to the effect of bodily labour. The most marked result is a widening of the whole abdominal splanchnic area, accompanied by so much constriction of the cutaneous vascular area, and so much increase of the heart's beat as is sufficient to neutralize the tendency of the widening of the splanchnic area to lower the mean pressure, or perhaps even sufficient to raise slightly the mean pressure.

Any large widening of the cutaneous area, especially if accompanied by muscular labour and the incident widening of the arteries of the muscles, would tend so to lower the general blood-pressure (unless met by a wasteful use of cardiac energy) as injuriously to lessen the flow through the active digesting viscera. A moderate constriction of the cutaneous vessels on the other hand, by throwing more blood on the abdominal splanchnic area without tasking the heart, is favourable to digestion, and is probably the physiological explanation of the old saying, "If you eat till you're cold, you'll live to be old."

In fact during life there seems to be a continual give-and-take between the blood vessels of the somatic and those of the splanchnic divisions of the body; to fill the one, the other is proportionately emptied and vice versa.

§ 195. We have seen (§ 174) that certain afferent fibres of the vagus forming in the rabbit a separate nerve, the depressor nerve, are associated with the vaso-constrictor nerves and the vasomotor centre in such a way that impulses passing centripetally along them from the heart lower the blood-pressure by diminishing the peripheral resistance, probably inhibiting the tonic constrictor influences exerted along the abdominal splanchnic nerves, and so as it were opening the splanchnic flood-gates. We do not possess much exact information about the use of these afferent depressor fibres in the living body, but probably when the heart is labouring against a blood-pressure which is too high for its powers, the condition of the heart starts impulses which, passing along the depressor fibres up to the medulla oblongata, temper down so to speak the blood-pressure to suit the cardiac strength.

We have moreover reason to think that not only does the heart thus regulate the blood-pressure by means of the depressor fibres, but also that the blood-pressure, acting as it were in the reverse direction regulates the heart-beat; a too high pressure, by acting directly on the cardio-inhibitory centre in the medulla oblongata (either directly, that is as the result of the vascular

condition of the medulla itself, or indirectly by impulses reaching the medulla along afferent nerves from various parts of the body,) may send inhibitory impulses down the vagus, and so slacken or tone down the heart-beats.

In the following sections of this work we shall see repeated instances, similar to or even more striking than the above, of the management of the vascular mechanism by means of the nervous system, and we therefore need dwell no longer on the subject.

We may simply repeat that at the centre lies the cardiac muscular fibre, and at the periphery the plain muscular fibre of the minute artery. On these two elements the central nervous system, directed by this or that impulse reaching it along afferent nerve fibres, or affected directly by this or that influence, is during life continually playing, now augmenting, now inhibiting, now the one, now the other, and so, by help of the elasticity of the arteries and the mechanism of the valves, directing the blood-flow according to the needs of the body.



