

THINGS TO MAKE
IN YOUR
HOME WORKSHOP

WAKELING

From the collection of the

o P^{z n}re^mlinger^a
v Library
t p

San Francisco, California
2008

THINGS TO MAKE
IN YOUR HOME WORKSHOP

THINGS TO MAKE IN YOUR HOME WORKSHOP

FURNITURE, SHIP MODELS, TOYS, HOUSE AND GARDEN CON-
VENIENCES—WOODWORKING METHODS—USE AND CARE
OF TOOLS—WOOD TURNING—PAINTING AND DECORATING

Edited by **ARTHUR WAKELING**
HOME WORKSHOP EDITOR, *Popular Science Monthly*

*With 350 Working Drawings,
Diagrams, and Illustrations*



POPULAR SCIENCE PUBLISHING CO., INC.
NEW YORK

COPYRIGHT, 1930

By POPULAR SCIENCE PUBLISHING CO., INC.

All Rights Reserved

Printed in the United States of America by
J. J. LITTLE AND IVES COMPANY, NEW YORK

PREFACE

“WHAT shall I make next?” is a question often asked by the man or boy who is fortunate enough to have a home workshop. This book is an endeavor to answer that question. It contains plans for shop equipment ranging from a simple kitchen table workbench to a heavily built carpenter’s bench, and designs for furniture of many varieties, some pieces so simple that they can be made by the beginner with relatively few tools and others so elaborately turned, inlaid, or otherwise decorated that they will stimulate the ingenuity and craftsmanship of those who have small woodworking machinery and many tools at their disposal. There are instructions for making a toy fire engine that really pumps water, a doll’s house, and other toys, all of which are especially satisfactory projects because they give so much pleasure to the children for whom they are built. Many suggestions, too, are offered for improving the house and garden: clothes closet conveniences, kitchen cupboards, valance boards, mantels, lily ponds, trellises, and benches.

The remarkable popularity of model making as a hobby led to the inclusion of a chapter describing in detail the construction of a model of the *Santa Maria* and one of a 42-in. racing yacht. Those who master the construction of these models will find little difficulty in building similar models from the various blueprints and plans available in large variety—much less difficulty, in fact, than if merely a brief and sketchy de-

scription of a large number of models had been given in this book.

In addition to telling what to make, the editor has included in a condensed form as much information as possible on how to make it. The first three chapters are substantially a condensed manual on the choice, care, and use of tools, the making of joints, inlaying, and veneering. Chapter V contains the essentials of operating small woodworking machinery, and Chapter VI is really a complete course in wood turning. Painting and decorating, too, have been allotted a chapter, although only the less familiar points have been taken up—the special finishes and treatments upon which information is not readily obtainable elsewhere.

The best work of many of the leading contributors to the Home Workshop Department of *Popular Science Monthly* is represented in this book. Their names would stand at the head of any list of amateur craftsmen and industrial arts teachers it would be possible to compile.

Emanuel E. Ericson, director of Industrial Education, State Teachers College, Santa Barbara, Calif., was responsible for much of the first three chapters. William W. Klenke, instructor of shopwork in the Central Manual Training High School, Newark, N. J., and a practicing architect, prepared practically all of Chapter V; and Herman Hjorth, of the Saunders Trade School, Yonkers, N. Y., who is the author of *Reproduction of Antique Furniture* and *Principles of Woodwork-*

ing, wrote almost all of Chapter VI. Edward Thatcher, for many years a teacher of decorative metal work and wood carving at Teachers College, Columbia University, and F. Clarke Hughes, a teacher of industrial arts in Spokane, Wash., and author of *Hand Work for Boys*, were the designers of the toys in Chapter VII. Capt. E. Armitage McCann, secretary of the Ship Model Makers' Club, author of three books on ship model making, and one of the world's foremost authorities on ship models, built the *Santa Maria*, and A. M. Youngquist, of the Morrison R. Waite High School, Toledo, Ohio, de-

signed the sailing yacht model, both described in Chapter IX.

Special acknowledgments are due to Leon H. Baxter, Jonathan Bright, Frederick J. Bryant, Warren N. Crane, Everett Eames, J. C. Eddie, Berton Elliot, Carl G. Erich, Frederick E. Fox, Chelsea Fraser, Samuel Gore, Charles A. King, Kenneth R. LaVoy, Edwin M. Love, Joseph J. Lukowitz, Philip H. Miller, E. M. Oren, L. M. Roehl, B. G. Seielstad, Hi Sibley, Ernest F. Spencer, R. C. Stanley, Harold P. Strand, Frank O. Taafel, Marie Childs Todd, and F. N. Vanderwalker.

ARTHUR WAKELING

New York, August, 1930

TABLE OF CONTENTS

CHAPTER	PAGE
I TOOLS FOR WOOD AND METAL	9
II HOME WORKSHOP EQUIPMENT	23
III BETTER HOME WORKSHOP METHODS	39
IV BUILDING FURNITURE BY HAND	73
V SMALL WOODWORKING MACHINERY	98
VI WOOD TURNING SIMPLIFIED	115
VII TOYS TO DELIGHT THE CHILDREN	156
VIII IMPROVEMENTS FOR HOUSE AND GARDEN	175
IX MODEL MAKING	201
X PAINTING AND DECORATING	224
APPENDIX	251
INDEX	253

CHAPTER I

TOOLS FOR WOOD AND METAL

TOOLS, like fine weapons, are very wonderful things when you come to know them well. They have made history. Every time we pick up a saw or an automatic drill or our "mikes," we are taking advantage of tool-building discoveries and achievements that run all the way back to the Age of Bronze.

Little excuse exists for any home workshop enthusiast who does not have his tools always in good condition. There is not much more excuse, in these days when the choice of tools is so large and their cost relatively so small, in his not having sufficient high-grade equipment to accomplish any task he sets out to do. And yet how many times have you seen a handy man laboriously hacking a shelf or whatnot out of a board with a dull and rusty saw! No wonder he misses the satisfaction in his work always felt by those who have the true craftsman's attitude toward tools—pride in their good condition.

There are a few pointers which should recommend themselves to the home worker, whether he is inclined towards woodwork or metalwork, whether he has an elaborate shop or wishes to do merely a few odd useful jobs around the house.

Buy only the best tools; they may be a little more expensive at first but they are true economy in the end.¹

¹A list of approved tools can be obtained free from the Popular Science Institute, 381 Fourth Avenue, New York. The Institute has been testing tools for years in special laboratories at New York University. The tools on this list therefore can be purchased with assurance that they are efficient, correctly designed products and will withstand usage and prove satisfactory for the purposes for which they are intended.

Be sure to get the tools you really need. Only the expert mechanic can do good work with makeshifts, and he usually will not try, for often the time and material wasted on a single job are worth more than the cost of the proper tool. If, however, you have only a limited amount to spend on tools, choose a few good ones rather than a number of cheap and second-grade tools.

No matter how excellent the tools may be, their effective use depends largely upon the skill of the workman. Therefore learn to use them with the utmost precision so that your work will always be finely done. The best way invariably is the easiest, the simplest, and the quickest in the long run.

To maintain edge tools in proper condition, notice the cutting angles that have been given to them by the manufacturers and, as nearly as possible, preserve the same angles through the life of the tool. The angles may range all the way from those of a penknife to a heavy lathe tool. It is always a matter of selecting an edge that will be sharp and reduce friction and at the same time be strong and permanent enough to stand up under the work to be done. You may be sure the toolmaker has worked out the angles very carefully, so that all you have to do is to use your grindstone and oilstone constantly to keep those angles right. Having edge tools well sharpened and well lubricated is half the battle.

Tools in what may be termed, roughly speaking, the hammer, punch, trowel,

and wrench class will not trouble you much, but the tools you use for making and testing measurements deserve your utmost consideration. Even a heavy steel square or a try-square can be spoiled in no time by a little carelessness; and rules, gages, calipers, surface plates, protractors, levels, and the like, require the best of treatment if they are to retain their accuracy. Protect these tools in every way from being strained, warped, nicked, or damaged.

TOOLS FOR WOODWORKING

As the amateur mechanic gains experience, he does not need much advice as to what tools to buy. This is determined by the sort of work he is doing, his own special interests, the space available for his workshop, and other individual factors. The beginner, however, is very likely to make the mistake of buying the wrong tools if he does not have some advice at the outset. Yet it is not at all easy to tell the beginner what tools he is likely to find most useful, any more than it is a simple matter to advise the man who has never owned an automobile as to what car will prove the most satisfactory for his own family use.

In order to avoid the prejudices of any one man, six expert craftsmen who contribute to the Home Workshop Department of *Popular Science Monthly* were asked to act as a jury to select a small household tool assortment, a small home workshop set of tools, and a complete, ideal home workshop outfit.

For the first and smallest assortment they selected tools which they thought best for doing repair jobs about the house and garden and for simple wood-working—a typical handy man's set that no household should be without.

HOUSEHOLD TOOL ASSORTMENT

- Nail (or claw) hammer, bell face preferred
- Crosscut (or hand) saw, 24 in. or 26 in., 8 points to the inch
- Carpenter's chisel, socket firmer, bevel edge, 1 in.
- Carpenter's chisel, square edge, ½ in.
- Bit brace, 8-in. sweep, ratchet preferred

- Auger bits, ⅜, ½, and ¾ in.
- Bit-stock drills for metal, ⅜ and ½ in. (useful also for wood)
- Screw drivers, 4 in. and 8 or 10 in.
- Combination pliers, 6 or 8 in.
- Files—saw files, 6 or 7 in.; flat or mill bastard, 8, 10, or 12 in.; auger bit file
- Jack plane
- Try-square, 6 or 8 in.
- Steel (framing) square
- Zigzag folding rule, 4 ft.
- Marking gage
- Pipe wrench, 10 in.
- Monkey wrench, 10 in.
- Miter box
- Wrecking bar, small
- Oilstone, artificial, combination
- Nail set, ¼ in.
- Oil can
- Half hatchet
- Cold chisel, ⅝ in.
- Putty knife

Several of the same jurymen wished additional tools included in this assortment. Three of them thought that a rip-saw was necessary but disagreed as to the size, one voting for a 22-in., another for a 24-in., and a third for a 26-in. rip-saw. The remaining jurymen, however, felt that whatever ripping had to be done in connection with the average small repair job could be accomplished satisfactorily with a 24- or 26-in. cross-cut saw, provided it was sharpened for general work and was not finer than 8 points to the inch. The always useful hand drill, with its assortment of drill points, also received three votes.

The next assortment selected was for the home worker who wishes to do a certain amount of simple bench work and make furniture, toys, household utilities, sporting equipment, and the like. The tools selected and the number of votes cast for each were as follows:

SMALL HOME WORKSHOP OUTFIT

- Nail hammer, bell face preferred (6 votes)
- Machinist's ball peen hammer, 1¼ lb. (4)
- Round mallet, hickory or lignum vitae (5)
- Crosscut saw, 22 or 24 in. or 26 in. (6). See note following this list
- Ripsaw, 24 or 26 in. (6)
- Back saw, 10 or 12 in. (4)
- Hack saw frame and blades (5)

Coping (fret) saw frame and blades or bracket saw frame and blades (6)

Compass saw (6)

Ratchet brace (6)

Block plane (6)

Smooth plane (5)

Jack plane (5)

Fore plane or jointer (4)

Rabbet plane, $\frac{7}{8}$ or 1 in. (3)

Chisels—mortise, $\frac{1}{4}$ or $\frac{3}{8}$ in. (5); socket firmer, $\frac{1}{4}$, $\frac{3}{8}$, $\frac{1}{2}$, $\frac{3}{4}$, and 1 in. (6)

Gouge, firmer, beveled outside, $\frac{3}{8}$ or $\frac{1}{2}$ in. (6)

Auger bits, $\frac{1}{4}$, $\frac{3}{8}$, $\frac{1}{2}$, $\frac{5}{8}$, $\frac{3}{4}$, and $\frac{7}{8}$ in. (4 or more votes each)

Expansive bit, $\frac{7}{8}$ to 3 in. (4)

Rose countersink (4)

Screw driver bit, $\frac{3}{8}$ in. or $\frac{1}{2}$ in. (6)

Bit stock drills for metal, $\frac{1}{8}$, $\frac{3}{16}$, $\frac{1}{4}$, and $\frac{3}{8}$ in. (4 or more votes each)

Automatic drill with drill points (4)

Hand drill with drill points (4)

Screw drivers, 4 in. and 8 or 10 in. (6)

Pliers—combination, 6 or 8 in. (6); round nose, 5 in. (5)

Files—Saw files, 5 and 6 in. (4); flat or mill bastard, 8, 10 or 12 in. (6); round bastard, 6 or 8 in. (6); half round bastard, 6 or 8 in. (5); cabinet or wood file, 8 or 10 in. (5); cabinet rasp, 8 or 10 in. (5); auger bit file (5)

Try-square, 6 or 8 in. or combination square (6)

Steel (framing) square (4)

Sliding T-bevel, 8 in. (6)

Boxwood folding rule, 2 ft. (5)

Zigzag rule, 4 ft. (5)

Cabinet scraper, 3 by 5 in. (6)

Marking gage, wooden, or mortise gage (6)

Dowel plate (5)

Scriber or divider with pencil point, 6 in. (6)

Bench, Sloyd, or pocket knife (4)

Spokeshave (4)

Drawknife, 8 or 10 in. (4)

Pipe wrench, 10 in. (4), 16 in. (2)

Monkey wrench, 10 in. (5), 12 in. (1)

Tinner's snips (6)

Level and plumb, 24 in. (4)

Miter box, wooden or metal (4)

Glass cutter (6)

Tool grinder (5)

Hand screws, one pair, 10 in. (6)

Cabinetmaker's clamps, one pair 3 ft. or 5 ft. (6)

Burnisher for scraper (4)

Saw set (4)

Wrecking bar, small (4)

File card or cleaner (5)

Oilstone, artificial combination (4), Arkansas (a natural stone) (3)

Nail sets, $\frac{1}{16}$ and $\frac{1}{8}$ in. (6)

Oil can (6)

Half hatchet (5)

Cold chisel, $\frac{5}{8}$ in. (6)

Saw vise (4)

Soldering copper, $1\frac{1}{2}$ lb. (4), $\frac{1}{2}$ lb. (3)

Putty knife (6)

Glue pot and brush (4)

Bench with quick-acting woodworker's vise (6)

One point of interest in regard to this list is the fact that a wide difference of opinion developed as to the best lengths of saws. Two of the jurors thought that both a 22-in. and a 24-in. crosscut saw should be included in the list; two of the jurors held out for a 26-in. crosscut saw, and the remaining two gave a vote apiece for a 22- and a 24-in. saw.

In the rip saw classification one vote was cast for a 22-in. saw, two for a 24-in. saw, and three for a 26-in. saw. The difference of opinion, of course, was due to the belief of some of our jurors that the amateur mechanic should follow the example of the professional woodworker and select a large saw so as to get the benefit of a long stroke, and if he wishes to do fine and delicate work, obtain a saw specially designed for fine cutting and sharpen it accordingly. The opposing view was that in doing small work, which comprises the majority of home workshop jobs, the amateur usually finds it easier to control a shorter saw. Boiled down, it is largely a matter of personal preference, provided the time element does not enter into consideration; for fast work a large saw should be used.

Finally the jury was asked to name the ideal home workshop outfit—a complete equipment, such as will take care of the needs of the amateur mechanic interested alike in house repairs, general woodwork, and all the many varieties of cabinetmaking.

THE IDEAL HOME WORKSHOP OUTFIT

All the tools mentioned in the preceding list and—

Tack hammer (4 votes)

Light bell-faced nail hammer, about 13 oz. This is in addition to a hammer weighing a pound or a little more for ordinary work (3)

- Riveting hammer, 8 oz. (2)
- Upholsterer's hammer, $\frac{3}{8}$ -in. face (3)
- Soft mallet, rawhide or rubber (3)
- Crosscut saws, 22 and 26 in. in place of the single crosscut saw mentioned in the preceding list (4)
- Dovetail saw, 8 in. (2)
- Turning saw, 18 in. (3)
- Combination plane (6)
- Rabbet and filletster plane (3)
- Router (3)
- Chisels—socket firmer, $\frac{7}{8}$ in. (3); beveled edge butt, $1\frac{1}{4}$ in. (3)
- Gouges—firmer beveled outside, $\frac{3}{8}$, $\frac{1}{2}$, and $\frac{3}{4}$ in. (4); beveled inside, $\frac{1}{2}$ in. (5)
- Auger bits—complete set up to $\frac{7}{8}$ in.
- Bits—gimlet, Nos. 2 to 8 (3)
- Square reamer (3)
- Screw driver bit, $\frac{1}{2}$ in. (3)
- Automatic (spiral) screw driver (4)
- Jeweler's screw driver (5)
- Pliers—flat nose, 6 in. (4)
- Files—saw, 4 in. (3); flat or mill bastard, 8 and 12 in. (6); hand file, smooth, 10 in. (3); square, 6, 8, or 10 in. (3)
- Combination square (5) (as well as try-square)
- Mortise marking gage (2)
- Bit depth gage (4)
- Pincers, carpenter's, 6 or 8 in. (4)
- Bradawl (4)
- Pipe wrenches, 10 in. (5), 16 in. (3)
- Adjustable iron miter box (4)
- Cabinetmaker's miter block (2)
- Doweling jig (5)
- Bench duster (3)
- Plumb bob and line (3)
- Hand screws, at least a pair each, 4 and 10 in. (6)
- Cabinetmaker's clamps, one pair 3 ft. (5), one pair 5 ft. (4)
- Inside calipers, 6 or 8 in. (3)
- Outside calipers, 6 or 8 in. (3)
- Oilstones—Arkansas (4), India combination (4), assorted slipstones (4)
- Carving chisels—set of 6 or 12 (3)
- Prick punch (4)
- Scratch awl (3)
- Center punch (5)
- Machinist's vise, $3\frac{1}{2}$ -in. jaws (6)
- Cabinetmaker's bench with two wooden vises and bench stops, or bench mentioned in the preceding list (6)
- Blowtorch (5)
- Pipe vise, if machinist's vise does not have pipe jaws (3)
- Taps and dies, small set (6)
- Sandpaper block, cork or rubber faced, homemade or purchased (6)

Many other woodworking tools, of course, were given consideration. It was conceded by the jurors that additional tools often came in useful for special work, but the consensus of opinion was that the wisest plan for the average home worker is to purchase such tools as the need for them arises, so that they will not merely lie around in his tool-chest, but will be of service from the outset.

Tools in this classification are:

Edge trimming plane, scraper plane, dado plane, curve rabbet plane, dovetail plane, tongue-and-groove plane, shooting board and plane, various special cabinetmaker's planes, corner chisel, many types of files and bits, butt gage, bolt clipper, special duty pliers, picture frame and other special types of vises, bench brackets and bench dogs, panel and cutting gages, beam compass, bit and square level, cornering tool, plug cutting bit, dowel sharpener, extension bit holder, circular glass cutter.

The tools listed are mainly for woodworking; for what might be called a "home machine shop" the assortments would be altogether different.

It is becoming generally believed, of course, that no home workshop can be regarded as complete without a bench lathe and several motorized machines or a combination electric workshop such as those illustrated in Chapter V. A lathe, a circular saw, a grinding and polishing head, and an electric drill are now almost as much a part of a well-equipped shop as chisels and planes.

SHARPENING CHISELS AND PLANES

Better and faster work can be done when plane irons and chisels are kept sharp. The first step in sharpening is to test the edge for squareness with a try-square as shown at *A*, Fig. 1. Grind the cutting edge straight and square by holding it against the side of a tool-grinding wheel as at *B*. A power grinder, small hand wheel, or common grindstone may be used for sharpening the bevel as at *C*. The tool can be held with or without the aid of a support. The bevel angle

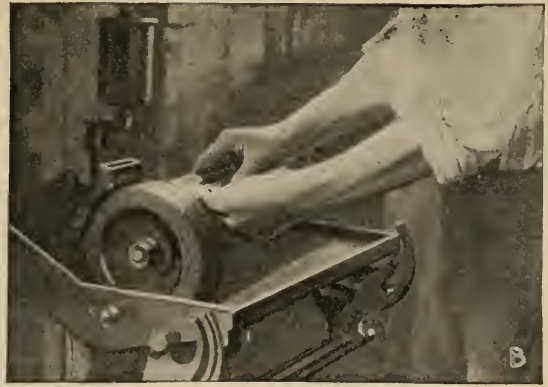
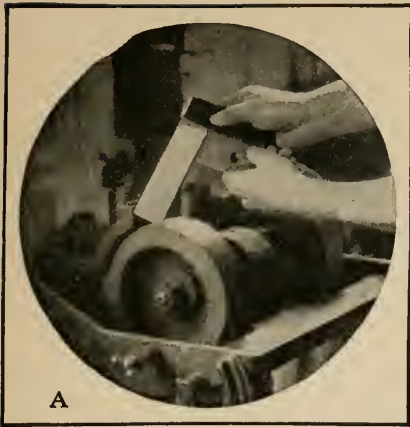

FIG. 1.—Steps in sharpening chisels, plane irons, and other chisel-edged cutters. How the keenness of the edge may be tested on the thumb nail.

ranges from 15 degrees for soft wood to 20 degrees for hard wood.

The fine "wire edge" left by grinding may be pulled off by making a slanting cut in a bit of soft wood. The finishing is done on a fine oilstone, upon which a few drops of oil have been placed. Hold the

bevel flat on the stone and rub either with a circular or a back-and-forth stroke as at *D*. Turn the plane iron or chisel over and lay it perfectly flat on the stone as shown at *E*. Take a few strokes back and forth to remove the fine "wire edge." Stroking the edge

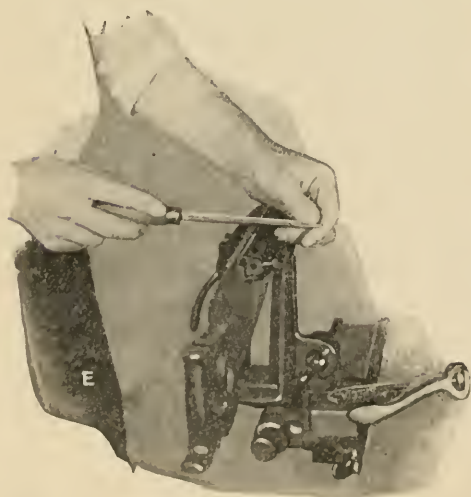
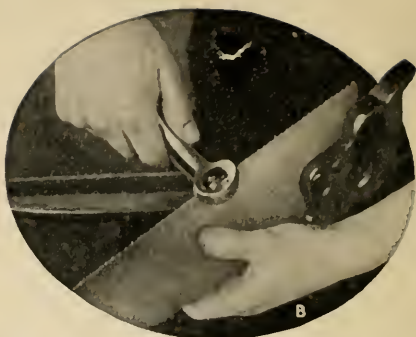

FIG. 2.—How to file a handsaw: jointing the teeth, setting them, filing both crosscut saws and rip saws, and removing kinks.

through a piece of soft wood may again be necessary, and sometimes the entire whetting process will have to be repeated for best results.

Test the tool for sharpness by letting it bite on the thumb nail as at *F*. If it does not catch on the nail when resting with only its own weight, it is not properly sharpened. The final stropping is sometimes given on leather. Mechanics often strop the edge a few times in the palm of the hand in order to give a last keen finish.

HOW TO FILE A HANDSAW

First true up the edge with a saw jointer or a flat file held on a block of wood as shown at *A*, Fig. 2. Take smooth, forward strokes. The edge should be a trifle convex or crowned.

Using a properly adjusted saw set, bend out every alternate tooth slightly for not more than half its depth as shown at *B*. Then reverse the saw and set the remaining teeth the opposite way.

A crosscut saw may be filed either against the cutting edge of the teeth or with the teeth. The first method is illustrated at *C*, with the file pointing toward the handle. (Many experts use this method, but it is perhaps easier and undoubtedly more common to point the file toward the end of the saw.) Run the file in front of every tooth that points out toward you.

Turn the saw in the saw vise and file the remaining teeth. The file is horizontal, but points back toward the handle as shown at *F*. Watch the points and stop filing when they are sharp.

When the teeth are sharp, lay the saw on a flat surface and take a stroke or two on each side with a fine oilstone as shown at *D*.

To file a rip saw, hold the file at right angles to the blade as shown at *E*. Each tooth must be perpendicular on the front edge. Some mechanics prefer to lower the file handle a trifle. In either case it is well to file every alternate tooth from one side and then turn the saw. This compensates for errors.

How to straighten a kink with block

and mallet is shown at *G*. Beginners will find it a good plan to leave a few teeth at the extreme handle end of the blade untouched. It is these few teeth that will serve as a standard guide for setting and filing the saw.

SHARPENING AUGER BITS

The auger bit is one of the most delicate tools in the woodworker's kit. It must be of high-grade manufacture to begin with; even so, it will stand little abuse, and if it is not kept in first-class condition there is no pleasure in using it.

Cutting into nails with a bit is probably the most common cause of damage. In many instances, however, a bit that has apparently been ruined can be restored by proper treatment.

Auger bits of various types may be had for different kinds of work, but the principal specification in which the aver-

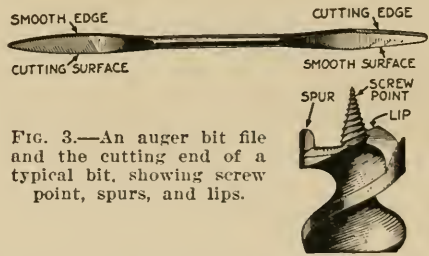

FIG. 3.—An auger bit file and the cutting end of a typical bit, showing screw point, spurs, and lips.

age user is interested concerns the speed with which the bit is drawn into the wood. The boring speed depends upon the pitch or twist of the thread at the screw point. In this regard auger bits usually are classified as slow screw, medium screw, and fast screw. For all ordinary work the medium screw is most satisfactory, but it is well to get advice from the tool dealer before making the purchase.

It is well to remember also that the original cost of an auger bit, or any other tool, is not the sole consideration, but that it is more important to obtain a tool that will "stand up" and give satisfactory service.

There are three principal parts of the auger bit (Fig. 3) that may receive injury through contact with foreign sub-

stances in the wood—(1) the screw point (the screw that feeds the bit); (2) the lips (horizontal cutting surfaces); (3) the spurs (vertical cutting edges). All of these can be reconditioned, provided the damage done has not been too great.



FIG. 4 (above).—How the lips of the bit are sharpened on top by means of an auger bit file.

FIG. 5 (at right).—Filing the spur on the inside. To file the outside would ruin the bit.

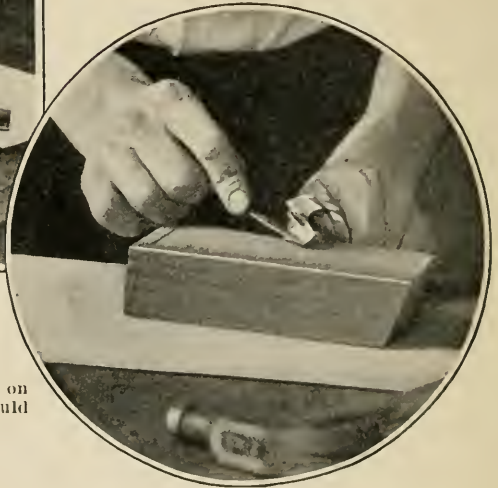

not be carried beyond the point where a fine wire edge or burr appears. If a small sharpening stone is available, it should be used for a very light stroke or two on the underside of the lip in order to remove the wire edge; if no stone is at hand, the file may be used for the same purpose. For this delicate operation, the bit is turned with the spurs upward and laid against the edge of the workbench. Care must be taken not to file too much and to follow the original surfaces.

The spurs are sharpened with the bit in the left hand and held against the edge of the bench as shown in Fig. 5. It should be kept in mind that the spurs must be long enough to cut deeper into

For sharpening auger bits, either a file or a small sharpening stone may be used. A suitable file is one about 4 in. long, very fine cut ("dead smooth"), and half round in shape. It is better, however, to use a special auger bit file (Fig. 3), which can be obtained in any large hardware store. Such a file is made with "safe" edges adjacent to the cutting surfaces, and there is no danger of filing in the wrong place.

The lips are filed or sharpened with a stone on the top side, the bit being held in the position indicated in Fig. 4. The edge must be kept thin, and filing should

the wood than the lips when the bit is in operation, hence no wasteful strokes should be made at this point. If they are worn too short, the lips probably can be filed back in order to relieve the difficulty. Needless to say, all filing on the spurs must take place on the inside, except the smoothing up or removing the burr, as previously described.

Sometimes, after striking a nail at a certain angle, the spurs are bent inward very decidedly. In such cases, instead of removing all the distorted metal with the file and thus losing a large part of the nibs, it is possible to reshape the bit by

ending the point back into position with a pair of small pliers. In doing this care must be taken not to break off any part. After the tip is put into position, it is sharpened in the usual way.

The screw point is probably the most difficult part to put into condition after it has been injured. Patient work with a special oilstone having a very thin edge as shown in Fig. 6 will usually give satisfactory results. If considerable injury

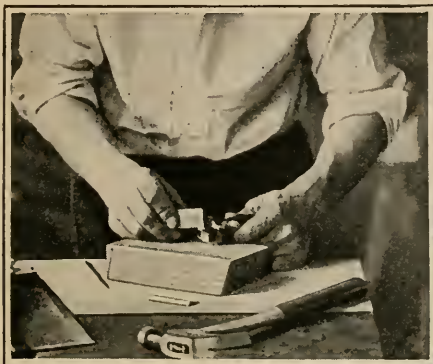

FIG. 6.—Doctoring the screw point with an oilstone (usually called a "slip") that has a thin edge.

FIG. 7.—To straighten a bit, lay it on a hardwood block and drive another block heavily against it with a hammer or mallet.



auger bit for straightness is to lay it on a straight surface and revolve it slowly while watching for irregularity in the space between the bit and the surface at various points.

SHARPENING A CABINET SCRAPER

If the scraper is of the usual square-edged type, first drawfile it with strokes taken horizontally away from you as

has been received at this point, the bit may afterwards require a slight pressure to assist the screw in feeding; but since that requirement can be met with in all ordinary work, its efficiency is not materially reduced.

An auger bit which has been bent out of shape may be straightened as in Fig. 7. A block of wood, preferably some hard variety, is used as a support, and a wooden block, held on end, makes contact from above. A smooth-faced wooden mallet may take the place of both hammer and block. A good way to test an

shown in Fig. 8 at *A*. Lift the file when it is pulled back on the return stroke. Continue until there is a burr on the cutting edges.

Lay the scraper flat on an oilstone as shown at *B*, and smooth it. Use a fine stone and one that is straight on the surface. Do not lift the outer edge of the scraper while doing this. Alternate between this position and that shown at *C* until the burr or wire edge is removed. A square piece of wood may be placed against the steel blade, if necessary, to help to hold the scraper upright.

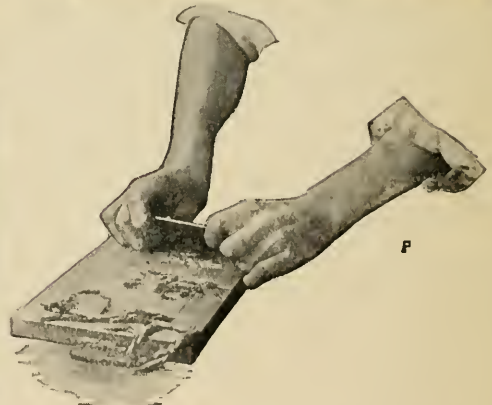
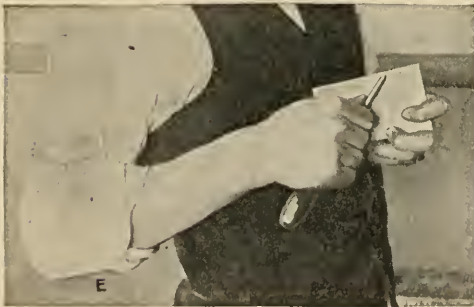

FIG. 8.—Steps in sharpening a cabinet scraper, first by draw filing, second by rubbing it on an oilstone, and third by burnishing it. How a scraper is held in actual use.

Hold a burnisher (the tool sold for burnishing scrapers) or a nail set at about 75 degrees to the flat side of the scraper as shown at *D*. Press hard and push away from you. One firm stroke should be sufficient. If accidentally turned too far, the cutting edge can be raised with the burnisher point as shown at *E*.

Knife-edge or beveled scrapers are sharpened like plane irons and the edge is then turned with a burnisher in the

same way as a square-edged scraper.

How the cabinet scraper is held and pushed is shown at *F*. It should be kept enough to cut fine shavings when held at an angle of from 60 to 45 degrees.

HOW TO KEEP YOUR KNIFE KEEN

Take out your pocketknife, open the most used blade, and hold it vertically before you as illustrated in Fig. 9. Your

back should be toward a strong light.

Scan the edge carefully from tip to base. Is it one long, bluish, indistinct line, so thin that it seems more imaginary than real? Or is the edge in places quite clear and distinct, like a white line? If it is, the blade has lost its keenness. To what extent, you can judge by the width of the white line.

Test it further by drawing the ball of the thumb lightly at right angles across the edge. If you notice a slight clinging effect, the blade is sharp. If it slips over the flesh very easily, it is dull.

Next, draw the edge of the thumb nail along the blade (Fig. 10). A sense of friction indicates that the blade is keen. If there is the most minute nick, the test will reveal it.

There is still another test—one especially valuable when you buy a new knife. Take along a small hardwood block, say beech or maple, and, after picking out the style of knife you want, ask the salesman for permission to cut a thin shaving across the end grain. If the blade is too soft, it will bend over along the edge and a sort of hook will be felt when the thumb is drawn across one side or the other of the blade. If, on the other hand, it is too hard, small particles are apt to break off the edge, leaving it ragged. If the blade is correctly tempered, tough and hard, the edge will remain keen and undamaged.

The best of knives, however, will not long give good service unless they are kept sharp. Deep nicks should be ground out on a grindstone or an emery wheel. Lay the blade flat upon the tool rest so that the edge will come squarely against the wheel. Press lightly and draw the blade slowly and evenly back and forth across the stone.

When you are satisfied that the edge is true, set the rest at the proper beveling angle, or hold the knife freely in the hand at this angle, and grind down both sides, moving the blade constantly across the face of the wheel while so doing. Exert very light pressure so as not to overheat the edge. Water should be

poured on a grindstone during this process, and, in the case of an emery wheel, upon which water is never applied, the tool should be dipped frequently in water to cool it off.

Blades need to be reground only when very dull. Ordinarily it is sufficient to hone them on an oilstone. Indeed, even when they have been ground, the sharpening must be finished on a stone.

Slight nicks can be removed by placing the edge down squarely on the oilstone and working it back and forth. Clamp the stone in a vise or otherwise



FIG. 9 (at left).—Scrutinizing the cutting edge to note the width of the white line.



FIG. 10 (below).—The thumb-nail method of testing sharpness.

fasten it down, if possible, and lubricate the surface with clear oil, kerosene, or a mixture of olive oil and kerosene.

One method of honing is to place the blade across the center of the stone in such a way as to give the longest possible bearing upon the cutting bevel and lay the tips of two fingers of the left hand upon the upper side of the blade (Fig. 11); work the steel back and forth from end to end of the stone, keeping the angle as shown in Fig. 12. While it requires considerable practice to do properly, some experts, instead of holding the blade flat, lift the point slightly above the stone and draw the knife with a slanting stroke so that it is sharpened from heel to point by contact with the stone along a relatively narrow

path near the edge of the stone. This is easier to do than describe, and is so effective that a stroke or two, expertly



FIG. 11.—When honing a knife, take long strokes back and forth on the oilstone, turning the blade at each stroke and sharpening against the edge. In other words, the cutting edge is pushed forward.

given, will sharpen the edge to factory-like perfection.

After honing both sides of the blade, wipe off the surplus oil and test for wire edge by drawing the sides slantwise across the ball of the thumb. If considerable honing has been done, one or the other side of the blade will have a sort of hooked roughness where the exceedingly thin edge has been bent over. This wire edge can be removed in two ways. One method, a rough and ready one, is to hone it down with lighter pressure. The other, for finer results, is to strop it off by "wiping" the blade upon a piece of oiled leather or an oiled basswood block. A mechanic sometimes strops the blade on the palm of his left hand.

Oil the blades and joints lightly with a good grade of thin machine oil. Avoid cutting apples, oranges and lemons with the knife, but, if it must be done, be sure to wipe the juice off with a dry cloth. If water gets into the knife, dry the blades and the interior at once.

To remove rust or discoloration from the blades, rub them with fine emery cloth moistened with kerosene.

Incidentally, notice the uses to which you commonly put your pocketknife so that when you go to buy a new one you will be able to select the size and style of blades that will best serve your purposes.

For ordinary whittling and all-around cutting the spear point blade, called a pen point in the smaller sizes, is considered the best. The clip point is useful for working in recesses and for carving. The bevel point is excellent for cutting paper, cardboard and cloth, and it is also a good veiner and chipper for carving. The sheep-foot point is useful for sharpening pencils, scribing, and some types of carving. The Wharncliffe can be used for the same work, but possesses a slimmer point. The various saber points are for heavier cutting. Farmers, nurserymen and those interested in gardening will find a pruning blade of advantage, and a budding blade has no superior for grafting purposes.

Another important consideration is to buy a pocketknife that will open easily,

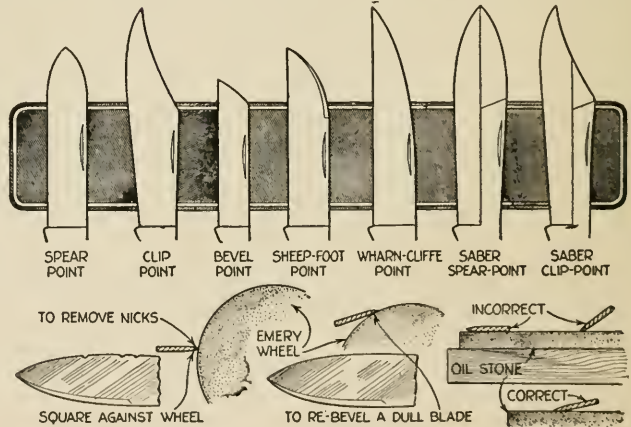

FIG. 12.—Some of the more common shapes for pocketknife and jackknife blades; how to remove nicks and regrind and hone a dull blade.

yet with blades that will spring shut when about two thirds closed.

CARE OF JACKKNIVES

How long does a jackknife last? Statistics show the average knife carried by man abides with him only ten months. This period can be lengthened if rea-

sonable care is taken and if the following suggestions are observed for overcoming the general run of knife troubles. By adopting them you can make your own jackknife stand by you a longer period of time than the average.

it is keen. Whittle out a short handle, as at *B*. Outline the initials with a soft pencil or a sharpened piece of soap. Set the graver as at *C* and push it forward, while, at the same time, you roll your hand from side to side. The rocking cre-

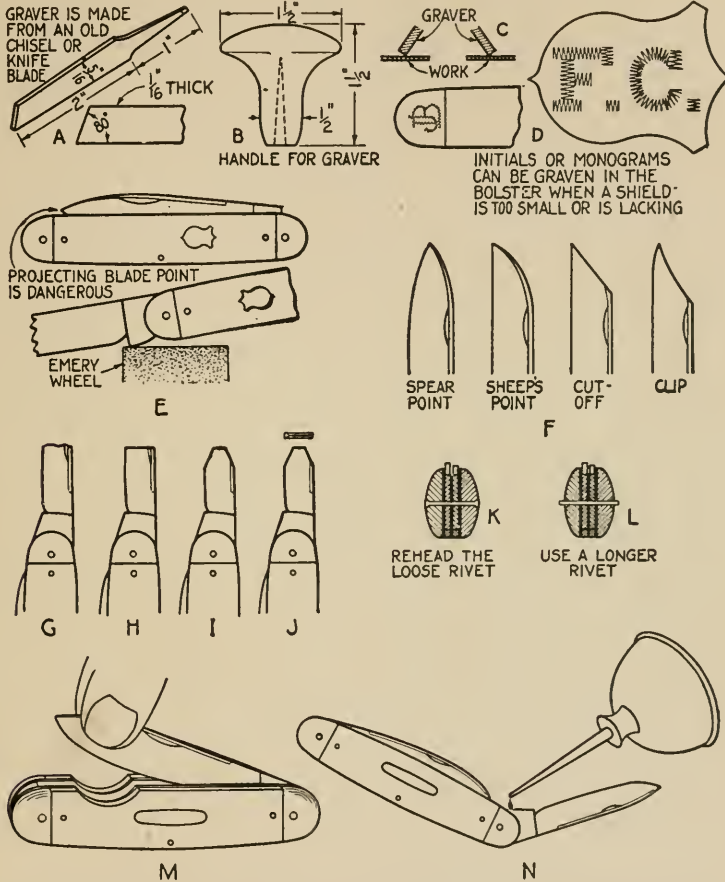

FIG. 13.—*A, B, C,* and *D* show how to make and use a simple graver for initialing a jackknife. *E* shows the method of grinding down a projecting nub of the blade tang; *F*, various points into which a broken blade tip may be ground; *G, H, I* and *J*, the evolution of a screw driver blade; *K* and *L*, how to tighten a loose blade; *M*, how to make a thumb-and-forefinger grip; and *N*, where to oil a sticking blade.

Initialing a Knife. If your initials are on your knife, it is more likely to be returned to you in case you lose it. You can make the graver from an old chisel or any good piece of tool steel. Grind the chisel or blade down to the dimensions given at *A*, Fig. 13, and hone the cutting edge or point on an oilstone until

ates a series of V-shaped cuts, as at *D*. *Projecting Blade Points.* To remedy these it is necessary only to grind or file off the projecting nub of the blade tang, as at *E*. *Repointing a Broken Blade.* At *F* are shown four different points you can produce by grinding and honing a broken

blade tip. You may find that you will like one of these better than you did the original one. Be careful not to draw the temper of the blade during the grinding process.

Folding Screw Driver. When a pen-blade has been broken off too hopelessly for redemption as a cutting tool as at *G*, it can be transformed into a neat folding screw driver for light work. Grind off the broken end until it is square as at *H*, taper the cutting edge and the back edge as at *I*, and slightly bevel the sides of the blade as at *J*.

Stiffening a Wobbly Blade. After a knife has been in use for some time, especially in heavy whittling, the heads of the rivets upon which the blades are pivoted often crumble off. The simplest remedy is to countersink the hole slightly at the loose end, then rehead the rivet in the cavity by using a nail set

or blunt punch as at *K*. Another method consists in withdrawing the rivet and inserting a slightly larger one made from a piece of brass wire or a wire brad as at *L*. This should then be headed at both ends by tapping while the knife rests on a piece of iron.

Providing a Thumb-and-Finger Grip. Sometimes it is desirable to provide a way of lifting the blade of a knife by gripping it with the thumb and forefinger as at *M*. With a round file, make a curving notch about 1 in. wide in the handle of the knife, reducing both wood and lining plates.

Relieving Sticking Blades. You can usually renew the easy action of a blade that sticks by putting a few drops of kerosene oil between the bolsters and the blade as at *N* and working the blade back and forth for a few moments. Repeat the process if necessary.

CHAPTER II

HOME WORKSHOP EQUIPMENT

LACK of space for a workshop or even for a workbench is proving more and more to be a serious difficulty in the average small home. The modern flat or apartment is planned without any thought of giving the handy man a chance to express himself in mechanical work.

The apartment dweller who wishes to use tools does not need to give up in despair, however, nor does anyone else who is deprived of access to a regular workshop or to a workbench. In almost every household there is a kitchen table or other sturdy small table available and if not, one can be bought at a very low price. And in a few minutes' time such a table can be converted into a satisfactory workbench for ordinary work, through the use of a simple, detachable bench top like one of those shown in Figs. 1-8. When the work is completed, the top may be removed quickly and the table returned to the housewife for its customary uses.

KITCHEN TABLE BENCH

Such a bench top consists chiefly of a piece of plank 2 by 12 in. and about 8 in. longer than the length of the table top. Southern pine, Douglas fir, cypress or any other soft wood that is not too expensive is satisfactory for this. It is advisable to get the best grade available and to insist that the piece be dry in order to prevent warpage. If it is ordered surfaced on four sides (S4S), its dimensions will be $1\frac{5}{8}$ by about 11 in., which

is satisfactory. The exact size, however, is of no especial importance.

This plank is fastened to the table with two large C-clamps, one at each end, so placed as to be out of the way as much as possible. It is well to screw two cleats



FIG. 1.—Bench top with quick-acting woodworking vise for use on a kitchen table. The top is fastened on the table with heavy C-clamps.

across the board on the underside, spaced so as to fit snugly against the ends of the table top. These take much of the strain from the C-clamps when planing or similar work is being done.

For the simplest arrangement, two hand screws will form an inexpensive and satisfactory substitute for a regular vise. This expedient, which is illustrated in three views on this page, keeps the

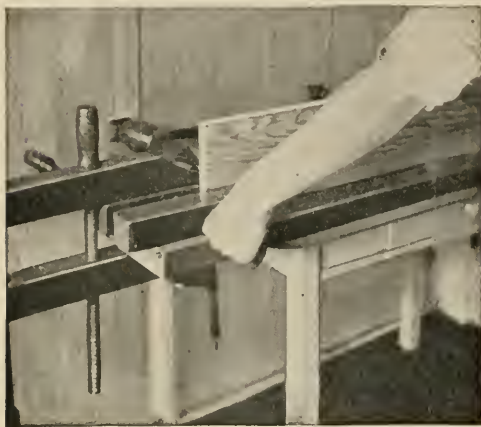

FIG. 2.—Using two hand screws as a substitute for a vise.

top piece clear of cumbersome permanent attachments and makes it easier to store in a small space when not in use. In addition, the hand screws are of frequent use in clamping together work that has been glued, especially furniture.

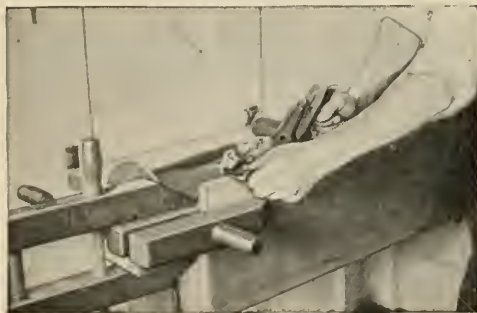

FIG. 3.—How the hand screws are placed on the kitchen table bench for planing wide boards.

Figure 2 shows how the hand screws are applied to the top surface of the bench for planing the edges of boards that are not too wide to be supported in this way.

For wider boards, the screws are placed so that the inner jaw of the hori-

zontal one comes even with the edge of the bench (Fig. 3). Used in this way, the hand screws serve much like the ordinary vise. If the boards to be planed are long, the free end must have some means for support; suggestions for providing this will be given later. When attached as illustrated in Fig. 4, the improvised vise serves well for ripping because the saw can be run down past the level of the bench.

A bench stop made of wood will prove quite satisfactory for this type of bench. Such a stop will also help to keep down the cost to a minimum. It can be made by the common method of sawing a V-shaped cut in one end of a piece of wood and nailing it on the bench at the left-hand end.

A little more time and effort will produce a more satisfactory stop as shown in Fig. 5. This stop is made from three pieces of hardwood $\frac{3}{4}$ by $1\frac{3}{4}$ by 6 in.



FIG. 4.—This method of attaching the hand screws is a useful one when boards are to be ripped.

One edge of each of the two wedge-shaped pieces is beveled to prevent the clamping piece from rising when pressure is applied. If enough taper is put on the pieces, the stop will grip stock varying in thickness from $\frac{1}{4}$ to $1\frac{1}{2}$ in.

Many a home worker undoubtedly will wish to increase the possibilities of this outfit by using a metal stop and a small metal vise. Both of these usually may be obtained at the hardware store. If not, they can be had on special order.

There are several excellent types of stops available, but the kind that is adjusted with a screw driver is preferred

by many because it stays "put." To fit in such a stop, first bore a hole large enough to allow the bar to move freely. Then place the stop in position and mark around the horizontal surface with a knife or awl. The cutting is completed with a chisel, until the top of the plate lies flush with the bench top. The stop is fastened with screws as illustrated in Fig. 6.

The rapid-acting type of vise probably is preferable for a small bench. It may be only 4 in. in length, but one

into account so that it will come flush with the jaw of the vise. Such an apron can be nailed to the edge of the plank or under the edge, according to the construction decided upon; the former is the easier method.

A substitute for a vise that is sometimes used is a block about $1\frac{3}{4}$ by 3 by 8 in., which is cut on a long bevel for 3 or 4 in. on one of the flat faces and screwed against the upper left-hand corner of the apron in such a way that the beveled part forms a V-notch into which



FIG. 5 (at left).—A homemade wooden stop for planing. FIG. 6 (center).—Fastening an iron stop in place. FIG. 7 (at right).—How a rapid-acting vise is fitted. The same vise is shown in use in Fig. 1.

with 6-in. jaws will prove more satisfactory in the long run. These vises are made for tops of $2\frac{1}{4}$ -in. thickness, so for this job it is necessary to build up the thickness by using a $\frac{3}{4}$ -in. piece of wood as a filler.

To fit the vise in place, turn the plank over as shown in Fig. 7. Detach the free jaw of the vise temporarily for convenience in working; then fit the stationary part to the top. Cut back in the edge of the top for the thickness of the jaw, and also make allowance for screwing a thin piece of wood to each of the inside surfaces of the jaws to prevent marring the work.

If an "apron" piece is to be used to hold up long boards as shown in Figs. 1 and 8, the thickness of it must be taken

one end of a board may be pushed when it is to be planed. The board is further supported by two pins inserted into holes in the apron.

When thin stock is to be planed on the surface and you have not fitted a regulation bench stop, you can nail a strip of wood temporarily across the face of the bench board to act as a stop. If you prefer, you can make a removable stop by nailing or screwing a block $\frac{3}{4}$ by $1\frac{1}{2}$ by 4 in. across one end of a thin piece of hardwood $\frac{1}{4}$ by 4 by 12 in. To use this stop, the block at the end is gripped in the vise in such a way that the thin board lies flat across the bench top.

To do smooth surface planing, it is important that the table be rigid. It can

be braced by cutting a stick of wood to reach diagonally from under the left end of the bench top to the juncture of the floor and wall of the kitchen or to any convenient stop on the floor. This brace will resist the tendency of the

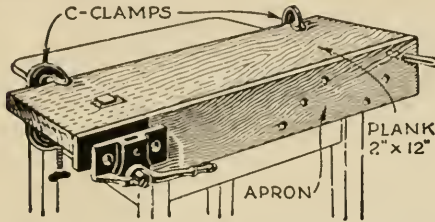

FIG. 8.—One form of portable bench top with an apron, a quick-acting vise, and an adjustable planing stop.

table to sway when the plane is pushed forward.

Because of the bulkiness for storage, it may be better in some cases to omit the apron and use instead a special support constructed like an old-fashioned window stick, having a number of notches to suit boards of various widths.

The completed top with metal stop and vise and with an apron containing a series of holes for supporting long boards is shown in Figs. 1 and 8. With such a convenience the handy man is not prohibited from doing small jobs in repair and construction even though modern civilization has forced him into restricted quarters in which to work.

A PORTABLE WORKBENCH

How one "home workshopper" overcame the obstacle of having no place to work in a small modern apartment is shown in Fig. 9. Lumber from old boxes and crates was used; in fact, the only materials purchased were four hinges $2\frac{1}{2}$ in. wide, four handles for drawers, four casters, five cents' worth of $2\frac{1}{2}$ -in. round-headed screws, and $\frac{1}{2}$ lb. sixpenny nails, costing altogether sixty-nine cents.

The tools used were a hammer, crosscut and rip saws, try-square, plane, ruler, screw driver, and drill.

First the two sides $\frac{3}{4}$ by $11\frac{1}{2}$ by 30 in. were cut, and a piece $\frac{3}{4}$ by $1\frac{3}{4}$ by 19 in. was nailed across the front end of these at the top, and a piece $\frac{3}{4}$ by $3\frac{1}{2}$ by 19 in. across the bottom and extending $\frac{3}{4}$ in. lower than the ends of the sides—to allow for the thickness of the bottom. Two vertical pieces $\frac{3}{4}$ by $1\frac{3}{4}$ by $25\frac{1}{2}$ in. were then nailed to the sides to complete the frame of the front.

The bottom, $\frac{3}{4}$ by $11\frac{1}{2}$ by 19 in., was nailed under the sides, the ends of it being flush with the sides. The back, $\frac{1}{2}$ by 19 by $30\frac{3}{4}$ in., was then nailed on. Before the slides for the drawers were attached, the depth of the drawers was figured out to suit exactly what was intended to be kept in each.

The top was made of $\frac{3}{4}$ -in. stock. One piece 15 by $20\frac{1}{2}$ in. was cut to run from front to back, extending $2\frac{1}{2}$ in. over the front and $\frac{3}{4}$ in. over each side. The other section or layer of the top was made 15 by 19 in., thereby allowing $\frac{3}{4}$ in. on each end for a piece of quarter-round molding 15 in. long. The first board was nailed to the sides, front, and back, and then the skeleton of the cabinet was



FIG. 9.—The apartment-size cabinet workbench ready for use (above) and raised on casters (at left). It can be rolled away and stored in a closet.

inverted on the other board, the grain of which runs at right angles to the grain of the first one; after an allowance of $\frac{3}{4}$ in. had been made on each side for the molding, the first board was screwed to the second. When the cabinet was right end up, it had a smooth top without visible screws or nails. The molding at the ends of the top was next nailed with 1-in. brads.

Now for the most interesting part—the method of mounting the casters on pieces of wood $3\frac{1}{2}$ by $12\frac{1}{2}$ in. that are fastened to the bottom of the bench with hinges set $\frac{3}{4}$ in. from the ends. The width of these pieces is of great importance; it has to be exactly $3\frac{1}{2}$ in. so that when the cabinet is tilted each will flip outward of its own momentum and not hit the floor. If they were too wide, the weight of the cabinet would fall on the hinges and, of course, break them very soon. At this width, the weight rests on the corner of the cabinet, allowing a needed $\frac{1}{4}$ in. before the hinges on the tilted side are opened to capacity.

The casters are ball bearing and have flat tops or screw plates $1\frac{1}{4}$ by $1\frac{3}{4}$ in. with four screw holes. They are set in 1 in. from each side and $1\frac{1}{2}$ in. from the end of the hinged pieces to which they are attached.

This simple device works perfectly. When filled with tools, including the heavy vise, it takes all the strength of two men to lift the cabinet, yet when the casters are set in place under it, the bench can be moved wherever desired with one finger.

SMALL CABINET WORKBENCH

It is all right to do model making or other light work on the kitchen table or at a makeshift bench, but sooner or

later every amateur mechanic feels the need for a real workbench.

Although not large, the bench¹ illustrated in Figs. 10 and 11 will serve ordinary needs for cabinetwork on a small scale, model making, toy building, and household repairs—in fact, all the work that is likely to be carried out by a



FIG. 10.—Planing at the small cabinet bench. Note how a drawer has been partly drawn out to help support the long board.

handy man or an amateur cabinetmaker. In addition, it can be moved from place to place as easily as a piece of furniture.

A workbench must be strong and rigid. The errors of the inexperienced home worker in constructing a temporary bench and the later disappointments from inaccurate and unsatisfactory work are too common to be needlessly repeated. After all, it takes nearly as much material and time to make a poor bench as a good one; the difference is

¹ Working drawings and a list of materials for a somewhat larger cabinet bench than this are contained in BLUEPRINT No. 15 listed in the Appendix.

chiefly in the design and the care with which the work is done. No really expert mechanical ability is required. Accuracy in taking and working to measurements is necessary for the bench must be square and level, but this requires care rather than skill.

The wood to be used depends somewhat upon what your lumber dealer has

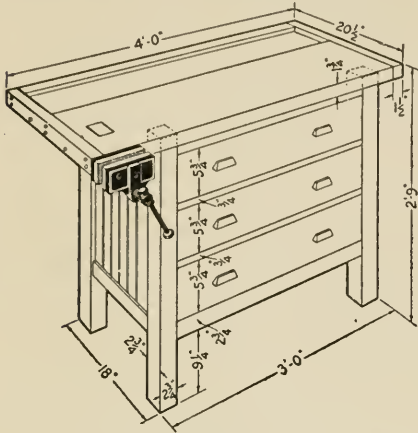

FIG. 11.—The dimensions of this bench, which is shown in use in Fig. 10, are especially suitable for a small home workshop.

in stock. It is advisable to use hardwood for the top piece; but, if the bench is not to have excessive use, hard pine or even Douglas fir will last a long time. All parts except the top can well be of soft wood; indeed, it is perhaps better for the beginner not to attempt to make the framework of hardwood. Your lumber dealer will be glad to suggest the most economical and serviceable woods he has on hand for this purpose. Ask his advice.

Your order, as you will give it to the lumber dealer, will be practically as follows:

Douglas fir (or equivalent), clear, S4S (that is, surfaced on four sides)—1 pc. 3 by 3 in. by 12 ft., for legs; 1 pc. 2 by 3 in. by 16 ft., for rails; 1 pc. 1 by 3 in. by 10 ft., for three rails for drawers; 2 pcs. 1 by 1 1/2 in. by 12 ft. (or blind-stop) for runs for drawers; 1 pc. 1 by 6 in. by 16 ft., for drawer fronts and backs; 1 pc. 1 by 6 in. by 14 ft., for ends and bottom of top recess at the back of the bench top.

Maple or birch, clear S4S—1 pc. 2 by 14 in.

by 4 ft., and 1 pc. 1 1/2 by 2 in. by 8 ft., for the top.

Beaded ceiling, 30 lin. ft., 5/8 by 4 in., for ends and back.

Quarter round, 1 pc. 1/2 in., for tool trough and legs.

Plywood, pine or poplar, 3 pcs. 1/4 by 18 in. by 3 ft., for drawer bottoms.

The thicknesses and widths mentioned are nominal sizes and represent the sizes of the boards before they are dressed at the planing mill. When delivered, 1-in. boards will be a scant 7/8 in. thick, and the width will be about 1/4 in. less than that specified.

If the 2 by 3 in. material and the 1 1/2 by 2 in. hardwood or any of the other sizes are not in stock, purchase a shorter piece of greater width, from which the required parts can be ripped without much extra labor.

The hardware and metal fittings should be purchased at the same time as the lumber. Some of these may have to be ordered, and it is well to allow time for shipment. The following will be needed:

Twenty-two No. 14 flat-head bright screws, 3 1/2 in. long, and 8 No. 12, 2 1/4 in. long.

Sixpenny finishing nails, 1 lb.

Four small iron brackets for fastening bench to floor.

Eight fasteners for fastening top to frame.

Six drawer pulls (wooden ones will do if desired).

Vise, 7-in. jaws, rapid acting, or continuous screw.

Bench stop.

When the lumber has been delivered, the first step is to cut the pieces roughly to the length in which they will be used. Remember that haste makes waste. It is a wise plan to lay out and label each of the pieces before doing any cutting. This is the cutting list:

Legs, 4 pcs. 3 by 3 by 32 in.

End rails *E*, 4 pcs. 2 by 3 by 18 in.

Back rails and lower front rail, 3 pcs. 2 by 3 by 36 in. Other front rails *F*, 3 pcs. 1 by 3 by 36 in.

Top, *G*, 1 pc. 2 by 14 by 48 in. (probably already cut to size).

End cleats for top, 2 pcs. 1 1/2 by 2 by 20 in.

Back edge piece for top, 1 pc. $1\frac{1}{2}$ by 2 by 48 in.

Bottom for tool trough, 1 pc. 1 by 6 by 48 in.

Drawer fronts *J*, 3 pcs. 1 by 6 by 31 in.

Drawer backs *H*, 3 pcs. 1 by 6 by 30 in.

Drawer ends *K*, 6 pcs. 1 by 6 by 18 in.

Drawer bottoms *L*, 3 pcs. $\frac{3}{8}$ by 18 by 36 in.

Runs for drawers *M*, 8 pcs. 1 by $2\frac{1}{2}$ by 16 in.

Guides for drawers *N*, 6 pcs. 1 by 1 by $12\frac{1}{2}$ in.

Ends and back *P*, 18 pcs. ceiling, 20 in. long.

If you can visualize the work so clearly that you know just what each piece of lumber is for, it is not necessary to cut out all the pieces at once; in fact, a workman of experience probably pays little attention to these suggestions and will prepare only the material for the frame. However, it pays a beginner to lay out the pieces in advance as a safeguard against discovering during the course of the work that some boards have been ruined for their purpose by unwise cutting.

In the method of procedure, too, the expert and the amateur do not follow the same steps. One good method to use in making the bench from this point is as follows:

Check up on the legs for squareness. If two adjacent sides can be found that are straight and reasonably square to each other, it is not necessary to do any planing, except possibly to clean the surfaces. If they are not square, it is better to plane them down in order to avoid future trouble.

Mark the two face sides of each leg thus selected and plane the other sides until all are the same size, working from the face corner.

Cut the legs to $31\frac{1}{4}$ in. in length, if the height of 33 in. has been accepted. A rather short person may like 32 in. better, and in that case the legs will be $30\frac{1}{4}$ in. The job then will be carried out exactly as shown in the drawing above, except that the distance below the lower rail will be $8\frac{1}{4}$ in.

It will probably be found that the legs are very nearly $2\frac{3}{4}$ in. square. If not, it is easier to make allowances in the plans than to reduce the legs to the exact size indicated.

True up the 2 by 3 in. rails on one side and both edges, if necessary, and mark the true face and one edge. Next, if a plow plane is available, run grooves the thickness of the ceiling, as shown in Fig. 13, on one edge of all of them except the lower front rail. Place the groove as in detail No. 1 of Fig. 12. If no plow plane is at hand, strips can be nailed on to receive the ceiling after the joints have been made. Cut the rails to such a length that $1\frac{3}{4}$ in. is allowed for a tenon

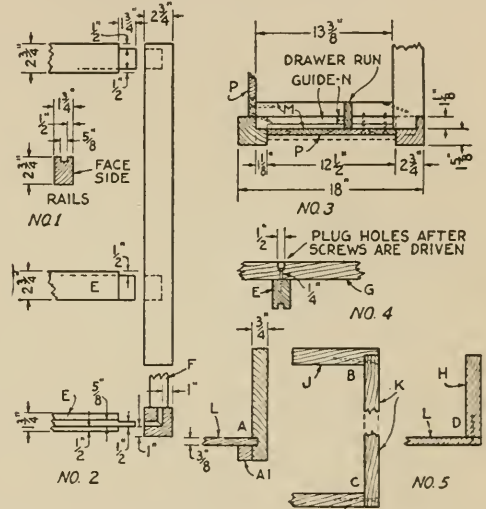

FIG. 12.—Leg and rail joints and a horizontal cross section through one end of the bench that is shown in Figs. 10 and 11; how the top is fastened and details of the drawers.

on each end. Similarly prepare the three light rails for the front.

Lay out the mortises on the legs. Take care to calculate the reduction required on account of the depth of the grooves as shown in Fig. 14. The upper mortise must not come closer than $\frac{1}{2}$ in. from the top of the leg. Use $\frac{1}{2}$ -in. mortises, placed as illustrated in detail No. 2 of the above drawing, Fig. 12.

Bore out the mortises with a $\frac{1}{2}$ -in. auger bit, making holes as close together as possible and the entire length of the mortise. Then clean out the hole along the sides with a wide chisel, and at the ends with one $\frac{1}{2}$ in. wide. In boring, care must be taken not to cut through the leg. A bit gage is a convenient tool to use

for regulating depth. One can be made by boring a hole through a piece of wood of the right length and sliding it onto the bit. Lay out and cut open mortises in each leg to receive the drawer rails and runs as in detail No. 3 of Fig. 12.



FIG. 13.—Using a combination plane to plow grooves in the rails. Strips can be nailed on instead of making grooves.

Lay out the tenons to fit the mortises, using knife, square, and marking gage. Then cut exactly to the lines with a rip saw for end grain cutting and a crosscut saw for side grain cutting. Some workers prefer to cut a distance from the line with the saw and then chisel to the line.

Now assemble the ends and back without using glue, and nail in pieces $\frac{1}{2}$ by $\frac{1}{2}$ in., or quarter-round molding, on the legs as shown in Fig. 15, to receive the ceiling. These strips can be left off until the entire job is assembled.

Cut the pieces of ceiling to length, allowing not less than $\frac{1}{8}$ in. for clearance. Also trim the last piece to correct width so that no delay will occur in the final gluing.

The upper rail on the front is fitted with a dovetail joint as shown in Fig. 16. This is easy to make and adds strength to the bench.

Cut tenons on the ends of the drawer rails to fit the mortises in the legs as shown in detail No. 3 of Fig. 12.

Assemble the ends first, using glue on the tenons but not on the paneling. A good grade of liquid glue is satisfactory. Pull the joints together with bar clamps, if available, and be sure to test the frame for squareness.

It is better to let the ends dry before assembling the whole frame, but if the joints are tight, or if clamps can be kept on the ends, there is no need to wait. Put the two back rails in place, insert the paneling as before; then put the front rails in and set the second end in place. Again, if clamps can be used, the joints can be drawn up tighter. Put the top rail on in front after the frame has been put together.

Now make the top as shown in Fig. 11. The end pieces are glued and screwed on with $3\frac{1}{2}$ -in. screws. The bottom of the tool trough is fitted into the frame



FIG. 14.—Mark the legs by placing the end of each rail in position.

and fastened with screws (or nails) on one edge and the ends, and a piece of quarter-round molding is laid around it to close the joint. A more substantial job would result from making the top piece from narrow strips and running long bolts through from edge to edge, but the treatment shown here is much easier and

makes a strong bench top. Attach the vise before the top is fastened.

Fit and nail the $2\frac{1}{2}$ -in. drawer runs in place against the end and back ceiling; nail through the ceiling as indicated in detail No. 3 of Fig. 12. Fasten the 1-in. guides between the legs and nail through them into the runs.

Attach the top by driving $2\frac{1}{4}$ in. No. 12 screws as in detail No. 4 of Fig. 12. In front, run screws up through the upper rail. There should be no tendency for this top to pull loose, so all that needs to be done is to hold it in place.

Fit the bench stop. In doing this, first bore a hole for the main part, insert the bench stop, scribe around it, and chisel to the lines.

The drawers are easy to make, for now you have a bench to work on. Indeed, the making of the drawers can be postponed, if necessary, for more urgent work, but it is strongly advised to make them at once in order to have a storage place for tools and materials. They will also serve as supports for wide material that is held for planing as in Fig. 10.



FIG. 15.—Strips are nailed to the legs to correspond to the grooves in the rails.

In making drawers, the grooving for the bottoms, as in detail No. 5 of Fig. 12, is the only problem. If no plane is at hand, it is quite possible to nail on strips all around, as at *A*¹ to make a seat for the bottom, and thus eliminate the groove. Or, if there is a commercial woodworking establishment in the neigh-

borhood, you can get the work done there.

The joints at the front corners are usually the half butt or rabbeted type as at *B*, while those at the back can be

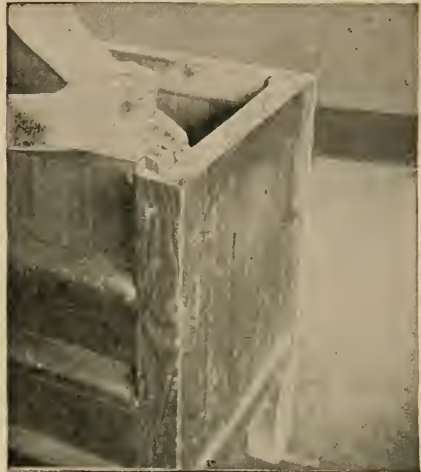

FIG. 16.—The upper front rail is dovetailed into the legs to prevent them from spreading.

plain butt joints as at *C*. The back pieces usually are not grooved, but are cut off in width so that the bottom slides under as at *D*. The bottom is then nailed to the edge of the back. Since plywood does not shrink, many workers now make grooves all around and simply insert the bottom before the drawer is nailed up.

Fasten the bench to the floor with angle braces and put in some hooks on the ends to take care of the bench hook, cutting boards, dusting brush, and other articles that cannot be placed conveniently in the drawers. Also partition the drawers and make definite places for the tools that are to be kept there.

A coat or two of varnish or clear brushing lacquer will help keep the bench clean and prevent glue, stains, and dirt from discoloring it.

HEAVY-DUTY WORKBENCH

Every amateur woodworker and every man who does much household repair or undertakes reasonably large woodworking projects needs a fairly large, rigid

workbench. Wherever there is room available—in the basement, garage, or large attic—the bench illustrated in Figs. 17 and 18 will make its appeal to the worker because of its strength, durability, and simplicity of design and construction.

A bill of lumber is the first concern of anyone who wishes to construct this bench. The wood can be obtained at any lumberyard. Hard (yellow) pine can be used throughout with the exception of



FIG. 17.—A man-size bench of the carpenter's type for the amateur mechanic who does much woodworking and repairing.

the leg at the vise and the vise jaw, which should be made of maple or a similar hardwood. The top also will be better if of hardwood, but the construction will be a little more difficult.

For convenience two separate lists are given: first, the lumber order as it may be turned over to the mill or lumberyard; second, a stock bill showing the actual widths and thicknesses of planed lumber as it comes from the mill and the finished sizes to which the material must be cut by the worker himself. The pieces may vary slightly from the dimensions stated, but the variations will

not materially affect the finished workbench.

The following order of procedure is suggested:

1. Cut the four legs to the required length. (The length indicated in the drawing, 30 in., is a good, standard height.) Attach the vise-screw nut.

2. Cut the two upper cross rails for the ends to the length given.

3. Cut lower rails.

4. Hold all four legs together with a hand screw or other clamp in such a way that their outer edges are exposed. With pencil and square, draw crosslines to indicate the location of the cross rails. The upper rails act also as backs for the tool compartments.

5. Now nail up the two ends for the bench, using glue in the joints for added rigidity, and not less than three eight-penny box nails or common nails in each joint. Check for squareness with a steel square.

6. Glue and nail the piece of $1\frac{3}{16}$ -in. maple on the face of the vise leg as shown in the drawing. This should not be cut to length at this time, but should be trimmed even with the surface of the top after the top is applied.

7. Cut the two aprons to the proper length (first checking the length of the pieces for the top). Cut away from one of them the part displaced by the piece of maple facing on the front leg previously mentioned; then glue and

nail them in place. Use the square frequently while nailing up the frame.

8. Take the actual measurement for the stretcher or shelf that runs between the two lower cross rails. If desired, this can be made to overlap a little at each end for effect. This wide stretcher will serve as a shelf for tools and materials.

9. Cut out the place for the drawer on the front apron. This is best done by boring holes in two diagonal corners of the rectangle to be taken out and starting the cuts with a compass or keyhole saw.

10. Fit one of the 9-in. boards at each

side of this opening, making them also support the top at these points. Before fastening these boards, nail on them the slats which form supports for the drawer.

11. Fit the shelves in the ends, nailing them to the under edge of the cross rails or against these rails as may be determined by the width of the boards and the distance the aprons extend.

12. Joint (plane the edges) and glue up the two planks for the top. Use four $\frac{1}{2}$ -in. dowels for the joint. Care must be taken to mark accurately for the dowels; use a marking gage, knife, and square.

attempt to finish the top end of it until after the vise screw and the follower have been fitted.

16. Clamp the vise jaw in place with the upper end protruding slightly above the top. Locate center of vise screw to coincide with the flanged nut center; bore a hole to allow screw to pass freely, and fasten collar.

17. Now tighten up the vise and bore a series of holes through both jaw and leg in one operation for the follower or "lock strip." These holes should form a slot nearly the full size of the cross sec-

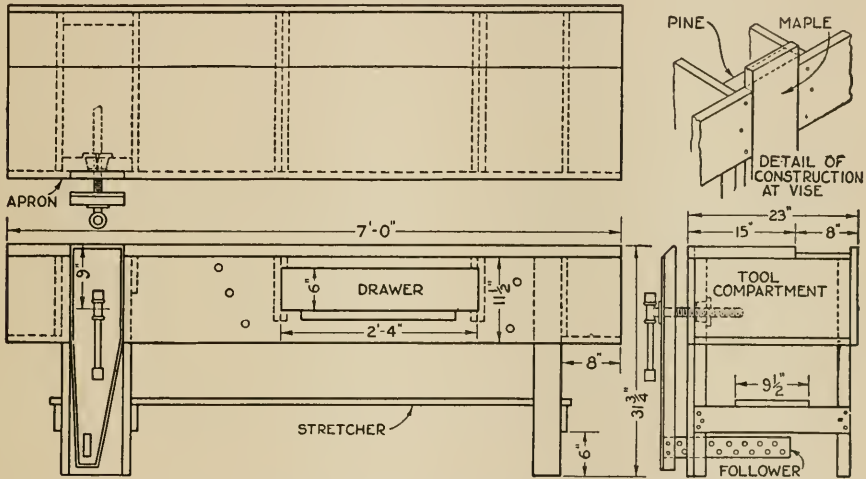

FIG. 18.—Top, front, and end view of the heavy-duty workbench, and a detail of the stationary jaw of the carpenter's vise.

13. Trim the top to the length of the aprons and fasten it with $2\frac{1}{2}$ -in. No. 12 flathead screws. First bore a $\frac{1}{2}$ -inch hole $\frac{1}{2}$ in. deep to receive each screw; then drill a hole right through into which the screw thread will slip easily. Hold the top in place, drill $\frac{3}{16}$ -in. holes into the rails, drive the screws, and glue plugs into the $\frac{1}{2}$ -in. holes.

14. Cut the board for the bottom of the tool trough for length and also for width, if necessary. Nail this in place and nail on the strip along its outer edge.

15. Form the vise jaw to required shape, making it about 7 in. at the top and $4\frac{1}{2}$ in. at the bottom. Plane a bevel on the outer edges of this, but do not

tion of the follower, that is, $1\frac{3}{16}$ by 3 in. Then chisel out for a tight fit in the jaw and a sliding fit in the leg.

18. Bore a series of holes $\frac{1}{2}$ in. in diameter through the follower in a zig-zag pattern about 1 in. apart, as shown.

19. Glue and dowel the follower into the vise jaw, being particular that it is put in square with the jaw.

20. Tighten up the vise, plane off the end of the jaw, and run a bevel on the front side of it.

21. Make the drawer as required by the size of the opening.

22. Cut out a slot in the apron so that the drawer may be opened without using handles.

23. Bore $\frac{3}{4}$ -in. holes in the apron and

MATERIALS FOR HEAVY-DUTY BENCH

<i>What Lumber to Order</i>				<i>Sizes of Finished Pieces</i>					
PART	No. Pcs.	T.	W.	L.	PART	No. Pcs.	T.	W.	L.
Top (pine or maple).....	1	2	8	14 ft.	Top	2	1 $\frac{3}{4}$	7 $\frac{1}{2}$	7 ft.
Bottom for trough and lower cross rails....	1	1	8	16 ft.	Top	1	1 $\frac{3}{16}$	11 $\frac{1}{2}$	7 ft.
Aprons	1	1	12	14 ft.	Top	1	1 $\frac{3}{16}$	1 $\frac{1}{4}$	7 ft.
Shelves, upper cross rails, and stretcher.	1	1	12	18 ft.	Aprons	2	1 $\frac{3}{16}$	11 $\frac{1}{2}$	7 ft.
Drawer	1	1	6	8 ft.	Upper cross rails (end rails)	2	1 $\frac{3}{16}$	10 $\frac{3}{4}$	21 $\frac{3}{8}$
Legs	1	2	4	6 ft.	Upper cross rail....	1	1 $\frac{3}{16}$	5	21 $\frac{3}{8}$
Legs	1	2	10	6 ft.	Lower cross rails (cut from 1 by 8 in. board)	3	1 $\frac{3}{16}$	3 $\frac{5}{8}$	21 $\frac{3}{8}$
Vise jaw (maple).....	1	2	8	2 ft.6 in.	Drawer rails	2	1 $\frac{3}{16}$	9	21 $\frac{3}{8}$
Follower (maple) ...	1	1	4	2 ft.6 in.	Shelves	2	1 $\frac{3}{16}$	8	21 $\frac{3}{8}$
Back for vise (maple)	1	1	8	2 ft.8 in.	Stretcher (cut after bench is nailed up)	1	1 $\frac{3}{16}$	9 $\frac{1}{2}$	6 ft.
Strip for tool trough..	1	1	1 $\frac{1}{4}$	12 ft.	Legs	2	1 $\frac{3}{4}$	3 $\frac{5}{8}$	2 ft.6 in.
Drawer bottom (3-ply)	1	$\frac{1}{4}$	24	24	Legs for vise end (pine)	2	1 $\frac{3}{4}$	9 $\frac{1}{2}$	2 ft.6 in.
Dowels (birch)	1	$\frac{1}{2}$ dia.		18 in.	Backing for vise (maple)	1	1 $\frac{3}{16}$	7 $\frac{1}{2}$	2 ft.8 in.
All dimensions are in inches (and all material is hard pine, dressed four sides) except as noted. This lumber, because of the waste in planing, will be less in thickness and width than stated here; 1-in. boards D4S are about 1 $\frac{3}{16}$ in. thick, for example.					Vise jaw (maple; cut top end after fitting vise screw)	1	1 $\frac{3}{4}$	7 $\frac{1}{2}$	2 ft.5 in.
					Follower for vise (maple)	1	1 $\frac{3}{16}$	3	2 ft.
					Drawer front (pine).	1	1 $\frac{3}{16}$	6	2 ft.4 in.
					Drawer sides	2	1 $\frac{3}{16}$	6	20
					Drawer back	1	1 $\frac{3}{16}$	5 $\frac{1}{2}$	26 $\frac{1}{4}$
					Slats to support drawer	4	1 $\frac{3}{16}$	1 $\frac{1}{4}$	20 in.
					Drawer bottom (cut as needed from 3-ply).				
					All dimensions are in inches except as noted.				

Hardware

- 1 lb. eightpenny box nails.
- $\frac{1}{2}$ lb. sixpenny box nails.
- 1 screw for vise.
- 1 bench stop.
- 1 small machinist's vise (if desired).
- 1 doz. 2 $\frac{1}{2}$ -in. No. 12 flathead bright screws.

All dimensions are in inches except as noted.

perhaps one or two in the rear leg where pegs may be placed to support wide boards on edge for planing.

24. Fit an iron bench stop, placing it about 3 in. from the front edge of the bench top and not nearer than 6 in. from the left end.

WOODEN MITER BOX

To make a wood miter box, proceed as shown in Fig. 19. Plane and face mark one side and edge of the 1 $\frac{1}{4}$ -in. (or thicker) bottom piece; then gage the width as at *A*. Square the edges as at *B*.

Plane the $\frac{3}{4}$ in. thick sidepieces, preferably of hardwood, as at *C*. Gage for

width. Assemble as at *D* with eightpenny box nails, or use screws.

Knife mark 45-degree lines with carpenter's square as shown at *E*. Mark lines down the sides, inside and out, from the extremities of the angular lines as shown at *F*.

Saw both edges at once, as shown at *G*, with the saw that is to be used with the box. An additional square cut at one end is an aid in cutting off squarely stock of small dimensions.

TWO PORTABLE TOOL CASES

The tool case in Fig. 20 holds saws and steel square, and has ample space for planes, level, bit brace, and other

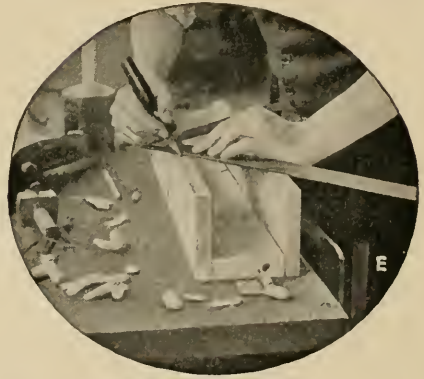
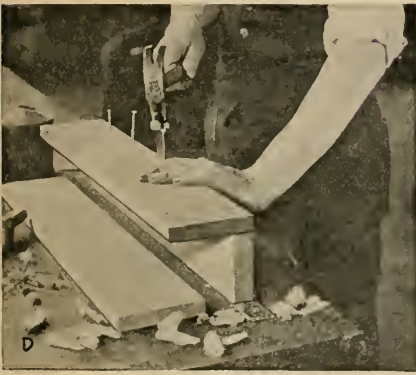

FIG. 19.—Steps in making a miter box of wood. The work must be done with extreme care, and the cuts should be made with the saw which is to be used with the box.

large tools, and two drawers for small tools.

The materials needed are $\frac{1}{2}$ - and $\frac{3}{4}$ -in. thick white pine or other soft wood stock, two drawer knobs or pulls, a catch for holding the drawers in place, and a broom handle or other long, round

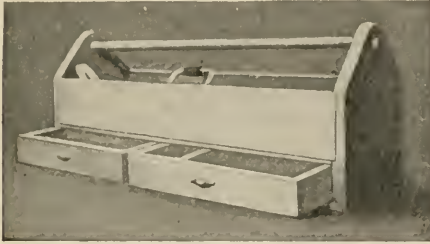

FIG. 20.—This extremely compact and convenient portable tool box has divisions for saws and planes; also two drawers for chisels and small tools.

rod of sufficient strength to support the weight.

The bottom piece is set into a rabbet in the ends, and the front and back pieces also are set in rabbets (Fig. 21). This construction is strong enough to withstand hard usage and even abuse.

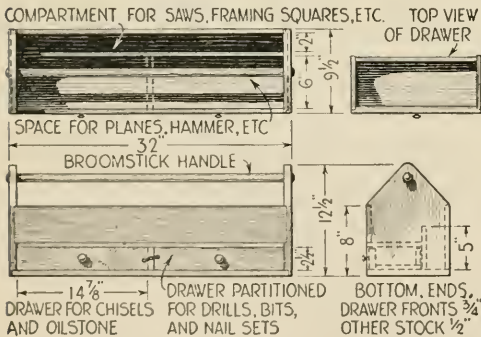

FIG. 21.—The front and end views of the tool-carrying box shown in Fig. 36, and the drawer.

Most boxes of this sort, not being stained or painted, soon become grimy. If you wish to keep the box the natural color of the wood, by all means give it a thin coat or two of white shellac. The pleasure of having a clean, neat looking tool box will more than repay you for this slight trouble.

The popularity of the type of tool case

shown in Figs. 22 and 23 is sufficient proof of its many merits. Although used primarily by the carpenter, it is a fine case for the handy man with his informal set of tools. Its ease of portability makes it useful even to the mechanic who already possesses one or more large chests or cabinets.

The materials needed are: 1 pc. oak $\frac{3}{4}$ by 8 in. by 8 ft.; 2 pcs. oak (3 ply) $\frac{3}{8}$ by 16 by 30 in.; 1 pc. white pine $\frac{3}{8}$ by 6 in. by 6 ft.; 1 tool box lock, 2 tool box clasps, 8 box corners, 3 hinges, 1 leather sample case handle; 42 No. 5— $\frac{1}{2}$ -in. screws, 40 No. 6—1-in. screws and 28 No. 6— $1\frac{1}{4}$ -in. screws, all of the round-headed type; 2 doz. $\frac{1}{8}$ by 1 in. machine screws; 1 package twopenny

FIG. 22.—Another type of tool case, which can be carried easily from one job to another. It is one of the most popular designs among mechanics.

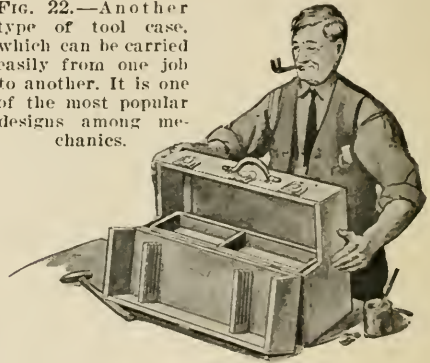

brads. All hardware should be of solid brass.

Cut the 16 in. long end pieces from the $\frac{3}{4}$ by 8 in. piece of oak and the $31\frac{1}{2}$ in. long top and bottom pieces from the same stock. Rabbet the ends of the top and bottom $\frac{3}{8}$ by $\frac{3}{4}$ in. as shown for the joints. Mark the end pieces and the top for the door and saw out with fine saws very carefully. Plane down the other pieces to make up for the saw kerf.

Rabbet the long edges of the top, bottom and end pieces $\frac{3}{8}$ by $\frac{3}{8}$ in. to receive the $\frac{3}{8}$ in. thick side panels flush. Glue up the top, bottom and end pieces and use three screws from both directions, being sure that the case is square. Square one side and the end of the side panels and cut them to size; then glue and screw them in place. One side, of

course, will have to be cut out for the door.

Perhaps it will be best to leave the tray to the ideas and needs of the individual, but it is made to rest on cleats placed on the ends and at the middle of the box so that its upper edge will be flush with the joint of the door. It should be a little narrower than the inside measurements of the box to allow room for the steel square, which will be kept in the back of the box.

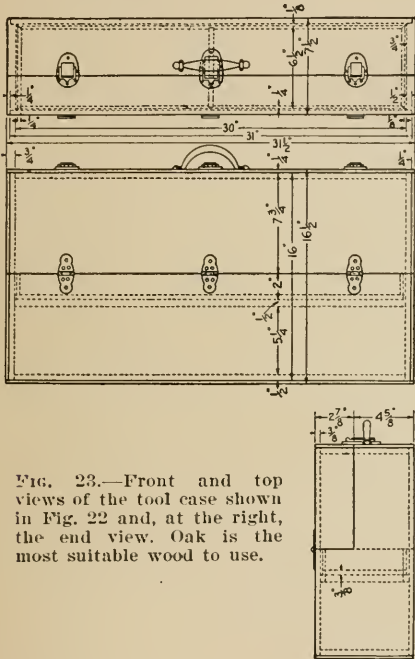

FIG. 23.—Front and top views of the tool case shown in Fig. 22 and, at the right, the end view. Oak is the most suitable wood to use.

Cleats should be arranged in the door to carry the saws. Hooks and other cleats can be installed for holding other tools.

Stain or merely oil the case with pure boiled linseed oil, as preferred. When the wood is dry, use two coats of shellac, rubbing each down with fine sandpaper. Follow with two coats of varnish (on the outside only); rub the first with fine sandpaper and leave the second as applied or rub it with fine powdered pumice and oil, according to whether a dull or glossy finish is desired. For a finish that can be applied more quickly, use stain, one coat of thin shellac, and two coats of high grade, clear brushing lacquer.

Mark the location of the hardware. Use the 1/2-in. round-headed screws for the hinges and corner clips and the 1/8 by 1 in. brass machine screws for the locks, snaps and handle. Rivet the inside ends to make it impossible to open the box merely by turning out the screws.

A LARGE TOOL CRIB

Plywood packing cases are an excellent source of material for the home craftsman. The stock seems mainly to be oak, maple, birch, and poplar. While the plywood is not made quite as well as regular cabinet stock of this kind, nevertheless careful selection will produce some really good sides that will



FIG. 24.—This tool cabinet, made from a packing case, is suspended from the first floor beams in the basement.

answer many purposes. One good use for a case is to form a large tool crib as shown in Fig. 24.

It might be added in this connection that when it is necessary to remove the plywood from the frame of a packing case, a fine saw should be used to cut around the frame on the inside. Sacrifice the little plywood left on the frame in order to get out the sheet in good shape. In selecting cases at the store, look for sides which are as free from imperfections as possible and those whose grain markings are most pleasing. Let the light fall slantingly on the side under examination and look for smooth surfaces, free from many waves.

In the construction of particular work, it is best to use regular cabinet plywood for the exposed surfaces that are to re-

ceive a fine polished finish. For the backs, drawer bottoms, partitions, and any less conspicuous sections, the cases provide far less expensive plywood.

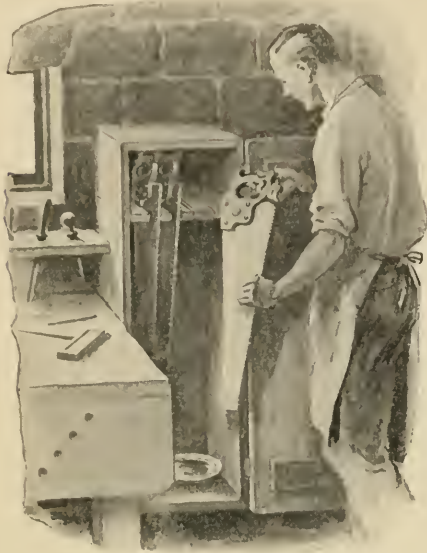

FIG. 25.—The purpose of this cabinet is to protect hand saws from rust and damage.

A few hints on handling plywood: Keep it in a dry place; for although much of it is made with waterproof (casein) glue, it will curve and buckle and the plies may separate if left in a damp place. It is well upon acquiring a plywood case to saw the sides out and lay the sheets flat, one on top of the

other, in a warm, dry place, with a few flat boards upon them for weight. Do not attempt to use a warped piece of plywood in a cabinet unless the frame which supports it can be braced to overcome this, which is usually not possible. In sawing plywood place it on a wide, flat surface, like a large, smooth-top box free from nails, and make the start and finish of the cut by cutting into the box as well as the plywood, in such a way as to prevent splintering the plies.

RUSTPROOF SAW CASE

The case illustrated in Fig. 25 was designed to protect saws from dampness in a basement shop that was none too dry. It is hung on the wall, and a dish of kerosene is kept in the bottom.

Another advantage of a cabinet of this type is that the teeth are not exposed to accidental damage as when the saws are hung on nails in the open shop.

The box can be built of waste lumber $\frac{7}{8}$ in. thick. It is 12 in. deep, $14\frac{1}{4}$ in. wide, and 42 in. high. The saw holder is $12\frac{1}{2}$ by 11 in. with slots $2\frac{1}{2}$ in. apart, running with the grain. There should be a reinforcing cleat 4 by $12\frac{1}{2}$ in. across the underside of the saw holder, at the back. The doors, too, should be well cleated to prevent warping, and hung with three hinges.

Finish the case with stain and varnish, or paint, as preferred.

CHAPTER III

BETTER HOME WORKSHOP METHODS

A MOMENT of great anticipation! The home mechanic removes the clamps from his assembled radio cabinet and prepares to give it a last cleaning before applying the paint, varnish, or lacquer. What does his inspection show?

Does he mutter under his breath and reach for the plastic wood, putty, glue and sawdust, or powdered-brick crack filler, or does he smile with pleasure as he finds every joint tight and the broad surface free from mars? Much depends on whether or not he has done his work "decently and in order."

By taking thought, any amateur woodworker can do craftsmanlike work. Probably as many mistakes come through improper laying out as through unskillful handling of tools.

Lumber, as it comes to the mechanic these days, is generally of uniform thickness and often flat enough for cabinet building. Nevertheless, in the order of the work, it should be treated as if the sides were not parallel.

One side, usually the better, should be lightly marked with an "X" to identify it as a face side. It is against this side and only this side that the try-square is held for testing the edges. An edge, jointed (planed) straight and square, is likewise taken for a working edge; against this the square is held for marking the ends to be sawed off.

The wise amateur avoids a pencil in laying out. He uses a sharp knife or an awl point. A soft pencil makes a line that is easy to see, but there its virtues

end, for a saw wobbling from side to side on it may vary as much as $\frac{1}{16}$ in. A hard pencil is better, but a knife point locates a measurement exactly.



FIG. 1.—Scribing a line along the inner edge of a steel framing square.

When the framing square is used, the marking tool should trace along the inner edge that rests against the wood (Fig. 1) rather than against the outer edge, which does not touch the surface of the wood and therefore allows the point to vary. If carefully sawed along

a well-scribed line, the end of the board will be square with the face edge. The other edge may be located either by accurate measurement at the ends—useful especially if it is not to be parallel with the working edge—or by gaging.

Two difficulties beset the man who joints the edge of a board. The plane may scoop out the center, leaving the

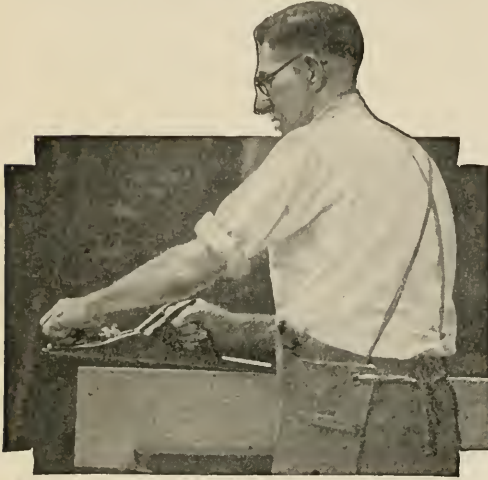

FIG. 2.—How to lift a jointer plane at the end of a stroke to prevent “dubbing” or slightly rounding the corner.

ends high; or more commonly, it may reduce the ends while leaving the center.

In the first case, the jointer plane is probably so dull that it chatters at the start, and the user unconsciously confines his efforts to the center, where the plane rides easily. The remedy is to hone the plane iron and take shavings at the ends of the board until the edge is fairly straight, and then to finish with full-length cuts. In the second, the heel of the plane is dropped at the start, and the toe at the end of the stroke, with the result that gradually the ends become “dubbed” off. If the plane is lifted bodily at the end and carried back, a straight edge is more likely to result (Fig. 2). Incidentally, the wear on the plane iron is cut nearly in half.

Accurate measurements depend upon accurate measuring sticks. If the various parts of a cabinet are measured with a square, inaccuracies in reading may

cause slight variations in the relative length or width of the mating parts, making their assembly difficult or even impossible.

In simple cabinets, it is better to lay out one part and take from it the corresponding measurements on other parts. For pieces that are complicated it is best to lay out a rod (Fig. 3); then measurements are made once for all, and the layout is easily transferred from piece to piece.

In making measurements on the rod, stand the square on edge, so that the division lines will meet the surface of the wood. Locate the points with a knife. Score these lines across the width and label them with a pencil.

An intricate piece, upon which you expect to work for weeks, requires more than a mere stick. For it you should prepare what a cabinetmaker would call a “rod” but what is really a thin board,



FIG. 3.—Laying out a measuring rod for a piece of furniture with the square held vertically.

often as wide as 11 in., upon which a full size sectional plan and an elevation are drawn accurately with a pencil. The edges of the board must be straight and parallel so that a square can be used in drawing the various members.

In sawing, never forget that the blade takes up space. The kerf is usually a little less than $\frac{1}{16}$ in. wide, but is some-

times wider. If the mechanic cuts on the line, he is not sure of the placing, and if the measurement is accurate the pieces will be at least $\frac{1}{32}$ in. undersize.



FIG. 4.—The shoulder of a tenon can be cut more easily if a notch is first made for starting the saw.

For all joints, the proper method is to allow the teeth of one side of the saw to cut the center of the scratch, removing half the line and leaving half on the

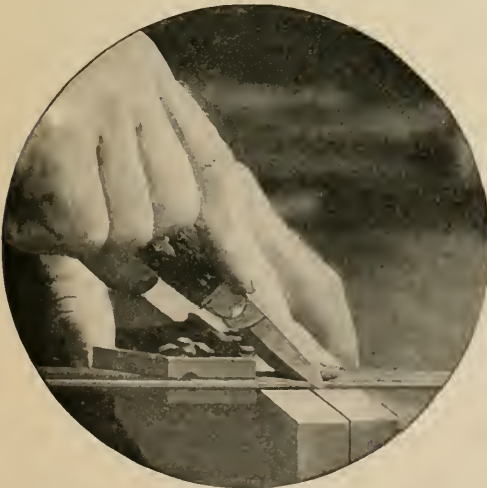

FIG. 5.—Squaring the edges of two boards to locate the position for boring dowel holes.

piece. This keeps the blade in the waste wood, retains a positive working line at all points, and insures a straight cut. If the edge is to be dressed after being sawed, the cut may be made a trifle to

the side—enough to allow two or three shavings to be removed before the center of the line is reached.

In starting a side cut for a dado or for the shoulder of a tenon, it is often helpful to cut the starting corner with a knife, notching it in the waste wood (Fig. 4). This gives a starting point for the saw and prevents it from dancing around on the surface before biting in.



FIG. 6.—Boring a dowel hole with a block of wood on the bit to serve as an improvised depth gage.

If two boards are doweled together, it is most important that the face edges come smoothly flush. This requires great accuracy in the location of the dowel holes. Clamp the two pieces together, joining edges up, with both face sides out, and square across the edges to locate the holes with reference to the length (Fig. 5). With a gage set to center on the thickness of the wood, scratch across these lines from the face side of each board. As the head of the gage bears against the face sides, any variation from the center on one piece is duplicated on the other. If the boring is true, the faces must be in line when glued up.

Since the grain of the wood will "lead"

the bit point, it is well to center-punch the intersection of the marks with a nail or a nail set so that the bit will start accurately. A bit gage or a wooden block bored to slip over the bit, is a help in boring the holes to a uniform depth and eliminates the danger that some of the dowels will strike and prevent the joint from closing (Fig. 6).

Another precaution: a small amount of space at the bottom of the hole must be allowed for imprisoned excess glue. Glue is no more compressible than water



FIG. 7.—Whenever wood must be hammered, use a soft block of waste wood as a protective cushion.

and is too thick to ooze past the dowel pin; if, then, the clamps are screwed tightly enough, the glue will expand the hole by splitting the wood.

The assembling of cabinet parts often requires them to be tapped with a hammer to force the joints together. Every hammer blow, however light, means a bruise on the wood, unless a block of soft wood is used as a buffer between the hammer and the work (Fig. 7). Blocks should also be used under clamp jaws.

Scratches and mars on the piece seem inevitable, but much ordinary scuffing is avoidable. Only necessary tools should be

rested on finished surfaces of the wood. Touch the square gently to the surface; and do not lay a saw on the board at all, for when the tool is picked up again the teeth will surely scratch. Before laying a smoothed side against the bench top or sawhorse, be sure that all shavings, sawdust, and splinters have been swept away.

Most cabinets should be sponged with warm water before the final sanding; this process not only swells flush any small bruises, but raises the grain. When the grain has been sandpapered down again, it will not be affected to any great extent by the application of the stain, which otherwise might raise it badly. Deep bruises often can be steamed out with the aid of wet blotting paper and a hot flatiron.

HINTS ON DRIVING NAILS

Hammer and nails are in common use in every household. Yet driving nails, the commonest of all mechanical operations, is not often done in such a way as to get the full holding power of the nails. A few plain facts about nails and their uses



FIG. 9.—“Toe-nailing” (at right) calls for more practice.

FIG. 8 (left).—Handling a hammer for straight nailing. Note that it is gripped near the end.



would, if they were carefully observed by the amateur woodworker, decrease the difficulties encountered and save much effort and subsequent disappointment in the failure of joints.

The proper way to hold a hammer is the first important thing to learn. The amateur has the natural feeling that the less of the handle he uses, the less likely he is to miss the nail. The truth of this is not borne out in practice, however, for

after one has become accustomed to holding the hammer handle at the end, as shown in Fig. 8, he will miss the nail if he tries the former method. It is safe to assume that the manufacturers of any good hammer know something about the best length of handle to use.

The angle of a nail hammer or the "hang" of it will have to be sensed from experience. It will not take long before a person will automatically hold his hammer handle just low enough as the hammer strikes the nail.

Sometimes an otherwise good hammer seems to slide off the nail. At such a time it will be a good thing to rub the face of it on a piece of fine sandpaper, for it has probably become greasy.

For ordinary use, a bell-faced hammer (one with a convex driving surface) will prove the most satisfactory; it will not mar the surface when the nail is "driven home." The weight of the hammer is partly a matter of choice, al-



FIG. 10.—The proper way to use a hammer when drawing a nail.

though the tendency of the amateur is to try to use a hammer that is too light. From 12 to 16 oz. is the common range, depending upon the required use.

Sharp, decisive blows will produce best results, and confidence on the part of the driver will keep nails from bending.

"Toe-nailing," as shown in Fig. 9, is somewhat more difficult than straight

driving. For this it is better whenever possible to start the nails before the pieces are in the final position. Care must be taken not to slant the nails too much or they will not reach the second member properly. This is a common error of the amateur. After some practice one can drive the nails very close in a corner without scarring the wood.

Pulling a nail requires just as much care as driving one. The extra large sup-



FIG. 11.—A block under the claws of the hammer is necessary in drawing long nails.

ply of hammer handles at the hardware store is kept principally for those who have not learned how to pull nails. The main thing to bear in mind is the necessity of keeping the fulcrum near the nail. This is taken care of by the shape of the hammer when the head of the nail is close to the wood as in Fig. 10. In this way great pulling power is applied by only a few pounds of pull, and the handle is safe.

It is after the nail comes up a distance and the fulcrum shifts toward the face of the hammer that the handle is in danger, both from less mechanical advantage and from the fact that the pull ceases to be vertical. At such a time the wise operator will take time to find a block to put under the hammer as shown in Fig. 11.

There is a trick in "setting" nails that it takes a little time to develop. Most amateurs make a big ugly hole around the head. Figure 12 shows the proper way to hold the nail set. Steady it with

the fingers against the wood so that it will not slip; then make a decisive blow so that the nail goes down below the surface. After that it is easy to drive it as deep as desired without trouble.

In Fig. 13 is shown how to draw pieces into position by the use of nails. The nail is started at an angle from the higher piece, with a crevice left open between the two until the nail has caught the second member. When the



FIG. 13 (right).—Skillful nailing will draw uneven parts into place.

FIG. 12 (left).—How the nail set should be used. The fingers of the left hand prevent it from slipping.



the first piece of wood if two pieces are to be held together as in Fig. 15.

A smaller bit or drill matched to the size of the root or core of the threaded



FIG. 14.—Placing the bit on the shank of the screw to obtain the correct size before boring.

part, but no larger, is used to bore to the entire depth of the screw. If this is not done the screw will often break before it is fully driven in place. In soft

nail is driven in, the joint is closed and the lower piece is drawn up into position.

It is well to bore a hole in the end of the hammer handle with a $\frac{1}{2}$ -in. auger bit and fill it with soap. After dipping the tip of nails into the soap, the driving becomes much easier.

WOOD SCREWS

“What is there to be said about driving wood screws?” the beginner in wood-work is apt to ask. But the old mechanic and those who have studied the results of recent laboratory tests on the holding qualities of screws, know that a good deal can be said.

In all hard woods, two sizes of bits or drills should be used in boring for screws. The larger one should be from 80 to 90 percent of the diameter of the shank of the screw. After some experience, one can gage the size by placing the drill on the shank of the screw as shown in Fig. 14. With this drill, a hole is bored to the depth of the shank or entirely through

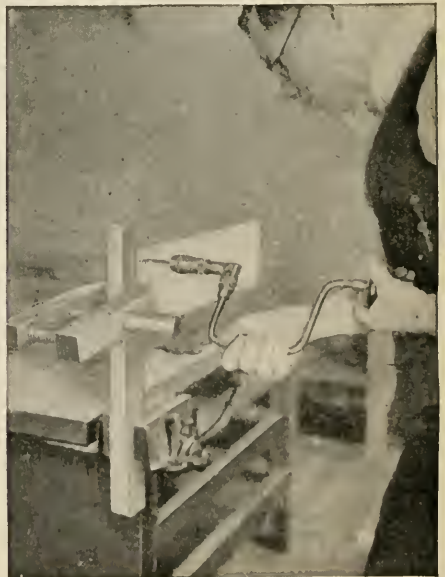

FIG. 15.—Before driving screws, it is of primary importance to know what size holes to bore for them.

wood, smaller drills can be used and a hole of the same size throughout is often satisfactory.

When an attempt is made to fasten two pieces of wood together without adequate boring, the joint sometimes cannot be pulled tight because the shank of the screw will not slide in the first

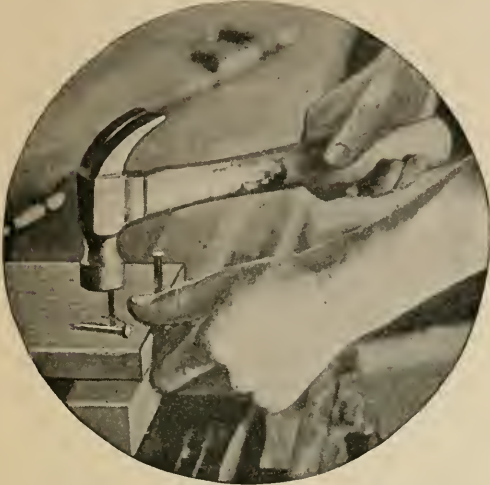

FIG. 16.—Hammering a screw part way in is not as bad practice as is commonly thought.

or uppermost board. In such a case the only remedy is to remove the screws and bore larger holes for their shanks.

A small amount of lubricant, usually soap, placed on the threads of a screw, will make it easier to drive and help prevent breakage. Tests have proved that the holding power of the screw is not appreciably diminished by this practice.

A countersink should always be used to make a seat for flat-headed screws.

To drive screws a part of the way with a hammer, Fig. 16, is not so vicious a practice as some would believe, for scientific tests seem to indicate that the holding power of a screw is slightly increased by being so treated, provided it is not driven too far. The blow of the hammer bends the fibers of the wood downward around the screw and in this position they offer additional resistance.

The use of a screw-driver bit in a brace is shown in Fig. 17. Such a tool facilitates the driving of all larger screws.

Care must be taken, however, not to drive the screws too tight, for the mechanical advantage of the brace is great. Other things being equal, longer screws have more holding power than shorter and heavier ones. Screws inserted in end grain will not hold more than 75 per cent as much as those in the side grain, therefore use longer screws.

HOW TO USE GLUE

In building and repairing, glues play such an important part that we should know more about these sticky substances and how to use them so that the articles made or mended with their aid will hold together under all reasonable conditions of everyday use and even abuse.



FIG. 17.—Using a brace and bit makes easy work of driving a screw.

Glue has been used for many centuries. Back in the days of the Egyptian pharaohs it was used to build beautiful veneered work. Through the centuries its uses have been multiplied.

Like the earliest glues, the bulk of those made today are from scraps of the hides, the fleshings, and the bones of animals. They are sold in ground, flake, and sheet forms.

Liquid glue usually is made from fish stock, which is washed and cooked in a similar way to animal stock. A very in-



FIG. 18.—Weighing both the dry glue and water is necessary to obtain the best results.

teresting characteristic of glue made from fish stock is that the gelatine or extracted glue does not jell, but remains in a fluid state at ordinary temperatures.

Cheap liquid glue should be avoided, because it gathers moisture. It contains large amounts of salts, such as sodium chloride or common table salt. These salts absorb moisture just as salt on the table will do and on a wet or humid day the glued materials are apt to fall apart.

Good liquid glue has many advantages over other adhesives for use in the home workshop. It is purchased ready for use, so no weighing, soaking, or heating is required. On account of its slow setting quality, the workman is given ample time to get the joints properly together, whereas with hot glue the work must be done quickly before the glue sets or jells. Slow setting also means good penetration of the glue into the wood and added strength. When strength is compared, good liquid glue is as strong as good animal glue.

During the war, glues made from

casein were developed rapidly. Casein glues come in dry powder form and are prepared simply by stirring into cold water. They make a strong, moisture-resisting joint. For glued work exposed to outside weather conditions they have no superior. They are used universally in building airplanes.

There are other so-called glues made from starches, dextrines, and blood albumen, which are used commercially for many purposes.

To obtain the best results with glue in the home workshop, we must have certain equipment. This should include a can of the best quality liquid glue, some high grade cabinet flake glue, a jacketed gluepot, two glue brushes, a cheap dairy thermometer, clamps, and hand screws.

Gluepots can be purchased at any hardware store. The outer vessel is filled with water and heated over a gas-burner or stove. There are more expensive pots heated by electricity.

Good bristle glue brushes with brass ferrules cost from 60 cents to \$1 each, according to size. However, a basswood stick soaked in water for from two to three days and hammered so that the end fibers become separated makes a good substitute. As the end wears away, more of the fibers can be separated. If a brush gets hard, soaking it in water will restore it to its soft condition. The dairy type of thermometer costs about \$1. Carriagemakers' iron clamps and carpenters' hand screws cost from 40 cents up.

The various utensils used with glue should be cleansed carefully and frequently with boiling water. Any small amounts of spoiled glue remaining in the gluepot or on the brushes greatly weaken and sometimes ruin fresh glue.

When liquid glues are set aside after use, the containers ought to be closed tightly. If through evaporation the glue becomes too thick, dilute it slightly with clean, warm water. Do not use vinegar.

Ground, flake and sheet glues should be kept in a clean, dry place, preferably in a tightly covered container of some sort.

In preparing dry animal glues, the glue should be soaked until soft in clean, cold

water. It always should be stirred *into* the water to insure complete soaking. Sheet glues should be allowed to soak at least 12 hours; flake glues, from 4 to 9 hours, according to thickness of the flakes; and ground glues from 2 to 4 hours. It is advisable to let them all soak overnight or prepare them in the morning if they are to be used during the evening.

The amount of water depends upon the grade of glue. The water-taking quality of hide glues varies from $1\frac{1}{2}$ to 3 parts of water to 1 part of glue. Medium grade hide glues take $2\frac{1}{2}$ parts of water to 1 part glue by weight. While bone glues are not recommended for wood jointing, sometimes they are used and they take only from 1 to $1\frac{1}{2}$ parts of water.



FIG. 19.—A dairy thermometer may be used to avoid accidentally heating animal glue beyond 150° F.

Both hide and bone glues have a wide range of grades, but it pays to use the best glue obtainable.

It always is best to weigh the glue and water each time after the right proportion has been determined (Fig. 18). Glue cannot be prepared by guesswork. Animal glue should not be too thick. It is necessary for glue to penetrate into the articles to be glued in order to bind them together. If too thick, it jells on the surface.

Scales were not mentioned in the list

of equipment as they are expensive. Usually a local store will allow you to weigh your glue.

After soaking, the glue should be dissolved in the gluepot. If the soaking is complete, the glue will melt readily. If all the water has not been absorbed, leave it with the glue in the pot. Be sure there is water in the jacket of the pot.

Place the thermometer in the glue and be sure the temperature does not rise above 150° F. (Fig. 19). Glue does



FIG. 20.—Hot glue always should be applied freely to both edges of the wood to be joined.

not have to be "cooked" to make it sticky. Heat is simply to dissolve it and to keep it liquid. When the temperature rises about 160° F., glue rapidly loses strength and if this temperature is continued for some time, the glue is ruined.

Casein glues of good grade usually are prepared by stirring rapidly 1 part of glue into 2 parts of cold water by weight. Continued mixing is required until all lumps are broken up. The mixture should stand from 15 to 30 minutes for the completion of the chemical action. Only enough glue for the day should be mixed, as these glues become solid like a piece of cheese after about 12 hours.

The preparation of the articles to be glued is important, especially if wood. The joint should be clean and dry. No wood that has not been thoroughly kiln dried should be used with either animal or fish glues. Wood not thoroughly dried can be glued with casein glue.

The wood should be jointed perfectly before applying glue. Uniform contact between the two pieces must be assured. Brush glue on quickly and vigorously and apply it to both parts to be joined

(Fig. 20). Then clamp the work tightly so as to force the joint together and allow the glue to dry.

When repairing furniture and other articles that have been glued previously, scrape away all old glue and have the joints perfect again before gluing.

In cold weather it always is well to have the parts warm before applying the glue. Animal glue sets quickly and if it jells before the wood comes together



FIG. 21.—Liquid glue should be brushed on vigorously and all parts of the joint well covered.

firmly, the joint is worthless. When the wood is warm, it retards the "set" and gives the glue a chance to penetrate.

When prepared liquid glue is applied to a joint, it is quite possible to obtain good results by giving one coat of glue to the parts and pressing them together immediately. This is the common way of using liquid glue, but it is not the best way. A little additional pains will insure a very much stronger joint.

First apply a thin coat of liquid glue and allow it to penetrate into the wood. It is not necessary to thin or dilute the glue; simply brush it out thinly. Then apply a second coating and allow the glue to become "tacky" to the finger before pressing the joint together and tightening the clamps, hand screws, wedges, or whatever means of pressure is to be used.

Liquid glue should not be heated except in cold weather when it has become chilled and is too thick. If the glue then is warmed or heated to a temperature not exceeding from 100° to 120° F., it is in no way injured. It is a common cus-

tom when liquid glue is purchased in a can to place the container with the chilled glue in a pan of hot water (Fig. 21). It soon becomes liquid enough to apply on any material.

When hot animal glue is used, coat the wood freely on both sides of the joint, press the parts together, and clamp immediately.

When glued wood is placed in the clamps or presses and these are set up (Fig. 22), the surface glue is squeezed into the wood as well as out to the surface of the joint. If the proper pressure is applied, the surplus glue is eliminated—that is, the surplus that is not pressed into the grain of the wood. When a joint is broken, no surplus glue should appear on the broken parts. The glue should be forced into the wood or squeezed out.

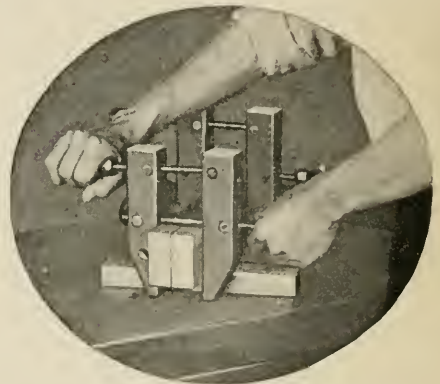

FIG. 22.—In using hand screws, keep the jaws parallel with the wood and use moderate pressure.

Casein glues should be applied to both sides of the joint and clamped. Plenty of time can be taken to do this, as these glues set slowly. It is well to wipe off whatever surplus glue is squeezed out in clamping, as casein glue dries like flint.

In setting up wood in the clamps or hand screws, only enough pressure should be used to bring the two pieces firmly together. Too much pressure squeezes most of the glue out. The wood should be allowed to remain in the clamps 24 hours in a dry place.

There are many other purposes for

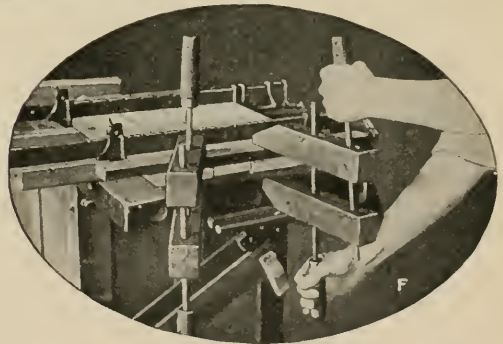
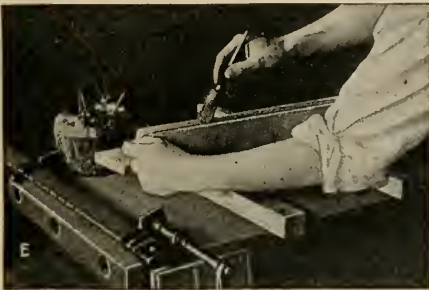
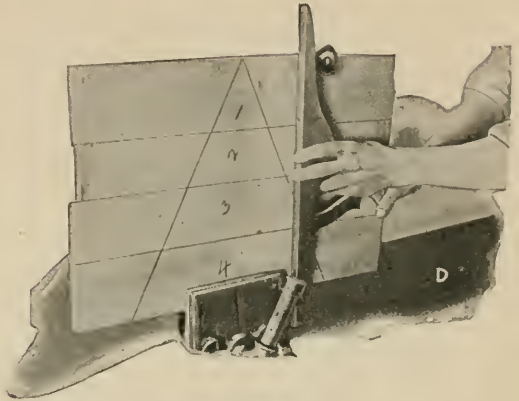

FIG. 23.—How to glue boards together: arranging them, planing, testing for trueness, applying the glue, and clamping.

which glue can be used in the home workshop, such as for sizing different materials to give them body and also to cover a surface so that other materials to be applied will not penetrate. Much liquid glue also is used in the preparation of plastic art clays, often called "gesso."

The preparation of gesso is not difficult. Mix 1 gill of liquid glue, $1\frac{1}{4}$ cups of whiting, and 3 teaspoons each of linseed oil and varnish. These will give about 1 cup of high-grade gesso when mixed. If the paste is too thin, add more whiting.

Gesso is used for plastic or modeled decorations on picture frames, novelties, and furniture. It can be applied with a

brush or by means of one of the tools ordinarily used in applying decorative frosting on pastry.

GLUING BOARDS TOGETHER

The first step in gluing boards together to form table tops or wide pieces for other purposes is to arrange them with reference to color and grain. Put the wider pieces toward the edges, if possible. Mark two lines across in V shape

as shown in Fig. 23 at *A*, and number the boards.

The inside edge of the first board at either side is planed straight and free of "wind" as at *B*. No squaring is needed as the facing edge is to be planed to the corresponding angle. Have the plane sharp. Note how the jointer plane is held parallel to the edge and how the fingers of the left hand help to keep it steady. When the edge of the next board has been planed, the joint is sighted as at *C*. At the ends the joint must be absolutely tight and true; the middle may be slightly open. When each joint has been planed, the whole piece is set up and tested for straightness as at *D*.

Two pieces are laid across the bench to support the work as at *E*. Clamps are adjusted for length before glue is applied. If the shop is cold, the joints should be warmed, but not made hot. Use freshly made glue of the best quality. If flake cabinet glue is used, it should be soaked beforehand in cold water. A good grade of liquid glue will serve, but warm the tin in water. Do not clamp too tightly. Level the joints on the face side with a mallet, or a block and a hammer. The glued-up boards are kept straight by the use of wooden cross-pieces and hand screws as at *F*. These are put on each end of the work. The work is left for about 24 hours so that the joints will dry thoroughly.

PLANING A BOARD ACCURATELY

Surface planing should be done, if possible, with strokes made the whole length of the board, as shown in Fig. 24 at *A*. If the board is wide, "cross plane" it first; then start at one edge, letting each shaving partly overlap the previous one until the whole surface is covered. Repeat, working back to the first edge.

Test the surface with the edge of the plane against the light as shown at *B*. Also test from corner to corner to detect twist or "wind." If the board is large, this is done on the bench, using a straight edge, if the plane is not long enough.

Plane the end as at *C*, after one broad surface and one long edge have been

planed. The long planed edge is toward the worker. Note that one corner is chiseled off to prevent the wood from splitting. When the edge is planed, the chiseled corner disappears.

Test with the square as shown at *D*. The end must be tested both from the broad surface and the long edge. Hold the handle firmly against the surface and let the square down slowly. The last plane stroke must be right across.

Gage for thickness as at *E*. Hold the marking gage firmly against the wood and tilt the bar forward. Mark both ends and edges. When planing, put the rough end against the bench stop.

Mark to length as shown at *F*. Lay the rule on the surface, locate the knife at the correct point, then move the square up against knife. For accurate work, draw the lines all around the board.

Saw the board $\frac{1}{16}$ in. beyond the knife line as shown at *G*, to allow for truing the end with the plane by the method previously used.

Mark to width as shown at *H* when a board is too wide for the gage.

PLANING A HARDWOOD SURFACE

If you have a glued-up hardwood surface to plane, first support it firmly on the bench against one or two strips thinner than itself as shown at *A*, Fig. 25. It is essential, too, that the bench be absolutely rigid. If your bench happens to give when pushed against, brace it in any convenient way.

Level off diagonally at *B*, and then plane straight with a jointer plane.

Adjust the smooth plane blade and back iron by holding the sharpened iron as shown at *C*, and pushing the cap forward with the thumb until the cutting edge appears no wider than a thread. Hold it in place with the left hand and tighten the screw.

Plane lengthwise with the smooth plane as at *D*. Have the iron exceedingly sharp and adjusted accurately to make the thinnest possible shavings.

Scrape the surface with the grain, but at a slight angle as at *E*. Sharpen the

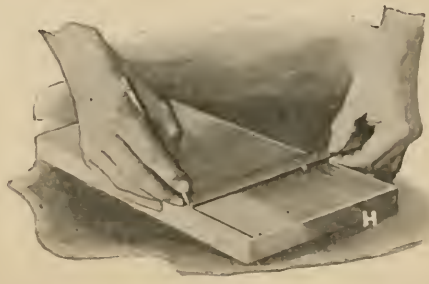
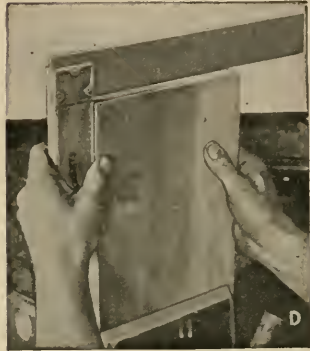

FIG. 24.—Steps in planing a board accurately. Testing the surface and ends for trueness, gaging for thickness, sawing off to length, and marking for width.

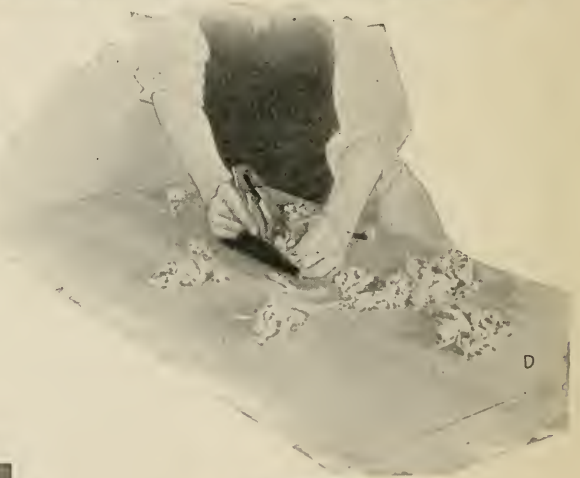
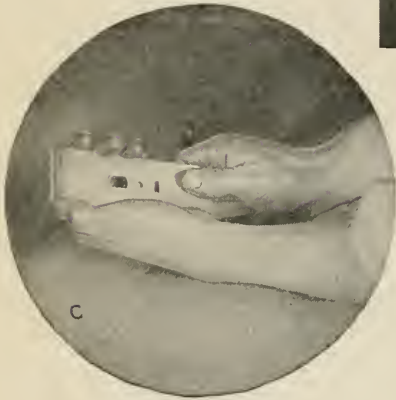
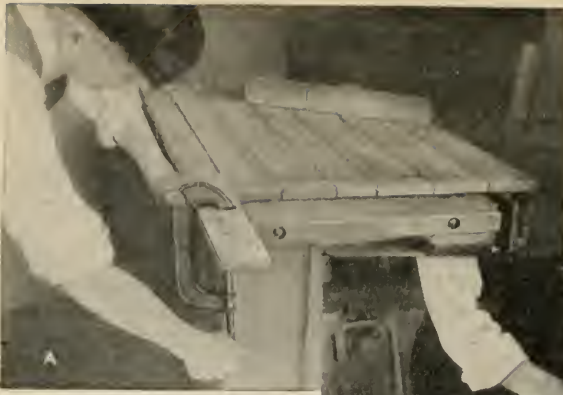

FIG. 25.—Planing a glued-up hardwood surface. Methods of leveling, adjusting the smoothing plane blade, using the cabinet scraper, and sandpapering.

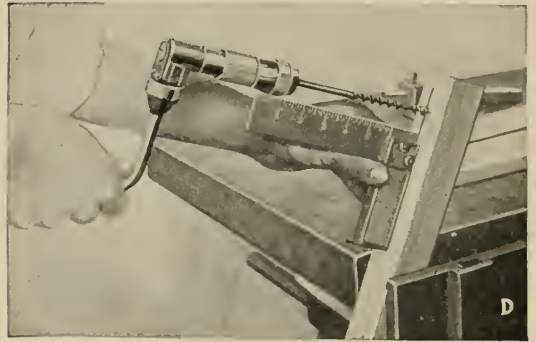
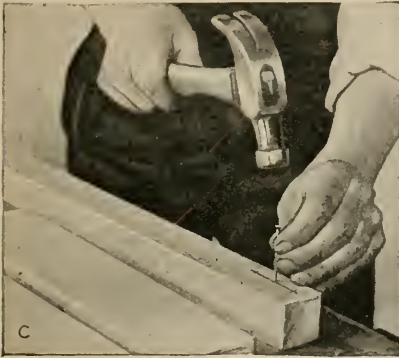
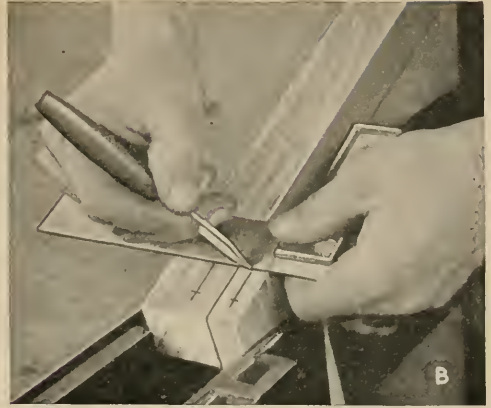
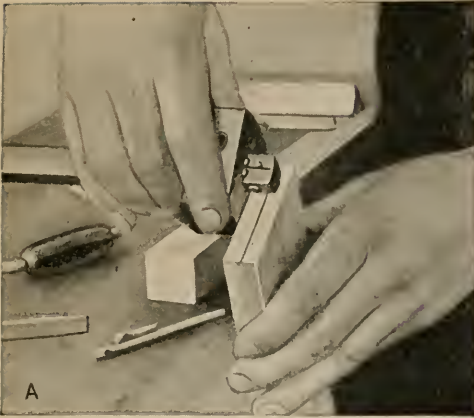

FIG. 26.—How to make doweled butt joints. Gaging and marking for the dowel holes, boring them, making the dowels, and testing the joint.

cabinet scraper by the method described and illustrated on pages 17 and 18.

Next sandpaper with No. 1, $\frac{1}{2}$, or 0 paper, depending upon the wood and quality of surface desired. Wrap the paper around a block and make straight strokes back and forth with the grain as at *F*. Crosswise or circular strokes are

certain to leave scratches that will later show through the polish.

DOWELED BUTT JOINTS

The doweled butt joint is useful in building screen frames, doors, furniture, and many types of glued woodwork.

After the pieces have been squared, the first step is gaging center lines for the dowel holes. Do the gaging from the face-marked sides as shown in Fig. 26 at *A*. If you are making a table, for example, mark the rails first; then reset the gage for marking the legs.

How to mark the location of the dowel holes is shown at *B*. The corresponding rail and leg are gripped temporarily in the vise and cross lines are scratched on with a knife. Accuracy is the prime consideration at this point if a square, tight-fitting joint is to result.

Marking the centers is shown at *C*. A fine finishing nail is used as a prick punch to make a place for the spur of the auger bit. If this is not done, the grain of the wood may throw the bit out of line before the spur has taken hold. Another method of marking two pieces is simply to place common pins on one part and press the other part on the first in the correct position.

Boring the dowel holes is illustrated at *D*. A try-square if used when boring serves to test the angle of the auger bit and in a measure indicates the depth of the hole. Note the advance of the chuck along the blade to tell how deep the point of the bit has gone in. Set the table leg at an angle in the vise to allow the knob of the brace to go against your body. Get each hole as nearly perpendicular as possible. In the average work a good depth for the holes is about $1\frac{1}{8}$ in. for 2-in. dowels.

Making the dowels is done as at *E*. If they are not purchased ready-made, the wooden dowels must be made of straight-grained hard wood. Split the rough pieces and plane them as shown or make a wooden block with a triangular groove to support the wood. A dowel plate—a steel plate with holes of various sizes—also may be used.

Testing the joint is shown at *F*. The dowels are cut to length and pointed slightly at the ends. If they fit the holes very tightly, it is well to run the plane over them to make a narrow flat surface, or make a saw kerf their full length. This allows the pocketed air and surplus glue to escape and lessens the chance of

the wood's splitting. Use a small brush or a stick slightly less than the dowels in diameter to put glue in the holes. Then insert the dowels in the rails. Glue the joining surfaces, press the parts together, and apply clamps. Test again when the clamps are in place, to see that the clamps have not been so tightened as to distort the joints, which sometimes causes unexpected difficulties.

RABBETED JOINTS

Amateur mechanics who nail and screw together their woodwork without any pretense at joinery are missing half the fun of woodworking. To make a workmanlike joint—even so simple a joint as a plain rabbeted joint—gives real delight.

You will find many uses for rabbeted joints in making furniture, and, indeed, in all sorts of woodwork. Drawer fronts, for instance, are often rabbeted to take the side pieces, instead of being dove-tailed. Sometimes this is called an end-lap joint.

After face-marking the pieces, place one member on the other and even at the end and edges, and make a mark in the inner corner as shown in Fig. 27 at *A*. Both pieces, it might be well to remind the beginner, should have carefully squared ends.

Remove the vertical member and place the knife in the mark previously made. Then move a try-square against the knife and draw a line across the surface as at *B*. Continue the line halfway down each edge. On rough work a pencil is used instead of a knife, but it is easier to work accurately to a knife line.

Set a marking gage for whatever amount of end grain is to remain visible in the rabbeted member as at *C*—this may be one half the thickness, but usually is less. Gage along the end and down to the knife lines along the edges. Place the piece in a vise and cut down on the gage lines with a rip saw, beginning the cut on the nearer corner as at *D*. As you proceed with the cutting, bring the saw level.

Lay the piece flat on a bench hook



FIG. 27.—Rabbeted joints. How to measure and mark the width and depth of the rabbet, saw out the surplus wood, and nail the boards together.

or fasten it in the vise and cut away the surplus wood with a crosscut or backsaw as at *E*. Beginners usually find it best, and it is always safest, to cut a V-groove with a knife or chisel before making a saw cut of this kind.

Glue the joint and fasten with plenty of finishing nails or screws as at *F*, at the same time testing for squareness.

MORTISE AND TENON JOINTS

The mortise and tenon joint is universally useful in constructing furniture. To lay out a joint for connecting a table leg and rail, for example, first mark the limits of the mortise, as shown in Fig. 28 at *A*. This length may be two-thirds or three-quarters the width of the rail.

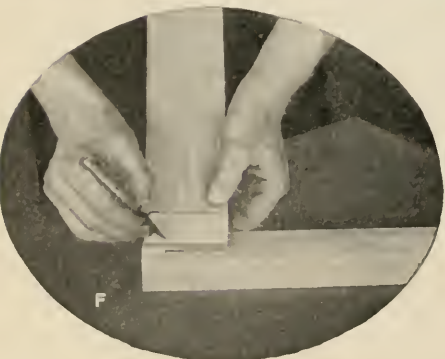
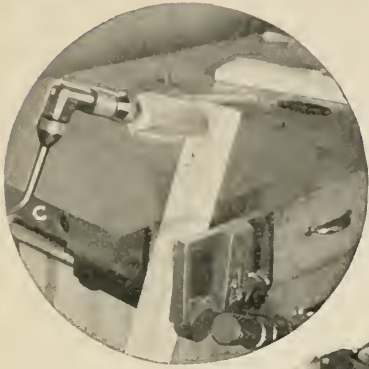

FIG. 28.—Steps in making a mortise and tenon joint. How to gage and mark the mortise and tenon in the leg and rail of a table; using the auger bit and chisel to make the mortise, and the rip saw to cut the tenon; pressing the finished joint together.

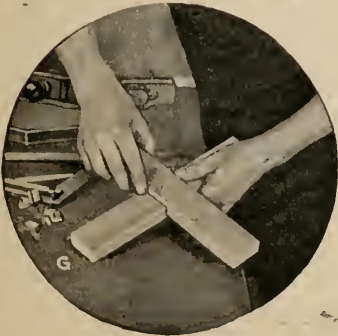
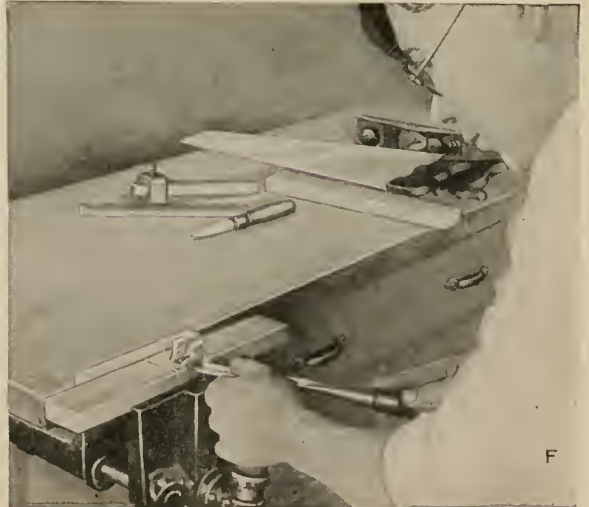
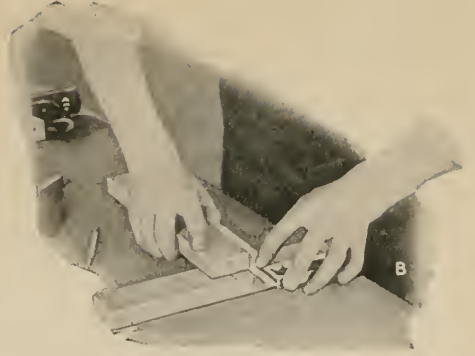

FIG. 29.—Illustrating a good method of making a cross-lap joint. Squaring and face-marking the pieces, gaging and marking the depth of the lap with a gage, making the saw cuts to the knife lines, chiseling out the waste wood, and lapping the joint together.

Set a gage to locate the mortise on the leg. When marking the rail as at *B*, use a thin piece of wood as shown to provide for the desired offset. Mark the center of the mortise as a boring guide. Bore holes close together along the mortise, using an auger bit the full size that the finished cut is to be, as at *C*. If no depth gage is at hand, make one from a block of wood. Next clean up the mortise with a wide chisel as at *D*, tapping it with your hand or a mallet. Square up the ends with a chisel of suitable width. Some mechanics cut mortises entirely with a mortise chisel.

Cut the tenon with a fine rip saw (six points or finer) as at *E*, and a backsaw or fine crosscut saw. Mark the width the finished tenon is to be by holding it close to the mortise. Then use a marking gage or simply gage with a pencil held against the thumbnail as at *F*. Remove surplus wood with rip saw and crosscut saw.

The finished joint should fit so that it can be put together by the pressure of the hands as shown at *G*.

CROSS-LAP JOINTS

The first steps in fitting a cross-lap joint, useful for framing or furniture construction, are to square and face-mark the pieces, as shown in Fig. 29 at *A*, and find the middle point of each or the middle point of the joint, if it is not to be central. Through each point square a line with your knife.

Lay one piece on the other as shown at *B*, guiding the upper one against a square. Then remove the square and mark points at each side for the width. Square a line across the wood at the points you have just marked, as at *C*, and also halfway across each edge. Both this step and that shown at *B* must be followed out on both of the pieces. Set your marking gage for approximately one-half the thickness of the wood and mark the edges of both pieces, working from the face side as at *D*.

Either use a backsaw for cutting the joint, first chiseling a V-shaped groove

to start the blade, or clamp a piece of wood to the stock as a guide and cut snugly against it with a fine handsaw as at *E*. An expert woodworker does not need this aid, as he can run a fine saw against a knife line by eye with great precision. The saw cut must be accurate so that no trimming will have to be done. Make a cut or two in the waste wood to aid in chiseling. Hold the work with a waste piece behind it as shown at *F* and use as wide a chisel as possible to remove the waste wood.

The finished joint shown at *G* should go together without forcing. The joint may be laid out in other ways, but this is a safe, easy method for beginners.

DADO JOINTS

The dado is a useful joint for door and window frames, shelving and furniture. After the boards are planed to dimensions, square a knife line across one of them at a distance from the end equal to the thickness of the stock plus the desired extension as shown in Fig. 30 at *A*. This line marks the inner cut for the dado.

Place the second board on the first one, mark the width of the stock and square a second line across as at *B*. Then carefully mark the depth of the dado with a gage.

Unless you are an expert with the saw, it is advisable first to make a V-groove for starting the saw as at *C*. This insures a clean and very accurate cut. Use a backsaw or any fine handsaw. Start the cut on the farther side and gradually lower the saw to a horizontal position as at *D*. Cut exactly to the depth of the gage lines on both edges.

Remove the waste wood with as wide a chisel as possible, working first with the bevel down and then with the bevel up as at *E*. Test the bottom of the dado with a square.

If the dado is made accurately, the parts should fit without play when pressed firmly together as at *F*. The joint may be fastened with glue or nails, or both. It must be very accurately fitted if glue alone is to be used.



FIG. 30.—Steps in making a dado joint. Marking the inner cut for the dado and the width of the stock; making a V-groove for starting the saw; sawing to the gage lines, removing the waste wood with a chisel, and testing the joint.

DOVETAIL JOINTS

If you will pull out one of the drawers of almost any well-built piece of furniture, you will find the front and sides are fastened together with a multiple dovetail joint—the aristocrat of wood joints. This is at once one of the strong-

est and neatest of fastenings at the command of a cabinetmaker.

It can be made in three principal forms—the half, half-blind, lapped or stopped dovetail, as at the front corners of a drawer; the through dovetail, as in fine boxes, chests and cases and sometimes at the back corners of drawers;

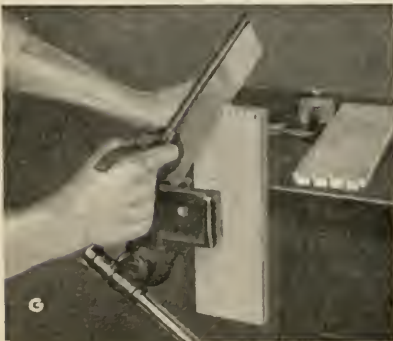
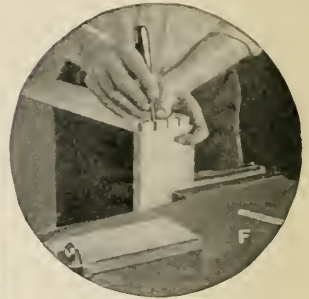
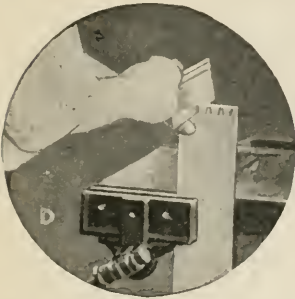

FIG. 31.—How to make a multiple dovetail joint of the type used in drawers. This is often called a "lapped" dovetail because the joint does not show from the front. It is one of the strongest and most craftsmanlike joints.

and the mitered or secret dovetail, which outwardly looks the same as a mitered joint.

There are many ways of making dovetail joints. The experienced mechanic often lays out the tails by eye. He takes care, if doing fine work, to make the pins much narrower than the tails. This distinguishes a handmade dovetail from the much commoner machine dovetail, in which pins and tails are the same width.

The illustrations A to H, Fig. 31, show how to make a half dovetail (as for a drawer). The steps in construction are as follows:

Mark the thickness of each side on the front as shown at A.

Square across each side for the distance it is to lap over the front as shown at B. Gage a corresponding line on the end of the front.

On the side-pieces mark the length and angles (15 or 20 degrees) of tails as at C.

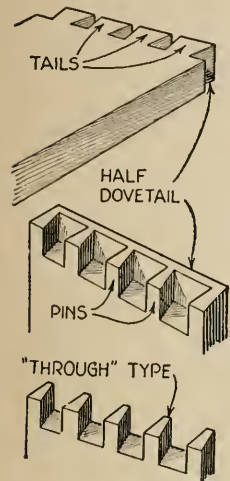

FIG. 32.—The two members of a "half" or "lapped" dovetail, and one member of a "through" dovetail.

Cutting the tails with a fine back- or dovetail saw is shown at D. Several pieces at a time can be cut.

Remove the waste wood with a chisel as at E. Work from both sides and split the lines with great care.

Transfer the exact shape of the tails to the front member by holding the pieces in position and marking with a knife as at F. Continue the lines on the inside down to the cross line, which was drawn with the square and knife. Saw down on the lines at an angle as shown at G; the wood between the pins then can be carefully removed with a chisel.

Properly made, the joint may be pressed together by hand as shown at H. Apply a little glue before assembling.

Substantially the same process can be followed in making a through dovetail joint, except for the preliminary laying out. Figure 32 shows the difference between the two types.

The gaged line at the end of the drawer front referred to previously may be from $\frac{1}{8}$ to $\frac{1}{4}$ in. in from the front face. This lap is shown in the middle of the three drawings of Fig. 32; compare with A, B, and F, Fig. 31.

HOW TO DO INLAYING

Inlaying is often regarded by the amateur craftsman as a difficult process. This is because he has never seen how inlaying is done and, therefore, does not realize how comparatively simple and easy the process really is.

While inlaying is quite easy to do, it is a process that does not lend itself readily to machine production. Inlaid pieces of furniture command a good price by virtue of the handwork lavished upon them, while the painted imitations and plain pieces sell for very much less.

The home woodworker, who is interested and ambitious enough to experiment a little with inlaying, will be amply repaid for his trouble through the satisfaction he will experience in being able to make furniture not only of greater beauty and distinction, but also of greater intrinsic value—a value that can be measured directly in dollars and cents.

Inlay in general is made in two forms, lines or bands of varying widths and patterns, and inserts of a multitude of shapes and designs. This material is made by specialists. The lines are in pieces one yard long and vary in price from less than a cent to about twelve cents a yard. The inserts are sold by the piece; those described in this article cost from 50 cents or less to \$1 each.

When lines are to be inlaid, a groove must first be cut in the wood of exactly the same width as the line and of a depth about equal to the thickness of the line. The tool for cutting such a groove (Fig. 33) can easily be made of an old hack saw blade or similar piece of thin

steel. It is ground down on an emery wheel to approximately the right width, after which it is sharpened on one side only like a chisel. The more carefully



FIG. 33.—Cutting grooves for inlays with a modified marking gage which has a cutter instead of a point.

this sharpening is done the better it will cut. The spur is removed from an ordinary marking gage and this piece of steel inserted in its place (Fig. 34).

A groove is then cut with this tool, and if it is too wide the cutter is ground down. For the best results the groove should be so narrow that the inlay must be forced gently in place. This tool will

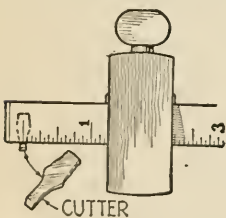

FIG. 34.—Tool for cutting grooves made from common marking gage.

cut grooves across the grain, but corners and awkward places generally must be cut and cleaned up with a pocketknife and a $\frac{1}{16}$ -in. chisel (sometimes ground down to $\frac{1}{32}$ in., depending on the width of the inlay). It is recommended to make a cutter for the plain satin lines, $\frac{1}{16}$ in. wide. For wider lines, two or more cuts can be made with this cutter until the desired width is obtained.

When the grooves have all been cut and the corners cleaned, the lines are cut to length and mitered in the corners. Thin glue is then run into the grooves and the inlay forced in place

with the aid of a hammer. The surplus glue should be wiped off with hot water and the inlaid piece allowed to dry overnight. If an insert is to be used in the center, as on the serving tray shown in Fig. 35, it may be glued in place at the same time.

Inserts sold by manufacturers of marquetry are always glued to a piece of brown wrapping paper and set in a piece of mahogany veneer. This surplus veneer around the edges is first cut away with a knife. The insert is then placed *face down* in the exact center of the tray, and a fine line marked around it with a sharp pencil. Draw perpendicular center lines both on the tray and the insert. If the insert is of an oval or circular shape, the outline is cut down with a sharp penknife, after which the wood in the center is cut away

with a router plane. Set the plane to cut only a thin shaving at a time until the desired depth (equal to the thickness of the insert) has been reached. If the work has been carefully done, the insert

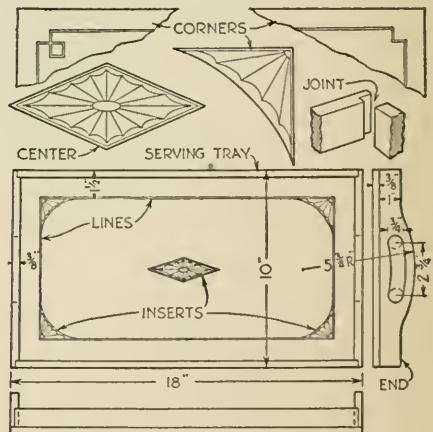

FIG. 35.—Tray with border lines and corner and center inserts; note alternative designs for the corners.

should fit in the recess that has been cut. It is glued in place *face down*, with the brown paper on top, and is held in place by a weight. When it has dried overnight, it is scraped with a cabinet or

vener scraper. This removes the brown paper and brings out the pattern of the inlay. The corner inserts are inlaid after the line inlay has dried.

A serving tray such as illustrated in Fig. 35 is a serviceable as well as beautiful addition to the furnishings of the dining room. Before beginning work on it, however, it is well to ascertain if the dimensions given are suitable for the stand or tea wagon on which it is to be placed.

Its construction is very simple. The bottom is made and inlaid as described above. The frame consists of four pieces put together with a rabbetted joint at the corners, as shown. The opening to form the handle is carefully laid out on one piece, after which the two end pieces are clamped together and a number of holes are bored through them with a 3/4-in. auger bit. The bits of wood left between these holes are cut away with a chisel and smoothed with scraper, file and sandpaper. It is better to cut these holes before cutting the outside shape and making the joints, because there is less danger of splitting.

The frame is glued together, smoothed and sanded, after which it is either glued or screwed to the bottom. The writer has found gluing the easier, if enough hand screws are available. It is not

recommended to use a glass plate over the bottom, because dust will collect under the glass in time and make it unsightly, and if any liquid is spilled it is likely to run under the glass. If the tray is finished with linseed oil it will

not be marred easily even if something is spilled on it.

The mirror shown in Fig. 36 is suitable for a hall, a parlor, or a bedroom. The four pieces forming the frame are first squared to dimensions, after which the rabbets are cut for the glass. They are then joined in the corners with dowels as shown, glued, smoothed and sanded.

The grooves for the inlay are cut with the marking gage, the head bearing against the outside edges of the wood. The insert is glued in place as described above, after which the whole frame is scraped and smoothed. A small bead as indicated in Fig. 36 may be cut with an ordinary marking gage on the inside edges of the frame after

it has been glued together.

The top piece is glued to the top of the frame after the insert and the turned rosettes have been glued in place. The joint is covered by a piece of molding, which can either be bought ready made or worked out with a gouge, scraper and sandpaper.

The backing should be of soft pine or

MATERIALS FOR TRAY, FRAME, AND TEA TABLE

No.	Pcs.	T.	W.	L.	Part
<i>Serving Tray</i>					
1	3/8	10	18	Bottom	
2	3/8	1	17 1/2	Sides	
2	3/8	1 3/4	10	Ends	
2 yds.				Inlay	
1				Center insert	
4				Corner inserts	
<i>Mirror Frame</i>					
2	1	2 3/4	25 3/4	Sides	
1	1	3 1/2	10 1/2	Top	
1	1	4 3/4	10 1/2	Bottom	
1	3/4	4 3/4	16	Top	
1	1/2	1 1/2	17	Bottom	
1	3/4	1 1/4	19	Molding	
1	3/8	12	19	Backing	
2	3/16	1 1/2		Rosettes (turned)	
2				Inserts	
5 yds.				Inlay	
1	1/4	11 3/4	18 3/4	Plate glass	
<i>Tea Table</i>					
2	1 1/4	1 1/4	30 1/2	Frame	
2	1 1/4	1 1/4	8	"	
1	1 1/4	1 1/4	18 1/2	"	
4	1 1/4	5	8 1/2	"	
1	1	3 1/4	29	Lower brace	
1	1	2	29	Upper "	
1	1/2	18	24	Tray	
1	3/4	3/4	78	Molding	
2 yds.				Inlay	
1				Insert	
2		3/4	1 1/2	Hinges	
1				Catch	

All dimensions are in inches except where otherwise specified.

whitewood and nailed in place. It is a good plan to place several layers of paper between the glass and the backing.

The tea table shown in Fig. 37 is a piece of furniture that is a little out of the ordinary. It consists of a tray hinged to a frame.

The frame is very simple of construction, consisting of five pieces joined by doweled joints. The vertical sides each have two shaped pieces of the same thickness as the frame glued to them. These pieces may be beaded on the edges as shown by first gaging the beads with a marking gage and then slightly rounding them with chisel, scraper, and sandpaper.

The two sides of the frame are joined with the shaped stretcher at the bottom, which is mortised into them and glued

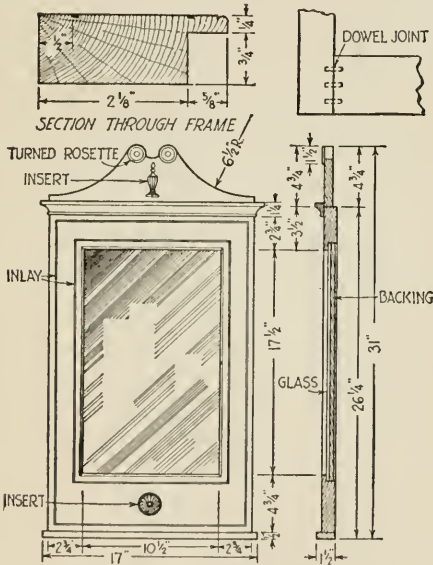

FIG. 36.—A mirror of rare charm with in-laid lines, decorative inserts, and rosettes.

in place. The piece to which the tray is hinged is glued and screwed to the frame.

The tray, which is 1/2 in. thick, is in-laid as shown, after which a molding is fitted and glued in place flush with the edges. It is hinged to the crosspiece in such a way that when it is in the horizontal position it projects an equal

amount on each side of the frame. The hinges should work rather stiffly so that the tray will not tip when placed in the vertical position. When used for serving tea (in the horizontal position), it is prevented from tipping by a catch, which locks it securely to the crosspiece.

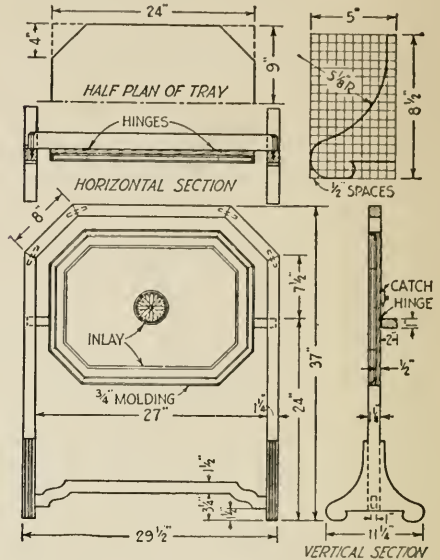

FIG. 37.—When this distinctive tea table is not in use, the top stands upright.

If mahogany is used for the three pieces of furniture described above, it is recommended to stain it with lime dissolved in water, as this does not discolor the inlay. If stained with bichromate of potassium or ordinary stain, the inlay has to be scraped afterwards with a very sharp knife to remove the stain, and this is a rather difficult and tedious process.

HOW TO DO VENEERING

Amateur woodworkers are prone to consider veneering a phase of woodworking entirely beyond the range of their abilities and to speak of it with a note of awe and longing in their voices. To demonstrate that the simpler forms of veneering are not beyond the abilities of any home worker with a fair degree of skill, the making of a veneered box will be described. It is such a box (Fig

38) as any young lady will value as a gift from her father, her brother, or even more from some other girl's brother.

The box itself (Fig. 39) may be made of any easily worked, thoroughly seasoned $\frac{1}{2}$ in. thick wood, but the veneer should be mahogany, rosewood, walnut, or other fancy wood. Veneers can be purchased from some lumber dealers, from many plywood manufacturers and dealers in fancy woods, and usually from cabinetmakers and furniture repair men.

The corners and the top and bottom of the box should be made with halved joints to reduce the amount of visible end wood, which might show beneath the veneer under certain circumstances. Fit the joints carefully to insure squareness, and glue and nail the parts together with 1-in. No. 16 brads, being careful that the nails will not interfere later on with sawing the box at *C*.

Before the top and bottom are glued in place, cut $\frac{1}{4}$ -in. pieces the width of the space between the top and bottom inside of the box (about $3\frac{1}{2}$ in.) and just the length to fit snugly as indicated by dotted lines *D*. A drop or two of glue on the end wood will hold these pieces, which are to resist the pressure of the hand screws and prevent the sides and top from bending inwards when the veneer is clamped on.

Be sure the outside of the box is planed smooth, for rough and imperfect places will almost always show through thin veneer. As this article is primarily a discussion of veneering, the box itself can be left to the skill of the worker without further directions.

The veneers for the ends should be cut about $\frac{1}{2}$ in. larger each way than the size of the box, as at *E*. Make straight, smooth cauls (blocks) of some soft wood about the size suggested at *F*. Provide pieces of folded newspaper to be placed between the veneer and the caul as at *G*; the paper will absorb moisture coming through the veneer from the glue. Set hand screws or clamps as at *H* ready

for immediate use. Two may do but four will be better.

You are now ready for gluing. The room should be warm—at least 80° F., although 100° would be better. Heat the ends of the box, the veneer, and the cauls. Wax the latter with a piece of paraffin to prevent any danger of sticking.

Use rather thick glue of good grade,



FIG. 38.—Attractive pieces like this trinket case or jewel box can be made by any woodworker who learns the art of veneering.

newly mixed and very hot. Equally important are the speed and skill of the worker. Spread the glue on one end of the box, not on the veneer; place the veneer on the glue, then add the paper and the caul. Turn the box to rest vertically on this caul and repeat the process on the other end.

Put the hand screws on without disturbing the cauls, and apply enough pressure to insure perfect contact. Too much pressure on such a small surface will force the glue out around the edges and "starve" the joint just where the greatest strength is needed. Another pair of hands to hold pieces in place, if you can get someone to help you, will simplify this process.

When the squeezed-out glue has hardened to a gummy texture, cut it away and save some trouble later on. Allow the box to remain at least twenty-four hours, and longer if possible. On a broad surface more time would be necessary.

Trim the veneer to the other surfaces of the box with the utmost care. Prepare veneer, paper, and cauls for the sides of the box and repeat the gluing process, using six hand screws if they are available, although four will answer the pur-

Cut strips of veneer $\frac{3}{4}$ in. wide and glue them around the joining edges of both box and cover. Gently rub each piece in place, after all are cut and fitted, with the flat face of a hammer. This must be done rapidly.

Glue the box edges first, for example, and place a piece of paper and a caul upon the veneer and weigh it down while the veneer is being placed on the cover. Remove the weights from the caul and place paper and the cover upon it as

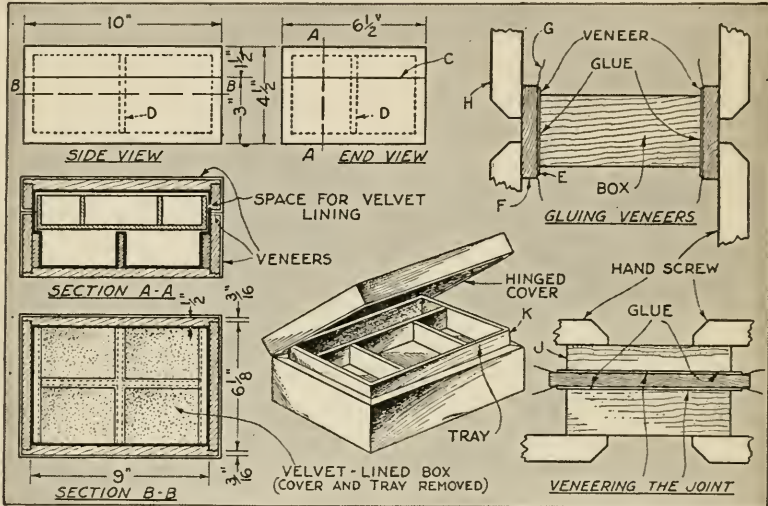

FIG. 39.—This box is a typical example of veneering within the range of home workshop equipment. Note the use of paper *G*, blocks *F*, and hand screws *H*.

pose if placed judiciously. Allow the same time for setting and repeat the process upon the top. No veneer will be needed on the bottom, although a piece of felt, glued on the last thing, will finish the bottom correctly.

Sandpaper all the veneered surfaces. Round the corners slightly to prevent splintering, but not more than the thickness of the veneer.

With a sharp gage make an accurate line *C* $1\frac{1}{2}$ in. from the top. Saw very carefully around the box and remove pieces *D*. With a perfectly conditioned plane, smooth the sawed edges, being sure that no splinters are broken from the veneers. Be sure to make the joint fit accurately.

shown at *J*. Apply hand screws with moderate pressure, and allow the work to set. Later trim and sandpaper the edge veneers.

Hang the cover with $\frac{3}{4}$ -in. narrow butt hinges or place small butterfly hinges on the back; the latter is by far the simpler. Cut in a small lock or catch, although either would be more ornamental than useful.

Make the tray about $\frac{3}{16}$ in. smaller than required to allow for the velvet lining which should cover the inside completely. Make the tray of $\frac{3}{16}$ -in. wood with butt joints throughout. Plane the front face of the tray back on a slight angle as at *K* to allow the cover to close without striking the front of the tray.

Finish with three or more thin coats of shellac, rubbed with No. 4/0 sandpaper between coats, and polish with a first-class grade of furniture wax.

FITTING HINGES EXPERTLY

Few problems give a more accurate measurement of a home worker's skill than the fitting of a pair of hinges. In doing this the only mark or cut that is "good enough" is that which is as near absolute accuracy as the worker can make it.

The exact length of the hinge *AA* in Fig. 40 should be marked from the hinge itself with a knife point. Never use a pencil where such accuracy is required. Line *B* should be made with a sharp gage set about the thickness of a piece of paper less than the parallel thickness of the hinge from the joint as shown at *E*, which will prevent the joint from becoming hinge bound. The gage line *C* should equal the distance between the edge of the hinge plate and the pin, as shown at *E*; if very fine work is desired, the distance should be as at *C'*, but *C* is commonly used.

In cutting to the lines, use a thin edged chisel about $\frac{1}{8}$ in. wider than the distance *C*. Make the first cuts as shown at 2, which will allow cuts *A* to be made accurately as at 3. Cut the wood away by using the chisel as at 4 and work carefully to depth line *B*. Place the edge of the chisel in line *B*, as shown at 5. Cut the wood away back to the line *C*; hold the chisel as at 6 and cut gently, for there is danger of breaking out the wood back of *C*.

Trim the cuts carefully, making the lower surface or bed of the hinge *ABC* and the back cut straight and smooth as at 7. Fasten the hinges with screws as at 8. Be sure the pin is in accurate alignment with the corner *D*.

Lay out the distance *C* where each hinge is to be placed on the other member of the joint, and locate the exact endwise relationship. Set the hinges at these marks and drill a hole in the wood at the center of one hole in each hinge. Drive the screws until each hinge is

pulled down to its place. Inspect the surface relations of the members of the joint. Small inaccuracies may be remedied by loosening the first screw of one

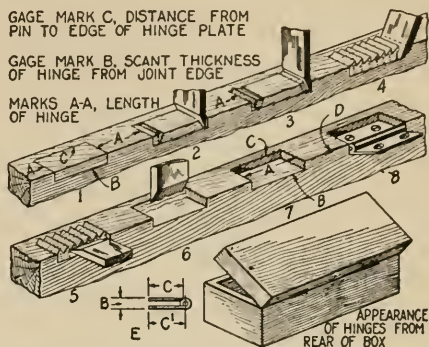

FIG. 40.—The steps to follow in marking and chiseling hinge mortises on box lids and cabinet doors.

or both hinges as may be necessary and drilling a hole for the other screw of each hinge close to that side of the hole, which will tend to force the hinge endways or sideways as may be needed.

FRICITION CATCHES FOR DOORS

The home worker often desires to keep the door of a cabinet or cupboard closed without the use of a lock, a latch, or a surface catch of any kind. The best solution is to apply a friction catch (Fig. 41), which is cheap, efficient, and, above all, easy to fit.

Ball friction catches usually range between $\frac{1}{4}$ and $\frac{1}{2}$ in. in diameter and $\frac{1}{2}$ and 1 in. in length. The size most commonly used for work about the house is $\frac{3}{8}$ by $\frac{3}{4}$ in., for a catch of that size may be safely placed in a $1\frac{3}{16}$ -in. rail or partition.

This type of catch may be purchased in almost any well-stocked hardware store. It is best to obtain the adjustable variety, if possible; then the ball may be screwed in or out to compensate for the shrinkage or swelling of the door. To turn the ball, it is necessary to insert the points of a pair of dividers in the slots or holes made for that purpose.

Fit and hang the door accurately, al-

lowing for the "sinkage"—let us say $\frac{1}{32}$ in. Then it is necessary to decide whether the catch is to be located in the top or bottom edge of the door about 1 in. from the lock edge, or in the lock edge of the door near the knob or pull.

If the face of the door twists out a little or is not perfectly straight at the top, the catch may be placed at the top; it will then hold the door straight unless it is too badly out of true. If the lower

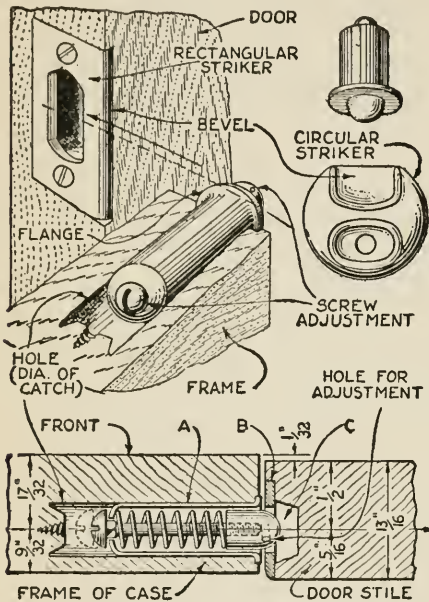

FIG. 41.—How a friction catch is inserted in a hole bored in the door frame and how the striker is fastened to the door.

corner springs out when the door is closed, the catch should be placed there. If placed near the center of the lock edge, the shrinkage of the door may demand more frequent adjustment of the catch, but the door can be opened and closed more easily.

Locate the center of the catch about as indicated, the dimensions being intended to show only the relation between the ball and the front of the frame as compared with the center of the striker socket and the face of the door. The dimensions will vary with the thickness of the door and frame and the surface sinkage of the door.

Bore the hole in the frame to receive the plug and drive the plug into the hole as at *A*. Close the door and work it back and forth a few times to mark upon the edge of the door the point where the center of the ball rests when the door is closed. A broad chalk mark made at this place to receive the track made by the ball will make the point show more definitely.

Place the striker plate on the door with its beveled edge facing the inside of the door as at *B*. Have the center of the striker socket coincide with the center point marked by the ball on the edge of the door.

Mark accurately around the striker with a sharp-pointed knife. With knife or chisel cut a recess to these lines so the face of the plate will fit closely, and of the depth to allow the striker plate to rest flush with the wood when fastened in place with screws. Cut away the wood under the striker socket to allow the ball to enter freely as at *C*.

If the frame of the door opening is not thick enough to receive the plug, it will be necessary to set it in the edge of the door. This is not so satisfactory as placing it in the frame.

DRAWER LOCKS

The first step in fitting an ordinary drawer lock of the type shown in Fig. 42, regardless of the size, is to lay off distance *X* of the lock from the top edge of the drawer front, adding a trifle, say $\frac{1}{16}$ in.—just enough so that the face of the lock will set below the edge of the drawer to allow planing if necessary. Mark this point with an awl, and through the front bore a hole as at *A*. This may be a $\frac{1}{4}$ -in. hole or smaller, depending upon the size of the lock. Push the projecting key pin of the lock into the hole from the back, center it, and pencil-mark around the front plate of the lock as at *B*. Lay the drawer front face down on the bench and with a fine saw make triangular cuts as at *C*.

Cut the wood out to receive the body of the lock as at *D*. Lay the lock in this space as at *E* and knife-mark around the

faceplate. The back plate is seldom set flush with the inside of the drawer front, but this may be done, if desired.

Cut out for the face plate as at *F* and finish the keyhole with a pad saw or keyhole saw. If the work has been done accurately, the lock should appear about as at *G* when it is fastened in place.

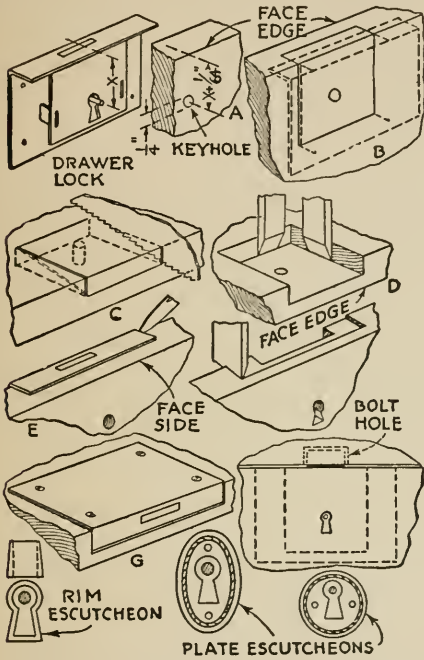

Fig. 42.—By following these steps, the amateur cabinetmaker can fit drawer locks easily and accurately.

Run the drawer partially in its case. With the key turn the bolt out and touch the face with black grease or paint. Close the drawer and turn the key until the bolt stops against the partition, as at *H*. This will leave a black mark on the wood. Remove the drawer and with a chisel a little wider than the thickness of the bolt, cut out the bolt hole.

FITTING A NIGHT LATCH

Many home workers have fitted night latches successfully, but others have not been so fortunate in their attempts. A few suggestions which do not usually appear in the printed instructions ac-

companying the locks may be of help in simplifying the work.

We shall consider first the fitting of a rim spring latch of the standard type in the usual way for a right- or left-hand door (Fig. 43). Locate the desired height of the latch, about 3 ft. 6 in. from the floor but somewhat less if the approach is from a porch floor that is lower than the floor of the house. If the distance from the center of the cylinder to the edge of the door is supposed to be 2 in., it is well to mark it actually $2\frac{1}{16}$ in., so as to set the latch back $\frac{1}{16}$ in.; this allowance is for planing, should the door stick at any time. Bore a 1-in. hole entirely through the door stile.

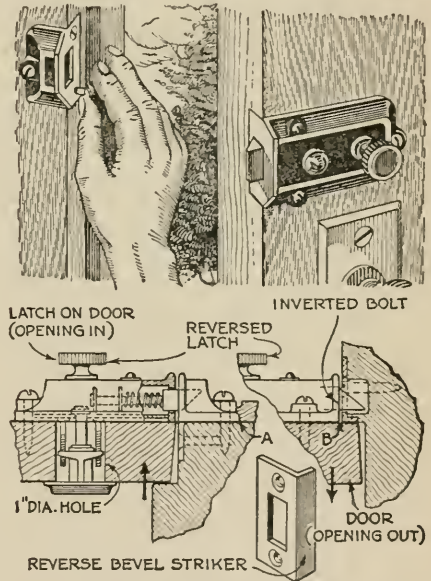

Fig. 43.—A standard night latch can be fitted in two ways, depending on whether the door is one opening in or out.

Break the connecting bar and the screws as indicated on them to suit the thickness of the door. Slip the cylinder through the outside ring until the back of the face is seated. Insert the cylinder from the outside of the door with the keyhole down. Place the false cap or perforated plate on the lock side with the screw holes above the center. Drive home the two connecting screws that

fasten the false cap, the cylinder, and the face ring firmly in place. Locate the latch accurately and drive the screws which hold it in place on the door.

To apply the striker—the member which is engaged by the latch—it may be necessary in certain cases to cut into the door casing as at *A*, as well as into the edge of the door jamb.

In fitting a night latch on a door opening out, the lock must be set back far enough from the edge of the door to clear the corner of the rabbet at *B*. We shall assume that the rabbet is $\frac{1}{2}$ in., which, in the case of a close-fitting door, will require that the cylinder center should be set back about $2\frac{9}{16}$ in. This must be verified in every case. Bore the 1-in. hole, remove the backplate of the latch, reverse the latch itself, replace the backplate, and proceed as previously described.

A reverse bevel striker must be fitted to the rabbet so that the latch will engage. The striker should be set in a notch cut into the jamb to receive it as illustrated.

When locks and other hardware are of unusual design, the manufacturers supply full instructions for fitting them.

CRAFT WORK WITH NEWSPAPER

When used in conjunction with a boiled starch paste, newspaper becomes an ideal material for many construction purposes. From it numerous articles have been made, including the astronomical camera and boat illustrated in Fig. 44.

First a framework is constructed, preferably of wood, having slats that are placed fairly close together. The spacing of the slats depends, of course, on the desired final strength.

Next prepare a generous quantity of boiled starch paste. Take sufficient water for the amount of paste required and heat to boiling. While this is heating, mix common starch in a small quantity of cold water until it is perfectly smooth and of the consistency of heavy cream. When the water is boiling vio-

lently, remove it from the fire and stir rapidly while pouring the starch mixture into it. Keep on adding the starch until

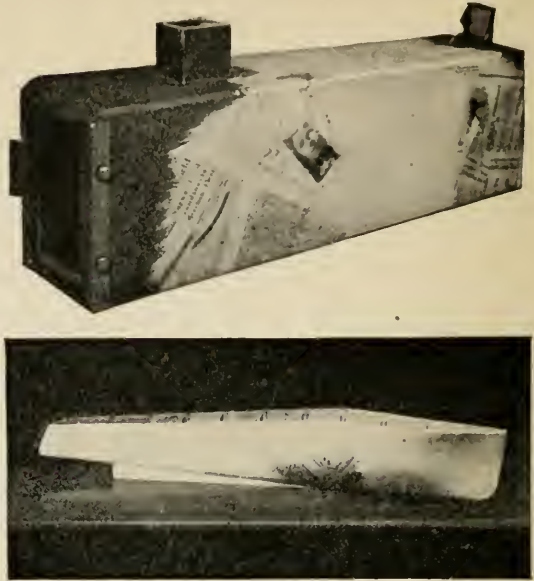

FIG. 44.—The astronomical camera shown above was covered by using newspaper strips. The model hull shown below was constructed by pasting many layers of newspaper on a framework of thin wood strips built to the shape required.

the paste is about the consistency of molasses. Use a good and reasonably stiff brush for applying the paste, and coat the wood frame first; then coat the paper with paste on both sides and apply it to the frame. If the paste is of the correct consistency, the paper will absorb it and appear quite wet.

Layer after layer of paper is applied in this manner until from six to twenty or more layers have been used, according to the required strength. The paper should be forced into complete contact with the preceding layer with the paste brush. Apply pieces of all shapes and sizes, torn to shape rather than cut, as the ragged edges are less liable to form ridges on the finished surface.

As the paste dries it will cause the paper to contract and the finished article will be found to be very smooth and almost as hard as vulcanized fiber. In spite of its smoothness and hardness, it will not be brittle and therefore will

not break easily. The covering can be sandpapered and even filed to remove any inequalities in the surface. Any desired finish can be used.

DRILLING GLASS

For small holes in either window glass or plate glass, a triangular saw file makes an acceptable drill. Grind the point to make three surfaces corresponding to the sides of the file as shown in Fig. 46. It is better to use a grinding wheel that runs in water or oil in order to be sure not to heat the file, but if a dry wheel must be used, apply the file with very light pressure and dip the tip in water



FIG. 45.—The way a file is held in a brace for drilling glass. Note the ring of putty which retains the turpentine.

often. If the temper is drawn, the file is useless.

To prepare the surface of the glass for drilling, mark the place for the hole by a scratching action of the point of the file. Then make a circular container around this mark, using putty or other plastic substance. Leave the glass ex-



FIG. 46.—How the point of a file is ground for drilling glass.

posed in the center and fill the little bowl with turpentine.

The drilling is done with the file in a brace as shown in Fig. 45. A breast drill or a hand drill can be used for greater speed. Use light pressure and reverse the glass as soon as the point goes through.

The process of drilling in this manner is not rapid but, unless a large number of holes are to be made, it will prove satisfactory. The size of the file selected will, of course, determine the maximum size hole that can be drilled in this way.

For larger holes effective work can be done by using a brass tube. A suitable piece of tubing often can be had for the asking at a plumbing shop. Some such device as that illustrated in Fig. 47 is necessary for holding the tubing in place and perpendicular to the glass. It consists of a baseboard upon which the glass rests, a small block to serve as a spacer, and a two-by-four through which has been bored a hole just large enough to allow the tube to rotate freely.

In the process of boring with a tube, which should be cut square on the end, carborundum or other abrasive powder is used as the grinding agent. In order

to allow this powder to enter under the edge of the tube, eight or more shallow notches are filed in the end.

The jig is then fastened on the worktable as shown in Fig. 47, and the plate

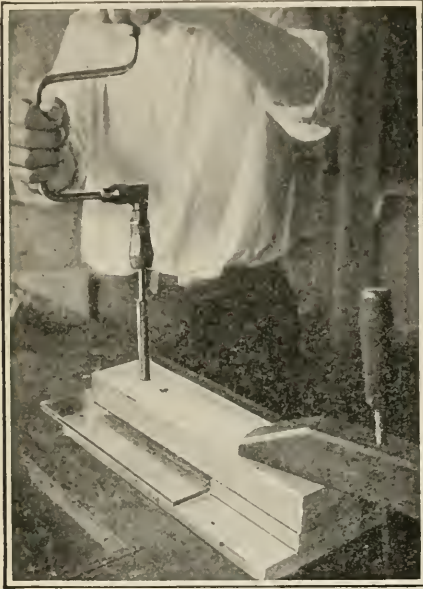

FIG. 47.—Grinding a hole in plate glass with a brass tube charged with abrasive powder.

placed in correct position under the tube. Carborundum powder may be poured into the tube or applied outside of it, together with a small amount of water. The glass is clamped down or wedged in to prevent its moving when the boring begins.

A rose countersink or a reamer set in the brace or drill stock will serve to rotate the tube, for no great power is necessary. The use of a drill press or lathe or any other application of motor power reduces the time necessary for the job.

If care is taken, the tube can be allowed to cut through the glass, but a safer way is to reverse it, provided the

jig can be fixed in exactly the right position on the opposite side.

A little practice will teach just how much pressure can be applied for best results in cutting. After the groove has been made, it should be kept filled with water; and additional abrasive should be applied when necessary. If the edge around the hole is somewhat sharp or rough, polish it with carborundum powder held on a piece of wet cloth or rubbing felt.

For use with the tube method of drilling—or, more properly, grinding—glass, an efficient guide can be made from a cut iron washer with a hole slightly larger than the drill tube (Fig. 48). A bit of beeswax is melted and poured on

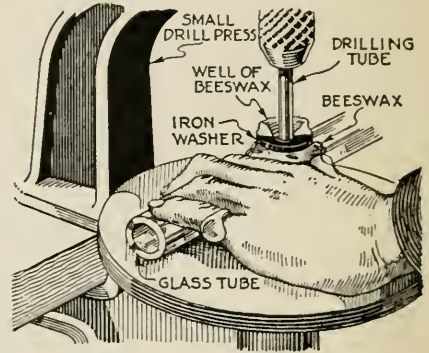

FIG. 48.—An iron washer and beeswax serve as a guide for drilling glass tubing.

the place to be drilled, and the washer is pressed into it.

The surplus wax is removed from the hole in the washer and, with a little additional wax, is formed into a funnel-like well about the drill. The well is filled with turpentine or water, and the drilling proceeds as usual. This method of making a guide is easily applied to flat sheets or to convex surfaces and gives rigid support at the cutting edge of the drill where it is most needed.

CHAPTER IV

BUILDING FURNITURE BY HAND

FOR the man who likes to make things, few pleasures compare with building fine pieces of furniture in a well-equipped home workshop. The cabinet woods in themselves are beautiful and pleasant to work with; the crisp cutting action of plane and saw have

tear woodworker is likely to encounter are discussed in following chapters, but there is nothing in the technic of wood-working which cannot readily be mastered. Where beginners are apt to fail is in selecting designs. It is no more difficult and, indeed, often easier, to make a well-designed piece of furniture than something that is clumsy and unsightly.

In this chapter designs will be given for constructing reproductions of several Colonial pieces of noteworthy design and for making some modern pieces which are especially adapted for the amateur cabinetmaker who has to rely mainly, if not entirely, upon hand tools. Of course, if small wood-working machinery is available, the same methods outlined in Chapter V can be used for making the pieces of furniture illustrated and described in this chapter.



FIG. 1.—This type of table, originally used in taverns, is highly prized by collectors of American antiques.

a music all their own; and every stage of the work, from jotting down the cutting list to the last stroke of the polish cloth, is of utmost interest.

The problems involved in cabinet work, such as laying out and making joints, are less difficult than commonly believed. Many of the processes the ama-

teur woodworker is likely to encounter are discussed in following chapters, but there is nothing in the technic of wood-working which cannot readily be mastered. Where beginners are apt to fail is in selecting designs. It is no more difficult and, indeed, often easier, to make a well-designed piece of furniture than something that is clumsy and unsightly.

Tavern tables were among the earliest types developed in this country and were very common before the Revolutionary War. The few to be found today are highly prized by their owners. They were made with round, oval, or square tops and varied from the size of this one to a length of 4 ft. or more.

Reproductions are popular because a table of this type blends well with almost any style of modern furniture

COLONIAL TAVERN TABLE

(Fig. 1). We see them used as side tables and radio tables and for holding smoking sets; in fact, everywhere in the home.

This table¹ is made of maple, except for the one-piece top, which is pine. It has seen a lot of hard use and has been painted a number of times. At present it is finished in its natural color and has two coats of white shellac and one coat of wax—a most beautiful finish.

requires the use of a lathe, but if you have none, you can have the legs made by a local wood turner or cabinetmaker.

To get the best results in turning the legs, it may be advisable first to lay out the shape full size on paper (Fig. 2). Two sections of each leg are left square. Sandpaper the turned work in the lathe as smooth as possible.

The stretchers at the bottom and the

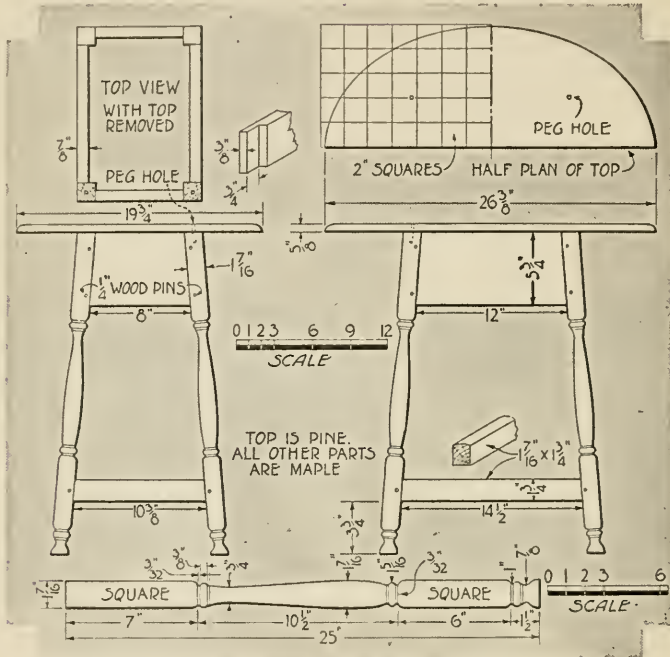

FIG. 2.—Measured drawings of a genuine Colonial tavern table: side and front views, the framework, half plan of the top, and details of the legs, joints, and stretchers.

Because screws were unknown when this table was made, the joints are reinforced with wooden pins or dowels. Even the top is held down with pegs; and no metal is to be found in its construction.

A copy can be made of almost any kind of wood, and the finish is entirely a matter of choice. To make the legs

rails under the top are mortised and tenoned into the legs. The stretchers are as thick as the legs, but the rails are only $\frac{7}{8}$ in. thick. However, all the rails are flush with the outside of the table legs, as shown in the top view.

To find the correct angle in cutting the rails and stretchers, lay out a full size drawing of the end and side views of the table. Don't forget to allow about $\frac{3}{4}$ in. for the tenons on each end.

After all your joints are made, glue

¹Larger drawings are contained in *Popular Science Monthly* BLUEPRINT No. 105, listed in the Appendix.

MATERIALS FOR TAVERN TABLE

No. Pes.	T.	W.	L.	Parts
1	$\frac{5}{8}$	$19\frac{3}{4}$	$26\frac{3}{8}$	Top
4	$\frac{17}{16}$	$\frac{17}{16}$	25	Legs
2	$\frac{17}{16}$	$1\frac{3}{4}$	16	Long stretchers
2	$\frac{17}{16}$	$1\frac{3}{4}$	$11\frac{3}{8}$	Short stretchers
2	$\frac{7}{8}$	$5\frac{3}{4}$	$13\frac{1}{2}$	Long rails
2	$\frac{7}{8}$	$5\frac{3}{4}$	$9\frac{1}{2}$	Short rails

All dimensions are in inches. The top on the original table is pine. The other stock is maple. Each dowel is about $\frac{1}{4}$ in. in diameter, and the ends of the pegs are almost square.

the end frames together. Wipe off the surplus glue and put the frames aside until the glue hardens. In the meantime you can work on the table top.

No doubt you will have to use two or more pieces for the top; a board $19\frac{3}{4}$ in. wide isn't always available. Three 7-in. boards are suggested, as this will allow enough extra stock to be planed down to the finished measurements.

An easy way to lay out the oval shape is to cut out a heavy paper pattern $9\frac{7}{8}$ in. wide and $13\frac{3}{16}$ in. long. Rule this paper off into 2-in. squares, starting from the lower right-hand corner. Now refer to the crosslines shown on the drawing and point off your outline on the paper pattern. Connect the pencil points with an easy, graceful curve and cut the design with a pair of shears.

Place your pattern on the table top, which should measure exactly $19\frac{3}{4}$ by $26\frac{3}{8}$ in. Have the pattern touch one end and one side and mark the outline. Repeat this on the other three corners. You are now ready to remove the extra wood and spokeshave down to the line. The upper edge of the top should be rounded over and sandpapered.

Glue the end frames, the 12-in. side rails, and the $14\frac{1}{2}$ -in. stretchers together. Proceed as before and test your work with a steel square to be sure the frame is true.

The top can be fastened down with

angle irons on the underside or pegged into place as in the original table. Whether you dowel all your joints and the top depends upon how closely you wish to copy the original table.

As the legs do not stand in a vertical position, each one will have to be filed or sawed a little at the bottom. A coarse



FIG. 3.—A chest as well proportioned and decorative as this is worthy of display in any room, particularly one with Colonial furnishings.

wood rasp will serve very well, and a level bench, table, or floor will do to test the work on.

The finish depends upon the kind of wood from which the table is made. If you select mahogany, walnut, or gumwood, an oil stain, filler, and varnish may be used. Colored enamels or brushing lacquers will also give good results.

ANTIQUÉ SEA CHEST

During the past few years there has been a tremendous interest in ship model making, and many of those who are indulging in this fascinating hobby have collected a variety of special tools, books, and pamphlets on ship models, templates, and other accessories. It seems appropriate, therefore, to offer a drawing of a genuine old-time sea chest (Fig. 3) in which to store these materials. Aside from its quaint charm and

fascination, the chest can be used for this or a number of other purposes.

This chest (Fig. 4) is one of a number in the marine room of the Peabody Museum at Salem, Mass. It was chosen because it is not too large, is not difficult to build, and is attractive in appearance. The cost of the lumber—only from twenty to twenty-five board feet of white pine—is only a few dollars.

$\frac{3}{4}$ in. thick, 11 in. wide, and 15 in. long at the base and $13\frac{3}{4}$ in. long at the upper edge.

Making the dovetail joints is not a difficult process. A careful layout, sharp tools, and a little patience will insure good results. First select the front side and score a sharp knife line across the board and $\frac{3}{4}$ in. in from the end. Do this on all four boards and on both out-

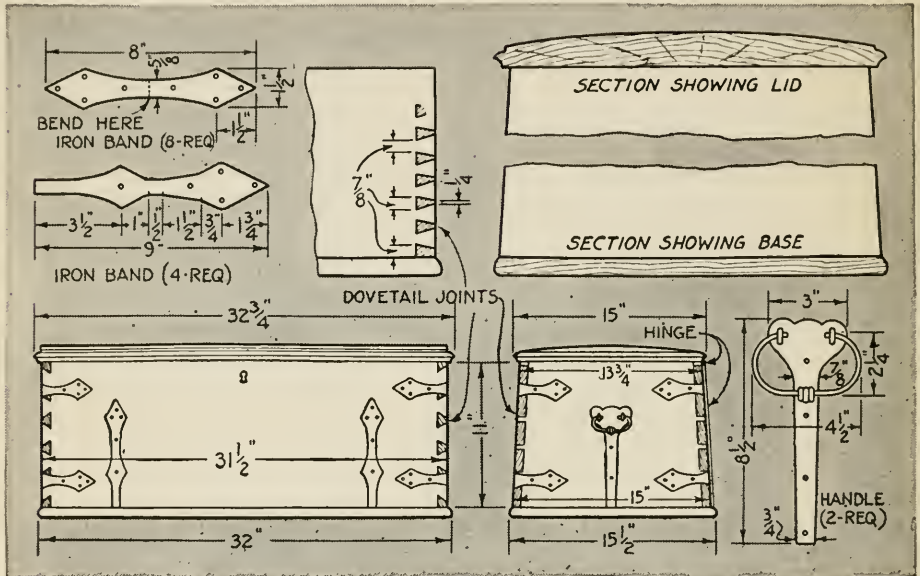

FIG. 4.—Drawings prepared from sketches and measurements made by Frederick J. Bryant in the Marine Room of the Peabody Museum, Salem, Mass. The original chest is of pine.

The design can be altered in various ways, if desired, to suit individual requirements. For example, the interior can be lined with red cedar, or rope handles can be substituted for the metal ones. A chest of a decorative type, but not so practical, can be made by using a flat cover without any overhang, on the top surface of which is drawn an ellipse measuring, say, 7 by 12 or 8 by 14 in. Within this oval may be painted a picture of a sailing vessel or a marine view.

To make an exact copy of the original chest, select two pieces of white pine $\frac{3}{4}$ in. thick, 11 in. wide, and $31\frac{1}{2}$ in. long. The two pieces for the ends are

side and inside surfaces. On the boards for the front and the back measure off with a pair of dividers or compasses a series of $\frac{7}{8}$ -in. spaces (see the detail drawing of the dovetails).

Next take a piece of scrap wood, place a knife line $\frac{3}{4}$ in. in from the edge, and lay out a full size dovetail, measuring $\frac{7}{8}$ in. at the back and $\frac{1}{4}$ in. at the edge.

From this layout or pattern of one dovetail, set your sliding T-bevel to determine the slope of the sides. Then set the bevel against the $\frac{7}{8}$ -in. measurements on the front board, hold it firmly, and mark the lines with a knife. Now pass the lines across the ends of the

board, using a try-square. Finally, score the lines on the inside of the board, using the bevel again. All the dovetails on both ends of the long pieces should be alike.

Place the board in a vertical position in the vise and saw very carefully just inside the knife lines with a dovetail saw or a fine hacksaw. Chisel out the stock between the cuts, being careful not to cut beyond any knife line. Some may prefer to place the board down on the bench and remove the surplus wood with a chisel and a mallet. Every dovetail should be clean-cut, and all uneven spots must be cut away.

The next step is to cut the tenons or pins in the end boards. See that the stock checks up with the measurements on the drawing. Place one piece in a vertical position in the vise and set one of the long boards in position on it, lined up corner to corner. Hold it so that it cannot move and with a sharp knife transfer the outline of the dovetails to the ends of the short board. It is a good practice to number the corners of your chest and check these numbers each time the corners are mated.

Take the long board out of the way and square the knife lines from the end layout down each side as far as the $\frac{3}{4}$ -in. line. This time you are to cut away the stock between the dovetail marks (see the end view of the chest, Fig. 4, page 6).

Next try to assemble the chest, but do not glue it yet. Check the corner numbers and press the joints together; do not pound the work with a mallet. See that all parts fit snugly and test the assembly with a steel square. If everything is satisfactory, you are ready to glue the joints. Any defective work can be remedied by using a plastic wood composition.

The bottom of the chest is $\frac{3}{4}$ in. thick and extends $\frac{1}{4}$ in. beyond the sides and ends of the box. This edge is rounded over. As the sides slope somewhat, it will be necessary to "level off" the upper and lower edges of the chest before fitting the cover and base. Screws and glue

are usually used to fasten the bottom of the chest.

The cover is rather unusual. It is evidently a plank about $1\frac{1}{4}$ in. thick. Along the outside edge it is only $\frac{5}{8}$ in. thick and has an overhang with a molded edge of the same dimensions. Some of the overhang over the hinges may have to be reduced to allow the cover to be opened wide; this depends upon the offset of the hinges used.

The iron trimmings on the original chest are handmade. The material is quite thin and appears to be hammered. The hinges, which are made of two strips of stock $\frac{3}{4}$ in. wide, pass underneath the cover. On the backboard each hinge extends down as far as the bottom. The hinges are placed $5\frac{3}{4}$ in. in from the corners of the chest.

The handles also are handmade, and the bails are made of round stock with three knurls or knobs in the center. All the iron fittings are painted black. Ready-made hinges and handles may be used if an exact duplicate is not desired. An iron lock with a small escutcheon for the keyhole is necessary to complete the fittings.

Whatever kind of stock you may use, it is well worth your while to sandpaper the chest inside and out as thoroughly as possible.

If your chest is made of white pine, it will look well finished with oil; or one coat of white shellac and another of varnish will make a fine contrast with the black iron bands and trim. Sea chests sometimes were painted, and you may prefer to paint yours in an attractive color.

"LADDER-BACK" CHAIR

This "ladder-back" chair, which takes its name from the arrangement of the slats forming the back, is a good specimen of some of the earliest chairs made in this country. Chairs of this type, because of their decorative appearance and Colonial associations, are popular and in demand for use in a hallway (Fig. 5), living room, or bedroom. They are not,

it must be admitted, especially comfortable.

The design illustrated in Fig. 6 was chosen because it is not difficult to copy. The back legs are plain except for the

rately. Another feature is the fact that this chair can be made without a lathe.

It may be well to cut and fit the mortises before rounding over the legs by hand or turning the stock in a lathe. If the stock is left square until the slats are fitted into place and the holes are made for the rounds, it is a simple matter to lay out the work.

Soft pine fillers can be placed temporarily into the mortises if the legs are to be turned. The fillers will prevent chipping near the edges. All of the mortises and holes should be about $\frac{3}{4}$ in. in depth. Wooden dowels or pins are used to strengthen the slat joints.

To make the back legs by hand, plane the stock exactly square with the base $1\frac{3}{4}$ in. and the top $1\frac{1}{16}$ in. On the larger end measure in from each corner exactly $\frac{1}{2}$ in. Connect these points cornerwise and you will have laid out an eight-sided figure—an octagon. Do the same on the smaller end, measuring $\frac{7}{16}$ in. instead of $\frac{1}{2}$ in. With the aid



FIG. 5.—Handmade reproductions of this type of chair are highly prized for their decorative quality and antique look.

upper ends. The irregularly shaped knobs may be part of the legs or turned sepa-

of a straight stick, draw lines the full length of the posts to connect these corner measurements. Now plane or bevel the corners of the leg, being careful not to cut below the bevel lines. All of the bevels should measure about $\frac{5}{8}$ in. wide at the big end.

As the next step, remove the remaining corners with a plane. The knobs at the top can be omitted if necessary. After this comes the seraping, filing, and sandpapering. The front legs are made in the same manner.

The seat rounds are $\frac{3}{4}$ in. in diameter, and on them is woven the rush² or fiber seat. Rush was used on the original, but fiber is easier for the amateur to handle.

MATERIALS FOR "LADDER-BACK" CHAIR

Parts	No.	Dia.	Length
Legs—back	2	$1\frac{3}{4}$	$38\frac{1}{2}$
front	2	$1\frac{1}{16}$	16
Rounds—front	2	1	$18\frac{1}{2}$
side	4	1	$12\frac{1}{2}$
back	1	1	$12\frac{1}{2}$
seat	1	$\frac{3}{4}$	$12\frac{1}{2}$
seat	1	$\frac{3}{4}$	$18\frac{1}{2}$
seat	2	$\frac{3}{4}$	13
Slats, bowed	4	$\frac{5}{16}$ by $2\frac{1}{2}$ by 13 long.	

Fiber or rush sufficient for one seat.

The stock is maple. All dimensions are in inches

²Information as to where to obtain rush or fiber, if it cannot be had locally, may be obtained from the Information Department of *Popular Science Monthly*, 381 Fourth Ave., New York, N. Y.

Simple printed directions are usually given with the fiber when it is purchased.

The chair rounds below the seat are $\frac{3}{4}$ in. at the ends and 1 in. in the middle. These are usually shaped by hand. Only one round is to be placed under the seat and between the back posts; this is on the same level as the bottom one on the front side. As a matter of fact, I could find no sign of a rear round on the old chair, but for additional strength it seems advisable to include one.

The slats are only $\frac{5}{16}$ in. thick. As they are bowed slightly, each piece can be steamed or soaked in boiling water and then clamped to a form. Another way is to shape each slat from a piece of stock 1 in. thick with the aid of a spoke-shave.

At the present time many old chairs of this type are being re-finished in modern ways. Some are even painted jet black with touches of gilt or bronze paint; others are given a dark brown or chocolate color. For an antique maple finish, a very light walnut stain may be used and wiped or sandpapered off in places here and there over the surface to give a high-lighted effect.

CHESTS IN POPULAR DESIGNS

When we consider the beauty, the romance, and the practical value of the cedar chest, we wonder what piece of furniture offers the amateur craftsman more satisfactory returns for his work. This section discusses the major points to be considered in making a Colonial and other popular types of cedar chests.

Thoroughly weather-dried red cedar, if obtainable, will yield more of the characteristic odor of cedar, but kiln-dried lumber will hold its shape better. Often a pine or whitewood chest can be lined with $\frac{3}{16}$ -in. red cedar, though as far as the safety of the contents is concerned, cedar may be omitted and the goods laid away in naphthalene flakes.

Cedar is prized for its beauty, its odor, and the sentiment attached to it through its long use in chests, but for all practical purposes any good cabinet wood

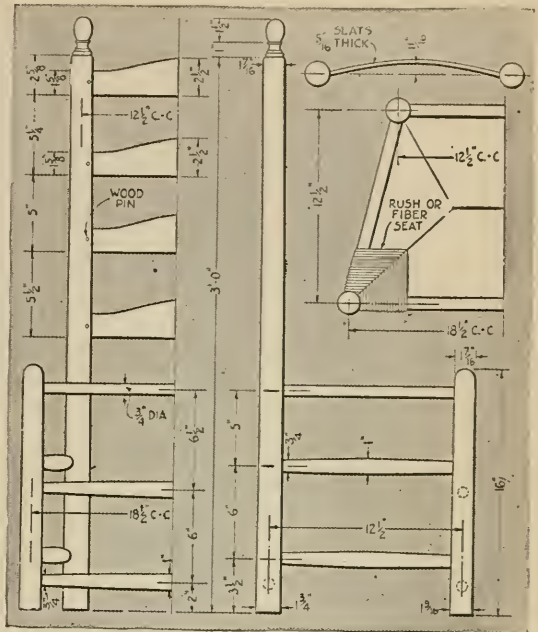

Fig. 6.—Measured drawings of Colonial "ladder-back" chair of fine proportions and unusual simplicity.

will serve for making the chests illustrated. Plywood can be used by adapting dimensions to the differences in thickness; this will eliminate all gluing of wide boards.

Red cedar boards are seldom more than 8 in. wide and usually have many blemishes, but we must be thankful that the unwise lumber waste of the past has left us even these. They should be planed $\frac{3}{4}$ or $\frac{7}{8}$ in. in thickness, as may be required. If a tray is desired, one of the poorer boards may be resawed and planed to $\frac{3}{8}$ in.

Saw out the boards to 1 in. longer than required and make a liberal allowance for width. Joint (plane) the edges for gluing. The simplest joint—the plain glued joint—has no reinforcement; the doweled joint is the best for this work, for the matched and splined joints are more suitable for machine fitting.



FIG. 7.—An attractive and practical chest seat. For the working drawings, see Fig. 11.

Dowels may be located by driving small brads about halfway in one of the edges to be joined at the points where the dowels are required and cutting them off so as to leave about $\frac{1}{8}$ in. projecting. Carefully place the two boards together and rap them sharply with a mallet. Separate them and pull out the brads. The small holes will be in perfect alignment and will indicate where to bore the dowel holes in both edges.

After the boards have been glued, plane them roughly to a straight surface and to an even thickness at the ends. Select the face sides of all pieces, joint the best edge of each, mark and saw the lengths accurately with a fine saw, and plane the parts to accurate widths.

The Colonial chest illustrated in Fig. 8 is assembled by fastening the end pieces to the sides with $1\frac{1}{2}$ -in. No. 9 screws and hiding the screw heads with plugs. Bore a $\frac{7}{16}$ -in. hole as at A $\frac{1}{4}$ in. deep, and drill a $\frac{3}{16}$ -in. hole the rest of the way. Make the plug by sawing $\frac{1}{2}$ in. from the end of a $\frac{1}{2}$ -in. board and

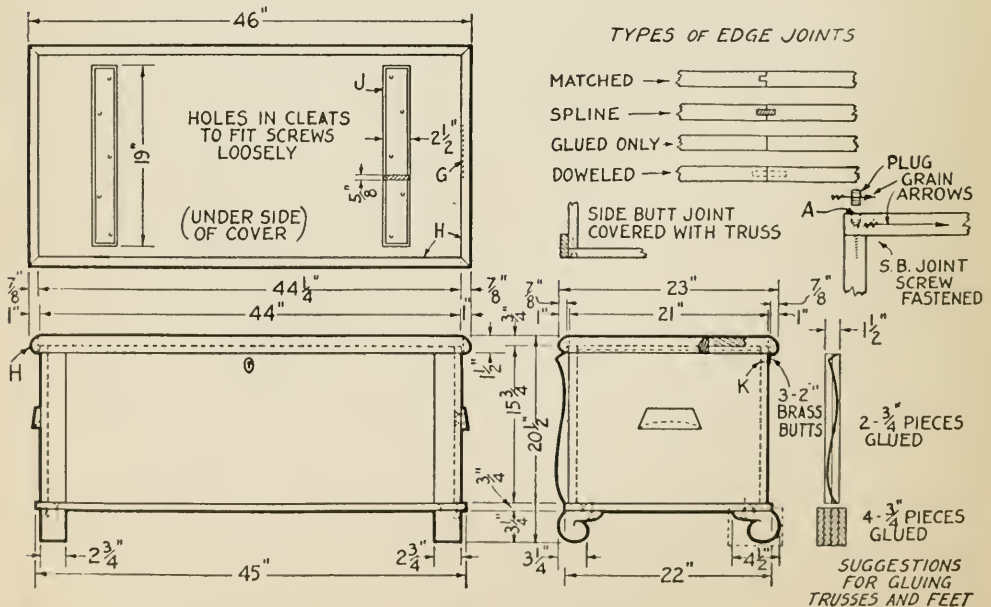

FIG. 8.—Colonial chest with various types of edge joints—matched, splined, butted and glued, doweled, and two kinds of side-butteted and screwed joints. Any of these can be used, of course, in making any types of chest.

planing, whittling, or filing it round and tapered so it can be driven closely into the $\frac{7}{16}$ -in. hole. Drive the screw; then glue and set the plug in the hole. The grain of the plug should coincide with the grain of the surface. Later on the

plug can be trimmed flush with the board.

Chests may be assembled by several other methods illustrated in Figs. 9, 10, and 11.

In the high chest (Fig. 9), the open

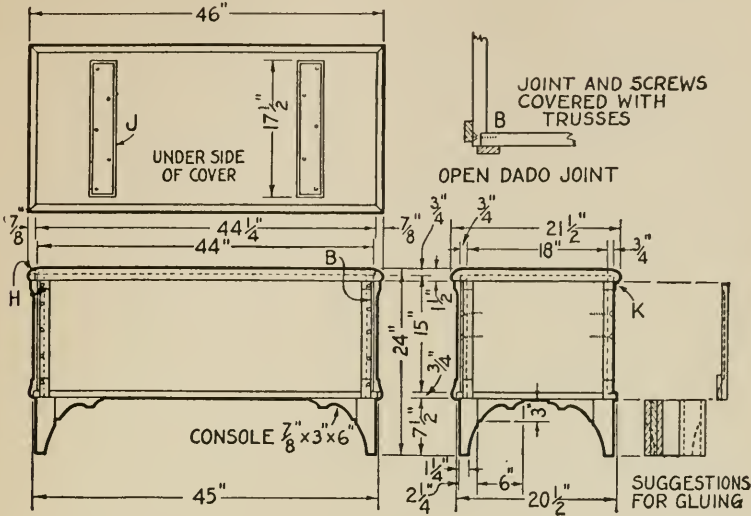

Fig. 9.—High chest with shaped legs. It gives a lighter and more graceful impression than a low, boxlike chest.

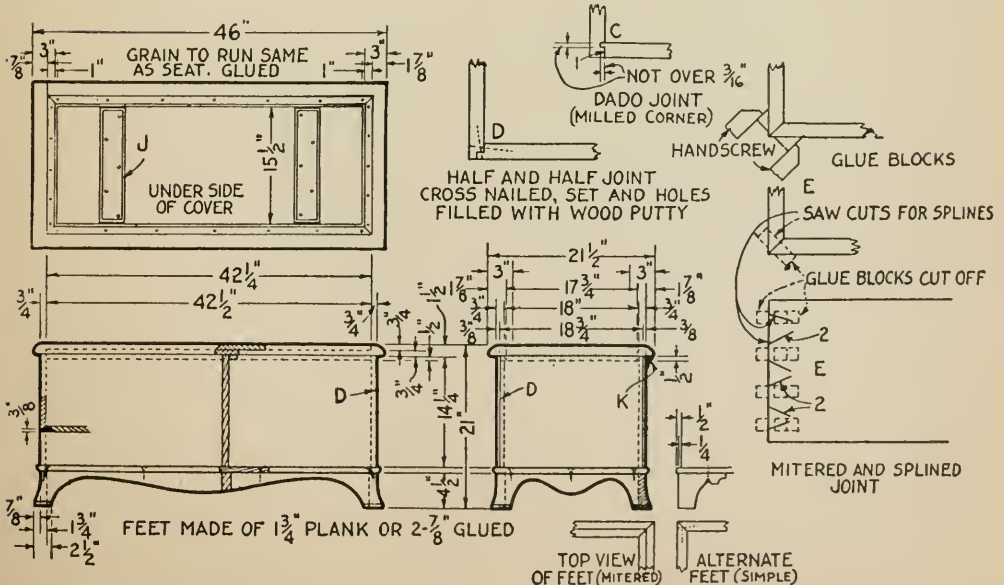

Fig. 10.—Hepplewhite chest with details of the legs and various types of corner joints.

dado joint *B* is assembled by means of $1\frac{1}{2}$ No. 8 screws driven a little slantingly. The countersunk screw holes and the joint are covered with a strip.

In the Hepplewhite chest (Fig. 10), the dado or milled corner *C* requires the use of a circular saw; the grain at *I* is

and sandpaper. Fasten these in place with glue and with nails or screws.

Handles may be made of $\frac{7}{8}$ -in.-thick wood hollowed underneath and fastened with glue and screws.

Make the cover $\frac{1}{8}$ in. larger all around than the body of the chest, with

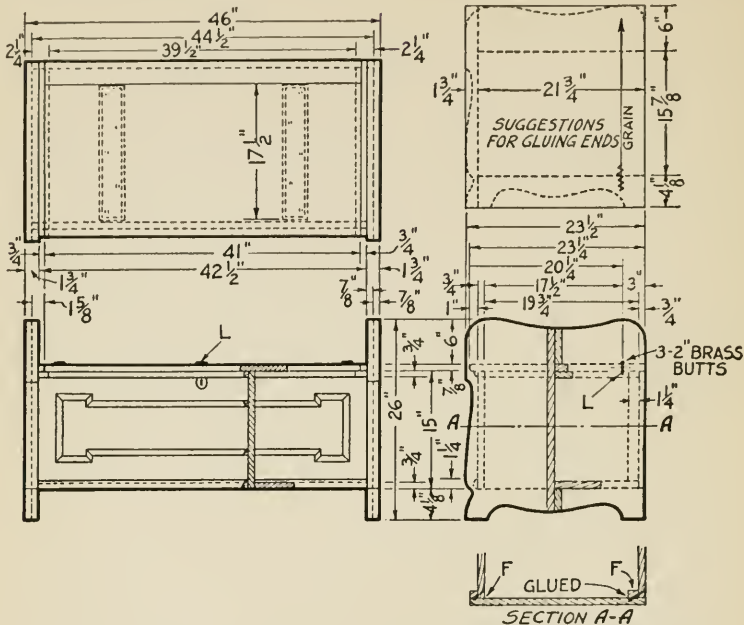

FIG. 11.—Dimensioned drawings of the chest seat. Compare with Fig. 7.

a weak place. The half-and-half joint at *D*, nailed two ways and with the nails set and the holes filled with putty, makes a good joint. The mitered and splined joint *E* is the best joint shown; it is strengthened by splines *S*, made of veneer and glued into slanting saw cuts of suitable width.

The construction of the seat chest (Figs. 7 and 11) permits a simpler form of corner. The sides and ends may be securely nailed as at *F*.

A chest bottom should be perfectly square and fastened to the bottom with sixpenny finishing nails or with screws, say $1\frac{1}{4}$ No. 9 in size.

The trusses and feet may be made from $\frac{3}{4}$ -in. pieces cut larger than required, glued together, sawed, and the curves smoothed with spokeshave, file,

square edges and true angles. The molding *H* (Colonial chest, Fig. 8) around the cover is $\frac{7}{8}$ by $1\frac{1}{2}$ in. It is fitted to the edge, mitered, and fastened with glue and sixpenny finishing nails. Place the glue in the middle of the end as at *G*, which will allow the cover to shrink and swell without twisting. Take the same precautions in fastening cleats *J* with glue—that is, apply the glue only at the center—and have the screw holes fit the screws loosely. The edge of the cover should project 1 in., but it may be $\frac{1}{16}$ in. less so *H* will just clear the body.

Regular chest hinges, which have one leaf offset, as shown in the upper left-hand corner of Fig. 12, are ordinarily used. The offset leaf is attached with screws to the upper edge of the back of the chest and to the inner surface of the

back. Hinges of this type can be obtained at the larger hardware stores and manual training supply houses.

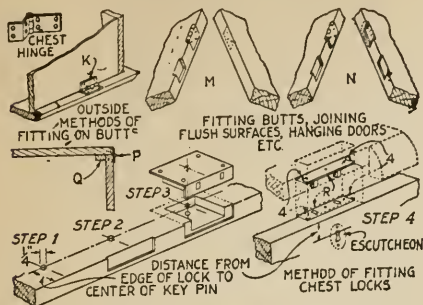

Fig. 12.—A chest hinge; various methods of applying butt hinges; the steps in fitting a chest lock.

Ordinary butt hinges *K* also can be used and, of course, are obtainable anywhere. To apply them, lay the cover and chest upside down; place the butts and drive the screws while in that position. If the cover and back are flush, the hinges may be placed as at *P*. In that case, a strip $\frac{1}{2}$ by 1 in. in cross section should be fastened to the inside of the cover as at *Q* to make the joint tight.

Fasten a piece of chain, strap, or webbing about 18 in. long from the chest to the cover, inside, to prevent the cover from falling too far back.

Butts placed at *L* in Fig. 11 may be cut entirely into the cover (as shown at *M* in Fig. 12) or one half their thickness may be set into the cover and half into the back piece, as at *N*.

Fit the chest lock by following the steps illustrated. Place the striker *R* in the lock and turn the key; drop the cover on the striker and the points *4* will mark the underside. Raise the cover, place the striker in the marks accurately, and mark carefully around the plate with a knife. Sink the depth of the plate until the cover will be held firmly when the chest is locked. After the chest has been finished, the escutcheon may be fastened in place.

The chest may be finished on the outside in its natural color or stained. Give the wood two coats of shellac and two of rubbing varnish or rubbing lacquer.

Rub the undercoats with No. 4-0 sandpaper, and, if varnish is used, rub the last coat with powdered pumice stone and oil. Do not finish the inside in any way or the aroma of the cedar will be destroyed.

Some manufacturers sell knocked-down cedar chests in a variety of designs. These usually have finely machined corner joints so that the parts practically lock together. Their assembly is, therefore, a simple matter.

Manual training supply dealers and stores which carry hardware specialties often have on hand a supply of special hardware for chests, including copper bands, corners, hinge plates, escutcheons, handles, and chest lid supports.

PIANO BENCHES

Several designs for piano benches are suggested in Figs. 13 and 14. The main difference in the various types lies in the shape of the legs. Use the design which will harmonize best with your piano; although, of course, a bench with plain legs (Fig. 13) will be in good taste for use with practically any instrument.



Fig. 13.—A neat, strong, easily made piano bench with storage space underneath the seat.

To make the simplest of the benches illustrated—that for which complete side and end views are given—prepare four legs $1\frac{3}{4}$ by $1\frac{3}{4}$ by $18\frac{5}{8}$ in. and taper them as shown on the inside faces from a point $4\frac{1}{2}$ in. from the top to the bottom, where they are 1 in. square.

Make two side rails $\frac{7}{8}$ by $3\frac{3}{4}$ by $36\frac{1}{2}$ in., and two end rails $\frac{7}{8}$ by $3\frac{3}{4}$ by $10\frac{1}{2}$ in. Rabbet the rails to receive the $\frac{1}{2}$ in. thick bottom and bore for dowel joints. Smooth, sandpaper, and assemble

piece $\frac{1}{4}$ by 1 by $36\frac{1}{2}$ in. as at *D*, if you wish, to bring the top of the hinge rail flush with the outside of the back legs.

Smooth and sandpaper the seat, and the bench will be ready for finishing.

If music is not to be kept in the top, the top rails may be made narrower and the bottom omitted. Bottom rails and a stretcher may be fitted as shown at *E*, if desired.

The bench may be elaborated by making the top rails 6 in. wide and saw-

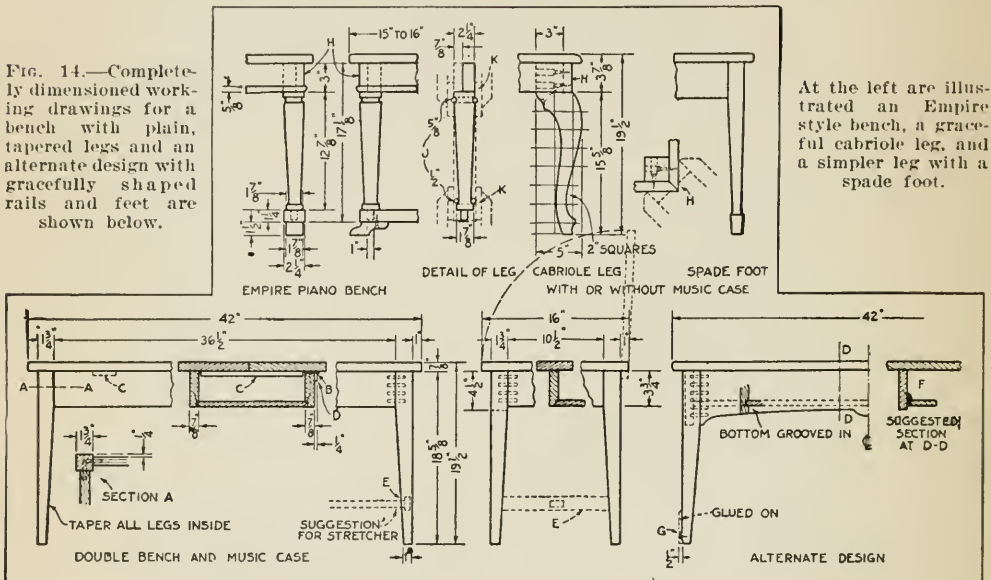

legs and rails. Fit the bottom and fasten it securely in place with $1\frac{1}{4}$ -in. No. 16 brads.

Glue up a well-selected piece for the seat $\frac{7}{8}$ by 16 by 42 in.; or if you prefer you may use plywood, provided you can obtain it as thick as $\frac{3}{4}$ in. In using glued-up stock, plane and sandpaper the underside and fit two cleats $\frac{3}{8}$ by $2\frac{1}{2}$ by 11 in. as at *C* and fasten them with 1-in. No. 8 screws.

Plane the tops of rails and legs to fit the seat and hang it with 3 in. wide brass butt hinges as at *B*. The hinge must project back far enough to allow the top to be opened fully without binding on the legs, and you may therefore fit a

design upon the bottom of each. The bottom may be fitted into a groove, or fitted square after the legs are assembled as at *F*, Fig. 14. Feet may be suggested as at *G* by gluing on pieces of $\frac{1}{2}$ -in. wood and working them to a pleasing shape. The spade foot leg (Fig. 13) may be used as an alternate design.

The Empire bench and the bench with cabriole legs (Fig. 13) are made with mitered rails, fitted and glued together as at *H* and strengthened with screws. The Empire legs may be made from $2\frac{1}{4}$ in. square wood and the semicircular holes *J* bored with sharp, clean cutting auger bits; each hole should be square and parallel with its related surfaces.

Pieces *K*, held in place with hand screws, will help in boring these holes.

The cabriole legs may be cut from 5 in. square stock. Make a pasteboard pattern, mark each of the squares on adjacent sides, and take the wood to a mill to be band sawed. Smooth with spoke-shave, file, and sandpaper.

The bench may be stained to match the piano and finished with shellac or a hard varnish. Rub all undercoats with No. 4/0 or 6/0 sandpaper and the last coat with FF powdered pumice stone and oil, finishing with wax if desired.

Benches may be made shorter than 42 in., but not for duet playing.

LACQUERED CABINET MADE FROM OLD WASHSTAND

Chinese lacquered cabinets are fashionable, and the prices asked for high-class ones are prohibitive. It is not a difficult task to make one, however, especially if an old washstand can be found in the attic or at a second hand furniture store to serve as the box part.

The cabinet illustrated in Fig. 15 was made by Marie Childs Todd, an art teacher in an Indianapolis high school. Her imagination was fired by an illustration in Frederick Litchfield's *History of Furniture*. This showed a cabinet in red lacquer with Chinese landscapes in gold and silver, mounted with engraved metal hinges, on a stand carved with a female mask, and decorated on the inside with foliage on a red ground.

Quoting Mr. Litchfield—"Within the last ten to fifteen years there has been in England a greatly increased appreciation of lacquered furniture. Cabinets of the square, boxlike form, having two doors opening and disclosing an interior arrangement of various small doors, now realize five or six times the original amount—the red variety being that which is in most favor. In July, 1920, a cabinet of this description mounted on a Chippendale lacquered stand realized 950 guineas."

One friend of Miss Todd's took a kindly interest in her plans and gave her an old washstand. A furniture repair

man followed her sketches and put the piece in shape to decorate with lacquer in Oriental style. He took off the old drawer and added a straight piece at the back of the top and two small corners below to change the lower line.



FIG. 15.—A Chinese lacquered cabinet in red and gold. The box part is from a discarded washstand.

The cabinet was to be used to conceal a small mahogany box phonograph. The repair man placed the phonograph inside the embryo cabinet, after removing the shutter and cover of the box and making a new sounding board. He bored a hole in the back of the cabinet so that the handle for regulating the machine would not be seen. He also made legs and stretchers of gumwood (Fig. 17).

Such a cabinet would house a radio set in regal splendor. It could be adapted equally well to serve as a writing desk by adding a drawer and a slide of wood,

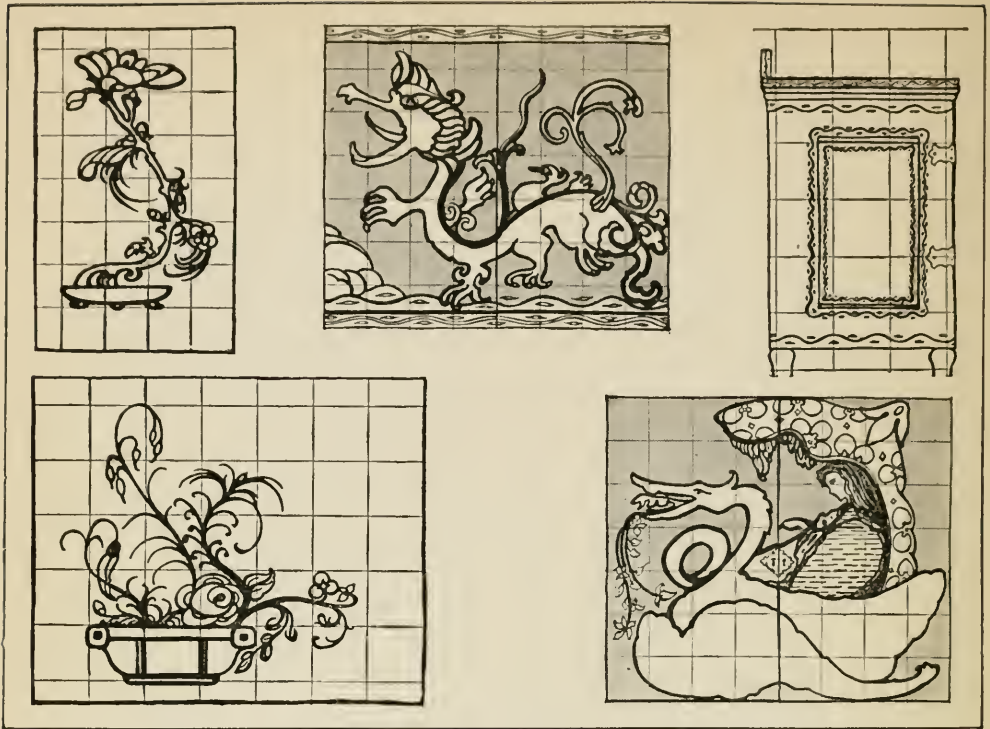

FIG. 16.—Decorations for the cabinet shown in Fig. 15. Above at left: The design used on the inside of the doors. Center: The dragon may be used as an alternative for the design in the lower right-hand corner or combined with that design. Right: The wave and spot design used on the sides of the cabinet. Below at left: The bowl and flower design was applied in black and gold on the back of the cabinet. Right: Design for the front of the doors.

or it might be fitted with many little doors and drawers and, perhaps, a secret compartment or two intended for papers, jewels and miscellaneous trinkets.

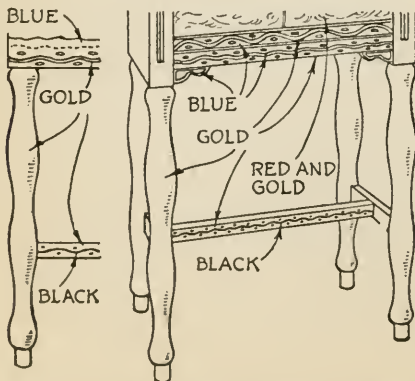

FIG. 17.—The legs were finished in green gold and black lacquers. Note the coloring of the conventional, wave-like borders.

The first step in finishing the cabinet was to use paint and varnish remover on the old walnut, sandpaper the wood thoroughly, and apply a paste wood filler.

Meanwhile Miss Todd had two pairs of brass hinges and a key-lock design about 3 by 3 in. made of brass $\frac{1}{16}$ in. thick. The edges were designed like the notched margins of certain leaves. Her sketch was sent to a brass foundry where such pieces were made. The cost was about three dollars. Later the brass was treated with acid and salt to give an antique effect.

The principal design for ornamenting the cabinet was drawn freehand on paper and then copied on the cabinet (Fig. 15). The basic idea was a dragon guarding the journey of the Spirit of Music and Harmony to the earth. This is shown on squares (Fig. 16) so that you can en-

large it for the two door panels of your own cabinet; or you may use a dragon design, or make an original design.

A claylike material (it can be obtained in artists' supply shops) called gesso was used to raise the design slightly above the wooden background, after a transparent liquid filler or varnish had been applied carefully on the part that was to receive the gesso pattern. There are

In the design illustrated in Fig. 15, the dragon, boat and canopy of flowers are raised a trifle higher than the Spirit of Music part of the motif.

The gesso must be allowed to set for several days; then the design is sandpapered to remove any rough places.

Before painting the surface of the raised design with green gold bronze, several coats of Chinese red lacquer are

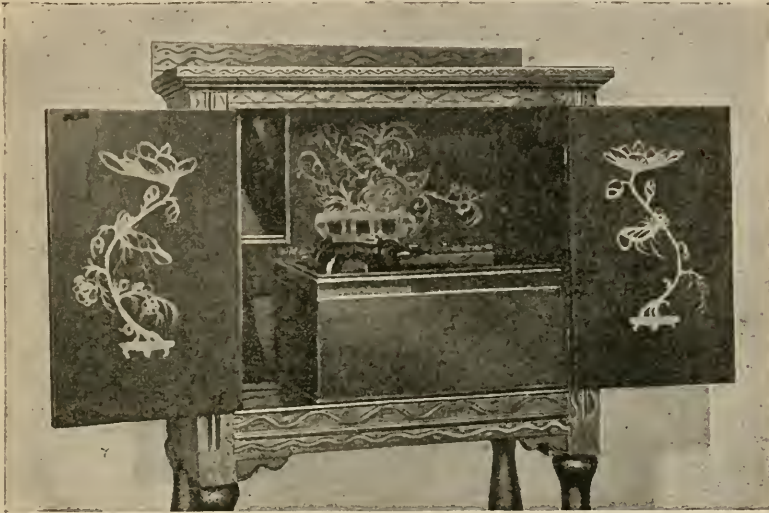

FIG. 18.—The interior of the cabinet, which holds a phonograph, is finished in black Russian lacquer with artistic flower designs in gold.

many ways of making and using gesso: it is essentially a mixture of glue (preferably liquid glue) and whiting with a little linseed oil and varnish added. The gesso is put on with a patting motion, using the brush full and the gesso about the consistency of medium thick cream.

It is a process that is very simple, but must not be hurried. It is as fascinating as wood carving, but much simpler. The work should be done evenly so that no patching is needed, as that is apt to cause cracks over the surface. If you must add to a spot, let the first coat set overnight. Use a little water to thin your gesso composition. After it hardens, it may be sandpapered with 00 sandpaper, or may even be carved a little with small chisels, but for a less elaborate design this process is not necessary.

brushed on the cabinet. For this purpose a high-grade brushing lacquer may be used. Some may prefer a black and gold or a dark green, black, and gold color scheme for their cabinets. Any of these color harmonies are correct from the standpoint of furniture history.

Use a new house-paint brush about 3 in. wide and flow the lacquer on swiftly, with an even pressure on the brush. If there should be a slight tendency to ripple, such defects are readily corrected with a second coat, which may be applied within an hour. The following day a third coat is applied.

The next step was the application of green gold to the design itself; that is, to the gesso. The green gold, which comes in powder form, is mixed with an oil medium (this can be obtained in paint

and art stores of any size) and should be stirred constantly and kept medium thin—a little thicker than water. The gesso surface, though slightly rough, takes gold preparation perfectly if it is applied with an ordinary soft camel's-hair brush, such as is sometimes used for applying washes in water color painting.

spot pattern. The other smaller borders on the front of the cabinet are blue wave and spots on gold backgrounds. The borders vary in width from $\frac{1}{2}$ to 2 in. They are used on the sides of the cabinet as illustrated.

The 3 in. wide upright strip at the back of the cabinet on top has a gold



FIG. 19.—Authentic Terry shelf clocks are highly prized because of their rarity and their decorative value in any Colonial setting.

After the gold surface is dry, other colors are added for accent or contrasting color harmony. On the cabinet accents of black laequer and cerulean blue oil paint were used; these softened what might have been a bizarre color effect. From the dragon's head float painted sprays of cerulean blue and gold flowers and leaves.

On the front are painted bands of blue and gold to serve as backgrounds for the borders. The border designs are a line and spot repetition, suggesting waves and foam flecks on water. This is repeated in a 2 in. wide border just below the two door panels and has a cerulean blue background with gold wave and

background, which partly conceals and partly reveals the red laequer. On this the wave border is painted in black. This treatment is repeated throughout.

Later, to lighten the solid effect of the red laequer on the front, a few touches of Chinese vermilion oil paint are added; and, after these have dried for several days, an irregular line pattern is applied in gold to suggest the edges of clouds in the red background.

The interior of the cabinet (Fig. 18) is finished in stately black laequer and gold designs. To the left, beside the phonograph box, which has been transformed from polished mahogany to a black laequer finish, there are four up-

right record compartments made of wood. On the inside of the back is a flower arrangement done in green gold. On the inside panel of each door are tall, slender lily designs in tiny bowls, drawn with free brush lines after the Chinese or Japanese fashion.

If you wish to copy these designs, you may cut paper to the size of the spaces you wish to decorate and, after practicing changing the proportions to suit your space limitations, transfer your design either by chalking the back of the paper or by placing yellow carbon, or impression paper, against the wood and going over your pattern with a medium pencil with a sharp point. The advantage of chalk in transferring the design to a dark background with a high glaze is that it may be readily seen and yet all traces are easily removed when your work is completed.

Last of all two coats of flat varnish are applied. These dry dull and do not require rubbing, although polishing gently with a soft cloth adds to the soft-toned luster.

This cabinet makes a piece of furniture that would grace any living room or studio. If Chinese red is used, care must be taken, of course, in placing paintings or prints near by on the wall so that they will be subordinate in color to the beauty of the cabinet.

TERRY SHELF CLOCK

Anyone who is interested in antique furniture will recognize the shelf clock shown in Figs. 19 and 20. The design was made and perfected by Eli Terry, one of the most noted of the early clock makers in Connecticut.

Terry's "pillar-and-scroll" shelf clock was first made in 1814. Seth Thomas, another clock maker, paid Terry one thousand dollars for the right to use this design. The first year the shelf clocks were put on the market these two men made more than six thousand of them. The selling price was fifteen dollars each.

Genuine Terry shelf clocks are not easy to purchase because their owners prize them highly. It is interesting to

see the number of reproductions on sale in the stores, but the copies are as a rule about one half the size of this one. Even so, the effect is pleasing, and anyone interested in this design can make the case half size if he wishes.

The clock movement should be an eight-day wind. The dial, of thin wood or metal, measures 11½ in. square. One can be made by pasting a piece of the finest white drawing paper on a sheet of zinc and doing the necessary drawing in India ink with compasses and rule. In each corner a small floral decoration in colors should be added. This trouble, however, may be avoided, for dials, pictures, brass ornaments, mahogany ve-

MATERIALS FOR CLOCK CASE

No.	Pcs.	T.	W.	L.	PARTS For Case
2	¾	4	21		Veneered mahogany for sides
1	⅜	4½	16⅜		Pine for top
1	¾	4	16⅜		Pine for base
1	½	¾	30		Mahogany or walnut base molding
1	⅜	13¼	21		Pine for backboard
2	⅝	1½	21		Pine for back strips
2	1	1	13¼		Pine for corner blocks
1	1	1	3		Pine for center block
3	⅛	1½	1½		Mahogany for block caps
2	1⅛	1½	21		Mahogany for pillars
2	⅜	4¾	7		Mahogany veneer (plywood) for top scrolls
2	⅜	1	3		Mahogany veneer for top end scrolls
1	⅜	2½	17		Mahogany veneer for base scroll
2	⅜	2½	4½		Mahogany veneer for base end scrolls
3					Brass ornaments
For Clock Door					
2	¾	1	21		Mahogany veneer for sides
2	¾	1	13⅜		Mahogany veneer for ends
1	¾	¾	12		Mahogany veneer for center partition
2					Special hinges (as shown)

Note: Make door cross-grained as shown in drawing.

neer, and pillars can be purchased at reasonable cost.

The picture in the space below the dial was always painted directly on the glass. A colored picture of Mt. Vernon, George Washington's home, is well adapted for this style of clock.

The making of the case is easy and the materials³ should not be difficult to

sidepieces is given as 4 in. This was the width of the sidepieces on the original clock, but it does not provide a sufficient depth for present-day movements. Obviously, the easiest way to obtain sufficient depth is to increase the dimension to 5 in., but that will not satisfy the craftsman who wishes to make a perfectly proportioned reproduction.

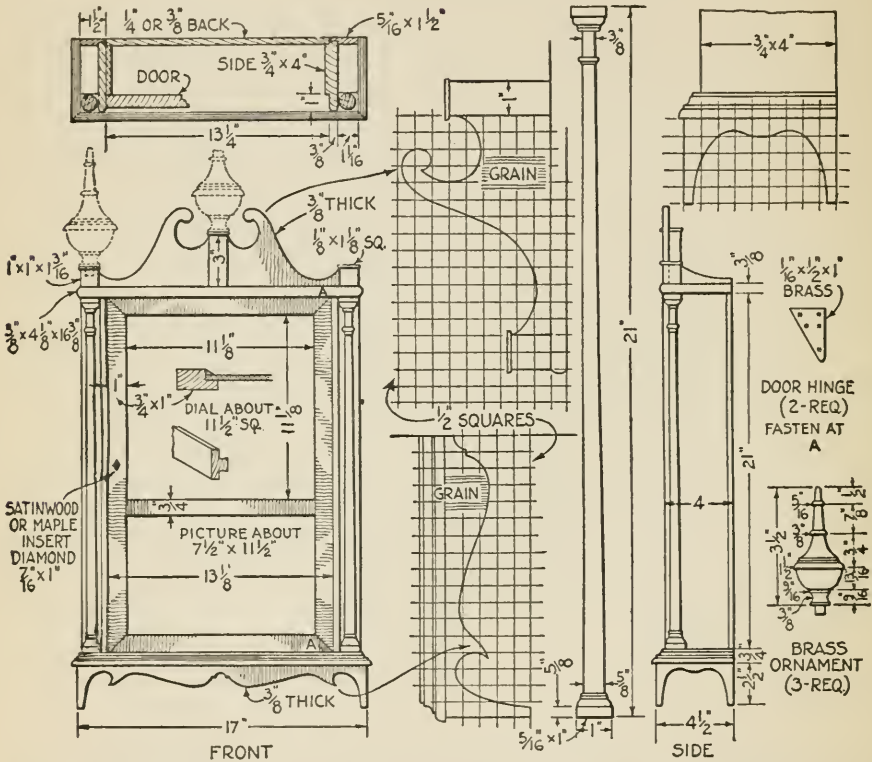

FIG. 20.—Measured drawings of a genuine Eli Terry pillar-and-scroll shelf clock made about 1814. The wood used is mahogany, except for a few hidden blocks.

obtain. Your lumber dealer can obtain the veneer for you, if he does not have it in stock. Ask for three-ply 3/8-in. stock.

In making any clock, particularly one of this type, it is advisable to purchase the movement before beginning to construct the case. On the drawing and in the bill of material the width of the

Another way to gain more space is to cut through the back to make an opening into which the movement can project. Additional clearance can be obtained by adding a wooden rim of the necessary thickness around the opening at the rear. After the works are in position, this opening can be covered with a sheet of zinc.

Prepare two pieces 3/4 by 4 by 21 in. for the side of the case. If you use 3/8-in. veneer you will have to glue additional

³A list of dealers in clock movements, dials, ornaments, veneer, and other supplies can be obtained upon request from the Information Department of *Popular Science Monthly*.

stock on the inside surface to make up the $\frac{3}{4}$ -in. thickness. Some work can be saved by purchasing a small amount of $\frac{3}{4}$ -in. veneer for the case sides and door. Notice that the front edges of these pieces are cut away for the door and a similar groove or rabbet is made for the insertion of the backboard. The front edge is rounded over slightly.

The top board of the case and the base are doweled or pinned to the sides, but screws at the top and bottom are better. The top board is also rounded over. The baseboard is made of pine with a molding fastened to the front edge and the ends.

At each corner and at the top is a wooden block 1 by 1 by $1\frac{3}{16}$ in. and in the center is a third piece 1 by 1 by 3 in. Between them is the scroll, made of $\frac{3}{8}$ -in. mahogany veneer. Under the baseboard are the base scrolls, which are made in three parts of the same material. The corners are mitered and a number of pine blocks or cleats are glued in the angles for additional strength. Cut away or bevel the inside edges of all the scrolls, a $\frac{1}{4}$ -in. bevel being about right.

The pillars are plain except for the caps at the top and bottom. Each one is set in place near the front edge.

The door is made of $\frac{3}{4}$ -in. stock with mitered corner joints. Note the direction of the grain of the face veneer. The door hinges are unique—merely two small pieces of brass made as shown and fastened to the door as at *A* on the drawing. A small roundhead brass nail or screw is used as a pivot.

The three ornaments should be of brass and similar to the design shown. Copies are available, but some readers may prefer to turn a pattern and have castings made. Fairly good-looking ornaments can be turned on the lathe and the wood gilded to imitate brass.

At the back edge of the case behind the pillars are two thin strips of wood $\frac{5}{16}$ by $1\frac{1}{2}$ by 21 in. In the original clock some thin strips of wood are fastened inside to support the works and dial.

In finishing or staining the case, do not use a red mahogany stain. A brown shade is far better and more like the

original case. The front surface of the three blocks at the top is almost black in color, offering a pleasing contrast with the scroll material. Terry also made these clocks with the posts veneered with satinwood or maple.

One coat of brown mahogany oil stain (not varnish stain), followed by a wash coat of thin shellac and two coats of varnish, will prepare the clock for use.

BANJO CLOCK

How many home workers have wished to make a banjo clock case but hesitated because of the difficulty in obtaining suitable movements and ornamental brass work! That is no longer an obstacle, for the clock illustrated in Figs. 21 and 22 will fit one of the standard sets of brasses sold for use by craftsmen.

Such a kit usually includes an eight-day movement, a silvered dial, a bronze-plated sash, a pair of pierced hands, two side brass scrolls, an eagle finial, and two decorative glass panels. The cost is in the neighborhood of seven dollars. To this, of course, must be added the cost of the wood, which is trifling, and finishing materials—not more than ten dollars altogether. Whitewood, birch, gum, or any wood which will take mahogany stain can be used, if genuine mahogany cannot be obtained.

Make the top drum in segments as indicated by lines 1-2 at *B*, Fig. 22. Twelve segments $\frac{3}{4}$ in. thick will be needed, or 18 pieces $\frac{1}{2}$ in. thick, each with the grain running lengthwise. Make a pasteboard pattern and cut the inside curve of each segment accurately, but leave the outside curve with sufficient allowance for working it down to size after the drum has been glued. Lay each segment so the inside coincides with a $4\frac{1}{2}$ -in. circle drawn upon a piece of pasteboard. Build up the drum and glue and fasten the segments with brads. Break the joints about as indicated by lines 1-2, whether the segments are in two or three layers. Be sure the inside is just $4\frac{1}{2}$ in. in diameter and $1\frac{1}{2}$ in. deep.

Fasten on the $\frac{1}{4}$ -in. back with glue and brads, and make the outside of the

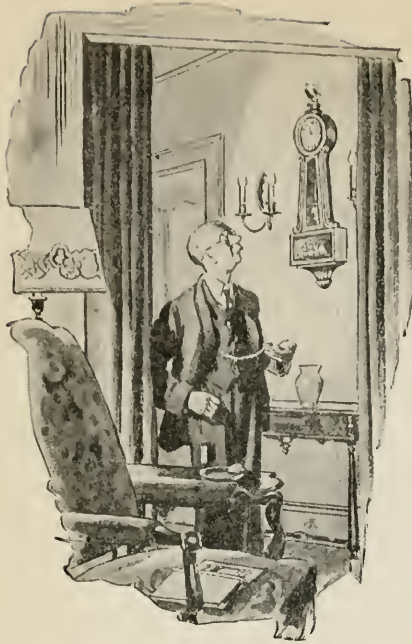

FIG. 21.—A banjo clock is one of the easiest of timepieces to construct.

by $8\frac{3}{4}$ in., tapering to 2 in. wide at the top. Prepare the base block, $1\frac{3}{4}$ by $4\frac{1}{8}$ by $7\frac{1}{8}$ in., with two pieces $\frac{3}{8}$ by $1\frac{3}{4}$ by $4\frac{1}{8}$ in. glued and bradded on the ends as at *C* to cover the end wood.

Plane a flat place at *D* on the drum to rest upon the top of the shaft block. Glue and fasten drum and shaft with $1\frac{1}{2}$ -in. No. 8 screws. Plane another flat place $1\frac{3}{4}$ in. wide on top of drum at *E* to receive the finial base.

Either dowel the base block and shaft together, or bore holes *F* and *F*¹ through the base block and fasten the shaft with glue and screws.

The molding for the glass panel frames must be rabbeted, but the face may be either flat or round as at *A*; the latter is preferable, but it is more work.

Another choice exists in making the corners of the frames: they must be mitered, glued, and bradded, but may be left plain or covered with a small piece of wood glued on as at *G*. If rounded molding has been used, however, the squares must be set in as at *G*¹. Do not fasten the panels to the blocks until after finishing the clock.

Make the finial base and the pendant with the grain running vertically in each.

drum $5\frac{3}{4}$ in. in diameter and as smooth as possible.

Get out the shaft block, $1\frac{1}{2}$ by $3\frac{1}{2}$

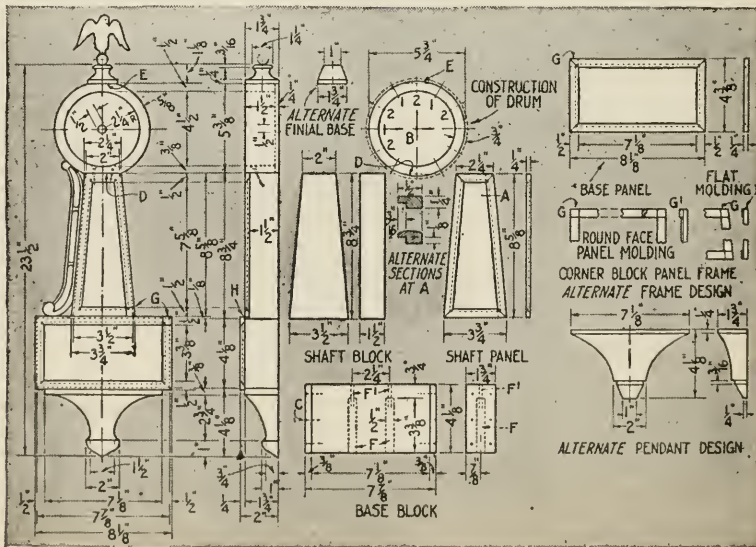

FIG. 22.—Front and side views of a banjo clock case; construction of drum; the shaft and base clocks; panels and moldings; base and pendant designs.

They may be band sawed if a very fine band saw is available. Note the simpler alternate designs. Be sure that the forms are true and the corners straight. Fasten them in place with glue and brads.

Make a piece $\frac{1}{8}$ by $\frac{1}{4}$ by $3\frac{1}{2}$ in. to fit under the shaft panel frame as indicated in the drawing at *H*, and glue in place.

Smooth and sandpaper all exposed surfaces carefully. Stain all pieces and apply three or four light coats of shellac. Rub each coat with No. 4/0 sandpaper. Finish the last coat with wax.

Fill the panel frames with the ready-made glass panels. If these are not used, plain glass may be cut to fit the rabbets of each frame and either left as it is or decorated by hand or by fitting a picture behind the glass.

Fasten the frames to the base and shaft with a few $\frac{3}{4}$ -in. No. 19 brads. Set the brads, fill the holes with colored putty, and touch with wax. Put the brasses in place and install the movement, dial, and sash.

COMBINATION CHEST AND DESK

An unusually interesting piece of furniture, especially for a small apartment,

is the combination chest of drawers and desk illustrated in Figs. 23 and 24. What appears to be the top drawer is a well appointed desk when pulled out.

The simple construction brings the

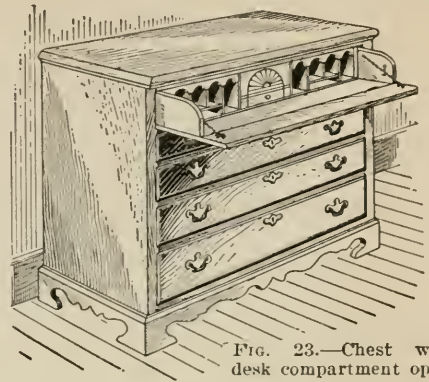

FIG. 23.—Chest with desk compartment open.

project easily within the range of the amateur cabinetmaker. It may be made of birch, maple, oak or mahogany.

Make the ends *a* (Fig. 24) of $\frac{3}{8}$ -in. plywood. Glue and brad in place at both the back and front of *a* the $\frac{7}{8}$ by $\frac{7}{8}$ in. pieces *b*, which are cut to lengths equaling the height of the drawers. Leave $\frac{3}{4}$ -in. spaces between pieces *b* to receive drawer partitions *c* and drawer

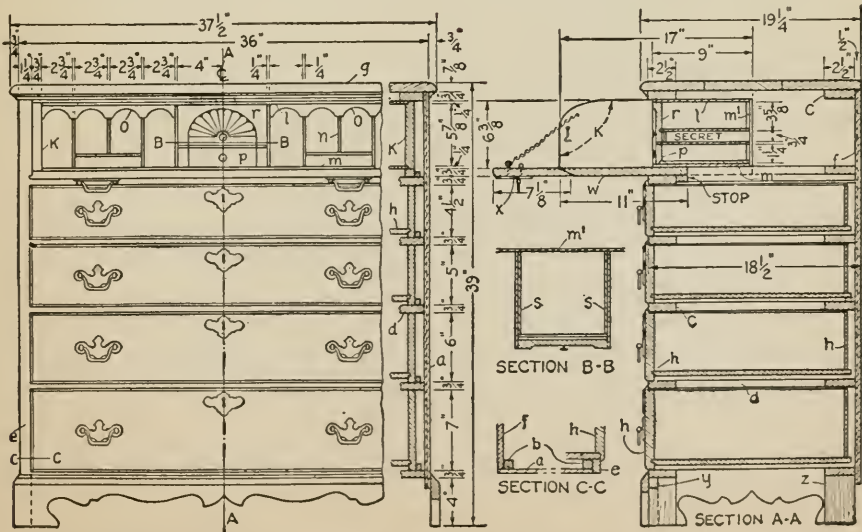

FIG. 24.—Front view of the chest partly broken away to show a section through the end; a sectional view through the center from front to back showing drawers and desk slide.

ledges *d* as indicated. Joint (plane) the front edge of each sidepiece and glue front facings *e* in place. The facings should be $\frac{3}{4}$ by $1\frac{1}{4}$ by $38\frac{1}{8}$ in. and extend to the floor. Two $2\frac{1}{2}$ -in. square blocks or false legs *z* should be fitted to support the back of the case and receive the rear end of the base.

Cut drawer partitions *c*, $\frac{3}{4}$ by $2\frac{1}{2}$ by $35\frac{1}{4}$ in., to fit exactly inside of ends *a*. Place these together and cut all shoulders to fit around facings *e* at once to insure accuracy. Assemble the case, fitting a back *f* of $\frac{1}{2}$ -in. sheathing or plywood. Be sure the case is square. Make top *g* of solid wood, work a thumb molding on the edge, nail it in place, and miter a cavetto (stock cove molding) under it.

Make the drawer fronts, sides, bottoms and backs as indicated at *h*, allowing $\frac{1}{16}$ in. less in length of front to aid in fitting. Make the desk drawer sides *k* $\frac{3}{4}$ by $6\frac{3}{8}$ by 17 in., fit the pigeonhole top *l* and the bottom *m*, $\frac{1}{4}$ by 9 by $32\frac{1}{2}$ in., by means of rabbets into *k*; fit the partitions *n* and the shelves of $\frac{1}{4}$ -in. wood between *l* and *m* and fasten all with brads. Make the arch spandrels *o* $\frac{1}{4}$ in. thick, each of one piece, and fit them with their faces flush with fronts of *l m o*. Fasten the $\frac{1}{4}$ -in. back *m*¹ in place.

Make lids *w* and *x*; fit and fasten them to *k* as shown. The front of each of the middle drawers *p* and *r* may be made by fitting the sides in front by means of a rabbet and cutting the back between the sides, which should be $\frac{1}{4}$ in. thick; the bottom is bradded to their bottom edges. The $\frac{1}{4}$ -in. sides *s* of the secret compartment support the drawer *r*.

Make the $\frac{5}{8}$ in. thick base, mold the top edge, miter it, draw the design, and have the profile cut by a band saw if possible. Sandpaper the piece thoroughly and fasten it in place with glue, brads and glue blocks *y*.

Fit broad flap hinges to join *w* and *x*. Fasten a chain support to desk lid *x* and a hook to hold the lid in place when the drawer is closed. Bore holes to receive the drawer pulls and fit the locks and escutcheons.

Sandpaper all surfaces thoroughly.

Finish in natural color, or stain if preferred. Give three thin coats of white or orange shellac, rub between coats with No. 4/0 sandpaper, and polish with wax.

TEA TRAY STAND

A tea server (Figs. 25 and 26) is a real asset for the busy housewife during the afternoon tête-à-tête. To construct one requires little skill or expense



FIG. 25.—An easily lifted stand for a tea tray, which can be constructed at small cost.

for materials, especially if whitewood, redwood, white pine, cypress, or other easily worked woods are used.

The materials required are: 2 sides $\frac{3}{4}$ by $2\frac{1}{2}$ by 32 in.; 2 leg pieces 2 by 4 by 19 in.; 2 pieces $\frac{3}{4}$ by $2\frac{1}{2}$ by 24 in., one for the tray rest and the other for the lower brace; 1 piece $\frac{3}{4}$ by 5 by 26 in. for the handle; 2 pieces $\frac{1}{4}$ by $\frac{5}{8}$ by 12 in. for tray supports; 1 dowel stick $\frac{1}{4}$ by 24 in.; 1 piece cardboard 4 by 10 in.; glue and small brads.

One pattern serves for laying out all the curves. It is drawn upon a piece of cardboard 4 by 10 in., divided into 1-in. squares as shown near the top of Fig. 26. This basic design can be changed as desired to suit the taste of the worker.

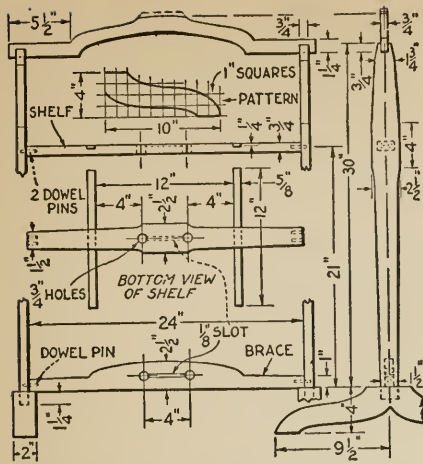

FIG. 26.—Side and end views of the stand, bottom view of shelf, and pattern for laying out the curves.

The quickest and easiest way to cut the curves is with a band saw, but good results may be obtained by using a turning saw. All the edges should be rounded with spokeshave, file, and sandpaper—not a great deal on the ends, but sufficiently on the handle to give an easy grip.

The curved feet receive the ends of the legs, which are tapered to serve as tenons. Glue and toenail the joints with $1\frac{1}{4}$ -in. brads, driven and countersunk from the inside to avoid marring the surface.

Holes $\frac{1}{4}$ in. in diameter are now sunk in the ends of the tray shelf and the lower brace and also in the end pieces to receive dowels. The dowels for the lower brace should be placed so that the lower edge of the brace rests on the flat upper surface of the curved foot pieces. The upper dowels are placed so that the tray shelf is 21 in. from the top edge of the feet. The joints are glued, fastened with small brads, and clamped and tested with a square.

The tray may be purchased from any department store. However, one may design and make his own, using medium heavy picture framing for the sides and covering the bottom with glass.

Rubber headed tacks are cut so as to have a flat vertical surface and driven in the tray shelf. These bits of rubber press against the tray ends and hold the tray in place. If you do not wish to remove the tray, it may be placed on the support as the finishing varnish is drying. The varnish will hold the tray firmly.

The piece may be stained any desired color, shellacked, rubbed down, and varnished. Either a velvet finish or high gloss varnish may be used. Lacquer, too, will give a beautiful finish, and a stippled effect also would be distinctive. Tassels may be fastened on the legs.

SMALL WELSH DRESSER

Sound, knotty white pine should be used in making a small Welsh dresser like that illustrated in Figs. 27 and 28 so that it will be in strict keeping with



FIG. 27.—Welsh dresser noteworthy for its graceful design and small size. It is made of knotty pine.

original antiques of this type. The original antiques of the small Welsh dresser are highly prized and valuable.

In finishing the dresser an attempt should be made to imitate the mellow tones of fine old pine furniture. This can best be done by applying one coat of boiled linseed oil followed by a coat of one part walnut oil stain to five parts turpentine. Allow the stain to dry thoroughly and then rub the high parts with fine sandpaper until the wood is almost bare, so as to give the piece a worn effect

Body or base unit. Turn the four legs carefully to the design indicated. Work out the rails to the desired profile and hand dress them thoroughly. Cut all joints and assemble the frame. The bottom shelf must be built in at the same time the project is being glued together.

Construct the drawer and put it in place. Work out the top and fasten it to the frame from the underside by using panel irons or similar fastenings that will allow for expansion and contraction. Apply all moldings.

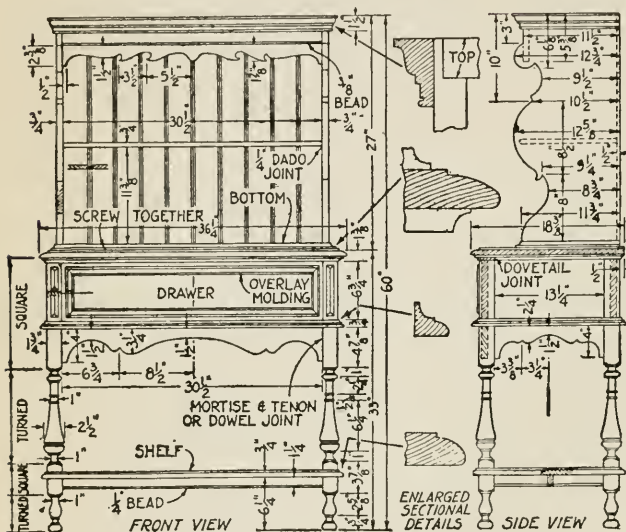

FIG. 28.—Front and side views of the dresser, and details of the moldings. The upper and lower sections are assembled separately.

at those places where wear would naturally become visible in the course of years. Follow this treatment with two thin coats of white shellac and a well-rubbed coat of furniture or floor wax.

All the applied moldings shown in the drawings (Fig. 28) are of stock design and can be obtained in most localities, although it is possible to substitute other stock moldings in their places. The drawer pulls should have the finish of dull, antique brass.

The dresser is made in two separate units and these, when completed, are screwed together. The instructions for constructing the two parts of the dresser may be summarized briefly.

Shelf unit. Hand dress all the stock. Cut out the profiles of the sides and the top-piece. Cut dado joints in the sides. Carefully fit the shelf, the top, and bottom, and assemble the whole. Fasten the back in place by nailing through into the shelf and the top and bottom pieces.

Apply the top molding. Screw the shelf part to the body part from the underside. Fit and fasten the molding at the junction of the two units. Clean all parts thoroughly with sandpaper and finish as previously suggested.

When a lacquered finish is desired instead of shellac and wax, the following method may be substituted.

Give the wood an antique appearance with greatly thinned brown oak alcohol wood dye or a stain made by dissolving eight tablespoonfuls of air-drying asphaltum varnish in a quart of gasoline. Allow this to dry thoroughly and apply a coat of one part orange shellac and one part denatured alcohol. Smooth this, when dry, with the finest obtainable sandpaper and rub through the stain to form "high lights" as described previously. Dust well and apply another coat of three parts orange shellac to one part alcohol. Finish with two coats of clear lacquer and rub the second with FF pumice stone and crude oil. Finally polish the piece, and the lacquered finish is completed.

A PIRATE'S CHEST

Pirates, treasure, jewels, Spanish galleons, romance, adventure on the high seas—all these are vividly suggested by the ancient chests of dull brown oak, clasped with bands of iron, that are now so highly prized as decorations for living room, library, and bedroom.

The chest ⁴ shown in Fig. 29 may be made of any kind of wood and stained as desired. Red oak, however, is recommended; it bears out the romance of the oaken chest and the wood is not too hard for the home worker to handle.

The decorations may be of lead, copper, linoleum or even well-shellacked

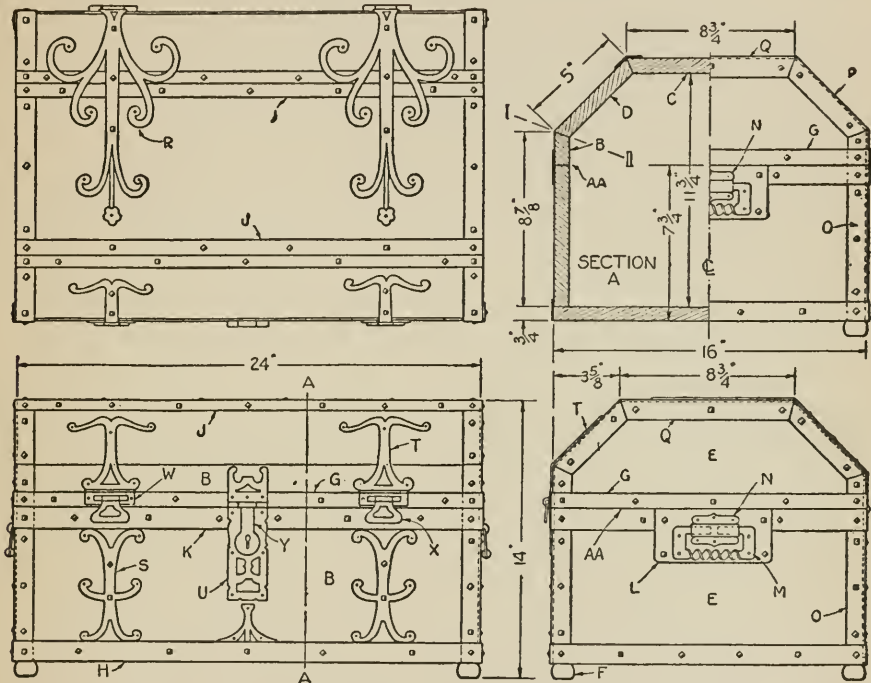

FIG. 29.—Top, front, and two end views of an ornamental treasure chest. The fittings may be thin plywood, wall board, linoleum, gesso, sheet lead, copper, or real wrought iron.

Almost everyone would like to have one of these timeworn, battered old strong boxes, but they are practically unobtainable except in expensive reproductions. To make one, however, is a simple task compared to the constructing of almost any other piece of furniture. The chest itself can be nailed together, and the effect of hand-forged metalwork may be obtained in a number of ways ranging from the use of thick cardboard, wall board, wood, or gesso to real wrought iron.

heavy pasteboard if glued in place before any shellac is applied. It is quite possible, indeed, to obtain the desired effect of an iron-bound chest by the use of gesso (whiting and liquid glue with a little varnish and boiled oil) or plastic paint. In any case, the presence of the antique nailheads is an important factor in carrying out the illusion.

⁴Larger drawings of this and another chest are contained in BLUEPRINT No. 78, listed in the Appendix. The reference letters in Fig. 29 correspond to reference letters used on the blueprint and in the accompanying bill of materials.

CHAPTER V

SMALL WOODWORKING MACHINERY

MACHINERY is remaking all our home workshops. More than anything else, the introduction of compact, efficient, and reasonably priced woodworking machines has helped to popularize the hobby of making things with tools. Why? Because machines lend new zest to the work, they take away the drudgery, and they make it possible for the beginner as well as the trained craftsman to turn out satisfactory projects.

It is the purpose of this chapter to show the amateur how to make beautiful, useful, and substantial pieces of furniture almost entirely with these motorized home workshops, and do it more easily and accurately than by hand.

COLONIAL FOOTSTOOL

The first project, a footstool of Colonial design (Figs. 1, 2, and 3), allows a variety of machine operations to be learned. Obviously, any similar small piece of furniture will involve the same methods.

Mexican mahogany is an excellent material to use for the visible parts, although other woods such as birch or maple may be substituted and stained to imitate mahogany, if desired.

Step No. 1—Getting Out the Stock for the Rails. On the circular saw cut the four rails (two side and two end pieces) to the approximate sizes to make it easier to handle them on the planer. Pine or whitewood will serve for them if they are to be covered with upholstery. Plane

one surface smooth and true and mark it with an X on all pieces to indicate the working face. Hold this face against the planer fence and joint (plane) one edge smooth and true. This edge on each piece should be marked with an X in order to identify it as the working edge.



FIG. 1.—A Colonial footstool of especially graceful design yet simple construction.

A few suggestions may well be offered parenthetically in regard to jointers (Fig. 6). The 4-in. jointer is about as small as is practical and works very well on all general work. The best type jointers are made with three knives or cutters, which are securely fastened in a cylindrical head. The cutters must face the operator, since the machine revolves towards him. There need be no fear about working at this machine as jointers are carefully guarded; however, a few safety rules must be observed in order to avoid the likelihood of any accidents.



FIG. 2.—Original pencil sketch of the footstool, which was made as a preliminary to illustrating the various steps in machining the parts. For details, see the drawings in Fig. 3.

Before starting any machine, try all adjustments to make sure that no parts are loose. Revolve the machine by hand to see that the knives swing clear of the throat. All three knives must be set exactly the same distance out so as to make a smooth cut, free from ridges.

Never run any wood over the jointer smaller than $\frac{1}{2}$ by 1 by 10 in. For all thin pieces use a block set on top of your work to push the material across the cutters. Never rest the hand or a finger on the extreme rear end of the wood.

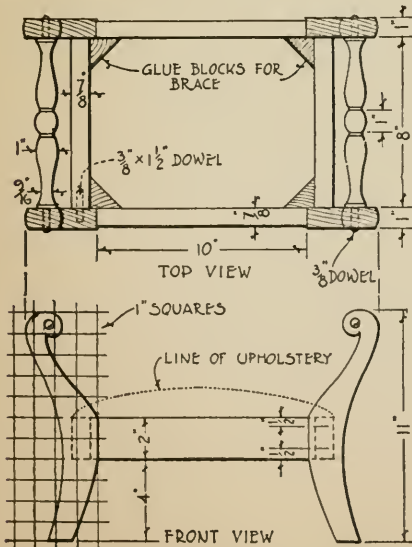

FIG. 3.—Dimensioned views which show the shape of the leg and spindles and the exact location of the dowels.



FIG. 4.—How to hold the rails (sidepieces) when cutting them to exact length on the circular saw.

When stock is pushed across the jointer, the pressure is placed on the part of the planer furthest away from the operator. It is good practice to skip over the throat portion of the machine

with the hands, moving forward as you go along. Do not take too coarse a cut; it is better to make several finer ones, as it will lessen the chance of the wood's getting away from you. When making any adjustments, always be sure to turn the power off.

To return to the operations in making the footstool, continue as follows after the working face and the working edge of each piece has been planed:

On the circular saw hold the working edge against the fence and rip all pieces to the width of $2\frac{1}{16}$ in. ($\frac{1}{16}$ in. being allowed for planing). In like manner cut the four pieces (if necessary) to the thickness of $1\frac{5}{16}$ in. ($\frac{1}{16}$ in. extra for planing). Now cut one end of each piece square (Fig. 4). Adjust the guard to get each pair of pieces exactly the same length, and cut the other end of each. Plane the remaining surfaces and edges smooth and true on the planer (Fig. 6).

$\frac{1}{8}$ in. for truing up on the lathe. Locate the center of each end by drawing diagonal lines. Bore small holes to receive the points of the lathe centers. Rough the corners off with a gouge and then turn to the largest diameter. Next cut down a short distance to give the exact length from shoulder to shoulder—8 in. Turn the spindle to the design (Fig. 8) and sandpaper it in the lathe. Turn the dowels at the ends to exactly $\frac{3}{8}$ in. in

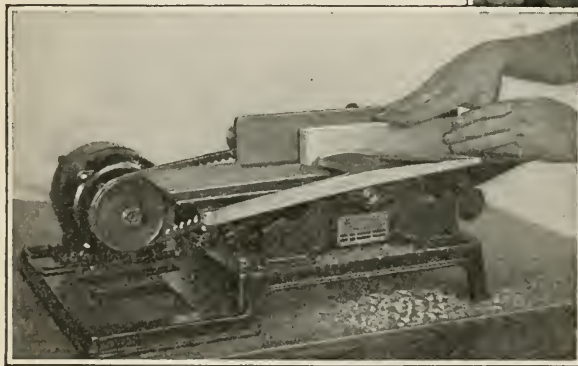
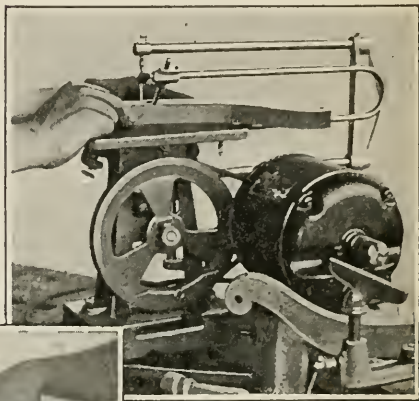

FIG. 5 (above).—Cutting one of the footstool legs on the jig saw. Note the rod and adjustable foot which holds down the stock on the table. FIG. 6 (at left).—One face of each piece is planed; then this face is held against the fence or guide of the planer and one edge is jointed (made true) as shown. The position of the hands is important. A swinging guard presses against the wood.

Step No. 2—Legs. Draw and cut out an accurate cardboard pattern. Use it to mark the wood. To avoid splitting, bore $\frac{3}{8}$ -in. holes for the handles or cross spindles before sawing the curves. On the jig saw (Fig. 5) cut the design out carefully, keeping just outside the lines. Be sure to make "safety" cuts in the waste stock where necessary to avoid having to back out the saw at acute corner curves and perhaps cause the blade to break.

Step No. 3—Spindles. The stock should be $1\frac{1}{8}$ by $1\frac{1}{8}$ in.; this allows

diameter and $11\frac{1}{8}$ in. long, and as you cut the work free, round up the ends with a small skew chisel.

Step No. 4—Sandpapering. On the disk sander true up and smooth all flat surfaces and convex curves. For concave curves use a drum sander, if available (Fig. 7); otherwise turn a cylinder to 3 in. in diameter and fasten a sheet of No. 1 $\frac{1}{2}$ sandpaper to it.

Step No. 5—Joints. Locate accurately all centers for the dowel holes—two in each end of each of the four rails and corresponding holes in the legs. By

means of the lathe and a chuck, bore all the holes. If you use a short auger dowel bit, which is advisable, first file off the threads on the point (leave the point itself) to prevent the bit from pulling too fast.

Step No. 6—Assembling. Make a trial fitting of all parts between clamps but without glue. Mark the joints of mating members No. 1 and No. 1, No. 2 and No. 2, and so on. Two separate gluing

true surface, that the frame is square, and that the tops of all rails are in line. It is a good idea to have some fine sawdust on hand when gluing to sprinkle over the glue that oozes out; this will absorb it sufficiently to allow it to be peeled off like gum immediately afterwards with a chisel. When the glue has set, glue the corner blocks in place.

Step No. 7—Cleaning Up. Remove all excess glue with a sharp chisel, cutting, wherever possible, across the grain. Sandpaper thoroughly all parts with No. ½, 0, and 00 paper, rubbing with the grain. Round the corners slightly.

Step No. 8—Finishing. There are many ways of finishing mahogany. One of my favorite methods is as follows: Buy a high grade mahogany water stain powder and dissolve according to directions, or obtain a prepared wood stain or dye of first-class quality. Use lib-



FIG. 7 (above).—Cleaning up the convex curves of the legs on a drum sander. If this type of sander is not available, a sanding cylinder can be turned from wood for use in the lathe. The edges of the sandpaper should be wedged into a longitudinal groove by means of a small strip of wood. FIG. 8 (at right).—The spindles or handles in the lathe. Calipers are used to make measurements.

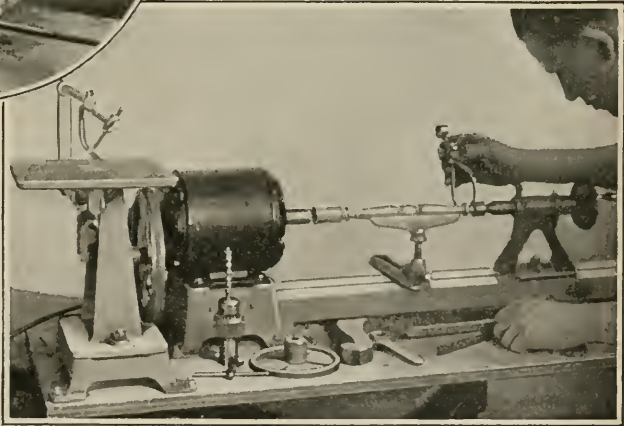

operations are necessary. First glue the long rails and legs together. Place a scrap of wood under the clamp to avoid bruising the legs. Put plenty of glue into the holes and on the dowel pins; then clamp the work together lightly. Use only a liquid glue of the best quality or a tested brand of flake hide glue. Sight across the legs for any twist. Allow at least five hours for the glue to dry.

Next assemble the project completely, being sure that all four legs rest on a

erally and let it dry. Brush on very thin white shellac and sandpaper when dry with No. 00 paper. Apply two coats of paste wood filler, following the directions on the can. Allow at least two full days for the filler to harden. Apply three thin coats of white shellac, rubbing each coat when dry with No. 00 sandpaper, and the last coat with crude oil (or light machine oil) and fine pumice stone powder. If you have a spraying outfit, spray clear lacquer on instead of shellac.

PRISCILLA SEWING CABINET

Roomy as is the Priscilla sewing cabinet shown in Figs. 9, 10, and 11, it has the advantage of being easy to carry

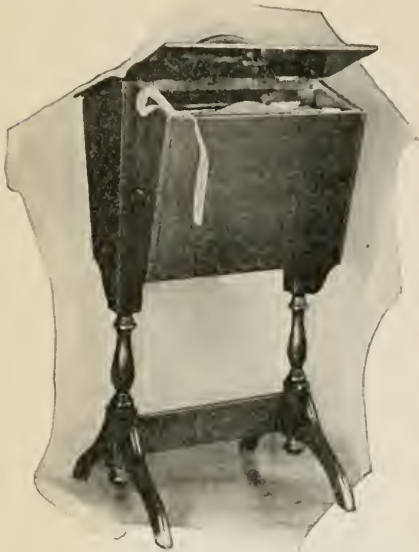

FIG. 9.—Of all sewing cabinets the Priscilla is perhaps the favorite because of its Colonial grace.

about the house from place to place. As is customary, it contains a sliding tray, divided into four compartments, for buttons, needles, and small accessories.

Mexican mahogany is perhaps the best material for this project, although you may substitute cheaper woods and stain them to imitate mahogany.

Step No. 1—Getting Out the Stock. On the planer dress one surface of each piece smooth and true and mark it with an X; this is known as the working face. Hold the marked surface against the fence of the planer and plane one edge at right angles to the working face. Mark this edge with an X; this is called the working edge. There are only two surfaces to mark.

Now go to the circular saw and, holding the working edge against the fence, rip the stock to the correct width, allowing $\frac{1}{16}$ in. extra for the final planing (Fig. 12). In like manner, obtain the thickness, if not already correct. Return to the planer and dress all surfaces smooth and true.

Follow this method for getting out all stock. At this point it is advisable to cut out cardboard patterns of all curved parts to insure the required accuracy of size and shape.

Step No. 2—Turned Legs. The stock should be at least $\frac{1}{2}$ in. longer than needed to allow for turning the bottom end without striking the point of the dead center. Draw diagonal lines on both ends of the stock to locate the centers. Drill small holes at these points to receive the center pins of the centers. Square lines around the stock, locating the portions that are to remain square. Rough the stock with a gouge and turn to the design (Fig. 14). Sandpaper thoroughly while in the lathe.

Step No. 3—Curved Feet. On the jig saw cut out the curved outline. On the drum sander smooth the edges just sawed. Use the disk sander for the flat

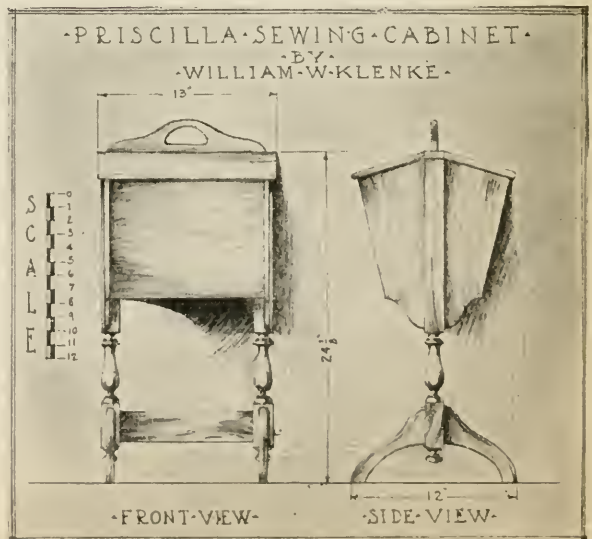

FIG. 10.—The cabinet sketched in pencil. See Fig. 11 for the completely dimensioned working drawings.

edges at the top and bottom (Fig. 13). If you are not already accustomed to these machines, you will be agreeably surprised at their speed and accuracy.

Step No. 4—Hopper Part. The end dado or box joints (see the detail drawing of the corner joints) can be made easily on the circular saw as follows:

the curves at the bottom of the end pieces and cut the curves on the power jig saw.

Step No. 5—The Handle. The jig saw is a real help in the construction of the handle. Bore a 1/2-in. hole in each corner of the cut-out portion, insert a saw blade in one hole, and saw out the grip part

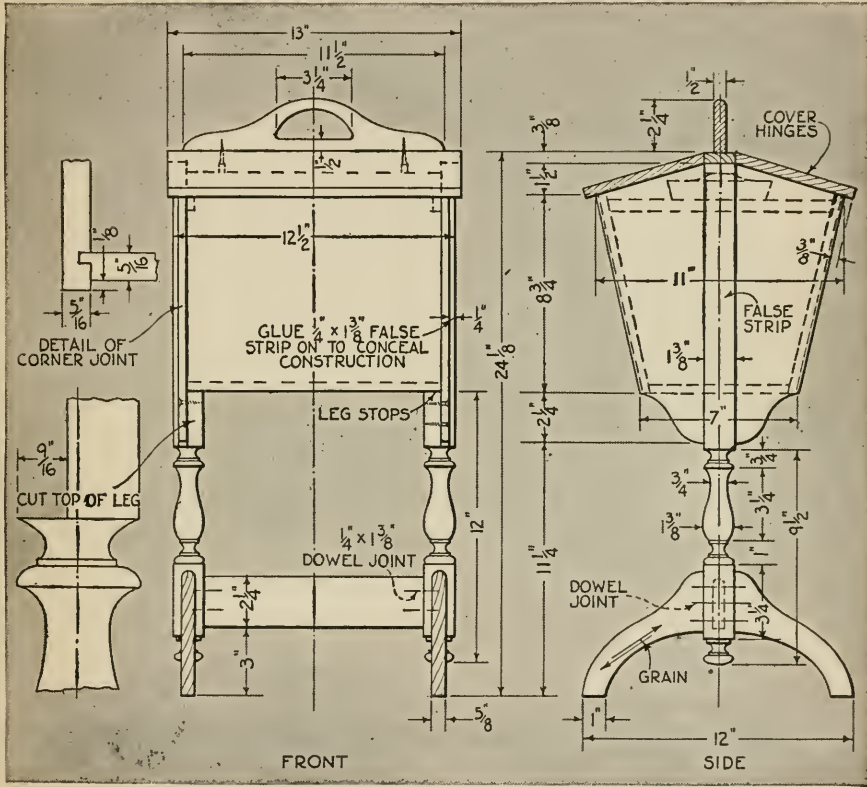

FIG. 11.—Assembly views of the Priscilla cabinet and details of the joints at the corners of the hopper and between the legs and end pieces.

Set the circular saw a little over 1/8 in. above the saw table, and set the ripping gage at the proper distance from the saw blade, so as to make the four grooves on the end pieces. If your blade is thick enough, one cut will be sufficient. Now take the sidepieces and cut the tongues or tenons to fit these grooves just made. The cut should be made in two operations to insure a perfect fit. Use the cardboard pattern for laying out

(Fig. 16). Next cut out the outside curve. Return to the drum sander and smooth all curved edges. A smooth finish is important.

Step No. 6—Assembly. The handle is fastened to the top strip by screws from beneath, as indicated. Glue the hopper with high grade liquid glue or flake hide glue. The work should be allowed to set between clamps until the glue is hard.

Step No. 7—Dowel Joints. Put the

chuck in the lathe, use the correct size auger bit for the dowels (in the case $\frac{1}{4}$ in.) and, while the power is on, very carefully file the threads off the screw end to prevent the bit from pulling into the wood too fast; do not, however, remove the point. Locate accurately all centers of all holes and bore the holes in the lathe as illustrated in Fig. 15.

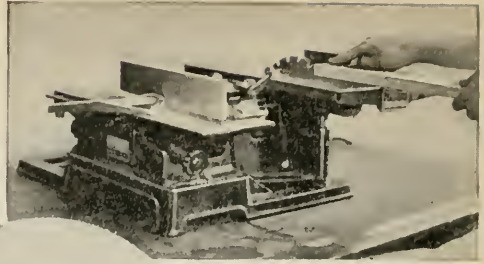

FIG. 12 (above).—Ripping stock to width, the guard being removed for clearness.

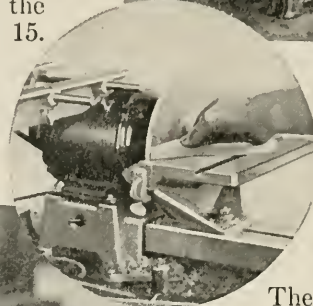
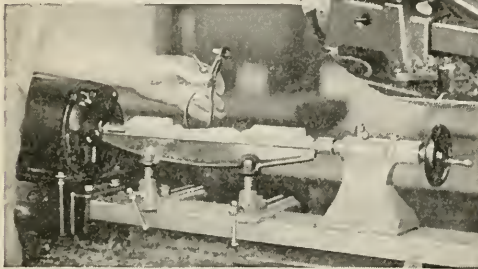

FIG. 13 (in circle).—Sanding the joint edge of the foot.

FIG. 14 (below).—Caliper-ing a leg in the lathe.



Make sure by careful test that the $\frac{1}{2}$ by $2\frac{1}{4}$ in. cross brace is exactly the right length to suit the length of the hopper.

Step No. 8—Assembly. Glue the legs and curved feet first; then glue the cross brace. When dry, this entire bottom unit is fastened to the hopper with screws. Glue a false strip over the center of the hopper to make the leg appear as if it continued all the way up. Next screw the bottom in place and fit the covers and hinges.

Step No. 9 — Tray. On the various machines, work out the tray in the same way as the other parts.

Step No. 10 — Cleaning up. Remove all excess glue with a sharp chisel, cutting where possible across the grain. Sandpaper thoroughly all parts with Nos. $\frac{1}{2}$, 0, and 00 paper, always rubbing with the grain if practicable. Round the corners slightly.

Step No. 11—Finishing.

There are many ways of finishing mahogany. One requires the use of bichromate of potash, which can be purchased at any drug store. Make a saturated solution of the crystals and water and apply a coat of one part saturated solution and four parts of water. When dry, sandpaper lightly with No. 00 sandpaper; then give an even coat of ready-mixed penetrating mahogany wood stain.

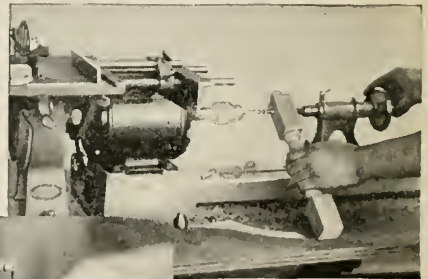

FIG. 15 (above).—Boring the dowel holes. Should holes have to be bored all the way through the stock, a block is bored and fitted over the tailstock spindle to save the bit from damage.



FIG. 16 (at left).—Cutting the inside of the handle on the jig saw is as simple as guiding a sewing machine.

Follow with paste wood filler and finish with several coats of shellac, varnish, or clear lacquer.

MARYLAND END TABLE

In learning to use small woodworking machinery or a motorized home workshop, you will find the Maryland end table shown in Figs. 17, 18, and 19 is a

face against the fence of the planer and plane one edge at right angles to the working face. Mark this edge also with an X to identify it.

Hold the working edge against the fence of the circular saw and rip the stock to the correct width, allowing $\frac{1}{16}$ in. for planing. In like manner obtain the thickness. Return to the planer (Fig. 19) and dress all sawed surfaces smooth

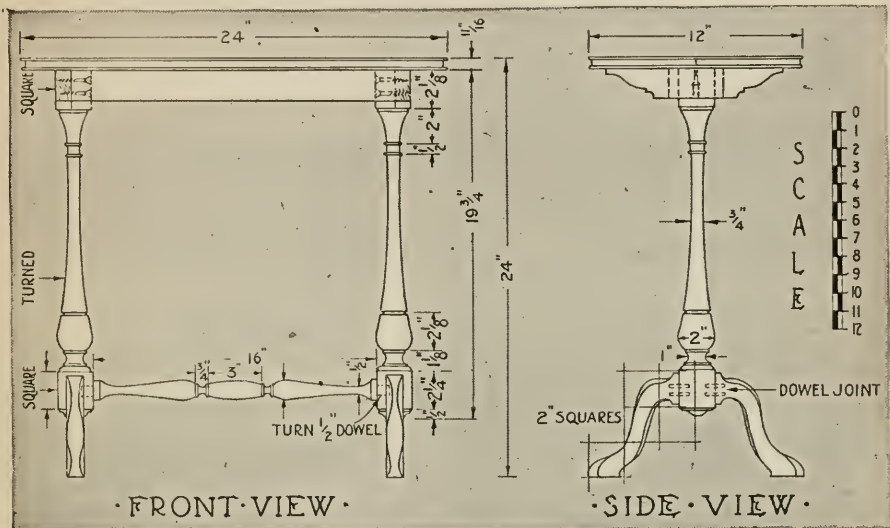

FIG. 17.—A table slightly simpler in design than the one shown in Fig. 18. The edges of the top can be left unornamented.

particularly instructive and desirable piece of furniture to build. Because of its delicate proportions and graceful lines, it is a little gem; at the same time it is simple in construction.

Mexican mahogany is one of the best materials for this table, unless you intend to finish it with colored brushing lacquer, perhaps in some brilliant tone to make the piece individual and outstanding, in which case birch or maple is suitable. Because of the delicate proportions, a hard wood must be used.

Step No. 1—Getting Out Stock. Using the planer and circular saw, get out all the stock in the following manner:

On the planer, dress one surface smooth and true; mark this with an X to indicate the working face. Hold this

and true. Follow this method for preparing all the pieces. Cut out cardboard patterns of all curved parts.

Step No. 2—Turned Legs. The stock for the legs should be at least $\frac{1}{2}$ in. longer than the finished measurement, to allow for turning the bottom end without striking the point of the dead center.

Draw diagonal lines on both ends of the stock to locate the centers. Bore small holes at these points to receive the center pins. Square lines around the stock to locate the portions that are to remain square.

Rough the stock with a gouge and turn to the design. Sandpaper thoroughly while in the lathe.

Step No. 3—Curved Feet. Cut out the curved outline on the jig saw and smooth

the edges on the drum sander. Use the disk sander for the flat bottom and top edges as in step No. 5.

Step No. 4—Top Brace. On the jig saw cut out the outlines of the braces; on the drum sander, true and smooth the outline.

Step No. 5—Joints. True the top and bottom flat edges of the curved feet on the disk sander. Carefully locate all the

is done fasten the top to the braces with screws.

Step No. 8—Cleaning Up. Remove all excess glue with a sharp chisel, working across the grain where possible. Thoroughly sandpaper all parts with No. 1/2, 0, and 00 paper, always rubbing with the grain where possible, and rounding the corners slightly.

Step No. 9—Finishing. If a lacquer finish is to be used, first apply two coats of white shellac, rubbing each coat when dry with 00 sandpaper. Apply the lacquer according to directions on the can.

If you have used mahogany or walnut or a wood which is to imitate them, brush on water stain or a prepared wood stain or dye of the desired color, and



FIG. 18.—A graceful Maryland end table constructed with the aid of small wood-working machines.

FIG. 19 (at right).—Planing the edges of the table top on a bench jointer. It is essential to hold the wood very firmly against the fence.

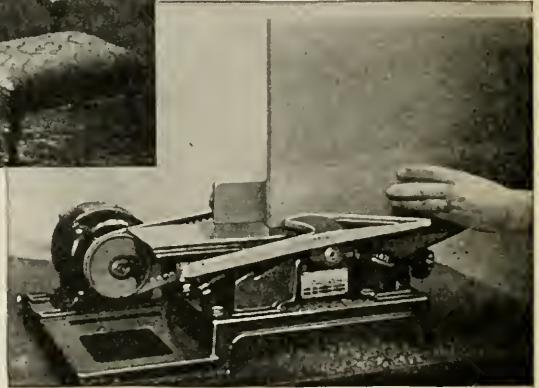

dowel holes. Place the chuck and dowel bit in the lathe and bore all the holes the correct depth.

Step No. 6—Sandpapering. Before assembling the table, thoroughly sandpaper all parts with No. 1 followed by No. 1/2 and 0 paper.

Step No. 7—Assembly. Make a trial fitting between clamps without glue. First, glue the curved feet to the legs; then assemble the entire project, using plenty of first-class liquid glue or hide flake glue of good quality. The tops of the legs are held together by gluing a strip on each side of the leg. After this

after it is thoroughly dry apply a very thin coat of shellac. Water stain has a tendency to raise the grain, and the shellac will stiffen these fibers and make them brittle. Sandpapering lightly with No. 00 or finer paper will cut them down clean and smooth.

Apply two coats of good quality paste wood filler (unless you have used some close-grained wood) according to directions you will usually find on the can containing the paste. Allow at least two full days—a longer time is even more desirable—for the filler to harden. Then brush on three coats of white shellac,

rubbing each coat when dry with No. 00 or finer sandpaper and the last coat with rubbing oil, light machine oil, or crude oil and fine pumice stone powder.

With a spraying outfit, you can spray on clear lacquer instead of using shellac.

CHIPPENDALE MIRROR

The motor-driven saw is the greatest aid a woodworker has. Skillfully handled, it will perform wonders in cutting up stock quickly and accurately, in making joints of many different varieties, and in doing with ease and speed the preliminary operations which are most common in building furniture and most tedious to do by hand.

As an object lesson for demonstrating in greater detail than heretofore the use of the circular saw, the Chippendale mirror illustrated in Figs. 20 and 21 is excellent. Aside from the handwork needed in assembling and finishing, the frame of this graceful piece can be made almost entirely with the saw and its attachments. The operations are simple and the finished product is useful; so, in making the mirror, not only will a good-looking piece of work result, but excellent practice will be given in machine sawing.

As to stock, mahogany and maple are two appropriate woods to use. Extreme care should be taken in selecting the pieces for the top and bottom to see that the grain forms an attractive figure.

Step No. 1—Making the Patterns. From the working drawing (Fig. 21) lay out full size squares on heavy paper, such as wrapping paper or cardboard; then plot the curves. Cut these patterns out in template form. It will be necessary to make only half patterns of the top and bottom, as the half can be used for both sides. For the top and bottom it is advisable to use five-ply laminated stock to avoid possible splitting.

Step No. 2—The Frame. Although the design as it is given for the molding is a

good one to follow, you can substitute any suitable stock picture molding of about the same size.

Circular saws are made in three different types—rip, crosscut, and combination or miter. The rip saw is used to cut with the grain. The teeth are rather large and, as with a hand saw, are filed at right angles to the blade. The cut is like that made with a chisel. The cross-cut saw has much smaller teeth and,

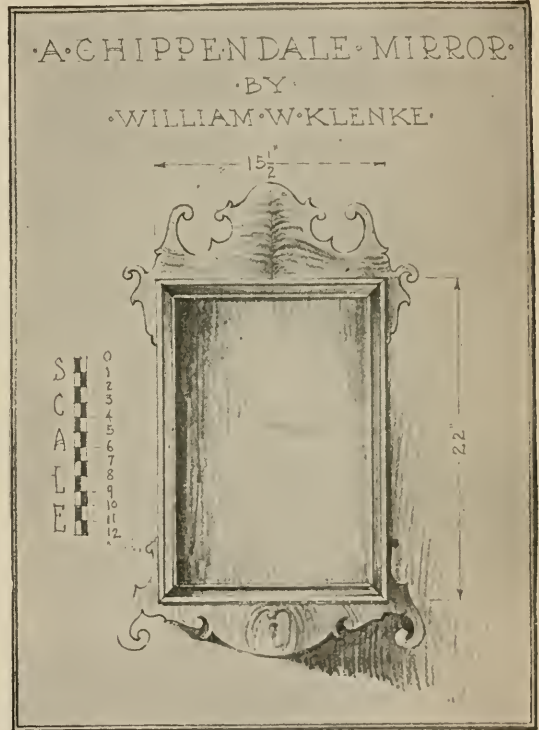

FIG. 20.—Pencil drawing of a Chippendale mirror showing dimensions and scale. Details of construction are given in Fig. 21.

as with a hand saw, the teeth are filed at an angle. This saw is used on all general work except ripping. Both of these saws are set to give clearance. The combination or miter saw, as the name implies, is made up of both crosscut and rip teeth and is usually hollow ground, requiring no setting. The cut made with a good sharp blade of this type will be very smooth, oftentimes good enough

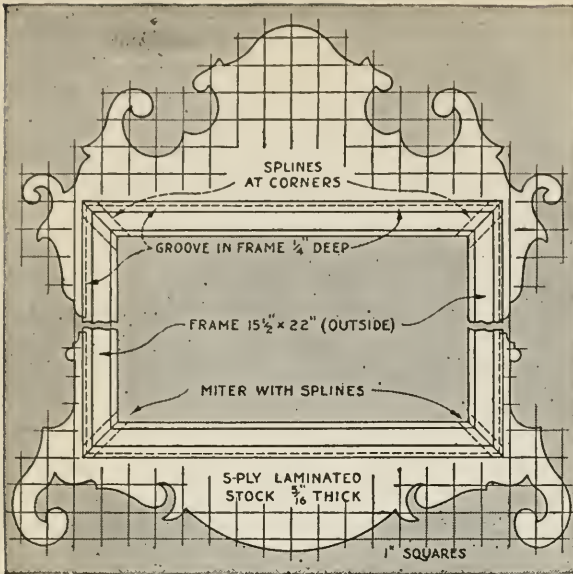

FIG. 21.—Half-patterns of the curved outlines can be made by plotting them on heavy wrapping paper ruled with 1-in. squares.

for a joint without the slightest necessity of planing.

If you purchase only one blade, the best advice is to buy a combination saw. There is one disadvantage, however, in using this type of blade; it often binds and will need frequent pointing up with a file.

For this work we shall use the combination or miter saw (Fig. 22). Set the cutting-off fence so as to make a 45° cut (Fig. 23). To do this, make a trial cut on two scrap pieces of wood and place them together; if they test square, the cut is at exactly forty-five degrees. With a slow stroke make all the miter cuts. Next, cut the grooves for the splines by lowering the blade to about 1/2 in. high and holding the miter flat on the table. As a guide for this operation, use the ripping fence. The upper sketch of Fig. 25 should be consulted for the form and application of the spline.

Step No. 3—Assembly of Frame. Glue temporary ears (triangular blocks of wood) on all the corners, so as to have something on which to get a grip when

clamping up the frame. By temporary ears, in cabinet-work, we mean pieces of soft wood that are cut so that the grain in them runs the long way and are glued in place. The ears should have two angles of 45° each and one of 90° as shown in the sketch.

Allow the glue at least four or five hours to set. Next, assemble the entire frame, using plenty of the best glue. Test the corners to be sure that they are square and that there is no twist to the frame. Be certain that the grain in the splines runs the short way, as shown; this adds much to the strength of the frame. Make the splines a little wide at first and cut them to shape after the glue has hardened.

Step No. 4—Cleaning Up the Frame. By means of the sanding disk, clean up the corners, especially where the ears were fastened and where the splines projected. Having thus obtained the best result, you are now ready to turn to the next step.

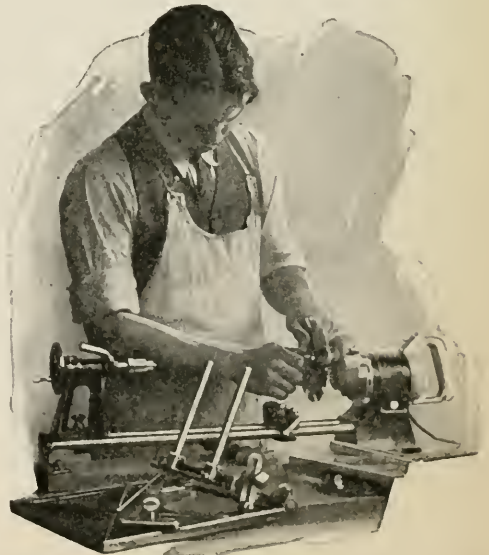

FIG. 22.—The saw blade is mounted so that the top teeth point toward the operator.



FIG. 23.—The common method of cutting miters with the cut-off fence at 45 degrees and the table level.

Step No. 5—Cutting the Grooves. Cut the groove on the top and bottom edges and part way on both sides, to receive the head and bottom pieces (Fig. 26).



FIG. 24.—Cutting miters by tilting the table at 45 degrees and placing the molding on its edge.

Step No. 6—Cutting Out the Curved Designs. With the template, transfer your curved design to the wood. Next, cut just outside the lines with a jig or band saw. If you are working with a small machine, it will be necessary to place the design on both sides of the wood, to be able to work from each side.

Step No. 7—Truing Up the Edges. Use a drum sander on all of the curved edges possible; the inaccessible curves will

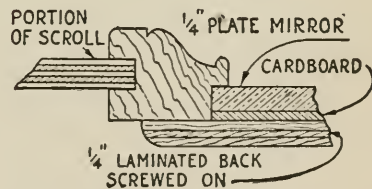
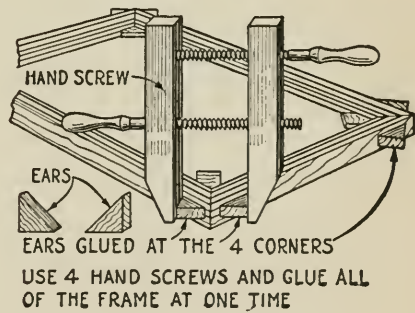
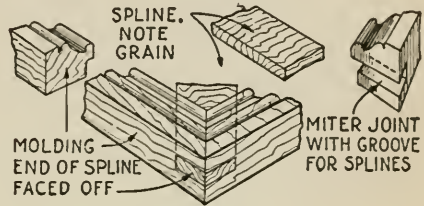

FIG. 25.—The spline joint, the "ears" used to facilitate clamping, and a cross section of the frame.

have to be cleaned up with a file and sandpaper. If you have done the sawing carefully, there will be very little sanding to do.

Step No. 8—Assembly of Scrolls. First, put plenty of glue in the groove and on the edges to be glued; then, force the various parts together. Be careful to

wipe away all of the excess glue after the parts are assembled.

Step No. 9—Cleaning Up the Work. If there is any excess glue on the work, remove it with a sharp chisel. Sandpaper



FIG. 26.—The grooves for the head and bottom pieces are cut after the frame is assembled and cleaned.

all of the parts thoroughly first with No. 0, then with No. 00 sandpaper. Round off all of the edges slightly.

Step No. 10—Finishing. For mahogany: Apply either a mahogany water stain powder or a prepared dye or wood stain of first-class quality. Brush on a very thin coat of white shellac. When it is dry, sand with No. 00 sandpaper. In order to fill the grain in the wood, a paste wood filler must be applied. Shellacking is the next process. Apply then three thin coats of shellac. After the first and second are dry, rub each with No. 00 sandpaper, but for the last coat use a mixture of powdered pumice stone and crude or machine oil. If you have a spraying outfit available, spray on a clear lacquer instead of the application of shellac.

For an antique finish on maple: There are two good methods. One is quite similar to the method stated above for mahogany except that an amber stain is

used. Since maple is a close-grained wood, no filler need be applied; the shellac will fill any small pores that may be present. The other method is to use an oil walnut stain, and after it dries rub the high-lights almost through to the bare wood with No. 00 sandpaper in order to give the effect of a worn surface. The finish then is applied as in the other cases.

HANGING BOOKSHELVES

The curved outlines of the attractive hanging bookshelves shown in Figs. 27 and 28 make an ideal problem for a more detailed study of the use of the motor-driven jig saw. The bookshelves will prove an addition to the living room

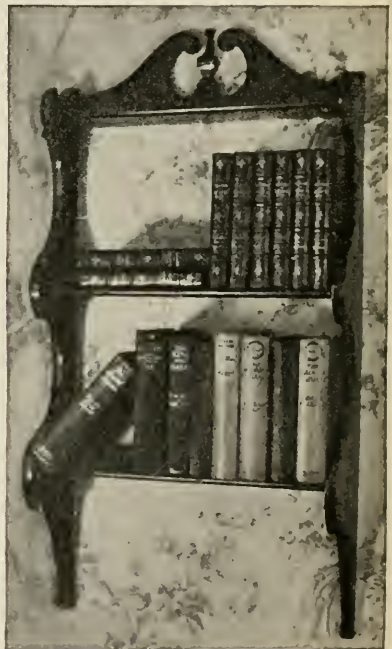

FIG. 27.—These bookshelves form an ideal object lesson in the use of the jig saw.

or den, or, indeed, may be placed in the breakfast room to hold artistic pieces of china or pottery.

In choosing the type of wood to be used, much depends on the finish. One

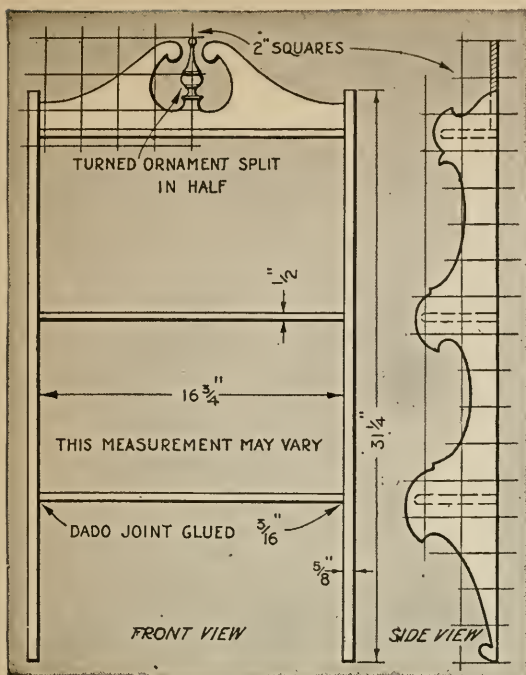

FIG. 28.—Assembly drawing of the shelves with the curved outlines, which are to be enlarged by laying them out in 2-in. squares.

good choice would be a cheerful color of lacquer, agreeing with the color scheme of the room in which the shelves are to hang. Whitewood, or even wood taken from packing cases, may be used, if close grain.

Step No. 1—Making the Patterns. On a sheet of heavy cardboard 5 by 31 $\frac{1}{4}$ in., lay off 2-in. squares, and from the working drawing (Fig. 28) plot the curves. Cut along the outline with scissors. In like manner lay out and cut the headpiece on a sheet of cardboard 5 by 16 $\frac{3}{4}$ in.

Step No. 2—Getting Out the Stock. On the jointer, join all edges of the various pieces—the two sides, the headpiece, and the three shelves.

Step No. 3—Using the Circular Saw. On the circular saw, rip the pieces to the correct width and again join these edges on the jointer. Cut the ends off square, making all the shelves the

same length. If you have a shaper (shaping machine), use it for putting any desired molded edge on the front of all shelves. Of course, you can easily round these edges, as shown, with a hand plane.

Step No. 4—Using the Jig Saw. Jig saws are constructed on two different principles. The one type works on a cam or eccentric, with a little handle or crank on the side of the wheel connected with the saw; and as this wheel revolves, the handle pushes the saw frame up and down (Fig. 29). The second type (Fig. 30) is constructed with a horizontal sliding block or crosshead, which moves the saw frame up and down by means of a crank mechanism.

The table of the jig saw is set to an angle of 90 degrees in order to make a square cut. Insert a rather coarse blade in the frame, seeing that the teeth point down. Now adjust the finger for holding down the work to the proper thickness.

You will have to work in from both ends on account of the length of the sides; it may even be necessary to do a little handwork if your machine will not reach to the center from both ends. It will pay you to do the jig-

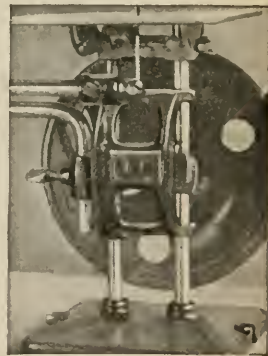
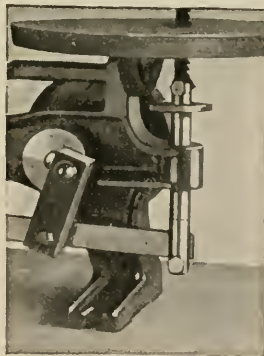

FIGS. 29 and 30.—Two types of jig saw mechanisms. At the left is the crank motion and at the right the horizontal motion mechanism.

sawing with the greatest possible care, as it will eliminate a great deal of handwork.

Step No. 5—Smoothing Up the Edges. Use a drum sander on all possible curves. Curves that are too abrupt for the sander must be smoothed with a cabinet file, followed with sandpaper. For some of the curves, a small spokeshave will help a great deal; and on the convex curves and flat pieces, a sharp chisel is the best tool to use. A good, careful cabinetmaker tries to use the file as little as possible.

Step No. 6—Cutting the Dado Joints. Place the two sides together, being sure to have a right and left side. With a try-square, mark the location of the three shelves. Use a groover of the proper size and fasten this in the circular saw, $\frac{3}{16}$ in. above the saw table. Groove out both sides. Note that the grooves do not run to the front edge; this means that you must raise the stock up so as to start cutting at the right mark. A little hand-work will be necessary at this point. The end can best be cleaned out by boring a $\frac{1}{2}$ -in. hole with a Forstner type bit; make the holes $\frac{3}{16}$ in. deep. The rounded front edge of the shelf will fit the hole perfectly. A simpler method, though not so good, for fastening the sides to the shelves, is to make butt joints and screw the job together with round-headed screws.

Step No. 7—Turning the Ornament. Glue two pieces of stock together with a sheet of paper between, making a piece $1\frac{1}{2}$ in. square, and turn the ornament in the lathe. The purpose of the paper is to allow the splitting apart of the two pieces after the turning operation is completed.

Step No. 8—Sandpapering. Using No. $\frac{1}{2}$ sandpaper, thoroughly sand all parts. Repeat with No. 0 sandpaper.

Step No. 9—Assembling. Make a trial fitting between clamps to make sure that all joints fit. Mark the companion pieces as they are to go together. Use plenty of the best glue and clamp the work tightly. Clean off all of the excess glue

by throwing fine sawdust over the glue that oozes out of the joints and then scraping it off at once with your chisel.

Step No. 10—Cleaning Up. After allowing the glue to harden for at least five hours, carefully remove any excess glue that may still remain. Then sandpaper with No. 0 sandpaper, rounding all sharp edges. The piece will then be ready for the finishing operation.

Step No. 11—Finishing. Apply one coat of

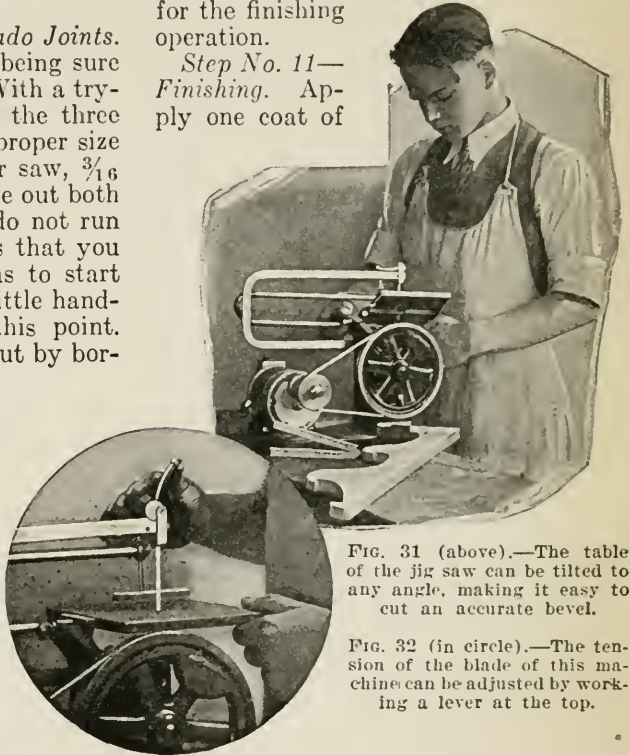

FIG. 31 (above).—The table of the jig saw can be tilted to any angle, making it easy to cut an accurate bevel.

FIG. 32 (in circle).—The tension of the blade of this machine can be adjusted by working a lever at the top.

thin white shellac to all parts. When this is hard and dry, sandpaper thoroughly with No. 0 sandpaper. Now apply the desired color of lacquer, using a sprayer if available.

SMALL BAND SAWS

Another useful machine, although not illustrated, is a small band saw. It is especially helpful for curved cutting like that required in making a graceful chair. After a little practicing has been done, the back legs of a chair can be sawed

out almost as easily as a woman sews a seam on a sewing machine.

Many woodworkers who have had some experience in the use of band saws do not know how to twist the saw blade into three loops, which is the usual way of storing or shipping them. Hold the saw in the palms of your hands, teeth pointing outward, and allow a portion of it to rest on the floor. Let the saw form an ellipse. Place your feet on the blade and give the hands a twist inward so as to make the teeth above the feet point inward; drop the saw blade and you will find it in the three loops.

In putting the blade in place, lower the top wheel as far as it will go or sufficiently to allow the blade to be slipped over the wheels. Place the saw on the top wheel first and see that the teeth point forward and down. Then work it on the bottom wheel, revolving the wheels by hand. Next adjust the upper wheel, working the handwheel with the left hand and feeling for the tension with the right hand.

Revolve the wheel a dozen times to see if the saw blade is running in the center of the wheel rims. If it does not run true, it is an easy matter to tilt the top wheel in either direction by turning the adjusting knob in the center of the top wheel. When the blade runs true, see that the guides are supporting the blade.

The table on most band saws can be tilted at an angle when necessary by a few turns on the machine screw under the table in the back part of the machine. See that the table is firmly fastened before starting work. Set the saw guide to the proper height to allow the wood to pass under.

There are only a few safety precautions to observe in running a band saw. First of all, have a good guard on the machine. Always spin the saw around a few times by hand to make certain that everything is as it should be. Do not allow anyone to stand at the side of the machine while it is running. Be sure to keep the machine well oiled at all times.

The actual sawing on this machine requires little practice. No matter what happens, never back out of a cut; to do so may pull the saw blade off. If you get off the line, do not twist the wood but



FIG. 33.—Some types of portable jig saw motors can be easily dismantled and used as electric hand drills for drilling screw holes, making holes for inserting a jig saw, and other light work.

pull it towards you and start that portion of the cut over again.

The amateur woodworker will soon master the use of the band saw if he follows the directions carefully and practices on some of the furniture designs.

CATCHING SAWDUST

With some types of small combination woodworking machines it is possible to use a bag for catching the sawdust from the circular saw and prevent it from being scattered about the room and over the clothes of the operator. Figure 34 shows a saw with a sawdust chute which serves a double purpose—to guard the blade under the saw table

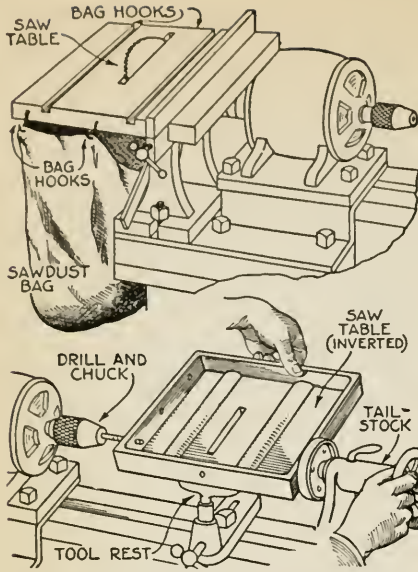

FIG. 34.—The sawdust bag in place (upper view); and how the holes for the hooks are drilled.

and to catch and discharge the sawdust in one direction. A sugar bag lining is slipped under this chute and fastened to the sides of the saw table with four S-hooks.

The S-hooks hang in holes drilled in the sides of the saw table. How these holes may be drilled is also illustrated. The tool rest is adjusted to support the saw table at the right height and the work is then fed to the drill by means of the faceplate mounted on the threaded spindle of the tailstock.

A revolving circular saw causes considerable wind, and it is this air in motion which whirls the sawdust about the room. A sugar bag lining acts like a vacuum cleaner bag, for it allows the air to escape but catches the dust. In arranging a bag about a saw that is not shielded under the table, there may be some danger of the bag's becoming entangled in the whirling saw. This should be carefully guarded against.

CHAPTER VI

WOOD TURNING SIMPLIFIED

YOU can add greatly to your enjoyment in making things and at the same time improve your craft work in quality and variety by learning how to do wood turning. And this is not hard to do, especially now that such excellent motor-driven lathes are available at reasonable prices.

There is an unescapable fascination about wood turning. The shapes seem to form by magic under one's gouge and chisel. Perhaps that is why kings and princes and even queens and ladies of high rank amused themselves by practicing wood turning during the seventeenth century. Examples of their handwork are to be found in many European museums.

Simple as wood turning is, the beginner will make much faster progress if he takes the pains to observe some preliminary suggestions.

Much that is called wood turning is in reality what may be termed more accurately "wood scraping." This can be mastered more quickly and, generally speaking, is more exact than orthodox wood turning. While it is not quite so fast, this is a matter of small importance from the standpoint of the amateur. Almost anyone can do scraping at once without the many discouraging and disheartening slips of the tool and consequent spoilage of work so characteristic of wood turning practice.

Those who have learned or taught wood turning in the generally accepted way may disapprove of this method. In its justification, however, it may be

stated that pattern makers do all turned work on wooden patterns by means of scraping. If the method is effective in such accurate work, why is it not equally useful in producing turned parts for other purposes? Many manual training teachers will permit scraping in difficult places and on what is called faceplate work. Why not then be frank about it

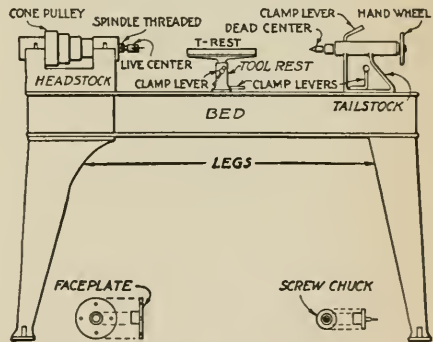

FIG. 1.—A typical wood turning lathe. All lathes have substantially the same parts.

and teach a method that will give the most pleasure and profit to the learner?

It is with this need in view that the following instructions, which have proved successful in actual school work, are given. The procedure is the same whatever the size of the lathe and whether you are turning a candlestick on a small motorized home workshop outfit or a table leg on a larger lathe such as that shown in Fig. 1. Note well the names of the various parts, for they will be mentioned repeatedly.

CHOOSING A LATHE

Selecting a lathe depends, of course, on several factors, such as the type of work to be done, the space available and the price. The majority of the many small lathes now on the market suitable for home work are equipped with attachments for sawing, boring, grinding, buffing, sanding and the like. A surprising amount of work can be done on such an outfit.

For general woodworking and furniture making, it is well to select a lathe that is at least 30 in. long between centers—the standard length of a table leg—and has a swing of at least 9 in. The height of the lathe center over the bed indicates the swing; that is the diameter of the stock which can be turned. If it is 6 in. above the bed, the lathe has a 12-in. swing. Lathe beds of extra length can usually be obtained at a slight additional cost.

A motor-head lathe, that is, one with a variable speed motor mounted directly on the headstock, is the most convenient to use and takes up the least space. The more common type of lathe shown in Fig. 1 is driven by means of a cone pulley belted to a countershaft, which has a similar cone pulley and also a tight and loose pulley. The countershaft is generally fastened to the ceiling beams above the lathe. A small motor drives the countershaft and this in turn drives the lathe. By means of a belt-shifting device, generally consisting of an iron fork to which a wooden handle is fastened, the belt is moved from the loose to the tight pulley when it is desired to start the lathe. Sometimes a special motor is furnished with the lathe and is fastened to the legs below the headstock. This makes the countershaft unnecessary.

A lathe should run at a speed of about 2500 revolutions a minute when the belt is on the smallest step of the cone pulley. If it is necessary to buy new pulleys when installing a lathe, their diameters can be easily calculated if it is remembered that the diameter of the driven pulley times the number of revolutions it makes is always equal to the diameter

of the driving pulley times the number of revolutions it makes.

Suppose we buy a lathe with its corresponding countershaft and the cone pulleys have three steps, the smallest being 3 in. in diameter and the largest 9 in. The tight and loose pulleys measure 6 in. in diameter. We have a $\frac{1}{4}$ -H.P. motor with a speed of 1200 revolutions a minute. The motor is equipped with a pulley 4 in. in diameter. Will this motor drive the lathe at the proper speed?

It is first necessary to find the speed at which the countershaft will revolve when it is belted to the motor.

The revolutions of the motor multiplied by the diameter of the pulley equal the revolutions of the countershaft multiplied by the diameter of the loose pulley.

$$\begin{array}{rcl} 1200 \times 4 = \text{rev. of countershaft} & \times & 6 \\ 4800 = & 800 & \times 6 \\ 4800 = & & 4800 \end{array}$$

The countershaft makes 800 R.P.M., therefore the cone pulley on the countershaft also makes 800 R.P.M. The problem now is to find how many revolutions the lathe spindle makes.

The revolutions of the countershaft multiplied by the diameter of the large cone pulley equal the revolutions of the live spindle multiplied by the diameter of the small cone pulley.

$$\begin{array}{rcl} 800 \times 9 = \text{rev. of live spindle} & \times & 3 \\ 7200 = & 2400 & \times 3 \\ 7200 = & & 7200 \end{array}$$

Stock not more than 3 in. in diameter can be turned at the highest speed of the lathe (2500 R.P.M.); stock from 3 in. to 6 in. in diameter should be turned at a medium speed with the belt on the second step of the cone pulley, and stock over 6 in. in diameter should be turned at the slowest speed of the lathe.

Before the stock is rounded off and runs true in the lathe, it causes a good deal of vibration. The lathe should, therefore, be run at a lower speed until this process has been completed, as excessive vibration may cause the stock to be thrown violently from the lathe.

For the first lathe work, the following tools (see Fig. 2) are sufficient: 1-in. gouge, $\frac{3}{4}$ -in. square-nose chisel, $\frac{1}{2}$ -in. skew chisel, $\frac{1}{8}$ -in. parting tool, $\frac{1}{2}$ -in. round-nose chisel, $\frac{1}{2}$ -in. diamond-point

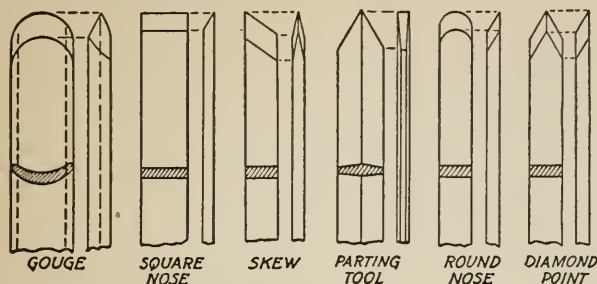

FIG. 2.—A set of turning tools for the beginner. They must be supplemented by calipers, dividers, rule, oilstone, and slip stone.

chisel, 6-in. outside spring caliper, 6-in. inside spring caliper, 8-in. wing dividers, rule, oilstone and slip stone.

The gouge is ground to semicircular shape with the bevel extending well around to the sides so as to leave no sharp corners as on the carpenter's gouge. The bevel should be about twice as long as the gouge is thick. It is ground on a sandstone or an emery wheel. If no water or kerosene runs over the stone, care should be taken to dip the tool frequently during the grinding process to prevent overheating and drawing the temper of the steel.

Grasp the handle with the right hand, hold the blade to the surface of the stone with the left hand and move the gouge across the face of the stone with a rolling motion.

When ground, the gouge is whetted on an oilstone. The bevel is brought in contact with the stone and the gouge moved back and forth and simultaneously rolled from one side to the other. The wire edge, which is bent towards the inside by this process, is removed by rubbing the rounded edge of a slip stone back and forth over it. Keep the whole edge of the slip stone in contact with the inside of the gouge during this operation.

While the square-nose turning chisel is longer than an ordinary chisel, any

common chisel can be used in place of it if it has a long blade and is fairly heavy. To sharpen this type of chisel, place the bevel in contact with the oilstone, raise the chisel and slowly move it back and forth, pressing on the blade with the left hand. Reverse the chisel, place it absolutely flat on the oilstone, press on it with the left hand, and move it back and forth a few times. Repeat the process until the wire edge is removed. Test the sharpness of the iron on the thumb nail as in Fig. 3. If the iron is sharp it "takes hold," if it is not sharp, the nail slides over it.

The skew chisel is ground so that two bevels are formed instead of one. The cutting edge should be at an angle of about 65 degrees to the side of the chisel. While grinding, grasp the handle firmly in the right hand, press down on the blade with the left, and hold the chisel at such an angle that the



FIG. 3.—Thumb-nail test for a chisel; if it "takes hold," it is really sharp.

cutting edge is parallel with the axis of the grindstone or emery wheel as in Fig. 5. Whet the chisel on the oilstone.

The parting or cutting-off tool has two bevels, which should be of equal length



FIG. 4.—The edges of scraping tools are sometimes turned over with a burnisher to form a burr or almost microscopic hook.

and meet in the ridge that runs through the center of the blade. If they do not meet at this point the tool will bind and stick in the wood.

The round-nose chisel is ground in much the same way as a gouge, and the diamond-point or spear-point chisel is held on the stone at an angle so that its edge is parallel to the axis as shown in Fig. 5. The method of grinding the various chisels used in work is very simple and will be easily mastered.

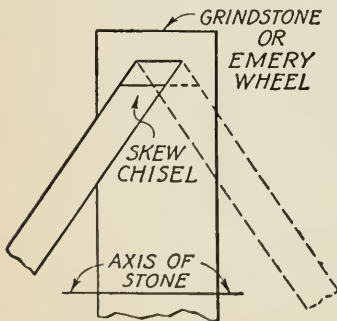

FIG. 5.—A skew chisel is held in an angular position for grinding.

When a tool is used for scraping, its cutting edge dulls more quickly than when it is used for cutting. To overcome this disadvantage and also to make the tool cut better, the edge is sometimes

turned with a burnisher so that it forms a sort of miniature hook or burr. This is done after the tool has been sharpened as explained above. A good way to turn the edge is to clamp the tool in a vise and stroke its edge with a burnisher. The first stroke should be at about the same angle as the bevel. In the following strokes the burnisher is gradually raised, so that at the last stroke it is held almost in a horizontal position (see Fig. 4). It may be of advantage to turn the edge of square- and round-nose chisels and diamond-point chisels. The



FIG. 6.—Use a wooden mallet to drive the live center into the wood. This is particularly important when the stock is hard wood.

gouge and skew chisel are cutting tools and should not have their edges turned, neither should the parting tool, which has two bevels. The burnisher illustrated in Fig. 4 was made by grinding the teeth off a triangular saw file.

The oilstone and slip stone are hard, smooth stones used for whetting tools. Machine oil thinned with kerosene is a good lubricant to use on them.

FIRST STEPS IN TURNING

When a lathe is purchased, the manufacturer usually gives directions for setting it up and provides a set of the more essential tools, but the actual operation has to be learned by experience.

Saw the stock to dimensions. If it is square or rectangular, draw diagonals on

end, and bore a small hole in the center of the other end.

Remove the live center from the headstock of the lathe. Usually this is done by pushing it out with an iron rod, which can be inserted from the opposite end of the headstock. Drive the center with a *mallet* into that end of the wood on which the diagonals were sawed, so

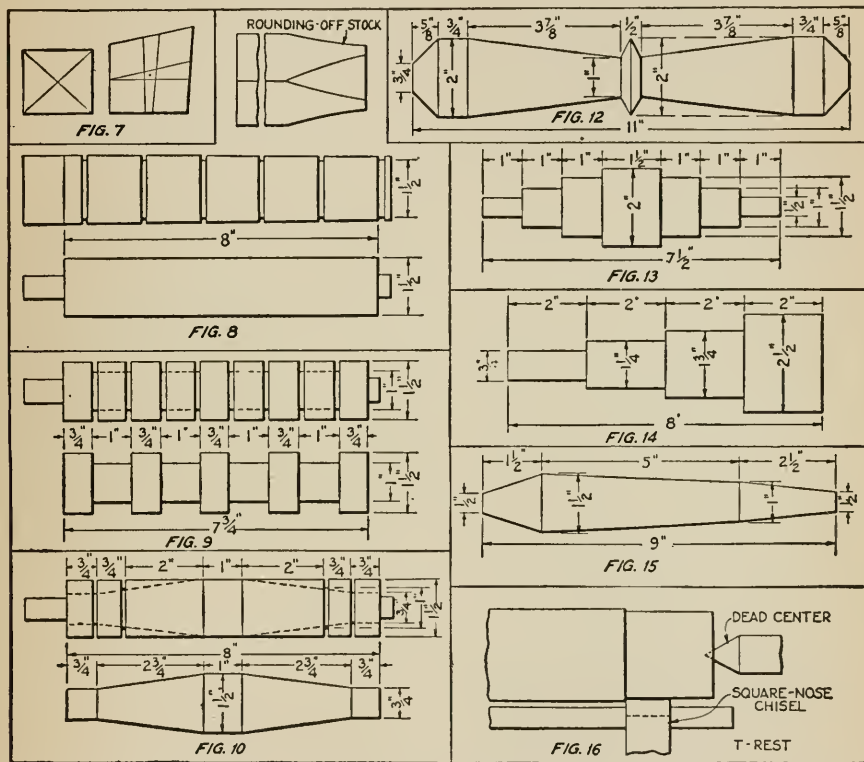

FIGS. 7 TO 16.—Steps in centering the work and in turning cylinders and various other forms that are derived from the cylinder.

each end. The center of the piece lies in their point of intersection. If the stock is irregularly shaped, set a pair of dividers to approximately half the thickness of the piece, hold one of the legs of the dividers against one of the edges, and scratch a line parallel to it. Repeat on the other three edges. The center then may be determined. A marking gage may be used instead of the dividers (see Fig. 7). If the wood is very hard, make a saw cut on the two diagonals on one

that the prongs enter a saw cut. Do not drive the wood on the live center while it is in the lathe if it can be avoided.

Turn the other end of the wood up and drip machine oil on it. Allow the oil to soak in. If the wood is not oiled or if the oil has dried, the friction on the dead center will cause the wood to burn.

Replace the live center in the headstock and press the wood against it, so that its spurs enter the depressions previously formed in the wood. Clamp the

tailstock firmly so that the point of the dead center is a couple of inches away from the end of the wood; then turn the



FIG. 17.—Start the cut near the dead center and move the tool toward it. Hold the tool as illustrated and stand in the position shown.

handwheel until the dead center enters the end wood so deeply that the wood cannot be revolved by hand. Loosen the handwheel a little until the wood can be revolved quite freely by hand. Clamp the dead center in this position.

Adjust and clamp the tool rest so that it is about $\frac{1}{8}$ in. away from the edge of the wood that is nearest to it when the stock is revolved. Fasten the T-rest at the correct height, which varies somewhat with the height of the person; it is never below the center of the piece, how-



FIG. 18.—Use a parting tool and calipers. Groove the work to the required diameter at points about 1 in. apart. The grooves serve as depth guides and make it easy to turn a true cylinder.

ever. It is generally from $\frac{1}{8}$ to $\frac{1}{4}$ in. above the center. Turn the pulley by hand and make sure that the wood has

sufficient clearance. See that the clamps are all tight before turning on the power.

If the stock is well centered and not over 2 in. square, the lathe may be started with the belt running on the smallest step of the cone pulley—that is, at full speed. Suppose you wish to turn a cylinder (Fig. 8). Use the gouge for the first cut. Grasp then the handle near the end with the right hand; hold the blade firmly against the T-rest with the left hand, so that the palm of the hand near the wrist and also the little finger are in contact with the T-rest. Hold the handle of the gouge well down and roll the gouge a little towards the right. This



FIG. 19.—Smooth the cylinder with a square-nose turning chisel or a firmer chisel with a long blade.

will throw the shavings away from you. Raising the hand holding the handle will start the gouge cutting (Fig. 17).

Start cutting a couple of inches from the dead center and move the gouge away from you towards the dead center. Begin the next cut a couple of inches farther to the left and continue making similar cuts until only an inch or so is left. Roll the gouge towards you and move it towards the live center to round off the last part of the stock. When too long a cut is taken while rounding off the corners, large chips are liable to fly off and injure the operator.

Move the gouge freely from one end of the piece to another until it is perfectly cylindrical and a little larger in size than actually needed. Stop the lathe and move the T-rest closer to the stock.

Set the outside calipers to about $\frac{1}{16}$

in. more than the finished diameter. Grasp the parting tool in the right hand and the calipers in the left. Cut into the wood with the parting tool while holding the calipers in the groove being cut



FIG. 20.—Use a skew chisel to square both ends. Be careful not to cut too close to the live center, to avoid damaging the tool.

until the calipers slip over the cylinder (Fig. 18). Make several cuts about 1 in. apart.

Smooth the cylinder with a square-nose turning chisel or an ordinary firmer chisel with a long blade. Hold the beveled side down and place the chisel flat on the T-rest (Figs. 16 and 19). Cut to the bottom of the grooves made with the parting tool until the cylinder is smooth and of the same diameter throughout. Test it by placing a straightedge along it.

Square the end running on the dead center with the parting tool. If the hole left by the dead center will be unsightly in the finished object, this cut should be made about $\frac{1}{2}$ in. from the end. Cut down to about $\frac{1}{4}$ in. on both ends. When the piece is removed from the lathe, the ends can then be sawed off with a back saw and smoothed with a chisel. The ends can also be squared with a skew chisel; it is placed on its side, flat on the T-rest, and the cutting is done with the toe, where the cutting edge makes an acute angle with the side (Fig. 20). Test

for squareness by holding the side of the tool against the end (Fig. 21). Measure the length and make a cut on the other end.

To make shoulder cuts, proceed as follows: You may use the cylinder just turned or make a similar one, laying it out according to Fig. 9. Place a rule on it and mark all the points without moving the rule. Steady the pencil on the T-rest and press its point against one of the marks on the cylinder. Revolve the cone pulley with the left hand so that the pencil scores a line all around the cylinder. Repeat at all the other points.

Set the calipers to a little more than 1 in. in diameter and cut with the parting tool on the inside of the lines indicating the 1-in. divisions (Fig. 18). Leave a little stock for finishing.

Remove the wood between the cuts with the square-nose chisel, making that part of the cylinder 1 in. in diameter. Finish the shoulder cuts with the parting tool or skew chisel. Cut off the projections on both ends.

Two other problems are suggested in Figs. 13 and 14. Any lumber may be



FIG. 21.—Test the end for squareness by resting the side of the tool against the wood. If no light can be seen between the tool and the work, the edge must be perfectly square.

used and the dimensions changed as necessary. However, start out with a drawing and definite dimensions. See how closely you are able to follow them. A good plan is to make two turned pieces

from each drawing and compare them. Lay off the measurements as explained before. Cut down to the proper diameters with the parting tool, but allow $\frac{1}{16}$ in. more than the diameters needed on the taper cuts. Finish the square sections on the ends with a square-nose chisel.

With a $\frac{1}{2}$ -in. gouge or a round-nose chisel, remove the wood on the tapers almost down to the cuts made by the parting tool. The round-nose chisel, like the other scraping tools, should be held flat on the tool rest with the bevel down. Finish the tapers with a square-nose chisel, a diamond-point chisel or a skew chisel as shown in the remaining drawings.

Two supplementary drawings (Figs. 12 and 15) are given for practice purposes on page 119.

CONCAVE AND CONVEX CUTS

As soon as the amateur wood turner has learned how to turn a cylinder and make shoulder and taper cuts, he is ready to undertake ornamental work that requires concave and convex cuts.

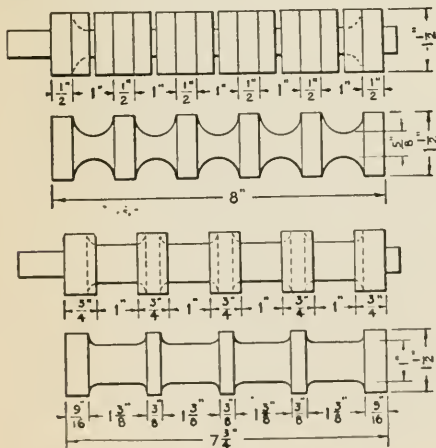

FIG. 22.—Two simple exercises in making concave cuts. Once mastered they give the wood turner power to do ornamental work.

To practice making concave cuts, first turn a cylinder $1\frac{1}{2}$ in. in diameter and 8 in. long and lay it out as shown in Fig. 22 at the top. Set the calipers to

$\frac{1}{16}$ in. more than the smallest finished diameter and cut down with the parting tool at the center of the curves. Use the

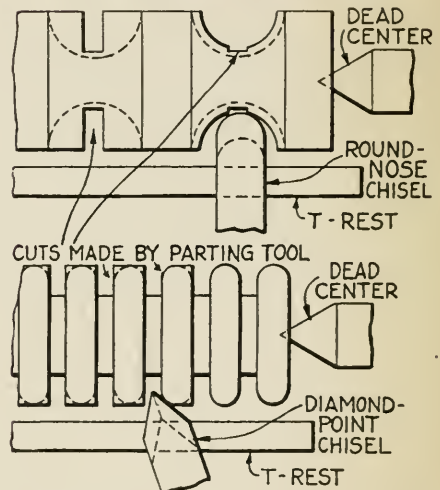

FIG. 23.—Above: A round-nosed turning chisel held flat on the T-rest is used for shaping concave surfaces. Below: How the round-nose and diamond-point chisels are manipulated.

round-nose chisel for making the concave cuts and hold it perfectly flat on the T-rest (see Fig. 23). Begin the cuts a little inside the lines and gradually work down to the bottom of the cuts made with the parting tool.

Another exercise is shown at the bottom of Fig. 22. Use a cylinder with shoulder cuts made as suggested in Fig. 9 and lay off the measurements indicated in Fig. 22. Make the concave cuts with the round-nose chisel. The supplementary exercise, Fig. 24, is designed to

give practice on curves of longer and shorter sweep.

Convex cuts come next. Turn a cylinder $1\frac{1}{2}$ in. in diameter and 8 in. long, lay out measurements according to Fig. 25 at top. Make small V-cuts with the

beading tools, from $\frac{1}{8}$ to $\frac{5}{8}$ in. in width, can also be obtained and used for this purpose.

For the purposes of illustration, each of the preceding exercises has been designed to deal with only one type of cut. In most turned work, however, two or more of these cuts are combined, as in the simple projects illustrated at the bottom of Fig. 26 and in Figs. 27 and 28.

Chisel handles are of two kinds. One type, illustrated in Fig. 26, is tapered to fit into the socket of a chisel. As these tapers vary, it is necessary to verify or change the dimensions of the taper, as the case may be. It should be remembered that the smaller end of all turned work should be run on the dead center, so that the end may be squared or rounded more easily

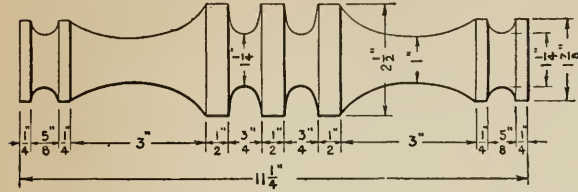

FIG. 24.—A design which combines the two exercises shown in Fig. 22.

diamond-point chisel. Round off the sharp corners with the diamond-point or skew chisel. For a second exercise (Fig. 25 at bottom) lay out a cylinder as shown and cut down to the smallest diameter with the parting tool; then

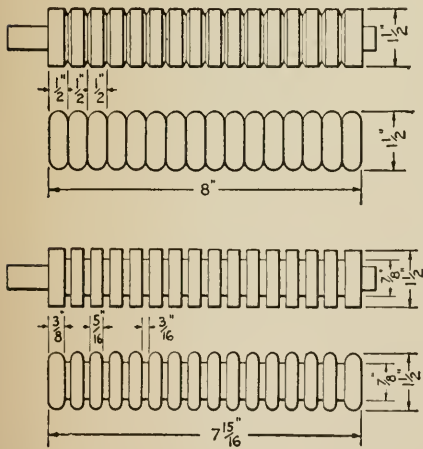

FIG. 25.—Useful exercises in making beads, which are frequently used in ornamental wood turning.

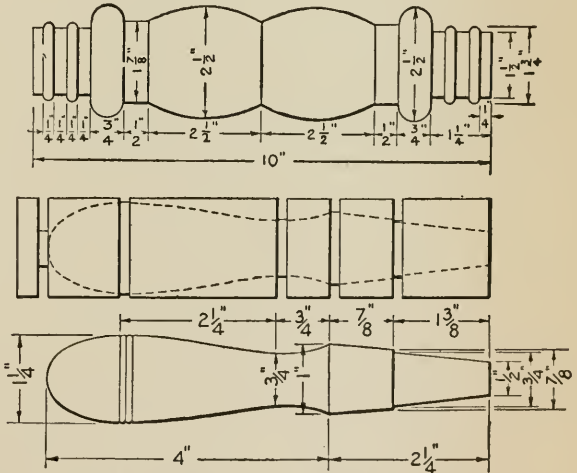

FIG. 26.—Above: Another exercise in turning. Below: A tapered handle for a socket chisel.

round off the corners with the diamond-point (see Fig. 23) or the skew chisel.

Beads of different diameters, such as the ones shown in Fig. 25 and on the supplementary exercise, Fig. 26 at top, are used extensively on turned work. It is therefore important to be able to make smooth and well-rounded beads. Specially shaped turning chisels, called

and safely. In this case, therefore, the tapered end of the handle should run on the dead center. As the hole made by the dead center will not be objectionable in the finished product, it is better not to cut it away.

It is recommended to turn the taper first. The stock may be removed from the lathe and tried as often as necessary,

until it fits the socket. The rest of the handle is then finished in the usual way, the concave part with the round-nose chisels and the convex part with the diamond-point or the skew chisel. The

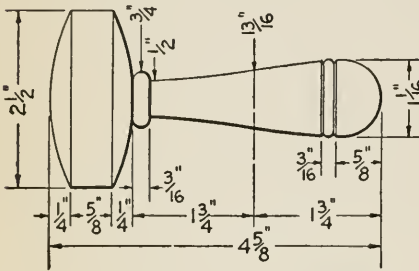
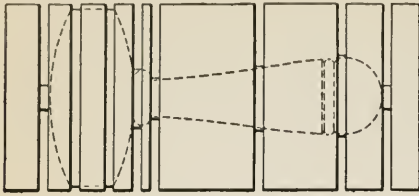

FIG. 27.—A time-honored wood turning project—a stocking darner with a springy steel clamp for holding the stocking in place.



three lines on the handle near the end are cut for ornamentation. They are made with the point of the skew chisel.

The other kind of chisel handle is for the tang type of wood chisel. Each handle is fitted with a brass ring called a "ferrule," which prevents the wood from splitting when the tang of the chisel is driven into the handle. Ferrules can be bought in different diameters, according to the size of the chisel. They should fit so tightly on the chisel handle that they must be driven in place with a mallet. All handles should be sandpapered as smooth as possible.

When sanding in the lathe, it is best to remove the T-rest. The sandpaper is folded into narrow strips and moved rapidly back and forth over the work. If it is held in one place, rings will appear

on the object being sanded. Care should be taken not to round sharp edges. When the tools are kept sharp very little sanding is needed. Ordinarily sandpaper No. 1/2 or 0 and No. 00 should be used.

Stocking darners are made in many different shapes. The one illustrated in Fig. 27 may be made in either one or two pieces. A clamp may be made out of an old clock or phonograph spring and fitted around the head of the darner. This will hold the stocking tightly over the convex face during the darning proc-

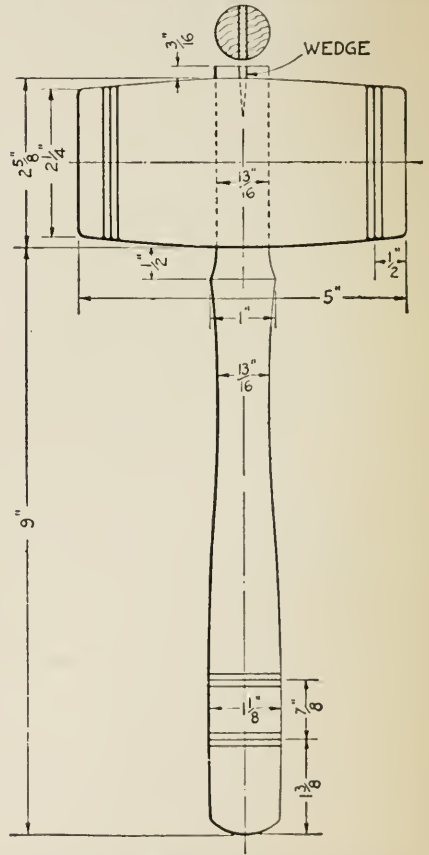

FIG. 28.—A design for a hickory mallet, which will give beginners good practice in accurate turning.

ess. If the ends of the spring are heated, they may be bent as shown. The edges should be smoothed with file and emery paper.

The mallet, Fig. 28, is a serviceable

tool for any woodworker. It is made in two pieces. The end of the handle entering the mallet head should be turned

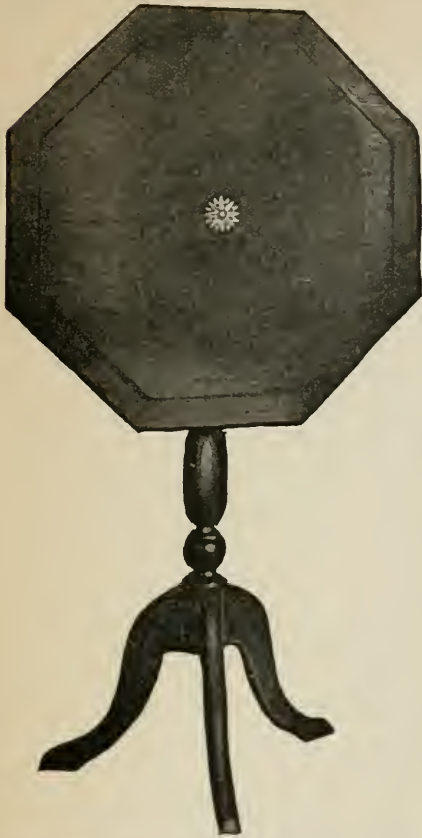

FIG. 29.—A tilt-top table with a turned column. The top is decorated with an inlaid insert and border.

very accurately to the diameter indicated. To do this, a gage is made by boring a $\frac{13}{16}$ -in. hole in a thin piece of wood. This gage may be hung on the dead center while the handle is being turned, so that it is not necessary to remove the stock when testing.

When the head has been turned to size, the exact center between the ends is measured and a line marked around the head at this point. Wrap a narrow strip of paper around the mallet head on this center line and cut it so that the two ends just meet. Remove the paper and fold it once. Wrap it around the mallet

head again and mark a point on the center line at each extremity of the folded paper. These points, directly opposite each other, indicate the centers of the hole to be bored for the handle. The hole should be bored halfway from each side in order to get it true. If the halves should not meet exactly in the center, any unevenness may be removed with an inside-bevel gouge.

The mallet head may be held between the lathe centers or in a vise while the hole is being bored. In any case it is well to have someone "watch" the bit to see that it is held horizontally and parallel to the ends of the mallet head.

Before joining the pieces, the end of

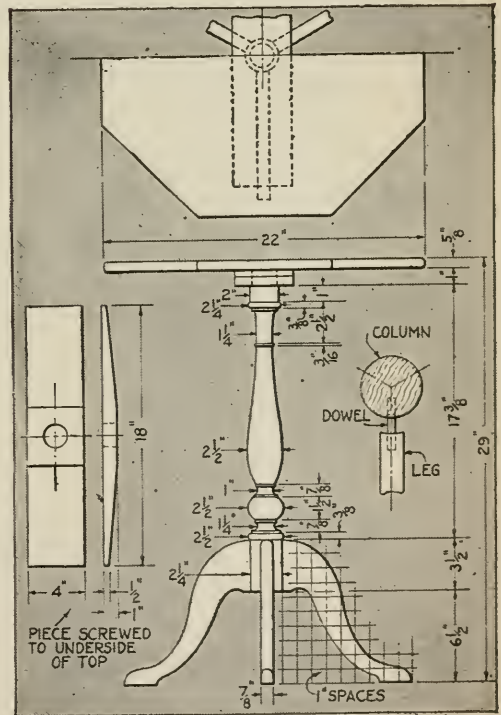

FIG. 30.—Elevation and partial top view of the table shown in Fig. 29; details of the leg joint and top brace.

the handle should be split along the center with a hack saw. When the handle and head are ready to be glued together, a wedge is made and driven into this saw cut. The end of the handle may be

allowed to project a little, or it may be cut off flush with the head. Hickory is the best of the commonly available woods for this project.

SMALL TABLE

The stand or small table illustrated in Figs. 29 and 30 is an example of what the woodworker can accomplish in the line of furniture making when he has an elementary knowledge of wood turning. From the wood turner's point of view, this project is very simple, as there is only one turned piece. The turning of this piece, moreover, does not involve any particular difficulties. The method of procedure is clearly shown in Fig. 31.

A cardboard pattern should be made for the three legs according to the method of laying out shown in Fig. 30. In placing the pattern on the wood, see that the grain runs the long way, otherwise the legs are likely to snap at their narrowest point. They may be fastened to the turned column either with a mortise and tenon joint or with dowels. The latter method is the easier and, indeed, gives a stronger joint than a poorly made mortise and tenon.

First cut the legs with a turning saw or on a band saw, square the ends, and round the outer edges with spokeshave,

scraper, and sandpaper. The part of the legs that fits the column must be curved. This can be done easily by turning a cylinder a little less in diameter than the column—in this case about 1¼ in. Glue



FIG. 32.—Using a sandpaper-covered cylinder to shape the legs to fit the turned column.

a piece of No. 1½ or 2 sandpaper to it. When dry, put the cylinder in the lathe and hold the end of the legs against it until a curve of the proper shape has been formed (Fig. 32).

Locate the centers for the dowels as

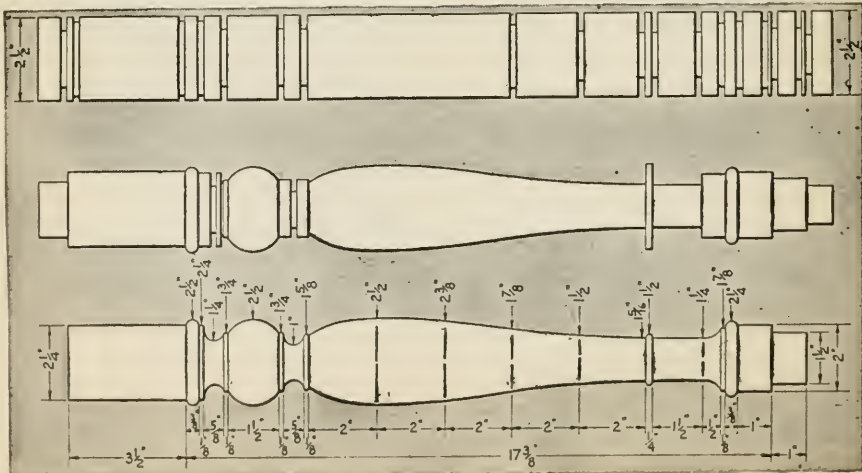

FIG. 31.—Three steps in turning the tilt-top table column. Grooves are first turned to the correct depths, as previously described, and these guide the finishing cuts.



FIG. 33.—One of the legs with dowels inserted, all ready to be glued to the turned column.

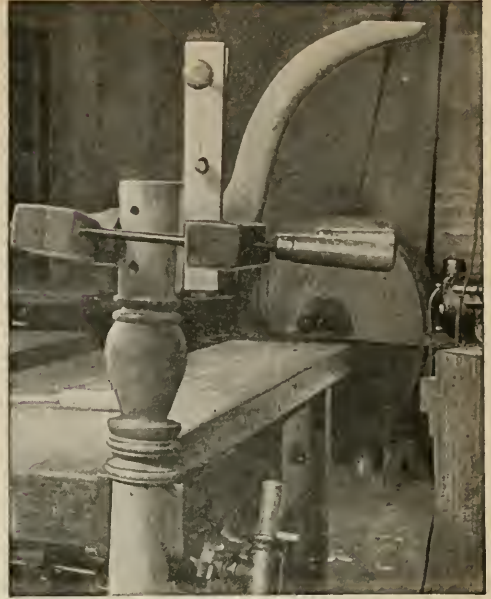

FIG. 34.—One leg at a time is glued to the column and held firmly with three hand screws.

follows: Wrap a piece of paper around the column and cut it so that the ends just meet. Fold it into three equal parts and lay off these divisions on the column. Place each of these marks level with the top of the tool rest and draw horizontal lines on the column.

Mark the corresponding center lines on the legs with a marking gage and lay out the points for the dowels. Set the marking gage to 1 in. and, holding the block of the gage against the lower end of the column and against the corresponding edge of the legs, mark lines crossing the six center lines already marked. Set the gage to $2\frac{1}{2}$ in. and from the same edges mark another set of lines crossing the center lines. Bore for dowels at these twelve points (Fig. 33) and fit each leg to the column.

Glue one leg at a time as shown in Fig. 34, using three hand screws. One of these is clamped firmly to the leg to be glued, and the other two force it tightly against the column.

The top may be octagonal, round, elliptical, or kidney shaped; it may be embellished with inlays or painted deco-

rations, or it may be left plain. If it is to be fixed firmly to the base, a piece 1 by 4 by 18 in. with a $1\frac{1}{2}$ -in. hole bored in the center, is screwed to its under-

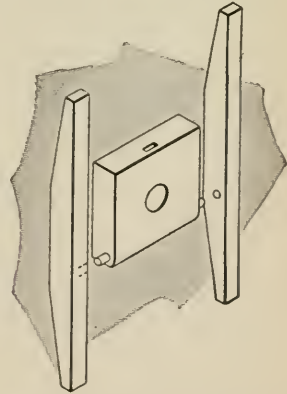

FIG. 35.—The three parts that are necessary to mount the table if the top is to tilt.

side. The top is then fastened to the base.

If the top is to be made to tilt, two strips $\frac{7}{8}$ by 1 by 18 in. and a block 1 by 6 by 6 in., as shown in Fig. 35, provide

the tilting mechanism. A $1\frac{1}{2}$ -in. hole is bored in the center of the block, which is later glued to the top of the column. Two dowels are also glued into one end of the block, and corresponding holes are bored in the side strips. The upper rear end of the block is rounded off so that the top can move freely.

It should be remembered to glue the block to the column in such a way that one leg is perpendicular to the surface of the top when the latter is tilted to a vertical position, as otherwise the stand would be unstable. A brass catch, called a table catch, is screwed to the underside of the top and locks it to the block when in a horizontal position.

ORNAMENTAL FOOTSTOOL

The footstool illustrated in Fig. 36 is a simple project from the standpoint of both wood turning and joinery. Notice that the upper parts of the four legs are

all around on the four sides of the piece. Start cutting a little outside the lines with a very sharp skew chisel; rest its edge on the T-rest and bring the point gradually in contact with the wood. This will nick the corners of the square piece. After a light cut with the skew chisel, cut down to the same depth with the parting tool. Then repeat the process until the parting tool is in contact with the wood at all points. Round off the rest of the piece with a gouge and finish to the proper diameter as described in previous articles.

Finish the square cut with the skew chisel, as shown in Fig. 37. If by accident the square corners should be broken off beyond repair, turn this part of the stock down to form a round tenon $\frac{3}{4}$ in. in diameter and 1 in. long. Blocks $1\frac{1}{2}$ in. square and $1\frac{3}{4}$ in. long then may be cut, a $\frac{3}{4}$ -in. hole 1 in. deep bored in the center of one end of each, and the turned legs afterwards glued to them.

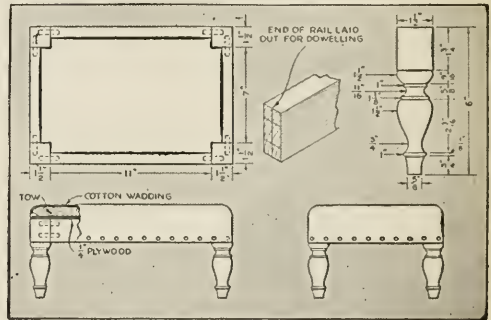
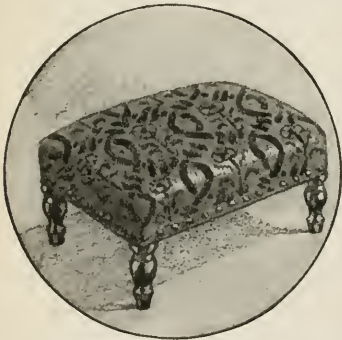

FIG. 36.—Left: A neatly finished footstool with simple turnings. Right: Side and end views, top view of the framework, and details of the legs and doweled joints.

square, and that the rails are joined with dowels to this square part in such a way that the outside faces of the legs and rails are flush.

When getting out the stock for the legs, cut it somewhat larger, say $1\frac{3}{4}$ in. square, so as to allow for the final squaring after the legs have been turned. In this way any unevenness in centering or any slightly broken-off corners can be remedied.

When beginning the turning, lay off the square part by squaring a pencil line

If you succeed in turning the legs in one piece, the square part is planed down to $1\frac{1}{2}$ in. so that the turned part is perfectly centered. The rails are then squared to dimensions. Be careful to see that all the ends are square and that each pair of rails are exactly the same length.

Mark the outside faces of the legs and rails and set a marking gage to half the thickness of the rails. Gage a line through the center of the ends of each rail, and corresponding lines (two) on

each leg, holding the block of the marking gage against the outside faces of the legs and rails. Next set the gage to $\frac{1}{2}$ in. and mark lines from the top edges of legs and rails crossing the lines already marked. Then set the gage to $1\frac{1}{4}$ in. and mark another set of lines also from the

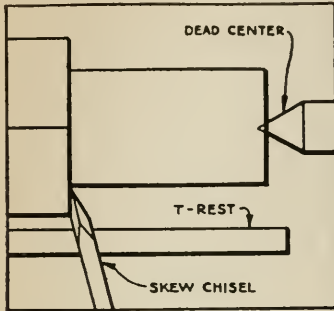

FIG. 37.—Finishing the shoulder of the square cut on the leg.

top edges, crossing the vertical lines first marked. Bore holes $\frac{3}{8}$ in. in diameter and $\frac{3}{4}$ in. deep at all points of intersection. If the work has been accurately done, the rails and legs when joined will be flush both on the top and on the sides. If it is found that a hole has been bored inaccurately, glue a $\frac{3}{8}$ -in. dowel into it, cut off the dowel flush, and bore a new hole after the glue has set.

When all joints fit perfectly, the legs and rails may be glued together. It is best to glue either two ends or two sides first and let the glue set, rather than attempt to glue the whole stool together at once.

The stool may be upholstered very easily as follows: Smooth off any little unevenness from the joints, nail a piece of $\frac{1}{4}$ -in. plywood to the top, and plane it flush with the sides of the stool. Plane a bevel on the plywood top on all four sides and tack a piece of webbing or burlap about 3 in. wide to it so that the tacks are driven into the center of the bevel and the burlap hangs over the sides of the stool.

Buy $1\frac{1}{2}$ lb. of fine tow from an upholsterer and form it into an even roll $\frac{1}{2}$ in. in diameter. Place it on the bevel

and fold the burlap over it, tacking the burlap to the plywood top so that a hard roll is formed all around the top edges of the stool.

Place a layer of tow evenly over the top of the stool, picking or separating it well so that it becomes light and fluffy. Stretch a piece of muslin over the tow and tack it to the sides of the rails near the lower edge. Drive the tacks only part way into the wood, because the muslin must be restretched several times and the tow manipulated until the seat is smooth.

Hair is an excellent material to use for this purpose, but more expensive than tow. A layer of hair or moss on top of the tow will improve the seat.

After the muslin has been finally tacked in place, it is covered with a piece of upholsterers' blue cotton wadding, after which the covering, such as tapestry or leather, is stretched over it and tacked. The edges are trimmed with a pair of scissors and covered with a narrow band or "gimp" made of the same material or bought ready-made to match. This is nailed in place with upholsterers' fancy nails.

The legs should be stained and finished before the covering is tacked in place.

MATERIALS FOR FOOTSTOOL

No. Pcs.	T.	W.	L.	Part
4	$1\frac{1}{2}$	$1\frac{1}{2}$	6	Legs
2	$\frac{3}{4}$	$1\frac{3}{4}$	7	Rails
2	$\frac{3}{4}$	$1\frac{3}{4}$	11	Rails
1	$\frac{1}{4}$	10	14	Top
1	..	15	24	Muslin
1	..	12	16	Cotton wadding
1	..	15	24	Covering
1 lb. fine tow, tacks, and upholsterers' nails.				

All dimensions are in inches.

TABLES WITH TURNED LEGS

In no other way can you turn your wood turning to better advantage than in making legs for decorative tables. Rarely has a home too many small tables; there is always room for a

graceful occasional table like that illustrated in Fig. 39 or a book-trough end table such as is shown in Fig. 40.

The occasional table with its folding top may be used, as its name implies, for different purposes and in a room with almost any type of furniture. When folded, it takes up the minimum space but still remains an ornament. Because of its adaptability, it is particularly suited to modern requirements.

Proceed cautiously with the cutting as shown in one of the views of Fig. 42.

A plain square rail, the same length as the stretcher, is used between the legs at the top. The joints may be made with either dowels or mortises and tenons. To this upper rail the top is hinged. Between the rail and the stretcher is pivoted the winglike table top support. Notches are cut on opposite sides of the rail to receive the projections at the

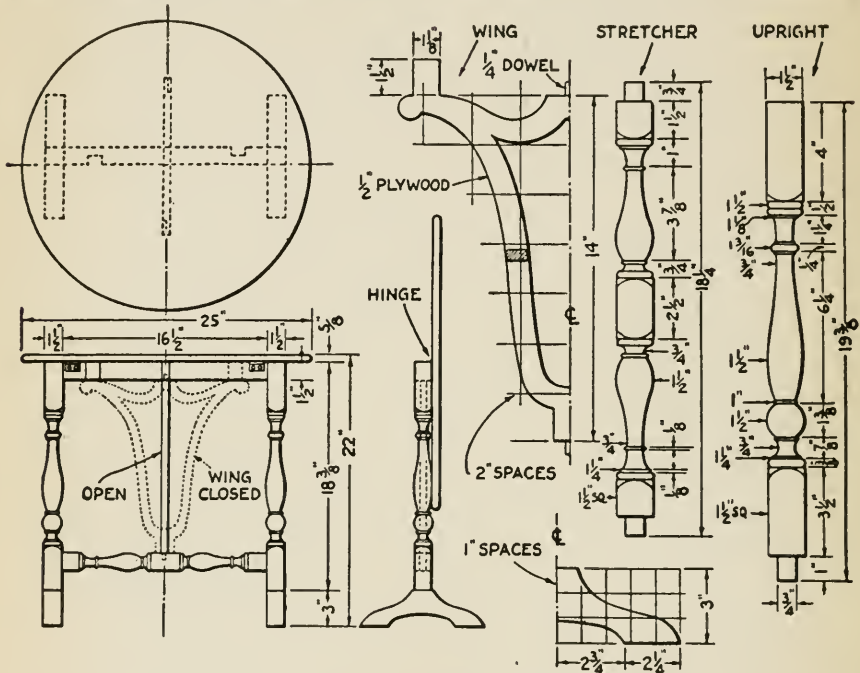

Fig. 38.—Front, top, and end views of the occasional table, and details of the uprights, feet, stretcher and wing.

Three turned parts are required: two uprights exactly alike, which are glued into the feet, and one stretcher connecting them (Fig. 38). The uprights have two square parts and the stretcher three. As to the method of turning, refer to the directions given for the footstool. After those portions which are to be turned are finished and the cuts at the square parts have been made, round the corners slightly with a skew chisel held flat on the T-rest. Lay off the distance of the rounding—about $\frac{3}{8}$ in.—by squaring lines on all sides of the square pieces.

upper part of the wing when it is turned parallel to the rail. The wing support is cut from $\frac{1}{2}$ - or $\frac{3}{8}$ -in. plywood and a $\frac{1}{4}$ -in. dowel is glued into each end to enter corresponding holes in the centers of the top rail and the stretcher. If desired, an additional turned rod may be inserted in the wing as suggested in Fig. 39. Obviously, the wing must be put in place before the table is glued together.

If, for the sake of simplicity, it is desired to omit the wing, a table catch may be bought and fastened to the underside of the top in such a way as to lock the

top to the upper rail when the top is in the horizontal position.

A line of inlay near the edge of the top and an insert in the center will add to the decorative quality of the table if it is to be stained and varnished. Similarly, an art transfer (decalcomania) can be used in the center of the top if

dowels. Glue up the two ends of the table separately. When the glue is dry, complete the assembly of the frame-



FIG. 39.—When tilted down, the top of this little occasional table is supported by a graceful pivoted wing.

the table is finished with brushing lacquer or enamel.

The end table, Figs. 40, 41, and 42, requires the turning of four legs. Care must be taken to have them exactly alike. In making the ornamental book-trough end pieces, it is well to square them and cut the dadoes (grooves) before shaping the edges. Remember to plane and sandpaper the two boards which form the trough before laying out the dadoes into which they are to fit, so as to insure tight, workmanlike joints.

The shaped ends, as well as the upper rails, may be joined to the legs with



FIG. 40.—Book-trough end table made of maple and stained a rich antique amber color.

work by joining the two ends, the two long rails, and the two book-trough boards.

The top is fastened by means of cleats about $\frac{7}{8}$ in. square, screwed to the inside of the rails flush with their upper edges.

The choice of lumber and of the finish for both these projects is a matter of individual preference. The end table illustrated in Fig. 40 was made of maple and given an amber stain to imitate the

MATERIALS FOR TABLES

No. Pcs.	T.	W.	L.	Part
For Occasional Table				
2	1½	1½	19¾	Legs
2	1½	1½	18¼	Stretchers (plain and turned)
2	1½	3	10	Feet
1	½	14	14	Support
1	⅝	25	25	Top
1 pair			2	Fast joint butt hinges
For End Table				
4	1½	1½	26¼	Legs
2	¾	2½	10	Rails
2	¾	2½	24	Rails
1	¾	13	27	Top
2	¾	8½	8	Sidepieces
1	½	4	24	Trough
1	½	4½	24	Trough

All dimensions are in inches.

color of antique maple. The stain was followed by a thin coat of shellac, which, when dry, was rubbed with No. 00 steel wool. A coat of clear brushing lacquer

finally applied and rubbed to a soft sheen. The result was perfect.

TURNING CANDLESTICKS

Faceplate turning, the next phase of the work, is no more difficult than spindle turning; and no set of exercises need be mastered before real work can be attempted.

The tools are the same as those described in the beginning of this chapter,



FIG. 41.—Looking down on the inlaid top of the end table. The wood is bird's-eye maple, beautifully figured.

was next applied, and this was rubbed smooth with powdered pumice stone and crude oil. A coat of liquid wax was

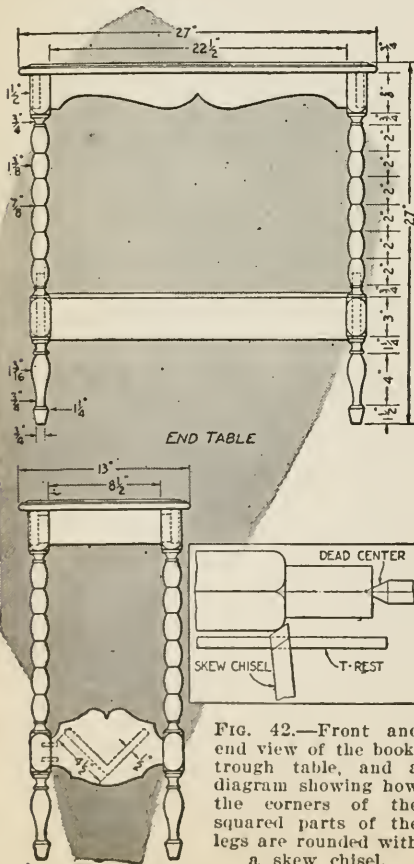

FIG. 42.—Front and end view of the book-trough table, and a diagram showing how the corners of the squared parts of the legs are rounded with a skew chisel.

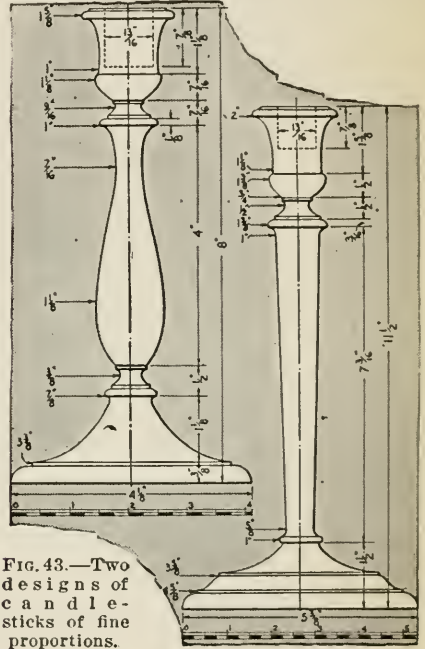

FIG. 43.—Two designs of candlesticks of fine proportions.

and the methods of using them do not differ materially from the ones employed in spindle turning.

By mastering faceplate turning, you can make candlesticks, lamps, smoking stands, frames, rings, boxes, trays, and bowls. These projects can be turned only by the use of chucks and faceplates.

A candlestick (Figs. 43 and 44) consists of two parts, the upright and the base. Let us turn the upright first. One end of it has a round tenon fitting into the base. The other end must be bored for the candle. Bore this hole with an auger bit before putting the stock in the

lathe. As candle ends vary in diameter from $\frac{3}{4}$ to $\frac{7}{8}$ in., it is best to bore a hole $\frac{13}{16}$ in. in diameter and of about the same depth. A quick boring auger, that is, one with few threads on the spur, is the most satisfactory for end-wood boring.

Turn a plug or short cylinder to fit this hole accurately. It should be about

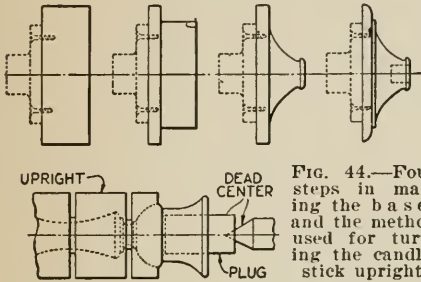

FIG. 44.—Four steps in making the base, and the method used for turning the candlestick upright.

$1\frac{1}{2}$ in. long, but in cutting it off be careful not to cut away the end with the hole made by the dead center. The plug should fit so that it can be forced with the hands into the hole in the candlestick. If too tight, it is likely to split the wood when it is turned down to size; if too loose, it may have a piece of paper wrapped around it.

When the plug is placed in the hole, the end having the mark of the dead center should project so that it can run on the dead center of the lathe (Fig. 44). In this manner the hole bored for the candle will be accurately centered when the stock is turned. Turn the upright according to either of the designs given in Fig. 43.

Get out the stock for the base, plane it flat and true on one side, and cut the sharp corners off it. Screw a faceplate to the planed side of the piece, centering the plate as well as possible. The screws should be rather heavy, and their length depends upon where the screw holes in the faceplate are placed; there must be no danger of cutting into them.

If a small enough faceplate is not available, it will be necessary to use a screw chuck, which is merely a small faceplate with a screw in the center. In hardwoods small holes must be bored

for the screws, and soap put on the threads of the screws will act as a lubricant and make it easier to drive them.

After the stock has been securely screwed to the faceplate, the live center is removed from the headstock of the lathe, and the faceplate is screwed on the end of the live spindle.

Adjust the T-rest so that it is parallel to the face of the disk (at right angles to the lathe bed), at a height a little below the center of the stock and $\frac{1}{4}$ in. away from it. See that the work revolves freely and start the lathe at its medium speed.

With the toe of a skew chisel held at right angles to the face of the base, remove enough of the material from the edge to make the base circular (Fig. 45). This will diminish the vibration caused by uneven centering. The cut should be stopped about $\frac{1}{8}$ in. from the rear face of the base, for the wood may split if the cut is extended all the way across the edge of the base.

If the face of the base is rough or much material has to be removed, first



FIG. 45.—Making the base circular by removing wood from the edge with the toe of a skew chisel. Note the position of the T-rest.

use a round-nose chisel, holding it flat upon the T-rest and at right angles to the base. Move the chisel across the face of the base from the front to the center and back again. Smooth the face with a square-nose chisel and test for flatness with a try-square as in Fig. 46.

Mark the diameter of the base by setting a pair of dividers to a distance equal to the *radius*. Place one leg on the center and scribe the circle with the other leg while the stock is revolving.

Another way is to set the dividers to the required *diameter*. Rest one leg of

the dividers on the T-rest and place it in contact with the revolving stock. Bring the other leg of the dividers gradually in contact with the stock. If two circles are marked, shift the dividers so that the points come in contact with the stock halfway between the two cir-



FIG. 46.—After the base has been trued with a round-nosed chisel and smoothed with a square-nosed tool, it should be tested for flatness.

cles, when only one circle will be marked (Fig. 47, lower view).

The second method is more exact and is especially useful when the center has been cut away. It is very quickly mastered.

Reduce the base to the required diameter as explained before. Then adjust the T-rest parallel to the lathe bed and to the edges of the base, and with the square-nose chisel remove the thin piece of material left on the rear edge of the base.

Next mark a pencil line all around the base to represent the thickness of the part which is to be of the greatest diameter. To make the explanation simpler to follow, the base of the candlestick shown at the left in Fig. 43 will be used

as an example. The line just mentioned will accordingly be $\frac{3}{8}$ in. from the rear face of the base (see Fig. 44).

Change the T-rest to its first position (parallel to the face of the base); set the calipers to $3\frac{3}{8}$ in. and mark another circle with the dividers as described above. Cut down to the pencil line with the skew chisel on this diameter ($3\frac{3}{8}$ in.). Set the dividers to $\frac{7}{8}$ in., mark the circle, and cut the concave curve between this circle and the one previously marked ($3\frac{3}{8}$ in.). To do this, adjust the T-rest at an angle and as near to the surface being turned as possible. Cut the square bead and round off the corners on the $4\frac{1}{8}$ in. part with a skew or square-nose chisel.

With the dividers, mark the diameter of the hole in which the tenon of the upright piece is to fit. Cut on the inside of the line with the toe of a $\frac{1}{4}$ -in. skew chisel and remove the center with the



FIG. 47.—Upper view: Using the toe of a keen $\frac{1}{4}$ -in. skew chisel to bore the hole that is to take the tenon of the candlestick upright. Lower view: Marking the diameter of the base with dividers held on the T-rest and centered by trial.

skew chisel or a round-nose chisel (Fig. 47, upper view). Cut the hole so that the tenon fits snugly.

Leave the base as it is in the lathe, put a little thin glue on the tenon and in the hole, and fit the tenon in place. Clamp the base and the upright together in the lathe by pressing the dead center

into the plug in the end of the upright. Wipe off any surplus glue with a piece of waste moistened with hot water, and leave the candlestick to dry in the lathe.

Sandpaper and stain the candlestick to the desired color. If a water stain is used, it is well to wet the wood before applying the stain. The water raises the grain, making it feel rough to the touch, and it is therefore necessary to sand the candlestick again when it is dry. It will be found that the wood will dry more rapidly if the lathe is running. A second wetting of the wood with water stain will not raise the grain.

If the wood is very porous, such as oak or Philippine mahogany, it should be filled with paste wood filler thinned with turpentine until of the consistency of cream. Apply it to the candlestick with a brush. After a little while it will lose its luster and become flat. The lathe then should be run at its slowest speed while the filler is rubbed into the pores of the wood with a cloth. Wipe clean with a piece of waste, and allow the filler to dry for twenty-four hours.

A thin coat of shellac as an undercoat for the finish next should be applied with a brush. On relatively close-grained woods, such as birch or Santo Domingo mahogany, the filler coat may be omitted and the shellac coat applied directly after the stain has dried.

The shellac should be allowed to dry for several hours. The lathe then may be started and this coat rubbed down with No. 00 steel wool. Be careful not to rub through the stain on sharp edges and beads.

Next a coat of clear lacquer may be brushed on evenly. Do not brush twice over the same place. The lacquer, which dries very quickly (within an hour), may be rubbed down with No. 5/0 waterproof sandpaper or powdered pumice stone sprinkled on a rag dipped in soapsuds or rubbing oil (crude oil). If a higher gloss is desired, two coats of lacquer may be applied, only the second coat being rubbed. Do not use an oil stain or oil in any form under a lacquer finish.

A thin coat of liquid wax also adds to

the luster. This is applied with a piece of cotton waste or a rag and polished with a flannel cloth while the work is revolving in the lathe.

The candlestick is now finished. The plug is removed from its upper end (a pair of gas pliers may be helpful for this purpose), and the faceplate is unscrewed from the base. The holes left by the



FIG. 48.—Gracefully turned table lamp of a type any home worker can make on a small lathe.

screws may be plugged by filling them with wood cement or stick shellac. This is sold in all colors; it looks like sealing wax and is melted in the same way.

A piece of thin felt may be glued to the base. Apply the glue to the bottom of the base, *not to the cloth*, press the cloth in place, and set away to dry. The edges of the cloth may be trimmed later with a pair of scissors.

Another method of turning the base, so as to avoid the screw holes, will be explained in the following section.

TABLE LAMP

The turned table lamp illustrated in Figs. 48 and 49 consists of two parts, the upright and the base. Before the upright can be turned, a hole must be made lengthwise through its center for

the electric wires. This hole may be made either by boring through a solid piece of wood or by gluing two pieces together after first cutting a groove in each.

In the first method the advantage of having a solid piece of wood is offset by

The hole in the other end is left the way it is and runs on the dead center.

The base may be turned so as to avoid screw holes in the bottom. Get out the stock, plane one side, and screw it to the faceplate as explained in the preceding section.

Reduce the wood to the thickness and diameter required and cut a little depression in its center about $\frac{1}{16}$ in. deep and about 1 in. less in diameter than the total diameter of the base (Fig. 50). This is the bottom of the base, and the depression is cut to make it stand well.

Bore a hole with a $\frac{3}{8}$ -in. auger bit into the edge of the base and well past its center. Sandpaper the bottom and edge of the base and remove it.

A device called a "chuck" is now made from a piece of wood, preferably soft and at least 1 in. larger in diameter than the base. This is screwed to the faceplate, faced off, and turned to its largest possible diameter.

Caliper the diameter of the lamp base carefully, mark this diameter on the soft wooden disk, and cut a recess into it about $\frac{1}{4}$ in. deep. The base should fit

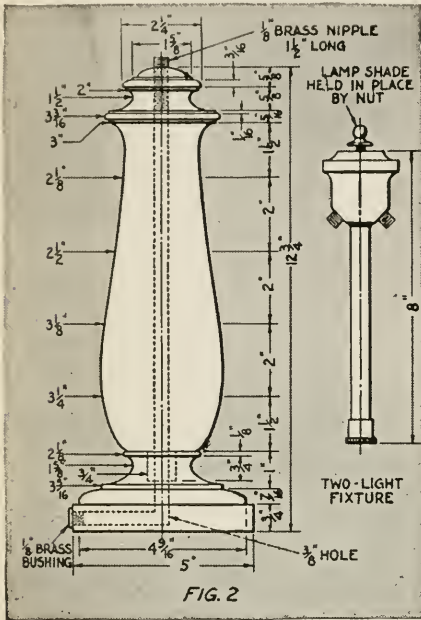

FIG. 49.—The base of the lamp is turned in a wooden chuck as shown in Fig. 50.

the difficulties encountered in boring the hole. The auger bit to be used should have a spur for end-wood boring, and, as the ordinary auger bit is not long enough, a hole must be bored from each end. If the ends are squared accurately with the sides and the holes started on a drill press, there is a good chance to have them meet in the center; moreover, any little unevenness may be readily removed by inserting a red-hot iron rod.

The only difficulty about the second method is to plane the faces of the two pieces accurately, so that they will make a perfect joint. A groove $\frac{3}{16}$ in. deep and $\frac{3}{8}$ in. wide should be cut in the center of each piece before gluing.

When turning the upright, block the hole in the end running on the live center (the tenon) with a piece of soft wood.

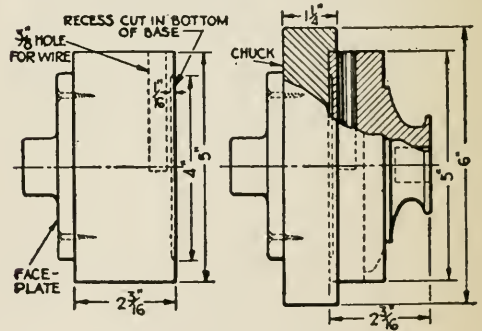

FIG. 50.—The base is roughed out on the faceplate (left), then finished in a wooden chuck with a suitable recess (right).

very tightly in this recess. To begin with, cut well within the line marked and gradually enlarge the recess until the right diameter has been reached.

If the recess should be too large, place a piece of paper over it and drive the base in place. If this should not hold the base tightly, face the disk off and try again. When the base fits properly and

is driven tightly up against the bottom of the recess so that it runs true, it may be turned in the usual manner without danger of coming loose. This operation is called "chucking." To remove the base from the chuck, grasp it firmly with one hand and tap the face of the chuck with a hammer.

It is best to stain and finish the upright and the base separately. A 1/8-in. metal bushing is screwed into the hole bored into the side of the base, and a 1/8-in. brass nipple about 2 in. long is screwed into the top of the upright so

as to project about 3/8 in. From the lower end of the upright, remove the wooden plug; pull the lamp cord through the hole, and glue the upright to the base. The lamp may be held in the lathe until the glue has set, the base fitting in the chuck and the brass nipple over the dead center.

A two-light fixture, such as shown in Fig. 49, is screwed to the nipple. It is fitted with two pull sockets to which the proper wire connections are made. The other end of the lamp cord is fitted with a plug.

The shape, color, and fabric of the shade is a matter of individual taste.

SMOKING STAND

Similar problems in wood turning are involved in making the smoking stand shown in Fig. 51. It consists of three main parts—the base, the upright, and the top. First turn the upright.

The base should be turned without chucking it, as it is not important to

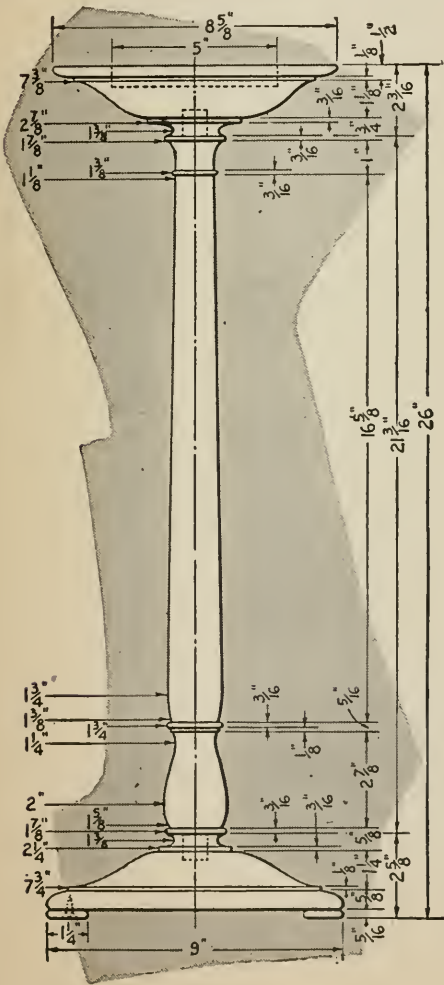

FIG. 51.—This smoking stand is an interesting project from the turner's standpoint and makes a fine gift.

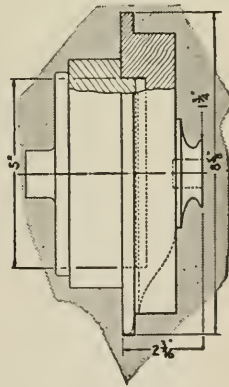

FIG. 52.—How the top member of the smoking stand is held on a wooden chuck.

hide the screw holes. When the three little feet are screwed to its underside, it will stand firmly. Before turning these, bore 3/16-in. holes for the screws through the center of the stock. The feet are turned exactly as in one of the exercises given under convex turning (see Fig. 25).

Unlike the base, the top must be

chucked before being turned to avoid unsightly screw holes. Instead of fitting inside the chuck, as in the case of the base for the table lamp, it fits over it and against a shoulder turned on it (see Fig. 52). The recess cut in the top is for a glass or metal tray. The diameter and depth of this recess, therefore, will vary according to the dimensions of the ash tray.

Glue the parts together and finish the stand as previously suggested.

SIX DESIGNS FOR GIFTS

A variety of attractive objects is suggested in Fig. 53. They were selected because of their suitability as gifts and also because they are small and simple. In making them, the following outline of the processes will be of assistance to the inexperienced wood-turner:

Flower Holder. Step No. 1—Base: Stock $1\frac{5}{8}$ in. thick and $3\frac{1}{2}$ -in. in diameter. Turn on a screw chuck. Work the bottom side to correct form. Rechuck and turn face. Step No. 2—Shaft: Bore hole for test tube, plug hole, and turn

around this hole. Fit the shaft dowel into the base. Step No. 3—Stain and polish in the lathe.

Teapot Stands. Step No. 1—Turn the bottom to shape and rechuck. This operation may be omitted, if desired, to simplify the turning. Step No. 2—Turn the face side. Step No. 3—Stain and polish in the lathe. Step No. 4—Fasten an etched copper or German silver top to the stand.

Picture Frame Moldings. Step No. 1—Turn the face side or molding design. Step No. 2—Stain and polish in the lathe. Step No. 3—Rechuck and turn the rebate for the picture and glass. Five designs are given below.

Lady's Writing Set. Look around the house for a small ink bottle of about the size shown on the drawing. Step No. 1—Box part: Turn out the inside of the box to fit the bottle. Step No. 2—Rechuck and turn the outside. Step No. 3—Cover: Turn the inside of the cover to fit over the neck of the bottle. Step No. 4—Rechuck and turn the outside of the cover to design. Stain and polish in the lathe. Step No. 5—Make the base and

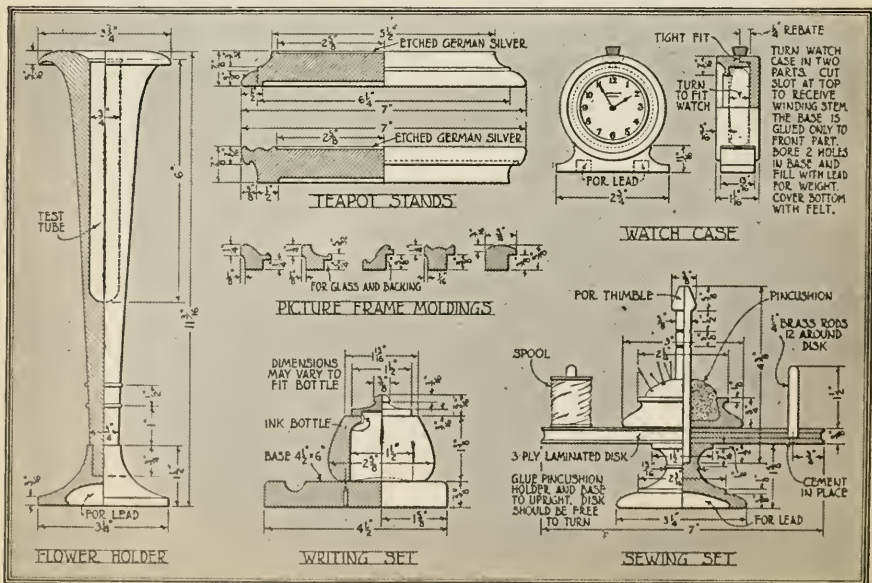

FIG. 53.—Flower holder, teapot stands, picture frame moldings, writing and sewing sets, and watch case. The dimensions indicated have proved satisfactory, but they can be modified by the individual worker.

screw into the box part from the bottom. Glue felt to bottom.

Boudoir Watch Case. Purchase the watch first; a cheap one with radiolite face will be satisfactory. Step No. 1—Turn the face portion first, rechucking and turning the back to fit the watch. Step No. 2—Turn the back portion, fitting it to the face portion.

Sewing Set. Step No. 1—Base: Turn the bottom side. Rechuck and turn the face side to design. Step No. 2—Turn

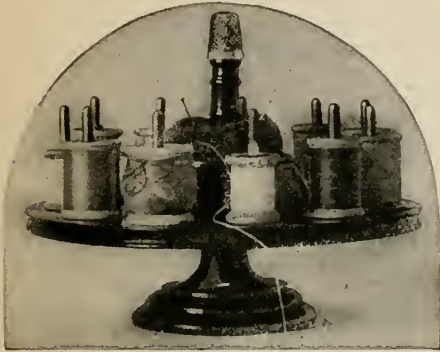

FIG. 54.—As a gift for any woman, what could be more appropriate than this graceful sewing set?

the disk on both sides. Step No. 3—Turn the cushion holder. Step No. 4—Turn the shaft between centers. Step No. 5—When gluing the parts together, do not fasten the disk; it should be free to revolve. Cement the brass dowels in place. (See above illustration, Fig. 54.)

TURNING RINGS

The turning of a solid ring of wood represents an advance in the line of faceplate work previously discussed. An example of ring turning is the napkin holder illustrated in Fig. 55 at *A* and *B*. This is turned partly between centers and partly on the faceplate.

If it is desired to turn two napkin rings, cut a piece of wood at least $\frac{1}{4}$ in. thicker and wider than the finished outside diameter of the ring and about 2 in. longer than the combined length of two rings. For two rings of the di-

mensions indicated at *A*, the rough stock should be $2\frac{1}{4}$ by $2\frac{1}{4}$ by 6 in.

Square one end of the piece carefully with the sides, an operation which may be done conveniently by sawing the stock in a miter box. Locate the center by drawing diagonals and bore a $\frac{3}{16}$ -in. hole about $\frac{1}{2}$ in. deep and a gimlet or twist bit. Fasten the piece to a screw chuck, which is simply a small faceplate with a single heavy screw in the center.

If a screw chuck is not a part of the lathe equipment, an ordinary faceplate may be used. Screw a piece of wood to the faceplate and turn a circular disk. Mark the center on the disk while it is revolving in the lathe and bore a $\frac{3}{16}$ -in. hole, countersinking it on the side which is against the faceplate. Insert a heavy flat-head screw of the proper length (depending upon the thickness of the disk) and fasten the piece to be turned firmly to the disk as at *C*.

The dead center is now run against the free end of the $2\frac{1}{4}$ -by- $2\frac{1}{4}$ -by-6-in. piece, which is rounded off and smoothed in the usual manner. The napkin rings are then laid out, turned, and sanded as explained in previous articles.

When the outside shape of the rings has been formed, the dead center is moved out of the way and the tool rest placed close to the end of the piece and at right angles to the lathe bed. Mark the diameter of the $1\frac{1}{2}$ -in. hole with a pair of dividers (use the second method described in the section on candlesticks) and start the boring of the hole with a very sharp round-nose chisel. Begin in the center and gradually work out towards the edge. Alternate with a $\frac{1}{2}$ -in. skew chisel, which should be held so that it cuts with the toe (see Fig. 47, upper view). Test the diameter of the hole with a pair of inside calipers. Then round the edges and sandpaper the work.

The dead center should now be moved up again, so that its point bears against the wood at the bottom of the hole just cut. This added support is needed for cutting the first napkin ring away with the parting tool. The remaining one is then bored and cut off in the very same manner.

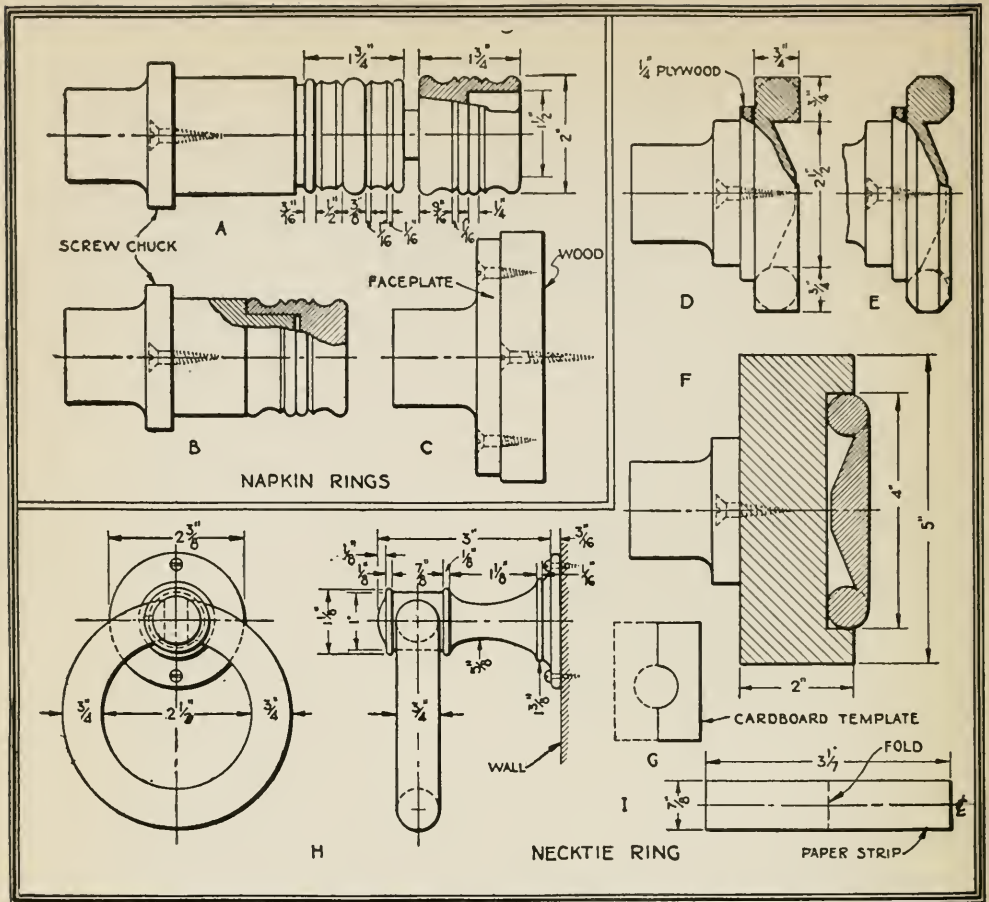

Fig. 55.—Any wood turner who masters these two projects and those shown in Fig. 56 will be able to do a large variety of similar wooden ring work.

The remaining end of the 6-in. piece is now turned until it is equal to the diameter of the holes which have just been cut halfway through the two napkin rings. The length should be a little less than the depth of the hole, so that the napkin rings will butt up against the square shoulder formed on the piece as at B.

While turning this chuck, try the fit of both napkin rings frequently, because the hole cut in one napkin ring is likely to be slightly larger than the hole cut in the other. Finish the larger one first and then cut down the chuck to fit the smaller one. Do not force the rings too tightly on the chuck or they may split.

Bore the other half of the hole in each ring as explained above. Then stain and polish the rings.

When a ring having a circular cross section is to be turned from a solid piece of wood, the stock, after being faced off, should have the same thickness as the diameter of the cross section of the ring, as indicated at D. A piece of 1/4-in. plywood is placed between the screw chuck and the material to be turned and prevents the screw in the chuck from penetrating the 3/4-in. disk.

After facing off the disk and turning it to the required outside diameter—in this case 4 in.—it is cut down as shown at D. The square corners are then

cut off (*E*), after which the ring is rounded as shown at *F*.

A template may be made of a piece of strong cardboard or veneer about 2 in. square. Proceed as follows: Draw a straight pencil line about in the center of the piece of cardboard. Tack it to a piece of wood, place the screw of an auger bit of the desired diameter—in this case $\frac{3}{4}$ in.—on the center line, and bore a hole. Cut on the line with a knife, thus dividing the cardboard in two pieces. Use half of it as a template as at *G*.

Chuck the partly turned ring as shown at *F*. The wood used in making the chuck may be soft, and it is well to have it thick in case the recess cut in it should be too large; in that case it may be faced off again and another recess cut. The center is now cut away and the turning of the ring completed.

Such rings may be used for the hanging of curtains or portières, or as towel or necktie rings. A necktie holder is shown at *H*. It fits into another turned piece, which is screwed to the wall or to a closet door.

A small section is cut out of the ring, thus permitting it to be sprung a little and slipped into a hole bored in each side of the turned piece. The center of these holes is found by wrapping a strip of paper $\frac{7}{8}$ in. wide around the piece. Cut the ends of the paper so that they just meet. Remove the paper and fold it once in the center. Draw a pencil line lengthwise through the center of the paper, wrap it again around the wood, and prick a hole on the center line where the ends of the paper meet and another where the pencil line crosses the fold as at *I*. Bore these holes while the turned piece is in the lathe and before the ends have been cut off.

A towel ring should be a little larger. It may be flattened slightly on one side and fastened at right angles to a wall or a door with a round-head screw as in the upper drawing of Fig. 56.

These rings may be made stronger and more interesting if they are made of three or more layers of wood, preferably of contrasting colors, such as walnut and

birch. Thin layers of ebonized wood about $\frac{1}{16}$ in. thick will appear as black inlaid lines. The layers should always be an uneven number. If three are used, the inside layer should run at right angles to the two outside layers (see the

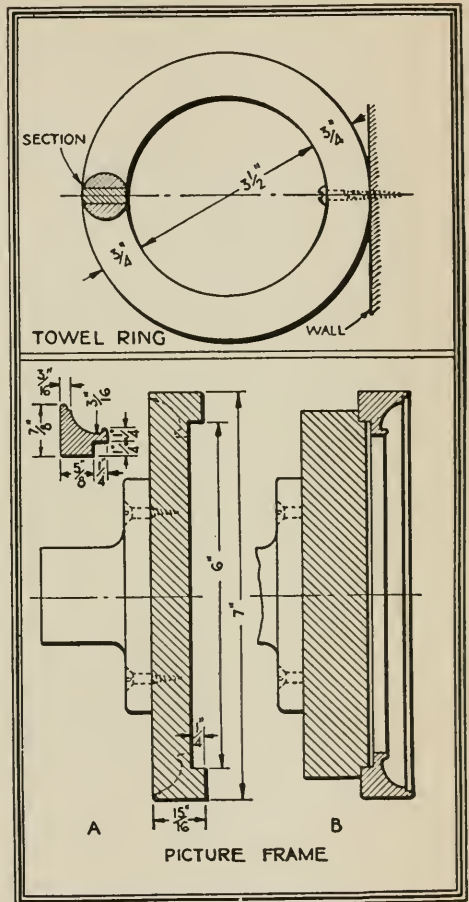

FIG. 56.—For these two pieces, as well as those shown in Fig. 55, a close grained wood such as birch, mahogany, or walnut should be used, or, for more ornamental effects, a combination of contrasting woods glued in layers.

sectional view). It is obvious that the layers should be glued up into a solid block or disk before the ring is turned.

The turned picture or mirror frame (Fig. 56, lower drawing) is simply another type of ring. Make a full size drawing of the frame and screw a piece of wood of the required dimensions to a

small faceplate. Face off and turn the piece to the desired diameter. Cut the recess for the picture, glass, and backing as shown at A. If the frame is going to be thinner than the one shown, it will then be necessary to back it up with a piece of plywood as shown in Fig. 55 at D to prevent cutting into the screws.

Remove the disk from the faceplate and turn a chuck as shown in Fig. 56 at B. The disk is now fitted to the chuck, its center cut away, and the design of the molding turned.

Some wood turners prefer first to turn and polish the face of the frame, then to chuck it, and finally to cut the recess for the glass. The method described above permits the molding to be finished and polished after all the cutting has been done and prevents it from being marred by chucking.

Other designs for picture frame moldings are shown in Fig. 53. Books on wood

turning having many attractive designs may also be consulted in most public libraries. The following are to be recommended: *Course in Wood Turning*, Milton and Wohlers; *Art and Education in Wood Turning*, William W. Klenke; *Wood Turning*, George A. Ross.

To obtain the best results, a close grained wood such as birch, maple, mahogany, or walnut should be used for rings and frames.

TURNED AND INLAID TRAYS

In turning and inlaying trays, the tool processes involved are only a step in advance of those previously described.

The tray illustrated in Fig. 57 at A is turned from a solid circular disk not less than 1 1/8 in. thick and 6 1/4 in. in diameter. A circle 6 1/4 in. in diameter is scribed on the wood with a pair of dividers. The wood is then sawed as nearly

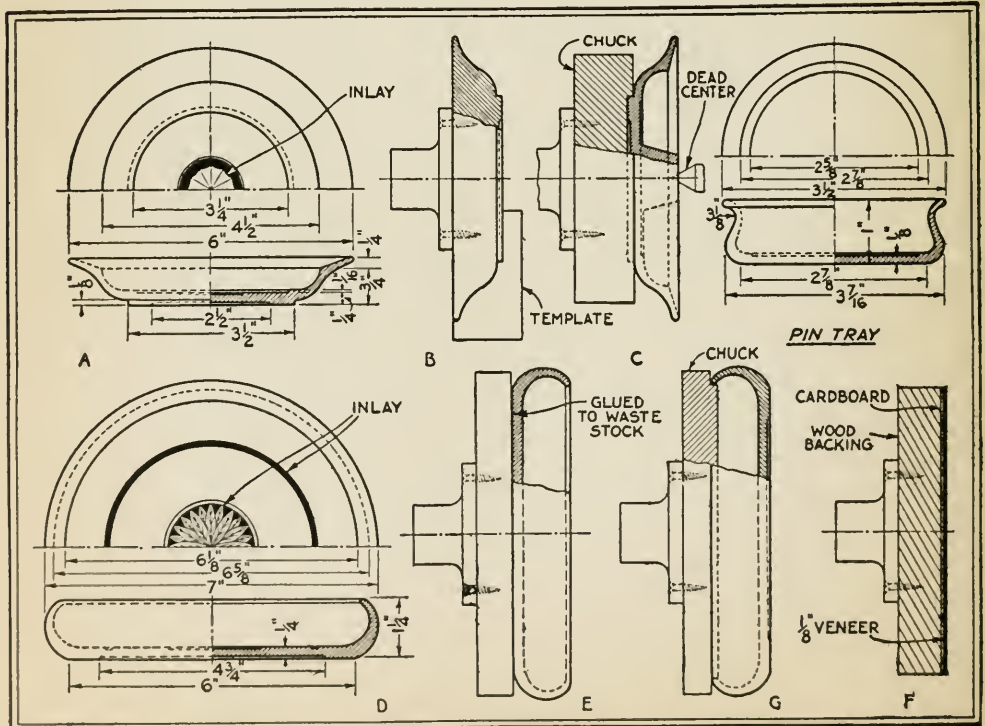

FIG. 57.—A tray with an inlaid ornament (A) and how it is turned (B and C); a tray with an additional line or band of inlay (D, E, F, and G); and a design for a pin tray.

round as possible and screwed to a faceplate.

Its outside shape is first turned. For this work it is advisable to use a template of cardboard or thin wood such as shown at *B*. If it is to be guided properly, the template should bear against a flat surface—in this case the underside of the tray. The recess in this surface is therefore cut after the outside shape of the tray has been completed. Obviously, the purpose of this bottom recess is to make the tray stand well on a flat surface.

The tray is now unscrewed from the faceplate and chucked as at *C*. It is well to support it during the hollowing-out process by running the dead center up against it. When the tray has been hollowed to the extent shown at *C*, the tailstock is moved out of the way and the central part turned down level with the rest of the bottom.

On the half plan at *A* is shown a circular inset, which is inlaid in the bottom of the tray. Such insets are sold by manufacturers of marquetry and are inexpensive. They are made up of many separate small pieces of wood about $\frac{1}{2}$ in. thick, which are glued to a piece of brown paper. A piece of veneer surrounds the inset for protection; it should be carefully cut away with a pocketknife.

A shallow recess of the correct diameter to receive the inset is cut with a skew chisel in the bottom of the tray. The inset is glued into this recess face down, that is, with the papered surface towards the top of the tray. If glue were applied to the papered surface, a good bond would not be made, because the paper might split and parts of the inset come loose.

The gluing may be done by clamping a block of wood over the inset, which should be allowed to dry for at least six hours. Then the bottom of the tray is faced off and sandpapered smooth. The brown paper is removed by this process and the inset now stands out clearly and beautifully.

The tray shown at *D* is turned by a process known as "gluing to waste stock." This is done as follows:

Turn a circular disk of the proper diameter and face it off very carefully, so that it is absolutely flat and level. Prepare the stock from which the tray is to be turned. Plane one of its surfaces true and level and saw the stock to the required diameter.

Glue the planed surface of the tray to the waste stock, but *place a piece of paper between the two glued surfaces*. In order to center the stock for the tray

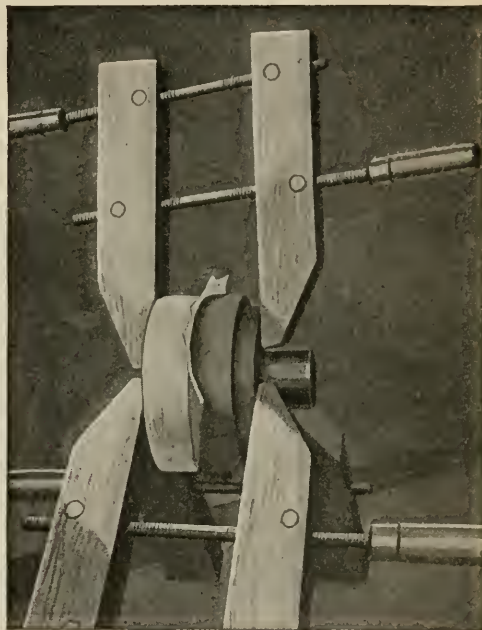

FIG. 58.—How the wood for a tray is glued to a piece of waste stock with a sheet of paper between, to facilitate splitting them apart.

accurately, first glue the paper to the waste stock and then mark the diameter of the tray on this papered surface with a pencil. This is easily done while the waste stock is revolving in the lathe. Remove it from the lathe and glue and clamp the stock for the tray securely to it as shown in Fig. 58. When the glue is thoroughly dry, turn the tray as shown in Fig. 57 at *E*.

Besides an inset in the center, which is inlaid in the manner described above, this tray also has a line inlay. Ordinary straight lines of inlay cannot be bent

to form a circle of such a small diameter. This line is therefore turned from a piece of veneer in the form of a ring.

To accomplish this, a piece of $\frac{1}{8}$ -in. veneer is glued to a circular disk, with a piece of cardboard between the disk and the veneer as at *F*. When the glue

resetting the dividers, turn a recess for the ring, and glue it in place. When the glue is dry, face off and sandpaper the inlaid bottom, and then stain and polish the tray.

The tray is removed from the waste stock by driving a sharp chisel into the

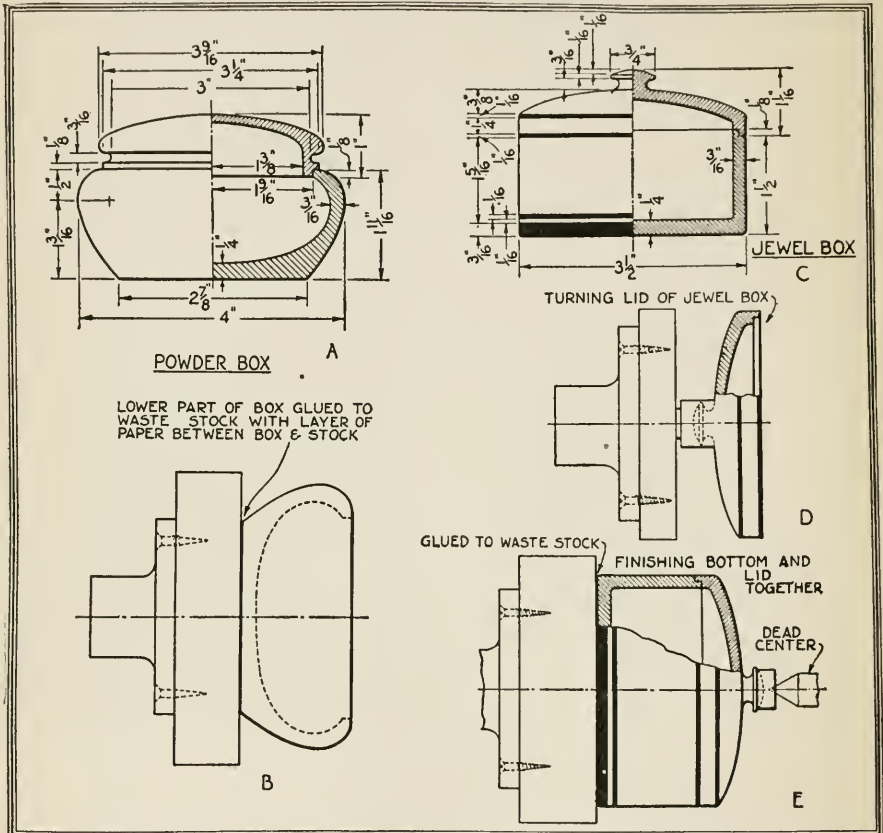

FIG. 59.—Designs for a powder box and a jewel box, and how the lower part of each box is glued to waste stock to facilitate turning.

is dry a ring of the desired width and diameter is turned from the veneer. Use two pairs of dividers with very sharp points, one pair to mark the inside diameter of the ring, and the other pair to mark its outside diameter. Mark lightly, then cut on these lines with the toe of a very sharp $\frac{1}{4}$ -in. skew chisel. The ring can now be separated from the cardboard layer.

Mark the bottom of the tray without

latter $\frac{1}{16}$ in. back of the glue joint. This will cause the paper between the tray and the waste stock to split. The tray may now be chucked as shown at *G* for the purpose of cutting the recess on its underside. The chuck may be made from the waste stock.

A supplementary design for a pin tray, which is turned by the same method, is given in Fig. 57 for those who wish further practice in wood turning.

BOXES AND BOWLS

Making small boxes is one of the most interesting and fascinating types of work that can be done on a lathe.

The cover of the powder box, Fig. 59 at *A*, is turned from a piece of wood at least 1 in. more in diameter than the finished dimensions call for. This piece of wood is securely screwed to a face-plate or screw chuck, after which it is

cover will fit snugly and yet not so tightly that it must be forced in place. The size of the opening should be tried while it is being turned by fitting the cover to it.

The lower part of the box may be used as a chuck for the lid, which must be smoothed off and sanded at the central point where it was cut with the parting tool. The whole box is now stained and polished, after which its lower part

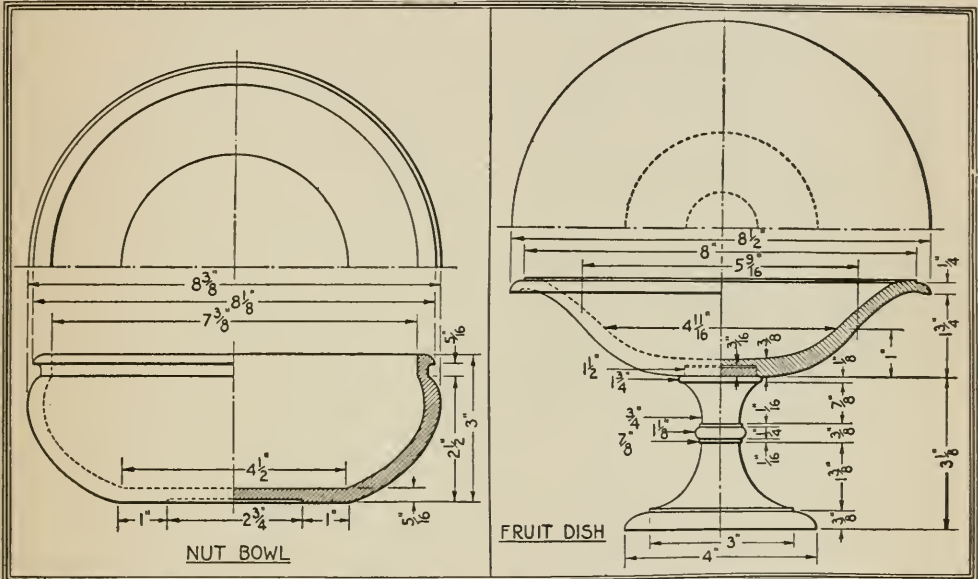

FIG. 60.—Designs for a nut bowl and a fruit dish with suitable dimensions. Variations in the designs can be made to suit the individual taste.

turned to diameter and leveled. It is best to turn the inside of the cover first, and then to cut the recess which fits into the lower part of the box. Use a template for this work. When the outside of the cover has been turned, it is cut off with a parting tool or skew chisel as near to the line as possible. Hold the parting tool with the right hand and grasp the lid with the left when it is cut away from the waste.

The lower part of the box is turned in the same manner as the tray shown in Fig. 57 at *D*. It is cut to approximate size, glued to waste stock (Fig. 59, *B*), and turned in the usual manner.

Particular care must be taken to turn the diameter of the opening so that the

is removed from the waste stock by driving a sharp chisel into the latter $\frac{1}{16}$ in. behind the glued joint. A recess may be cut on the underside of the box by chucking it as shown in Fig. 57 at *G*.

The jewel box, Fig. 59, *C*, is turned in exactly the same manner as the powder box; but as it is inlaid, the stock must be prepared in a different way. The lines of inlay are produced by gluing different colored woods together in layers. The lowest layer, for example, may be a dark-colored piece of wood, such as black walnut or imitation ebony, $\frac{3}{16}$ in. in thickness. The next layer is a light-colored wood, such as maple or birch, $\frac{1}{16}$ in. thick. This is followed by a dark

layer $\frac{1}{16}$ in. in thickness, and this again by a layer of light colored wood $1\frac{5}{16}$ in. thick.

If these layers can be had in the thicknesses required, they may be glued up in one solid block as shown in Fig. 61. The block is then prepared and turned in the usual manner. If this is not possible, the following slower method is recommended: The lower part of the box may be built up by gluing a piece

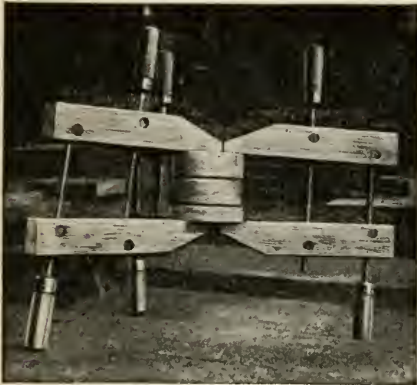

FIG. 61.—How layers of woods of different colors are glued together for making an inlaid box.

of dark wood to the waste stock as explained above. When the glue is dry, it is turned down to $\frac{3}{16}$ in. in thickness and made perfectly level and flat. The next layer of light wood is glued in place and faced off, followed by the dark layer and then the final light layer. When the required layers, reduced to the proper thicknesses, have been glued together in this way, the stock is ready to be turned. The cover for the box is built up in the same manner. The first lay of light wood is 2 in. thick and is screwed directly to a faceplate. This is faced off and followed by a dark layer, this in turn by a light layer, and this by a dark layer.

As the cover must be of exactly the same diameter as the lower part of the box, these two parts are put together as shown in Fig. 59 at *E*, smoothed, and sanded. The dead center is run into that part of the cover from which the knob

is turned. This adds to the stability of the box during the final smoothing and sanding.

The knob is the last part of the box to be turned. This is easily done while the whole box is mounted between centers as shown at *E*. Enough material should be left on the knob when the cover is cut off so that the mark made by the dead center may be entirely cut away.

In all inlay work it is well to remember not to have too violent a contrast between the inlay and the inlaid surface. If, for example, imitation ebony (ebonized wood) and maple are used for the jewel box, the maple should be stained a darker color such as amber, which resembles antique maple.

After completing the trays and boxes, the woodworker who has followed this series of articles should be able to analyze and determine for himself the best way to do any ordinary job in spindle and faceplate turning.

The nut bowl, Fig. 60, is turned by the "glue-to-waste-stock" method as explained before. The design may be modified so that a small circular block is left in the center similar to the one shown in Fig. 57 at *C*. In this case, however, the block is not removed. Instead, small holes are bored in it for receiving the nut picks when not in use.

The fruit dish, Fig. 60, consists of two parts. The base is turned between centers in the usual way. The top may be turned in the way the covers of the boxes were turned (see Fig. 59, *D*). It has to be chucked so that a hole may be bored in its underside for the $\frac{3}{16}$ by $1\frac{1}{2}$ in. tenon on the base. In gluing the parts, leave the upper part in the chuck and center the lower part by running up the dead center.

RADIO TABLE AND MIRROR

Split turning is a form of furniture decoration that came into vogue in the early part of the seventeenth century during the Jacobean period. Jacobean furniture has again become popular and reproductions adapted to modern needs

are made by many high-class furniture manufacturers.

As the name implies, split turning means that ordinary turned work is split or divided into two or more parts, which in turn are glued to flat wood surfaces (see Figs. 62, 63, and 64). Obviously, it would be impracticable to split or divide a solid turned column; split turnings are made from separate pieces of stock fastened together before they are turned.

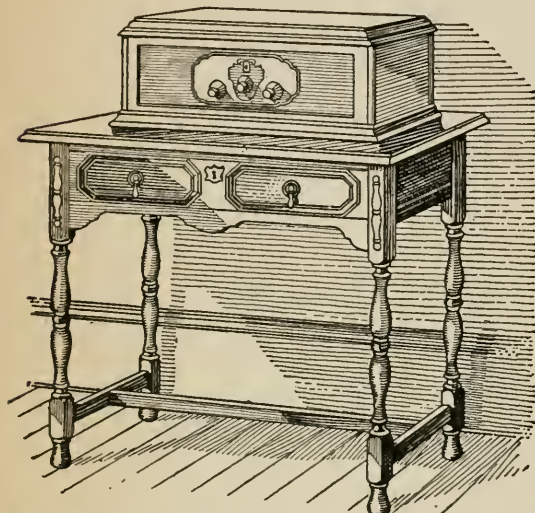

FIG. 62.—A radio table which has a rich and ornate appearance yet is not particularly difficult to make.

If turned halves, such as those used to decorate the radio table and the mirror frame, are to be made, the method of procedure is as follows:

Prepare two pieces of stock, making them a little wider than the greatest diameter of the turned pieces, and about 3 in. longer. The thickness of these two pieces should be equal to half their width, and they should be planed so that their faces fit accurately against each other. They may be fastened by screwing their ends together in the manner suggested in Fig. 65, at *A*, by gluing their ends together for a distance of about $1\frac{1}{2}$ in., by gluing them throughout their entire length with a piece of paper placed between the joint, by bolting them together as at *B*, or by driving

corrugated fasteners into the end wood at both ends. The work of fastening them together must be carefully and securely done.

The pieces are now set up in the lathe and turned between centers in the usual way. When the turning is completed, the pieces are removed, and the two ends holding them together are cut off with a saw.

When quarter sections are wanted, four pieces are fastened together as shown at *B*, Fig. 65. At *D* is indicated how a quarter section may be used in a corner. Turned quarter sections are often used on chests of drawers, clock cases, mirror frames, and other pieces of furniture.

Sometimes it is desired to fit a turned column over a square corner as at *E*. In this case a quarter section is sawed out of the solid piece from which the column is to be turned. On account of the waste in sawing, this piece cannot be used, but another piece of the proper dimensions is prepared and glued in its place with a piece of paper dividing the joint, as at *C*. When the turning has been completed, the glued piece can be easily removed by forcing the blade of a chisel into the joint, thereby causing the paper to split.

The remainder of the paper and glue is now removed from the column, after which it may be glued in place.

Turned moldings, which are decorative and easy to make, should be of especial interest to amateur woodworkers who have difficulty in working out moldings by hand. The various steps in the procedure of turning moldings are illustrated at *F*. Step No. 1 shows the end of a square piece of stock, to the sides of which four pieces of wood are glued. A piece of paper is placed between the joints, so that the finished strips of molding may be separated easily from the square stock.

It is very important to center the square piece accurately in the lathe; otherwise the four strips of molding will

not be uniform in size. It is well to cut into the square piece near each end with a parting tool until the tool is in contact with the wood all around. If it is found that the parting tool has cut

joint at either end. This causes the paper to split. The molding may be glued to a backing of any desired shape as shown in Step No. 3.

The radio table, Figs. 62 and 63, is a

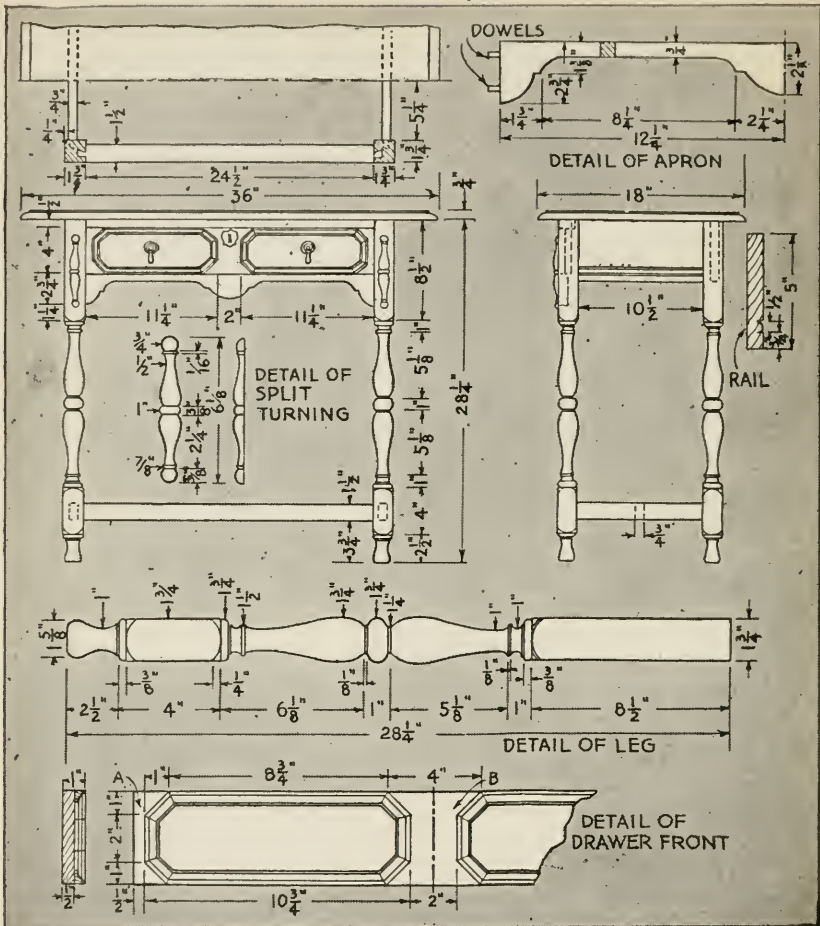

FIG. 63.—This piece is a modern adaptation of Jacobean furniture design. Note the split turnings and the recessed effect of the drawer front.

deeper into one or two sides than into the others, these sides should be planed until the cut of the parting tool is uniform on all four sides.

The stock is now rounded off as shown in Step No. 2, after which the design of the molding is laid out and turned. The four strips of molding are then separated from the square core by forcing the blade of a thin, sharp chisel into the

typical adaptation of Jacobean furniture design to modern needs. Although the piece is ornate in appearance, the construction is really simple.

First lay out and turn the four legs; then get out the side rails and stretchers and join them to the legs with mortise and tenon joints. The two sides are next connected by means of a central stretcher mortised into the side stretch-

ers, a rear rail, and two front rails. The upper front rail is joined to the legs with a half-lap dovetail joint as shown on the plan view, and the lower rail or apron is joined to the legs with dowels

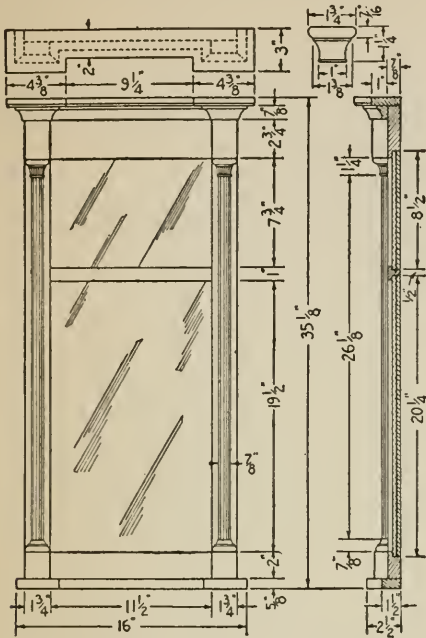

FIG. 64.—Split turnings in the form of reeded columns form the principal ornaments of this mirror.

as shown in the detail. This completes the framework.

The drawer front consists of a 1/2-in. piece to which four 1 1/2 by 4 in. blocks, shaped as shown at A in the drawer front detail, are glued at each end, and a block B, 1/2 by 4 by 4 in., in the center. A suitable molding is fitted and glued around these blocks and along the top and bottom edges. The drawer is then constructed and fitted in place.

The split turning is applied to the front legs as shown, after which the top is made and then screwed to the rails by means of cleats. Two pear-shaped drawer pulls (and a lock, if desired) should be applied and then removed until the table has been sandpapered and finished. Any good cabinet wood is suitable for this table.

In the mirror frame, Fig. 64, split turnings again form the decoration. The frame itself consists of two side pieces, a top piece, a bottom piece, and a narrow central piece. These pieces, which are all rabbeted to receive the glass and back, may be joined with dowels. After being glued, the frame is planed level and smooth.

The two half columns then are made and glued in place. Each column consists of the reeded central part, two turned caps, and two rectangular blocks. The columns may be turned in a single piece or they may be made in several parts; that is, the rectangular blocks, the caps, the bases, and the central part may be made separately, fitted together, and glued to the sides of the frame. A simple molding is now made and fitted around the top part of the frame as

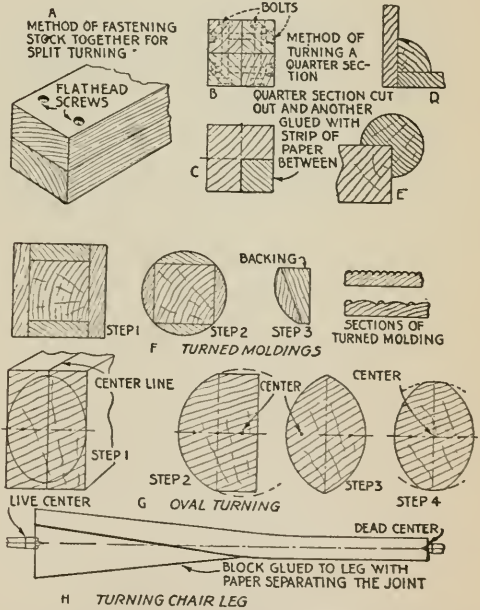

FIG. 65.—How the stock is prepared for split work, and how oval and irregular pieces are turned.

shown in the plan view. A top and a bottom piece screwed or doweled in place complete the frame. A turned molding may be used instead of the one shown, if the top piece is made plain like the

BILL OF MATERIALS				
No.	Part	T.	W.	L.
For Radio Table				
4	Legs	1 $\frac{3}{4}$	1 $\frac{3}{4}$	28 $\frac{1}{4}$
2	Side rails	$\frac{3}{4}$	5	12
2	Side stretchers	$\frac{3}{4}$	1 $\frac{1}{2}$	12
1	Rear rail	$\frac{3}{4}$	5	26
1	Front rail	$\frac{1}{2}$	1 $\frac{1}{2}$	26
1	Apron	$\frac{3}{4}$	2 $\frac{3}{4}$	24 $\frac{1}{2}$
1	Center stretcher	$\frac{3}{4}$	1 $\frac{1}{2}$	26 $\frac{1}{2}$
1	Drawer front	$\frac{1}{2}$	4	24 $\frac{1}{2}$
1	Drawer front block....	$\frac{1}{2}$	4	4
2	Drawer front blocks....	$\frac{1}{2}$	1 $\frac{1}{2}$	4
1	Molding	$\frac{1}{2}$	$\frac{5}{8}$	84
2	Drawer sides	$\frac{1}{2}$	4	12
1	Drawer back	$\frac{1}{2}$	3 $\frac{1}{4}$	24
1	Drawer bottom	$\frac{1}{4}$	12	24
2	Split turnings	$\frac{1}{2}$	1	6 $\frac{1}{8}$
1	Top	$\frac{3}{4}$	18	36
2	Drawer pulls			
1	Lock with escutcheon			
For Mirror				
2	Sides for frame	$\frac{7}{8}$	1 $\frac{3}{4}$	33 $\frac{7}{8}$
1	Top for frame.....	$\frac{7}{8}$	3 $\frac{5}{8}$	11 $\frac{1}{2}$
1	Bottom for frame.....	$\frac{7}{8}$	2	11 $\frac{1}{2}$
1	Center for frame.....	$\frac{7}{8}$	1	11 $\frac{1}{2}$
2	Lower column blocks... 1	2	2	2
2	Upper column blocks... 1	2	3 $\frac{5}{8}$	
2	Column caps	$\frac{7}{8}$	1 $\frac{3}{4}$	1 $\frac{1}{4}$
2	Column bases	$\frac{7}{8}$	1 $\frac{3}{4}$	$\frac{7}{8}$
2	Columns	$\frac{7}{16}$	$\frac{7}{8}$	26 $\frac{7}{8}$
1	Top	$\frac{5}{8}$	3	18
1	Bottom	$\frac{5}{8}$	2 $\frac{1}{2}$	16
1	Back	$\frac{1}{4}$	8 $\frac{1}{2}$	12 $\frac{1}{4}$
1	Back	$\frac{1}{4}$	20 $\frac{1}{4}$	12 $\frac{1}{4}$
1	Molding	$\frac{3}{4}$	$\frac{3}{4}$	24
1	Mirror	$\frac{1}{4}$	8 $\frac{1}{2}$	12 $\frac{1}{4}$
1	Mirror	$\frac{1}{4}$	20 $\frac{1}{4}$	12 $\frac{1}{4}$

All dimensions are in inches.

things as a hammer handle, which can be bought so cheaply. As a matter of interest, however, the process deserves description. The shape of the oval is laid out on the end of a piece of stock of slightly larger dimensions (see Step No. 1, Fig. 65, *G*). The larger center line, that is, the longest axis of the oval, is marked all around the stock as shown.



FIG. 66.—Marking a column to be reeded. The divisions are transferred from a paper strip.

bottom piece. The process of reeding will be explained in a following section.

It is advisable to place a piece of paper between the mirror and the backing. The backing itself is of plywood. If the frame is constructed of thinner stock or the rabbet is made more shallow, the backing may be made in one piece and screwed to the outside of the frame.

OVAL AND IRREGULAR TURNING

A knowledge of oval turning occasionally may be found useful, although it is hardly worth while to turn such

The other center line is then marked and the centers determined and laid out on both ends. Small holes should be bored in the ends at these points.

Mount the stock in the lathe, using a pair of centers nearest to the operator, as in Step No. 2. Run the lathe at slow speed and turn the stock until the center lines marked along it are reached. Stop the lathe frequently and inspect the work, as it is impossible to take any caliper measurements.

Next mount the stock on the pair of centers farthest from the operator and

turn as before (Step No. 3). The stock is finally mounted on the true centers and the sharp points cut away (Step No. 4); then it is sanded until it is smooth.

Pieces that are not straight, such as the rear leg of a chair, may be turned as shown at *H*. A piece of wood is glued at one end of the piece so that there will be the same weight of material on each side of the centers. An uneven

Draw a vertical center line on the ends of the box and place the turned piece in the box so that the surface to be reeded is about level with the upper side of the box. Mark where the centers of each end of the piece should be located on the vertical center lines drawn on the ends of the box. Bore $\frac{7}{32}$ -in. holes at these points, insert ordinary wood screws from $1\frac{1}{2}$ to 2 in. long, and

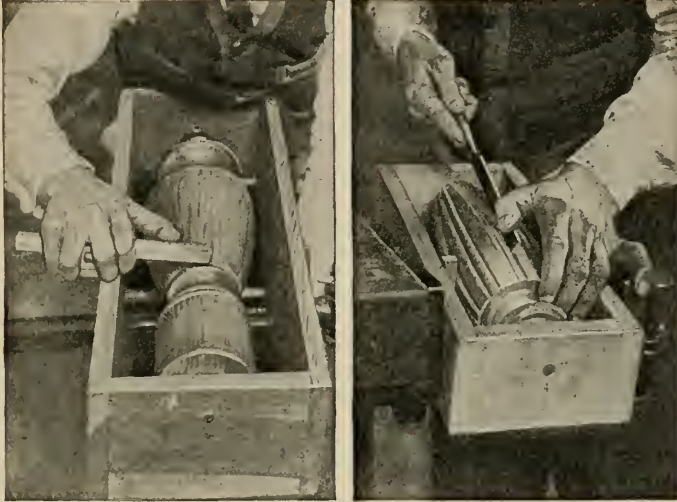

Fig. 67.—Left: How the marks for the reeds are scored with a marking gage. Right: The method of chiseling out the reeds.

weight would cause excessive vibration and make the turning difficult. The block is removed as soon as the turning is completed.

REEDING AND FLUTING

Turned work may be decorated by a few simple forms of wood carving. Although such carving greatly enhances the beauty as well as the intrinsic value of the piece, it requires little practice and no outlay for new tools.

Reeding may be described as the process of carving beads or astragals on a turned column. First make the sides and ends of a box such as would be needed if the column had to be packed and shipped (Figs. 66 and 67). Remember that this box has neither cover nor bottom.

screw them into the centers of the turned piece.

In Fig. 67 (at the left) the screw at one end is much nearer the top of the box than that in the other end. This is because the turned piece is of a larger diameter at one end than at the other; and in order to bring the surface to be reeded level with the top of the box, the end having the greater diameter must be lower than the other.

The column is now divided into the desired number of divisions. Wrap a strip of paper around the column at any point, cut it so that the ends just meet, remove it, and lay out the divisions. For an even number like sixteen, this may be done by folding the paper; for an uneven number, the divisions should be stepped off with a pair of dividers. Wrap

the paper around the column again, hold it firmly in place, and transfer the divisions to the column with a pencil as shown in Fig. 66.

Now set a marking gage to half the outside width of the box, and gage lines along the entire length of the portion

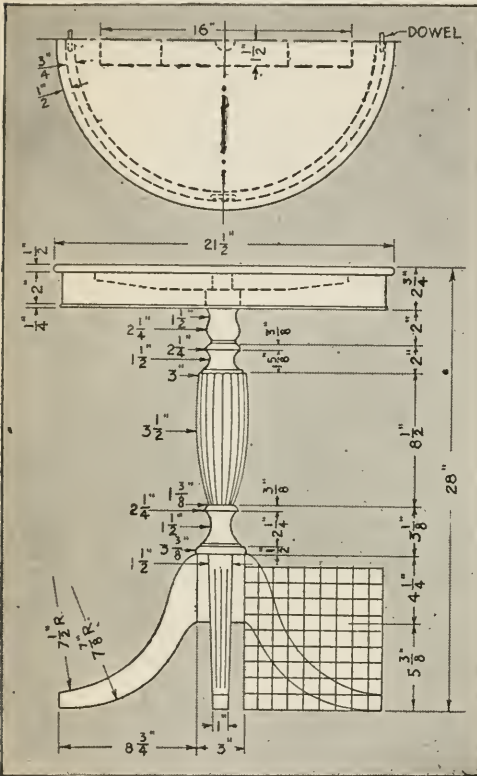

FIG. 68.—A graceful round table with a turned and reeded column and band sawed and reeded legs.

to be reeded at all the division points laid out from the strip of paper as shown at the left of Fig. 67. Let the point of the marking gage project about $\frac{1}{2}$ in. and hold the block firmly against one side of the box.

Begin chiseling V-cuts on the lines just gaged as indicated at the right of Fig. 67. Use an ordinary $\frac{1}{2}$ -in. paring chisel, preferably with a long blade that is beveled along its sides. Fasten the box holding the turned piece in a bench vise and drive a small wedge between

the side of the box and the turned piece so as to hold it firmly during the carving process.

Be careful to note the direction of the grain, and do not make too deep or too large cuts, thereby losing control of the chisel. Gradually deepen the V-cuts and then round the edges slightly. Finish with a scraper and sandpaper.

Reeds may be applied to advantage to a number of projects such as lamps, stands, tables of many kinds, mirrors (see Fig. 64), and the edges of table tops.

The tables shown in Figs. 68 and 69 (which differ in respect to the shape of the top) are typical of how turned work may be decorated by reeding.

To make the round top and the apron, as in Fig. 68, draw a full size layout on a plywood panel or a piece of heavy paper. Templates should be made from this full size drawing, from which the four pieces forming the apron may be cut. As the apron is only 2 in. wide, it may be cut from a 2-in. plank. These pieces should be sanded in the lathe by the method illustrated in Fig. 70.

The segments must be fitted together and joined with $\frac{3}{8}$ -in. dowels. To mark for the dowel holes, gage a vertical center line on both ends of the four pieces forming the apron. Do this by holding the block of the marking gage against the convex sides of the pieces. Then set the marking gage to $\frac{1}{2}$ in. and gage horizontal lines on both ends of each piece. With a setting of $1\frac{1}{2}$ in. gage another set of horizontal lines on the ends of the four pieces. The intersection between the two horizontal gage lines and the vertical lines are the points where the holes for the dowels are to be bored.

Glue the four pieces of the apron together by wrapping a piece of sash cord twice around them and twisting it tightly with a small stick. Clamp the apron to a flat surface while the glue is drying—the table top will do. When the glue is dry, sand off the unevenness at the joints on the disk sander. Finish by hand sanding, and screw the apron to the underside of the top.

The column is reeded as explained above. The method of sawing out the legs and fitting and gluing them to the column is the same as for the small table illustrated in Figs. 29 and 30.

The column and the top are joined



FIG. 69.—A clover leaf top, a reeded column, and fluted legs are the features of this little table.

together by means of a piece 1 by 3 by 16 in., shown by dotted lines in Fig. 68. This is screwed to the underside of the top at right angles to the direction of the grain in the latter. The tenon turned on the end of the column is glued into a corresponding hole bored in the center of this piece.

The photograph, Fig. 69, shows flutes cut into the legs. Flutes are laid out in the same way as reeds, but they are cut with a gouge. They are more difficult to cut than reeds.

If it is desired to make spiral reeds instead of straight reeds, the part of the column to be reeded is divided into the same number of parts at each extremity by the method shown in Fig. 66. Then cut a strip about $\frac{1}{2}$ in. wide from a piece of heavy paper or flexible cardboard and use this as a ruler. Select a point at the

lower end of the part to be reeded and wrap the flexible strip about the column, for example, halfway around. Draw a line along its edge, move it to the next pair of points, and continue in this manner until all the reeds have been marked. Cut and shape the reeds as described above. Spiral reeds are easier to cut than straight reeds because they do not follow the grain of the wood.

SPIRAL TURNING

Spiral turning is of Eastern origin. In the seventeenth century examples of this form of decorative art were brought to Europe by Portuguese explorers. It was incorporated in the prevailing type of furniture design and became very popular.

Spiral turning is done commercially on special wood-turning lathes. The method described in this article, however, is the old-fashioned hand carving used by the individual craftsman. Like reeding,



FIG. 70.—How pieces such as the segments of the apron under a circular table top are sanded.

spiral carving is easy to do and requires little or no previous practice.

Figure 71 shows the method of laying out various types of spirals. At A is shown a common single spiral. The part to be carved is turned as a plain cylinder and divided lengthwise into a number

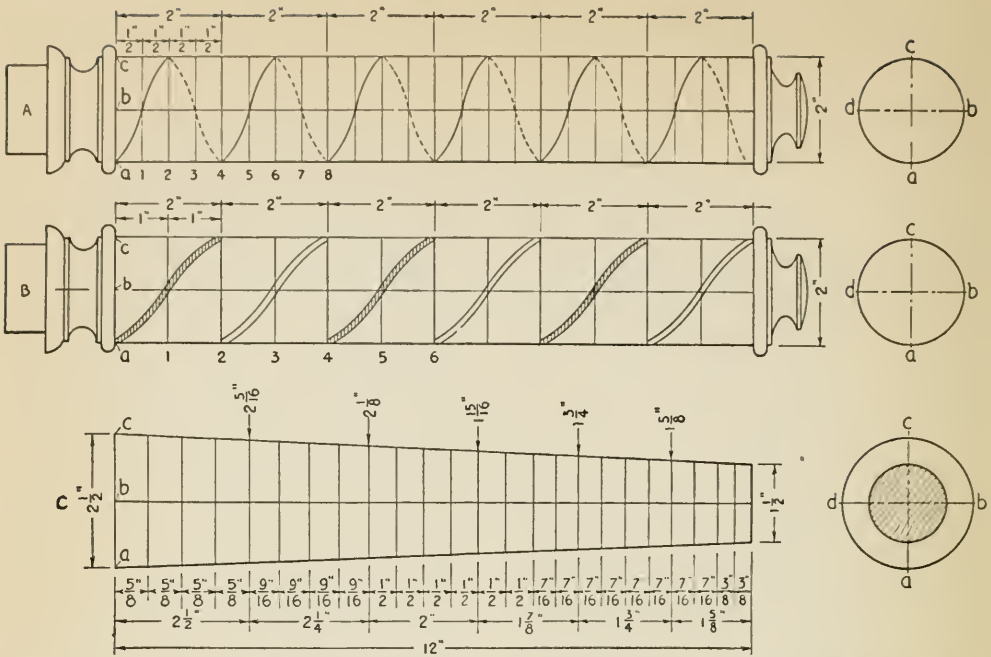

FIG. 71.—Diagram to illustrate the method of laying out spiral turnings. At A is shown a common single spiral; at B, double hollow spirals, in which lines are left high like ridges; at C, a tapered spiral.

of equal parts, the length of each being about equal to the diameter of the turned cylinder, in this case 2 in. Divide each of the major parts into four equal parts and mark circles at all these points around the cylinder.

Wrap a strip of paper around the cylinder and divide it into four parts. Move the T-rest close to the cylinder and draw four horizontal lines, *a*, *b*, *c*, and *d* at the points laid out from the paper strip.

Start the spiral line at one end of the cylinder on one of the horizontal lines (in this case line *a*). Proceed to the intersection of the line *b* and circle 1, then continue to line *c* and circle 2, then to line *d* and circle 3, and around to line *a* and circle 4.

One complete revolution of the spiral line has now been made. Continue drawing the spiral in this manner until the other end of the cylinder has been reached. Do not let the spiral begin or end too abruptly, but make it more nearly parallel to the turned beads at both ends.

With a backsaw cut along the spiral line, at the same time revolving the lathe slowly by hand. Chisel a V-cut with an ordinary 1/2-in. chisel to the bottom of the saw cut. Then file along the bottom of the V-cut with a round file. Round off the edges with a half-round file or rasp and finish with sandpaper. These various steps are clearly shown at the left in Fig. 72.

If the spiral is to taper, it is laid out as shown at C in Fig. 71. Measure the diameter at the larger end and lay off this distance along the cylinder. Then measure the diameter at this point and lay off the distance along the cylinder. Continue in this way until the small end of the cylinder has been reached. The lengths are now slightly adjusted so that they diminish proportionately and add up to the total length desired. The subdivisions are arranged in a similar way. The spiral is drawn as at A.

If it is desired to lay out a double hollow spiral such as shown at the right in Fig. 72, proceed as in B, Fig. 71. In this case each of the major divisions is

divided only in two. The first spiral line—that shown as shaded with short vertical strokes—starts on line *a*, goes to line *b* and circle 1, then to line *c* and circle 2, from there to line *d* and circle 3, and then to line *a* and circle 4. This makes one complete revolution. The second spiral line, which has been left white, starts at line *c* and goes to line *d* and circle 1, then to line *a* and circle 2, from there to line *b* and circle 3, and then to line *c* and circle 4.

The spiral lines in this case are about $\frac{3}{16}$ in. wide. They may be laid out from a strip of heavy paper cut $\frac{3}{16}$ in. wide and wrapped around the cylinder. The spiral lines on *B* form the ridge (see Fig. 72 at right).

The ropelike tapered double spiral shown in the center of Fig. 72 is laid out according to the method explained above (Fig. 71, *C*), but in this case, as in other double spirals, the major divisions are subdivided only in two.

The coffee table, Fig. 73, is a typical example of the use of spiral turning in furniture construction. The shaped



FIG. 72.—Single spiral turning (at left); tapered double spiral (center); hollow spiral (at right).

stretchers cross each other and are joined with a cross-lap joint.

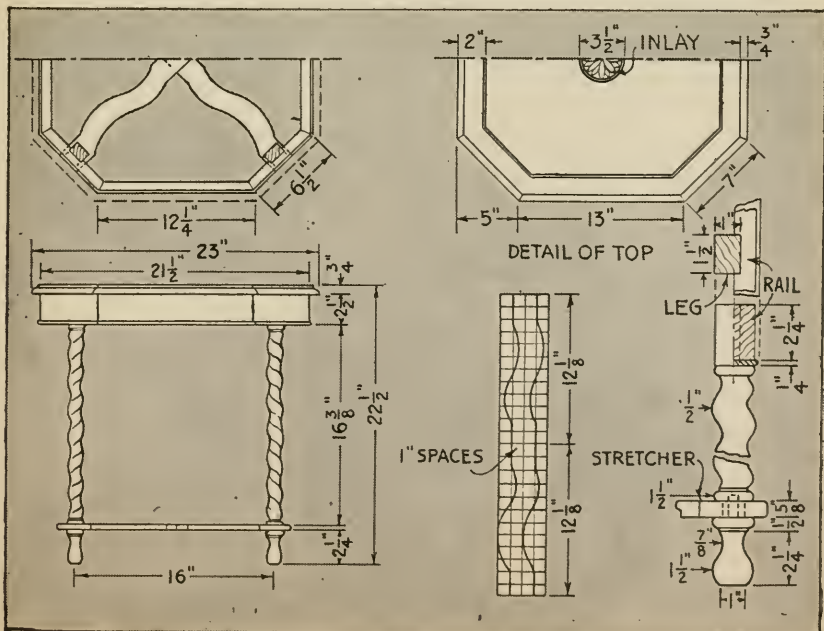

FIG. 73.—Assembly views and working details of a coffee table that is a typical example of spiral turnings.

CHAPTER VII

TOYS TO DELIGHT THE CHILDREN

NO TOYS are equal to those made by Daddy. And here are some that are quite simple for him to make. They are toy tractors and trucks, strongly built of wood and as large as the expensive ones sold in the stores. They "work" too! The fire engine squirts a good stream of water from the hose; the sprinkling truck sprinkles water just like a big one; the dump truck has a hoist that tips up the body; and the tractor, being quite large and heavy, makes a noise like an engine exhaust as it rolls along on the cleats of its bull wheels.¹

SPRINKLING TRUCK

Let us begin with the sprinkler shown in Figs. 1, 2, and 3. The chassis is made of a single length of pine or whitewood board $\frac{7}{8}$ in. thick, $4\frac{1}{2}$ in. wide, and $17\frac{5}{8}$ in. long. This board is cut at an angle underneath at both ends as shown with a chisel and plane. The running boards may be a single piece of $\frac{1}{4}$ - or $\frac{3}{8}$ -in. stock, $6\frac{1}{2}$ in. wide and $8\frac{1}{4}$ in. long, glued and screwed or nailed to the bottom of the chassis. All corners of the chassis and running boards should be nicely rounded.

The hood and radiator may be made from a single block of soft pine or whitewood $2\frac{1}{2}$ by 3 by $4\frac{1}{16}$ in., or, as in all the models shown, built of several layers of $\frac{7}{8}$ -in. boards, glued together bread-and-butter fashion, as ship models

are made. This block may be sawed with hand saws or band sawed out, then planed to shape, and the ends finished on a disk sander, if you have one, or with a sandpaper block.

The filler cap is a length of $\frac{1}{4}$ -in. dowel set in a hole bored for it. If a hole is to be bored near the end grain of the wood, as in this case, it is better to bore it before the block is cut off at this end, to avoid splitting. The block forming the hood and radiator is nailed and glued flat on the chassis.

The cab is made of pieces of $\frac{1}{4}$ - or $\frac{3}{8}$ -in. whitewood or pine or laminated wood (plywood). Two pieces of the same size and shape ($4\frac{1}{2}$ in. wide and 4 in. high) are cut for the front and back of the cab. In the one used as a front, an opening is sawed with the coping saw to represent a windshield. A smaller opening is cut in the back for a rear window.

Two sidepieces are next cut out; they are 2 in. wide at the bottom and $2\frac{1}{2}$ at the top, and are 4 in. high. Windows and the front edge of each side are cut as shown.

The seat is a single block, nailed and glued to the floor of the chassis. To it the sides and the back of the cab are nailed and glued. The front of the cab is glued and nailed to the hood block and to the floor. It is a good plan to put the front in position first and then drill a slanting hole to receive the dowel rod used to support the steering wheel.

The steering wheel is a large wooden button mold screwed to the end of the

¹Larger drawings of these toys are contained in BLUEPRINT No. 101, listed in the Appendix.



FIG. 1.—A discarded tin can serves as the tank of the sprinkler truck, and fruit jar rubbers form the tires on the wooden wheels.

dowel, on which it may be turned. When the wheel is in place, the sides, back, and top of the cab may be put in place. The top, $4\frac{1}{8}$ in. long and $4\frac{3}{4}$ in. wide, has all its upper edges well rounded over with plane and sandpaper.

Two dozen fruit jar rubbers will be enough to make tires for the four wheels, five being used for each of the two front wheels and seven for the wider back wheels. As sold now, jar rubbers have a

little lip on one side; this may be easily trimmed away with the scissors.

Saw out or turn up four disks of wood, each one being as wide as your tire is to be. These disks should be of the same diameter as the central opening in the jar rubbers. Next saw or turn slightly larger disks of thin wood for the sides which hold the jar rubbers in place. All these disks should have a $\frac{5}{16}$ -in. hole drilled through the center.

If you have a lathe, you may save much time by roughly sawing out these thin wooden disks, slightly large, drilling a hole through each one, and nailing them all together with the holes centered, using two long thin brads. Mount a straight $\frac{5}{16}$ -in. diameter bolt, with the head cut off, in your lathe chuck, so that a good length of thread projects beyond the chuck. Screw the disks on this, nailed together, and then place a

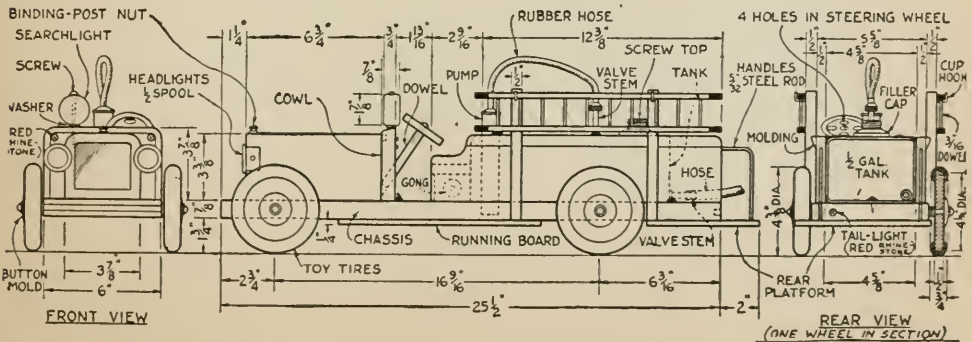
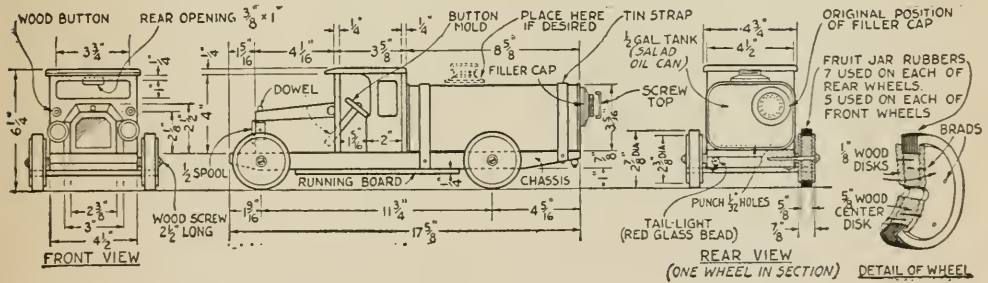
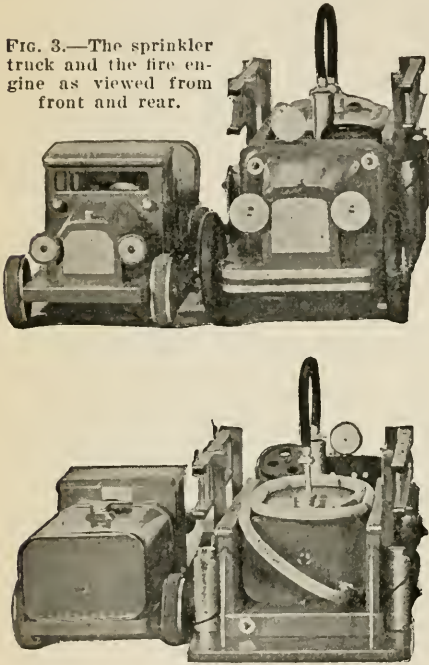

FIG. 2.—Front, side, and rear views of the sprinkler and the fire engine. Compare these dimensioned drawings with the photographs reproduced in Figs. 1, 3, and 7.

washer on the end of the bolt and screw on the nut to hold the disks in place while you turn them to size. After turning, the disks may be separated with a thin knife blade. All the wheels of the toys shown here were turned on a bolt in this way, and they run very true.

After the disks are cut out, glue and nail one thin disk to one side of each thicker disk which is to receive the tires. When the glue is dry, slip the jar rubbers

FIG. 3.—The sprinkler truck and the fire engine as viewed from front and rear.



in place and cement them together with rubber cement. When each tire is cemented on, glue and brad the other disk on the outside of each wheel. Use another $\frac{7}{16}$ -in. bolt to make up each wheel, so as to keep the disks lined up until each wheel was finished. Two small metal washers are placed between each wheel and the chassis and one under each screw head on the outside of each wheel. Round-headed wood screws No. 15, $2\frac{1}{2}$ in. long, were used to fasten each wheel to the chassis. These are $\frac{1}{4}$ in. in diameter. It is always best to have rather large holes in toy wheels, as should there be any inequalities in the mounting of

them, each wheel may drop down a bit, so that they will all roll when the model is pulled.

An ordinary spool with flanges about 1 in. in diameter is cut in two to make the headlights. This is slightly flattened on the side where it is fastened to the hood block, a hole having been previously bored for the screw or nail. The side lights on the front of the cab are small round wooden buttons held to the front of the cab with glue and a large tack, the end of the tack being silvered to represent a lens. The tail-light is a round red glass bead taken from a ten-cent necklace; it is screwed under the rear of the chassis with a nickel-plated, round-headed screw, which serves to throw back the light through the bead.

Of course, you should obtain the can for the tank before you make your truck. If you have to buy a new full can, the housewife will know what to do with the cooking oil or other contents! Empty the can through the screw top provided; do not punch holes in to empty it or you will have to solder them up.

In the sprinkler truck tank shown, the filler cap is on top, having been carefully melted off the end of the can with a blowtorch and the hole left in the can covered with a disk of tin. It might be even better to leave the screw top in the original position on the end. Then the truck can be easily stood on end while being filled with water, and when it is put down level the water will run out of the sprinkler holes. After the water has started to run, it may be stopped by screwing down the cap, if this is made air-tight. The sprinkler holes are punched in a row with a sharp ice pick, each hole being about $\frac{1}{32}$ in. in diameter, or slightly less.

You may, of course, put any kind of a body on such a simply made chassis. A round can may be used for the tank truck, or a box or crate body made and fastened on the chassis back of the cab.

The entire chassis and the body of the truck are painted a khaki color, first having been primed with thin shellac and then painted with semigloss household paints. Lacquers may be used, if

preferred. The wheels are painted Chinese red with silver stripes or rims. The straps that hold the tank to the chassis are made of strips of bright tin. The radiator is represented with silver paint; the ends of the spools used for headlights are silvered, as is the filler cap on the radiator, and the headlights.

An easy way to make an even stripe or rim on each of the red wheels, is to place each wheel back on the bolt in the lathe chuck on which it was turned and hold a small brush, charged with silver paint, against each wheel edge where the stripe is to go, the brush resting on the tool rest. Turn the lathe slowly by hand.

A MINIATURE TRACTOR

How the tractor is made is shown in Figs. 4, 5, and 6. The chassis is $\frac{7}{8}$ by $3\frac{1}{2}$ by 12 in. The 5-in. drivewheels are screwed directly to this, but the $3\frac{1}{2}$ -in. front wheels are screwed to a rigid wooden axle, $\frac{7}{8}$ by 1 by $4\frac{5}{16}$ in., which is glued and nailed or, if desired, screwed under the front end of the chassis.

A slanting hole is bored in the back piece for the steering column. To the top of this piece is screwed a large

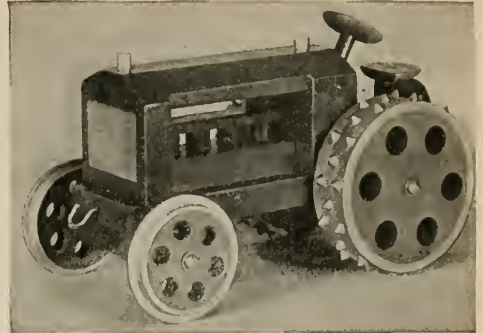

Fig. 4.—The toy tractor is built entirely of wood with nail-studded "bull" wheels.

wooden button mold, spool top, or wooden disk. The seat is a button mold or disk of wood, with a piece cut off. It is glued and screwed to a springlike form of wood.

The engine block is made of wood. The sides slant in toward the cylinders, which are short lengths of dowel stick

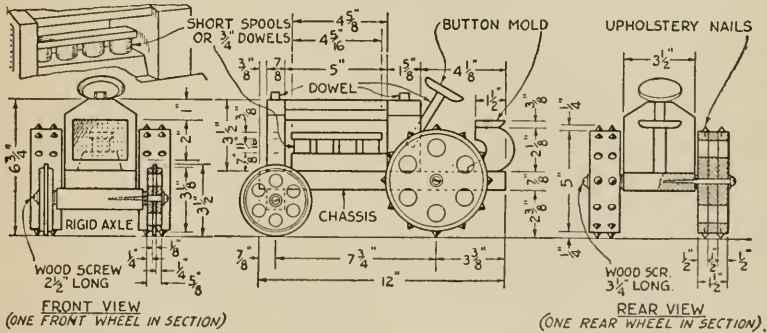

Fig. 5.—Dimensions of the tractor, and full details of front, side, and rear. Compare with the photographs of Figs. 4 and 6.

The radiator is a block $\frac{7}{8}$ by $3\frac{1}{2}$ by $3\frac{1}{2}$ in. Two more pieces are cut out the same size and shape as the radiator, or a single block made to be mounted 5 in. back from the radiator. Between these parts at the top is fitted a piece of wood as shown in Figs. 4 and 5. These may be glued and nailed together and then nailed and glued to the tractor chassis.

glued to the base block. The cylinder cover is a length of wood glued and nailed to the tops of the cylinders. Short spools also make good cylinders.

The large wheels may be solid disks of wood, sawn or turned, but the ones shown are made up of three disks of wood, each $\frac{1}{2}$ in. thick, glued and nailed together, with the grain of the center

disk running across the grain of the other two. This makes a very strong wheel, and it is also much easier to form if you have no lathe. You can cut the disks with a coping saw.

Six holes are bored in each wheel to make it more realistic. The cleats are upholstery nails with cone-shaped brass heads driven in the rim; or, if you like, short lengths of wood may be nailed across the rim for cleats, as on some tractor wheels.

The front wheels are each made of three disks, the center disk being of

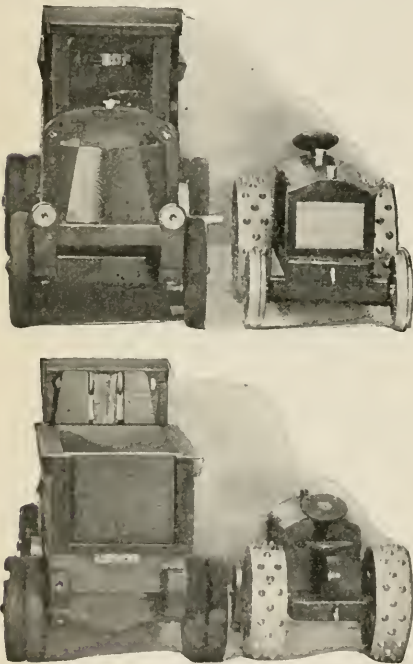

FIG. 6.—The tractor and the truck as viewed from both the front and rear.

laminated wood, if available. (You can make small pieces of laminated wood by gluing firmly together thin berry-box wood, the grain of the center piece running at right angles to the pieces next to it.) This center disk is glued between two thicker disks of a small diameter, to make the characteristic front wheel of a tractor.

The tractor wheels are painted Chinese red with silver rims and cleats and

the steering wheel and seat are of the same red. The chassis and other parts of the tractor are painted jade green, except the engine, which is dull gray. The front and back of the radiator is silver, as are the filler caps.

Small shaped bits of wood may be attached to the engine block and painted with gold paint to represent carburetors and other brass parts.

PUMPING FIRE ENGINE

The fire engine is illustrated in Figs. 2, 3, and 7. It is a good plan to make the tank and pumping arrangements before you build the wooden parts.

First get a half-gallon can of the type shown—a strong well-soldered can that may be made air-tight. If the can is new, the oil should be emptied out (the cooking oil, of course, may be put in glass jars until used). To empty it, remove the screw cap, carefully puncturing the top of the cap without destroying the threads on it. Use a blowtorch to melt off this entire piece, which is soldered to the can. It may be pushed off with a stick when the solder is melted. Use only enough heat to loosen the solder. This will leave a large round hole in the end of the can. Now wash out the can thoroughly with soap and warm water. Leave this hole open until all the other soldering is done to allow air and moisture to escape.

If the screw top provided with the can has a well defined thread (which most of them have not) and will screw up air-tight, it may be used for the filler cap on the tank. It will generally be found much better to cut or melt off a better top from a can such as is used to hold liquids for mending leaky radiators.

Scrape away the label on the can where the filler top and the tire valves are to be soldered, and proceed to solder the filler top to the top of the tank. A job like this had best be done by someone who has done such work before, as it is apt to be difficult for one who has never tried his hand at it and does not understand soldering. (An excellent

flux for tin and brass is made of equal parts of muriatic acid and glycerin.)

After soldering on the filler top, punch a hole in it to admit a small funnel in top of tank right under the open top of the filler.

Next obtain two bicycle tire valve stems, also one good valve inside assembly. Scrape the disklike ends of each valve stem clean; tin each one with a hot soldering iron, well charged with solder. Also tin the tank where the valves are to be soldered. Punch a hole with a sharp ice pick in the tank where each valve stem is to be soldered. Hold each in position with small pliers or a wooden clothespin while soldering it on the tank.

When the valve stems and filler top are soldered, cut out a disk of clean tin and solder it over the hole in the end of the tank left by melting off the filler cap. To see that the tank is air-tight, first screw the valve insides in the valve stem on top of the tank; attach a small bicycle tire pump to this in the usual manner; and then screw on an extra valve cap on the other open valve stem on the end of the tank. Place the whole tank under water and pump it up with a moderate pressure. If there are any leaks, the escaping air bubbles will show it. The filler top or screw cap should, of course, be provided with a leather or cork washer inside.

If all is well, remove the tank from the water, open the screw cap, and fill the tank about three fourths full of water. Remove the extra valve cap and attach a length of hose with a nozzle made of the spout of a sewing machine oil can. Pump up the tank after screwing on the filler cap. If you have made a good job of it, the water will certainly squirt out of the hose nozzle.

The chassis of the fire engine is $7\frac{3}{8}$ by 6 by $25\frac{1}{2}$ in. Underneath this are attached

a board $\frac{1}{4}$ by $7\frac{3}{8}$ by $10\frac{1}{4}$ in. to form the running boards and another $\frac{1}{4}$ by $7\frac{3}{8}$ by $5\frac{3}{4}$ in. to form the rear platform. The latter should be attached after the sides or body of the fire engine is in place, because the pieces of wire or rod forming the rear handles are first pushed in holes bored for them in the sides of the body. The platform, after having holes bored in it for the ends of the handles, is fitted on, glued, and nailed.

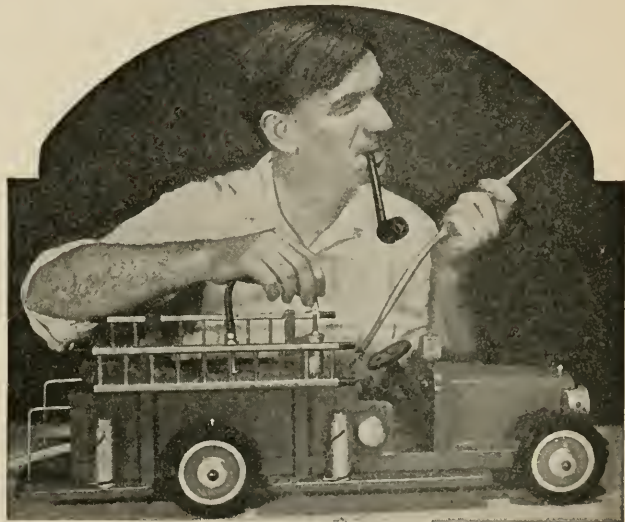

FIG. 7.—Toy "pumper" being demonstrated by Edward Thatcher, noted teacher and craftsman, who designed and built it as well as the sprinkler, tractor, and dump truck.

The radiator and hood are made of a single or built-up block of wood $3\frac{7}{8}$ in. wide, $3\frac{3}{8}$ in. high, and $6\frac{3}{4}$ in. long. The cowl board is $\frac{3}{4}$ by $3\frac{7}{8}$ by 6 in. In this board is drilled a slanting hole for the steering column, which is a length of dowel. The steering wheel is a $2\frac{1}{2}$ -in. disk of laminated wood with four holes bored in it. Tacks are driven in the cowl board to represent various gages and the foot and brake pedals.

The sides of the body are single pieces of wood $\frac{1}{2}$ by $3\frac{3}{8}$ by $14\frac{3}{4}$ in., with a little strip of molding glued to the outer edges along the top. The seat is a single block of wood on which is glued a thinner strip to represent upholstery.

The ladder supports, provided with

cup hooks to hold the ladders, are attached as shown in Fig. 2. The ladders are made of narrow strips of pine or whitewood drilled out for the rungs, which are made of a $\frac{3}{16}$ -in. dowel.

Just back of the front of the body are two wooden blocks that fit between the body sides and the pump to hold it in place. A hole is drilled in the chassis for the end of the pump to rest in. Thick shellac may be used to cement the pump in place.

Two screws and washers in the top of the blocks hold the tank in place. One screw and washer hold down the rear of the tank; the washer engages the edge of the can, next to the floor, and the screw is driven into the floor.

The headlights are made of one large spool cut in two. The large end of each piece is turned to a funnel or reflector shape. When painted with aluminum, it catches the light realistically.

The searchlight on the cowl is a flat disk of wood $\frac{7}{8}$ in. thick and $1\frac{7}{8}$ in. in diameter with the back edge rounded over. A hole is drilled through it for the long screw on which it turns and a metal washer is placed between the searchlight and the cowl. The red rhinestone buttons used for the side and tail-lights, which are $\frac{5}{16}$ in. in diameter, are set in shallow holes. Eighteen of the buttons cost ten cents at a ten-cent store.

The four dummy fire extinguishers are turned, or each can be made of a length of dowel with a short dowel of a smaller diameter glued to the top of it. Round shoelaces are used for hose and nozzles. The extinguishers may be set on dowel pegs mounted in the running boards and in the rear platform so that they may be lifted off.

A very small gong is mounted on the right side of the fire engine seat, but a small friction top can lid will make a good substitute.

The wheels are flat wooden disks $\frac{1}{2}$ in. thick and $4\frac{1}{8}$ in. in diameter. A wooden button mold or spool end $1\frac{1}{2}$ in. in diameter is glued on the outside cen-

ter of each wheel. The toy tires, usually obtainable at large toy stores, are stretched over the wooden disks.

Except for the parts painted silver or black as shown in Fig. 7, the entire fire engine is painted a Chinese red.

DUMP TRUCK

The dump truck, Figs. 6, 8, 9, and 10, is the largest of the four toys. The chassis is built somewhat differently from the others, in order to allow the body to be raised to a better position for



FIG. 8.—The dump truck has a foolproof elevating mechanism, the parts being a dowel, a spool, and a piece of tape.

dumping. A very good truck of this kind may also be built on one of the simpler chassis previously described.

The chassis requires two beamlike pieces $\frac{7}{8}$ by $1\frac{7}{8}$ by $25\frac{5}{8}$ in. These are held $4\frac{1}{4}$ in. apart at the front end by a piece $\frac{7}{8}$ by $4\frac{1}{4}$ by $11\frac{7}{8}$ in.; this runs to back of the cab. The dummy springs are spring-shaped pieces of wood screwed to the underside of the chassis as shown. Between the two front springs is fastened a piece $\frac{7}{8}$ by 1 by $4\frac{1}{4}$ in. to represent the front axle, and between the two rear ones is a piece of wood cut from a piece $\frac{7}{8}$ by $2\frac{1}{8}$ by $4\frac{1}{4}$ in. to represent the rear axle and differential housing (see Fig. 6).

The body rests on three cross members, notched out as shown. Two of them are $\frac{7}{8}$ by $2\frac{1}{4}$ by 6 in., and the forward one is $\frac{7}{8}$ by $1\frac{3}{8}$ by 6 in. The body is hinged to the rear crosspiece with a common steel butt hinge.

The running boards or steps are made by gluing and screwing a length of wood $\frac{1}{4}$ by $3\frac{3}{8}$ by 8 in. under the chassis.

The hood is shaped from a block $3\frac{3}{4}$ in. high, $4\frac{3}{4}$ in. wide, and $5\frac{5}{8}$ in. long. The radiator block is $1\frac{1}{8}$ in. thick, $4\frac{5}{16}$

The holes in it should be bored before the crank shape is sawn out; then the crank and shaft are glued in. Deep saw cuts are made in each end of the crank and part way into the dowels so that a piece of thin berry-box wood can be

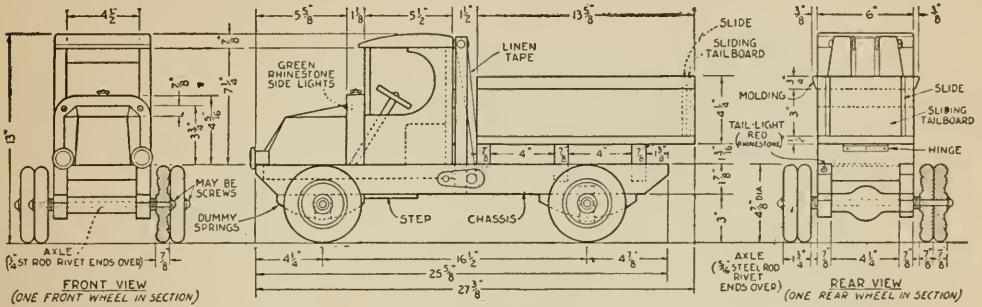

FIG. 9.—Working drawings of the dump truck. Of impressive size, this truck is an exceptionally rugged toy for rough play.

in. high, and 6 in. wide. The filler cap is a screw cap from a shaving cream tube, fastened to the block with a round-headed screw. Two green rhinestone buttons are set into $\frac{5}{16}$ -in. holes bored in the front of this piece for side lights, and a red one is set in the rear end of one of the chasis beams. The buttons are cemented in with shellac.

The headlights are made of a spool as in the preceding models, and a green or yellow rhinestone button is pushed or cemented in each.

The cab consists of a front and rear piece $\frac{3}{8}$ by $5\frac{1}{4}$ by $7\frac{1}{4}$ in., and two side-pieces $\frac{3}{8}$ by $5\frac{1}{2}$ by $7\frac{1}{4}$ in., cut with a coping saw. The top is made of a thicker piece of wood ($\frac{7}{8}$ by 6 by 6 in.), planed and sanded to give the characteristic curve at the top. The front end may be made, if preferred, by gluing and nailing two uprights to the radiator block with a cross member between to support the roof. The steering wheel and seat are made as before.

The hoist is made of two wooden uprights shaped and mounted on the chassis and to the cab back as shown in Fig. 10. Bolt holes are bored at the top for the bolt on which the spool pulley turns. The crank handle may be made of thick laminated wood or of soft wood.

glued in each cut, across the grain, to prevent the handle from splitting. One end of a strong linen tape is screwed to the lower part of the front end of the truck body with short screws passing through a narrow strip of tin across the end of the tape, which also may be glued

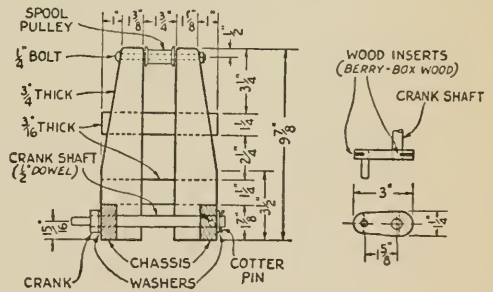

FIG. 10.—How the hoist (left) and crank (right) for the dump truck are made.

to the body. The other end of the tape is secured to the crank shaft, between the hoist, in the same way.

The body is a strong box of $\frac{1}{2}$ -in. wood, $4\frac{1}{4}$ by 6 by $13\frac{5}{8}$ in. in outside dimensions. The rear end is left open. A sliding tailboard fits in between narrow strips of wood, or slides may be nailed and glued in place so that this

tailboard may be pulled up or removed for dumping. Along the top of each side-piece is a simple molding made of a planed strip of wood (see Fig. 6).

The wheels are $4\frac{7}{8}$ in. in diameter, of white wood, birch, or maple, turned to represent disk wheels with large truck

bored clear through each to take the axle.

The chassis of the truck is painted Chinese red, as are the wheels, steering wheel, hoist, and headlights. The hood, radiator, cab, and body are painted black; the inside of the cab is jade green,



FIG. 11.—This doll's house is a realistic model of a fine Colonial home.

tires, but excellent ones may be made of plain sawn disks. Notice that double wheels are used on the rear end (Fig. 6). These wheels are secured to the chassis by large, strong round-headed screws, two or three iron washers being placed between each wheel and the chassis, and one under each screw head.

Extra strong axles may be made for this truck by using lengths of $\frac{1}{4}$ or $\frac{5}{16}$ in. diameter soft steel rod to run across the chassis and through the wheels. Steel washers are used as before and the ends of each axle are riveted over to hold the wheels on, an iron washer being under each rivet head thus made and the wheel. In this event the wooden front and rear axles may be set forward slightly to clear the steel rod, or a hole may be

and the inside of the body, khaki color. Silver paint is used to stripe the wheels, for the crank and pulley, on the sides of the radiator, front of the headlights, filler cap, and bolt heads on the hoist. The top of the seat inside the cab is painted black, and the tires on the wooden wheels, a dark gray or rubber color.

COLONIAL DOLL'S HOUSE

No gift is apt to delight a small girl quite so much as a really fine doll's house. To her it is a fairy home where her doll children can live and play. She can devise new furnishings, redecorate the rooms, and sweep, dust, wash and cook to her heart's content.

And after all, isn't that the secret of

a satisfying toy? It must allow the child to do something genuinely constructive and stimulate her imagination and ingenuity; at the same time, it should

popular Colonial designs, may appear to be complicated in its construction, but when examined closely and studied well it will be found relatively simple for any handy man or boy to build in spare moments in his home workshop. Only household tools are needed and no

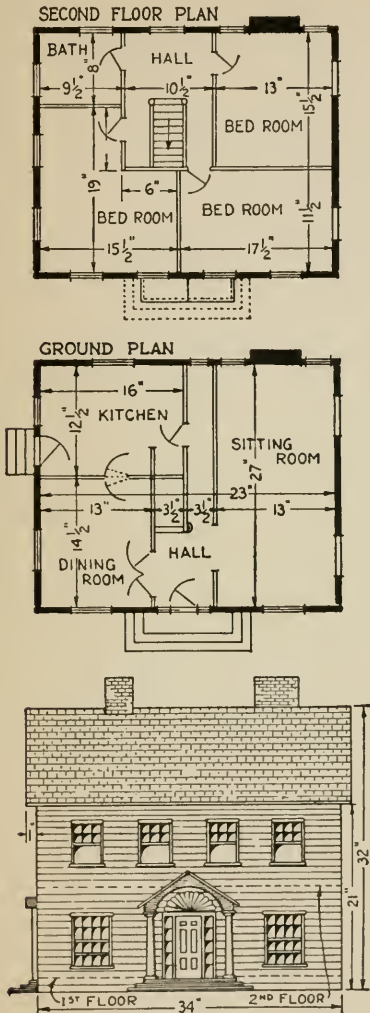

FIG. 12.—How closely the model resembles a real house is shown by the plans and front view.

convey a sense of grown-up reality. A doll's house does all this, especially if it is as complete and realistic a model of a house as the one illustrated on this page.

At first glance the doll's house in Fig. 11, which is based upon one of the most

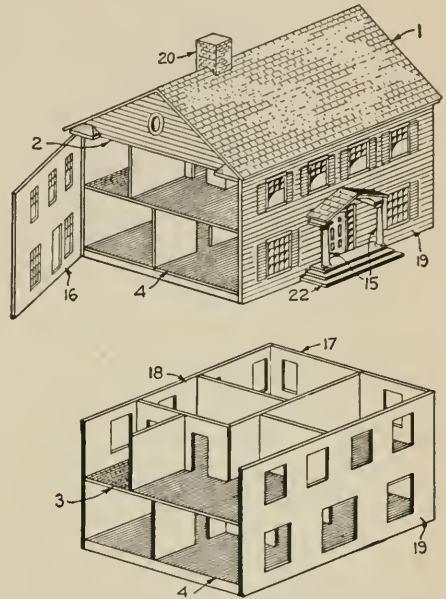

FIG. 13.—The floors, walls, and partitions before and after the roof and trimmings are added.

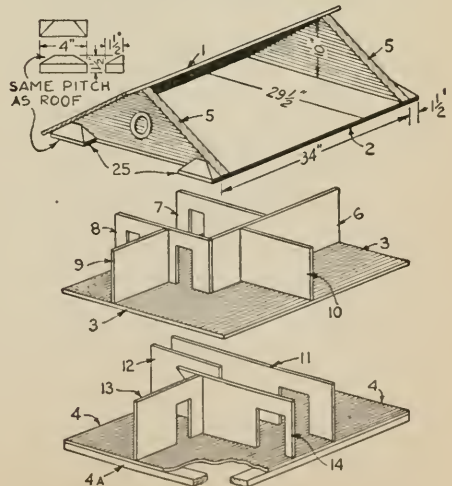

FIG. 14.—The house is made in three parts. The small fittings are added before putting the sections together.

high degree of skill or previous experience is called for.²

The first thing to do is to study the drawings (Figs. 12 to 16) until a clear understanding of the method of construction is obtained; the next is to examine the list of parts.

The best material to use is either plywood or wallboard, because they do not readily warp or split. The thickness for all the major parts of the house should be preferably 1/2 in., although 3/8-in. stock can be used if the other cannot be obtained. Of course, any difference of thickness will make a slight variation in the length of some of the parts. As many of these materials come in regular sizes of 1/4 in., they may be glued together and used double thickness to make 1/2 in.

Veneered stock such as is found in some packing boxes may be made use of in the construction of the house. This usually is 3/8 in. thick and may be had very cheaply.

The drawings are for a house that is just one twelfth the size of a real house, and all of the furniture and parts are planned on this scale. A smaller house may be made by reducing the dimensions proportionately.

In Figs. 13 and 14 is shown the method of construction. With the two floor boards, Nos. 3 and 4, squared and sandpapered and the upper ceiling board No. 2 in shape, the position of the walls should be marked off carefully, using the plans in Fig. 12 as guide. Nos. 3 and 4 are each 1/2 by 27 by 33 in., while No. 2 is 1/2 by 29 1/2 by 34 in. The main floor board is reinforced on the edges with a 1 by 2 in. strip marked 4A in Fig. 14; this extends all the way around the edge and across the middle.

As the second floor board (No. 3) serves as floor and ceiling, it is sandpapered on both sides.

The rooms will be so small when the house is assembled that it will be next to impossible to do much nailing or other work within them. For this reason

²Larger drawings are contained in BLUEPRINT No. 72, listed in the Appendix, and designs for a variety of suitable furniture for the doll's house appear in BLUEPRINT No. 73.

MATERIALS FOR DOLL'S HOUSE

No.	Item and Remarks	T.	W.	L.	Rq.
1	Roof	1/2	19	37	2
2	Second floor ceiling.	1/2	29 1/2	34	1
3	" " "	1/2	27	33	1
4	First " " "	1/2	27	33	1
4A	" " base ..	1	2	34	4
5	Gable ends	3/4	29 1/2	10	2
6	Wall	1/2	9	23	1
7	"	1/2	9	15 1/4	1
8	"	1/2	9	15 3/4	1
9	"	1/2	9	9 1/4	1
10	"	1/2	9	11 1/4	1
11	"	1/2	10	27	1
12	"	1/2	10	18 1/4	1
13	"	1/2	10	16 1/4	1
14	"	1/2	10	20 1/4	1
15	Columns 1 in. in diameter at large end	1			
16	Left end	1/2	21	27	1
17	Right "	1/2	21	27	1
18	Back	1/2	21	34	1
19	Front	1/2	21	34	1
20	Small chimney	3	3	4	1
21	Large " (proper)	1	6	21	1
21A	" " (top)...	2	5	15	1
22	Fireplace	1/2	6 1/2	4	1
23	Front porch roof....	1/4	6 3/4	2 3/4	2
24	Back " "	1/4	2 3/4	1 1/2	2
25	Return roofs at ends	1 1/2	1 1/2	4	4
26	Front porch steps...	1 1/2	4 1/2	14	1
27	Back " " ...	1 1/2	3 1/4	5	1
28	Front porch arch....	2 1/4	10	4	1
29	Back " frame ..	1/2	3 1/2	9 1/4	1
30	Stair horse	1/4	3	15 1/2	1
31	Steps—triangular ...	3/4	2 5/32	3	13
32	" —treads	1/8	1 1/4	3	13
33	Stair posts (clothes pins)	1			
34	Stair posts (clothes pins)	1			
35	Stair rails	3/16	1/4	8 1/2	3
36	" balustrade (of match sticks)	30			
Doors and windows made like drawing to fit.					
Casings 1/8 by 1/2 in. wood or cardboard.					
Small brass hinges, 3 pairs.					
All dimensions are in inches. All material wood except where otherwise specified.					

it will be best to do all the fitting of doors, bases, casing, stairs, and the like before the house is completed. The three sections shown in Fig. 14 should each be assembled as separate units. Do all wall painting or decorating and floor

polishing while the sections are still open.

Next, the outside walls should be made up. The door and window openings should be marked out accurately on both sides of the board and cut out with an ordinary coping saw or keyhole saw.

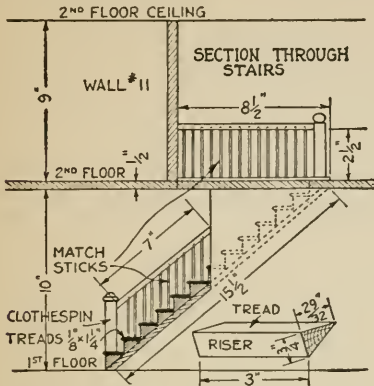

FIG. 15.—The stairs are made by gluing triangular steps to a thin board and adding tiny treads.

For casing and finishing the doors and windows see Fig. 16. The casings may be made of 1/8-in. wood. The cheap yardsticks that some firms use as advertising mediums, if planed smooth and ripped through the center, are just the thing for the purpose. If these cannot be found, heavy cardboard or berry crates will serve quite well. If the casings are placed even with the edge of the openings, frames will not be needed. The baseboards should be 3/4 in. wide and the same thickness as the casings.

The stairs (Figs. 15 and 18) will be found to be the most difficult part of the construction. It is hardly possible to show their construction fully enough, but the details can be supplemented by the reader's observation and ingenuity. The stair steps may be glued to a thin board, each

step being a solid block. Another plan would be to cut the steps from a solid block. Only the six lower steps are exposed to view, the other seven being hidden between walls Nos. 12 and 14. The stair well in the second floor is 3 by 7 1/4 in. and cut so that it is directly between walls 12 and 14.

The balustrades are made of match sticks glued between a top and bottom rail. The newel post may be a clothespin or a round penholder.

When all of the small details are in place and the walls tinted, the three sections shown in Fig. 14 may be assembled, using 3/4-in. flat-head screws. The front and back should be screwed in place at this time and the two ends and roof hinged. One hinge on the roof will have to have an extension soldered to it to allow it to open out to the line of the chimney.

It is left to the reader as to what kind of roof he will use (see Fig. 17). Small shingles may be nailed or glued in place; they look well but take a great deal of time to construct. The divisions between the shingles may be represented by making grooves with the point of a nail set or a chisel. The same method may be used for lining the siding boards.

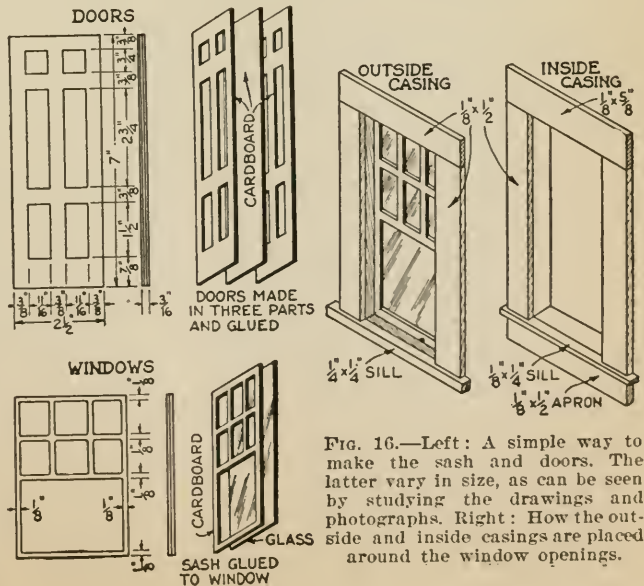

FIG. 16.—Left: A simple way to make the sash and doors. The latter vary in size, as can be seen by studying the drawings and photographs. Right: How the outside and inside casings are placed around the window openings.



FIG. 17.—Left: Front view of the house showing how the roof section and the side walls are hinged to allow ready access to both upstairs and downstairs rooms. Right: A view of the house as seen from the rear.

The chimneys are made of solid blocks of wood and the bricks carved with a chisel or sharp knife.

The construction of the front entrance is shown in Fig. 12. The arch is shaped with the coping saw; the roof boards are made to match the main roof. The columns may be turned on a lathe or made square, or a small bracket may be used to support the sides of the roof.

The steps in front and at the side are merely three $\frac{1}{2}$ -in. sections fastened together and carved like the chimneys. The sunburst design over the door may be carved with a knife or carving chisel.

Making up the window sash is more tedious than difficult. A good sharp knife will be the greatest asset. The method is shown in Fig. 16. Tough and quite heavy cardboard should be used. When the sash are cut, they are glued to a piece of glass or celluloid of the same width and length. Each sash should be made to fit its particular opening. The construction of the door also is shown in Fig. 16.

Small green shutters serve to brighten the appearance of the house and may be made easily. A piece of very thin wood with a simple design grooved in the outside face is all that is needed for each shutter. These pieces are nailed to the side of the windows.

Small window boxes—blocks with holes for the flowers—may be used under the windows. Pieces of sponges, colored like plants and shrubs and glued on top of the boxes, are quite effective.

Careful painting adds greatly to the attractiveness of the house; it is one of the most important items. The colors suggested (see Fig. 17) are green for roof and shutters, white for the body and doors and window sash, and red for the steps and chimneys. It is well to give the house two or three coats of paint or brushing laequer.

The inside woodwork (Fig. 18) should be painted white along with the doors.



FIG. 18.—How the stairs are built and the hall is furnished with a miniature clock, table, chair, and mirror.

The floors may be stained or finished with clear varnish. Paper or tint the walls.

Furniture, bath and kitchen fixtures may be obtained ready made at the toy shops, where some substantial and well formed models are to be found. These should be of the proper size to match the house. It is more satisfactory, however, to make the pieces in the home shop.³

The porcelain fixtures for the bathroom and kitchen may be shaped or carved from solid wood to resemble as closely as possible the real pieces. These models are covered with a heavy layer

³ Full size designs for tables, chairs, a couch, a hall clock, a bed and other furnishings are given in BLUEPRINT No. 73, listed in the Appendix.



FIG. 19.—The screen may be used as a playhouse, as it appears above, or as scenery for children's plays, as suggested in the illustration at the right.

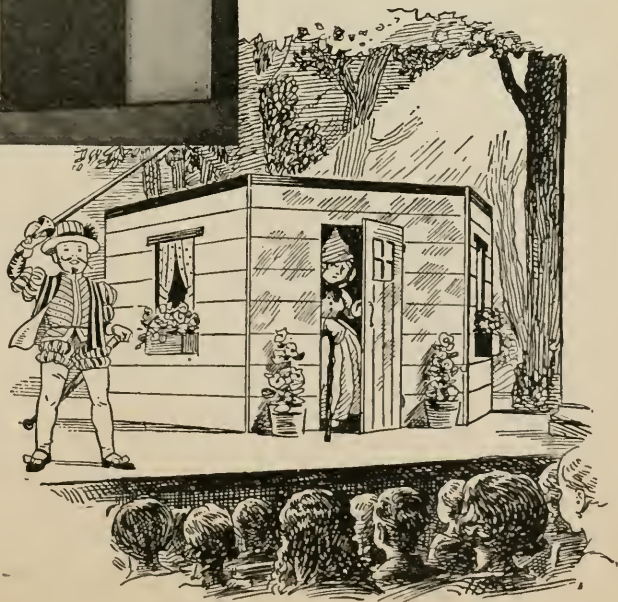

of gesso made of glue and whiting and painted with white enamel to give them the resemblance of porcelain.

PLAY SCREEN

A play screen that resembles a house and can be folded for storage when not in use makes a splendid addition to any child's toys.

As a school project, too, its construction is such that it makes an instructive problem; and it is almost indispensable as part of the kindergarten equipment.

To construct the screen (Figs. 19 and 20), any available lumber may be used, but much labor and time can be saved by purchasing 1 by 2 in. white pine in random lengths from a lumber or planing mill. If wall board is used to cover the framework, this can be ordered at the same time. Two sheets 4 by 10 ft. must be purchased, although only one and a half sheets are needed.

Cut the wall board into four pieces, each 4 by 5 ft. Then cut pieces of wood to length for the outside frame of each section, and glue and nail them to the wall

board. All of these pieces are placed even with the edge of the wall board except the bottom piece of the middle section, which is placed $\frac{1}{8}$ in. from the edge. This is done to leave room for the band iron that is screwed in place later. The crosspieces forming the top of the door and the windows, the pieces under the windows, and the vertical pieces at the sides of the doors and windows, are fitted and glued and nailed in place in

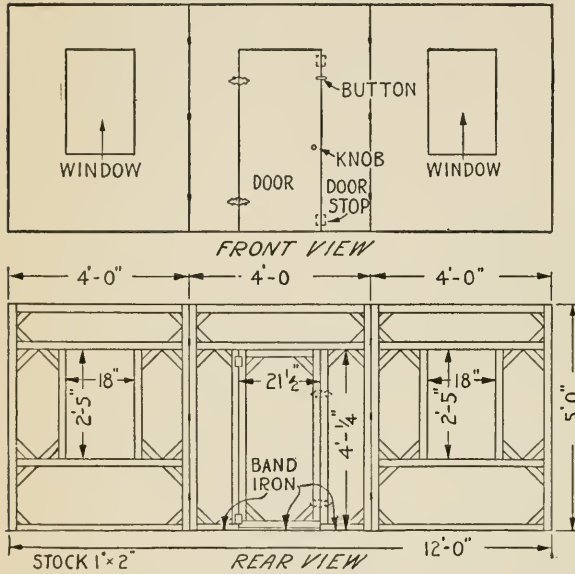

FIG. 20.—Assembly of the play screen showing front plan of the door and windows and scenerylike construction of the back members.

the order named. The three sections can be lightened considerably by covering the framework either with burlap or unbleached muslin instead of wall board. However, if this is done, it will be necessary to strengthen the frame. The corners will have to be mitered, lapped, or mortised and tenoned, and the other joints also mortised and tenoned. The covering should be lapped over the edge and tacked on the edge or the back.

The frame for the door can be cut, glued, and nailed in place next. In sawing out the door, leave $\frac{1}{8}$ in. on all sides for clearance when the door is fitted into position.

The braces shown in the corners are made from the short pieces of 1 by 2 in. stock left after the framework is made. They are cut in a miter box to about 6 in. long and are glued and nailed in place. The sections are allowed to stand overnight to give the glue a chance to set before cutting in the door and windows.

A series of $\frac{1}{8}$ -in. holes are drilled in the two corners diagonally opposite each other in the two window openings and a keyhole saw used to start the cut, sawing close to the frame. After the cut is started it is easy to complete the sawing with a crosscut handsaw. The same method applies to the cut across the doorway. In sawing out the door, be sure to saw close to the pieces forming the doorway, leaving any surplus wall board on the door.

The center section has a piece of $\frac{1}{8}$ by $\frac{3}{4}$ in. by 4 ft. band iron screwed to the bottom edge across the doorway to hold the two sides of the section rigid.

The door is to be hung with a pair of ornamental brass-plated hinges, although any available hinges or butts may be used. There are two stops glued and screwed to the inside on one side of the door frame to prevent the door from swinging

in too far. A small wood button is screwed to the outside of the frame to keep the door closed when the screen is folded for storage. A small knob is also added to the outside of the door.

The three sections are hinged together with double-acting screen hinges to allow for the proper opening and folding of the screen.

The effects possible through decoration are unlimited. The screen can be painted to harmonize with any desired color scheme. The door frame and the window frames can be painted in a darker color to give a realistic effect. Another possibility is to paint bricks,

shingles, or weather boarding on the walls. Small flower boxes for the outside of the windows and cretonne curtains on the inside of the windows give a pleasing effect.

The colors of the paint, cretonne, and other decorations are necessarily left to the individual taste of the builder of the screen. With a little thought and planning a realistic and attractive effect can be obtained.

BIRDS AND ANIMALS

Toy making is not difficult. It may be done quite as well by women and girls as by men and boys. In fact, very few of those who have never attempted the work realize how simple it is to

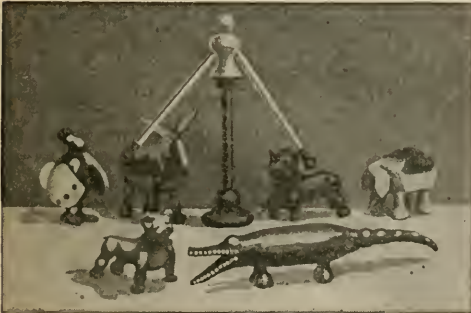

FIG. 21.—Some toys from the collection of F. Clarke Hughes, who is a specialist in their design and construction.

construct attractive toys—toys that will give keen and lasting delight to the children who receive them.

About the only equipment necessary for making many little toys are a coping (fret or bracket) saw, a jackknife, a hammer, and a rule. While other tools are sometimes needed and are always useful, they are not essential. Do not, therefore, let the lack of tools or a bench prevent you from beginning.

Once you have fallen under the fascination of the work and discovered what fun there is in making toys, you will delight in adding new tools to your kit, and in a short time you will have a home workshop equipped for much more ambitious undertakings.

The subject of tools cannot be dismissed without mentioning a lathe. Indeed, for many of the spindle toys so much in vogue these days, a wood turn-

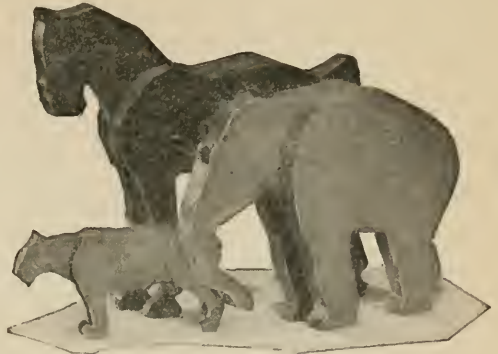

FIG. 22.—Well-designed wooden animal toys are more popular to-day than ever, and making them is great fun.

ing lathe is the thing to use. Those who become thoroughly interested in toy making will want to have a lathe sooner or later, but in the beginning it is usually possible to devise a substitute tool process or change the design of the toy so that turning is not required.

In cutting out practically all of the toys illustrated in Figs. 21 to 26, an ordinary coping saw is sufficient. These saws may be purchased at hardware stores and are among the most inexpensive of tools. A supply of extra coping saw blades should be obtained; they, too, are cheap, so that the breaking of them,



FIG. 23.—“Cute” may justly be used to describe some of these brilliant and charming little toys.

which is bound to happen now and then, is a small matter.

The correct method of using a coping saw is illustrated in Fig. 24. Boards as heavy as 1 in. in thickness, if of white pine, basswood or any soft wood, may be sawed quite easily in this way.

In Fig. 26 are shown a number of animal forms that were drawn especially

square draw whatever appears on the corresponding but much smaller square in Fig. 26, so that you will obtain an exact enlargement of the original drawing. The elephant, for instance, is 7½ in. long over all and 5½ in. high; the pelican is 7 in. long and 5½ in. high; the puppy dog is 4½ by 5 in., and the others are of corresponding proportions. There

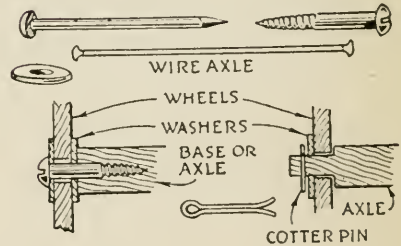
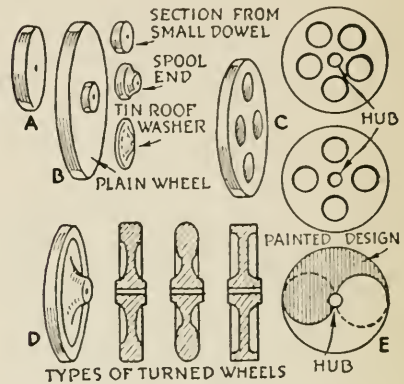
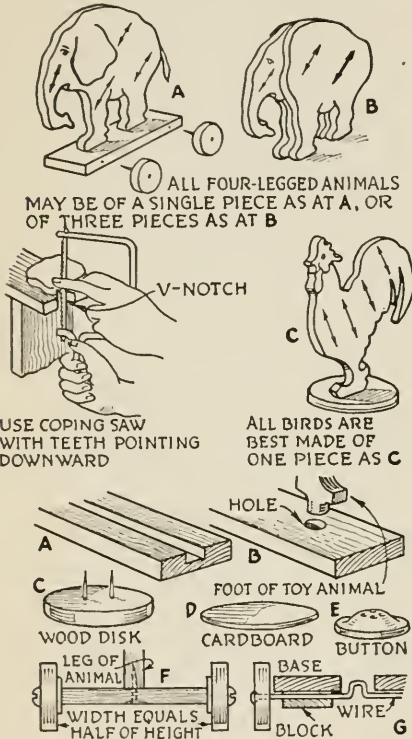

FIG. 24.—Left: One- and three-piece toys and several types of bases; how to cut the forms with a coping saw. Right: Wheel construction at a glance; various hubs, decorations, and methods of mounting.

for wooden toys. These may be enlarged and used as patterns for toys of many types and sizes.⁴

Decide first to what size you wish to enlarge the toy. Draw on a piece of stiff paper or thin cardboard the same number of squares as appear over the outline you intend to copy, but make the squares proportionately larger. In each

is enough variety to keep you busy for weeks.

From the full size drawings you can transfer whatever designs you wish on the wood by means of typewriter carbon paper. Another method, which is quicker if you intend to make a quantity of the toys or have the children help with the work, is to paste the various designs on bristol board or tough, thin cardboard and then cut them out so that they can be used as templates to trace around.

⁴Full size drawings of a number of bird and animal toys are given in BLUEPRINT No. 56, listed in the Appendix.

Attention is called to the character of most of these forms, with their simple lines and large feet. If these forms had not been changed in this way the smaller parts would split when cut from wood. Tails in most cases should be removed entirely when sawing and leather or twine substituted.

It will be noticed also that all of the illustrations of birds in Fig. 26 show only one leg; and of the animals; only the cow has all four legs. This simplifica-

should run. If three-ply wood is used, the grain usually can be ignored.

What thickness of wood to select depends upon the size of the toy, the form of construction, and, to a lesser degree, upon the kind of wood. Three-ply parts can be thinner than those of solid wood.

An elephant made the size shown should be $\frac{3}{4}$ in. thick if a single piece, and $\frac{5}{16}$ or $\frac{3}{8}$ in. thick if in three parts. The cow, cat and donkey should be $\frac{1}{2}$ in. thick if single and $\frac{5}{16}$ in. if in three

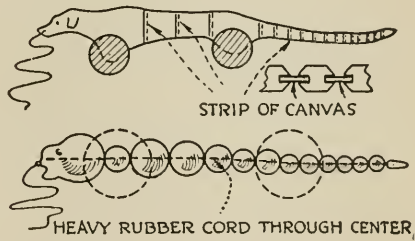
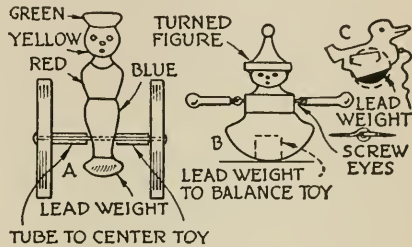
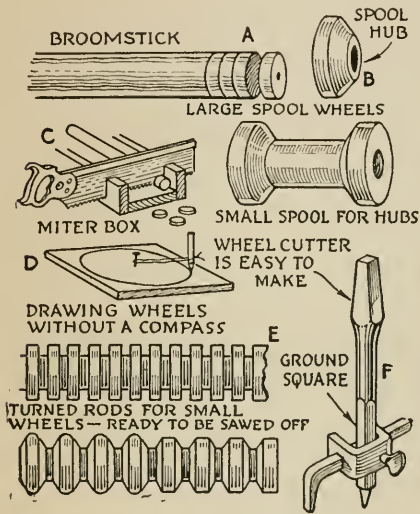

FIG. 25.—Left: Broomsticks and spools as used for wheels; methods of turning wheels; a wheel cutter. Right: Toys weighted so as always to remain upright; "wiggle" toys with jointed bodies.

tion, if the toys are cut from one piece of wood, makes the work easier and the result more satisfactory from the standpoint of durability.

You are not limited to these designs. Many pictures of animals may be found in books, magazines and newspapers, and these may be made adaptable to wooden toys if simplified in the light of the designs shown.

If a toy is to be cut from plain boards, the grain of the wood must be considered and made to run in the direction best serving to strengthen the weaker parts. The different drawings in Fig. 26 have arrows to indicate the direction in which the grain of the wood

pieces. The birds and fowl may all be $\frac{1}{2}$ in. thick.

The duck can be made into an especially attractive toy if cut from $\frac{3}{4}$ in. thick stock with the head separate and loosely doweled in place so that it will turn. The puppy looks best if $\frac{3}{4}$ in. thick.

After the toy has been cut to shape and smoothed with a bit of sandpaper, the kind and style of base should be carefully considered, because the base has much to do with the general attractiveness of the finished article. Each individual toy seems to call for a special type of base and the form should be studied with this in mind. Some toys

look best on a round base, others need a square base.

If wheels are to be used on the base, the size of the wheels should be con-

sidered in relation to the width of the base. As a general rule, the width of the base should equal about one half the height of the toy.

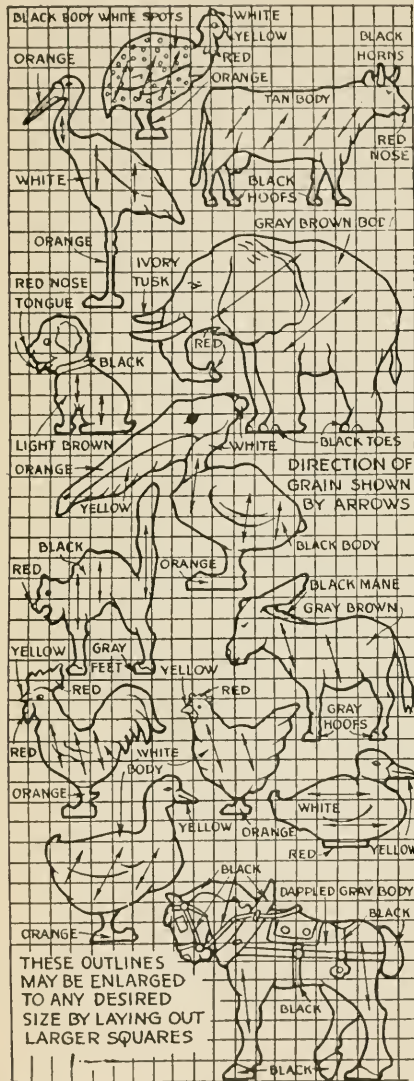

FIG. 26.—Outlines of bird and animal toys on squares to facilitate enlarging them.

Wooden animals may be made up in a single piece, or in three sections nailed together, as in Fig. 24. For birds and fowls either a base is used or wheels with a counterbalance (Fig. 25).

Small wheels may be made from a broomstick or curtain rod as suggested in Fig. 25. A stop block placed in the miter box helps to keep the thickness uniform. Two styles of small turned wheels are shown.

In finding the center and drilling the holes in all of the wheels, care must be observed, or they will be one-sided. A jig with a fixed center can be devised to aid in drilling these centers.

If a washer cutter, such as used by steam fitters for cutting gaskets, is to be had, a very good set of wheels may be cut out, provided the wood does not exceed $\frac{1}{2}$ in. in thickness. A satisfactory wheel or washer cutter may indeed be improvised as shown in Fig. 25. The shank is made from an old auger bit.

The larger wheels may be varied in appearance by using different hubs with a plain wheel, as shown in Fig. 24.

Among the newer wooden toys on the market are to be found some that are weighted so they always remain in an upright position. Figure 25 suggests how several of these little novelties are made. Beads sometimes may be used as spacers instead of tubes.

Other toys have one end hinged so that the other can be moved up and down by an eccentric in one of the axles as indicated in Fig. 24.

The jointed toy made in several sections and arranged to wiggle when it is drawn along is always interesting to the children and quite simple in construction, as shown in Fig. 25.

The main points in successful toy making are simple lines, solid construction, and clear, bright colors.

For the smaller toys the gloss paints, carriage or auto enamels and colored lacquers are satisfactory.

CHAPTER VIII

IMPROVEMENTS FOR HOUSE AND GARDEN

YOU can put more of the closet space in your home to practical use by building in some additional shelves, coat rails, and compartments and by adding hooks, rods, and hangers.

Figure 1 shows a simple and practical way to place shelves at the back or end of a closet. A post, $\frac{3}{4}$ by $1\frac{1}{2}$ in. and of a length to reach from the top edge of the baseboard to the ceiling, is placed at each side of the closet as shown at *A*. Posts *B* of similar size, about 1 ft. long, are set in the corners at the back between the shelves, which may be as wide as desired and as long as the width of the closet. The shelves are held in place by nailing through the long post, as shown at *C*. This places the first shelf about 18 in. from the floor.

The front post may be toenailed to the wall, and the baseboard and the corner posts facenailed. By building the shelving to the ceiling, materials that are not frequently used may be stored on the upper shelves, and thus space is used that otherwise would be idle.

Another way to increase the working space in a closet is to build two coat or cloak rails as indicated in Fig. 6. In addition to the usual rail at 5 ft. 8 in. from the floor, an additional rail is placed at 4 ft. 6 in. from the floor. This is especially helpful for children's use. The hooks on the lower rail are placed halfway between those on the upper rail.

Figure 6 also shows a shelf placed on the top of the upper rail for hats and mittens; and resting on the baseboard is a shelf for shoes. The latter should be

either 11 or 12 in. wide. It is well to finish the shelf with spar varnish. It need not be nailed to the baseboard; thus it may be taken out for cleaning.

A method of keeping rubbers and mittens in a closet is indicated in Fig. 2. Three shelves are placed 6 in. apart, and on them partitions are placed so as to make compartments 6 in. square. The case is built or placed on the baseboard at the back or end of the closet. It should be noted that the shelves are 10 in. wide and that the grain of the wood in the partitions runs vertically. By this construction, pieces 6 in. long may be cut from a 10-in. board for the partitions; in like manner two pieces $13\frac{3}{4}$ in. long may be cut for the ends if the wood is $\frac{7}{8}$ in. thick.

A very simple and satisfactory way of hanging a rod for holding coat hangers for coats and dresses is illustrated in Fig. 7. A $\frac{3}{8}$ - or $\frac{1}{2}$ -in. iron or brass rod, or a $\frac{1}{2}$ -in. piece of hardwood doweling, is placed across the closet at about 18 in. from the rear end. One end of the rod is placed in a hole in the coat rail as shown at *A*; the other end is held up by placing it in a notch, which is cut in a $\frac{3}{4}$ by 1 by 4 in. block *B*, screwed to the rail exactly on the opposite side of the closet.

Hooks may be placed near the top edge of the head casing on the inside of a closet door as shown in Fig. 4. This is a handy place for hanging hats. It is especially useful in a downstairs closet for the men to hang their hats as they come in. Since this space is out of view,

common nails will serve instead of hooks.

One place in closets that is usually idle is the inside surface of the door. This space may be put to use by making a trousers rack as shown in Fig. 3 and fastening it to the cross rails of the door. The rack consists of a piece of wood $\frac{7}{8}$ by 3 by 16 in. for the main member, five

hung at one time. As the bottom rod is near the back of the main member and each one above is a trifle nearer the front, each pair of trousers hangs nearly plumb. It adds to the neat appearance of the rack if it is made of the same material and finished in the same way as the door.

The inside of a closet door also may be used for a rack for neckties. A sug-

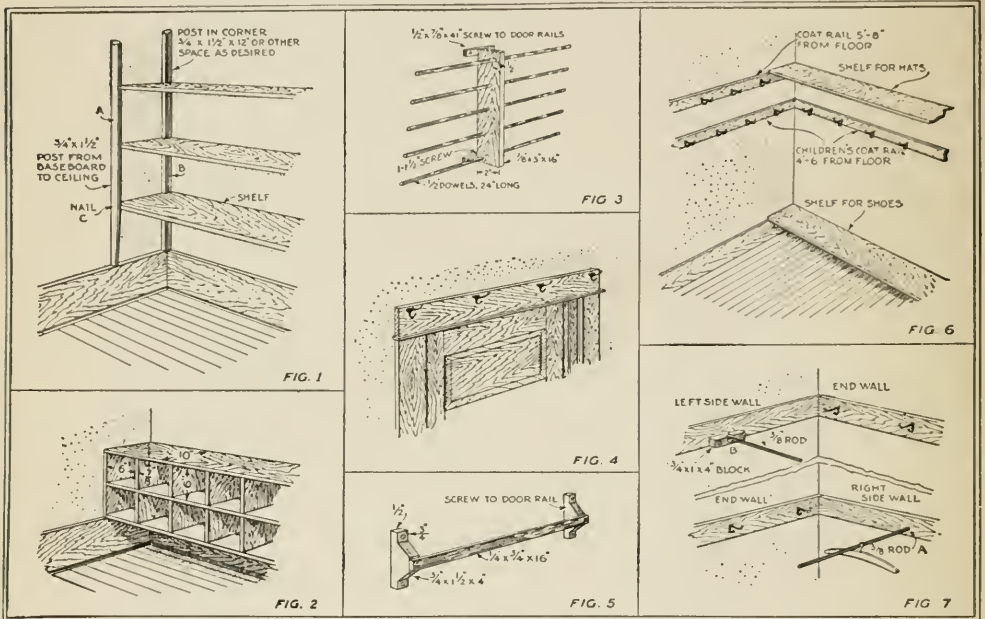

FIGS. 1 TO 7.—Seven ways to increase the capacity of the ordinary clothes closet with shelving, racks, cabinets, and extra hooks.

and two pieces of wood $\frac{1}{2}$ by $\frac{7}{8}$ by 4 in. The $\frac{1}{2}$ -in. dowel rods are placed through the main member so that the upper one is $\frac{1}{2}$ in. from the top end and front edge, and the lower one $\frac{1}{2}$ in. from the lower end and 2 in. from the front edge. The other three dowel rods are placed on a line between the upper and lower ones.

The rack is fastened to the door by the use of two blocks, one at each end at the back. A $1\frac{1}{2}$ -in. flathead wood screw is used to secure each block to the rack, but 1-in. roundhead screws are used to fasten the blocks to the door.

The trousers are folded once and slipped onto the rods. Ten pairs may be

gested for making such a rack is shown in Fig. 5. It consists of two blocks $\frac{3}{4}$ by $1\frac{1}{2}$ by 4 in., shaped as shown. A piece of hardwood $\frac{1}{4}$ by $\frac{3}{4}$ by 16 in. is fastened to the two main blocks with $\frac{3}{4}$ -in. roundhead wood screws, and the rack is attached to the rail of the door with 1-in. screws.

COMBINATION SHOE BOX AND RACK

The combination shoe box and rack shown in Figs. 8 and 9 provides a handy place for shoes in everyday use and allows less frequently needed footwear to be stored in a dust proof container.

To estimate the inside length of the box, multiply the number of pairs of shoes by 9 in.; the other dimensions are as shown in Fig. 9. Although it is most practical to have a back and bottom,



FIG. 8.—The rack on top provides a place for everyday shoes; the box beneath, for those used less often.

they may be left out and the box ends fastened to the wall and the bottom of the closet.

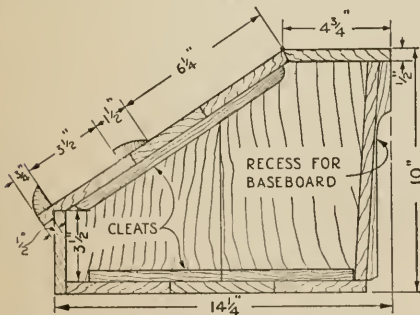

FIG. 9.—End view of the shoe holder shown in Fig. 8. The length depends on the number of shoes.

In making the end pieces, care should be taken that the grain runs vertically. These ends can be made in two pieces, held together with cleats on the inside. If no floor board is used, the thickness of

$\frac{1}{2}$ in. should be added to the height of the end pieces.

Fasten the ends, back, and front together so that the ends are inclosed by the front but inclose the back, allowance being made for the floor and baseboard moldings. The top and bottom next can be put in place, after the top has been beveled to accommodate the lid. The butt hinges for the lid should be spaced about 12 in. apart.

The rack should be thoroughly sanded. For a finish any good penetrating wood stain or dye of the desired color may be used, followed by several coats of shellac, varnish, or clear brushing lacquer.

KITCHEN CUPBOARDS

In modern homes a kitchen cupboard extending from floor to ceiling often is built along one entire wall. If you live in a house without this convenience, you can construct a suitable cabinet yourself without much difficulty or great expense (Fig. 10).

Measure exactly the space the cabinet is to occupy and make a drawing to aid you in both ordering the material and constructing the case.

The lower part of the cabinet with the table or work shelf should be of a height to suit the housewife and in no case too low. For a large and elaborate cupboard, the lower part can be as deep as 2 ft., but a toe space should be left at the bottom as shown. This space extends 4 in. under the cabinet and is $2\frac{1}{2}$ in. high.

The upper part can be relatively shallow and entirely separated from the lower part. Screw $\frac{1}{2}$ by 2 in. strips to the ceiling joists to serve for hanging the upper section and, of course, also fasten it to the wall.

The doors can be made with white pine frames and either plywood or pressed wood panels, the latter being thinner and cheaper, yet strong and durable.

A good way to make the table top is to cleat together 1 by 12 in. white pine boards and then cement floor linoleum on top. To lay the linoleum cement

easily, make a trowel or paddle with a chisel edge from a thin board about 4 in. wide and notch the edge in saw-tooth fashion. Apply the cement and scrape the surface with the trowel, leaving only small ridges, not too close together. On this lay linoleum felt, heavy building felt, or even building paper.

Cut the linoleum to fit snugly and lay it on the felt, after applying the cement in the same way. Roll it down well and apply a small hardwood binding strip along the front edge of the top. At the back, along the wall and resting on top of the linoleum, a wooden strip 3 in.

will suggest color schemes. The door panels can be decorated, if desired, with transfer (decalcomania) designs.

A bread board can be made of $\frac{3}{4}$ -in. plywood. If the plywood is not of the so-called waterproof variety, put together with casein glue, it should be liberally treated with linseed oil.

FITTING UP A BOY'S ROOM

A boy's bump of acquisition is immense. In the earlier years his pockets suffice to store accumulated treasures, but not so in his teens. No pocket has yet been designed that could accommodate a model cruiser or an electric derrick.

It is important that he should have a place to keep these possessions, many of them of his own construction, as well as a room for entertaining his friends. Boys certainly resent being shooed off into the basement or garage when two or three cronies come to see them.

One way to keep young men contented at home is to give them a room, absolutely their own, and to have it equipped in a manner they appreciate. The design illustrated in Figs. 11, 12, and 13 covers about everything a boy from ten to eighteen could want—except, of course, a workshop, and that has been left out purposely, for it should be given separate and special consideration.

Although the plan is for a comparatively small room, the built-in features make it as convenient as much larger quarters. The double-deck bed has the advantage of occupying little space and at the same time will accommodate overnight visitors very comfortably. Besides, it is mildly reminiscent of a ship or a mountain cabin, and therein lies much of its attraction. Adjoining it is a roomy closet for a dresser. A screened vent in the ceiling provides ventilation.

It is assumed that the location is a corner room and that casement windows, opening out, afford good light and



FIG. 10.—A homemade built-in kitchen cupboard with linoleum covered working top. At the bottom is a recess to provide toe space.

or more in width should be placed, to protect the plaster. Three coats of spar varnish will give the linoleum a durable surface.

How attractive the cupboard looks depends mainly upon the good taste and care with which it is painted. A study of modern commercial kitchen cabinets



FIG. 11.—A real boy's room—one where he can have all of his treasured possessions and where he can entertain his companions. A room as carefully planned as this can be kept looking neat with little effort.

permit the room to be aired quickly. Unsightly shade rollers are eliminated by using monk's cloth curtains, substantially supported on rods independent of the individual windows.

The low window seat with cushion is an invitation to read; books are conveniently at hand on either side. Below the shelves are cupboards, and the top shelves with their glass doors serve as exhibition cabinets for model boats, mechanical devices, and such items as the boy has built himself.

A drawing desk is an important feature. This also is built in, with space between it and the flanking bookshelves so that there is plenty of elbow room to use a T-square handily. The lid lifts up to give access to a compartment for paper and other equipment.

Behind the door to the hall is a rack for golf clubs, baseball bats, fishing rods, canoe pad-

dles, and other sporting accessories.

A special table is suggested, covered with Spanish leather to withstand somewhat rougher use than a polished surface

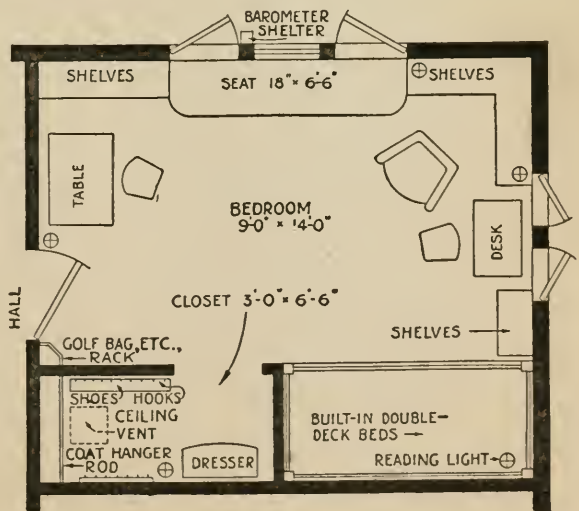

FIG. 12.—A plan of the boy's room pictured in Fig. 11, showing the arrangement of the built-in beds, closet, window seat, desk, and other furniture.

deserves. It is fitted with some drawers, and a narrow space is provided for chess- or checkerboard.

Two chairs in keeping with the design of the table are indispensable. When

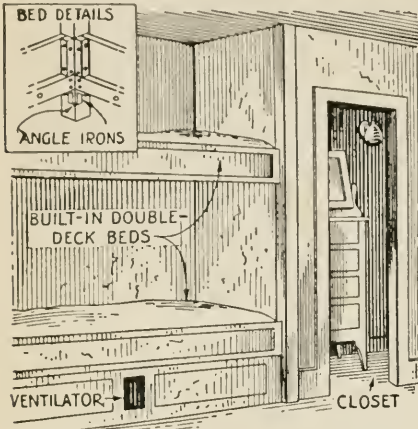

FIG. 13.—Double-decked beds save space and lend a picturesque note of the sea. How the joints are made.

four play a game, the table is drawn up to the window seat, and the two straight chairs are used opposite. A large leather armchair is also desirable for reading and studying in the evening.

Although the chairs and tables are of modernistic design and therefore expen-

sive to buy, any young man skilled in the manual arts should be able to make them. Likewise the bracket lamps, of square pattern, made up of black sheet iron with strap-iron framework and pearl or opalescent glass.

The bed frame consists of four 4 in. square posts with sideboards rabbeted in and further secured with short cleats inside. A 1 by 3 in. piece along the bottom edge of the sideboards supports the slats or springs and mattress. Drawers are built under the lower bunk and a grille is provided for airing the space below.

The interior finish and decoration are, of course, matters of personal taste. With rough plaster walls a very light green tint would be effective in setting off weathered oak woodwork. A good Navajo or other Indian blanket would not be amiss on the floor, and by all means allow the occupant to put up all the relics he wishes on the walls; they are a part of his life and ideals.

VALANCE BOARDS

Valance boards across the tops of the windows often will give a room just that touch of distinction necessary to raise it above the commonplace (Figs. 14 and 15). The advantage of a wooden or wall-

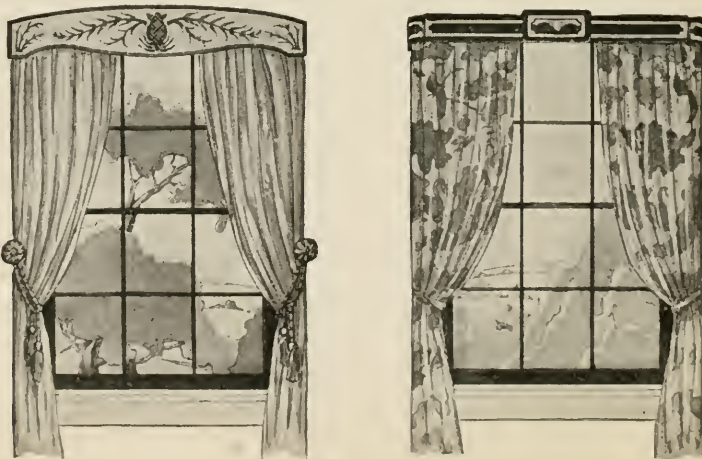

FIG. 14.—A graceful painted board in the early American character is shown at the left; curved corners are the distinguishing feature of the other design.

board valance is that it is easily cleaned, the colors may be retouched, and it outwears a textile valance. It also conceals unsightly curtain rods.

The sketches in Fig. 16 will suggest ways of varying the designs of any valances you make so that they will express

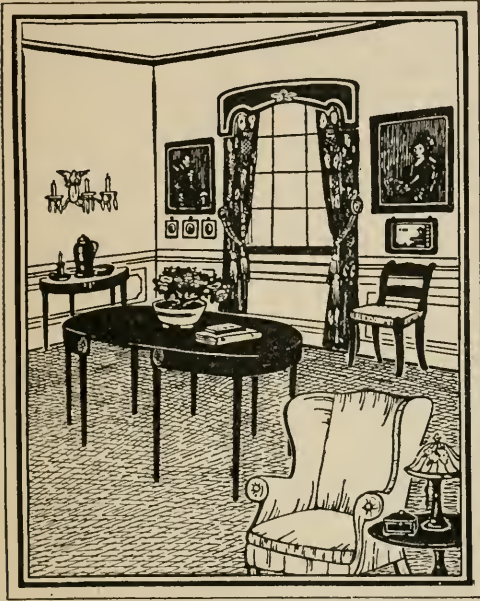

FIG. 15.—Both the valance and draperies in this charming room are matched in respect to their background color.

your own taste in line, mass, and color, and give the individuality that is of paramount importance in all matters of home decoration.

These valances are just as effective in houses and apartments in our country today as they were in the Colonial mansions of the early Eighteenth Century. One of the most charming customs was the use of painted valances for windows and for four-poster beds.

A bedroom with original Eighteenth Century furnishings was exhibited recently. It had graceful, colorful wooden valances for the windows and also a four-poster bed valance to match. The color scheme was rose and gray-blue and yellow on an old ivory background tone. Music was the motif, or idea, for the center design of the window valances—

an oblong medallion formed of a group of three musical instruments combined with an open book of music. The end boards of the valances, which were fastened against the wall at either side of the windows, were made with graceful curved surfaces. The window and four-poster bed draperies were of block-printed muslin in a light and dark red on an ivory white background similar to the very popular *toile de Jouey* hand-printed cloth.

The valance boards give a crowning

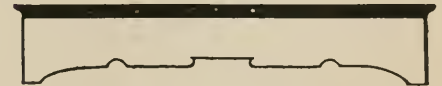
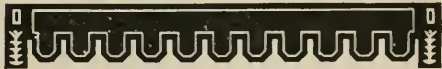

FIG. 16.—Eight valances that suggest the many ways in which designs may be developed. The first two motifs are in raised gesso work; the other boards are textile covered, painted, or decorated with transfers.

touch of elegance to modern rooms and heighten the charm and color of window draperies, whether used in living

rooms, bedrooms, dining rooms, or breakfast rooms.

A wooden valance does not need to be exactly the color of the woodwork of a room, but its background tone should harmonize either with the drapery color scheme or with the walls.

First find the exact over-all width of your windows. To this add $1\frac{1}{2}$ in. to allow $\frac{3}{4}$ in. on each end for the bracket or end pieces, which are screwed against the outside of the casing (Fig. 17). These valances are usually about

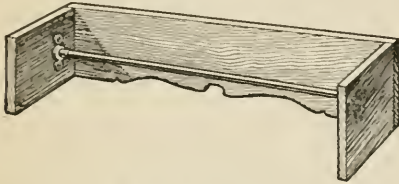

FIG. 17.—Rear view of a wooden valance board with the curtain rod in place.

9 in. deep. When more than one valance board from the same pattern is required, always start with the broadest window and diminish the pattern for the smaller windows.

Woods that are good for these valances are white pine, gum, yellow poplar, maple and birch. Thoroughly seasoned and kiln dried stock should be obtained from a lumber company or your carpenter or cabinetmaker. White pine is especially good for staining in an antique tone and waxing; it is a wood much associated with Colonial interiors.

Fiber wall board is readily adaptable to the making of window valances or cornices and has the advantage of being light and very easy to cut. The edges must be sandpapered and treated with shellac to insure a neat appearance when finished.

The tools necessary, if you use wood, are a keyhole or compass saw (or a turning saw), an ordinary handsaw, a small plane, a rasp or wood file, and plenty of sandpaper. A spokeshave also is an aid for smoothing curves, and often several large sized auger bits or an expansive bit can be used to advantage.

Cut your board first in a rectangular shape the length and depth desired. It

is a good plan to allow about $\frac{1}{8}$ in. extra all around for planing and sandpapering.

Find the center of your board and place the pattern on the center line. Working toward the right-hand end, thumb-tack your pattern to the board and trace it carefully. Then remove your pattern, reverse it and mark the other half of the board.

In sawing keep about $\frac{1}{8}$ in. outside the outline. Use a wood file or spokeshave to remove the rough edges and finish with sandpaper.

Two end pieces are required for each valance board; these usually are 4 in. in depth. These are nailed or screwed to each end of the valance boards and the whole is then ready to be screwed to the upper outside trim of the window after finishing. A rod for curtains may be screwed to the inside of the end pieces 2 in. above the lower edge.

An attractive guest bedroom in one English style suburban home has wooden window valances used with an especially finished effect. They hold a group of two windows on opposite sides of the room in harmony, one valance being used over each group. The shape is a plain rectangle with a raised molding—a triple line of gesso—slightly gilded. The background color is old ivory, on which are painted flat flower designs, one in the center and one toward each end.

Making valance boards is something women can do as well as men. Two examples of what can be accomplished in this way by women came recently to the writer's attention. In the first case, a bride had desired a window valance of wood painted to match her breakfast room. She copied an early American valance with a slightly curved lower edge. After the valance board had gone through the preliminary process of sawing and preparation for painting, she painted the background with peacock blue laquer. Then, after using two coats of laquer and allowing the last to dry overnight, she transferred a floral design by coating the back of her tracing paper with white chalk and tracing over the lines with a medium hard lead pencil.

The design formed an oval medallion, 10 in. long.

In the second case, a pair of valances was made by a girl of sixteen for her room. She planned her boards for two single windows on opposite walls, one window being narrower than the other, thus requiring different sized boards. She painted the background tone a light gray-blue enamel to match the background of her draperies. She used three thin coats of enamel, after having first applied a good liquid filler or varnish. As enamels are apt to become marked unless perfectly dry, she waited a day for each coat to dry, and then several days after the last before she transferred her design on the board and painted it in gay colors.

Pictures of distinguished people mentioned in the early history of our country may be cut out, silhouette fashion, and painted black with opaque water-color paints, or may be traced from old papers and painted black. These paper designs are glued to the center of the valance boards after a background tone has been painted. Then a decorative border of black may be painted around them so that the effect is like an old miniature medallion painted on wood. The whole surface of the valance should receive a flat coat of white shellac or of transparent varnish afterward.

One charming French wood valance in a blue-and-ivory bedroom has rounded corners representing the Greek acanthus leaf; this is carved and gilded in relief. Five-sided oblongs are repeated with a notched effect along the lower edge of the valance. Light blue-green silk overdraperies fall in graceful folds to the floor.

Gay colored birds may be cut from wall paper or curtain material and applied as a decoration.

Designs worked out with a keyhole saw are quite effective, as their height above one's eye level in a room makes them resemble open lacelike patterns in

old architectural wood carvings. A stock molding may often be used for the upper edge of the valance as a good decorative finish. If one has skill as a craftsman and cares to make his wood valance a more elaborate affair, he may carve and stain it, using gumwood, oak or white pine.

HOW TO BEAUTIFY YOUR FIREPLACE

For ages the fireplace has been the most enduring memorial of home life—a haven of comfort and cheer. In our day the main purpose of the fireplace is an aesthetic one, and if it is not beautiful it has little reason for existence. It

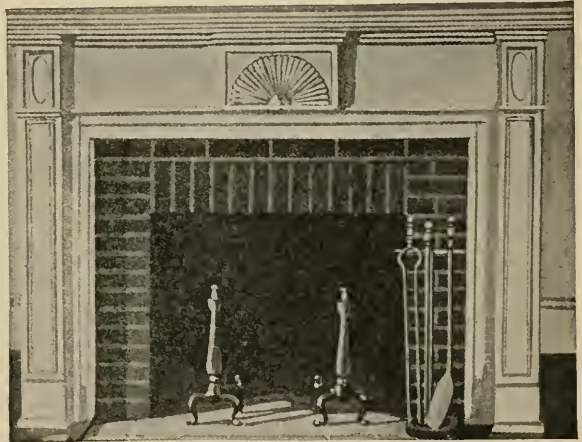

FIG. 18.—A Colonial mantel of unusual distinction, which was built at a cost of only \$7.50 for wood and moldings.

is not enough that its proportions simply be practical; they should be artistic and make the fireplace the most attractive feature of the room.

Too often the design of the fireplace is left to chance. The result, although it may be a good job of carpentry, is of indifferent appearance. Frequently, of course, the funds available do not warrant the purchase of a well designed and correctly built mantel, but for the man with a home workshop this should be no obstacle. Enough material can be bought for about \$7.50 to build a mantel which would cost \$100 in the finished state.

As the tendency in small house archi-

teecture today is more and more toward the Colonial, the mantels to be described will be found particularly appropriate (Figs. 18 to 21).

The first step, after removing the old woodwork, if any, is to construct a hol-

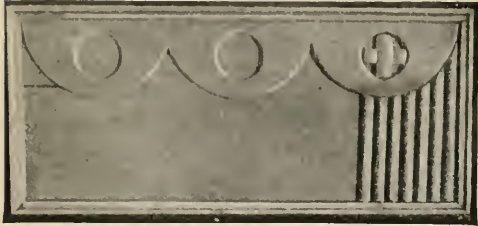

FIG. 19.—An unfinished mantel ornament, showing how the apparently carved parts are glued on.

low rectangle of the size required by the fireplace opening, allowing a margin the length of one brick on each side and 10 or 12 in. at the top. The horizontal edge should line up with one of the layers of mortar.

The amount of lumber required depends upon the size of the opening, which may vary from 24 by 30 in. to 32 by 48 in. or even larger; a good average is 28 by 36 in. wide. Of the three large pieces required for the latter size, two should be 9½ by 40 in. and one 13 by 70 in. Whitewood, white pine, basswood, or any other available soft wood that will take paint readily and can be easily worked, may be used. The back should be reinforced and plenty of hot glue and wood screws used as indicated in Fig. 20.

To allow room for suitable moldings and ornamentation, the upper piece should not be less than 13 in. in. width and preferably of one piece. Stock this width usually can be obtained in white-wood; in fact, the writer once made the backs of some breakfast nook seats of stock 26 in. wide.

All Colonial mantels have pilasters of some form. The base for these is indicated in Fig. 20. It should be glued into position and clamped.

While the glue is hardening, visit a woodworking mill and select a number of moldings. Those used in the construction of the mantel in Fig. 18 are shown

in detail in Fig. 21. It is seldom possible to obtain just what is wanted, but the required design can be improvised by planing down one or more corners or surfaces of stock moldings. Those marked Nos. 3 and 4 were obtained in this way, as indicated in cross section. An old wooden molding plane was used to make the flutes in the pilaster, marked No. 7.

The central decoration is what really gives a Colonial mantel its character. The Colonial motifs are carved from one piece, but the home "workshopper" can successfully imitate the carved ones by building up the designs piece by piece.

The design should first be laid out directly on the wood with compass and

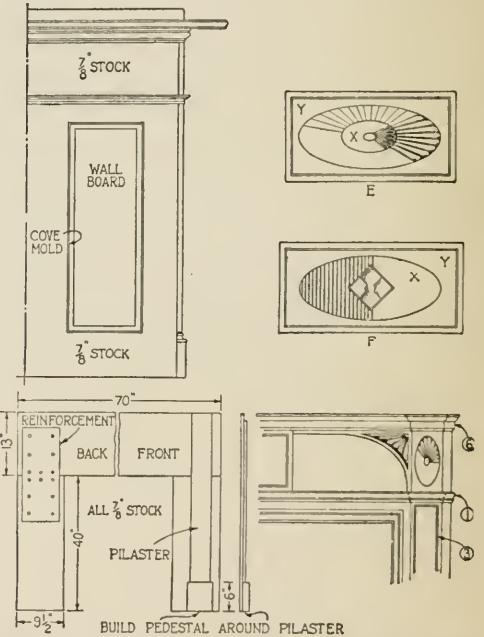

FIG. 20.—How the foundation work is erected, end view of the mantel, and two suggestions for central ornaments, which are built up like that in Fig. 19.

rule, and lines drawn to indicate the location of each individual piece. Only in this way can an accurately symmetrical design be built up.

Jackknife, plane, file and sandpaper will quickly shape the fan "blades" and

sunburst "rays." These "rays" and "blades" should be made about half as thick at the narrow end as at the wide end, which will be either $\frac{1}{4}$ or $\frac{5}{16}$ in., depending on the thickness of the upper part of the panel, mentioned later. Basswood is excellent for these small parts as the grain is absolutely straight and never turns the cutting tool from its course.

The easiest motifs to make are those with the vertical half-round pieces worked into the design (Fig 19 at left; Fig 20, *F* and Fig 21, *C*). Each piece should be glued and bradded firmly in position, but it is not necessary to use hot glue as there is no strain on these parts.

The panel upon which the designs are built up consists of two parts, the $\frac{3}{8}$ -in. base marked *X* in Figs. 20 and 21, and the $\frac{1}{4}$ to $\frac{5}{16}$ in. cut-out part, *Y*. In making the latter, a fret saw is brought into play to make the long oval or half-round cuts. This piece first should be attached to the base; the centerpiece, where required, next, and lastly the blades or strips, as the case may be. All brads should be countersunk.

In placing the molding, the cut-and-try method is recommended. The corners must be mitered perfectly. If the miter box has a tendency to play tricks, the file and plane must be resorted to. All of the molding should be glued on, as well as bradded, for the mantel will be heated and cooled and accordingly subjected to many strains.

Enough moldings, center and corner motifs have been shown to make up a dozen designs by putting together various combinations. It is not wise, however, to put on too much decoration.

A coat of thin white shellac should be applied both front and back in order to minimize the absorption of moisture. Leave the top piece of molding loose until ready to set the mantel up. Then drive in a screw wherever a stud can be located through the plaster. The lower end then is toenailed to the floor and a quarter round molding applied as a final finish at the point where the mantel meets the floor.

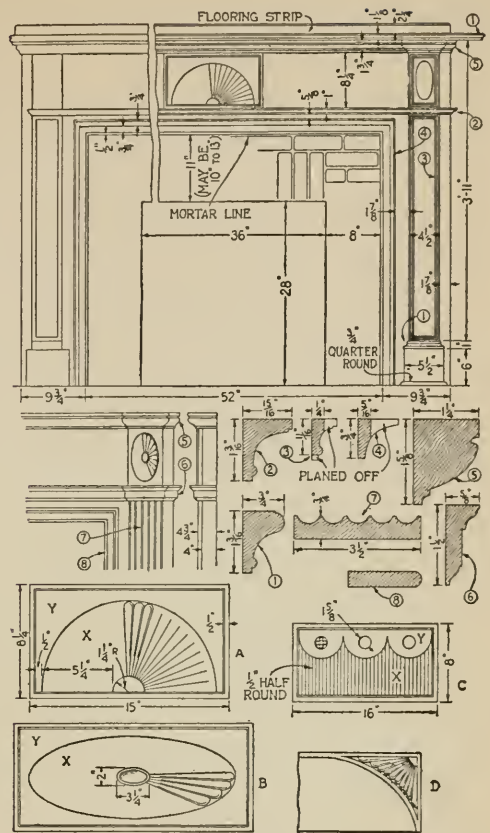

FIG. 21.—Working drawings of the mantel shown in Fig. 18, a key to Fig. 19, and several alternative designs.

The shelf is put up last and may be of $\frac{7}{8}$ -in. stock as the molding marked *No. 1* is used around the edge to make it appear of heavier construction. A piece of flooring or other $2\frac{1}{2}$ -in. or $2\frac{1}{4}$ -in. strip should be beveled on one corner and used as a finishing strip between the shelf and the wall.

The painting is a part of the interior decorator's job and may safely be left to his discretion. Two coats of enamel undercoater and at least two coats of the highest grade of enamel are required.

INDOOR INCINERATOR

Disposing of paper, sweepings, and other combustible rubbish, which constantly accumulates in every home, is an

endless task. Worse still, their storage while awaiting disposal creates a serious fire hazard. To burn the rubbish in the furnace quickly chokes the pipes, ruins the fire in winter, and heats the house in summer. If the house is equipped with an oil burner, the accumulated trash must be burnt out of doors where it may annoy the neighbors and possibly endanger surrounding property from flying sparks.

A simple solution of the problem is to build a brick incinerator in the cellar and keep the trash fires indoors where they belong. It is not necessary to be a mason to accomplish the feat; anyone can construct an incinerator like that illustrated in Figs. 22 and 23. The princi-



pal materials required are a bag of Portland cement, 15 lbs. of unslaked lime, about 150 common brick, a clean-out door, and a few other metal parts to be mentioned later.

A cement base is first laid, followed by three courses of brick. On top of the third course a grate is formed of metal strips; then the walls are built to the desired height. The top is then put on and a proper connection made to the chimney.

The incinerator shown has a capacity of about a barrel and a half of loose newspapers, but the dimensions may be varied, of course, to suit conditions. If the base of a fireplace chimney or a large main chimney is accessible, it may be used as one wall of the incinerator.



FIG. 22.—All the combustible waste of the household can be burned in this type of incinerator. At the left is shown how the brick walls are laid up after the first grate bars are in place.

The base should be made of one part of cement to three parts of sand. Its thickness should equal or exceed the overhanging flange of the clean-out door. An 8 by 10 in. door is recommended; it may be obtained at any large hardware store. When the base has set sufficiently, place the door in position by stacking bricks in front and in back of it. Next lay up three courses of brick. Break the joints and use a $\frac{3}{8}$ -in. layer of mortar. The top of the third course will come about level with the top inner flange of the clean-out door.

A strong, easily handled mortar is made as follows: To one bucket of sand sifted through fly screening add one quarter bucket of slaked lime and one third bucket cement, mixed in the dry

state. This amount of lime should give the mortar a clinging quality not possessed by an ordinary cement, sand, and water mixture. To slake the lime, place the lumps loosely in a pan or a wooden box and slowly pour on water until the bubbling and steaming cease. The heat produced should dry out the lime quickly to a powdery state unless too much water has been added. If it remains in a smooth, pasty condition, it requires more mixing and should not be added to the sand, cement, and water until they have been mixed. Be careful not to touch the lime while it is slaking, as it is much hotter than boiling water; and do not try to mix the mortar in a pail, but use a mixing board or the concrete floor of the cellar. About two buckets of mortar should be sufficient for three courses of brick.

The grate should be built up of $\frac{1}{8}$ by 1 in. steel strips laid 1 in. apart and supported down the middle with a $\frac{3}{8}$ by $1\frac{1}{2}$ in. steel bar, one end of which rests against the inside edge of the door and the other on the rear brick wall. If the steel strips do not lie flat on the side walls, bend them slightly in the middle so that they will just clear the middle support. They will settle into position later. About 17 lbs. (40 ft.) of 1-in. strips will be required for this, but 20 lbs. should be bought as a few strips are required to support the top.

Continue the bricklaying until the desired height is reached—a total of from ten to twelve courses. Point up the mortar with a rounded stick after it has set for about an hour. In order to make a true and square job, a carpenter's level should be employed unless the base of a chimney is being used as a starting point, in which case a straightedge will do.

Place steel strips edgewise between the joints of the brick to support the top, which is a piece of heavy galvanized sheet iron with a hole cut out with a cold chisel for the smoke pipe. A short piece of ordinary stovepipe should be attached to the opening thus made. This can be accomplished by using a pair of tin snips to make a number of cuts 1 in. long and approximately $\frac{3}{4}$ in. apart around one

end of the pipe. Alternate tabs should be bent outward at right angles and the end of the pipe thus "fringed" thrust through the opening in the galvanized sheet. The tabs which pass through should be bent outward at right angles

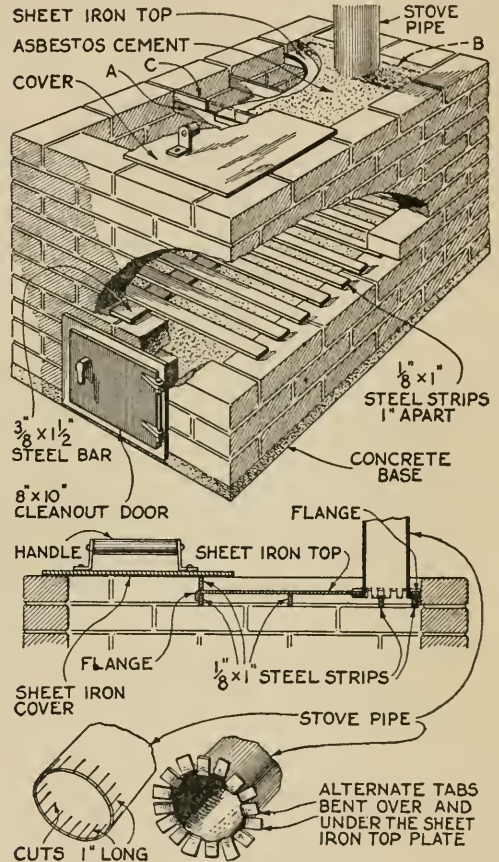

FIG. 23.—A broken-away drawing of the incinerator, showing the grate, the top, and the cover; a longitudinal section through the top, and a detail of the joint between smoke pipe and top.

on the underside and both sets hammered tight so that the pipe is held rigidly.

If the smoke pipe is joined to the heater pipe, an opening for it may be cut with a cold chisel, provided a piece of cordwood or any other heavy object is thrust into the pipe to cut against. It is not necessary to cut an accurate hole, as the joint can be sealed easily enough

with asbestos cement. The top from *A* to *B*, Fig. 23, is covered with asbestos cement.

All that remains is to make a cover for the opening into which the rubbish is to be dumped. This is a piece of sheet steel $\frac{1}{8}$ in. thick to which is attached a handle. If a hinged cover is preferred, the steel strip marked *C* should be drilled for rivets and hinged to the cover before it is set in the mortar.

STORAGE FOR GARDEN PRODUCE

If you cultivate a vegetable garden of any size, it is highly desirable to construct a vegetable and fruit storage room in the basement of your house (Fig. 24). A plan for such a room is shown in Fig.



FIG. 24.—Shelves arranged in this manner allow ample space for storing a variety of fruits and vegetables. Note the potato crates in the lower right-hand corner.

25, the size suggested being 8 by 10 ft.—large enough for most family requirements.

A corner of the basement should be selected, if possible, so as to require building only one side and one end. By the use of one basement sash, ample

ventilation is provided. The window is screened to prevent entry of flies and vermin, the screen being left on permanently. The sash is hinged at the top and provided with a hook so that it may be kept open except during extremely cold weather. When the sash is up, a piece of burlap may be hung over the window to darken the room without seriously interfering with the circulation of air.

The framework of the wall is made of 2 by 4 in. material. Each side is covered with building paper and matched lumber or with wall board, which prevents the heat from the furnace from raising the temperature of the vegetable room.

By the use of two doors, as indicated in Fig. 25, the doorway is sealed against the circulation of air. The doors may be made of 1-in. matched lumber, and should be well strapped and braced.

Potatoes keep better if they are in crates than if they are dumped on the ground or floor of the cellar. Place 2 by 4 in. pieces or 1 in. thick boards on the ground or floor where it is desired to set the potato crates. If merely dropped in place, the pieces of wood may be removed easily for cleaning the room. For only one row of crates placed along a wall, pieces from 12 to 17 in. long will do. If two rows are required, the pieces need to be from 30 to 34 in. long. It is preferable to place a second row of crates on the first, to save floor space.

If crates are not at hand for storage purposes, the four-bushel crate or bin, as dimensioned at *B* in Fig. 26, is suggested. Since a bushel of potatoes contains 2,688 cu. in., a crate for holding four bushels may be made of one piece 2 by 4 by 12 ft., and 42 linear feet of $\frac{3}{4}$ by 4 in. boards.

The 2 by 4 in. piece is cut into six

pieces 2 ft. long, and three pieces are assembled for each end, as shown, with tennenny common nails. Four pieces of the $\frac{3}{4}$ -in. material 24 in. long are fastened at each side and end by using six-

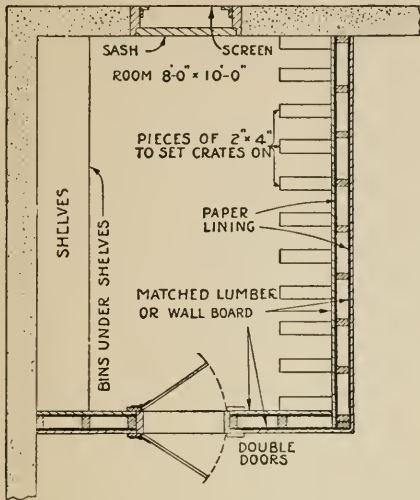

FIG. 25.—Plan of the vegetable room showing the position of the shelves, window, bins, and racks for supporting crates like the one shown in Fig. 26.

penny common nails. A space of 1 in. is left between the boards.

The floor of each bin consists of five pieces of the $\frac{3}{4}$ -in. material placed on the sills to allow ample air space under the crates. If space is limited, one crate may be placed on another.

Shelves for the storage of cans and fruit are built along the wall of the storage room, opposite the potato crates, as shown at A in Fig. 26. Bins for vegetables, built under the shelves, are part of the same construction. It is to be understood that the length of the shelving is determined by the length of the available wall space.

The framework is made of 2 by 4 in. material, assembled with sixteenpenny common nails. The depth of the shelf is $15\frac{3}{4}$ in., the width of three matched "roofers"—tongued-and-grooved boards.

The framework and shelving should be assembled away from the wall, so that the boards can be slipped in from the

end. By using eight posts that are 6 ft. long, shelving 10 ft. long can be supported. By setting the five shelves 12 in. apart, a space of 26 in. is left below the bottom shelf, which gives ample space for vegetable storage bins. Two $15\frac{3}{4}$ in. long roofers are nailed to the inside uprights at the bottom, making three bins.

The front boards should be removable to facilitate cleaning the bins. A simple

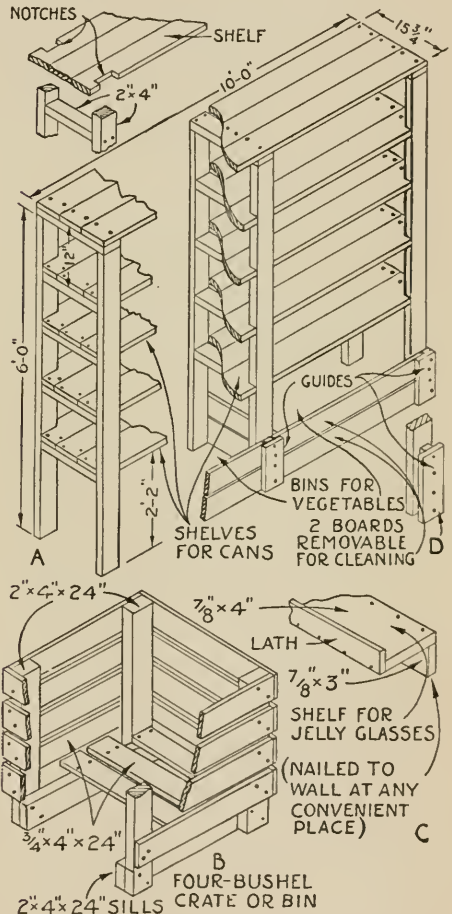

FIG. 26.—Construction of the fruit jar and can shelves, the four-bushel vegetable bins, and the special jelly glass racks.

way to accomplish this is by making and nailing guides to the fronts of the posts at the bottom as shown at D. A 1 by 2 in. piece is nailed to the post

and a 1 by 4 in. piece fastened to it at the front, forming a pocket for the boards.

A handy shelf for jelly glasses may be made as indicated at *C* in Fig. 26, and nailed to the wall or studding.

LAUNDRY CASE WITH REMOVABLE BAG FOR SOILED LINEN

The laundry case illustrated in Figs. 27 and 28, aside from being an attractive receptacle for soiled linen, has the added advantage of being so constructed that the full, heavy laundry bag can be removed easily by taking out the front of the holder. No heavy lifting is necessary.



FIG. 27.—By removing the front of this laundry case, the tied bag can be easily taken out and an empty one hung in place.

For the family that is now stowing its soiled linen and clothing wherever it will best be out of sight, this case would be a much appreciated addition to the house furnishings.

The sides may be made of $\frac{1}{2}$ -in. boards glued to give the required sizes; but to avoid danger of warping and

splitting and to insure strength, we will assume that $\frac{1}{2}$ -in. plywood will be used. Cut the back and the front $18\frac{3}{4}$ in. wide, the two ends 11 in. wide, and all $29\frac{1}{4}$ in. long. These widths will allow the pieces to be cut from plywood 30 in.

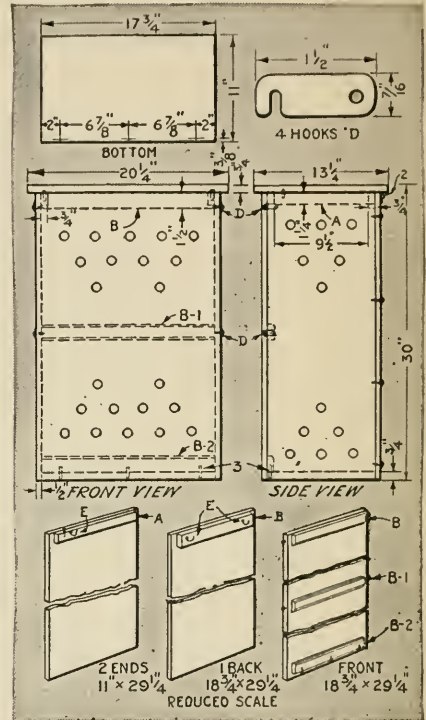

FIG. 28.—Assembly drawing of the laundry case and details of the construction of front, back, and sides.

wide, which is a stock size. Make two cleats *A*, $\frac{3}{4}$ by $1\frac{1}{4}$ by $9\frac{1}{2}$ in. and three cleats, *B*, *B-1*, and *B-2*, $\frac{3}{4}$ by $1\frac{1}{2}$ by $17\frac{3}{4}$ in. and bevel them $\frac{1}{4}$ in. as shown. Bore $\frac{3}{8}$ -in. holes for dowels in cleat *B-2* and fasten all cleats with glue and brads. Bore 1-in. ventilating holes as indicated in all sides. Make the bottom $\frac{3}{4}$ by 11 by $17\frac{3}{4}$ in. and the top $\frac{3}{4}$ by $13\frac{1}{4}$ by $20\frac{1}{4}$ in. Fit and glue pointed $\frac{3}{8}$ -in. dowels in *B-2* and bore holes in the front of the bottom to receive them.

Assemble with brads through the back and ends into the bottom and with screws through the back, for brads alone will not hold so well. Fit the front in

place. Make or buy four flat brass hooks *D* and fit in place with $\frac{3}{4}$ -in. No. 10 roundhead screws, filing their points off where they come through the ends. Hang the top with 2 by $1\frac{1}{4}$ in. butts (hinges)



FIG. 29.—A large shoe cabinet. The bracket that holds the foot piece can be folded up and hidden behind the two doors.

as at 2 in the side view. Fit and glue a $\frac{3}{8}$ -in. pointed dowel in cleat *A* of each end and bore a corresponding hole nearly through the top to hold the top front corner of the ends in place when the front is down.

Prepare two cloth laundry bags that will fit the case loosely, making them about 1 yd. high to allow for a draw string in the top edge. When a filled bag is sent away, an empty one may be put in its place. To remove the bag, tie the draw string, close the cover, raise hooks *D*, draw the top of the front forward, lift the dowels in *B-2* out of their holes, and pull the bag out through the front. Replace the front, lift the cover, and put in the empty bag. Hooks placed at *E* and corresponding rings or loops on the outside of the bag will be convenient in keeping the bag open. Pieces of tape or wide rubber bands fastened to the in-

side of the cover to hold laundry lists will constantly remind each one to record daily deposits.

The case may be painted or lacquered in attractive colors. Four casters or polished steel glides may be placed in the bottom to move the case about.

SHOE STORAGE AND POLISHING CABINET

In making the combination shoe case and polishing outfit shown in Figs. 29 and 30, any easily worked wood may be used. It is made up of two ends $\frac{3}{4}$ by $10\frac{1}{4}$ in. by 5 ft. 5 in., one top $\frac{3}{4}$ by 10 by 20 in., one bottom the same size, and one plywood back $\frac{1}{4}$ by 20 in. by

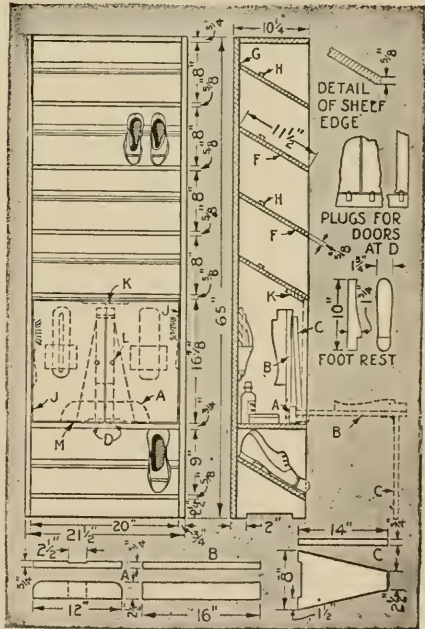

FIG. 30.—Assembly views of the shoe case and polishing outfit. Note the position of the foot-piece bracket when folded and when open.

5 ft. 5 in.; boards may be used for the latter if preferred. Assemble these pieces with sixpenny finishing nails, fastening the back in place with fourpenny common nails.

Make five shelves *F* $\frac{5}{8}$ by $11\frac{1}{2}$ by 20 in. and bevel their back edges as at

G, and the front edges as shown by the detail. Cleats *H*, $\frac{1}{2}$ by $\frac{3}{4}$ by 20 in., may be fastened with 1-in. brads at a distance from the back edge of each shelf *G* to suit the shoes to be kept thereon. Fasten these in place at about the angle indicated with sixpenny finishing nails, watching carefully while the nails are being driven to be sure that they do not come out of the side of the shelf.

Cut out two $\frac{3}{4}$ by 10 by $16\frac{7}{8}$ in. plywood doors. In fitting them, hang with $1\frac{3}{4}$ -in. brass butts placed as at *J*, with a stop $\frac{1}{2}$ by 2 by 6 in. glued and bradded as at *K*. Fit a brass spring friction catch at *D* to hold each door, with the striker on the inside of the bottom. A $\frac{3}{4}$ -in. brass knob should be attached at *L*.

Fasten piece *B* into *A* with glue and 1-in. No. 9 screws. Make a foot rest and fasten to *B* as suggested. Hang piece *C* to *B* with a 3-in. iron strap hinge, place the assembled pieces on the bottom of the closet, and fasten with 2-in. hinges located as at *M* and back far enough to allow the doors to open and close freely.

The back and ends of the inside of the closet, together with the pieces *A*, *B*, *C*

and the foot rest, should be painted black, for any other color will be defaced by spots of shoe blacking. The remainder of the case may be painted, lacquered or stained to suit.

Straps of cloth or leather or wood cleats may be fastened to the walls of the closet as indicated, to receive brushes, boxes, and bottles of shoe polish, and other accessories.

FURNITURE IN UNUSED DOORWAYS

That unused doorway in your house, through which no member of the family ever passes, may be easily fitted with built-in furniture, which, if constructed separately, would occupy considerable space in the room.

Figures 31-34 show how to build a desk, a linen closet, a service closet, or a combination breakfast table and ironing board. Some of the designs, as in Fig. 33, are adaptable to other pieces, such as a buffet or a china closet.

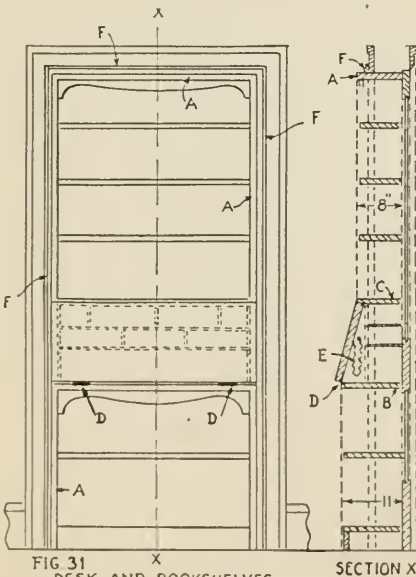

FIG. 31
D F S K AND BOOKSHELVES

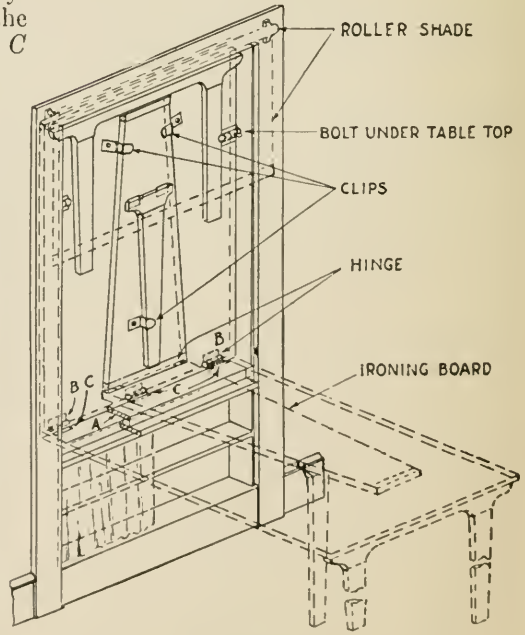

FIG. 32
BREAKFAST TABLE AND IRONING BOARD.

FIGS. 31 AND 32.—Two suggestions for utilizing those superfluous doorways in old houses which are rarely or never used. Built-in furniture of this type has the great advantage of requiring no extra wall space.

The design in Fig. 31 can be used in building a desk and bookshelves, or merely the bookshelves. The combination desk and bookshelf takes the place of two bulky articles and extends only about 6 in. into the room. The case *A* is made about $\frac{1}{4}$ in. narrower and shorter than the doorway itself. The shelves may be either grooved or nailed into place. The desk lid may be supported most easily by using brass hinges as at *D* and chain desk-shelf supports as at *E*, but regular desk stays may be fitted if preferred. The top of case *A* and the desk shelves *B* and *C* are the full width of the case at these points, but the other shelves are set back about $\frac{1}{8}$ in. so that the outer edges are not quite flush with the edges of the sides of the case.

Cloth or thin wall board can be used to cover the back of the case. After the completed piece is placed in the opening and fastened securely, a piece of molding *F*, $\frac{1}{2}$ by $1\frac{1}{4}$ in., may be mitered around the case to hide the joints and attached with brads.

If the unused doorway is in the kitchen or the living room, it may be used to contain a breakfast table and ironing board as shown in Fig. 32. First fit and fasten the crosspieces as shown in section at *A*. The table top, which is made of $\frac{3}{4}$ -in. plywood, is fitted to swing freely and hung from 3-in. brass hinges screwed to the closed door at the back of the case and to the table top, as at *B* and *C*. These hinges are so fastened that when the table top is lowered for use its underside will rest on the piece *A*, which serves as a support.

The ironing board should be hung with smaller hinges from the underside of the

table top, so that it will not interfere with the dropping of the larger piece. When the table top is locked in a vertical position, the ironing board may be lowered for use. The upper part of the opening may be covered with a curtain on a roller, the lower with bright colored cloth. The table top is kept in a vertical position by a strong bolt fastener, and metal clips made as shown

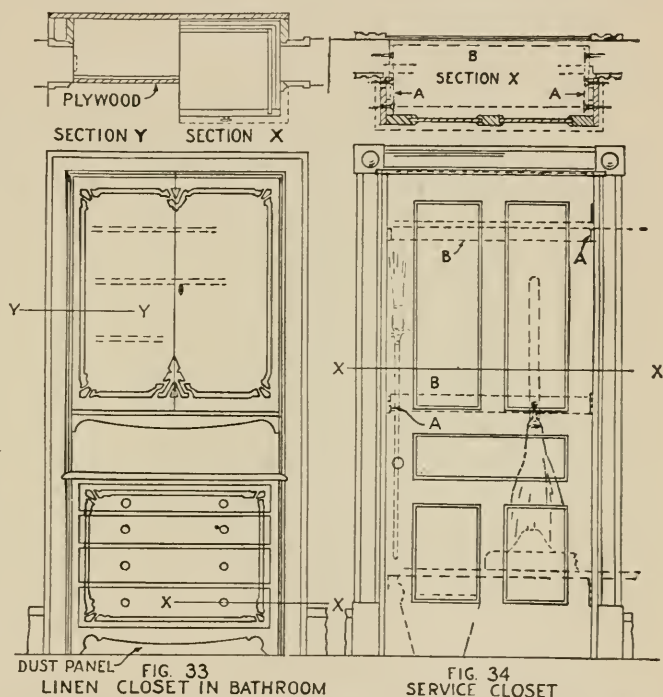

DUST PANEL— FIG. 33
LINEN CLOSET IN BATHROOM

FIG. 34
SERVICE CLOSET

FIGS. 33 AND 34.—These two ideas for securing additional closet space, as well as those shown in Figs. 31 and 32, may be changed or adapted to suit the family requirements.

hold the ironing board firmly in place.

An old chest of drawers, which is easily obtainable, may be used in making the linen closet shown in Fig. 33. Shelves are built above to contain linens and are concealed by doors of $\frac{1}{2}$ -in. plywood. If a search of used furniture stores fails to reveal a suitable chest, the making of one will be an absorbing project for the ambitious homemaker. Trouble in sweeping can be avoided by filling in the space between the feet of the chest with a panel. Cross sections of the upper

and lower parts are shown in the upper part of the drawing. Section X shows the construction of the lower cabinet, section Y the upper.

The service closet in Fig. 34 should be made deep enough, by building an extension out or in, to contain the vacuum cleaner. A diagram of this construction is shown in section X. Wall board forms the back of the closet, the original door the front. Brooms, mops, and dustpans may be held in place by the cleats A

are no rocks or boulders for miles, and when one has had no experience with cement, is another matter—the one pictured in Fig. 35 is the result of this particular set of circumstances.

After digging and shaping the hole to the desired size, the first problem was controlling the depth of water and providing means for draining the pool when necessary. A very simple plan was adopted, as shown in Fig. 36.

The real brain-teaser was concreting



FIG. 35.—A beautiful little rock-bordered pool for plants and goldfish.

which may also serve as shelf supports. The wall board back is stiffened by cleats B, which support shelves placed as desired to hold dusting cloths, cans of polish, and cleansers.

AN INEXPENSIVE LILY POND

Most of us like the shimmer and sheen of a sheet of water near by, and a small back yard furnishes an easy means of gratifying this particular desire.

When the contour of the land is favorable and there is a small stream, a spring, or other natural water supply, the problem is comparatively easy; but putting one in a place flat as a billiard table, where the soil is sandy and there

the sides, as the irregular shape made it almost impossible to build a mold. Various schemes presented themselves and were discarded, and then a very simple solution was found. A pile of broken slabs of cement sidewalk was lying in a fill along a railroad right of way not far distant from the house, so a load was brought to the garden for use in making the sides of the pool. These slabs were fitted into place by standing them up edgewise around the sides and cementing them together as any ordinary masonry work.

The bottom of some of the shallows around the "big deep" are of the same material, with concrete in between. The bottom of the deep part of the pool is

about 5 in. of poured concrete on a bed of ashes 8 in. deep.

Broken rock and boulders are piled around the edges to form a rock garden. The boulders are the result of a scouting expedition—the tumble-down foundation of a barn destroyed by fire.

After the concrete had hardened, the day for the first filling arrived with much

is desirable on account of unattractive surroundings. In the small home garden where space is at a premium, the trellis or fence should serve at least two purposes—a support for climbing vines and tall shrubs and a useful screen for some portion of the garden.

Materials best suited for this work are pine, cypress, western cedar, and fir;

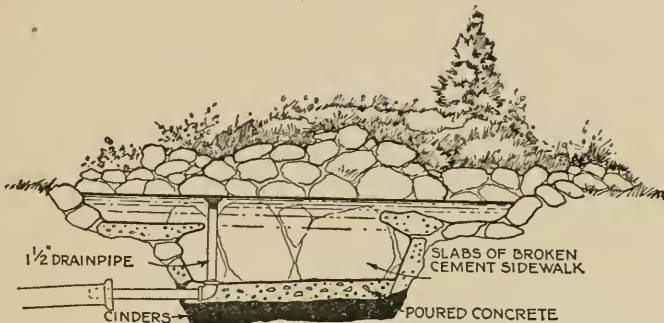

FIG. 36.—A sketch showing how the sides of the pool shown in Fig. 35 were built up of broken concrete slabs. The overflow pipe can be removed for draining the pool.

speculation as to whether there were any leaks. There were, plenty! A liberal use of cement in all suspicious looking places, with repetitions, if necessary, finally stopped them all.

TRELLISES AND ORNAMENTAL GARDEN FENCES

Trellises and fences in unlimited variety may be made by any handy man or boy. And the most artistic are often the least expensive to construct, because their beauty lies in their proportions and design, their simplicity and appropriateness, rather than their size and elaboration. Indeed, if the work is planned early enough, many odd bits of excellent materials may be salvaged from the kindling pile or may be obtained from the waste and cuttings about a new building.

Nothing adds so much to the general appearance of the average garden or lawn as a well-designed trellis or a small fence (Fig. 37). Artificial supports are always pleasing if carefully planned and wisely placed, and a clean white fence gives an air of seclusion wherever that

however, any wood that will withstand the sun and rain without checking too much or twisting out of shape will serve the purpose.

All commercial lumberyards have stock suitable for the construction of these trellises. Two of the more common sizes are $\frac{3}{8}$ by $1\frac{3}{8}$ in. and $\frac{3}{4}$ by $1\frac{3}{4}$ in., otherwise known nominally as $\frac{1}{2}$ by $1\frac{1}{2}$ in. and 1 by 2 in. These stock sizes may be purchased surfaced on four sides and ready to cut into lengths. Many sizes, both larger and smaller, can be obtained and often are desirable.

In the case of the trellis shown at A in Fig. 38, for example, the stock used is $\frac{3}{4}$ by $\frac{3}{4}$ in., of which 26 ft. are necessary, as well as a piece of $\frac{3}{4}$ by 6 by 14 in. for the brackets. It is put together with half lap joints, although thin, flat strips might be used and a plain nailed joint substituted for the half lap. The half lap joint is not difficult to make and adds much to the attractiveness and solidity of the trellis.

The most important thing in cutting a half lap joint is to have it laid out accurately to start with. In constructing

the trellis at *A*, all the parts should be cut to size and laid on the floor in the positions they will have after the joints have been cut. A few small brads may be driven through the members to hold them firmly in place while the joints and angles are being laid out. When cutting the joints it is best to saw on the inside of the lines so that a very tight fit may

shop where for a small amount the cutting will be done on a band saw.

Wooden barrel hoops are sometimes used effectively to make curved parts of trellises.

In the trellis shown at *B* it will be seen that a variation of the half lap joint has been indicated; if this type of construction is used, a very strong joint

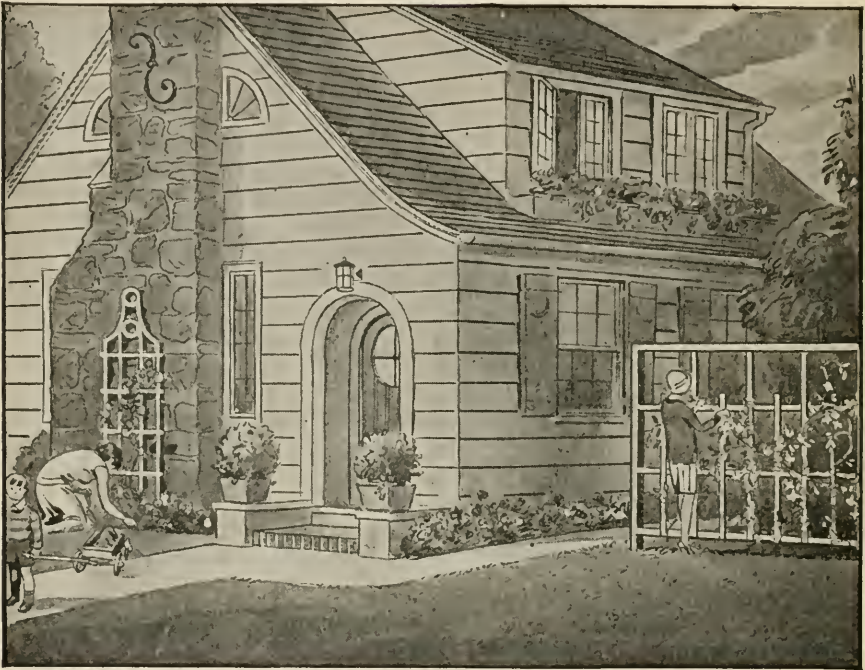

FIG. 37.—Well-designed trellises and fences and adequate planting enhance the beauty of any home, whether the architecture itself is plain or ornate.

be obtained. If too tight, the extra stock may be gradually trimmed away.

The two brackets can be laid out full size with the aid of the 1-in. squares as shown at *F*. Note that the two shapes are suggested, one 6 by 7 in. over-all and the other, 6 by 9 in.; either may be used. Two can be cut from a piece 6 by 14 in. by laying them out in the most economical way; that is, one within the other like two reversed and interlocking *C*'s. The pieces are sawed with the aid of a compass saw, turning saw, or fret saw; or the drawing can be taken to a cabinet

will be the result. The curved braces or brackets are the same size and shape as those used in the first trellis. The material necessary is 24 ft. of $\frac{3}{4}$ by $\frac{3}{4}$ in. stock and one piece $\frac{3}{4}$ by 6 by 14 in. Other designs are suggested at *C* and *D*; indeed, the possibilities are endless.

For the design at *C* it is necessary to have 17 ft. of $\frac{3}{8}$ by $1\frac{3}{8}$ in. stock and a piece $\frac{3}{8}$ by 4 by 8 in. for the semicircular top, if used. For that at *D* the materials are 35 ft. of $\frac{3}{4}$ by $1\frac{1}{2}$ (or $1\frac{3}{4}$) in. stock and one piece $\frac{3}{4}$ by 12 in. by 3 ft. 6 in. for cutting curves and rings.

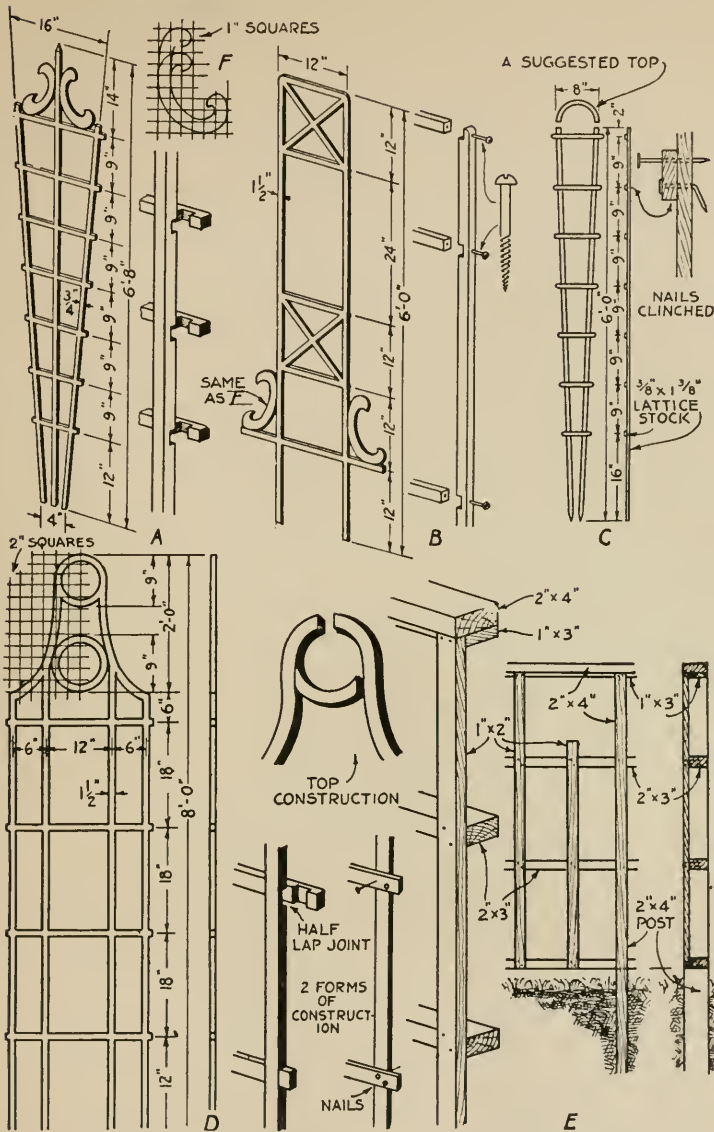

FIG. 38.—Various trellis designs suggested for home craftsmen. These can be modified in countless ways.

What has been said of the construction of trellises and supports is also true of making simple fences. Figure 38 at E shows a relatively light and inexpensive design. Some very interesting patterns may be worked out in the building of these fences, as is shown in Fig. 39.

It will be understood, of course, that

the dimensions given are merely suggestions; the designs can be worked out in various sizes and many different ways. The amateur's tendency perhaps is to err on the light side. Fences are exposed to considerable stress and strain, especially in the northern states where winters are severe and there is much ice and

snow. It is astonishing how even 1 by 2 in. stock will sag under the pressure of high snow drifts and ice crusts.

When a fence is low and quite long and the cost must be kept at a minimum, it is sometimes possible to work out a satisfactory design by using ordinary

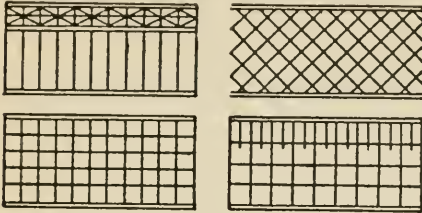

FIG. 39.—Four methods of making light, decorative fences to serve as vine supports and screens.

plasterer's lath instead of lattice strips, although the fact that laths are not smoothed renders them rather difficult to finish with paint.

The setting or putting into place of a trellis, fence, or other garden fixture is quite important. If it is placed carelessly

in the ground and the earth is not tamped firmly, it will soon sag and lean.

A good method of setting up the ordinary trellis is to place a post exactly under where the trellis is to stand. Sink it at least 18 in. deep. This post should be tamped in place and sawed off so that about 6 in. of it extends above the surface. To this protruding end may be attached the trellis with either nails or screws. If desired, the post may be set in concrete, and a more stable and rigid construction thus obtained.

In the case of fences, small split 2 by 4 in. or 4 by 4 in. posts may be used. These should be sunk in the ground an ample distance to insure solidity, and preferably well below the frost line.

Some method of finishing garden furnishings is necessary because the surface of the wood must be protected from the sun and the rain or decay soon begins. Either stain or paint may be used, but paint has the greater protective value. White, cream, brown, or green are the colors ordinarily used, all of which look well and attractive in a garden setting.



FIG. 40.—Concrete garden benches of this type are useful and ornamental, yet they are not difficult to make and are relatively inexpensive.

If paint is used, apply not less than three coats, the first of which should be well thinned with linseed oil. If stain is used, one coat of a high grade oil stain for outdoor use will always serve the purpose very well.

CONCRETE GARDEN SEATS

Sturdy garden seats (Fig. 40) can be made of concrete with but little equipment. Two forms made as shown in Fig. 41 will serve for making benches for the

made 3 by 18 in. for the short sides and 3 in. by 4 ft. 8 in. for the long. Strips cut with a 7/8-in. bevel—that is, triangular pieces—are mitered at the corners and nailed as shown to the sides but not to the bottom board.

Make short cleats to hold the side-pieces in place and screw the sides to the ends with 1 1/2 No. 8 flathead screws. Two pieces for suspending iron dowel pins in the cement are next made and placed in position as shown.

Only one end form is necessary. The

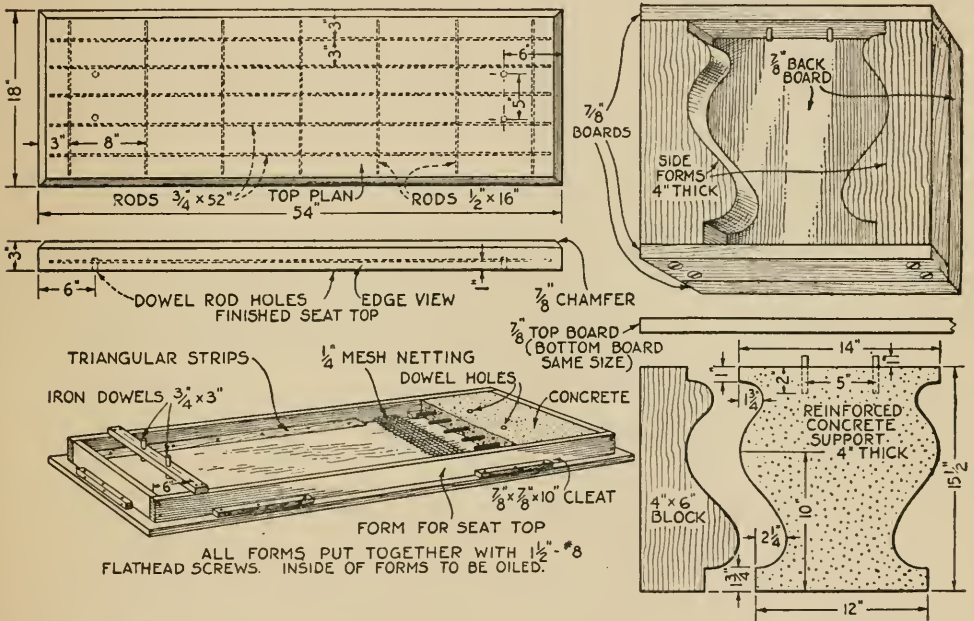

FIG. 41.—How the wooden forms are constructed for casting the reinforced concrete slab for the seat top and the two ornamental end supports of the bench illustrated in Fig. 40.

gardens of an entire neighborhood. A few alert boys working together can make seats for their own yards and sell others to friends and neighbors. As a matter of fact, many of these seats have been made in the course of their school work by boys and girls not more than twelve years old.

The form for the top, or seat portion, is made from 1-in. stock, preferably pine; it should be about 22 in. wide and 4 ft. 10 in. long. As the seat is to be 3 in. thick, the edge pieces should be

curved pieces are best sawed from blocks of pine 4 in. thick, 6 in. wide, and 15 1/2 in. long. The curves may be cut with a turning or web saw, but for a very small expenditure this will be done at a wood-working mill or carpenter's shop on the band saw.

A top and bottom board are screwed on as shown, and well oiled wooden dowels are suspended from the top board (to leave holes in the cement for the iron pins which prevent the seat top from shifting).

Apply linseed oil to all parts that come in contact with the cement mixture. Prepare reinforcing wire and rods as indicated for the seat top, and provide two $\frac{3}{4}$ by $1\frac{1}{2}$ in. iron rods and sufficient wire mesh to reinforce each of the seat supports. The mesh, or hardware cloth as it is preferably called, should extend to within about 1 in. of the edges all around.

Mix thoroughly one part cement and two parts dry, clean, sharp sand. Cup this up cone shape with a square-nosed shovel and scoop out the center, into which pour enough water to fill the hollow three quarters full. Scrape the sides of the cone into the hollow evenly all around and add enough water to make a quaky mixture.

Take four times as much gravel—running from $\frac{3}{4}$ to $1\frac{1}{2}$ in. in diameter—as the amount of cement originally used. Wet the gravel thoroughly and work it into the cement and sand mixture. Have the final mixture still of a quaky consistency.

Place the mixture evenly in the forms, working it into corners with a trowel.

See that all air pockets are broken up. Allow the concrete to set for half an hour; then smooth the surface lightly with a trowel.

The casting will harden overnight but should remain in the form about three days. Sprinkling it daily will insure its drying out evenly.

To improve the surface and conceal any slight air pockets and roughnesses, apply with a 2-in. paint brush a mixture of one part cement to one part sand. A still more even, smooth surface may be obtained by rubbing the concrete with a carborundum stone or a common brick dipped in cement and water.

For one seat, 1 bag cement, $1\frac{1}{2}$ cu. ft. sand, and 2 cu. ft. gravel will be ample.

In placing the seat in its desired location, dig holes about 8 by 16 in. in area and about 10 in. deep for the ends to rest on. These holes are filled with a mixture of one part cement to three parts sand and gravel. Let this dry overnight and then lay a mortar of one part cement and one part sand about 1 in. thick for the ends to rest upon. Use loam to fill in level with the grade so grass will grow.

CHAPTER IX

MODEL MAKING

MOST model makers¹ would enjoy building a model of that famous ship, the *Santa Maria*, if they knew that the result of their efforts would be reasonably like the vessel in which Christopher Columbus sailed to America.

It can be safely asserted that few of the models of the *Santa Maria* seen here, there, and everywhere are much like any vessel Columbus could have used. The best of them are a century out of date.

The "store models" are obviously not like any ship that ever floated, although one has no objection to them when used purely as decorations.

One learns that Christopher Columbus encountered fanatical opposition to his mad adventure and that, despite royal mandates, no one would supply him with vessels until—to quote "Gloomy Ocean"—"Palos now offered as a second caravel a certain carack, grown old from service, named the 'Gallega'; large comparatively, and heavy, but very solid. Although improper for the service now assigned to her, neither Columbus nor his counsellor, Father Juan Perez, dared to refuse her, for fear of thus protracting the delay already too greatly extended." A poor ship for exploration!

Columbus could not even get this vessel properly calked. How then would he contrive to make of her the gaily decorated, smart craft usually depicted?

Nevertheless, it was the habit to paint colorfully all manner of vessels. Sacred

emblems were considered almost essential and Columbus was a High Admiral of the Ocean Sea, therefore he would be entitled to flags and banners, which would be supplied by his royal backers, and the shields of his companion adventurers might well be hung on the pavisades. Thus, although we are not going to make a seventeenth century, brand-new carnival kind of ship, ours will be equally beautiful, if not more so, than the usually accepted model.

After exhaustive research, the writer believes his model (Figs. 24 to 37) is of a ship such as Columbus might, and probably did, use in making his famous voyage. No smallest detail or touch of color has been embodied without reason. For example, the shade of the blue used on the loopholed bulwarks is not there because it is pretty, but because it is the blue that was used on ships for centuries, and is still to be found in the flags of Catholic countries, as the "blue of the Virgin's robe."

Having given reasons for this *Santa Maria*, instead of the all too common one usually seen, we may get to work, feeling confident that the result will more than compensate for the time and care involved. The model looks complicated, but if the plans and instructions are followed and troubles are not anticipated, it will be found to work out quite simply.²

² Full size drawings are almost essential in building so elaborate a model, but if you do not wish to draw them yourself you can obtain them in the form of blueprints. They are listed as Nos. 74, 75, and 76 in the Appendix.

¹ Many blueprints relating to both ship models and airplanes will be found listed in the Appendix.

The tools required will be the usual domestic kit, with, in addition, a fret saw, spokeshave, half-round file or rasp, small round-nosed and cutting pliers, some small C-clamps or spring clothes-

bought except the pine for the hull, the reed spline and a few dowel sticks, with cord, wire and canvas for the rigging; indeed, five dollars should cover all the material. It must be kept in mind, how-



FIG. 24.—This beautiful and decorative model of Columbus' vessel is as authentic in all its essential details as painstaking research could make it. The model was built by Capt. E. Armitage McCann, noted authority on ship models and the secretary of the Ship Model Makers' Club.

pins, a light hammer, small nail set, tweezers, and some very small wire twist drills with a handle. A set of die-sinker's files are useful, as is a jeweler's saw.

The material needed will be referred to as the work proceeds. Little need be

ever, that ingenuity is constantly needed in all model making. When the desired material cannot be obtained, use something else. The list is as follows:

From lumber dealer: One piece white pine for lifts, $\frac{1}{2}$ by $5\frac{1}{2}$ in. by 15 ft. 6 in., for hull—cuttings from this will make

keel, stem, stern, hatches, channels, rudder, boat, etc.; one piece three-ply hardwood or pine $\frac{3}{32}$ by $5\frac{1}{2}$ by $7\frac{1}{2}$ in. for cow bridge—cuttings from this will make decks; two pieces three-ply hardwood or pine $4\frac{1}{2}$ by 5 in. for fore- and after-castle decks; 20 ft. of chair-mender's spline $\frac{1}{8}$ by $\frac{3}{16}$ in. for wales and skids; two pieces white pine $\frac{1}{8}$ by 3 by $9\frac{1}{2}$ in. for main and after bulwarks; two pieces hardwood $\frac{1}{16}$ by $1\frac{1}{2}$ by $9\frac{1}{4}$ in. for poop overlays; two pieces hardwood $\frac{1}{16}$ by $1\frac{1}{2}$ by $5\frac{1}{2}$ in. for bulkhead and stern overlays; one strip $\frac{1}{8}$ by $\frac{1}{4}$ by 28 in. for fore-castle framework; one strip hardwood or white pine $\frac{3}{32}$ by 1 by 30 in. for fore- and after-castle sides; 90 in. of $\frac{1}{10}$ in. square stock for fore- and after-castle sides; 62 in. of scant $\frac{1}{8}$ in. square stock for corridor framework; one piece hardwood $\frac{1}{8}$ by $1\frac{1}{8}$ by 10 in. from which stern-castle supports are cut; one piece hardwood $\frac{1}{8}$ by $\frac{1}{8}$ by 14 in. for stern-castle support beams; one strip $\frac{1}{8}$ by 20 in. for awning frame; one piece oak, $\frac{3}{8}$ by 2 by 5 in. for base.

From hardware dealer: Dowel sticks, one each $\frac{3}{8}$ and $\frac{3}{16}$ in., and two $\frac{1}{2}$ in. for spars; casein or carpenter's glue and liquid glue; a few small and large escutcheon pins or round-headed nails; assorted No. 20 brads; twisted linen fishing lines, about 50 ft. each, $\frac{1}{64}$, $\frac{1}{32}$, and $\frac{3}{64}$ in. diameters or equivalent to thickness of 4, 8, and 12 sheets of magazine or thin book paper; spool soft brass or copper wire, No. 20 or 22, for dead-eye straps; scrap of lead for anchors; sandpaper.

Sundry: Spool No. 40 black sewing cotton, ordinary pins, $\frac{1}{2}$ -in. bank pins, silk for flags, canvas for sails (about 10 by 30 in.).

From paint store: one large tube artists' oil color, white; one small tube each of Harrison red, cerulean blue, Vandyke brown, raw sienna, verdigris green (or viridian); old oak and mahogany stain; clear varnish; alcohol; water color or stamp color for flags.

Miscellaneous: As required.

The hull is made of a series of layers or lifts, so first we must have full sized drawings of each of them. These may

be enlarged from the plans given in Fig. 25 to give a model with a 19-inch hull and an overall size of 23 in. long and $21\frac{1}{2}$ in. high.

Clear white pine is the best wood. One board $\frac{1}{2}$ by $5\frac{1}{2}$ in. (nominally 6 in.) by 15 ft. 6 in. will be sufficient. On this draw the outlines of the lifts *A* to *N*, of which *A* to *F* extend the full length of the vessel. *G*, *H* and *J* are short pieces at the bow, and those from *K* to *N* are half-length lifts at the stern end. It will also be noted that the hull is at its widest at lift *E*, and from there "tumbles home," or narrows, as it rises, nearly all its midship length.

On each lift, before cutting, mark the midship line and the necessary cross lines (*I* to *VIII*), extending them over the edges. With the fret saw or hand saw and spokeshave, cut each piece to size. To reduce the weight and make the hull less liable to warp, lifts *B* to *E* may be hollowed to within $\frac{1}{4}$ in. of the outline of the lift immediately below. Lifts *G*, *H*, *K* also may be hollowed. Glue together lifts *A* to *F*, being careful that the construction lines coincide. Leave this block clamped or heavily weighted for a day.

From a piece of cardboard cut a series of templates to the lines of the bow and stern profiles (sheer plan) and to the body lines (body plan), marking on each where the lower edge of lift *E* cuts them.

Cut away the projecting corners from the block until the bow and stern templates fit it at the ends. Shave down the center of the top to the deck line, and shave away at the sides until your templates nearly fit when held at their respective construction lines (*I* to *VIII*).

Glue on the bow lifts *G H J* and the stern pieces *K* to *N*. Note that the lower edge of *L* follows *K* upwards, but that the upper edge comes sharply out to coincide with piece *M* (see the body plan at line *VIII*). Piece *M* starts at line *VI*, and piece *N* $\frac{1}{2}$ in. abaft line *VIII*. Cut the upper-deck line sheer on these and then shape the whole up to the templates. If your lifts are cut properly to shape, this should be a matter of shaving away the projecting corners until you

have a smooth surface with easy, flowing lines. The ends should be flat and $\frac{1}{4}$ in. across the stem and stemposts.

From $\frac{1}{4}$ -in. wood, cut a keel, stem and stern. This is more easily made in three pieces, joined as shown. Glue and nail on these pieces firmly. Make a bracket for either quarter from $\frac{1}{4}$ -in. wood as shown at *O*, cutting away the hull so that the forward, upright edge

here until the glue dries, and reinforce, if desired, with a pin used as a nail.

Sandpaper the deck smooth and mark the deck planks with a very hard pencil. The lines should run truly fore and aft at about $\frac{1}{4}$ -in. intervals.

Across the after bulkhead there will be an overlay *S* either of a hardwood such as mahogany or a piece of a cigar box. It should be as thin as possible.

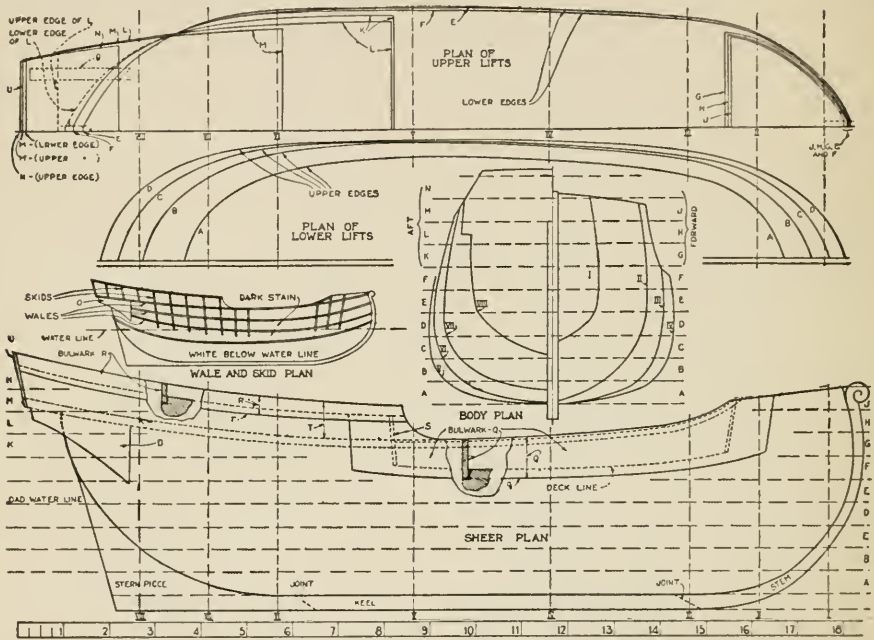

FIG. 25.—Sheer plan, body plan, and upper and lower lift plans drawn to the inch scale indicated; and a wale and skid plan drawn to a smaller scale.

of these pieces is flush with the main hull. Glue and nail these in position.

To the line *q* (Figs. 25 and 26) cut a rabbet, a bare $\frac{1}{8}$ in. deep, and to the line *r* along the stern do the same. Into these rabbets fit white pine bulwarks *Q* and *R*, $\frac{1}{8}$ in. thick. Try these out in cardboard before cutting the wood. Glue and lightly nail them in position, then cut their top edges to the lines, making sure that both are the same height. Along the after part set in similar $\frac{1}{4}$ -in. strips *R*. Sandpaper all flush with the hull. The parts *R* extend forward over *Q*, ending in the one curve; clamp them together

Mark or carve on it a center door flanked by windows. The latter can be cut right out and backed with pieces of celluloid or mica; it is glued and lightly nailed on. A similar piece may be made for the forward bulkhead, but will not show.

Similar overlays should be made to glue onto the poop sides *T*, each with six $\frac{1}{4}$ in. sq. windows, two between each of the four after skids. The photographs show them all the way along, but that may be too many and the drawings should be followed. Across the forward end of the after deck glue a thin strip to cover the joint, and along the after

bulwarks a similar but wider strip, flush inside but projecting $\frac{1}{16}$ in. outboard.

Across the stern is overlay *U*. This may be plain with the exception of two little doors. It is possible, however, that because Columbus named his ship "Santa Maria," one of his few friends at court may have given him a painting of the Madonna, which he fastened to the stern of his ship. Suitable little pictures may be bought. This piece is nailed flat; the top rail continues over it and similar pieces cover the side joints.

The cow bridge, or midship half-deck, comes next. This is best made of thin three-ply wood, but can be of thin pine about $\frac{3}{32}$ in. thick, with the grain athwart. It lies along the bulwarks until it reaches the after curves, from where it runs straight to the after bulkhead. Its shape will be seen in the deck plan, Fig. 27. It is planked-across, butts up to the forward bulkhead, and has an extra support underneath with some posts glued to the bulwarks and four posts under the inner edges. If of pine, it had better have a thin batten glued along the inner edges to prevent splitting when bent to the sheer of the bulwarks.

The wales, or longitudinal strengtheners, should now be glued and nailed on. These also may be of pine, but rattan, reed or cane, such as is used by chair menders (they call it spline) for fastening woven cane seats in place, is better because it bends easily without steaming. Nearly 20 ft. of this will be wanted, $\frac{1}{8}$ in. thick and $\frac{3}{16}$ in. wide. Their position is shown in Fig. 25. The first one starts at the curl of the stem, comes level with the top edge of the cow bridge at station point *III*, and continues to the stern at the lower edge of the poop overlay. The others are parallel, except that they are slightly closer at the ends.

In between these, plank marks may be scored with a sharp point. The upright skids are half-lapped (skid and wale being notched) so that they set in almost flush. They are splines of the same size. Note that the midship ones are almost upright, but that the others slant more and more as they work fore and

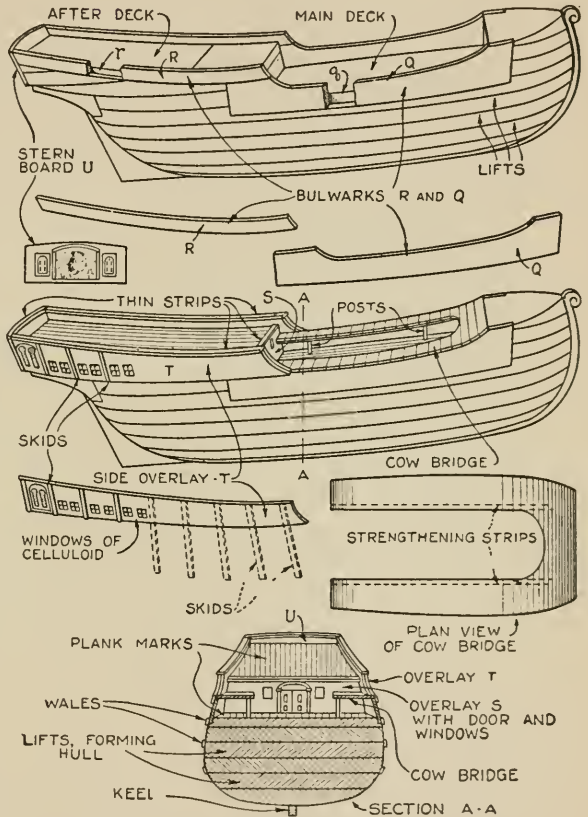

FIG. 26.—The hull construction and the method of fitting the decks, bulwarks, cow bridge, and other details.

aft. If they are fastened with round-headed nails, such as escutcheon nails, the effect is good. The short pieces at the forward end of the cow bridge are set in between the skids.

We have now done all the heavy work. Give the lower part two or three coats of flat white paint up to the water line (top edge of *D*), the deck a coat of light brown stain, and the rest of the hull some darker stain. The final color-

ing will come later. You can also make a temporary base in which to hold the model upright. Such a base may be seen in Fig. 28. The top part revolves on a peg in the lower.

The forecastle is a platform resting on timbers that are bolted to the fore part of the hull and project over the stem (Figs. 29 and 30). To make it correctly, first nail to the hull two strips of wood $\frac{1}{8}$ in. thick, $\frac{1}{4}$ in. wide and $4\frac{1}{2}$ in. long, with their centers $2\frac{1}{2}$ in. apart at the after edge and $\frac{3}{4}$ in. apart at the fore ends. Nail other pieces from the extreme after corners, beveled to meet the first pieces at the fore ends. Across these lay five smaller battens at equal distances,

$\frac{1}{16}$ -in. moldings. On the front end there may be an ornament.

Stain the supporting timbers dark brown and the rest light brown inside; paint the outsides with cerulean (sky) blue, but not too brightly. After the blue has been applied, rub a little green and Vandyke brown into it.

On the after deck, first make the corridor or half deck *W*, Fig. 27. (See also Figs. 30 and 31.) Make ten strips $1\frac{5}{8}$ in. long, ten 1 in. long and eight $4\frac{3}{8}$ in. long, all $\frac{1}{8}$ in. square in cross section. Lay two of the long pieces $\frac{5}{8}$ in. apart and with $\frac{1}{2}$ -in. pins nail five $1\frac{5}{8}$ -in. pieces to them at equal distances. Nail the lower ends of these uprights to the

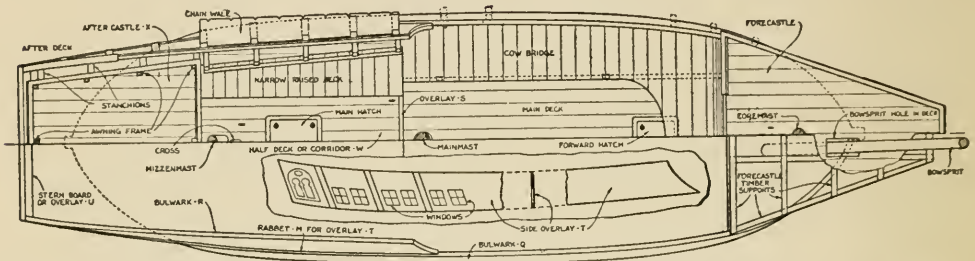

FIG. 27.—The deck plan, which should be compared carefully with Figs. 29 and 30; and a detail of the ornamental overlays for the sides of the model.

except that there must be room between the second and third for the mast and bowsprit holes. The ends, which will be cut off square, will project slightly beyond the side timbers.

To the size and shape of this triangular support, cut a thin piece of wood, such as from a cigar box. Score it to represent deck planks and cut a round hole for the mast and a square one for the bowsprit, as in Fig. 27. (Also see Fig. 34.) Cut five other pieces of wood not more than $\frac{1}{8}$ in. thick and $\frac{3}{4}$ in. wide to go around this, with the exception of a $1\frac{1}{2}$ -in. gap in the middle of the after part. Along the two sides and after ends bore two rows of holes at equal distances apart and of a full $\frac{1}{8}$ in. diameter. These are for the protection of the archers or musketeers. Nail and glue these to the platform with mitered or square corners. Along them glue three

inside of the bulwarks. Fasten one of the strips to the deck with its midship edge $1\frac{1}{8}$ in. from the bulwark at the fore end and the whole parallel to the center line of the vessel; to a fourth strip nail the ends of the shortest pieces, and nail their lower ends to the deck strips. To fit on this superstructure, lay a thin deck with the grain athwart and the planks marked. Do the same for the other side and steady the two with a strip across the whole at the after end. Note that the long pieces follow the line of the sheer, and the uprights slope slightly aft.

The after castle (X) is of the same construction as the forward one, but rests on ten curved stanchions and skids. There should be four stanchions to a side and two right aft (although these may be omitted). From the half deck to the stern there are four to a side, nailed to

the inside of the bulwarks. They slope slightly aft. To the sides of these, level with their tops, are nailed skids, the forward one being $3\frac{3}{4}$ in. long and the after one $2\frac{3}{4}$ in. The others are lined up between lengths. The two after stanchions are similarly shaped; they support the after skid from underneath.

On these rests the after castle, which is similar to the forecastle. The deck

A little awning from some gay striped material of rough texture may be made to cover this. It had better not be spread right over, however, but rolled up and bound to one of the athwart skids.

This top part should not be put in position until after the mizzenmast has been rigged.

Note that, to save space, instructions are frequently given to nail or glue, but

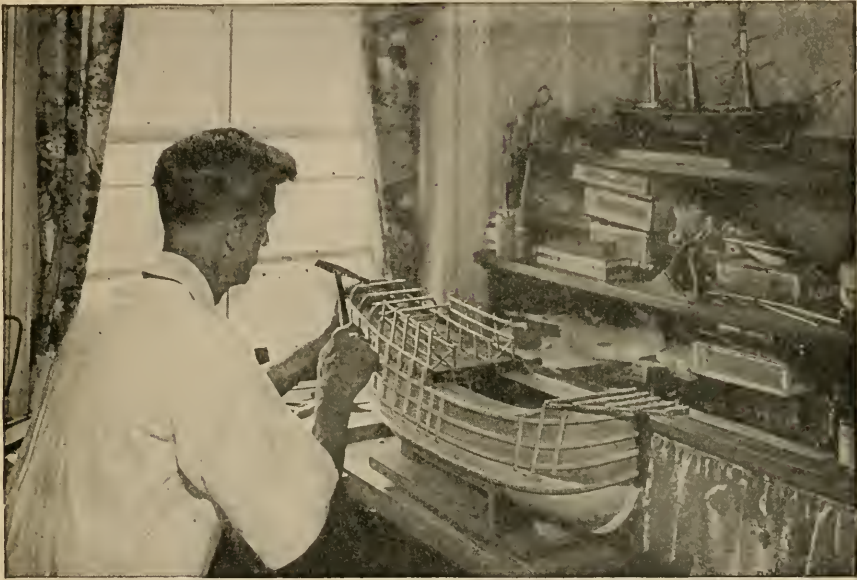

FIG. 28.—Captain McCann working on the aft deck structure. It is at this point that authorities appear to agree that other *Santa Maria* models are in error because they have an inclosed after castle.

is cut to fit on the skids, but is just $\frac{3}{16}$ in. less in width. Instead of a center opening at the after end, there is one at each side to lead into the half decks.

On this are erected the stanchions and skids for the tilt or awning. This has center posts $1\frac{3}{8}$ in. long aft and $1\frac{7}{8}$ in. long forward, the forward one being $\frac{3}{8}$ in. off center, to make room for the mizzenmast. On these rests a fore-and-aft skid, and from it to the side posts, which are $1\frac{1}{4}$ in. long, are stretchers with light skids supporting their outer ends where they meet the uprights.

All these parts are stained light and dark brown with blue outside to match the forward part.

in every case, throughout the model, parts should be both nailed and glued wherever possible. For very small nailing, $\frac{1}{2}$ in. long bank pins are best, but where possible $\frac{3}{8}$ -in. or longer No. 20 brads should be used.

On the main deck there will be a hatch (Fig. 27), which can be made of wood $\frac{1}{4}$ by 1 by $1\frac{1}{8}$ in. with a line scored around the top to represent the part that lifts off. It should be stained almost black and glued to the deck 2 in. forward of line IV. Another hatch, somewhat smaller, will lie between the mizzen and mainmasts.

There should be a ladder with four steps at one side of the mainmast,

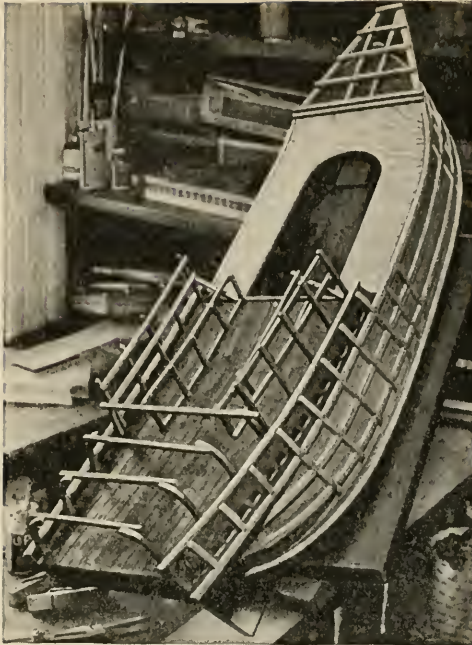

FIG. 29.—The strips for supporting the forecastle, and the framework for the stern superstructure.

leading from the lower (main) to the poop. It is made from flat strips of wood about $\frac{3}{16}$ in. wide and as thin as you can handle them.

The following parts can now be made, but should not be put in position until after the rigging is done:

Two light cannon on swivel supports. There is no certainty as to the exact pattern of these. These are made from wood, but if you are a good metal worker, by all means make them of brass, for then you can have the stands of lighter pattern. If of wood, they should be painted to represent antique bronze, using yellow ochre, green and black. They will stand on the after end of the cow bridge.

Right aft there should be a basket lantern on a bracket. The lantern can be made from strips of metal soldered, but cardboard is easier to use. Shave the end of a round stick to form a mold for the inside of the lantern; over the end of this lay three strips, holding their ends evenly in position with a rubber band. Around these glue three other strips, clipping their overlapping ends to-

gether with clamps or other bands. When this is dry, slip the stick out and there is your basket. Put a very thin piece of paper around the stick first, so that the strips will not be glued fast to it.

In the bottom of the basket set a thin piece of wood. The wooden bracket should be nailed to the deck and glued to the bulwark. The basket is nailed to the outer end of the bracket.

The small boat (Fig. 32) is $3\frac{3}{4}$ in. long, $1\frac{1}{4}$ in. wide and $\frac{7}{8}$ in. deep. It is double-ended with a big sheer. The keel and ends, all in one curve, may be

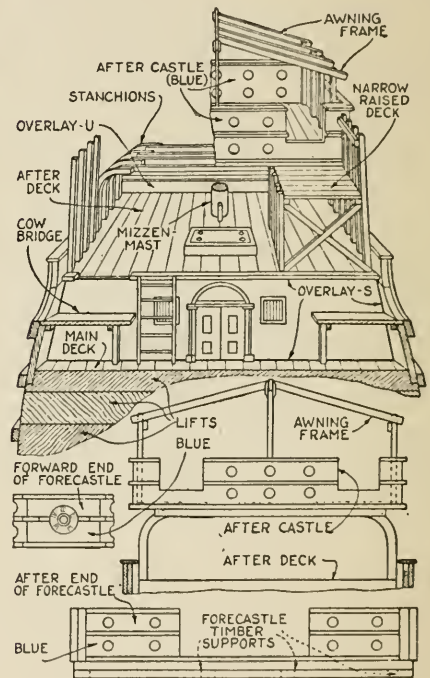

FIG. 30.—A section through the stern superstructure; forecastle and after castle.

left on in the cutting, or a piece of spline may be nailed on. The boat should be hollowed out as thin as possible, with solid ends and four thwarts. It may be fitted with oars and painter. At each end there should be a single block stapled to the solid parts. It may be painted antique white, bluish white inside, with brown thwarts and gunwales, the latter,

of course, being bored for the oar holes.

There will be four anchors. These may be bought ready made, cast from bronze or lead, or cut from the latter. The forward ones will be $1\frac{3}{4}$ in. long; the after $1\frac{3}{8}$ in. or less. They will have wooden stocks, made by cutting the stock to shape, then splitting it down the center, fitting it to the shank and gluing it in

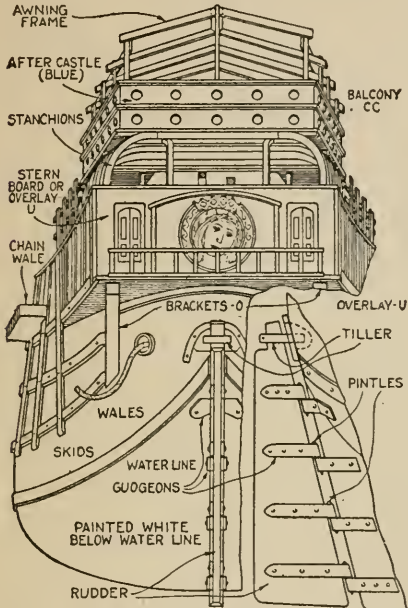

FIG. 31.—Comparing this view with Fig. 29 will make clear the stern construction.

place with thread bindings. The stocks will be very dark brown and the metal parts bronze.

Across the stern there may be a little balcony. It is a thin platform $\frac{3}{8}$ in. wide by $4\frac{1}{2}$ in. long. On each corner erect a $\frac{1}{8}$ -in. post, $\frac{5}{16}$ in. high; onto these glue and nail a very thin handrail, half-lapped at the corners, and connect the rail to the platform, between posts, with thin round sticks. Bore entirely through the platform and half-way through the handrail for these. Glue and nail the balcony from underneath to the sternboard at its lower edge, so that the platform will slope with the sheer of the ship. This can be placed in position when made.

The hawse pipes for the forward anchors are $\frac{3}{16}$ -in. holes, $1\frac{1}{2}$ in. from the stem, between the first and second wales. They should have wooden or gesso (glue and whiting) rims. The cat-holes for the after-anchor cables are smaller holes, 1 in. from the stern and $\frac{1}{2}$ in. above the lowest wale (in line with the tiller hole).

There should be circular mooring ports on either side, just above the level of the main deck and near its extremities; these also should have lips. They are for mooring ropes and to let the water off the deck.

The rudder can be seen in Fig. 33. It is the same thickness as the sternpost and extends 4 in. up from the keel line. The top is cut square to take the tiller, which fits on it and extends into the hull, through a semicircular hole, with its lower edge $3\frac{1}{2}$ in. in from the keel. The rudder may be hung with double-pointed nails driven into it and the sternpost or with regular pintles and gudgeons. The pintles may be made from thin nails clipped in the center of strips of thin brass or tin; the strips are then brought around the edges and nailed to the flat of the rudder. The gudgeons are similar, except that the nails are withdrawn, leaving holes for the pintle nails to fit into; they are nailed to the sternpost, so that both parts lie horizontal. The lower edge of the pintle straps coincides with the upper edge of the gudgeon straps, allowing the rudder to turn.

A good compromise method is to make eyes from pins and hooks from other pins and drive them into the edges of the sternpost and rudder respectively.

The hull may now be finally colored. An antique effect for this model is desirable. This antiquing is difficult to describe and the result will necessarily depend considerably on the builder.

The lower part to the water line should be white, but with a lot of Vandyke brown rubbed in, with here and there

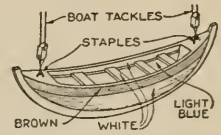

FIG. 32.—How to whittle the ship's boat. It is only $3\frac{3}{4}$ in. long.

touches of raw sienna, green and a minute amount of red.

The upper parts outside will be various shades of brown stain—mahogany and old oak stain, both separately and blended, to get a rich effect, with here and there some verdigris green (artist's oil color) rubbed in. The skids are the darkest, and on the wales some Harrison



FIG. 33.—Captain McCann putting the finishing touches on the hull of his own exhibition model of the ship, which is half as large again as that in the accompanying drawings.

red is rubbed to look as if they had once been painted red but most of the color had been rubbed off. For all decks and uprights use an irregular and lighter shade of brown, making the uprights and skids always darker than the decks.

When all the coloring is done, the whole (excepting the white) may be given a thin coat of varnish—enough to bring up the color but not to make anything shiny. Shiny parts should be rubbed flat with pumice-stone powder.

All the spars (Figs. 34 and 35) can

best be made from straight-grained dowel sticks. The mainmast will set about $\frac{3}{4}$ in. into the deck and extend 17 in. It is $\frac{3}{8}$ in. at the base and tapers to about one half that at the top, as do all the masts. The foremast is 9 in. long and the mizzen 7 in., each measuring $\frac{1}{4}$ in. in diameter at the base.

The main yard is in two pieces of $\frac{1}{4}$ -in. dowel, each 8 in. long. They overlap 4 in. where they are lashed (bound) together with four cord lashings. The main topsail yard is 4 in. long and $\frac{3}{16}$ in. in diameter; the fore yard is 6 in. long and a bare $\frac{1}{4}$ in. in diameter, and the lateen yard at the mizzen is in two pieces, each $6\frac{1}{2}$ in. long by $\frac{3}{16}$ in., overlapping $2\frac{5}{8}$ in. All the yards taper to nearly half their diameter at the ends. They and the masts should be stained and lightly varnished a reddish brown to represent antique pitch pine.

The foremast should be almost upright. The mainmast lies aft at an angle of 6 degrees, the mizzen at about 11 degrees, and the bowsprit rises at an angle of about 32 degrees.

The bowsprit is $\frac{1}{4}$ in. in diameter, tapered; it extends $5\frac{1}{2}$ in. from the deck. The hole to step it in is bored in the hull through the square hole in the forecastle deck, close up to the right side of the foremast. Have it firmly fixed and nailed down if necessary so that it will not lift from the strain put upon it by the forestay.

The chainwales (the modern name is channels) to spread the rigging are wooden platforms $\frac{3}{4}$ in. wide, $4\frac{1}{2}$ long and $\frac{3}{16}$ thick. They extend from the first skid abaft the mast to the fifth. They are notched inside to fit on the skids and lie on the upper wale. The outside edge of each has nine equidistant notches to take the chains.

When these are on it will be necessary to make 56 heart-shaped deadeyes, $\frac{1}{4}$ in. high, $\frac{3}{16}$ wide and $\frac{1}{8}$ thick. I

believe they should have three holes each, but it is possible that the original deadeyes had only one large one. They have a groove round their narrow edges.

For the sake of brevity and clearness, a few nautical terms must be used in describing the rigging. Most of these are self-explanatory, and all of them are

in line with the shroud and in line with the other nails.

The forward rigging has no chainwales. The "chains" are about $\frac{3}{4}$ in. long and made and fastened the same as at the main. There are no deadeyes or chainwales necessary at the mizzen.

For all the rigging it is best to use

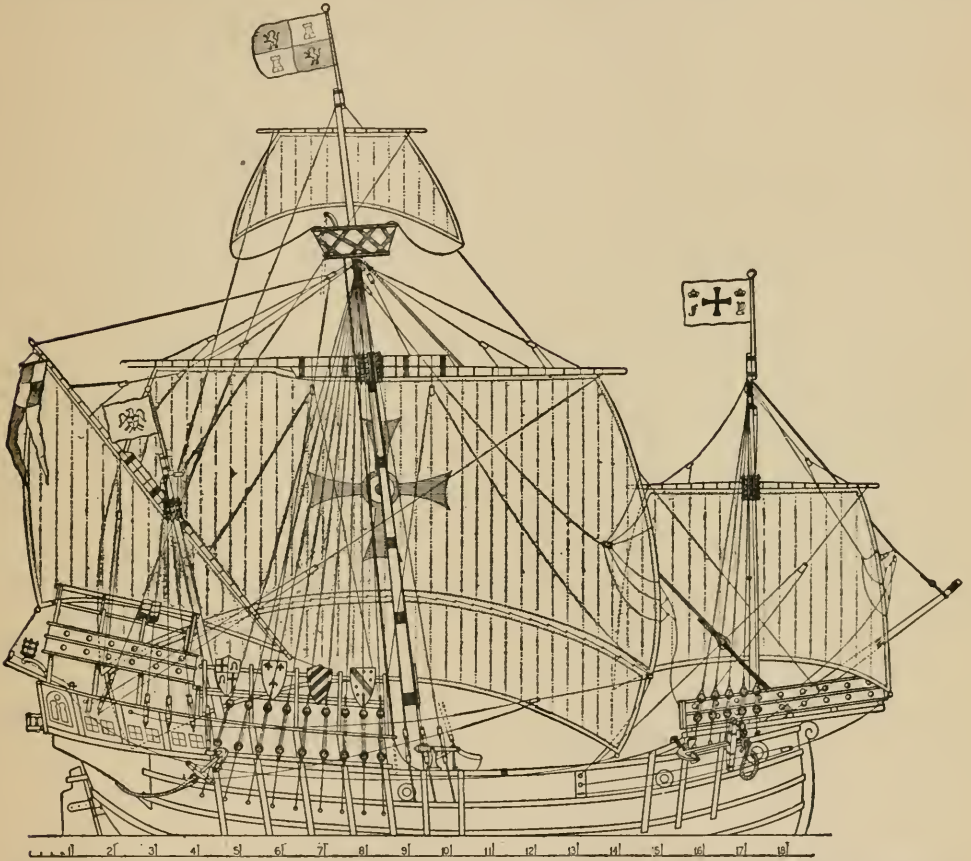

FIG. 34.—The rigging plan. As in all conventional drawings of sailing ships, the yards are shown diagrammatically fore and aft, although in the actual model they should be braced diagonally.

defined and many are illustrated in unabridged dictionaries.

The lower deadeyes were probably fastened to the hull by chains, but thin wire (say No. 22 soft) twisted around them with an eye in the lower end is sufficiently good. Each deadeye should sit on the chainwale, and the lower eye should be fastened to the hull about $1\frac{1}{4}$ in. below by a round-headed nail, placed

linen cord, such as fishline; it looks like rope, is not "hairy," and does not stretch and slack with the weather. It should be stained a rich dark brown before use. Three thicknesses will be sufficient; one about as thick as twelve sheets of magazine or thin book paper, another two thirds of that, and the finest half of that again. The latter may be stained a much lighter brown.

There should be 12 main shrouds, but the three forward ones may be omitted. They will, of course, be of the heaviest cord. The first pair (pendants) goes up one side and down the other; the others go around the masthead and down on the same side again, starting with the forward pair and alternating the sides. Cut each pair amply long, make a loop in



FIG. 35.—The model partly rigged and with masts, shrouds, yards, main- and forestay in place.

the middle with a thread binding, slip it over the masthead to the position shown, and, when all are on, bind them firmly on the mast.

The first three (forward of the chainwales) are temporary, and have double blocks in their lower ends, connected with thin cord lanyards to single blocks fastened to the hull with short chains or heavy cords. The others set up by lanyards through deadeyes or hearts to the lower deadeyes. The ends of the shrouds

are fastened to their hearts by passing them around with single hitches on top and then lashing with thread around the ends, so that they are all in one line conforming with the sheer of the ship. The centers of the upper deadeyes should be about 1 in. above the lower.

The forward shrouds are rigged exactly the same, but with a shorter drift between the deadeyes. There should be five on a side.

The mizzen shrouds set up with double and single blocks, the forward pair coming to the after end of the chainwales, and the other three aside to staples about $\frac{3}{8}$ in. below the top of the bulwark, to which they are fastened by thin cord or wire.

The blocks for the rigging, and nearly all the others, are just oblong blocks of wood with holes bored in them and the corners rounded, one hole in each direction, or in the case of double blocks, two holes together in one direction and one in the other. The sizes are determined by the holes that have to be bored in them to take the cord. Keep them as small as possible.

The mainstay should be three parts of the heavy cord twisted together. It starts above the shrouds and has a large heart turned in the other end, to lie abaft the foremast. From there it sets up, with a lanyard, through the forecastle deck to the stem.

The forestay sets up with a smaller heart to the bowsprit.

Model makers will be glad to learn that ratlines would be incorrect for the period. In place of them there is a Jacob's ladder, abaft the mast. This is easily made. First make some 28 steps from slips of wood not more than $\frac{1}{16}$ in. square and a bare $\frac{1}{2}$ in. long. Then get a double piece of the thick cord, long enough to reach from the mast top to the poop deck. Starting $1\frac{1}{4}$ in. from the loop of this and holding the two parts together, open the strands with a sharp point at $\frac{3}{8}$ in. intervals and slip the steps through. When all are in, separate the cords so that the bare ends of the steps are still through each strand, making a tiny ladder. Bind the top and bot-

tom steps in position with thread. When you are ready to put the top on, pass the loop of this ladder through its square hole and over the mast and fasten the lower ends to staples in the deck so that it is almost upright. A part of the ladder appears in the illustration on the opposite page.

The top must now be made (Fig. 36). Cut a round piece of thin wood $1\frac{3}{8}$ in. in

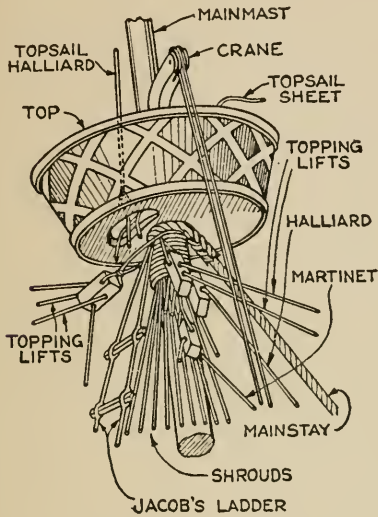

FIG. 36.—The mast top in position on the mainmast directly above the shrouds and mainstay.

diameter. Around this glue a piece of cardboard, so that it flares out as shown and is $\frac{3}{4}$ in. high. This may be painted antique white with red crisscross stripes and may have thin spline moldings top and bottom. It has a hole in the center to fit the mast very snugly where it rests on the rigging. There is another oblong hole abaft this, and three staples are set in the bottom.

The top should also be fitted with a top-crane for hoisting up fighting material, such as arrows and stones. The crane is a curved piece of wood nailed to the floor of the mast top, with a pulley or hole in the protruding end. Fasten the top down on the eyes of the rigging as illustrated above with glue and a small nail through to the mast.

The sails are the next thing to be considered. Any thin "canvassy" looking material, linen for preference, will do. Their size and shape can be seen in Fig. 34. Note that the mainsail proper has a bonnet, which is a primitive provision for reefing, laced to it.

The canvas looks best if it is stitched in rows about $\frac{1}{4}$ in. apart to represent seams. The edges should have a narrow hem and may have a cord sewn to that.

As the rest of the model is being antiqued, the sails also should be treated. Strong tea makes a good base color, with other browns streaked in while the sails are wet, and a restrained touch of green and perhaps red.

Fasten the sails to the yards with heavy brown thread or thin cord. Use a marline hitch, which is the same as a buttonhole stitch. To the leeches of the main- and foresails are fastened thin cord and bead crow's-feet. Those leading abaft are called martinets and those forward bowlines. At the bottom corners of all make loops in the cord or sew on little rings.

The yards are held to the masts by parrels (Fig. 37). A turn of cord will serve for this, but the correct method is to use rollers (beads) and battens (four rows of five beads and five little battens) to keep them apart, with thin cords through both beads and battens.

Halyards are used to suspend the yards. There should be two of heavy

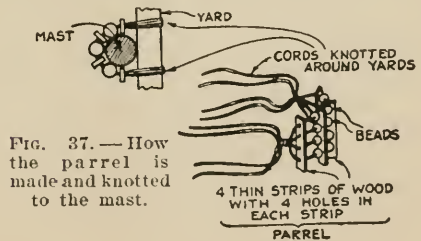

FIG. 37.—How the parrel is made and knotted to the mast.

cord at the main, hitched to the yard near the middle and leading through blocks lashed to the mast, over the shrouds, then down to double blocks, which are connected by thin cords to other double blocks fastened to staples in the deck.

The yards are kept horizontal with topping lifts, two to a side at the main and one at the fore. The cords are tied to the yard, pass through single blocks and back to the yard; from the blocks other cords lead through blocks at the masthead and to the deck.

From the martinets other thin cords lead through masthead blocks to the deck and cords lead from the clews through blocks lashed under the yards to the deck.

To the clews heavy cords are hitched, one part leading aft to a large single block to form a sheet and the other forward for the tack. The tack goes through a hole in the forward bulwark and back through another hole beneath and then forward to form the fall of the fore sheet, its end being fastened to a staple beneath the two holes. A strengthening piece may be glued to the bulwark where these holes come, called a chestree. The fall of the main sheet starts from a bolt in the hull, abaft and below the chainwale, and passes back to a hole in the after bulwark. There will also be a single heavy cord from the clew of the bonnet leading aft.

The main brace pennant is from the yardarm to a large block and its fall comes from a staple in the hull to a hole in the after bulwark.

The fore brace pennant is similar but shorter, and its fall leads from a bolt in the forechains to the post upholding the cow bridge on the opposite side of the deck.

The lateensail at the mizzen has a similar but smaller parrel; a single halyard; an elaborate crow's-foot leading to the mainmast head; a single or double sheet to a short boom extending over the stern, and a tack made fast to the main rigging.

The main topsail is but a small sail. A cord parrel and a single halyard making fast to a staple in the top will hold it. The sheets also lead to other staples in the top, and light braces lead through single blocks lashed to the mizzenmast head. There should also be preventer backstays from the masthead to blocks abaft the mizzen rigging.

Models most frequently have their yards directly across the ship, but it is preferable in a case like this to have them slightly diagonal, or braced in as if for a quarterly breeze, and for this model they were stiffened and belled out. This was accomplished by coating the after sides with thin, tinted casein glue, blowing them out with an electric fan while drying.

The anchor cables are three parts of the thick cord laid together, or other heavy cord; they are hitched to the anchor rings, the ends being glued and nailed inside the hawse pipes, forward and aft.

The flukes of the forward anchors are lashed to staples in the cow bridge and their stocks to the fore rigging. The after anchors are lashed to the chainwales, the cables leading from the cat-holes.

The flags are best made from thin white silk, and painted with artists' water colors. A little gum may be used with the water. Photo stamp colors serve well. The flag at the fore is green on white, and represents the badge of the Band of Discoverers. At the main is the royal standard of Castile and Aragon in red and yellow; at the mizzen the escutcheon of their Catholic Monarchs with the eagle of St. John; and at the mizzen peak, the streamer of the Castile Armadas.

A line of thin white shellac around the edges of the flags will prevent their fraying when cut. The staffs can be of wood or wire; reed chair spline is the best because it bends when accidentally knocked.

Other gay touches may be shields hung on the pavisades. These are easiest made from thin wood. A flat staple in the back of each, representing the arm hold, serves to hang it on a pin driven into the pavisade guardrail. The shields should also be tied in position. The designs given are more or less arbitrary, supposedly the arms of Columbus' companions.

To the mainmast there should be hung a slightly larger shield painted with the arms of Castile and Aragon, perhaps centered with those of Leon. This is to be carried ashore when new lands are

taken possession of. Similarly, a cross on a long staff may be placed by the mizzenmast.

Everything is done now but the base on which to stand the model. Any kind may be used, but the simplest form is advisable. That for the original model consists of two pieces of $\frac{3}{8}$ -in. oak, cut to fit on the bottom of the hull 6 in. apart, with the edges just curved out a little and joined with a square stick of the same wood, projecting through and fastened with wooden pegs.

“SEA SCOUT” RACING YACHT MODEL

Model sailing is a sport for men as well as boys. Boy Scouts, Sea Scouts, and “good scouts” everywhere are building and racing model yachts.

For many, this desire to own and sail a boat finds expression in purchasing a toy boat. At best this is a makeshift compared with building one’s own model



FIG. 45.—The 42-in. racing yacht model adopted as a standard design by the National Sea Scouts.

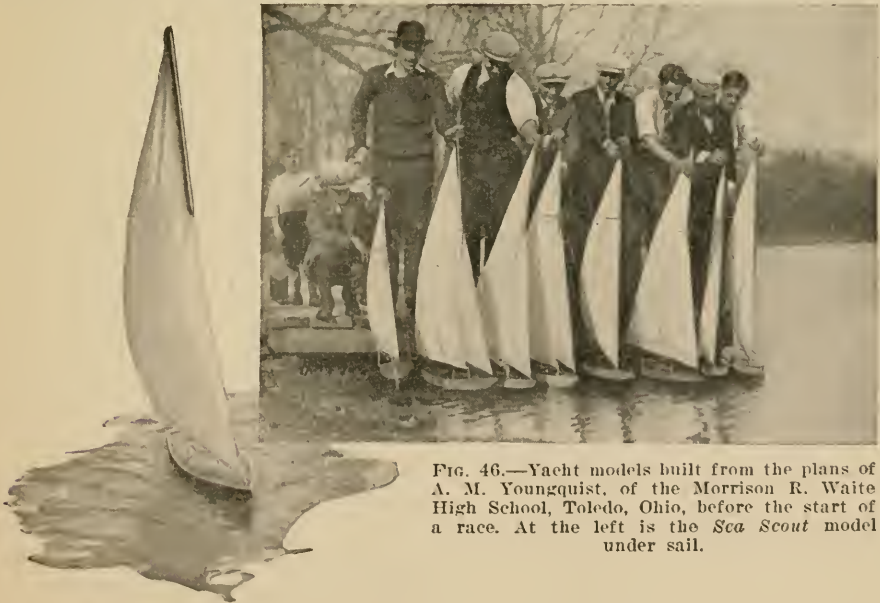

FIG. 46.—Yacht models built from the plans of A. M. Youngquist, of the Morrison R. Waite High School, Toledo, Ohio, before the start of a race. At the left is the *Sea Scout* model under sail.

from carefully designed plans of a yacht that really sails well, and in form and detail is as scientifically correct as any large racing craft.

High school boys in the Industrial Arts Department of the Morrison R.

Waite High School, Toledo, Ohio, who have been building model yachts for years, have experimented with many designs, ranging in size from 20 to 72 in. The most successful design for boys, and the one now adopted for model club and



FIG. 47.—Racing yacht models built under Mr. Youngquist's direction, and hulls in various stages of construction. The large yacht in the background is a 72-in. model.

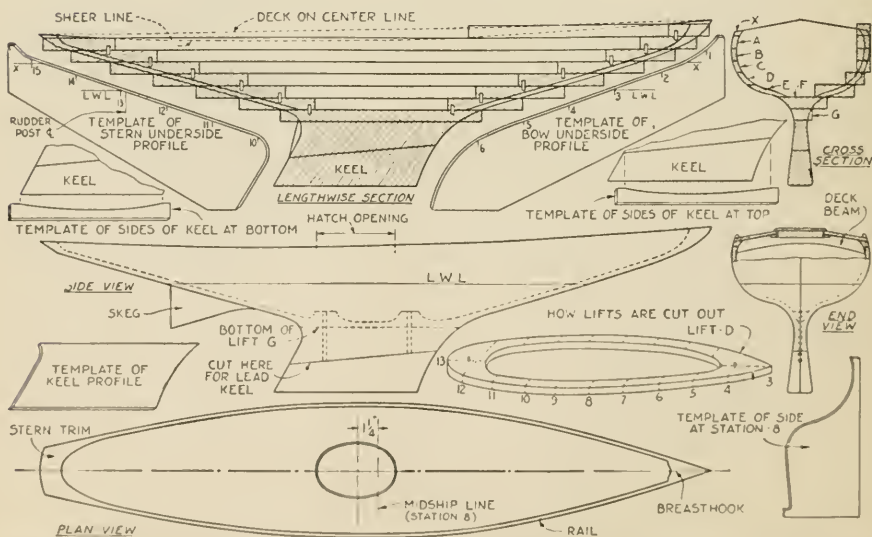

FIG. 48.—Working drawings of the *Sea Scout* hull showing how the lifts are cut out, how they are doweled and glued together, and how the final shaping is completed with the aid of carefully made templates.

interschool competition in Toledo, is the 42-in. model *Sea Scout* (Figs. 45, 46, and 47).

This model has been recommended for adoption as the standard in the model building test by the Sea Scouts. A national program of racing contests in this class is under way in the Sea Scout organization. This is a challenge to boys

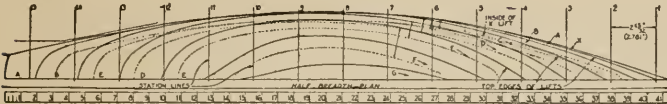

FIG. 49.—Plan showing the shape to which the lifts are cut. For a larger drawing of this and all other necessary plans, blueprints can be obtained. (Refer to the Appendix.)

everywhere to match their skill in building and racing these models. And it must be emphasized here that half the fun is in building them.

The average cost of constructing the *Sea Scout* is between four and five dollars. The materials are easily obtained and no extensive equipment is needed.

Besides a workbench and woodworking vise, the following woodworking tools are required: jack plane or smoothing plane, spokeshave, chisel, gouge, try-square, hand screws, hammer, nail set, screw driver, brace and bits, crosscut and rip saws, keyhole saw, knife, and half-round cabinet, rasp. For making the fittings: flat file, rat-tail file, hand drill and set of drills, tinner's snips, hack saw, two or three small screw clamps, and a soldering outfit. A small metal vise is also desirable.

The hull is constructed on the "bread and butter" or lift method, which means that the seven layers of 3/4-in. wood, marked A to G, Figs. 48, 49, and 50, must be cut accurately to the designed water lines and then glued together. The best wood is well-seasoned, clear white pine or sugar pine without checks. The grade of white pine used by pattern makers is the best, if obtainable. The Philippine wood often used in place of mahogany makes a beautiful model in a natural finish, although it is slightly heavier than white pine. Some of the Waite High School models are built of

mahogany above the load water line and white pine below.

It is advisable to make manila paper half patterns for the lifts.⁶ These can be prepared by fairing the lines from the accompanying table of offsets. First establish center lines and accurately locate sections or station lines at right angles to the center line and 2²/₂ in. apart. On the station lines measure from the center lines the half-breadths given in the table. Bend thin wood strips or splines to pass through these points and draw the water lines.

When the half patterns have been cut out, mark accurate center lines on the wood. Secure a half pattern by means of thumb tacks to one of the pieces and draw a pencil line around the pattern. It is necessary also to transfer the section or station lines to the wood in order later to locate each layer in respect to every other layer.

HALF BREADTHS OUT FROM CENTER LINE									
STA.	DECK	A-WL	B-WL	C-WL	D-WL	E-WL	F-WL	G-WL	D ² -WL
F.P.	0								
1	5/16	1/32							
2	1 7/32	1/16	23/32						
3	2 1/16	31/32	1 23/32	5/16	0				
4	2 13/16	2 3/4	2 5/8	2 11/32	1 11/16	3/16			
5	3 13/32	3 13/32	3 5/16	3 1/8	2 11/16	1 25/32	1/4		
6	3 23/32	3 27/32	3 13/16	3 23/32	3 3/8	2 25/32	1 13/32	1/4	
7	4 3/32		4 3/32	4 1/16	3 7/8	3 13/32	2 1/4	23/32	5/16
8	4 5/32		4 1/32	4 1/32	4 1/16	3 11/16	2 5/8	19/16	13/32
9	4 1/8		4 2/32	4 1/4	4 1/8	3 23/32	2 11/16	23/32	5/16
10	4 1/32		4 3/32	4 3/32	3 5/16	3 7/16	1 7/8	5/32	
11	3 27/32		3 7/8	3 13/16	3 3/16	2 3/4	3/16		
12	3 15/32		3 15/32	3 13/16	2 13/16	5/16			
13	2 31/32		2 15/16	2 13/32	0				
14	2 7/16	2 7/16	2 7/32						
15	1 13/16	1 13/16							* DEADWOOD
TRANSOM	1 1/2	1 1/2							

STATIONS SPACED - 2²⁵/₃₂" LENGTH OVER ALL - 42"
 WATER LINES SPACED - 3/4" LENGTH L.W.L. - 27¹³/₁₆"
 DRAFT - 7" BEAM L.W.L. - 8¹/₈"
 LEAD - 5.3 LBS. SAIL AREA - 735 SQ. IN.
 DISPLACEMENT - 390 CU. IN. RATING - 22

- Turn the half pattern over and draw it for the other half of the water line. Do the same for each lift. Then cut the wood with saw, spokeshave, and plane accurately to the line, leaving square edges.

To simplify the work of hollowing the

⁶The simplest way to prepare these is to enlarge the half size half-breadths plan given on *Popular Science Monthly* BLUEPRINT No. 106, listed in the Appendix. There are two blueprints in the *Sea Scout* set, Nos. 106 and 107.

hull, lifts *A* to *E* are sawed out as shown by a perspective sketch of lift *D* in Fig. 48 and indicated in the views marked "lengthwise section" and "cross section." Use a keyhole or turning saw to cut out the interior of the lifts. Enough stock

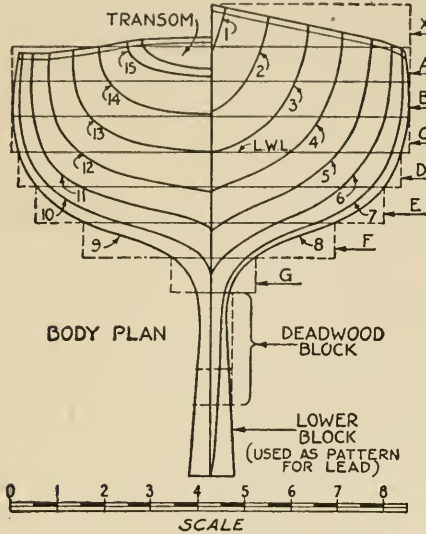

FIG. 50.—Body plan showing the shape or cross section of the hull at the station points 1 to 15 and at the stern.

must be left for at least $\frac{1}{2}$ in. of gluing surface between each subsequent layer, and at the ends an inch or more is left.

Begin with lift *A*, as the interior sawed out may be used for a smaller lift. Fit $\frac{1}{4}$ -in. wooden dowels at both ends to fix the relative position of each layer and prevent any slipping or inaccuracy in gluing up. The station or section lines on each layer must coincide. It is advisable to mark the midship station (No. 8) distinctly on each lift and to make these marks coincide. Care should be taken not to have the dowel holes too deep or they may come through when the outside corners are pared away in the final shaping of the hull.

Before gluing make a careful trial clamping with wood hand screws. If plenty of hand screws are available, lifts *A*, *B*, *C*, *D*, *E*, *F*, and *G* are glued together at one time. If the number of hand screws is limited, one lift may be

glued on at a time. When no hand screws are available, the necessary pressure may be obtained by using weights or by fitting strong backs and bolts for tightening. Care should be taken not to apply too much pressure, which might crack a lift.

A waterproof casein glue, mixed according to the manufacturer's directions, should be used. Casein glue, which comes as a white powder, is mixed with cold water to a consistency of thick cream. It should be stirred continuously for twenty minutes before being used. Mix only enough to finish the job in hand, as it soon hardens and is then unfit for further use.

When the lifts are glued up and the glue has hardened for at least twelve hours, secure the model to the bench top by clamping it with hand screws at lift *A* or by fitting wooden cleats or dogs to the bench top. With a chisel, gouge, plane, and cabinet rasp, cut off the square corners just to the lift edges and sandpaper the whole smooth. This should give the correct shape to the hull.

It is sometimes advisable to make cardboard templates from sections or stations 4, 6, 8, 10, and 12 on the body plan for testing the model form, as indicated in Fig. 51. Leave the forward half of the lift *A* with square edges to

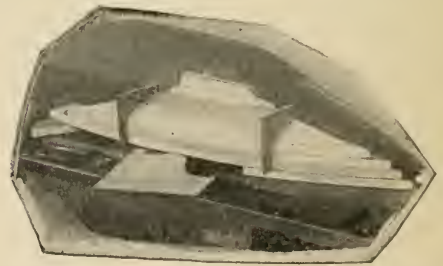

FIG. 51.—How cardboard templates may be used, if necessary, to aid in shaping the hull accurately.

allow lift *X* to be clamped on a little later. Leave the bottom lift *G* with square edges but gouge out part of the interior.

Clamping the model in the vise by means of the square edges on lift *G* is

not as secure as it might be because of the rounded form, so first gouge out the interior at the bottom in lift *F* only sufficient to allow the keel bolts to be inserted. When this is done, cut out to the profile the "deadwood" portion of the

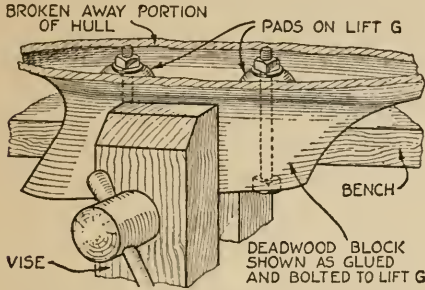

FIG. 52.—A partial view of the rough hull showing it held in the vise by the deadwood.

keel and glue it on, holding it by means of the $\frac{1}{4}$ -in. (or $\frac{3}{16}$ -in.) keel bolts instead of clamps. This deadwood piece now is a firm member for securing the model in the vise for gouging out the remainder of the interior, as shown in Fig. 52. The lower part of the keel block, if made of two pieces temporarily screwed together, will later serve for making the keel pattern.

In gouging out the interior, care must be taken to work with the grain of the wood and to test often so as not to cut through the hull. Holding the hull over a strong light will show if the wood is dangerously thin. The shell or wall of the hull should be about $\frac{1}{8}$ in. thick. Note, however, the pads which are left at the bottom for receiving the nuts of the keel bolts. A plastic wood composition is useful in repairing any defects in the hull, and it acts as a binder when applied over seams on the inside of the hull wherever there appears to be any defect in the gluing.

The next step is to glue lift *X* on the forward half. To save material, this may be in two pieces mitered on the center line forward. Then finish shaping the outside and gouging the inside.

To draw on the sheer line, lay out points with a pair of dividers on each station the distance of the sheer line

from the water line (the glue line) between lifts *A* and *B*. Bend a thin strip of wood or a spline through these points and draw in the sheer line. Cut this line with a spokeshave or a small plane and test by eye to see that the curve is a fair one, without humps or hollows.

A wooden skeg (Fig. 53) just forward of the rudder should be fitted for the best racing results. Younger or less skillful boys sometimes find it difficult to make a good job of this skeg, and it may be omitted if desired. If it is fitted, this should be done next. It is fastened to the hull with glue and long, thin brass screws from the inside, as shown below. The skeg is "streamlined" and given additional stiffness by a heavy plastic wood fillet. The weight of the hull should now be about 1.6 lbs.

Four $\frac{3}{16}$ by 1 in. pine deck beams cut to the proper camber curve are next secured in place by means of brads and

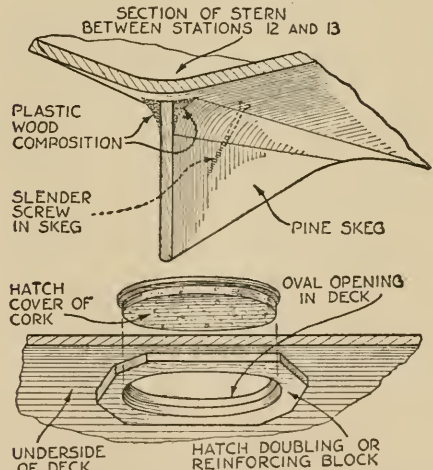

FIG. 53.—How wooden skeg is fitted, and construction of hatch opening and cover.

glue. They are located as shown in Fig. 54. A support $\frac{1}{8}$ by $\frac{3}{4}$ in. is fitted under the deck beam to the shell bottom under the mast to take the pressure of the mast at that point.

The interior of the hull should be painted with two coats of white lead paint before fitting the deck. The deck is made of one piece of $\frac{1}{8}$ -in. clear white

pine or mahogany. It is advisable to cut out the deck to the shape of the hull first, leaving it about $\frac{1}{8}$ in. oversize all around for trimming after it has been fastened down. If the deck is to be plank-marked, the necessary lines should be drawn on it with a hard pencil before it is put in place.

A round or oval shaped hatch opening for bailing out any water and for airing the inside should be cut in the deck (Fig. 53). A $\frac{1}{8}$ in. thick doubling or reinforcing piece should be fitted under the deck around the opening as shown above. A simple hatch cover may be made of two pieces of wood glued together; or better, a piece of mahogany or walnut for the top and a piece of cork to fit snugly in the opening. The underside of the deck should be painted with two coats to prevent its warping when wet.

The deck is fastened to the hull with glue and fine brass screws or brads. The brads should be placed close to the outside edge so as to be covered by the rail and slanted in so as not to come through the outside of the hull, especially fore and aft where the hull slopes in. It should be noted here that unless the oval hatch in the deck is of the size indicated on the plans (sufficiently large to permit access of a hand for tightening the keel bolts nuts inside the hull), it will be necessary to attach the lead keel before the deck is fastened down.

The model next requires the $\frac{1}{8}$ in.

thick mahogany or walnut rail, breast-hook, and stern trim, which are fastened in place with fine brads and glue. However, do not fasten the rail where the chain plates (Fig. 55) are to go, because

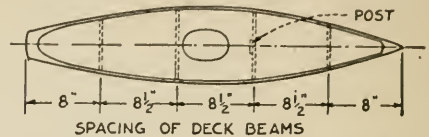

FIG. 54.—Diagram giving location of the four deck beams and the extra vertical support under the mast.

the chain plates must be slipped under it.

As the next step, the entire hull should be smoothed with fine sandpaper and the surface put in as perfect condition as possible.

It is necessary to make a split wood pattern of the lead keel—a pattern split vertically in half the long way. Two short pegs are set in one half of the split pattern to fit in corresponding holes in the other half; these pins should extend about $\frac{1}{4}$ in. and fit loosely in the holes. The pattern should be slightly larger than the finished keel to allow for trimming, fairing to the hull, and smoothing.

For the molding, two molder's flasks and molder's sand of proper consistency and dampness are desirable, although homemade flasks and plaster of Paris (instead of molder's sand) may be used, the latter making very smooth castings.

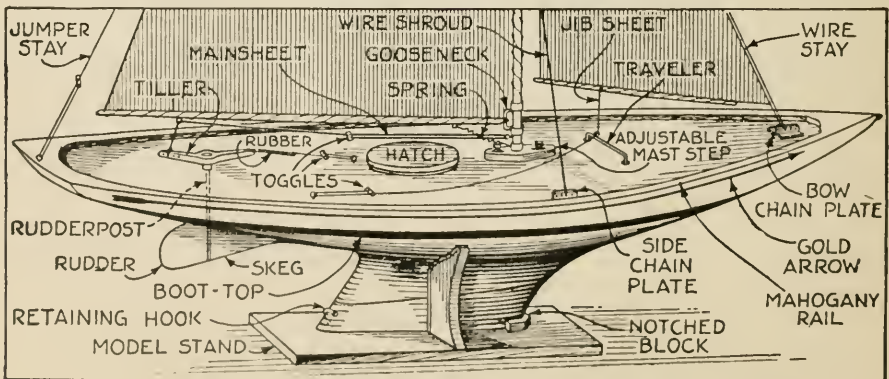

FIG. 55.—The completed hull of the 42-in. *Sea Scout* model showing all the deck fittings and the stand.

Detailed information on pattern making and molding may be found in any public library. It is advisable to obtain such information or to visit a foundry; however, Fig. 56 shows the molding in detail. About 8 lbs. of pure lead are required, also an iron kettle and a ladle for pouring. Lead becomes molten at a relatively moderate temperature, so that the heat from an ordinary gas burner is sufficient.

The cast-lead keel should be smoothed and accurately fitted to the wood hull with $\frac{1}{4}$ - or $\frac{3}{16}$ -in. holding bolts. These may be cast into the lead or tapped into it afterwards; or holes may be drilled all the way through the keel and the boltheads countersunk in the lead. The keel should be trimmed away as necessary to obtain the correct trim and weight, so that the model will float on the designed load water line. Use a generous amount of white lead in the bolt holes and between the lead keel and the deadwood to insure a water-tight job.

A hand plane or any cutting tool may

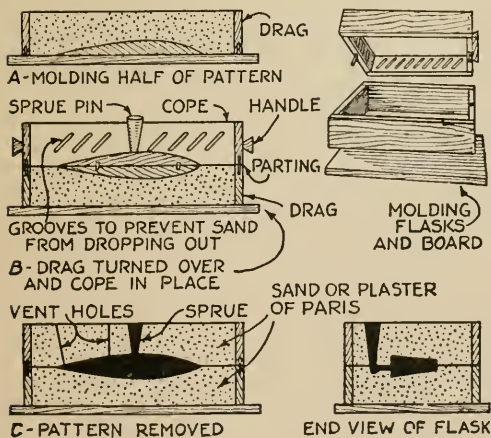

FIG. 56.—How the mold for the lead keel is prepared. Use either sand or plaster of Paris.

be used on pure lead without injury to the tool. A coarse cabinet rasp also is useful for trimming the lead. When the keel is secured to the hull and finally shaped and faired to the deadwood, it should be sanded smooth. The finished keel should weigh about 5.3 lbs.

For the rudderpost (Fig. 57) a $\frac{7}{32}$ -in. brass tube is fitted through the hull. Care should be taken to drill close to, and in line with, the after side of the

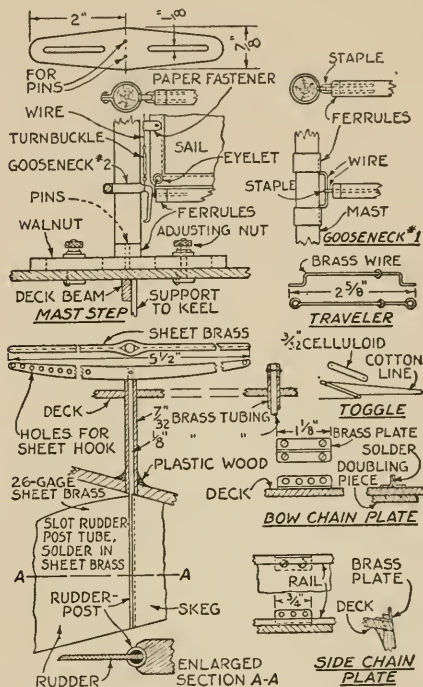

FIG. 57.—Mast step, rudder, two types of gossenecks, toggles, traveler, chain plates.

rudder skeg. Threading the outside of the rudderpost tube at the lower end and turning it into a hole in the wood slightly smaller than the tube insures a tighter job. It is advisable to use white lead in this hole also.

The model should be carefully cleaned and sanded with No. 00 sandpaper preparatory to applying the paint and finish. The model may be painted, enameled, varnished, or lacquered in a variety of suitable colors. For a paint or enamel job, a thin priming coat of white lead and oil is applied. Care must be taken not to paint out the load water line—the glue line between lifts C and D. A narrow stripe—"boot-topping" or "boot-top" for short—of contrasting color is usually painted between the topside paint and the bottom paint. A strip of

adhesive tape, cut to the boot-top's measurements, may be applied to the hull while painting above and below. When removed, it leaves a clear-cut line of the desired width for the boot-top painting.

At least three coats of any finish should be applied and each coat (except lacquer, which should not be sanded between coats) lightly sanded with No. 00 sandpaper. The final coat should be rubbed with pumice- or rottenstone and

or walnut rail, a white enameled topside, a red boot-topping, and a marine green bottom.

Between coats, while the paint is drying, the builder can make the fittings and spars (Fig. 58). The mast and booms are made of clear, straight grained white pine or spruce, planed square to the required dimensions. The corners are then planed off to an octagonal shape, and finally the remaining corners are planed off, too, and sandpapered smooth and round. The spars should be varnished. A standard $\frac{1}{2}$ -in. brass ferrule and two pins are fitted at the bottom of the mast, as illustrated in Fig. 57.

The mast step is made of mahogany or walnut and secured by means of No. 8-32 brass machine screws with adjusting nuts on top.

The rudderstock is made of $\frac{1}{8}$ -in. brass tubing slotted on one side with a hack saw to take the 26-gage brass rudder, which is then soldered in. The tiller is made of the same sheet brass, bent double and riveted or pinned to the rudderpost. Holes are drilled in the tiller for the sheet line hook. This permits the shortening of the lever arm to suit the pull on the tiller, which varies according to the wind pressures. The rudder, when completed and fitted in place, should be free to swing back and forth at the slightest pull on the tiller.

The chain plates are of sheet brass, bent and drilled as shown. The brass fittings may be polished with fine emery cloth and lacquered bright, or they may be nickel plated or, of course, painted.

A simple gooseneck (that marked No. 1 in Fig. 57) can be made with brass ferrules and brass wire. Gooseneck No. 2 is very satisfactory but more difficult to make.

German silver wire is excellent for the stays, but bronze wire also may be used. The stays should be tightly looped around the mast (36 in. above the deck) over fine cotton cord lashing, varnished in place so as not to slip down. Turnbuckles in the 1-in. size can be purchased from several supply firms. The jumper stay from the mast tip to the taffrail aft should be light cotton cord or fishline

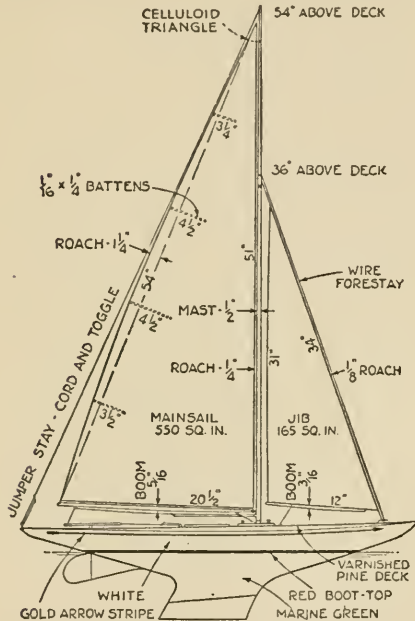

FIG. 58.—Dimensions of masts, spars, and sails, and suggestions for painting the hull.

oil. A high-grade standard finish should be used, and the varnish must be of the quality known as "outside spar."

If desired, a gold or bronze arrow stripe may be painted just below the deck line. The name should be painted across the stern transom.

One of the most attractive Waite High School models is built of mahogany, the topsides being filled with light brown paste wood filler and varnished and rubbed. The bottom is marine green, the boot-topping a gold bronze. Another attractive color combination is a pine deck in a natural varnish finish, a mahogany

with a toggle adjustment. The toggles are made of celluloid, bone, or hard maple, with a small hole at each end in which the cord binds or grips when the pull is at an angle. These toggles permit of rapid adjustment.

To aid in keeping the sail flat and to prevent the boom from lifting, a light spring or a rubber band is secured about 2 in. from the end of the boom to the mast step.

The jib sheet traveler may be made of brass wire (about 18 gage), bent as shown, with the eyes sufficiently large to take small oval-headed brass screws.

The sails may be made of Egyptian spinnaker cloth, balloon cloth, union silk, or high-grade cambric. Two-ounce spinnaker cloth is satisfactory and may be secured through any canvas dealer.

It is advisable to make full sized manila patterns of the sails. In order that the weave may take the strain without stretching out of shape, it is essential that the leech (after edge) of both sails be parallel to the selvage edge of the cloth. Draw around the patterns with a sharp, soft pencil. This line represents the finished size of the sails, so a cutting line should be drawn $\frac{3}{8}$ in. outside of the pattern to allow for a $\frac{1}{4}$ -in. hem. Baste the hems carefully and, for the most satisfactory results, sew them on a machine with silk.

A triangular piece of celluloid is cemented and sewed inside the hem at the head of the mainsail to keep the corner flat. The batten pockets, which are sewed on, may be of tape with selvage edges or of the sailcloth (with the raw edges turned under). The outer ends of the pockets are left open until the celluloid or wood battens are inserted, and then these edges are closed with hand sewing.

To take the strain of the hoist and thus prevent undue stretching of the sailcloth, a strong cotton draw string may be threaded through the hem at the luff (forward edge of the sails) and made fast at the corner eyelets. The draw string should be just taut enough to permit a full hoist without puckers in the hem.

In each corner of the sails a metal eyelet is inserted with an eyelet punch; but the punch should not be used to make the preliminary holes or the eyelets might work out. The holes should be pierced or stretched open with an awl or bodkin. If an eyelet punch is not available, the holes may be buttonhole stitched.

The simplest method of attaching the sails to the mast is by lacing them with a needle and a linen thread through the hem of the sail and around the mast. A neater arrangement, and one which readily permits of dropping the sails, is to run a fine German silver wire fitted with a turnbuckle from the gooseneck to the mast tip. This arrangement is shown on the same detail drawings as gooseneck No. 2. The sails are attached to the wire by means of brass paper fasteners of the type indicated; these are pressed into the hem of the sail. It is advisable to fit two or three fine open hooks along the mast, into which the wire can be snapped to prevent its sagging from the mast.

In bending or securing the sails to the spars, they should not be stretched at all. Allow them to lie evenly and comfortably along the booms with the out-hauls easy.

A small 2- or 3-in. silk American yacht ensign (or, less correctly, the American flag) may be sewed to the cord jumper stay. If a model yacht club is organized and a club flag is adopted, a miniature of this may be flown from the mast tip. For club racing, a black racing number of the size and location directed in the rules of the Model Yacht Racing Association of America should be sewed to the main sail.

A stand for the model should be made. A simple one is constructed of a $\frac{1}{2}$ by 7 by 14 in. plywood baseboard with an upright support at its center, the latter cut to the shape of the hull amidships and extending from the bottom of the keel to the load water line. This center support should have felt glued to the narrow contact surface in order to protect the finish of the model. A hook locks the model securely to the stand

CHAPTER X

PAINTING AND DECORATING

THANKS to the great popular interest in home painting and decorating which has developed in recent years, all the ordinary problems are reasonably well understood. Indeed, the paint manufacturers distribute such excellent literature on all phases of the household use of paints, varnishes, enamels, and lacquers, that there is little excuse for repeating the information in a book of this type. What follows in this chapter, therefore, are a number of suggestions on processes and treatments with which the average amateur is not so familiar or upon which no complete, practical information is readily available elsewhere.

REFINISHING AN AUTOMOBILE WITH LACQUER

If modern methods are employed, it is not difficult to refinish an automobile at home. Quick-acting chemical paint removers and electrically operated paint sprayers are rapidly replacing tedious scraping and brushing operations.

The cost of a small motor-driven spraying outfit can be more than saved by doing the job in one's own garage, and the outfit remains to become a permanent and valuable addition to the home workshop equipment. Several reliable, ruggedly built outfits are now on the market, priced under fifty dollars.

Although not hard, the work takes time—for a novice, about forty hours of actual working time. With lacquer finishing there is no waiting for paint to

dry, as one side of the car will dry while the other is being sprayed. The car therefore need not be out of commission more than a week or ten days, which is about the time required by a professional finishing shop.

Before the work is undertaken, the following materials should be assembled. The quantities listed are sufficient for a sedan having a 120-in. wheel base and will cost about twenty dollars.

- 3 quarts paint remover
- 2 quarts red oxide of iron primer
- 2 quarts undercoat (color similar to finish)
- 2 quarts finishing lacquer for final gloss (sometimes called "retarder thinner"; it contains approximately 80 per cent thinner and 20 per cent body material)
- 1 gallon lacquer (total for one or more colors)
- 5 gallons lacquer thinner
- 1 tube glazing putty
- 1 gallon high test gasoline
- 1 gallon benzole
- 1 steel scraper
- 2 steel scratch brushes, one 2 by 6 in., and one $\frac{3}{4}$ by 6 in.
- 6 sheets No. 2/0 emery cloth
- 6 sheets No. 280 waterproof sandpaper (also numbered 8/0)
- 6 sheets No. 400 waterproof sandpaper (also numbered 10/0)
- 2 rolls masking tape (if two colors are to be used)
- Sufficient tin to be cut into 3-in. strips for holding paper over the windows.

First, have the running gear washed at a garage under high pressure water and specify that the wheels be washed with gasoline to remove all grease. Then remove all easily detachable accessories, plated side lamps, and door handles. The engine hood should be taken off and

used to experiment with; that is, every unfamiliar operation should be tried first on this part. Cover the wheels, engine, tires, and top with paper or rags (Fig. 1).

Proceed to remove the finish as follows: Brush a coat of paint remover on the hood and allow it to stand until



FIG. 1.—Cover the motor, wheels, and top with paper or old clothes before applying the paint remover.

the finish crinkles up; then scrape the loose material off with the steel scraper (Fig. 2). As some patches will be harder to loosen than others, another brushing should be given and the remover allowed to stand twenty minutes while a part of the body is being brushed over. The second treatment will loosen all but a few traces of paint in the corners and along the edges of the metal. Remove the thoroughly softened residue by scrubbing with the larger steel brush (Fig. 3). Continue this process over all the steel parts, not overlooking the underside of the hood, but under no circumstances allow the remover to come in contact with any of the wooden parts.

All the steel should now be rubbed with the emery cloth until bright and clean, special attention being given to corners around windows and pressed in or raised parts of the body and seams which form any sort of decoration.

If the wheels are to be refinished, they may be removed and the tires taken off, but this is usually done after the body is finished, as the process is much simpler.

Before proceeding further, run the

car out and sweep up the dried finish scraped from the body. Also sweep down the walls of the garage and remove anything that would be injured by spots of lacquer. It is not necessary or desirable to wet down the walls or floor as in the case of other methods of finishing; in fact, the final three coats of lacquer should not be sprayed on in rainy or humid weather.

All the usual precautions should be observed in regard to fire. There must be no smoking nor open flames in the vicinity of highly volatile liquids, such as the gasoline, benzole, and thinner.

Good ventilation is also essential, for, although the fumes of lacquer solvents have a pleasant banana odor, continued breathing of the atomized material itself might cause dizziness to anyone unused to it. Keep a window and the main door of the garage open unless the breeze is too strong. If one is especially sensitive to strong fumes, a small respirator, costing fifty cents, may be worn while one is operating the sprayer.

Neatness and cleanliness are equally



FIG. 2.—Scraping off the old finish. The crinkled finish peels off easily when softened by the remover.

essential in the actual application of the priming coats and the finishing lacquer.

Start with the hood, which should be set up on an old table or box and given another good washing with benzol. Do

not run over the surface hurriedly, but rub it hard. After it seems as though nothing could possibly be left, rub the whole surface with a lintless cloth dampened with thinner. During the cleaning, remember that the edges and seams require the most attention.

Mix a pint of rust inhibitive red oxide of iron with a pint of thinner and fill the jar of the spray gun three quarters full. Start the motor and try the spray

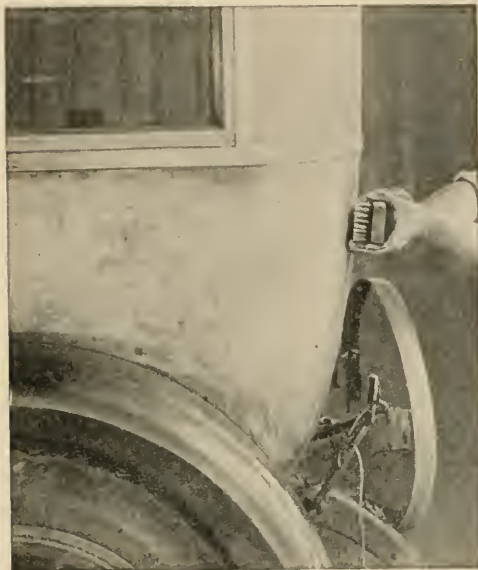

FIG. 3.—Thoroughly clean the body of all old paint by "scratch brushing" it with a stiff wire brush.

against a piece of tin. If the mixture is of the right consistency, a smooth, even coat will be deposited. A lumpy or pitted surface indicates that the liquid is too heavy and should be cautiously thinned further. If it sags or runs, it is too thin and more primer should be added. Now spray the hood all over the outside, keeping the spray constantly in motion and held about 8 in. from the surface. Move the spray at an even speed back and forth horizontally and keep it pointed directly at the surface at all times. Start the gun in operation away from the work and swing it on while spraying. Lap each parallel deposit about one quarter over the previous

stroke. Never stop the gun abruptly on the work; swing it away so that any necessary joining of sprayed surfaces will be "feathered."

Do not be startled by the appearance, as the correct color is bright orange. Allow the primer to dry one hour and inspect for "wet spots." If there are only a few small shiny places ($\frac{1}{2}$ in. in diameter or so), they may be overlooked because they will disappear as more of the finish is applied. If there are many spots or streaks, or one or two large spots, wash off the whole coat of primer with the thinner and scrub again with benzole and thinner. When judgment of cleanliness has been developed, apply the primer over the entire body.

Between each filling of the paint jar, it should be half filled with thinner, shaken, and operated a few seconds to flush out the tubes and nozzle. If the gun does not discharge freely, partly clogged tubes are to blame; do not turn it against the car again until a full spray is delivered. It is well to have three or four extra mason jars on hand, one for clear thinner and the others for different colors.

Do not apply a heavy coat of primer, just enough to cover the metal thoroughly. Allow it to dry at least an hour and sandpaper lightly with the No. 280 paper or equivalent, using the paper dry.

The hood may now be given three coats of surfacer, each coat following the other at intervals of at least twenty minutes. The surfacer behaves somewhat differently and is harder to lay evenly on account of its quicker drying qualities. Special pains must be taken to dilute it sufficiently to prevent the formation of a rough "orange peel" surface. A little over fifty per cent of thinner will be required.

It is advisable not to stop the gun until the jar of material is completely sprayed, otherwise the tubes will clog slightly. If this happens, spray some thinner through the gun. After learning how on the hood, proceed with the body. Do not be disturbed if the coat looks somewhat rough in spots; the sanding operations will eliminate all traces of

such unevenness. However, it saves labor to lay the coat on smoothly in the first place.

Now go over the surface for visible file marks or depressions and fill them with glazing putty. This should be allowed to set overnight and then scraped and sanded flush with the surface. The car should now be given a water sanding with waterproof sandpaper. Under the paper hold a piece of folded cloth, and keep it well soaked with water. Rub rather gently, making only three or four passes over any one spot. To check the smoothness of the surface, rub the fingers along the sanded parts as the work proceeds and resand all places that do not feel glass smooth. If any spots are rubbed through, the place should be re-sprayed after washing with gasoline and wiping with a cloth dampened (not wet) with thinner.

The whole car should now be washed with gasoline and wiped with a lintless cloth to prepare it for the lacquer finish coats (Fig. 4). Three coats are required, using a fifty per cent dilution.

If two colors are being used, spray the upper one first and then cover it with paper bound on with masking tape. Spray the other color in the same manner as the first. If a molding strip is to be still another color, cover the surface on each side with the tape before spraying. Do not attempt to peel the tape off for at least two hours after the last spraying, and then only after thoroughly soaking it with water applied with a paint brush. This will prevent any of the finish being lifted off with the tape.

The whole car is now to be sanded again with No. 280 paper soaked in gasoline and held over a cloth pad as before. Sand gently and make strokes "every which way" until a glasslike surface is obtained. Wash thoroughly with gasoline and give another sanding, using the No. 400 paper. Wash again with gasoline and wipe clean of all free color which has been sanded off. Spray on two coats of retarder thinner. This will smooth all traces of unevenness in tone and leave a natural gloss, which may be further heightened with any of the

standard auto polishes compounded for lacquer finishes.

To refinish the wheels, sand with gasoline and with waterproof sandpaper, just enough to smooth the old finish unless the coating is badly flaked off, in which case the entire finish should be removed.



FIG. 4.—The sprayer should be held at about 8 in. from the work and kept in motion at all times.

Spray on three coats of finishing enamel, several varieties of which are available in quart sizes.

To complete the work, spray the underparts of the fenders with two coats of black lacquer; an inexpensive enamel will do if diluted with turpentine. The top should be painted with a brush in the regular way; that is, brushing lengthwise and using the dressing just as it comes from the can. If any work is required on the inside of the car, use a brushing lacquer on the instrument board and spar varnish for the molding around the windows. If any striping is required, the car should be taken to a professional striper, as a steady, experienced hand is necessary for this finishing touch.

As a precaution against the chipping of the finish, run a safety razor blade along the edge of all metal moldings be-

fore the finish has thoroughly set. Cutting down to the metal in this way will prevent any slight movement of the parts from breaking the glass-hard lacquer surface. Save any small portions of material left over as it will come in handy for the purpose of retouching scratches or scraped fenders.

WHAT UNDERCOATS TO USE

The question of what undercoat to apply for some specific painting job is one that generally bothers the amateur painter, but the selection of the proper priming coat is little more than following a few common sense rules.

For all general purposes undercoats can be divided into four classes: for use under enamel, varnish, lacquer, and flat wall paint.

In enameling, the procedure is to build up a foundation of flat undercoats before the final finishing coat or coats of full enamel is applied. The process is substantially the same regardless of the surfaces being finished. However, where new woods of the open-grain type are to be finished, the pores should be filled with paste filler. This also should be done on previously finished open-grain woods from which the old coatings have been removed with paint and varnish remover.

The material generally used for enamel undercoats is a prepared "enamel undercoater," sold at most paint stores for the purpose. White lead and oil paint is also used, but the home craftsman usually avoids mixing his own paint. Flat wall paint also makes a good enamel undercoat. While it is softer than the specially prepared undercoaters and therefore does not make quite so hard and firm a foundation, it has the advantage of coming in a variety of colors.

The prepared undercoaters generally come in white only and are adapted for use under white enamel and the light tints of ivory, cream, and gray. The amateur painter will find it better, when enameling in stronger and brighter colors, to use flat wall paint of a color closely approximating the enamel finish.

Any skipped or too thinly spread-out places will not be so apparent when there is not so great a contrast between the undercoating and the finishing coats.

The surface should be rubbed down with fine sandpaper (No. 00) to platelike smoothness before the first coat, and lightly between coats, to remove brush marks and level off nibs, bits of grit, and dust. The loose particles must be dusted off thoroughly.

Just a word about the application of enamel undercoats. A three-coat job is generally used for white and the light tints, as follows: first coat, flat undercoater; second coat, a mixture of equal parts of flat undercoater and enamel; third coat, full enamel.

Yellow pine, cedar, cypress, and similar pitchy, resinous, or oily woods, should be sealed over with a coat or two of thinned shellac before starting to build up the enamel foundation, as it prevents the pitch or oily substance from coming through and discoloring the finish.

In the refinishing of mahogany and other dark, stain-finished, woods with light colored enamels, a sealing coat of shellac should be applied before the first undercoats; this will prevent the stain from bleeding through in the majority of cases. It is, however, almost impossible to apply a light enamel finish satisfactorily over some types of penetrating red mahogany and cherry stains.

The most practical way to build up a varnish foundation, especially for the home finisher, is to apply as many coats of varnish as necessary over a foundation provided by the use of paste filler, if the wood is of the open-grain type.

The filler, which ordinarily comes in paste form either in a light or "natural" color, or stained dark, is reduced with benzine or turpentine to about the consistency of heavy cream, and is applied to the surface with a brush. After standing a few minutes until it commences to set—this is indicated by a dulling out or loss of gloss—it should be vigorously wiped off with a cloth, across the grain. Care should be taken that every bit of the filler is removed except that which has entered the pores. Allow the work to

stand for at least twenty-four hours, until the filler in the pores has dried. The surface is now ready for the finishing coats of varnish.

Liquid fillers are used to some extent on close-grain woods, where paste filler cannot be forced into the pores. Although it is a general practice in the varnish finishing of interior woodwork and floors of close-grain woods to start applying the varnish directly over the wood without any undercoat material of any kind, a liquid filler may be used to advantage on furniture and other surfaces where the finest finish is desired.

Some finishers also apply a coat of liquid filler to open-grain woods after the paste filler has dried thoroughly hard, to fill the tiny wood cells that are not filled by the paste filler, thus giving an absolutely smooth surface and permitting a finish of mirrorlike appearance. Liquid filler is applied with a brush and after it is thoroughly dry is rubbed down close to the wood with fine sandpaper or steel wool.

A brushing lacquer, which dries a few minutes after application, is somewhat different from other finishing materials. It is reasonably satisfactory without undercoats. In the first place, though it does not have any wood-filling properties to speak of, its make-up is such that it seals over the surface, very much as shellac, instead of soaking into it as do painting materials made with oil and turpentine. Therefore it will stand out on the surface fairly well without the use of an undercoating. It also has better hiding power than the transparent enamels; hence, surface discolorations are usually hidden and a solid covering finish obtained with two coats of lacquer without the use of undercoats.

For the finest possible lacquer finish on new work, however, open-grain woods should be filled with paste filler (as previously described for varnish undercoats). Close-grain woods also may be brought to a better finish if liquid filler is employed to fill the small pores.

A practice favored by many is to apply a wash coat of thinned shellac (regular four-pound cut shellac reduced

with about an equal part of denatured alcohol) as a primary coat. Since lacquer can be applied perfectly over shellac, this method may be regarded as good general practice for the amateur finisher. Of course, the advantage of this sealer coat is much greater in the case of the softer woods, and with the extremely soft woods the use of shellac is almost necessary for satisfactory results, unless several extra coats of lacquer are applied.

The use of shellac as a first coater in refinishing old painted, varnished, enameled, and stained surfaces with brushing lacquer also renders the use of the lacquer more satisfactory.

Prepared undercoaters for use under lacquer are sold by some manufacturers. They combine the qualities of a sealer with a higher solid content than the lacquer itself, thus adding fullness and richness to the finish. These should be used according to the directions accompanying the particular make of undercoater that is being used.

In conclusion, a word should be said about undercoats on interior walls. It is absolutely necessary that bare plaster walls which have never been previously painted be given a sizing coat to seal over the extremely porous plaster. If this is not done, an indefinite number of coats could be applied to the surface, soaking in as fast as applied, without producing a satisfactory finish.

Regular wall size or varnish size (sold at all paint stores), mixed with equal parts of the wall paint being used for the work, is extensively employed for the sizing coat. Prepared wall primers also are now available in most localities; in these the size is already incorporated, making a very convenient form of material to use. Either type of material is thoroughly satisfactory.

FOUR-HOUR FINISHES

The utility of the quick-drying brushing lacquers is well known to amateur painters, but the relatively new varnishes and enamels that dry in four hours appear to be less familiar, perhaps because they are a later development in

painting materials. With them you can refinish a floor or other woodwork in the evening and use it the next morning, or you can apply one coat in the morning and a second in the afternoon.

These exceptionally convenient and durable finishes can be obtained at all up-to-date paint stores in the larger cities, and in the course of time they will be available everywhere.

As they undoubtedly mark another great step forward in finishing materials, especially from the standpoint of the home owner and amateur painter, a word about their manufacture will not be amiss. They are not merely old-line varnishes and enamels with the drying forced by driers to the impairment of their durability, but an entirely different product, made possible through the use of a new form of synthetic resin. This is produced from formaldehyde and phenol and is closely allied to bakelite. It is used in making the four-hour varnishes in place of fossilized varnish gums. After being incorporated with linseed oil, china wood oil, and other materials in accordance with the formula of the particular varnish being made, it is cooked over varnish fires of the standard type. The enamels, of course, are a combination of four-hour drying varnish with the necessary pigments to give the desired coloring.

Let us now compare these new quick-drying materials with ordinary varnishes and enamels. Which is preferable is entirely a matter of whether or not quickness of drying is of importance. If there is ample time for drying, there is no reason for using the new type materials. In most homes, however, quick drying is a great convenience, if not of extreme importance. This is true where there are children in the household, especially in the varnishing of floors, from which it is next to impossible to keep the little folks until the varnish has dried.

Even with varnishes that normally dry overnight, the weather and the temperature of the room have so much to do with their drying that often they are still tacky or sticky the next day; and sometimes under unusually unfavorable

conditions, it is at least forty-eight hours before the finish has become thoroughly hardened. With the four-hour drying materials there is never the least question about the finish drying overnight.

As to appearance, there is no difference between the finish produced by the new and old materials. The four-hour materials also are quite as easily applied as other varnishes and enamels.

Now let us compare the four-hour finishes with the cellulose brushing lacquers which came in with almost startling suddenness a little more than two years ago and have since enjoyed great popularity. It is not likely that four-hour varnishes and enamels will be used to any great extent in the field in which brushing lacquers have been almost exclusively used up to this time; their field is one in which the brushing lacquers have never been extensively used. Lacquer has been used largely for finishing unpainted novelty furniture, such as magazine racks, tilt top tables, and the like, and for refinishing chairs and other small pieces of furniture about the house. For such work it is seemingly best adapted. There is a very definite advantage in being able to go right over the surface with a second coat almost immediately after finishing the first coat and also in applying the trimming colors and finishing the piece at one time. There is a fascination in using materials that dry before your eyes. Besides, the semidull sheen of lacquer finishes is very pleasing to the majority of people and corresponds with the sprayed lacquer finishes of the highest-class furniture. With the improvements that have been effected in brushing lacquer during recent years, the home worker as a rule has no difficulty in using them for the finishing of small pieces.

When it comes to comparing the four-hour varnishes and enamels with lacquer for such requirements as the finishing of floors and interior woodwork, the advantages are in favor of the newer materials. The varnishing of a floor, for instance, is a different matter from doing a small end table or a sewing cabinet. It is not so easy to apply the cellulose-

type lacquers on a large surface of this kind and handle the brush so deftly that laps will not show. This also is true of interior woodwork. Very little brushing lacquer has been used for this purpose by home decorators, although professional painters have made effective use of lacquer finishes in some public building work of the better class.

The durable new four-hour varnishes and enamels, on the other hand, are just the thing for floors and woodwork. They can be used as easily on large surfaces by the amateur painter as the ordinary varnishes and enamels which he has been accustomed to use.

In summarizing, the best current practice for amateurs seems to be as follows:

Brushing Lacquers. Use for unpainted furniture and woodenware novelties, for refinishing furniture, and for all similar decorative requirements.

Four-Hour Varnishes and Enamels. Use for floors, interior woodwork and other architectural requirements.

Standard Varnishes and Enamels. Use for all purposes where a varnish or an enamel finish is desired and there is ample time for the surfaces to dry before use.

It should be remembered, of course, that there will always be those who have a decided preference for either an enameled or a lacquered finish, as well as certain individual requirements which may make one or the other way more suitable. The preceding classification is purely for the convenience of those who have had little or no experience with the various finishes; those who have used them to a reasonable extent will understand the differences from actual experience and can use their own judgment.

Four-hour varnishes and enamels may be applied over either new wood or previously painted, varnished, enameled, or lacquered surfaces. Prepare the work in the usual way in respect to cleaning, sandpapering, and dusting.

Generally speaking, the handling of the new materials is the same as the old-line varnishes and enamels; however, a few precautions should be taken. Being generally of a heavier nature than the

ordinary varnishes and enamels, they should be flowed out in a thinner coat than has been the usual practice. The surface cannot be brushed for as long a time and a closer watch must be kept for sags, runs, and other defects. Formerly some painters made it a practice to coat a considerable amount of surface before going back and "picking up" runs with a corner of the brush, but it will be found that this cannot be satisfactorily done with the four-hour drying materials.

While durability was sacrificed to some extent in the first finishes of this type placed on the market, improvements have been discovered, until now many of the high-grade makes of four-hour drying floor varnishes have practically the same durability under hard wear on floors as long-oil and spar varnishes of well-proved quality.

NOVELTY FINISHES FOR ART WARES

The vogue for home painting and decorating offers many opportunities for making smart gifts at a cost far less than their actual worth and market value. Because of their individuality, such gifts are far more appreciated than ones that are bought. Boxes, book racks, book ends, and novelties finished in the modernistic fashion and in colorings to correspond with the decoration and furnishings in the home of the recipient, are gifts of real personality.

New treatments and fashions are being constantly brought into popularity. At this time the trend is toward the modernistic—angles, triangles, rectangles, and geometrical forms. The use of *pure* color in the decoration of furniture, accessories, and art wares is a prevailing characteristic, as is the use of rich gold and silver for edgings.

After objects have been finished in the usual manner with enamel, lacquer, or other painting materials, we can decorate them in any of the following ways.

First, with art transfer patterns (decalcomanias). Modernistic designs have been developed by transfer manufacturers, and many decorative requirements, therefore, can be easily met from

patterns available at up-to-date paint stores. The method of applying transfers will be described in detail in a following section. Usually the manufacturer supplies brief instructions with the transfers.

Stencils are also obtainable in nearly every locality. Since the advent of sprayers, stenciling has been used extensively for the decoration of furniture novelties and accessories. The stencils should be held very tightly against the



FIG. 5.—Modernistic design applied to a potted plant holder by the new and very simple method of using masking tape, as illustrated in Fig. 7.

surface to guard against blurred or ragged edges.

Pins or tacks cannot be put into fine art wares and furniture, but a stencil usually can be held down with weights around the edges, or holes can be made in the stencil at intervals around the edges and gummed paper or pieces of tape placed over the holes and pressed through onto the surface being decorated. Ordinarily this will not leave any mark on the surface, but in case it does, the remaining adhesive can be readily removed with a cloth moistened with water or a mild mixture of half gasoline and half water.

When stenciling is done with a sprayer, any type of material may be used—enamel, lacquer, or paint. The surface

surrounding the stencil design must, of course, be protected from the spray. Cut a hole a little larger than the design part of the stencil in wrapping paper or newspaper and place the mask on the surface you are decorating. Then fasten the stencil in position over the hole, letting its edges overlap the mask.

When stenciling is done by pouncing with a brush, lacquer has a tendency to pick up the undercoatings; if carefully done, however, it can be put on through the stencil openings with a soft camel's-hair brush.

Oil colors reduced with turpentine are ideal for stenciling, but, of course, give a flat finish. The design can be brightened up, however, with a coat of clear varnish or lacquer applied with a small brush over the design part only, or as a protective coating over the entire surface.

Another method of obtaining modernistic designs, and one which permits more individual treatment, is to take a suitable design in the new dress goods or draperies or from a magazine illustration, trace it on a sheet of oiled paper, and cut a stencil with a sharp knife or razor blade, leaving the necessary "ties" at frequent intervals to prevent portions of the design from dropping out.

Those with a talent for free-hand drawing can make original designs for stencils or paint directly on the piece being decorated. In modern art, the expression of one's personality is unhampered by precedent or traditions; and motifs, while taken largely from nature, are rendered in cubist style, or geometrically, or in other novel ways.

The use of "masking tape" often helps in painting modernistic angular ornamentation (Figs. 5, 6, and 7). The tape temporarily covers portions of the surface to keep them from being coated with the colors you are applying.

Regular masking tape is sold by dealers in the large cities who sell supplies to automobile paint shops. However, gummed craft paper tape used for wrapping packages makes one of the best kinds of masking tape. It has a straight edge, is tough and durable, and comes

off easily without disfiguring the surface. Craft tape can be obtained in cities from large commercial stationers and wholesale paper houses. It comes in various widths and costs little. In smaller towns it usually can be had at some factory or store that uses tape for wrapping.

Angular designs of various forms can be produced by pasting strips of tape on the surface so tightly that there will be no opportunity for the paint to run



FIG. 6.—After it has protected one part while another is being painted, the masking tape is peeled off.

under the edges. When the paint has dried, the paper will generally peel off readily, but in case it does stick, it can be soaked off with water.

Masking tape also will be found useful for striping borders. Along the edge of the table top or whatever is being decorated, coat a strip about an inch wide with the color desired for the border stripe. Then cut a piece of tape the width of the stripe and of the necessary length. Cut it with a knife and straightedge to be sure the edges are absolutely straight. Paste this down and then coat the entire surface with the body color. When the color is dry, peel off the tape to expose the straight, even stripe of border color.

The use of gold and silver for edging and otherwise ornamenting furniture and art objects is effective with any type of



FIG. 7.—Gummied tape is used to make masks for shielding certain parts of the design before painting.

decoration. While the most widely used method of gilding is to brush on a mixture of gold bronze powder and a bronzing liquid ("banana oil" or some other type), a much stronger, brighter color with greater depth and richness is obtained by coating the surface with japan gold size, and, as soon as it gets tacky, pouncing on the gold or silver bronze with a chamois or soft cloth (Fig. 8). Surplus particles should be blown off.

The very finest gilding, of course, is



FIG. 8.—Dusting gold bronzing powder on a jewel box previously coated with japan gold size.

done with pure gold leaf. This may be applied by the home decorator if done with extreme care, although it is really a job for the skilled craftsman.

Metal leaf, gold and silver, and substitutes for them come in small sheets

with thin paper between. The surface to be gilded is coated with japan gold size put on evenly and only where the leaf is to adhere. Necessarily, the size must be applied over a well sealed surface so that it will not soak into the wood.

As soon as the size becomes sticky or tacky to the proper degree, a sheet of the leaf is removed from the box, lifted

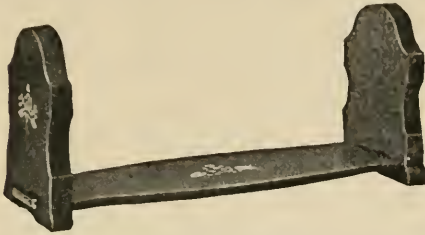

FIG. 9.—Chinese red bookrack, sponge stippled with gold and bright green and decorated with transfers.

gently by a corner, and laid on the tacky size. It is then smoothed out with cotton batting and patted down.

Where small or narrow surfaces are being gilded, the leaf may be cut to the desired size with a razor blade. Wherever one piece of leaf overlaps another, the laps are allowed to remain until the size has dried hard, when all surplus portions of the leaf are wiped off.

The gilded surfaces, if not to be subjected to much handling or wear, may be left without a protective coating, but if they are to receive any amount of hard wear, they should be coated over with a thin, pale varnish, which may be rubbed with fine pumice stone powder and oil if it is not desired to leave them in a gloss finish.

Among other new finishes are the stippling lacquers recently brought out under various names. Artistic work can be done by stippling them on with a sponge after the piece has been lacquered with a suitable foundation color (Fig. 9). Stipple effects are especially suitable for use in panels and surfaces inside of a molding or a border, or for a finish around a panel of ornamental design.

Stippling lacquers usually are furnished in the form of a colored bronze powder and a special liquid preparation

in two separate tin compartments. The bronze powder and liquid are mixed together immediately before use, and only as much should be mixed as will be needed for the particular work, because the material does not keep well after being combined.

For stippling, use a close-grained sponge. Soften it in water and wring it out practically dry; then dip it, flat side down, into the stippling mixture, which can be poured out on a plate, saucer, or even a piece of paper folded to several thicknesses. Tap the sponge a few times on a sheet of paper to remove the excess; then tap it lightly on the surface to be decorated.

It is often desirable to go over the surface two or more times to even up the effect. A second or third stipple color



FIG. 10.—Candlestick with marbled finish obtained by drawing it through a film of floating colors.

may be applied by cleaning out the sponge with lacquer thinner or using another sponge, and going over the surface again in the same way.

Another type of treatment particularly suited for gift wares is what is generally termed "spatter" finishing. Small spatters of color are flecked onto a plain-

color background by dipping a brush into the spatter color, wiping it off on the edge of the container until only scant full, and then striking it against a stick or the back of the hand to jar off countless tiny specks of color onto the surface being decorated.

Two or more spatter colors may be applied, one following the other. A fine or coarse brush may be used, according to the effect desired, and a little practice will soon develop uniform workmanship. Either one or two strokes should always be made against a sheet of paper or other trial surface to make sure the brush is not too heavily loaded with paint or enamel.

An enamel finish is generally used for the background and enamel of a harmonizing or contrasting color for the spatter work. The spatter color should be thinned a little. If applied while the foundation coat is still wet, the spatters will sink level with the surface, but if the ground coat has become dry, they will lie on top of the surface in a raised or pebbled effect.

Another novelty treatment that produces a remarkable blending of colors is as follows: Fill a deep dish with water and drop a little of each of three or four colors of enamel on the surface of the water. Run them together somewhat with a spoon or small paddle to form a pattern like marble.

The object to be decorated, as for instance the candlestick in Fig. 10, is then let down into the water by means of a wire loop, and pulled up slowly through the film of enamel floating on top of the water. This coats the surface with a finish of unusual beauty.

With a few practice dippings, anyone can get the knack of the operation. Unsatisfactory attempts can be wiped off with gasoline. After being dipped, the object should be allowed to drip and dry. Suspend it over a newspaper by means of a hook formed on the other end of the loop of wire.

Now that we have covered various methods of home painting and decorating, we shall take up the art of preparing gifts at low cost.

GIFTS AT LOW COST

Artistic and genuinely desirable gifts can be prepared at absurdly little expense if you know the secret. It is just this: Buy well designed but cheaply finished novelties and art wares, or else get entirely unfinished articles, and decorate them yourself by the methods just described or by any of those to be outlined in this section.

All manner of things may be decorated (Fig. 11). Vases, candlesticks, flower holders, bowls, book ends, plaques, boxes, door stops, salt and pepper sets, cake boards, wooden spoon and fork sets and the like may be found in ten-cent stores, variety shops and hardware and house furnishing stores. Woodenware, glass, pottery, china and metal articles may be purchased unfinished in artists' supply and department stores. And in every home there are already many objects waiting to be redecorated.

Polychroming is one simple and effective method of decoration. It is the application of a plastic composition, which is stippled into textured or relief effects and then colored, bronzed, and wiped off to produce a multicolored surface.

Various plastic materials are employed. Gesso clay or Italian clay, sold in small cans, is extensively used, as is plastic wall paint. A gesso preparation may be made by mixing together about $\frac{1}{2}$ pt. whiting, $\frac{1}{4}$ pt. liquid glue, and 3 teaspoons each of varnish and linseed oil. The proportions may be varied slightly as necessary to produce a composition of good working consistency; it must be sufficiently stiff to stay put when modeled into relief effects.

The material is brushed on to the surface or applied with a knife. After it has set for a few minutes, it is stippled in various ways. A brush, spoon, spatula or paring knife may be used to produce scrolls and fanciful designs. Confectioners' icing tools or pastry ornamenting tubes are sometimes used for more elaborate designs.

When thoroughly dry, the surface is usually given a sealing coat of shellac or special size adapted for that purpose.

With some plastic compositions this is not absolutely necessary, but it is always a safe practice. It may then be given any color treatment desired.

A typical method is to give the surface a foundation coating of gold, silver, copper or green bronze, or a suitable tint

oughly dry with other colors handled in the same manner. One color peeps from beneath the edge of another, producing beautiful effects. Frequently the polychroming is completed entirely with bronze powders—first a foundation brush coat of gold, silver or any desired



FIG. 11.—Wall plaque, made from a color print, covered with cheesecloth and shellacked so that it resembles an oil painting. The frame is polychromed gesso. Below: "Pour-finished" preserve jars, one with a transfer design, and other articles bought for ten cents each and lacquered in any colors.



of flat wall paint, enamel or lacquer, and then to use for the polychroming either oil colors, flat wall paint, glazing colors or the new brushing lacquers. The glazing colors are applied with a brush. Before they have commenced to set, they are wiped with a cloth from the high spots and other places, as may be desired. One or more colors may be applied and wiped off, followed when thor-

shade, then a coating of japan gold size, and a "patting" on of bronze powders of other colors with a piece of velvet.

"Pour finishing" is one of the newer forms of treatment. Brushing lacquer seems to be especially adapted for this work, both as to working properties and appearance. The only supplies necessary are several cans of lacquer of different colors and a drip pan, which may be

any pan, plate, or other shallow receptacle.

The object to be decorated is placed in the drip pan and one color of lacquer poured over it so that it runs down the sides (Fig. 12). If the object is set up on a block a little smaller than its base, the color will drip off and not form a bead around the bottom edge. Before the color has commenced to dry, another color is poured on, or as many colors as may be desired, until the surface is entirely covered. The lacquer runs down in irregular streaks and stripes, blending in fanciful formations and producing the most exquisite effects.

A little variation of the treatment will cause a different appearance. For instance, if each color is allowed to dry until it becomes "tacky" before the succeeding color is poured, there will be less blending and a more definitely streaked effect. Still different blends can be made by those with freehand or china-painting experience by pouring on one or two colors and working up scrolls and other designs. Vases, cruets and bottles of artistic shapes also are sometimes decorated by pouring the lacquer into the object and twirling until the entire inside is colored; the excess lacquer is then poured out. By pouring in two colors, a unique streaked effect is obtained. The pour finish is not wasteful; surplus lacquer is poured back into the can. Vases so decorated cannot be used for flowers; standing water may loosen the paint.

Spraying allows the amateur to produce many shaded and stippled effects. Inexpensive sprayers for the purpose are sold by some paint dealers, and an ordinary insecticide spray gun may be used.

Regular brushing lacquer may be sprayed quite satisfactorily with this equipment by reducing it from $\frac{1}{2}$ to $\frac{1}{3}$ thinner, which must, however, be made by the same manufacturer as the lacquer. Some practicing should be done to learn the manipulation of the sprayer, and the spray should be used rather cautiously.

Frosting is a pleasing effect, which may be obtained by blowing gold, aluminum, green or copper bronze powder from a paper onto an enameled or lacquered surface while it is still wet. On a lacquered surface it is necessary to work speedily before the quick-drying lacquer commences to set.

Texturing colored prints is another new idea. Fine prints such as are found in magazines or bought at a nominal cost can be given an appearance closely resembling that of a real oil painting.



FIG. 12.—How a preserve jar or any inexpensive piece of pottery may be decorated by pouring lacquer over it.

Lay the print, picture side up, on a clean, perfectly level surface, and place a piece of cheesecloth over it. Then apply a coat of shellac over the cheesecloth, brushing it out evenly and thoroughly into the meshes. As the shellac dries, it will cement the cheesecloth to the print. The texture gives a surprising softness and richness to the print and makes a truly artistic picture, which can be framed, passe-partouted or mounted on a plaque and polychromed, as desired. It may be used without glass, as the shellacked surface will permit wiping off with a damp cloth whenever necessary.

The cheapest grade of cheesecloth,

very sleazy and with wide meshes, should be used. The better grades, which are closely woven, hide the picture too much.

The cheesecloth should be shaken just before using to remove loose pieces of lint. In some cases the shellac "bleeds" the colors in the print and causes them to run a little, but this is seldom objectionable. The colors generally seem to blend together so that the effect under the meshing is quite delightful. If the picture does not show through plainly enough, apply a second coat of shellac.

ART TRANSFERS

So popular has become the use of transfer patterns on commercial furniture and art wares that it is surprising more home workers have not taken advantage of this decorative vogue. Many, of course, do not understand how easily transfers are applied and still fewer amateur decorators appreciate the variety of brilliant effects made possible by these designs.

The decaalomania (*de-kal-ko-mania*) transfers, as they are called, have been



FIG. 13.—The application of a transfer design of this type will give a piece of painted furniture a really artistic touch.

used in the furniture trade for years to give expensive pieces the artistic finishing touches they need. Now they are available, too, in almost all department stores (usually in the paint or art materials departments), as well as in many neighborhood hardware, wall paper, and paint stores; and they are carried by the larger mail order houses. An almost endless variety of designs, motifs, colorings,

shapes and sizes can be thus obtained.

A transfer is nothing more or less than a paint film attached temporarily to a paper backing. When applied to enameled or lacquered furniture or other finished surfaces, the paper backing is moistened and removed, the paint film being left attached to the surface.

Some transfers are quite flat, while others have a texture and depth that make them appear almost as if hand painted. The best types have virtually the appearance of hand painting; you can see the brush marks!

The main use of transfers is, of course, on painted furniture, that is, on pieces which have already been finished with white or colored enamel or lacquer. They are used less often, but frequently with striking effect, upon natural finished furniture—pieces that have been stained and varnished. The many ways in which this can be done are best learned by observing closely good examples in a high class furniture store.

Among the most popular motifs are *floral* designs, which are appropriate for almost every decorative purpose. *Ships* are much in vogue at present, although their use is more restricted, as are *bird* and *fruit* designs. Many colorful *nursery* pictures can be obtained; these work wonders in brightening up both the furniture and permanent woodwork in children's rooms. *Silhouette* transfers fill the need for a contrasty, posterlike style of treatment (Fig. 13). *Medallions* are useful for more formal decorative work. Other classifications from which one can choose are *conventional* designs, which are for the more formal pieces; *oriental* designs resembling the work of Chinese and Japanese artists, especially desirable for red or black lacquered radio cabinets, secretaries, chests, telephone stands and so-called occasional pieces in oriental color schemes; *landscapes*, for rather ornate painted furniture in period designs, and *Colonial* designs, which are now enjoying great popularity.

If you decide which of these classifications is most appropriate for the piece you wish to decorate, you will find the process of choosing appropriate trans-

fers will be much easier than if you make a hasty and haphazard hunt through the large variety of samples of all these types which you will be shown in any well-stocked shop.

In addition to these classifications, there is another type of transfer intended especially for use over natural finished furniture, which gives the effect of inlaid bandings and inserts. So perfect are some of these that it is almost impossible to tell them from actual inlays, although they can be obtained for a fraction of the cost and require none of the skill which genuine inlaying calls for.

When you have decided upon the type of design you wish, make up your mind



FIG. 14.—A center line on the back of the transfer is a great aid in placing it centrally and vertically.

as to the approximate size. It should be proportionate to the surface on which it is to be applied. The tendency is to select a design that is too small. The shape, too, should correspond to the surface on which the transfer is to be used.

Your good taste will govern in selecting the coloring. If you can take a small sample of the background color with you when buying transfers, it is a simple matter to choose.

Some articles can be decorated with almost any type of pattern. A magazine rack, for instance, would be in good form decorated with any motif with the exception, perhaps, of fruit. Breakfast sets are generally done with four corner designs. Card tables and other small tables often have a central design combined with corner pieces and occasionally a narrow border is run entirely around the table top or connected with the corner

designs. Linal borders are obtainable for this purpose in 2-ft. lengths.

You will find that the back of each transfer usually is marked with vertical and horizontal guide lines. These are to



FIG. 15.—Varnish or other adhesive is applied to the transfer and allowed to stand until "tacky."

aid you in centering the design and applying it exactly horizontal or vertical (Fig. 14). If there are no guide lines, trim the top of the transfer paper to a straight edge just above the design and mark the vertical center line.

Make careful measurements before applying transfer and do not rely merely upon your eye. The best design will not be satisfactory if off center or crooked.

A thin, quick-drying varnish is an ideal adhesive for transfers, as it is elastic and does not cause puckering. The various proprietary adhesive cements

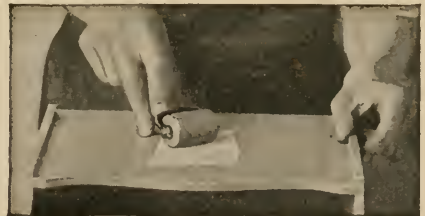

FIG. 16.—The transfer is pressed down, from the center outwards, with a rubber roller or a cloth.

made on a varnish base also are usually excellent. A good grade of liquid glue is often used by home decorators because it is so convenient; its adhesive properties are entirely satisfactory, but there is some tendency for glued trans-

fers to draw and pucker up while drying.

Apply a thin, even coat of the adhesive selected to the face of the transfer, covering every bit of design (Fig. 15). Allow to stand until the adhesive is "tacky" or sticky. Place the transfer on the surface to be decorated and rub

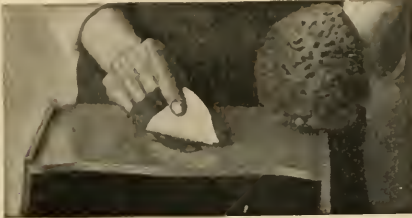

FIG. 17.—After being saturated with water, the paper backing is either lifted up or slipped off.

down hard with a cloth or, preferably, with a rubber roller such as is used for mounting photographs (Fig. 16). Work from the center outwards to avoid wrinkling.

Next saturate the paper backing with lukewarm water. Wait about thirty minutes before doing this, however, if glue has been used as an adhesive. If any air bubbles are seen after applying the water, smooth them with the roller. Then lift or slide off the paper backing as shown in Fig. 17.

Clean the surface immediately by sponging with water (Fig. 18). In case the transfer has been applied with varnish, the water will not remove surplus deposits of varnish, so go over the entire surface a second time with gasoline diluted about 50 per cent with water. No hesitation need be felt in doing this if the surface, whether paint, enamel, lacquer or varnish, is thoroughly dry, as it will not appreciably affect its appearance. Even should the finish become streaked for some reason or other during the application of the transfers, it can be polished with furniture polish or wax to restore the luster.

It is important to wash up the surface at once after removing the paper backing because the gum remaining on the face of the transfer is otherwise almost

certain to pucker and crack the design.

Even the best of transfers sometimes seem a bit temperamental and occasionally one may go wrong, but if reasonable care is used, there will rarely be any difficulty.

If one has had any experience in art work or decorative painting, it is often possible to touch up designs with artist's oil colors so as to bring out the high lights and shadows and tone down or change the colors, where necessary, to bring the design more in harmony with the body color. If well done, this makes the design appear wholly hand painted. It is frequently resorted to by professional furniture decorators.

Whether a protective coat of varnish should be applied over the transfers depends upon the individual piece, how it will be used, and the effect desired. If it is going to have any hard wear over the decorated surface, as, for instance, in the case of a breakfast table or the back of a chair, the transfer must be protected; otherwise the hand-painted effect will be most fully preserved by leaving the transfer uncoated.



FIG. 18.—The surface is cleaned first with clear water, then with gasoline diluted with water.

Varnish, when used as a protective coating, is generally applied with a small brush, following the outline as closely as possible. This gives a glossy luster to the design and changes the effect considerably. Clear brushing lacquer may be used and, as it has not so high a

gloss, gives a more artistic effect than varnish; indeed, it is an ideal coating for this purpose. Clear lacquer does not, as one might expect without trying it, "pick up" the transfer colors or cause them to "bleed." Flat varnish also may be used; it dries without gloss, but has little wearing qualities.

Sometimes a pleasing effect is obtained by coating the entire surface of lacquered articles with clear lacquer. One should always make sure of the effect in advance, however, by trying a small sample, as this treatment will change considerably the appearance of a colored lacquer finish. If the piece had been finished with enamel instead of colored lacquer, do not conclude that varnish can be similarly used over the entire surface, because it gives a distinctly yellow tone, especially over light and delicate tints.

After making a few experiments with decalcomania transfers, you will find you have at your command one of the most inexpensive and attractive methods of decoration ever developed for furniture and craft work.

ENAMELING FRONT DOORS

Although we expect much of the front doors of our homes, we pay scant attention to them once they have been selected to give the right atmosphere and architectural detail. There is, however, something else besides the character and design of the front door that conveys to guests their first impression of the home, and that is its state of preservation.

Too many fine doors with outside exposure have come to be a source of annoyance because the finish has crumbled away, faded or blistered in the sun, or because they have warped badly or even show signs of falling apart on their hinges.

For the exacting service of finishing doors it must be remembered that only the finest paint, enamel, varnish, or lacquer should be used. Furthermore, every inch of the door must be protected, not merely the front and back faces and the lock edge. Even painters, in their

rush to finish a job taken on a price basis, often fail to coat the top and bottom edges of doors to seal the surface against moisture. And what is the use of sealing the front and back if we leave the top and bottom edges to draw up water like a sponge?

Some doors, particularly those of the flush-panel type, consist of a soft wood core of many small pieces glued together and veneer glued on the exposed surfaces. Even if waterproof glue has been used in the construction of a door of this kind, it will be affected by moisture unless well protected with a waterproof finish, and if ordinary glue has been used, it has about as much chance to hold together in the presence of moisture as a Japanese lantern.

Doors made of planks or of solid wood stiles with solid panels will withstand water reasonably well, but they are likely to warp as much as $\frac{1}{2}$ or $\frac{3}{4}$ in. out of line unless well protected. Doors are made from very dry wood, and it is well known that unless they are given a coating of some protective material the minute they arrive at a new building they are likely to absorb enough moisture, if only from the damp air, to cause them to warp.

This section will describe in detail the application of enamels of the varnish-base type (not brushing lacquers).

Be sure to choose an enamel made specifically for exterior wear. It will cost from \$5 to \$8 a gallon, but you will need only about one quart for a door. Exterior enamel usually comes in white alone, but sometimes it can be obtained in light tints. White enamel can be tinted by adding to it a little of the desired color ground in japan—that is, in varnish. If only a small amount of color is needed for a very light tint, it is possible to use the more common and easily obtained tinting colors ground in oil. In either case, thin a little of the color with turpentine and break up the lumps, if any, of course; then strain it through cheesecloth before adding it to the white enamel.

Before the enamel is applied, however, a new door should have at least

two coats of enamel undercoater. This also must be of a type made for exterior use. An enamel undercoater for interior wear may turn gray or black when exposed outside. In place of a prepared

second coat, use the straight undercoater.

One of the best brushes for applying both the undercoats and the enamel is a 2- or 2½-in. flat varnish brush. You must have a good one.

A convenient procedure is to remove the door and stand it on the front or back edge. Paint the top and bottom edges, hang the door again, and paint the front and back edges. Then paint the front and back faces. In the case of a four- or six- or eight-panel door it is well to paint the edges, then the moldings on the edges of the panels, front and back, then the panel faces, and finally the remainder of the face surfaces.

As to the handling of the brush, avoid stretching the enamel undercoater out too much. While it should be firmly brushed into contact with the surface, it should not be spread to make a very thin film, as is done with outside paints. Applying the enamel is a bit more difficult. Fill the brush well and, except on the edges, apply the enamel with the idea of covering about one square foot with a brushful. Just flow it on and do not brush it any more than you must to distribute it evenly. Repeat with a second brushful and do not work over the first area until you have coated in about a square yard.

Then wipe the brush on the side of the pot until all surplus enamel has been worked out, and brush over the surface which you have coated. This is to distribute the enamel finally and to pick up any excess. Repeat this series of operations until the whole surface has been coated. Watch closely for about twenty minutes. If too much enamel has been put on in places, it will sag or "curtain." If you act quickly you can brush out the enamel evenly again and eliminate any defects.

In enameling the panels or in working around lights of glass in a door, as in Fig. 19, be careful to avoid leaving too much enamel on the edges of moldings and in the corners.

Each coat of enamel undercoater should be rubbed lightly with No. 00



FIG. 19.—Applying the first coat of enamel on a front door.

undercoater, you can use a coat of white lead thinned with a mixture of three parts turpentine and one part boiled linseed oil.

An old door that has been varnished should first be sandpapered well with No. 1 paper to cut the gloss. If the old varnish is simply dull or shows fine hair-line cracks, there is no need to remove it. If, however, it is scaling off, sandpaper hard enough to take off all the varnish. Unless it comes off easily, use a liquid varnish remover, which will hasten the work.

If you have to finish an old door from which all the varnish has been removed, use as a first coat the enamel undercoater as it comes from the can (Fig. 19). If some of the varnish remains, however, the first coat of enamel undercoater should have a few ounces of the enamel added to it to make it take a firmer hold on the old surface. For the

sandpaper—merely to cut off any dust and dirt nibs. Then wash the surfaces clean with a sponge and water and let them dry before painting again.

If a hand-rubbed effect is wanted on gloss enamel, wait two or three days until the second coat of enamel is hard and then rub it with fine powdered pumice stone and water on a piece of soft felt tacked to a block of wood as in Fig. 20. Fold the felt over the ends of



FIG. 20.—For the finest effect on a front door, the enamel is rubbed smooth with pumice stone and water.

the block and place the tacks in the ends; otherwise they would scratch the surface. Wet the enamel with water, wet the felt, and pick up some of the dry pumice stone. Rub with an even pressure up and down, that is, lengthwise of the boards, and do the same amount of rubbing on each division of the area.

Do not rub the moldings and door edges, as it is very easy to cut through the enamel at such places. At most give these places one or two strokes with the rubbing pad, or use a short stiff bristle brush.

If a noticeable amount of dust collects on the first coat of enamel, it is well to water-rub it instead of merely sandpapering it lightly. Do not rub any more than is necessary to cut off the gloss.

The task of rubbing enamel is not nearly as hard as amateur painters are likely to imagine. By stroking off the

sludge with one's thumb and inspecting the surface, it is easy to see just how far the rubbing process should be continued to give the smooth, satiny appearance which is so greatly prized and is always indicative of the highest grade enamel work.

A satisfactory effect can be obtained without rubbing through the use of a special semiflat drying enamel instead of a high gloss enamel. The last coat of this type of enamel does not require to be rubbed.

There is something to be said, too, in favor of using high gloss enamel and letting the last coat stand without rubbing. It is claimed that an unrubbed gloss enamel resists the elements a little better than one which has been rubbed because it presents such a tough, smooth, and unbroken film. Furthermore, the shiny glare of a newly enameled door, even if it is not rubbed, becomes softened quickly enough in most localities because of the dust and soot in the atmosphere and the consequent necessity of frequent washings.

PAINTING RADIATORS

After remaining for years unchanged as an object of often garish and commonplace appearance, the radiator now is yielding to the artist's touch, like all our household furnishings.

Radiator covers to protect walls and curtains from dust, as well as to beautify the appearance of the heating coils, have come into common use. Recesses sometimes are left in the walls for the radiators so that they can be wholly or partially concealed; and in some new houses built-in radiators are provided. In finishing radiators when they are exposed to view, color combinations are being used to harmonize with the general decorative scheme.

If the proper colors and types of finishes are chosen it is now possible, because of researches which have been conducted by engineering societies and universities, to save many dollars in your coal bills. That is because you can choose a type of finish that will cause

practically no impairment in the radiation of heat as compared to other finishes which may retard radiation as much as fifteen per cent.

By refinishing radiators before the fire is started for the coming winter, the home

owner in contrasting color. When a wall of plain color constitutes the background, the color may be matched with flat wall paint.

For radiators that stand in front of paneled woodwork in enamel finish,



FIG. 21.—Radiators are now decorated to harmonize with their surroundings. A good time to refinish them is before the fall fire is started. At right: Applying a stippled coat with a sponge to match a so-called Tiffany finished or mottled wall.

owner can improve the appearance of his rooms with very little effort and at small cost. The essential idea is to make the radiators less conspicuous. This is accomplished by using colors that blend with the background. In certain cases, however, a necessary accent in a room can be obtained by decorating the radi-

ator in contrasting color. When a wall of plain color constitutes the background, the color may be matched with flat wall paint. If a good match cannot be obtained in standard shades of wall paint or enamel, you can use oil colors, which come in tubes or small cans especially for tinting pur-

poses, to tint a standard shade until it does match. Your dealer will tell you the proper tinting color to use, and by experimenting with small quantities you can mix the color you need.

If the wall decoration is wall paper of a pronounced pattern or paint-stippled or Tiffany two-tone blended effects, the ideal treatment for the radiator is stippling (Fig. 21). This will harmonize with the background perfectly.

The first step is to make sure that the radiators are in good condition for re-painting. They must be thoroughly clean and free from grease and dust. Wash them with soap and water. Clean any greasy spots with gasoline, and scrape and sandpaper all scaling or rusty places.

If the radiators happen to be new and never have been painted, or if the finish is in a very bad condition, apply a priming coat of red lead-in-oil and boiled linseed oil, or other rust-inhibitive metal paint.

Give the radiator two solid covering coats of flat wall paint of the desired foundation color. The stippling then may be done in two ways.

The simplest method is to apply the color with a sponge cut across the grain to give a good painting surface. Pour some of the stippling color on a board or a piece of paper, dip the sponge into the color, tap it out two or three times on a piece of paper to remove the excess paint, then pat it straight onto the radiator without twisting or turning. Reload the sponge with color and continue the process until the entire surface has been covered. When the paint is dry, a second and even a third stippling color may be applied in the same way. The sponge should be washed out in gasoline and thoroughly cleaned with soap and warm water after it has been used with each color.

The other method of applying the stippling color is often termed polychroming. After the foundation coats have been applied, the stippling color is brushed on and worked into the scrolls and embossing of the radiator. Then it is wiped from the high spots with a cloth so that in some places only the foundation coat

is seen, in others only the stippling coat, and in others a blend of the two.

For this work oil colors or specially prepared glazing or mottling colors, thinned with glazing liquid or flattening oil, are most satisfactory. The advantage of the prepared glazes is that they do not set up as rapidly as turpentine, and speed in handling them is not so necessary. The strength of the colors may be governed by varying the proportions of the thinner. In no case should too much surface be coated with a stippling color before the wiping off or mottling is done.

Two- or three-tone effects may be produced by spotting on two or three different colors at the same time and then blending them together with a stippling cloth. The mixtures must be prepared in separate containers and put on with separate brushes. This treatment is, of course, especially suited where the wall decoration is Tiffany paint stippling; it goes well with mottled and blended wall papers and the new plastic wall paint finishes.

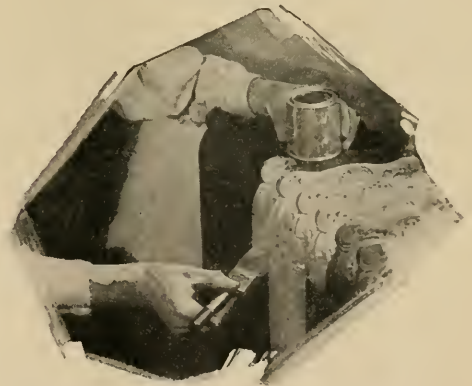

FIG. 22.—Flat-drying paint of the kind often used for walls is ideal for decorating the radiator coils.

The highest efficiency in radiation is obtained with flat paints and enamels (Fig. 22). There appears to be a very slight advantage in favor of the flat finishes over the enamels. Gold, bronze, and aluminum finishes (flake metal finishes) have been shown to be less efficient when applied to radiators because the surface does not dissipate the heat into the room

as rapidly as it is transmitted through the metal of the coils. That does not mean that the metallic finishes must be removed from the radiator in order to allow it to release the maximum amount of heat. If coated over with any good paint or enamel, the surface will not retard the heat and the efficiency will be increased. The improvement will be from nine to (in a few special cases) eighteen per cent, according to comparative tests of radiator finishes reported by William H. Severns, of the University of Illinois, in the "Journal of the American Society of Heating and Ventilating Engineers."



FIG. 23.—With a sprayer, whether hand, foot, or motor-driven, it is easy to finish radiators.

The new brushing lacquers also are of high efficiency in respect to the radiation of heat. They are very nearly the equal of flat wall paint; and, like it, they will withstand the heat to which radiators are subjected.

The hand, foot, electric and vacuum-cleaner paint sprayers now so common are especially adapted for use in finishing radiators, which have so many irregular surfaces and hard-to-get-at places. The wall behind and the floor beneath, of course, must be thoroughly covered, and the painting material has to be used in a thinner consistency than for brush coating (Fig. 23).

After being decorated, the radiators should be warmed up slowly the first time they are used to allow the finish to bake slowly on the surface.

OIL RUBBING FURNITURE

When all the necessary patching and repairing have been done to a piece of antique furniture and the old finish has been removed, one of the best ways to refinish it is by rubbing it with oil and polishing it with wax.

You may wonder why the removal of the old finish should be delayed until after the patching has been done. That is because it is not the best practice to wash off surplus glue from newly made joints. If the gluing is done before the old finish is removed, the surplus glue comes off with the old finish. If the finish were removed first, the surplus glue would have to be scraped off, and the scraping would mar the surfaces.

Genuine boiled linseed oil is the best agent for giving a deep, lustrous appearance to old wood. Brush the oil out thin so as to apply no more than will be absorbed by the wood. The oil will require from twenty-four to seventy-two hours to dry thoroughly, the time varying with the temperature.

There are a number of opinions as to how linseed oil should be applied—whether full strength or diluted, whether boiled or raw. A very hard wood will not absorb as much oil as a softer one, so it is well to examine the wood and dilute the oil enough so that all will be absorbed. A good practice is to use one part boiled oil and one part turpentine for all wood, but to apply more than one coat if the first coat sinks in so that it is clear the wood will absorb more. If too much oil is applied, the surplus will dry on the surface and must be removed with steel wool—a very tedious and annoying job. It should, therefore, be avoided.

The accepted method for refinishing antique furniture is to leave it in the natural wood, that is, to polish the wood without the use of stains or varnish. If this finish is desired, allow the piece to stand a day after removing the old finish so that the varnish remover will evaporate entirely; then oil the wood and allow ample time for drying.

If the patches appear new and of a lighter color than the surrounding wood,

there are a number of ways in which they may now be treated:

1. Make a paste of dehydrated lime and water, the consistency of thick cream. Apply this paste about $\frac{1}{16}$ in. thick to the new wood, let it stand for a day, and remove it carefully with a scraper and steel wool. If the wood still does not look old enough, repeat the process.

2. Dilute nitric acid with an equal amount of water and apply with a fine brush or a small swab to the new wood. Allow a day for the action of the acid and then wash it off with alcohol. This method is convenient and is used by many, but has several serious disadvantages. The acid is dangerous in the hands of those who are not accustomed to using it; and, furthermore, it often seems to give the wood an unnatural appearance.

3. Commercial wood dyes of the alcohol type, or spirit stains, as they are sometimes called, can be diluted with alcohol to the desired shade. These dye the wood a fast color and can be given a rubbed oil finish without difficulty.

When the new wood matches the old and the entire piece has been well oiled, polishing can be started (Fig. 24). Use any good grade of floor wax. Apply it with cotton cloth that has been washed and is perfectly free from lint. Rub the wax back and forth across the grain or use a circular movement. Continue rubbing until the wax has been rubbed in and both the surface and the cloth are almost dry. Apply more wax and repeat the rubbing. Continue until the grain of the wood is thoroughly filled.

Let the piece stand until the turpentine in the wax has evaporated and then give a final polish. A good rubber for this purpose may be made from a piece of wood 2 by 2 by 8 in., padded on one side and over all of the face edges with

a layer of cotton from $\frac{1}{4}$ to $\frac{1}{2}$ in. thick, and covered with strong cloth. Tack the cover to the block halfway up the edges and ends. Place over the rubber a loose cloth.

You will find the rubbing is strenuous exercise, but the result will be a polish to delight those who appreciate a beautiful patina.

FURNITURE POLISHING SECRETS

After a piece of old furniture has been oiled and waxed, the grain of the wood, especially in dark wood, may appear white. This is nothing to be discouraged over; it proves that the grain has been well filled with the wax, as should be the case.



FIG. 24.—The final polish is given to the oiled and waxed top of a low boy with a rubbing block.

"White grain" is easily eliminated by rubbing the piece down with either raw or boiled linseed oil or with a good furniture polish. The use of a polish does not remove the wax from the grain.

There are also times when wood that has had undue exposure to the weather will look "sick" and lifeless after it is oiled. The life, or deep luster, which the wood should have, may be restored by a modification of the French polish.

To apply this polish, make a rubber (large enough not to cramp the hand)

from cotton cloth and apply a good grade of clear varnish to the rubber with a small brush or swab as shown in Fig. 25. With the finger tips or a very small brush or swab, add a few drops of raw linseed oil to the center of the varnish already applied. Then rub the wood with a circular or across-the-grain stroke. Repeat the application of varnish and oil as often as necessary and rub well until a good coat of varnish has been applied. It will be noted that the fine color is returning to the wood because, with the



FIG. 25.—Applying clear varnish to a rubber made of cloth for use in a modified French polishing process.

aid of the oil, the varnish is being rubbed into the wood instead of onto it.

When the color has been restored, time must be allowed for the varnish to dry, and the presence of the oil will probably prolong the process. When dry, the piece will appear cloudy because of the oil. This cloudiness may be removed by rubbing with wood or denatured alcohol.

If a dull rubbed natural wood finish is desired, the piece should be sandpapered with No. 0, or $\frac{1}{2}$ sandpaper, then rubbed down well with No. 0 steel wool (this will remove some of the varnish but not the restored color), and waxed and rubbed as previously explained.

If a highly polished surface is desired, the polish is carried to a finish by sanding lightly with No. 00 sandpaper the first coat of oil and varnish, after the alcohol rub; then adding two or more coats in the same manner, treating all coats alike except the last, which is given only the alcohol treatment and a thorough rubbing with a good furniture polish or polishing oil.

The French polish does not change the color of the wood; it merely brings out the natural color and shows it to best advantage. In many instances, however, it is desired to make a walnut or mahogany piece darker to match other pieces with which it is to be used. This must be done with the first application of oil.

In using the penetrating wood dyes previously mentioned (brown mahogany is best for walnut and dark mahogany for mahogany; the other colors as recommended on the manufacturers' labels), add enough of the required color to the linseed oil, diluted as before, to give the wood the shade desired. Try it out on some unexposed part of the piece to be sure it is the right tone. Apply this colored oil as a first coat and the wood dye will dry in with the oil, imparting a permanent color which will take a rub finish. Carry out the finish as before.

Boiled linseed oil diluted with equal parts of turpentine is excellent for all wood except old curly maple, which it darkens too much. This is one wood on which gasoline or benzine should be used, in the proportions of one part linseed oil to three parts of the other. These liquids are highly inflammable.

A great number of antique pieces are found which have black spots and rings on their tops. Some would rather have these marks, while others will not allow them at all.

If it is desired to remove them, proceed in the usual way as far as the first coat of oil. After this is dry, use a cabinet scraper to scrape out the spots and enough of the surrounding surface so that the scraped places do not show as holes dug in the wood. Apply the diluted boiled oil frequently to the parts being

scraped. After the spots are removed, apply the modified French polish described above to the places scraped, and finish as before.

PLASTIC PAINT FOR WALL DECORATION

The rough textured walls that have become increasingly popular in recent years are produced with what is known as "plastic paint." Ordinarily this is sold under various trade names in the form of a white powder. Only water and color need to be added. The mixture is applied with a large brush, and while it still is tacky the texture is developed.



FIG. 26.—Before being added to the plastic paint, the tinting color is mixed into a paste with water.

Perhaps the best way to learn to use this remarkable finishing material is to buy a 10-lb. package and practice on a piece of wall board. Usually a booklet of instructions is furnished with the paint.

In experimenting with the paint, follow directions exactly. First, clean the surface thoroughly and apply a coat of size. The size comes in powdered form

separate from the plastic paint and is mixed with water. The size should be allowed to dry for at least six hours.

Later, when doing an entire room, use pails for mixing the plastic paint, but for the test job a kitchen mixing bowl will serve. The proportions of the mix will probably be about one pint of water to one pound of plastic paint. This usually gives a consistency of heavy cream. Next, mix the tint in a separate pan. If, for example, you have decided



FIG. 27.—The Spanish texture is obtained by stroking the wet paint with the bowl of a common kitchen spoon.

on a buff color and a rough texture adapted from Spanish style architecture, use dry yellow ochre mixed with water to the consistency of a paste. Add the color to the plastic paint and stir the whole until the color is evenly distributed (Fig. 26). The plastic paint comes out a very little lighter on the walls than in the paint, and this must be allowed for.

For applying the paint, use a Dutch kalsomine brush and lay the material on from $\frac{1}{16}$ to $\frac{1}{8}$ in. thick. When it begins to "set up" slightly, try the development of the Spanish texture. The tool to use is an ordinary kitchen spoon, and all that is required is to move the back of the spoon across the paint in short, partially curved strokes (Fig. 27).

It is now necessary only to repeat the performance on the walls and to observe the one extra precaution of mixing



FIG. 28.—Semicircular sweeps of a 4-in. wall brush produce the so-called "monastic" texture.

enough material to cover the entire wall area. If two or more batches have to be mixed, it will be difficult to match the color exactly.

If you are decorating over a painted wall it is not necessary to apply a coat of size; but where the paint is scaling or loose, it must be scraped off. Small

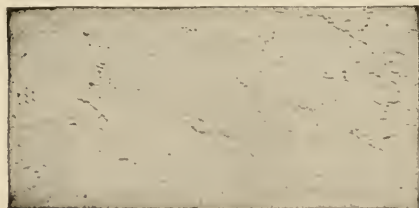

FIG. 29.—The Italian texture, which is copied after a finish found in many fine old Roman villas.

crevices may be filled with a thick mixture of the plastic paint and then sandpapered.

For the ceilings what is called a "monastic" texture is excellent. This is similar to wall finishes often found in old monasteries. Yellow ochre, only this time less of it, can be used to tint the paint a

cream color. Again make a test panel so as to be sure of your ability to reproduce the texture before starting on the ceiling. Incidentally, this method of practicing on a panel is the way of "making sure you're right before going ahead."

For reproducing the monastic texture, a 4-in. wall brush is worked in short, semicircular sweeps so that one brush sweep crosses another or starts out from it (Fig. 28). Actually, the brushing can be called "at random"; the entire surface virtually is covered with brush marks.

In order to get the best effect, go over walls and ceilings, after they are thoroughly dry, with a piece of sandpaper to soften the welts that seem too sharp. And to make the finish more washable,



FIG. 30.—Developing a Colonial stipple finish. The brush is known as a painter's "stippling block."

give the walls and ceiling a coat of size.

The finished appearance is practically certain to exceed your anticipations. The walls and ceilings will be of different but harmonious tints. The rough textures will break up the light waves and diffuse a soft glow through the room. And the furniture will have an interesting and effective background.

The possible textures are almost unlimited. Indeed, the handbooks distributed by the various manufacturers of plastic paints usually give directions for a large number.

Two of the most popular are the Italian texture, copied after old Roman finishes and shown in Fig. 29, and the Colonial stipple finish illustrated in Fig. 30.

APPENDIX

AFTER the amateur mechanic has started a home workshop and learned how to use tools with a reasonable degree of skill, he is confronted with two problems. The first is to find suitable designs for worth while projects; the other is to discover where to obtain exactly the materials required for each piece of work he undertakes, which is not so easy as it would appear to be.

This book should help beginners to solve the first problem, because it offers an unusual variety of projects, large and small, simple and elaborate. There is, however, one additional source of information that should be mentioned—the *Popular Science Monthly* series of Home Workshop Blueprints.¹ With the idea of giving home workshop enthusiasts large size drawings from which to work, the editor of this manual started a blueprint service in *Popular Science Monthly* in 1922. This service is still continuing, and 117 blueprints have been issued up to the time this was written. Some of the blueprint projects have been incorporated in this book. The complete list of those now available is as follows:

LIST OF HOME WORKSHOP BLUEPRINTS

AIRPLANE MODELS

50. 36-in. Rise-off-Ground Tractor
69. Lindbergh's Monoplane (3-ft. flying)
82. 30-in. Single Stick
86. 35-in. Twin Pusher
87. 30-in. Seaplane
- 89-90. *Bremen* (3-ft. flying)
102. Morris Seaplane (record flight 12½ min.)
104. Tractor (record flight 6,024 ft.)

¹To defray the cost of designing, drafting handling, mailing, etc., a charge of 25 cents a sheet is made for these blueprints. The sheets are serially numbered; therefore, if a subject is preceded in the list by one number, the charge is 25 cents; if by two numbers, 50 cents; and if by three numbers, 75 cents. The blueprints are distributed by the Blueprint Service Department of *Popular Science Monthly*, 381 Fourth Avenue, New York, N. Y.

FURNITURE

1. Sewing Table
2. Smoking Cabinet
3. End Table with Book Trough
5. Kitchen Cabinet
11. Bench and Tilt Top Table
13. Tea Wagon
17. Cedar Chest
18. Telephone Table and Stool
19. Grandfather Clock
20. Flat Top Desk
21. Colonial Desk
24. Gateleg Table
27. Kitchen Cabinet Table
31. Two Sewing Cabinets
33. Dining Alcove
36. Rush-Bottom Chair
37. Simple Bookcase
38. Sheraton Table
39. Chest of Drawers
49. Broom Cabinet
60. Welsh Dresser
68. Magazine-Rack Table and Book-Trough Table
- 70-71. Console Radio Cabinet
77. Simple Pier Cabinet and Wall Shelves
78. Treasure Chests
88. Modernistic Stand; Modernistic Bookcase
91. Modern Folding Screens
93. Three Modern Lamps
100. Modernistic Book Ends, Book Shelf, Low Stand
105. Tavern Table and Colonial Mirror

RADIO SETS

42. Three-Stage Amplifier
43. Four-Tube (battery operated)
54. Five-Tube (battery operated)
55. Five-Tube Details
79. Electric
80. Electric High Power Unit
81. Electric Low Power Unit
97. One-Tube Electric

- 98. Two-Tube Electric
- 99. Four-Tube Electric
- 103. One-Tube (battery operated)
- 109. Screen-Grid Set

SHIP AND COACH MODELS

- 44-45. Pirate Galley or Felucca
- 46-47. Spanish Treasure Galleon
- 48. 20-in. Racing Yacht
- 51-52-53. Clipper—*Sovereign of the Seas*
- 57-58-59. *Constitution* ("Old Ironsides")
- 61-62. Viking
- 63-64. 29-in Toy Motor Boat
- 66. Ship Model Weather Vane
- 74-75-76. *Santa Maria* (18-in. hull)
- 83-84-85. *Mayflower* (17½-in. hull)
- 92. Baltimore Clipper (8 in. long)
- 94-95-96. Mississippi Steamboat
- 106-107. 42-in. Racing Yacht, *Sea Scout*
- 108. Scenic Half-Model of Barque
- 110-111-112. Schooner *Bluenose*
- 115-116-117. Concord Stage Coach, *Diamond Tally-Ho*

TOYS

- 28. Pullman Play Table
- 29. Tea Cart, Wheelbarrow, and Garage
- 56. Birds and Animals
- 67. Lindbergh's Plane
- 72. Colonial Doll's House
- 73. Doll's House Furniture
- 101. Fire Engine, Sprinkler, Truck, Tractor
- 113. Lathe, Drill Press, Saw, and Jointer
- 114. Airplane Cockpit with Controls

MISCELLANEOUS

- 9. Arbor, Gate, and Seats
- 15. Workbench

- 23. One-Car Pergola Type Garage
- 26. Baby's Crib and Play Pen
- 30. Tool Cabinet, Boring Gage, and Bench Hook
- 34. Garden Trellises
- 65. Six Simple Block Puzzles

HARD-TO-GET MATERIALS

Often after selecting a project, the home worker finds it difficult to obtain exactly the materials specified by the original designer. Perhaps more ingenuity has to be used in obtaining hard-to-get materials than in any other part of the work of an amateur mechanic.

When the desired supplies are not to be purchased at a reasonable price or can not be had in small enough quantities, use your ingenuity to find acceptable substitutes. Perhaps a visit to the junk yard will give you just what you want; possibly you can buy a manufactured article in a five-and-ten-cent store or in a secondhand shop and take it apart to obtain whatever is necessary. A study of the catalogues of large general mail order houses will often reveal materials which can not be obtained locally unless you happen to live in a large city.

When all is said and done, however, you will occasionally find it impossible to complete a project for the lack of the proper materials. In such cases if, as a last resort, you will write to the Information Department of *Popular Science Monthly*, inclosing a stamped and self-addressed envelope, a list of dealers or manufacturers of the particular item desired will be sent you provided any promising sources of supply can be found through the extensive research facilities of that magazine.

INDEX

- Animal and bird toys, 171-174
Auger bit:
 sharpening, 15
 straightening, 17
Automobiles, refinishing, 224
- Banjo clock, 91
Benches:
 cabinet, 27
 garden, concrete, 199
 heavy-duty, 31
 kitchen table, 23
 piano, 83-85
 portable, 26
Bench stop, 24
Bevel, cutting with jig saw, 112
Bird and animal toys, 171-174
Bit, auger, sharpening, 15
Bookrack, painting, 234
Bookshelves:
 hanging, 110
 in doorway, 192
Book trough and end table, 131
Bowls:
 fruit, 146
 nut, 146
Boxes:
 jewel, 65, 145
 jewel, refinishing, 233
 powder, 145
Boy's room, fitting up, 178
Built-in furniture for doorways, 192
Butt joints, doweled, 53
- Cabinets:
 Chinese lacquered, from old washstand, 85
 sewing, Priscilla, 102
 shoe storage and polishing, 191
 tool, 37
Cabinet scraper, sharpening, 17
Candlesticks:
 painting, 234, 235
 turned, 132
Cases, tool, portable, 34
Case, watch, 139
Catches, friction, for doors, 67
Cedar chests, 79-83
Chairs:
 "ladder-back," 77
Chests:
 antique sea, 75
 cedar, various designs, 79-83
 Colonial, 80
 drawer, with built-in desk, 93
 Chests (Continued):
 Hepplewhite, 82
 high, with legs, 81
 pirate's decorative treasure, 97
 seat, 82
 Chinese lacquered cabinet made from old
 washstand, 85
 Chippendale mirror, 107
 Chisel handle, turning, 123
 Chisel, sharpening, 12
 Clocks, 89, 91
 Closets:
 built in doorways, 192
 coat rails for, 175
 compartments for rubbers in, 175
 racks for, 176
 shelves for, 175
 space-savers in, 175, 176
 Colonial:
 chest, 80
 footstool, 98
 "ladder-back" chair, 77
 tavern table, 73
 Cross-lap joints, 58
 Cupboards, 177
 Curtain rings, 141
 Dado joints, 58
 Darner, stocking, turning, 124
 Decalomania transfers, 238
 Decorating and painting, 224-250
 Den, boy's, fitting up, 178
 Desks, 93, 192
 Doll's house, Colonial style, 164
 Doors:
 catches, friction, for, 67
 enameling, 241
 friction catches for, 67
 night latch for, 69
 Doorways, furniture built in, 192
 Dovetail joints, 59, 76
 Doweling, 41
 Drawer locks, 68
 Dresser, Welsh, 95
 Drilling glass, 71
 Dump truck, toy, 162
- End table, Maryland, 105
- Fences, garden, ornamental, 195
Finishes, four-hour, 229
Fire engine, toy, 160
Fireplaces, beautifying, 183
Flower holder turned from wood, 138

- Fluting, 151
 Footstools, 98, 128
 Frames:
 mirror, 141, 149
 moldings for picture, 138
 picture, 141
 Furniture:
 built by hand, 73-97
 oil rubbing, 246
 polishing, 247
 Garden:
 bench, concrete, 199
 fences, ornamental, 195
 improvements, 175-200
 seats, concrete, 199
 trellises, 195
 Gesso, 87, 235
 Gifts, painting, 231, 235
 Gilding, 233
 Glass, drilling, 71
 Glue, how to use, 45
 Gluing boards together, 49
 Hammer, nail, 45
 Handle, chisel, turning, 123
 Handsaw, filing, 15
 Hepplewhite chest, 82
 Hinges, fitting, 67
 House and garden improvements, 175-200
 Household tool assortment, 10
 Incinerator, indoor, 185
 Inlaying, 61
 Ironing board built in doorway, 192
 Jackknives, care of, 20
 Jig saw, motor-driven, operating, 110
 Joints, hints on using, 98
 Jointing, 40
 Joints:
 butt, doweled, 53
 cross-lap, 58
 dado, 58
 dovetail, 6, 59
 mortise and tenon, 55
 pinned, 73
 rabbeted, 54
 Kitchen cupboard, 177
 Knife:
 blade shapes, 20
 finger grip, 22
 initialing, 21
 projecting blade, 21
 repointing, 21
 screw driver from broken, 22
 sharpening, 18
 sticking, 22
 "Ladder-back" chair, 77
 Lamp, table, 135
 Latch, night, 69
 Lathe:
 wood turning, choosing, 116
 wood turning, speed, 116
 Laundry bag holder, 190
 Lily pond, 194
 Linen closet built in doorway, 192
 Locks:
 chest, fitting, 83
 drawer, 68
 night latch, 69
 Machinery, woodworking, 98-114:
 jointers, 98
 sawdust from, 113
 saws, band, 112
 saws, circular, 107
 saws, jig, 110
 Mahogany, finishing, 104
 Mallet, turning from wood, 124
 Mantel, Colonial style, 184
 Maryland end table, 105
 Measuring, 40
 Mirror frame, 141, 149
 Mirrors:
 Chippendale wall, 107
 inlaid, 63
 Miter box, wooden, 34
 Model making, 201-223
 Models:
 racing yacht, 215
 Santa Maria, 201
 Moldings, picture frame, 138
 Mortise and tenon joints, 55
 Nailing, 42, 74
 Nails, 42, 74
 Nail set, using, 43
 Napkin rings, 139
 Necktie rack, 176
 Necktie ring, 141
 Newspaper craft work, 70
 Novelties, painting, 231, 235
 Oil rubbing furniture, 246
 Paint:
 four-hour finishes, 229
 plastic, for walls, 249
 quick-drying, 229
 Painting:
 automobile, 224
 bookrack, 234
 box, jewel, 233
 doors, front, 241
 four-hour finishes, 229
 gilding, 233
 marble finish, 235
 novelties and gifts, 231, 235
 potted plant holder, 232
 pour finishing, 236
 radiators, 243
 spatter finish, 234
 stippling, 234
 undercoats, 228
 walls, plastic paint, 249
 Painting and decorating, 224-250
 Penknife:
 initialing, 21
 sharpening, 18
 Piano benches, 83-85
 Picture frames, 138, 141
 Pirate's chest, 97
 Plane, sharpening, 12

- Planing, 50
 Plastic paint, walls, 249
 Playhouse, children's, formed of folding screen, 169
 Playroom, boy's, 178
 Pocketknife:
 initialing, 21
 sharpening, 18
 Polishing furniture, 247
 Polychroming, 235
 Pond, lily, for garden, 194
 Pool, garden, 194
 Priscilla sewing cabinet, 102
 Pump on toy fire engine, 160
- Rabbeted joints, 54
 Radiators, painting, 243
 Radio table, 146
 Reeding, 151
 Rings:
 curtain, 141
 napkin, 139
 necktie, 141
 towel, 141
 turning from wood, 139
- Santa Maria* ship model, 201
 Saw, case, 38
 Sawdust, catching, 113
 Sawing, 40
 Saws:
 band, 112
 circular, operating, 107
 jig, operating, 110
 Scenery, stage, for children, 169
 Scraper, sharpening, cabinet, 17
 Screen, folding, for playhouse, 169
 Screws, wood, driving, 44
 Sea chest, 75
 Seat:
 chest, 82
 garden, concrete, 199
 Server, tea, 94
 Service closet built in doorway, 192
 Serving tray, inlaid, 63
 Sewing cabinet, Priscilla, 102
 Sewing set, 139
 Sharpening tools, 12-20
 Shelf clocks, Terry, 89
 Shelves:
 book, hanging, 110
 closet, 175
 fruit and vegetable, 188
 hanging on wall, 110
 storage, cellar, 188
 Ship models:
 racing yacht, 215
 Santa Maria, 201
 Shoe box and rack, 176
 Shoe cabinet, 191
 Smoking stand, 137
 Spatter paint finishing, 234
 Spiral turning, 153
 Sprinkling truck, toy, 156
 Stage scenery for children's plays, 169
 Stands:
 sewing, 139
 smoking, 137
- Stands (Continued):
 teapot, 138
 tea tray, 94
 Stippling, 234
 Stocking darning, turning, 124
 Stop, bench, 24
 Storeroom, cellar, for garden produce, 188
- Table lamp, 135
 Tables:
 breakfast, built in doorway, 192
 clover leaf top, 152
 coffee, 155
 Colonial tavern, 73
 end, Maryland, 105
 end, with book trough, 131
 occasional, 129
 radio, 146
 round, 152
 tavern, 73
 tea, inlaid, 64
 tilt-top, 126
 Tavern table, 73
 Teapot stands, 138
 Tea table, inlaid, 64
 Tea tray stand, 94
 Terry shelf clock, 89
 Toe-nailing, 43
 Tool cabinet, 37
 Tool cases, portable, 34
 Tools, 9-22:
 household assortment, 10
 sharpening, 117
 wood turning, 117
 workshop assortment, large, 11
 workshop assortment, small, 11
 Towel ring, 141
 Toys to delight the children, 156-174
 Tractor, toy, 159
 Transfers, art, 238
 Trays:
 inlaying, 142
 pin, 144
 serving, inlaid, 62
 turning, 142
 Tray stand, 94
 Treasure chest, 97
 Trellises, 195
 Trouser rack, 176
 Trucks, toy, 156, 162
 Turning, wood, simplified, 115-155
- Undercoats, in painting, 228
- Valance boards, 180-183
 Veneering, 64
 Vise, bench, 24
- Wall clock, banjo, 91
 Wall mirror, Chippendale, 107
 Watch case, 139
 Welsh dresser, 95
 White pine, finishing, 77
 Window valances, 180-183
 Wood finishing:
 mahogany, 104
 white pine, 77

- Wood screws, driving, 44
- Wood turning simplified, 115-155
- Woodworking machinery:
 - jointers, 98
 - sawdust from, 113
 - saws, band, 112
 - saws, circular, 107
- Woodworking machinery (Continued):
 - saws, jig, 110
 - small, 98-114
- Workbenches, *see* Benches
- Workshop equipment, 23-38
- Workshop hints, 39-72
- Writing set, 138



