

71J
7580

HARVARD UNIVERSITY



Library of the
Museum of
Comparative Zoology



TIJDSCHRIFT VOOR ENTOMOLOGIE

UITGEGEVEN DOOR

DE NEDERLANDSE ENTOMOLOGISCHE VERENIGING

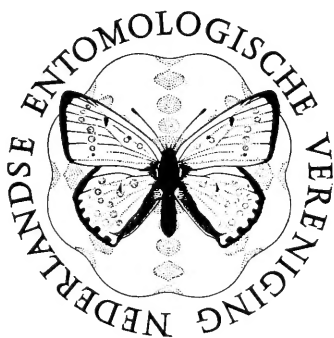

INHOUD

Achterberg, C. van. — Revision of the genera of Braconini with first and second metasomal tergites immovably joined (Hymenoptera, Braconidae, Braconinae)	137
Belle, J. — A synopsis of the South American species of <i>Phyllogomphoides</i> , with a key and description of three new taxa (Odonata, Gomphidae)	79
Bellinger, P. F., zie Ellis, W. N.	
Diakonoff, A., S. A. Ulenberg & L. Vári. — A new Tortricid of <i>Nerine</i> plants originating from Southern Africa (Lepidoptera, Tortricidae)	225
Ellis, W. N. & P. F. Bellinger. — Generic names of Collembola: Supplement 1973-1983	1
Gaskin, D. E. — The genus <i>Roxita</i> Bleszynski (Lepidoptera, Pyralidae, Crambinae): new species and combinations and a reappraisal of its relationships	17
Graham, M. W. R. de V., zie Vlug, H. J.	
Gustafsson, B. — New species of <i>Stigmella</i> from The Gambia (Lepidoptera, Nepticulidae)	165
Móczár, L. — New and little known Mesitiinae from southern Europe and Africa (Hymenoptera, Bethyridae)	101
Oosterbroek, P. — The <i>Nephrotoma</i> species of Japan (Diptera, Tipulidae)	235
Theowald, Br. — Taxonomie, Phylogenie und Biogeografie der Untergattung <i>Tipula</i> (<i>Tipula</i>) Linnaeus, 1758 (Insecta, Diptera, Tipulidae)	33
Ulenberg, S. A., zie Diakonoff, A., et al.	
Vári, L., zie Diakonoff, A., et al.	
Vlug, H. J. — The types of Platygastriidae (Hymenoptera, Scelionoidea) described by Haliday and Walker and preserved in the National Museum of Ireland and in the British Museum (Natural History). 2. Keys to species, redescription, synonymy	179
Vlug, H. J. & M. W. R. de V. Graham. — The types of Platygastriidae (Hymenoptera, Scelionoidea) described by Haliday and Walker and preserved in the National Museum of Ireland and the British Museum (Natural History). 1. Designation of lectotypes	115

NEDERLANDSE ENTOMOLOGISCHE VERENIGING

BESTUUR (BOARD)

Voorzitter (Chairman)	C. A. W. Jeekel
Vice-voorzitter (Vice-President)	L. H. M. Blommers
Secretaris (Secretary)	R. de Jong
<i>Address</i>	<i>Rijksmuseum van Natuurlijke Historie, Raamsteeg 2, Leiden 2311 PL</i>
1e Penningmeester (Treasurer I)	L. P. S. van der Geest
<i>Address</i>	<i>Doornenburg 9, Landsmeer 1211 GP</i>
2e Penningmeester (Treasurer II)	P. Oosterbroek
<i>Address</i>	<i>Baanstraat 2, Edam 1135 CB</i>
Bibliotheecaris (Librarian)	W. N. Ellis
	<i>Plantage Middenlaan 64, Amsterdam 1018 DH</i>
Lid (Member)	B. van Aartsen

TIJDSCHRIFT VOOR ENTOMOLOGIE

Redactie (Editorial Board)	P. J. van Helsdingen, R. de Jong, J. Krikken, M. A. Liefstinck, C. van Achterberg, S. A. Ulenberg
<i>Address</i>	<i>Rijksmuseum van Natuurlijke Historie, Raamsteeg 2, Leiden 2311 PL</i>

The journal serves the publication of papers on Insecta, Myriapoda and Arachnoidea.
Subscription rate: D.Fl. 245,— per year.

Issues 1—3 appeared on 10.VIII.1984
Issues 4—7 appeared on 31.XII.1984
Issues 8—11 appeared on 14.VI.1985

ISSN 0040-7496

TIJDSCHRIFT VOOR ENTOMOLOGIE

UITGEGEVEN DOOR

DE NEDERLANDSE ENTOMOLOGISCHE VERENIGING



MUS. COMP ZOOL
LIBRARY

AUG 4

HARVARD
UNIVERSITY

INHOUD

WILLEM N. ELLIS and PETER F. BELLINGER. — Generic names of Collembola:
Supplement 1973—1983, pp. 1—15.

GENERIC NAMES OF COLLEMBOLA: SUPPLEMENT 1973-1983

by

WILLEM N. ELLIS

Zoölogisch Museum, Plantage Middenlaan 64, Amsterdam

and

PETER F. BELLINGER

Biology Department, California State University, Northridge, California

ABSTRACT

An update is presented of the list of Collembolan generic names that was published by the authors in 1973. Some 109 new generic names are included in the list. Full bibliographic citations and records of the type selection are given for each nominal genus. Some errors of the previous list are corrected and a few Opinions have been included.

INTRODUCTION

In the decade that has passed since the publication of our annotated list of generic names of Collembola¹⁾, many new names have been proposed. A few homonyms have been renamed and Opinions have been published deciding the cases brought by us before the International Commission. We therefore think it worthwhile to present an update to our prior list, at the same time using the opportunity to correct some errors and imprecisions that had remained in the original.

We have included all new names and nomenclatural actions that have come to our attention. It is possible that we have omitted some names in publications of the last year or two which we have not seen; we would appreciate it if our colleagues would call our attention to such omissions. All new names have been checked against Neave's Nomenclator Zoologicus and its supplements, and against the lists of new generic and subgeneric names that appear annually in series 20 of the Zoological Record.

In the original publication we neglected to state explicitly that the capital letters F, M and N signified the nomenclatural gender of the name: Feminine, Masculine and Neuter. The same convention is used in the present update. New taxa are marked with an asterisk. Entries are intended to modify the original entry, or to be inserted at the appropriate point in alphabetic order in the original list.

Acanthonotus Von Olfers*

Manuscript name for *Stylonotus lanuginosus* Von Olfers, cf. Handschin, 1926 (Ent. Mitt. 15 (2): 174).

Unavailable name.

Acheroxenylla Ellis, 1976*

Tijdschr. Ent. 119 (†): 237.

Type-species: *A. cretensis* Ellis, 1976, l.c., by original designation. F.

Adbiloba Stach, 1951

Note: Cassagnau, 1979 (Biologia gallo-hellenica 8: 187) subsequently selected *Adbiloba pauliani* Massoud, 1963, as type-species; this action, however, is contrary to art. 61 of the International Code.

¹⁾ Ellis, W. N., & P. F. Bellinger, 1973. An annotated list of the generic names of Collembola (Insecta) and their type-species. — Monogrn Ned. ent. Veren. 7: 1-74.

Adelphoderia Greenslade, 1982*

J. aust. ent. Soc. 21: 82.

Type-species: *A. regina* Greenslade, 1982, l.c., by original designation. F.

Afrobella Cassagnau, 1983*

Nouv. Revue Ent. 13 (1): 16, 19.

Type-species: *Neanura (Bilobella) guineense* Murphy, 1965, by original designation. F.

Afrodontella Deharveng, 1981*

Trav. Lab. Ecobiol. Arthrop. édaph. 3 (1): 13.

Type-species: *Odontella septemlobata* Salmon, 1954, by original designation. F.

Albanura Cassagnau, 1983*

Nouv. Revue Ent. 13 (1): 7, 15, 18.

Type-species: *Neanura (Deutonura) nana* Cassagnau & Peja, 1979, by original designation. F.

Note: the generic name *Albanura* is attributed by Cassagnau to "Deharveng, 1982", but the paper by Deharveng is cited as still in press. Since, however, Cassagnau's paper does not present a diagnosis of *Albanura*, his usage of the name must be considered an unavailable nomen nudum.

Allochaefferia

Must be *Alloschaefferia* [our misspelling].

Americanura Cassagnau, 1983*

Nouv. Revue Ent. 13 (1): 11, 15.

Type-species: *Americanura mexicana* Cassagnau, 1983, l.c., by original designation. F.

Note: both the generic name and that of the type-species are attributed to a paper in print by Cassagnau & Palacios Vargas. As the published information contains a nomenclaturally valid diagnose of the new genus (and by implication the type-species as well), the present publication takes precedence.

Anaphorura Izarra, 1972*

Physis B. Aires 31 (83): 547, ut subgenus *Tullbergia* Lubbock, 1867.

Type-species: *Tullbergia (Anaphorura) lavadoi* Izarra, 1972, l.c., by monotypy. F.

Anjavidielli Betsch, 1974*

Bull. Mus. natn. Hist. nat. Paris [3] 219 (Zool. 147): 560.

Type-species: *Anjavidielli ankaratrensis* Betsch, 1974, l.c., by original designation. F.

Note: the generic name appeared the same year a few months earlier in *Pedobiologia* 14 (2/5): 180, 181, as a nomen nudum.

Anurida Laboulbène, 1965

Add a line to the note:

According to Cowan, J. Soc. Bibliogr. nat. Hist. 6 (1): 18-29, the plate figuring *Achorutes maritimus* was probably issued in August 1837.

Assamanura Cassagnau, 1980*

Trav. Lab. Ecobiol. Arthrop. édaph. 2 (3): 1, 2.

Type-species: *Assamanura besucheti* Cassagnau, 1980, l.c., by original designation. F.

Australonura Cassagnau, [1980]*

Proc. int. Seminar Apterygota 1, Siena: 127, ut subgenus *Neanura* MacGillivray, 1893.

Type-species: *Neanura grossi* Yosii, 1966, by original designation. F.

Balkanura Cassagnau, 1979*

Biologia gallo-hellenica 8: 190.

Type-species: *Neanura* (*Neanura*) *jugoslavica* Palissa & Živadinović, 1974, by original designation. F.

Barbagastrura Massoud, Najt & Thibaud, 1975*

Nouv. Revue Ent. 5 (2): 111.

Type-species: *B. palpigera* Massoud, Najt & Thibaud, 1975, l.c., by original designation. F.

Betschurinus Dallai & Martinuzzi, 1980*

Atti Accad. fisiocrit. Siena (14) 12: 31.

Type-species: *Betschurinus farmae* Dallai & Martinuzzi, 1980, l.c., by monotypy. M.

Biacantha Martynova

Date of publication of generic name and of species *Biacantha nana* is 1968.

Replaced by *Martynovella* Deharveng, 1979.

Blasconura Cassagnau, 1983*

Nouv. Revue Ent. 13 (1): 16, 19.

Type-species: *Achorutes hirtellus* Börner, 1906, by original designation. F.

Bonetogastrura Thibaud, 1975*

Spelunca Mem. 8: 207.

Type-species: *Typhlogastrura balazuci* Delamare Deboutteville, 1951, by original designation. F.

Note: the generic name appeared earlier that year as a nomen nudum in Ann. Speleol. 30 (1): 189.

Bonetrura Christiansen & Bellinger, 1980*

Collembola of North America: 559.

Type-species: *Guthriella boneti* Yosii, 1962, by original designation. F.

Borneaphysa Yoshii, 1981*

Ent. Rept. Sabah For. Res. Cent. 3: 8, ut subgenus *Callyntrura* Börner, 1906.

Type-species: *Callyntrura borneensis* Yoshii, 1981, l.c., by original designation. F.

Bourletides Betsch & Massoud, 1972*

Annl. Soc. ent. Fr. [2] 8 (1): 234.

Type-species: *Bourletides wallacei* Betsch & Massoud, 1972, l.c., by original description. M.

Bourletielitas Betsch, 1974*

Bull. Mus. natn. Hist. nat. Paris [3] 219 (Zool. 147): 554.

Type-species: *Bourletielitas imerinensis* Betsch, 1974, l.c., by original designation. M.

Note: the generic name appeared a few months earlier in the same year in Pedobiologia 14 (2/5): 180, 181, as a nomen nudum.

The gender of the name was originally not stated; it must therefore be treated as masculine, on the base of art. 30b(ii).

Calistella Schött, 1902

Note: the genus is attributed by Schött, l.c., to Reuter, but there is no evidence that this is anything more than a politeness.

Caputanurina Lee, 1983*

Korean J. Ent. 13 (1): 28.

Type-species: *Caputanurina serrata* Lee, 1983, l.c., by original designation. F.

Cassagnaudiella Ellis, 1975*

Bull. zool. Mus. Univ. Amst. 4 (9): 78, ut subgenus *Bourletielita* Banks, 1899.

Type-species: *Sminthurus pruinus* Tullberg, 1871, by original designation. F.

Cassagnella Najt & Massoud, 1974*

Revue Ecol. Biol. Sol 11 (3): 370.

Type-species: *Cassagnella alba* Najt & Massoud, 1974, l.c., by original designation. F.

Catalanura Cassagnau, 1983*

Nouv. Revue Ent. 13 (1): 7, 15, 17.

Type-species: *Neanura (Deutonura) catalana* Deharveng, 1979, by original designation. F.

Note: unavailable nomen nudum. The note under *Albanura* is applicable here as well.

Ceratophysella Börner, 1932

Add to entry:

Placed on the official list of generic names in zoology: 2135, Opinion 1193 (1981).

Junior objective synonym of *Cystioceras* Börner in Schille, 1912.

Chaetaphorura Rusek, 1976*

Canadian J. Zool. 54 (1): 27.

Type-species: *Chaetaphorura vancouverica* Rusek, 1976, l.c., by original designation. F.

Chaetobella Cassagnau, 1983*

Nouv. Revue Ent. 13 (1): 16, 19.

Type-species: *Lobella (Propeanura) numatai* Yosii, 1966, by original designation. F.

Cryptonura Cassagnau, 1979*

Biologia gallo-hellenica 8: 191, 192, ut subgenus *Neanura* MacGillivray, 1893.

Type-species: *Lathriopyga franzi* Stach, 1951, by original designation. F.

Cystioceras Börner in Schille, 1912*

Spraw. Kom. fizyogr. Krakow 46 (2): 126, 127.

Type-species: *Podura armata* Nicolet, [1842], by monotypy. (Gender neuter, although treated as masculine by Schille.) N.

Placed on the Official index of rejected and invalid generic names in zoology: 2119, Opinion 1193 (1981). Suppressed for the purposes of the Law of Priority, but not for those of the Law of Homonymy.

Senior objective synonym of *Ceratophysella* Börner, 1932.

Delamarerus Mitra, 1977*

Revue Ecol. Biol. Sol 13 (4): 645-647.

Type-species: *Delamarerus immisi* Mitra, 1977, l.c., by original designation [cf. p. 647]. M.

Note: issue 4 of the journal bears an indication: "depot legal 2e Trim. 1977".

Desertia Tshelnokov, in Martynova, Tshelnokov & Kaplin, 1979*

Doklad. Akad. Nauk turkmenskoj SSR 1979: 38.

Type-species: *Desertia kaplini* Tshelnokov, 1979, l.c., by monotypy or original designation. F.

Note: paper not seen, reference based on Informations aptérygotologiques 519.

Deuterostminthurus Börner, 1901

Replace type indication and note as follows:

Type-species: *Smynthurus bicinctus* Koch, 1840, by Opinion 1042 (1976).

Placed on the Official list of generic names in zoology: 2017.

Deutonura Cassagnau, 1979*

Biologia gallo-hellenica 8: 192, ut subgenus *Neanura* MacGillivray, 1893.

Type-species: *Achorutes phlegraecus* Caroli, 1912, sensu da Gama, 1964, by original designation. F.

Note: the type selection reads: "subgénératype: *phlegraea* (Caroli, 1910) sensu da Gama 1964".

"Caroli, 1910" is a lapsus calami for "Caroli, 1912" as given by da Gama. The slightly irregular form of the type selection cannot be resolved with art. 70(b).

Dicranorchesella Mari Mutt, 1977*

Proc. ent. Soc. Wash. 79 (3): 377.

Type-species: *Dicranorchesella boneti* Mari Mutt, 1977, l.c., by original designation. F.

Dicyrtoma Bourlet, 1842

Replace type indication and note as follows:

Type-species: *Papirius fuscus* Lubbock, 1873, by Opinion 1092 (1977).

Placed on the Official list of generic names in zoology: 2049.

Dicyrtomina Börner, 1903

Replace type indication and note as follows:

Type-species: *Podura minuta* O. Fabricius 1783, by Opinion 1092 (1977).

Placed on the Official list of generic names in zoology: 2050.

Dimorphiella Grinbergs, 1968

Replaced by *Dimorphotoma* Grinbergs, 1975.

Dimorphotoma Grinbergs, 1975*

Ent. Ber., Amst. 35 (8): 101.

Type-species: *Proisotoma (Dimorphiella) muriphila* Grinbergs, 1968 (art. 67 i). F.

New name for *Dimorphiella* Grinbergs, 1968, nec Valkanov, 1928.

Doutnacia Rusek, 1974*

Vest. čsl. Spol. zool. 38 (1): 64, 65.

Type-species: *Doutnacia xerophila* Rusek, 1974, l.c., by original designation. F.

Ectonura Cassagnau [1980]*

Proc. int. Seminar Apterygota 1, Siena: 127, 128.

Type-species: *Achorutes natalensis* Womersley, 1934, by original designation. F.

Note: the original type selection designated *Ectonura [Achorutes] natalensis* (Womersley, 1934) sensu Coates, 1968. There is no indication in Coates' or Cassagnau's papers that Coates' determination of Womersley's species is erroneous, and therefore art. 70(b) of the Code does not apply.

Endonura Cassagnau, 1979*

Biologia gallo-hellenica 8: 192, ut subgenus *Neanura* MacGillivray, 1893.

Type-species: *Achorutes tetrophthalmus* Stach, 1929, by original designation. F.

Franzura Cassagnau & Deharveng, 1976*

Bull. Soc. Hist. nat. Toulouse 112 (1/2): 199, ut subgenus *Hypogastrura* Bourlet, 1839.

Type-species: *Hypogastrura (Franzura) synacantha* Cassagnau & Deharveng, 1976, l.c., by original designation. F.

Friesea Von Dalla Torre, 1895

Placed on the Official list of generic names in zoology: 2023, Opinion 1049 (1976).

Gamachorutes Cassagnau, 1978

Bull. Soc. Hist. nat. Toulouse 114 (1/2): 17.

Type-species: *Gamachorutes verrucosus* Cassagnau, 1978, l.c., by original designation. M.

Gisnianus Betsch, 1977*

Revue Ecol. Biol. Sol 14 (1): 212.

Type-species: *Sminthurinus flammeolus* Gisin, 1957, by original designation. M.

Gnathogastrura Diaz & Najt, 1983*

Nouv. Revue Ent. 13 (2): 29, 30.

Type-species: *Gnathogastrura paramoense* Diaz & Najt, l.c., by original designation. F (although treated as neuter by the authors).

Granuliphorura Rusek, 1976*

Canadian J. Zool. 54 (1): 24.

Type-species: *Granuliphorura obtusochaeta* Rusek, 1976, l.c., by original designation. F.

Gunungphysa Yoshii, 1982*

Ent. Rept. Sabah For. Res. Cent. 6: 2, ut subgenus *Callyntrura* Börner, 1906.

Type-species: *Callyntrura gunung* Yoshii, 1982, l.c., by original designation. F.

Guthriella Börner, 1966

Date of publication is 1906.

Hawinella Bellinger & Christiansen, 1974*

Pacif. Ins. 16 (1): 36.

Type-species: *Hawinella lava* Bellinger & Christiansen, 1974, l.c., by original designation. F.

Heteromurtrella Mari Mutt, 1979*

J. Agric. Univ. Puerto Rico 63 (2): 214, ut subgenus *Heteromurus* Wankel, 1860.

Type-species: *Heteromurus (Heteromurtrella) puertoricensis* Mari Mutt, 1979, l.c., by original designation. F.

Heteromurus Wankel, 1860

Replace note as follows:

Placed on the Official list of generic names in zoology: 2034, Opinion 1064 (1976).

Inameria Cassagnau, 1983*

Nouv. Revue Ent. 13 (1): 16, 20.

Type-species: *Neanura corallina* Imms, 1912, by original designation. F.

Isotomodella Martynova

Date of publication of the genus name, and of the specific name *Isotomodella pusilla*, is 1968.

Istanaphysa Yoshii, 1981*

Ent. Rept. Sabah For. Res. Cent. 3: 15, ut subgenus *Callyntrura* Börner, 1906.

Type-species: *Callyntrura (Istanaphysa) istana* Yoshii, 1981, l.c., by original designation. F.

Jacutogastrura Martynova, 1981*

Zool. Zhurn. 60 (1): 151.

Type-species: *Jacutogastrura silvatica* Martynova, 1981, l.c., by original designation. F.

Japonphysa Yoshii, 1982*

Ent. Rept. Sabah For. Res. Cent. 6: 24, ut subgenus *Callyntrura* Börner, 1906.

Type-species: *Paronella japonica* Kinoshita, 1917, by original designation. F.

Jestella Najt, 1978*

Nouv. Revue Ent. 7 (4): 363, 366.

Type-species: *Jestella siva* Najt, 1978, l.c., by original designation. F.

Note: according to a note on the wrappers the 4th issue of the journal was published 15.ii.1978.

Jevania Rusek, 1978*

Acta ent. bohemosl. 75: 255, 256.

Type-species: *Jevania fageticola* Rusek, 1978, l.c., by original designation. F.

Karlstejnia Rusek, 1974*

Vest. čsl. Spol. zool. 38 (1): 61.

Type-species: *Karlstejnia annae* Rusek, 1974, l.c., by original designation. F.

Kaszabellina Betsch, 1977*

Annl. hist.-nat. Mus. natn. hung. 69: 79.

Type-species: *Kaszabellina variabilis* Betsch, 1977, l.c., by original designation. F.

Kudatphysa Yoshii, 1982*

Ent. Rept. Sabah For. Res. Cent. 6: 22, ut subgenus *Callyntrura* Börner, 1906.

Type-species: *Callyntrura kudatensis* Yoshii, 1981, by original designation. F.

Lubbockia Haller, 1880

Replaced by *Deuterolubbockia* Von Dalla Torre, 1895.

Macgillivraya Grote, 1894

Suppressed under the Plenary powers, and placed on the Official index of rejected and invalid generic names in zoology: 2070, Opinion 1049 (1976).

Marcuzziella Rusek, 1975*

Vestn. čsl. Spol. zool. 39 (3): 236-238.

Type-species: *Marcuzziella tripartita* Rusek, 1975, l.c., by original designation. F.

Martynovella Deharveng, 1979*

Revue Ecol. Biol. Sol 15 (4): 554.

New name for *Biacantha* Martynova, 1968, nec Wolfgang, 1954.

Type-species: *Biacantha nana* Martynova, 1968 (art. 67 i). F.

Note: the last page of issue 4 of the journal bears a note: "depot legal 1er trimestre 1979".

Massoudia Betsch, 1975*

Revue Ecol. Biol. Sol 11 (4): 566.

Type-species: *Massoudia griveaudi* Betsch, 1975, l.c., by original designation. F.

Note: the last page of issue 4 of the journal bears a note "depot legal 1e trimestre 1975".

Megalothorax and **Megalanura**

Change the order of these two entries.

Micranurophorus Bernard, 1977*

Great Lakes Ent. 10 (2): 75.

Type-species: *Micranurophorus musci* Bernard, 1977, l.c., by original designation. M.

Millsurus Betsch, 1977*

Revue Ecol. Biol. Sol 14 (1): 214.

Type-species: *Neosminthurus sminthurinus* Mills, 1934, by original designation. M.

Mimoderus Yoshii, 1980*

Contr. biol. Lab. Kyoto Univ. 26 (1): 11.

Type-species: *Mimoderus saikebi* Yoshii, 1980, l.c., by original designation. M.

Monobella Cassagnau, 1979*

Biologia gallo-hellenica 8: 191.

Type-species: *Achorutes grassei* Denis, 1923, by original designation. F.

Morulodes Cassagnau, 1955

Add to the note: This error is repeated by Cassagnau, 1983. — *Nouv. Revue Ent.* 13 (1): 15.
Neanura serrata is a subjective synonym of the type-species.

Mucracanthus Stebaeva, 1976*

Novie i maloizvestnie vidi fauni Sibiri 10: 46.

Type-species: *Mucracanthus altaicus* Stebaeva, 1976, l.c., by original designation. M.

Murphysa Yoshii, 1982*

Ent. Rept. Sabah For. Res. Cent. 6: 18, ut subgenus *Callyntrura* Börner, 1906.

Type-species: *Microphysa vestita* Handschin, 1925, by original designation. F.

Myopia Christiansen & Bellinger, 1980*

Collembola of North America: 768, ut subgenus *Isotoma* Bourlet, 1839.

Type-species: *Isotoma (Myopia) alaskana* Christiansen & Bellinger, 1980, l.c., by original designation. F.

Narynia Martynova

Date of publication of the generic name, and of the specific name *Narynia setosa*, is 1968.

Neanurella Cassagnau, 1971

Type-species: *Neanurella microphthalmalma* Cassagnau, 1968 [not *N. caeca*, as erroneously stated].

Neorchesella Mari Mutt, 1981*

J. Agric. Univ Puerto Rico 65 (1): 8.

Type-species: *Neorchesella mexicana* Mari Mutt, 1981, l.c., by original designation. F.

Nilgirella Cassagnau, 1983*

Nouv. Revue Ent. 13 (1): 16, 20.

Type-species: *Achorutes indicus* Handschin, 1929, by original designation. F.

Odontellina Deharveng, 1981*

Trav. Lab. Ecobiol. Arthrop. édaph. 3 (1): 14.

Type-species: *Xenylloides nivalis* Cassagnau, 1959, by original designation. F.

Orogastrura Deharveng & Gers, 1979*

Trav. Lab. Ecobiol. Arthrop. édaph. 1 (2): 4.

Type-species: *Xenyllogastrura dilatata* Cassagnau, 1959, by original designation. F.

Paleonura Cassagnau, 1982*

Trav. Lab. Ecobiol. Arthrop. édaph. 3 (3): 6.

Type-species: *Paleonura spectabilis* Cassagnau, 1982, l.c., by original designation. F.

Palmanura Cassagnau, 1983*

Nouv. Revue Ent. 13 (1): 11, 15.

Type-species: *Palmanura mirabilis* Cassagnau, 1983, l.c., by original designation.

Note: the same note as under *Americanura* applies here.

Parabourletiella Betsch, 1975*

Revue Ecol. Biol. Sol 12 (2): 477.

Type-species: *Parabourletiella mahafalensis* Betsch, 1975, l.c., by original designation. F.

Parachaetoceras Salmon, 1941

The gender of the generic name is neuter (N), not masculine.

Parawillemia Izarra, 1975*

Physis B. Aires [C] 34 (88): 93.

Type-species: *Parawillemia pampeana* Izarra, 1975, l.c., by original designation. F.

Parisotoma Bagnall, 1940

The gender of the generic name is feminine (F), not masculine.

Paruzelia Martynova

Date of publication of the generic name is 1968.

Paruzelia Martynova, 1971

Zool. Zhurn. 50 (11): 1644, 1645.

Unavailable name; see original entry.

Parvatinura Cassagnau, 1982*

Trav. Lab. Ecobiol. Arthrop. édaph. 3(3): 7.

Type-species: *Parvatinura dobremezi* Cassagnau, 1982, l.c., by original designation. F.

Paulianitas Betsch, 1978*

Bull. Soc. ent. Fr. 82 (5/6): 119.

Type-species: *Paulianitas viettei* Betsch, 1978, by original designation. M.

Note: the gender of the name was not explicitly stated originally; it is fixed herewith in accordance with art. 30 b (ii).

Pectinura Cassagnau, 1983*

Nouv. Revue Ent. 13 (1): 15, 18, nec Forbes, 1843. — Proc. linn. Soc. Lond. 1 (17): 167 (Echino-dermata).

Type-species: *Womersleya hongkongensis* Yosii, 1976, by original designation. F.

Junior homonym. No replacement name available.

Pentacanthella Deharveng, 1979*

Revue Ecol. Biol. Sol 15 (4): 557.

Type-species: *Pentacanthella decemocolata* Deharveng, 1979, l.c., by original designation. F.

Note: the 4th issue of the journal bears a note: "depot legal 1er trimestre 1979".

Permobrya Riek, 1976*

Palaeont. afr. 19: 141. Fossil.

Type-species: *Permobrya mirabilis* Riek 1976, l.c., by original designation. F.

Pratanurida Rusek, 1973*

Vest. čsl. Spol. zool. 37 (3): 187.

Type-species: *Pratanurida cassagnau* Rusek, 1973, l.c., by original designation. F.

Note: misspelled *Pratanuria* on p. 183.

Probolaphorura Dunger, 1977*

Abh. Ber. naturk. Mus. Görlitz 50 (5): 1, 2.

Type-species: *Probolaphorura sachalinensis* Dunger, 1977, l.c., by original designation. F.

Propeanura Yosii, 1956

Note: the subsequent selection of *Lobella (Propeanura) ieti* Yosii, 1966, as type species by Cassagnau, [1980] (Proc. int. Seminar Apterygota 1, Siena: 128) violates art. 61 of the International Code.

Protanura Börner, 1906

Note: the subsequent selection of *Neanura pseudomuscorum* Börner, 1903, as type species by

Cassagnau, 1979 (*Biologia gallo-hellenica* 8: 192) is in disagreement with art. 61 of the International Code.

Protolobella Cassagnau, 1983*

Nouv. Revue Ent. 13 (1): 15, 18, ut subgenus *Lobella* Börner, 1906.

Type-species: *Lobella (L.) assamensis* Yosii, 1966, by original designation. F.

Pseudodicranocentrus Mari Mutt, 1981*

J. Agric. Univ. Puerto Rico 65 (2): 91.

Type-species: *Dicranocentrus circulatus* Mari Mutt, 1979, by original designation. M.

Pseudonychiurus Lin Shan-Xiang, 1980*

Acta ent. sinica 23 (2): 189, nec Bagnall, 1948.

Type-species: *Pseudonychiurus shanghaiensis* Lin Shan-Xiang, 1980, l.c., by original designation.

Junior homonym. No replacement name available.

Pseudosalina Mitra, 1974*

Revue Ecol. Biol. Sol 10 (3): 359, 360.

Type-species: *Salina nigrocephala* Mitra, 1966, by original designation. F.

Note on the date of publication: the last page of the issue bears an infrapaginal note: "Depot legal 1er trimestre 1974".

Pseudosorensia Izarra, 1972*

Physis B. Aires 31 (82): 77.

Type-species: *Pseudosorensia fueguensis* Izarra, 1972, l.c., by original designation. F.

Ptenura Templeton, 1844

Placed on the Official index of rejected and invalid generic names in zoology: 2074, Opinion 1064 (1976).

Pumilinura Cassagnau, 1979*

Biologia gallo-hellenica 8: 192, 193.

Type-species: *Pumilinura travei* Cassagnau & Peja, 1979, by original designation. F.

Rhopalothrix Schött, 1917

Author's name is Schött, not Schöt.

Richardsitas Betsch, 1975*

Revue Ecol. Biol. Sol 12 (2): 480.

Type-species: *Richardsitas najtae* Betsch, 1975, l.c., by original designation. M.

Note: the gender of the name is fixed herewith, in accordance with art. 30 b (ii).

Riozura Cassagnau, 1983*

Nouv. Revue Ent. 13 (1): 15, 18.

Type-species: *Lobella yoshibai* Yosii, 1963, by original designation. F.

Rusekianna Betsch, 1977*

Annl. hist. -nat. Mus. natn. hung. 69: 61, 62.

Type-species: *Rusekianna mongolica* Betsch, 1977, l.c., by original designation. F.

Salmonides Bagnall, 1949

Gender is masculine (M).

Sensillanura Deharveng, 1981*

Nouv. Revue Ent. 11 (1): 9.

Type-species: *Neanura barberi* Handschin, 1928, by original designation and art. 67 (e). F.

Note: the type selection reads: "Espèce type: *Neanura pseudoquadrioculata* Stach, 1951 (= *Neanura quadrioculata* Guthrie, 1903)". Both *Biloba pseudoquadrioculata* Stach, 1951, and *Achorutes barberi* Handschin, 1928, were proposed as replacement names for *Neanura quadrioculata* Guthrie, 1903, nec Börner, 1901. The two names are therefore objective synonyms and the earlier name, *barberi*, is valid.

Sensiphorura Rusek, 1976*

Canadian J. Zool. 54 (1): 19, 20.

Type-species: *Sensiphorura marshalli* Rusek, 1976, l.c., by original designation. F.

Sminthuridia Massoud & Betsch, 1972*

Revue Ecol. Biol. Sol 9 (1): 70.

Type-species: *Sminthurides sphaeridioides* Murphy, 1960, by original designation. F.

Sminthurinus Börner, 1901

Replace type indication and notes as follows:

Type-species: *Smynthurus niger* Lubbock, 1862, by designation under the plenary powers, Opinion 1027 (1974).

Placed on the Official list of generic names in zoology: 2004.

Smynthurella Houlbert, 1924

Placed on the Official index of rejected and invalid generic names in zoology: 2050, Opinion 1027 (1974).

Songhaica Lasebikan, Betsch & Dallai, 1980*

Syst. Ent. 5: 179.

Type-species: *Songhaica nigeriana* Lasebikan, Betsch & Dallai, 1980, l.c., by original designation. F.

Spatulosminthurus Betsch & Betsch-Pinot, 1983*

Pedobiologia 25 (4): 216.

Type-species: *Sminthurus lesnei* Carl, in Denis, 1925, by original designation. M.

Note: the generic name appeared some months earlier as an unavailable name (art. 8(3)) in Colloque international sur les Aptérygotes 5, résumés: 36.

Sphaeronura Cassagnau, 1983*

Nouv. Revue Ent. 13 (1): 15, 19.

Type-species: *Propeanura chaotica* Yosii, 1976, by original designation. F.

Stachorutes Dallai, 1973*

Redia 54: 23, 24.

Type-species: *Stachorutes dematteisi* Dallai, 1973, l.c., by original designation. M.

Stenogastrura Christiansen & Bellinger, 1980*

Collembola of North America: 207.

Type-species: *Stenogastrura hiemalis* Christiansen & Bellinger, 1980, l.c., by original designation. F.

Stenognathriopes Betsch & Lasebikan, 1979*

Bull. Soc. ent. Fr. 84 (7/8): 166.

Type-species: *Stenognathriopes huetheri* Betsch & Lasebikan, 1979, l.c., by original designation. M.

Sultanaphysa Yoshii, 1982*

Ent. Rept. Sabah For. Res. Cent. 6: 28, ut subgenus *Callyntrura* Börner, 1906.
Type-species: *Callyntrura sultana* Yoshii, 1982, l.c., by original designation. F.

Synameria Cassagnau, 1983*

Nouv. Revue Ent. 13 (1): 16, 20.

Type-species: *Phylliomeria miranda* Yosii, 1966, by original designation. F.

Telobella Cassagnau, 1983*

Nouv. Revue Ent. 13 (1): 15, 18, ut subgenus *Lobella* Börner, 1906.

Type-species: *Propeanura wayang* Yosii, 1976, by original designation. F.

Tetradontophora auctorum (e.g. Živadinović)

Unavailable incorrect subsequent spelling for *Tetrodontophora* Reuter, 1882.

Tetraloba Lee, 1983*

Korean J. Ent. 13 (1): 37.

Type-species: *Tetraloba seolagensis* Lee, 1983, l.c., by original designation. F.

Tiancanthella Rusek, 1979*

Vestn. česk. Spol. zool. 43 (2): 138.

Type-species: *Tiancanthella martynovae* Rusek, 1979, l.c., by original designation. F.

Travura Cassagnau & Deharveng, 1980*

Trav. Lab. Ecobiol. Arthrop. édaph. 2 (2): 2, 3.

Type-species: *Travura divergens* Cassagnau & Deharveng, 1980, l.c., by original designation. F.

Tremoisea Cassagnau, 1973*

Biologia gallo-hellenica 5 (1): 65, 66.

Type-species: *Tremoisea enigmatica* Cassagnau, 1973, l.c., by original designation. F.

Tricanthella

Must be *Triacanthella* [our misspelling].

Triaena Tullberg, 1971

Placed on the Official index of rejected and invalid names in zoology: 2071, Opinion 1049 (1976).

Uralaphorura Martynova, 1978*

Ent. Ber., Amst. 38 (4): 53.

New name for *Uralia* Martynova, 1976, nec Mulsant & Verreaux, 1866.

Type-species: *Uralia schilovi* Martynova, 1976 (art. 67 i). F.

Uralia Martynova, 1976*

Novie i maloizvestnie vidi fauni Sibiri 10: 6, ut subgenus *Onychiurus* Gervais, 1841, nec Mulsant & Verreaux, 1866. — Mém. Soc. imp. Sci. nat. Cherbourg 12: 225.

Type-species: *Uralia schilovi* Martynova, 1976, l.c., by original designation. F.

Junior homonym. Replaced by *Uralaphorura* Martynova, 1978.

Ussuriaphorura Martynova, 1979*

Ent. Obozr. 58: 800.

Type-species: *Ussuriaphorura pluri pseudocellata* Martynova, 1979, l.c., by original designation. F.

Vatomadiella Betsch, 1974*

Bull. Mus. natn. Hist. nat. Paris [3] 219 (zool. 147): 567.

Type-species: *Vatomadiella pauliani* Betsch, 1974, l.c., by original designation. F.

Note: the generic name appeared in *Pedobiologia* 14 (2/5): 182 as a nomen nudum a few months earlier in the same year.

Wankeliella Rusek, 1975*

Vestn. čsl. Spol. zool. 39 (3): 231, 232.

Type-species: *Wankeliella peterseni* Rusek, 1975, l.c., by original designation. F.

Yosiides Massoud & Betsch, 1972

Revue Ecol. Biol. Sol 9 (1): 72.

Type-species: *Sminthurides himachal* Yosii, 1966, by original designation. F.

Zealandella Salmon, 1964

Page of publication is 111 [not 11, as incorrectly stated].

Zealandotoma Salmon, 1964

Name of type-species is *Isotomina novazealandia* [not *I. novaezealandiae*, as incorrectly stated].

INDEX TO SPECIES

- alba* Najt & Massoud, 1974 (*Cassagnella*)
Cassagnella Najt & Masoud, 1974
alaskana Christiansen & Bellinger, 1980 (*Isotoma*
(Myopia))
Myopia Christiansen & Bellinger, 1980
altaicus Stebaeva, 1976 (*Mucracanthus*)
Mucracanthus Stebaveva, 1976
ankaratrensis Betsch, 1974 (*Anjavidiella*)
Anjavidiella Betsch, 1974
annae Rusek, 1974 (*Karlstejnina*)
Karlstejnina Rusek, 1974
armata Nicolet, [1842] (*Podura*)
Cystioceras Börner in Schille, 1912; see notes
Ceratophysella Börner, 1932 — obj. syn.
assamensis Yosii, 1966 (*Lobella* (*Lobella*))
Protolobella Cassagnau, 1983
balazuci Delamare Deboutteville, 1951
(Typhlogastrura)
Bonetogastrura Thibaud, 1975
barberi Handschin, 1928 (*Achorutes*)
Sensillanura Deharveng, 1981
besucheti Cassagnau, 1980 (*Assamanura*)
Assamanura Cassagnau, 1980
boneti Yosii, 1962 (*Guthriella*)
Bonetrrura Christiansen & Bellinger, 1980
boneti Mari Mutt, 1977 (*Dicranorchesella*)
Dicranorchesella Mari Mutt, 1977
borneensis Yoshii, 1981 (*Callyntrura*)
Callyntrura (*Borneaphysa*) Yoshii, 1981
caeca Gisin, 1963 (*Neanura*)
Delete this entry
cassagnau Rusek, 1973 (*Pratanurida*)
Pratanurida Rusek, 1973
catalana Deharveng, 1979 (*Neanura* (*Deutonura*))
[*Catalanura* Cassagnau, 1983 — nomen nudum]
chaotica Yosii, 1976 (*Propeanura*)
Sphaeronura Cassagnau, 1983
circulatus Mari Mutt, 1979 (*Dicranocentrus*)
Pseudodicranocentrus Mari Mutt, 1981
corallina Imms, 1912 (*Neanura*)
Inameria Cassagnau, 1983
cretensis Ellis, 1976 (*Acheroxenylla*)
Acheroxenylla Ellis, 1976
decemoculata Deharveng, 1979 (*Pentacanthella*)
Pentacanthella Deharveng, 1979
dematteisi Dallai, 1973 (*Stachorutes*)
Stachorutes Dallai, 1973
dilatata Cassagnau, 1959 (*Xenyllogastrura*)
Orogastrura Deharveng & Gers, 1979
divergens Cassagnau & Deharveng, 1980 (*Travura*)
Travura Cassagnau & Deharveng, 1980
dobremezi Cassagnau, 1982 (*Parvatinura*)
Parvatinura Cassagnau, 1982
enigmatica Cassagnau, 1973 (*Tremoisea*)
Tremoisea Cassagnau, 1973
fageticola Rusek, 1978 (*Jevania*)
Jevania Rusek, 1978
farmae Dallai & Martinozzi, 1980 (*Betschurinus*)
Betschurinus Dallai & Martinozzi, 1980
flammeolus Gisin, 1957 (*Sminthurinus*)
Gisinianus Betsch, 1977
franzi Stach, 1951 (*Lathriopyga*)
Neanura (*Cryptonura*) Cassagnau, 1979
fueguensis Izarra, 1972 (*Pseudosorensia*)
Pseudosorensia Izarra, 1972
fuscus Lubbock, 1873 (*Papirius*)
Dicyrtoma Bourlet, 1842
grassei Denis, 1923 (*Achorutes*)
Monobella Cassagnau, 1979
griveaudi Betsch, 1975 (*Massoudia*)
Massoudia Betsch, 1975
grossi Yosii, 1966 (*Neanura*)
Australonura Cassagnau, [1980]
guineense Murphy, 1965 (*Neanura* (*Bilobella*))
Afrobella Cassagnau, 1983
gunung Yoshii, 1982 (*Callyntrura*)

- Callyntrura* (*Gunungphysa*) Yoshii, 1982
hiemalis Christiansen & Bellinger, 1980
 (*Stenogastrura*)
Stenogastrura Christiansen & Bellinger, 1980
himachal Yosii, 1966 (*Sminthurides*)
Yosiides Massoud & Betsch, 1972
hirtellus Börner, 1906 (*Achorutes*)
Blasconura Cassagnau, 1983
hongkongensis Yosii, 1976 (*Womersleya*)
 [*Pectinura* Cassagnau, 1983 — homonym]
huetheri Betsch & Lasebikan, 1979 (*Stenognathriopes*)
Stenognathriopes Betsch & Lasebikan, 1979
ieti Yosii, 1966 (*Lobella* (*Propeanura*))
 see *Propeanura*
imerinensis Betsch, 1974 (*Bourletiellitas*)
Bourletiellitas Betsch, 1974
immsi Mitra, 1977 (*Delamarerus*)
Delamarerus Mitra, 1977
indicus Handschin, 1929 (*Achorutes*)
Nilgirella Cassagnau, 1983
istana Yoshii, 1981 (*Callyntrura* (*Istanaphysa*))
Callyntrura (*Istanaphysa*) Yoshii, 1981
Japonica Kinoshita, 1917 (*Paronella*)
Callyntrura (*Japonphysa*) Yoshii, 1982
jugoslavica Palissa & Zivadinović, 1979 (*Neanura*
 (*Neanura*))
Balkanura Cassagnau, 1979
kaplini Tshelnokov, 1979 (*Desertia*)
Desertia Tshelnokov, 1979
kudatensis Yoshii, 1981 (*Callyntrura*)
Callyntrura (*Kudatphysa*) Yoshii, 1982
lava Bellinger & Christiansen, 1974 (*Hawinella*)
Hawinella Bellinger & Christiansen, 1974
lavadoi Izarra, 1972 (*Tullbergia* (*Anaphorura*))
Tullbergia (*Anaphorura*) Izarra, 1972
lesnei Carl, in Denis, 1925 (*Sminthurus*)
Spatulosminthurus Betsch & Betsch-Pinot, 1983
mahafalensis Betsch, 1975 (*Parabourletiella*)
Parabourletiella Betsch, 1975
marshalli Rusek, 1976 (*Sensiphorura*)
Sensiphorura Rusek, 1976
martynovae Rusek, 1979 (*Tiancambella*)
Tiancambella Rusek, 1979
mexicana Mari Mutt, 1981 (*Neorchesella*)
Neorchesella Mari Mutt, 1981
mexicana Cassagnau, 1983 (*Americanura*)
Americanura Cassagnau, 1983
microphthalma Cassagnau, 1968 (*Neanurella*)
Neanurella Cassagnau, 1971
minuta O. Fabricius 1783 (*Podura*)
Dicyrtomina Börner, 1903
mirabilis Riek, 1976 (*Permobrya*)
Permobrya Riek, 1976
mirabilis Cassagnau, 1983 (*Palmanura*)
Palmanura Cassagnau, 1983
miranda Yosii, 1966 (*Phyllimeria*)
Synameria Cassagnau, 1983
mongolica Betsch, 1977 (*Rusekianna*)
Rusekianna Betsch, 1977
muriphila Grinbergs, 1968 (*Proisotoma*
 (*Dimorphiella*))
- Dimorphotoma* Grinbergs, 1975
musci Bernard, 1977 (*Micranurophorus*)
Micranurophorus Bernard, 1977
najtae Betsch, 1975 (*Richardsitas*)
Richardsitas Betsch, 1975
nana Martynova, 1968 (*Biacantha*)
Martynovella Deharveng, 1979
nana Cassagnau & Peja, 1979 (*Neanura* (*Deutonura*))
 [*Albanura* Cassagnau, 1983 — nomen nudum]
natalensis Womersley, 1934 (*Achorutes*)
Ectonura Cassagnau, [1980]
nigeriana Lasebikan, Betsch & Dallai, 1980 (*Songhaica*)
Songhaica Lasebikan, Betsch & Dallai, 1980
nigrocephala Mitra, 1966 (*Salina*)
Pseudosalina Mitra, 1974
nivalis Cassagnau, 1959 (*Xenylloides*)
Odontellina Deharveng, 1981
numatai Yosii, 1966 (*Lobella* (*Propeanura*))
Chaetobella Cassagnau, 1983
obtusochaeta Rusek, 1976 (*Granuliphorura*)
Granuliphorura Rusek, 1976
palpiger Massoud, Najt & Thibaud, 1975
 (*Barbagastrura*)
Barbagastrura Massoud, Najt & Thibaud, 1975
pampeana Izarra, 1975 (*Parawillemia*)
Parawillemia Izarra, 1975
paramoense Diaz & Najt, 1983 (*Gnathogastrura*)
Gnathogastrura Diaz & Najt, 1983
pauliani Massoud, 1963 (*Abdiloba*)
 see *Abdiloba*
pauliani Betsch, 1974 (*Vatomadiella*)
Vatomadiella Betsch, 1974
peterseni Rusek, 1975 (*Wankeliella*)
Wankeliella Rusek, 1975
phlegraeus Caroli, 1912 sensu da Gama, 1964
 (*Neanura*)
Neanura (*Deutonura*) Cassagnau, 1979
pluripseudocellata Martynova, 1979 (*Ussuriaphorura*)
Ussuriaphorura Martynova, 1979
pruinosis Tullberg, 1871 (*Sminthurus*)
Bourletiella (*Cassagnaudiella*) Ellis, 1975
pseudomuscorum Börner, 1903 (*Neanura*)
 see *Protanura*
pseudoquadriculata Stach, 1951 (*Biloba*)
 see *Achorutes barberi* Handschin, 1928
puertoricensis Mari Mutt, 1979 (*Heteromurus*
 (*Heteromurtrella*))
Heteromurtrella Mari Mutt, 1979
regina Greenslade, 1982 (*Adelphoderia*)
Adelphoderia Greenslade, 1982
sachalinensis Dunger, 1977 (*Probolaphorura*)
Probolaphorura Dunger, 1977
saikehi Yosii, 1980 (*Mimoderus*)
Mimoderus Yosii, 1980
schilovi Martynova, 1976 (*Uralia*)
 [*Uralia* Martynova, 1976 —
 homonym]
Uralaphorura Martynova, 1978
seolagensis Lee, 1983 (*Tetraloba*)
Tetraloba Lee, 1983
septemlobata Salmon, 1954 (*Odontella*)

- Afrodontella* Deharveng, 1981
serrata Lee, 1983 (*Caputanurina*)
Caputanurina Lee, 1983
shanghaiensis Lin Shan-Xiang, 1980 (*Pseudonychiurus*)
 [*Pseudonychiurus* Lin Shan-Xiang, 1980 —
 homonym]
silvatica Martynova, 1981 (*Jacutogastrura*)
Jacutogastrura Martynova, 1981
siva Najt, 1978 (*Jestella*)
Jestella Najt, 1978
sminthurinus Mills, 1934 (*Neosminthurus*)
Millsurus Betsch, 1977
spectabilis Cassagnau, 1982 (*Paleonura*)
Paleonura Cassagnau, 1982
sphaeridioides Murphy, 1960 (*Sminthurides*)
Sminthuridia Massoud & Betsch, 1972
sultana Yoshii, 1982 (*Callyntrura*)
Callyntrura (*Sultanaphysa*) Yoshii, 1982
synacantha Cassagnau & Deharveng, 1976 (*Franzura*)
Franzura Cassagnau & Deharveng, 1976
tetrophthalmus Stach, 1929 (*Achorutes*)
Neanura (*Endonura*) Cassagnau, 1979
travei Cassagnau & Peja, 1979 (*Pumilinura*)
Pumilinura Cassagnau, 1979
tripartita Rusek, 1975 (*Marcuzziella*)
Marcuzziella Rusek, 1975
vancouverica Rusek, 1976 (*Chaetophorura*)
Chaetophorura Rusek, 1976
variabilis Betsch, 1977 (*Kaszabellina*)
Kaszabellina Betsch, 1977
verrucosus Cassagnau, 1978 (*Gamachorutes*)
Gamachorutes Cassagnau, 1978
vestita Handschin, 1925 (*Microphysa*)
Callyntrura (*Murphysa*) Yoshii, 1982
viettei Betsch, 1978 (*Paulianitas*)
Paulianitas Betsch, 1978
wallacei Betsch & Massoud, 1972 (*Bourletides*)
Bourletides Betsch & Massoud, 1972
wayang Yosii, 1976 (*Propeanura*)
Telobella Cassagnau, 1983
xerophila Rusek, 1974 (*Doutnacia*)
Doutnacia Rusek, 1974
yoshibai Yosii, 1963 (*Lobella*)
Riozura Cassagnau, 1983



TIJDSCHRIFT VOOR ENTOMOLOGIE

UITGEGEVEN DOOR

DE NEDERLANDSE ENTOMOLOGISCHE VERENIGING

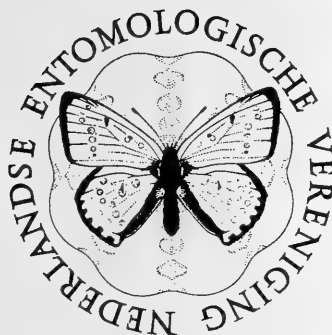

MUS. COMP. ZOOLOGICAL
LIBRARY

AUG 21 1984

HARVARD
UNIVERSITY

INHOUD

DAVID E. GASKIN. — The genus *Roxita* Błezynski (Lepidoptera, Pyralidae, Crambinae): new species and combinations and a reappraisal of its relationships, pp. 17—31, figs. 1—23.

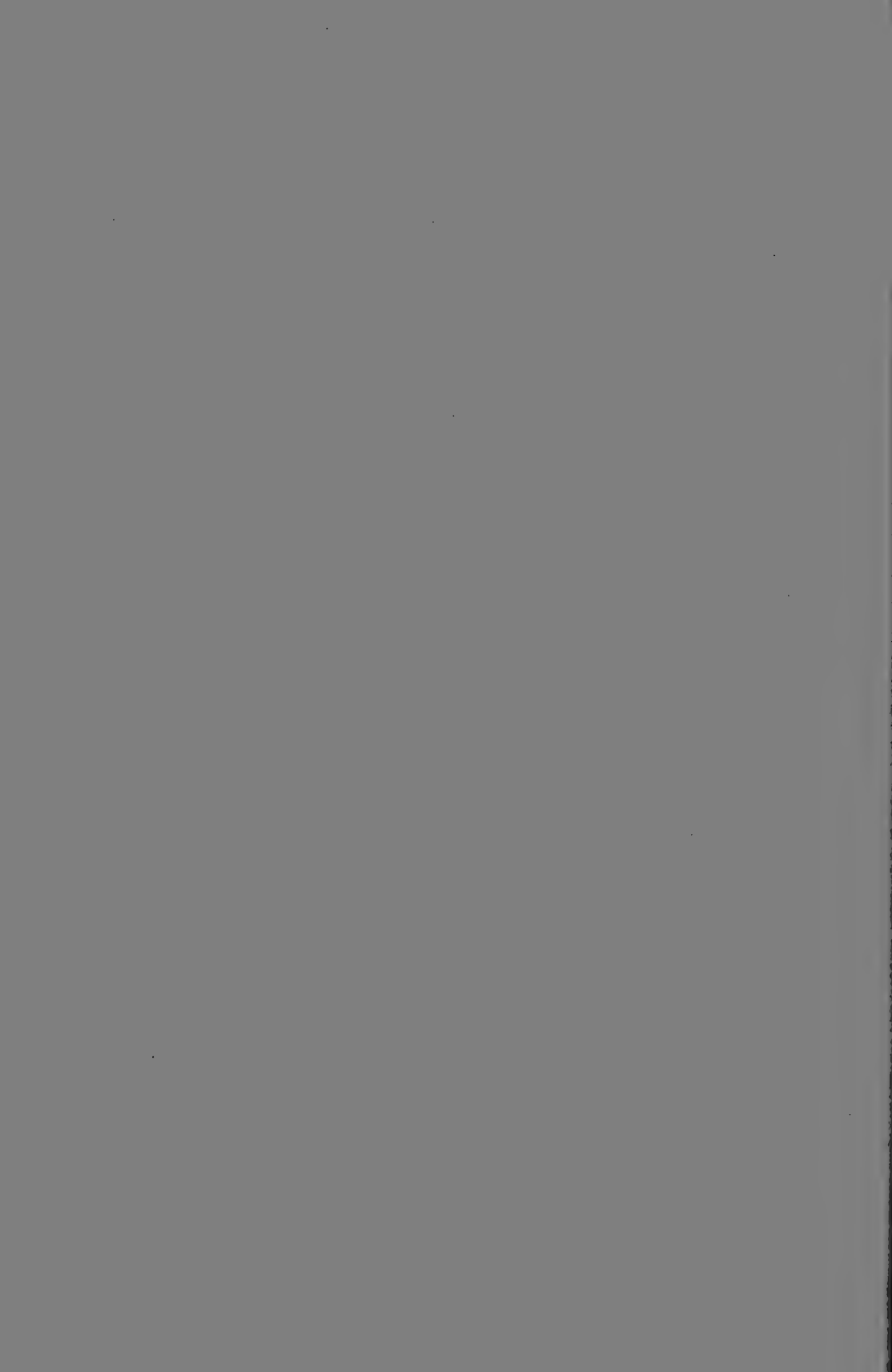

THE GENUS *ROXITA* BLESZYNSKI (LEPIDOPTERA, PYRALIDAE, CRAMBINAE): NEW SPECIES AND COMBINATIONS AND A REAPPRAISAL OF ITS RELATIONSHIPS

by

DAVID E. GASKIN

Department of Zoology, University of Guelph, Guelph, Ontario, Canada

ABSTRACT

The Indo-Oriental genus *Roxita* Bleszynski is redefined. Four new species, *apicella*, *fletcheri*, *mululella* and *reductella* are described. *Modestia* Bleszynski is a synonym of *Roxita* and the two species *M. szetschwanella* (Caradja) and *M. bipunctella* (Wileman & South) are transferred to *Roxita*, as is *Diptychophora adpersella* Snellen. Bleszynski concluded that *Modestia* (= *Roxita*) was closely allied to *Paveromene* Osthelder (Crambinae, Diptychophorini); in fact the genitalia of both sexes show many characters linking them to *Corynophora* Berg and *Tawhitia* Philpott (Crambinae, Crambini, Corynophorina). The zoogeography of *Roxita* is briefly discussed.

INTRODUCTION

In 1963 Bleszynski established the monotypic genus *Roxita* to accommodate a new species *eurydyce*, based on the series (two specimens) of *Culladia szetschwanella* f. *modesta* Caradja & Meyrick (1933: 140, nomen nudum). Later he described a new genus *Modestia* Bleszynski (1965: 64) and transferred *szetschwanella* proper to that genus from *Culladia* Moore, designating a male of the syntypic series (5 males, 1 female) as a lectotype. Previously (1963: 28) he has synonymized *Crambus modestellus* Caradja (praeocc. by *Crambus modestellus* Barnes & McDunnough, 1918) with *szetschwanella*. He also commented (1965: 65) that f. *modesta* was either a nomen nudum or an incorrect spelling of *modestellus*, and indicated that "... the specimens listed as f. *modesta* belonged to a totally different genus and species which he planned to describe later" (my quotes, from translation). It is quite evident he had forgotten that he had already described these specimens as the type of *Roxita eurydyce* (1963: 176), and also failed to recognize that they were members of the same genus as *szetschwanella*.

The latter error was particularly puzzling until Mr. Michael Shaffer of the British Museum of Natural History obtained the type series from the Muzeul G. Antipa in Bucharest for the author, and observed that the female was a damaged and undescribed species of *Glaucocharis*

Meyrick. It seems likely that Bleszynski was misled in his conclusions about the status of f. *modesta* by the genitalia of this misidentified specimen.

Further comparative studies and a search of the British Museum collections in close cooperation with Mr. Shaffer led to the conclusion that both described species of *Modestia*, *M. szetschwanella* (Caradja) and *M. bipunctella* (Wileman & South) should be transferred to *Roxita*, that *Modestia* was a synonym of *Roxita*, that *Diptychophora adpersella* Snellen should also be transferred to *Roxita*, and that four previously undescribed species *apicella* n. sp., *fletcheri* n. sp., *mululella* n. sp. and *reductella* n. sp. should also be assigned to *Roxita*. All seven species are rather small, yellowish or brownish crambine moths, with or without fasciae, 10–17 mm in wingspan, which could be confused with several diptychophorine genera on the basis of external appearance. They were therefore of considerable interest to the author, who is revising the world Diptychophorini. The genitalia of the known females of *Roxita* sp. however, are quite distinctively corynophorine, with an external limen formed by fusion of the lamellae ante- and postvaginales, so that the extremity of the antrum protrudes. Nor is the structure of the male valvae at all characteristic of the quadrate form (with undeveloped sacculus) typical of *Glaucocharis* and most other diptychophorine

genera. On the basis of the former morphology alone *Roxita* must be excluded from the Diptychophorini, as defined by Gaskin (1971).

The subtribe Corynophorina, previously known only from Australia and New Zealand (Gaskin, 1975: 376) has its distribution greatly extended by the addition of *Roxita* to the two genera previously assigned, *Corynophora* Berg and *Tawhitia* Philpott. The distribution of *Roxita* itself may be extended by future discoveries, but at present appears to be exclusively Indo-Oriental.

Roxita exhibits several specialized features in addition to loss of forewing m_1 ; the most significant of these is atrophy of the juxta in most species. In *Tawhitia* species the juxta is retained, and the saccus of the male has a characteristic ventral flap. The anal papillae of female *Tawhitia* are fused distally to form a "dutch clog-shaped" structure. *Corynophora* is decidedly more primitive than either of the above genera; the anal papillae are barely fused distally, the corpus bursae bears unmodified signa reminiscent of those found in generalized Crambina, the evagination of the sterigmal sclerites is rudimentary (albeit present) in contrast to the condition in the other genera, and in the male the narrowing of the valva and the segregation and elaboration of the costal region has not progressed far. The uncus, gnathos, sacculus and ventral region of the valvae however, are essentially the same structures found in other genera. The morphology of the venation and genitalic structures in both sexes provides strong evidence for common ancestry.

The Corynophorina present an interesting zoogeographical problem. One of the alternative hypotheses put forward by Gaskin (1975: 274) concerning the evolution of Crambini was the postulation of southern origin. The Corynophorina were believed to have been isolated in Australia and New Zealand, while the Crambina, with a less restricted Gondwanic distribution, avoided this isolation and were able to colonize tropical grasslands and eventually the temperate grasslands of the northern hemisphere. Obviously, while southern origin remains a strong possibility, the corynophorine isolation hypothesis must now be re-assessed. Two alternatives present themselves; 1) Were the Corynophorina more widely dispersed in the southern hemisphere before the separation of Australia from Antarctica than previously thought? or 2) Is the present distribution the re-

sult of extension of range from Australia into southern Asia in the late Tertiary, with subsequent isolations leading to further speciation?

The former appears most likely, for several reasons. True Australian faunal elements appear to have had little success colonizing the tropics to the north of the continent, except for penetrations into New Guinea. The most primitive genus of the Corynophorina, *Corynophora* itself, has survived, like so many other relict groups, in isolation in Australia. Modification of the basic corynophorine plan in the more specialized genus *Tawhitia* could well be related to this genus being distributed in the extreme southeast of Australia and in southern New Zealand, areas which have had more radical late Tertiary geomorphological and climatic histories than much of subtropical and warm-temperate eastern Australia (see Fleming, 1962, 1963a, b, for example) and hence perhaps experienced more rigorous selection pressures.

Both *Tawhitia* and *Roxita* possess characters obviously apomorphic with respect to *Corynophora*, but they are not the same characters, suggesting segregated radiation over a long period. The valval elaborations in *Roxita* are quite characteristic, and the juxta has become atrophied. In *Tawhitia* the latter structure has become rather strong and complex. While *Corynophora* so far is known only from Australia, one species of *Tawhitia* is endemic to the alpine habitat of the South Island of New Zealand. The New Zealand alpine (*T. glaucophanes* Philpott) may well be a relict derivative of ancient eastern Gondwanic stock; the other species (*T. pentadactyla* (Zeller)) on the other hand, is so close to the Australian form that colonization in or even since Quaternary time has to be a distinct possibility.

Corynophorines seem to be absent from Africa and South America, yet common to all major geographic zones of the Indo-Australasian/Oriental regions. It seems reasonable therefore, to assume that the segregation, speciation and dispersal of *Roxita* occurred in the northern Gondwanic periphery, i.e. what is now the Malaysian-southern Oriental region, with subsequent colonization of India and Ceylon. It must not be overlooked however, that one of the least specialized members of the genus occurs in Sri Lanka. Absence of *Roxita* from South America, Africa, Australia and New Zealand tends to imply that its radiation has been a phenomenon of the middle to late Tert-

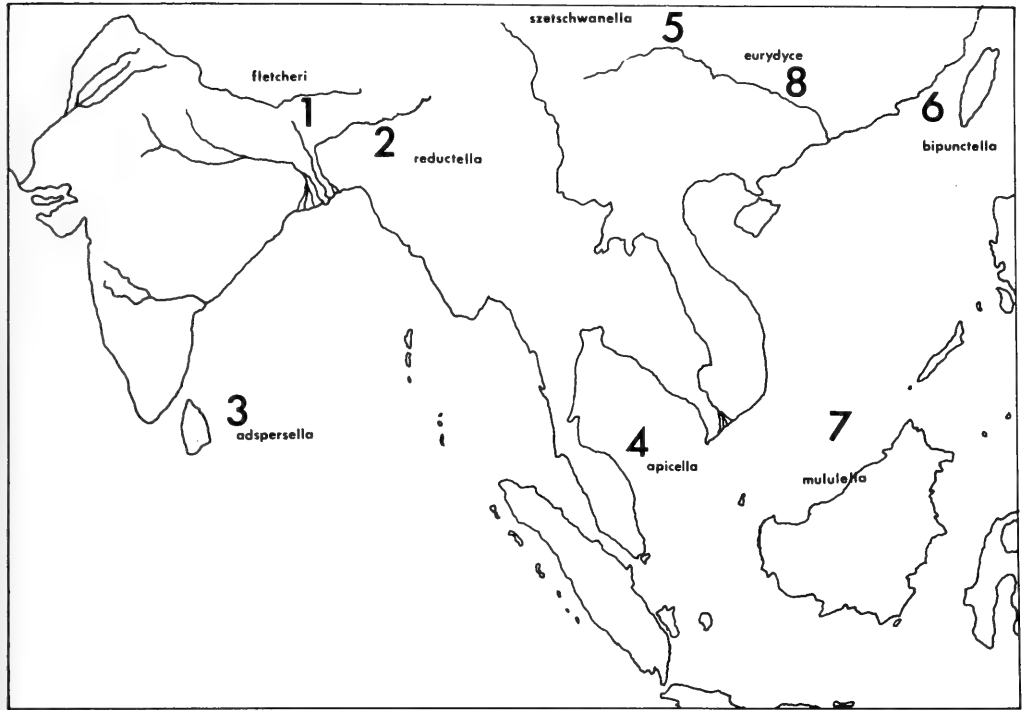

Fig. 1. Records of *Roxita* species. 1, *fletcheri* (southern Himalayas); 2, *reductella* (Khasia hills of Assam); 3, *adpersella* (Sri Lanka); 4, *apicella* (West Malaysia); 5, *szetschwanella* (western China); 6, *bipunctella* (Taiwan); 7, *mululella* (East Malaysia); 8, *eurydyce* (southern China).

ary period, well after the separation of the major continental elements of the Gondwanic complex.

Within *Roxita* itself three distinct species groups can be recognized. Differences in size and habitus are at first sight rather extreme in this genus, but are in fact no greater than those found within *Orocrambus* Purdie of New Zealand (Gaskin, 1975). The closest relationship is that between *apicella* and *mululella*, distributed in West and East Malaysia respectively (fig. 1), indicating a similar history to butterflies of "faunal element 1B" of this region (Holloway, 1973), and prompting speculation that the genus will be found in Sumatra as well, and possibly in the Lesser Sunda Islands, Celebes and the Philippines. The relationships of *reductella* cannot be determined without further material. The Oriental species *bipunctella* and *szetschwanella* of Taiwan and western China are closely related, as might be expected. The third group, containing *adpersella* of Sri Lanka, *fletcheri* of northern India and *eurydyce* of southeast China, is the most widely distributed. As might

be expected, although there are clear affinities between the species, these are not quite as close as those among the previous species pairs. As aforementioned, the Sri Lanka species is the most primitive of these three, in contrast to the usual situation where faunal elements of Sri Lanka and southern India are derivative with respect to northern India (Holloway, 1974).

Roxita Bleszynski

Type-species: *Roxita eurydyce* Bleszynski, 1963 (partim), by monotypy.

Roxita Bleszynski, 1963: 176.

Modestia Bleszynski, 1965: 64. Type-species: *Culladia szetschwanella* Caradja, 1931, by monotypy.

New synonymy.

Revised description.

Terminology throughout descriptions follows Diakonoff (1954), Klots (1956) and Dugdale (1966). The abbreviation "LMB ratio" in the descriptions of male genitalia refers to length to medium breadth ratio of the aedeagus.

In forewings, Sc and r_1 separate, r_3 and r_4

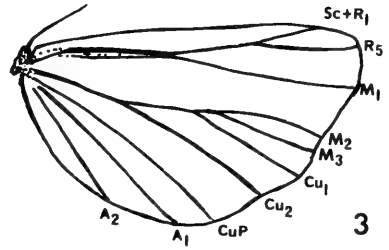
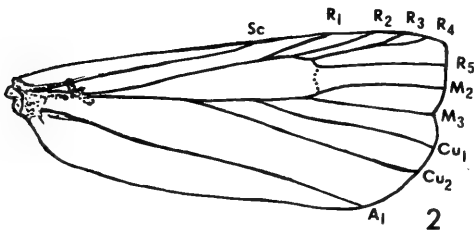

Figs. 2, 3. Forewing (2) and hindwing (3) venation of typical *Roxita* species.

with common stalk, r_5 free, not stalked with r_4 as in Crambini, m_1 absent (fig. 2). In hindwings, m_2 , m_3 and cu_1 arising from common stalk, hindwing cell open (fig. 3). Male genitalia with valvae characteristically much tapered, folded, developed into prongs, lobes and/or setae, especially in costal region. Sacculus and ventral margin of valva may also be so developed. Female genitalia having lateral extremities of antrum fused with eighth tergite, which has much reduced anterior apophyses. Lamella antevaginalis (sterigal sclerotization forming anterior lip of antrum) often drawn out into a spade-shaped external protrusion of the antrum which takes the form of a rather elongated, evaginated sclerotized tube (limen). Little or no modification of the posterior margin of the seventh sternite is involved. Corpus bursae usually asiginate; two elongate signa present in one species. Early stages not known.

KEYS TO THE SPECIES OF *ROXITA* BLESZYNSKI

A. External features

- 1. Ground colour of forewings dull buffish yellow 2
- Forewings brown, with or without horizontal or transverse dark-bordered whitish fascia 3
- 2. Ante- and postmedial fasciae represented by incomplete dark borders only (fig. 4) *apicella* n. sp.
- Ante- and postmedial fasciae white, dark-bordered (fig. 5) *mululella* n. sp.
- 3. Forewing brown, but devoid of antemedial fasciae of either type, with dark brown subterminal zone (fig. 6) *reductella* n. sp.
- Forewing brown; with or without white horizontal or transverse fasciae, subterminal zone same colour as rest of wing 4
- 4. Well-marked transverse fasciae on forewing; no trace of pale, horizontal fascia . . . 5

- Well-marked or indistinct pale horizontal fascia on forewing, with or without transverse fascia 6
- 5. Antemedial fascia broad, white with thick chocolate brown distal margin, postmedial fascia not touching termen (fig. 7) *adpersella* (Snellen)
- Antemedial fascia tapering sharply from costa, becoming obsolete before dorsum except for thin dark distal streak; postmedial fascia touching termen in two places (fig. 8) *fletcheri* n. sp.
- 6. Apical zone of forewing yellowish ochre proximally, whitish distally. Dark-bordered, buff transverse fascia at about 0.3 from base (fig. 9) *eurydyce* Bleszynski
- Apical zone of forewing dark brown with white distal patch. No transverse fascia as described above 7
- 7. Apical zone of forewing dark except for narrow white terminal stripe (fig. 10) *szetschwanella* (Caradja)
- Apical zone of forewing dark, but with broad oval white zone against terminal margin (fig. 11) *bipunctella* (Wileman & South)

B. Male genitalia

(Male genitalia of *reductella* n. sp. not known)

- 1. Valva bearing long, curved costal setae 2
- No such costal setae present 3
- 2. Basal costal prong absent; setae flattened, apically expanded (fig. 12) *apicella* n. sp.
- Basal prong absent, setae tapered (fig. 14) *mululella* n. sp.
- 3. Only costal region of valva bearing protuberances 4
- Valva ventral margin folded, with elongate protuberance 6
- 4. Costa of valva with single apical prong (fig. 16) *adpersella* (Snellen)

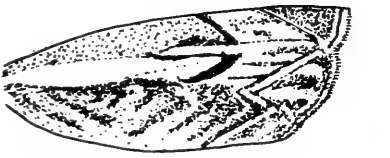
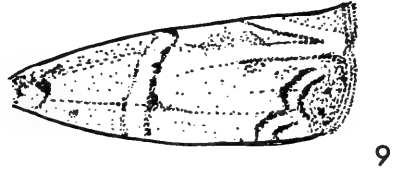
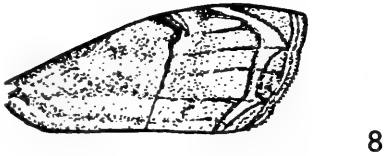
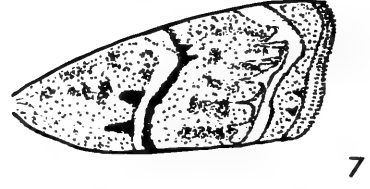
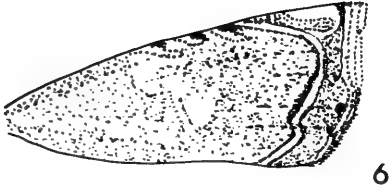
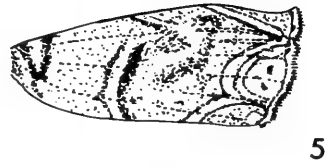
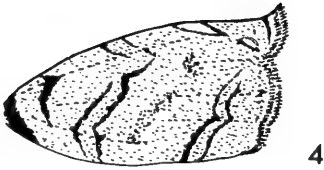

Figs. 4—11. Forewing patterns of the species of *Roxita*. 4, *apicella*; 5, *mululella*; 6, *reductella*; 7, *adpersella*; 8, *fletcheri*; 9, *eurydyce*; 10, *szetschwanella*; 11, *bipunctella*.

- Costa of valva with basal and apical prongs 5
- 5. Apical prong of valval costa with short curved spur near its base; basal prong of costa very slender, and as long as apical prong (fig. 18)..... *fletcheri* n. sp.
- Apical region of valval costa lacking such a prong, robust basal prong considerably shorter than apical (fig. 15).....
..... *eurydyce* Bleszynski
- 6. Pyramidal costa, elongate, slender apical prong (fig. 20).... *szetschwanella* (Caradja)
- Costa only slightly arched, with broad, flattened apical prong, curved sharply dorso-introtrorsely (fig. 22)
..... *bipunctella* (Wileman & South)

C. Female genitalia

(Female genitalia of *eurydyce* and *reductella* not known)

1. Corpus bursae with two signa; "fatty"-looking subantral sac present (fig. 13)
..... *apicella* n. sp.
- Corpus asignate, no such sac present 2
2. Strong fusion between base of antral region and anterio-lateral angles of eighth tergite. Antrum without lateral extensions, apically spatulate 3
- Weak fusion between antral base and eighth tergite. Antrum with lateral extensions ... 4
3. Ductus bursae about 3.5 × length of posterior apophyses (fig. 17)
..... *adpersella* (Snellen)

- Ductus bursae about 6 × length of posterior apophyses (fig. 19) *fletcheri* n. sp.
- 4. Antral region with slight lateral extensions (fig. 21) *szetchwanella* (Caradja)
- Antral region with broad lateral “wing-like” extensions (fig. 23) *bipunctella* (Wileman & South)

Roxita adspersella
(Snellen, 1893) n. comb.
(figs. 7, 16, 17)

Diptychophora adspersella Snellen, 1893: 61, pl. 3 fig. 4.

Diptychophora adspersella Snellen; Bleszynski & Collins, 1962: 295.

External characters. — Labial palpi creamy-buff, 1.5 × head length. Head whitish-buff, frons rounded. Thorax, legs and abdomen pale buff.

Forewings (fig. 7) with ground colour pale creamy buff. Basal fascia absent. Antemedial fascia dark brown, with pale proximal edging,

broad, waved, angled at about 0.2 with one or two “teeth” on distal side of angle, costal extremity yellow in some specimens. Basal half of wing clouded with dark brown in interneural spaces. Postmedial fascia (*not* touching terminal margin as in *fletcheri*) broad, silvery white, flanked proximally with “toothed” yellow margin, the “teeth” extending into the discal region with some grey scaling between them. Apical and terminal region plain buff, with a pair of black spots on the margin at 0.6 and 0.7, flanked distally by small buff marks. Cilia bounded proximally by a thin, brown marginal fascia, themselves buff with brown tips. Ventral surface dull mid-brown.

Hindwings creamy white, or with apical brown shading, cilia pale buff with a dark terminal fascia. Ventral surfaces dull pale brown.

Expanse 10—12 mm.

Male genitalia. — Fig. 16. Uncus strong, narrow, sharply pointed, curved steeply ventrad. Gnathos apically spatulate and lightly scobinate, lateral elements narrow. Tegumen weak, elon-

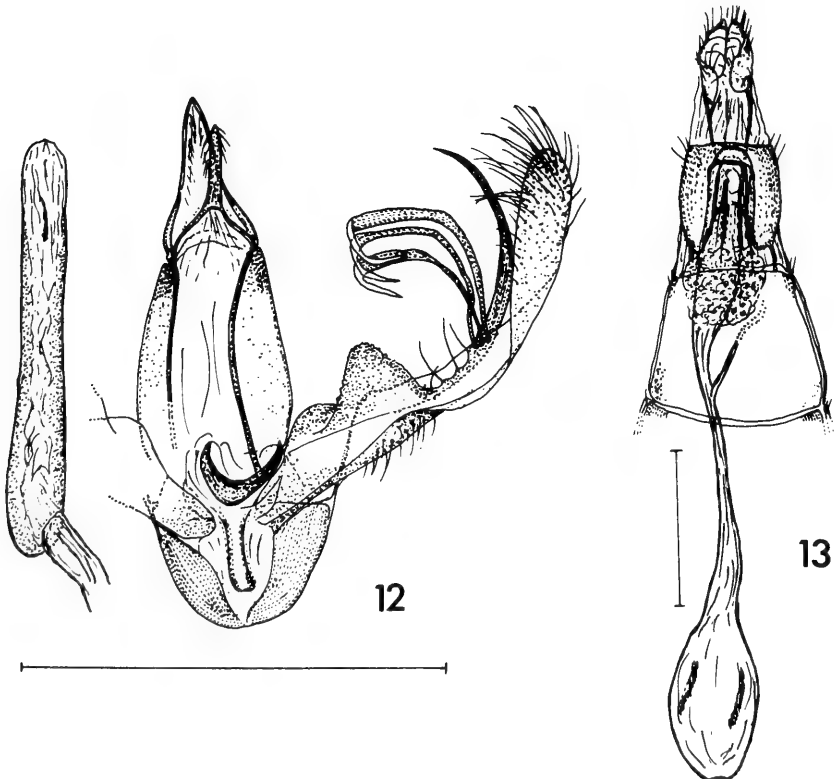

Figs. 12, 13. Male and female genitalia of *R. apicella*. In this and all subsequent genitalia drawings the indicated scale is 1 mm.

gate, basally narrowed. Vinculum absent, or indistinguishable from lateral wall of saccus. Saccus moderate, bluntly rounded, about $0.5 \times$ length of uncus. Juxta weak, rhomboidal. Valva about twice length of uncus, with strong demarcation of broad costal region. Costa terminating in a large, curved, strong apical prong, dorsad of which is a blunt lobe at termination of costal sector. Valva proper very elongate, tapered to point, with weak cucullus. Sub-basal part of valva has a weak elongate ridge which may represent demarcation of a distinct saccular region. Aedeagus massive, stout, LMB ratio about $5 : 1$, lacking cornuti, but with sub-apical ridge at right angles to longitudinal axis.

Female genitalia. — Fig. 17. Anal papillae moderately sclerotized, free, about half length of posterior apophyses. Eighth abdominal tergite quite massive, about twice as long as anal papillae, fused in latero-ventral lines with margins of antrum. Anterior apophyses about $0.75 \times$ length of posteriors. Lamella postvaginalis forming a very strong dorsal roof to antrum; it is to this plate that the tergite margins fuse. Lamella antevaginalis forming a similar, but curved, apically spatulate plate, half of which projects some distance beyond the curved posterior margin of the seventh sternite. Ductus bursae about $3.5 \times$ length of posterior apophyses, with a "kink" in the partly recurved portion at about $0.3-0.4$, ductus seminalis junction obscure in available preparation, but apparently at about 0.4 . Corpus bursae asignate.

Types. — Lectotype ♂, Sri Lanka (Ceylon), ("u.d.P."), genitalia preparation GS 6746; unpublished (?) designation by E. G. Munroe (label) (BMNH). Paralectotypes, 2 ♂, bearing original "u.d.P." labels, but additionally erroneously labelled "Pontiak W. Borneo (Andre)" (BMNH).

Material examined. — Ceylon, 2 ♂ "Ceylon" (Rothschild Bequest), no other data; 2 ♂, "Ceylon", 1892 (acq. Doncaster); 1 ♂, "Ceylon", 9-26 (Green coll.); 1 ♂, "Ceylon, R.07", 2 ♀ "Ceylon, 95-37" (1 in CNC, Ottawa); 1 ♀ "Putlam, Ceylon, C.F.H./96"; 1 ♀ Kegala, Oct. 1909, 4184 (Mackwood), genitalia prep. BM pyral. 14700; also 1 ♀, "4184" (presumably also a specimen from Kegala) (all in BMNH unless otherwise stated).

Remarks. — The life history is unknown, except that the flight period includes September and October. While the valval costa is charac-

teristically differentiated (fig. 16) it is of essentially simpler structure than in the other species. *R. adpersella* forms a rather discrete species subgroup with *R. fletcheri*; both are considerably smaller ($10-13$ mm) than other members of the genus and more closely related to *R. euridyce* than any other species. Discovery of *adpersella* in India would not be surprising.

Roxita fletcheri new species

(figs. 8, 18, 19)

External characters. — Labial palpi $2 \times$ head length, whitish-scaled. Head whitish, frons rounded. Thorax creamy yellow, legs, abdomen similar.

Forewings (fig. 8) with grey ground colour, costa clouded basally with mid-brown. Basal fascia absent, antemedial fascia touching costa at about 0.6 , dark brown, rather indistinct, angled sharply at about 0.2 , the costal extremity marked distally with a small yellow bar. Discal region grey, with slight brown costal clouding, but penetrated from silvery white subterminal band by neural stripes of solid yellow scaling reaching central discal region. Post-medial fascia narrowly edged proximally by yellow, more thickly distally by blackish scaling. Outer margin of fascia sharply angled twice, touching the margin at about 0.3 and 0.7 (these angles are important features for distinguishing this species from *adpersella* on forewing pattern). Apical region and the two other marginal areas cut off by angles of postmedial fascia, all buff, with a pair of black marginal spots at 0.5 and 0.6 . Terminal extremity of apex bearing a wedge of golden brown scales. Ventral surface mid-greyish brown, with marginal and apical markings faintly repeated from dorsal surface.

Hind-wings mid-brown, slightly paler beneath, with sinuate termen.

Wing expanse $11-13$ mm.

Male genitalia. — Fig. 18. Uncus nearly straight in profile, narrow when viewed from below, apex sharply pointed. Gnathos only slightly shorter than uncus, apically rounded and slightly spatulate. Tegumen weak, narrow. Vinculum small, sub-triangular, with very strong margins. Saccus massive, tapered, apically rounded, about $1.25 \times$ length of uncus. Juxta a weak plate, more or less quadrate, but indeterminate in shape. Valva about $3.75 \times$ length of uncus, very elongate, narrow, apically rounded, with weak cucullus. Valval costa extending to about 0.5 of dorsal margin, with slender basal

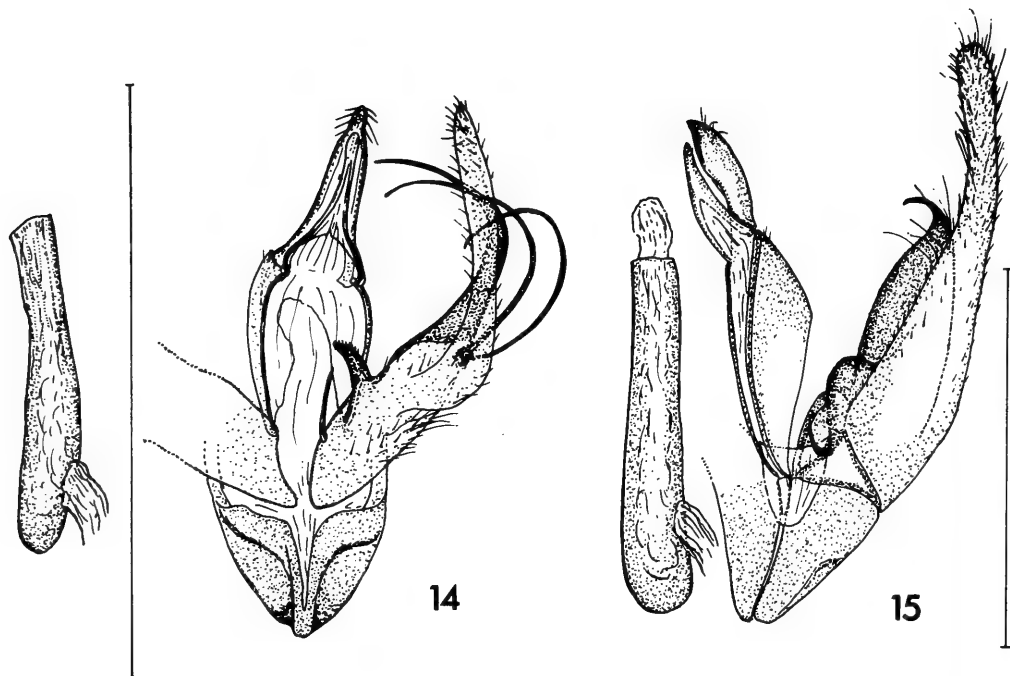

Figs. 14, 15. Male genitalia of *R. mululella* (14) and *R. eurydyce* (15).

prong nearly length of uncus, and a pair of apical prongs at 0.6, one long, one short, both pointed, curved dorsad. Aedeagus about $0.8 \times$ length of valva, LMB ratio about 9 : 1, tubular, with single irregular sub-apical cornutus.

Female genitalia. — Fig. 19. Anal papillae relatively strong, free, somewhat tapered apically. Posterior apophyses about twice length of papillae. Eighth abdominal tergite strong, with ventro-lateral sterigmal extensions, fusing with lateral margins of antrum. Anterior apophyses reduced to short stubs. Lamella antevaginalis with strong, spatulate extension protruding beyond the posterior margin of the seventh sternite; lamella postvaginalis with a similar but much smaller extension as dorsal roof of antrum. Rest of both lamellae weaker, but staining intensely blue with chlorazol black. Ductus bursae lightly scobinate, $6 \times$ length of posterior apophyses (measured from posterior lip of antral shield), ductus seminalis joining at about 0.15. Corpus bursae asignate.

Types. — Holotype ♂, N. India, Himachal Pradesh, Dharmsala (32 14'N 76 24'E), 8.vii.59, genitalia prep. BM pyral. 14772 (BMNH). Paratypes: N. India, 1 ♂, Bhimtal to Mukto'sar,

5,000—6,000 ft., 11.ix.1923 (Fletcher) (BMNH). Nepal, 1 ♂ Bhimpedi, 400 m, 4—7.iv.1962 (G. Ebert and H. Falkner) SB 5792 (München). Sikkim, 1 ♂, 2,800 ft., vi.1895 (J. G. Pilcher) BM pyral. 7483 (BMNH); 1 ♀ Dikchu, 2,500 ft., 22.iv.1924 (R. W. G. Hingston) BM pyral. 14788 (BMNH).

Remarks. — This close relative (and apparent derivate) of *R. adpersella* is presently known from northern India, Sikkim and Nepal, and the flight period includes April, June, July and September. The early stages are unknown. It is clearly distinguishable from *adpersella* by the form of the postmedial fascia of the forewing, the complex spinose costa of the male valva, and the ventrally fused eighth abdominal tergite with short anterior apophyses in the female.

Roxita eurydyce Bleszynski (figs. 9, 15)

Roxita eurydyce Bleszynski, 1963: 176 (fig. 64, ♂ genitalia, but fig. 62, labelled ♀ genitalia, is a misidentification).

External characters. — Described from holotype male by Bleszynski (1963), accurately ex-

cept that the costal portion of the apical area of the forewing is yellow and the terminal zone white, not the reverse as in his description (fig. 9). True female of this species not known.

Male genitalia. — Fig. 15. As described and figured by Bleszynski (redrawn here for comparative purposes), but the basal process of the valval costa is smooth and slender, not stout as drawn by Bleszynski.

Type. — Holotype ♂, China, Lung-Tao-Shan, Kwangtung, 230 km from Canton, genit. prep. 2611-SB, Muzeul G. Antipa, Bucharest.

Remarks. — As indicated in the Introduction, the paratype female of the type series is in fact referable to the genus *Glaucocharis* Meyrick. The specimen is very damaged and does not merit description as a new species until more material is obtained. While *eurydyce* stands a little isolated from *szetschwanella* and *bipunctella* on one hand, and *apicella* and *mululella* on the other, the affinities in male genitalic characters with *fletcheri* and *adpersella* are striking. Bleszynski's statement (1963: 178) that the species was described from "two females" is obviously a simple typographic error.

Roxita reductella new species

(fig. 6)

External characters. — Labial palpi about

1.75 × head length, buffish yellow. Head buff, frons rounded, thorax, legs, buff with yellow scales.

Forewings (fig. 6) with ground colour of whitish brown, discal region covered with scattered brown scaling. Basal and antemedial fasciae absent, although position of latter is marked on costa by one or two obscure white and black marks. Disc buffish brown. Postmedial fascia narrow, white, edged with dark brown, curved from costa, with slight zig-zag at about 0.8. Subterminal zone clouded with dark brown. Pair of black sub-marginal spots characteristic of genus situated at 0.6 and 0.8. Apical zone white, with a medial buffish yellow zone. Some yellowish patches are also present in the sub-costal region of the disc. Ventral surface dull, pale brown. Cilia buffish, with dark bases (most outer cilia missing in available specimen).

Hindwings pale brown, apical cilia with dark brown bases, otherwise also pale brown.

Wing expanse 16.5 mm.

Type. — Holotype ♂, N.E. India, Khasia, Aug. 1894 (nat. collr), Rothschild Beq. 1939—1, no abdomen (BMNH).

Remarks. — I describe this species, despite the missing abdomen, since it is clearly a new species of *Roxita* which could not be confused

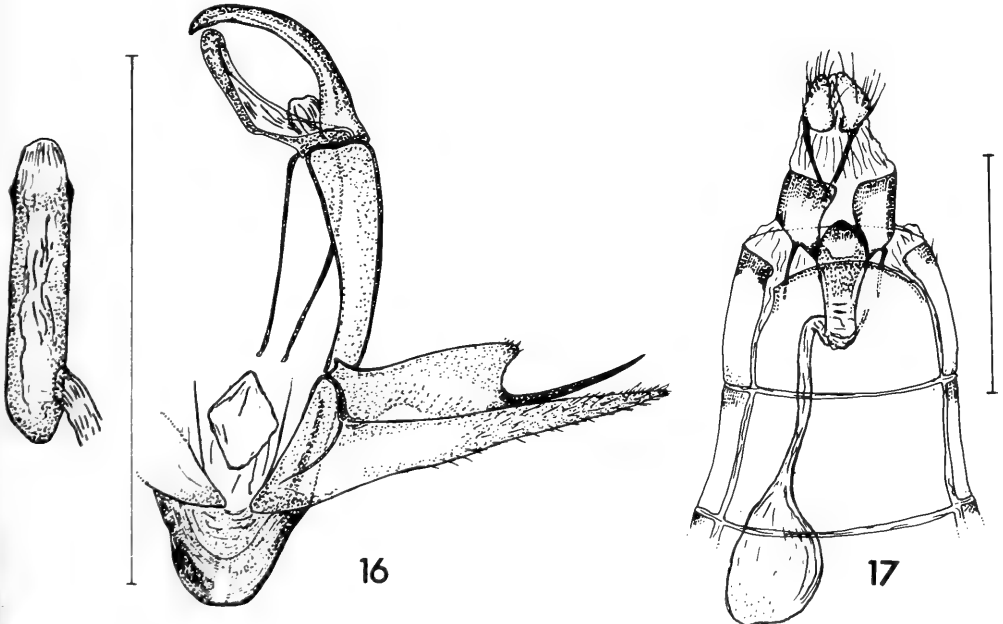

Figs. 16, 17. Male and female genitalia of *R. adpersella*.

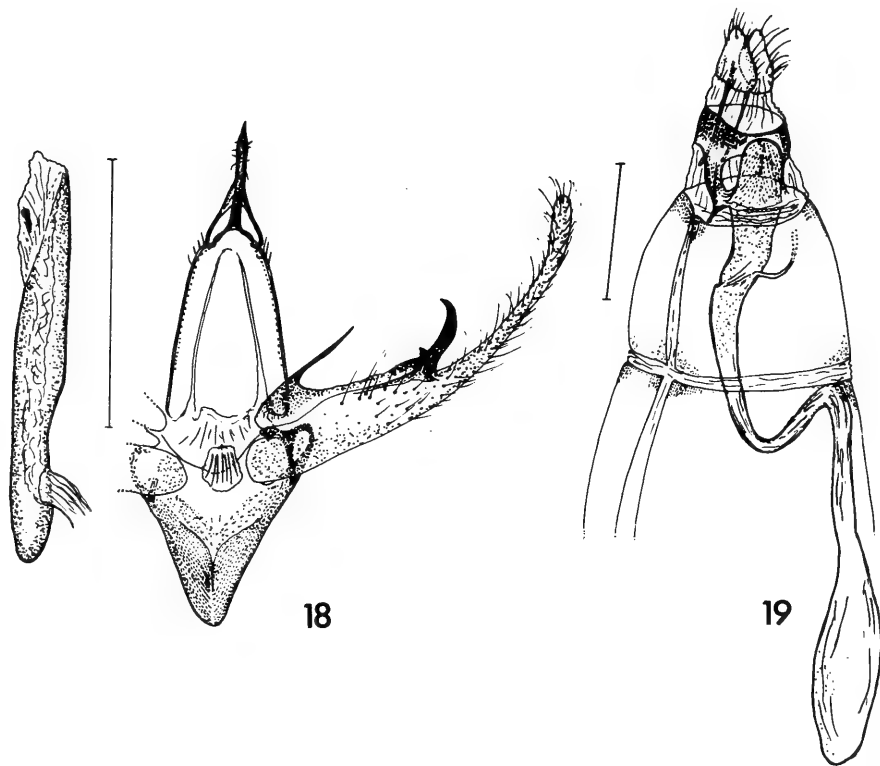

Figs. 18, 19. Male genitalia of *R. fletcheri*.

with other known members of the genus. Only the unique holotype has so far been collected.

Roxita szetschwanella
(Caradja) new combination
(figs. 10, 20, 21)

Crambus modestellus Caradja, 1927: 395 (praeoc.).

Culladia szetschwanella Caradja, 1931: 203.

Culladia szechwanella Caradja; Caradja & Meyrick, 1933: 140 (misspelling of *szetschwanella*).

Modestia szetschwanella (Caradja); Bleszynski, 1965: 64 (partim), pl. 2 fig. 17, pl. 34 fig. 17 (δ genitalia), pl. 87 fig. 17 (δ genitalia).

Modestia szetschwanella (Caradja); Bleszynski, 1970: 59.

External characters. — Described by Caradja (1927, 1931), briefly re-described, and illustrated in colour, by Bleszynski (1965, p. 64 & pl. 2 fig. 17). I also present fig. 10, provided for comparative purposes.

Male genitalia. — Fig. 20. Illustrated by Bleszynski (1965, pl. 34 fig. 17) redrawn and re-

described here, with re-interpretations. Uncus and gnathos about equal in length, sharply and bluntly pointed and curved ventrad and dorsad respectively. Tegumen simple. Saccus somewhat tapered in preparation, but probably rounded in reality. Vinculum an elongate triangular structure about $0.4 \times$ as wide as length of uncus. Juxta not recognized in preparation. Valva about $3 \times$ length of uncus ($4 \times$ if apical costal prong included). Costal region strong, massively sub-pyramidal at about 0.8, then terminating in apical prong, curved slightly posteriad, and about length of uncus. Valva proper apically and moderately tapered, with weak cucullus, and an introrse ventral fold, bearing a sub-basal curved prong at about 0.4 from base, and a much longer (nearly $1.5 \times$ length of uncus) flattened, gently tapered prong with rounded apex. Aedeagus about equal to length of valva, tubular, truncate, LMB ratio about 10 : 1, apical quarter slightly curved and scobinate.

Female genitalia. — Fig. 21. The paralectotype specimen (slide GU-2904-B1), stated by

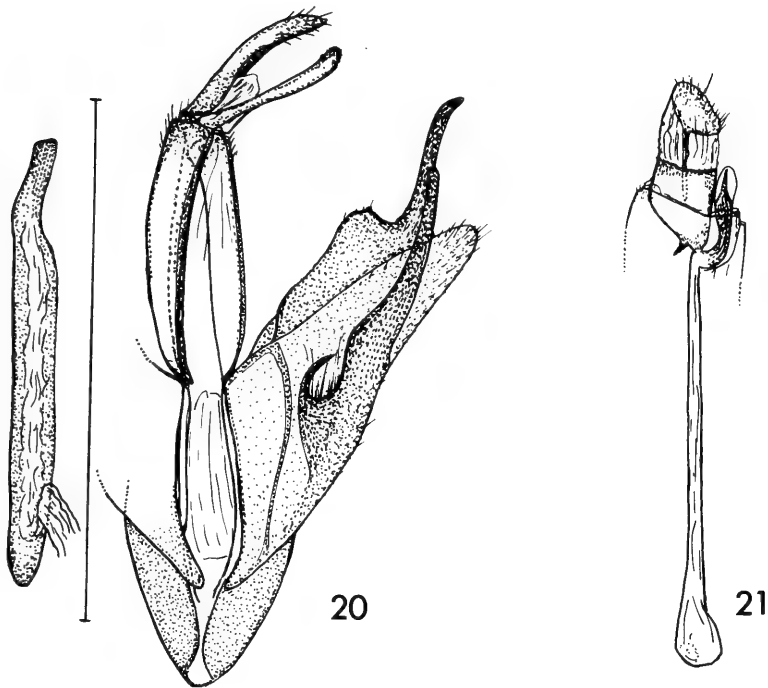

Figs. 20, 21. Male and female genitalia of *R. szetschwanella*.

Bleszynski (1965) to be in the Antipa collection in Bucharest, could not be obtained for re-examination. Since this is the only known female, Bleszynski's figure is redrawn here. His drawing reveals relatively little detail, and the junction of the ductus seminalis was not shown. The margin of the antrum however, can be seen to be extruded from the membrane posterior to the seventh sternite, and the base of the antrum is fused with the latero-anterior angles of the eighth tergite. The corpus bursae is angulate.

Types. — Lectotype ♂, China, Kwanshien, Szetschwan, Etikette coll., Muzeul G. Antipa, Bucharest. Also 4 ♂ and 1 ♀ paralectotypes, Bucharest. Holotype ♂ of *Crambus modestellus* Caradja (praeocc.), same locality as *szetschwanella*, dated 19.vii.—, also in Bucharest.

Material examined. — W. China, 6 ♂, Mt. Omei, 4,000 ft., —vii.32; 1 ♂, same data but —viii.32. One of former lacks left wings and has genitalia prep. BM pyral. 5468 (GU—964—B1) (BMNH). This latter specimen has been used for a venation preparation. Another ♂ bears a label "Gewalt von Dr. F. Gregor fur Micr. Pal.", and is the specimen figured by Bleszynski (1965, pl. 2 fig. 17).

Remarks. — Closely related to *R. bipunctella* of Taiwan, but the forewing of *szetschwanella* is proportionally more slender, with more white in the distal position of the apical triangle. The female of *szetschwanella* lacks the swollen subostiolear sac present in *bipunctella* and the costal prong of the male valva is quite slender and not recurved in the former species.

Roxita bipunctella

(Wileman & South) new combination

(figs. 11, 22, 23)

Culladia bipunctella Wileman & South, 1917: 148.

Culladia bipunctella Wileman & South; Bleszynski & Collins, 1962: 288.

Modestia bipunctella Wileman & South; Bleszynski, 1970: 58.

External characters. — Briefly described by Wileman & South (1917), re-described and illustrated here (fig. 11). Labial palpi $1.25 \times$ head length, pale brown, whitish on inner surfaces. Thorax, legs, pale brown.

Forewings with whitish ground colour, baso-posterior region clouded with buff and darker brown scales. Costa with broad chocolate band to about 0.6 from base, basal fascia obsolete ex-

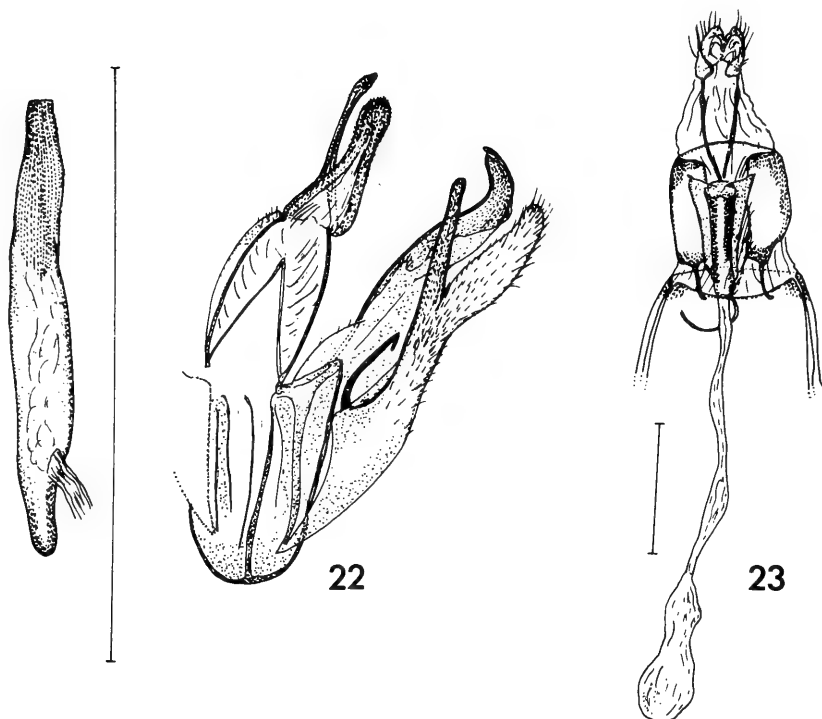

Figs. 22, 23. Male and female genitalia of *R. bipunctella*.

cept for dark blotches, from which a neural streak of dark brown, expanded distally, runs from base to about 0.4 in disc. "Antemedial" fascia broad, whitish, invaded by brown scaling, edged distally with an obscure, broken, thick brown line, zig-zagged at 0.3 from costa. Fascia displaced to beyond medial position in this species. True postmedial fascia narrow, clear white, edged with dark brown, almost touching termen at 0.3, zig-zagged sharply at 0.7. Reniform stigma absent, proximal portion of disc with scattered dark brown scaling, a pair of silvery streaks from angle of postmedial fascia at 0.3, the anterior-most extended in a dark streak across disc. Another pale streak, edged with dark brown, erupts from the angle of postmedial fascia at 0.7. Subterminal region dark brown, as is apical sector, except for a marginal white patch. The two black spots in the subterminal zone, characteristic of this genus, are distinct at 0.5 and 0.7. Ventral surfaces mid-brown with apical and terminal markings repeated from dorsal surface. Cilia pale brown with dark bases.

Hindwings pale brown, both above and below.

Wing expanse 12-15 mm.

Male genitalia. — Fig. 22. Uncus narrow in ventral aspect, laterally flattened, curved ventrad. Gnathos slightly shorter than uncus, apically rounded, and spatulate, minutely spinose, curved slightly dorsad. Tegumen simple, with relatively weak margins. Vinculum narrow, about $0.3 \times$ as wide as uncus is long. Saccus broad, rounded. Juxta not recognized in preparation. Valva complex, about $2.5 \times$ length of uncus, with strong costa terminating in a broad apical prong, curved dorso-intorsely. Valva proper with ventral fold, which has a sub-basal curved spine, apically hooked, about half length of uncus, and a broad, apically rounded, nearly straight, flattened protuberance, tapered only slightly from its base, arising at about 0.5. Segregation of valva proper and costal region extends to about 0.6 from base. Aedeagus equal in length to valva, LMB ratio about 8 : 1, apical third scobinate or minutely spinose. Cornuti absent.

Female genitalia. — Fig. 23. Anal papillae weakly fused dorsally, flattened, almost clog-shaped in profile, posterior apophyses about $2.5 \times$ length of papillae. Eighth tergite about as long as posterior apophyses, anterior apophyses reduced to short, curved protrusions barely $0.3 \times$ length of posteriors. Antrum a complex tube, lamella ante-vaginalis drawn out into a pair of lateral flanges on each side of the posterior ductus, and curving dorso-introtrorsely to fuse through moderately sclerotized but flexible extensions to the ventro-anterior angles of the eighth tergite. Eighth sternite absent, or incorporated with lamella postvaginalis into dorsal wall of antrum. Ductus bursae about $4 \times$ length of posterior apophyses, with ductus seminalis joining at base of antral region. Corpus bursae asiginate.

Types. — Lectotype: ♂, Taiwan. White oblong label "Kanshirei, Formosa, 1,000 ft., 13.vi.1906 (A. E. Wileman); faded white oblong "*Culladia bipunctella* sp.n. Type male". Purple-bordered circular label "lectotype", red-bordered label "Type", and blue label "abdomen missing" (BMNH). Paralectotypes: 4 ♂ Taiwan, 3 as above but 12.vi.1906, BM pyral. 7437; 16.ix.1906, BM pyral. 7485; and 15.ix.1906; one from Koannania, 15.ix.1906 (all BMNH).

Other material examined. — Taiwan, 1 ♂, 1 ♀, Suisha, 2.vi.1934 (L. Gressitt) (BMNH), BM pyral. 16812 ♀.

Remarks. — Presently known only from Taiwan, flight period known to include February, June and September. Differs from *szetschwanelia* only in minor (but distinctive) character proportions in the male genitalia, but shows an apomorphic character (sub-antral sac) in female genitalia.

Roxita apicella new species

(figs. 4, 12, 13)

External characters. — Labial palpi about $1.5 \times$ head length, silvery grey. Head yellowish, frons rounded, thorax, legs and abdomen yellowish brown with scattered darker scaling.

Forewings (fig. 4) with bright orange-brown ground colour. Base of wing blackish brown, position of basal fascia represented by black streak. Antemedial fascia broad, dull white, flanked irregularly by dark brown, sharply angled at 0.2. Discal region with an indistinct, quadrate yellowish reniform. Postmedial fascia relatively broad, white, angled sharply at about

0.3 and interrupted in the subapical region, edged thickly with blackish brown. Apical region plain orange-brown, bounded at its base by a segment of the interrupted white postmedial fascia. The apex is characteristically turned dorsad and sharply pointed or "tufted". Sub-apical indentation of the termen very distinct, and filled with white cilia. Cilia otherwise dark brown except at 0.8 from apex, where margin has a tertiary indentation filled with shining brown cilia. Margin bears a pair of indistinct black spots at 0.5 and 0.6. Ventral surface mottled brown.

Hindwings and outer cilia dark brown, inner cilia pale brown, ventral surfaces mottled brown.

Wing expanse 13—14 mm.

Male genitalia. — Uncus simple, tapered, pointed. Gnathos about $0.75 \times$ length of uncus, tapered sharply at 0.4 from base, pointed apical element nearly cylindrical to tip, slightly setulose. Tegumen simple, but with strong dorsal margins. Vinculum triangular, fused with base of valval costa. Saccus large, massive, anteriorly rounded. Juxta a narrow, horizontal crescentic plate. Valva very complex; elongate and narrowed, valva proper apically rounded and spatulate with weak cucullus. Sub-basal margin of valval costa and valva proper bears a large, flat, projecting lobe with a crenellate margin. Costal lobe separate from main valva from about 0.6, tapering to a strong, pointed apical prong nearly twice length of uncus and curved dorsad. The area of the costal/valva junction bears a number of small setae, and three very long, expanded, pointed, ribbon-like flattened setae, each slightly larger than costal prong, giving the genitalia a deceptively endotrichine appearance. Aedeagus simple, tubular, rather truncate, about $0.8 \times$ length of valva, LBM ratio about 10 : 1, with a single irregular sub-apical cornutus.

Female genitalia. — Fig. 13. Anal papillae weakly fused dorsally, posterior apophyses about $2 \times$ length of papillae. Eighth tergite virtually fused in ventral midline to margins of ostiolar region. Anterior apophyses reduced, only about $0.5 \times$ length of posteriors. Antrum a narrow tube, more or less circular in cross-section, lamella ante- and postvaginales developed and fused to antrum to surround and enclose it ventrally and dorsally as elongate overlapping shields. Subantral region bearing an irregular "fatty" looking sheath, staining blue with chlorazol black. Ductus bursae about $6 \times$ length of posterior apophyses in total, with ductus semi-

nalis joining near 0.4. Corpus bursae bearing two elongate, crescentic, toothed signa.

Types. — Holotype ♂: West Malaysia, Trengganu, Gunung Lawit summit ridge; 4,200 ft., 17.iii.1974 (102 36'E 5 25'N), at light, genitalia preparation BM pyral. 14878 (BMNH). Paratypes: ♂, West Malaysia, Perak Hijau, 4,000—4,900 ft., 1891 (Doherty) (BMNH); ♂, Gunung Ijau, Perak (Rothschild Bequest) (BMNH) BM pyral. 14554; ♀ same data (BMNH), BM pyral. 16751.

Remarks. — Presently collected only from West Malaysia, flight period known to include March. Sister species of *R. mululella* of Borneo, with which it shares the strong, very elongate curved setae of the valval costa.

Roxita mululella new species

(figs. 5, 14)

External characters. — (Head missing.) Thorax, legs and abdomen pale yellow.

Forewings with pale yellow ground colour and scattered, dark chocolate brown scaling in distal region of disc. Basal fascia represented only by irregular pair of dark brown smudgy stripes. Antemedial fascia obscure, irregular, edged broadly with dark brown scaling distally, narrowly edged with brown proximally. Reniform area devoid of scattered scaling. Postmedial fascia narrowly defined, white, edged with dark brown, angled to touch termen at about 0.3, and again at about 0.8. Silvery white streaks penetrate disc from each of these angles. Postmedial region of costa bright yellow, as is apical zone except for distal white streak on cilia, and sharply edged with black. The costal apex characteristically turns anteriorly. Secondary and tertiary indentations of termen present. Subterminal region clouded with deep bright yellow, with two black spots, inset from margin at about 0.5 and 0.7. Ventral surface brown with apical and terminal markings distinctly repeated from dorsal surface. Inner cilia shining gold, outer cilia shining brown.

Hindwings dull white with long white cilia,

Wing expanse 12 mm.

Male genitalia. — Fig. 14. Uncus tapering sharply at about 0.4 in ventral aspect, then parallel-sided, then tapering again to blunt, setulose apex. Gnathos narrowed to pedicel, bluntly pointed, with slightly expanded apex. Tegumen simple. Juxta not recognized in preparation.

Vinculum reduced to a narrow strip at base of valva. Saccus broad, elongate, nearly length of uncus, apically rounded with partial ventral "keel". Valva about $2.75 \times$ length of uncus, much narrowed. Single curved spine arising from basal region of costo-valvular junction, followed by a more typical costal protrusion at about 0.25 from base, curved dorso-introrsely, with shortly setulose apex. Distal region of costa and costo-valva junction produced into one broad and two narrow (setae-like), elongate ($1.5 \times$ length of uncus) curved spines. Valva tapering abruptly at about 0.5 to parallel-sided distal region with bluntly rounded, lightly setulose apex. Aedeagus simple, tubular, about $0.75 \times$ length of valva. LMB ratio about 7.5 : 1, slightly scobinate in apical third, cornuti absent.

Type. — Holotype ♂, Sarawak, site 26, G. Api Pinnacles, 428545, open scrub, April 1977 (J. D. Holloway), BM pyral. 16774 (BMNH).

Remarks. — Presently known only from unique holotype from Mt. Mulu region, Sarawak, flight period including April. Closely related to *R. apicella*; see Remarks on that species.

REFERENCES

- Bleszynski, S. 1963. Studies on the Crambidae (Lepidoptera). Part 41. On some tropical Crambidae with descriptions of the new genera and species. — Acta Zool. Cracov. 8: 133—181.
- , 1965. Crambinae. In: H. G. Amsel, F. Gregor & H. Reisser (ed.), *Microlepidoptera Palaearctica 1: i—xlvii*, 1—553. — Verlag Georg Fromme & Co., Wien.
- , 1970. A revision of the genus *Culladia* Moore (Studies on the Crambinae, Lepidoptera, Pyralidae, Part 50). — Tijdschr. Ent. 113: 44—59, figs. 1—28.
- Bleszynski, S. & R. J. Collins. 1962. A short catalogue of the world species of the Family Crambidae (Lepidoptera). — Acta. zool. Cracov. 7: 197—389.
- Caradja, A. 1927. Die Kleinfalter der Stotzner'schen Ausbeute, nebst Zuträgen aus meiner Sammlung. (Zweite biogeographische Skizze "Zentralasien".) — Mem. Sect. stiint. Acad. rom. Bucharesti 4: 361—428.
- , 1931. Dritter Beitrag zur Kenntnis der Pyraliden von Kwanhsien und Mokanshan (China). — Bull. Sect. Sci. Acad. Rom, 14: 203—212.
- Caradja, A. & E. Meyrick. 1933. Materialien zu einer Microlepidopteren-Fauna Kwantungs. — Deutsch. ent. Zeit. Iris 47: 123—167.
- Diakonoff, A. 1954. Considerations on the terminology of the genitalia in Lepidoptera. — Lep. News 8: 67—74, figs. 1—2.

- Dugdale, J. S. 1966. A Revision of the New Zealand Schoenotenini and Cnephasiini (Lepidoptera: Tortricidae: Tortricinae). — *N.Z. J. Sci.* 9: 731—775.
- Fleming, C. A. 1962. New Zealand biogeography: A palaeontologist's approach. — *Tuatara* 10: 53—108.
- , 1963a. Palaeontology and southern biogeography. In: J. L. Gressitt (ed.), *Pacific Basin Biogeography, A Symposium*: 369—385. — Bishop Museum Press, Honolulu.
- , 1963b. Age of the alpine biota. — *Proc. N.Z. Ecological Society* 10: 15—18.
- Gaskin, D. E. 1971. A revision of New Zealand Ditychophorini (Lepidoptera: Pyralidae: Crambinae). — *N.Z.J. Sci.* 14: 759—809.
- , 1975. Revision of the New Zealand Crambini (Lepidoptera: Pyralidae: Crambinae). — *N.Z.J. Zool.* 2: 265—363.
- Holloway, J. D. 1973. The affinities within four butterfly groups (Lepidoptera: Rhopalocera) in relation to general patterns of butterfly distribution in the Indo-Australian area. — *Trans. R. ent. Soc. Lond.* 125: 125—176, figs. 1—23.
- , 1974. The biogeography of Indian butterflies. In: M. S. Mani (ed.), *Ecology and Biogeography in India*: 473—499. — Dr. W. Junk b.v. Publishers, The Hague.
- Klots, A. B. 1956. Lepidoptera. In: S. L. Tuxen (ed.), *Taxonomist's glossary of genitalia in insects*: 97—111. — E. Munksgaard, Copenhagen.
- Snellen, P. C. T. 1893. Beschrijving en Afbeelding van eenige nieuwe of weinig bekende Crambidae. — *Tijdschr. Ent.* 36: 54—66.
- Wileman, A. E. & R. South. 1917. New species of Lepidoptera from Japan and Formosa. — *Ent.* 50: 145—148.

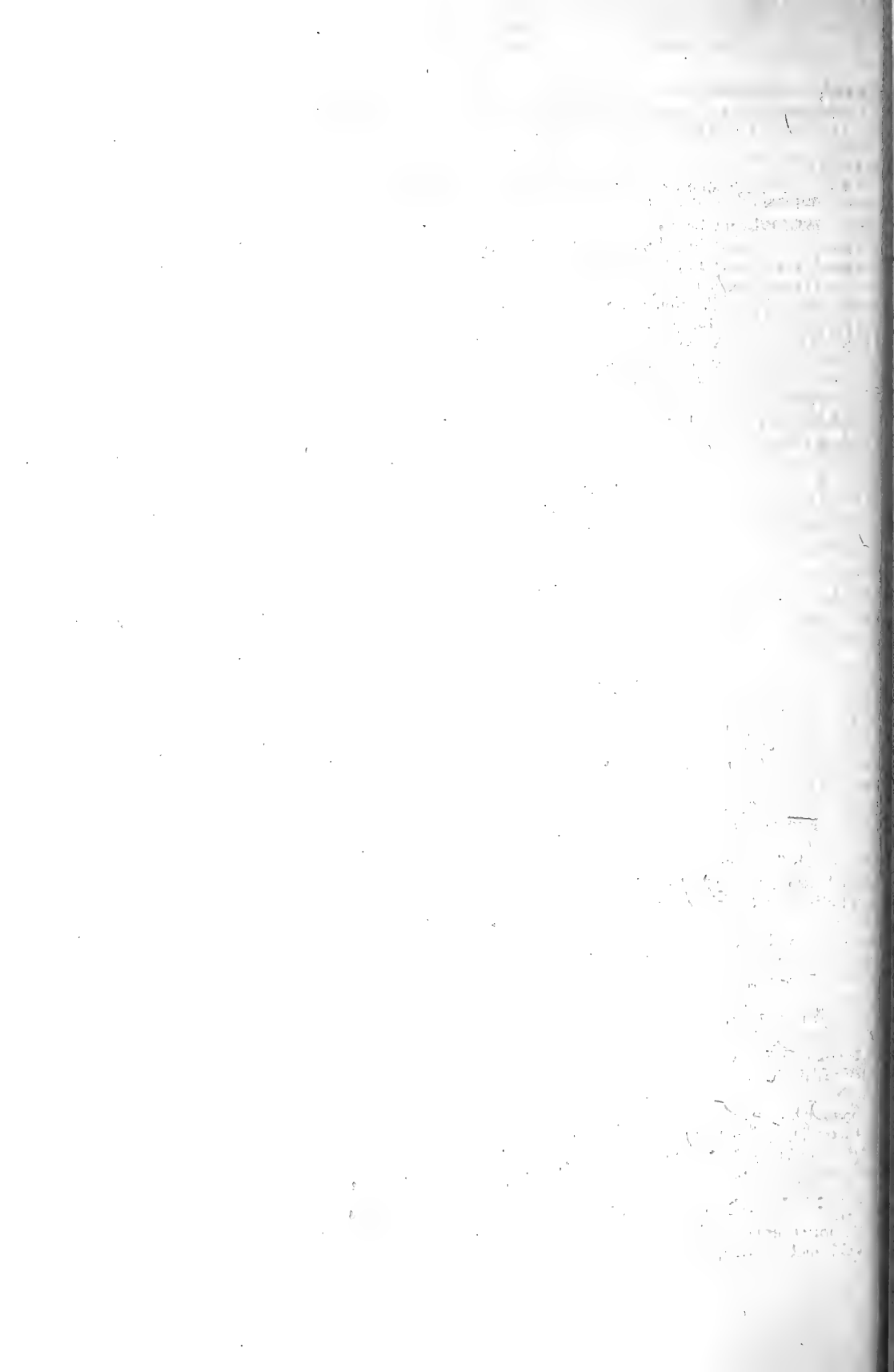



TIJDSCHRIFT VOOR ENTOMOLOGIE

UITGEGEVEN DOOR

DE NEDERLANDSE ENTOMOLOGISCHE VERENIGING

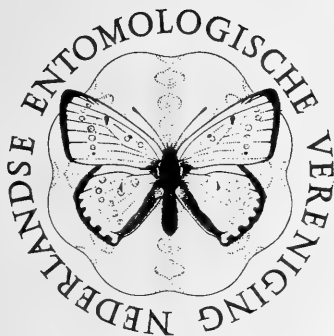

MUS. COMP. ZOOL
LIBRARY

AUG 21 1984

HARVARD
UNIVERSITY

INHOUD

- BR. THEOWALD. — Taxonomie, Phylogenie und Biogeographie der Untergattung *Tipula* (*Tipula*) Linnaeus, 1758 (Insecta, Diptera, Tipulidae), pp. 33—78, figs. 1—24.

TAXONOMIE, PHYLOGENIE UND BIOGEOGRAPHIE DER UNTERGATTUNG *TIPULA* (*TIPULA*) LINNAEUS, 1758 (INSECTA, DIPTERA, TIPULIDAE)

von

BR. THEOWALD

Instituut voor Taxonomische Zoölogie (Zoölogisch Museum), Plantage Middenlaan 64, 1018 DH Amsterdam

ABSTRACT

All species recently mentioned as belonging to the subgenus *Tipula* (*Tipula*) are studied. Five are excluded from the subgenus: *dichroa* Bezzi (*Acutipula*), *jonesi* Alexander (*Leptotarsus*), *microcephala* Bigot (*Lecteria*), *rothschildi* Alexander (*Savtshenkia*) and *setosipennis* Alexander (*Yamatotipula*). New synonymies are: *abyssinica* Jaennicke, 1867 = *strigata* Loew, 1866; *bevisiana* Alexander, 1956 = *soror mashona* Alexander, 1920; *curtipennis* Mannheims, 1961 = *eumecacera* Speiser, 1909; *niligena* Jaennicke, 1867 = *bicolor* Loew, 1866; *venturii* Loi, 1964 = *plumbea* Fabricius, 1781. Most probably *chubbi* Alexander is a hybrid of *soror mashona* Alexander × *frater* Alexander and *hungarica* Lackschewitz a hybrid of *oleracea* Linnaeus × *orientalis* Lackschewitz. Four new taxa are described: *consobrina* (Zimbabwe, Mozambique), *italica errans* (Sardinia, Balkan Peninsula, Turkey), *loeffleri* (Ethiopia) and *zimbabwensis* (Zimbabwe).

As up till now mostly short descriptions without illustrations were published of the Afrotropical species, all are figured and described here. For the well-known Palaearctic species only the most important literature is mentioned.

The relationships between species and species groups, based on synapomorphies, are presented in cladograms. Most probably the *loveridgei* group of the subgenus *Acutipula* is the sister group of the subgenus *Tipula*. A publication dealing with the relationships between the subgenera *Acutipula* and *Tipula* is in preparation.

The history of the subgenus *Tipula* is discussed and an areogram is presented. It is not possible to date with certainty the degrees of differentiation of this predominantly mediterranean subgenus.

ZUSAMMENFASSUNG

Alle in jüngerer Zeit in der Untergattung *Tipula* angeführten Arten wurden überprüft. Fünf Arten gehören nicht in dieser Untergattung: *dichroa* Bezzi (*Acutipula*), *jonesi* Alexander (*Leptotarsus*), *microcephala* Bigot (*Lecteria*), *rothschildi* Alexander (*Savtshenkia*) und *setosipennis* Alexander (*Yamatotipula*). Nachfolgende Synonymien wurden festgestellt: *abyssinica* Jaennicke, 1867 = *strigata* Loew, 1866; *bevisiana* Alexander, 1956 = *soror mashona* Alexander, 1920; *curtipennis* Mannheims, 1961 = *eumecacera* Speiser, 1909; *niligena* Jaennicke, 1867 = *bicolor* Loew, 1866; *venturii* Loi, 1964 = *plumbea* Fabricius, 1781. *T. (T.) chubbi* Alexander ist wahrscheinlich ein Hybrid von *soror mashona* Alexander × *frater* Alexander, und *hungarica* Lackschewitz ein solcher von *oleracea* Linnaeus × *orientalis* Lackschewitz. Neu beschrieben werden vier Taxa: *consobrina* (Zimbabwe, Mozambique), *italica errans* (Sardinien, Balkanhalbinsel und Türkei), *loeffleri* (Äthiopien) und *zimbabwensis* (Zimbabwe).

Eine sichere Bestimmung der afrotropischen Arten war, der ungenügenden Beschreibungen wegen, bis

heute unmöglich. Von all diesen Arten wurden neue Beschreibungen und Abbildungen angefertigt, und die gesamte Literatur wurde erwähnt. Von den gut bekannten palaearktischen Arten ist nur die wichtigste Literatur angeführt.

Unter Zugrundelegung von Synapomorphien werden verwandtschaftliche Beziehungen erörtert und in Kladogrammen bildlich dargestellt. Als Schwestergruppe der Untergattung *Tipula* kommt nur die *loveridgei*-Gruppe der Untergattung *Acutipula* in Betracht. Die damit zusammenhängenden taxonomischen und nomenklatorischen Änderungen werden anderswo (De Jong, in Vorbereitung) ausgearbeitet.

An Hand eines Areogramms wird die wahrscheinliche Geschichte der Untergattung dargestellt. Sichere Datierung der im Areogramm verzeichneten Vorgänge war für diese hauptsächlich an mediterranes Klima gebundenen Arten nicht möglich.

EINLEITUNG

Lackschewitz (1930) brachte acht *oleracea* Linnaeus-ähnliche Arten zusammen in einer Artengruppe (*oleracea*-Gruppe). Edwards

(1931) stellte in seiner Arbeit über die Untergattungen der Gattung *Tipula* diese Arten in die Untergattung *Tipula*, weil *oleracea* Typusart ist. Er bemerkte dabei, daß er keine wesentliche Unterschiede fand zwischen diesen Arten und jenen der Untergattung *Platytipula*. Aufgrund dieser Bemerkung stellte Alexander (1935) die Arten der *luteipennis-ultima*-Gruppe (Untergattung *Platytipula*) in die Untergattung *Tipula*. Mannheims (1952) führte überdies die Arten der *luna*-, *vittata*-, *pruinosa*- und *moesta*-Gruppe in dieser Untergattung ein. Savtshenko (1961) beschränkte sie wieder auf die Arten der *oleracea*-Gruppe sensu Lackschewitz, 1930. Diese Auffassung wurde von allen späteren Autoren übernommen.

Die Untergattung *Tipula* (Karte 1) zählt heute 26 Taxa im palaearktischen und afrotropischen Gebiet. Im palaearktischen Gebiet ist die Verbreitung der meisten Arten auf die mediterrane Subregion der Westpalaearktis beschränkt, nur *oleracea*, *paludosa* und *subcunctans* reichen nach dem Norden bis Fennoskandien, letztge-

nannte Art auch nach dem Osten bis Japan. Im afrotropischen Gebiet finden sich die Arten in den Gebirgen von Ost- und Südafrika. Der europäische Kulturschädling *paludosa* wurde vor etwa 100 Jahren durch Fischerboote in Ballast nach Newfoundland gebracht und hat sich von dort auf dem Festland weiter verbreitet (Alexander, 1962; Jackson & Campbell, 1975). Auf ähnliche Weise wurde die Art wahrscheinlich auch dann und wann nach den makaronesischen Inseln gebracht, wo sie — im Gegensatz zur dort heimischen *mediterranea* — nur in einzelnen Exemplaren gesammelt wurde: Madeira, 1855, 1 ♂, 1 ♀; Gran Canaria, 1903, 1 ♂, 1 ♀; Tenerife, 1918, 1 ♂ (Theowald, 1972, 1977b).

Diese Arbeit stützt sich hauptsächlich auf die reichhaltigen Sammlungen des Zoologischen Museums Amsterdam, in denen fast alle Arten dieser Untergattung, manche von vielen Fundorten, vertreten sind. Für die Verbreitung der palaearktischen Arten stand uns durch Mithilfe von Herrn Dr. H. Ulrich auch die Sammlung des Museums Koenig (Bonn) zur Verfügung.

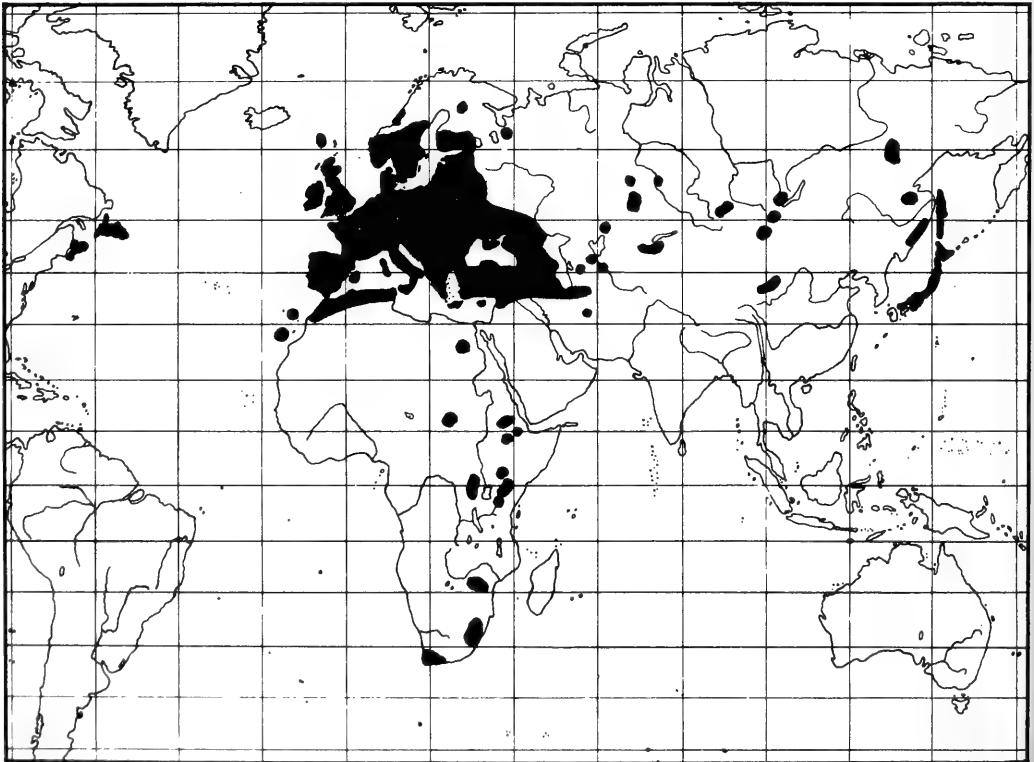

Karte 1. Verbreitung der Untergattung *Tipula* (*Tipula*) Linnaeus.

Herr Dr. A. Hutson sandte uns interessante Arten aus der afrotropischen Sammlung des Britischen Museums. Herr Kollege Dr. P. Oosterbroek brachte aus Washington (United States National Museum) Material der Sammlung Alexander mit. Alle erhaltenen Typen der afrotropischen Arten wurden überprüft. Sie finden sich in einer Reihe von Museen und Instituten und wurden uns jeweils ohne Schwierigkeiten zugeschiedt. Allen Kollegen, die uns so freundlich unterstützten, danken wir herzlich für ihre Mithilfe.

Obwohl das Hauptziel dieser Arbeit das Studium der Phylogenie und der Biogeographie von *Tipula* (*Tipula*) war, stellte es sich schon bald heraus, daß man sich nicht verlassen konnte auf Beschreibungen und Abbildungen der Arten. So wurde auch eine taxonomische Revision dieser Untergattung notwendig.

Für kritische Bemerkungen zu dieser Arbeit danke ich allen Studenten, die an unserem Institut an Tipuliden arbeiten, besonders den Kollegen Dr. P. Oosterbroek und Frau I. Tangelder. Herr G. Theischinger war so freundlich, das MS kritisch zu lesen und sprachlich zu korrigieren. Auch ihm sei herzlich gedankt.

ZUR TAXONOMIE

Alphabetisches Verzeichnis der Arten der Untergattung *Tipula*

In diesem Verzeichnis sind nur die Arten aufgenommen, die in der rezenten Literatur in der Untergattung *Tipula* angeführt sind, nicht solche, die man ehemals in diese Untergattung stellte, heute aber in eine der weiteren Untergattungen stellt. Die palaearktischen Arten sind eindeutig beschrieben und abgebildet, hauptsächlich in Lackschewitz (1930), Mannheims (1952) und Savtshenko (1961). Für sie ist nur die wichtigste Literatur erwähnt. Die afrotropischen Arten dagegen sind nie zusammenfassend bearbeitet worden, ihre Beschreibungen sind fast immer unvollständig, und wichtige Merkmale des Hypopygs wurden nur selten deutlich abgebildet. Deshalb sind von allen afrotropischen Arten Beschreibung und Abbildung des Hypopygs aufgenommen und ist die Literatur vollständig verzeichnet. Weil der Kopf oftmals mehr oder weniger unter dem Thorax gekrümmt ist, ist als Länge immer nur die Länge von Thorax und Hinterleib angegeben.

(*abyssinica* Jaennicke, 1867) = *strigata* Loew, 1866 (syn. nov.)

Literatur: Alexander, 1978 (unter *abyssinica*).

Typus-Lokalität: Simen (das heutige Naturschutzgebiet Simen — auch geschrieben Simien oder Siemen — nordöstlich von Gondar in Äthiopien).

Holotypus ♂: Nach Jaennicke im Museum Senckenberg (Frankfurt/Main). Er ist dort nicht mehr vorhanden und existiert wahrscheinlich nicht mehr (auch der Typus von *strigata* ist nicht mehr aufzufinden).

Bemerkung: Alexander (1978) verzeichnet diese Art von Addis Abeba. Ich habe das Material überprüfen können. Alle Merkmale stimmen überein mit Jaennickes Beschreibung von *abyssinica* und mit Loews Beschreibung von *strigata*. Beide Beschreibungen stimmen auch weitgehend mit einander überein. Deshalb stelle ich *abyssinica* als jüngeres Synonym zu *strigata*.

atlantica Mannheims, 1962

Literatur: Den Hollander, 1975a; Theowald, 1977a.

Typus-Lokalität: Madeira, Curral das Freiras, Vasco Gil.

Holotypus ♂: Im Museum Helsinki.

Bemerkung: Diese Art wurde von Mannheims (1962) deutlich beschrieben und abgebildet. Sie ist nur von Madeira bekannt.

(*bevisiana* Alexander, 1956b) = (*mashona* Alexander, 1920d) (syn. nov.)

Literatur: Alexander, 1964; Den Hollander, 1975a (= *zimbabwensis*).

Typus-Lokalität: Lesotho, Basutoland, Mokhotlong.

Holotypus ♂: Im Museum and Art Gallery, Durban.

Bemerkung: An Hand von Typen und später gesammelten Exemplaren konnte ich feststellen, daß *bevisiana* und *mashona* identisch sind.

bicolor Loew, 1866 (Abb. 1)

Literatur: Jaennicke, 1867 (unter *niligena*); Bezzi, 1905 (unter *niligena*); Mannheims, 1952.

Typus-Lokalität: Simen (das heutige Naturschutzgebiet Simen — auch geschrieben Simien oder Siemen — nordöstlich von Gondar in Äthiopien, seit Kertesz, 1902, verwechselt mit Jemen, Arabien).

Holotypus ♂: Im Museum für Naturkunde an der Humboldt-Universität, Berlin (vid. Mannheims, 1951).

Männchen. — Kopf oben grau, hinten gelblichbraun; Augen unter dem Kopf schmal getrennt, Trennung kaum so breit wie das 1. Füh-



Abb. 1. Hypopyg von *Tipula (T.) bicolor* (a, Hinterrandfortsatz des 9. Tergits von oben; b, Hinterrandfortsatz des 9. Tergits von der linken Seite; c, linker *od* von der Außenseite; d, linker *id* von der Außenseite; e, linker *id* von der Innenseite).

lerglied; Rostrum gelb mit deutlichem Nasus; Palpen dunkelbraun; Fühler 13-gliedrig, zurückgeschlagen etwa bis zur Flügelwurzel reichend, Basalglieder und Basis des 1. Geißelgliedes gelb, weitere Glieder dunkelbraun, Wirtelhaare etwa so lang wie die zugehörigen Glieder. Thorax gelblichbraun bis grau, Mesonotum mit vier dunkelgerandeten Längsstreifen; Coxae und Basalhälfte der Femora gelb, distale Hälfte der Femora sowie Tibiae und Tarsenglieder dunkelbraun bis schwarz; Tarsalklauen in der Mitte mit deutlichem Zahn; Flügel fast glashell, schwach gelblich getrübt, Stigmenflecken klein und kaum dunkler gefärbt; Squama mit etwa vier kurzen Borsten; Schwinger hell bräunlich mit kaum verdunkeltem Knopf. Hinterleib gelb, die Hinterränder der Segmente an Ober- und Unterseite schwarz, Rückenstreifen kaum sichtbar, Seitenstreifen undeutlich, das 2. Sternit an der Basis mit einem runden Fleck. Hypopyg mit auffallend scharfem Kiel; *id*-Vorderteil mit durchsichtigem Kamm, außen mit einem kleinen Kissen kurzer weißer Haare, an der Innenseite mit einem Saum längerer Haare; *id*-Hinterteil oben abgerundet, an der Vorderseite mit einigen Borsten, an der Innenseite mit einer

nicht scharf abgegrenzten Gruppe nah zusammen liegender sensorischer Poren; der Haken des *id* ist ziemlich hoch am *id*-Hinterteil ange-setzt; *od* am Oberrand breit abgestutzt; Vorsprung des 9. Tergits mit schmaler Basis.

Weibchen. — Eidonomische Merkmale wie beim Männchen, aber Hinterleib mit deutlichem Rückenstreifen, und Tarsalklauen ungezähnt.

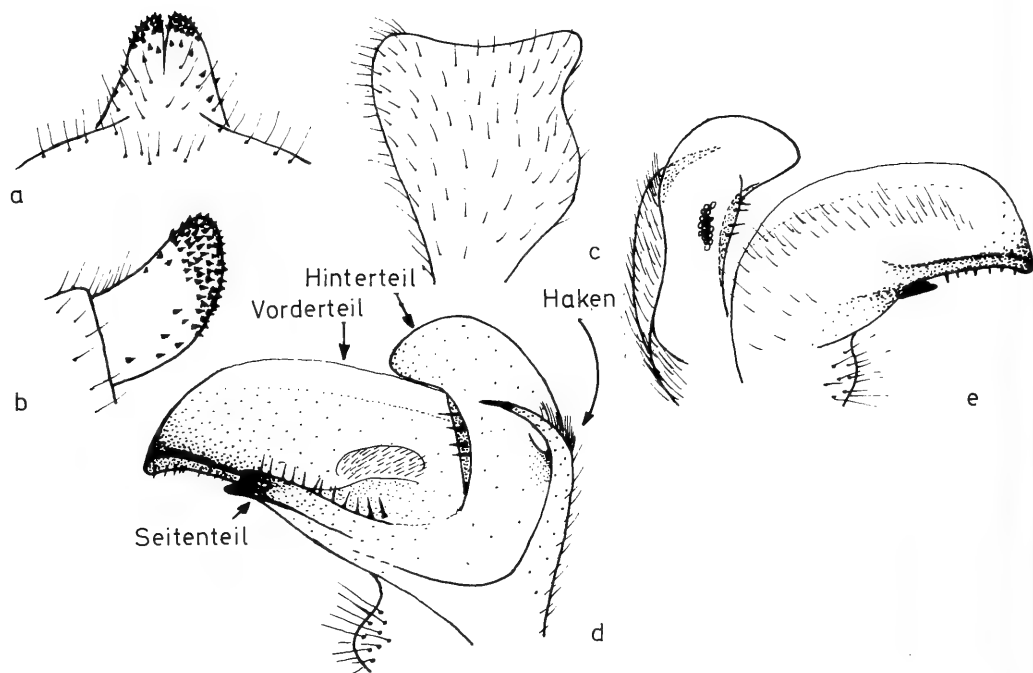
Länge von Thorax und Hinterleib: ♂ 14 mm, ♀ 22 mm; Flügellänge: ♂ 18 mm, ♀ 21 mm.

Verbreitung: Äthiopien (Simen, Adi Agri, Djem-Djem Forest).

Biologie: Von den drei bekannten Exemplaren wurde eines im Juli in unbekannter Höhe, ein zweites im September in etwa 2800 m gesammelt, vom dritten sind keine genaueren Daten bekannt.

capnionaura Speiser, 1909 (Abb. 2)

Literatur: Alexander, 1956a; Mannheims, 1958, 1961; Den Hollander, 1975a; Theowald, 1977a.

Typus-Lokalität: Kilimandjaro, Kiboscho, 2950 m.

Lektotypus ♂: Naturhistoriska Riksmuseet, Stockholm (des. Theowald, 1982).



Abb. 2. Hypopyg von *Tipula (T.) capnioneura* (a—e wie Abb. 1).

Männchen. — Kopf oben und hinten grau; Augen unter dem Kopf ziemlich breit getrennt, Trennung etwa zweimal breiter als das erste Fühlerglied; Rostrum braun mit deutlichem Nasus; Palpen dunkelbraun, Endglied fast schwarz; Fühler 13-gliedrig, zurückgeschlagen fast bis zum Ende des Hinterleibs reichend, die drei Basalglieder gelblichbraun, weitere Glieder allmählich dunkler werdend, Fühlerende fast schwarz, die längsten Wirtelhaare halb so lang wie das zugehörige Glied. Mesonotum braun mit vier dunkelgerandeten dunkelbraunen Längsstreifen; Femora gelblichbraun mit dunklem Ende, Tibiae und Tarsenglieder gegen das Ende allmählich dunkler werdend, am Ende schwarz; Tarsalklauen ohne Mittelzahn; Flügel hellbräunlich getrübt mit hellem Wisch in der Diskalzelle, Costalzelle und Stigmenfleck dunkler braun, ein brauner Schattensaum cu und mcu entlang; Squama meist mit zwei kurzen Borsten; Schwinger mit braunem Stiel und schwarzem Knopf. Hinterleib braungrau mit dunklen Rücken- und Seitenstreifen, Sternite dunkel-

grau. Hypopyg mit breitbasigem bedorntem Vorsprung am 9. Tergit; *id*-Vorderteil ohne durchsichtigen Kamm und ohne Haarkissen an der Außenseite, an der Innenseite aber mit langen Haaren; *id*-Hinterteil ziemlich kurz, oben zangenförmig, an der Außenseite mit Dorn, an der Innenseite mit verstreut stehenden sensorischen Poren; *od* undeutlich birnförmig.

Das nach Speiser zugehörige Weibchen ist in Alkohol aufbewahrt und ganz entfärbt. Es ist kurzflügelig. Die Fühler reichen zurückgeschlagen fast bis zur Schwingerbasis (bei den gleichfalls kurzflügeligen Weibchen von *flagellicurta* sind sie kaum länger als Kopf und Rostrum), und das erste Geißelglied ist länger als das Fühlerbasalglied und fast zweimal so lang wie das zweite Geißelglied (*flagellicurta* gleichlang wie oder kürzer als das Basalglied und nur wenig länger als das zweite Geißelglied).

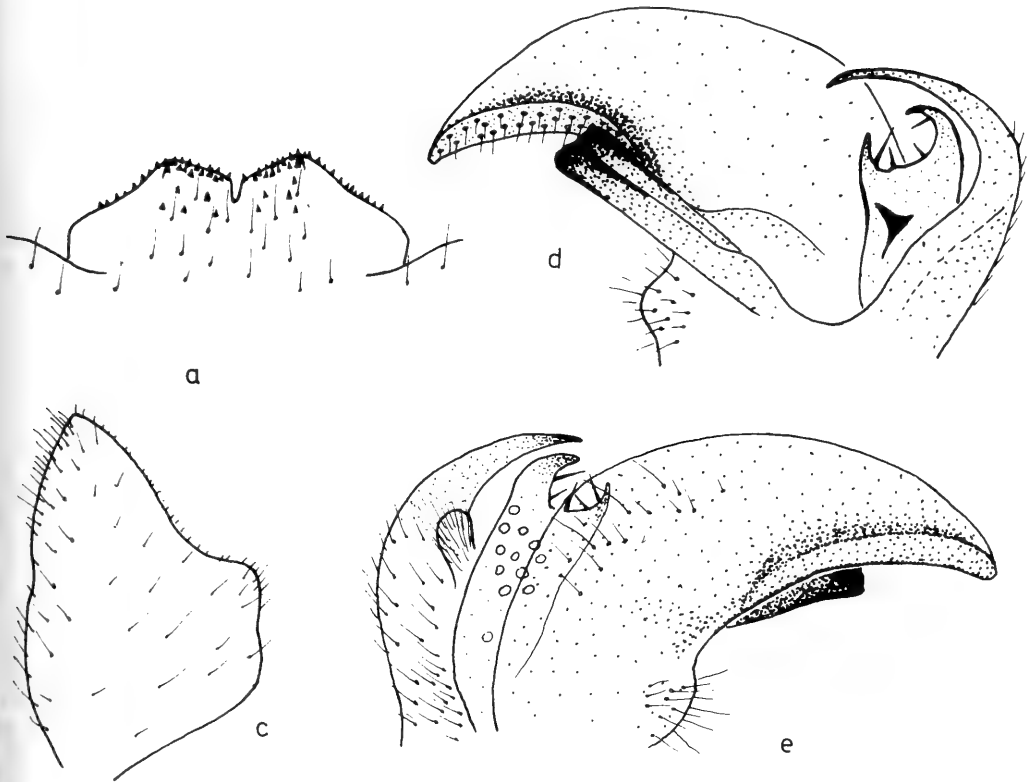
Länge von Thorax und Hinterleib: ♂ 14—17 mm, ♀ 19 mm; Flügellänge: ♂ 18—22 mm, ♀ 1.5 mm.

Verbreitung: Tanzania (nur Kilimandjaro).

Biologie: Die Art wurde erstmals von Sjöstedt und später von Lindner gesammelt, und zwar im Februar an der Südwestseite des Kili-mandjaro auf alpinen Wiesen in 2950—3500 m Seehöhe.

(*chubbi* Alexander, 1956b (Abb. 6g)) = *soror mashona* × *frater*?

Literatur: Alexander, 1964.

Typus-Lokalität: Lesotho, Basutoland, Mokhotlong.

Holotypus ♂: Im Museum and Art Gallery, Durban.

Bemerkung: Vom Holotypus existieren zwei Präparate auf Glas: eines mit Hypopyg (ohne linken *id*) im Museum Durban und eines mit linkem *id*, einem Flügel, einem Fühler und den Tarsen eines Beines im United States National Museum, Washington (Sammlung Alexander). Weitere Teile des Holotypus sind nicht vorhanden. Nach den mir vorliegenden Teilen und nach der Beschreibung Alexanders gibt es nur zwei Unterschiede gegenüber *frater*: der Kamm des *id*-Vorderteils ist am Ende deutlich stärker abgerundet (Abb. 6g), und die Fühler sind normal lang und nicht verkürzt. Der auffallend kurze Kamm von *frater* (nur auf dem distalen Ende des *id*-Vorderteils) ist nicht immer gleich lang und z.B. bei unseren Exemplaren von Zimbabwe (Abb. 6h) deutlich länger als bei denen von Südafrika. Aufgrund dieses Unterschiedes in der Größe des Kammes sollte man *chubbi* nicht als eigene Art betrachten. Sie stellt höchstens eine Varietät von *frater* dar. Es bleibt aber der Unterscheid der Fühler, die deutlich länger sind als bei *frater*. Die Fühler sind überdies 14-gliedrig, wie dies nur von *soror mashona* (Südafrika) und *paludosa* (Europa) bekannt ist, und nicht 13-gliedrig wie jene von *frater* und allen weiteren Arten dieser Untergattung. *T. frater* und *soror mashona* wurden beide in der unmittelbaren Umgebung der Typus-Lokalität von *chubbi* gesammelt. Es ist deshalb wahrscheinlich, daß *chubbi* keine gute Art ist, sondern ein Hybrid von *soror mashona* × *frater*. Es gibt ja auch Hybriden zwischen den europäischen Arten *oleracea*, *paludosa* und *subcunctans* (Den Hollander, 1975b, 1975c und dort erwähnte Literatur).

consobrina nov. spec. (Abb. 3)

Tipula (*Tipula*) *consobrina* nov. spec.

Holotypus ♂: Port E. Africa, Gorongoza Mt., 840 m, IX.1957, Stuckenberg leg.; im United States National Museum, Washington

(Sammlung Alexander) als Präparat auf Glas unter dem Namen *Tipula* (*Tipula*) *frater* Al. (Hinterleibsende mit Hypopyg, Flügel, Vorder- und Mittelbein).

Paratypen: 3 ♂, 1 ♀, S. Rhodesia, Salisbury, Smithers, 10.IX.1956/17.II.1957/12.IV.1957/18.IV.1957; 1♀, S. Rhodesia, Penhalonga, 17.I.1955, Stuckenberg leg. (Präparat auf Glas: mit Fühler, Flügel und Hinterbein als *Tipula* (*Tipula*) *frater* Al.). Paratypen im United States National Museum, Washington (Sammlung Alexander) und im Zoologischen Museum, Amsterdam.

Bemerkung: Alexander hat in den Sechzigerjahren Präparate dieser neuen Art auf Glas angefertigt und sie irrtümlicherweise als *frater* gedeutet. Er (Alexander, 1956a) führt sie an als *frater* mit "dorsal crest long and narrow", während er die tatsächliche *frater* als *soror* mit "dorsal crest short and high" anführt.

Männchen. — (Die genadelten Exemplare waren feucht, und die Farben können sich deshalb etwas geändert haben.) Kopf und Rostrum gelblich, Rostrum an der Unterseite etwas dunkler; Augen unter dem Kopf schmal getrennt, Trennung kaum breiter als das erste Fühlerglied; Nasus deutlich; Palpen schwarz; Fühler 13-gliedrig, kurz, kaum länger als Kopf und Rostrum, gelb und nur gegen das Ende zu etwas verdunkelt, Wirtelhaare etwa so lang wie die zugehörigen Glieder. Thorax gelblich; Mesonotum mit vier grauen dunkelgerandeten Längsstreifen; Coxae gelb, Femora etwas dunkler und mit schwarzer Spitze, Tibiae und Tarsenglieder schwarz, Tarsalklauen mit deutlichem Mittelzahn; Flügel etwas getrübt, die hellen Längsstreifen sind weniger deutlich als bei *frater* und kaum deutlicher als bei *soror*, Zelle R_5 ist deutlich hell gefärbt, Vorderrand und Stigmenfleck sind kaum dunkler als die übrige Flügelfläche; Squama mit einigen kurzen Haaren; Schwinger mit hellem Stiel und dunklem Knopf. Hinterleib gelblich braun, Rücken- und Seitenstreifen nur angedeutet; Hypopyg gelblichbraun wie der Hinterleib; 9. Sternit auffallend gekielt; Hinter randfortsatz des 9. Tergits schmalbasig; *id*-Vorderteil mit Kamm, an der Außenseite mit Haarkissen, an der Innenseite lang behaart; *id*-Hinter teil sehr charakteristisch, breit kappenförmig mit bedorntem Vorsprung, an der Außenseite mit stark entwickeltem Auswuchs, an der Innenseite mit einer nicht scharf abgegrenzten Gruppe sensorischer Poren; der Haken ist nur am Ende schmal und geht schnell in eine sehr breite Basis über; *od* breit birnförmig.



Abb. 3. Hypopyg von *Tipula (T.) consobrina* (a—e wie Abb. 1; f, linker *id* (ohne Vorderteil, von oben).

Weibchen. — In allen eidonomischen Merkmalen dem Männchen ähnlich, hat aber keinen Mittelzahn an den Tarsalklauen.

Länge von Thorax und Hinterleib: ♂ 14—15 mm, ♀ 20 mm; Flügellänge: ♂ 16—17 mm, ♀ 19 mm.

Verbreitung: Zimbabwe (Salisbury, Penhalonga), Mozambique (Gorongosa Mts.).

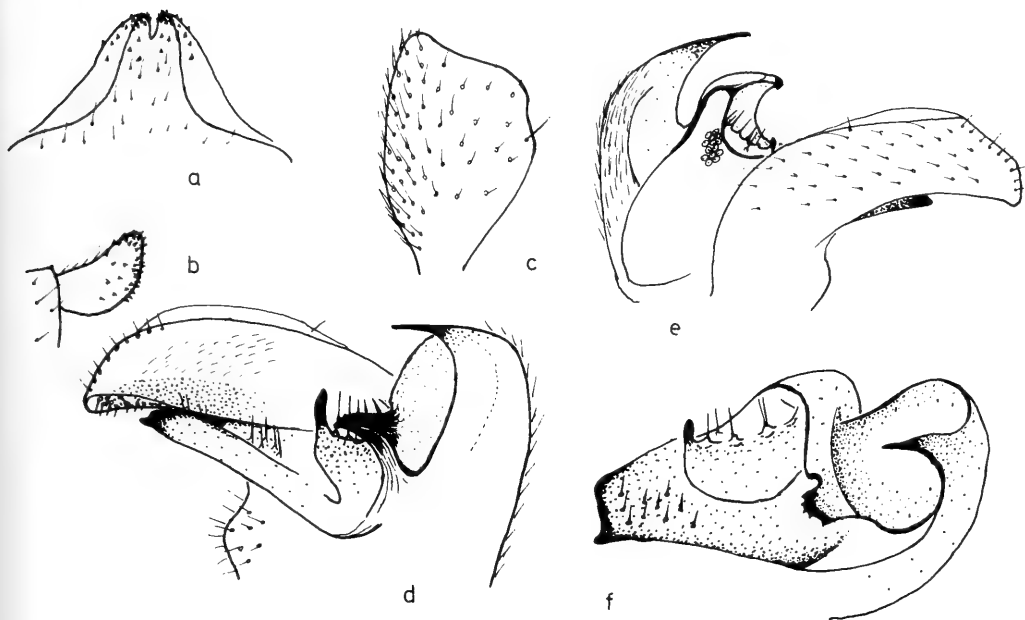
Biologie: Die bekannten Exemplare wurden im September, Januar, Februar und April gesammelt. Den Fundorten nach ist *consobrina* keine Hochgebirgsart.

Name: *consobrina* (= Kusine) in einem Faunengebiet, wo es schon eine *Species frater* (= Bruder) und eine *Species soror* (= Schwester) gibt.

(*curtipennis* Mannheims, 1961) = *eumecacera* Speiser, 1909 (syn. nov.)

Literatur: Theowald, 1977a.

Typus-Lokalität: Kilimandjaro, Kibo (Tanganjika).

Holotypus ♂: Im Staatlichen Museum für Naturkunde, Stuttgart.

Bemerkung: Der Holotypus ist nach allen Merkmalen ein kurzflügeliges ♂ von *eumecacera* Speiser. Die drei Paratypen (in den Museen Amsterdam, Bonn und Stuttgart) dagegen sind kurzflügelige ♂ von *flagellicurta* Mannheims.

(*czizeki* de Jong, 1925) = *subcunctans* Alexander, 1921b

Literatur: Seit Tjeder, 1953, wurde für diesen Kulturschädling in der europäischen Literatur der Name *czizeki* benutzt. Nach I.C.Z.N. Opinion 1160 (1980) muß aber für diese Art der Name *subcunctans* benutzt werden.

Typus-Lokalität: De Jong (1925) hat keinen Holotypus designiert. Das von ihm für die Beschreibung verwendete Material stammte aus den Niederlanden.

(*dichroa* Bezzi, 1905 (*Acutipula*)) (comb. nov.)

Literatur: Riedel, 1914; Hutson, 1980.

Typus-Lokalität: Nordäthiopien (Adi Caie, Asmara-Keren).

Holotypus ♂: (zwei Flügel, zwei Schwinger, ein Bein, Thoraxrücken und Basis des Hinterleibes) im Museo Zoologico de "La Specola", Florenz.

Bemerkung: Frau Dr. Sarah Mascherini war so freundlich, die Reste des Typus-Exemplares zu überprüfen und schickte mir Fotos der Flügel. Nach der Beschreibung und nach dem Flügelgeäder gehört diese Art in die Untergattung *Acutipula* und nicht in *Tipula*, unter welcher Hutson (1980) sie im afrotropischen Katalog aufführt. Riedel (1914) meldet *dichroa* von Britisch-Ost-Afrika (Kijabé, im Süden von



Abb. 4. Hypopyg von *Tipula (T.) eumecacera* (a—e wie Abb. 1).

Aberdare-Ränge, heute Kenya). Seine Exemplare (1 ♂, 1 ♀, Museum Paris) stimmen in allen Merkmalen mit der Beschreibung von *dichroa*, aber auch mit der Beschreibung von *elliotti* Alexander von Uganda überein. Vielleicht sind beide Arten identisch. Aufschluß darüber sollte das Auffinden topotypischer Exemplare von *dichroa* geben.

eumecacera Speiser, 1909 (Abb. 4)

Literatur: Alexander, 1956a; Mannheims, 1958, 1961 (unter *eumecacera* und *curtipennis*); Den Hollander, 1975a; Theowald, 1977a.

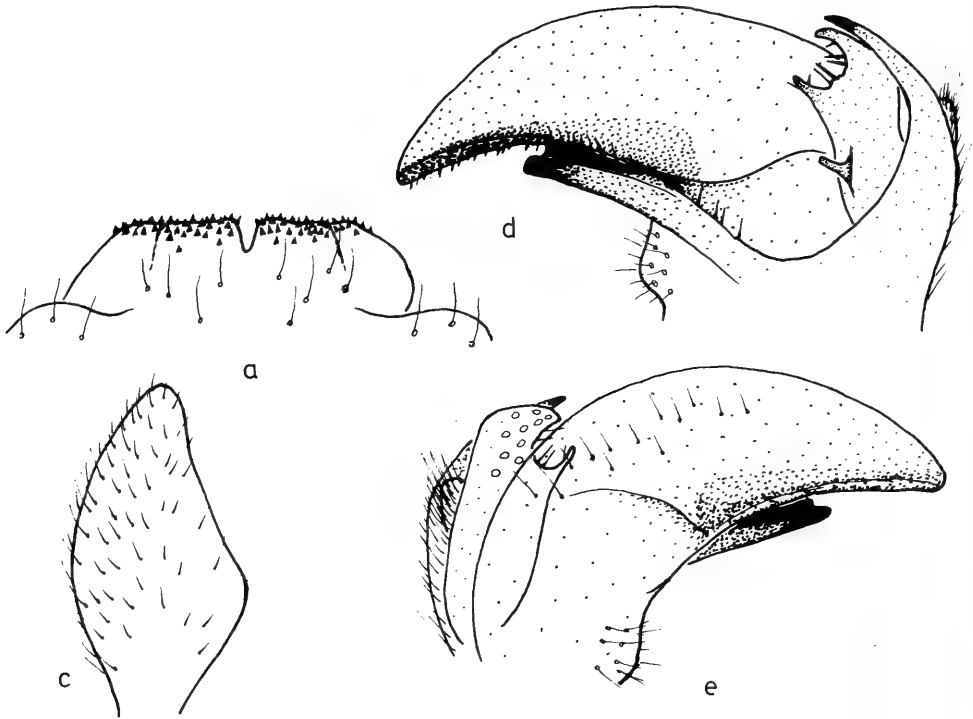
Typus-Lokalität: Kilimandjaro, Kiboscho, 2950 m.

Lektotypus ♂: Naturhistoriska Riksmuseet, Stockholm (Lektotypus des. Mannheims, 1957).

Männchen. — Kopf oben grau, hinten gelblichbraun; Augen unter dem Kopf breit getrennt, Trennung drei- bis viermal breiter als das erste Fühlerglied; Rostrum gelblichbraun mit deutlichem Nasus; Palpen gelblichbraun mit fast schwarzem Endglied; Fühler 13-gliedrig, auffallend lang, zurückgeschlagen fast bis zum Ende des Hinterleibs reichend, ganz gelb-

lichbraun, Wirtelhaare zwei- bis dreimal so lang wie die Breite des zugehörigen Gliedes. Thorax gelblichbraun; Mesonotum mit vier hellbraunen dunkelgerandeten Längsstreifen; Beine gelblichbraun, nur am Ende schwärzlich verdunkelt; Tarsalklauen ohne Mittelzahn; Flügel fast glashell mit bräunlicher Costalzelle und braunem Schattensaum entlang cu, Stigmenfleck gleich dunkel wie die Costalzelle; Squama mit meist zwei kurzen Borsten; Schwingerstiel an der Basis gelblich, gegen Ende schwärzlich, Knopf schwarz. Das erste Segment des Hinterleibs hat dieselbe gelblichbraune Farbe wie der Thorax, weitere Segmente dunkelbraun mit schwarzen Rücken- und Seitenstreifen und dorsal grau bereift, Sternite heller gefärbt; Hypopyg kaum verschieden von dem von *capnioneura*, Vorsprung des 9. Tergits breitbasig; *id*-Vorderteil ohne Kamm, und an der Außenseite ohne Haarkissen, an der Innenseite mit langen Haaren; *id*-Hinterteil ziemlich klein, oben zangenförmig, an der Außenseite mit Dorn, an der Innenseite mit verstreut stehenden sensorischen Poren; *od* schlank birnförmig.

Das Weibchen ist unbekannt, sicher aber kurzflügelig.

Länge von Thorax und Hinterleib 10—12 mm; Flügellänge 13—15 mm.

Verbreitung: Tanzania; nur Kilimandjaro, woher sie von mehreren Fundorten an der Südseite bekannt geworden ist.

Biologie: Die Art wurde im Februar und Anfang März auf alpinen Wiesen in 2850—3500 m Seehöhe gesammelt. Ein in 3500 m Höhe gesammeltes ♂ ist kurzflügelig und hat einen unterentwickelten Thorax. Die Fühler sind ein wenig kürzer als bei normalflügeligen ♂ und ab zweitem Geißelglied bräunlich verdunkelt. Alle weiteren eidonomischen und hypopygialen Merkmale sind aber wie bei normalflügeligen ♂. Mannheims (1961) hat dieses kurzflügelige ♂ als *curtipennis* beschrieben (mit kurzflügeligen ♂ von *flagellicurta* als Paratypen).

errans nov. subsp. (siehe unter *italica* Lackschewitz).

(*fimbriata* Meigen, 1818) = *paludosa* Meigen, 1830

Literatur: Der Name *fimbriata* wurde für diese Art kaum benutzt und durch I.C.Z.N. Opinion 1160 (1980) unterdrückt zugunsten von *paludosa*.

Typus-Lokalität: Unbekannt.

Holotypus: Vielleicht ist das Exemplar, das Meigen als *Tipula plumbea* von Herrn Megerle (Kustos des k.k. Hofmuseums) geschickt bekam und als *fimbriata* beschrieb, noch im Museum Wien.

flagellicurta Mannheims, 1958 (Abb. 5)

Literatur: Riedel, 1914 (unter *strigata* p.p.); Mannheims, 1961 (unter *curtipennis* p.p.); Den Hollander, 1975a.

Typus-Lokalität: Kilimandjaro.

Holotypus ♂: Im Staatlichen Museum für Naturkunde, Stuttgart.

Männchen. — Kopf oben ziemlich grau, hinten braun; Augen unter dem Kopf ziemlich breit getrennt, Trennung zweimal breiter als das erste Fühlerglied; Rostrum braun mit deutlichem Nasus; Palpen braun mit fast schwarzem Endglied; Fühler 13-gliedrig, zurückgeschlagen bis zum zweiten Hinterleibssegment reichend, Basalglied gelblichbraun, zweites Glied meist etwas heller gefärbt, erstes Geißelglied meist braun, weitere Geißelglieder zunehmend dunkler bis schwarz, Wirtelhaare meist etwa halb so lang wie die zugehörigen Glieder. Thorax braungrau mit vier dunklen Längsstreifen auf dem Mesonotum, die mittleren sind meist gegen



Abb. 5. Hypopyg von *Tipula* (*T.*) *flagellicurta* (a—e wie Abb. 1).

die Mitte dunkelgerandet und haben zwischen ihnen eine helle Medianlinie; Beine braun, Femur- und Tibiaende verdunkelt, Tarsenglieder fast schwarz, Tarsalklauen ohne Mittelzahn; Flügel ein wenig verdunkelt, die Membran zwischen den Adern ein wenig aufgeheilt, Stigmenfleck braun, Costalzelle etwas heller braun; Squama mit meist zwei kurzen Borsten; Schwingerstiel braun, Knopf schwarz. Hinterleib dunkelbraun mit schmalen schwarzen Rücken- und Seitenstreifen, Sternite braungrau. Hypopyg mit breitbasigem Vorsprung des 9. Tergits; *id*-Vorderteil ohne Kamm, an der Außenseite — im Gegensatz zu *capnioneura* und *eumecacera* — mit einem auffallenden Kissenerker kurzer weißer Haare, an der Innenseite mit langen Haaren; *id*-Hinterteil ziemlich klein, oben zangenförmig, an der Innenseite mit verstreut stehenden sensorischen Poren; *od* etwa birnförmig.

Das wohl zu dieser Art gehörende Weibchen ist kurzflügelig, ziemlich einheitlich braun, mit ein wenig verkürzten und ziemlich stark behaarten Beinen und mit kurzen Fühlern, die kaum länger sind als Kopf und Rostrum zusammen, und deren drei Basalglieder braun und weitere Glieder schwarz sind.

Länge von Thorax und Hinterleib: ♂ 15—17 mm, ♀ 17 mm; Flügellänge: ♂ 19—23 mm; ♀ 1.5 mm.

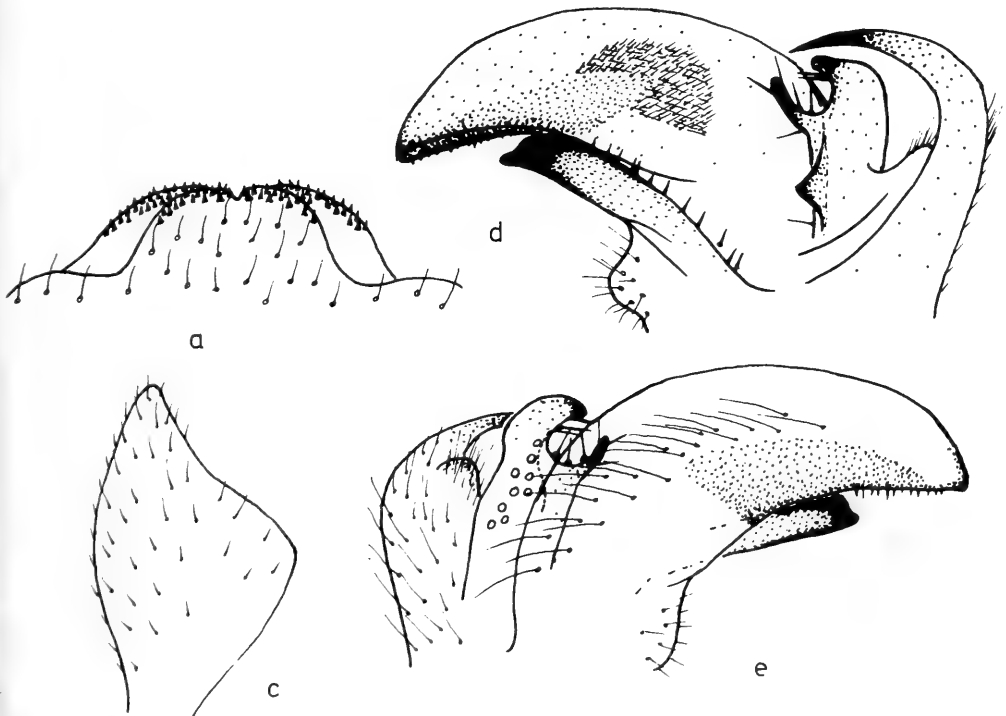
Verbreitung: Tanzania, nur Kilimandjaro.

Biologie: Diese Art wurde im März und April auf Wiesen an der Südseite des Kilimandjaro in 2800—3500 m Höhe gesammelt. In 3500 m Höhe sind die Männchen kurzflügelig. Sie sind dort etwas dunkler und schön grau bereift, haben den Thorax unterentwickelt, wie die kurzflügeligen ♂ von *eumecacera*. Nach allen weiteren Merkmalen sind sie aber mit den normalgeflügelten ♂ identisch. Sie wurden, mit einem kurzflügeligen ♂ von *eumecacera* zusammen, von Mannheims (1961) als *curtipennis* beschrieben.

Bemerkung: Eines der zwei ♂, die Riedel (1914) als *strigata* Loew (Deutsch-Ost-Afrika: Kilimandjaro, Wiesen der alpinen Zone, 2800—3000 m, Ch. Alluaud, 1909) anführte, erwies sich nach Überprüfung als *flagellicurta*.

(*flavolutescens* Pierre, 1921) = *paludosa* Meigen, 1830

Literatur: Mannheims, 1952; Theowald, 1972.

Typus-Lokalität: Kanarische Inseln, Grande Canarie (Tafira).

Holotypus ♂: Im Museum Paris (vid. Mannheims).

Bemerkung: Nach Theowald, 1972, ist die Synonymie gesichert.

frater Alexander, 1921a (Abb. 6)

Literatur: Alexander, 1956a, 1957, 1960, 1964; Den Hollander, 1975a.

Typus-Lokalität: Pretoria, Transvaal.

Holotypus ♂: Im South African Museum, Kapstadt.

Bemerkung: Aufgrund von Alexander bestimmten Materials konnte ich feststellen, daß Alexander in seinen Veröffentlichungen *soror*, *frater* und *consobrina* verwechselt hat. Alexander (1956a) verzeichnet im Schlüssel *id*-Merkmale von *frater* unter *soror* und von *consobrina* unter *frater*. Die von ihm angeführten Fundorte unter *frater* in den Veröffentlichungen seit 1956 beziehen sich zum Teil auf *frater*, zum Teil auf *consobrina*.

Männchen. — Kopf oben verdunkelt, hinten bräunlich; Augen unter dem Kopf schmal getrennt, Trennung weniger breit als das erste Fühlerglied; Rostrum bräunlich, oben etwas verdunkelt, Nasus deutlich; Palpen fast schwarz; Fühler 13-gliedrig, kurz, etwa so lang wie Kopf und Rostrum zusammen, hellbraun, die längsten Wirtelhaare kaum so lang wie die zugehörigen Glieder. Thorax bräunlich, Mesonotum mit vier dunkelgerandeten Längsstreifen; Thoraxseiten und Coxae hellbraun, Femurbasis etwas dunkler, Femurende sowie Tibiae und Tarsenglieder dunkelbraun bis schwarz; Tarsalklauen mit Mittelzahn; Flügel bräunlich mit zwei auffallend hellen Längsstreifen: die Zellen zwischen r und m (einschließlich Diskoidalzelle) sind ganz, und die Zelle hinter cu größtenteils hell; Squama-Haare kaum oder nicht vorhanden; Schwinger mit graubraunem Stiel und dunkelbraunem Knopf. Hinterleib bräunlich mit dunkelbraunen Rücken- und Seitenstreifen; an der Basis des zweiten Sternits ein runder dunkelbrauner Fleck; *id*-Vorderende mit halbblangem Kamm, an der Außenseite ohne deutliches Haarkissen, wohl aber an einigen Stellen behaart, an der Innenseite mit deutlichen Haaren; *id*-Hinterende oben kappenförmig mit bedorntem Vorsprung, an der Innenseite mit ziemlich deutlich begrenzter Gruppe sensorischer Poren; *od* oben breit abgestutzt; Vor-



Abb. 6. Hypopyg von *Tipula* (*T.*) *frater* (a—e wie Abb. 1; g, Kamm des *id*-Vorderteils von *chubbi*; h, Kamm des *id*-Vorderteils der Exemplaren von Zimbabwe).

sprung des 9. Tergits schmalbasig.

Das Weibchen gleicht in allen eidonomischen Merkmalen dem Männchen; die Tarsalklauen sind jedoch ohne Mittelzahn.

Länge von Thorax und Hinterleib: ♂ 13—17 mm, ♀ 18—23 mm; Flügelänge: ♂ 16—20 mm, ♀ 18—23 mm.

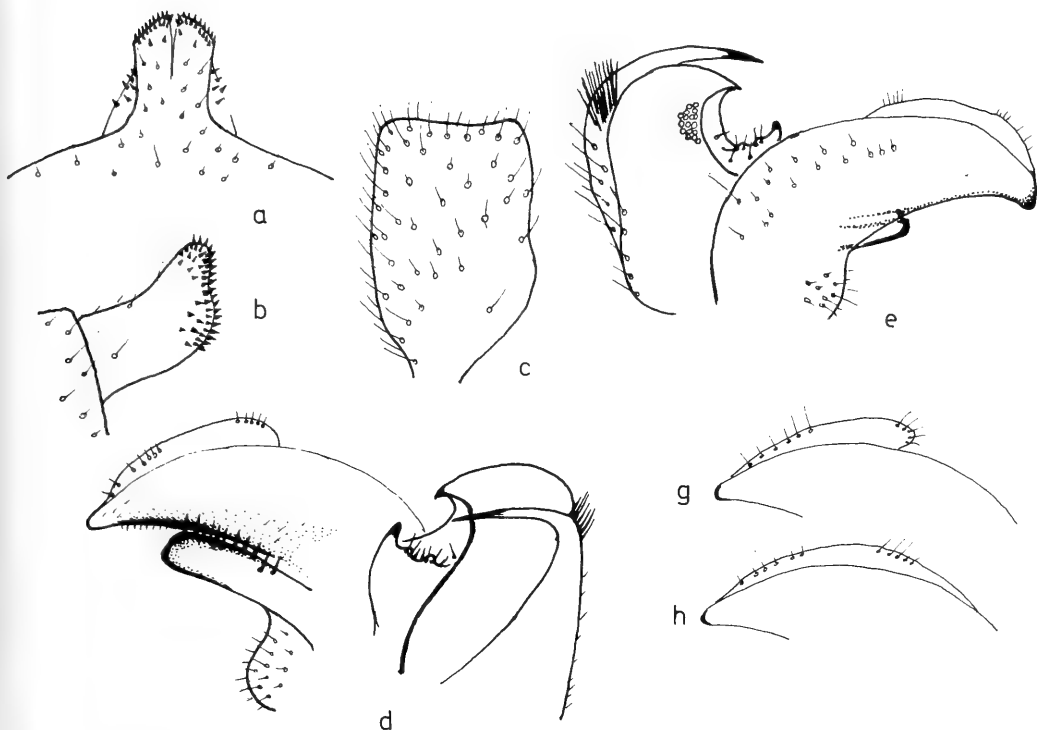
Verbreitung: Südafrika (Natal, nach dem Norden bis Pretoria in Transvaal und nach dem Süden bis in den Nordosten der Kap-Provinz), Lesotho, Zimbabwe (nur Inyanga). Letztgenannter Fundort liegt isoliert von den anderen. Ich fand aber keine deutlichen Unterschiede zwischen den beiden Populationen, es sei denn, daß die Exemplare von Inyanga einen etwas längeren Kamm haben.

Biologie: Diese Art wurde im September/Oktober und von Januar bis März (zwei Generationen?) in 1600—2100 m Seehöhe gesammelt.

(*fusca* Staeger, 1840 (nec Bloch, 1776)) = *subcunctans* Alexander, 1921b

Literatur: Mannheims, 1952; Tjeder, 1953.

Typus-Lokalität: Charlottenlund (Dänemark).

Holotypus ♂: Im Museum Kopenhagen (vid. Mannheims).

hollanderi Theowald, 1977a (Abb. 7)

Typus-Lokalität: Nordabfall Mt. Batu, Baale Berge, Äthiopien.

Holotypus ♂: Im Zoologischen Museum Amsterdam.

Männchen. — Kopf oben und hinten grau; Augen unter dem Kopf ziemlich breit getrennt, Trennung etwa zweimal so breit wie das erste Fühlerglied; Rostrum oben grau, unten braun, Nasus deutlich; Palpen dunkelbraun, Endglied schwarz; Fühler 13-gliedrig, lang, zurückgeschlagen bis zum Anfang des 2. Hinterleibssegmentes reichend, die drei basalen Glieder gelblichbraun, weitere Glieder dunkelbraun bis schwarz, Wirtelhaare sehr kurz und kaum länger als die Breite des zugehörigen Gliedes. Thorax unterentwickelt, größtenteils hellgrau, die dunkelbraunen Rückenstriemen mehr oder weniger miteinander verwachsen zu einem undeut-



Abb. 7. Hypopyg von *Tipula (T.) hollanderi* (a—e wie Abb. 1).

lichen dunkelbraunen Fleck; Flügel sehr kurz (1.5 mm); Beine von normaler Länge, Vordercoxae bräunlich, weitere grau, Femora basal gelblich, nach distal zunehmend dunkler werdend, Tibiae und Tarsenglieder dunkelbraun bis schwarz; Tarsalklauen ohne Mittelzahn; Schwinger mit dunkelbraunem Stiel und schwarzem Knopf. Hinterleib an der Basis hellbraun, hintere Hälfte silbergrau bereift und mit deutlichen Rücken- und Seitenstreifen; Hypopyg mit Vorsprung des 9. Tergits ziemlich schmalbasig; *od* birnförmig; *id*-Vorderende ähnlich wie bei *frater*, mit einem verkürzten Kamm in der Vorderhälfte, an der Außenseite ein Kissen kurzer weißer Haare, an der Innenseite mit langen Haaren; *id*-Hinterende kapfenförmig mit bedornem Vorsprung, an der Außenseite mit einem deutlichen Dorn, an der Innenseite mit einigen verstreut stehenden sensorischen Poren.

Das zugehörige Weibchen gleicht in fast allen eidonomischen Merkmalen dem Männchen, die Fühler sind aber kürzer und reichen zurückgeschlagen kaum bis zur Flügelbasis, die Beine sind deutlich verkürzt und die Augen sind unter dem Kopf breit getrennt, Trennung etwa vier-

mal so breit wie das erste Fühlerglied.

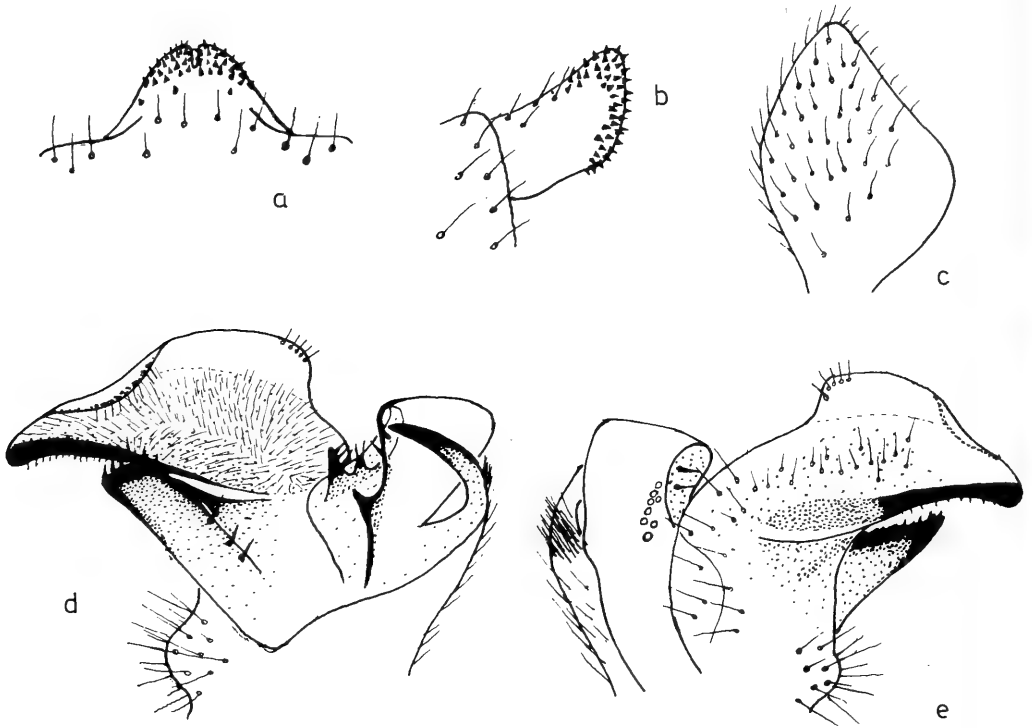
Länge von Thorax und Hinterleib: ♂ 10 mm, ♀ 12 mm; Flügellänge: ♂ und ♀ 1.5 mm.

Verbreitung: Äthiopien, nur Baale Berge.

Biologie: Die Art wurde Anfang April in 3600—3800 m Seehöhe gesammelt.

Bemerkung: Die kurzflügeligen Männchen mit unterentwickeltem Thorax, aber mit normallangen statt verkürzten Beinen, sehen aus wie die kurzflügeligen Männchen, die von *eumecacera* und *flagellicurta* bekannt wurden. Diese beide Arten sind in niedriger gelegenen Fundorten normalflügelig. Es ist nicht auszuschließen, ja sogar wahrscheinlich, daß auch bei *hollanderi* in niedriger gelegenen Lokaltäten normalflügelige Männchen vorkommen.

(*hungarica* Lackschewitz, 1930) = *oleracea* × *orientalis*?

Literatur: Mannheims, 1952; Simova, 1977 (Fig. 68 d, e, f, unter *orientalis*).

Typus-Lokalität: Weiden, Burgenland, Österreich.

Lektotypus ♂: Im Museum Wien (des. Mannheims, 1950).

Bemerkung: *T. hungarica* wurde von Lack-

schwewitz (1930) und Mannheims (1952) deutlich beschrieben und abgebildet. Sie ist den beiden einander nächstverwandten Arten *oleracea* (westmediterran) und *orientalis* (ostmediterran) sehr ähnlich und bis heute nur von einzelnen Exemplaren bekannt geworden. Diese wurden im Norden der Balkanhalbinsel (Österreich, Ungarn und Jugoslawien), im Gebiet, wo beide Vergleichsarten zusammen vorkommen, gesammelt. Es ist wahrscheinlich, daß die *hungarica*-Exemplare Hybriden von *oleracea* × *orientalis* sind. Es gibt ja auch Hybriden zwischen den mitteleuropäischen Arten *oleracea*, *paludosa* und *subcunctans* (Den Hollander, 1975b, 1975c und die dort erwähnte Literatur).

italica Lackschewitz, 1930

Literatur: Mannheims, 1952; Simova, 1977 (Fig. 68b unter *orientalis*); Vály, 1982 (unter *mediterranea*).

Typus-Lokalität: *T. italica* wurde beschrieben nach Exemplaren von Illyria, Ronchi bei Görz und von Italien, Forli, Pineta di Ravenna.

Typen: Im Museum Wien. Bis heute ist kein Lektotypus designiert worden.

Bemerkung: Nach Lackschewitz (1930) ist der Haken des *id* am Ende kolbenförmig angeschwollen und hat der *id*-Hinterteil am hinteren Rande einen kräftigen braunen Zahn. Nach Mannheims (1950, 1952) ist der Haken nicht immer kolbenförmig angeschwollen. Nach dem Material unserer Sammlung kommt die typische *italica* mit keulenförmig verdicktem Ende des Hakens und mit kräftigem Zahn auf dem *id*-Hinterteil nur auf dem italienischen Festland vor. Bei Exemplaren von der Balkanhalbinsel ist der Haken schlank, ohne keulenförmige Verdickung und mit am Ende einer ganz feinen Spitze, und der Zahn des *id*-Hinterteils ist meist weniger deutlich. Auf Sardinien sieht die Art aus wie auf der Balkanhalbinsel. Auf Korsika variiert sie: der Zahn ist meist wohl deutlich, aber der Haken ist manchmal schlank, manchmal ein wenig verdickt, aber niemals so stark verdickt wie bei Material vom Festland (ich sah aber nur vier ♂). Vielleicht gibt es auf Korsika eine Mischpopulation. Der *id* der Balkanform wurde von Simova (1977) als der einer Varietät von *orientalis* (Fig. 68b) und von Vály (1982) unter *mediterranea* abgebildet. Die typische Form hat Lackschewitz (1930) eindeutig beschrieben. Im Gegensatz zu allen weiteren Arten dieser Untergattung haben die beiden Formen von *italica* die kegelförmigen Auswüchse

auf den sensorischen Poren (sensilla basiconica) dunkelgefärbt statt glashell.

Die beiden Formen sind geographisch isoliert, obwohl im Norden von Jugoslawien (und auf Korsika?) eine Hybridisationszone zu erwarten wäre. Sie sind deshalb als Unterarten aufzufassen. Die typische Unterart mit kolbenförmigem angeschwollenem Haken und kräftigem Zahn am *id*-Hinterteil wurde von Lackschewitz (1930) aus Italien beschrieben. Die Unterart von der Balkanhalbinsel und von Sardinien nenne ich *italica errans* **nov. subspec.**, weil sie schon mehrmals zu Irrtümern Anlaß gegeben hat. Sie hat einen schlanken Haken und einen weniger kräftigen Zahn am *id*-Hinterteil.

Holotypus ♂: Ellas, Lésvos, 10 km Z.O. v. Kalloni, bedding v.d. Kriónéri, 10.XI.1973, A. C. & W. N. Ellis leg.

Paratypen: 38 ♂ und 25 ♀ vom selben Fundort; 14 ♂, 2 ♀ Sardegna, Tempio Pausania 30.IX-6.X.1957, C. A. W. Jeekel leg.

Typen im Zoologischen Museum, Amsterdam.

(*jonesi* Alexander, 1920 (*Leptotarsus*))

Literatur: Hutson, 1980.

Bemerkung: Alexander, 1920a, verzeichnet bei der Beschreibung von *Tipula mosambicensis* nov. spec. Unterschiedsmerkmale gegenüber einer noch unbeschriebenen *Tipula jonesi* von Natal. Die Unterschiede sind deutlich, weshalb es eine *Tipula jonesi* Alexander, 1920, gibt mit Typus-Lokalität Natal. Diese Art wurde weiter in der Literatur nicht mehr erwähnt. Im Dipterenkatalog des afrotropischen Gebietes führt Hutson (1980) sie in der Untergattung *Tipula*. Im Jahre 1921 beschrieb Alexander *Habromastix jonesi* nov. spec. von Südafrika, M'fongosi, Zululand. Dieser Fundort liegt in Natal. Wenn wir die Beschreibung von 1921 vergleichen mit den Bemerkungen von 1920 wird klar, daß die erst als *Tipula jonesi* verzeichnete Art im Jahre 1921 als *Habromastix jonesi* (jetzt *Leptotarsus (Longurio) jonesi*) beschrieben worden ist, leider ohne Hinweis auf die Veröffentlichung von 1920. Im afrotropischen Katalog erscheint sie jetzt unter *Leptotarsus* und unter *Tipula* auf. Sie ist unter *Tipula* zu streichen.

kleinschmidti Mannheims, 1950

Literatur: Mannheims, 1952.

Typus-Lokalität: Cercedilla, Spanien.

Holotypus ♂: Im Instituto Espanol de Entomologia, Madrid.



Abb. 8. Hypopyg von *Tipula (T.) lobeliae* (a—e wie Abb. 1).

Bemerkung: Mannheims (1950) gibt eine deutliche Beschreibung und eine Abbildung des *id*. Die Abbildung des Adminiculum ist ungenügend, weil die Gonapophysen nicht gezeichnet sind. Diese Art ist nur von der iberischen Halbinsel bekannt.

lobeliae Alexander, 1956a (Abb. 8)

Literatur: Den Hollander, 1975a; Theowald, 1977a.

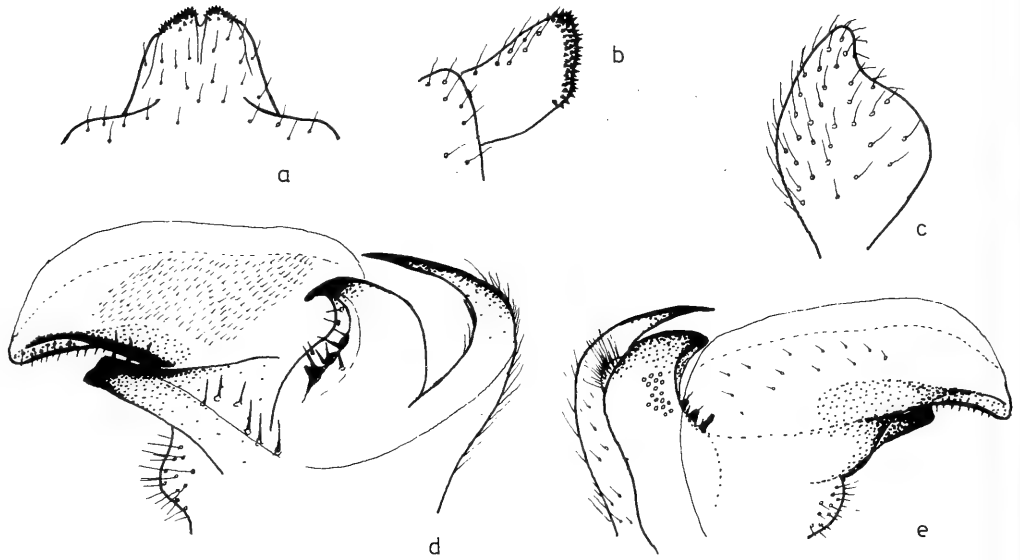
Typus-Lokalität: Mount Elgon, Kenya.

Holotypus ♂: Im British Museum (Natural History).

Männchen. — Kopf oben grau, hinten braun; Augen unter dem Kopf ziemlich breit getrennt, Trennung etwa dreimal so breit wie das erste Fühlrglied; Rostrum braun mit deutlichem Nasus; Palpen braun, Endglied fast schwarz; Fühler 13-gliedrig, zurückgeschlagen kaum bis zur Flügelbasis reichend, basal gelb, gegen Ende zunehmend dunkler werdend, die Basis der Glieder etwas verdickt; die längsten Wirtelhaare etwa so lang wie das zugehörige Glied. Thorax hellbraun, Pleuren und Scutum silbergrau bereift, Mesonotum mit vier dunkelbraunen, zumal an der hellbraunen Mittellinie entlang, dunkelgerandeten Längsstreifen; Beine dunkelbraun und am Ende fast schwarz; Tarsalklauen ohne Mittelzahn; Flügel fast glashell, nur die Costalzelle ein wenig verdunkelt und entlang cu und m-cu ein breiter Schattensaum; Squama mit meist zwei winzigen Borsten; Schwinger mit

hellbraunem Stiel und schwarzem Knopf. Hinterleib ein wenig dunkler als der Thorax, mit deutlichen schwarzen Rücken- und weniger deutlichen Seitenstreifen; Hypopyg mit Vorsprung des 9. Tergits ziemlich schmalbasig, *od* birnförmig, *id*-Vorderteil mit Kamm, an der Außenseite mit einem Kissen feiner kurzer Haare, an der Innenseite mit langen Haaren, *id*-Hinterteil spitz kappenförmig, an der Vorderseite deutlich beborstet (die Borsten stehen nicht auf einem Vorsprung, wohl aber auf einem kleinen Hügel), an der Außenseite ohne Dorn, an der Innenseite mit verstreut stehenden sensorischen Poren.

Das zugehörige Weibchen ist in allen eidonomischen Merkmalen dem Männchen ähnlich, hat aber kürzere Beine und ist kurzflügelig.

Länge von Thorax und Hinterleib: ♂ 11—14 mm, ♀ 16 mm; Flügelänge: ♂ 14—18 mm, ♀ 1,5 mm.

Verbreitung: Kenya, Uganda (nur Mount Elgon).

Biologie: Diese Art wurde Ende Dezember und im Februar auf alpinen Wiesen in 3000—4400 m Seehöhe gesammelt. Die in Höhen von über 3500 m gesammelten ♂ sind kurzflügelig wie die Weibchen. Wie bei den kurzflügeligen Männchen von *eumecacera* und *flagellicurta* ist der Thorax unterentwickelt, nach Alexander (1956a) sind — im Gegensatz zu den Vergleichsarten — die Beine verkürzt. Als Holotypus hat Alexander ein kurzflügeliges Männchen,

gesammelt in 13.500 ft (4400 m) Seehöhe, designiert.

loeffleri nov. spec. (Abb. 9)

Tipula (*Tipula*) *loeffleri* nov. spec.

Holotypus ♂ und drei Paratypen ♂: Äthiopien, Baale Berge, Nordabfall Mt. Batu, 3600—3800 m, 2.IV.1976, Löffler leg.; im Zoologischen Museum Amsterdam.

Männchen. — Kopf oben und hinten grau; Augen unter dem Kopf ziemlich breit getrennt, Trennung etwa zweimal so breit wie das ziemlich dicke Fühlerbasalglied; Rostrum braun mit deutlichem Nasus; Palpen dunkelbraun; Fühler 13-gliedrig, zurückgeschlagen fast bis zur Flügelbasis reichend, Basalglieder gelblich bis braun, Geißelglieder dunkelbraun bis schwarz, Wirtelhaare kurz, die längsten kaum halb so lang wie das zugehörige Glied. Thorax hellgrau bereift; die Längsstreifen des Mesonotum kaum sichtbar, nur undeutliche Reste des Innenrandes der Mittelstreifen; Coxae hellgrau bereift, Beine braun, Femur- und Tibia-Ende ein wenig dunkler; Tarsalklauen ohne Mittelzahn; Flügel fast glashell, nur die Costalzelle bräunlich und cu und m-cu mit Schattensaum; Squamabehaarung undeutlich, meist nur zwei winzige Borsten; Stiel und Knopf der Schwinger hellbraun. Hinterleib braun mit Bereifung, Rücken/Seitenstreifen kaum sichtbar, Hinter- und Seitenränder der Tergite ein wenig aufgehellte; Vorsprung

des 9. Tergits schmalbasig; *od*-Oberrand abgestutzt; *id*-Vorderteil mit deutlichem Kamm, an der Außenseite mit einem Kissen kurzer weißer Haare, an der Innenseite lang behaart; *id*-Hinterteil kappenförmig mit bedorntem Vorsprung, an der Außenseite ohne Dorn, an der Innenseite mit einer scharf begrenzten Gruppe sensorischer Poren.

Das Weibchen ist unbekannt.

Länge von Thorax und Hinterleib: ♂ 10—11 mm, Flügellänge: ♂ 13—16 mm.

Verbreitung: Nur Äthiopien (Baale Berge).

Biologie: Diese Art wurde zusammen mit den kurzflügeligen Männchen und Weibchen von *hollanderi* gesammelt, und zwar auf alpinen Wiesen in 3600—3800 m Seehöhe.

Name: Diese Art wurde dem Sammler, Herrn Univ.-Prof. Dr. H. Löffler, gewidmet.

lowrensi Den Hollander, 1975a (Abb. 10)

Literatur: Riedel, 1914 (unter *strigata* p.p.); Theowald, 1977a.

Typus-Lokalität: Tanzania, Kilimandjaro, Umgebung Bismarckhütte.

Holotypus ♂: Im Zoologischen Museum Amsterdam.

Männchen. — Kopf oben und hinten grau; Augen unter dem Kopf ziemlich breit getrennt, Trennung zweimal so breit wie das erste Fühlerglied; Rostrum orangebraun mit deutlichem Nasus; Palpen dunkelbraun; Fühler 13-gliedrig,



Abb. 9. Hypopyg von *Tipula* (*T.*) *loeffleri* (a—e wie Abb. 1).



Abb. 10. Hypopyg von *Tipula (T.) lourensi* (a—e wie Abb. 1).

zurückgeschlagen etwa bis zur Flügelbasis reichend, Basalglieder und Basalhälfte des ersten Geißelgliedes gelblich, weitere Geißelglieder schwarzbraun, die längsten Wirtelhaare fast so lang wie das zugehörige Glied. Thorax orange-gelb; Mesonotum mit vier graubraunen dunkelgerandeten Längsstreifen; Coxae orangegelb, Beine gelblichbraun mit Femur- und Tibiaende und Tarsengliedern verdunkelt; Tarsalklauen ohne Mittelzahn; Flügel gelblich, Costalzelle nur wenig dunkler, Stigmenfleck dunkelbraun, cu und m-cu mit Schattensaum; Squama mit drei bis vier kurzen Borsten; Schwingerstiel gelblich, Knopf verdunkelt. Erstes Hinterleibsegment orange-gelb wie der Thorax, weitere Segmente grauschwarz mit hellgrauem Schimmer und samt-schwarzen Seitenstriemen; Vorsprung des 9. Tergits breitbasig; *od* schmal birnförmig; *id*-Vorderteil ohne Kamm, an der Außenseite ohne Haarkissen, an der Innenseite lang behaart; *id*-Hinterteil oben zangenförmig, an der Außenseite mit Dorn, an der Innenseite mit einigen verstreut stehenden sensorischen Poren. Das Weibchen ist unbekannt.

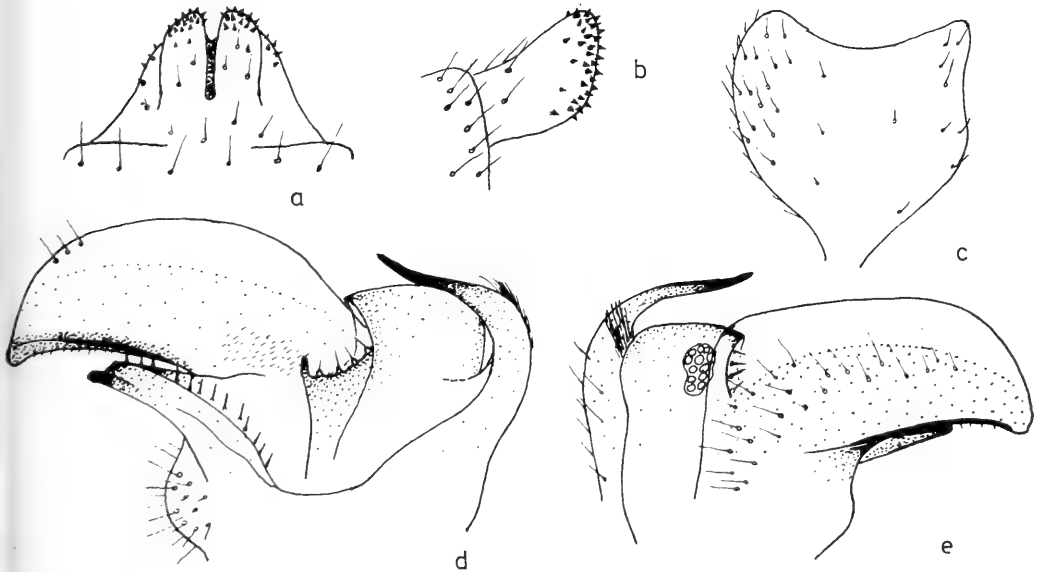
Länge von Thorax und Hinterleib: ♂ 13—16 mm, Flügellänge: ♂ 19—22 mm.

Verbreitung: Tanzania, Kilimandjaro, nur Umgebung Bismarckhütte.

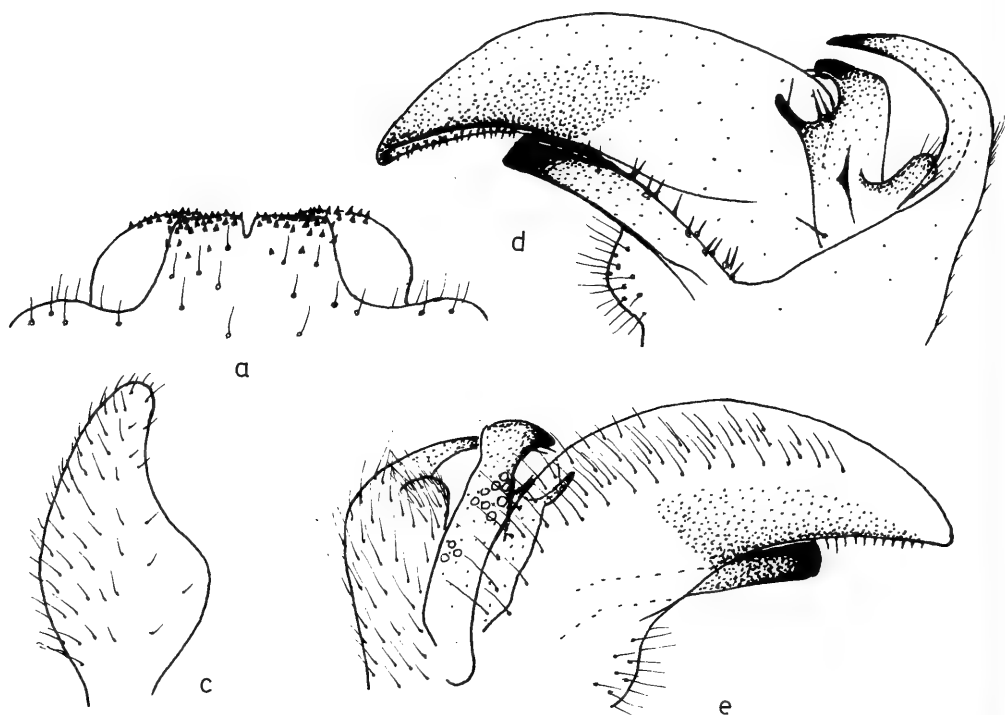
Biologie: Alluaud sammelte diese Species am 3.IV.1912 auf alpinen Wiesen in der Umgebung der Bismarckhütte in 2740 m Seehöhe. Auch Lourens sammelte sie dort (8-9.III.1971 in 2800—3100 m). Sie fliegt dort zusammen mit den in vielen Merkmalen ähnlichen, aber doch deutlich verschiedenen Arten *eumecacera* und *flagellicurta*.

(*mashona* Alexander, 1920d) = *soror* subsp. *mashona* Alexander (stat. nov.)

Literatur: Alexander, 1964.

Typus-Lokalität: Salisbury, Mashonaland (Zimbabwe).

Holotypus ♂: Im British Museum (Natural History).

Bemerkung: Vom Typus-Exemplar sind nur noch erhalten: Thorax, Abdomen mit Hypopyg, ein Flügel, Femur, Tibia und erstes Tarsenglied eines Beines. Aufgrund dieser Reste ist *mashona* entweder identisch mit *soror* (Kapstadt und Umgebung: 13 Fühlerglieder) oder mit *bevisiana* (Gebiet der Drakensberge: 14

Fühlerglieder). Aus der Sammlung Alexander sah ich aber noch zwei weitere Exemplare von der Typus-Lokalität (1 ♂ und 1 ♀). Beide haben 14 Fühlerglieder wie *bevisiana*. Deshalb stelle ich *bevisiana* Alexander, 1956, als jüngeres Synonym zu *mashona* Alexander, 1920. *T. mashona* und *soror* gleichen einander weitgehendst, der einzige deutliche und konstante Unterschied besteht in der Anzahl der Fühlerglieder. Deshalb führe ich *mashona* als Unterart von *soror*.

Verbreitung: Das Gebiet der Drakensberge (Osten der Cape Province, Natal, Transvaal, Lesotho) und Zimbabwe (nur Salisbury).

Biologie: Diese Species wurden von Januar bis April und von September bis November in 1000—2600 m Seehöhe gesammelt.

mediterranea Lackschewitz, 1930

Literatur: Mannheims, 1952; Vály, 1982 (= *italica*).

Typus-Lokalität: Die Art wurde beschrieben nach Exemplaren von Österreich, Sizilien und Tenerife (Kanarische Inseln).

Typen: Im Museum Wien. Bis heute ist kein Lektotypus designiert worden.

Bemerkung: Diese Art wurde von Lackschewitz (1930) und Mannheims (1952) deutlich beschrieben und abgebildet. Sie hat ihre Hauptverbreitung im westmediterranen Gebiet. Irrtümlicherweise ist sie in Savtshenko (1961) (Fig. 276) unter *paludosa* statt unter *mediterranea* abgebildet.

(*microcephala* Bigot, 1858 (*Lecteria*)) (comb. nov.)

Literatur: Hutson, 1980.

Bemerkung: Diese Art wurde beschrieben nach einem ♀ von Gabon. Die Fühler des Typus-Exemplares waren abgebrochen. Bigot war sich nicht sicher, ob sie in die Gattung *Tipula* gehörte. Hutson (1980) führt sie im afrotropischen Katalog in dieser Untergattung. Die Untergattung *Tipula* ist nur bekannt von Ost- und Südafrika und nicht von Gabon in Westafrika. Die Beschreibung paßt auch nicht für eine *Tipula*, wohl aber für die vom dortigen Gebiet bekannte Limoniide *Lecteria africana nigrilinea* Alexander. Wahrscheinlich hat Bigot diese oder eine dieser nächstverwandte Art vorgelegen. Ich konnte das Typus-Exemplar nicht auffinden. Jedenfalls ist *microcephala* im afrotropischen Katalog unter *Tipula* zu streichen.

(*niligena* Jaenicke, 1867) = *bicolor* Loew, 1866 (syn. nov.)

Literatur: Bezzi, 1905.

Typus-Lokalität: Simen (Äthiopien).

Holotypus ♂: Im Museum Senckenberg, Frankfurt/Main.

Bemerkung: Nach der Beschreibung und nach Vergleich der Typen ist *niligena* ein jüngers Synonym von *bicolor*.

oleracea Linnaeus, 1758

Literatur: Lackschewitz, 1930; Mannheims, 1952.

Typus-Lokalität: Kochem/Mosel (Deutschland).

Neotypus ♂: Im Zoologischen Museum Alexander Koenig, Bonn.

Bemerkung: Durch I.C.Z.N., Opinion 1160 (1980) wurde der Name festgelegt und ein Neotypus angewiesen. Die Art wurde von Lackschewitz (1930) und Mannheims (1952) deutlich beschrieben und abgebildet. Sie hat ihre Hauptverbreitung in West- und Mitteleuropa. Ihre Verbreitung auf der Balkanhalbinsel ist unklar.

orientalis Lackschewitz, 1930

Literatur: Mannheims, 1952; Simova, 1977 (p.p. *orientalis* (Fig. 68a), p.p. *italica* (Fig. 68b), p.p. *hungarica* (Fig. 68 d.e.f.)); Den Hollander, 1975a (unter *plumbea*: Insel Dilos).

Typus-Lokalität: *T. orientalis* wurde beschrieben nach Exemplaren von Kärnten, Burgenland, Illyria, Cypern, Dobrudscha, Dalmatien, Albanien, Korfu, Toscana, Apulia, Corsica, Transkaspien und Ägypten.

Typen: Im Museum Wien. Bis heute ist kein Lektotypus designiert worden.

Bemerkung: Diese Art wurde von Lackschewitz (1930) und Mannheims (1952) deutlich beschrieben und abgebildet. Sie hat eine weite Verbreitung im ostmediterranen Gebiet.

paludosa Meigen, 1830

Literatur: Lackschewitz, 1930; Mannheims, 1952.

Typus-Lokalität: Hamburg (Deutschland).

Holotypus ♀: Im Museum Paris (Sammlung Meigen) (vid. Mannheims, 1951).

Bemerkung: Durch I.C.Z.N. Opinion 1160 (1980) ist der Name *fimbriata* Meigen, 1818, zugunsten von *paludosa* Meigen, 1830, unterdrückt worden. Diese Art wurde von Lackschewitz (1930) und Mannheims (1952) deutlich

beschrieben und abgebildet. Sie hat ihre Hauptverbreitung in West- und Mitteleuropa. Irrtümlicherweise ist sie in Savtshenko, 1961 (Fig. 272) unter *mediterranea* statt unter *paludosa* abgebildet.

plumbea Fabricius, 1781

Literatur: Den Hollander, 1975a; Loi, 1964 (unter *venturii*).

Typus-Lokalität: Musei, Sardinien.

Neotypus ♂: Im Zoologischen Museum Amsterdam.

Bemerkung: Diese Art wurde von Den Hollander (1975a) und Loi (1964) deutlich beschrieben und abgebildet. Sie ist nur von einigen Fundorten in Italien und Südfrankreich bekannt. Das Exemplar von Griechenland (Kiklades) Dilos in Den Hollander (1975a) ist nicht *plumbea* sondern *orientalis*.

(*rothschildi* Alexander, 1920b (*Savtshenkia*)) (comb. nov.)

Literatur: Alexander, 1978.

Typus-Lokalität: Addis Abeba (Äthiopien).

Holotypus ♀: Im Muséum National d'Histoire Naturelle, Paris.

Bemerkung: Das Typus-Exemplar ist in Alkohol konserviert und ziemlich stark be-

schädigt. Es fehlen die Geißeln, eine der Palpen, die Knöpfe der Schwinger und der linke Flügelstummel. Von den Beinen sind nur Femur und Tibia eines Mittelbeines vorhanden. In der Sammlung Alexander findet sich noch ein Präparat auf Glas mit dem rechten Flügelstummel und einem Hinterbein. Zu den von Alexander erwähnten füge ich noch nachfolgende wichtige Merkmale hinzu: Kopf oben und hinten hellgrau, oben mit feinem schwarzem Mittelstrich; Rostrum kurz, ohne Nasus; Augen unter dem Kopf zweimal so breit getrennt wie die Breite des ersten Fühlergliedes; das vierte Palpenglied ist zweimal so lang wie das dritte. Hinterleib mit deutlichen Mittel- und Seitenstreifen; Ovipositor mit sehr schlanken Cerci. Länge von Thorax und Hinterleib etwa 10 mm. Mesonotum (nach Trocknen) mit drie hellbraunen Längsstreifen auf hellgrauem Untergrund, der mittlere breit aber undeutlich (vielleicht sind es zwei nah aneinander liegende Streifen); diese Längsstreifen sind nicht dunkelgerandet; Tibia des Mittelbeines mit zwei Dornen.

Nach der Gesamtheit der Merkmale ist dieses kleine kurzflügelige Weibchen eine Tipulide und keine Limoniide. Von den afrotropischen Gattungen kommt nur die Gattung *Tipula* in Betracht. Es gehört aber sicher nicht in die Un-



Abb. 11. Hypopyg von *Tipula* (*Yamatotipula*) *setosipennis* (a—e wie Abb. 1).

tergattung *Tipula*, sondern in die Untergattung *Savtschenkia*. Bis heute sind vom afrotropischen Gebiet keine *Savtschenkia*-Arten genannt worden. Die Beschreibungen und Abbildungen der vom afrotropischen Gebiet erwähnten *Pterelachsis*-Arten deuten aber darauf hin, daß sie alle in die neulich aufgestellte Untergattung *Savtschenkia* gehören. Letztgenannte Untergattung (und nicht *Pterelachsis*) kommt damit im ganzen ost- und südafrikanischen Gebiet vor. Sie war bis jetzt von Äthiopien unbekannt, dürfte dort aber sicher auch in mehreren Arten vorkommen.

(*setosipennis* Alexander, 1920c (*Yamatotipula*) (comb. nov.)) (Abb. 11)

Literatur: Alexander, 1921a, 1956b, 1957, 1964.

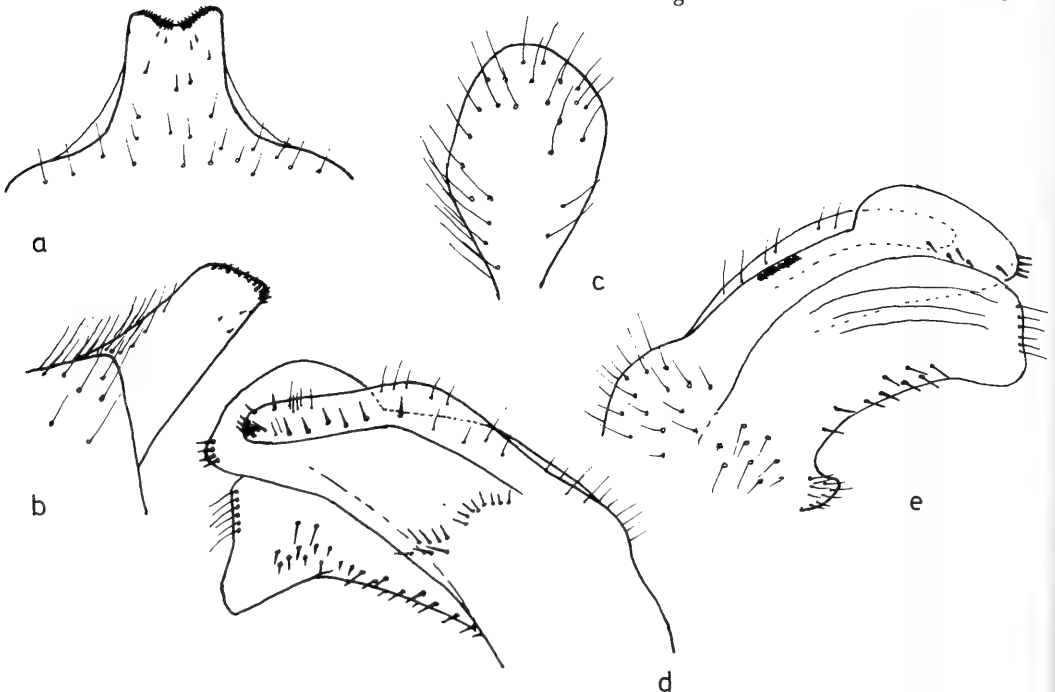
Typus-Lokalität: Pretoria, Transvaal.

Holotypus ♂: Im United States National Museum, Washington (Sammlung Alexander).

Bemerkung: Nach Alexander (1956b) ist sie eine stark abweichende Art der *oleracea*-Gruppe. In nachfolgenden wichtigen Merkmalen steht sie allen Arten der Untergattung *Tipula* gegenüber: Rostrum auffallend kurz und Nasus nicht oder kaum entwickelt (statt Rostrum ziemlich lang mit deutlichem Nasus); Flügel-

ader m-cu trifft auf m_4 (statt auf $m_3 + 4$); Flügelader rs ist 2 bis 2,5 mal so lang wie m-cu (statt 1,5 bis 2 mal); Tibialsporne 1-1-2 (statt 1-2-2); *od* klein (statt groß und die *id* verdeckend); *id*-Seitenteil (Mannheims: pars 4; Alexander: lower beak) nicht entwickelt (statt stark entwickelt und dunkel gefärbt); *id*-Haken (Mannheims: pars 1; Alexander: outer arm of outer basal lobe) breit bandförmig, mit vielen kurzen Stacheln und eng an den *id*-Hinterteil anschließend (statt hakenförmig, nackt und frei); sensorische Poren an der Rückseite des *id*-Hinterteil (statt an der Innenseite); 9. Sternit breit U-förmig eingeschnitten (statt schmal oder nicht); Adminiculum mit langen, dünnen Gonapophysen (statt mit kurzen, dicken). Aufgrund dieser vielen wichtigen Unterschiede gegenüber allen Arten der Untergattung *Tipula* ist es unmöglich, *setosipennis* in diese Untergattung aufzunehmen. Sie gehört aufgrund ihrer Merkmale in die Untergattung *Yamatotipula*, in der sie aber verwandtschaftlich isoliert steht.

soror Wiedemann, 1820 (Abb. 12)

Literatur: Wiedemann, 1820, 1828; Bergroth, 1888; Lackschewitz, 1930; Alexander, 1917, 1956a, 1956b, 1964; Wood, 1952; Den Hollander, 1975a.



Abb. 12. Hypopyg von *Tipula* (*T.*) *soror* (a—e wie Abb. 1).

Typus-Lokalität: Prom. bon. spei (Kap der Guten Hoffnung), Südafrika.

Holotypus ♀: Im Universitetets Zoologiske Museum, Kopenhagen (vid. L. Lyneborg, 1982).

Bemerkung: Aufgrund von Beschreibungen und von Material, das Alexander bestimmt hat, konnte ich feststellen, daß Alexander seit etwa 1950 *soror* und *mashona* mit *frater* verwechselt hat. Beide erstgenannten Arten führt er seit damals als *bevisiana*, letztgenannte als *soror*. Die Fundorte, die er in seiner Südafrika Arbeit (1964) unter *bevisiana* anführt, gehören zum Teil zu *soror*, zum Teil zu *mashona*, die unter *soror* zum Teil zu *soror*, zum Teil zu *mashona* und zum Teil zu *frater*, die unter *frater* zum Teil zu *frater* und zum Teil zu *consobrina*. Aufgrund dieser Verwirrung kommt Den Hollander (1975a) nach Literaturstudien zu der Meinung, *soror* und *frater* seien identisch.

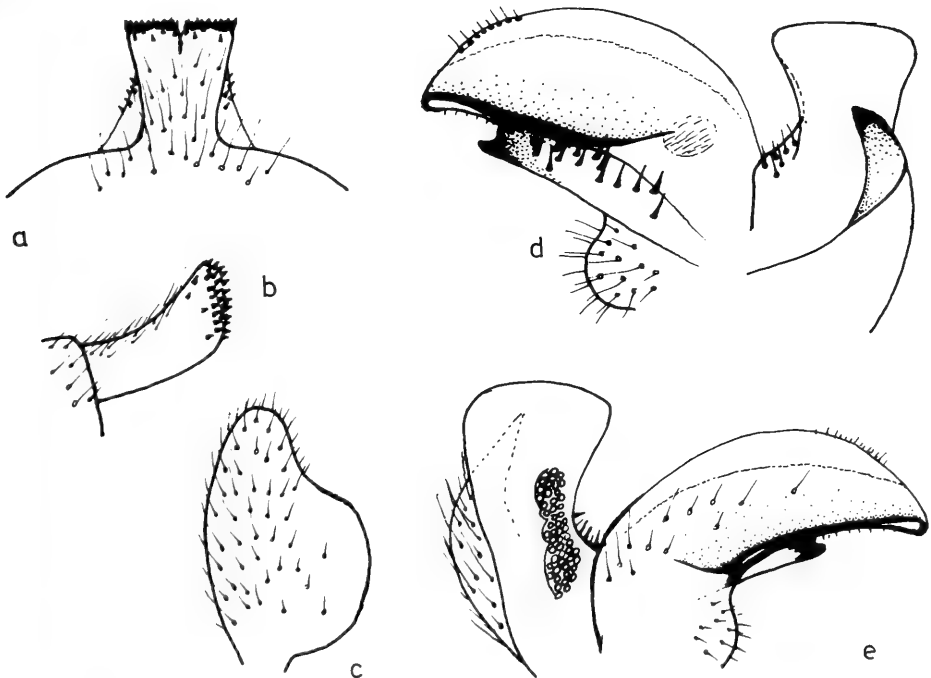
Männchen. — Kopf oben und hinten braun, grau bereift; Rostrum braun mit deutlichem Nasus; Augen unter dem Kopf schmal getrennt, Trennung kaum breiter als das erste Fühlerglied; Palpen braun, Endglied schwarz; Fühler 13-gliedrig, zurückgeschlagen etwa bis zur Flügelbasis reichend, Basalglieder gelb, Geißel gelblichbraun, kaum dunkler als die Basalglieder, die Geißelglieder an der Basis und am Ende ein wenig verdickt, Wirtelhaare etwa so lang wie die zugehörigen Glieder. Thorax braun, grau bestäubt; Mesonotum mit vier mehr oder weniger deutlichen, dunkelgerandeten Längsstreifen; Coxae und Femora etwa gleich hellbraun wie die Thoraxseiten, Femurende verdunkelt, Tibiae und Tarsenglieder dunkler bis schwarz; Tarsalklauen mit Mittelzahn; Flügel mit undeutlichen hellen Längsstreifen, deutlicher in Zelle R_5 . Costalzelle und Stigmenfleck verdunkelt; Squama Haare undeutlich; Schwingerstiel hellbraun, Knopf ein wenig dunkler. Hinterleib hellbraun mit kaum sichtbaren Rücken- und Seitenstreifen; Mittelfortsatz des 9. Tergits am Ende auffallend geradlinig abgestutzt; *od* breit birnförmig; *id*-Vorderteil mit Kamm, an der Außenseite mit Haarkissen, an der Innenseite mit wenigen langen Haaren; *id*-Hinterteil oben abgerundet, an der Vorderseite mit einem wenig deutlichen Vorsprung, auf dem eine Gruppe von Dornen steht, an der Außenseite ohne Dorn, an der Innenseite mit einer ziemlich deutlich abgegrenzten Gruppe sensorischer Poren; *id*-Haken auffallend kurz und breitbasis.

Das Weibchen gleicht in allen eidonomischen

Merkmale dem Männchen, nur sind die Fühler kaum länger als Kopf und Rostrum zusammen, und die Tarsalklauen ohne Mittelzahn.

Länge von Thorax und Hinterleib: ♂ 12—16 mm, ♀ 14—22 mm; Flügellänge: ♂ 19—21 mm, ♀ 19—20 mm.

Verbreitung: Nur die weitere Umgebung von Kapstadt; zu diesem Gebiet ist bis heute nur eine Art der Untergattung *Tipula* bekannt geworden, weshalb ich das Typus-♀ nicht überprüft habe.

Biologie: Die von Wood (1952) und mir gesehenen Exemplare wurden von August bis November und im Januar und März gesammelt. Die Art fliegt dort von Meereshöhe bis zu etwa 1500 m.

Unterarten: Fast identisch mit *soror* ist *mashona* (Gebiet der Drakensberge und Zimbabwe). Ich fand nur einen konstanten Unterschied: *soror* hat 13 Fühlerglieder, *mashona* dagegen 14. Deshalb führe ich *mashona* Alexander als Unterart von *soror* Wiedemann (siehe unter *mashona*).

speiseriana Alexander, 1930 (Abb. 13)

Literatur: Alexander, 1956a; Den Hollander, 1975a; Theowald, 1977a.

Typus-Lokalität: Kabara Camp, on southwest Slope of Mt. Mikeno, Kivu, Belgian Congo (jetzt Zaire).

Holotypus ♂: Nach Alexander (1930) in seiner Sammlung. Ich sah Präparate auf Glas von drei Paratopotypen.

Männchen. — Kopf oben grau, hinten braun; Rostrum braun mit deutlichem Nasus; Augen unter dem Kopf schmal getrennt, Trennung kaum breiter als das erste Fühlerglied; Palpen fast schwarz; Fühler 13-gliedrig, zurückgeschlagen etwa bis zur Flügelwurzel reichend, manchmal aber deutlich kürzer, Basalglieder gelblichbraun, die ersten zwei Geißelglieder zunehmend dunkler, weitere Geißelglieder dunkelbraun bis schwarz, Wirtelhaare etwa so lang wie das zugehörige Glied. Thorax bräunlich; Mesonotum mit vier grauen dunkelbraungerandeten Längsstreifen; Coxae und Beine braun, Femur- und Tibiaende verdunkelt, Tarsenglieder fast schwarz; Tarsalklauen ohne Mittelzahn; Flügel mit kaum sichtbaren Längsstreifen, in der Zelle R_5 noch am deutlichsten, Costalzelle und Stigmenfleck ein wenig dunkler, ein deutlicher Schwattensaum entlang *cu* und *m-cu*; Squama mit etwa sechs kurzen schwarzen Haaren; Schwingerstiel- und Knopf geschwärzt. Hinterleib braun mit verdunkelten Rücken- und



Abb. 13. Hypopyg von *Tipula* (*T.*) *speiseriana* (a—e wie Abb. 1).

Seitenstreifen, an der Basis des 2. Sternits ein undeutlicher schwarzer Fleck; Vorsprung des 9. Tergits schmalbasig; *od* breit birnförmig; *id*-Vorderteil mit Kamm, an der Außenseite ohne Haarkissen, an der Innenseite mit wenigen langen Haaren; *id*-Hinterteil kappenförmig mit bedornem Vorsprung, an der Innenseite ohne Dorn, an der Außenseite mit einer ziemlich deutlich abgegrenzten Gruppe sensorischer Poren.

Weibchen: dem Männchen in fast allen eidonomischen Merkmalen ähnlich, die Fühler aber sind meistens ein wenig kürzer.

Länge von Thorax und Hinterleib: ♂ 15—18 mm, ♀ 19—22 mm; Flügellänge: ♂ 17—21 mm, ♀ 17—21 mm.

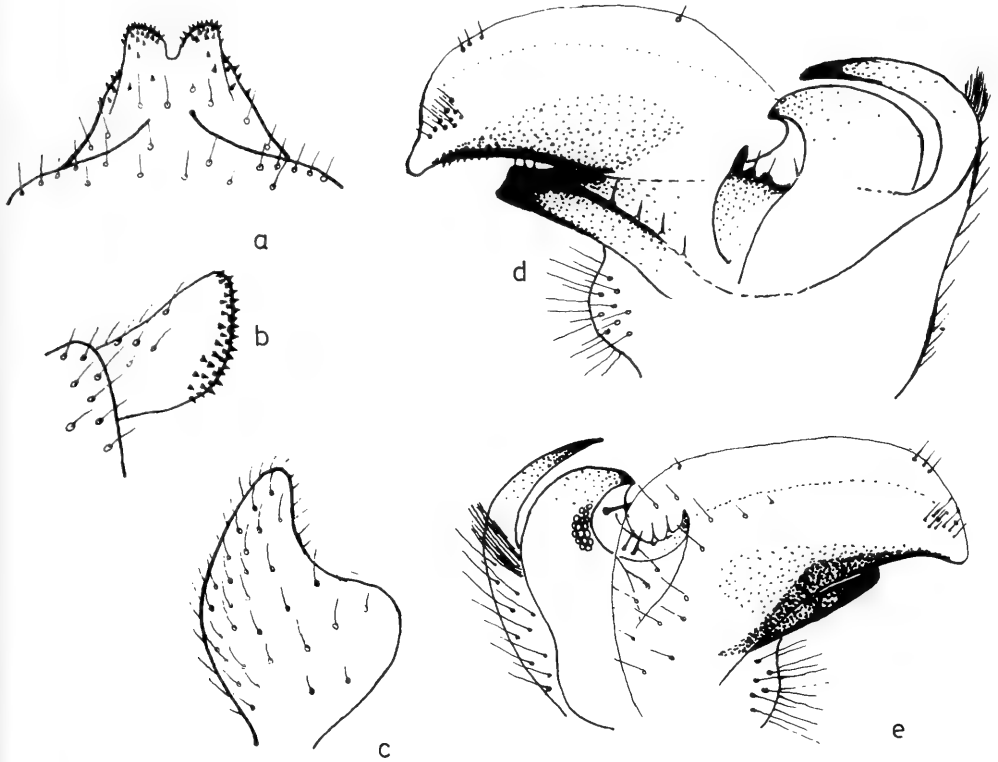
Verbreitung: In den Gebirgen östlich und westlich des Viktoria-Sees, wahrscheinlich auch Mt. Elgon (siehe Field notes by Edwards in Alexander, 1956a), bis heute nicht vom Kilimandjaro bekannt.

Biologie: Diese Species wurde in allen Monaten von Oktober bis April in den Gebirgen von 1500 bis 3500 m Seehöhe gesammelt. Edwards

sammelte in 3500 m Höhe ein kurzflügeliges Weibchen dieser Art (Kenya, Aberdare, Nyeri Track, 10500 ft, X.1934, British Museum). In den verzeichneten Gebieten ist die Art häufig und findet sich wohl in jeder Ausbeute von dort.

strigata Loew, 1866 (Abb. 14)

Literatur: Riedel, 1914 (ist aber *flagellicurta* und *lourensi*); Alexander, 1978 (unter *abyssinica* Jaenicke).

Typus-Lokalität: Nubien.

Holotypus ♂: Verbleib unbekannt, nach Mitteilung von Herrn Dr. H. Schuman befindet er sich nicht in der Sammlung Loew, Museum Berlin. Bemerkung: Die Beschreibungen von *strigata* Loew und *abyssinica* Jaenicke stimmen fast vollständig überein und sie passen bis in Einzelheiten auf die Exemplare, die Alexander (1978) als *abyssinica* anführt. Deshalb stelle ich *abyssinica* Jaenicke, 1867 als jüngeres Synonym zu *strigata* Loew, 1866 und nehme die von Alexander als *abyssinica* angeführten Exemplare als Basis der folgenden Beschreibung.



Abb. 14. Hypopyg von *Tipula (T.) strigata* (a—e wie Abb. 1).

Männchen. — Kopf oben und hinten grau; Augen unter dem Kopf schmal getrennt, Trennung etwa zweimal so breit wie das erste Fühlerglied; Rostrum gelb, an der Oberseite grau; Nasus deutlich; Palpen fast schwarz; Fühler 13-gliedrig, zurückgeschlagen etwa bis zur Flügelwurzel reichend, das letzte Glied winzig, Basalglieder und größter Teil des ersten Geißelgledes gelb, weitere Glieder braun, die Wirtelhaare fast so lang wie die zugehörigen Glieder. Thoraxrücken und ein größerer Teil der Thoraxseiten hellgrau bestäubt, Schildchen gelbbraun, Mesonotum mit drei kaum sichtbaren braunen Längsstreifen, die wohl die Mittellinie und die gemeinsamen Ränder von Mittel- und Seitenstreifen darstellen; Coxae und basale Hälfte der Femora gelb, distale Hälfte der Femora bräunlich, Tibiae und Tarsenglieder braun bis schwarz, Tarsalklauen in der Mitte mit deutlichem Zahn; Flügel glashell, Vorderrand bräunlich mit dunkelbraunem Stigmenfleck, cu bräunlich gesäumt; Schwinger dunkelbraun. Hinterleib an der Basis gelb, ab Hinterrand des

3. Segmentes schwarz, die gelbe Basis mit schmaler schwarzer Rückenstrieme und Teilen von Seitenstriemen, das 2. Sternit an der Basis mit einem runden schwarzen Fleck. Hypopyg gelbbraun; Vorsprung des 9. Tergits mit schmaler Basis; *id*-Vorderteil mit durchsichtigem Kamm, außen am Unterrand mit einem Kissen kurzer weißer Haare, Innenseite mit einem Saum langer Haare; *id*-Hinterteil oben kappenförmig mit bedorntem Vorsprung, an der Außenseite mit einem ziemlich großen dornförmigen Vorsprung, an der Innenseite mit einer scharf abgegrenzten Gruppe sensorischer Poren; *od* birnförmig.

Länge von Thorax und Hinterleib 13—15 mm; Flügellänge 16—18 mm.

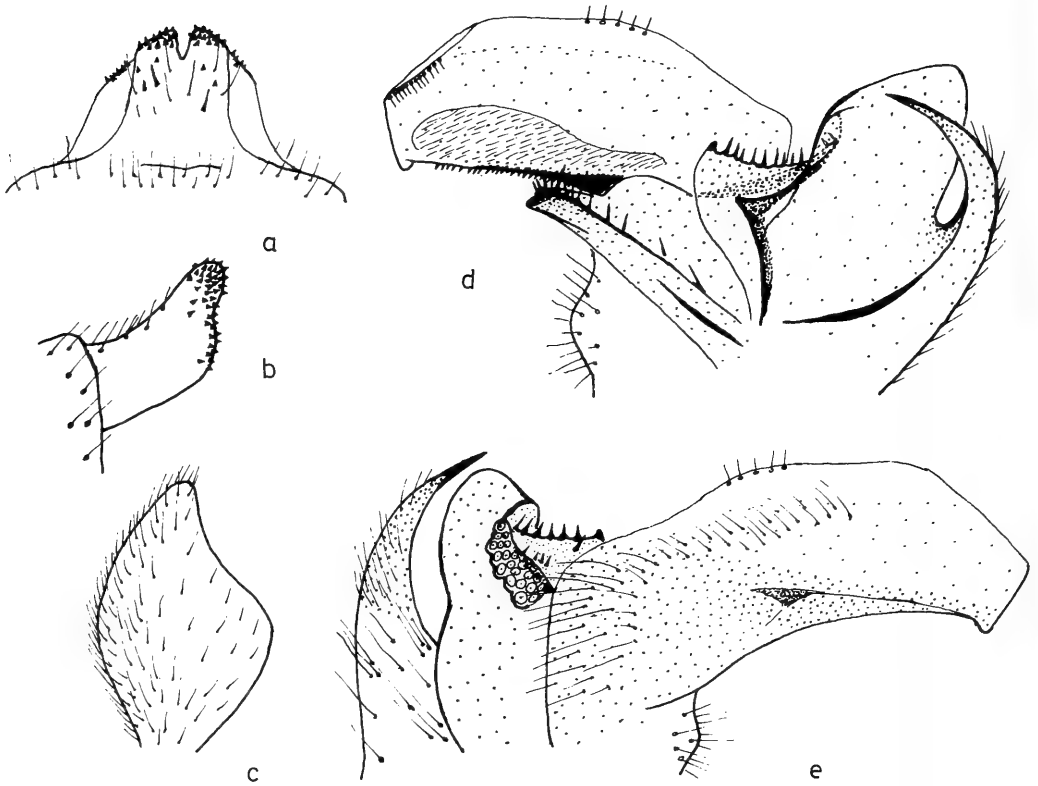
Weibchen: Alexander (1978) kennt "a small number of both sexes" from Addis Abeba, gesammelt von Richter und Schäuffele. Die Weibchen dieser Serie sind aber nicht mehr aufzufinden. Er kennt auch ein Weibchen, gesammelt von Rothschild in Addis Abeba im Mai 1904. Von diesem Exemplar ist in der Sammlung

Alexander (Washington) nur ein Präparat mit einem Flügel und Teilen von zwei Beinen. Für *rothschildi*, die nach Alexander (1978) vielleicht mit *abyssinica* (= *strigata*) identisch ist, siehe unter *rothschildi*.

Verbreitung: Äthiopien (Simen, Addis Abeba) und Nubien.

Biologie: Die Exemplare von Addis Abeba, Ausbeute Richter und Schäuffele, wurden im Dezember in 3020 m Seehöhe gesammelt, das von Rothschild gesammelte Weibchen stammt vom Mai und unbekannter Höhe.

Bemerkung: Riedel (1914) verzeichnet *strigata* vom Kilimandjaro und von Britisch-Ost-Afrika. Die Exemplare sind zum Teil im Museum Paris und wurden von mir überprüft. Die Exemplare vom Kilimandjaro sind zum Teil *flagellucurta*, zum Teil *lourensi*, die von Britisch-Ost-Afrika konnte man im Museum Paris nicht mehr finden. Sie gehören wahrscheinlich zur dort häufig vorkommenden Art *speiseriana*.

subaptera Freeman, 1950 (Abb. 15)

Literatur: Alexander, 1956a; Theowald, 1977a.

Typus-Lokalität: Tanganyika, Kilimandjaro.

Holotypus ♂: Im British Museum (Natural History).

Männchen. — Kopf oben und hinten silbergrau bereift; Rostrum braun mit deutlichem Nasus; Augen unter dem Kopf breit getrennt, Trennung mehr als zweimal so breit wie das erste Fühlerglied; Palpen dunkelbraun bis schwarz; Fühler lang, zurückgeschlagen fast bis zum Anfang des zweiten Hinterleibssegmentes reichend, 13-gliedrig, die Basalglieder gelblichbraun, Geißelglieder etwas dunkler, die längsten Wirtelhaare etwa halb so lang wie die zugehörigen Glieder. Thorax braun; Thoraxrücken dunkler und silbergrau bereift, die Längsstreifen des Mesonotum kaum sichtbar; Beine nicht oder kaum verkürzt, braun, gegen Ende fast schwarz; Tarsalklauen ohne Mittelzahn; Flügel kaum entwickelt (1.5 mm); Schwingerstiel dunkelbraun, Knopf schwarz, Hinterleib braungrau mit Silberschimmer und undeutlichen Rücken- und Seitenstreifen, Sternite dunkelbraun; Vorsprung des 9. Tergits breitbasig; *od* breit birnförmig; *id*-Vorderteil ohne Kamm, an der Außenseite mit einem Kissen kurzer weißer



Abb. 15. Hypopyg von *Tipula* (*T.*) *subaptera* (a—e wie Abb. 1).

Haare, an der Innenseite lang behaart; *id*-Hinterteil klein, oben zangenförmig, an der Außenseite mit Dorn, an der Innenseite mit verstreut stehenden sensorischen Poren.

Weibchen. — In allen eidonomischen Merkmalen dem Männchen ähnlich, hat aber deutlich verkürzte und kurz behaarte Beine. Ich sah ein Männchen mit Länge von Thorax und Hinterleib 9 mm und ein Weibchen mit Länge 21 mm. Nach der Originalbeschreibung sind Männchen und Weibchen 11—23 mm lang.

Verbreitung: Tanzania, nur Kilimandjaro.

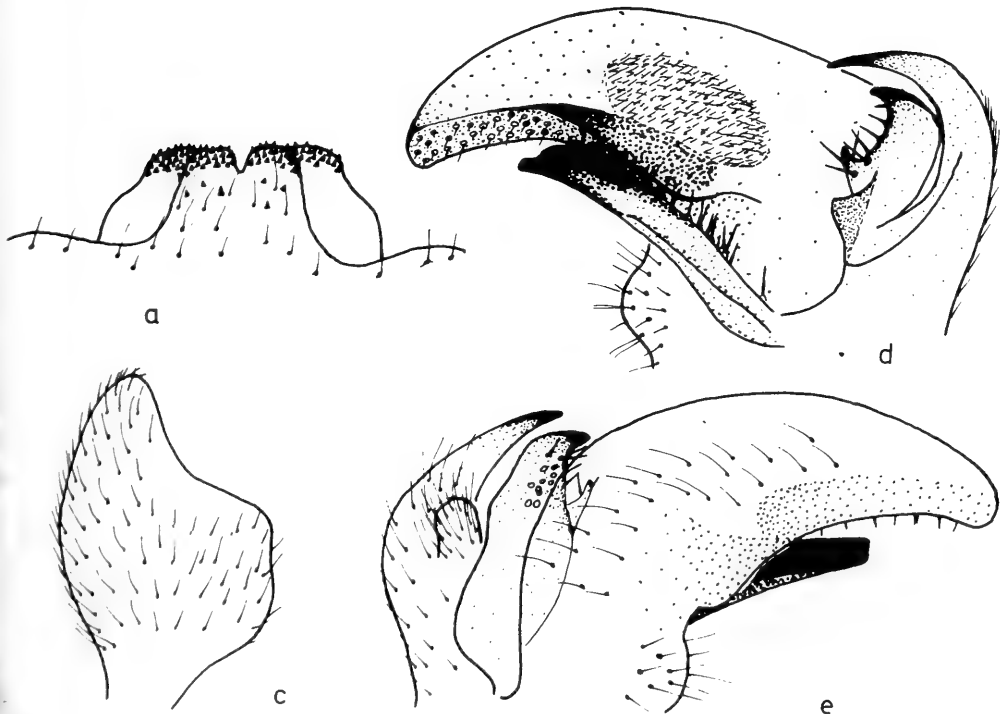
Biologie: Diese Art wurde im Oktober an der Westseite des Kilimandjaro (Shira) in 4000—4750 m Seehöhe gesammelt.

Bemerkung: *T. subaptera* ist in vielen Merkmalen *flagellicurta* ähnlich. Im Gegensatz zu den kurzflügeligen Männchen der letztgenannten Art haben jene von *subaptera* verkürzte und verdickte Beine. Die Weibchen von *flagellicurta* haben im Gegensatz zu denen von *subaptera* spinnenartig behaarte Beine. Beide Arten sind einander deutlich nächstverwandt.

subcunctans Alexander, 1921b

Literatur: Lackschewitz, 1930 (unter *czizeki*); Mannheims, 1952 (unter *fusca*).

Typus-Lokalität: Sapporo (Japan).

Holotypus ♀: Im United States National Museum, Washington (Sammlung Alexander).

Bemerkung: Diese Art wurde von Lackschewitz (1930) und Mannheims (1952) deutlich beschrieben und abgebildet. Sie hat eine weite Verbreitung im palaearktischen Raum, von Westeuropa bis in Japan.

(*submendosa* Tjeder, 1941) = *oleracea* Linnaeus, 1758

Bemerkung: Nach Tjeder, 1941, 1953, soll *oleracea* Linnaeus identisch mit *paludosa* Meigen sein. Er benannte *oleracea* sensu aut., nec Linnaeus, *submendosa*. Nach Überprüfung des Exemplares von *oleracea* in der Sammlung Linnaeus (Hutson, Vane-Wright & Cranston, 1976) wurde klar, daß *oleracea* Linnaeus identisch ist mit *subcunctans* Alexander. In I.C.Z.N. Opinion 1160 (1980) wurde der Name *oleracea* Linnaeus festgelegt für *oleracea* sens. aut. Damit wurde *submendosa* ein jüngeres Synonym von *oleracea*.

(*venturii* Loi, 1964) = *plumbea* Fabricius, 1781 (syn. nov.)

Literatur: Den Hollander, 1975b.

Typus-Lokalität: Toscana, Fucecchio (Italien).

Syntypen: 12 Exemplare von der Typus-Lokalität wurden verzeichnet. Sie sind wahrscheinlich im Instituto di Entomologia agraria della Università di Pisa.

Bemerkung: Diese Art wurde Den Hollander (1975b) bekannt von Sardinien und Südfrankreich (Var). Er stellte fest, daß diese Art nur identisch sein könnte mit *plumbea* Fabricius. *venturii* Loi, 1964 ist damit ein jüngeres Synonym von *plumbea* Fabricius, 1781.

(*wollastoni* Lackschewitz, 1936) = *paludosa* Meigen, 1830

Literatur: Mannheims, 1952; Theowald, 1977b.

Typus-Lokalität: Madeira.

Holotypus ♂: Im British Museum (Natural History).

zimbabwensis nov. spec. (Abb. 16)

Tipula (*Tipula*) *zimbabwensis* nov. spec.

Literatur: Den Hollander, 1975a (unter *bevisiana*).

Holotypus ♂ und ein Paratypus ♂: South Rhodesia, Inyangani Mountains, 13.XI.1963, H. A. W. Paine-Smit leg.; im Zoologischen Museum Amsterdam.

Männchen. — Kopf oben grau, hinten braun; Rostrum braun, oben grau, mit deutlichem Nasus; Augen unter dem Kopf ziemlich breit getrennt, Trennung zweimal so breit wie das erste Fühlerglied; Fühler 13- oder 14-gliedrig (beide Basalglieder der einzigen vollständigen Geißel sind zum Teil verwachsen), zurückgeschlagen bis zur Flügelbasis reichend, zwei oder drei basale Glieder gelblich, weitere Glieder dunkelbraun, Wirtelhaare auffallend kurz, kürzer als die halbe Länge der zugehörigen Glieder. Thorax braun, Thoraxrücken größtenteils hellgrau bestäubt; Mesonotum mit undeutlichen dunkelgerandeten Längsstreifen; Coxae und Femora bräunlich, Tibiae und Tarsenglieder dunkelbraun bis schwarz; Tarsalklauen ohne Mittelzahn; Flügel ein wenig gräulich getrübt, Vorderrand und Stigmenfleck schwach bräunlich gefärbt, keine hellen Längsstreifen und auch die Zelle R₅ nur wenig heller; Squama kaum oder gar nicht beborstet; Schwinger dunkelbraun. Hinterleib schwarz mit gelblichweißem Hinterrand der Tergite und Sternite, 9. Tergit und 9. Sternit braun; Vorsprung des 9. Tergits schmalbasig und fast senkrecht abgestutzt; *od* birnförmig; *id*-Vorderteil mit Kamm, an der Außenseite

te mit Haarkissen, an der Innenseite mit nur wenigen langen Haaren; *id*-Hinterteil oben abgerundet, an der Vorderseite ohne Vorsprung, aber mit einer Reihe Borsten, an der Außenseite ohne Dorn, an der Innenseite mit einer deutlich abgegrenzten Gruppe sensorischer Poren; *id*-Haken normal lang und nicht, wie bei der ähnlichen *soror*, verkürzt.

Das Weibchen ist unbekannt.

Länge von Thorax und Hinterleib: ♂ 11—12 mm; Flügellänge: ♂ 13—14 mm.

Verbreitung: Bis heute nur von Zimbabwe bekannt.

Biologie: Unbekannt.

Name: Nach dem Herkunftslande Zimbabwe (früher Southern Rhodesia).

Bemerkung zu den südafrikanischen Arten

In dem alphabetischen Verzeichnis kam mehrmals zur Sprache, daß Alexander in seinen Arbeiten die südafrikanischen Arten verwechselt hat. Er bearbeitete sie um 1920 und nach etwa 1950. In seiner Sammlung finden sich nur Belegstücke aus der zweiten Periode. Das Material der ersten Periode ging fast ausnahmslos an

die verleihenden Museen zurück. Alexander hat wohl das spätere Material an Hand von Beschreibungen und ungenügend detaillierten Abbildungen bearbeitet und sich deshalb in der Interpretation der Arten geirrt. Den Hollander (1975a) hat nur Alexanders Beschreibungen benutzt und keine Typen studiert. Offenbar kam ihm die Sache nicht ganz geheuer vor. Tabelle 1 gibt einen Überblick über die Interpretation der nunmehr bekannten südafrikanischen Arten durch Alexander (um 1920 und nach 1950) und Den Hollander (1975a). Dieser Überblick wurde zusammengestellt nach Überprüfung des von ihnen bestimmten Materials. Aufgrund dieses Überblicks sind Beschreibungen, Tabellen und Fundorte in den Arbeiten der genannten Autoren wohl besser zu deuten.

Bestimmung

Sichere Bestimmung der Männchen ist meistens nur möglich anhand des Baues des *id*. Von trockenen Exemplaren läßt sich mit Hilfe einer Nadel leicht ein *od* entfernen. Der *id* ist dann sichtbar. Bestimmung der Weibchen ist schwieriger und das Ergebnis oft unsicher, vor allem



Abb. 16. Hypopyg von *Tipula (T.) zimbabwensis* (a—e wie Abb. 1).

weil von etwa einem Drittel der Arten die Weibchen noch unbekannt sind. Nach ihrer Verbreitung sind die Arten in vier Gruppen aufzuteilen:

a. palaearktische Arten

Sie sind leicht zu bestimmen anhand der Abbildungen von Lackschewitz (1930) oder mit Tabellen und Abbildungen von Mannheims (1952). Für *atlantica*, *italica errans* und *plumbea* siehe unter den alphabetischen Verzeichnissen (Seiten 33, 43, 48).

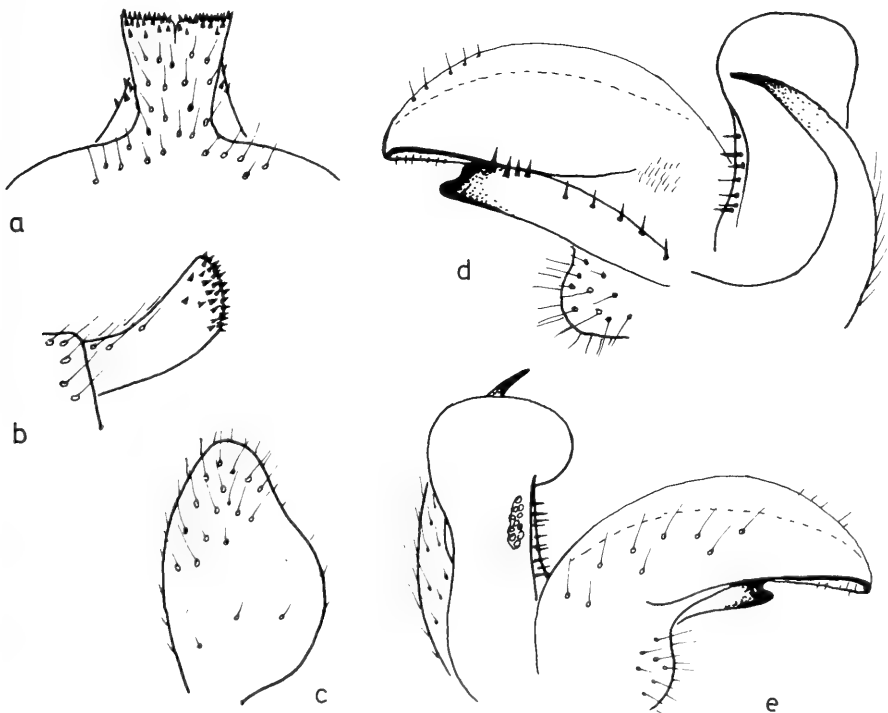
Die zugehörigen Arten sind:

atlantica Mannheims, 1962 — nur Madeira

italica italica Lackschewitz, 1930 — nur Italien

italica errans nov. subspec. — Balkanhalbinsel, Sardinien (und Korsika?)

kleinschmidti Mannheims, 1950 — iberische Halbinsel

mediterranea Lackschewitz, 1930 — ganzes westmediterranes Gebiet

oleracea Linnaeus, 1758 — ganzes mediterranes Gebiet und West- und Mitteleuropa

orientalis Lackschewitz, 1930 — ostmediterranes Gebiet bis Afghanistan im Osten und Ägypten und Sudan im Süden

paludosa Meigen, 1830 — West- und Mitteleuropa

plumbea Fabricius, 1781 — Italien und Südfrankreich

subcunctans Alexander, 1921 — Westeuropa bis Japan

b. äthiopische Arten

Diese Arten sind leicht zu bestimmen anhand

der Abbildungen in dieser Arbeit. Sie sind: *bicolor* Loew, 1866 — Äthiopien (Abb. 1) *hollanderi* Theowald, 1977 — Baale Berge (Abb. 7)

loeffleri nov. spec. — Baale Berge (Abb. 9)

strigata Loew, 1866 — Äthiopien (Abb. 14)

Es ist nicht auszuschließen, daß die hauptsächlich palaearktische *orientalis*, die neuerlich auch von Ägypten und Sudan bekannt geworden ist, überdies in Äthiopien vorkommt.

c. Arten aus den Gebieten um den Viktoria-See

Die zugehörigen Arten sind:

capnioneura Speiser, 1909 — nur Kilimandjaro (Abb. 2)

eumecacera Speiser, 1909 — nur Kilimandjaro (Abb. 4)

flagellicurta Mannheims, 1958 — nur Kilimandjaro (Abb. 5)

lobeliae Alexander, 1956 — nur Mount Elgon (Abb. 8)

lourensi Den Hollander, 1975 — nur Kilimandjaro (Abb. 10)

speiseriana Alexander, 1930 — ganzes Gebiet um den Viktoria-See (Abb. 13)

subaptera Freeman, 1950 — nur Kilimandjaro (Abb. 15)

Für die fünf Arten des Kilimandjaro, die einander im Bau des Hypopygs sehr ähnlich sind, gebe ich nachfolgend einen Bestimmungsschlüssel. Die beiden Arten *lobeliae* und *speiseriana*, die nicht vom Kilimandjaro bekannt sind, lassen sich leicht bestimmen mit Hilfe der Abbildungen.

nummehr bekannt als	Alexander, um 1920, unter	Alexander, nach 1950, unter	Den Hollander, 1975a, unter
<i>consobrina</i>	---	<i>frater</i>	---
<i>frater</i>	<i>frater</i>	<i>soror</i>	<i>soror</i> = <i>frater</i>
<i>soror mashona</i>	<i>soror</i> und <i>mashona</i>	<i>bevisiana</i>	---
<i>soror soror</i>	<i>soror</i>	<i>bevisiana</i>	---
<i>zimbabwensis</i>	---	---	<i>bevisiana</i>

Tabelle 1. Interpretation der südafrikanischen Arten durch Alexander und Den Hollander.



Abb. 17. Hypopyg von *Tipula (Acutipula) schulteni* (a—e wie Abb. 1).

1. *id*-Vorderteil an der Außenseite mit einem Kissen kurzer, weißer Haare 2
- *id*-Vorderteil an der Außenseite unbehaart 3
2. (Wahrscheinlich) nur kurzflügelig vorkommende Art mit deutlich verkürzten und verdickten Beinen *subaptera*
- Normalflügelige Art, deren ♂ zwar in etwa 3500 m Seehöhe kurzflügelig sind, in diesem Falle aber normallange und normal dünne Beine haben *flagellicurta*
3. Fühler zurückgeschlagen kaum bis zur Flügelbasis reichend *lourensi*
- Fühler sehr lang, zurückgeschlagen wenigstens bis zum vierten Hinterleibssegment reichend 4
4. Auffallend kleine Art mit Thorax und dem ersten Hinterleibssegment goldgelb *eumecacera*
- Normalgroße, braungraue Art *capnionaura*

d. südafrikanische Arten

Die zugehörigen Arten sind leicht zu bestimmen anhand der Abbildungen in dieser Arbeit. Von den beiden Unterarten von *soror* hat *s. soror* 13-gliedrige und *s. mashona* 14-gliedrige Fühler. Die Arten sind:

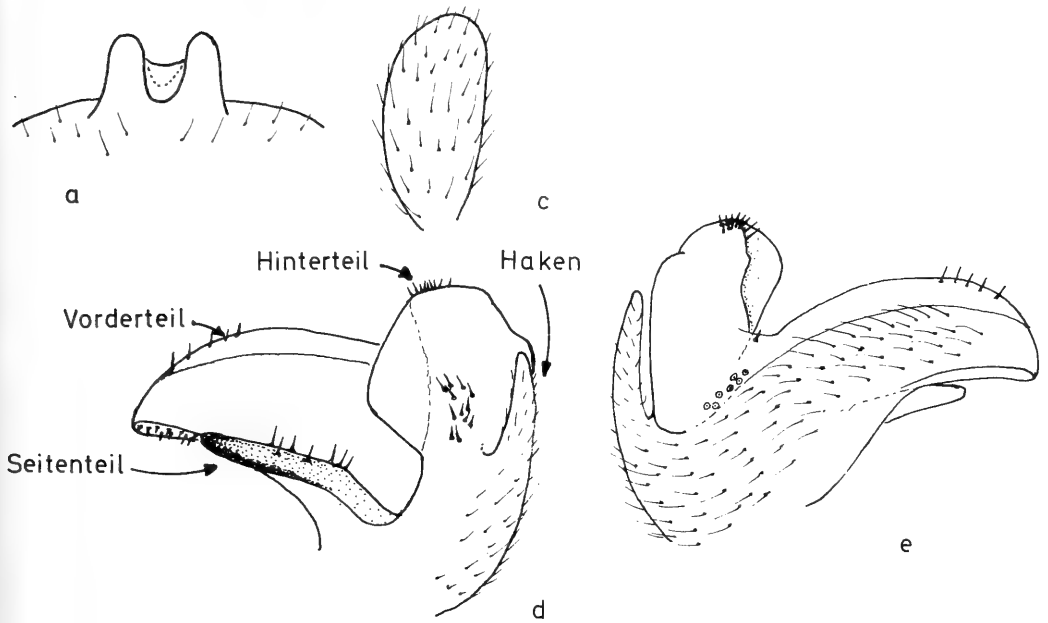
- consobrina* nov. spec. — Zimbabwe, Mozambique (Abb. 3)
- frater* Alexander, 1921 — Drakensberge, Zimbabwe (Abb. 6)
- soror soror* Wiedemann, 1820 — um Kapstadt (Abb. 12)
- soror mashona* Alexander, 1920 — Drakensberge, Zimbabwe (Abb. 12)
- zimbabwensis* nov. spec. — Zimbabwe (Abb. 16)

Bestimmung aller unter a—d angeführten Arten ist auch mit Hilfe der im zweiten Abschnitt dieser Arbeit aufgestellten Kladogramme möglich.

ZUR PHYLOGENIE

Monophylie der Untergattung *Tipula*

Die zur Untergattung *Tipula* gehörenden Arten haben viele Merkmale gemeinsam und wurden deshalb von Lackschewitz (1930) zusammen in eine und dieselbe Artengruppe gestellt (*oleracea*-Gruppe), die seit Edwards (1931) als Untergattung geführt wird. Gemeinsame Merkmale sind: Rostrum etwas länger als Kopf; Nasus etwa ein Drittel der Länge des Rostrums; Mesonotum mit vier dunkelgerandeten Längs-

streifen, bei Hochgebirgsarten aber meist durch hellgraue Bestäubung verdeckt; Costalzelle meist dunkler als Rest der Flügel; rs fast zweimal so lang wie m-cu; m-cu an der Spaltung von m_3 und m_4 oder kurz davor (proximal); m-Äste kurz behaart; Squamae mit zwei bis vier kurzen Borsten; Tibien der Mittelbeine mit zwei deutlichen Dornen; 9. Tergit und 9. Sternit ringförmig verwachsen; an den oberen Ecken der Basistyli ein Büschel langer Haare; Hinterrand des 8. Sternits unbehaart und ohne Differenzierungen; Hinterrand des 9. Tergits in der Mitte mit einem distal eingeschnittenen und mit kleinen Dornen besetzten Vorsprung; *od* groß und *id* vollständig verdeckend; *id* aus vier Teilen (Abb. 1, 17) zusammengesetzt: Vorderteil hackmesserförmig, Seitenteil rinnenförmig, Hinterteil an der Außenseite des Vorderteils und am distalen Ende artcharakteristisch differenziert, Haken fingerförmig mit deutlicher unbehaarter Spitze, sensorische Poren (sensilla basiconica) auf der Innenseite des Hinterteils; Gonapophysen spatelförmig und etwa so lang wie die Penishülle; Ovipositor mit ziemlich langen, schmalen, stumpf endenden Cerci.

Durch diese Kombination von etwa 20, zum Teil plesiomorphen, zum Teil apomorphen Merkmalen ist die Untergattung *Tipula* gegenüber allen weiteren Untergattungen und Artengruppen deutlich abgegrenzt. Unter diesen Merkmalen sind drei auffallende Apomorphien, die sich sonst nirgendwo finden: der fingerförmige Haken der *id* endet spitz und unbehaart, statt stumpf und behaart; die sensorischen Poren liegen an der Innenseite des *id*-Hinterteils statt an der Basis; die *od* sind stark vergrößert statt klein und verdecken die *id* vollständig. Aufgrund dieser drei Synapomorphien müssen die Arten der Untergattung *Tipula* als eine monophyletische Gruppe betrachtet werden.

Die Schwestergruppe der Untergattung *Tipula*

Nach den Merkmalen von Larven, Puppen und Imagines sind die Untergattungen *Acutipula*, *Tipula* und *Yamatotipula* einander nächstverwandt. Savtshenko (1966, 1979) ist der Meinung, daß *Tipula* von *Acutipula* abgezweigt hat, nach Alexander (1935, 1965) steht sie vielleicht *Yamatotipula* näher.

Tipula und *Yamatotipula* zeigen keine Synapomorphien, mit denen ein Schwestergruppenverhältnis eindeutig belegt werden kann. Die Arten beider Untergattungen sehen einander ziemlich ähnlich. Die Merkmale, die sie gemeinsam haben, sind aber zum Teil Plesiomorphien,

zum Teil Apomorphien, die auch in weiteren Untergattungen der Gattung *Tipula* vorkommen. Die Arten beider Untergattungen haben z.B. den Hinterrand des 8. Sternits undifferenziert, eine Plesiomorphie, die sich, wie zu erwarten, auch findet in Artengruppen weiterer Untergattungen. Ein bedornter, am distalen Ende eingeschnittener Vorsprung am Hinterrand des 9. Tergits und dunkelgerandete Längsstreifen auf dem Mesonotum sind Apomorphien. Auch sie kommen bei Artengruppen weiterer Untergattungen vor. Unter den ziemlich vielen Merkmalen, die *Tipula* und *Yamatotipula* gemeinsam haben, fand ich keine einzige Apomorphie, die nur in diesen beiden Untergattungen vorkommt. Für die Vermutung Alexanders, daß diese beiden Untergattungen Schwestergruppen sind, fand ich damit keine Evidenz.

Aber auch die Auffassung Savtshenkos, daß *Tipula* und *Acutipula* Schwestergruppen sind, läßt sich nicht begründen. *Acutipula* zählt etwa 150 Arten, die zu mehr als 15 Artengruppen gehören. Es ist zweifelhaft, ob es Apomorphien gibt, mit denen die Monophylie von *Acutipula* eindeutig belegt werden kann, geschweige denn Apomorphien, mit denen das Schwestergruppenverhältnis mit *Tipula* zu belegen ist.

Die Untergattung *Acutipula* wurde von Alexander (1956a) und Savtshenko (1961) in eine Reihe von Artengruppen unterteilt, die meist charakterisiert sind durch einen ein- oder zweispitzigen, bedornten oder unbedornten Vorsprung am Hinterrand des 9. Tergits und besonders durch den Bau des *id*. Bei vielen Artengruppen sind die *id* ziemlich einfach gebaut und zeigen nur einen mehr oder weniger komplizierten Vorder- und Hinterteil, bei einigen sind sie deutlich aus vier Teilen zusammengesetzt, und es kommen auch noch ein Seitenteil und ein Haken dazu. Derartig zusammengesetzte *id* finden sich bei den Arten der europäischen *maxima*- und *fulvipennis*-Gruppe und bei den afrikanischen Arten der *loveridgei*-Gruppe (Theowald, 1983). Beide erstgenannten Gruppen sind einander nächstverwandt (Vermoolen, in Vorbereitung). Die *loveridgei*-Gruppe dagegen, und wahrscheinlich die ganze *zambesiensis*-Gruppe sensu Alexander, 1956a (De Jong, in Vorbereitung), steht der Untergattung *Tipula* am nächsten.

Die *id* der Arten der *loveridgei*-Gruppe (*schulteni*, Abb. 17) und jene der Arten der Untergattung *Tipula* (vergl. z.B. mit *bicolor* (Abb. 1), *soror* (Abb. 12) und *zimbabwensis* (Abb. 16)) sind einander sehr ähnlich und zeigen eini-

ge auffallende Synapomorphien gegenüber den Arten der *maxima*- und *fulvipennis*-Gruppe. Der *id*-Hinterteil ist bei allen Arten der erstgenannten Gruppe verwachsen mit den drei anderen *id*-Teilen, er ist keulenförmig und am distalen Ende artcharakteristisch differenziert. Bei den Arten der *loveridgei*- und *fulvipennis*-Gruppe dagegen (Vermoolen, 1983) ist er nicht mit den anderen Teilen verwachsen, mehr oder weniger dornförmig und verzweigt. Der Haken ist bei den Arten der *loveridgei*-Gruppe und jenen der Untergattung *Tipula* fingerförmig und verwachsen mit dem *id*-Hinterteil und dem *id*-Seitenteil, bei den Arten der *maxima*- und der *fulvipennis*-Gruppe dagegen ist er niemals mit dem *id*-Hinterteil und dem *id*-Seitenteil verwachsen, sondern breitbasig und fast dreieckig. Aufgrund dieser Synapomorphien stehen einerseits die *loveridgei*-Gruppe und die Untergattung *Tipula*, andererseits die *maxima*- und die *fulvipennis*-Gruppe einander am nächsten. Beide Paare von Gruppen haben vierteilige *id*; die vier Teile des *id* in der *maxima*- und *fulvipennis*-Gruppe sind aber sicher nicht homolog sondern analog zu je-

nen der *loveridgei*-Gruppe und der Untergattung *Tipula*.

Aufgrund des Schwestergruppenverhältnisses der *loveridgei*-Gruppe (Untergattung *Acutipula*) und der Untergattung *Tipula* kommt es zu taxonomischen Änderungen. Sie werden aber erst veröffentlicht werden, wenn ein eingehendes Studium über die einander wohl nächstverwandten Untergattungen *Acutipula*, *Platytipula*, *Tipula* und *Yamatotipula* abgeschlossen ist (De Jong, in Vorbereitung).

Die *loveridgei*-Gruppe zeigt gegenüber der Untergattung *Tipula* eine auffallende Autapomorphie: die Vorsprünge am Hinterrand des 9. Tergits sind — im Gegensatz zu fast allen mehr oder weniger verwandten Artengruppen — unbedornt statt bedornt.

In Kladogramm 1 ist das Verhältnis zwischen beiden Gruppen bildlich dargestellt. Die Apomorphien sind: 1. *id*-Hinterteil verwachsen mit Vorderteil, Seitenteil und Haken, und distal artcharakteristisch differenziert; 2. *id*-Haken fingerförmig und verwachsen mit Hinter- und Seitenteil; 3. *id*-Haken am Ende zugespitzt; 4. sen-

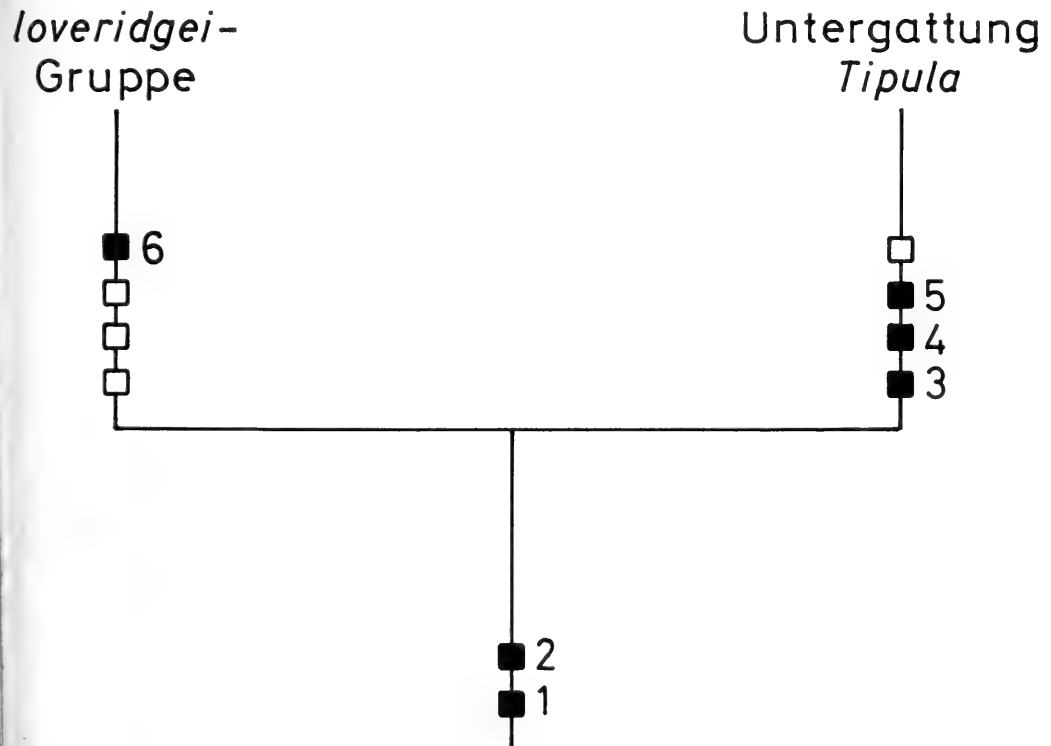

Kladogramm 1. Das Schwestergruppenverhältnis von *Tipula* (*Tipula*). ■ Apomorphien, □ Plesiomorphien.

sorische Poren an der Innenseite des *id*-Hinterteils; 5. *od* stark vergrößert; 6. Vorsprünge am Hinterrand des 9. Tergits unbedornt.

Verwandschaftliche Beziehungen innerhalb der Untergattung *Tipula*

Großeinteilung

Eine Reihe von Arten läßt sich aufgrund von fast identischem Bau der *id* leicht zu Gruppen einander nächstverwandter Arten zusammenfassen, z.B. *oleracea* — *orientalis*; *kleinschmidti* — *mediterranea*; *soror soror* — *soror mashona*; *zimbabwensis* — *bicolor*; *flagellicurta* — *subaptera* — *lourensi* — *eumecacera* — *capnioneura*. Eidonomische Merkmale sind in diesen Gruppen mosaikartig verstreut und zur Abgrenzung derselben unverwendbar. Deshalb werden sie auch nicht benutzt zur Einreihung von schwieriger aufzustellenden Arten. Merkmale des Ovipositors konnten nicht benutzt werden, weil von einem Viertel der Arten die Weibchen noch unbekannt sind. Die Phylogenie konnte deshalb nur mit Hilfe der Merkmale des Hypopygs der Männchen belegt werden.

Aufgrund einiger deutlicher Apomorphien sind die Arten der Untergattung *Tipula* in drei Gruppen einzuteilen: die beiden Unterarten von

soror, die afrotropischen Arten excl. *soror*, und die palaearktischen Arten. Im Gegensatz zu allen weiteren Arten haben die beiden Unterarten von *soror* den Haken kurz, kaum länger als die Arten der *loveridgei*-Gruppe. Alle weiteren Arten haben den Haken stark verlängert, eine deutliche Apomorphie.

Die afrotropischen Arten haben ihn, wie *soror*, von der Basis bis zum Ende konisch zugespitzt, bei den palaearktischen Arten steht auf der Basis ein langer Dorn, eine Apomorphie gegenüber dem konisch zugespitzten Haken (vgl. Abb. 20a—d).

Alle afrotropischen Arten, incl. *soror*, haben die Innenseite des *id*-Vorderteils deutlich behaart wie die Arten der *loveridgei*-Gruppe, bei den palaearktischen Arten dagegen ist sie unbehaart, eine Apomorphie. Bei primitiven Tipuliden ist die Innenseite des *id* fast immer behaart.

Auch im Bau des *id*-Hinterteils gibt es Unterschiede zwischen den afrotropischen und den palaearktischen Arten (Abb. 18 und 19). *T. soror*, *bicolor*, *zimbabwensis* und alle palaearktischen Arten haben einen *id*-Hinterteil mit kurzem Stiel, auf dem ziemlich hoch die sensorischen Poren sitzen, und mit einem mehr oder weniger keulenförmigen distalen Ende. Die drei erstgenannten Arten haben das distale Ende un-



Abb. 18. *id*-Hinterteil, von der Innenseite, der palaearktischen Arten *Tipula* (*T.*); a, *subcunctans*; b, *paludosa*; c, *atlantica*; d, *mediterranea*; e, *kleinschmidti*; f, *italica*; g, *plumbea*; h, *orientalis*; i, *oleracea*.



Kladogramm 2. Die Großgruppen innerhalb der Untergattung *Tipula*. ■ Apomorphien, □ Plesiomorphien.

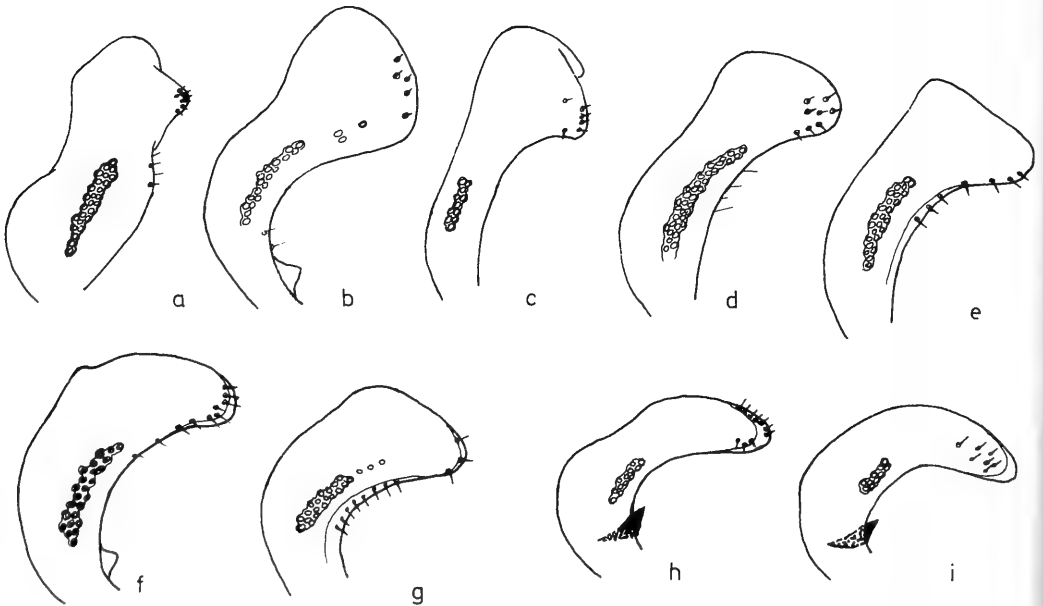
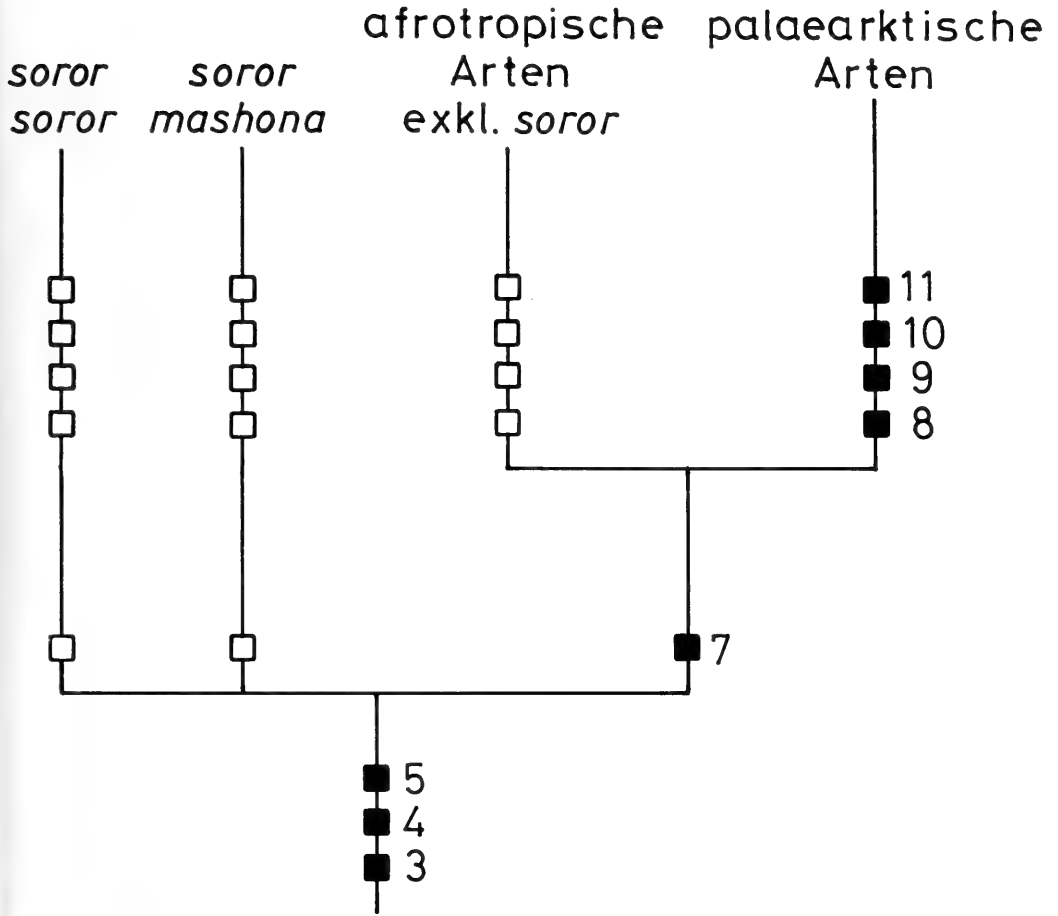

Abb. 19. id-Hinterteil, von der Innenseite, einiger afrotropischen Arten von *Tipula* (T.); a, *bicolor*; b, *speiseriana*; c, *lobeliae*; d, *capnioneura*.

differenziert und unbedornt. Bei ihnen stehen sensorische Dornen an der Vorderseite des Stiels. Die palaearktischen Arten dagegen haben das distale Ende differenziert. Bei *kleinschmidti* und *plumbea* sitzen sensorische Dornen von der Vorderseite des Stiels bis zum distalen Ende, bei den anderen Arten sitzen sie am differenzierten distalen Ende und an der Vorderseite des Stiels, wo bei *kleinschmidti* und *plumbea* sensorische Dornen stehen, sitzen jedoch nur noch einige Haare. Die afrotropischen Arten excl. *soror*, *bicolor* und *zimbabwensis* haben das Ende des *id*-Hinterteils reduziert (Abb. 19b—d). Der Hinterteil ist im Vergleich zu den weiteren Teilen des *id* kürzer (vgl. auch Abb. 1—16). Die sensorischen Poren liegen bei diesen Arten fast am Ende des *id*-Hinterteils, bei ihnen ist die Vorderseite des Stiels mit den sensorischen Dornen stark differenziert. Es zeigen sich damit deutlich zwei Entwicklungslinien: im afrotropischen Gebiet sehen wir eine Reduktion des distalen Endes des *id*-Hinterteils und eine starke Diffe-

renzierung des sensorischen Feldes an der Vorderseite des Stiels, im palaearktischen Gebiet dagegen eine auffallende Entwicklung des distalen Endes des *id*-Hinterteils und eine Reduktion des sensorischen Feldes an der Vorderseite des Stiels. Plesiomorph ist der Bau des *id*-Hinterteils bei *soror*, *bicolor* und *zimbabwensis*. Apomorph ist einerseits die Reduktion des distalen Endes und die starke Entwicklung der Vorderseite des Stiels bei den afrotropischen Arten excl. *soror*, *bicolor* und *zimbabwensis*, andererseits die Differenzierung des distalen Endes, wie man sie von den palaearktischen Arten kennt.

Eine weitere Apomorphie der palaearktischen Arten ist das Vorkommen einer Reihe langer Haare vorne am Oberrand des *id*-Vorderteils. Sie finden sich nicht bei *oleracea*, bei der der *id*-Vorderteil fast zu einem Haken reduziert ist. Wir müssen wohl annehmen, daß bei dieser Art die Haare sekundär verloren gegangen sind.

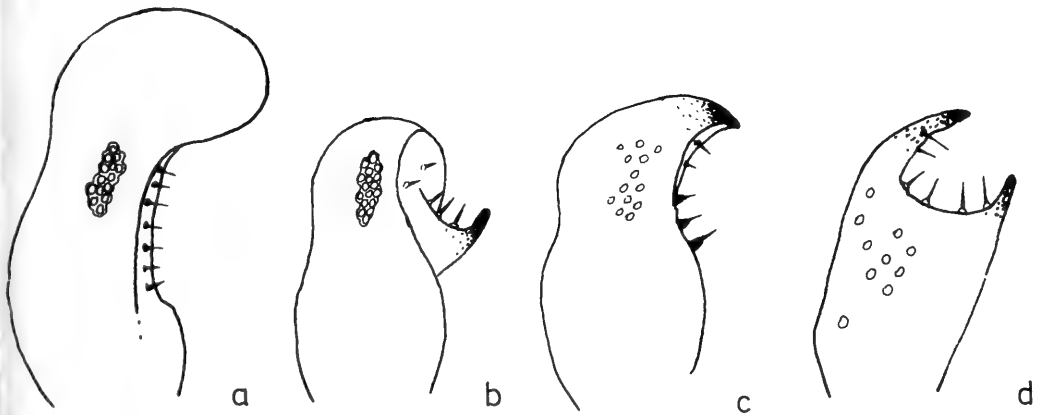
Die beiden Unterarten von *soror* haben viele Merkmale gemeinsam. Ich fand für sie aber kei-



Abb. 20. a—d, *id*-Haken von *Tipula* (T.): a, *schulteni*; b, *soror*; c, afrotropische Arten excl. *soror*; d, palaearktische Arten; e—h, Verbindung zwischen *id*-Hinterteil und *id*-Haken von *Tipula* (T.): e, *oleracea*; f, *mediterranea*; g, *atlantica*; h, *capnioneura*.



Kladogramm 3. Die afrotropischen Arten von *Tipula* (*Tipula*), excl. *soror*. ■ Apomorphien, □ Plesiomorphien.

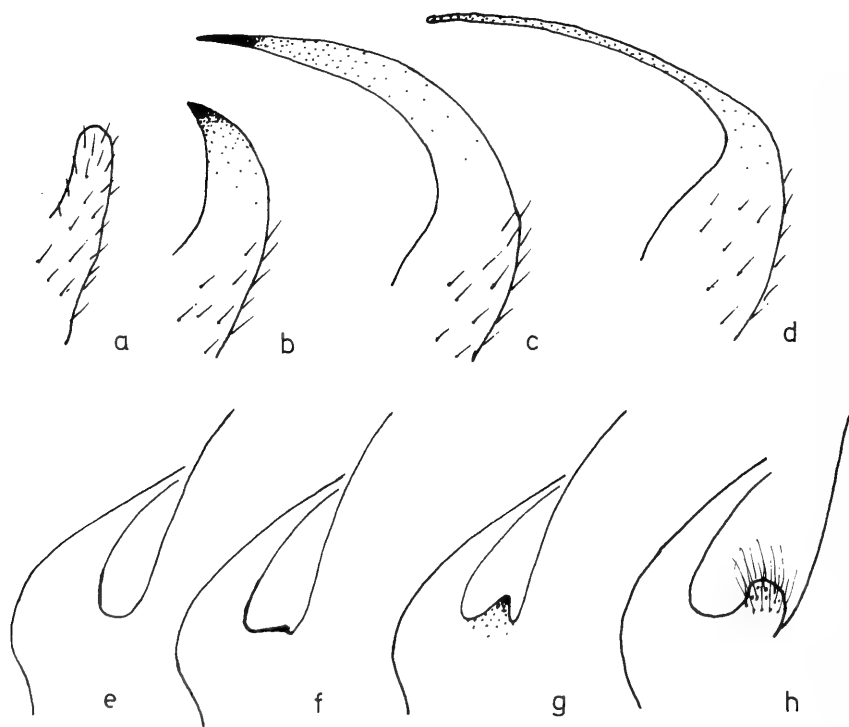
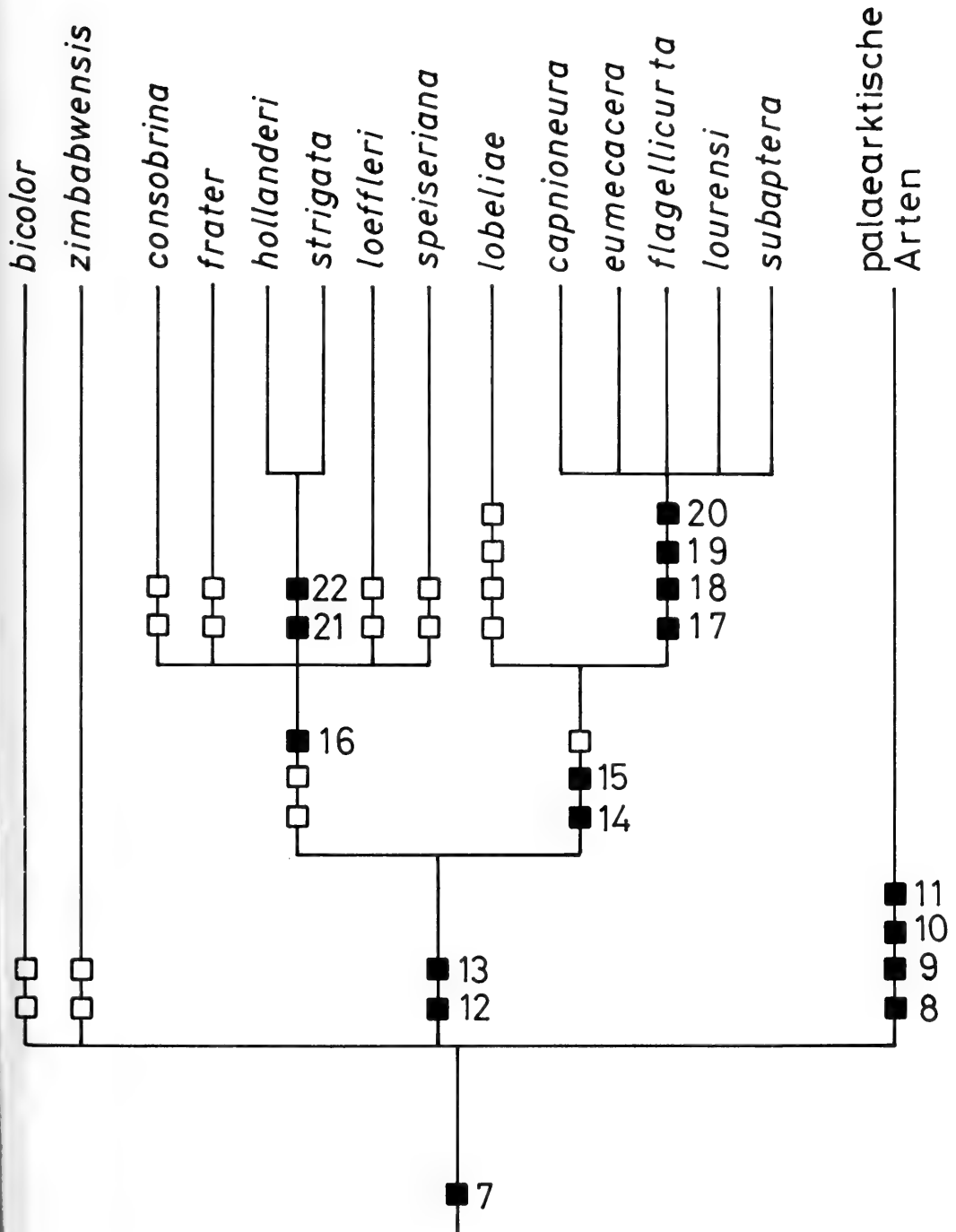

Abb. 21. Linker *od*, von der Außenseite, der palaearktischen Arten (a—i wie Abb. 18).

ne einzige Synapomorphie. Alle gemeinsamen Merkmale sind Plesiomorphien.

Im Kladogramm 2 sind die angeführten Verhältnisse bildlich dargestellt. Die benutzten Apomorphien sind: 7. Haken lang statt kurz; 8. Haken endet in einem Dorn statt konisch; 9. Innenseite des *id*-Vorderteils nackt statt behaart; 10. distales Ende des *id*-Hinterteils differenziert statt einfach oder reduziert; 11. Oberrand des *id*-Vorderteils mit Haarsaum statt mit Kamm oder statt ohne Kamm und ohne Haarsaum.

Die afrotropischen Arten excl. *soror*

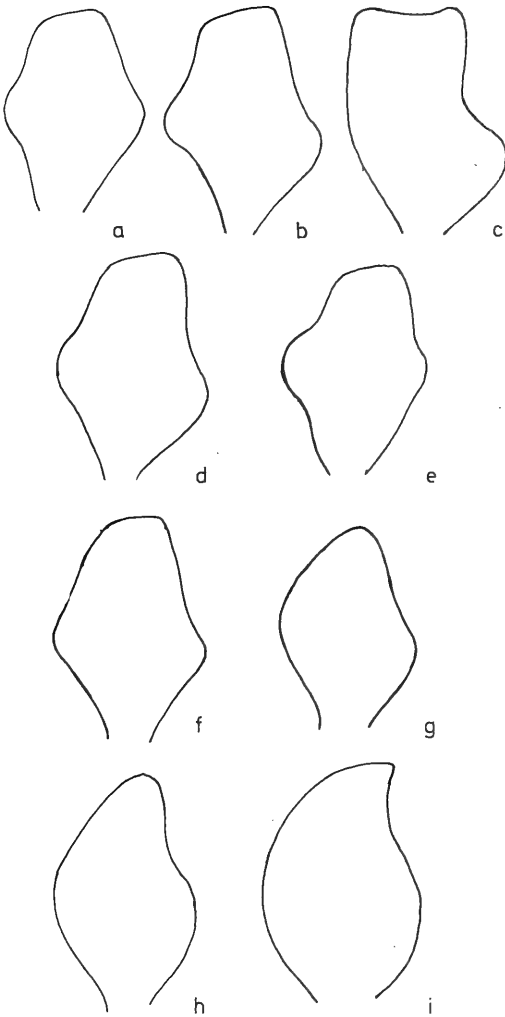
Im Kladogramm 3 sind diese Arten geordnet

aufgrund einer Reihe von Apomorphien. Diese sind: 12. *id*-Hinterteil verkürzt (Abb. 19b—d, vgl. auch Abb. 1—16); 13. sensorische Dornen an der Vorderseite des *id*-Hinterteils sitzen zum Teil auf verdickter Basis (vgl. Abb. 19b—d mit 19a); 14. sensorische Poren an der Innenseite des *id*-Hinterteils sitzen verstreut (bei allen Arten weiterer verwandter Artengruppen sitzen sie nah aneinander auf einem abgegrenzten Feld (vgl. Abb. 19c—d mit 19a—b und mit 18)); 15. distales Ende des *id*-Hinterteils an der Vorderseite zugespitzt statt kappenförmig (vgl. Abb. 19c—d mit 19b) (diese Apomorphie wird deutlich, wenn man das Feld mit den sensorischen Borsten auf dem Stiel von *soror*, *bicolor* und *zimbabwensis* betrachtet: dieses Feld ist oben breit und abgerundet; bei Reduktion des distalen Endes des *id*-Hinterteils ergibt sich deshalb eine Kappe (Abb. 19b) und nicht eine schnabelförmige Spitze (Abb. 19c—d)); 16. innerhalb der Kappe ist ein halbmondförmiger Auswuchs, auf dem die sensorischen Borsten sitzen (Abb. 19b); (plesiomorph ist der Zustand bei *lobeliae* (Abb. 19c)); 17. *id*-Hinterteil am distalen Ende zangenförmig (Abb. 19d); 18. zwischen Haken und *id*-Hinterteil steht ein abgerundeter, stark behaarter Höcker (Abb. 20h) statt eines kaum auffallenden (Abb. 20e—g); 19. ein kleiner, scharfer Dorn an der Außenseite des *id*-Hinterteils (Abb. 2, 4, 5, 10, 15); 20. *id*-Vorderteil ohne Kamm und ohne jegliche Behaarung; 21. der kappenförmige *id*-Hinterteil ist an der Außenseite dornartig vergrößert (Abb. 7, 14); 22. Kamm des *id*-Vorderteils vorne umgeschlagen (Abb. 7, 14); (kein Artefakt, denn sowohl die zwei Exemplare von *hollanderi* und auch die vier von *strigata*, die mir bekannt sind, haben diesen vorne umgeschlagenen Kamm).

Die palaearktischen Arten

Im Kladogramm 4 sind diese Arten geordnet aufgrund einer Reihe von Apomorphien. Diese sind: 23. kissenförmiges sensorisches Feld vorne an der Unterseite des *id*-Vorderteils nach hinten verdickt (Abb. 24b, c gegenüber a), hiermit zusammen finden sich Differenzierungen am distalen Ende des *id*-Seitenteils (Abb. 23); 24. distales Ende des *id*-Hinterteils an der Vorderseite abgeplattet, bei allen weiteren Arten, in denen es nicht reduziert ist, ist es abgerundet (Abb. 24e gegenüber f); 25. Haken fließend, ohne Höcker, mit dem *id*-Hinterteil verbunden (Abb. 20e gegenüber f, g, h), bei allen weiteren Arten ist die Verbindung eckig oder mit Höcker; 26. kissenförmiges sensorisches Feld liegt nicht an

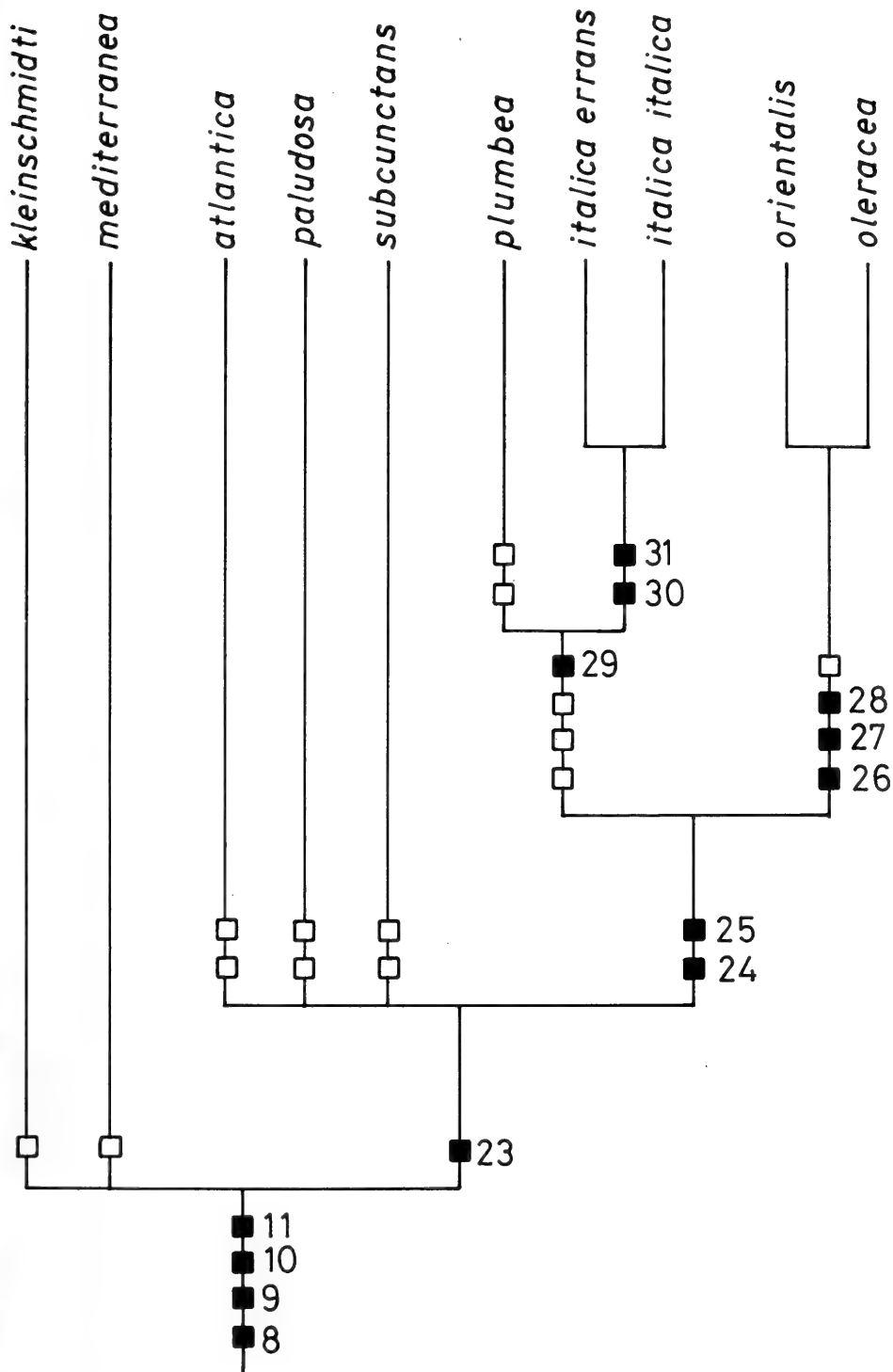

Kladogramm 4. Die palaearktischen Arten von *Tipula* (*Tipula*). ■ Apomorphien, □ Plesiomorphien.



Abb. 22. Distales Ende des linken *id*-Seitenteils, von oben, der afrotropischen Arten von *Tipula* (*T.*): a, *bicolor*, *lobeliae*, *soror*, *zimbabwensis*; b, *capnioneura*, *eumecacera*; c, *lourensi*; d, *subaptera*; e, *flagellicurta*; f, *loeffleri*, *speiseriana*; g, *strigata*, h, *hollanderi*, i, *consobrina*, j, *frater*.

der Unterseite, sondern an der Außenseite des *id*-Vorderteils; 27. *id*-Seitenteil distal eckig an das sensorische Feld anschließend (Abb. 23h, i und 24b); 28. *id*-Hinterteil distal verlängert und nach vorne gebogen (Abb. 18h, i); 29. *id*-Seitenteil distal pottfischzahnähnlich nach außen gebogen (Abb. 23f, g); 30. *id*-Hinterteil mit zahnförmigen Auswuchs an der Rückseite (Abb. 18f); 31. kegelförmige Auswüchse auf den sensorischen Poren dunkelgefärbt (bei allen weiteren Arten der Untergattung *Tipula* sind sie glashell).

Nicht benutzte Merkmale des Hypopygs
Einige, manchmal deutlich sichtbare Merkmale des Hypopygs konnten nicht benutzt werden.

a. — Adminiculum und Gonapophysen. Sie sind von einfachem Bau und ein wenig nach hinten gebogen, wie in vielen Artengruppen von *Acutipula*. Zwischen den Arten der Untergattung *Tipula* gibt es keine deutlichen Unterschiede. Bei den Arten der *loveridgei*-Gruppe sind die Gonapophysen ein wenig kürzer und dünner. Dieser Unterschied ist aber gering (siehe

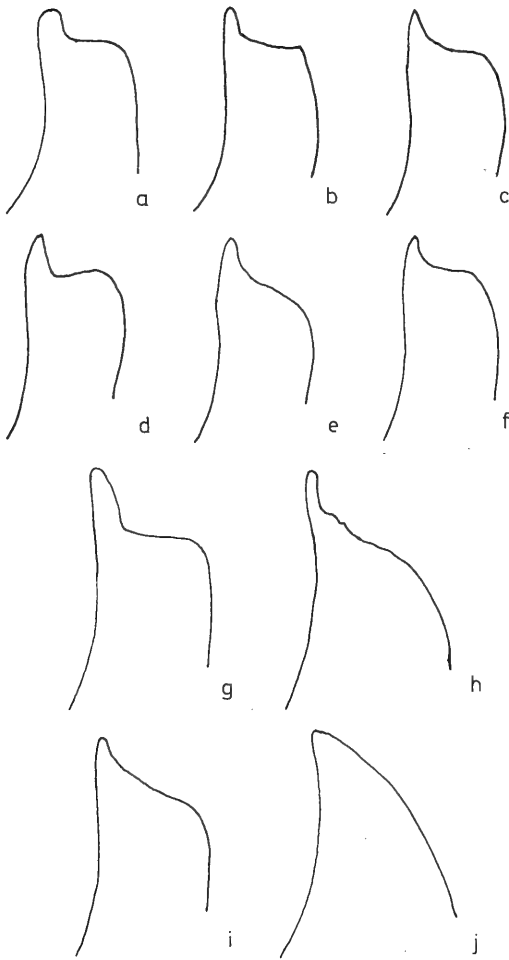

Abb. 23. Distales Ende des linken *id*-Seitenteils, von oben, der palaarktischen Arten von *Tipula* (*T.*) (a—i wie Abb. 18).

auch De Jong, in Vorbereitung).

b. — Vorsprung am Hinterrand des 9. Tergits. Bei den afrotropischen Arten mit Synapomorphien 17—20 (Kladogramm 3) sind sie die Basis meist schmaler. Der Unterschied ist aber manchmal undeutlich, weshalb "breitbasig" als Apomorphie den Synapomorphien 17—20 nicht angefügt ist. *T. soror* und *zimbabwensis* haben diesen bedornten Vorsprung geradlinig abgestutzt (Abb. 12, 16). Wie das Merkmal breit- oder schmalbasig zeigt sich auch dieses Merkmal nicht immer gleich deutlich und, zumal bei aufgeweichten Exemplaren, sind diese Unterschiede manchmal gar nicht mehr zu erkennen.

c. — *Od.* Sie sehen meist etwas birnförmig deutlich breitbasig, bei den anderen Arten ist aus, sind aber bei mehreren Arten distal verbreitert (Abb. 1, 3, 6, 9, 21). Die Verbreiterung kommt nicht immer auf dieselbe Weise zustande. Betrachtet man sie als Synapomorphie, dann

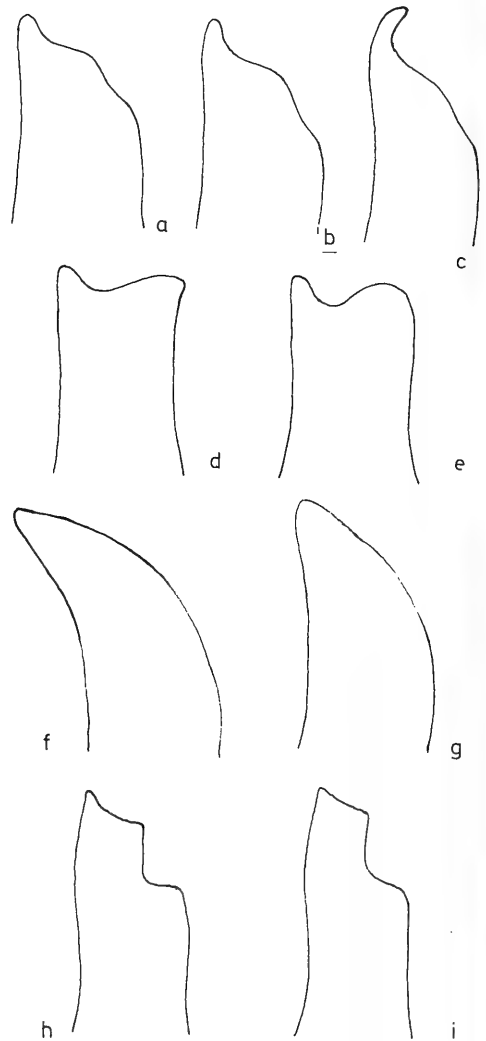
werden viele der benutzten Synapomorphien zu Konvergenzerscheinungen. Auch in weiteren Untergattungen finden sich manchmal bei nahverwandten Arten *od* von sehr verschiedener Form.

d. — *Id*-Seitenteil. Bei den meisten Arten schließt er eng gegen den *id*-Vorderteil an, ist vorne mehr oder weniger abgestutzt und hat am distalen Ende an der Außenseite einen kleinen Vorsprung (Abb. 22, 23). Bei vielen palaearktischen Arten ist das sensorische Feld an der Basis des *id*-Vorderteils nach hinten verdickt, und damit zusammenhängend, ist das distale Ende des *id*-Seitenteils artcharakteristisch differenziert (Abb. 24a—c). Die Art und Weise der Differenzierung konnten bei diesen Arten als Synapomorphien benutzt werden. Bei den afrotropischen Arten dagegen finden sich nur vier auffallende Differenzierungen (Abb. 22g—j), die sich für das Feststellen von verwandtschaftlichen Beziehungen unverwendbar erwiesen.

e. — Dorn oder Buckel auf dem Stiel des *id*-Hinterteils. Bei den palaearktischen Arten *italica*, *mediterranea*, *oleracea*, *orientalis* und *paludosa* findet sich basal an der Vorderseite des Stiels des *id*-Hinterteils ein mehr oder weniger buckelförmiger Dorn (Abb. 18). Bei *oleracea* und *orientalis* steht er immer an derselben Stelle und hat eine ähnliche Form, bei den anderen Arten aber nicht. Bei *paludosa* gibt es ausnahmsweise Exemplare ohne Buckel, bei *mediterranea* finden sich oft in einer und derselben Population Exemplare mit und Exemplare ohne Buckel. Das Vorkommen eines Buckels ist sicher apomorph. Für Kladogramm 4 konnte diese Apomorphie aber nicht benutzt werden.

f. — Behaarung der Außenseite des *id*-Vorderteils. Eine Reihe afrotropischer Arten (Abb. 1, 3, 5, 7, 8, 9, 12, 14, 15, 16) hat eine mehr oder weniger auffallende Behaarung an der Außenseite des *id*-Vorderteils. Manchmal sind es nur wenige längere Haare, manchmal sind es kürzere Haare, die dann vielfach kissenförmig zusammenstehen. Ein solches Kissen kann vorkommen am distalen Ende, in der Mitte oder an der Basis des *id*-Vorderteils. Die Arten der *loveridgei*-Gruppe haben den *id*-Vorderteil an der Außenseite unbehaart, und in der Untergattung *Tipula* ist eine derartige Behaarung wahrscheinlich eine Apomorphie. Sie wurde für das Feststellen von Verwandtschaften in den Kladogrammen 1—3 nicht benutzt, weil der Eindruck besteht, daß eine derartige Behaarung konvergent bei mehreren Arten auftritt.



Abb. 24. a—c, distales Ende des linken *id*-Vorderteils und *id*-Seitenteils von oben von *Tipula* (*T.*): a, *mediterranea*; b, *oleracea*; c, *italica*; d—e, distales Ende des *id*-Hinterteils von *Tipula* (*T.*): d, *mediterranea* von der Seite; e, *mediterranea* Querschnitt; f, *oleracea* Querschnitt.



Kladogramm 5. Zusammenfassende Übersicht. ■ Eindeutige Synapomorphien, ● Autapomorphien und Hinweise auf Verwandtschaften, ○ Konvergent vorkommende Apomorphien.

Autapomorphien und weitere Hinweise auf Verwandtschaften

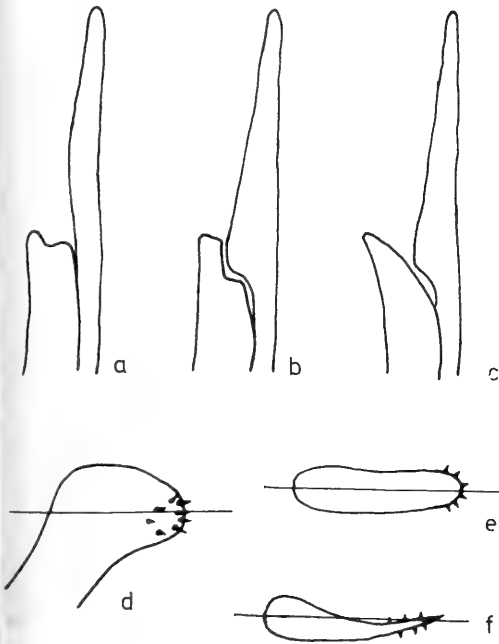
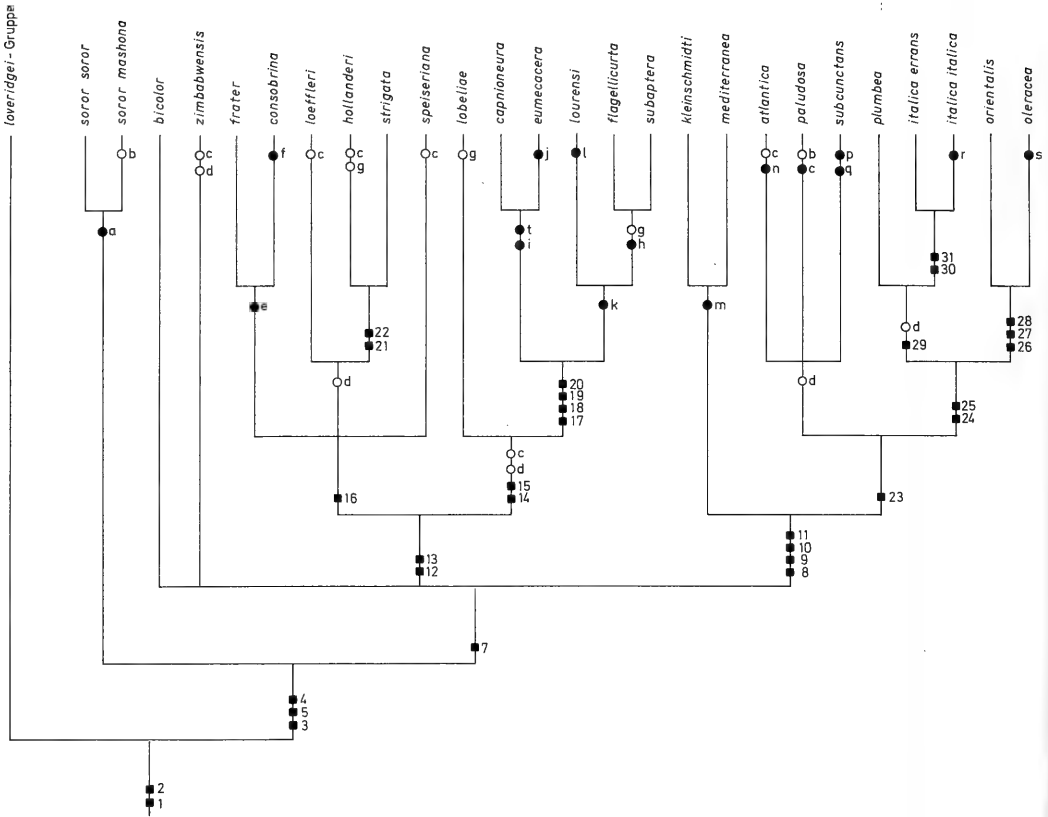
In den Kladogrammen 1—4 sind keine Autapomorphien verzeichnet. Als Synapomorphien sind nur diejenigen benutzt, die eindeutig bei den entsprechenden Arten vorhanden sind oder nicht, und die nicht konvergent auch noch bei einer oder mehreren weiteren Arten vorkommen. Nicht benutzt sind einerseits die vielfach mosaikartig verstreut vorkommenden eidonomischen Merkmale, andererseits Merkmale des Hypopygs, die entweder nicht eindeutig sind, oder die konvergent vorkommen. Aufgrund der benutzten Synapomorphien ist die Einteilung in Artengruppen, wie in den Kladogrammen 1—4 durchgeführt, ziemlich sicher richtig.

In Kladogramm 5 sind die Kladogramme 1—4 zusammengefaßt. Außerdem sind Autapomorphien zugefügt. Aufgrund von in den Kladogrammen 1—4 nicht benutzten Merkmalen sind einige Arten zusammengefaßt und einige

Artengruppen weiter aufgeteilt. Die dazu benutzten Merkmale sind manchmal schwerwiegende, manchmal schwächere Apomorphien. Sie sind im Kladogramm 5 nicht mit Ziffern sondern mit Buchstaben bezeichnet und werden nachfolgend besprochen.

Die beiden Unterarten von *soror*, die einander fast in allen Merkmalen identisch sind, sind zusammengestellt (a). Eine Apomorphie für *mashona* sind die 14-gliedrigen Fühler (b), die wir sonst nur bei *paludosa* finden.

Es gibt keine Hinweise, aufgrund derer wir *bicolor* und *zimbabwensis* zusammenfassen können. Die auffallende orangegelbe Farbe von *bicolor* ist wahrscheinlich plesiomorph. Wir finden sie auch bei den Arten der *loveridgei*-Gruppe. Autapomorphien für *zimbabwensis* sind: Tarsalklauen ungezahnt (c) und Augen unter dem Kopf breit getrennt (d). Beide Apomorphien kommen konvergent auch bei einigen anderen Arten vor und sind dort im Kladogramm

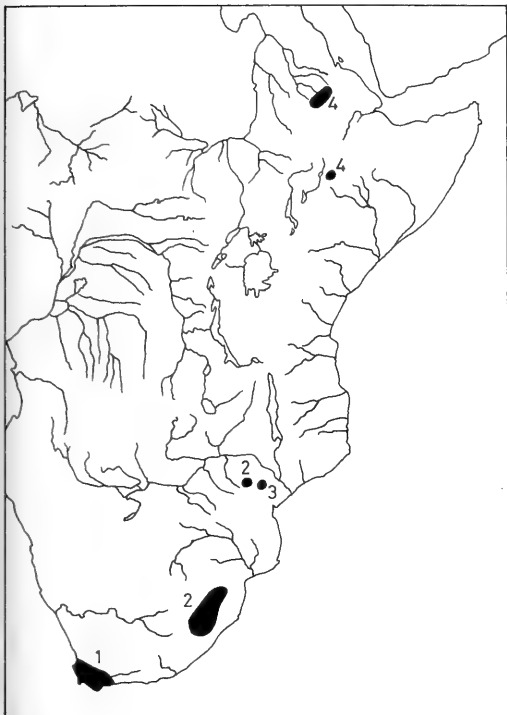

Karte 2. Verbreitung einiger afrotropischer Arten von *Tipula* (*Tipula*): 1, *soror soror*, 2, *soror mashona*, 3, *zimbabwensis*, 4, *bicolor*.

5 mit denselben Buchstaben bezeichnet.

Mit Synapomorphie 16 stehen im Kladogramm 3 vier Arten ohne Synapomorphien (*consobrina*, *frater*, *loeffleri* und *speiseriana*) gegenüber zwei Arten mit zwei Synapomorphien (*hollanderi* und *strigata*). Von diesen 6 Arten sind *consobrina* und *frater* zusammenzustellen, weil sie, den *id*-Hinterteil ausgenommen, einander sehr ähnlich sind und beide stark verkürzte Fühler haben, eine Apomorphie, die sonst in der Untergattung *Tipula* nicht vorkommt (e). *T. consobrina* hat nachfolgende Autapomorphie: Kappe des *id*-Hinterteils und Haken stark vergrößert (f). Von den vier weiteren Arten haben *loeffleri*, *hollanderi* und *speiseriana* die Tarsalklauen ungezähnt (c), eine Apomorphie, die so verstreut vorkommt, daß man die drei Arten nur auf sie begründet nicht zusammenfassen kann. *T. loeffleri*, *hollanderi* und *strigata* haben alle die Augen unter dem Kopf breit getrennt (d), eine Apomorphie, die viel weniger verstreut vorkommt. Wir finden sie bei der isoliert stehenden *zimbabwensis*, bei allen Arten mit Synapomorphien 14—15, bei den drei plesiomor-

phen Arten *atlantica*, *paludosa* und *subcunctans* und bei den Arten mit Synapomorphie 29. Die breite Trennung der Augen unter dem Kopf präsentiert einen schwachen Hinweis darauf, daß die Arten *loeffleri*, *hollanderi* und *strigata* nahe zusammengehören. *T. hollanderi* hat die konvergent vorkommende Autapomorphie: Fühler verlängert (g).

Die Gruppe mit Synapomorphien 14—15 hat für ihren Zusammenhang noch zwei, allerdings nicht schwerwiegende, weil konvergent vorkommende, Apomorphien: alle zugehörigen Arten haben die Augen breit getrennt (d) und alle haben die Tarsalklauen ungezähnt (c). Eine Autapomorphie von *lobeliae* sind die verlängerten Fühler (g), wie sie konvergent bei mehreren weiteren Arten vorkommen. Von den Arten mit Synapomorphien 17—20 haben die beiden einander im Bau des Hypopygs fast identischen Arten *flagellicurta* und *subaptera* in der basalen Hälfte des *id*-Vorderteils an der Außenseite an genau derselben Stelle ein Kissen kurzer, weißer Haare (h), wie wir es bei keiner der weiteren Arten der Untergattung *Tipula* finden, und das

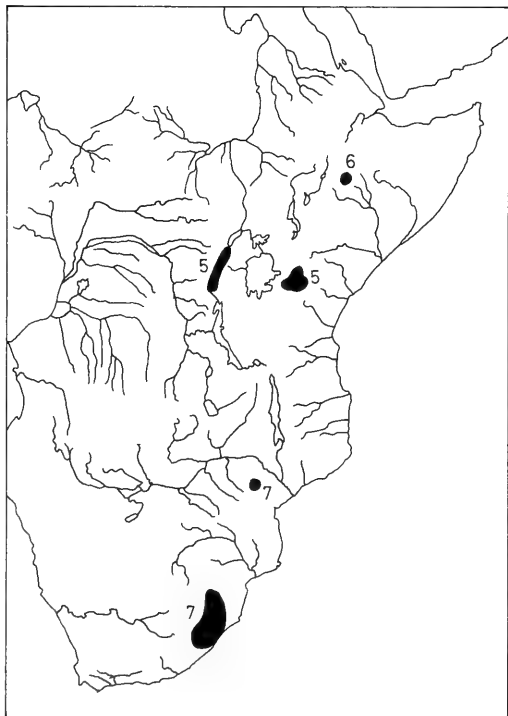

Karte 3. Verbreitung einiger afrotropischer Arten von *Tipula* (*Tipula*): 5, *speiseriana*, 6, *loeffleri*, 7, *frater*.

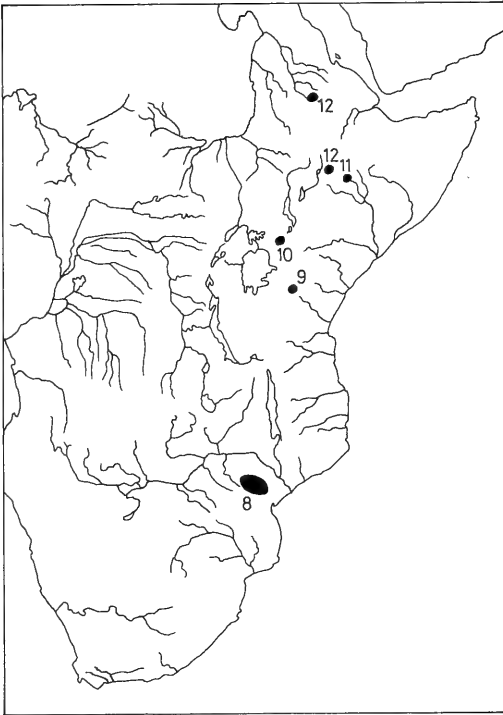

Karte 4. Verbreitung einiger afrotropischer Arten von *Tipula* (*Tipula*): 8, *consobrina*, 9, *capnioneura*, *eumecacera*, *flagellicurta*, *lourensi* und *subaptera*, 10, *lobeliae*, 11, *hollanderi*, 12, *strigata*.

damit eine schwerwiegende Synapomorphie darstellt (siehe auch den vorigen Paragraph). Sie haben überdies beide die Fühler verlängert (g), was aber konvergent bei mehreren Arten vorkommt. Die beiden Arten *capnioneura* und *eumecacera*

haben als Synapomorphien: Fühler sehr stark verlängert, fast bis zum Ende des Hinterleibs reichend (t) und einen langen Dorn an der Basis des *id*-Hinterteils (i). Eine Autapomorphie für *eumecacera* ist ihre Größe (j), diese Species ist viel kleiner als alle anderen Arten der Untergattung *Tipula*. *T. lourensi* hat den Dorn an der Außenseite des *id*-Hinterteils ähnlich wie *flagellicurta* und *subaptera*, d.h. kurz und breitbasig (k), statt lang und schmalbasig wie *capnioneura* und *eumecacera*. Nur mit dieser schwachen Begründung wurde *lourensi* zu beiden vorhergenannten Arten gestellt. Autapomorph hat diese Art das erste abdominale Segment gleich hell wie den Thorax und nicht, wie bei anderen Arten, gleich dunkel wie das übrige Abdomen (l).

T. kleinschmidti und *mediterranea* stehen allen Arten mit Synapomorphie 23 gegenüber. In eidonomischen Merkmalen sind sie einander nicht sehr ähnlich. Die *id* beider Arten sind aber, den Hinterteil ausgenommen, fast identisch (m) und deutlich verschieden von den *id* aller übrigen palaearktischen Arten. Aufgrund dieser Ähnlichkeit sind beide Arten zusammengestellt worden. *T. kleinschmidti* hat plesiomorph sensorische Dornen an der ganzen Vorderseite des *id*-Hinterteils, *mediterranea* dagegen hat sie apomorph nur am distalen Ende, wie die meisten palaearktischen Arten.

Die drei Arten *atlantica*, *paludosa* und *subcunctans* haben nur eine gemeinsame Apomorphie, die aber in mehreren Gruppen auftritt: die Augen sind unter dem Kopf breit getrennt (d). Jede der drei Arten hat Autapomorphien. *T. atlantica* hat einen etwa fingerförmigen Fortsatz am distalen Ende des *id*-Hinterteils (n) und



Karte 5. Verbreitung von *Tipula* (*T.*) *kleinschmidti*.



Karte 6. Verbreitung von *Tipula* (*T.*) *mediterranea*.

überdies die Tarsalklauen ungezahnt (c). Letztgenanntes Merkmal kommt in mehreren anderen Arten vor. *T. paludosa* hat das distale Ende des *id*-Hinterteils blasenförmig vergrößert (o) und überdies 14 Fühlerglieder (b). Letztgenanntes Merkmal kommt sonst nur noch bei *soror mashona* vor. *T. subcunctans* hat den Stiel des *id*-Hinterteils verbreitert (p) und die Fühlerbasalglieder schwarz (g). Beide Merkmale kommen nur bei dieser Art vor.

Von den beiden Unterarten von *italica* ist die typische stärker apomorph; sie hat den *id*-Haken am distalen Ende kolbenförmig geschwollen (r).

T. oleracea ist in höherem Grade apomorph als *orientalis*: sie hat den *id*-Vorderteil hakenförmig verschmälert und ohne Haarsaum (s).

Kladogramm 5 gibt die Zusammenhänge zwischen Arten und Artengruppen der Untergattung *Tipula* wider, begründet auf meist nicht konvergent vorkommende stärkere und schwächere Synapomorphien. Die in diesem Kladogramm entholtenen, konvergent vorkommenden Apomorphien kommen alle auch in weiteren Untergattungen und Artengruppen

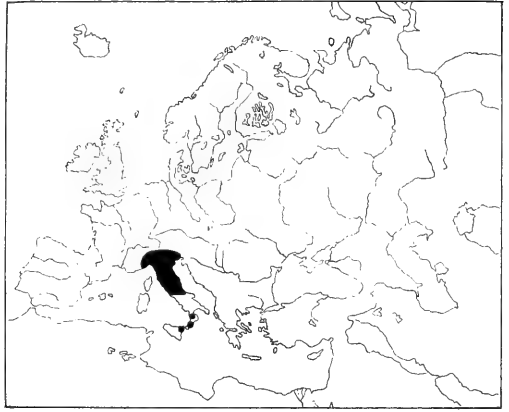

Karte 8. Verbreitung von *Tipula (T.) italica italica*.

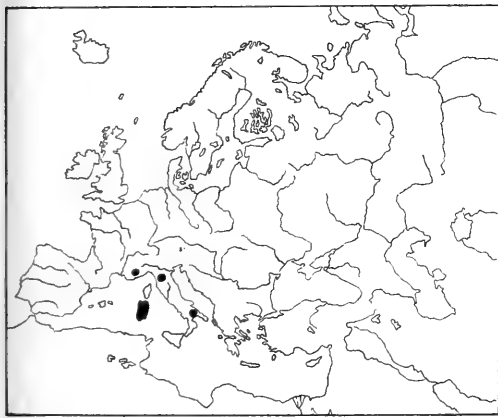

Karte 7. Verbreitung von *Tipula (T.) plumbea*.

der Tipuliden konvergent vor. Die verwandtschaftlichen Verhältnisse zwischen den Arten und Artengruppen der Untergattung *Tipula*, wie in Kladogramm 5 dargestellt, sind somit wohl ziemlich gut fundiert.

ZUR BIOGEOGRAPHIE

Die Arten der Untergattung *Tipula* finden sich über die gesamte palaearktische und afrotropische Region (Karte 1). Von den palaearkti-

schen Arten ist eine (*subcunctans*) über das ganze Gebiet verbreitet, kommen zwei (*paludosa* und *oleracea*) im mediterranen Gebiet und überdies im übrigen Europa vor, und sind die meisten rein mediterran. Die afrotropischen Arten sind in ihrer Verbreitung auf die montanen Gebiete Ostafrikas beschränkt, einige von ihnen haben dort sogar alpine Verbreitung. Das Hauptverbreitungsgebiet läßt sich, wie folgt, aufteilen: 1. Süden Afrikas: die Gebirge von Kapstadt nach dem Norden bis zum Zambesi; 2. Zentralafrika: die Gebirge um den Viktoria-See; 3. die Gebirge von Äthiopien; 4. ostmediterranes Gebiet: hauptsächlich Balkanhalbinsel und Italien; 5. westmediterranes Gebiet: hauptsächlich Iberien und der palaearktische Teil von Nordafrika. Die drei afrotropischen Gebiete sind durch ausgedehnte trockene Steppen und Wüsten von einander getrennt. Jedes hat seine eigene charakteristische Fauna von Arten der Untergattung *Tipula*, was darauf hinweist, daß für diese Arten Austausch zwischen den genannten Gebieten schwierig ist (Karte 2—4). Auch die beiden europäischen Gebiete haben jeweils ihre charakteristische *Tipula*-Fauna, sind aber deutlich weniger stark von einander getrennt als die afrotropischen Gebiete (Karte 5—13). Die Verbreitung mehrerer mediterraner Arten in Italien und auf den mediterranen Inseln ist unklar. Vielleicht sind diese Kulturschädlinge in diesem alten Kulturgebiet im Ballast durch den Menschen verschleppt worden. Die Verbreitung von *oleracea* in Finnland (Karte 13) ist nach Mannheims, 1954, 1964. Es ist kaum vorstellbar, daß er sich in der Bestimmung geirrt hat. Es ist aber merkwürdig, daß diese Art in Finnland sehr weit nördlich, in

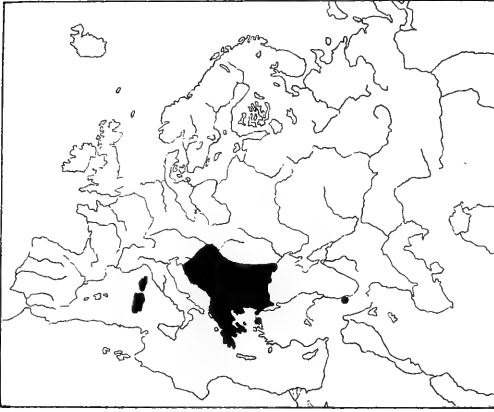
Karte 9. Verbreitung von *Tipula (T.) italica errans*.

Skandinavien dagegen nur im äußersten Süden vorkommt. Die Verbreitung von *subcunctans* in Sibirien (Karte 10) ist unklar, weil dort nur wenig gesammelt worden ist. Wahrscheinlich ist die Verbreitung dieser Art disjunkt und hat sich das Areal ziemlich rezent in einige Teilareale aufgeteilt.

Aufgrund von Kladogramm 5 ist ein Areogramm aufgestellt (Kladogramm 6). In diesem ist statt des Artnamens die Verbreitung verzeichnet. Übersichtshalber sind innerhalb der Gruppen die Arten nicht alphabetisch geordnet wie in Kladogramm 5, sondern nach Verbreitung: von links nach rechts die Arten aus dem südlichen Afrika, Zentralafrika, Äthiopien, dem ostmediterranen Gebiet und dem westmediterranen Gebiet. Damit ein Vergleich mit Kladogramm 5 erleichtert wird, sind die Namen der Arten abgekürzt hinzugefügt. Das Areogramm gibt keinen Anlaß zur Kritik an Kladogramm 5; im Gegenteil, die dort angeführten Verwandtschaften, die größtenteils auf deutliche Apo-

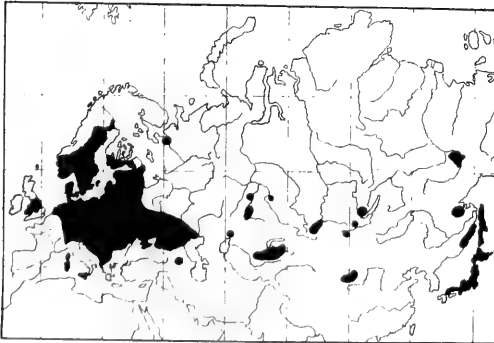
Karte 10. Verbreitung von *Tipula (T.) subcunctans*.

morphismen, zum Teil aber auch auf schwächere Hinweise begründet sind, finden im Areogramm eine biogeographische Bestätigung.

Aus dem Areogramm läßt sich die Geschichte der Untergattung *Tipula* ungefähr ablesen:

1. Durch Apomorphien 3—5 hat sich die Untergattung wahrscheinlich im Süden von Afrika differenziert, wo wir jetzt noch die primitiven Unterarten von *soror* finden, und wo auch die Arten der *loveridgei*-Gruppe heimisch sind.

2. Differenziert durch Apomorphie 7, hat sie sich von Südafrika über Ostafrika bis nach Europa verbreitet. Im südlichen Afrika finden wir noch die primitive *zimbabwensis*, in Äthiopien die primitive *bicolor*. In Zentralafrika hat die primitive Art sich durch Apomorphien 12—13, in Europa durch Apomorphien 8—11 weiter differenziert.

2. Weil die Arten mit Synapomorphien

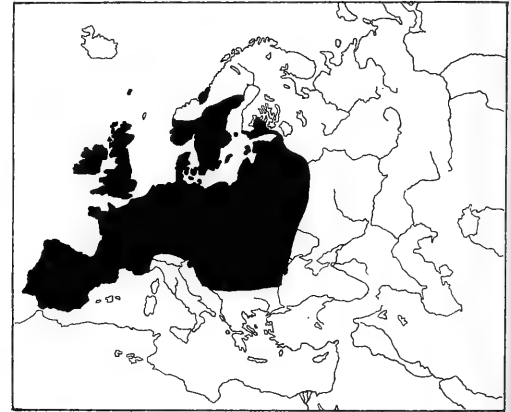
Karte 11. Verbreitung von *Tipula (T.) paludosa*.

14—15 alle alpin und jene mit Synapomorphie 16 fast durchwegs montan sind, hat in Zentralafrika wohl eine oekologische Differenzierung in eine alpine Art mit Synapomorphien 14—15 und eine montane mit Synapomorphie 16 stattgefunden.

4. Die alpine Art mit Apomorphien 14—15 hat sich wenigstens über die Gebirge östlich des Viktoriasees verbreitet, wo jetzt alpine Arten auf Mount Elgon im Norden und am Kilimandjaro im Süden nachgewiesen und aufgrund dieser Verbreitung wenigstens auch auf Mount Kenia und Aberdare Range zu erwarten sind.

5. Die montane Art mit Apomorphie 16 hat sich über ganz Ostafrika verbreitet, wo jetzt die einander sehr ähnlichen *frater* im südlichen Afrika, *speiseriana* in Zentralafrika und *loeffleri*

in Äthiopien vorkommen. Erst- und letztgenannte haben sich in ihrer Region jeweils in weitere Arten differenziert.

6. Die europäische Art mit Apomorphien 8—11 hat sich aufgespalten in eine plesiomorphe westmediterrane Art und eine wahrscheinlich ostmediterrane mit Apomorphie 23.

7. Die plesiomorphe westmediterrane Art hat sich aufgespalten in die iberische *kleinschmidti* und in die — aufgrund ihrer Verbreitung wahrscheinlich ursprünglich nordafrikanische — *mediterranea*. Letztgenannte hat sich später aber über das ganze westmediterrane Gebiet verbreitet.

8. Die angenommene ostmediterrane Art mit Apomorphie 23 hat sich wohl wieder in eine plesiomorphe westmediterrane und in eine ostmediterrane Art mit Apomorphien 24—25 aufgespalten.

9. Die plesiomorphe westmediterrane Art hat sich erst über ein größeres Gebiet ausgebreitet. Dann hat sich das Areal aufgeteilt und in jedem der Teilgebiete hat die Art sich weiter differenziert. Jetzt finden sich drei jeweils hochdifferenzierte Arten ohne wesentliche Synapomorphien: *atlantica* auf Madeira, *paludosa* ursprünglich in Iberien und mit einer deutlich nacheiszeitlichen Ausbreitung in Westeuropa, und *subcunctans* mit Verbreitung von Westeuropa bis Japan. Die heutige Verbreitung der letztgenannten Art in Westeuropa ist nacheiszeitlich entstanden. Es fällt auf, daß es von dieser Gruppe keine Art in Nordafrika gibt. Lebt dort noch eine unbekannte Art, oder hat *paludosa* vielleicht früher eine weitere Verbreitung gehabt?



Karte 12. Verbreitung von *Tipula (T.) orientalis* (auch Sudan, W. Darfur, Mts. Marra, 13°n.Br./24°30'ö.L.).

10. Aufgrund rezenter Verbreitung müssen wir annehmen, daß die ostmediterrane Art mit Synapomorphien 24—25 sich im ostmediterranen Raum aufgespalten hat in *plumbea* mit Apomorphie 29 und *orientalis* mit Apomorphien 26—28. Die heutige Verbreitung von *plumbea* und nächsten Verwandten gegenüber *orientalis* (Karte 7, 8, 9 und 12) läßt vermuten, daß sich damals eine Art der Balkanhalbinsel gegenüber einer kleinasiatischen differenziert hat.

11. *T. plumbea* hat sich im italo-balkanischen Gebiet in *plumbea* und *italica*, und letztgenannte wiederum in zwei Unterarten aufgespalten: *italica italica* in Italien *italica errans* auf der Balkanhalbinsel und auf Korsika und Sardinien. In-

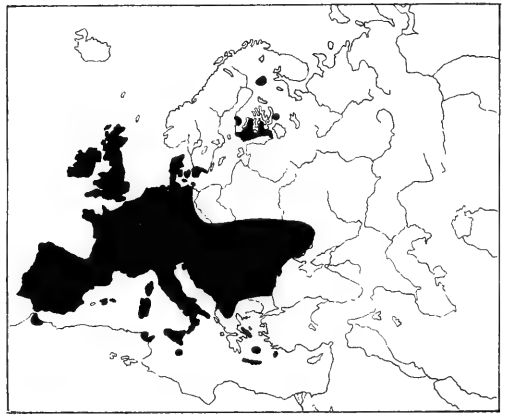

Karte 13. Verbreitung von *Tipula (T.) oleracea*.

nerhalb dieser Gruppe ist *plumbea* am meisten plesiomorph und diese Art hat heute wohl nur noch Relikt-Verbreitung (Karte 7).

12. *T. orientalis* hat sich stark ausgebreitet: nach dem Osten bis Afghanistan, nach dem Süden bis Sudan, nach dem Westen bis Iberien. Im letztgenannten Gebiet hat sie sich weiter differenziert zu *oleracea*, die sich später bis nach Italien und nacheiszeitlich über Westeuropa bis auf die Balkanhalbinsel ausgebreitet hat.

Die etwaige Differenzierung der Artengruppen und Arten der Untergattung *Tipula* läßt sich aufgrund des Areogrammes und der genauen Verbreitungsdaten auf Karte 2—13 ganz gut erfassen. Offensichtlich hat es nur einmal eine große Verbreitung von Südafrika über Ostafrika bis nach Europa gegeben (Apomorphie 7). Im afrotropischen Raum hat es später noch einmal eine vergleichbare Verbreitung gegeben (Apomorphie 16). In Europa dagegen hat sich dreimal eine Art über das ganze mediterrane

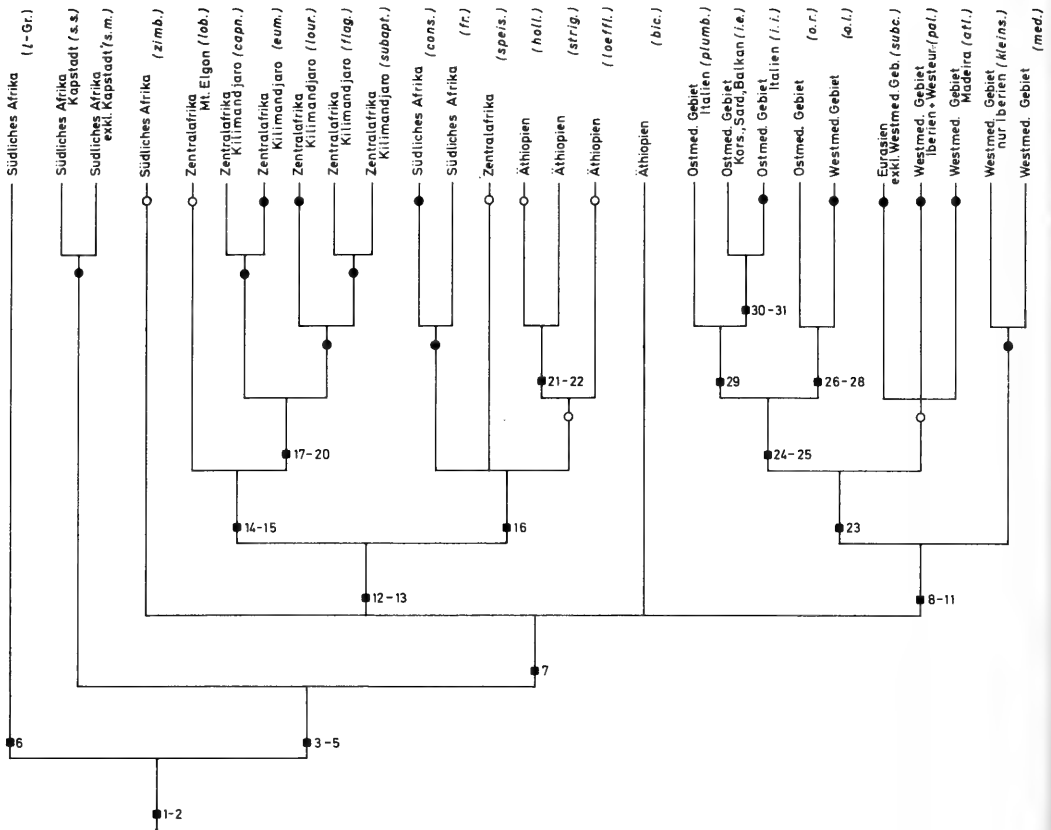

Areogramm 1. Areogramm basierend auf Kladogramm 5.

Gebiet ausgebreitet (Apomorphie 8—11, 23 und 26—28), und einmal fand eine größere Ausbreitung im ostmediterranen Raum statt (Apomorphie 24, 25), wo eine der Arten (*orientalis*), südlich bis in das afrotropische Gebiet (Sudan) gelangen konnte.

Genaue Datierung dieser Vorgänge ist schwierig, wenn nicht gar unmöglich. Palynologische Untersuchungen haben uns gelehrt, daß es im Pleistozän nicht vier Eiszeiten und Zwischeneiszeiten, sondern eine ganze Reihe kälterer und wärmerer Zeiten gegeben hat. Für an gemäßigtes Klima angepaßte Arten waren die Kaltzeiten wichtig. In diesen Zeiten lebten diese Species zurückgedrängt in südlichen Refugien, wo Artbildung stattfinden konnte. In Klima, das jenem von heute ähnelt, haben sie sich aber wieder über ganz Westeuropa ausgebreitet. Für die an wärmeres Klima angepaßten mediterranen Arten waren die Wärmezeiten des Pleistozäns wohl von größerer Bedeutung. Erst in solchen Zeiten konnten sie sich über größeren Tei-

len Europas ausbreiten, womit bei Abkühlung Zurückdrängen in ein west- und ostmediterranes Refugium — und damit Artbildung — möglich wurde. Heute sind die mediterranen Arten — auch die mediterranen Arten der Untergattung *Tipula* — noch deutlich in ihren Refugien. Es gibt aber Hinweise dafür, daß wenigstens einige mediterrane Tipuliden nacheiszeitlich eine größere Verbreitung gehabt haben. Sie kommen heute als Relikt noch irgendwo in Mittel- oder Westeuropa vor, z.B. *brunneinervis* Pierre (Eifel und Ardennen), *longidens* Strobl (Ardennen und bei Frankfurt/Oder), *pilicauda* Pierre (Mittelfrankreich: Puy de Dôme), *selenitica* Wiedemann (Umgebung von Paris), *pustulata* Pierre (bei Frankfurt/Oder, im Harz und in der Umgebung von Paris). Eine größere Verbreitung können diese Arten nacheiszeitlich nur im warmen Atlantikum gehabt haben (7.500—5.000 v.h.), als es in Nordwesteuropa die höchsten nacheiszeitlichen Sommertemperaturen gab (etwa 2° C höher als heute und etwa 18° C Mit-

telwert). Sommertemperaturen von 18° C—20° C fanden sich im Pleistozän etwa zehnmal und für deutlich längere Zeiten als während des Atlantikums. Aufgrund dessen ist anzunehmen, daß mediterrane Arten sich im Pleistozän etwa zehnmal über Europa haben ausbreiten können und damit zusammenhängend etwa zehnmal wieder in Refugien zurückgedrängt wurden. Wir können aber nur fünf solche Vorgänge aus Areogramm 1 ablesen (Apomorphien 8—11, 23, 24—25, 26—28, 30—31). Dies bedeutet, daß Arten der Untergattung *Tipula* sich wahrscheinlich wohl etwa zehnmal nach dem Norden ausgebreitet haben, aber weniger Male beim Anfang der Kaltzeiten in zwei isolierte Refugien zurückgedrängt wurden. Nicht auszuschließen ist aber, daß sie am Anfang einer Kaltzeit wohl in ein zweites Refugium kamen, sich dort aber nicht haben halten können. Vielleicht macht der Vergleich einer Reihe von Areogrammen mediterraner Tipulidengruppen den Einfluß der Wärmezeiten des Pleistozäns auf die Verbreitung von wärmeliebenden Insekten deutlicher.

Obwohl also genaue Datierung unmöglich ist, ist es wahrscheinlich, daß die Aufspaltung in Arten im palaarktischen Raum in den Kaltzeiten der zweiten Hälfte des Pleistozäns stattgefunden hat. Die Aufspaltung der afrotropischen Arten mit Synapomorphien 12—13 ist wohl vom gleichem Alter. Das Entstehen der Untergattung *Tipula* hat dann wahrscheinlich Anfang Pleistozän oder Ende Tertiär stattgefunden, wie auch Savtshenko (1966, 1979), wenn auch aus ganz anderen Gründen, vermutet.

LITERATURVERZEICHNIS

- Alexander, C. P., 1917. The crane-flies of South Africa in the South African Museum. — Ann. S. Afr. Mus. 17: 139—182.
- , 1920a. Undescribed crane-flies in the Paris Museum: African species. — Bull. Mus. Nat. Hist. nat. Paris 26: 134—137.
- , 1920b. Undescribed crane-flies in the Paris Museum: African species. — Bull. Mus. Nat. Hist. nat. Paris 26: 402—406.
- , 1920c. New or little-known Tipulidae. — Ann. Mag. Nat. Hist. (9) 5: 53—62.
- , 1920d. New or little-known Tipulidae, Ethiopian Species. — Ann. Mag. Nat. Hist. (9) 5: 337—351.
- , 1921a. The Crane-flies of South Africa in the South African Museum. — Ann. S. Afr. Mus. 18: 181—228.
- , 1921b. Undescribed species of Japanese crane-flies. — Ann. ent. Soc. Am. 14: 111—134.
- , 1930. The crane-flies, in: Report of the Har-

- vard-African Expedition upon the African Republic Liberia and the Belgian Congo 2. — Contr. Harv. Inst. trop. Biol. Med. 5: 1004—1021.
- , 1935. New or little-known Tipulidae from eastern Asia. — Philipp. J. Sci. 57: 81—148.
- , 1956a. Tipulidae. In: Ruwenzori Expedition 1934—35 1, 7: 129—380. London.
- , 1956b. New or little-known Tipulidae in the Durban Museum. — Durban Mus. Novit. 4: 293—327.
- , 1957. The crane-flies from Southern Rhodesia in the Natal Museum. — Ann. Natal Mus. 14: 131—154.
- , 1960. New or little-known crane-flies from Portuguese East Africa. — Ann. Natal Mus. 15: 1—43.
- , 1962. Taxonomic studies of crane-flies of Newfoundland. — Am. Phil. Soc. Year Book 1962: 267—271.
- , 1964. Diptera (Nematocera) Tipulidae. In: South African Animal Life, Results of the Lund University Expedition in 1950—1951, 10: 229—441. — Stockholm.
- , 1965. New subgenera and species of crane-flies from California. — Pacif. Insects 7: 333—386.
- , 1978. New or little-known African Tipulidae in the Staatliche Museum für Naturkunde in Stuttgart. — Stuttg. Beitr. Naturk. (A) 304: 1—9.
- Bergroth, E., 1888. On some South African Tipulidae. — Ent. Tidskr. 9: 127—141.
- Bezzi, M., 1905. Ditteri Eritrei. — Bull. Soc. ent. Ital. 37: 195—304.
- Bigot, J. M. F., 1858. Ordre VII, Diptères. In: Voyage au Gabon. Arch. ent. (Thomson) 2: 346—376.
- Bloch, M. E., 1776. Beytrag zur Naturgeschichte des Kopals. — Beschäft. Berlin. Ges. naturf. Fr. 2: 91—196.
- Edwards, F. W., 1931. Some suggestions on the classification of the genus *Tipula*. — Ann. Mag. Nat. Hist. (10) 8: 73—82.
- Fabricius, I. C., 1781. Species Insectorum 2: I—VIII, 1—552. — Hamburgi, Kilonii.
- Freeman, P., 1950. A subapterous species of *Tipula* from East Africa. — Entomologist 83: 61—63.
- Hollander, J. den, 1975a. The African species of the subgenus *Tipula*. — Beaufortia 23: 131—140.
- , 1975b. *Tipula (Tipula) plumbea* Fabricius, 1781: designation of a neotype. — Bull. Zool. Mus. Un. Amsterdam 4: 53—58.
- , 1975c. The growth of larvae of *Tipula oleracea* Linnaeus. — Tijdschr. Ent. 118: 67—82.
- , 1975d. The phenology and habitat of the species of the subgenus *Tipula* Linnaeus in the Netherlands. — Tijdschr. Ent. 118: 83—97.
- Hutson, A. M., 1980. Tipulidae. In: Crosskey, R. W. (ed.) Catalogue of the Diptera of the Afrotropical Region: 47—91. — London.
- Hutson, A. M., R. I. Vane-Wright & P. S. Cranston, 1976. Revived proposals for stabilizing names in the *Tipula oleracea* species-group. — Bull. zool. Nom. 33: 39—45.

- I.C.Z.N., 1980. Opinion 1160. *Tipula oleracea* Linnaeus, 1758 and related species (Insecta, Diptera): stabilisation by the use of the plenary powers. — Bull. zool. Nom. 37: 216—220.
- , 1936. New species of *Tipula* from the Pyrenees and Madeira. — Proc. R. ent. Soc. London (B) 5: 109—112.
- Jaenicke, F., 1867. Neue exotische Dipteren aus den Museen zu Frankfurt a.M. und Darmstadt. — Abh. senckenb. naturforsch. Ges. 6: 1—99.
- Jong, H. de, (in Vorbereitung). Studies on the phylogeny of the subgenera *Acutipula* Alexander, *Platytipula* Matsumura, *Tipula* Linnaeus and *Yamatotipula* Matsumura, with special references to the male genitalia.
- Jong, W. H. de, 1925. Een studie over emelten en hare bestrijding. — Verh. Mededel. Plantenz. Dienst Wageningen 42: 1—108.
- Kertész, C., 1902. Catalogus Dipteriorum 2. — Guilelmus Engelmann, Lipsiae.
- Lackschewitz, P., 1930. Die *oleracea*-Gruppe des Genus *Tipula*. — Konowia 9: 257—278.
- Jackson, D. M., & R. L. Campbell, 1975. Biology of the European crane fly, *Tipula paludosa* Meigen, in western Washington. — Wash. St. Univ. Tech. Bull. 81: 1—23.
- Loew, H., 1866. Beschreibung einiger afrikanischen Diptera nematocera. — Berl. ent. Ztg. 10: 55—62.
- Loi, G., 1964. *Tipula venturii* n.sp. — Frustula ent. 7, 2: 1—5.
- Mannheims, B., 1950. Die *Tipula oleracea*-Gruppe in Europa, ein Beispiel für Formenkreis-Parallelismus. Syllegomena biologica. Festschrift Kleinschmidt: 231—247. — Leipzig, Wittenberg/Lutherstadt.
- , 1952. Subgenus *Tipula*. In: Mannheims, B. & Br. Theowald, Tipulidae. — Fliegen palaearkt. Reg. 3, 5, 1: 74—96.
- , 1954. Die Tipuliden Ostfennoskandiens. — Not. Ent. 34: 29—50.
- , 1958. Ostafrikanische Tipuliden. — Stuttg. Beitr. Naturk. 6: 1—12.
- , 1961. Afrikanische Tipuliden. — Stuttg. Beitr. Naturk. 60: 1—6.
- , 1962. Die Tipuliden Madeiras. — Notul. ent. 42: 130—136.
- , 1964. Tipuliden und Limoniiden aus Südwest-Häme (Finnland). — Lounais-Hämeen Luonto 15: 20—22.
- Meigen, J. W., 1818. Systematische Beschreibung der bekannten Europäischen zweiflügeligen Insekten 1: 1—XXXVI, 1—259. — Aachen.
- , 1830. Idem 6: I—XI, 1—401.
- Pierre, C., 1921. IV Diptères. In: Faune entomologique des Isles Canaries. — Bull. Mus. Nat. Hist. nat. Paris 27: 298—301.
- Riedel, M. P., 1914. Nematocera Polyneura. In: Voyage de Ch. Alluaud et R. Jeannel en Afrique orientale (1911—1912). Résultats scientifiques. Insectes Diptères 3: 69—100. — Paris.
- Savtshenko, E. N., 1961. Tipulidae. In: Faune SSSR, N.S. 79: 1—486. — Akademii Nauk SSSR, Moskwa, Leningrad.
- , 1966. Tipulidae. In: Fauna Ukraini 14 (1): 1—550. — Kiev.
- , 1979. Phylogenie und Systematik der Tipulidae. — Tijdschr. Ent. 122: 91—126. (Savtshenko, E. N., 1966: 63—88, aus dem ukrainischen bearbeitet von B. Theowald & G. Theisinger).
- Schiner, J. R., 1864. Fauna Austriaca, Die Fliegen (Diptera) 2: I—XXXII, 1—658. — Wien.
- Simova, D., 1977. Diptères Tipulides. In: Faune de Macedoine 3: 1—198. — Musée d'Histoire naturelle, Skopje.
- Speiser, P., 1909. Orthorhapha Nematocera. In: Sjöstedt, B. Y. (ed), Wissenschaftliche Ergebnisse der schwedischen zoologischen Expedition nach dem Kilimandjaro, dem Meru und den umgebenden Massaisteppen Deutsch-Ostafrikas 1905—1906. 10, 4: 31—65. — Stockholm.
- Staeger, C., 1840. Systematisk fortegnelse over de i Danmark hidtil fundne Diptera, 2: Tipulidae terricolae. — Naturh. Tidsskr. 3: 1—58.
- Theowald, Br., 1972. Die Tipuliden der kanarischen Inseln. — Bull. Zool. Mus. Un. Amsterdam 2: 135—146.
- , 1977a. Die ungeflügelten afrikanischen Arten der Untergattung *Tipula* mit Beschreibung einer neuen Art aus Ethiopien. — Bull. Zool. Mus. Un. Amsterdam 6: 53—57.
- , 1977b. Die Tipuliden von Makaronesien. Ein systematischer und zoogeographischer Beitrag zur Kenntnis von Inselfaunen. — Beaufortia 26: 153—204.
- , 1983. *Tipula (Acutipula) schulteni* nov. spec. aus dem afrotropischen Region. — Bull. Zool. Mus. Un. Amsterdam 9: 137—141.
- Tjeder, B., 1941. Some thirty additions to the Swedish Fauna. — Opusc. ent. 6: 56—63.
- , 1953. The identity of *Tipula oleracea* L. — Opusc. ent. 18: 111—115.
- Vály, A., 1982. Data to the knowledge of the Tipulids of Hungary. — Fol. ent. hung. 43: 251—253.
- Vermoolen, D., 1983. The *Tipula (Acutipula) maxima* group. I. Taxonomy and Distribution. — Bijdr. Dierk. 53: 49—81.
- , (in Vorbereitung). The *Tipula (Acutipula) maxima* group. II Phylogeny and Biogeography. — Bijdr. Dierk.
- Wiedemann, C. R. G., 1820. Diptera exotica. I—XIX, 1—244. — Kiliae.
- , 1828. Außereuropäische zweiflügelige Insekten 1: I—XXXII, 1—608. — Hamm.
- Wood, H. G., 1952. The crane-flies of South-West Cape. — Ann. S. Afr. Mus. 39: 1—327.

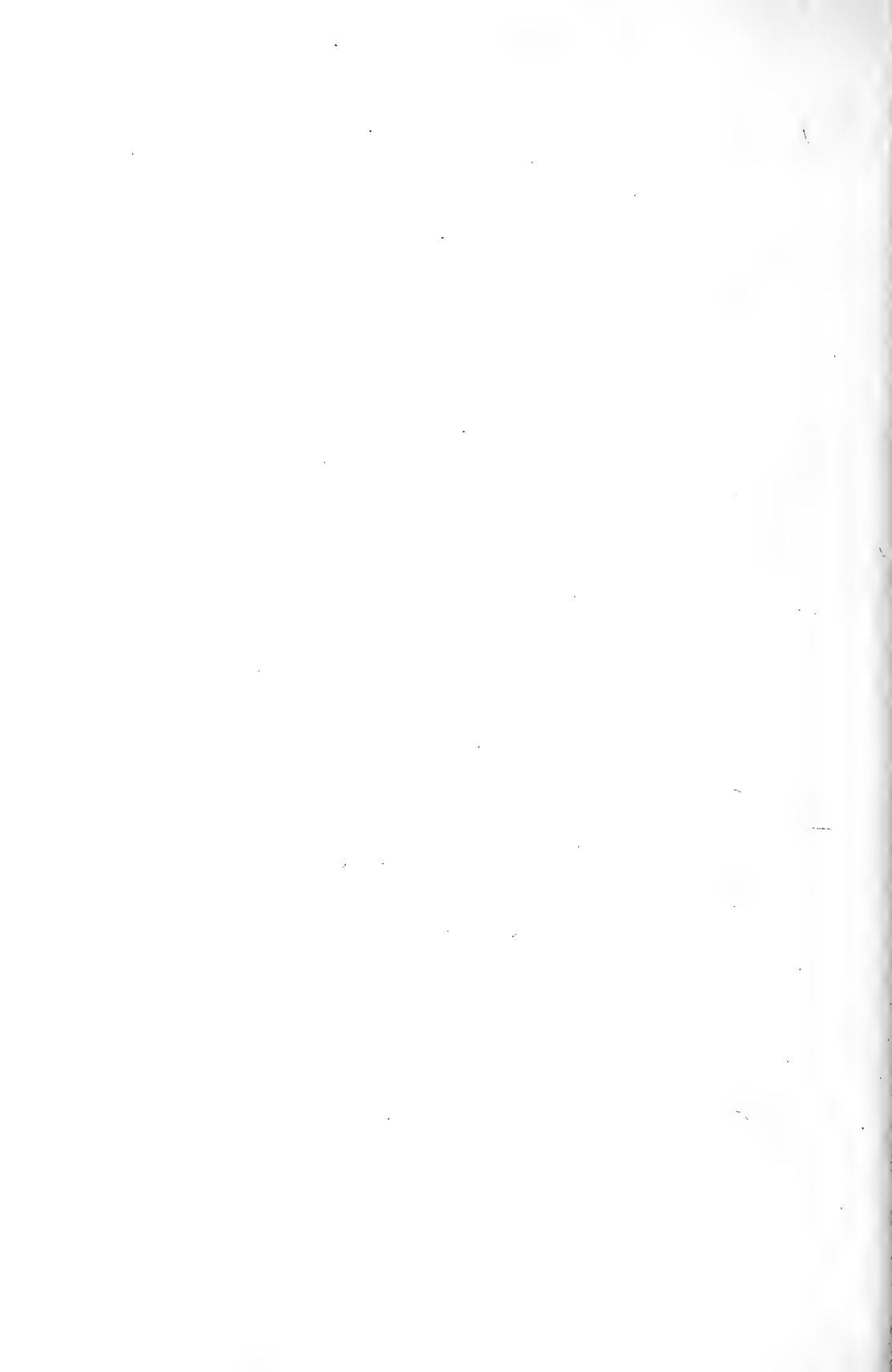



TIJDSCHRIFT VOOR ENTOMOLOGIE

UITGEGEVEN DOOR

DE NEDERLANDSE ENTOMOLOGISCHE VERENIGING

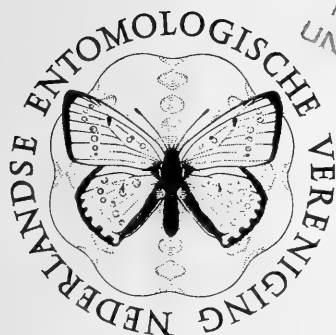

MUS. COMP. ZOOLOG.
LIBRARY
JAN 16 1985
HARVARD
UNIVERSITY

INHOUD

JEAN BELLE. — A synopsis of the South American species of *Phyllogomphoides*, with a key and descriptions of three new taxa (Odonata, Gomphidae), pp. 79—100, figs. 1—40.



A SYNOPSIS OF THE SOUTH AMERICAN SPECIES OF *PHYLLOGOMPHOIDES*, WITH A KEY AND DESCRIPTIONS OF THREE NEW TAXA (ODONATA, GOMPHIDAE)

by

JEAN BELLE

Onder de Beumkes 35, Velp, the Netherlands

ABSTRACT

A synopsis is given of the 25 representatives of the genus *Phyllogomphoides* Belle known from South America. The species are classified into eight groups, and a key to these species is given. Three taxa are introduced as new, viz., *Ph. major* (♂ holotype and ♀ allotype: Surinam River, Surinam), *Ph. pedunculus* (♂ holotype: Rio Uaupés, Amazonas, Brazil), and *Ph. pseudoundulatus* (♂ holotype: Rio Tapajós (Cachoeira I), Pará, Brazil). Descriptive and corrective notes on some of the previously described species are offered. The holotypes of *Gomphoides fuliginosa* Hagen in Selys and *Gomphoides audax* Hagen in Selys have been restudied. A neotype has been designated for *Gomphoides selysi* Navás and the female is described for the first time.

CONTENTS

	Page		Page
Introduction	79	Calverti Group	92
Acknowledgements and disposition of material studied	80	<i>Ph. calverti</i> (Kirby)	92
Systematic section	80	<i>Ph. camposi</i> (Calvert)	93
Keys to the South American species of <i>Phyllogomphoides</i>	81	<i>Ph. singularis</i> Belle	93
Fuliginosus Group	83	Annectens Group	93
<i>Ph. fuliginosus</i> (Hagen in Selys)	84	<i>Ph. annectens</i> (Selys)	93
<i>Ph. audax</i> (Hagen in Selys)	85	<i>Ph. regularis</i> (Selys)	93
<i>Ph. selysi</i> (Navás)	86	Cornutifrons Group	94
<i>Ph. imperator</i> Belle	87	<i>Ph. cornutifrons</i> (Needham)	94
<i>Ph. praedatrix</i> Belle	87	References	94
<i>Ph. major</i> spec. nov.	87		
Cristatus Group	88		
<i>Ph. cristatus</i> (Needham)	89		
Andromeda Group	89		
<i>Ph. andromeda</i> (Selys)	89		
<i>Ph. cassiopeia</i> (Belle)	89		
<i>Ph. cepheus</i> Belle	89		
Undulatus Group	89		
<i>Ph. undulatus</i> (Needham)	90		
<i>Ph. atlanticus</i> (Belle)	90		
<i>Ph. aculeus</i> Belle	90		
<i>Ph. angularis</i> Belle	90		
<i>Ph. pedunculus</i> spec. nov.	90		
<i>Ph. pseudoundulatus</i> spec. nov.	91		
Semicircularis Group	91		
<i>Ph. semicircularis</i> (Selys)	91		
<i>Ph. lieftincki</i> (Belle)	92		
<i>Ph. brunneus</i> Belle	92		

INTRODUCTION

The genus *Phyllogomphoides* Belle, 1970, comprises about forty species distributed all over the tropical parts of the New World, ranging from South Brazil, Paraguay and Bolivia northward through Central America to the southern and western borders of Texas in the USA. The species are predominantly forest dwellers, which avoid cultivated areas. Although little is known of the ecology of any of the species, such field observations as have been recorded indicate that their larvae live in the small and large streams which cross the forests. Most of the males stay near the banks of the streams which gave them birth, but the females move into the forest and visit only again their parent streams for ovipositing. Hence females are particularly rare in collections. Of the 25 species known from South America, the females

of nine and the males of three species are unknown. Our knowledge of the genus is decidedly scanty and it is virtually certain that several species wait to be discovered in the extensive jungles of the area involved. As Donnelly (1979) recently treated the Central American representatives of this genus, I have confined myself to the South American congeners in order to avoid reiterations. Also it seems unnecessary to recapitulate the generic characters of *Phyllogomphoides* since it has recently been compared with *Gomphoides* by Gloyd (1973) and Belle (1982), and with *Idiogomphoides* by Belle (1984).

Three new taxa have been detected, bringing the number of South American representatives of *Phyllogomphoides* up to 25. These three species are here described under the specific names *major*, *pedunculus* and *pseudoundulatus*. A neotype for *Phyllogomphoides selysi* (Navás) is designated as it appears necessary to stabilize its identity. The previously unknown female of this species is also described.

The Comstock-Needham nomenclature for the longitudinal veins is used. With the exception of figs. 31 and 32, all illustrations are original camera lucida drawings (details completed by free hand) or have been made from photographs (wings), while the figures representing colour patterns of the labrum and the pterothorax are diagrammatic and not drawn on scale.

ACKNOWLEDGEMENTS AND DISPOSITION OF MATERIAL STUDIED

I am indebted to many persons who have sent specimens on loan. The material studied for the preparation of this paper belongs to the institutions and personal collections mentioned below. The names are preceded by the acronyms used throughout the text of this paper, those of the collections in the institutions are proposed by Heppner & Lamas (1982).

- AC — Author's collection.
 ANSP — Academy of Natural Sciences, Philadelphia; Dr. Daniël Otte.
 BMNH — British Museum (Natural History), London; Mr. Peter H. Ward.
 CJ — Collection Jurzitza, Karlsruhe; Prof. Dr. Gerhard Jurzitza.
 CM — Collection Machado, Belo Horizonte; Prof. Dr. Angelo B. M. Machado.
 CU — Cornell University, Ithaca; Prof. Dr. L. L. Pechuman.

- FSCA — Florida State Collection of Arthropods, Gainesville; Prof. Dr. Minter J. Westfall, Jr.
 IRSN — Institut Royal des Sciences Naturelles, Brussels; Dr. Georges Demoulin.
 UCV — Instituto de Zoología Agrícola, Universidad Central de Venezuela, Maracay; Dr. Janis Rácenis (†) and Mr. Jorge De Marmels.
 MCZ — Museum of Comparative Zoology, Harvard University, Cambridge; Mr. Charles Vogt.
 RNHL — Rijksmuseum van Natuurlijke Historie, Leiden; Dr. Pieter H. van Doesburg.
 USNM — National Museum of Natural History (formerly United States National Museum), Smithsonian Institution, Washington, D.C.; Dr. Oliver S. Flint, Jr.
 NHMV — Naturhistorisches Museum, Vienna; Dr. A. Kaltenbach.
 SMF — Senckenberg Museum, Frankfurt-am-Main; Dr. Heinz Schröder.
 UMAA — University of Michigan, Ann Arbor; Dr. T. W. Moore.
 ZMHB — Zoologisches Museum, Humboldt Universität, East Berlin; Dr. Kurt K. Günther.
 ZMUH — Zoologische Institut und Zoologisches Museum, Universität von Hamburg, Hamburg; Prof. Dr. H. Strümpel.

Valuable information and help were also given by Mr. Carl Cook (Center), Dr. M. G. Emsley (Philadelphia), Mrs. Leonora K. Gloyd (Ann Arbor), and Dr. Jean Legrand (Paris).

SYSTEMATIC SECTION

The genus *Phyllogomphoides* belongs to the Gomphoidinae, together with the genera *Progomphus*, *Aphylla*, *Phyllocycla*, *Gomphoides*, and *Idiogomphoides*. It is a rather heterogeneous unit which is readily separated from *Progomphus* in having the male anal triangle in the hind wing reaching the hind angle of the wing, from *Aphylla* by the presence of two long flagellae at the glans of the penis, from *Phyllocycla* in not having the outer side of these flagellae fringed with microscopic serratures, and from *Gomphoides* and *Idiogomphoides* in having, in the hind wing of the male, vein A2, or a branch of it, convergent with vein A3 towards the wing margin. The larvae of *Phyllogomphoides* exhibit considerable differences in the structure of their

labia, and there seems to exist some parallelism with the morphology of the adult dragonfly. Based on these labial structures the genus is divisible into at least three sections (cf. Belle, 1982). In the present study the species are divided into eight infrageneric groups, the proposed groupings being based on similarities found in the form of the caudal appendages and accessory genitalia of the adult male and the labium of the larva. I am well aware that this division must be considered provisional. At this stage, it is difficult to determine the natural position of these groups within the genus since a given group frequently appears to display close relationships with several other groups. For the purpose of identification, however, it is more convenient to keep the adults united and combine them in one key. The species have several characters in common but the great diversity in the male caudal appendages and the genital organs shows that they are not all closely related. This variety is sufficiently indicated in the key to the species.

Separate keys have been prepared for the determination of males and females. The keys should be used with caution as a number of species is known only from a single specimen or

from one sex. Identifications should always be checked against the complete descriptions.

The groups have been treated in such a sequence as to allow expression of apparent relationships. Within each group, however, the species are treated chronologically. For each species are given a list of references, drawings and locality records, the new material studied, and a description or descriptive notes. References without comments or critical remarks have been omitted.

Table 1 lists all species presently known from South America, including the new taxa introduced in the present paper.

KEY TO THE SOUTH AMERICAN SPECIES OF
PHYLLOGOMPHOIDES
Males

(The males of *audax*, *cornutifrons*, and *praedatrix* are unknown)

1. Anterior hamules conch-shaped *singularis*
- Anterior hamules of other structure 2
2. Superior caudal appendages, in dorsal view, tweezers-shaped; each appendage more or

Table 1. — Alphabetic list of names of the South American species of *Phyllogomphoides*, with type status and type location.

Species	Type					
	holo	lecto	lost	neo	sex	location
1. <i>aculeus</i> Belle, 1982	X				♂	UMAA
2. <i>andromeda</i> (Selys, 1869)	X				♀	IRSN
3. <i>angularis</i> Belle, 1982	X				♂	UMAA
4. <i>annectens</i> (Selys, 1869)		X			♂	IRSN
5. <i>atlanticus</i> (Belle, 1970)	X				♂	RNHL
6. <i>audax</i> (Hagen in Selys, 1854)	X				♀	ZMHB
7. <i>brunneus</i> Belle, 1981	X				♂	FSCA
8. <i>calverti</i> (Kirby, 1897)	X				♂	BMNH
9. <i>camposi</i> (Calvert, 1909)	X				♂	ANSP
10. <i>cassiopeia</i> (Belle, 1975)	X				♂	USNM
11. <i>cephesus</i> Belle, 1980	X				♂	CM
12. <i>cornutifrons</i> (Needham, 1944)	X				♀	CU
13. <i>cristatus</i> (Needham, 1944)	X				♂	CU ?
14. <i>fuliginosus</i> (Hagen in Selys, 1854)	X				♀	MCZ
15. <i>imperator</i> Belle, 1976	X				♀	UCV
16. <i>lieftincki</i> (Belle, 1970)	X				♂	RNHL
17. <i>major</i> spec. nov.	X				♂	RNHL
18. <i>pedunculus</i> spec. nov.	X				♂	CM
19. <i>praedatrix</i> Belle, 1982	X				♀	UMAA
20. <i>pseudoundulatus</i> spec. nov.	X				♂	SMF
21. <i>regularis</i> (Selys, 1873)	X				♂	IRSN
22. <i>selysi</i> (Navás, 1924)	(X)		X	X	♂	ANSP
23. <i>semicircularis</i> (Selys, 1854)	X				♂	IRSN
24. <i>singularis</i> Belle, 1979	X				♂	FSCA
25. <i>undulatus</i> (Needham, 1944)	X				♂	CU

- less straight over whole length but slightly curving inward near apex 3
- Superior caudal appendages, in dorsal view, forcipate; each appendage strongly curving inward 5
3. Pale collar of thoracic dorsum and second pale antehumeral stripes absent or vestigial *andromeda*
- These stripes well-developed 4
4. Face green with black band along free border of labrum *cassiopeia*
- Face black with green markings on clypeus and labrum *cephews*
5. Anterior hamules of very complicated form, with bulbous frontal part, lateral leaf-like expansion, and backwardly elongated apex 6
- Anterior hamules of more simple structure 9
6. Inferior caudal appendage very short and deeply excised V-shaped *major*
- Inferior caudal appendage about half as long as superiors and divided shortly beyond its base into two branches 7
7. Second pale antehumeral stripes and pale metepisternal stripes absent or vestigial *imperator*
- These stripes well-defined 8
8. Large species; abdomen 56—57 mm (incl. caud. app.), hind wing 42 mm, costal edge of pterostigma in fore wing 5.5—5.8 mm. Pale basal marking of abdominal segment 7 covering far more than one-third of the segment *selysi*
- Smaller species; abdomen 50—54 mm (incl. caud. app.), hind wing 36—37 mm, costal edge of pterostigma in fore wing 4.8—5.0 mm. Pale basal marking of abdominal segment 7 covering one-third of the segment *fuliginosus*
9. Superior caudal appendage with two ventral processes on proximal half 10
- Superior caudal appendage without or with a single ventral process on proximal half 11
10. Lateral dilatations of abdominal segment 8 well-developed, leaf-like, and strongly convex *camposi*
- Lateral dilatations of abdominal segment 8 narrow and parallel-sided on apical half of segment *calverti*
11. Superior caudal appendage with a long, thin, finger-like basal-ventral spine 12
- Superior caudal appendage without or with a small basal-ventral spine or tooth 17
12. Superior caudal appendage strongly turning downward to tip, apex obtuse 13
- Superior caudal appendage not turning downward to tip, apex acute 14
13. Length of penial cornua half the length of abdominal segment 3. First pale antehumeral stripe broadly confluent with pale collar (fig. 17) *pseudoundulatus*
- Length of penial cornua two-thirds the length of abdominal segment 3. First pale antehumeral stripes isolated (fig. 16) *undulatus*
14. Posterior margin of anterior hamules with an acute hook. Subtriangle in hind wings uncrossed 15
- Posterior margin of anterior hamules with an excision. Subtriangle in hind wings crossed 16
15. Penial peduncle (seminal vesicle) slender and excessively elongated, being about half the length of abdominal segment 2 (fig. 36) *pedunculus*
- Penial peduncle shorter, being about one-third the length of abdominal segment 2 *angularis*
16. Superior caudal appendage with a superior tooth at about two-thirds the length *atlanticus*
- Superior caudal appendage without superior tooth *aculeus*
17. Inferior caudal appendage well-developed and divided shortly beyond its base into two branches 18
- Inferior caudal appendage very short and excised more or less V-shaped 19
18. Cornua of penis distinctly shorter than median segment of penis (fig. 27). Inferior caudal appendage with bottom of excision as wide as length of either branch. *regularis*
- Cornua of penis about as long as median segment of penis. Inferior caudal appendage with the length of either branch one and a half times the width of bottom of excision *annectens*
19. Superior caudal appendage with a superior tooth at about two-thirds the length 20
- Superior caudal appendage without superior tooth *cristatus*
20. Anterior hamules notched at inner margin *semicircularis*
- Anterior hamules notched at posterior margin 21
21. Labrum with a pair of pale spots *leftincki*
- Labrum entirely brown *brunneus*

Females

(The females of *aculeus*, *angularis*, *annectens*, *atlanticus*, *calverti*, *camposi*, *pedunculus*, *pseudoundulatus* and *singularis* are unknown)

1. Frons with a pair of large horns *cornutifrons*
- Frons without horns 2
2. Pale collar absent; first pale antehumeral stripe more or less pear-shaped oblong *andromeda*
- Pale collar present; first pale antehumeral stripe of different shape 3
3. Abdominal segment 8 with distinct lateral dilatations 4
- Abdominal segment 8 without or with no evident lateral dilatations 12
4. Width of lateral dilatations of abdominal segment 8 a quarter the middorsal length of segment 8 or wider (figs. 5, 8) 5
- Width of lateral dilatations of abdominal segment 8 one-sixth the middorsal length of segment 8 or narrower 10
5. Second pale antehumeral stripe and pale metepisternal stripe present 6
- These stripes undeveloped or vestigial *imperator*
6. Labrum largely pale, with a black band along free border *cassiopeia*
- Labrum with a pair of pale spots 7
7. Vulvar lamina very widely excised; the excision more or less semicircular; the lobes rather narrow and bluntly tipped *praedatrix*
- Vulvar lamina not very widely excised; the lobes broad 8
8. Pterostigma 6—7 mm long; excision of vulvar lamina more or less U-shaped (fig. 12); width of lateral dilatations of abdominal segment 8 nearly half the middorsal length of segment 8 *major*
- Pterostigma 5—6 mm; excision of vulvar lamina more or less V-shaped; width of lateral dilatations of abdominal segment 8 about one-third the middorsal length of segment 8 9
9. Large species; abdomen 55—56 mm (incl. cerci); hind wing 43 mm; lobes of vulvar lamina with projecting postero-lateral corners (fig. 10) *selysi*
- Smaller species; abdomen 51—53 (incl. cerci); hind wing 37—38 mm; lobes of vulvar lamina with round postero-lateral corners (fig. 9) *fuliginosus*
10. Large species; abdomen 50 mm (incl. cerci);

- hind wing 43 mm; vulvar lamina relatively small, its width about one-third the width of ninth sternum (fig. 11) *audax*
- Smaller species; vulvar lamina relatively wider 11
 - 11. Lateral dilatations of abdominal segments 8 and 9 equal in width; dorsum of prothorax with a pale twin-spot *undulatus*
 - Lateral dilatations of abdominal segment 8 twice as wide as that of abdominal segment 9; dorsum of prothorax entirely black *cephesus*
 - 12. Labrum black along free border *cristatus*
 - Labrum pale, green of (reddish) brown along free border 13
 - 13. Labrum entirely (reddish) brown 14
 - Labrum largely pale or with a pair of pale spots 15
 - 14. Dorsum of prothorax entirely black; vulvar lamina excised V-shaped for two-thirds its length *semicircularis*
 - Dorsum of prothorax with yellow twin-spot; vulvar lamina excised V-shaped for three-quarters its length *brunneus*
 - 15. Labrum (reddish) brown with a pair of pale spots *lieftincki*
 - Labrum entirely or largely pale *regularis*

FULIGINOSUS GROUP

The members of this infrageneric group are *fuliginosus*, *audax*, *selysi*, *imperator*, *praedatrix* and *major*. They are bound together by several striking features, in the adults as well as in the larvae, and there are some grounds for believing that a generic separation would be justifiable. The characters not encountered elsewhere in the genus are: (1) the regular division of both triangles and subtriangles into four cells in the fore wings and three in the hind (figs. 1—4); (2) the very peculiar conformation of the anterior genital hamule of the male (cf. Belle, 1970a: 112); (3) the aberrant form of the penial cornua, each cornu having the tip truncate and the apical margin concave (figs. 24, 25); (4) the different development of the lateral dilatations of the eighth abdominal segment in both sexes of the same species, those of the female being somewhat better developed than those of the corresponding male (from the same locality); and in the larva, (5) the striking structure of the lateral labial lobes having the inner margin smooth and slightly expanded on the apical half, and the end hook very large, sinuously pointed and sharply incurved.

The members *fuliginosus*, *audax*, *praedatrix*

and *major* have the usual thoracic colour pattern but in *selysi* the pale markings are more extended and in *imperator* the second pale antehumeral stripe and pale metepisternal stripe are undeveloped or vestigial.

The members of the *fuliginosus* group are known from the Amazon Basin, Mato Grosso, and the northern coastal area of South America.

There exists a certain confusion among some members of the *fuliginosus* group. In 1894, Selys referred ten specimens of *Phyllogomphoides* from (British) Guyana to the species *fuliginosus* and *audax* but expressed doubt about the correctness of his identification because he had not seen the female holotypes of the two species (loc. cit., page 178: "Il faudrait revoir les deux types de Hagen pour arriver à une certitude à cet égard"). Since I have been favoured to examine these types, I can set forth that the gomphids which he referred to *fuliginosus* belong to an undescribed species, here introduced under the specific name *major*, while the gomphids referred to *audax* are the true *fuliginosus*.

In the original descriptions (Selys, 1854), the measurements given for *fuliginosus* are "abdomen 53 mm; hind wing 38 mm" and those of *audax* "abdomen 49 mm; hind wing 44 mm". However, in Selys & Hagen's *Monographie des Gomphines* of 1858 the measurements "abdomen 49 mm; hind wing 44 mm" are (incorrectly) associated with *fuliginosus* and the measurements "abdomen 53 mm; hind wing 38 mm" with *audax*. Selys, probably confused by this transposition, referred the species with the largest wings (*major*) to *fuliginosus* and the species with the smallest wings (*fuliginosus*) to *audax*, a mistake in placement that has persisted down to the present day. Selys, then, described both sexes of *major* and *fuliginosus* under the names *Gomphoides fuliginosa* and *Gomphoides audax*, respectively. Needham (1944), apparently being misled by Selys' misidentification, gave a very detailed description and illustrations of the male of *major*, in the belief that he had the true *fuliginosus* in his hands. Belle (1970a), finally, trusting the identifications of the previous authors, erected the genus *Phyllogomphoides* with *Gomphoides fuliginosa* Hagen in Selys, 1854, as the type species, basing his generic diagnosis on characters found in the adult male and larva of both *major* and *fuliginosus* but thinking to have before him the species *fuliginosus* and *audax*, respectively. In size, *major* ap-

proaches *audax* but in its morphology, it differs considerably from that species.

Phyllogomphoides fuliginosus

(Hagen in Selys, 1854)

(figs. 1, 5, 9, 14, 20, 24, 38)

Gomphoides fuliginosa Selys, 1854: 74, 75 (55—56 sep.) — ♀ Essequibo, Chile = error pro Guyana (cf. Ris, 1904: 16). Selys & Hagen, 1858: 450, 451, 463, 471—474 (190, 191, 203, 211—214 sep.), pl. 11 figs. 5a—d (♀ occiput, genit. & apex abd.). Navás, 1916: 70 (key). Belle, 1970a: 112 (type species). Gloyd, 1974: 180.

Gomphoides audax; Selys, 1894: 176—178 (♂ ♀ Guyana).

Phyllogomphoides audax; Belle, 1970a: 116—119 (♂ Surinam), figs. (♂ genit., app. & apex abd.; larval struct.), pls. 15b (♂ photogr. wings), 16b (photogr. exuviae).

Material (in addition to that recorded by Belle, 1970a under *audax*). — Guyana: Demerara, 2 ♂, IRSN. — Venezuela: Territorio Federal Amazonas, Sanariapo, 23 March 1957, 1 ♀, J. Rácenis leg. (No. JR-03098); Puerto Ayacucho, 15—21 November 1982, 1 ♂, A. Chacon & G. Yopez leg. (No. 14420); same locality, 21 November 1982, 1 ♂, G. Romero leg. (No. 14421); same locality, 28 October 1983, 1 ♀, J. Sanchez leg. (No. 14433), UCV.

The description of this species has been based on a single female. The holotype, formerly stored in the Museum of Copenhagen, is now in the Museum of Comparative Zoology at Cambridge, Massachusetts (MCZ type No. 12378). The female is dry pinned. The labels attached to the pin of the specimen are "Hagen" (white label, printed), "*fuliginosa*" (white label, written), "Essequibo, Schmidt" (white label, written), and "Type 12378" (red museum label, printed). I have added the pin label "*Phyllogomphoides fuliginosus* (Hagen in Selys, 1854) comb. nov. Holotype Rev. J. Belle, 1984".

The type specimen lacks the abdominal segment 8 with the specifically distinctive vulvar lamina. The tip of the abdomen (i.e. segments 9 and 10) is mounted on the label "Essequibo, Schmidt". The stylets (cerci) are broken off and glued onto the apical part of the ultimate segment but not in the original position. Nearly all hairs of the occipital ridge are broken off and lost. The hind wing (fig. 1) is 38 mm long, its greatest width 10.2 mm, and its pterostigma 6 mm (costal edge 5.6 mm). Other measurements

are to be found in the Monographie des Gomphines under *audax*.

The labrum of the type has a pair of large, subtriangular yellow spots (fig. 20). The occipital ridge is slightly concave (fig. 38), and there is a large, yellow central spot on the rear of the occiput. The venation of the wings is blackish brown, including the frontal margin of the costae. The nodal index is 14:21—21:14/15:14—16:15 in fore and hind wings, respectively. The hind wings have a two-celled anal loop and the area posterior to vein Cu2 is four cells wide with an extra cell for a fifth row in the left hind wing. The veins Cu1 and Cu2 are slightly divergent towards the hind wing margin, i.e. there are three marginal cells between Cu1 and Cu2 in the left hind wing and four in the right.

In 1894, Selys gave descriptions (communicated by Mac Lachlan) of both sexes of *fuliginosus* (under the name *Gomphoides audax*), the descriptions being based on four males and one female from Guyana. After the descriptions he enumerated the differences between *fuliginosus* and *major* (under the names *Gomphoides audax* and *Gomphoides fuliginosa*, respectively). Belle (1970a) published illustrations of the male of *fuliginosus* (under the name *Phyllogomphoides audax*).

The two males in the Institut Royal des Sciences Naturelles at Brussels may have belonged to the Mac Lachlan collection. The pin labels of these males read "Demerara" and "*Gomphoides audax?* Hag. ♂". One of the males has more over two pin labels "103".

Dimensions of *fuliginosus*. Males from Surinam: total length 65—69 mm; abdomen 50—53.5 mm (incl. app. 3.4 mm); fore wing 37—38 mm; hind wing 36—37 mm; greatest width of hind wing 10 mm; costal edge of pterostigma in fore wing 4.8—5.0 mm. For the males from Venezuela these numbers are 62—63; 49 (3.3); 34—35; 33—34; 9.5; 4.5—4.6. For the Venezuelan female from Sanariapa: 64; 51 (2.1); 38.5; 37; 10.2; 5.3. For the Venezuelan female from Puerto Ayacucho: 62; 49 (2.5); 36; 34.5; 9.6; 4.9. Thus we see that the specimens from Venezuela are somewhat smaller than those from Guyana and Surinam.

Phyllogomphoides audax

(Hagen in Selys, 1854)

(figs. 2, 7, 11, 22, 39)

Gomphoides audax Selys, 1854: 75 (56 sep.) — ♀ Brazil. Selys & Hagen, 1858: 473, 474 (213, 214 sep.), pl. 11 figs. 6a—d (♀ occiput, genit. & apex abd.).

The description of this species has also been based on a single specimen. It is a female probably taken in Pará, Brazil (cf. Selys, 1894: 178 "sans doute du Para"). The species seems to be a rare gomphid, only the type being known so far. The holotype, stored in the Zoologisches Museum der Humboldt-Universität at East Berlin, is dry pinned. The pin labels are "2325" (white label, printed), "Type?" (red label, printed but question mark written), "Brasil" (green label, written), "*audax* Hag." (green label, written), "Zool. Mus. Berlin" (yellow label, printed; on reverse side written "I"), and "*Gomphoides audax* (Selys) Type?" (white label, written). The question marks are wrong since this female is the only known specimen of this species. I have added the pin label "*Phyllogomphoides audax* (Hagen in Selys, 1854) comb. nov. Holotype Rev. J. Belle, 1984".

The type specimen is in a fairly good condition. The colour pattern of the pterothorax is somewhat obliterated due to post mortem changes. The first pair of legs and the left second leg are missing. The right stylet (cercus) and the tip of the left stylet are broken off and lost. The lateral dilatations of the abdominal segment 8 are narrow, the width being only one-sixth the middorsal length of the segment (fig. 7). The labrum is largely yellow (fig. 22); in other members of the *fuliginosus* group with a pair of yellow spots. The occipital ridge is almost straight (fig. 39) and there is a large, yellow central spot on the rear of the occiput. The thoracic colour pattern is similar to that of *fuliginosus*. The venation of the wings is blackish brown, including the frontal margin of the costae. The nodal index is 12:21—21:13/13:16—15:13. The hind wings have the anal loop three-celled, the area posterior to vein Cu2 five to six cells wide, and the veins Cu1 and Cu2 markedly divergent towards the wing margin. The vulvar lamina (fig. 11) is rather small; its breadth is nearly one-third the width of the ninth sternum and its length is two-sevenths of the length of the ninth sternum. The posterior margin of the vulvar lamina is more or less excised U-shaped. The dimensions of the type are: total length 66 mm; abdomen 50 mm (incl. cerci); hind wing 43 mm; greatest

width of hind wing 11.5 mm; costal edge of pterostigma in fore wing 6.0 mm. These measurements are in agreement with those given in the original description of 1854 and with those given in the Monographie des Gomphines of 1858 for *fuliginosus*. The smallest of both species is *fuliginosus* but the difference appears greater than a mere comparison of hind wing lengths might imply.

Phyllogomphoides selysi (Navás, 1924)
(figs. 4, 6, 10, 15, 21)

Gomphoides selysi Navás, 1924: 318, 319 (6, 7 sep.), fig. (♂ apex abd.) — ♂ Iquitos, Brazil.

Gomphoides fuliginosa; Needham, 1944: 195 (♀ Brazil).

Phyllogomphoides selysi; Belle, 1970b: 254, 255, fig. (♂ apex abd.).

Material. — Peru: Dept. Loreto, Amazon River, San Juan (near Iquitos), August 1939, 2 ♂ (one of them neotype), Jose Schunke leg. (purchased from Joseph Hocking), ANSP. — Brazil: Amazonas, Amazon River (300 miles below Iquitos), 1 ♀, USNM.

In 1924, Navás added a third member of the *fuliginosus* group, *selysi*, from Peru, basing his description on a single male collected in Pebas at the Amazon River. No new record has appeared in the literature until now. In the collection of the Academy of Natural Sciences of Philadelphia there are two similar Peruvian males from the nearby environment of Iquitos, the type locality of *selysi*. Prof. Westfall (Gainesville), who detected the gomphids in the Philadelphia Academy collection, has generously turned them over to me for study. They correspond closely with Navás' description and figure, except for the length of the insect and the length of the abdomen. Both lengths are about 8 mm greater for the present males. But the measurements given in that description, "Long. corp. 62.5 mm Long. abdom. 48 mm", are probably in error. It is virtually certain that one of the middle segments of the abdomen (which was obviously broken in fragments) was lacking or neglected during the measuring since the disparity in the length (8 mm) is about the length of each of these middle segments apart. Navás' *selysi* shows very close affinity with *fuliginosus* and the question arises even whether *selysi* should be considered a subspecies of *fuliginosus* or not.

Neotype designation of *Gomphoides selysi* Navás, 1924. — When I (Belle, 1970b) made a study of the Neotropical Gomphidae described by Navás, the holotype of *Gomphoides selysi* could not be re-examined because its location was unknown. Navás' collections at the Jesuit's Colegio de Salvador in Zaragoza were partly destroyed and the rest was divided up between the Colegio in Zaragoza and the Museo de Zoología at Barcelona (cf. Lieftinck, 1965: 56). The late Prof. Dr. B. Elwood Montgomery made a search for the types of Navás during his European trip of 1968. In the Barcelona Museum he succeeded in locating the types of four Neotropical Gomphidae out of five described by Navás but failed with the type of *selysi*. I have also written to the Museum of Zoology at Ann Arbor, Michigan, as Williamson had accumulated notes and drawings of types and specimens of *Phyllogomphoides* with the intention of monographing the genus. But in reply Mrs. Gloyd informed me that Navás' type of *selysi* had never been sent to Williamson for study. She kindly sent to me a xerox copy of a letter (dated December 15, 1931) to Williamson in which Navás wrote: "J'ai décrit encore deux espèces: *Selysi* du Pérou et *Eugeniae* de l'Argentine; je ne les trouve plus. Je pense que le *Selysi* se trouve dans le Muséum de Paris..." When I visited the Paris Museum in 1977 I did not find any gomphid that recalled to this type. I therefore asked (June 17, 1983) Dr. Legrand to make a search for it. This he kindly did but he wrote me on August 31, 1983 that all his efforts remained ineffective. All in all, there is no reasonable hope that this type specimen is still extant. The close relationship between this species and *fuliginosus*, however, makes it advisable to stabilize the identity of *Gomphoides selysi* Navás, 1924. A neotype is therefore designated here. The specimen selected is one of the two males from Peru recorded above, with the features summarized below.

Dimensions: total length 72 mm; abdomen 56.6 mm (incl. caud. app. 3.6 mm); fore wing 44 mm; hind wing 42 mm; costal edge of pterostigma in fore wing 5.9 mm.

Pale collar confluent with pale middorsal stripe and first pale antehumeral stripe. Thoracic colour pattern shaped as shown diagrammatically in fig. 15. Colour pattern of labrum similar to that of *fuliginosus*. Lateral dilatations of abdominal segment 8 very broad, the greatest

width of these lateral dilatations one-third the middorsal length of the segment.

Venation of wings blackish brown but frontal margin of costae with a fine yellow line. Nodal index 15 : 21—22 : 16/16 : 16—16 : 14. Discoidal triangle and subtriangle three-celled in hind wings, four-celled in fore wings except for three-celled triangle of left fore wing. Hind wings with a two-celled anal loop, the veins Cu1 and Cu2 sub-parallel and the area posterior to Cu2 four (proximal) to five (distal) cells wide.

The distinguishing features of the other male are: dimensions as in neotype male but costal edge of pterostigma in fore wing 5.5 mm; pale collar not confluent with pale middorsal stripe and first pale antehumeral stripes narrowed at their conjunction with pale collar; venational characters of wings as in neotype but all discoidal triangles and subtriangles in fore wings four-celled; nodal index 14 : 21—20 : 14/15 : 16—15 : 15.

Female (first description; colours somewhat obliterated; tips of right wings broken off and lost; abdomen bristled, broken between segments 4 and 5; lateral leaf-like expansions of abdominal segment 8 eaten by tropical scavengers (fig. 6); right cercus broken off and lost). — Total length 72 mm; abdomen 56 mm (incl. cerci 3.2 mm); hind wing 43 mm; greatest width of hind wing 11.5 mm; costal edge of pterostigma in fore wing 5.8 mm.

Colour pattern resembling that of neotype male but pale markings on labrum more rounded (fig. 21), first pale antehumeral stripes not distinctly connected with pale collar, and pale marking of abdominal segment 7 extended on basal half of segment only.

Wings hyaline, venation dark brown including frontal margin of costae. Membrane of wings at base with brown patches reaching to just beyond arculus (patches better developed than in the present males). Discoidal triangle and subtriangle four-celled in fore wings, three-celled in hind wings. Supratriangle three-celled in fore wings, two-celled in hind wings. Nodal index 16 : 24—23 : 16/19 : 17—20 : 18. Second anal interspace of hind wings with two rows of cells but that of left hind wing with three marginal cells. Anal loop in hind wings two-celled. Cu1 and Cu2 in either hind wing very slightly diverging towards wing margin.

Vulvar lamina one-fourth as long as ninth sternum, at base two-thirds the width of eighth

sternum, its posterior margin excised V-shaped; the lobes with projecting corners, the interval between lobes about 90° (fig. 10). Posterior margin of lateral dilatation of segment 9 with teeth. Stylet (cercus) somewhat longer than middorsal length of ninth segment, pale for its apical two-fifths.

Ph. selysi is stouter, more robust and larger than its nearest ally, *fuliginosus*. The difference in size is most striking. The consistent differences between the male caudal appendages of both species are very slight. The lateral leaf-like dilatations of the abdominal segment 8 are better developed than in *fuliginosus*, the greatest width of these expansions being one-third of the middorsal length of the segment, in *fuliginosus* only a quarter of the middorsal length of the segment. The two males have the first pale antehumeral stripes confluent with the pale collar, in *fuliginosus* they are not connected with the pale collar. And finally, the pale basal marking of the abdominal segment 7 reaches far beyond the submedian transverse groove, while in *fuliginosus* only to this groove. The female differs from *fuliginosus* in having the outer corners of the lobes of the vulvar lamina more produced.

Phyllogomphoides imperator Belle, 1976

Phyllogomphoides imperator Belle, 1976: 197—200, figs. (♀ occiput, thorax, genit. & apex abd.) — ♀ San Fernando de Atabapo, Venezuela.

Mr. Cook wrote to me on February 3, 1983, that he had a male of *imperator* from El Infierno, Territorio Federal Amazonas, Venezuela. The male's colour pattern is essentially the same as that of the female holotype of this species with the second pale antehumeral stripe and the pale metepisternal stripe undeveloped. In conformation, the male inferior caudal appendage resembles that of *fuliginosus* and *selysi* by the presence of well-developed branches. These data were communicated by Mr. Cook, who has generously given me permission to use them to construct the key for the genus. A description of the male by him is in progress.

Phyllogomphoides praedatrix Belle, 1982

Phyllogomphoides praedatrix Belle, 1982: 3—5, figs. (♀ thorax, genit., frons & apex abd.) — ♀ Abunã, Mato Grosso, Brazil.

Phyllogomphoides major spec. nov.

(figs. 3, 8, 12, 23, 25, 40)

Gomphoides fuliginosa; Selys, 1894: 175—178 (♂ ♀ Guyana). Needham, 1944: 195—197 (♂ Surinam, sub *fuliginosus*), pl. 15 figs. 8a—d (♂ genit., app. & apex abd.). St. Quentin, 1967: 138.

Negomphoides fuliginosa; Rácenis, 1970: 25, 26 (♂ Venezuela), fig. (♂ apex abd.).

Phyllogomphoides fuliginosus; Belle, 1970a: 113—115, 118, 119, figs. (♂ app. & apex abd.; larval struct.), pls. 15a (♂ photogr. wings), 16a (photogr. exuviae). Geijskes, 1971: 665 (♂ French Guyana). St. Quentin, 1973: 343 (♂ Pará, Brazil, sub *fuliginosa*). Gloyd, 1973: 6. Donnelly, 1979: 247, 248.

Material (in addition to that recorded by Belle, 1970a under *fuliginosus*). — Guyana: Demerara, 2 ♂, IRSN. — Surinam: Surinam River, Aroesobanja Falls, 5 January 1959, 1 ♀ (in copula), J. Belle leg.; Kabalebo River, Avanavero (bank of river), 22 August 1973, 2 ♂, D. C. Geijskes leg., RNHL. — Venezuela: Bolívar, Canaima, 20 February 1958, 1 ♂, J. Rácenis leg.; T. F. Amazonas, Cacuri del Ventuari, 21 February 1959, 1 ♂, Cruxent et al. leg.; Bolívar, Río Paramichí, 9 January 1962, 1 ♂, Brewer leg.; Bolívar, Región Alto Caura, Cuchine (300 m), 11 April 1963, 1 ♂, 1 ♀; same locality, 12 April 1963, 1 ♂, all collected during Expedition La Salle; Bolívar, Kanarakuni (450 m), 3 February 1965, 1 ♂, Dr. Capriks leg.; T. F. Amazonas, Puerto Ayacucho, Estación de Piscicultura Fonaiaip, 3 February 1983, 1 ♂, G. A. Romero leg.; Bolívar, Río Caroní, San Francisco de Las Babas, 7—13 April 1983, 1 ♂, J. de Marmels leg., UCV.

In 1894, Selys published descriptions (communicated by MacLachlan) of both sexes of *major* (under the name *Gomphoides fuliginosa*), based on four males and one female taken in Guyana. Needham (1944) redescribed in length and illustrated the male of *major* (under the name *Gomphoides fuliginosa*), basing his description on seven males from adjoining Surinam. Belle (1970a) gave illustrations of the adult male and a description of its larva from a reared female under the name *Phyllogomphoides fuliginosus*, all after specimens from Surinam.

In size, *major* can be compared with *audax* but the females of these species show striking differences. The veins Cu1 and Cu2 of the hind wings are sub-parallel in *major*; they diverge markedly towards the wing margin in *audax* (figs. 2, 3). The lateral leaf-like dilatations of abdominal segment 8 of *major* are much better developed than those of *audax*. The greatest width of these expansions is nearly half the middorsal

length of segment 8; in *audax* only one-sixth the middorsal length of segment 8 (figs. 7, 8). The labrum of *major* has the usual symmetric pair of yellow spots, while that of *audax* is largely yellow (figs. 22, 23). The male of *audax* is unknown but I think that it will present the same characteristics.

The chosen holotype of *major* is a male labeled "Surinam", "Surinam River, Gansee, 27 Sept. 1957, J. Belle leg.", and "*Phyllogomphoides major* spec. nov. Holotype ♂ Det. J. Belle, 1984". It is in the author's collection but eventually will be deposited in the Rijksmuseum van Natuurlijke Historie at Leiden together with all other types in his collection.

Some features of the holotype are: total length 77 mm; abdomen 58.5 mm (incl. caud. app. 4 mm); fore wing 45.5 mm; hind wing 44 mm; greatest width of hind wing 6.5 mm; costal edge of pterostigma in fore wing 6.3 mm. Venation of wings brown but frontal margin of costae yellow at base of wings. Discoidal triangle and subtriangle four-celled in fore wings, three-celled in hind wings. Supratriangle three-celled in fore wings, two-celled in hind wings. Nodal index 15 : 23—25 : 15/19 : 16—18 : 17. Hind wings with a four-celled (right) and five-celled (left) anal triangle, with a two-celled anal loop, with area posterior to Cu2 four to five cells wide, and with two marginal cells between Cu1 and Cu2 in either wing.

The males from Guyana may also have belonged to the MacLachlan collection. They have the pin labels "B. Demarara" and "*Gomphoides fuliginosa* Hag. ♂". One of the males moreover has two pin labels "102".

The other specimens formerly recorded by me under the name *Phyllogomphoides fuliginosus* (cf. Belle, 1970a) as well as the present ones should be considered paratypes. The superior caudal appendages of the males from Venezuela have the subapical, superior inner strip and the inferior inner tooth at one-third length generally longer and more acuminate than those of the males from Surinam.

CRISTATUS GROUP

The species *cristatus* does not fit satisfactorily into any of the groups discussed in this paper. It is classified here as a separate group. *Phyllogomphoides cristatus* resembles several other species of the genus but it is aberrant in the male caudal appendages by the simplified structure of the superiors which lack any protuberance, and

by the extremely reduced inferior. The penis resembles that of the *fuliginosus* group but the apical margin of the truncate cornua is not concave. The larva of this group and that of the *andromeda* group and *undulatus* group, discussed below, has the inner margin of the lateral labial lobe armed with a few blunt teeth.

Phyllogomphoides cristatus is known only from Surinam.

Phyllogomphoides cristatus (Needham, 1944)
(fig. 26)

Gomphoides cristatus Needham, 1944: 202—204, pl. 15 figs. 10a—c (♂ genit. & apex abd.) — ♂ Paroe River, Surinam. Calvert, 1948: 65, 66. Lieftinck, 1971: 82.

Phyllocycla (*Cyclophylla*) *cristatus*; St. Quentin, 1967: 142; 1973: 346 (key).

Negomphoides cristatus; Belle, 1970a: 126—130, figs. (♂ ♀ apex abd.; ♀ 3rd femur; larval struct.), pls. 17b (♂ photogr. wings), 18a (♀ photogr. wings), 21a (photogr. exuviae); 1982: 2.

Phyllogomphoides cristatus; Gloyd, 1973: 6.

Only the location of the right pair of wings of the male holotype of this species is known. According to Needham (1944) the type should be in the Academy of Natural Sciences of Philadelphia, but the staff of this institution was not able to locate it (Dr. Emsley 1966, pers. comm.). As Needham made his studies of 1944 in the Cornell University, Ithaca (New York), I wrote to Prof. Pechuman for information. He kindly made a search for the type in the Cornell collections and on August 17, 1982 informed me as follows: "*Gomphoides cristatus*. C.U. Type No. 3070. ♂ holotype, 2 wings only; probably Needham returned the rest of the specimen to Philadelphia; there is no locality data on slide with wings. ♀ allotype in an envelope; in our type book it is noted you saw the ♀ allotype and said it was *undulatus*". I have also asked Prof. Westfall (Gainesville) for the whereabouts of the type and he kindly replied on November 9, 1982: "I had no record of any specimen of *Gomphoides cristatus* Needham, 1944, in my notes. I have a list of all the type specimens in the Philadelphia Academy collection when I was there and the name does not appear in that list. I also made a list of the species represented in the collection and it is not there."

ANDROMEDA GROUP

This group is composed of the three species *andromeda*, *cassiopeia* and *cephus*. The feature

possessed in common is the more or less tweezers-shaped conformation of the male superior caudal appendages.

The wide range of *andromeda* is very striking; it covers the area from the northern coast of South America to the northern regions of Argentina. The distribution of the other two members of the group seems to be restricted to Paraguay and the Brazilian State of Mato Grosso.

Phyllogomphoides andromeda (Selys, 1869)
(fig. 28)

Cyclophylla andromeda Selys, 1869: 194, 195 (31, 32 sep.) — ♀ Caripi, Pará, Brazil. Calvert, 1948: 66 (*andromache* lapsus pro *andromeda*).

Phyllocycla andromeda; St. Quentin, 1973: 346, 347 (key; ♂ Goiás, Brazil).

Negomphoides andromeda; Belle, 1970a: 145—150 (♂ ♀ Surinam), figs. (♂ thor., occiput, genit. & app.; ♂ ♀ apex abd.; larval struct.), pls. 19b (♂ photogr. wings), 20a (♀ photogr. wings), 21c (photogr. exuviae). Geijskes, 1971: 665 (♂ ♀ French Guyana). Lieftinck, 1971: 73.

Phyllogomphoides andromeda; Gloyd, 1973: 6. Belle, 1977: 291 (sub *andromedae*). Jurzitza, 1981: 117 (Argentina, sub *andromedae*). Belle, 1982: 2 (sub *andromedae*).

Material. — Argentina: Misiones, Parque Nacional Iguazú, Apepú, 22 January 1979, 1 ♀ (AC), 3 ♀; 20 February 1979, 1 ♂, all G. Jurzitza leg. CJ. — Brazil: Pará, Rio Tapajós, Itaituba, April 1921, 2 ♂, 1 ♀, A. H. Fassl leg., SMF. — Surinam: Coppename River, Raleigh Falls (on light), 7 March 1972, 1 ♀, D. C. Geijskes leg., RNHL. — Venezuela: T. F. Amazonas, Piedras Pintadas, 8 March 1957, 1 ♂ (teneral), J. Rácenis leg., UCV (No. JR—13219).

The present female from Surinam has the subtriangle in the right hind wing two-celled; the subtriangle in the hind wings of this species is normally open.

Phyllogomphoides cassiopeia (Belle, 1975)

Gomphoides cassiopeia Belle, 1975: 129—133, figs. (♂ occiput, thor. & app.; ♀ genit.; ♂ ♀ apex abd.) — ♂ ♀ San Pedro, Paraguay.

Phyllogomphoides cassiopeiae; Belle, 1980: 177.

Phyllogomphoides cepheus Belle, 1980

Phyllogomphoides cepheus Belle, 1980: 176—180, figs. (♂ head, dorsum thor. & app.; ♂ ♀ apex abd.) — ♂ ♀ Sinop, Mato Grosso, Brazil.

UNDULATUS GROUP

This group is made up of the six species *un-*

dulatus, *atlanticus*, *aculeus*, *angularis*, *pedunculus*, and *pseudoundulatus*. The feature possessed in common, which permits recognition of the group, is the possession of a long, thin basal spine at the inferior margin of each male superior caudal appendage.

The group is chiefly Amazonian in its distribution but two members, *undulatus* and *atlanticus*, also occur in the northern coastal area of South America.

Phyllogomphoides undulatus (Needham, 1944)
(figs. 16, 29)

Gomphoides undulatus Needham, 1944: 199—201, pl. 15 figs. 9a—e (♂ genit., app. & apex abd.), 203, 204 (♀, under *Gomphoides cristatus*, cf. Belle, 1970a: 126) — ♂ ♀ Litani River, Surinam; ♂ Mappaoni River, Territorio do Amapa, Brazil. Geijskes, 1964: 40, 41, fig. (♀ apex abd.). St. Quentin, 1973: 344 (key; ♂ ♀ Pará, Brazil). Liefstinck, 1971: 118.

Negomphoides undulatus; Belle, 1970a: 131—133, figs. (♂ app. & apex abd.; ♀ 3rd femur; larval struct.), pls. 18b (♂ photogr. wings), 19a (♀ photogr. wings), 21b (photogr. exuviae); 1972: 236.

Phyllogomphoides undulatus; Gloyd, 1973: 6. Belle, 1977: 291. Kiauta, 1979: 268, 269. Belle, 1982: 2.

Phyllogomphoides atlanticus (Belle, 1970)

Negomphoides atlanticus Belle, 1970a: 133—136, figs. (♂ occiput, genit., app. & apex abd.), pl. 20b (♂ photogr. wings) — ♂ Coppename River & Brownsberg, Surinam. Liefstinck, 1971: 76.

Gomphoides atlanticus; St. Quentin, 1973: 344 (key).

Phyllogomphoides atlanticus; Gloyd, 1973: 6.

Phyllogomphoides aculeus Belle, 1982

Phyllogomphoides aculeus Belle, 1982: 5—8, figs. (♂ thor., genit. & app.) — ♂ Iquitos, Peru.

Phyllogomphoides angularis Belle, 1982

Phyllogomphoides angularis Belle, 1982: 8—11, figs. (♂ thor., genit. & app.) — ♂ Porto Velho, Amazonas & Belém, Pará, Brazil.

Phyllogomphoides pedunculus spec. nov.

(figs. 18, 33—36)

Gomphoides atlanticus; St. Quentin, 1973: 345.

Material. — Brazil: Amazonas, Rio Uaupés, Taraquá, 18 August 1964, 1 ♂ (holotype), Machado & Pereira leg., CM.

The specimen here recorded is No. 78 of St. Quentin (1973), who provisionally placed it under *atlanticus*. In fact the male belongs to a new

species which is very closely related to *angularis*. It differs from *atlanticus* and agrees with *angularis* by the uncrossed subtriangle in the hind wings (fig. 34) and in having the posterior margin of the anterior hamules armed with an acute hook (fig. 35). It differs from *angularis* in having the first pale antehumeral stripes not confluent with the pale collar and in having the penial peduncle (seminal vesicle) excessively elongated being about half as long as the second abdominal segment (fig. 36); it is only one-third the length of the second abdominal segment in *angularis*. The superior caudal appendages are not curved so very strongly mesad as in *angularis* (fig. 33).

Male (holotype; thorax partly crushed; legs broken off except for the right third leg; abdomen broken between segments 3 and 4). — Total length 52 mm; abdomen 39.5 mm (incl. caud. app. 2.0 mm); hind wing 30 mm; costal edge of pterostigma in fore wing 4.0 mm.

A brown species marked with green, resembling *angularis*.

Head brown, the following green: a large oblong spot on each side of labrum, basal half of mandibles externally, anteclypeus, lateral sides of postclypeus, and superior surface of frons for its anterior half.

Prothorax with a middorsal pale twin-spot on middle lobe. Thoracic colour pattern shaped as shown diagrammatically in fig. 18.

Tibiae, tarsi and claws black. Lamina tibialis of first tibiae one-third the tibial length.

Wings hyaline but extreme bases very slightly flavescent. Wing venation blackish brown but frontal margin of costae proximal to nodus with a very fine yellow line. Nodal index 11 : 19—20 : 12/13 : 15—15 : 11. Cubito-anal interspace of either fore wing with an extra cross-vein at level of arculus. Anal triangle in hind wings made up of four (right) and five (left) cells.

Abdomen predominantly dark brown, the pale markings green on basal segments, yellow on other segments. Segments 1 to 6 with a pale middorsal line which becomes very fine on apex of 5 and on 6. Sides of 1 and 2 pale. Sides of 3 to 6 with pale basal spots which become shorter on rear segments, successively, reaching to a point three-quarters the way along the segment on 3, and to a point a quarter the way along the segment on 6. Base of 7 pale to submedian transverse groove.

Accessory genitalia and caudal appendages shaped as shown in accompanying figures. Gen-

ital hamules pale, the chitinized tip of the hooks brown. Penial peduncle brown, its posterior margin deeply cleft and with a strong median tooth on the bottom of the cleft. In profile, the apical segments of the abdomen, including the caudal appendages, are very similar to those of *angularis*.

Phyllogomphoides pseudoundulatus

spec. nov.
(fig. 17)

Material. — Brazil: Pará, Rio Tapajós (Cachoeira I), May 1920, 1 ♂ (holotype), A. H. Fassel leg., SMF.

The resemblance between this species and *undulatus* is so strong that on a superficial view they can easily be confused. With the exception of the penile organs, the morphological differences are very slight and they can better be stated by direct comparison than by description. The new species, here introduced under the specific name *pseudoundulatus*, is somewhat smaller and more delicate than *undulatus*. The cornua of the penis, when pressed close to the venter of the abdomen, reaches to a point half-way between the base and the submedian transverse groove of the third abdominal segment; in *undulatus* to a point on level with these grooves. The lateral dilatations of the abdominal segments 8 and 9 are twice as narrow as those in *undulatus*. The superior caudal appendages of both species are very similar in configuration but those of *pseudoundulatus* are a trifle more slender. The most striking difference in the coloration is found on the thoracic dorsum. In *pseudoundulatus* the first pale antehumeral stripe is wide and broadly confluent with the pale collar, while in *undulatus* it is narrow and does not reach the pale collar (figs. 16, 17).

Male (holotype; head partly and thorax completely hollowed out by scavengers; thoracic colour pattern largely obliterated by post mortem changes; fragmented). — Total length 53 mm; abdomen 41 mm (incl. caud. app. 2.1 mm); hind wing 28 mm; costal edge of pterostigma in fore wing 3.5 mm.

A brown specimen with pale markings, seemingly yellow originally.

Face brown. Labrum with nondescript lighter markings (in *undulatus*, black with a symmetric pair of green spots). Base of mandibles pale. Vertex dark brown. Occipital plate brown.

Prothorax blackish brown. Thoracic colour pattern shaped something like in fig. 17. Thoracic dorsum dark brown with broad pale stripes. Sides of pterothorax largely pale. Brown midlateral stripe partly developed. Brown femoral stripe indistinct.

Ventral side of femora pale (in *undulatus*, the ventral side of the second and third pair of femora is blackish brown). Lamina tibialis of first tibiae one-third the tibial length.

Flavescence at extreme bases of wings less developed than in *undulatus*. Reticulation of wings less dense than in *undulatus*. Nodal index 13 : 18—17 : 10/12 : 13—13 : 12.

Abdomen predominantly dark brown, almost black on middle segments. Segments 1 and 2 similar to those of *undulatus* but segments 3 to 7 lacking pale dorsobasal markings. Instead, the sides of 3 are largely pale, medially interrupted by black, and the sides of 4 are pale at both ends only.

SEMICIRCULARIS GROUP

The species composing this large group are very nearly allied inter se. Most of its members occur in Central America. Three species, viz. *semicircularis*, *lieftincki* and *brunneus*, belong to the fauna of South America. However, there is always a possibility that members known hitherto from Central America turn up in Colombia, and conversely. Features possessed in common and not encountered elsewhere in the genus include the semicircular form of the male superior caudal appendages and the crenate inner margin of the lateral labial lobes of the larva.

The range of this group covers the whole area of Central America and the northwestern part of continental South America, southward to Bolivia.

Phyllogomphoides semicircularis (Selys, 1854) (fig. 30)

Gomphoides semicircularis Selys, 1854: 75, 76 (56, 57 sep.) — ♂ "South America". Selys & Hagen, 1858: 469, 475, 476, 686 (209, 215, 216, 426 sep.), pl. 12 figs. 1a—g (♂ occiput, genit., app. & apex abd.). Fraser, 1940: pl. 6 fig. 5 (penis; cf. Belle, 1970a: 154; 1982: 13). St. Quentin, 1967: 139, 150; 1973: 344 (key).

Negomphoides semicircularis; Belle, 1970a: 152—155, figs. (♂ thorax, genit., app. & apex abd.).

Phyllogomphoides semicircularis; Gloyd, 1973: 6. Belle, 1982: 2, 3, 11—14, figs. (penis; ♀ genit.; ♂ ♀ Colombia, Venezuela. Erratum: 13, line 12 from top: "eastern" should read "western").

Phyllogomphoides lieftincki (Belle, 1970)

Negomphoides lieftincki Belle, 1970a: 154—158, figs. (♂ thorax, app. & apex abd.; ♂ ♀ genit.) — ♂ ♀ Tingo María, Huallaga River & Mishuyacu, Peru; ♂ ♀ Chácara, Bolivia. Lieftinck, 1971: 97. Belle, 1972: 236, figs. (♂ dorsum thorax).

Gomphoides lieftincki; St. Quentin, 1973: 344 (key).

Phyllogomphoides lieftincki; Gloyd, 1973: 6.

Material. — Bolivia: Dept. Santa Cruz, Buenavista (400 m), November 1930, 2 ♂, Fr. Steinbach leg., UMAA. — Peru: Dept. Huánuco, Shapajilla (630 m), 22 July 1938, 1 ♂, Felix Woytkowski leg., UMAA; Dept. Huánuco, Tingo María, November 1949, 1 ♂, H. A. Allard leg., USNM; Dept. Junín, Prov. Jauja, District Andamarca, Satipo (750 m), January 1937, 1 ♂, K. Meskendahl leg., ZMUH; same locality, no date, 1 ♂; April (no year), 1 ♂; June 1941, 1 ♂; May 1945, 2 ♂; June 1945, 1 ♂; May 1947, 1 ♂, all Pedro Paprzycki leg.; Dept. Junín, La Merced, Hda "La Salud" (3500'), no date (no date on field envelope, but date on others in same purchase are for March & June 1931. Rec'd VIII-1943, via Pacific Coast Biol. Serv. L. K. Gloyd), 2 ♂, Juan de Rivas S. leg.; Dept. Junín, Sani Beni (840 m; 8 km east of Satipo), 9 December 1935, 1 ♀, Felix Woytkowski leg., UMAA.

Phyllogomphoides brunneus (Belle, 1981)

Phyllogomphoides brunneus Belle, 1981: 173—176 (♂ thor., apex abd., genit., app. & wings; ♀ genit.) — ♂ ♀ Macas & Limóncocha, Ecuador. Belle, 1982: 13.

Material. — Ecuador: Napo-Pastaza, C-Z trail, between Campamento & Zatazayacu [From Macintyre's letters, this locality would seem to be not far from El Partidero. L. K. Gloyd], 4 August 1935, 1 ♀; Napo-Pastaza, Puyo, 16 March 1957, 1 ♂ (teneral), both William Clarke-Macintyre leg., UMAA; Santiago-Zamora, Zumbi, Río Zamora (Elev. 700 m, ca. 3°50' S, 78°26' W), 25 October 1941, 1 ♂, UMAA; same locality, 29 October 1941, 1 ♂ (AC), both David B. Laddey leg. — Venezuela: Tachira, Río Negro, 11—13 December 1980, 1 ♂, J. de Marmels leg., UCV.

Phyllogomphoides brunneus hitherto was known from Ecuador only; its discovery in Venezuela extends the range of this species considerably eastwards.

The colour design of the thoracic dorsum varies greatly in this species. The male from Vene-

zuela has the first pale antehumeral stripes uneven and broadly confluent with the pale collar. The second pale antehumeral stripes are reduced to a dorsal spot, a kind of reduction also observed in the related congeners *semicircularis* and *lieftincki* (cf. Belle, 1970a: 157; 1972: 231; and 1982: 14).

The Ecuadorian male and female from Napo-Pastaza have completely undeveloped second pale antehumeral stripes, while the first pale antehumeral stripes are not connected with the pale collar. The pale collar and antehumeral stripes are weakly developed in the female, and they are about twice as narrow as those in the male.

One of the males from Santiago-Zamora is stored in a triangular envelope with the field note: "Sometimes found in deep woods, away from water, D.B.L."

CALVERTI GROUP

In this group I place the two very closely related species *calverti* and *camposi*. The most striking features in common are the fundamental similarity in the form of the male superior caudal appendages and the penis. Each superior caudal appendage has two inferior processes on the proximal half while the preputial fold of the penis (c.f. Fraser, 1940: 544) is much produced ventrally (figs. 31, 32).

Tentatively I place *singularis* in this group as well. I have long hesitated about its classification as the male abdominal terminalia are unknown. But judging from the conformation of the accessory genitalia, *singularis* seems to fit best into the *calverti* group. This disposition may later be confirmed when better material becomes available.

The distribution of *camposi* is remarkable in that it occurs in the western part of the Andean Cordilleras while the other two members of the group are known from the Amazon and eastern Bolivia. Apparently the Andean watershed offers no barrier to the spread of the group.

Phyllogomphoides calverti (Kirby, 1897)

(fig. 31)

Cyclophylla calverti Kirby, 1897: 613, 614, pl. 12 fig. 2 (♂ whole insect) — ♂ Pará, Brazil. Kimmins, 1969: 292.

Gomphoides calverti; Campion, 1920: 134—136, 141, pl. 6 figs. 6, 7 (♂ apex abd. & penis). Fraser, 1940: pl. 6 fig. 6 (penis).

Phyllocycla calverti; St. Quentin, 1973: 346 (key).

Phyllogomphoides calverti; Gloyd, 1973: 6.

Phyllogomphoides camposi (Calvert, 1909)
(fig. 32)

Gomphoides camposi Calvert, 1909: 219—221, pl. 7 fig. 127 (♂ apex abd.) — ♂ Quevedo, Ecuador. Campion, 1920: 134—136, 141, pl. 7 figs. 8, 9 (♂ genit.). Campos R., 1922a: 2, 31; 1922b: 86 (Pal-enque & Quevedo, Ecuador). Navás, 1916: 71 (key).

Phyllocycla (*Cyclophylla*) *camposi*; St. Quentin, 1973: 346 (key).

Phyllogomphoides camposi; Gloyd, 1973: 6.

Phyllogomphoides singularis Belle, 1979

Phyllogomphoides singularis Belle, 1979: 39—41, figs. (♂ thorax, 3rd tibia, genit. & detail wing) — ♂ Todos-Santos, Bolivia.

ANNECTENS GROUP

This group is composed of two closely linked species, *annectens* and *regularis*. The two important features shared by these species are also the fundamental similarity in the form of the male caudal appendages and the penis. Each male superior caudal appendage has a strong inferior tooth at the extreme base. The penis is peculiar in having the stem provided with an obtuse apical, dorsal spine, in having the median segment unusually stout and the cornua broad and grooved (fig. 27).

The range of this group seems to be restricted to the eastern regions of the South American highland.

Phyllogomphoides annectens (Selys, 1869)

Gomphoides ? annectens Selys, 1869: 192, 193 (29, 30 sep.) — ♂ Nova Friburgo, Rio de Janeiro, Brazil. Calvert, 1905: 152.

Gomphoides annectens; Selys, 1873a: 766 (38 sep.); 1873b: 506 (62 sep.). Calvert, 1909: 221. St. Quentin, 1973: 344, 345 (key; ♂ Minas Gerais, ♂ ♀ Paraíba, ♂ Parana, ♀ Mato Grosso).

Cyclophylla (*Phyllocycla*) *annectens*; St. Quentin, 1967: 140, 141, figs. (♂ thorax, genit. & app.; ♀ genit.; ♂ ♀ Rio Grande do Sul); 1973: 344 (key).

Negomphoides annectens; Belle, 1970a: 138—141, figs. (♂ genit. & app.; ♂ Santa Catarina).

Phyllogomphoides annectens; Gloyd, 1973: 6. Donnelly, 1979: 261. Belle, 1982: 1.

Material. — Brazil: Rio Grande do Sul, no date or collector, 1 ♀, NHMV.

This species was described after two males as may be apparent from the measurements given in the original description "Abdomen 44—46. Aile inférieure 37—38". In the Selysian collection in Brussels there are three specimens placed

under *Gomphoides annectens*: (1) a male in fairly good condition; it was selected as the lectotype by me (cf. Belle, 1970a); (2) a male, lacking the abdomen, with the labels "P Br" (green label), "*Cyclophylla ? annectens*. De Selys a renvoyer" (an old label in Selys' handwriting), "det. Selys *Gomphoides annectens* Selys" (a recent white label in an unknown handwriting), and "Paratypus" (red museum label); (3) a female, lacking the apical half of the abdomen, with the labels "Para schl." (green label), "*Gomph. annectens*" (an old label in Selys' handwriting), and "Paratypus" (red museum label). This specimen was called the allotype female of *Gomphoides annectens* by St. Quentin (1967: 141). The female, however, belongs to the genus *Aphylla* Selys.

The male lectotype of *annectens* is peculiar in having the end segments of the abdomen densely covered with rather long, stiff hairs.

Phyllogomphoides regularis (Selys, 1873)
(figs. 13, 19, 27, 37)

Gomphoides regularis Selys, 1873a: 765, 766 (37, 38 sep.) — ♂ ♀ Carrancas, Minas Gerais, Brazil. Navás, 1916: 71 (key). St. Quentin, 1973: 344 (key).

Cyclophylla (*Phyllocycla*) *regularis*; St. Quentin, 1967: 133.

Negomphoides regularis; Belle, 1970a: 141—145, figs. (♂ app.; ♂ ♀ genit.; ♀ apex abd.; ♂ ♀ Santa Catarina).

Phyllogomphoides regularis; Gloyd, 1973: 6. Donnelly, 1979: 261. Belle, 1982: 1.

Material. — Brazil: Rio Grande do Sul, no date or collector, 1 ♀, NHMV. Brazil ? : 1 ♀ (teneral), Scheider (Berlin) leg., SMF.

The examples of this species recorded from Santa Catarina by me (Belle, 1970a) differ from those of Minas Gerais in having the prothorax entirely dark brown, whereas in the (type) specimens from Minas Gerais the prothorax is largely pale with dark brown markings on the middle lobe only. But the most striking difference is found in the thoracic colour pattern which in the specimens from Santa Catarina is composed of black, brown and white-green stripes (fig. 19). This colour difference between the thoracic stripes is also observed in *annectens* but in less degree.

The present female from "Brazil ?" has the same coloration as the (allotype) female from Minas Gerais. The female from Rio Grande do Sul was referred to *annectens* by St. Quentin but

is referable to *regularis* since the end segments of the abdomen are scarcely provided with hairs, a character displayed by the male holotype and female allotype of *regularis*. The pterothorax of the female from Rio Grande do Sul is completely eaten out by scavengers, while the thoracic colour pattern cannot sufficiently be studied because it is largely obliterated. St. Quentin's figure 5d of its vulvar lamina is quite misleading. The excision is in fact much deeper. The configuration of the vulvar lamina of this female is as shown by my camera lucida drawing fig. 13.

CORNUTIFRONS GROUP

The position of the sole member of this group, *cornutifrons*, is not clear as long as the male sex of this species is unknown. The peculiar characteristic of the female, viz. the presence of a pair of large horns on the top of the frons, has led me to keep this species in a separate group.

Phyllogomphoides cornutifrons is known only from the isle of Trinidad.

Phyllogomphoides cornutifrons (Needham, 1944)

Aphylla cornutifrons Needham, 1944: 194, 195, pl. 14 fig. 6 (♀ frons) — ♀ Tunapuna, Trinidad.

Negomphoides cornutifrons; Belle, 1970a: 150, 151, figs. (♀ frons, apex abd. & 3rd femur).

Phyllogomphoides cornutifrons; Gloyd, 1973: 6.

REFERENCES

- Belle, J., 1970a. Studies on South American Gomphidae (Odonata) with special reference to the species from Surinam. — Stud. Fauna Suriname 11: 1—158; pls. 1—21.
- Belle, J., 1970b. On the Neotropical Gomphidae of Longinos Navás (Odonata). — Tijdschr. Ent. 113: 253—260.
- Belle, J., 1972. Further studies on South American Gomphidae (Odonata). — Tijdschr. Ent. 115: 217—240.
- Belle, J., 1975. Two new gomphine species from Paraguay (Anisoptera: Gomphidae). — Odonatologica 4: 129—135.
- Belle, J., 1976. Three new gomphine species from Venezuela (Anisoptera: Gomphidae). — Odonatologica 5: 197—206.
- Belle, J., 1977. Some gomphine material from Surinam, preserved in the Leyden Museum of Natural History, with a note on the larva of *Desmogomphus tigrivensis* Williamson (Anisoptera: Gomphidae). — Odonatologica 6: 289—292.
- Belle, J., 1979. A new species of *Phyllogomphoides* Belle, 1970 from Bolivia (Anisoptera: Gomphidae). — Odonatologica 8: 39—41.
- Belle, J., 1980. Two new gomphoidine species from Brazil (Anisoptera: Gomphidae). — Odonatologica 9: 173—180.
- Belle, J., 1981. A new species of *Phyllogomphoides* from Ecuador (Odonata: Gomphidae). — Ent. Ber. Amst. 41: 173—176.
- Belle, J., 1982. Some new and interesting South American species of *Phyllogomphoides* in the Museum of Zoology, University of Michigan, Ann Arbor, Michigan (Insecta: Odonata: Gomphidae). — Occ. Pap. Mus. Zool. Univ. Mich. 701: 1—14.
- Belle, J., 1984. *Idiogomphoides*, a new genus from Brazil (Odonata: Gomphidae). — Ent. Ber., Amst. 44: 106—109.
- Calvert, P. P., 1905. Aeshnidae. — Biologia cent.-am. (Neuroptera): 145—196, 398—399; tabs. 7—8, 10.
- Calvert, P. P., 1909. Contributions to a knowledge of the Odonata of the Neotropical region, exclusive of Mexico and Central America. — Ann. Carneg. Mus. 6: 73—280; pls. 1—9.
- Calvert, P. P., 1948. Odonata (dragonflies) of Kartabo, Bartica District, British Guiana. — Zoologica, N.Y. 33: 47—87; pls. 1—2.
- Campion, H., 1920. Some new or little known gomphine dragonflies from South America. — Ann. Mag. nat. Hist. (9) 6: 130—141; pls. 6—7.
- Campos R., F., 1922a. Catálogo sistemático y sinonímico de los Odonatos regionales. — Rev. Col. Rocafuerte, Guayaquil, Ecuador: 1—75; 3 pls.
- Campos R., F., 1922b. Especies nuevas de insectos ecuatorianos. — Rev. Col. Rocafuerte, Guayaquil, Ecuador: 84—92.
- Donnelly, T. W., 1979. The genus *Phyllogomphoides* in Middle America (Anisoptera: Gomphidae). — Odonatologica 8: 245—265.
- Fraser, F. C., 1940. A comparative study of the penes of the family Gomphidae (order Odonata). — Trans. R. ent. Soc. Lond. (A) 90: 541—550; pls. 1—6.
- Geijskes, D. C., 1964. The female sex of *Cacus mungo*, *Gomphoides undulatus*, *Planiplax phoenicura*, *Planiplax arachne* and *Dythemis williamsoni*. — Stud. Fauna Suriname 7: 36—47.
- Geijskes, D. C., 1971. List of Odonata known from French Guyana, mainly based on a collection brought together by the Mission of the "Museum National d'Histoire Naturelle", Paris, (1) (2). — Ann. Soc. ent. Fr. (N.S.) 7 (3): 655—677.
- Gloyd, L. K., 1973. The status of the generic names *Gomphoides*, *Negomphoides*, *Progomphus*, and *Ammogomphus* (Odonata: Gomphidae). — Occ. Pap. Mus. Zool. Univ. Mich. 668: 1—7.
- Gloyd, L. K., 1974. A correction concerning the gender of the generic name *Gomphoides* (Anisoptera: Gomphidae). — Odonatologica 3: 179—180.
- Heppner, J. B. & G. Lamas, 1982. Acronyms for world museum collections of insects, with an emphasis on Neotropical Lepidoptera. — Bull. ent. Soc. Am. 28: 305—315.
- Jurzitza, G., 1981. Lista provisional de los odonatos

- del Parque Nacional Iguazú, provincia de Misiones, República Argentina. — *Notul. odonatol.* 1: 117, 118.
- Kiauta, B., 1979. The karyotypes of some Anisoptera from Surinam. — *Odonatologica* 8: 267—283.
- Kimmins, D. E., 1969. A list of the type-specimens of Odonata in the British Museum (Natural History) Part 2. — *Bull. Brit. Mus. (Nat. Hist.)* 23: 287—314.
- Kirby, W. F., 1897. List of the Neuroptera collected by Mr. E. E. Austen on the etc., during the recent expedition of Messrs. Siemens Bros. Cable S. S. "Faraday", with descriptions of several new species of Odonata (dragonflies). — *Ann. Mag. nat. Hist.* (6) 19: 598—617; pls. 12, 13.
- Liefwinck, M. A., 1965. *Macromia splendens* (Pictet, 1843) in Europe, with notes on its habits, larva, and distribution (Odonata). — *Tijdschr. Ent.* 108: 41—59, pl. 5.
- Liefwinck, M. A., 1971. A catalogue of the type-specimens of Odonata preserved in the Netherlands, with a supplementary list of the Odonata types described by Dutch scientists deposited in foreign institutional collections. — *Tijdschr. Ent.* 114: 65—139; pls. 1—7.
- Navás, L., 1914-1923. Neurópteros colombianos. — *Boll. Soc. Cienc. nat. (Bogotá)*, 1914: 141—148; 1916: 6—13, 21—29, 67—73, 105—110, 119—121, 137—143, 150—154; 1919: 137—144; 1920: 169—176; 1922: 201—208, 233—240; 1923: 265—272, 279—280.
- Navás, L., 1924. Odonatos nuevos o interesantes. — *Mem. Real. Acad. Cienc. Barcelona* 18: 315—332.
- Needham, J. G., 1944. Further studies on Neotropical gomphine dragonflies. — *Trans. Am. ent. Soc.* 69: 171—224; pls. 14—16.
- Rácenis, J., 1970. Los odonatos de la región del Auyantepuí y de la Sierra de Lema, en la Guayana venezolana. 2. Las familias Gomphidae, Aeshnidae y Corduliidae. — *Acta biol. venez.* 7: 23—39.
- Ris, F., 1904. Odonaten. — *Ergeb. Hamb. Magal. Samm.* 9: 3—44.
- Selys Longchamps, E. de, 1854. Synopsis des Gomphines. — *Bull. Acad. r. Belg.* 21: 23—112 (3—93 sep.).
- Selys Longchamps, E. de, 1869. Secondes additions au synopsis des Gomphines. — *Bull. Acad. r. Belg.* (2) 28: 169—208 (5—45 sep.).
- Selys Longchamps, E. de, 1873a. Troisièmes additions au synopsis des Gomphines. — *Bull. Acad. r. Belg.* (2) 35: 732—774 (5—46 sep.).
- Selys Longchamps, E. de, 1873b. Appendices aux troisièmes additions et liste des Gomphines, décrites dans le synopsis et ses trois additions. — *Bull. Acad. r. Belg.* [2] 36: 492—531 (47—87 sep.).
- Selys Longchamps, E. de, 1894. Causeries odonatologiques. — *Ann. Soc. Ent. Belg.* 38: 163—181.
- Selys Longchamps, E. de & H. A. Hagen, 1858. Monographie des Gomphines. — *Mém. Soc. r. Sci. Liège* 11: 257—720 (VIII + 460 pp. sep.); 23 pls.; 5 tabs.
- St. Quentin, D., 1967. Die Gattung *Gomphoides* Selys (Ordnung Odonata) und ihre Verwandten in der neotropischen Region. — *Beitr. neotr. Fauna* 5: 132—152.
- St. Quentin, D., 1973. Die Gomphidenfauna Südamerikas. — *Annln naturh. Mus. Wien* 7: 335—363.

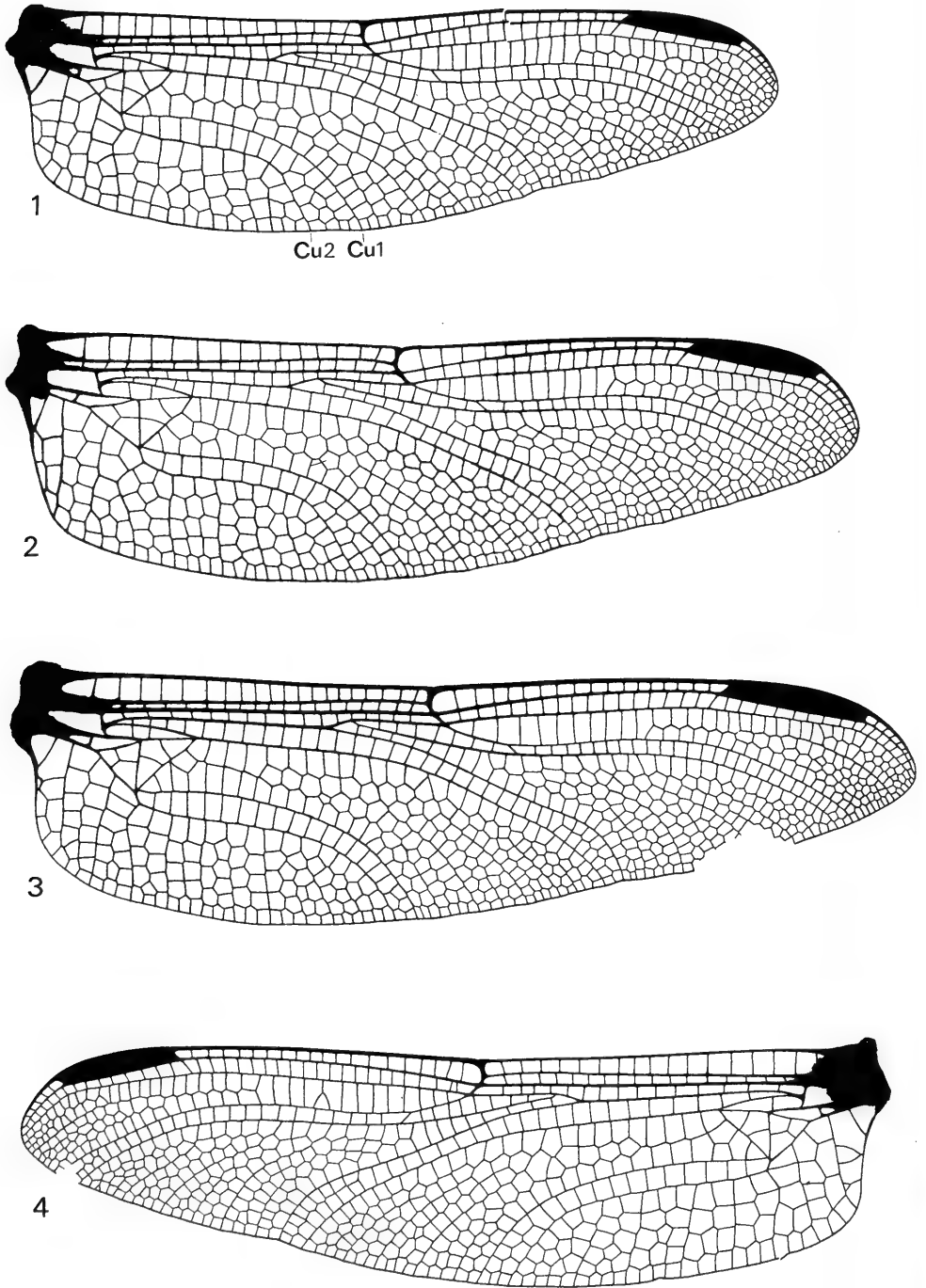

Figs. 1—3. Right hind wing in *Phyllogomphoides*: 1, *fuliginosus*, ♀ holotype; 2, *audax*, ♀ holotype; 3, *major*, ♀ allotype. Fig. 4. Left hind wing of first described ♀ of *Phyllogomphoides selysi*.

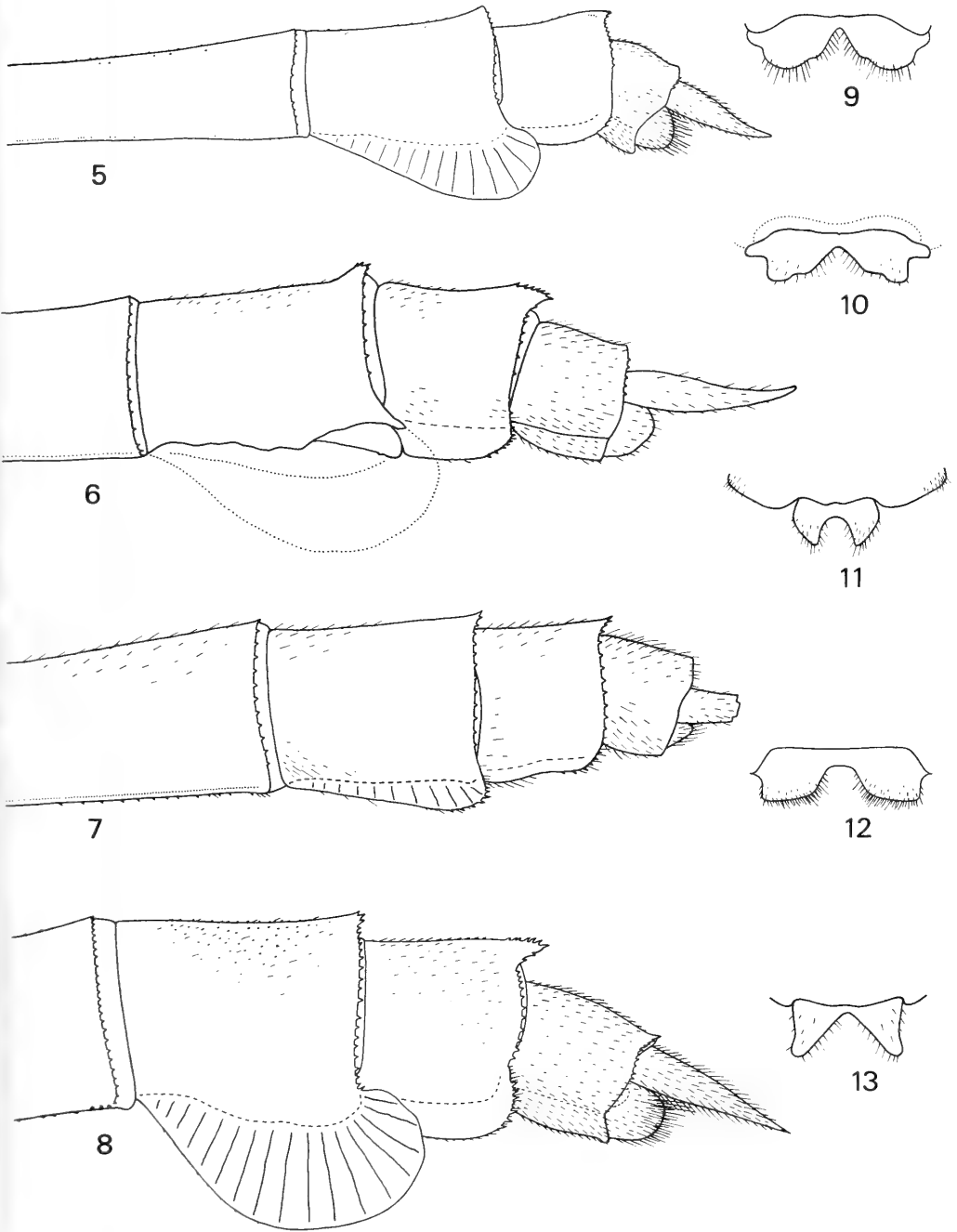

Figs. 5—8. Left profile view of apical segments of abdomen in *Phyllogomphoides*: 5, *fuliginosus*, ♀ Venezuela; 6, *selysi*, first described ♀ (possible outline of dilatation indicated by dotted line); 7, *audax*, ♀ holotype; 8, *major*, ♀ allotype. Figs. 9—13. Ventral view of vulvar lamina in *Phyllogomphoides*: 9, *fuliginosus*, ♀ Venezuela; 10, *selysi*, first described ♀; 11, *audax*, ♀ holotype; 12, *major*, ♀ allotype; 13, *regularis*, ♀ Rio Grande do Sul, Brazil.

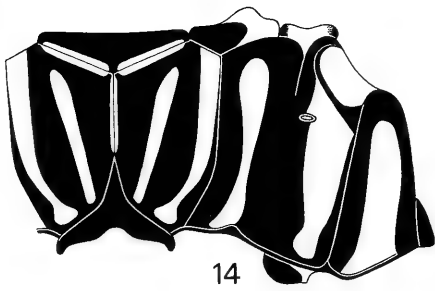

14

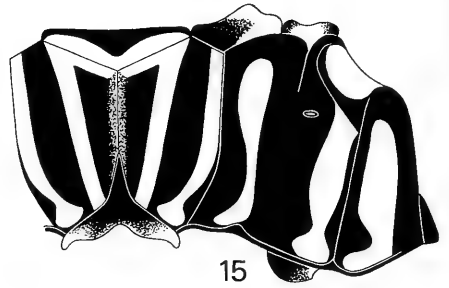

15

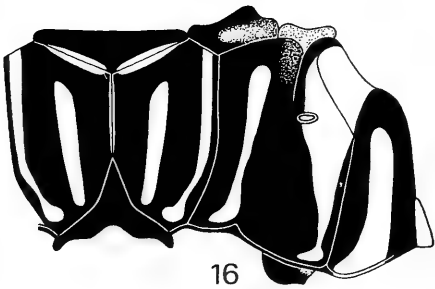

16

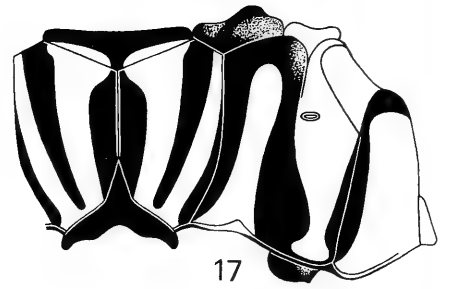

17

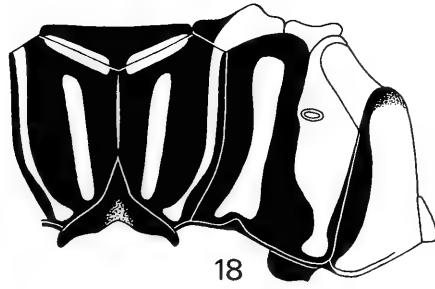

18

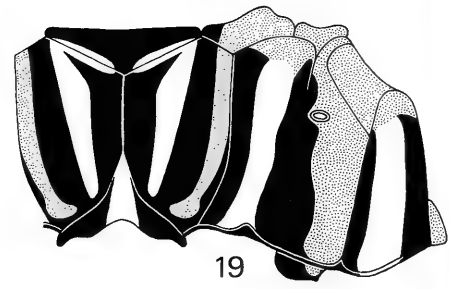

19



20



21



22



23

Figs. 14—19. Thoracic colour pattern in *Phyllogomphoides*: 14, *fuliginosus*, ♀ Venezuela; 15, *seylsi*, ♂ neotype; 16, *undulatus*, ♂ Surinam; 17, *pseudoundulatus*, ♂ holotype; 18, *pedunculatus*, ♂ holotype; 19, *regularis*, ♂ Santa Catarina, Brazil. Figs. 20—23. Colour pattern of labrum in *Phyllogomphoides*: 20, *fuliginosus*, ♀ holotype; 21, *seylsi*, first described ♀; 22, *audax*, ♀ holotype; 23, *major*, ♀ allotype.

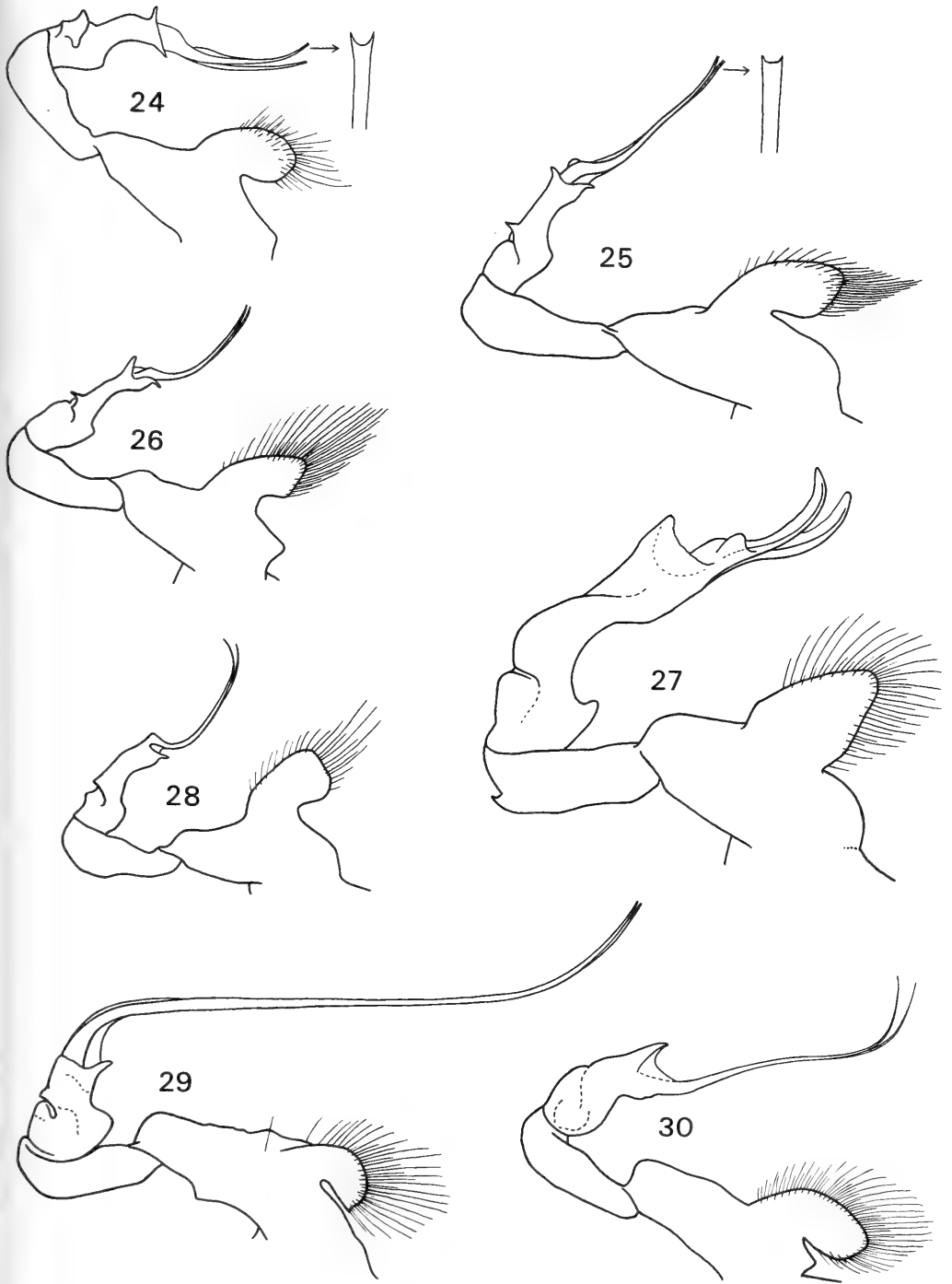

Figs. 24—30. Right profile view of penis in *Phyllogomphoides*: 24, *fuliginosus*, ♂ Surinam; 25, *major*, ♂ para-type Surinam; 26, *cristatus*, ♂ Surinam; 27, *regularis*, ♂ Santa Catarina, Brazil; 28, *andromeda*, ♂ Surinam; 29, *undulatus*, ♂ Surinam; 30, *semicircularis*, ♂ Colombia.

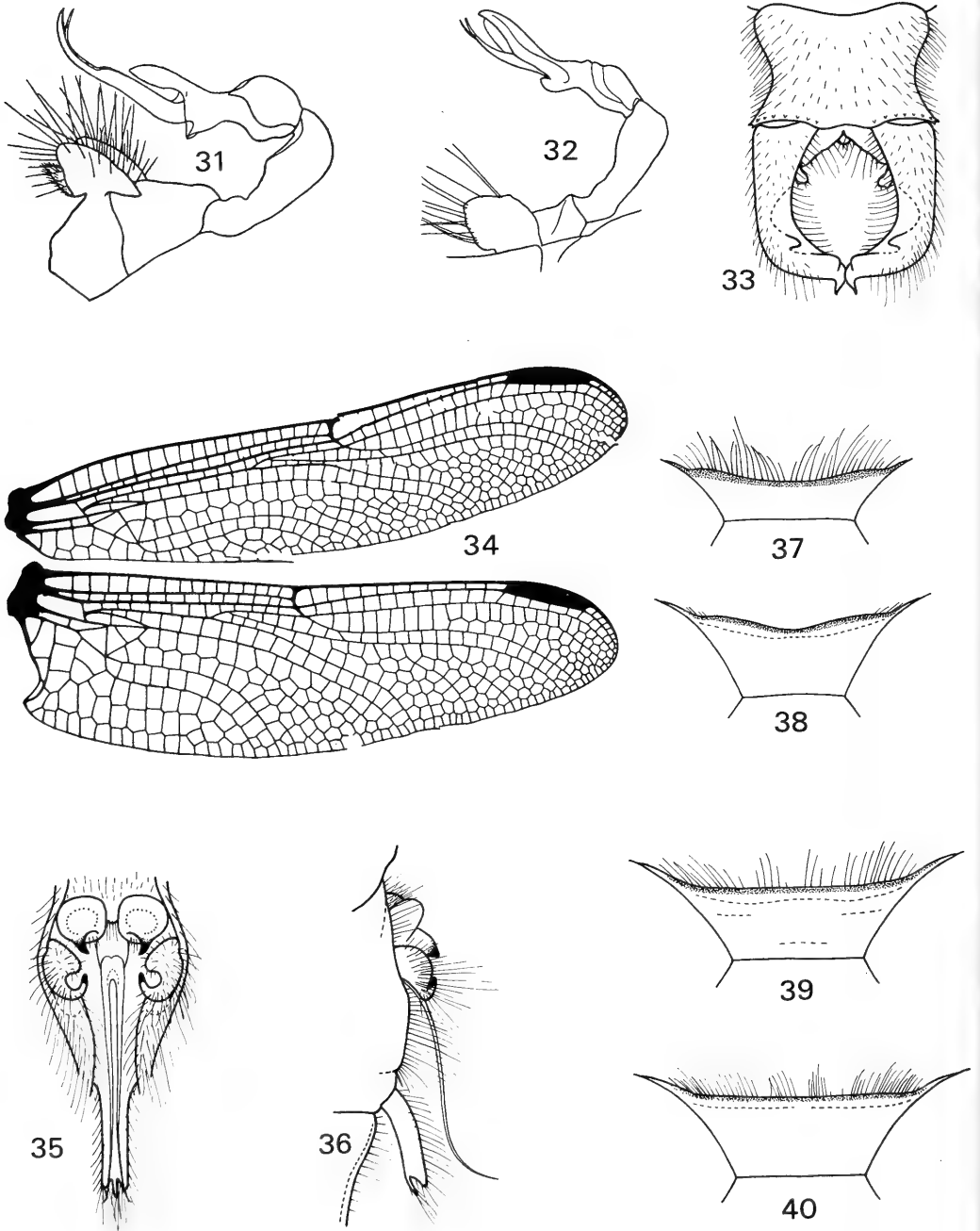

Figs. 31, 32. Left profile view of penis in *Phyllogomphoides*: 31, *calverti*, ♂ holotype (after Calvert in Campion, 1920); 32, *camposi*, ♂ holotype (after Calvert in Campion, 1920). Figs. 33—36. *Phyllogomphoides pedunculus*, ♂ holotype: 33, tenth abdominal segment and caudal appendages, dorsal view; 34, right pair of wings; 35, accessory genitalia, ventral view; 36, the same, right profile view. Figs. 37—40. Occipital plate in *Phyllogomphoides*: 37, *regularis*, ♀ Rio Grande do Sul, Brazil; 38, *fuliginosus*, ♀ holotype; 39, *audax*, ♀ holotype; 40, *major*, ♀ allotype.

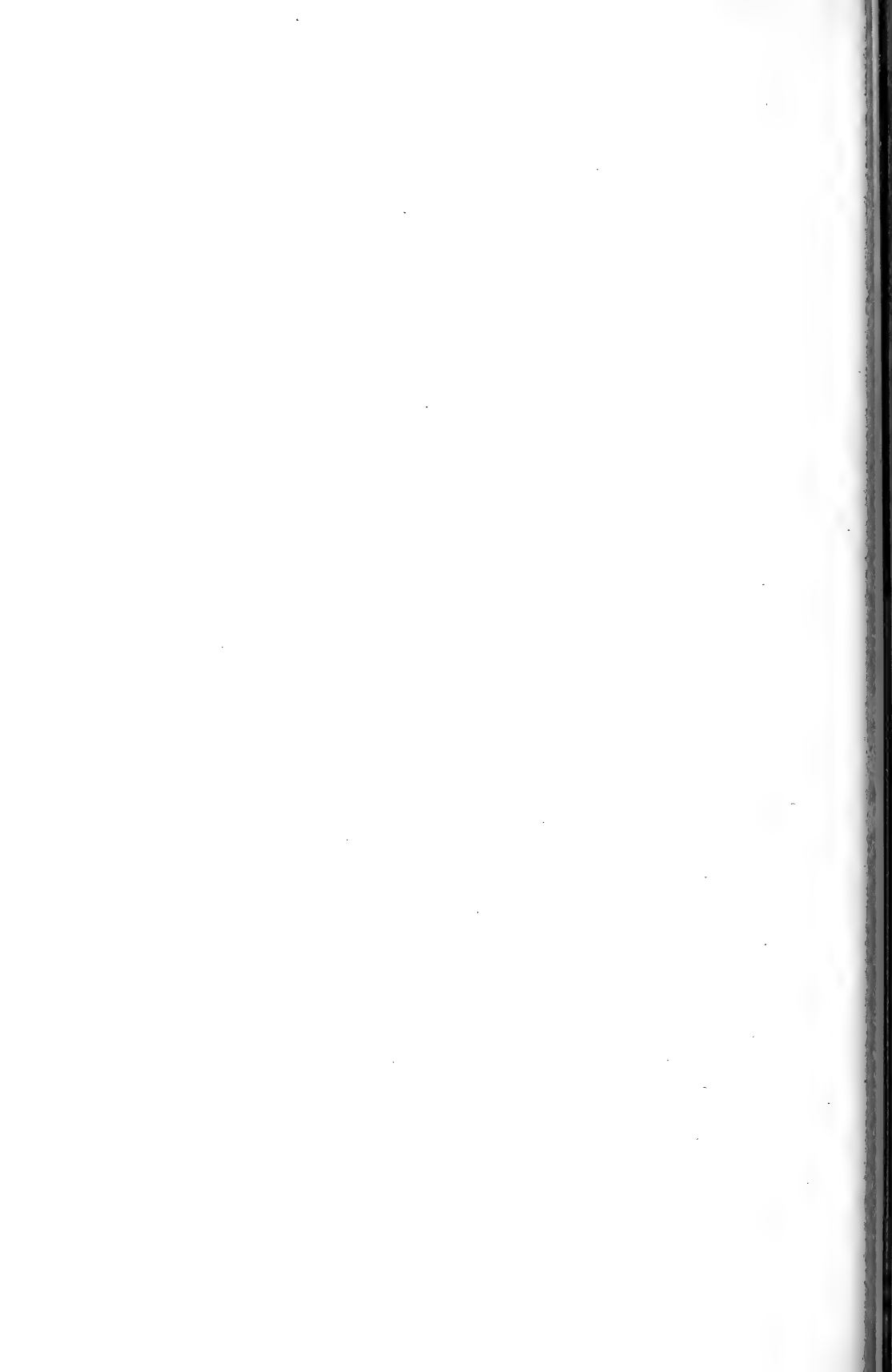





TIJDSCHRIFT VOOR ENTOMOLOGIE

UITGEGEVEN DOOR

DE NEDERLANDSE ENTOMOLOGISCHE VERENIGING

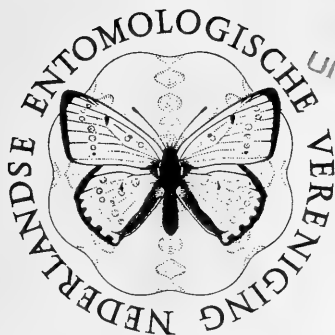

MUS. COMP. ZOOL
LIBRARY
JAN 16 1985
HARVARD
UNIVERSITY

INHOUD

- L. MÓCZÁR. — New and little known Mesitiinae from southern Europe and Africa (Hymenoptera, Bethyridae), pp. 101—113, figs. 1—27.



NEW AND LITTLE KNOWN MESITIINAE FROM SOUTHERN EUROPE AND AFRICA (HYMENOPTERA, BETHYLIDAE)

by

L. MÓCZÁR

Hungarian Natural History Museum, Baross u. 13, H-1088 Budapest

ABSTRACT

Of the South European and African Mesitiinae (Bethylidae) 19 species and subspecies are listed from new localities in the Mediterranean and Ethiopian regions, and from Southern U.S.S.R. Six new species are described: *Anaylax pardoi* sp. n. (♀), *Clytrovorus suarezi* sp. n. (♀), *Metrionotus bekkerei* sp. n. (♂), *Sulcomesitius grahamensis* sp. n. (♀), *S. zambiensis* sp. n. (♂), and *Heterocoelia nikolskajae* sp. n. (♀♂).

INTRODUCTION

In spite of the increasing number of known Mesitiinae species of the world, a raise from 35 (Kieffer, 1914) to 175 (Móczár, 1984), collections still yield numerous specimens which prove to be new species or to represent new locality data. The present species were mostly collected in the Mediterranean region and in the southern territories of the U.S.S.R., and partly in the Ethiopian region.

I received extensive help from many colleagues, to whom I express my sincere thanks: C. van Achterberg (Leiden, the Netherlands), M. Koponen (Helsinki, Finland), G. Pagliano (Torino, Italy), J. Suárez (Almeria, Spain), V. I. Tobias (Leningrad, U.S.S.R.), and H. Townes (Gainesville, Florida, U.S.A.).

Anaylax pardoi sp. n.

(figs. 1—3)

Female. — Length 4 mm. Black, mandibles and clypeus (except its basis), lower side of scape, anterior joint of antennae, anterior tibiae partly, tarsal segments, both ends of femora yellowish brown, rest brown; posterior margin of pronotum, abdominal tergites dark reddish translucent, sometimes last abdominal segments partly yellowish brown. Wings short, reaching at most to posterior margin of propodeum, veins light brown. Body very sparsely covered with light and short hairs.

Head elongated, remarkably longer than broad (42 : 34), strongly broadened behind eyes (viewed from above), nearly parallel just behind eyes, lateral corners rounded (fig. 1), posterior margin weakly arched, occipital carina very nar-

row; surface of head smooth, polished and finely alutaceous with scattered deep punctures (fig. 1) and with a row of denser punctures along eyes, frontal sulcus narrow and short before antennal sockets (on some paratypes less developed); ocelli very small, situated in an acute angle, outer margins with a hardly visible deepening, ocelli separated from each other by half the distance to the nearest eye (6 : 12); eyes remarkably flat, elongated, distinctly longer than broad (15 : 12), separated from mandibles by half their breadth (6 : 12) or by length of antennal joint 2; anterior margin of clypeus weakly arched, lateral sides parallel, surface raised into a sharp high longitudinal keel. Antennal joints except scape short, joints 2, 3, (fig. 1), and 13 at most twice as long as broad, joints 4, 7—11 of equal length, and 5 and 6 distinctly shorter than broad, length (and breadth) proportions of antennal joints 1—13 = 15 (6): 6 (3): 4 (3): 3.5 (3.5): 3.5 (4): 3.5 (4): 4 (4): 4 (4): 4 (4): 4 (4): 4 (4): 3.5 (3): 6 (3).

Pronotum about as long as broad (22: 22—24), anterior corners rounded (fig. 1), posterior margin weakly arched, surface sculptured like head, longitudinal furrow absent. Mesonotum, scutellum smooth, shining, alutaceous with few punctures (fig. 2), parapsidal furrow not distinct, notaulices with sharp margins, gradually converging towards scutellum. Propodeum short, medially as long as half the transverse diameter (14 : 14), all carinae and areas present, only sublateral carinae weakly developed anteriorly (in one paratype also posteriorly on left side), sublateral area alutaceous, partly finely shagreened, shining medially (fig. 3), with a

short carina (fig. 2) and some wrinkles on antero-medial part, postero-lateral corners acute without a separate spine (fig. 3), sometimes tip slightly raised. Lateral side of propodeum with diagonal wrinkles. Episternum with a diagonal groove below tegulae.

Abdomen smooth, shining, tergite 2 alutaceous basally and polished with only some fine punctures (fig. 2), tergites 3—6 alutaceous.

Male. — Unknown.

Holotype: ♀, "Taurirt B. Sicar-Marruecos A. Pardo coll. vi.1973" (Hym. Typ. No. 3694 Zool. Dept., Hungarian Nat. Hist. Museum, Budapest). — Paratypes: 4 ♀ with the same locality and date (1 ♀, Hym. Typ. No. 3695 Hungarian Nat. Hist. Museum, Budapest; 1 ♀, coll. Suárez, Almeria, Spain; 1 ♀, Rijksmuseum van Natuurlijke Historie, Leiden; 1 ♀, British Museum, Natural History, London).

I name this species in honour of the collector, A. Pardo.

This species is related to *A. moczari* (Nagy, 1968) and *A. integer* (Kieffer, 1906) but differs chiefly by the head and pronotum, which is smooth, shining, and with scattered deep punctures (fig. 1), by the propodeum (fig. 3), by the fine punctures on tergite 2 (fig. 2), by the largely black colour, etc.

Clytrovorus suarezi sp. n. (figs. 4, 5)

Female. — Length 3—4 mm. Black, anterior half of clypeus and mandibles, lower side of antennal joints 1—3, pronotum except three black spots, mesonotum, tegulae and scutellum except black anterior part, central area and posterior vertical part of propodeum, trochanters, femora apically, tibiae basally and apically, as well as tarsal joints 1—3, brownish red, abdomen partly dark reddish translucent. In one paratype the three dark spots of the pronotum are largely fused, and the lateral parts of the mesonotum outside notaulices as well as scutellum largely black; in two other paratypes the brownish red colour extends over malar space, over the whole pronotum, mesonotum and scutellum; moreover, in a lighter paratype (Almeria), mandibles, nearly the entire thorax, lateral side of propodeum and tibiae yellowish red, only propodeal disc in lateral half and thorax below tegulae black. Wings short, reaching only to propo-

deum. Body covered with sparse short, white hairs.

Head elongated, distinctly longer than broad (47 : 41), strongly broadened and nearly parallel just behind eyes (viewed from above), lateral corners rounded (fig. 4), posterior margin weakly arched, surface smooth, polished and finely alutaceous with scattered deep punctures (fig. 4), and with a row of denser punctures along eyes, frontal sulcus short, developed only before antennal sockets; ocelli very small, situated in an acute angle, outer margins narrowly excised, ocelli situated nearer to each other than to nearest eye (8 : 12); eyes remarkably flat, elongated, distinctly longer than broad (17 : 14), separated from mandibles by a distance equaling length of antennal joint 2; anterior margin of clypeus arched, lateral sides parallel, surface raised longitudinally into a sharp, high medial keel. Antennal joints short, except joints 1, 2 and 13, which are at least twice as long as broad, joint 3, which is nearly one-and-a-half time as long as broad; joints 4—9 hardly longer than broad, 10—12 as long as broad; length (and breadth) proportions of antennal joints 1—13 = 18 (7) : 7 (3.5) : 5.5 (4) : 5 (4.5) : 5 (4.5) : 5 (4.5) : 5 (4.5) : 5 (4.5) : 5 (4.5) : 4.5 (4.5) : 4.5 (4.5) : 4 (4) : 7 (4).

Pronotum nearly as long as broad (24 : 25), anterior corners rounded (fig. 4), lateral sides only weakly, gradually diverging towards tegulae, posterior margin slightly arched, surface uniformly finely alutaceous and shining with more scattered deep punctures than on head, without a trace of longitudinal furrow. Mesonotum, scutellum alutaceous, shining, only with very few punctures (fig. 4), parapsidal furrow weakly developed, notaulices deeper, distinctly convergent towards scutellum. Propodeum remarkably short, as long as half the transverse diameter (15 : 15), central carina distinct, median carinae hardly developed, and hardly perceptible, discal carinae parallel medially but diverging anteriorly and also posteriorly over less than one-fifth of its length (fig. 4), sublateral carina absent, lateral and transverse carinae well developed posteriorly, sublateral area with foveae of rather larger size along anterior margin but with smaller ones along lateral and posterior margins, surface of sublateral areas moderately bending postero-laterally towards spines and sharply curved down along its whole lateral margin, because of this the lateral carinae lying conspicu-

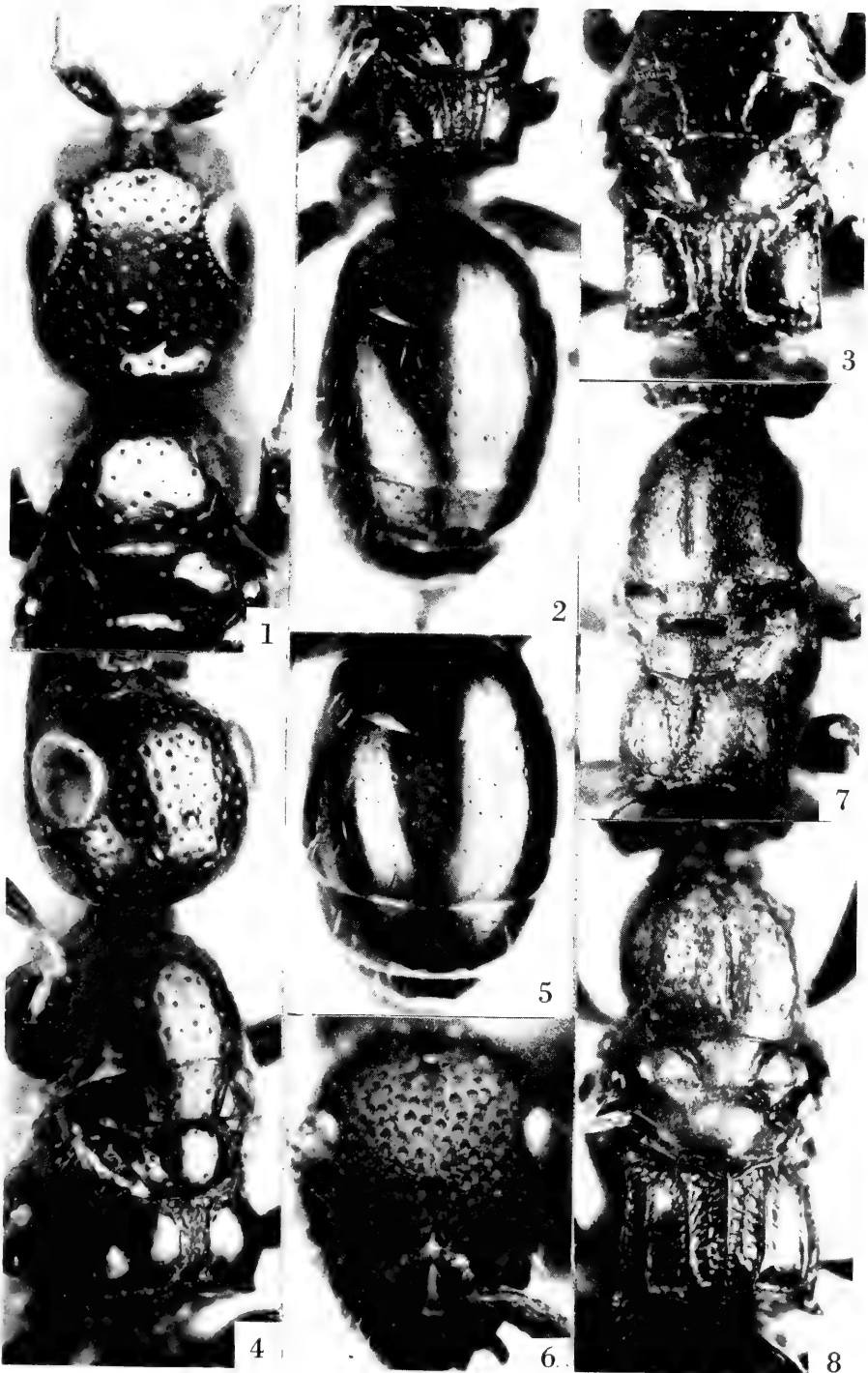

Figs. 1—3. *Anaylax pardoii* sp. n., ♀. 1, head and pronotum; 2, scutellum, propodeum and abdomen; 3, scutellum and propodeum. Figs. 4—5. *Clytrovorus suarezi* sp. n., ♀. 4, head and thorax; 5, abdomen. Fig. 6. *Mesitius africanus africanus* Kieffer, ♀, head in frontal view. Fig. 7. *Clytrovorus borvathi* (Kieffer), ♀, thorax. Fig. 8. *Mesitius ghilianii* Spinola, ♀, thorax.

ously deeper. Lateral spine hardly distinct, tips slightly raised, lateral side of disc finely wrinkled diagonally, its basis granulated similar to episternum, latter with deep diagonal groove below tegulae.

Abdomen smooth, polished, tergite 1 with only few very fine, 2 with some fine and scattered punctures (fig. 5), tergite 2 basally, 3—6 finely alutaceous.

Male. — Unknown.

Holotype: ♀, "Taurirt B. Sicar-Marruecos A. Pardo coll. v.1973" (Hym. Typ. No. 3696 Hungarian Nat. Hist. Museum, Budapest). — Paratypes 17 ♀: 2 ♀ with the same data (Hym. Typ. No. 3697—3698 Hungarian Nat. Hist. Museum, Budapest); 1 ♀, "La Joys Almeria J. Suárez leg. 2.iv.60", Spain (Hym. Typ. No. 3699, Budapest); 1 ♀, "Taurirt B. Sicar-Marruecos A. Pardo coll. 25.vi.1971" (Rijksmuseum van Natuurlijke Historie, Leiden); 1 ♀ with the same locality and collector, but data: "v.1972" (Hym. Typ. No. 3700, Budapest); 2 ♀ with the same data, but dated: "vi.1973" (coll. Suárez, Almeria, and Hym. Typ. No. 3701, Budapest); 8 ♀ with the same date, but dated: "v.1974" (2 ♀, British Museum, Natural History, London; 2 ♀, coll. Suárez, Almeria; 2 ♀, coll. Nagy-Argaman, Yaffo, Israel; 2 ♀, Hym. Typ. No. 3702—3703, Budapest) and 2 ♀ with the same data, but dated: "vi.1974" (coll. Suárez, Almeria, and Hym. Typ. No. 3704, Budapest).

I name this species in honour of the outstanding specialist of Mutillidae, Mr. Javier Suárez of Almeria, Spain.

This species is similar to *C. zavadili* (Hoffer, 1936), but differs by the shorter and obtuse spine of the propodeum, by the margin of the central area of the propodeum not being convergent anteriorly as well as posteriorly, by the lack of a small, rectangular fovea in this area, by the colour, etc.

This species is related to *C. horvathi* (Kieffer, 1906) (fig. 7) but differs mainly by the head and pronotum-mesonotum-scutellum not being granulated, by the propodeum without an acute spine, by the central area not being strongly broadened anteriorly and not parallel-sided posteriorly, by the surface of the sublateral area not gradually bending down towards lateral margin and spine, by the pronotum not having a deep and narrow longitudinal furrow (fig. 7), etc.

Mesitius africanus africanus Kieffer, 1906 (fig. 6)

Mesitius africanus Kieffer, 1906: 401 (♀).

Mesitius africanus africanus; Móczár, 1970a: 190, 192 (♀).

Specimens examined: 1 ♀, Zoco el Arba, Marruecos vi.1963 (Budapest); 1 ♀, San Roque, Cádiz, J. Ramirez, 7.ii.1976 (Budapest). 1 ♀; Cádiz, J. de Ferrer 7.ii.1976 (coll. Suárez, Almeria); 1 ♀, Algeciras, 15—22.iv.1926, Lindberg (Helsinki).

This species differs from *M. cameroni cameroni* Kieffer, 1906, chiefly by the only superficially punctured head (fig. 6), by the head being slightly shining instead of mat, by the sublateral area being scatteredly wrinkled and mat instead of striated and shining, etc.

It was reported from Morocco (Kieffer, 1906), Spain (Kieffer, 1908), France (Picard, 1932), and Algeria (Móczár, 1970a).

Mesitius apterus (Cameron, 1888)

Epyris apterus Cameron, 1888: 171.

Mesitius apterus; Móczár, 1970a: 191 (♀).

Mesitius apterus; Móczár, 1983: 203 (♀).

Specimens examined: 2 ♀, Zoco el Arba Marruecos, vi.1963, Spain (Budapest and coll. Nagy-Argaman).

This species is easy to distinguish from the related *M. szaboi* Móczár, 1970, by the longitudinal furrow before the antennae, by the distinctly concave lateral margin of the spoon-like keel of the clypeus, as well as by tergite 2 being without very fine scattered punctures.

It was reported from Gibraltar (Cameron, 1888) and Morocco, Jordan (Móczár, 1970a, 1983).

Mesitius ghilianii Spinola, 1851 (fig. 8)

Mesitius ghilianii Spinola, 1851: 73 (♀).

Mesitius ghilianii; Móczár, 1970a: 190, 194 (♀).

Specimens examined: 6 ♀, Taurirt (Beni Sicar): Marruecos, Melilla 7.vii. and 20.ix.1972, v.-24.vi.1974, Spain (4 ♀ Budapest and 2 ♀ coll. Suárez). — 1 ♀, Algeria, Bouira (= Bougie) 23.v.1981, leg. Boffa-Casale-Giachino-Risci-Scaramozzino (Budapest).

The above specimens correspond to those described from France (Móczár, 1970a: 190, 195) but the length varies between 4.2—6.5 mm; the

grooves of the ocelli are distinctly smaller than those in the French specimens and similar to the ones reported from Egypt (Móczár, 1983). In addition to the description: the surface of the sublateral areas (fig. 8) not shagreened nearly over its whole surface but only on its anterior half (1 ♀) and smoothly shining with only a very fine trace of striae nearly on its whole surface (5 ♀), pronotum not with fine but with distinct punctures (fig. 8), and length of head four-fifths of its breadth. These differences are not essential and fall within the variation of this species.

This species was reported before from Sicily (Spinola, 1851), Corsica (Marshall, 1874), Gibraltar (Cameron, 1889), Gallia (Dalla-Torre, 1898), Tunis, Algeria (Picard, 1932), Corfu (Nagy, 1969) and Egypt (Móczár, 1983).

***Metrionotus egypticus* Móczár, 1974**

Metrionotus egypticus Móczár, 1974: 174, 175 (♀).

Metrionotus egypticus; Móczár, 1983: 204 (♂ nov.).

Specimens examined: 1 ♀, Wadi Feran 4.iii.1935 and 1 ♀ Helwan 11.ii.1936, Egypt (Budapest).

This species is closely related to *Incertosulcus soikai* Móczár, 1970, from which it differs chiefly by the distinct and narrow longitudinal furrow of the pronotum, by length and breadth proportions of the pronotum (12 : 19, instead of 16 : 19), etc.

It was reported from Egypt (Móczár, 1974, 1983).

***Metrionotus bekkeri* sp. n.**

(figs. 9, 10)

Male. — Length 3.5 mm. Black, antennae, clypeus, mandibles, tegulae, legs and last abdominal segments yellowish brown, anterior half of mandibles, tarsal segments 1—3 yellowish, pronotum posteriorly, tergite 1 in anterior half, lateral side of abdomen dark reddish brown, translucent. Wings normally developed, fore wings hardly infuscated, veins and pterostigma brownish, yellowish only basally. Body sparsely covered with white hairs, antennae with suberect hairs, latter distinctly shorter than diameter of antennal joints.

Head one-fourth shorter than broad, remarkably broadened behind eyes (fig. 9), sides convergent (viewed from above), posterior margin nearly straight, occipital margin narrowly impressed; ocelli in a slightly acute angle POL-

: OOL = 4 : 5, outer margins of ocelli with shining grooves; head shagreened, only weakly shining with shallow, larger punctures (fig. 9), frontal sulcus developed from fore ocellus up to antennal sockets but interrupted medially; eyes remarkably small, hardly longer than broad, malar space as broad as the length of antennal joint 3, or mandibles separated from eyes by a distance of two-thirds length of eyes; anterior margin of clypeus nearly straight with obtuse lateral corners, sides parallel, surface raised into a sharp high keel medially. Antennal joints slender, 1 and 13 the longest, 3—7, as well as 8—10, and 11 and 12 of equal length, joints 3—7 hardly longer than 8—10, all joints at least twice as long as broad, the pedicel excepted, which is only 1.75 times as long as broad, length (and breadth) proportions of antennal joints 1—13 = 5 (3): 3.5 (2): 4 (2): 4 (2): 4 (1.6): 4 (1.5): 3.5 (1.2): 3.5 (1.2): 3.5 (1.2): 3 (1.2): 3 (1.2): 5 (1.2).

Pronotum hardly longer than three-quarters of its breadth (9 : 11), anterior corners slightly obtuse, lateral sides hardly convex medially and strongly diverging towards tegulae, posterior margin moderately arched, surface shagreened, hardly shining, with scattered larger but shallow punctures (fig. 9), longitudinal sulcus narrow, ending before posterior margin, mesonotum and scutellum shagreened, only moderately shining, with few fine and scattered punctures (figs. 9, 10), parapsidal furrow only in trace present, notaulices deep, gradually converging towards scutellum, longitudinal furrow absent. Propodeum longer than half its transverse diameter, central areas (fig. 10) well sculptured, sublateral areas granulated, not shining, surface of disc remarkably convex, postero-lateral corners lying conspicuously deep and slightly acute, their tips raised, practically without a distinct spine. Episternum shagreened below tegulae, behind transversal groove granulated latero-ventrally.

Abdominal tergite 1 smooth, polished, without punctures, 2 shagreened basally, with very fine and scattered punctures medially and polished posteriorly.

Female. — Unknown.

Holotype: ♂, "Sarepta Bekker 66" (Leningrad).

I named this species in honour of its collector. This species is related to *M. zuluensis* (Móczár, 1971), from which it differs mainly by the antennae being without dense proclinate hairs, by

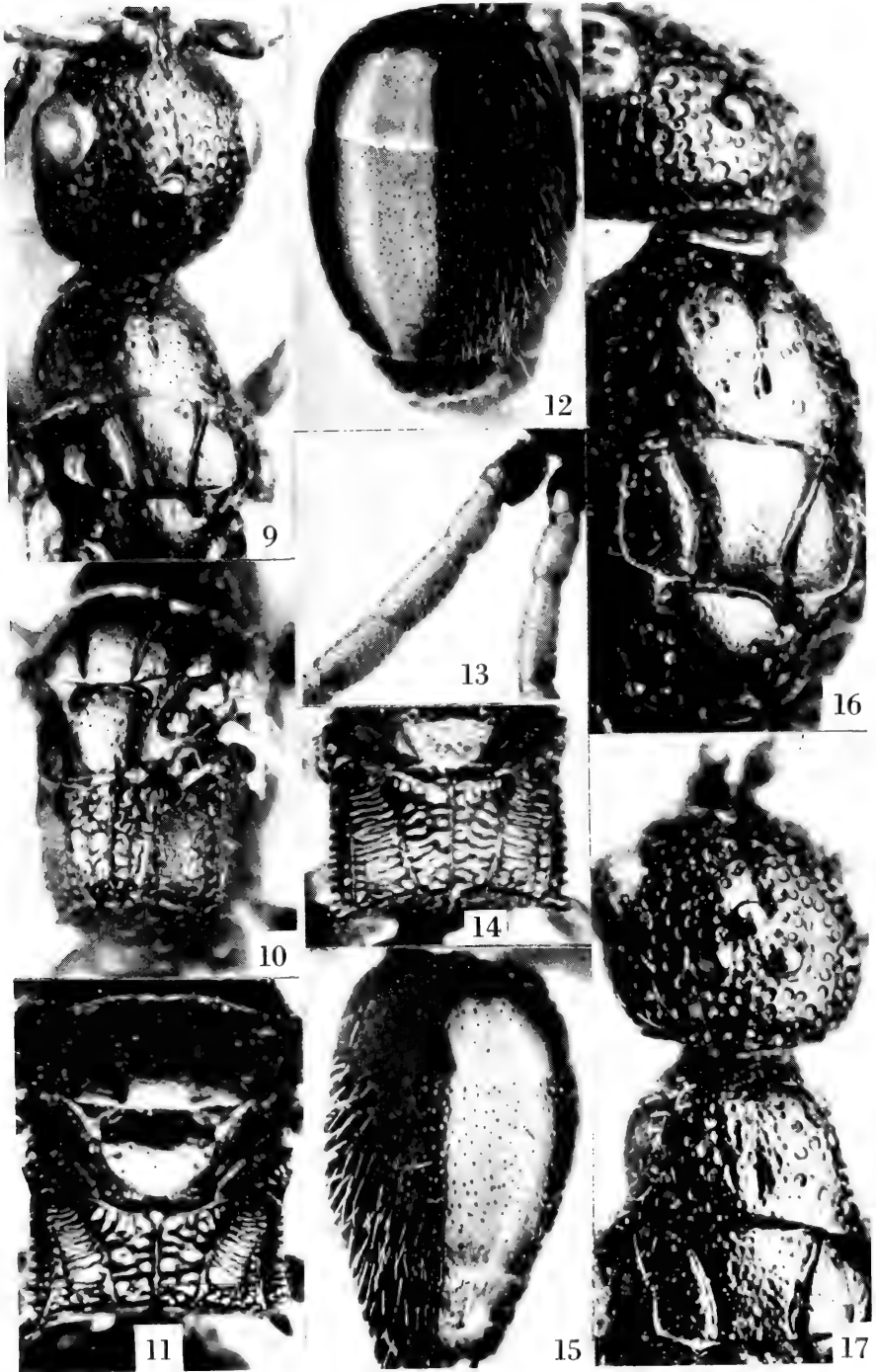

Figs. 9—10. *Metrionotus bekkeri* sp. n., ♂, 9, head, pronotum and mesonotum; 10, scutellum and propodeum. Figs. 11—17. *Heterocoelia nikolskajae* sp. n. 11, scutellum and propodeum (♀); 12, abdomen (♀); 13, first antennal joints (♂); 14, propodeum (♂); 15, abdomen (♂); 16, head, pronotum and mesonotum (♀); 17, head, pronotum and mesonotum (♂).

the pronotum having no distinct spine, by its larger size, by the ratio spine to length of propodeum being not 2 : 11, etc.

***Heterocoelia nikolskajae* sp. n.**

(figs. 11—17)

Female. — Length 5.3 mm. Black, antennae (except the light brownish joints 6—13), anterior half of mandibles and clypeus, legs, except coxae brown basally, yellowish red, basal parts of clypeus and mandibles as well as tegulae, brown, hind femora and tibia yellowish brown, abdominal tergite 1, lateral side of 2 and apical segments posteriorly dark brownish red, translucent. Wings normal, fore wings only weakly brownish infuscated, veins brown. Body and eyes with sparse, white hairs.

Head as long as broad (28 : 28), distinctly broadened behind eyes, sides gradually convergent (viewed from above), occipital margin narrowly impressed; ocelli in a rectangle, posterior ocelli as far from each other as from nearest eye, POL : OOL = 5 : 6, outer margins with shining grooves; head with very dense, larger but not very deep punctures (fig. 16), spaces between punctures fused into more or less longitudinal wrinkles, surface shining, frontal sulcus well-developed above antennal sockets; eyes large and rather convex, elongated, three-quarters as broad as long (9 : 12), separated from mandibles by a distance of nearly two-thirds length of eyes (7 : 12); anterior margin of clypeus moderately arched with obtuse corners, raised into a sharp, high keel medially. Antennal joints rather slender, scape very long, distinctly longer than antennal joints 2 and 3 together, joints 2—3 twice as long as broad and distinctly longer than 4—12, all joints longer than broad except 3—5, which are as long as broad, length (and breadth) proportions of antennal joints 1—13 = 11 (4) : 4 (2) : 5 (2.4) : 3.5 (3.5) : 3.5 (3.5) : 3.5 (3.5) : 3 (2.5) : 3 (2.5) : 3 (2.5) : 3 (2) : 3 (2) : 3 (2) : 4 (2).

Pronotum about two-thirds as long medially (excluding collar) as broad in front (13 : 18), anterior corners rounded, lateral sides parallel and diverging from middle towards tegulae, posterior margin nearly straight and broadly impressed (fig. 16), surface smooth, shining with dense minute and few larger punctures in anterior half, longitudinal furrow narrow and deep, especially anteriorly. Mesonotum, scutellum smooth, shining with minute dense punctures (fig. 16), parapsidal furrow narrow and rather deep, notaulices broader and deeper with sharp

margins, strongly converging in anterior half, parallel medially and diverging before posterior margin. Longitudinal furrow of mesonotum, as well as basal sulcus on scutellum, absent. Scutellum with some larger punctures laterally. Propodeum short, distinctly shorter medially than half its transverse diameter (10 : 12) (fig. 11), coarsely sculptured, all carinae present, lateral sides parallel, moderately diverging, beginning with spines, latter acute (viewed from above), truncate from the side, short, only about as long as one-third of length of propodeum medially (4 : 11). Lateral sides of disc along upper margin with a parallel wrinkle ending in vertical and postero-lateral edge of propodeum before spine. Sides of thorax rather coarsely sculptured, episternum with deep and broad groove below tegulae.

Abdomen smooth, tergites 1 and 2 polished, 1 with very fine punctures medially on dorsal side (fig. 12), 2 finely granulated basally, with fine and scattered punctures, except on side, and a small area medially in front of posterior margin, last tergites finely granulated with very fine punctures. Sternite 2 with scattered, deep and also minute punctures mixed with larger ones.

Male. — Length 3.6—3.9 mm. Coloration similar to female, but mandibles, clypeus and antennae entirely yellowish red, except apical brown tip of joint 13 and the more brownish coxae. Wings similar to female. Sparse white hairs of body longer than in female. Antennae with short, typical, proclinate hairs (fig. 13).

Head, ocelli correspond to female, POL : OOL = 4 : 5, sculpture of head finer, punctures smaller and shallower (fig. 17), spaces between punctures not forming longitudinal wrinkles, frontal sulcus shallower but also developed below fore ocellus, malar space narrower, only one-third as long as eye (3 : 9). Antennal joints remarkably slender, joint 3 1.75 times as long as 2 (fig. 13), joints 1 and 13, as well as 3—10 nearly of equal length, joints at least twice as long as broad, except pedicel, length (and breadth) proportions of antennal joints 1—13 = 6 (3) : 3.5 (2.5) : 5.5 (2.5) : 5 (2.5) : 5 (2.2) : 5 (2) : 5 (2) : 5 (2) : 5 (2) : 5 (2) : 4.4 (2) : 4 (2) : 6 (2) (after allotype).

Pronotum similar to female (8 : 12), surface moderately shining owing to rather dense smaller and few larger scattered punctures (fig. 17), and to finely shagreened interspaces; longitudinal furrow very shallowly developed anteriorly, in one paratype (of same locality as allotype) uniformly deep on its whole length, in other

paratype (Kondara) only posterior present. Mesonotum, scutellum as in female. Propodeum (fig. 14) remarkably longer than in female, nearly as long as half its transverse diameter (8 : 8.5), lateral spine minute, as long as wide at basis, tip projecting dorsally. Sides of thorax with finer sculpture than in female. Tergites similar to those in female, but tergite 2 with more scattered, distinct and deep punctures (fig. 15), but sternite 2 with denser and deeper uniform punctures.

Holotype: ♀, "Khodzha-obo-gari S skl. Gissar xr. Nikolskaja, 29.vii.944", Tadžikskaja S.S.R., NW from Dušambe (Leningrad). — Allotype: ♂, "Khodzha-obi-gari S skl. Gissar xr. Nikolskaja 28.vii.944 (Leningrad). — Paratypes: 1 ♂ the same data as holotype (Budapest, Hym. Typ. No. 3705); 1 ♂, the same locality but 17.viii.1944 (coll. Nagy-Argaman); 1 ♂, "Kondara 1100 m. d. Varzob, Tadžk. Gussakovskij 19.vi.938", Tadžikskaja S.S.R., 30 km NW from Dušambe (Budapest, Hym. Typ. No. 3706).

I name this species in honour of the collector, the late outstanding chalcidologist M. N. Nikolskaja.

This species seems to represent a transitional form between the genera *Heterocoelia* and *Metrionotus*. It can be included in *Metrionotus* on the basis of the sculpture of the pronotum, but it was nevertheless placed in *Heterocoelia* because of features of the propodeum and the head, and also because of its relation to the closely related species *H. hungarica* (Kieffer, 1906) and *H. c. carceli* (Westwood, 1874).

The female is easy recognizable by the black head (except antennae, mouth parts and part of clypeus), by the thorax and abdomen as well as by the rather smooth, shining pronotum with few larger punctures in anterior half, which distinguishes it from all other *Heterocoelia* species.

The male differs from *H. hungarica* by the pronotum being not densely and coarsely punctured and tergite 2; it differs from *H. c. carceli* especially by the pronotum usually being without narrow and deep longitudinal sulcus and without rather dense and larger punctures, as well as by tergite 2, which has more scattered and distinct punctures with larger smooth polished interspaces, etc.

Heterocoelia carceli carceli (Westwood, 1874)

Mesitius carceli Westwood, 1874: 166, pl. 31 fig. 9 (♀).

Heterocoelia carceli carceli; Móczár, 1971: 306, 308, 314 (♀♂).

Specimens examined: 6 ♀, Sarepta, Krasnodarmejsk, Russian S.S.R., Bekker, 1866, 1867, 1868 (Leningrad) and 4 ♀, 1 ♂ with the same data (Budapest). — 1 ♂, Dorzaband m. Lenkoran Talish Mountains, Azerbaidzhan S.S.R., coll. Veltishchev 21—26.viii.1938 (Leningrad) and 1 ♂ with the same data (Budapest). — 1 ♀, M. San. Aután. Málaga, v.1946, Cobos Sauchex (Budapest).

Additionally this species has been reported from the following territories: Mediterranean coast and Austria (Kieffer, 1906), England (Westwood, 1874), the Netherlands (Hoffer, 1936), Yugoslavia, Hungary (Móczár, 1971), South Russian S.S.R. (Nagy, 1968), and "Orient." (Schulz, 1906).

Heterocoelia carceli obscura (Kieffer, 1906)

Mesitius carceli var. *obscurus* Kieffer, 1906: 411, 535, 545 (♂) (incorrectly attributed to Snellen van Vollenhoven).

Mesitius carceli obscurus; Kieffer, 1914: 303 (♂).

Heterocoelia carceli carceli var. *obscura*; Móczár, 1971: 308, 315 (♂).

The citation of Snellen van Vollenhoven, 1867 (Tijdschr. Ent. 10: 222) given by Kieffer (1904: 40) is incorrect, because neither in Snellen van Vollenhoven's paper (1867, p. 222-226¹⁾) nor in any of his other publications any trace of the name "*obscurus*" has been found. Consequently, I propose to accept the opinion of C. van Achterberg (in litt.) that Kieffer is the author of *obscurus*. The first reference by Kieffer was based on a male. Kieffer (1906: 411, 535) in his catalogue mentioned neither a date nor a locality, as he did for other species, which indicates that he had no printed source or specimen; perhaps he received a letter from Snellen van Vollenhoven near the end of his life, containing data on "*obscurus*". On the other hand, Kieffer (1914: 303) recorded this species from "Holland". In the Leiden collection there is an old la-

¹⁾ The single unnamed taxon really is a Proctotrupid, not a Bethyloid, according to fig. 4 in Snellen Van Vollenhoven's paper of 1867.

bel, written by Snellen van Vollenhoven "*obscurus* Voll.". Unfortunately, the above four specimens were collected in Italy and not in "Holland", they are females and not males and clearly represent *Heterocoelia nagy* Móczár, 1969, and not *H. carceli* (Westwood). After the information kindly supplied by C. van Achterberg no male specimens of *Mesitius carceli* were found in the collection, so the original material is considered to be lost.

In the collection of Budapest (Hung. Nat. Hist. Mus.) there is a male specimen, which perfectly corresponds to Kieffer's description of *carceli obscurus*, collected at the foot of the Mountain Alps "Közseg, Méhely". I here designate this specimen as neotype (Hym. Typ. No. 3707 Mus. Budapest).

Kieffer's description can be supplemented as follows: frons and vertex differently punctured, latter only with superficial punctures, interspaces shagreened, hardly shining. Punctures of pronotum with sharper margins than in *carceli carceli* (Westwood). Tergite 2 slightly more densely punctured than in *carceli*, but not so deeply and densely as in *halidayi* (Westwood, 1874). Tergite 2 more extensively granulate basally than in *carceli*.

This subspecies is known from Hungary only.

Heterocoelia nagy (Móczár, 1969)

Mesitius nagy Móczár, 1969: 373 (♀).

Heterocoelia nagy; Móczár, 1971: 306, 307, 313 (♀ ♂).

Heterocoelia nagy; Nagy, 1972: 14 (♂).

Specimens examined: 2 ♀, Piemont Asti, Gribodo (Leiden). 1 ♀, Italy, Gribodo (Leiden), 1 ♀, Pedem(onte), Gribodo (Leiden). 1 ♀, Borgomale, 25.vi.1982, Piemonte, Italia, leg. Pagliano (Torino). 1 ♀, S. Benedetto Belbo, 26.vii.1980, Langhe-Piemonte, leg. Pagliano (Budapest). 1 ♀, Paterna, Alpujarras (Alm.), J. Suárez (Budapest).

This species was reported before from: Corsica, Italy, France (Móczár, 1969), Greece (Móczár, 1971), Greece: Insel Ka (Nagy, 1972).

Heterocoelia hispanica (Cameron, 1888)

Epyris hispanicus Cameron, 1888: 169 (♀).

Mesitius hispanicus; Kieffer, 1905: 111.

Heterocoelia hispanica; Móczár, 1971: 306, 317 (♀).

Specimens examined: 1 ♀, San Roque, Cádiz, J. Ramirez (Budapest). 1 ♀, Montequaque, Málaga, España, A. Pardo (Budapest).

This species was described from Gibraltar (Cameron, 1888). Further data are unreliable owing to erroneous synonymisation with *Mesitius carceli* Westwood (Kieffer, 1906).

With certainty known from Spain only.

Heterocoelia nigriventris (Dahlbom, 1845)

Cleptes nigriventris Dahlbom, 1845: 1 (♀).

Heterocoelia nigriventris; Dahlbom, 1854: 22.

Heterocoelia nigriventris; Móczár, 1971: 306, 318 (♀).

Specimens examined: 1 ♀, Tanger, Morocco, 25—29.iv.1926, Lindberg (Helsinki). 1 ♀, Meknes, 570, 16.iv.1963 (Budapest).

This species was reported from North Africa (Dahlbom, 1845; Picard, 1932, etc.), and from the Mediterranean coast (Marshall, 1874; Nagy, 1968).

Sulcomesitius capensis (Kieffer, 1911)

Mesitius capensis Kieffer, 1911: 455 (♀).

Sulcomesitius capensis; Móczár, 1970b: 411, 413, 426 (♀, ♂ nov.).

Specimens examined: 1 ♀, Grahamstown, 20.x.1970, S. Afr., leg. H. and M. Townes (Gainesville, Florida).

Known from South Africa only (Kieffer, 1911; Móczár, 1970b).

Sulcomesitius consimilis Móczár, 1970

Sulcomesitius consimilis Móczár, 1970b: 411, 413, 430 (♀ ♂).

Specimen examined: 1 ♀, Hluhluwe Game Res., 13.xi.1970, S. Afr., leg. H. and M. Townes (Gainesville, Florida).

This species was reported from South Africa before (Móczár, 1970b).

Sulcomesitius erdoesi Móczár, 1970

Sulcomesitius erdoesi Móczár, 1970b: 413, 429 (♂).

Specimen examined; 1 ♂, St. Lucia Estuary 15.xi.1970, S. Afr., leg. H. and M. Townes (Gainesville, Florida).

It was reported from South Africa (Móczár, 1970b).

Sulcomesitius grahamensis sp. n.

(figs. 18—23)

Female. — Length 5.8 mm. Head and thorax yellowish, partly darker red with blackish spots on upper side of antennae distally, on frons in-

cluding ocelli, on lower parts of head and on lateral areas of propodeum; legs brownish or, partly, lighter brownish red; abdomen black, segments dark reddish, translucent posteriorly. Wings rather short, reaching about the middle of tergite 2, fore wings dark brownish infuscated except base, tip and a rather broad transverse band outside of cells, veins dark brown, pterostigma yellowish brown. Body covered with sparse short white hairs, tergites without a tuft of short white hairs (fig. 23).

Head distinctly longer than broad (58 : 50), remarkably broadened behind eyes, sides straight and distinctly converging, corners rounded, occipital carina arched, margin narrowly impressed; ocelli in a sharp acute angle; hind ocelli separated from each other by a distance shorter than three-quarters of that from eyes, POL : OOL = 7 : 9, outer margins of ocelli with deep shining grooves; frontal sulcus very short, frons weakly shining with rather deep (fig. 18) and scattered punctures (compared to *S. masneri* Móczár, 1984), interspaces shagreened; eyes relatively larger, convex, longer than broad (21 : 18), separated from mandibles by a distance of about four-fifth length of eye (15 : 18); anterior margin of clypeus remarkably protruding and nearly straight with rounded corners laterally, surface raised longitudinally into a sharp, high keel medially. Antennae short, flagellar joints slightly thickened medially, antennal joints 1—3 slender (fig. 21), joint 3 longer than 2, 7 longer than 5—6 or 8—12, scape 2.5 times longer than broad, joints 2—3 about twice as long as broad, 4—12 broader than long, length (and breadth) proportions of antennal joints 1—13 = 20 (8) : 8 (4.5) : 10 (5) : 5 (5.5) : 4.5 (5.5) : 4.5 (5.5) : 5 (6) : 4 (5) : 4 (5) : 4 (5) : 4 (5) : 7 (4).

Pronotum 1.2 times broader than long (34 : 28), anterior corners obtuse, sides nearly parallel, slightly concave anteriorly, diverging towards tegulae, posterior margin slightly emarginate and shallowly impressed, surface shagreened, nearly granulated with larger punctures than on head, longitudinal furrow remarkably deep and narrow. Mesonotum finely shagreened, hardly shining, with scattered punctures, parapsidal furrow and notaulices well-developed and sharply margined (fig. 19), longitudinal furrow shallow. Scutellum slightly impressed medially, moderately shining. Propodeum short, as long medially as half its transverse diameter before spine, lateral margins gradually diverging backwards (fig. 20), spines

strongly acute (viewed from above and from the side), shorter than two-thirds length of propodeum (14 : 23). All carinae and areas well-developed, sublateral areas finely transversely wrinkled, sublateral carinae nearly straight, not bending before posterior margin of propodeum, because of this lateral area remarkably broader before spine than in *S. masneri*. Side of propodeum wrinkled diagonally also with a parallel longitudinal and stronger wrinkle below upper and along posterior margins, fusing at base of spine. Episternum coarsely sculptured with a rather deep and broad furrow transversely below tegulae.

Abdomen smooth, shining, tergite 1 polished, only with very scattered punctures, tergite 2 granulated on its basal third (fig. 23), with distinct, not deep and rather dense punctures medially and polished without any punctures on its posterior third, except for a very small finely alutaceous streak just along posterior margin, sides with fine denser punctures to posterior margin, except the broad polished and impunctate ventro-lateral margin on its whole length (fig. 22). Tergites 2—6 smooth, shining, partly alutaceous and partly with fine scattered punctures with semicircular impressions on posterior margins. Sternite 2 shining, deeper punctured only basally, more scattered medially and posteriorly.

Male. — Unknown.

Holotype: ♀, "Grahamstown x-20-70 S. Afr. H. and M. Townes" (Gainesville, Florida).

This species is similar to *S. masneri* Móczár, 1984 (reported from Sri Lanka) but differs chiefly by tergite 2 being without dense and deep punctures medially and without small polished area postero-medially, by the deeper and more sparsely punctured head, by the shallow and not well margined longitudinal furrow of the mesonotum, by the antennal joints 2—3 being of different length, by the colour, etc.

Sulcomesitius zambiensis sp. n.

(figs. 24—27)

Male. — Length 4.3 mm. Black, apical half of mandibles, hind tibiae partly on inner side, last tarsal joints partly, posterior margins of tergite 2—3, segments 4—7, brownish red, partly dark brown. Wings long, reaching to the posterior end of abdomen, fore wings distinctly blackish infuscated with broad lighter basis and a light band outside of cells, veins dark brown. Body sparsely covered with short, light hairs, antennae with very short brown proclinate hairs.

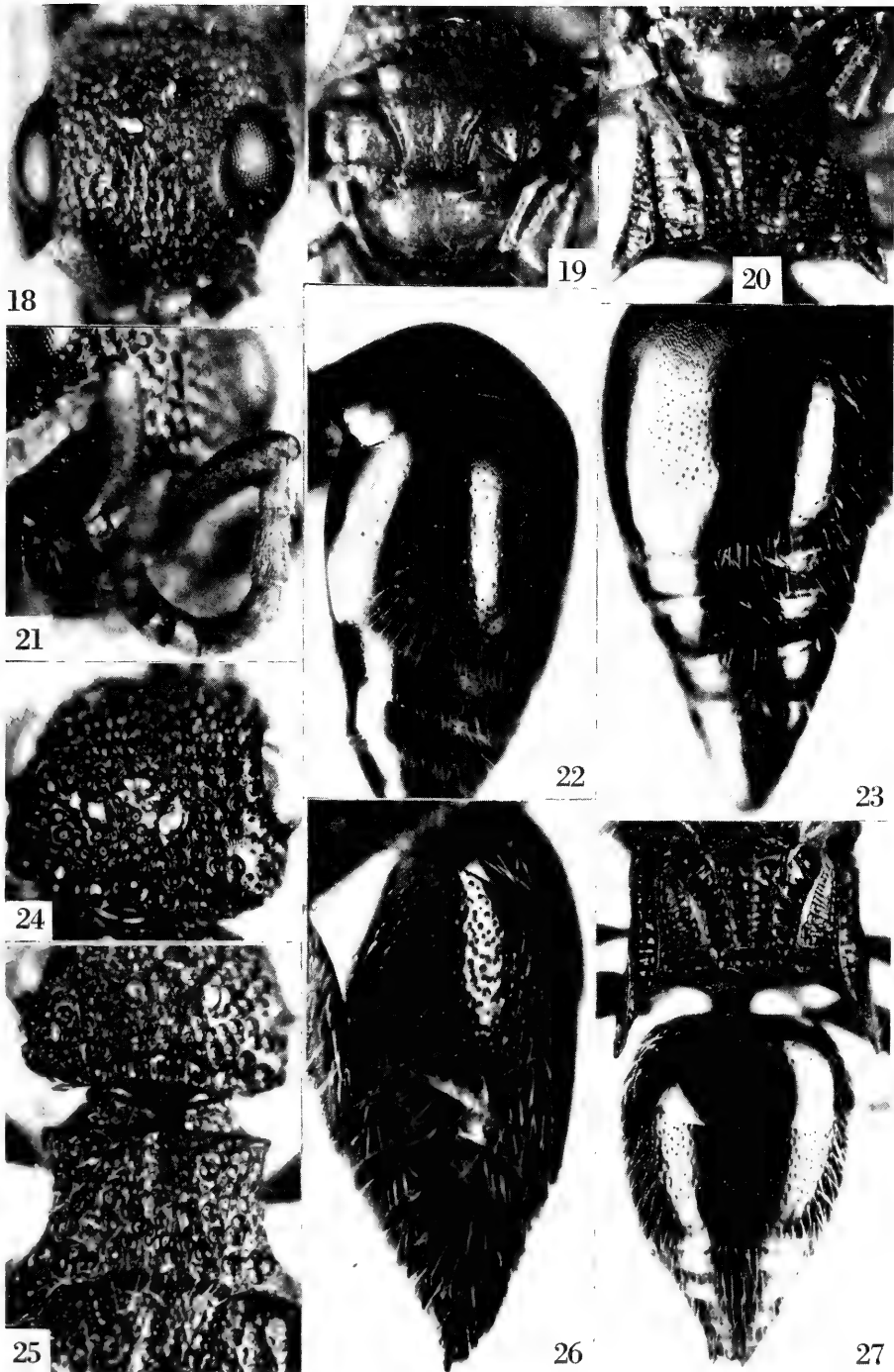

Figs. 18—23. *Sulcomesitius grahamensis* sp. n., ♀. 18, head in front; 19, mesonotum, scutellum; 20, propodeum; 21, antennal joints; 22, abdomen in lateral view; 23, abdomen. Figs. 24—27. *Sulcomesitius zambiensis* sp. n., ♂. 24, head, vertex; 25, posterior part of head, pronotum and mesonotum; 26, abdomen in lateral view; 27, propodeum and abdomen.

Head as long as broad (28 : 29), remarkably broadened backwards and parallel behind eyes (viewed from above), posterior margin nearly straight with very deep impressed row of irregular foveolae (figs. 24, 25), the larger ones situated behind ocelli; ocelli in a distinct obtuse angle, POL : OOL = 5 : 6, outer margins of ocelli with deep larger grooves (figs 24, 25); frontal sulcus shallow; head with coarse deep and very dense punctures, interspaces of vertex distinct and granulate (fig. 24), especially between ocelli and eye; clypeus semicircularly rounded and raised as a longitudinal sharp and high keel medially; eye very convex, slightly broader than three-fourths its length (9 : 11), separated from mandible by length of OOL or by hardly more than half the length of an eye (6 : 11). Antennae unusually thick and flattened, joints only slightly longer than thick, except joints 1, 3 and 10—13, inner sides of joints 5—10 curved, outer side straight, outer tips of these joints acute apically, inner ones rectangular, joints 2, 4—9 hardly longer than broad, 1, 12—13 at least twice as long as broad, length (and breadth) proportions of joints 1—13 = 8 (4) : 5 (4) : 7 (4.5) : 5.5 (4.5) : 5.5 (4.5) : 6 (5) : 6 (5) : 6 (4) : 6 (4) : 5 (3.5) : 5 (3) : 4.5 (2) : 7 (2).

Pronotum only two-thirds as long as its breadth anteriorly (14 : 21), anterior corners sharply triangularly protruding (fig. 25) owing to a wrinkle emerging on side and reaching corners, sides concave up to middle and diverging backwards, posterior margin only weakly arched, surface with very coarse, dense and deep punctures, latter larger than on vertex, few spaces granulated, longitudinal furrow deep and broad only in front. Mesonotum shagreened, hardly shining with scattered smaller and some larger punctures, notaulices broad, very deep and cross-wrinkled, parapsidal furrow weakly developed, longitudinal furrow broad and deep, developed only in posterior half (fig. 25). Scutellum without median sulcus, with deep and larger punctures. Propodeum strongly sculptured, all carinae well-developed, areas transversely wrinkled, propodeum as long medially as half transversal breadth of disc (14 : 13.5), lateral spine remarkably acute (fig. 27), also when viewed side and conspicuously long, nearly as long as four-fifth length of propodeum medially (11 : 14), side of propodeum with dense and larger not deep punctures, with a strong parallel wrinkle along upper and posterior margins, fusing into spine, this area strongly cross-wrinkled. Episternum strongly punctate

with a diagonal deep groove below tegulae.

Abdomen smooth, shining, tergite 1 polished with scattered distinct punctures medially and laterally, tergite 2 granulated basally with rather deep and rather dense punctures medially (fig. 27), with denser punctures laterally except the polished antero-lateral triangle (fig. 26) and the medio-posterior area. Last tergites distinctly punctured. Sternite 2 with deep dense punctures.

Female. — Unknown.

Holotype: ♂, "Zambia Africa Copperbelt Pr. Mwekera 323 i 1982 J. Selander leg." from Dept. Agr. Forest., Zool. Univ. Helsinki in exchange in Budapest (Hym. Typ. No. 3708).

This species is closely related to *S. townesianus* Móczár, 1983, but differs chiefly by tergite 2 being without sparse punctures laterally before ventro-lateral polished margin, by the ocelli not forming a right angle, by the vertex having no interspaces, by the area before the occipital carina being irregularly foveolate, by the pronotum being only slightly longer than half the frontal breadth, by the longer lateral spine of propodeum, by the colour, etc.

Pycnomesitius peringueyi (Kieffer, 1913)

Mesitius peringueyi Kieffer, 1913: 329 (♀).

Pycnomesitius peringueyi; Móczár, 1971: 301, 302 (♀, ♂ new).

Specimen examined: 1 ♂, Eshowe, Natal, 19.xi.1970, S. Afr., H. and M. Townes (Gainesville, Florida).

Reported from South Africa: Natal (Kieffer, 1913).

Pycnomesitius densepunctatus Móczár, 1971

Pycnomesitius densepunctatus Móczár, 1971: 167 (♀ ♂).

Specimens examined: 2 ♂, Eshowe, Natal, 19.ix.1970, S. Afr., H. and M. Townes (Gainesville, Florida, and Budapest).

Reported from South Africa (Móczár, 1971).

REFERENCES

- Cameron, P., 1888. Descriptions of twenty-three new species of Hymenoptera. — Mem. Proc. Manchester lit. phil. Soc. (4) 1: 159—183.
 Cameron, P., 1889. A decade of new Hymenoptera. Proctotrupidae. — Mem. Proc. Manchester lit. phil. Soc. (4) 2: 11—14.
 Dahlbom, A. G., 1845. Dispositio methodica specierum Hymenopterorum secundum familias insectorum naturales. Particula secunda *Chrysis* in sensu Linnaeano: 1—21. — Lund, Berlin.

- Dahlbom, A. G., 1854. Hymenoptera Europaea praecipue Borealia per familias, genera, species et varietates deposita atque descripta. Tomus secundus *Chrysis* in sensu Linnaeano, i-xxiii, 1—412, pls. 1—12.
- Dalla Torre, C. G. de, 1898. Chalcididae et Proctotrupidae. — *Catalogus Hymenopterorum* 5: i-viii, 1—598.
- Hoffer, A., 1936. Genus *Mesitius* Thoms. in der Čechoslovakiei (Bethylidae, Hym.-Vespoidea). — *Čas. čsl. Spol. ent.* 33: 119—124, figs. 1—3.
- Kieffer, J. J. & T. A. Marshall, 1904—1906. Proctotrupidae. — In: André, *Species des Hyménoptères d'Europe et d'Algérie* 9; 1904: 1—64; 1905: 65—288; 1906: 289—552, pls. i-xxi.
- Kieffer, J. J., 1905. Description de nouveaux Proctotrupides exotiques. — *Annls Soc. sci. Bruxelles* 29: 95—142, fig. 1—14.
- Kieffer, J. J., 1908. Hymenoptera. Fam. Bethylidae. — In: Wytzman, *Genera Insectorum* 76: 1—50, pls. i-iii.
- Kieffer, J. J., 1911. Cynipides et Béthylides de l'Afrique du Sud (Hymenopt.). — *Annls Soc. ent. Fr.* 80: 451—462.
- Kieffer, J. J., 1913. Nouveaux Serphides de l'Afrique du Sud. — *Boll. Lab. Zool. gen. agr. Portici* 7: 324—331.
- Kieffer, J. J., 1914. Hymenoptera. Bethylidae. — *Das Tierreich* 41: 1—595, figs. 1—205.
- Marshall, T. A., 1874. Description of a new European species of Bethylides (Hymenoptera: *Oxyura*). — *Entomologist mon. Mag.* 10: 222—223.
- Móczár, L., 1969. New *Mesitius* species Hymenoptera: Bethylidae). — *Acta zool. hung.* 15: 371—377, fig. 1.
- Móczár, L., 1970a. Mesitinae of world with new genera and species. I. (Hymenoptera: Bethylidae). — *Acta zool. hung.* 16: 175—203, fig. 1—16.
- Móczár, L., 1970b. Mesitinae of world, genera *Sulcomesitius* Móczár and *Metrionotus* Móczár. II. (Hymenoptera: Bethylidae). — *Acta zool. hung.* 16: 409—451, figs. 1—8.
- Móczár, L., 1971. Mesitinae of world, genera "*Mesitius* Spinola", *Pilomesitius* Móczár *Parvoculus* Móczár, *Pycnomesitius* Móczár and *Heterocoelia* Dahlbom. III. (Hymenoptera: Bethylidae). — *Acta zool. hung.* 17: 295—332, figs. 1—9.
- Móczár, L., 1974. On another new species of the genus *Metrionotus* Móczár (Hymenoptera: Bethylidae: Mesitinae). — *Acta biol. Szeged.* 20: 173—177.
- Móczár, L., 1983. New data of Bethylidae from the Priesner's collection. — *Acta biol. Szeged.* 29: 203—204.
- Móczár, L., 1984. Oriental Mesitiinae (Hymenoptera: Bethylidae). — *Folia ent. hung.* 45: 109—150, figs. 1—181.
- Nagy, C. G., 1968. A new record of Mesitinae (Hymenoptera, Bethylidae). — *Memorie Soc. ent. ital.* 47: 168—176, figs. 1—9.
- Nagy, C. G., 1969. Sur la sous-famille Mesitinae Berland (Hym., Bethylidae). — *Lucr. Sta. zool. marit. Agigea*, 3: 275—300, figs. 1—33.
- Nagy, C. G., 1972. Taxonomic remarks on Mesitinae (Hymenoptera, Bethylidae). — *Memorie Soc. ent. ital.* 51: 5—18, figs. 1—12.
- Picard, F., 1932. Contribution à l'étude des *Mesitius* du bassin méditerranéen (Hymenoptera Bethylidae). — *Soc. ent. Fr., Livre cent.*: 403—414, figs. 1—3.
- Schulz, W. A., 1906. Standgut. — *Spolia Hym.*: 76—269.
- Snellen van Vollenhoven, S. C., 1867. Drie nieuwe soorten van inlandsche Hymenoptera. — *Tijdschr. Ent.* 10: 222—226, pl. 10.
- Spinola, M. 1851. Compte rendu des Hyménoptères inédits provenants du voyage entomologique de M. Ghiliani dans la Para en 1846. — *Memorie Acad. Sci. Torino* (2) 13: 19—94.
- Westwood, J. O., 1874. Thesaurus entomologicus Oxoniensis; or Illustrations of new, rare and interesting insects, for the most part contained in the collections presented to the University of Oxford by the Rev. F. W. Hope, 4: 1—205, 40 pls. — Oxford Clarendon Press.



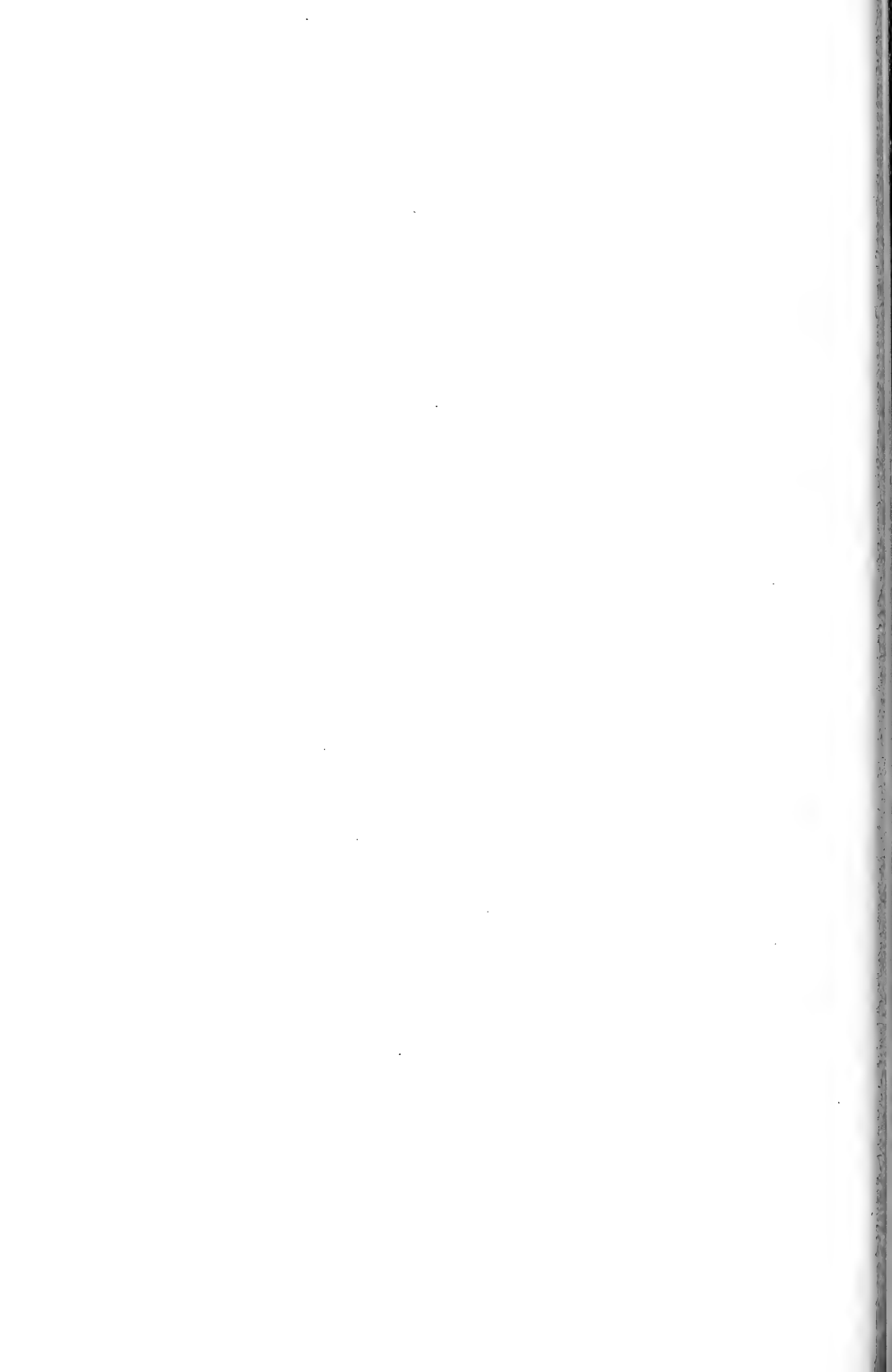





TIJDSCHRIFT VOOR ENTOMOLOGIE

UITGEGEVEN DOOR

DE NEDERLANDSE ENTOMOLOGISCHE VERENIGING

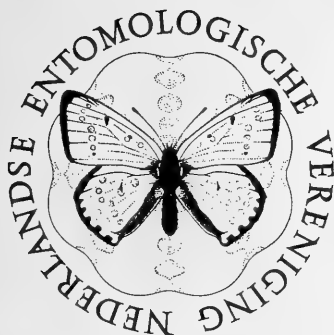
MUS. COMP. ZOOL
LIBRARY
JAN 16 1985
HARVARD
UNIVERSITY

INHOUD

- H. J. VLUG and M. W. R. DE V. GRAHAM. — The types of Platygastriidae (Hymenoptera, Scelionoidea) described by Haliday and Walker and preserved in the National Museum of Ireland and the British Museum (Natural History). 1. Designation of lectotypes, pp. 115—135.



THE TYPES OF PLATYGASTRIDAE (HYMENOPTERA, SCELIONOIDEA) DESCRIBED BY HALIDAY AND WALKER AND PRESERVED IN THE NATIONAL MUSEUM OF IRELAND AND THE BRITISH MUSEUM (NATURAL HISTORY)

1. DESIGNATION OF LECTOTYPES

by

H. J. VLUG

Instituut voor Plantenziektenkundig Onderzoek, Binnenhaven 12, Wageningen, The Netherlands

and

M. W. R. DE V. GRAHAM

5 Salisbury Crescent, Oxford, Great Britain

Abstract

A survey is given of the Platygastriidae described by Haliday and Walker from the British Isles. The relevant collections at the British Museum (Natural History) and the National Museum of Ireland have been studied and analysed as to types of pins, characteristics of mounting and, often subsequently attached, labels. Lectotypes are designated for nearly all species. *Eurostemma* Szélényi, 1938, is found to be a junior synonym of *Allotropa* Foerster, 1856.

INTRODUCTION

Although Masner (1965) published a paper on the types of the Proctotrupeoidea in the British Museum (Natural History) (BMNH) and in the Hope Department of Entomology at Oxford, the Platygastriidae described by Haliday and Walker have continued to be largely ignored. No less than 113 British, Irish and Scottish species of Platygastriidae have been described by Haliday and Walker. In addition to the BMNH material, the present authors have also studied the type specimens preserved in the National Museum of Ireland (NMI), Dublin. Two store-rooms at NMI, part of the Haliday collection and numbered 16 and 23, contain the majority of his own and Walker's platygastriid types. An account of the Haliday collection has been published by O'Connor & Nash (1982). Graham (1982) has provided additional notes on its history. Thanks to Dr. J. P. O'Connor, the senior author had the relevant contents of boxes 16 and 23 on loan for over a year. From this material 84 lectotypes have been designated. In addition, 27 lectotypes have been selected from

the material of the BMNH and one lectotype has been designated from specimens in the "Naturhistorisches Museum", Vienna. One species was not represented in any of the above institutions and it has to be regarded as a nomen dubium. Three species, renamed by Kieffer, have also been included in this paper.

The examined collections are amongst the earliest made of the Platygastriidae and they provide therefore a sound foundation for the study of the group. Although many taxa described by Nees (1834) are of earlier date, a larger number of species were described by Haliday and Walker. The Nees material has been lost and as a consequence neotypes for his species will have to be established eventually.

We have restricted our study to those species which were described by Haliday in 1833, Walker and Haliday in 1835 and Walker in 1838. On page 218 of his 1835 paper Walker states: "In the first volume of the Entomological Magazine there is an excellent methodical arrangement of these and other minute Hymenoptera, by Mr. Haliday; who, by the loan of his

MSS. and collection contributed much to the following descriptions—". The species described by Haliday, but which appeared in Walker's paper are therefore quoted as "Haliday in Walker" when Walker mentions: "(Haliday, MSS.)" or in the case of *Iphitrachelus lar*: "(Haliday)". However, whenever Walker states: "(Haliday, Curtis' Brit. Ent. 309)", Walker must be considered the authority. This situation arises because these names appeared in a list without any description (Curtis, 1830), Walker merely using the Haliday names for his own descriptions. For *Platygaster velutinus*, Walker only provides a figure of the male and female antennae. Although *P. elongatus* also appeared in Curtis (1830) without a description, Haliday has been retained as the authority since he characterized it in his 1833 key.

The type localities quoted in this paper are cited as they appeared in the original descriptions. Most of them are "near London" (which is actually near Southgate [Graham, 1979]), "New Lanark" (Scotland) and "Holywood" (Ireland, collected by Haliday).

A handwritten "Catalogue of Irish Insects" by Haliday is preserved in NMI. Although it has never been published, it is cited in this paper; undoubtedly it postdates 1838.

TYPE DESIGNATIONS

Unless Masner (1965) states explicitly "Lectotype", his designations are not considered valid. The term "unique" employed by him does not refer to either a holotype or a lectotype. This difficulty also arises with the labels, affixed to the BMNH material; these could indicate syntype status in some instances.

Although both Haliday and Walker utilized a variety of pins for their specimens, short English pins were used mainly for the Platygastriidae. Haliday usually colour-coded the pinheads as follows: red (English), green (Irish) and white (Scottish). In some cases, coloured labels were used to indicate provenance. Such evidence has enabled the authors to choose some lectotypes based upon the locality data given in the original descriptions. Whenever the pinheads were uncoloured and no other relevant data was available, a lectotype was selected if the relevant specimen agreed exactly with the published description. Walker and Haliday mounted their specimens in different styles. The former glued the specimens carelessly on the card which was cut regularly in a rectangular shape. He pinned the card exactly in the mid-

point along an edge. By contrast, Haliday carefully glued his specimens on their cards, spreading out the antennae, wings and legs. As Graham (1982) and O'Connor & Nash (1982) have pointed out, he pinned the often irregularly cut card in a corner. The BMNH material was repinned with continental pins by James Waterston in 1928 (J.W. labels). Since the original pins were not retained, this action may have destroyed evidence indicating provenance.

When specimens were not labelled according to species (e.g. Haliday box 16), we have attempted to assess the concept of a particular species by studying the original descriptions in detail and by examining its location in the original arrangement of the material in the box. The junior author made a detailed plan of the contents of this box in 1961, enabling a careful study of Haliday's arrangement to be made. A copy of this drawing has been deposited in NMI.

In 1961, the junior author listed the contents of Haliday boxes 16 and 23. This has provided a basis for type selection. The numbers cited in this paper refer to that list. The BMNH types have a different numbering system. All lectotypes have been given a red label stating "Lectotype H. J. Vlug 1982" and a determination label with "det. H. J. Vlug 1982". The NMI material has been mounted on polyporus blocks which is staged with continental-type pins. The original labels and pins have been preserved. The types are labelled either "box 16" or "box 23. Stood in original Haliday collection under..."

THE 1838 SPECIES

The arrangement of Walker's descriptions in his 1838 paper are even more complex than those of 1835 and the sequence has caused many problems for subsequent students. Later workers have been confused and this applies particularly to Kieffer (1914, 1926). Szelényi has already mentioned this difficulty in his 1938 paper on *Inostemma*.

Walker's descriptions follow the form of an identification key. The genus *Inostemma* commences with the word "Fem." and then continues with a morphological description of *I. hispo*. This is followed by the species number viz. "Sp.1. *Ino. Hispo. Fem.*" and a short characterization of the coloration. Next, he gives a detailed description of the colours, commencing with "Ater;". The description ends with "Found by Mr. Haliday" etc. The next species, *I. favo* and all subsequent ones are treated in a

similar manner. Each species description is therefore split into two sections by the insertion of the relevant species number, one part appearing above the number, the other below it. This is a most unusual system causing misinterpretation because normally a complete species description would follow its number in a list. Kieffer (1914) erred by starting in the case of *I. hispo* with "Sp. 1. *Ino. Hispo*" and ending just above "Sp. 2 *Ino. Favo*". He omitted the first part of the description of *I. hispo* and included the initial section of *I. favo* with the second one of *I. hispo*, thus combining the descriptions of the two species. Similarly, because he had become confused by Walker's sequence, he mixed up the description of *I. favo* with that of *I. boter*, *I. boter* with that of *I. europus* and *I. europus* with that of *I. ocalea*. He listed *I. ocalea* among the unrecognized species ("Ungenügend beschriebene Arten"), thus merely providing a translation of the second part commencing with "Sp. 5. *Ino. Ocalea*".

With the exception of two individuals labelled "*boter*", no specimens were provided with a specific name in either BMNH or NMI. No. 1198 in NMI does fit the description of *I. hispo* but it has a label with "*Inostemma syrinx*" on it. This manuscript name occurs in Haliday's catalogue where it is given the number 5. By contrast, *I. hispo* is numbered 4. Apparently, Haliday considered these two species separate and consequently no. 1198 is not considered to be a syntype of *I. hispo*. *I. favo* is number 3 in the catalogue. In Haliday's collection it is represented by nine specimens and these all fit the description. *I. boter* is represented by four specimens, two of which have the labels mentioned above. There are three specimens of *I. europus* which fit accurately the species description except that Walker cites a male. However, he states: "antennae clavatae" and "8us. 9us. et 10us. lati, clavam fingentes fusiformem" which fits a female antenna. Undoubtedly, Walker mistook his specimen (a female) for a male and miscounted the antennal segments which, in fact, are 9-segmented. It is, of course, possible that he never saw the relevant material, Haliday providing him with the description, and that a typographical error occurred. We are certain that *I. europus* was described from specimen no. 1225, a female glued on a card. The remaining male and female, mounted together on a single card (1226—1227), may have been subsequently

collected by Haliday who provided them with a green-headed pin and a green label. It is possible that these two specimens are those which appear in his catalogue as follows:

"*buchaetus* 10 *europus* ♀
mecrida ♂ *ulex*".

Evidently Haliday recognized *I. europus* and *I. mecrida* to be synonymous, but this has yet to be confirmed. The type of *I. mecrida* has been found in the Vienna Museum (Vlug, 1973); apparently this was the specimen on which Foerster founded the genus *Allotropia*. The Haliday collection contains two specimens which closely fit the description of *I. ocalea*. The species appears to belong to the genus *Metaclisis*. Szelényi (1938) placed it in *Parinostemma* but this is now considered to be a synonym of *Metaclisis* (Masner, 1965, 1981).

ACKNOWLEDGEMENTS

We wish to offer our sincere thanks to Dr. J. P. O'Connor for his kind help and hospitality during the two periods the senior author has spent in Dublin, for the loan of the Haliday collection and for his critical reading of the manuscript. Thanks are also due to Dr. N. D. M. Fergusson and the staff of the BMNH for their support and loan of types, Dr. M. Fischer of the Vienna Museum for the loan of relevant material, Dr. H. H. Evenhuis, Dr. L. Masner and Dr. L. Huggert for their useful comments and for reading the manuscript, the Uyttenboogaart-Eliassen Foundation and the staff of the Research Institute for Plantprotection for giving the senior author the opportunity to spend some weeks in Dublin and London, and Mr. C. van der Horst, Wageningen, for revising the English text.

Amblyaspis Foerster

Amblyaspis abas (Walker)

Platygaster abas Walker, 1835: 238 (♂♀).

Amblyaspis abas (Walker); Kieffer, 1914: 397.

Type locality: "July and August; on grass in woods; near London. New Lanark, Scotland."

Lectotype male (designated here), in NMI: "*abas*"; "1055"; "Box 16"; det. and type labels (H. J. Vlug, 1982). The type is pinned with a red-headed pin, indicating its English origin. Two more males, nos. 254 and 255, in NMI do not belong to *A. abas*.

Amblyaspis belus (Walker)

Platygaster belus Walker, 1835: 235, 236 (♀).
Amblyaspis belus (Walker); Kieffer, 1914: 408.

Type locality: "Found rarely at Holywood, in Ireland, by Mr. Haliday."

Lectotype female (designated here), in NMI: "Belus"; green label (Irish); "239"; "Box 23. Stood in original Haliday collection under *Platygaster belus*"; det. and type labels (H. J. Vlug, 1982). One other female (240) and one other male (243) under this name in NMI belong to different species.

Amblyaspis crates (Walker)

Platygaster crates Walker, 1835: 236 (♂).
Amblyaspis crates (Walker); Kieffer, 1914: 410.
Platygaster crates Walker, Vlug, 1973: 181.

Type locality: "September; Isle of Wight".

Lectotype male (designated here), in NMI: "245"; "Box 23. Stood in original Haliday collection under *Platygaster crates*"; det. and type labels (H. J. Vlug, 1982). Four other males and females (244 and 246—248) in NMI belong to different species.

Amblyaspis furius (Walker)

Platygaster furius Walker, 1835: 234, 235 (♂ ♀).
Amblyaspis furius (Walker); Kieffer, 1914: 408;
 Masner, 1965: 132.

Type locality: "July and August; near London. September; Isle of Wight. Penzance, Cornwall. Found in Ireland, by Mr. Haliday."

Lectotype male (designated here), in NMI: "furius"; "999"; "Box 16"; det. and type labels (H. J. Vlug, 1982). The material in NMI under the numbers 230—234 and 1019 does not belong to *A. furius*. The female in BMNH 9.563 has no type status.

Amblyaspis nereus (Walker)

Platygaster nereus Walker, 1835: 233 (♂ ♀).
Amblyaspis nereus (Walker); Foerster, 1856: 112.

Type locality: "July; on grass in woods; near London. September; near Linton, North Devonshire."

Lectotype female (designated here), in NMI: "216"; "Box 23. Stood in original Haliday collection under *Platygaster nereus*"; det. and type labels (H. J. Vlug, 1982). The other specimens in NMI (nos. 215, 217, 218 and 1012—1015) and the male in the Vienna Museum (Vlug, 1973) do not belong to *A. nereus*.

Amblyaspis otreus (Walker)

Platygaster otreus Walker, 1835: 236, 237 (♂ ♀).
Amblyaspis otreus (Walker); Kieffer, 1914: 395; Masner, 1965: 132.

Type locality: "August to October; on grass in fields; near London. September; Isle of Wight. New Lanark, Scotland. Found in Ireland, by Mr. Haliday."

Lectotype male (designated here), in NMI: "Otreus"; "1020"; "Box 16"; det. and type labels (H. J. Vlug, 1982). The males and females, nos. 249—251 and 1021 in NMI and 9.562 in BMNH, are not conspecific.

Amblyaspis prorsa (Walker)

Platygaster prorsa Walker, 1835: 237, 238 (♂ ♀).
Amblyaspis prorsa (Walker); Kieffer, 1914: 404;
 Masner, 1965: 133.

Type locality: "May to September; on grass in woods; near London. Isle of Wight; New Forest, Hampshire. New Lanark, Scotland."

Lectotype male (designated here), in BMNH: "*Platygaster prorsa*, Wk." and "Stood under this name in old BM collection (Rearranged 1928, J. W.); "*Prorsa* Wk."; "TYPE"; "B. M. TYPE HYM. 9.565"; det. and type labels (H. J. Vlug, 1982). The material in NMI (252, 253 and 1022—1024) does not belong to this species.

Amblyaspis roboris (Haliday)

Platygaster roboris Haliday, in Walker, 1835: 234 (♂ ♀).
Amblyaspis roboris (Walker); Foerster, 1856: 112.
Platygaster roboris Walker; Vlug, 1973: 182.

Type locality: "Found in Ireland, by Mr. Haliday".

Lectotype female (designated here), in NMI: "roboris"; "1308"; "Box 16"; det. and type labels (H. J. Vlug, 1982). Seven additional males and females in NMI (nos. 226, 228, 989, 990, 992, 993 and 1307). The specimens 225, 227, 229 and 1306 are different species; no. 991 has a red pin head, so this specimen cannot have type status; the specimen in the Vienna Museum (Vlug, 1973) has not been reexamined.

Amblyaspis scelionoides (Haliday)

Platygaster scelionoides Haliday, in Walker, 1835: 235 (♀).
Amblyaspis scelionoides (Walker); Kieffer, 1914: 409.

Type locality: "Found in Ireland, by Mr. Haliday."

Lectotype female (designated here), in NMI: "*Scelionoides*"; "14." (1814); "*Scelionoides*"; green ticket; "155"; "Box 23. Stood in original Haliday collection under *Platygaster scelionoides*"; det. and type labels (H. J. Vlug, 1982). Nos. 156, 157 and 235—238 in NMI are different species.

Amblyaspis tritici (Walker)

Platygaster tritici Haliday, in Curtis, 1830: folio 309 (second page) (nomen nudum).

Platygaster tritici Walker, 1835: 233, 234 (♂♀ first description).

Amblyaspis tritici (Haliday); Foerster, 1856: 112.

Amblyaspis tritici (Curtis); Muesebeck and Walkley, 1956: 326, 327.

Type locality: "Found by Mr. Haliday on *Cerealia* and willows in England and Ireland. March to May, and October; on grass; near London. June; New Forest, Hampshire. September; Cumberland; New Lanark, Scotland."

Lectotype male (designated here), in NMI: "220"; "Box 23. Stood in original Haliday collection under *Platygaster tritici*"; det. and type labels (H. J. Vlug, 1982). Two more males, nos. 219 and 222 in NMI are paralectotypes. The rest of the material in NMI under this name (nos. 221, 223, 224, 994—998, 1296—1301 and 1315—1317) is different in many aspects; some specimens may prove to be *A. tritici* when more is known about variation within this species. The male in the Vienna Museum (Vlug, 1973) is a different species.

Isocybus Foerster

Isocybus cotta (Walker)

Platygaster cotta Walker, 1835: 242 (♀).

Isocybus cotta (Walker); Foerster, 1856: 114.

Isocybas (sic!) *cotta* (Walker); Walker, 1872: 540.

Isocybus cotta (Walker); Muesebeck & Walkley, 1956: 362.

Type locality: "June; New Forest, Hampshire."

Lectotype female (designated here), in NMI: "273"; "Box 23. Stood in original Haliday collection under *Platygaster cotta*"; det. and type labels (H. J. Vlug, 1982). The remainder of the specimens under this name in NMI (nos. 272, 274 and 275) do not fit the description.

Isocybus erato (Walker)

Platygaster erato Walker, 1835: 241 (♂).

Isocybus erato (Walker); Foerster, 1856: 114.

Isocybas (sic!) *erato* (Walker); Walker, 1872: 540.

Isocybus erato (Walker); Masner, 1965: 133.

Type locality: "September; near Keswick, in Cumberland."

Lectotype male (designated here), in NMI: "269"; "Box 23. Stood in original Haliday collection under *Platygaster erato*"; det. and type labels (H. J. Vlug, 1982). The female no. 1083 in NMI (Irish origin) and the female no. 9.615 in BMNH have no type status.

Isocybus matuta (Walker)

Platygaster matuta Walker, 1835: 241, 242 (♂♀).

Isocybus matuta (Walker); Foerster, 1856: 114.

Isocybas (sic!) *matuta* (Walker); Walker, 1872: 540.

Isocybus matuta (Walker); Masner, 1965: 133.

Type locality: "September; near Keswick, Cumberland."

Lectotype male (designated here), in BMNH: "*Platygaster matuta* Wlk" and "Stood under this name in old BM collection (Rearranged 1928, J.W.); "*Matuta* Wlk"; "TYPE"; "B.M. TYPE HYM. 9.616"; det. and type labels (H. J. Vlug, 1982). Two further males, nos. 270 and 271, in NMI are paralectotypes. The lectotype has been remounted by Vlug and the right wings are mounted on a separate microslide, which is pinned on the same pin as the lectotype.

Isocybus walkeri Kieffer

Platygaster ruficornis (Latreille), sensu Walker, 1835: 240 (figs. 10—12).

Isocybus ruficornis (Latreille); Foerster, 1856: 114.

Isocybus walkeri Kieffer, 1926: 727 (♂♀).

Type locality: "July; on grass beneath trees; near London. England, Ireland, and Scotland, in marshes, Mr. Haliday."

Lectotype male (designated here), in NMI: "1091"; "Box 16"; det. and type labels (H. J. Vlug, 1982). Four other males (nos. 1087, 1088, 1090 and 1092) and three females (nos. 1084—1086) in NMI are paralectotypes. Nos. 265—268 and 1089 are not conspecific.

Leptacis Foerster

Leptacis halia (Walker)

Platygaster halia Walker, 1835: 229 (♂).

Synopeas halia (Walker); Foerster, 1856: 114; Fitton et al., 1978: 122.

Type locality: "August; on grass in fields; near London."

Lectotype male (designated here), in NMI: "196"; "Box 23. Stood in original Haliday collection under *Platygaster halia*"; det. and type labels (H. J. Vlugg, 1982).

Leptacis laodice (Walker)

Platygaster laodice Walker, 1835: 221, 222 (♀).
Leptacis laodice (Walker); Foerster, 1856: 113.

Type locality: "June; on grass in fields; near London."

Lectotype female (designated here), in NMI: "182"; "lectotype" (handwritten by Graham); "Box 23. Stood in original Haliday collection under *Platygaster laodice*"; det. and type labels (H. J. Vlugg, 1982). The female 9.575 in BMNH under this name belongs to *Platygaster attenuata* Walker.

Leptacis nice (Walker)

Platygaster nice Walker, 1835: 222 (♂).
Leptacis nice (Walker); Foerster, 1856: 113; Masner, 1965: 134.

Type locality: "June; on grass beneath trees; near London."

Lectotype male (designated here), in NMI: "181"; "Box 23. Stood in original Haliday collection under *Platygaster nice*"; det. and type labels (H. J. Vlugg, 1982). One male, 9.576 in BMNH is paralectotype; this specimen is badly damaged.

Leptacis nydia (Walker)

Platygaster nydia Walker, 1835: 221 (♀).
Leptacis nydia (Walker); Foerster, 1856: 113.
Synopeas nydia (Walker); Masner, 1965: 142; Fitton et al., 1978: 122.

Type locality: "June; Windsor Forest. — July; on grass in fields; near London."

Lectotype female (designated here), in NMI: "180"; "Box 23. Stood in original Haliday collection under *Platygaster nydia*"; det. and type labels (H. J. Vlugg, 1982). One other female, no. 179, is paralectotype.

Leptacis ozines (Walker)

Platygaster ozines Walker, 1835: 230, 231 (♂ ♀).
Synopeas ozines (Walker); Foerster, 1856: 114.
Leptacis ozines (Walker); Masner, 1965: 134.
Synopeas ozines (Walker); Kozlov, 1966: 99.

Type locality: "August; on grass in fields; near London."

Lectotype male (designated here), in NMI:

"202"; "Box 23. Stood in original Haliday collection under *Platygaster ozines*"; det. and type labels (H. J. Vlugg, 1982). One more female (no. 201) in NMI is paralectotype. The numbers 199, 203, and 204 in NMI and the female in BMNH (9.586) do not agree with the description and belong to *Synopeas*. No. 200 in NMI, placed under *P. ozines*, belongs to the family of Scelio-nidae.

Piestopleura Foerster

Piestopleura catilla (Walker)

Platygaster catillus Walker, 1835: 219 (figs. 2, 3) (♀).
Catillus walkeri Foerster, 1856: 111, 112 (♂ ♀). (Invalid change of Walker's species name *catillus*).
Piestopleura walkeri Foerster, 1856: 144.
Piestopleura catillus (Walker); Thomson, 1859: 75 (♂ ♀); Walker, 1872: 540 (fig. on p. 536); Muesebeck & Walkley, 1956: 384; Masner, 1965: 135.

Type locality: "June; on grass beneath trees; near London. New Forest, Hampshire. Mr. Haliday has found it under the shade of trees, once at Holywood, and once in Galway, Ireland."

Lectotype female (designated here), in BMNH: "*Platygaster catilla*, Wlk." and "Stood under this name in old BM collection (Rearranged 1928, J.W.)"; "*Catillus* Wk"; "B.M. TYPE HYM. 9.568"; det. and type labels (H. J. Vlugg, 1982). The males and females in NMI do not belong to *P. catilla*.

Piestopleura mamertes (Walker)

Platygaster mamertes Walker, 1835: 227 (♂; ♀?).
Synopeas mamertes (Walker); Foerster, 1856: 114; Marshall, 1873: 19 (♂; ♀?); Kieffer, 1926: 686 (♂); Fitton et al., 1978: 122.

Platygaster mamertes (female), see *Synopeas mamertes* Kieffer.

Type locality: "Found in September, on willows, in Kent; and at Holywood, in Ireland, by Mr. Haliday."

Lectotype male (designated here), in NMI: white label; "*mamertes*"; "953"; "lectotype" (handwritten by Graham); "Box 23. Stood in original Haliday collection under *Platygaster mamertes*"; det. and type labels (H. J. Vlugg, 1982). Two more males, nos. 193 and 954 in NMI are paralectotypes.

Piestopleura seron Walker

Platygaster seron Walker, 1835: 226, 227 (♂).
Synopeas seron Walker; Foerster, 1856: 114; Kozlov, 1971: 62; Fitton et al., 1978: 122.

Type locality: "September; on grass in fields; near London."

Lectotype male (designated here), in NMI: "192"; "Type"; "Box 23. Stood in original Haliday collection under *Platygaster seron*"; det. and type labels (H. J. Vlug, 1982). Seven more specimens of *P. seron* in NMI are not considered types (nos. 948, 951, 952, 1284, 1285, 1287 and 1288).

Platygaster Latreille

Platygaster abia Walker

Platygaster abia Walker, 1835: 258, 259 (♂ ♀).

Type locality: "New Lanark, Scotland. September; Cumberland."

Lectotype female (designated here), in BMNH: "NL" (New Lanark); "*Platygaster abia* Wlk" and "Stood under this name in old BM collection (Rearranged 1928, J. W.)"; "*Abia* Wk"; "TYPE"; "B.M. TYPE HYM. 9.595"; det. and type labels (H. J. Vlug, 1982). Paralectotype female, no. 1109, in NMI with red pinhead (most probably originating from Cumberland). The male no. 349 in NMI is a different species.

Platygaster abisares Walker

Platygaster abisares Walker, 1835: 262 (♂ ♀).

Type locality: "Autumn; near London. Isle of Wight. Land's End, Cornwall. Found in Ireland, by Mr. Haliday."

Lectotype male (designated here), in NMI: "*abisares*"; "1133"; "Box 16"; det. and type labels (H. J. Vlug, 1982). Paralectotype male, no. 369, in NMI. The female no. 9.596 in BMNH does not fit the description.

Platygaster acrisius Walker

Platygaster acrisius Walker, 1835: 244 (♀).
Prosactogaster acrisius Walker; Kieffer, 1926: 765 (♀).
Platygaster acrisius Walker; Fitton et al., 1978: 121.

Type locality: "Found near London."

Lectotype female (designated here), in NMI: "277"; "Box 23. Stood in original Haliday collection under *Platygaster acrisius*"; det. and type labels (H. J. Vlug, 1982). The female no. 278 in NMI is another species. The lectotype is missing A9 and A10 of the left antenna.

Platygaster aegeus Walker

Platygaster aegeus Walker, 1835: 261 (♀).

Type locality: "Found in Ireland, by Mr. Haliday."

Lectotype female (designated here), in NMI: "56"; "*aegeus*" (green label); "*aegeus*"; "426"; "Box 23. Stood in original Haliday collection under *Platygaster aegeus*"; det. and type labels (H. J. Vlug, 1982). Two more females, nos. 1130 and 1131, are conspecific but there is no evidence of type locality; most probably these females were collected in England and identified after the description of the species.

Platygaster athamas Walker

Platygaster athamas Walker, 1835: 264, 265 (♀).

Type locality: "Found near London."

Lectotype female (designated here), in NMI: "389"; "Box 23. Stood in original Haliday collection under *Platygaster athamas*"; det. and type labels (H. J. Vlug, 1982).

Platygaster attenuata Walker

Platygaster attenuatus Haliday, in Curtis, 1830, folio 309 (second page) (♀) (nomen nudum).
Platygaster attenuatus Haliday; Walker, 1835: 245 (♂ ♀) (figs. 14 <?>, 15) (first description).
Prosactogaster attenuata (Haliday), Dalla Torre, 1898: 470; Kieffer, 1926: 767 (fig. 305).
Platygaster attenuatus Haliday; Masner, 1965: 135.

Type locality: "April and May; on grass in fields; near London."

Lectotype female (designated here), in BMNH: "939"; "*Platygaster attenuatus*, Hal." and "Stood under this name in old BM collection (Rearranged 1928, J. W.)"; "TYPE"; "B.M. TYPE HYM. 9.622"; det. and type labels (H. J. Vlug, 1982). Paralectotypes male 280 and female 1074 in NMI.

Platygaster bucolion Walker

Platygaster bucolion Walker, 1835: 258 (♂).

Type locality: "Found near London."

Lectotype male (designated here), in NMI: "348"; "Box 23. Stood in original Haliday collection under *Platygaster bucolion*"; det. and type labels (H. J. Vlug, 1982).

Platygaster cebes Walker

Platygaster cebes Walker, 1835: 256 (♂).

Type locality: "New Lanark, Scotland."

Lectotype male (designated here), in NMI: "341"; "Box 23. Stood in original Haliday col-

lection under *Platygaster cebes*"; det. and type labels (H. J. Vlug, 1982).

Platygaster chrysippus Walker

Platygaster chrysippus Walker, 1835: 250 (♀).

Prosectogaster chrysippus Walker; Kieffer, 1926: 773, 774.

Platygaster chrysippus Walker; Masner, 1965: 136.

Type locality: "May; on grass in fields; near London."

Lectotype female (designated here), in BMNH: "*Platygaster chrysippus*, Wk." and "Stood under this name in old BM collection. (Rearranged 1928, J.W.); "*Chrysippus* Wk."; "TYPE"; "B.M. TYPE HYM. 9.629"; det. and type labels (H. J. Vlug, 1982). The female no. 301 in NMI is another species.

Platygaster cleodaeus Walker

Platygaster cleodaeus Walker, 1835: 262 (♂ ♀).

Type locality: "Found near London."

Lectotype male (designated here), in NMI: "365"; "Box 23. Stood in original Haliday collection under *Platygaster cleodaeus*"; det. and type labels (H. J. Vlug, 1982). A male and a female, nos. 363 and 364 respectively, do not agree with the description.

Platygaster cochleata Walker

Platygaster cochleatus Walker, 1835: 274 (♀).

Platygaster cochleata Walker; Dalla Torre, 1898: 471.

Synopeas cochleata Walker; Kieffer, 1914: 432.

Synopeas cochleatus Walker; Fitton et al., 1978: 122.

Type locality: "Found at Holywood, in Ireland, by Mr. Haliday."

Lectotype female (designated here), in NMI: Green label and green pin head. "980"; "Box 16"; det. and type labels (H. J. Vlug, 1982). Paralectotypes females: 168 and 983—985 in NMI. The females 981 and 982 in NMI are not considered to be paralectotypes because they bear a white label which indicates Scottish origin. The paralectotypes do not have green pin heads and/or green labels, but there is no evidence that they should not be of Irish origin.

Platygaster cratinus Walker

Platygaster cratinus Walker, 1835: 255 (♀).

Platygaster cratina Walker; Dalla Torre, 1898: 471.

Type locality: "New Lanark, Scotland."

Lectotype female (designated here), in NMI:

"334"; "Box 23. Stood in original Haliday collection under *Platygaster cratinus*"; det. and type labels (H. J. Vlug, 1982). One female, no. 333, is a different species.

Platygaster cyrsilus Walker

Platygaster cyrsilus Walker, 1835: 247 (♀).

Prosectogaster cyrsilus Walker; Kieffer, 1926: 772.

Platygaster cyrsilus Walker; Masner, 1965: 136.

Type locality: "May; on grass in fields; near London. Found in Ireland, by Mr. Haliday."

Lectotype female (designated here), in NMI: "290"; "Box 23. Stood in original Haliday collection under *Platygaster cyrsilus*"; det. and type labels (H. J. Vlug, 1982). The female in BMNH, no. 9.626 and the females in NMI, nos. 291 and 1053-1058, do not fit the description.

Platygaster deipyla Walker

Platygaster deipyla Walker, 1835: 256 (♂).

Type locality: "May; on grass beneath trees; near London."

Lectotype male (designated here), in NMI: "342"; "Box 23. Stood in original Haliday collection under *Platygaster deipyla*"; det. and type labels (H. J. Vlug, 1982).

Platygaster demades Walker

Platygaster demades Walker, 1835: 249, 250 (♂ ♀).

Prosectogaster demades Walker; Kieffer, 1926: 773.

Platygaster demades Walker; Masner, 1965: 136.

Type locality: "Found near London."

Lectotype female (designated here), in BMNH: "*Platygaster demades*, Wk." and "Stood under this name in old BM collection (Rearranged 1928, J.W.); "*Demades* Wk."; "TYPE"; "B.M. TYPE HYM. 9.628"; det. and type labels (H. J. Vlug, 1982). Paralectotype male no. 298 in NMI. The specimens 297 and 1065 in NMI are different species.

Platygaster dictys Walker

Platygaster dictys Walker, 1835: 254, 255 (♀).

Type locality: "Found near London."

Lectotype female (designated here), in NMI: "331"; "Box 23. Stood in original Haliday collection under *Platygaster dictys*"; det. and type labels (H. J. Vlug, 1982). The type lacks the head and the four basal segments of the left antenna and the three basal segments of the right antenna.

Platygaster dryope Walker*Platygaster dryope* Walker, 1835: 266 (♂).

Type locality: "Found in Ireland, by Mr. Haliday."

Lectotype female (!) (designated here), in NMI: "Dryope"; green label; "Type"; "169"; "Box 23. Stood in original Haliday collection under *Platygaster dryope*"; det. and type labels (H. J. Vlug, 1982). The female, 9.599 in BMNH does not fit the description (= *Amblyaspis* sp.). Walker described a male but has certainly mistaken the sex; the type fits the description excellently. It is a species with a short metasoma and this might be the reason of Walker's mistake; he apparently did not or miscounted the metasomal segments and did not pay attention to the fourth antennal segment.

Platygaster elongata Haliday

Platygaster elongatus Haliday, in Curtis, 1830, Folio 309 (second page) (? sex) (nomen nudum); Haliday, 1833: 270 (? sex) (first description); Walker, 1835: 244 (♀).

Platygaster elongata Haliday; Dalla Torre, 1898: 472. *Prosactogaster elongata* (Haliday); Kieffer, 1926: 769. *Platygaster elongata* Haliday; Fitton et al., 1978: 121.

Type locality: "June and July, on grass at Southgate." (Haliday, in Curtis, 1830). (The Walker estate was at Southgate. This place was situated just outside the city of London in Walker's time (Graham, 1979).

Available material: Three females: no. 279, which could very well be a Walker specimen; nos. 1081, 1082, which excellently fit the description of Walker, 1835, but are of Irish provenance (green pin head) and mounted obviously by Haliday. The description of Haliday (1833) only states: "Antennae apice sensim vel parum crassiores articulo 3tio. minuto vel penitus oblitterato... b. Scutellum obtusum..."; the female No. 279 fits this description well. However, the extensive description of Walker (1835) cannot be after this specimen but is instead obviously based on the Irish specimens.

Lectotype female (designated here), in NMI: "279"; "Box 23. Stood in original Haliday collection under *Platygaster elongatus*"; det. and type labels (H. J. Vlug, 1982).

Platygaster ennius Walker*Platygaster ennius* Walker, 1835: 261 (♀).

Type locality: "Found in Ireland, by Mr. Haliday."

Lectotype female (designated here), in NMI: "Ennius"; green label; "427"; "Box 23. Stood in original Haliday collection under *Platygaster ennius*"; det. and type labels (H. J. Vlug, 1982).

Platygaster eriphyle Walker*Platygaster eriphyle* Walker, 1835: 257 (♀).

Type locality: "Found near London."

Lectotype female (designated here), in NMI: "343"; "Box 23. Stood in original Haliday collection under *Platygaster eriphyle*"; det. and type labels (H. J. Vlug, 1982).

Platygaster euhemerus Walker*Platygaster euhemerus* Walker, 1835: 264 (♀).

Type locality: "Found near London."

Lectotype female (designated here), in NMI: "388"; "Box 23". Stood in original Haliday collection under *Platygaster euhemerus*"; det. and type labels (H. J. Vlug, 1982).

Platygaster evadne Walker*Platygaster evadne* Walker, 1835: 257 (♂ ♀); Masner, 1965: 137.

Type locality: "June and July; near London. New Forest, Hampshire."

Lectotype male (designated here), in BMNH: "*Platygaster evadne* Wlk" and "Stood under this name in old BM collection (Rearranged 1928, J.W.)"; "*Evadne* Wlk"; "TYPE"; "B.M. TYPE HYM. 9.592"; det. and type labels (H. J. Vlug, 1982). Paralectotype male no. 344 in NMI. The female no. 345 in NMI is a different species and the female in BMNH is not a Walker specimen.

Platygaster filicornis Walker

Platygaster filicornis Haliday, in Curtis, 1830: folio 309 (second page) (♂) (nomen nudum); Walker, 1835: 236 (♂) (first description).

Amblyaspis filicornis (Haliday); Kieffer, 1914: 404 (♂); Fitton et al., 1978: 122.

Type locality: "Found by Mr. Haliday, at Holywood, in Ireland."

Lectotype male (designated here), in NMI: "*filicornis*" (handwritten on green label); "429"; "Box 23. Stood in original Haliday collection under *Platygaster filicornis*"; det. and type labels (H. J. Vlug, 1982). Two more males, nos. 986 and 987, are paralectotypes, in NMI.

Platygaster galenus Walker

Platygaster galenus Walker, 1835: 251, 252 (♀).

Type locality: "Found in Ireland, by Mr. Haliday."

Lectotype female (designated here), in NMI: "Galenus"; "428"; "Box 23. Stood in original Haliday collection under *Platygaster galenus*"; det. and type labels (H. J. Vlug, 1982). The type is pinned on a pin with a green head. One more female, no. 1159 in NMI is paralectotype. The male, 9.602 in BMNH has no type status. The specimens 305—309 in NMI under this name belong to a different species and are in fact syntypes of *Platygaster otanes* Walker.

Platygaster gorge Walker

Platygaster gorge Walker, 1835: 250, 251 (♂ ♀).

Prosactogaster gorge Walker; Kieffer, 1926: 764, 765.

Platygaster gorge Walker; Fitton et al., 1978: 122.

Type locality: "Found near London."

Lectotype female (designated here), in NMI: "303"; "Box 23. Stood in original Haliday collection under *Platygaster gorge*"; det. and type labels (H. J. Vlug, 1982). One more male, no. 302 in NMI is a paralectotype.

Platygaster gyge Walker

Platygaster gyge Walker, 1835: 245, 246 (♀).

Prosactogaster gyge Walker; Kieffer, 1926: 774.

Platygaster gyge Walker; Fitton et al., 1978: 122.

Type locality: "April; on grass beneath trees; near London. Found in Ireland, by Mr. Haliday."

Lectotype female (designated here), in NMI: "Gyge"; "1079"; "Box 16"; det. and type labels (H. J. Vlug, 1982). The type is glued on a pentagonal piece of cardboard with a greenheaded pin. Two more females, nos. 281 and 1080 in NMI are paralectotypes. The female 1078 does not belong to the type series and the female 282 is of a different species.

Platygaster ilione Walker

Platygaster ilione Walker, 1835: 267 (♂).

Type locality: "Found near London."

Lectotype male (designated here), in NMI: "ilione"; "398"; "Box 23. Stood in original Haliday collection under *Platygaster ilione*"; det. and type labels (H. J. Vlug, 1982).

Platygaster inermis Walker

Platygaster inermis Haliday, in Curtis, 1830: folio 309 (second page) (nomen nudum).

Platygaster inermis Walker, 1835: 266, 267 (♂ ♀) (first description).

Type locality: "May; on grass beneath trees; near London. Found in Ireland, by Mr. Haliday."

Lectotype female (designated here), in NMI: "394"; "Box 23. Stood in original Haliday collection under *Platygaster inermis*"; det. and type labels (H. J. Vlug, 1982). The female no. 395 in NMI is a paralectotype and lacks the greater part of the body. The females nos. 1160—1166 in NMI are different species. The female in the Vienna Museum (Vlug, 1973) is a *Synopeas* sp. In the case of *Platygaster inermis* there is no evidence for the provenance of the lectotype, but it may be either England or Ireland.

Platygaster iolas Walker

Platygaster iolas Walker, 1835: 251 (♀).

Prosactogaster iolas Walker; Kieffer, 1926: 765.

Platygaster iolas Walker; Fitton et al., 1978: 122.

Type locality: "Found near London."

Lectotype female (designated here), in NMI: "304"; "Box 23. Stood in original Haliday collection under *Platygaster iolas*"; det. and type labels (H. J. Vlug, 1982). One other female in the Vienna Museum (Vlug, 1973) is a different species, *Platygaster demades*.

Platygaster laricis Haliday

Platygaster laricis Haliday, in Walker, 1835: 264 (♂).

Type locality: "Found in Ireland, by Mr. Haliday."

A male was mentioned in the description, but obviously the sex has been mistaken; the description states: "antennae pallide piceae, corporis dimidio longioris, extrorsum crassioris; articulus 1us. flavus; 2us. et sequentes ad 5um. fulvi; 7us. et sequentes lati, quasi nodosi:". This resembles the description of a female and indeed female no. 165 exactly fits this description.

Lectotype female (designated here), in NMI: "laricis" (handwritten on a green label); "165"; "Box 23. Stood in original Haliday collection under *Platygaster laricis*"; det. and type labels (H. J. Vlug, 1982). Female no. 166 in NMI dif-

fers slightly and is not considered a paralectotype.

Platygaster leptines Walker

Platygaster leptines Walker, 1835: 232 (♂).
Synoeps leptines Walker; Marshall, 1873: 19; Fitton et al., 1978: 122.

Type locality: "July; on grass in fields; near London."

Lectotype male (designated here), in NMI: "214"; "Box 23. Stood in original Haliday collection under *Platygaster leptines*"; det. and type labels (H. J. Vlug, 1982). The specimens nos. 212 and 213 in NMI are not conspecific.

Platygaster lysicles Walker

Platygaster lysicles Walker, 1835: 259—260 (♀).

Type locality: "Found in August by Mr. Haliday, in marshes and grass in drains, at Holywood, Ireland. September; on grass in fields; near London. Isle of Wight. New Lanark, Scotland."

Lectotype female (designated here), in NMI: "355"; "Box 23. Stood in original Haliday collection under *Platygaster lysicles*"; det. and type labels (H. J. Vlug, 1982). Two other females, nos. 1106 and 1107 in NMI are paralectotypes. Specimens nos. 356, 373 and 1108 in NMI belong to different species.

Platygaster manto Walker

Platygaster manto Walker, 1835: 263 (♂ ♀).

Type locality: "From spring to autumn; on grass in fields; near London. September; Isle of Wight. New Lanark; Scotland. Found in Ireland, by Mr. Haliday."

Lectotype male (designated here), in BMNH: "*Platygaster manto*, Wlk." and "Stood under this name in old BM collection (Rearranged 1928, J.W.); "*Manto* Wk"; "TYPE"; "B.M. TYPE HYM. 9.598"; det. and type labels (H. J. Vlug, 1982). In NMI one female, no. 1154, and one male, no. 378, are designated as paralectotypes.

Platygaster minthe Walker

Platygaster minthe Walker, 1835: 261 (♀).

Type locality: "Found near London."

Lectotype female (designated here), in NMI: "*Minthe*"; "362"; "Box 23. Stood in original

Haliday collection under *Platygaster minthe*"; det. and type labels (H. J. Vlug, 1982).

Platygaster munita Walker

Platygaster munitus Walker, 1835: 245 (♀).
Platygaster munita Walker; Dalla Torre, 1898: 474.
Prosactogaster munita Walker; Kieffer, 1926: 771—772 (fig. 308).

Platygaster munitus Walker; Masner, 1965: 137.

Type locality: "Found near London."

Lectotype female (designated here), in NMI: "283"; "Box 23. Stood in original Haliday collection under *Platygaster munitus*"; det. and type labels (H. J. Vlug, 1982). Two more females, nos. 1169 and 1170 in NMI are paralectotypes. Male no. 284 in NMI is not considered a paralectotype and female 9.623 in BMNH is slightly different.

Platygaster nisus Walker

Platygaster nisus Walker, 1835: 260 (♀).

Type locality: "Found near London."

Lectotype female (designated here), in NMI: "361"; "Box 23. Stood in original Haliday collection under *Platygaster nisus*"; det. and type labels (H. J. Vlug, 1982).

Platygaster oebalus Walker

Platygaster oebalus Walker, 1835: 248—249 (♀).
Prosactogaster oebalus Walker; Kieffer, 1926: 773.
Platygaster oebalus Walker; Masner, 1965: 137.

Type locality: "Found near London."

Lectotype female (designated here), in BMNH: "*Platygaster oebalus*, Wk." and "Stood under this name in old BM collection (Rearranged 1928, J.W.); "*Oebalus* Wk."; "TYPE"; "B.M. TYPE HYM. 9.627"; det. and type labels (H. J. Vlug, 1982). Another female, no. 296 in NMI is a paralectotype.

Platygaster oecus Walker

Platygaster oecus Walker, 1835: 258 (♂ ♀).
Misocyclops oecus Walker; Kieffer, 1926: 792, 793.
Platygaster oecus Walker; Fitton et al., 1978: 122.

Type locality: "Found in Ireland, by Mr. Haliday. May; near London. New Lanark, Scotland."

Lectotype female (designated here), in NMI: "347"; "Box 23. Stood in original Haliday collection under *Platygaster oecus*"; det. and type

labels (H. J. Vlugg, 1982). The other males and females in NMI, nos. 346, 1110—1115 and 1144 and female 9.631 in BMNH are different species. The lectotype appears to be an original Walker specimen.

Platygaster olorus Walker

Platygaster olorus Walker, 1835: 255, 256 (♂ ♀); Masner, 1965: 138.

Type locality: "Found near London."

Lectotype female (designated here), in NMI: "335"; "Box 23. Stood in original Haliday collection under *Platygaster olorus*"; det. and type labels (H. J. Vlugg, 1982). One male, no. 336 in NMI, is a paralectotype. Female no. 337 in NMI and female 9.590 in BMNH belong to different species.

Platygaster orcus Walker

Platygaster orcus Walker, 1835: 250 (♀).

Type locality: "Found near London."

Lectotype female (designated here), in NMI: "orcus"; "1052"; "Box 16"; det. and type labels (H. J. Vlugg, 1982). The female no. 300 in NMI is a paralectotype. A male under this name, no. 299 in NMI has no type status because Walker only described a female. The pin of the lectotype has a red head.

Platygaster orus Walker

Platygaster orus Walker, 1835: 254 (♂ ♀); Masner, 1965: 138 (type designation).
Polygnotus orus (Walker), Vlugg, 1973: 182.

Type locality: "Common in June; near London. Found in Ireland, by Mr. Haliday."

Lectotype female (designated by Masner, 1965), in BMNH: "*Platygaster orus* Wlk." and "Stood under this name in old BM collection (Rearranged 1928, J.W.); "*Orus* Wk."; "TYPE"; "B.M. TYPE HYM. 9.589"; "Lectotype L.M." One more male is paralectotype. Additional material: Two specimens in BMNH and nine specimens in NMI appear under this name but only one belongs to *P. orus*.

Platygaster oscus Walker

Platygaster oscus Walker, 1835: 259 (♂ ♀); Masner, 1965: 138.

Type locality: "Ireland, Mr. Haliday. Near London, England. New Lanark, Scotland."

Lectotype female (designated here), in NMI:

"*oscus*" (at underside of the mounting card); "354"; "Box 23. Stood in original Haliday collection under *Platygaster oscus*"; det. and type labels (H. J. Vlugg, 1982). Three more females, nos. 1127—1129 in NMI and one female, 9.594 in BMNH are paralectotypes. Nos. 350—353 and 1105 in NMI are not conspecific with the type.

Platygaster otanes Walker

Platygaster otanes Walker, 1835: 252 (♂ ♀).

Type locality: "Found near London."

Lectotype male (designated here), in NMI: "313"; "Box 23. Stood in original Haliday collection under *Platygaster otanes*"; det. and type labels (H. J. Vlugg, 1982). Two more females, nos. 312 and 1117 in NMI are paralectotypes. The nos. 1118 and 1119 in NMI belong to *P. otanes* but have no type status since they have the green pin heads and thus are of Irish origin. The specimens nos. 305—311 and 1116 in NMI under this name are different species.

Platygaster pedasus Walker

Platygaster pedasus Walker, 1835: 265, 266 (♀); Masner, 1965: 138.

Type locality: "July; on grass in fields; near London."

Lectotype female (designated here), in BMNH: "*Platygaster pedasus*, Wlk." and "Stood under this name in old BM collection (Rearranged 1928, J.W.); "*Pedasus* Wk."; "TYPE"; "B.M. TYPE HYM. 9.600"; det. and type labels (H. J. Vlugg, 1982). The female no. 392 in NMI is of a different species. The lectotype has the last antennal segment of the right antenna missing.

Platygaster pelias Walker

Platygaster pelias Walker, 1835: 247, 248 (♀).
Prosactogaster pelias (Walker); Kieffer, 1926: 772.
Platygaster pelias Walker; Masner, 1965: 138.

Type locality: "Found near London. August; on willows, in Ireland; Mr. Haliday."

Lectotype female (designated here), in NMI: "294"; "Box 23. Stood in original Haliday collection under *Platygaster pelias*"; det. and type labels (H. J. Vlugg, 1982). Two more females, nos. 1063 and 1064 in NMI are paralectotypes. The lectotype seems to originate from England and is Walker material. The two paralectotypes are apparently from Ireland and are labelled:

"*Salix* Aug."; a small square label "31" (which means 1831) and a label "*Pelias*". Both these females are glued on one card. In the NMI are two more females (nos. 292 and 293) and in the BMNH one female (9.624); these specimens have strong notauli, whereas Walker states: "mesothoracis parapsidum suturae vix conspicuae;" these are not considered paralectotypes.

Platygaster philinna Walker

Platygaster philinna Walker, 1835: 255 (♀).

Type locality: "Found near London."

Lectotype female (designated here), in NMI: "332"; "Box 23. Stood in original Haliday collection under *Platygaster philinna*"; det. and type labels (H. J. Vlug, 1982).

Platygaster pleuron Walker

Platygaster pleuron Walker, 1835: 253 (♂ ♀).

Polygnotus pleuron (Walker); Kieffer, 1926: 739, 740 (fig. 300a, b).

Platygaster pleuron Walker; Masner, 1965: 138 (type designation).

Type locality: "April to June; on grass in fields; near London."

Lectotype female (designated by Masner, 1965), in BMNH: "*Platygaster pleuron* Wk." and "Stood under this name in old BM collection (Rearranged 1928, J.W.); "*Pleuron* Wk."; "TYPE"; "B.M. TYPE HYM. 9.607"; "Lectotype L.M.". One more male is paralectotype in BMNH. Additional material: One male in BMNH and one male in NMI (no. 314). The rest of the specimens in NMI belong to different species (nos. 315—318 and 1093—1098).

Platygaster plotina Walker

Platygaster plotinus Walker, 1835: 265 (♂ ♀); Masner, 1965: 139.

Type locality: "Found near London."

Lectotype male (designated here), in BMNH: "*Platygaster plotinus* Wlk." and "Stood under this name in old BM collection (Rearranged 1928, J.W.); "*Plotinus* Wk."; "TYPE"; "B.M. TYPE HYM. 9.593"; det. and type labels (H. J. Vlug, 1982). Three specimens under this name in NMI (390, 391 and 1145) do not belong to *P. plotina*.

Platygaster rutubus Walker

Platygaster rutubus Walker, 1835: 242 (♂).

Isocybus rutubus (Walker); Kieffer, 1926: 724; Fitton et al., 1978: 121.

Type locality: "June; Windsor Forest."

Lectotype male (designated here), in NMI: "276"; "Box 23. Stood in original Haliday collection under *Platygaster rutubus*"; det. and type labels (H. J. Vlug, 1982).

Platygaster sagana Walker

Platygaster sagana Walker, 1835: 267 (♂ ♀); Masner, 1965: 139.

Type locality: "July; on grass in fields; near London."

Lectotype female (designated here), in BMNH: "*Platygaster sagana*, Wlk." and "Stood under this name in old BM collection (Rearranged 1928, J.W.); "*Sagana* Wk."; "TYPE"; "B.M. TYPE HYM. 9.601"; det. and type labels (H. J. Vlug, 1982). One female, no. 396 and one male, no. 397 in NMI are paralectotypes.

Platygaster sonchis Walker

Platygaster sonchis Walker, 1835: 253 (♂ ♀); Masner, 1965: 139.

Type locality: "April to July; on grass in fields; near London."

Lectotype female (designated here), in NMI: "320"; "Box 23. Stood in original Haliday collection under *Platygaster sonchis*"; det. and type labels (H. J. Vlug, 1982). The female in BMNH (9.587) does not fit the description. The specimens nos. 319 and 321—323 in NMI belong to different species.

Platygaster sterope Walker

Platygaster sterope Walker, 1835: 256 (♀); Masner, 1965: 139.

Type locality: "Found near London."

Lectotype female (designated here), in BMNH: "*Platygaster sterope* Wlk." and "Stood under this name in old BM collection (Rearranged 1928, J.W.); "*Sterope* Wk."; "TYPE"; "B.M. TYPE HYM. 9.591"; det. and type labels (H. J. Vlug, 1982).

Platygaster strato Walker

Platygaster strato Walker, 1835: 263, 264 (♂ ♀).

Type locality: "New Lanark, Scotland."

Lectotype male (designated here), in BMNH: "NL" (at underside of mounting card, which has a gold-painted edge; NL means New Lanark); "*Platygaster strato* Wlk." and "Stood un-

der this name in old BM collection (Rearranged 1928, J.W.); "Strato Wk." "TYPE"; "B.M. TYPE HYM. 9.597"; det. and type labels (H. J. Vlug, 1982). The male no. 384 in NMI has also the remark NL and is considered paralectotype. In NMI are four more specimens under this name (383 and 385—387), which are not considered to be paralectotypes.

Platygaster taras Walker

Platygaster taras Walker, 1835: 253, 254 (♂ ♀); Masner, 1965: 139 (type designation).

Type locality: "May; on grass in fields; near London."

Lectotype female (designated by Masner, 1965), in BMNH: "*Platygaster taras* Wk." and "Stood under this name in old BM collection (Rearranged 1928, J.W.); "*Taras* Wk."; "TYPE"; "B.M. TYPE HYM. 9.588"; "Lectotype L.M." Four males and females are paralectotypes, in BMNH. The specimens in NMI, nos. 324—327, do not belong to *P. taras*.

Platygaster tisia Walker

Platygaster tisia Walker, 1835: 247 (♀).
Prosactogaster tisia (Walker); Kieffer, 1926: 772.
Platygaster tisia Walker; Masner, 1965: 139.

Type locality: "May; on grass in fields; near London."

Lectotype female (designated here), in BMNH: "*Platygaster tisia*, Wlk." and "Stood under this name in old BM collection (Rearranged 1928, J.W.); "*Tisia* Wk."; "TYPE"; "B.M. TYPE HYM. 9.625"; det. and type labels (H. J. Vlug, 1982). Two more females, nos. 287 and 288 in NMI are designated as paralectotypes. Nos. 285, 286 and 289 in NMI are different species.

Platygaster (Urocyclops) vaenia Walker

Platygaster vaenia Walker, 1835: 248 (♀).
Misocyclops vaenia (Walker); Kieffer, 1926: 778, 779.
Platygaster vaenia Walker; Fitton et al., 1978: 122.

Type locality: "May; on grass in fields; near London."

Lectotype female (designated here), in NMI: "1167"; "Box 16"; det. and type labels (H. J. Vlug, 1982). The type has the red pin head which indicates its English origin. The female no. 295 in NMI is a *Leptacis* sp. *P. vaenia* belongs in the subgenus *Urocyclops* Maneval (sensu Huggert, 1974).

Platygaster vestinus Walker

Platygaster vestinus Walker, 1835: 260 (♂).
Platygaster vestina Walker; Dalla Torre, 1898: 477.
Platygaster vestinus Walker; Kieffer, 1926: 824;
Masner, 1965: 140.

Type locality: "September; near the Land's End, Cornwall."

Lectotype male (designated here), in NMI: "360"; "Box 23. Stood in original Haliday collection under *Platygaster vestinus*"; det. and type labels (H. J. Vlug, 1982). Another male, no. 358 in NMI is a paralectotype. The females 9.603 in BMNH and nos. 357 and 359 in NMI have no type status. The males in the Vienna Museum under this name are not conspecific.

Platygaster xeneus Walker

Platygaster xeneus Walker, 1838: 453 (♀).
Misocyclops xeneus (Walker); Kieffer, 1926: 781, 782.
Platygaster xeneus Walker; Fitton et al., 1978: 122.

Type locality: "Found by Mr. Haliday, in September, at Holywood, near Belfast, Ireland."

Lectotype female (designated here), in NMI: "September 1836" (handwritten, on underside of mounting card); "*xeneus*" (handwritten, on green label); "Type"; "167"; "Box 23. Stood in original Haliday collection under *Platygaster xeneus*"; det. and type labels (H. J. Vlug, 1982).

Platygaster zosine Walker

Platygaster zosine Walker, 1835: 266 (♂).
Polygnotus zozini (sic!) (Walker); Marchal, 1897: 93.
Platygaster zosine Walker; Fitton et al., 1978: 122.

Type locality: "Found near London."

Lectotype male (designated here), in NMI: "*zosine*" (sic!) (handwritten); "393"; "Box 23. Stood in original Haliday collection under *Platygaster zosine*"; det. and type labels (H. J. Vlug, 1982).

Synopeas Foerster

Synopeas abaris (Walker)

Platygaster abaris Walker, 1835: 230 (♂ ♀).
Synopeas abaris (Walker); Marshall, 1873: 19; Masner, 1965: 140.

Type locality: "August to October; on grass beneath trees; near London."

Lectotype male (designated here), in BMNH: "*Platygaster abaris*, Wk." and "Stood under this name in old BM collection (Rearranged 1928,

J.W.); "*Abaris* Wk."; "TYPE"; "B.M. TYPE HYM. 9.580"; det. and type labels (H. J. Vlug, 1982). Two more males, nos. 197 and 198 in NMI are paralectotypes.

Synopeas acco (Walker)

Platygaster acco Walker, 1835: 229 (♀).
Synopeas acco (Walker); Marshall, 1873: 19.

Type locality: "Found in Ireland, by Mr. Haliday."

Lectotype female (designated here), in NMI: green label (Irish provenance); "432"; "Box 23. Stood in original Haliday collection under *Platygaster acco*"; det. and type labels (H. J. Vlug, 1982). In NMI some of the remaining specimens under this name (box 16) belong to *Synopeas acco* but their provenance is uncertain (nos. 973—979).

Synopeas craterus (Walker)

Platygaster craterus Walker, 1835: 224 (♀).
Ectadius craterus (Walker); Foerster, 1856: 113, 144.
Polymecus craterus (Walker); Foerster, 1856: 113, 144.

Synopeas craterus (Walker); Thomson, 1859: 71.
Ectadius craterus (Walker); Kieffer, 1926: 654.
Leptacis craterus (Walker); Muesebeck & Walkley, 1956: 349.
Synopeas craterus (Walker); Masner, 1964: 149; Masner, 1965: 141; Kozlov, 1971: 62.

Type locality: "July; on grass in fields; near London."

Lectotype female (designated here), in NMI: "*crateru*" (at underside of mounting card; "s" is cut off); "*craterus*"; "1168"; "Box 16"; det. and type labels (H. J. Vlug, 1982). In NMI two additional females (nos. 185 and 1291) and in BMNH one female (9.632) are paralectotypes.

Synopeas euryale (Walker)

Platygaster euryale Walker, 1835: 229 (♀).
Synopeas euryale (Walker); Marshall, 1873: 19.

Type locality: "Found once at Hollywood, in Ireland, by Mr. Haliday."

Lectotype female (designated here), in NMI: "23" (1823?); "*Euryale*"; green (Irish) label; "964"; "Box 16"; det. and type labels (H. J. Vlug, 1982). The type is pinned with a green headed pin. The specimens nos. 159—162 in NMI do not belong to *S. euryale*.

Synopeas hyllus (Walker)

Platygaster hyllus Walker, 1835: 274 (♀).

Misocyclops hyllus (Walker); Kieffer, 1926: 778.

Type locality: "Found in Ireland, by Mr. Haliday."

Lectotype female (designated here), in NMI: "*Hyllus*"; "1035"; "Box 16"; det. and type labels (H. J. Vlug, 1982). Nine other females, nos. 399, 1033, 1034 and 1036—1042 in NMI are paralectotypes. The female 9.630 in BMNH is a *Platygaster* sp.

Synopeas jasius (Walker)

Platygaster jasius Walker, 1835: 228 (♂ ♀).
Synopeas jasius (Walker); Marshall, 1873: 19.

Type locality: "August and October; on grass in fields; near London."

Lectotype female (designated here), in NMI: "194"; "Box 23. Stood in original Haliday collection under *Platygaster jasius*"; det. and type labels (H. J. Vlug, 1982). The male no. 195 in NMI is not conspecific; it resembles *Synopeas rhanis*.

Synopeas larides (Walker)

Platygaster larides Walker, 1835: 232 (♂).
Synopeas larides (Walker); Marshall, 1873: 19; Masner, 1965: 141.

Type locality: "July; on grass in fields; near London."

Lectotype male (designated here), in BMNH: "*Platygaster larides*, Wlk." and "Stood under this name in old BM collection (Rearranged 1928 J.W.)"; "*Larides*"; "TYPE"; "B.M. TYPE HYM. 9.582"; det. and type labels (H. J. Vlug, 1982). One further male, no. 211 in NMI is a paralectotype.

Synopeas mamertes Kieffer

Platygaster mamertes Walker, 1835: 227 (♂; ♀?).
Synopeas mamertes (Walker); Foerster, 1856: 114; Marshall, 1873: 19 (♂; ♀?); Kieffer, 1926: 686 (♂, not ♀) (Proved to be a *Piestopleura* sp. See *Piestopleura mamertes*.)

Ectadius mamertes (Walker); Kieffer, 1926: 654 (♀). (This is Kieffer's interpretation of the ♀ doubtfully included in Walker's description, so it should be *Ectadius mamertes* Kieffer, 1926.)

Ectadius gynomamertes Hincks, 1944: 38 (♀, not ♂) (this is an invalid renaming because the description of Kieffer, 1926, is valid); Fitton et al., 1978: 122.

Type locality: "Found in September, on willows, at Hollywood, in Ireland, by Mr. Haliday."

Lectotype female (designated here), in NMI: "Salix Aug."; "27" (1827); "Mamertes"; "1018"; det. and type labels (H. J. Vlug, 1982). One more female paralectotype in NMI (no. 1016). A third female, no. 1017 in NMI presumably is not Irish.

Synopeas myles (Walker)

Platygaster myles Walker, 1835: 226 (♀).
Synopeas myles (Walker); Foerster, 1856: 114; Marshall, 1873: 19; Kozlov, 1971: 62; Fitton et al., 1978: 122.

Type locality: "Found at Holywood, in Ireland, by Mr. Haliday."

Lectotype female (designated here), in NMI: "type ?"; "431"; "Box 23. Stood in original Haliday collection under *Platygaster myles*"; det. and type labels (H. J. Vlug, 1982). Two more females, nos. 965 and 966 in NMI are paralectotypes. No. 967 in NMI is of a different species.

Synopeas (Sactogaster) osaces (Walker)

Platygaster osaces Walker, 1835: 222, 223 (♀).
Sactogaster osaces (Walker); Foerster, 1856: 113, 114.
Synopeas osaces (Walker), Fitton et al., 1978: 122.

Type locality: "September; on grass in fields; near London. Found once in September on willows at Holywood, in Ireland, by Mr. Haliday."

Lectotype female (designated here), in NMI: "ventr"; "13" (1813); "osaces" (green label, handwritten); "164"; "Box 23. Stood in original Haliday collection under *Platygaster osaces*"; det. and type labels (H. J. Vlug, 1982). In spite of the fact that Walker collected more material from the surroundings of London, this Irish specimen is the only specimen which could be found in both BMNH and NMI. It fits the original description well.

Synopeas rhanis (Walker)

Platygaster rhanis Walker, 1835: 225, 226 (♀).
Synopeas rhanis (Walker); Marshall, 1873: 19; Masner, 1965: 142.

Lectotype female (designated here), in NMI: "191"; "Box 23"; "Stood in original Haliday collection under *Platygaster rhanis*"; det. and type labels (H. J. Vlug, 1982). One more female, 9.579 in BMNH is a paralectotype; this specimen lacks the metasoma.

Synopeas sosis (Walker)

Platygaster sosis Walker, 1835: 224, 225 (♂♀).

Synopeas sosis (Walker); Marshall, 1873: 19; Muesebeck & Walkley, 1956: 401; Masner, 1965: 142 (type designation).

Platygaster sosis Walker; Vlug, 1973: 182.

Type locality: "May to August; on grass in fields; near London. Found by Mr. Haliday on willows, at Holywood, in Ireland."

Lectotype male (designated by Masner, 1965), in BMNH: "*Sosis* Wk"; *Platygaster sosis* Wlk"; and "Stood under this name in old BM collection (Rearranged 1928, J.W.); "TYPE"; "Lectotype L.M."; "selected as lectotype of *Platygaster sosis* Walker, 1835 male. By L. Masner, 13.XII.1965"; "B.M. TYPE HYM. 9.578"; "*Synopeas sosis* (Walk.) det. Huggert -77". One more male in BMNH is paralectotype. Most of the additional material in NMI is conspecific (nos. 186—190 and 968—972). Left antenna and left wings of the lectotype are mounted on a microslide and pinned on the same pin as the lectotype by L. Huggert.

Synopeas (Sactogaster) tarsa (Walker)

Platygaster tarsa Walker, 1835: 227, 228 (♀).
Synopeas tarsa (Walker); Marshall, 1873: 19.
Sactogaster tarsa (Walker); Kieffer, 1926: 664.
Synopeas (Sactogaster) tarsa (Walker); Kozlov, 1978: 647—664.

Type locality: "August; on grass in fields; near London."

Lectotype female (designated here), in NMI: Green label; "163"; "Box 23. Stood in original Haliday collection under *Platygaster tarsa*"; det. and type labels (H. J. Vlug, 1982). In spite of the green "Irish" label, I regard this specimen as the lectotype; the description fits accurately and this green label might eventually have been changed because of the four different pin holes in it. In addition, the method of mounting and of pinning the mounting card indicates that it might be a Walker specimen.

Synopeas trebius (Walker)

Platygaster trebius Walker, 1835: 231 (♂♀).
Synopeas trebius (Walker); Marshall, 1873: 19; Masner, 1965: 143.

Type locality: "Found near London."

Lectotype male (designated here), in NMI: "207"; "Box 23. Stood in original Haliday collection under *Platygaster trebius*"; det. and type labels (H. J. Vlug, 1982). One female, no. 208 in NMI is a paralectotype. The rest of the specimens in NMI, nos. 205, 206 and 209 and the

specimen in the BMNH 9.581 are different species.

Synopeas velutinus (Walker)

Platygaster velutinus Haliday, in Curtis, 1830: folio 309 (second page) (? sex) (nomen nudum).

Platygaster relutinus (sic!) Walker, 1835: 216 (♂ ♀) (figs. 5, 6) (first description).

Platygaster velutinus Walker, 1872: 536 (♂ ♀) (2 figs.); Kieffer, 1914: plate 10, figs. 5, 6.

There exists no actual description of this species. The name appeared for the first time in Curtis' "British Entomology" of 1830, where it is headed under the section I: "Scutellum produced or mucronated"; however, this cannot be adopted as a description. Later, Walker gives figures of both male and female antennae in his paper of 1835 (plate 12, figs. 5, 6). The species appears here under the name *Platygaster relutinus*, what seems to be a typographical error (a handwritten "v" and "r" can be rather similar).

Walker, in 1872, gives again the same figures of the antennae; here the species name is cited as *Platygaster velutinus*. In the Haliday collection in NMI one *Synopeas* female was found, provided with the name "*velutinus*". It was mounted by Haliday and it stands above a label in Walker's handwriting "*velutinus*". There is no indication of provenance. Lectotype female (designated here), in NMI: "*velutinus*"; "430"; "Box 23. Stood in original Haliday collection under *Platygaster velutinus*"; det. and type labels (H. J. Vlug, 1982).

Trichacis Foerster

Trichacis didas (Walker)

Platygaster didas Walker, 1835: 240 (♂ ♀).

Trichacis didas (Walker); Foerster, 1856: 115.

Trichasis (sic!) *didas* (Walker); Walker, 1872: 540.

Trichacis didas (Walker); Masner, 1965: 143.

Type locality: "June; on grass in woods; near London."

Lectotype male (designated here), in NMI: "264"; "Box 23. Stood in original Haliday collection under *Platygaster didas*"; det. and type labels (H. J. Vlug, 1982). Two more females, no. 263 in NMI and 9.614 in BMNH are paralectotypes.

Trichacis pisis (Walker)

Platygaster pisis Walker, 1835: 238, 239 (♂ ♀).

Trichacis pisis (Walker); Foerster, 1856: 115.

Trichasis (sic!) *pisiss* (Walker); Walker, 1872: 540.

Trichacis pisis (Walker); Muesebeck & Walkley, 1956: 404; Masner, 1965: 143.

Type locality: "May and June; on grass in woods; near London."

Lectotype male (designated here), in NMI: "256"; "Box 23. Stood in original Haliday collection under *Platygaster pisis*"; det. and type labels (H. J. Vlug, 1982). One male, no. 259 and one female, no. 258 in NMI are paralectotypes. Nos. 1070 and 1071 in NMI have no type status (Irish origin). The nos. 257 in NMI and 9.613 in BMNH are different species.

Trichacis remulus (Walker)

Platygaster remulus Walker, 1835: 239, 240 (♂ ♀).

Trichacis remulus (Walker); Foerster, 1856: 115.

Trichasis (sic!) *remulus* (Walker); Walker, 1872: 540.

Trichacis remulus (Walker); Muesebeck & Walkley, 1956: 404; Masner, 1965: 143.

Type locality: "June; on grass in woods; near London."

Lectotype male (designated here), in NMI: "262"; "Box 23. Stood in original Haliday collection under *Platygaster remulus*"; det. and type labels (H. J. Vlug, 1982). Two more females, no. 261 in NMI and 9.612 in BMNH are paralectotypes.

Acerotella Masner

Acerotella boter (Walker)

Inostemma boter Walker, 1838: 454, 455 (♂ ♀).

Acerota boter (Walker); Kieffer, 1914: 372, 373; Széleányi, 1938: 102.

Acerotella boter (Walker); Masner, 1964: 148; Masner, 1980: 1291—1303.

Type locality: "Found by Mr. Haliday, in September, at Holywood, near Belfast, Ireland."

Lectotype female (designated here), in NMI: "*boter*"; "1202"; "Box 16"; det. and type labels (H.J. Vlug, 1982). One female and one male in NMI, respectively nos. 1200 and 1201, are paralectotypes. No. 1199 is mounted in quite a different way and is thus not considered to be a paralectotype.

Allotropia Foerster

Eurostemma Széleányi, 1938, *syn. nov.*

Allotropia europus (Walker)

Inostemma europus Walker, 1838: 455 (♂).

Metaclisis europus (Walker); Kieffer, 1914: 366, 367.

Parinostemma europus (Walker); Kieffer, 1926: 566, 567.

Eurostemma europus (Walker); Szelényi, 1938: 99, 102; Muesebeck & Walkley, 1956: 353.

Metaclisis europus (Walker); Fitton et al., 1978: 120.

Type locality: "Found by Mr. Haliday, at Hollywood, near Belfast, Ireland."

Lectotype female (see introduction) (designated here), in NMI: "1225"; "Haliday. NMI 20-2-82"; det. and type labels (H. J. Vlugg, 1982). Additional material: nos. 1226, 1227 in NMI.

Allotropia mecrida (Walker)

Inostemma mecrida Walker, 1835: 273 (♂ ♀).

Allotropia mecrida (Walker); Foerster, 1856: 109; Walker, 1872: 540; Muesebeck & Walkley, 1956: 326; Vlugg, 1973: 180.

Type locality: "Found near London."

Lectotype male (designated here), in "Naturhistorisches Museum" in Vienna: "Or. Ex."; "20. Hal." and something written in scribbling handwriting, possibly gothic (written by Foerster); "Först." (printed); "Collect. G. Mayr"; "*All. Mecrida* Hal. det. Förster"; det. and type labels (H. J. Vlugg, 1984). Additional material: One male and one female in "Naturhistorisches Museum" in Vienna, collected and mounted on micropins by Foerster. No material found either in NMI or BMNH.

Inostemma Haliday

Inostemma favo Walker

Inostemma favo Walker, 1838: 454 (♀).

Acerota favo (Walker); Kieffer, 1914: 372 (♂ ♀).

Inostemma favo Walker; Szelényi, 1937—38: 112.

Acerota favo (Walker); Kozlov, 1966: 97.

Inostemma favo Walker; Fitton et al., 1978: 120.

Type locality: "Found by Mr. Haliday, at Hollywood, near Belfast, Ireland." Because Kieffer (1914) combined both the description of *Inostemma favo* and *Inostemma boter*, he concluded that Walker described a male as well as a female. In fact, only a female was described by Walker.

Lectotype female (designated here), in NMI: "1182"; "Box 16"; det. and type labels (H. J. Vlugg, 1982). Three females in NMI, nos. 1180, 1181 and 1186 are paralectotypes. Four females in NMI, nos. 1174—1177, glued together on one card, are not considered paralectotypes because they bear a label "39", which means 1839. These specimens are therefore of later date. The

female no. 1179 in NMI also has no type status because it is English (red pin head).

Inostemma hispo Walker, nomen dubium

Inostemma hispo Walker, 1838: 453, 454 (♀).

Brachinostemma hispo (Walker); Szelényi, 1937—38: 112.

Parinostemma hispo (Walker); Szelényi, 1937—38: 112.

Brachinostemma hispo (Walker); Szelényi, 1938: 102.

Metaclisis hispo (Walker); Fitton et al., 1978: 120.

Type locality: "Found by Mr. Haliday, at Hollywood, near Belfast, Ireland."

Remarks: see introduction.

Inostemma lycon Walker

Inostemma lycon Walker, 1835: 269, 270 (♀); Masner, 1965: 130.

Type locality: "Found near London."

Lectotype female (designated here), in BMNH: "TYPE"; "*lycon Wk.*"; "*Inostemma lycon, Wk.*" and "Stood under this name in old BM collection (Rearranged 1928, J.W.); "B.M. TYPE HYM. 9.553"; det. and type labels (H. J. Vlugg, 1982).

Inostemma melicerta Walker

Inostemma melicerta Walker, 1835: 269 (♀).

Inostemma melicerata (sic!) Walker; Masner, 1965: 130.

Type locality: "June and July; near London."

Lectotype female (designated here), in BMNH: "TYPE"; "*melicerta Wk.*" "*Inostemma melicerta, Wk.*" and "Stood under this name in old BM collection (Rearranged 1928, J.W.); "B.M. TYPE HYM. 9.551"; det. and type labels (H. J. Vlugg, 1982). The females under this name in NMI are different species.

Inostemma menippus Walker

Inostemma menippus Walker, 1835: 270 (♂ ♀); Masner, 1965: 130.

Type locality: "July; on grass in woods; near London."

Lectotype female (designated here), in BMNH: "*Inostemma menippus, Wk.*" and "Stood under this name in old BM collection (Rearranged 1928, J.W.); "*Menippus Wk.*"; "TYPE"; "B.M. TYPE HYM. 9.554"; det. and type labels (H. J. Vlugg, 1982). Two females, nos. 1194 and 1195 in NMI are considered paralectotypes.

Inostemma walkeri Kieffer

Inostemma bosci (Jurine) (sensu Walker), Walker, 1835: 268, 269 (♂ ♀).

Inostemma walkeri Kieffer, 1914:384 (♂ ♀); Masner, 1965: 130 (type designation).

Type locality: "On grass in woods, near London; during the summer and autumn. June; New Forest, Hampshire. New Lanark, Scotland. Found by Mr. Haliday, on Cerealia, in England, Ireland and Scotland."

Lectotype female (designated by Masner), in BMNH: "*Boscii*"; "TYPE"; "B.M. TYPE HYM. 9.552"; "Lectotype L.M." The lectotype has the left antenna missing. Two females and two males are paralectotypes.

Iphitrachelus Haliday**Iphitrachelus lar** Haliday

Iphitrachelus lar Haliday, in Walker, 1835: 273, 274 (♂) (fig. 1); Walker, 1851: 453—458.

Iphitrachelus lar Walker, Muesebeck & Walkley, 1956: 362; Masner, 1957: 1 (redescription).

Type locality: "Found in August, by Mr. Haliday, in the Isle of Arran, Scotland."

Lectotype male (designated here), in NMI: "Collin Glen"; "1173"; "Box 16"; det. and type labels (H. J. Vlug, 1982). Two males, nos. 1171 and 1172, which are conspecific, are not considered type material; they are of Irish origin. The female, described by Walker, 1851, could not be found.

Isostasius Foerster**Isostasius atinas** (Walker)

Inostemma atinas Walker, 1835: 272 (♀).

Monocrita atinas (Walker); Foerster, 1856: 109; Muesebeck & Walkley, 1956: 372.

Isostasius atinas (Walker); Masner, 1965: 131.

Type locality: "Found near London".

Lectotype female (designated here), in BMNH: "*Inostemma atinas*, Wk." and "Stood under this name in old BM collection (Rearranged 1928, J.W.); "*Atinas* Wk."; "TYPE"; "B.M. TYPE HYM. 9.557"; det. and type labels (H. J. Vlug, 1982).

Isostasius scrutator (Walker)

Inostemma scrutator Walker, 1835: 270, 271 (♀).

Isostasius scrutator (Walker); Bazin, 1856: 27—30 (fig. 5); Masner, 1965: 131 (type designation).

Type locality: "June; on grass in woods; near

London. Found rarely by Mr. Haliday, on Cerealia, at Holywood, in Ireland."

Lectotype female (designated by Masner, 1965), in BMNH: "Dsvgn. 6852"; "*Inostemma scrutator* Wk." and "Stood under this name in old BM collection (Rearranged 1928, J.W.); "5 scrutator"; "TYPE"; "B.M. TYPE HYM. 9.558"; "Lectotype L.M."; "Selected as lectotype of *I. scrutator* Walk. by L. Masner 7.XII.1961." Additional material: One female in BMNH and six females, nos. 1203—1208 in NMI.

Metaclisis Foerster**Metaclisis areolata** (Haliday)

Inostemma areolata Haliday, in Walker, 1835: 272 (♂ ♀), (figs. 16—20).

Metaclisis areolata (Haliday); Foerster, 1856: 109.

Metaclisis areolata (Haliday); Kieffer, 1926: 569, 570; Muesebeck & Walkley, 1956: 369; Vlug, 1973: 181.

Type locality: "Found by Mr. Haliday, on grass in drains of the seacoast, at Holywood, in Ireland;"

Lectotype female (designated here), in NMI: "H. Wood"; green label; "1223—4"; "Haliday N.M.I. 20-2-82"; "Box 16"; det. and type labels (H. J. Vlug, 1982). Two females are glued together on one card: nos. 1223 and 1224; the right female, no. 1224, has been chosen as lectotype. Four males and ten females in NMI are paralectotypes (nos. 1121, 1210, 1211 and 1213—1223). The female in the Vienna Museum (Vlug, 1973) is considered to be a paralectotype.

Metaclisis ocaleus (Walker)

Inostemma ocalea Walker, 1838: 456 (♀).

Parinostemma ocalea (Walker); Szelényi, 1937—38: 125, 126.

Metaclisis ocalea (Walker); Fitton et al., 1978: 120.

Type locality: "Found near London."

Lectotype female (designated here), in NMI: small white label; "1045"; "Box 16"; det. and type labels (H. J. Vlug, 1982). The mounting card is provided with two females of which one is mounted on its side, close to the pin, missing head and metasoma; this female is a paralectotype. The other female, far removed from the pin, is mounted on its back and is designated as the lectotype. These females are obviously mounted by Haliday whereas the description is from Walker. Nevertheless, these specimens could have been caught and/or mounted by

Haliday although the type locality is near London. The lectotype exactly fits the description.

REFERENCES

- Bazin, M. C., 1856. Notice sur un Insecte qui a causé les plus grands Ravages dans nos dernières Récoltes de blé sur pied, Cécidomyie du Froment, et quelques-uns de ses Parasites. Entomologie appliquée à l'agriculture: 27—30. — Paris.
- Curtis, J., 1830. British Entomology; being illustrations and descriptions of the genera of insects found in Great Britain and Ireland: containing coloured figures from Nature of the most rare and beautiful species, and in many instances of the plants upon which they are found: folio 309. — London.
- Dalla Torre, C. G. de, 1898. Catalogus Hymenopterorum. Hucusque descriptorum systematicus et synonymicus. V: Chalcidiae et Proctotrupii: 152 pp. — Aachen.
- Fitton, M. G. et al., 1978. In: Kloet, G. S. and W. D. Hincks: A check list of British Insects. 4: Hymenoptera. — Handbks Identif. Br. Insects 11 (4): i—ix, 1—159.
- Foerster, A., 1856. Hymenopterologische Studien. 2: Chalcidiae und Proctotrupii: 152 pp. — Aachen.
- Graham, M. W. R. de V., 1979. "Ambulator." Francis Walker, English entomologist (1809—1874). — Entomologist's Gaz. 30: 7—20.
- Graham, M. W. R. de V., 1982. The Haliday collection of Mymaridae (Insecta, Hymenoptera, Chalcidoidea) with taxonomic notes on some material in other collections. — Proc. R. Ir. Acad. 82B: 189—243.
- Haliday, A. H., 1833. An essay on the Classification of the Parasitic Hymenoptera of Britain, which correspond with the Ichneumonones minuti of Linnaeus. — Ent. Mag. 1: 259—276.
- Haliday, A. H., 18? Catalogue of Irish insects. Unpublished.
- Hincks, W. D., 1944. Notes on the nomenclature of some British parasitic Hymenoptera. — Proc. R. ent. Soc. Lond. (B) 13: 30—39.
- Huggert, L., 1974. Taxonomical studies on the species belonging to *Urocyclops* Maneval (Hym. Proctotrupeoidea, Platygasterinae). — Ent. Tidskr. 95: 58—63.
- Kieffer, J. J., 1914. In André: Species des Hyménoptères d'Europe xi: Proctotrypidae (3): 448 pp., pls. i—xii.
- Kieffer, J. J., 1926. Scelionidae. — Tierreich 48: 885 pp.
- Kozlov, M. A., 1966. Notes on Scelionidae and Platygasteridae (Hymenoptera, Proctotrupeoidea) of Moldavia (in Russian). — Trudy moldav. nauchno-issled. Inst. Sadov. Vinigr. Vinod., (Ent.) 13: 93—100.
- Kozlov, M. A., 1971. Proctotrupoids (Hymenoptera, Proctotrupeoidea) of the USSR. — Horae Soc. ent. U. Soviet 54: 3—67.
- Kozlov, M. A., 1978. Identification of the insects of the European part of the USSR. Hymenoptera 2. Platygasteridae. — Opred. Faune SSSR 120: 647—664.
- Marchal, P., 1897. Les Cécidomyies des Céréales et leurs parasites. — Annl Soc. ent. Fr. 66: 1—105.
- Marshall, T. A., 1873. A catalogue of British Hymenoptera; Oxyura: 27 pp. — London.
- Masner, L., 1957. Remarks to the genus *Iphitrachelus* Walker, 1835 (Hym. Scelionidae). — Čas. čsl. Spol. ent. 54: 1—8.
- Masner, L., 1964. A comparison of some Nearctic and Palearctic genera of Proctotrupeoidea (Hymenoptera) with revisional notes. — Čas. čsl. Spol. ent. 61: 123—155.
- Masner, L., 1965. The types of Proctotrupeoidea (Hymenoptera) in the British Museum (Natural History) and in the Hope Department of Entomology, Oxford. — Bull. Br. Mus. nat. Hist. (Entomology) 1: 154 pp.
- Masner, L., 1980. The Nearctic species of *Acerotella* Masner (Hymenoptera, Proctotrupeoidea, Platygasteridae). — Can. Ent. 112: 1291—1303.
- Masner, L., 1981. Revision of the Nearctic species of *Metaclisis* Foerster (Hymenoptera, Platygasteridae, Inostemmatinae). — Can. Ent. 122: 1069—1091.
- Muesebeck, C. F. W. & L. M. Walkley, 1956. Type species of the genera and subgenera of parasitic wasps comprising the superfamily Proctotrupeoidea (Order Hymenoptera). — Proc. U. S. natn. Mus. 105: 319—419.
- Nees von Esenbeck, C. G., 1834. Hymenopterorum Ichneumonibus affinum Monographiae, Genera Europaeae et Species Illustrantes 2: 297—310.
- O'Connor, J. P. & R. Nash, 1982. Notes on the entomological collection of A. H. Haliday (1806—1870) in the National Museum of Ireland, with a recommendation for type designations. — Proc. R. Ir. Acad. 82B: 169—175.
- Szelényi, G. von, 1937—38. Über Paläarktische Scelioniden (Hym. Proct.) I. Zur Systematik der Gattung *Inostemma* Walk. — Annl. hist.-nat. Mus. natn. hung. 31: 108—128.
- Szelényi, G. von, 1938. Über eine verkannte Gattung der Platygasteriden, nebst Beschreibung zwei neuer Arten aus der Familie der Scelioniden (Hym. Proctotr.). — Folia ent. hung. (ser. n.) 3: 97—106.
- Thomson, C. G., 1859. Sveriges Proctotruper. Tribus VII. Platygasterini. — Öfvers. K. VetenskAkad. Förh. 16: 69—87.
- Vlug, H. J., 1973. The species of Platygasteridae (Hymenoptera, Proctotrupeoidea) in the collection of the "Naturhistorisches Museum" in Vienna with special reference to the types of Förster. — Entomophaga 18 (2): 175—184.
- Walker, F., 1835. On the species of *Platygaster*, & c.

- Ent. Mag. 3: 217—274; explanation of plate on p. iv.
- Walker, F., 1838. Descriptions of some Oxyuri. — Ent. Mag. 5:453—458.
- Walker, F., 1851. Notes on Chalcidites, and Descriptions of various new species. — Ann. Mag. nat. Hist. 7: 210—216.
- Walker, F., 1872. Notes on the Oxyura. — Family 1. Platygastridae. — Entomologist 6: 535—542.



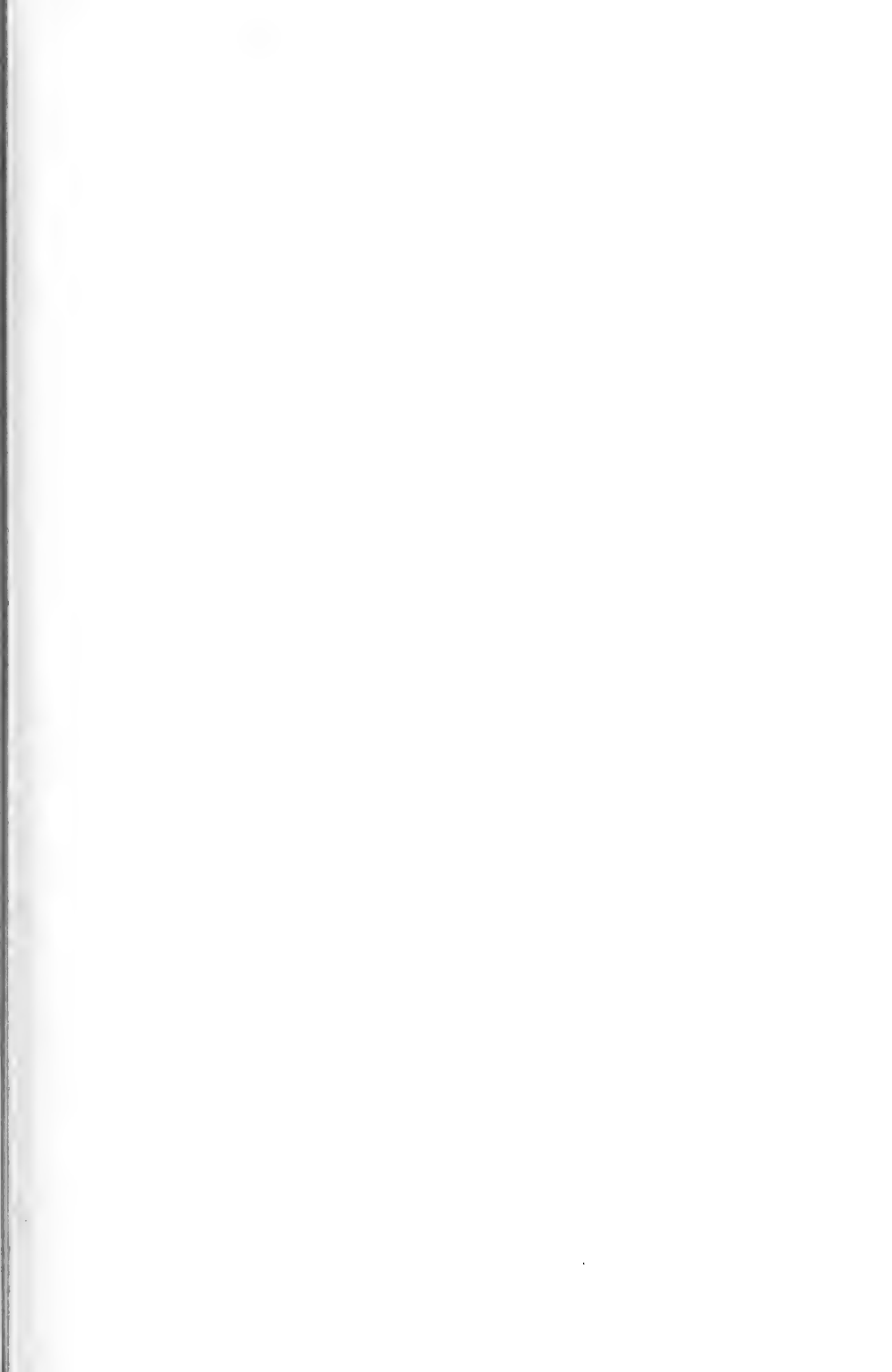

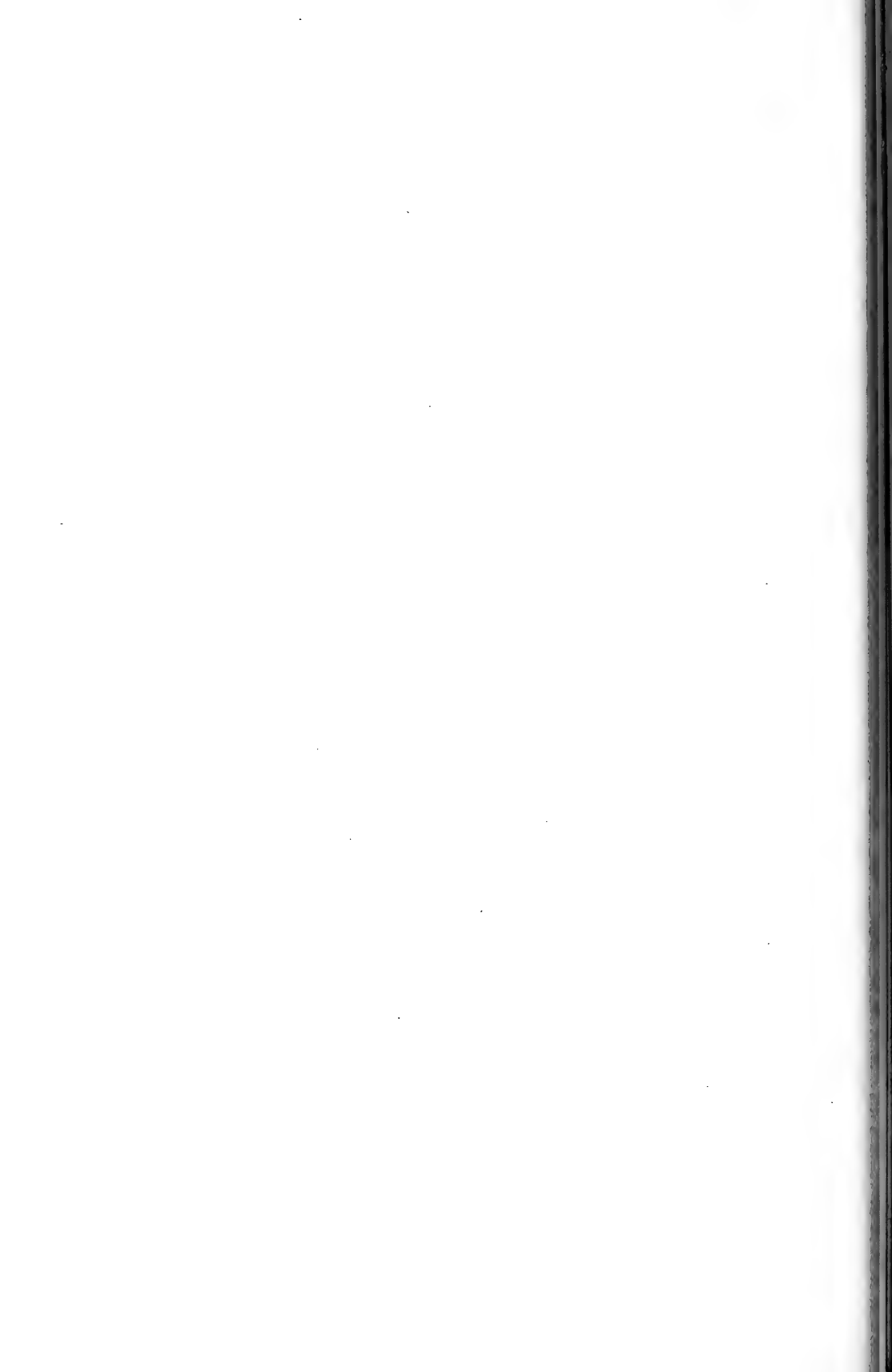





TIJDSCHRIFT VOOR ENTOMOLOGIE

US. COMP. ZOOL
LIBRARY
JAN 16 1985
HARVARD
UNIVERSITY

UITGEGEVEN DOOR

DE NEDERLANDSE ENTOMOLOGISCHE VERENIGING

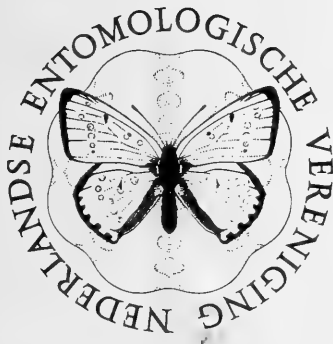

INHOUD

- C. VAN ACHTERBERG. — Revision of the genera of Braconini with first and second metasomal tergites immovably joined (Hymenoptera, Braconidae, Braconinae), pp. 137—164, figs. 1—153.

REVISION OF THE GENERA OF BRACONINI WITH FIRST AND SECOND METASOMAL TERGITES IMMOVABLY JOINED (HYMENOPTERA, BRACONIDAE, BRACONINAE)

by

C. VAN ACHTERBERG

Rijksmuseum van Natuurlijke Historie, Leiden, The Netherlands

ABSTRACT

The genera of the Braconini with the 1st and 2nd tergites immovably joined are keyed and illustrated. Four new genera are described: *Apotosoma* (type-species: *A. latimarginale* sp. nov.), *Aspidobracon* (type-species: *A. pierrei* sp. nov.), *Hyboteles* (type-species: *H. toxopeusi* sp. nov.), and *Pedinopleura* (type-species: *P. emarginata* sp. nov.). In addition to the four new type-species, three new species are described: *Apotosoma melateles* sp. nov., *Aspidobracon hesperivorus* sp. nov., and *A. noyesi* sp. nov. A lectotype is designated for *Physaraia furcata* (Guérin-Méneville, 1848). The genera are divided into two new subtribes: the Physaraiina (based on the genus *Physaraia* Shenefelt), and the Aspidobraconina (based on the genus *Aspidobracon* nov.)

INTRODUCTION

During my visit to the Paris Museum in 1979 I received a vial with specimens belonging to a genus unknown to me, reared by Mr. Jacques Pierre from *Acraea cepheus* (L.) (Lepidoptera, Nymphalidae, Acraeinae) on *Caloncoba welwitschii* Gilg. (Flacourtiaceae) and supposed to be infesting the egg-stage of the host. However, the vial contained no traces of eggs, only a chrysalis of the butterfly with a hole in it, and several cocoons of the parasites. Considering this, as well the size of the adult parasite (2.7-3 mm) and of the eggs of the host (1-1.5 mm by 0.5 mm), it is certainly not an egg-parasite. There remains the possibility that the eggs were infested, and that the embryo of the parasite remained dormant till the larva of the host was large enough for complete development of the parasite. However, this would indicate that it is an endoparasite, a feature unknown up to now in the Braconinae. For the moment it is most likely that the host reared from the egg-stage (Mr. Pierre, in litt.) was infested in the larval or pupal stage and that the gregarious parasite-larvae live as parasite in the host-chrysalis. The emergence from the pupa of the host is an exceptional feature in the Braconinae. All other genera of Braconinae are (as far known) ectoparasitic on holometabolous larvae. In this paper the genus *Aspidobracon* is described to include this species, together with other taxa in the Bra-

conini possessing the peculiar feature of the immovably joined 1st and 2nd tergites.

For the terminology used in this paper, see Van Achterberg, 1979: 242-249; the term "thyloid" (not mentioned in that paper) is used for the elongate sensillae on the antennal segments (figs. 2, 16, 136), and for the term "sub-ocular groove", see fig. 72.

PHYLOGENY

The group of genera treated in this paper belongs to the tribe Braconini Stephens of the Braconinae, defined by the robust scapus, which is truncate apically and ventrally as long as dorsally or somewhat shorter (in lateral view) (figs. 12, 45, 111, 137) and by vein 1r-m of hind wing shorter than vein SC+R1 (figs. 3, 30, 114, 138). The genera of the Braconini with 1st and 2nd tergites immovably joined (figs. 1, 41, 135) share a strong and complete medio-longitudinal carina on the propodeum (figs. 117, 147, but absent (secondarily lost?) in *Physaraia*), and mesoscutum regularly and (rather) densely setose. These features are also present in the *Plesiobracon* group as defined by Van Achterberg (1983: 185). Especially the Afrotropical genus *Carinibracon* Van Achterberg, 1983, resembles the genera treated in this paper. It has the 6th tergite sculptured, and it shares the strong dorsal carinae of the 1st tergite with several genera. Different are the movably joined 1st and 2nd

tergites, the wide obtuse lobe of the tarsal claws, and the minute medio-basal area of the 2nd tergite. Both other genera of the *Plesiobracon* group differ by the smooth 6th tergite. The genus *Kenema* Van Achterberg, 1983, differs also by the robust 2nd submarginal cell of the fore wing (but shares with *Physaraia* the medial carina on the mesoscutum and the sculpture of the head and mesoscutum). The genus *Plesiobracon* Cameron, 1903, differs by the shape of the claws, of the 4th tergite, and by the sculpture of the metasoma.

The genera treated in this paper fall into two distinct groups: the Physaraiina (subtribus nov., containing only *Physaraia* Shenefelt, 1978) and the Aspidobraconina (subtribus nov., based on *Aspidobracon* gen. nov., and including six more

genera). The Physaraiina differ by six apomorphic character-states from the Aspidobraconina: i) the reduction of the metasomal sutures, ii) 3rd tergite forked posteriorly, iii) 4th-6th tergites completely retracted, iv) lateral margin of 2nd and 3rd tergites slanted inwards, v) clypeus with dorsal carina, vi) mesoscutum with medial carina more or less developed. Except for the immovably joined 1st and 2nd tergites, and the medial carina of the metanotum, scarcely any synapomorphic character-states united the Physaraiina with the Aspidobraconina; this makes it uncertain if they are sister-groups, as depicted in fig. 153. Because no other group is known to be more related, this arrangement is the most plausible for the moment, despite the lack of synapomorphies.

Table 1. Synoptic table of most important character-states of the genera treated in this paper.

Genus	<i>Plesiobracon</i> group	<i>Physaraia</i>	<i>Dioxobracon</i>	<i>Apotosoma</i>	<i>Pedinopleura</i>	<i>Hypoteles</i>	<i>Eutropobracon</i>	<i>Aspidobracon</i>	<i>Philomacroploea</i>	
● = apomorphic										○ = plesiomorphous
1st and 2nd tergite immovably joined	○	●	●	●	●	●	●	●	●	1st and 2nd tergite movably joined
metasomal sutures largely absent	○	●	○	○	○	○	○	○	○	metasomal sutures completely developed
3rd tergite forked	○	●	○	○	○	○	○	○	○	3rd tergite without fork
clypeus with dorsal carina	○	●	○	○	○	○	○	○	○	clypeus without dorsal carina
mesoscutum with complete carina	●	●	○	○	○	○	○	○	○	mesoscutum without longitudinal carina
lateral margin of 2nd and 3rd tergites slanted inwards	○	●	○	○	○	○	○	○	○	lateral margin of 2nd and 3rd tergites confluent with rest of tergites, directed ventrally
claws simple	○	○	○	○	●	●	○	●	●	claws with lobe or lamella
eyes with subocular groove	○	○	●	●	●	●	○	○	○	eyes without subocular groove
metanotum with longitudinal carina	●	●	●	●	●	●	●	●	●	metanotum without longitudinal carina
propodeum with longitudinal carina	●	○	●	●	●	●	●	●	●	propodeum without longitudinal carina
pleural sulcus smooth	●	●	●	●	●	●	○	○	○	pleural sulcus crenulate
mesosternal suture smooth	●	●	●	●	●	●	●	○	○	mesosternal groove smooth
6th tergite emarginate	○	retracted	●	○	●	○	○	○	○	6th tergite truncate
antescutal depression present	●	○	○	○	○	○	○	○	○	antescutal depression absent
lateral margin of 3rd tergite lamelliform	●	○	●	●	●	●	●	●	○	lateral margin of 3rd tergite thick
3rd tergite widened laterally	○	○	●	●	●	○	○	○	○	3rd tergite not widened laterally
ovipositor short	○	○	●	○	○	●	○	●	●	ovipositor comparatively long
metanotum protruding	○	○	●	○	○	○	○	●	●	metanotum blunt dorsally
3rd tergite with antero-lateral grooves	●	○	●	●	●	○	●	●	○	3rd tergite without antero-lateral grooves
dorsal carinae of 1st tergite absent	○	○	○	●	○	○	○	○	○	dorsal carinae of 1st tergite present

The Aspidobraconina consist of two subgroups (fig. 153); the group including *Pedinopleura* gen. nov. and three other genera has a subocular groove, the pleural sulcus and mesosternal suture smooth, and occurs in New Guinea (three genera), Australia (one genus), Malagasy (one genus) and Oriental Region (one genus). The other group (including *Aspidobracon* gen. nov. and two other genera) has these three characters in the plesiomorphous state (except *Eutropobracon*, which has a virtually smooth mesosternal suture) and is provisional because of the lack of synapomorphies. All three genera of this group occur in the Oriental Region, with additional species in the Afrotropical Region and Japan. For further details of the supposed phylogenetic relationships, see fig. 153; the majority of the characters used for the analysis are listed in table 1.

KEY TO THE GENERA OF BRACONINI WITH 1ST AND 2ND METASOMAL TERGITES IMMOVABLY UNITED

- 1. Carapace of 1st—3rd tergites without deep transverse sutures medially (fig. 1); 4th—6th tergites retracted (figs. 1, 6); 3rd tergite forked apically (fig. 6); clypeus with dorsal carina (fig. 8); mesoscutum with medial carina (fig. 11), but sometimes absent; (subtribe *Physaraia* nov.) *Physaraia* Shenefelt
- Carapace of 1st—3rd tergites with deep and complete transverse sutures (figs. 13, 66, 121); 4th—6th tergites exposed; 3rd tergite truncate apically (fig. 27); clypeus without dorsal carina (figs. 26, 33, 91); mesoscutum without medial carina (figs. 35, 46, 64); (subtribe *Aspidobraconina* nov.) 2
- 2. Eye with distinct subocular groove (figs. 21, 29, 72); pleural sulcus smooth (figs. 13, 29, 54, 68); posterior half of mesosternal suture smooth; tarsal claws with a (small) ventral lobe (figs. 22, 51) or simple (figs. 37, 62, 75) 3
- Eye without subocular groove (figs. 82, 97, 109, 135); pleural sulcus crenulate (figs. 82, 109, 122, 135); posterior half of mesosternal suture crenulate, exceptionally obsolete or smooth (e.g., *Eutropobracon*); tarsal claws simple (fig. 102, 142), exceptionally with lobe (fig. 90) 6
- 3. Metanotum without complete medio-longitudinal carina (fig. 78); 6th tergite strongly convex (fig. 68); lateral lamelliform margin of 3rd tergite narrow, similar to margin of

- 2nd tergite (figs. 68, 77); dorsal carinae of 1st tergite united (fig. 80); tarsal claws without lobe (fig. 75) *Hyboteles* gen. nov.
- Metanotum with complete lamelliform medio-longitudinal carina (fig. 35); 6th tergite at most moderately convex (fig. 29); lateral lamelliform margin of 3rd tergite widened, and wider than margin of 2nd tergite (figs. 13, 29, 41, 63, 151); dorsal carinae absent (figs. 66, 149), or if present then not united (figs. 27, 39, 53); tarsal claws with small acute lamella (figs. 22, 51) or virtually absent (figs. 37, 62) 4
- 4. Notauli present (figs. 20, 35, 46); dorsal carinae of 1st tergite present, and more or less lamelliform (figs. 27, 39, 53); frons without narrow V-shaped groove (figs. 32, 44); lateral margin of 2nd tergite not (fig. 13) or abruptly (fig. 29) widened posteriorly; medial carina of metanotum tooth-shaped protruding (figs. 13, 29, 41); base of 4th—6th tergites variable (figs. 13, 29, 41) 5
- Notauli absent (fig. 64); dorsal carinae of 1st tergite largely absent (figs. 66, 149); frons with narrow V-shaped groove near antennal sockets (figs. 65, 152); lateral margin of 2nd tergite gradually widened posteriorly (figs. 63, 151); medial carina of metanotum not protruding (fig. 54); 4th—6th tergites with deep transverse depressions basally (figs. 67, 151) *Apotosoma* gen. nov.
- 5. Fifth and 6th tergites deeply impressed basally (figs. 29, 41); 6th tergite (rather) shallowly emarginate medio-apically (figs. 40, 47); propleuron flattened and with small posterior flange (figs. 29, 41); occipital flange very wide, about as wide as mandible-base and distinctly removed from base of mandible (figs. 29, 33, 41, 52); middle lobe of mesoscutum with pair of grooves anteriorly (figs. 35, 46); mesopleuron densely sculptured (figs. 29, 41) *Pedinopleura* gen. nov.
- Fifth and 6th tergites less impressed basally (fig. 13); 6th tergite deeply incised medio-apically (fig. 28); propleuron comparatively convex and without distinct posterior flange (fig. 13); occipital flange narrow, much narrower than width of mandible-base and close to base of mandible (figs. 13, 26); middle lobe of mesoscutum without pair of grooves anteriorly (fig. 20); mesopleuron sparsely sculptured (fig. 13) *Dioxybracon* Granger

6. Third tergite without lamelliform lateral margin (fig. 97); 6th tergite semi-circularly emarginate medio-apically (fig. 108, but less in ♂); 2nd tergite with medial carina more or less developed (fig. 107); antescutal depression present (fig. 97); malar suture (rather) deep (fig. 97).....
 *Philomacroploea* Cameron
- Third tergite with lamelliform lateral margin (figs. 82, 109, 122, 135); 6th tergite truncate (fig. 96) or protruding (figs. 121, 134, 144); 2nd tergite without medial carina (figs. 95, 121, 148); antescutal depression absent (figs. 82, 122) or present as narrow cleft (fig. 135); malar suture variable..... 7
7. Third to 5th tergites medially much shorter than laterally (fig. 95); 6th tergite truncate apically (fig. 96); ovipositor sheath somewhat longer than metasoma (fig. 86); tarsal claws with lobe (fig. 90); metanotum not protruding (fig. 81); vein cu-a of fore wing shortly postfurcal (fig. 85); dorso-lateral carinae of 1st tergite strong and lamelliform (fig. 82); angle between veins 1-SR and C+SC+R of fore wing about 55° (fig. 84); propodeal tubercle present (fig. 82).....
 *Eutropobracon* Ramakrishna Ayyar
- Third to 5th tergites medially about as long as laterally (fig. 121); 6th tergite protruding medio-apically (figs. 121, 134, 144); ovipositor sheath shortly protruding beyond apex of metasoma (figs. 109, 122, 135); tarsal claws without lobe (figs. 113, 130, 142); metanotum somewhat protruding (figs. 109, 122, 135); vein cu-a of fore wing interstitial (figs. 114, 138); dorso-lateral carinae of 1st tergite absent (figs. 109, 122, 135); angle between veins 1-SR and C+SC+R of fore wing more than 70° (figs. 115, 127, 141); propodeal tubercle absent (fig. 109).....
 *Aspidobracon* gen. nov.

PHYSARAIA SUBTRIBUS NOV.

Syn.: *Gastrothecini* Fahringer, 1928 (invalid, based on junior homonym).

Diagnosis. — Head in lateral view comparatively small (fig. 1), but in some species larger than in type-species; scapus truncate apically (fig. 12); clypeus with dorsal carina (fig. 8); pronotal sides anteriorly curved towards mesoscutum (fig. 1); mesoscutum densely setose and with medial carina (fig. 11), but sometimes absent; scutellar sulcus crenulate and comparati-

vely wide (fig. 11); vein cu-a of fore wing subinterstitial (fig. 3); vein 1r-m of hind wing short (fig. 3); fore tibia without pegs or spines; propodeum with pair of tubercles (fig. 1) and without medial carina; 1st—3rd metasomal tergites forming a strongly convex carapace, without deep transverse sutures medially and no antero-lateral grooves (figs. 1, 7); carapace with 3 pairs of spiracles, situated distinctly above ventral rim of carapace (fig. 1); ventral margin of 2nd and 3rd tergites slanted inwards and not lamelliform; 3rd tergite emarginate medio-apically and forked posteriorly (fig. 6); 4th—6th tergites completely retracted (fig. 1).

Contains only the genus *Physaraia* Shenefelt, 1978; the biology is unknown.

Physaraia Shenefelt, 1978

Shenefelt, 1978: 1714—1716.

Type-species: *Gastrotheca furcata* Guérin-Méneville, 1848 (original designation). Gender: feminine. Syn.: *Gastrotheca* Guérin-Méneville, 1848, nec Fitzinger, 1843.

Diagnosis. — Body finely rugose-coriaceous (figs. 1, 5—7, 11); eyes glabrous and slightly emarginate (fig. 8); antescutal depression absent; mesoscutum widely truncate anteriorly (fig. 11); propleuron rather flat (fig. 1); precoxal sulcus scarcely impressed (fig. 1); mesosternum without crenulate medial suture; pleural sulcus mainly smooth and shallow (fig. 1); metapleural flange large, lamelliform and obtuse (fig. 1); notauli shallowly impressed (fig. 11); metanotum with crest-shaped complete medial carina (fig. 11), and not protruding dorsally (fig. 1); antero-dorsal part of propodeum differentiated from posterior part, short, about as long as metanotum dorsally; propodeum in lateral view acute anteriorly (fig. 1); propodeal spiracle rather large and just behind middle of propodeum; angle between veins 1-SR and C+SC+R about 70° (fig. 3); tarsal claws with acute, robust sub-medial lobe, which is yellowish pectinate (fig. 9); whole 1st tergite strongly convex (fig. 7), its dorsal carinae meeting each other medially (fig. 7), and without dorso-lateral carinae (fig. 1); ovipositor protruding far beyond apex of metasoma, long (fig. 1); hypopygium of ♀ large and acute apically (fig. 1).

Rather small genus, most species known from the Afrotropical region, but the type-species has been reported from North Africa (Egypt, Libya), and one species has been described from

the Oriental Region (*P. sumatrana* Enderlein, 1905). There exists no reliable key to the species of *Physaraia*.

Physaraia furcata (Guérin-Méneville)
(figs. 1—12)

Guérin-Méneville, 1848: 349—350; fig. 4; Shenefelt, 1978: 1715.

Redescribed after ♀ from Ethiopia (Ara) compared with the lectotype; length of body 7.7 mm (including spines), of fore wing 7.1 mm.

Head. — Antennal segments 47 (with many thyloids, fig. 2), length of 3rd segment 1.1 times 4th segment, length of 3rd, 4th, and penultimate segment 1.5, 1.4, and 1.3 times their width, respectively; length of maxillary palp 0.8 times height of head; occipital carina absent, but with weak striae somewhat resembling a carina; length of eye in dorsal view 1.4 times temple (fig. 5); temple finely striate-coriaceous, dull, weakly roundly narrowed behind eyes; POL : diameter of ocellus : OOL = 5 : 4 : 10; frons and vertex coriaceous; face finely rugose-coriaceous; malar suture shallow; length of malar space 1.2 times basal width of mandible.

Mesosoma. — Maximum width of mesosoma equal to maximum width of head; length of mesosoma 1.2 times its height; precoxal sulcus reticulate-coriaceous anteriorly, more rugose posteriorly (fig. 1); rest of mesopleuron coriaceous; antero-dorsal part of propodeum rather coarsely reticulate and laterally coriaceous; posterior part of propodeum subvertical, medially, almost smooth, and with two pairs of posteriorly converging carinae.

Wings. — Fore wing: r : 3-SR : SR1 = 8 : 20 : 27; SR1 weakly sinuate (fig. 3); 1-CU1 : 2-CU1 = 1 : 28; 2-SR : 3-SR : r-m = 11 : 20 : 9; m-cu antefurcal, and subparallel to 1-M (fig. 3).

Legs. — Hind coxa coriaceous dorsally; length of femur, tibia and basitarsus of hind leg 3.6, 7.6, and 5.2 times their width, respectively; length of hind spurs both 0.5 times hind basitarsus.

Metasoma. — Length of 1st tergite 0.6 times its basal width, slightly coriaceous, almost smooth in front of dorsal carinae, and coarsely reticulate behind carinae; length of ovipositor sheath 0.70 times fore wing.

Colour. — Brownish-yellow; antenna (but radix yellowish), stemmaticum and ovipositor sheath, black; wing membrane uniformly light brownish; wing veins brown; pterostigma rather dark brown, but medially yellowish.

Redescribed after specimen in Muséum National d'Histoire Naturelle, Paris: "Labor. Colonial Museum, Abyssinie, Ara, Latham, 29.3.07", "Museum Paris, Abyssinie, 1910, J. Surcouf", "Conspecific with lectotype of *Gastrotheca furcata* G., Van Achterberg, 1978". Lectotype in same institute (in box 99 with label "Proctotrupide déterminé-Braconidae") and here designated: "63", "Museum Paris, Abyssinie, Ferret & Galinier, 1059 bis -92", "Type!", "*Gastrotheca furcata* Gue., Abyssinia" (an old handwritten label). Fore legs are absent, antenna and ovipositor are damaged, 1st metasomal suture weak, but complete, medial carina of mesoscutum present, but more weakly developed than in the specimen figured.

Shenefelt's statement (1978: 1815) that the type of *P. furcata* is the specimen in the Staatssammlung at Munich (from the locality "Port Natal") is not considered to be a lectotype designation. This ♀ is the only paralectotype and may belong to another species.

ASPIDOBRACONINA subtribus nov.

Diagnosis. — Head in lateral view of normal size (figs. 13, 29, 109); scapus truncate (figs. 15, 31, 45); clypeus without dorsal carina (figs. 26, 33, 91); dorsal margin of pronotal sides straight or bent downwards near notauli (figs. 13, 97, 109, 122); mesoscutum densely setose, and without medial carina (figs. 35, 46, 64); scutellar sulcus crenulate, wide to rather narrow (figs. 20, 46, 64); vein SR1 of fore wing straight; vein cu-a of fore wing interstitial (fig. 30) to shortly postfurcal (figs. 14, 85); vein 1r-m of hind wing (rather) short (figs. 14, 30, 57); fore tibia without pegs or spines; propodeum with complete lamelliform medio-longitudinal carina (figs. 63, 146); antero-dorsal part of propodeum not distinctly differentiated from posterior part (figs. 54, 109); tubercles of propodeum absent (figs. 29, 54), except in *Entropobracon* (fig. 82) and lateral carina sometimes somewhat protruding (fig. 13); 1st—3rd tergites forming a rather strongly convex carapace (figs. 13, 29), with two deep transverse sutures (figs. 13, 29, 95, 121), with (figs. 29, 109) or without (figs. 41, 97) antero-lateral grooves; carapace with three pairs of spiracles situated distinctly above ventral rim (figs. 29, 82); 3rd tergite truncate posteriorly (figs. 27, 95); ventral margin of 2nd and 3rd tergites projected downwards (figs. 13, 29, 122), and lamelliform (figs. 13, 29, 68), except in *Philomacroploea* (fig. 97); 4th—6th tergites distinctly exposed, strongly sclerotized and sculp-

ured (figs. 13, 41, 68, 109), but largely smooth in *Apotosoma* (figs. 54, 67, 150).

Contains the genera *Apotosoma* gen. nov.; *Aspidobracon* gen. nov.; *Dioxybracon* Granger, 1949; *Eutropobracon* Ramakrishna Ayyar, 1928; *Hyboteles* gen. nov.; *Pedinopleura* gen. nov.; and *Philomacroploea* Cameron, 1905. The subtribe is restricted to the Palaeotropics and Japan.

Apotosoma gen. nov.

Type-species: *Apotosoma latimarginale* sp. nov.

Etymology: from "apotomos" (Greek for "cut off, abrupt") and "soma" (Greek for "body"), because of the truncate apex of the metasoma. Gender: neuter.

Diagnosis. — Eye not emarginate (fig. 59), and with subocular groove (fig. 54); frons with narrow V-shaped groove near antennal sockets (figs. 64, 151); propleuron without flange posteriorly and normal (fig. 54); precoxal sulcus absent (fig. 54); pleural sulcus and mesosternal suture smooth; metapleural flange rather larger, obtuse and lamelliform (fig. 54); notauli absent (fig. 63), scutellar sulcus comparatively narrow (fig. 64); metanotum with complete lamelliform, non-protruding medio-longitudinal carina (fig. 64); vein cu-a of fore wing interstitial (fig. 57); tarsal claws nearly simple, somewhat protruding medially and finely pectinate subbasally (fig. 62); dorsal carinae of 1st tergite (largely) absent (figs. 66, 149) and without dorso-lateral carinae (figs. 54, 151); lateral margin of 2nd tergite gradually widened posteriorly (figs. 63, 151); 4th—6th tergites with deep transverse depressions basally (figs. 54, 67, 151); 6th tergite rather flat (fig. 54); ovipositor distinctly protruding beyond apex of metasoma, moderately long (fig. 54); hypopygium of ♀ rather large and somewhat protruding medio-apically.

Small genus, only known from New Guinea. Contains the type-species and *A. melateles* sp. nov. The biology is unknown.

Key to the species of the genus *Apotosoma*

1. Head and pterostigma yellowish-brown; lateral margin of 1st tergite comparatively wide and of 3rd tergite comparatively narrow (fig. 151); medial groove of vertex obsolescent (fig. 152); 1st and 2nd metasomal sutures narrowly sculptured (figs. 148, 151); 3 apical segments of antenna blackish, contrasting with other (yellowish) segments

- (figs. 150); length of fore wing about 4 mm; 2nd and 3rd tergites smooth (fig. 149); antennal segments about 34 (♂); propodeum with lateral carinae posteriorly *melateles* sp. nov.
- Head largely black; pterostigma (dark) brown; lateral margin of 1st tergite comparatively narrow and of 3rd tergite comparatively wide (fig. 54); medial groove of vertex distinct (fig. 65); 1st and 2nd metasomal sutures more widely crenulate (figs. 54, 66); 3 apical segments of antenna dark brown, concolorous with preceding segments; length 5.0—5.6 mm; 2nd and 3rd tergites partly punctate (fig. 66); antennal segments about 46 (♀); propodeum without lateral carinae posteriorly (fig. 54) *latimarginale* sp. nov.

Apotosoma latimarginale sp. nov.

(figs. 54—67)

Holotype, ♀, length of body 5.8 mm, of fore wing 5.5 mm.

Head. — Antennal segments 46, length of 3rd segment 1.2 times 4th segment, length of 3rd, 4th, and penultimate segments 2.3, 2.0 and 1.2 times their width, respectively; length of maxillary palp 0.6 times height of head; length of eye in dorsal view 3.5 times temple (fig. 65); temple punctulate; POL : diameter of ocellus : OOL = 4 : 4 : 7; frons, vertex and face punctulate; length of malar space 1.3 times basal width of mandible; malar suture deep.

Mesosoma. — Length of mesosoma 1.3 times its height; ventral half of mesopleuron punctulate, rest smooth; episternal scrobe indistinct (fig. 54); mesoscutum and scutellum punctulate; surface of propodeum punctulate; lateral carina of propodeum absent (fig. 54).

Wings. — Fore wing: r : 3-SR : SR1 = 10 : 27 : 68; 2-SR : 3-SR : r-m = 18 : 27 : 11; m-cu slightly converging to 1-M posteriorly (fig. 57).

Legs. — Hind coxa punctulate; length of femur, tibia, and basitarsus of hind leg 4.1, 9.5, and 6.4 times their width, respectively; length of hind spurs 0.35 and 0.30 times hind basitarsus.

Metasoma. — Length of 1st tergite 0.7 times its apical width, its surface smooth, with shallow and crenulate medio-longitudinal suture; and near anterior third with pair of depressions (fig. 66); 2nd tergite with some punctures and without antero-lateral grooves; 3rd tergite with pair of shallow antero-lateral grooves (fig. 54) and with some punctures (fig. 66); 2nd suture

coarsely crenulate and medially widened (fig. 66); apex of 6th tergite widely truncate and slightly emarginate medially (fig. 67); length of ovipositor sheath 0.31 times fore wing.

Colour. — Brownish-yellow; head (but temple ventrally, eye margins partly, mandible, labrum and pair of patches above toruli, yellowish), antenna (but radix, scapus and pedicellus partly apically, and annellus, yellowish), hind tarsus, and ovipositor sheath, black or dark brown; pterostigma, parastigma, and wing veins (but bases of C+SC+R, M+CU1 of both wings, and 1A of fore wing, completely yellowish), (dark) brown; wing membrane light brown.

Holotype in Rijksmuseum van Natuurlijke Historie, Leiden: "Neth. Ind.-Amer. New Guinea Exp., Lower Mist Camp, 14—1550 m, 31.i.1939, L. J. Toxopeus leg." Paratypes: 2 ♀ in same institute: "Neth. Ind.-American New Guinea Exped., Sigi Camp, 1500 m, 26.ii.1939, L. J. Toxopeus", other specimen from same locality, but 18.ii.1939.

Variation: Length of fore wing 5.0—5.6 mm, of body 5.5—5.8 mm; antennal segments 46 (2 ♀); length of ovipositor sheath 0.29—0.32 times fore wing.

Apotosoma melateles sp. nov.
(figs. 149—152)

Holotype, ♂, length of body 3.6 mm, of fore wing 3.8 mm.

Head. — Antennal segments 34, length of 3rd segment 1.3 times 4th segment, length of 3rd, 4th and penultimate segments 2.4, 1.9, and 1.9 times their width, respectively; maxillary palp hidden in glue; length of eye in dorsal view 2.6 times temple (fig. 152); temple, frons and vertex, smooth; face punctulate; POL : diameter of ocellus : OOL = 3 : 3 : 10; length of malar space 1.3 times basal width of mandible.

Mesosoma. — Length of mesosoma 1.5 times its height; mesopleuron smooth; episternal scrobe (virtually) absent; mesoscutum and scutellum smooth; surface of propodeum smooth; propodeum with short lateral carina posteriorly.

Wings. — Fore wing: r : 3-SR : SR1 = 5 : 12 : 33; 2-SR : 3-SR : r-m = 8 : 12 : 4; m-cu parallel to 1-M.

Legs. — Hind coxa smooth; length of femur, tibia, and basitarsus of hind leg 4.6, 9.6 and 8 times their width, respectively; length of hind tibial spurs 0.30 and 0.25 times hind basitarsus.

Metasoma. — Length of 1st tergite 0.8 times

its apical width, its surface smooth, except for an indistinctly crenulate shallow medial groove (fig. 149), its lateral margin wide (fig. 151); 2nd and 3rd tergites smooth; 2nd suture narrowly crenulate medially (fig. 149); 2nd—6th tergites with indistinctly crenulate and oblique incomplete antero-lateral grooves (fig. 151).

Colour. — Yellowish-brown; pterostigma and wing veins yellowish-brown; wing membrane slightly infuscated; posterior half of hind tarsus, and 3rd—10th antennal segments somewhat infuscated; 3 apical antennal segments blackish (fig. 149), and rest of antenna yellowish.

Holotype in British Museum (Natural History), London: "Papua: Mondo, 5,000 ft, ii.1934, L. E. Cheesman, B.M. 1934—321".

Aspidobracon gen. nov.

Type-species: *Aspidobracon pierrei* sp. nov.

Eymology: from "aspidos" (Greek for "shield") and the generic name "Bracon", because the metasoma is shield-like and the spp. resemble the genus *Bracon*. Gender: masculine.

Diagnosis. — Eye not emarginate (figs. 110, 132, 140), and without subocular groove (figs. 109, 122, 135); malar suture shallow (fig. 140); frons without V-shaped grooves (fig. 146); antescutal depression absent (fig. 109) or present as a narrow cleft (fig. 135); propleuron with narrow posterior flange (figs. 109, 122), but absent in *noyesi* sp. nov. (fig. 135), normal (fig. 109) to flat (fig. 135); precoxal sulcus at least shallowly impressed (figs. 109, 135); pleural sulcus (figs. 122, 135), and mesosternal suture (finely) crenulate; metapleural flange small (figs. 109, 122) or absent (fig. 135); notauli complete, not meeting posteriorly and smooth (figs. 117, 131) or finely crenulate (fig. 147); scutellar sulcus rather wide (figs. 117, 131); metanotum with complete (*pierrei* sp. nov.) or incomplete (other spp.) medial carina, slightly protruding dorsally (figs. 116, 122, 135); angle between veins 1-SR and C+SC+R of fore wing more than 70° (figs. 115, 127, 141); vein cu-a of fore wing interstitial (fig. 114); tarsal claws simple figs. 113, 130), but somewhat widened and finely pectinate in *noyesi* (fig. 142); dorsal carinae of 1st tergite present and united (figs. 132, 148), without dorso-lateral carinae (figs. 109, 122, 135); lateral margin of 2nd and 3rd tergites narrow, lamelliform, and not widened (fig. 135); 2nd tergite without medial carina (fig. 121); 3rd—5th tergites medially about as long as

laterally (fig. 121); 4th—6th tergites with shallow basal depressions (fig. 135); 6th tergite moderately convex (figs. 122, 135), and protruding medio-posteriorly (figs. 121, 134, 144); ovipositor shortly protruding beyond apex of metasoma (figs. 134, 135); hypopygium of ♀ variable.

Small genus, known from the Oriental (two spp.) and Afrotropical region (one sp.), and reared from Hesperidae and Nymphalidae-Acraeinae.

Key to the species of the genus *Aspidobracon*

1. Sixth tergite of metasoma comparatively acutely protruding apically (fig. 121); metanotum with complete medial carina (fig. 117); precoxal sulcus at least medially finely sculptured (fig. 109); propodeum distinctly sculptured medially (fig. 117); 2nd submarginal cell of fore wing somewhat longer (fig. 114; vein 3-SR about 3 times vein r); (Afrotropical) *pierrei* sp. nov.
- Sixth tergite less protruding apically (figs. 134, 144); posterior half of metanotum without medial carina (figs. 131, 147); precoxal sulcus smooth medially (figs. 122, 135); propodeum (except for medial carina and some crenulae) smooth medially (figs. 133, 147); 2nd submarginal cell of fore wing shorter (figs. 124, 138; vein 3-SR about 2 times vein r or less); (Oriental) 2
2. Temple behind eye with conspicuous black spot; body with black pattern; antennal segments of ♀ 35—37; scapus black; 6th tergite more gradually narrowed apically (fig. 144); claws more robust (fig. 142); (India) *noyesi* sp. nov.
- Temple behind eye without black spot; body (nearly) completely brownish-yellow; antennal segments of ♀ 33—34; scapus yellowish; 6th tergite more abruptly narrowed apically (fig. 134); claws less robust (figs. 130); (Sri Lanka) *hesperivorus* sp. nov.

Aspidobracon pierrei sp. nov.

(figs. 109—121)

Holotype, ♀, length of body 3.0 mm, of fore wing 2.5 mm.

Head. — Antennal segments 31 (long and densely setose (figs. 111, 112)), length of 3rd antennal segment 1.1 times 4th segment, length of 3rd, 4th, and penultimate segments 2.0, 1.8, and 1.7 times their width, respectively; length of maxillary palp 0.8 times height of head; length

of eye in dorsal view 3.4 times temple (fig. 120); temple smooth; vertex, frons and face, punctulate; POL : diameter of ocellus : OOL = 7 : 5 : 19; length of malar space 1.4 times basal width of mandible.

Mesosoma. — Length of mesosoma 1.3 times its height; precoxal sulcus coarsely (rugose-) punctate, rest of mesopleuron punctulate (fig. 109); mesoscutum and scutellum slightly punctulate; metanotum with complete medial carina (fig. 117); surface of propodeum coarsely transversely rugose (fig. 117).

Wings. — Fore wing: r : 3-SR : SR1 = 10 : 29 : 63; angle between 1-SR and C+SC+R 88° (fig. 115); 2-SR : 3-SR : r-m = 17 : 29 : 15; m-cu somewhat converging posteriorly to 1-M (fig. 114).

Legs. — Hind coxa smooth; length of femur, tibia and basitarsus of hind leg 4.6, 8.0, and 5.3 times their width, respectively; length of hind spurs 0.4 and 0.3 times hind basitarsus.

Metasoma. — Length of 1st tergite 0.6 times its apical width, its surface coarsely reticulate (fig. 121), its dorsal carinae weak; 2nd and 3rd tergites reticulate-rugose, with rather shallow antero-lateral grooves as in following tergites (fig. 109); 3rd and following tergites apically smooth, with a subapical transverse shallow groove (figs. 109, 121); 6th tergite rather acutely protruding posteriorly (fig. 121); length of ovipositor sheath 0.10 times fore wing; hypopygium medium-sized and apically truncate.

Colour. — Brownish-yellow; legs light yellowish; pterostigma and veins light brown; pedicellus slightly darker than scapus; wing membrane subhyaline.

Holotype in Muséum National d'Histoire Naturelle, Paris: "Gabon, Makokou, 0°34'N—12°52'E, 8.xii.1976, J. Pierre", "ovo-larval (?) parasite of *Acraea cepheus* on *Caloncoba wel-witschii* G.". Paratypes: 24 ♂ and 9 ♀ with same labels; pterostigma in both sexes sometimes dark brown, antenna (except scapus) also largely dark brown, and stemmaticum brown. However, males occur similarly coloured as ♀-holotype. Further 14 ♀ and 2 ♂ paratypes: "Mali, Koro, (caterpillar) on millet", "coll. 20.ix.1979, wlt's x.1979", one ♀ from December 13, 1979, Mopti Koro. Malar suture rather deep, mesosternal groove sometimes only finely crenulate, further as holotype.

Variation: antennal segments of ♀ 28 (1), 29 (3), 31 (4) or 32 (1), of ♂ 27 (1), 29 (5), or 30 (2); length of body 2.7—3.0 mm, of fore wing 2.2—

2.6 mm; length of ovipositor sheath 0.07—0.10 times fore wing. Paratypes are deposited in the museums at Leiden, Paris, London, and in the collections of USDA, Beltsville, and of Dr. D. Quicke (Nottingham).

Note. This species is named after Mr. Jacques Pierre (Paris), the specialist of the Acraeinae, who was the first to discover its host.

***Aspidobracon hesperivorus* sp. nov.**

(figs. 122—134)

Holotype, ♀, length of body 2.5 mm, of fore wing 2.6 mm.

Head. — Antennal segments 34, length of 3rd segment 1.2 times 4th segment, length of 3rd, 4th and penultimate segment 2.3, 2.0, and 2.0 times their width, respectively; length of maxillary palp 0.7 times height of head; length of eye in dorsal view 3.2 times temple (fig. 132); temple, vertex, frons and face smooth and pubescent; POL : diameter of ocellus : OOL = 8 : 7 : 16; length of malar space 1.4 times basal width of mandible.

Mesosoma. — Length of mesosoma 1.3 times its height; precoxal sulcus only impressed and smooth (fig. 122) rest of mesopleuron largely smooth dorsally, superficially coriaceous ventrally (fig. 122); mesoscutum smooth; scutellum sparsely punctulate; metanotum with short incomplete carina (fig. 131); surface of propodeum smooth (fig. 133).

Wings. — Fore wing: $r : 3-SR : SR1 = 6 : 9 : 36$; angle between 1-SR and C+SC+R 89° (fig. 126); $2-SR : 3-SR : r-m = 8 : 9 : 6$; m-cu slightly converging to 1-M posteriorly (fig. 124).

Legs. — Hind coxa coriaceous-punctulate; length of femur, tibia, and basitarsus of hind leg 4.2, 8.0, and 5.0 times their width, respectively; both hind spurs 0.3 times hind basitarsus.

Metasoma. — Length of 1st tergite 0.5 times its apical width, its surface reticulate, and its dorsal carinae distinct (fig. 133); 2nd—5th tergites rugose-reticulate and with complete antero-lateral diverging grooves (fig. 122); 3rd—5th tergites smooth apically and with subapical transverse crenulate groove; 6th tergite rugulose, rather angled laterally, and rather weakly protruding medio-apically (fig. 134); length of ovipositor sheath 0.12 times fore wing; hypopygium medium-sized, somewhat protruding posteriorly.

Colour. — Brownish-yellow, antenna (except yellowish scapus), stemmaticum and ovipositor sheath, dark brown; pterostigma and most veins, brown; wing membrane subhyaline.

Holotype in British Museum (Natural History), London: "Ceylon, Galle, 19.vii.1928, Dr. J. C. Hutson, pupa of a Hesperid on paddy (*Oryza sativa*), 6802". The probable host is *Erionota thrax* (Linnaeus) (Dr. R. de Jong, pers. comm.). Paratypes: 7 ♀ and 5 ♂, all with same label, obviously a series of gregarious specimens. Deposited in the British Museum (Natural History), Rijksmuseum van Natuurlijke Historie at Leiden, and in the collection of Dr. D. Quicke (Nottingham).

Variation: Antennal segments of ♀ 33 (3) — 34 (3), of ♂ 31 (1) — 32 (3); length of body 2.5—2.9 mm, of fore wing 2.5—2.6 mm; length of ovipositor sheath 0.11—0.14 times fore wing.

***Aspidobracon noyesi* sp. nov.**

(figs. 135—148)

Holotype, ♀, length of body and of fore wing both 3.0 mm.

Head. — Antennal segments 37, length of 3rd segment 1.1 times 4th segment, length of 3rd, 4th and penultimate segment 2.2, 2.0, and 1.7 times their width, respectively; length of maxillary palp 0.9 times height of head; length of eye in dorsal view 3.0 times temple (fig. 146); temple, frons (laterally), vertex, and face, punctulate; POL : diameter of ocellus : OOL = 5 : 3 : 9; length of malar space 1.4 times basal width of mandible.

Mesosoma. — Length of mesosoma 1.1 times its height; precoxal sulcus only medially shallowly impressed and with some curved striae in front (fig. 134); rest of mesopleuron indistinctly punctulate; mesoscutum and scutellum smooth; metanotum with short incomplete carina anteriorly (fig. 147); surface of propodeum smooth, except for some crenulae near medial carina (fig. 147).

Wings. — Fore wing: $r : 3-SR : SR1 = 6 : 11 : 36$; angle between 1-SR and C+SC+R 74° (fig. 141); $2-SR : 3-SR : r-m = 9 : 11 : 6$; m-cu parallel to 1-M (fig. 138).

Legs. — Hind coxa largely smooth; length of femur, tibia and basitarsus of hind leg 3.5, 9.0, and 5.0 times their width, respectively; length of hind spurs 0.35 and 0.5 times hind basitarsus.

Metasoma. — Length of 1st tergite 0.6 times its apical width, its surface coarsely rugose-reticulate, in front of dorsal carinae medially deeply impressed and with V-shaped crenulation (fig. 148), and dorsal carinae absent basally; 2nd—6th tergites coarsely rugose-reticulate, with shallow antero-lateral grooves; 3rd—5th tergites with subapical, transverse crenulate

grooves (fig. 135); 6th tergite gradually narrowed apically and only slightly angled laterally (fig. 144); length of ovipositor sheath 0.12 times fore wing; hypopygium large, and acute apically (fig. 135).

Colour. — Yellowish-brown; patch behind eyes, frons medially, stemmaticum and area behind it, scapus, pedicellus, mesonotal lobes largely, metasoma dorsally (but yellowish are: sides and base of metasoma, 1st and 2nd tergites medially widely, 3rd—6th tergites posteriorly and medially narrowly), black; rest of antenna, pterostigma (apically lighter), wing veins, and ovipositor sheath, dark brown; propodeum partly, humeral plate apically, base and apex of hind tibia, middle and hind tarsi infuscated; rest of legs, palpi, and temples ventrally, light yellowish; wing membrane slightly infuscated.

Holotype in British Museum (Natural History), London; "India: Karnataka, Mudigere, 26.x.—4.xi., 1979, J. S. Noyes". Paratypes: 3 ♀ (one in Rijksmuseum van Natuurlijke Historie, Leiden, rest in BM(NH)), two are topotypic and with same dates, the 3rd is labelled: "India: T. Nadu, Valparai, (Cinchona), 20—22.x.1979, J.S. Noyes".

Variation: Length of body 3.0—3.1 mm, of fore wing 2.8—3.1 mm; antennal segments 35 (2), 36 (1), and 37 (1); length of ovipositor sheath 0.10—0.13 times fore wing; colour rather variable; propodeum sometimes partly infuscated only and yellowish part of 3rd tergite wider medially or propodeum largely black and frons more extensively dark. This species is named in honour of Dr. J. S. Noyes, who brought together an important collection of Braconidae during his stay in India.

Dioxybracon Granger, 1949

Granger, 1949: 88; Shenefelt, 1978: 1683.

Type-species: *Dioxybracon bimucronatus* Granger, 1949 (original designation). Gender: masculine.

Diagnosis. — Eyes not emarginate (fig. 26); and with subocular groove (fig. 21); frons without V-shaped groove; occipital flange narrow, much narrower than width of base of mandible, and close to base of mandible (figs. 13, 26); propleuron comparatively convex and without distinct posterior flange (fig. 13); precoxal sulcus absent; mesopleuron sparsely sculptured (fig. 13); pleural sulcus and mesosternal suture smooth; middle lobe of mesoscutum without

pair of grooves anteriorly (fig. 20); notauli present (fig. 20); scutellar sulcus wide (fig. 20); medial carina of metanotum complete, lamelliform and obtusely protruding (fig. 13); vein cu-a of fore wing slightly postfurcal (fig. 14); tarsal claws with acute lamella (fig. 22); dorsal carinae of 1st tergite complete, lamelliform and running parallel posteriorly (fig. 27); lateral margin of 3rd tergite lamelliform and wider than margin of 2nd tergite (fig. 13); 4th and 5th tergites rather weakly impressed basally (fig. 13); 6th tergite deeply incised medio-apically (fig. 28); ovipositor distinctly protruding beyond apex of metasoma medium-sized (fig. 13); hypopygium of ♀ subtruncate apically and medium-sized.

Small genus, contains the type-species only and is restricted to Malagasy. The biology is unknown.

Dioxybracon bimucronatus Granger

(figs. 13—28)

Granger, 1949: 89, fig. 116; Shenefelt, 1978: 1683.

Paralectotype, ♀, length of body 5.6 mm, of fore wing 4.0 mm.

Head. — Antennal segments 43 (according to original description 42—43), length of 3rd segment 1.3 times 4th segment, length of 3rd, 4th, and penultimate segment 1.9, 1.5, and 1.3 times their width, respectively; length of maxillary palp 0.6 times height of head; length of eye in dorsal view 3.2 times temple (fig. 23); frons, vertex and face sparsely punctulate; POL : diameter ocellus : OOL = 7 : 7 : 15; length of malar space 1.4 times basal width of mandible.

Mesosoma. — Length of mesosoma 1.5 times its height; mesopleuron sparsely punctulate (fig. 13); mesoscutum and scutellum finely punctate; surface of propodeum largely finely rugose, but anteriorly smooth and with some transverse striae near medial carina (fig. 20).

Wings. — Fore wing: r : 3-SR : SR1 = 6 : 16 : 38; angle between 1-SR and C+SC+R 60° (fig. 25); 2-SR : 3-SR : r-m = 12 : 16 : 8; m-cu converging to 1-M posteriorly and short (fig. 14).

Legs. — Hind coxa smooth; length of femur, tibia, and basitarsus of hind leg 3.8, 6.8, and 6.4 times their width, respectively; length of hind spurs 0.3 and 0.45 times hind basitarsus.

Metasoma. — Length of 1st tergite 0.5 times its apical width, its surface coarsely reticulate, and in front of dorsal carinae slightly concave (fig. 27); 2nd tergite without antero-lateral grooves, weak on 3rd tergite (fig. 13); 2nd—6th tergites coarsely reticulate; 2nd—4th tergite

slightly serrate apically (fig. 13); length of ovipositor sheath 0.26 times fore wing; hypopygium subtruncate apically and medium-sized.

Colour. — Brownish-yellow; scapus, pedicellus, and ovipositor sheath, dark brown; pterostigma, antenna (except both basal segments), veins C+SC+R (except base), and 1-R1, and parastigma, brown; wing membrane slightly infuscated.

Lectotype here designated, ♀, in Muséum National d'Histoire Naturelle, Paris: "Madagascar, Bekily, Reg. Sud de l'Ile", "Muséum Paris, xi.36, A. Seyrig", "Type". Paralectotypes, 2 ♀ topotypic; figured ♀ collected in March, 1930, not in February as mentioned by Granger.

Eutropobracon Ramakrishna Ayyar, 1928, stat. nov.

Ramakrishna Ayyar, 1928: 40; Shenefelt, 1978: 1461 (synonym of *Bracon* Fabricius).

Type-species: *Eutropobracon indicus* Ramakrishna Ayyar, 1928 (original designation). Gender: masculine.

Diagnosis. — Eyes not emarginate and without subocular groove (figs. 82, 91); frons with medial groove (fig. 93); occipital flange narrow and close to base of mandible (fig. 82); antescutal depression absent; propleuron without posterior flange (fig. 82); precoxal sulcus slightly impressed (fig. 82); mesopleuron distinctly sculptured (fig. 82); pleural sulcus finely crenulate (fig. 82); mesosternal suture smooth; middle lobe of mesoscutum without grooves (fig. 92); notauli complete and finely crenulate (fig. 92); scutellar sulcus wide (fig. 92); medial carina of metanotum short (fig. 92), not protruding (fig. 82); propodeum with tubercles (fig. 82); angle between veins 1-SR and C+SC+R of fore wing about 55° (fig. 84); vein cu-a of fore wing shortly postfurcal (fig. 85); tarsal claws with obtuse lobe (fig. 90); dorsal carinae of 1st tergite complete, united in one curve posteriorly and lamelliform (fig. 95); lateral margin of 3rd tergite narrow and lamelliform (fig. 82); 3rd—5th tergites medially much shorter than laterally (figs. 82, 95); 5th and 6th tergites distinctly impressed basally and convex (fig. 82); 6th tergite apically truncate and lamella slightly upcurved (figs. 82, 96); ovipositor far protruding beyond apex of metasoma, long (figs. 82, 86); hypopygium of ♀ rather large and truncate apically.

Small genus, contains the type-species only

and is known only from India. The biology is unknown.

Eutropobracon indicus Ramakrishna Ayyar, stat. nov.

(figs. 82—96)

Ramakrishna Ayyar, 1928: 40, 41, fig. XI-3; Shenefelt, 1978: 1498 (as synonym of *Bracon koshunensis* Watanabe, 1934).

Lectotype, ♀, length of body and of fore wing both 3.5 mm.

Head. — Antennal segments 34, length of 3rd segment 1.1 times 4th segment, length of 3rd, 4th and penultimate segments 2.0, 1.8 and 1.8 times their width, respectively; length of maxillary palp 0.6 times height of head; length of eye in dorsal view 2.6 times temple (fig. 93); frons, vertex and face punctulate; POL : diameter of ocellus : OOL = 9 : 8 : 18; length of malar space 0.9 times basal width of mandible.

Mesosoma. — Length of mesosoma 1.4 times its height; mesopleuron rather coarsely punctate (fig. 82); mesoscutum and scutellum punctulate (fig. 92); surface of propodeum largely smooth, except some crenulae near medial carina and rugae near tubercles (figs. 82, 92).

Wings. — Fore wing: r : 3-SR : SR1 = 7 : 11 : 36; angle between 1-SR and C+SC+R 55° (fig. 84), 2-SR : 3-SR : r-m = 10 : 11 : 8; m-cu parallel to 1-M (fig. 85).

Legs. — Hind coxa smooth; length of femur, tibia and basitarsus of hind leg 3.6, 8.3 and 6.2 times their width, respectively; length of hind spurs both 0.5 times hind basitarsus.

Metasoma. — Length of 1st tergite 0.5 times its apical width, its surface largely smooth (fig. 94), and its dorso-lateral carinae behind spiracles strong and lamelliform (fig. 82), slightly concave in front of dorsal carinae; 2nd—6th tergites reticulate-punctate, with shallow antero-basal, curved and crenulate depressions (fig. 82); medial length of 3rd tergite 0.6 times medial length of 2nd tergite (fig. 95); 2nd suture narrowly crenulate (fig. 95); length of ovipositor sheath 0.63 times fore wing.

Colour. — Brownish-yellow; 2nd—5th tergites with pair of sublateral brown patches; pterostigma brown; apex of antenna, ovipositor sheath, stemmaticum partly, and hind tarsus largely, dark brown; wing membrane hyaline.

Lectotype here designated, in Tamil Nadu University, Coimbatore: "S. India, Walayar

forests (now state of Kerala), 29—30 Nov. 1924, Ramakrishna Coll." Paralectotypes: 4 ♀, of which 1 ♀ examined; same label as lectotype, and a label "*Eutropobracon indica* (sic!) n.g. & sp.". Very similar to lectotype, length of fore wing 3.3 mm, of body 3.4 mm, length of ovipositor sheath 0.67 times fore wing.

Hyboteles gen. nov.

Type-species: *Hyboteles toxopeusi* sp. nov.

Etymology: from "hybos" (Greek for "hump") and "telos" (Greek for "end"), because of the humped apical segment of the metasoma. Gender: neuter.

Diagnosis. — Eyes not emarginate (fig. 76) and with subocular groove deep (figs. 68, 72); frons with medial groove only (fig. 79); occipital flange narrow and close to base of mandible; posterior flange of propleuron obsolete (fig. 68); precoxal sulcus absent; mesopleuron largely smooth; pleural sulcus and mesosternal suture smooth; middle lobe of mesoscutum without grooves (fig. 78); notauli complete and slightly crenulate (fig. 78); scutellar sulcus wide (fig. 78); medial carina of metanotum short (fig. 78) and not protruding (fig. 68); propodeum without tubercles; angle between veins 1-SR and C+SC+R about 45°; vein cu-a of fore wing subinterstitial (fig. 73); claws without lobe (fig. 75); dorsal carinae of 1st tergite united and connected to medial carina (fig. 80); lateral margin of both 2nd and 3rd tergites narrow and lamelliform (fig. 68); 4th and 5th tergites shallowly depressed anteriorly; metasomal tergites without antero-lateral depressions (fig. 68); 6th tergite deeply impressed basally and truncate apically (figs. 68, 81); ovipositor sheath protruding but short (fig. 68); hypopygium of ♀ large and subtruncate apically.

Small genus, contains the type-species only, and is restricted to New Guinea and North Australia. The biology is unknown.

Hyboteles toxopeusi sp. nov.

(figs. 68—81)

Holotype, ♀, length of body 5.7 mm, of fore wing 5.0 mm.

Head. — Antennal segments 45, length of 3rd segment 1.2 times 4th segment, length of 3rd, 4th, and penultimate segments 2.0, 1.6, and 1.7 times their width, respectively; length of maxillary palp 0.7 times height of head; length of eye in dorsal view 4.0 times temple (fig. 79); POL : diameter of ocellus : OOL = 4 : 3 : 6; frons, vertex and face smooth; anterior tentorial pits

more pronounced than in the other taxa (fig. 76); length of malar space 1.2 times basal width of mandible.

Mesosoma. — Length of mesosoma 1.4 times its height; mesopleuron indistinctly punctulate (fig. 68); mesoscutum slightly punctulate (fig. 78); scutellum smooth; surface of propodeum sparsely and finely punctulate (fig. 78).

Wings. — r : 3-SR : SR1 = 14 : 31 : 54; angle between 1-SR and C+SC+R 44° (fig. 69); 2-SR : 3-SR : r-m = 19 : 31 : 13; m-cu converging to 1-M posteriorly (fig. 73).

Legs. — Hind coxa punctulate; length of femur, tibia and basitarsus of hind leg 4.4, 9.7, and 6.8 times their width, respectively; length of hind tibial spurs 0.20 and 0.25 times hind basitarsus.

Metasoma. — Length of 1st tergite 0.6 times its apical width, its surface coarsely longitudinally rugose, with finer reticulation between rugae (fig. 80), weakly concave and smooth in front of dorsal carinae; 2nd—6th tergites with coarse longitudinal rugae and finer reticulation in interspaces (figs. 80, 81); length of ovipositor sheath 0.12 times fore wing.

Colour. — Brownish-yellow; apical 17 segments of antenna yellowish, rest of flagellum, outer side of scapus and pedicellus, pterostigma and ovipositor sheath, dark brown; apical half of hind tarsus infuscated; wing veins brown; wing membrane light brown.

Holotype in the Rijksmuseum van Natuurlijke Historie, Leiden: "Neth. Ind.-Amer. New Guinea Exp. 1938—39, Hollandia vii.(19)38, L. J. Toxopeus lg.". Paratypes in British Museum (Natural History), London, and Rijksmuseum van Natuurlijke Historie, Leiden: "Mackay, Queensland, 1909—45" (1 ♀) and "Australia, N. Queensland, Redlynch, 20.x.1938", "Papuan Australian Expedition B.M. 1947—48" (17 ♂). Named in honour of its collector Prof. Dr. L. J. Toxopeus (1894—1951), who collected many new species of Braconidae in New Guinea.

Variation: Antennal segments of ♀ 43—45, of ♂ 35 (1)—37 (4)—38 (1); length of body of ♀ 5.1—5.7 mm, of ♂ 3.3—4.2 mm; length of fore wing of ♀ 5.0—5.2 mm, of ♂ 3.3—4.0 mm; 5—17 apical segments of antenna yellowish (-brown), usually 8 segments.

Pedinopleura gen. nov.

Type-species: *Pedinopleura emarginata* sp. nov.

Etymology: from "pedinos" (Greek for

Pedinopleura koshunensis (Watanabe)

comb. nov.

(figs. 41—53)

Bracon koshunensis Watanabe, 1934: 186, 187, fig. 1; Shenefelt, 1978: 1498.

Holotype, ♀, length of body 5.2 mm, of fore wing 3.7 mm.

Head. — Antennal segments 37 (according to original description 37—46), length of 3rd segment 1.1 times 4th segment, length of 3rd, 4th and penultimate segments 1.6, 1.4, and 1.3 times their width, respectively; length of maxillary palp 0.6 times height of head; length of eye in dorsal view 2.5 times temple (fig. 44); temple punctate, dorsally aciculate-striate (fig. 41); frons obliquely finely rugose (fig. 44); vertex and face transversely rugose; POL : diameter of ocellus: OOL = 3 : 4 : 10; length of malar space 1.4 times basal width of mandible.

Mesosoma. — Length of mesosoma 1.4 times its height; mesopleuron densely and coarsely punctate anteriorly, remotely punctulate posteriorly (fig. 41); metapleural flange small (fig. 41); mesoscutum medially punctate-coriaceous, laterally rugulose; scutellum punctulate (fig. 46); surface of propodeum superficially rugulose; lateral carina of propodeum long, lamelliform and anteriorly angular (fig. 41).

Wings. — Fore wing: r : 3-SR : SR1 = 7 : 19 : 42; angle between 1-SR and C+SC+R 52° (fig. 48); 2-SR : 3-SR : r-m = 12 : 19 : 9; m-cu converging to 1-M posteriorly and comparatively short (fig. 43).

Legs. — Hind coxa smooth; length of femur, tibia and basitarsus of hind leg 3.2, 6.2 and 5.3 times their width, respectively; length of hind spurs 0.3 and 0.4 times hind basitarsus.

Metasoma. — Length of 1st tergite 0.5 times its apical width, its surface reticulate and dorsal carinae present basally (fig. 53); lateral margin of 1st—3rd tergites rather narrow, gradually widened posteriorly (fig. 41); 4th—6th tergites with deep and crenulate basal groove (fig. 41); 2nd—6th coarsely reticulate-rugose; 6th tergite rather weakly acutely emarginate (fig. 47); length of ovipositor sheath 0.19 times fore wing.

Colour. — Yellowish-brown; 3rd—5th tergites with a dark spot at each side; antenna and ovipositor sheath, black; stemmaticum infuscated; pterostigma and parastigma dark brown; wing membrane subhyaline.

Holotype in the Institut für Pflanzenschutz-

forschung at Eberswalde-Finow (and not in Sapporo as indicated by Shenefelt): "Kankau (=Koshun), (Formosa), H. Sauter, vii.1912", "*Bracon koshunensis* Watanabe, ♀, Type". Paratypes: 2 ♂ and 6 ♀, of which are examined 1 ♂ (Eberswalde-Finow, "allotype") and 3 ♀ (two at Eberswalde-Finow and one in Budapest Museum). Male has antenna yellowish and also 6th tergite with pair of black dots and apically slightly emarginate, antennal segments 52 (not 49—50 as stated in original description); length of antenna equal to length of body (distinctly shorter in ♀, fig. 41).

Variation: Antennal segments 37—52; length of body 5.2—6 mm, of fore wing 3.7—4.3 mm; length of ovipositor sheath 0.19—0.20 times fore wing.

Philomacroploea Cameron, 1905

Cameron, 1905: 87; Shenefelt, 1978: 1713—1714.

Type-species: *Philomacroploea basimacula* Cameron, 1905 (monotypic). Gender: feminine.

Diagnosis. — Eyes without subocular groove (fig. 97) and not emarginate (fig. 106); frons and vertex with shallow medio-longitudinal depression (fig. 101); occipital flange narrow and close to mandible base (fig. 97); malar suture rather deep (figs. 97, 106); antescutal depression present (fig. 97); posterior flange of propleuron absent; propleuron normal (fig. 97); precoxal sulcus only medially impressed (fig. 97); mesopleuron distinctly sculptured anteriorly (fig. 97); pleural sulcus and mesosternal suture finely crenulate (fig. 97); middle lobe of mesoscutum without grooves; notauli crenulate and probably complete (fig. 105); scutellar sulcus medium-sized (fig. 105); medial carina only anteriorly present at metanotum (fig. 105) and slightly obtusely protruding dorsally (fig. 97); propodeum without tubercles and no lateral carina (fig. 97); angle between veins 1-SR and C+SC+R of fore wing about 70° (fig. 103); vein cu-a of fore wing interstitial (fig. 98); surroundings of vein cu-a of hind wing densely setose; claws simple (fig. 102); dorsal carinae of 1st tergite united and connected to medial carina (fig. 107) and dorso-lateral carinae indistinct (fig. 97); 1st—3rd tergites without differentiated lateral lamelliform margin (fig. 97); 4th—6th tergites slightly impressed basally (fig. 97); 2nd—6th tergite without antero-lateral grooves; 6th tergites (shallowly) semi-circularly emarginate medio-apically (fig. 108, but less in ♂); ovipositor sheath of type-species short (fig.

97); hypopygium of ♀ medium-sized and obtusely protruding apically.

Small genus, known from the Oriental region and probably Japan. The type-species has been reared from Nymphalidae-Danainae. According to Shenefelt (1978) 3 spp. should be included: the type-species (with short ovipositor, fig. 97), *P. pleuralis* (Ashmead, 1906) with ovipositor sheath as long as metasoma, and *P. cameroni* Subba Rao & Sharma, 1960. However, the inclusion of the latter two species may be incorrect.

***Philomacroplea basimacula* Cameron**
(figs. 97—108)

Cameron, 1905: 88 (♀, not ♂); Shenefelt, 1978: 1713, 1714.

Lectotype, ♀, length of body 3.8 mm, of fore wing 3.4 mm.

Head. — Antenna incomplete, remaining segments 19, length of 3rd segment 1.3 times 4th segment, length of 3rd and 4th segments 1.5 and 1.2 times their width, respectively; length of maxillary palp of paralectotype 0.4 times height of head; length of eye in dorsal view 2.6 times temple; POL : diameter of ocellus : OOL = 10 : 9 : 14; frons, vertex and face smooth; length of malar space 1.2 times basal width of mandible.

Mesosoma. — Length of mesosoma 1.2 times its height; mesopleuron partly rugulose anteriorly, rest punctulate (fig. 97); metapleural flange small and blunt (fig. 97); mesoscutum and scutellum finely punctulate; surface of propodeum largely smooth, but antero-laterally with patch of punctures (figs. 97, 105).

Wings. — Fore wing: r : 3-SR : SR1 = 11 : 19 : 66; angle between 1-SR and C+SC+R 67° (fig. 103); 2-SR : 3-SR : r-m = 17 : 19 : 12; m-cu subparallel to 1-M (fig. 98).

Legs. — Hind coxa punctulate; length of femur, tibia and basitarsus of hind leg 4.4, 8.2 and 5.0 times their width, respectively; length of hind spurs 0.25 and 0.3 times basitarsus.

Metasoma. — Length of 1st tergite 0.6 times its apical width, its surface (punctate-)reticulate (fig. 107); 2nd tergite with medial carina (fig. 107); 2nd—6th tergite punctate-reticulate (fig. 97); length of ovipositor sheath 0.07 times fore wing.

Colour. — Dark brown; head, mesosoma (but ventral half of mesopleuron, metapleuron, and mesosternum dark), brown; legs, palpi, tegulae, ovipositor sheath, large patch at posterior half of 1st and 2nd tergite medially, posterior

margins of 3rd—5th tergites, brownish-yellow; wing membrane subhyaline; pterostigma dark brown, veins rather dark brown.

Lectotype here designated, in British Museum (Natural History), London: "Type", "B.M. Type Hym. 3.c.506", "*Philomacroplea* (sic!) *basimacula* Cam., Type, Ceylon, Bred" (in Cameron's handwriting), "P. Cameron Coll., 1914—110". Paralectotype: 1 ♀, same museum and labels as lectotype.

Variation: Length of body 3.7—3.8 mm, of fore wing 3.3—3.4 mm, length of ovipositor sheath 0.07—0.10 times fore wing.

ACKNOWLEDGEMENTS

I wish to express my gratitude to the following persons for the loan of types and of new taxa: especially to Dr. K. D. Ghorpade (Hebbal, Bangalore) who travelled a long distance to collect the Ramakrishna Ayyar-types, to Mr. T. Huddleston (London), Dr. S. Kerner-Pillault (Paris), Prof. Dr. T. Kumaraswami (Coimbatore), Dr. J. Oehlke (Eberswalde-Finow), Dr. J. Papp (Budapest), Mr. J. Pierre (Paris), Dr. D. Quicke (Nottingham), and Mr. B. Sigwalt (Paris). Dr. R. Wharton (College Station) provided useful corrections to the text.

REFERENCES

- Achterberg, C. van, 1979. A revision of the subfamily Zelinae auct. (Hym., Braconidae). — Tijdschr. Ent. 122: 241—479, figs. 1—900.
- Achterberg, C. van, 1983. Six new genera of Braconidae from the Afrotropical Region (Hym., Braconidae). — Tijdschr. Ent. 126: 175—202, figs. 1—147.
- Cameron, P., 1905. On the phytophagous and parasitic Hymenoptera collected by Mr. E. Ernest Green in Ceylon. — Spolia zeyl. 3: 67—97.
- Fahringier, J. 1928. Aethiopische Region. — Opuscula braconologica 5: 1—50.
- Granger, C., 1949. Braconides de Madagascar. — Mem. Inst. scient. Madagascar A: 1—428, figs. 1—426.
- Guérin-Méneville, F. E., 1848. Voyage en Abyssinie exécuté pendant les années 1839—1843 par M. LeFebvre 6: 239—390, pls. 7, 8.
- Ramakrishna Ayyar, T. V., 1928. A contribution to our knowledge of South Indian Braconidae. I Vipioninae. — Mem. Dept. Agric. India, Ent. 10: 29—60, 3 pls.
- Shenefelt, R. D., 1978. Braconidae, pt. 10. — Hym. Cat. (nov. ed.) 15: 1425—1872.
- Watanabe, C., 1934. H. Sauter's Formosa-Collection: Braconidae. — Insecta matsum. 8: 182—205, figs. 1—6.

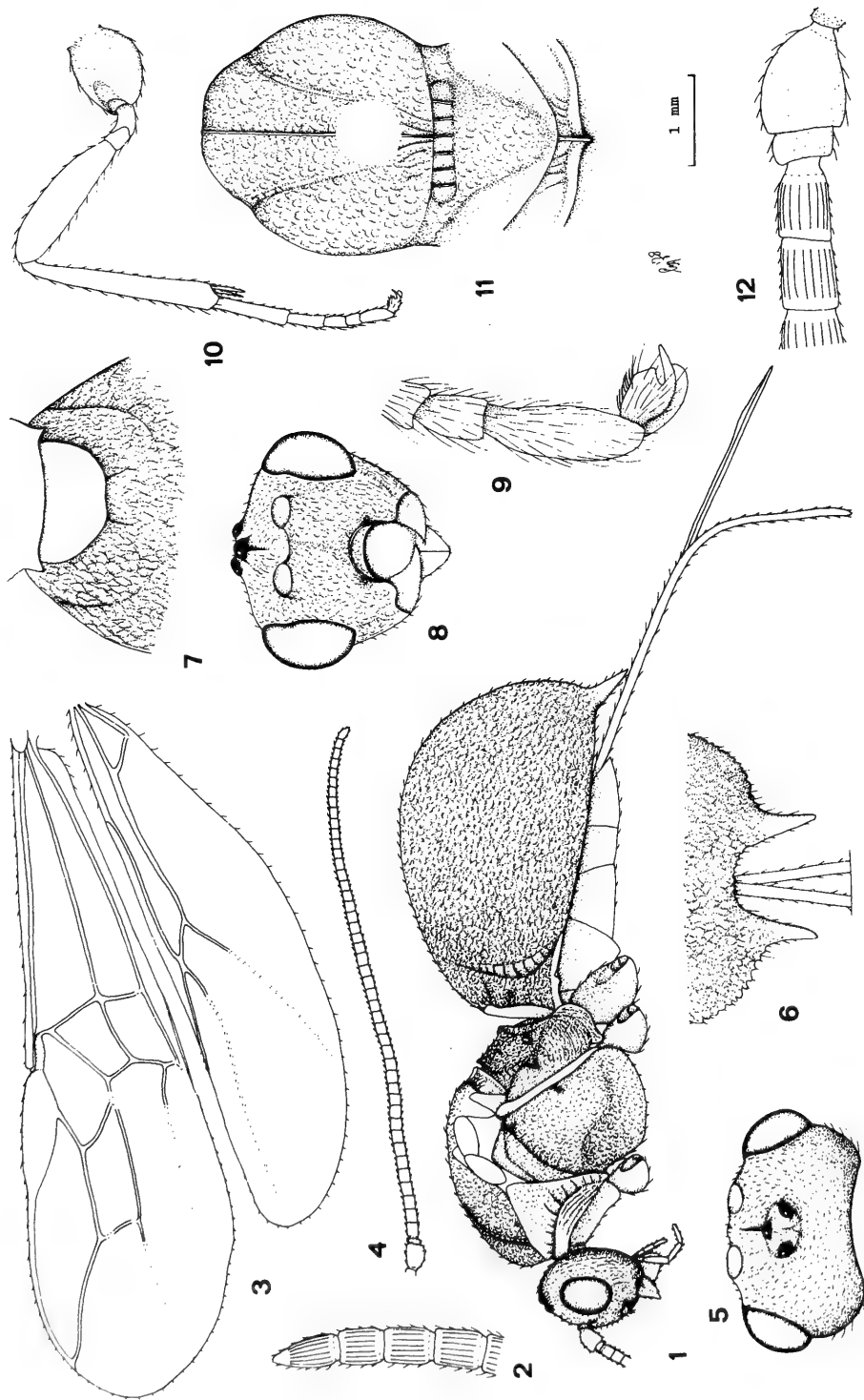

Figs. 1—12. *Physarata furcata* (Guérin-Ménéville), Ethiopia, Ara. ♀. 1, habitus, lateral aspect; 2, apex of antenna; 3, wings; 4, antenna; 5, head, dorsal aspect; 6, apex of 3rd tergite, dorsal aspect; 7, 1st tergite, dorsal aspect; 8, head, frontal aspect; 9, outer hind leg; 10, hind claw; 11, thorax, dorsal aspect; 12, base of antenna, outer aspect. 1, 3, 4, 10: scale-line (= 1 ×); 2, 9, 12: 5 ×; 5, 8, 11: 2 ×; 6, 7: 1.1 ×.

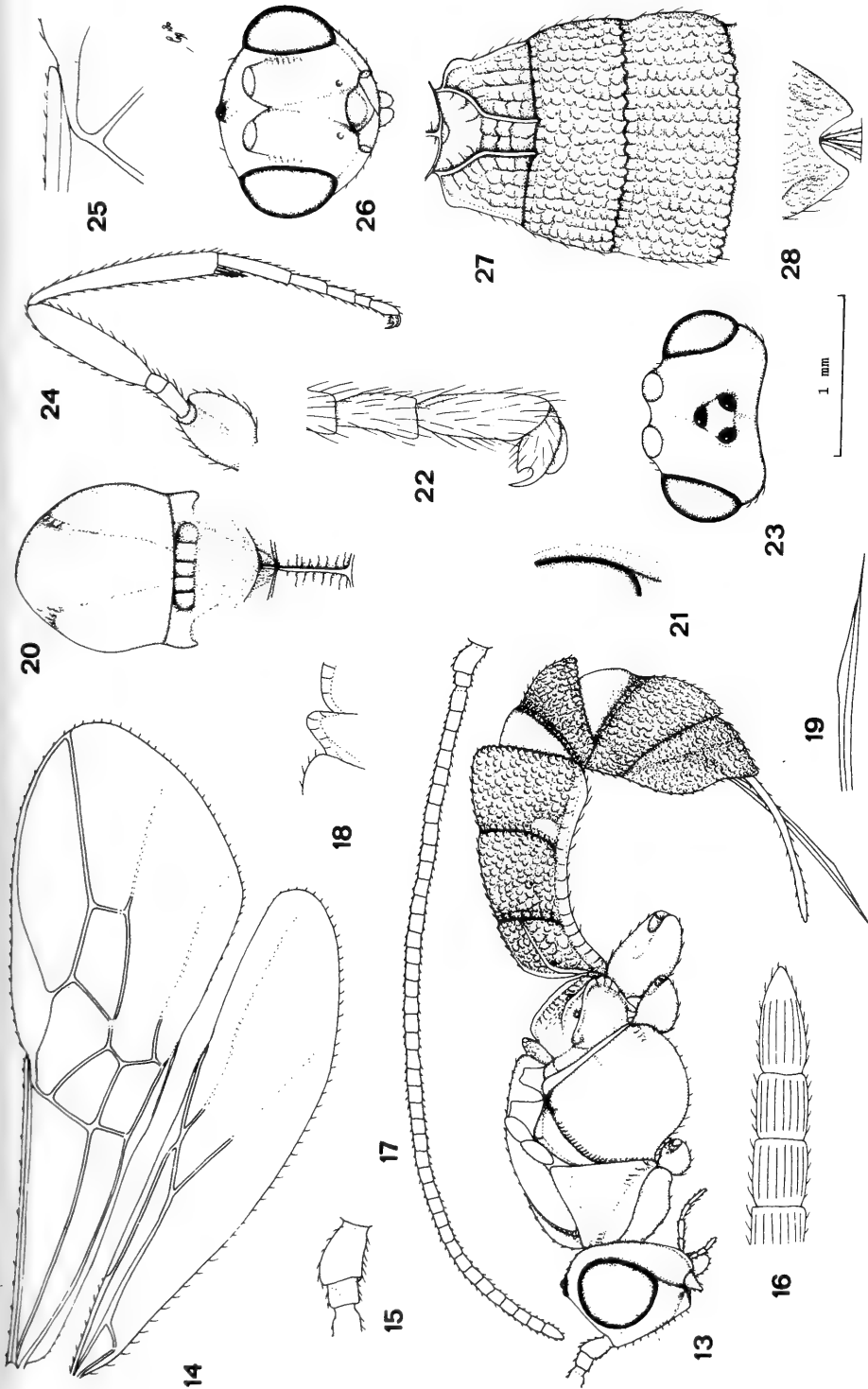

Figs. 13—28. *Dioxobracon bimacronatus* Granger, paratype, ♀. 13, habitus, lateral aspect; 14, wings, lateral aspect; 15, scapus and pedicellus, outer lateral aspect; 16, apex of antenna; 17, antenna; 18, metanotum, lateral aspect; 19, apex of ovipositor; 20, mesosoma, dorsal aspect; 21, subocular groove; 22, inner hind claw; 23, head, dorsal aspect; 24, hind leg; 25, vein 1-SR of fore wing; 26, head, frontal aspect; 27, 1st—3rd metasomal tergites, dorsal aspect; 28, 1st—3rd metasomal tergites, dorsal aspect; 28, apex of 6th tergite, dorsal aspect. 13, 14, 17, 24: scale-line (= 1 X); 15, 18, 19, 25: 2 X; 16, 21, 22: 5 X; 20, 23, 26—28: 1.1 X.

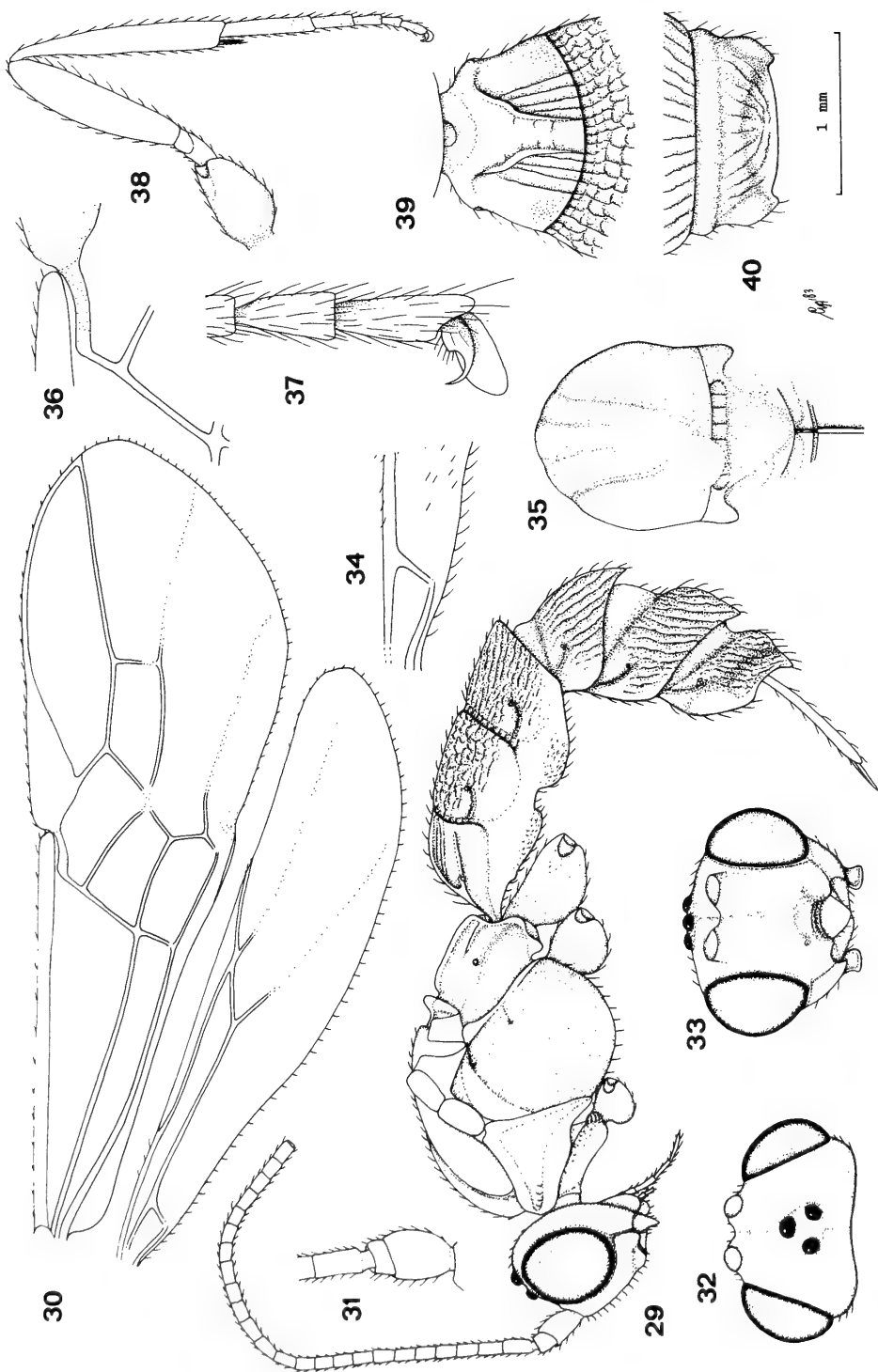

Figs. 29—40. *Pedinopleura emarginata* gen. et sp. nov., holotype, ♀. 29, habitus, lateral aspect; 30, wings; 31, base of antenna, outer aspect; 32, head, dorsal aspect; 33, head, frontal aspect; 34, base of hind wing; 35, mesosoma, dorsal aspect; 36, vein 1-SR of fore wing; 37, hind claw; 38, hind leg; 39, 1st metasomal tergite, dorsal aspect; 40, 6th tergite, dorsal aspect. 29, 30, 38: scale-line (= 1 ×); 31, 34, 36: 2 ×; 32, 33, 35, 39, 40: 1.2 ×; 37: 5 ×.

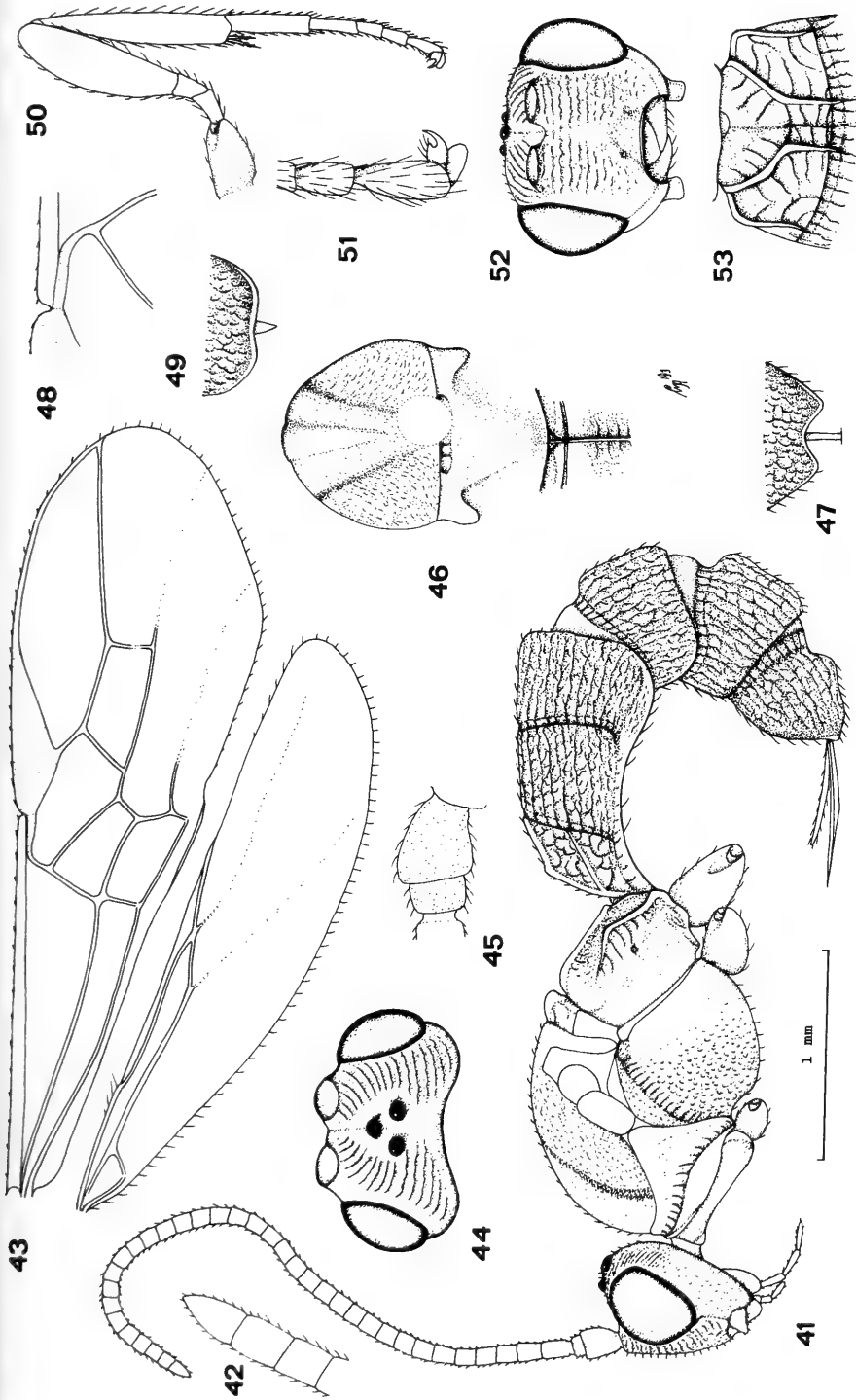

Figs. 41—53. *Pedinopleura koshunensis* (Watanabe), holotype, ♀ (but 49 of paratype, ♂). 41, habitus, lateral aspect; 42, apex of antenna; 43, wings; 44, head, dorsal aspect; 45, scapus and pedicellus, outer aspect; 46, mesosoma, dorsal aspect; 47, apex of 6th tergite of ♀, dorsal aspect; 48, vein 1-SR of fore wing; 49, apex of hind leg of ♀, dorsal aspect; 50, head, dorsal aspect; 51, outer hind claw; 52, head, frontal aspect; 53, 1st metasomal tergite, dorsal aspect. 41, 43, 47, 49, 50, 53: scale-line (= 1 ×); 42, 45, 51: 2.5 ×; 44, 46, 52: 1.2 ×; 48: 1.5 ×.

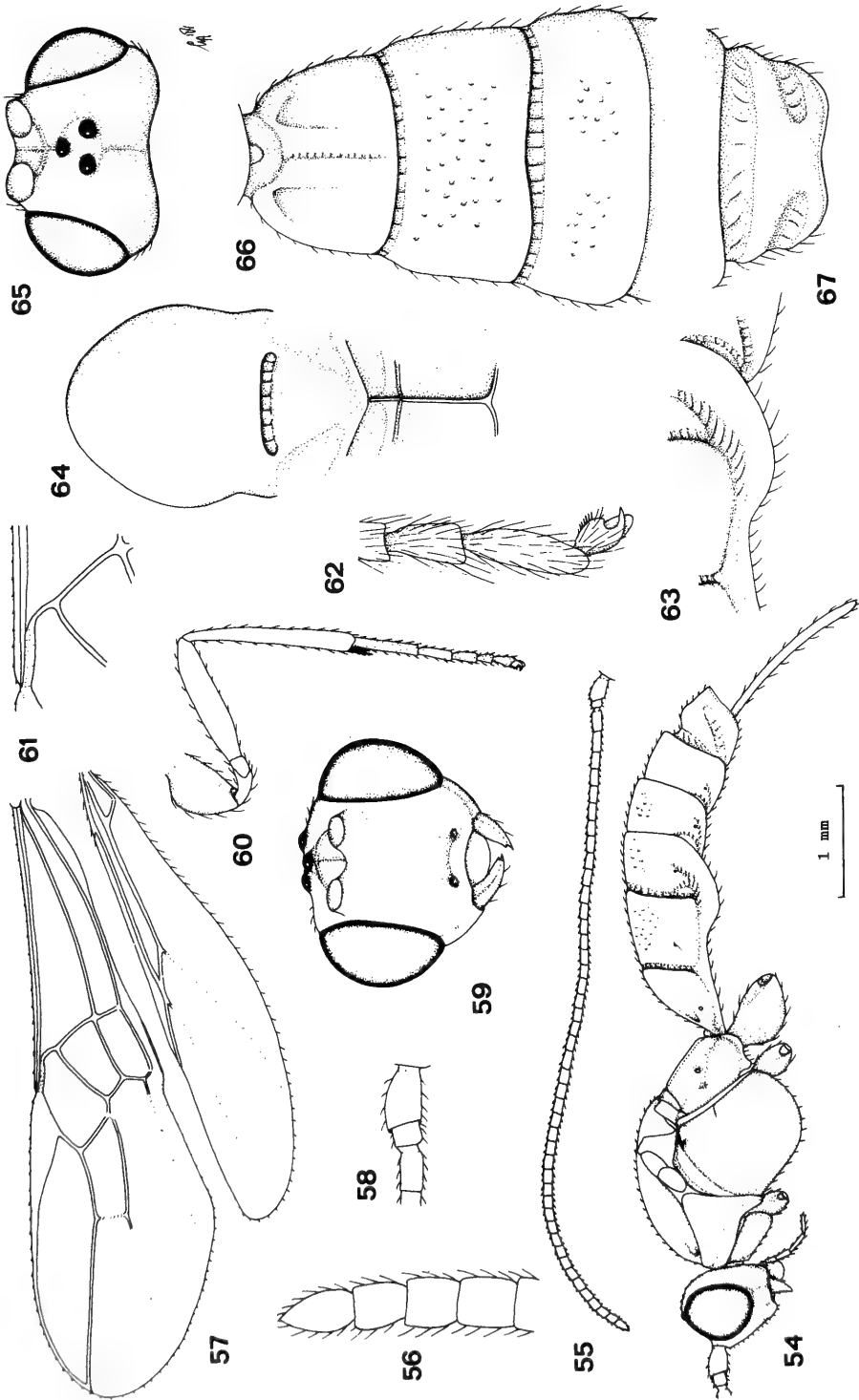

Figs. 54—67. *Apotosoma latimarginale* gen. et sp. nov., holotype, ♀. 54, habitus, lateral aspect; 55, antenna; apex of antenna; 57, wings; 58, base of antenna, outer aspect; 59, head, frontal aspect; 60, hind leg; 61, vein 1-SR of fore wing; 62, outer hind claw; 63, lateral margin of 2nd and 3rd tergites; 64, mesosoma, dorsal aspect; 65, head, dorsal aspect; 66, 1st—3rd metasomal tergites, dorsal aspect; 67, 6th tergite, dorsal aspect; 67, scale-line (= 1 ×); 56, 62: 5 ×; 58, 59, 61, 63—67: 2 ×.

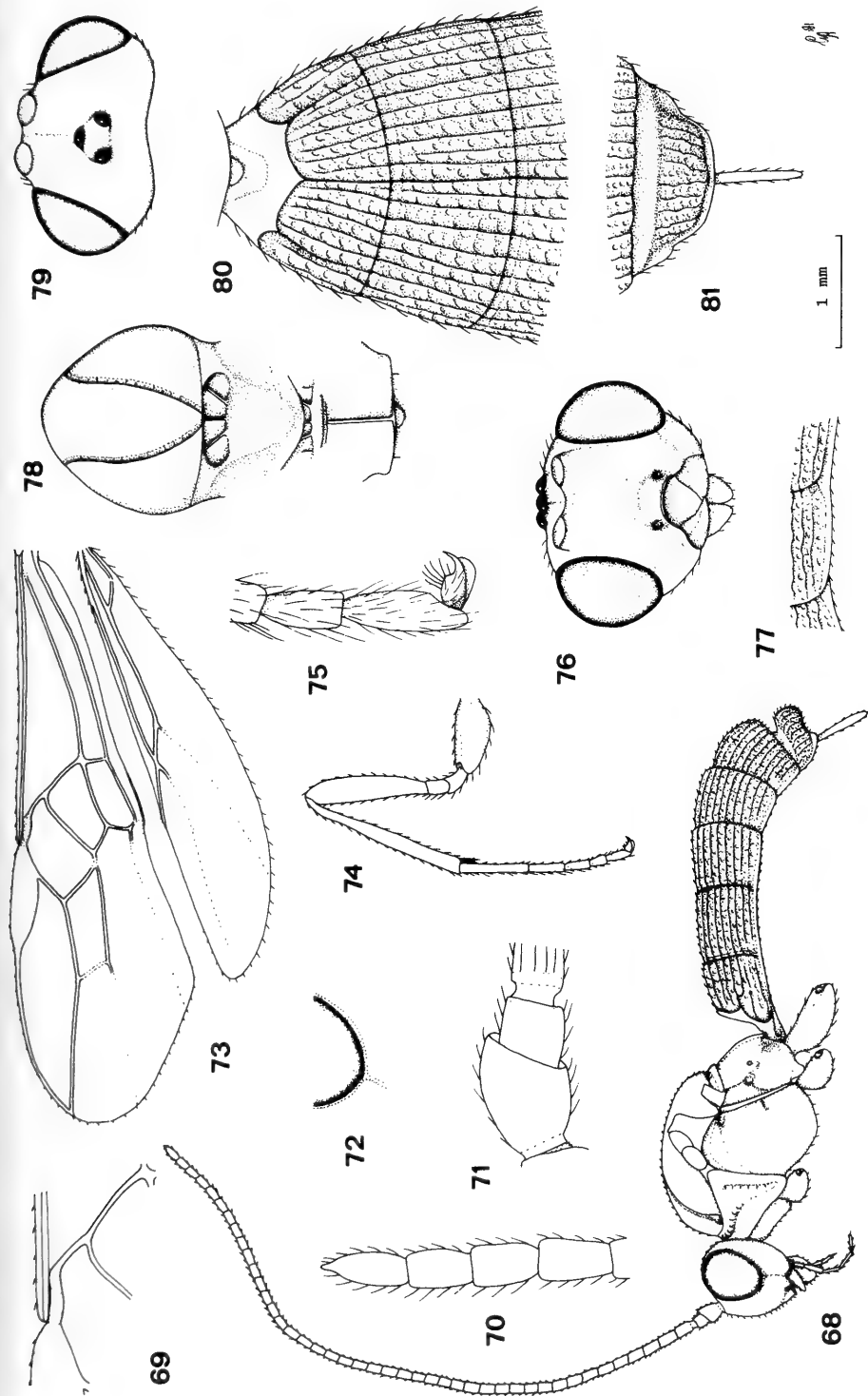

Figs. 68—81. *Hybotetes toxopeusi* gen. et. sp. nov., holotype, ♀. 68, habitus, lateral aspect; 69, vein 1-SR of fore wings; 70, apex of antenna; 71, scapus and pedicellus, outer aspect; 72, subocular groove; 73, wings; 74, hind leg; 75, outer hind leg; 76, head, frontal aspect; 77, lateral margin of 3rd tergite; 78, mesosoma, dorsal aspect; 79, head, dorsal aspect; 80, 1st and 2nd metasomal tergites; dorsal aspect; 81, 6th tergite, dorsal aspect. 68, 73, 74: scale-line (= 1 ×); 69, 72, 76—81: 2 ×; 70, 71, 75: 5 ×.

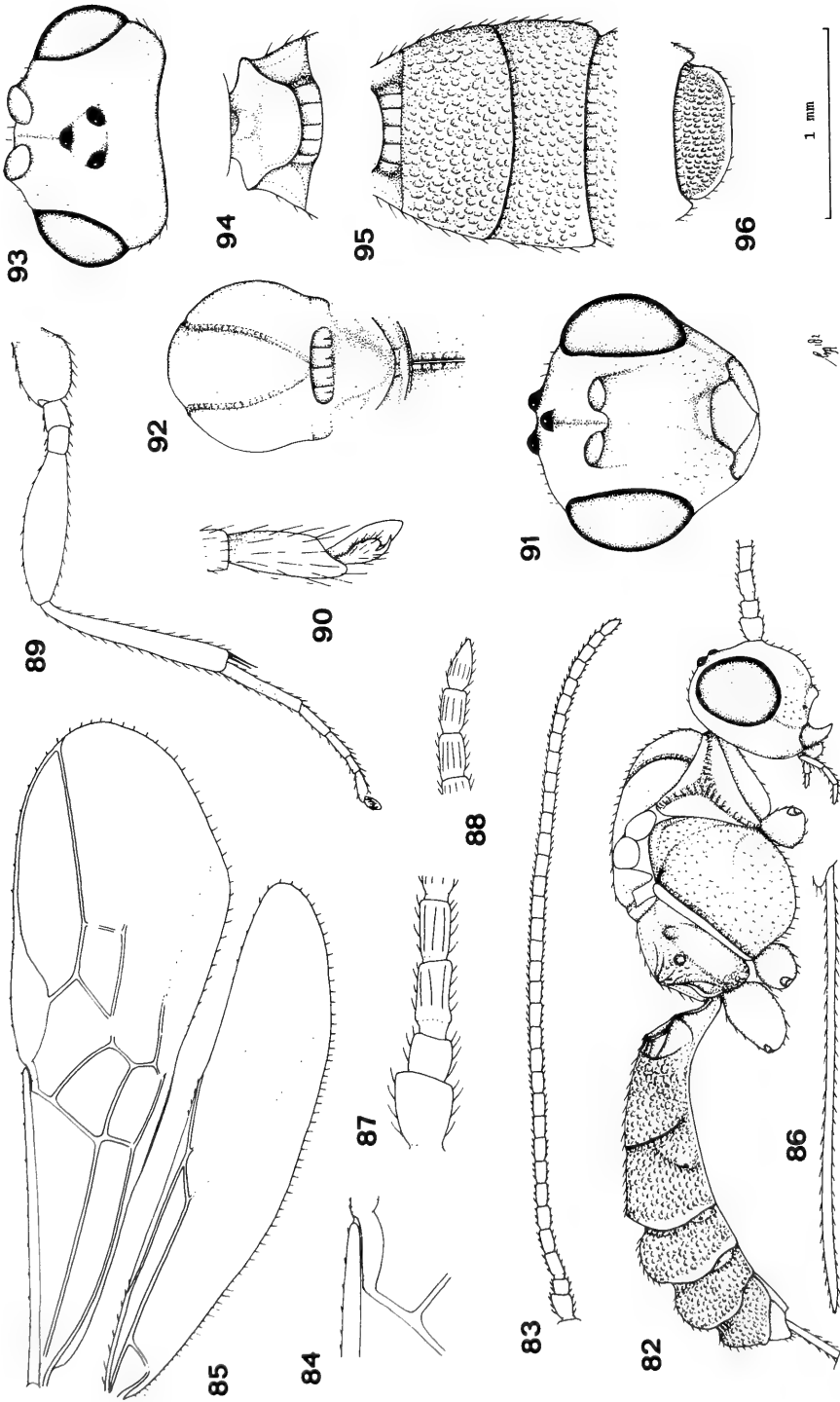

Figs. 82—96. *Eutropobraton indicus* Ramakrishna Ayyar, lectotype, ♀. 82, habitus, lateral aspect; 83, antenna; 84, head, lateral aspect; 85, wings; 86, ovipositor; 87, 1st—4th antennal segments, outer aspect; 88, apex of antenna; 89, hind leg; 90, outer hind claw; 91, head, frontal aspect; 92, mesosoma, dorsal aspect; 93, head, dorsal aspect; 94, 1st metasomal tergite, dorsal aspect; 95, 2nd and 3rd tergites, dorsal aspect; 96, 6th tergite, dorsal aspect. 82, 83, 85, 86, 89: scale-line (= 1 ×); 84, 87, 88, 90: 2.5 ×; 91, 93: 1.5 ×; 92, 94—96: 1.1 ×.

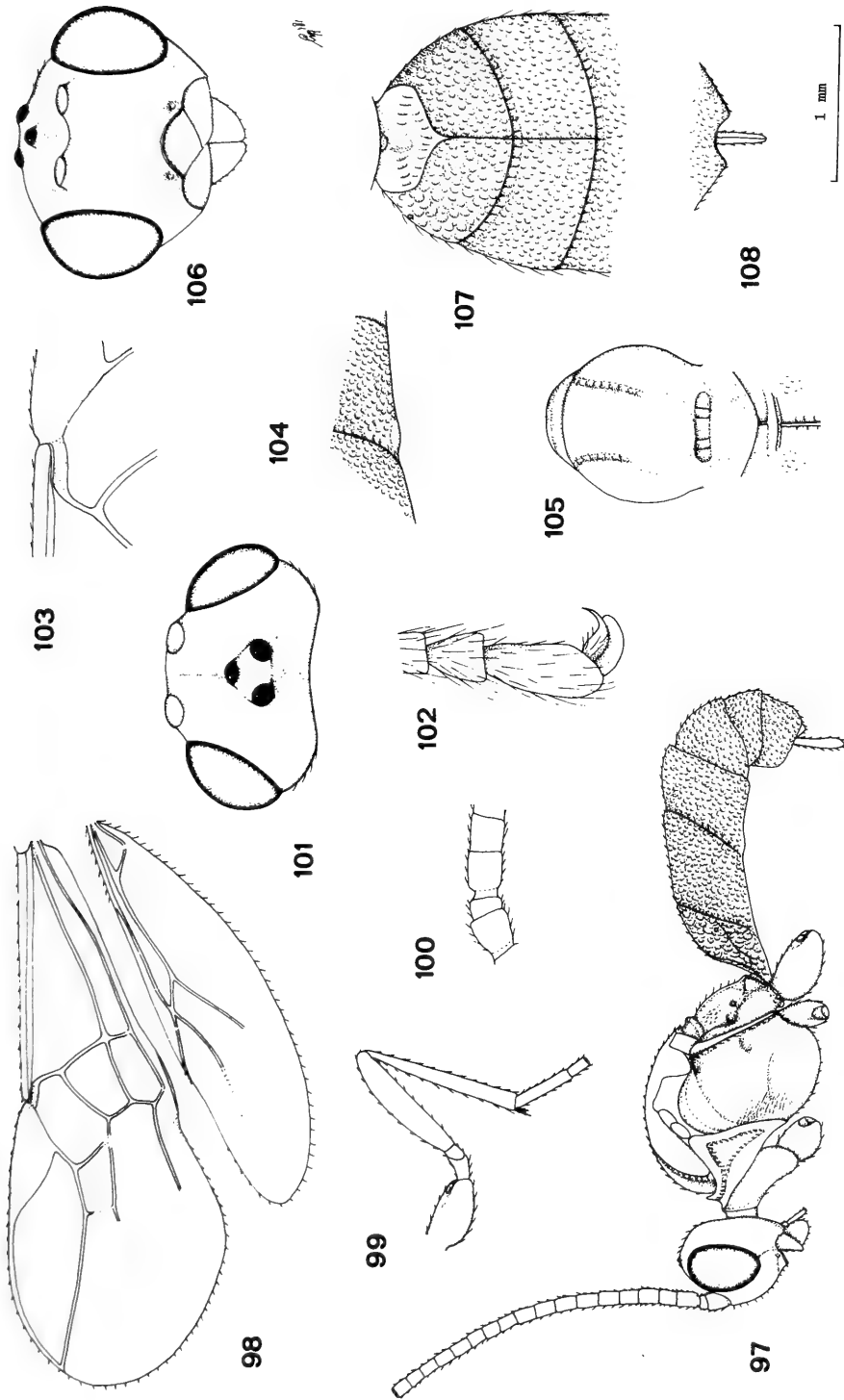

Figs. 97—108. *Philomacroploea basimacula* Cameron, lectotype, ♀. 97, habitus, lateral aspect; 98, wings; 99, hind leg; 100, 1st—4th antennal segments; 101, head, dorsal aspect; 102, outer middle claw; 103, vein 1-SR of fore wing; 104, lateral margin of 3rd tergites; 105, mesosoma, dorsal aspect; 106, head, frontal aspect; 107, 1st and 2nd tergites, dorsal aspect; 108, 6th tergite, dorsal aspect. 97—99: scale-line (= 1 ×); 100, 101, 103, 104, 106: 2 ×; 105, 107, 108: 1.5 ×; 102: 5 ×.

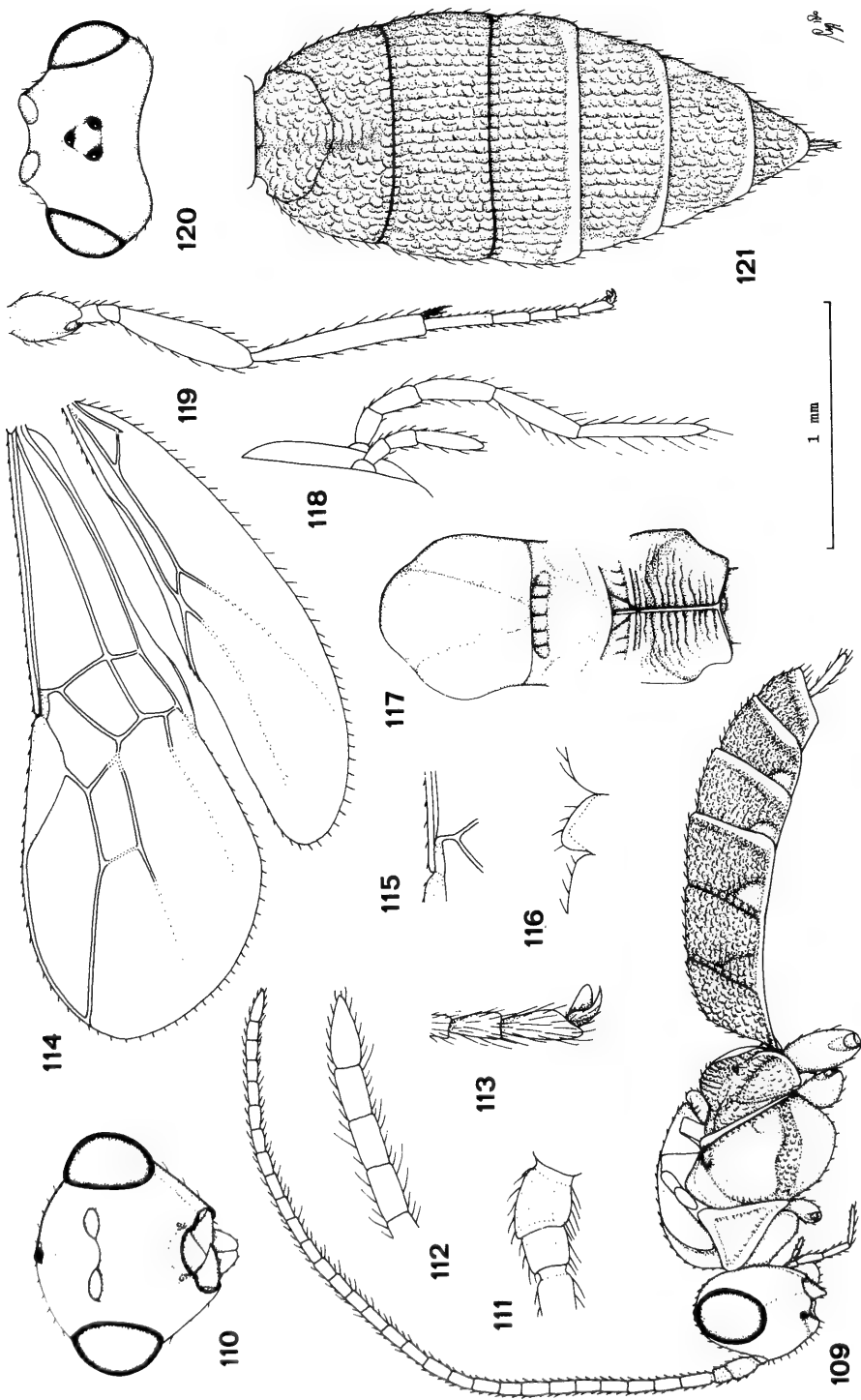

Figs. 109—121. *Aspidobracon pierreii* gen. et sp. nov., holotype, ♀ (but 118 of paratype, ♂). 109, habitus, lateral aspect; 110, head, frontal aspect; 111, scapus and pedicellus, outer aspect; 112, apex of antenna; 113, outer hind claw; 114, wings; 115, vein 1-SR of fore wing; 116, metanotum, lateral aspect; 117, mesosoma, dorsal aspect; 118, palpi of ♂ paratype; 119, hind leg; 120, head, dorsal aspect; 121, metasoma, dorsal aspect. 109, 114, 119: scale-line (= 1 ×); 110, 115, 117, 120, 121: 1.4 ×; 111—113: 2.5 ×; 116, 118: 3.5 ×.

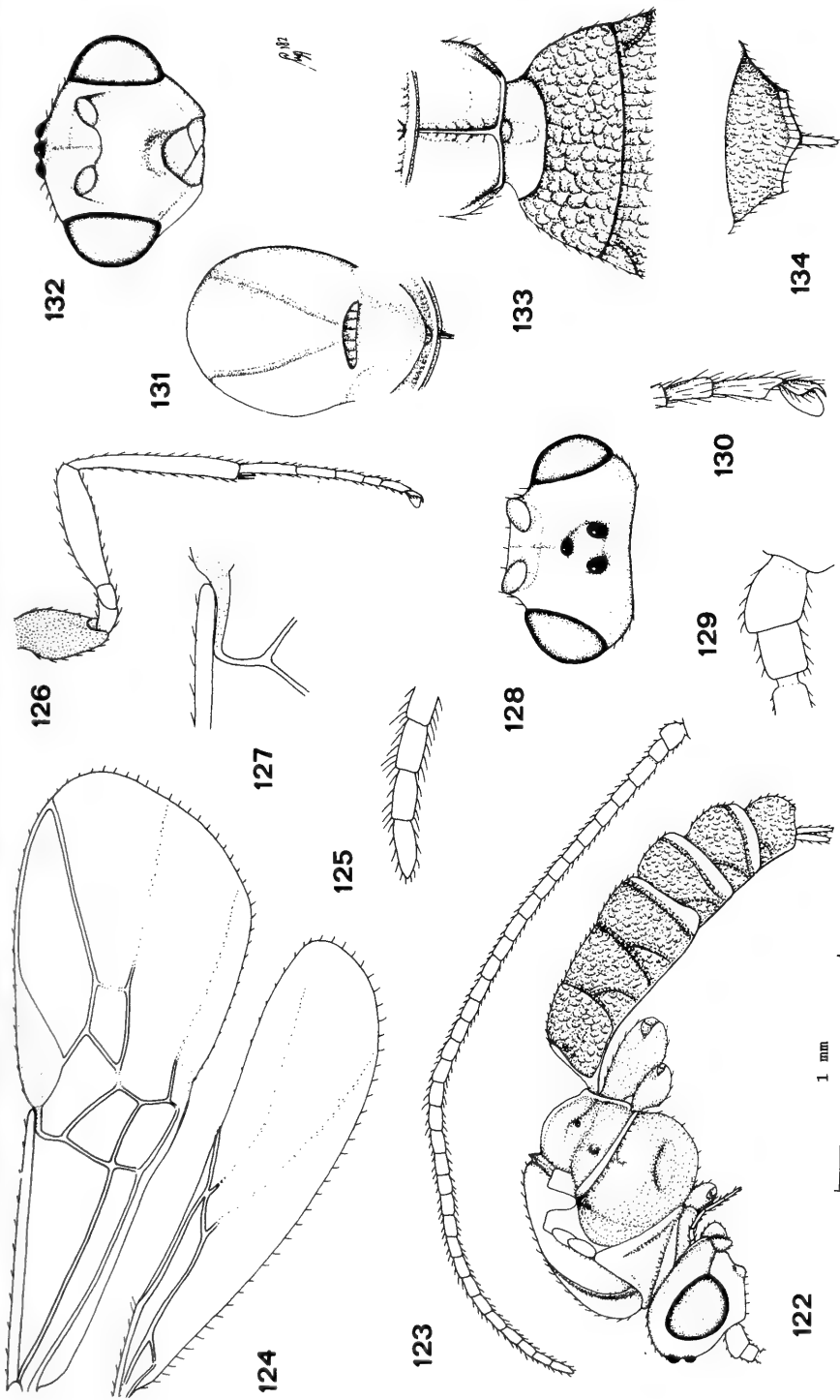

Figs. 122—134. *Aspidobracon hesperivorus* gen. et sp. nov., holotype, ♀. 122, habitus, lateral aspect; 123, antenna; 124, wings; 125, apex of antenna; 126, hind leg; 127, vein 1-SR of fore wing; 128, head, dorsal aspect; 129, scapus and pedicellus, outer aspect; 130, hind claw; 131, thorax, dorsal aspect; 132, head, dorsal aspect; 133, propodeum and 1st metasomal tergite, dorsal aspect; 134, 6th tergite, dorsal aspect. 122—124, 126: scale-line (= 1×); 125, 129, 130: 2.5×; 127: 2×; 128, 131—134: 1.3×.

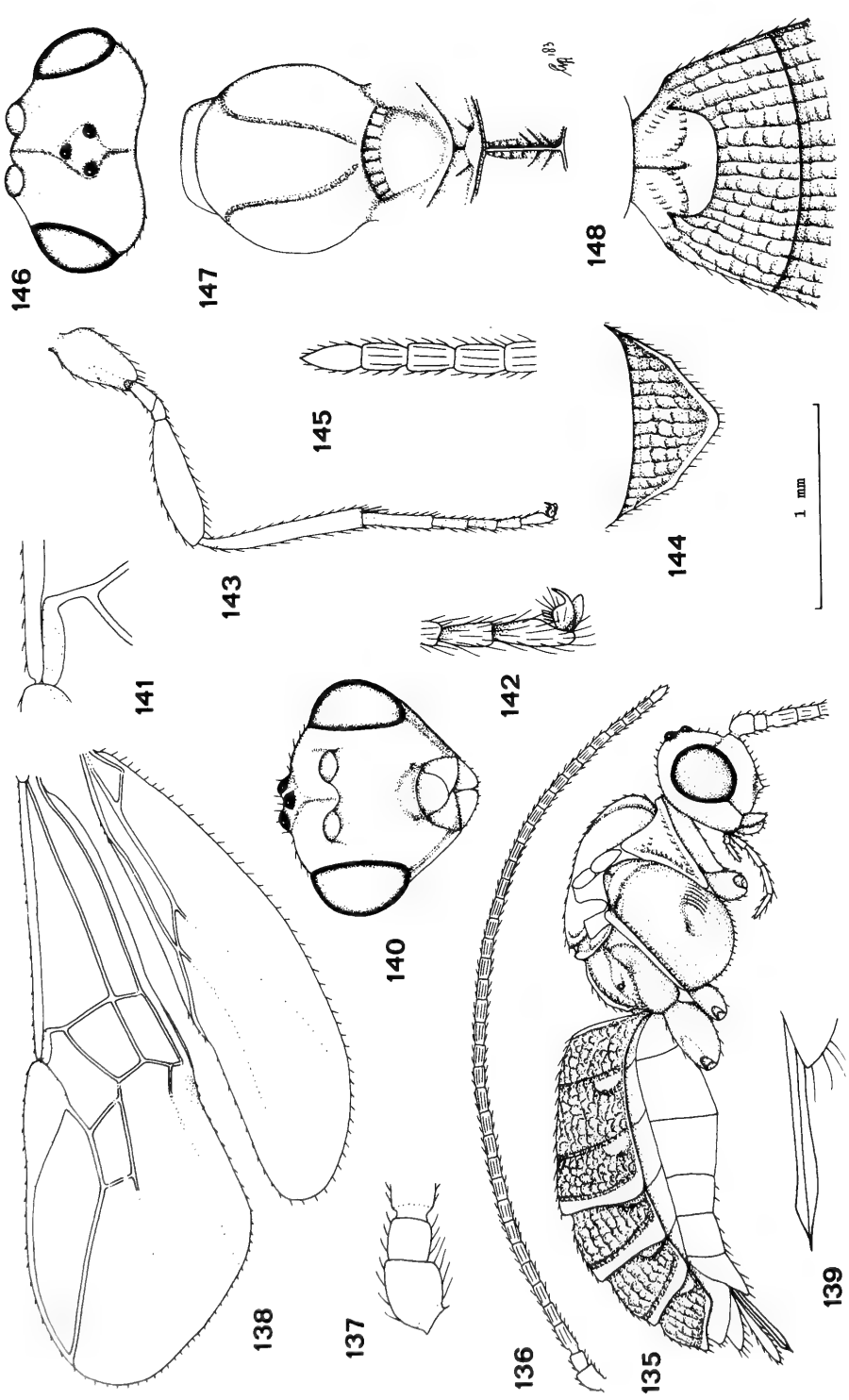

Figs. 135—148. *Aspidobracon moyesi* gen. et sp. nov., holotype, ♀. 135, habitus, lateral aspect; 136, antenna; 137, scapus and pedicellus, outer aspect; 138, wings; 139, ovipositor; 140, head, frontal aspect; 141, vein 1-SR of fore wing; 142, hind leg; 143, hind leg; 144, 6th metasomal tergite, dorsal aspect; 145, apex of antenna; 146, head, dorsal aspect; 147, mesosoma, dorsal aspect; 148, 1st tergite, dorsal aspect. 135, 136, 138, 143: scale-line (1 ×); 137, 139, 141, 142, 145: 2.5 ×; 140, 144, 146—148: 1.5 ×.

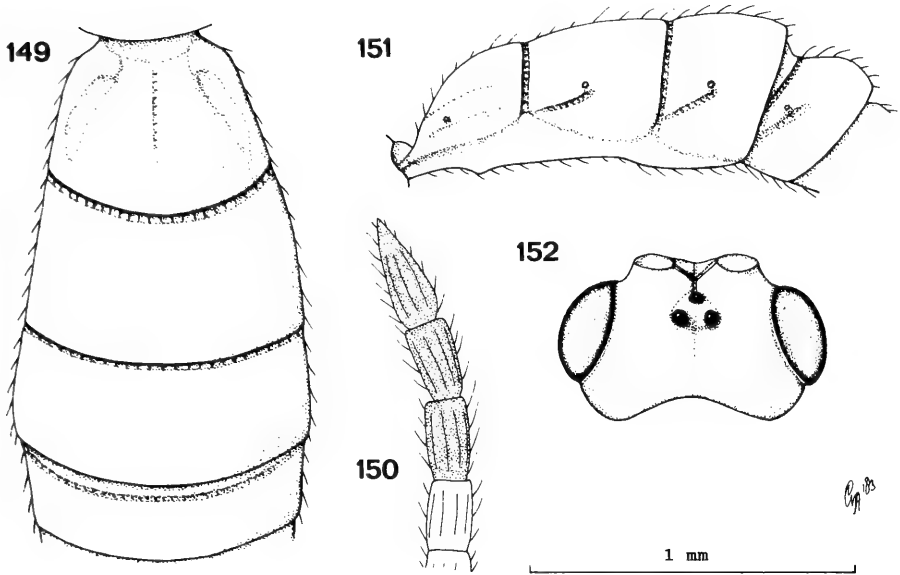

Figs. 149—152. *Apotosoma melateles* gen. et sp. nov., holotype, ♂. 149, 1st—4th metasomal tergites, dorsal aspect; 150, apex of antenna; 151, 1st—4th tergites, lateral aspect; 152, head, dorsal aspect. 149, 151, 152: scale-line (= 1 ×); 150: 2.5 ×.

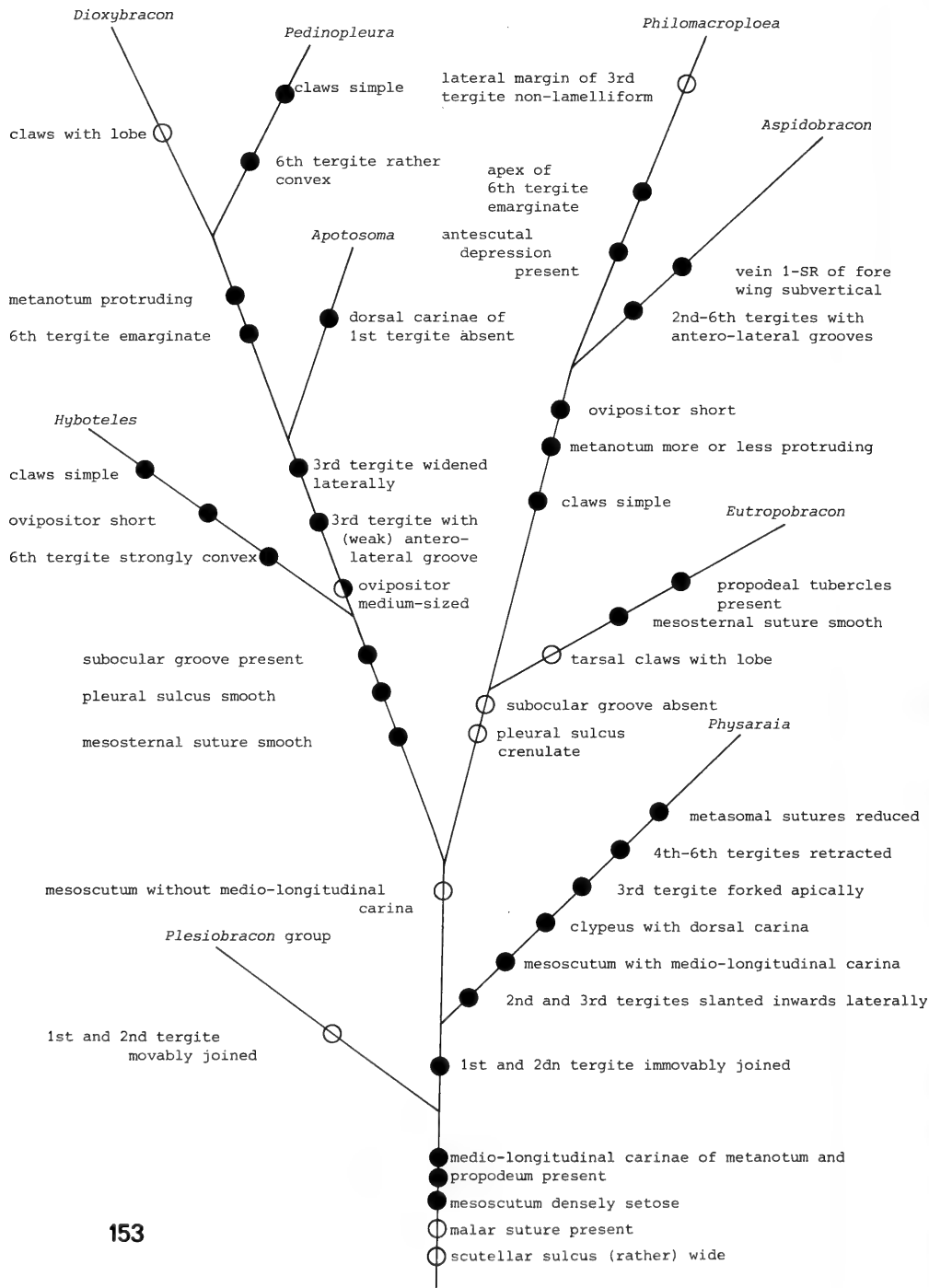
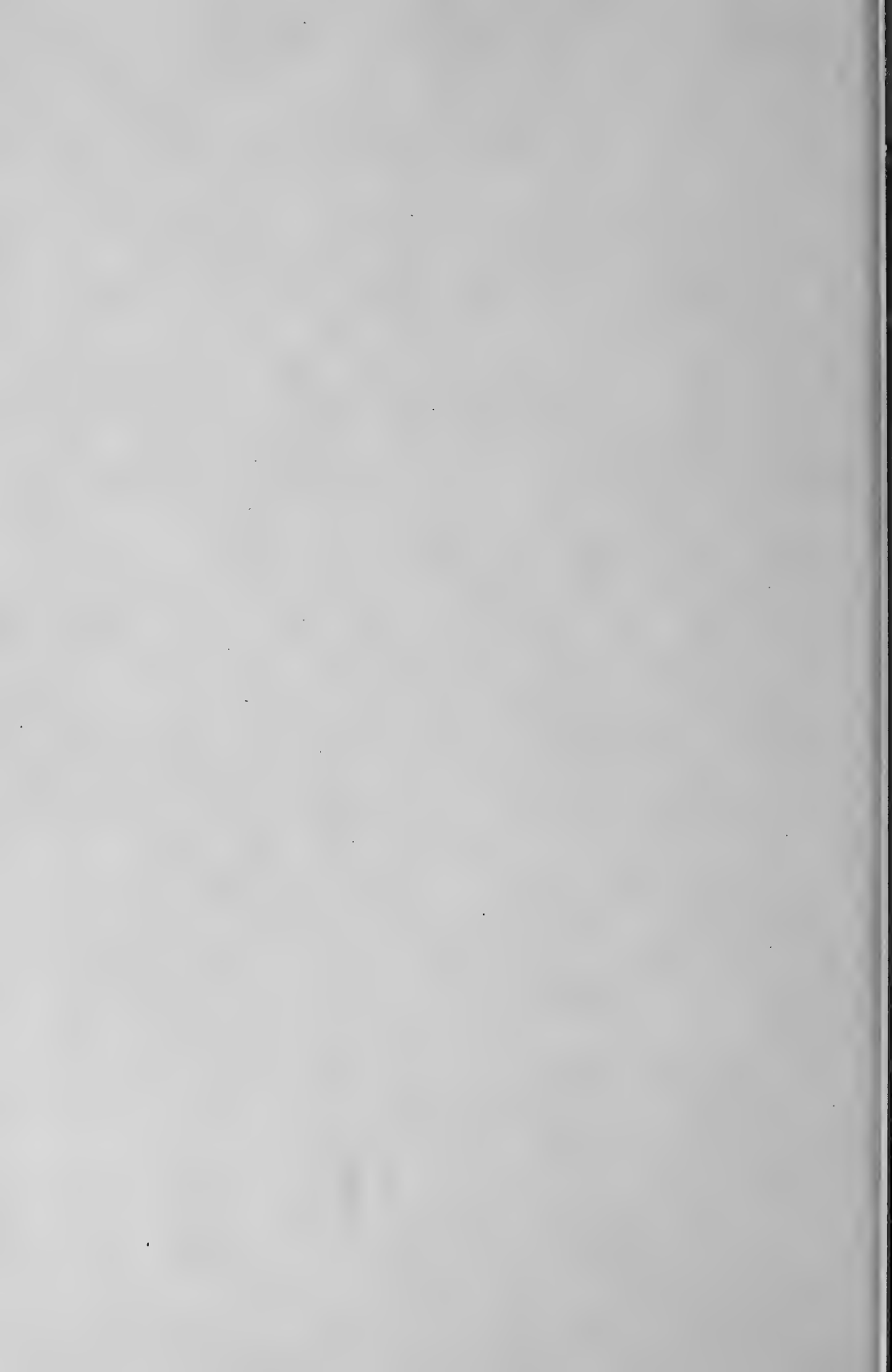

Fig. 153. Cladogram of the genera treated in this paper.





TIJDSCHRIFT VOOR ENTOMOLOGIE

UITGEGEVEN DOOR

DE NEDERLANDSE ENTOMOLOGISCHE VERENIGING

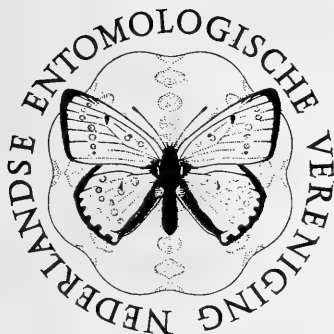

MUS. COMP. ZOOL
LIBRARY
JUN 24
HARVARD
UNIVERSITY

INHOUD

B. GUSTAFSSON. — New species of *Stigmella* from The Gambia (Lepidoptera, Nepticulidae), pp. 165—177, figs. 1—7.

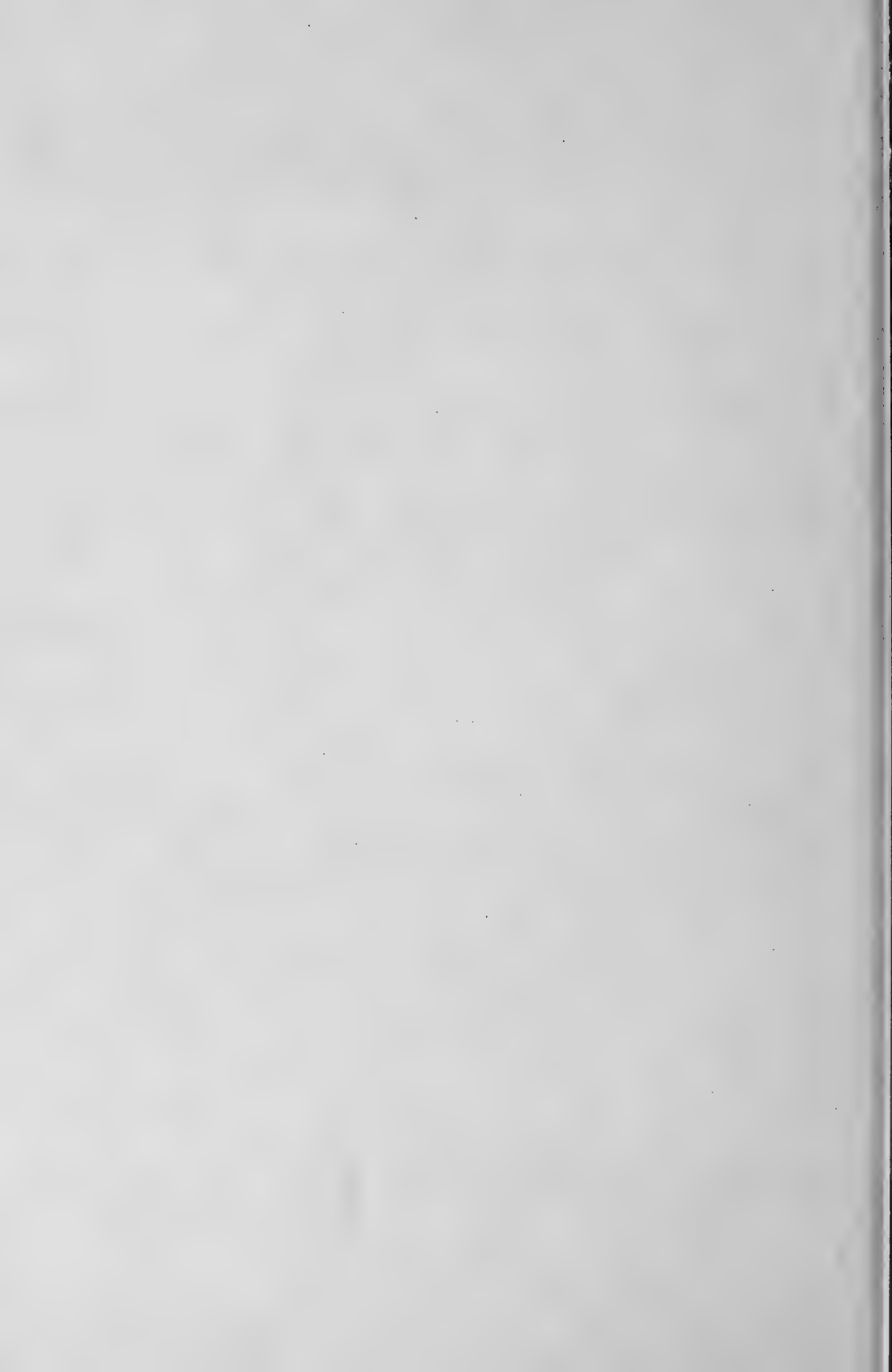

NEW SPECIES OF *STIGMELLA* FROM THE GAMBIA (LEPIDOPTERA, NEPTICULIDAE)

by

BERT GUSTAFSSON

Swedish Museum of Natural History, Stockholm, Sweden

ABSTRACT

Descriptions or redescrptions of adults and immature stages of the following Nepticulidae are presented: *Stigmella rhomboivora* n. sp., *S. allophylivora* n. sp., *S. ficivora* n. sp., *S. ziziphivora* n. sp., *S. birgittae* n. sp., *S. maytenivora* n. sp. and *S. wollofella* (Gustafsson, 1972).

INTRODUCTION

The Nepticulidae on which the present paper is based were collected by me in The Gambia from 3—15 November 1981 and 30 November—13 December 1982. The visits were confined to the western part of The Gambia, mainly the surroundings of Bakau and Banjul. Hitherto only three species of Nepticulidae had been described from The Gambia (Gustafsson, 1972). They were all collected in a searchlight on the ship MS "Lady Wright" on 5 December 1970.

The terminology used in the descriptions mainly conforms with Scoble (1983) (adults) and Gustafsson (1981) (larvae). The descriptions of larvae refer to the final instar. Generic characters are mentioned in the generic description only.

Stigmella Schrank, 1802

Diagnosis. — *Stigmella* can be distinguished from *Trifurcula* and *Ectoedemia* by the absence of signa reticulata in the bursa, the absence of a scale patch on the underside of the hindwing in the males (*Trifurcula*), and by the rectangularly shaped epistomal ridge in the larvae.

Description.

Adult. — Very small moths with a wingspan of 3—5.3 mm.

Head. — Palps shining, yellowish grey. Antennae more than half length of forewing, scape expanded into a large eyecap. Tuft on front of head and vertex. A collar attached to the back of the head.

Wings. — Forewings roughly scaled, some-

times with a shining, postmedial fascia. Cilia distinctly or indistinctly separated by a row of darker scales. Hindwing narrow, grey with grey fringe.

Abdomen. — Pale ventrally. Male with anal tufts on eighth tergite.

Male genitalia. — Tegumen and vinculum of variable form. Uncus bilobed. Gnathos with a pair of lateral processes, the horizontal element sometimes with a tongue-shaped projection. Valvae of variable shape. Transtilla present, ventral arms present or absent. Juxta present or absent. Aedeagus well sclerotized. Vesica with cornuti of various shape.

Female genitalia. — Bursa copulatrix with or without pectinations, signum present or absent. Apophyses relatively short.

Larva. — Head prognathous, partially retracted into thorax with heavily sclerotized endo-skeletal ridges. Epistomal ridge rectangular. Anterior and posterior tentorial arms of same length. Labial palpi consisting of two short segments provided with a long seta in the apical area. Prothorax with a broad ventral sclerite and a paired dorsal sclerite. Abdomen without pigmentation. A spinose integument of various extent present or absent. Prothorax with 13 pairs of setae, mesothorax with 11 pairs, abdominal segments 1—8 with 6 pairs, 9 with 3 pairs and 10 with 2 pairs of setae. In the anal end a pair of strongly sclerotized, small bands. Calli (ambulatory warts) well defined on meso- and meta-thorax, as well as on abdominal segments 2—7.

Distribution. — It is likely that the present species are confined to the western part of Africa, but future investigations will prove.

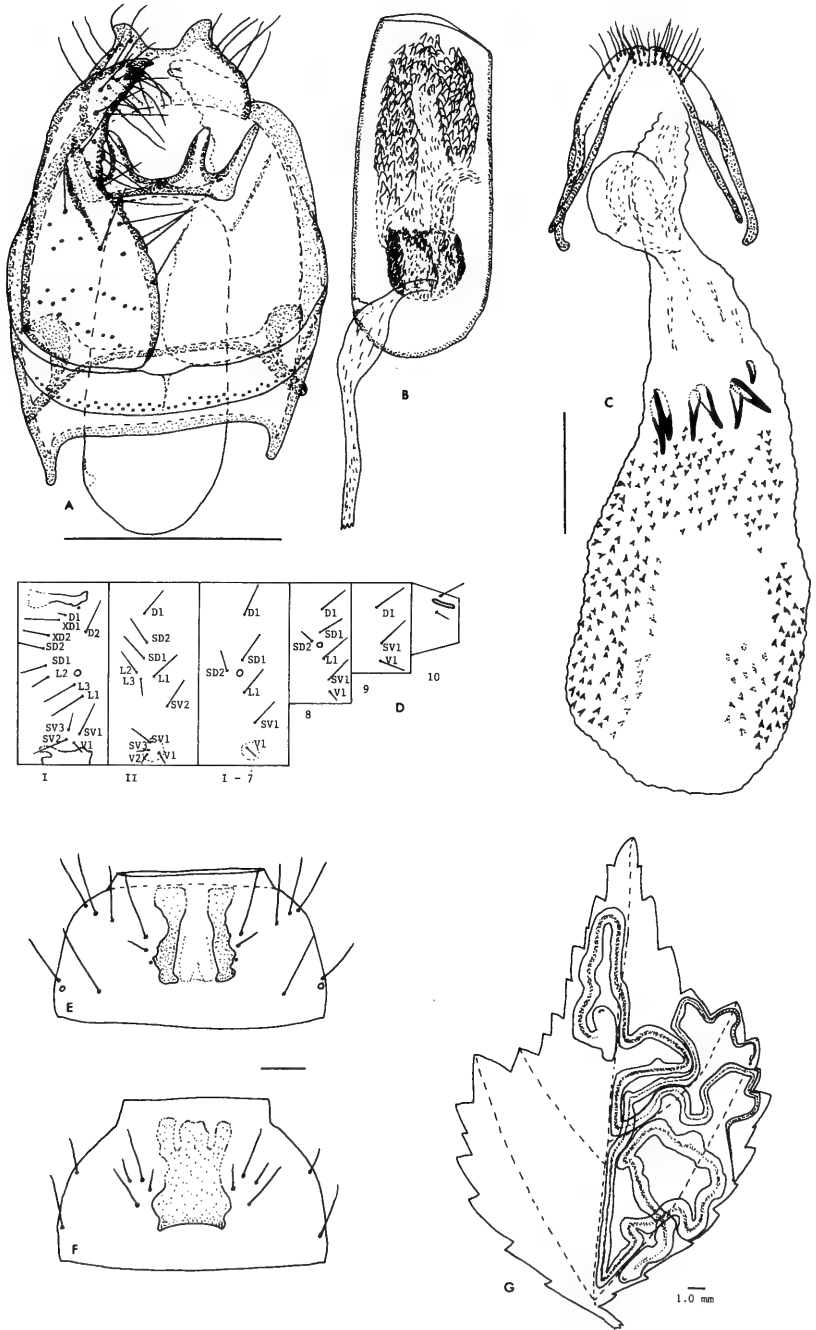

Fig. 1. *Stigmella rhomboivora* n.sp. A, B, Male genitalia. C, Female genitalia. D, Larval chaetotaxy. E, F, Larval prothoracic sclerites, dorsal and ventral view. G, Leaf-mine. — Scales = 0.1 mm, except where indicated otherwise.

***Stigmella rhomboivora* n. sp.**

(figs. 1a—g)

Type locality. — Bakau, Kotu Stream.

Type material. — Holotype ♂, Kotu Stream: ex larva on *Triumfetta rhomboidea* Jacq., 9.xi.1981, emerged 16.xi.1981.Paratypes: Same locality as holotype, 11 ♂, 11 ♀, ex larva on *T. rhomboidea* Jacq., 9—15.xi.1981, emerged between 16.xi and 1.xii.1981; 18 ♂, 21 ♀, ex larva on *T. rhomboidea* Jacq., 1—12.xii.1982, emerged between 9.xii.1982 and 7.i.1983; Bakau: 17 ♂, 14 ♀, ex larva on *T. rhomboidea* Jacq., 3—10.xi.1981, emerged between 9—23.xi.1981; 3 ♂, ex larva on *T. rhomboidea* Jacq., 30.xi.1982, emerged 9.xii.1982.Diagnosis. — Deviates from the closely related *charistis* Vári, 1963, especially in the female genitalia. There is only one signum in bursa copulatrix in *charistis*, but more than five in *rhomboivora*.

Description.

Male. — Wing expanse 3.7—4.2 mm. Thorax and forewing dark fuscous with straw yellow apex and light greyish fringe. Antennae brownish, eye-caps yellowish white, tuft on front of head and vertex yellowish, collar yellowish white.

Genitalia (figs. 1a, b). — Tegumen slightly curved; ventral plate of vinculum of median length, anterior extension excavated; uncus weakly bilobed; gnathos with a pair of short horns, lateral processes longer; valves excavated at tip to form two small hooks; transtilla with ventral arms fairly long; length of aedeagus approximately that of genital capsule, broad with a large, irregular patch of denticulate cornuti on vesica.

Female. — Wing expanse 3.4—4.4 mm. No noticeable difference in habitus from male.

Genitalia (fig. 1c). — Ductus bursae and bursa copulatrix approximately 2.5 times as long as apophyses; bursa copulatrix covered with minute spines; signum consisting of some small, narrow teeth; anterior apophyses with broad base, curved towards tip; posterior apophyses straight and narrow, almost of same length as anterior ones.

Pre-imaginal stages. — Eggs laid on the upper surface of the leaf. Larva (figs. 1d—f): length 2.8—4.2 mm, diameter 0.7 mm; head light brown with endoskeletal ridges dark brown; maximum width 0.3 mm, maximum length 0.3

mm. Thorax and abdomen yellowish green. Prothorax without spines, meso- and metathorax with a patch of spines between the D1 and SD1 setae, spinose on the calli and on a big patch in front of the SV1 setae. Abdominal segments 1—7 spinose between the SV1 setae, segment 8 spinose between the D1 and SV1 setae, segment 9 spinose between the SV1 setae, segment 10 with some spines in front of the setae. Abdominal segment 10 with 2 pairs of setae, the ventral pair shorter than the dorsal one.

Examined larvae. — 1 ex., Banjul N'Ding, 13.xi.1981; 5 ex., Kotu Stream, 14.xi.1981; 2 ex., Kotu Stream, 10.xii.1982; 10 ex., Kotu Stream, 12.xii.1982.

Mine (fig. 1g). — A long and slender ophiome with a central frass-line.

Cocoon. — Yellowish white.

Host plant. — *Triumfetta rhomboidea* Jacq. (Tiliaceae).***Stigmella allophylyvora* n. sp.**

(figs. 2a—f)

Type locality. — Banjul N'Ding.

Type material. — Holotype ♂, Banjul N'Ding; ex larva on *Allophylus* cf. *africanus* Beauv., 7.xii.1982, emerged 27.xii.1982.Paratypes. — Same locality as holotype, 2 ♂, 1 ♀, ex larva on *A.* cf. *africanus* Beauv., 7.xii.1982, emerged between 27.xii.1982 and 10.i.1983.Diagnosis. — Deviates from the related *allophylica* Scoble, 1978, in the male genitalia, especially in the aedeagus. The vesica of *allophylyvora* is marked with large and strongly sclerotized teeth, so as in contrast to the inconspicuous ring of denticles in *allophylica*.

Description.

Male. — Wing expanse 4.4—4.6 mm. Thorax and forewing dark greyish fuscous, with bronze and a few purple reflections, fringe dark greyish. Antennae greyish brown, eye-caps yellowish white, tuft on front of head and vertex orange-yellow, collar shining yellowish.

Genitalia (figs. 2a, b). — Tegumen comprising an arcuate band, slightly swollen at ends; ventral plate of vinculum of median length, anterior extension short, weakly excavated; uncus weakly bilobed; gnathos broadly U-shaped with the lateral arms somewhat curved inwards; valves broad with small, papillate style widely separated from cuiller; juxta narrow, spatula-

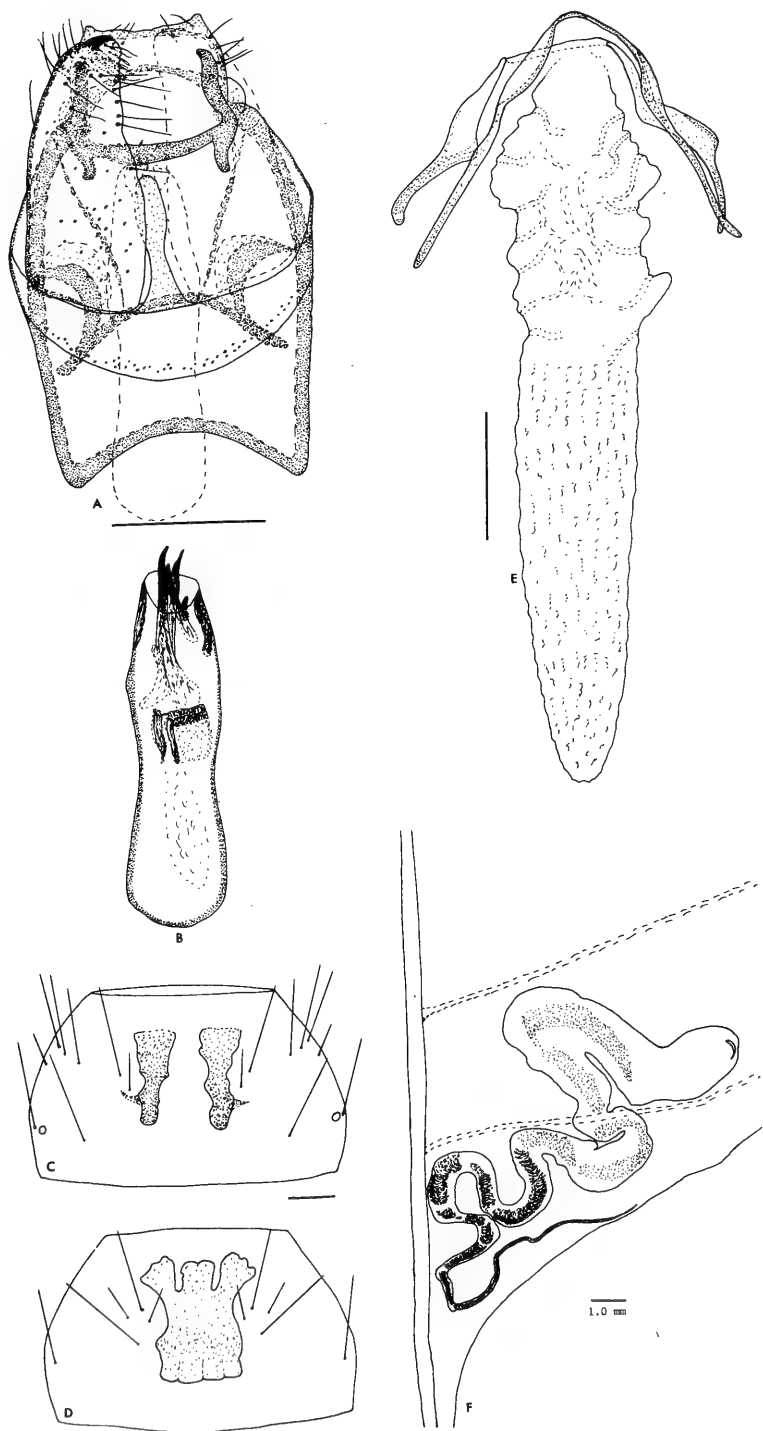

Fig. 2. *Stigmella allophylivora* n.sp. A, B, Male genitalia. C, D, Larval prothoracic sclerites, dorsal and ventral view. E, Female genitalia. F, Leaf-mine. — Scales = 0.1 mm, except where indicated otherwise.

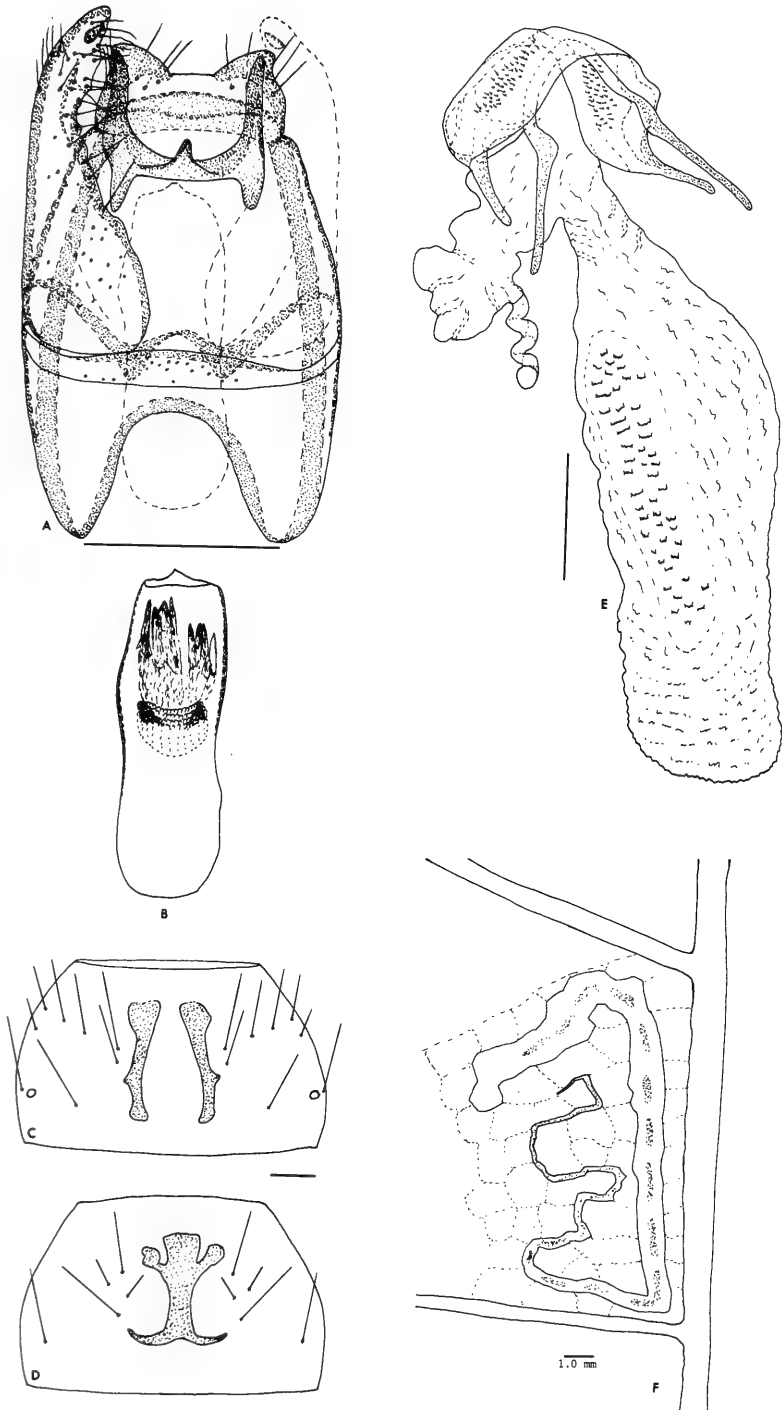

Fig. 3. *Stigmella ficivora* n.sp. A, B, Male genitalia. C, D, Larval prothoracic sclerites, dorsal and ventral view. E, Female genitalia. F, Leaf-mine. — Scales = 0.1 mm, except where indicated otherwise.

formed; transtilla robust with ventral arms long; aedeagus 0.75 times length of genital capsule, vesica with a number of large teeth posteriorly and a centrally placed arcuate thickening.

Female. — Wing expanse 4.0 mm. No noticeable difference in habitus from male.

Genitalia (fig. 2e). — Ductus bursae longer than apophyses; bursa copulatrix pectinate, without signum.

Pre-imaginal stages. — Eggs laid on the lower surface of the leaf. Larva (figs. 2c, d): length 3.6–4.0 mm, diameter 0.7 mm; head light brown with endoskeletal ridges dark brown. Thorax and abdomen yellowish green. Prothorax without spines, meso- and metathorax with a patch of spines between the D1 and SD1 setae, spinose on the calli and on a big patch in front of the SV2 setae. Abdominal segments 1–8 spinose between the SV1 setae and on a patch in front of the L1 setae, on the dorsal side without spines in segment 2–5, segment 9 spinose between the SV1 setae, segment 10 with a few spines in front of the setae. Abdominal segment 10 with 2 pairs of setae, the ventral pair shorter than the dorsal one.

Examined larvae. — 3 ex., Banjul N'Ding, 7.xii.1982.

Mine (fig. 2f). — A long ophionome with the frass deposited as a compact line in the initial part, as zig-zag arcs in the middle part, and as separate granules in the end part. The larva emerges through upper surface of leaf to pupate.

Cocoon. — From yellowish to brownish.

Host plant. — *Allophylus* cf. *africanus* Beauv. (Sapindaceae).

Stigmella ficivora n. sp.

(figs. 3 a–f)

Type locality. — Bakau.

Type material. — Holotype ♂, Bakau: ex larva on *Ficus parasitica* coll., 30.xi.1982, emerged 20.xii.1982.

Paratypes. — Same locality as holotype, 2 ♀, ex larva on *F. parasitica* coll., 30.xi.1982, emerged 20.xii.1982.

Diagnosis. — It has a similar gnathos to *platyzona* Vári, 1963, but shows a much longer valve and the ventral plate of the vinculum is not so deeply excavated.

Description.

Male. — Wing expanse 3.0 mm. Thorax and forewing dark fuscous with a purplish reflection, a broad, postmedial fascia, shining yellowish white. Antennae greyish brown; eye-caps yellowish, tuft on front of head and vertex orange-yellow; collar yellowish.

Genitalia (figs. 3a, b). — Tegumen slightly curved; ventral plate of vinculum short, slightly bulging in middle of posterior margin, anterior projection long, deeply excavated; uncus bilobed; gnathos a broadly U-shaped horizontal element with small tongue-shaped projection; valves gently curved apically, apex with small characteristic knob; transtilla robust with ventral arms virtually absent; aedeagus approximately 2/3 length of genital capsule, vesica with a number of large spines and a small, curved thickening.

Female. — Wing expanse 3.2–3.5 mm. Antennae yellowish, otherwise no noticeable difference in habitus from male.

Genitalia (fig. 3e). — Ductus bursae with a large accessory sac; bursa copulatrix with a pair of long bands with irregular sclerotizations; anterior apophyses with broad base and spinose in the central part; posterior apophyses straight and narrow.

Pre-imaginal stages. — Eggs laid on the lower surface of the leaf. Larva (figs. 3c, d): length 3.0 mm, diameter 0.5 mm; head light brown with endoskeletal ridges dark brown. Thorax and abdomen greyish yellow. Prothorax without spines, meso- and metathorax spinose on the calli and on a patch in front of the SD2 setae. Abdominal segment 1 with some spines between the L1 setae, segment 2–7 spinose on the calli and on a big patch between and in front of the SV1, L1 setae, segment 8–9 heavily spinose, segment 10 spinose on the ventral side. Abdominal segment 10 with 2 pairs of setae, the ventral pair much shorter than the dorsal one.

Examined larvae. — 2 ex., Bakau, Camalou Corner, 5.xii.1982.

Mine (fig. 3f). — An upper surface ophionome with the frass deposited as separate granules almost invisible without translucent light. Larva emerges through lower surface of leaf to pupate.

Cocoon. — From yellowish white to brownish.

Host plant. — *Ficus parasitica* coll. (Moraceae).

***Stigmella ziziphivora* n. sp.**
(figs. 4a—f)

Type locality. — Bakau, Kotu Stream.

Type material. — Holotype ♂, Bakau: ex larva on *Ziziphus mauritania* Lam., 13.xii.1982, emerged 29.xii.1982.

Paratypes. — Same locality as holotype, 16 ♂, 50 ♀, ex larva on *Z. mauritania* Lam., 7—13.xii.1982, emerged between 16.xii.1982 and 3.i.1983; Kotu Stream: 1 ♂, 1 ♀, ex larva on *Z. mauritania* Lam., 3.xii.1982, 14.xi.1981, emerged 13.xii.1982 and 27.xi.1981.

Diagnosis. — This species is related to *paliurella* (Klimesch, 1940) and *zizyphi* Walsingham, 1911. The uncus and aedeagus differ in shape, the head tuft is orange-yellow in *ziziphivora*, black or dark fuscous in the related species.

Description.

Male. — Wing expanse 4.1—5.3 mm. Thorax and forewing greyish yellow, heavily irrorated with fuscous; fringe light greyish. Antennae light brownish; eye-caps yellowish; tuft on front of head and vertex orange-yellow; collar yellowish.

Genitalia (figs. 4a, b). — Tegumen slightly curved; ventral plate of vinculum of median length, anterior extension weakly excavated; uncus bilobed; gnathos with a pair of straight horns, lateral and anterior processes forming a pair of triangular plates; valves curved apically; transtilla with ventral arms fairly long; aedeagus of approximately same length as genital capsule, vesica with some strong spines.

Female. — Wing expanse 4.0—5.0 mm. No noticeable difference in habitus from male.

Genitalia (fig. 4e). — Bursae covered with minute, scallop-shaped pectinations; signum comprising a band of very small, narrow teeth; anterior apophyses with broad base; posterior apophyses straight and narrow.

Pre-imaginal stages. — Eggs laid on the lower surface of the leaf. Larva (figs. 4c, d): length 3.0—4.5 mm, diameter 0.7 mm; head light brown with endoskeletal ridges dark brown; maximum width 0.3 mm; maximum length 0.3 mm. Thorax and abdomen yellowish green. Prothorax without spines, meso- and metathorax spinose on the calli and on a patch in front of the SV2 setae. Abdominal segment 1 without spines, segments 2—7 spinose on the calli, segment 8 spinose between the SV1 and D1 setae, segment 9 with a few spines on the ventral side, segment 10 with some spines in front of the setae. Abdominal segment 10 with 2 pairs of setae,

the ventral pair shorter than the dorsal one. The larva mines with the ventral side upwards.

Examined larvae. — 2 ex., Bakau, Camalou Corner, 7.xii.1982; 1 ex., Banjul N'Ding, 7.xii.1982; 27 ex., Bakau, Cape Creek, 9.xii.1982; 5 ex., Bakau, Cape Creek, 13.xii.1982.

Mine (fig. 4f). — An upper surface ophistigmatonome; larva emerges from lower surface of leaf to pupate.

Cocoon. — Yellowish white.

Host plant. — *Ziziphus mauritania* Lam. (Rhamnaceae).

***Stigmella birgittae* n. sp.**
(figs. 5a—f)

Type locality. — Kotu Stream.

Type material. — Holotype ♂, Kotu Stream: ex larva on *Ziziphus mauritania* Lam., 15.xi.1981, emerged 27.xi.1981.

Paratypes. — Same locality as holotype, 1 ♂, 1 ♀, ex larva on *Z. mauritania* Lam., 15.xi.1981, emerged 1.xii.1981.

Diagnosis. — Deviates from the closely related *ziziphivora* n. sp. in the male genitalia, especially in the aedeagus, transtilla and gnathos.

Derivation of the name. — After the author's wife Birgitta.

Description.

Male. — Wing expanse 3.7—4.4 mm. External features of wings, head and thorax similar to *ziziphivora*.

Genitalia (figs. 5a, b). — Tegumen slightly curved; ventral plate of vinculum of median length, anterior extension weakly excavated; uncus bilobed; gnathos with a pair of straight, long horns, lateral and anterior processes forming a pair of triangular plates; valves weakly curved apically; transtilla with ventral arms fairly long; aedeagus of approximately same length as genital capsule, vesica with some strong spines.

Female. — Wing expanse 3.7 mm. No noticeable difference in habitus from male.

Genitalia (fig. 5f). — Bursa copulatrix covered with minute, scallop-shaped pectinations; signum comprising a band of very small, narrow teeth; anterior apophyses with a broad base; posterior apophyses straight and narrow.

Pre-imaginal stages. — Eggs laid on the upper surface of the leaf. Larva (figs. 5c, d): length 4 mm, diameter 0.7 mm; head light brown with

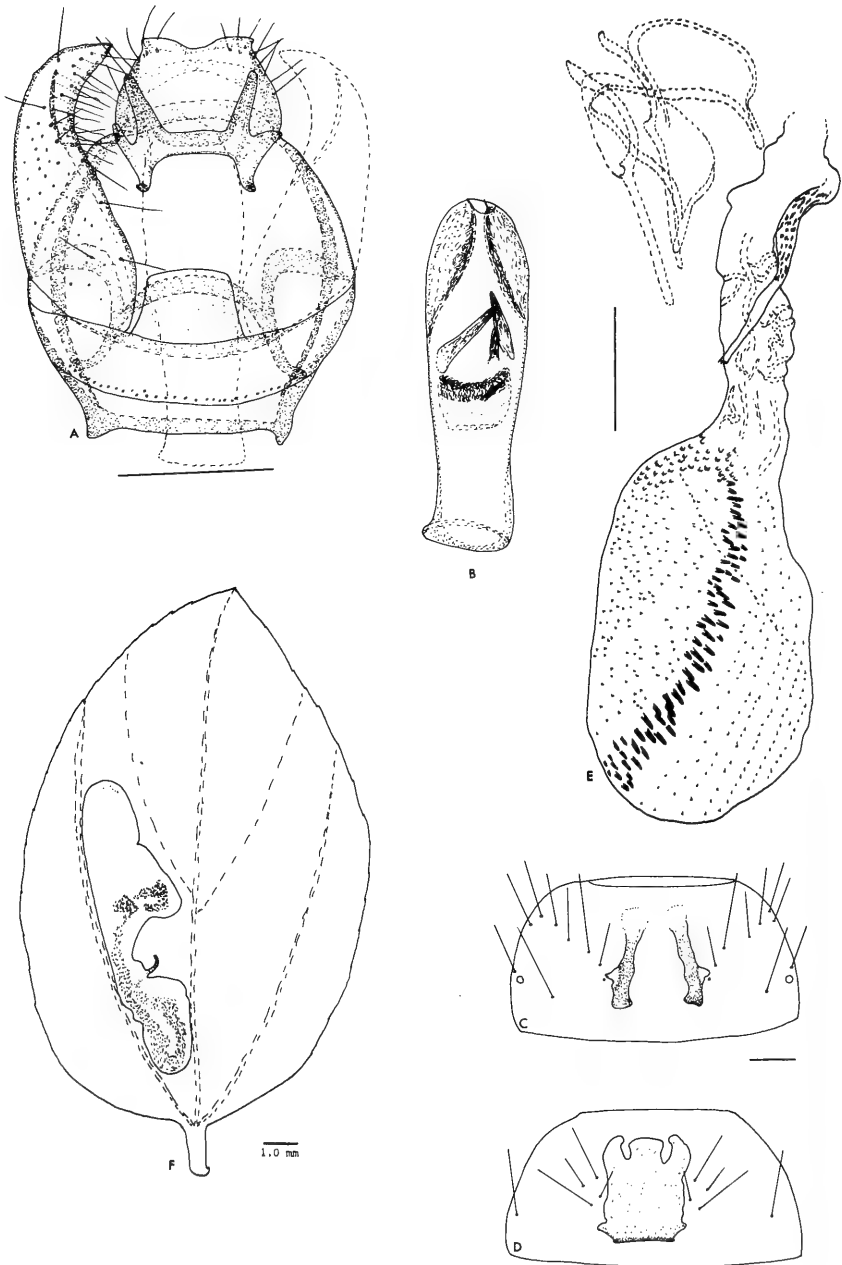

Fig. 4. *Stigmella ziziphivora* n.sp. A, B, Male genitalia. C, D, Larval prothoracic sclerites, dorsal and ventral view. E, Female genitalia. F, Leaf-mine. — Scales = 0.1 mm, except where indicated otherwise.

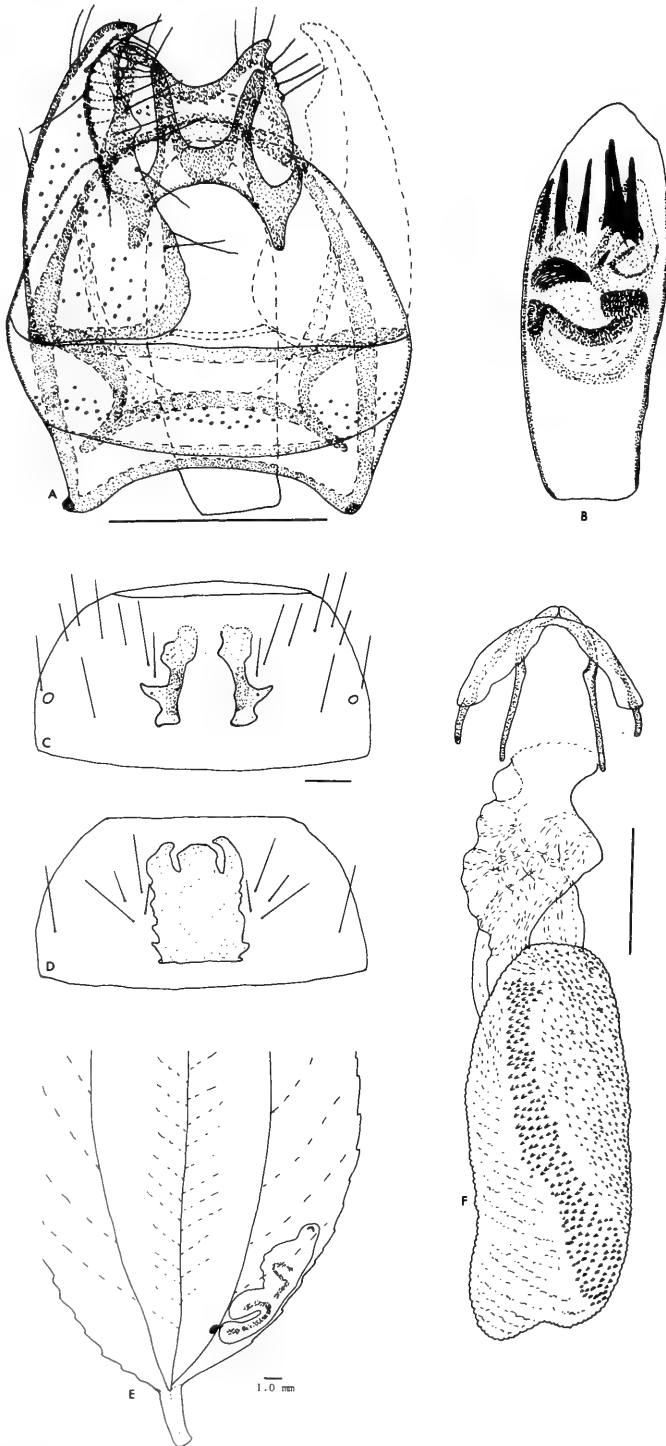

Fig. 5. *Stigmella birgittae* n.sp. A, B, Male genitalia. C, D, Larval prothoracic sclerites, dorsal and ventral view. E, Leaf-mine. F, Female genitalia. — Scales = 0.1 mm, except where indicated otherwise.

endoskeletal ridges dark brown; maximum width 0.3 mm; maximum length 0.3 mm. Thorax and abdomen yellowish green. Prothorax without spines, meso- and metathorax spinose on the calli and on a patch in front of the SV2 setae. Abdominal segment 1 spinose between the SV1 setae, segments 2—7 spinose on the calli and on a patch in front of and between the SV1 and L1 setae, segments 8—9 spinose, segment 10 with some spines in front of the setae. Abdominal segment 10 with 2 pairs of setae, the ventral pair shorter than the dorsal one.

Examined larvae. — 1 ex., Kotu Stream, 14.xi.1981; 1 ex., Bakau, Cape Creek, 13.xii.1982.

Mine (fig. 5e). — An upper surface ophistigmatonome; larva emerges from upper surface of leaf to pupate.

Cocoon. — Yellowish white.

Host plant. — *Ziziphus mauritania* Lam. (Rhamnaceae).

Stigmella maytenivora n. sp.

(figs. 6a—d)

Type locality. — Bakau.

Type material. — Holotype ♂, Bakau: ex larva on *Maytenus senegalensis* (Lam.) Exell, 30.xi.1982, emerged 17.xii.1982.

Paratypes. — Same locality as holotype, 2 ♂, 3 ♀, ex larva on *M. senegalensis* (Lam.) Exell, 4—10.xi.1981, emerged between 18 and 25.xi.1981.

Diagnosis. — No particular close relatives of this species are known.

Description.

Male. — Wing expanse 3.7—4.1 mm. Thorax and forewing dark greyish, heavily irrorated with fuscous; fringe light grey. Antennae light brownish grey; eye-caps yellowish; tuft on front of head and vertex redbrown; collar yellowish.

Genitalia (figs. 6a, b). — Tegumen a narrow, slightly curved band; ventral plate of vinculum of median length, anterior extension weakly excavated; uncus weakly bilobed with a pair of widely separated, lateral papillae; gnathos with a pair of straight horns, lateral and anterior processes forming a pair of triangular plates; valves with pointed style and a rectangular cuiller; transtilla with ventral arms absent; aedeagus large, approximately 1.5 times length of genital

capsule, vesica with long, longitudinally running band of cornuti.

Female. — Wing expanse 3.5—4.2 mm. No noticeable difference in habitus from male.

Genitalia (fig. 6d). — Ductus bursae long and broad with a very large accessory sac; bursa copulatrix densely covered with fishscale-shaped sclerotizations; signum absent.

Pre-imaginal stages. — Eggs laid on the lower surface of the leaf. Larva: yellowish green with pale brown head.

Mine (fig. 6c). — An upper surface ophistigmatonome; larva emerges from the upper surface of leaf to pupate.

Cocoon. — Yellowish white.

Host plant. — *Maytenus senegalensis* (Lam.) Exell (Celastraceae).

Stigmella wollofella

(Gustafsson, 1972) comb. nov.

(figs. 7a—d)

Nepticula wollofella Gustafsson, 1972: 158—159.

Type locality. — Gambia River between Banjul and Basse Santa Su.

Type material. — 1 ♂, collected on the ship MS "Lady Wright".

Material studied. — Holotype ♂, 5.xii.1970; 1 ♂, 2 ♀, The Gambia, Bakau, Camalou Corner, ex larva on *Ziziphus mauritania* Lam., 7.xii.1982, emerged 16.xii.1982; 1 ♂, The Gambia, Barra, ex larva on *Z. mauritania* Lam., 11.xii.1982, emerged 30.xii.1982.

Diagnosis. — No particular close relatives of this species are known. The male genitalia resemble those of *mandingella* Gustafsson, 1972 — but are distinct by the shape of the juxta.

Description.

Male. — Wing expanse 4.5 mm. Thorax and forewing dark greyish fuscous with dark greyish fringe. Antennae brownish; eye-caps yellowish white; tuft on front of head and vertex orange-yellow; collar yellowish white.

Genitalia (figs. 7a, b). — Tegumen a broad arcuate plate; ventral plate of vinculum narrow, lateral arms broad and articulating with tegumen at dorsal extremities, saccus more than 3 times width of ventral plate of vinculum; uncus bilobed; gnathos broadly U-shaped with the lateral arms curved outwards; valves clearly divided into a pointed style and a rounded cuiller;

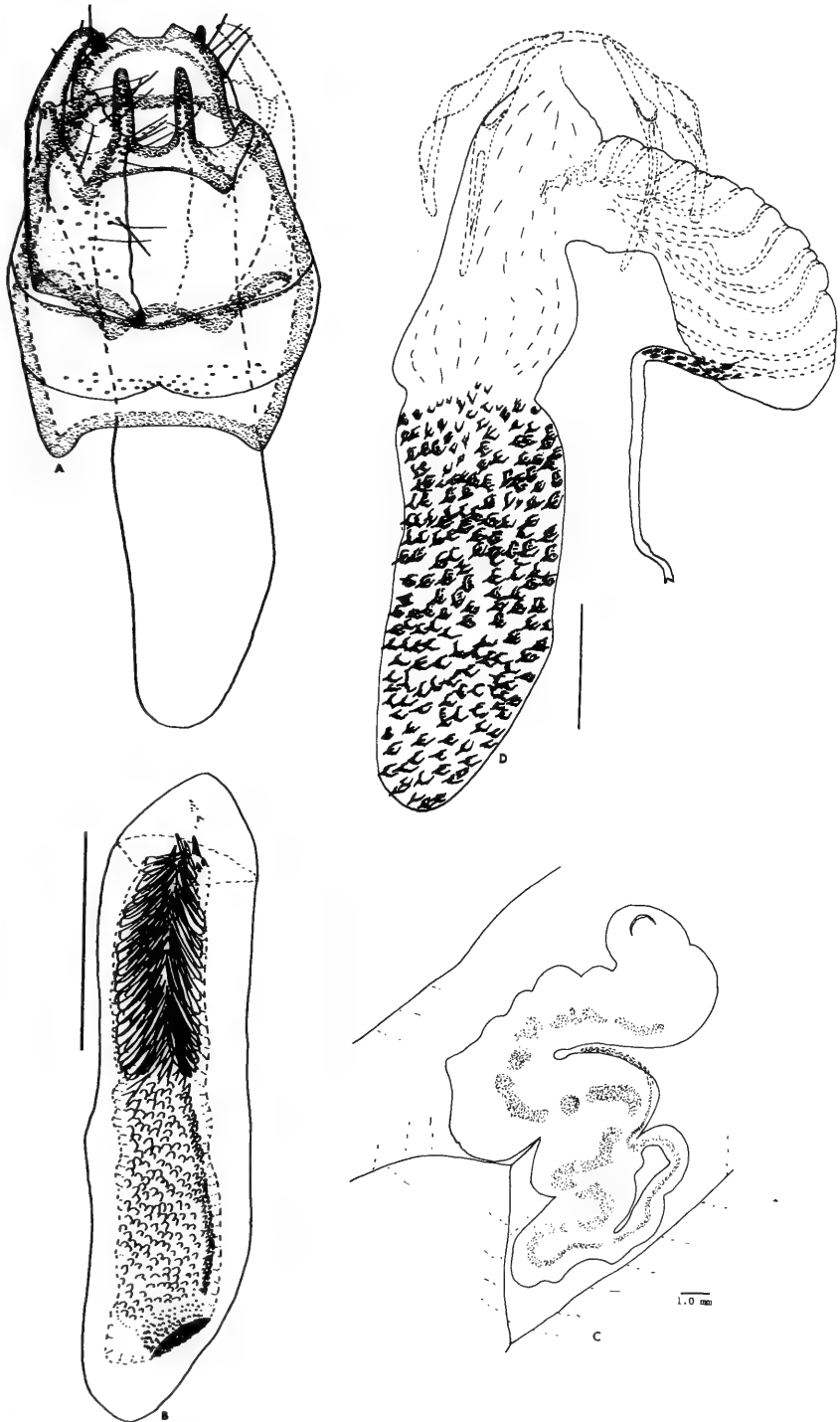

Fig. 6. *Stigmella maytenivora* n.sp. A, B, Male genitalia. C, Leaf-mine. D, Female genitalia. — Scales = 0.1 mm, except where indicated otherwise.

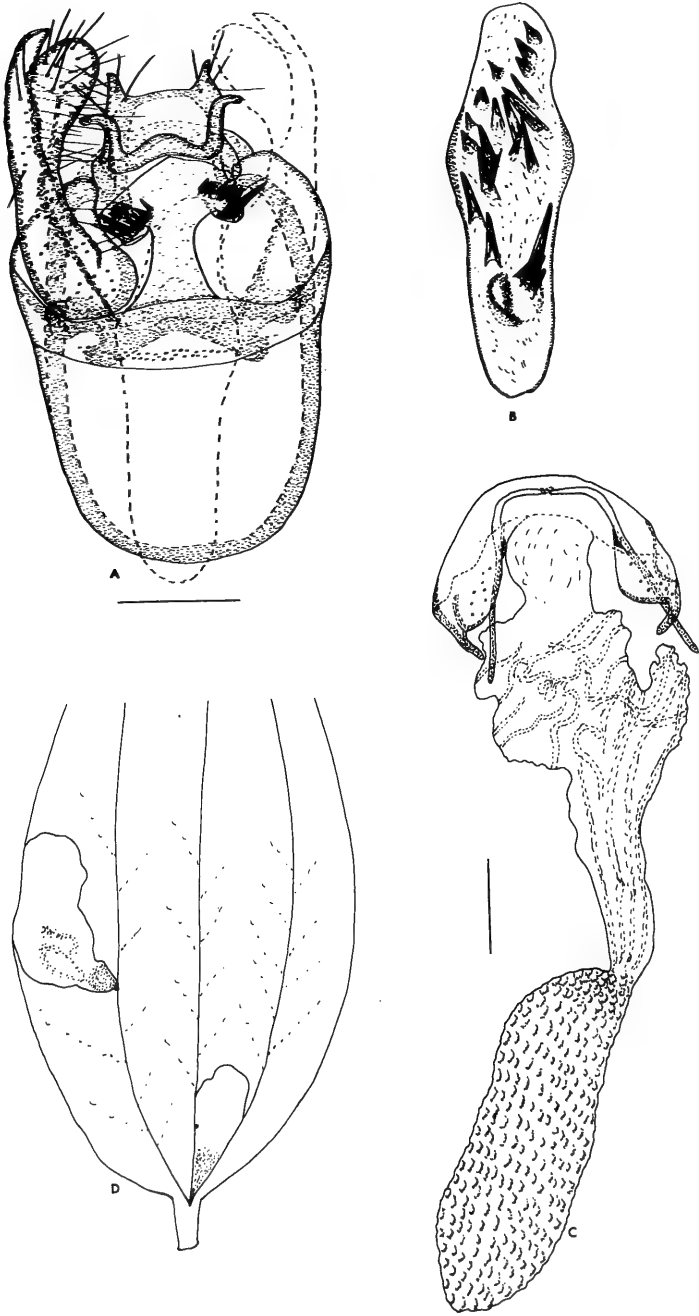

Fig. 7. *Stigmella wollofella* (Gustafsson). A, B, Male genitalia. C, Female genitalia. D, Leaf-mine. — Scales = 0.1 mm, except where indicated otherwise.

juxta in form of a triangular arrow with strong spines; transtilla with ventral arms short and stout; aedeagus with a number of denticulate cornuti on vesica.

Female. — Wing expanse 4.5 mm. No noticeable difference in habitus from male.

Genitalia (fig. 7c). — Ductus bursae very large relative to the bursa copulatrix; the latter covered with scallop-shaped pectinations; signum absent; anterior apophyses arcuate, broad basally; posterior apophyses straight and narrow.

Pre-imaginal stages. — Eggs laid on the upper surface of the leaf. Larva: yellowish green with pale brown head.

Mine (fig. 7d). — An upper surface ophistigmatonome; larva emerges from the lower side of the leaf to pupate.

Cocoon. — Yellowish green.

Host plant. — *Ziziphus mauritania* Lam. (Rhamnaceae).

ACKNOWLEDGEMENTS

I wish to express my sincere thanks to Dr. K. J. Hedqvist, Dr. L.-Å. Janzon and Mr. T. Sjölin, who accompanied me on the collecting trips. Thanks are also due to Dr. K. Bremer and Dr.

C.-J. Clemedson for help with the identifications of the host plants and to Dr. E. Sylvén for the interest shown in this study.

RELEVANT LITERATURE

- Gerasimov, A. M., 1937. Minierende Motten V. Neue *Stigmella* (*Nepticula*)- und *Tischeria*-Arten (Lepid. Stigmell. und Tischer.). — Mitt. zool. Mus. Berl. 22: 282—285.
- Gustafsson, B., 1972. Three new species of *Nepticula* from Gambia (Lep. Nepticulidae). — Ent. Tidskr. 93: 156—159.
- Gustafsson, B., 1981. Characters of systematic importance in European Nepticulidae larvae (Lepidoptera). — Ent. scand. 12: 109—116.
- Klimesch, J., 1940. Über eine Nepticulidae-Ausbeute von Triest. — Zeitschr. Wr. Ent. Ges. 25: 177—179, 188—189.
- Scoble, M. J., 1978. Nepticulidae of Southern Africa: A Taxonomic Revision of the Genus *Stigmella* Schrank (Lepidoptera: Monotrypsia). — Ann. Transv. Mus. 31: 87—129.
- Scoble, M. J., 1983. A revised, cladistic classification of the Nepticulidae (Lepidoptera) with descriptions of new taxa, mainly from southern Africa. — Transvaal Museum Monograph 2: I—XI, 1—105.
- Walsingham, L., 1911. Algerian microlepidoptera. — Entomologists mon. Mag. 47: 190—191.
- Vári, L., 1963. South African Lepidoptera, 3. Descriptions of new Stigmellidae. — Koedoe 6: 66—75.





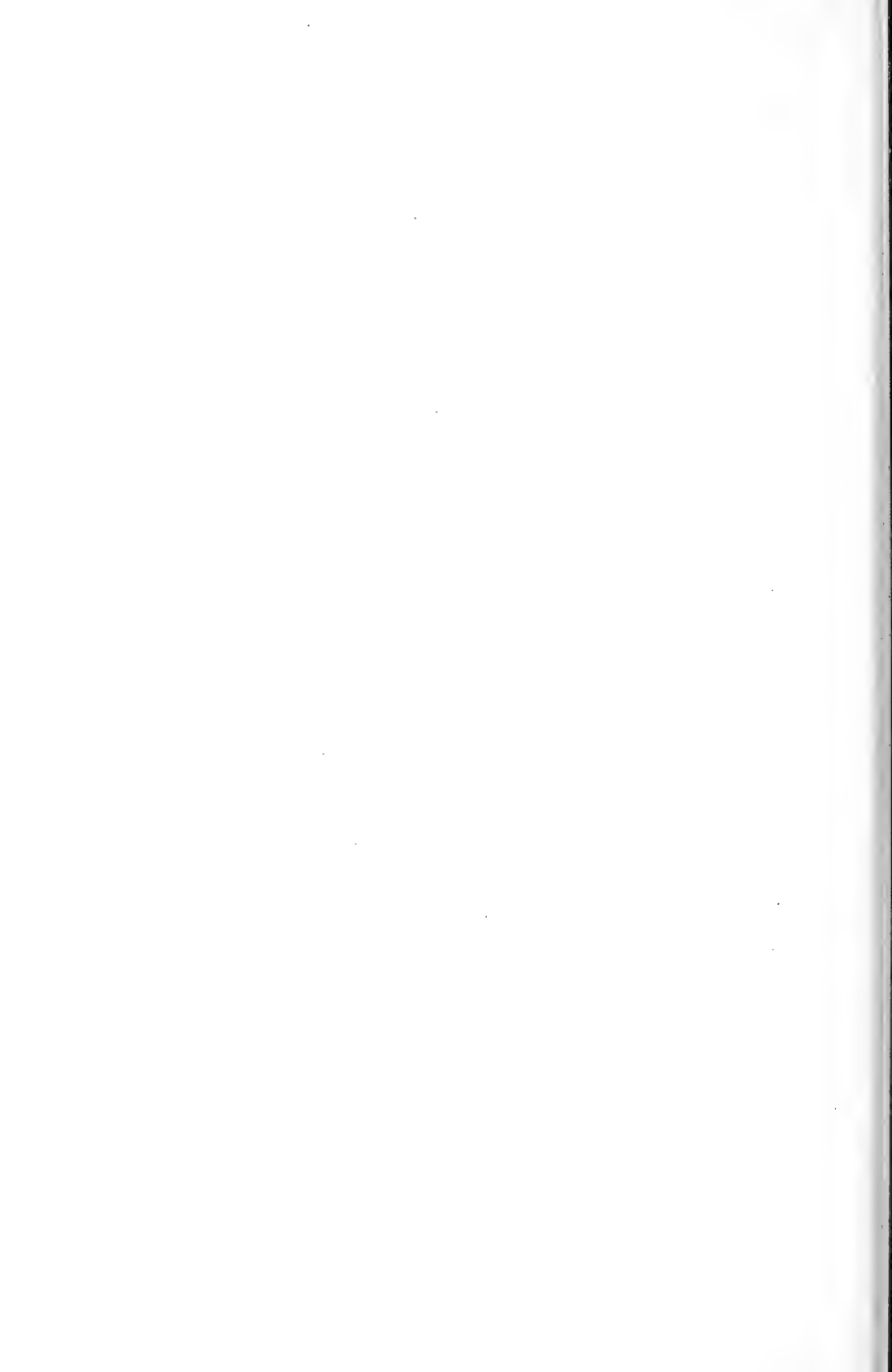



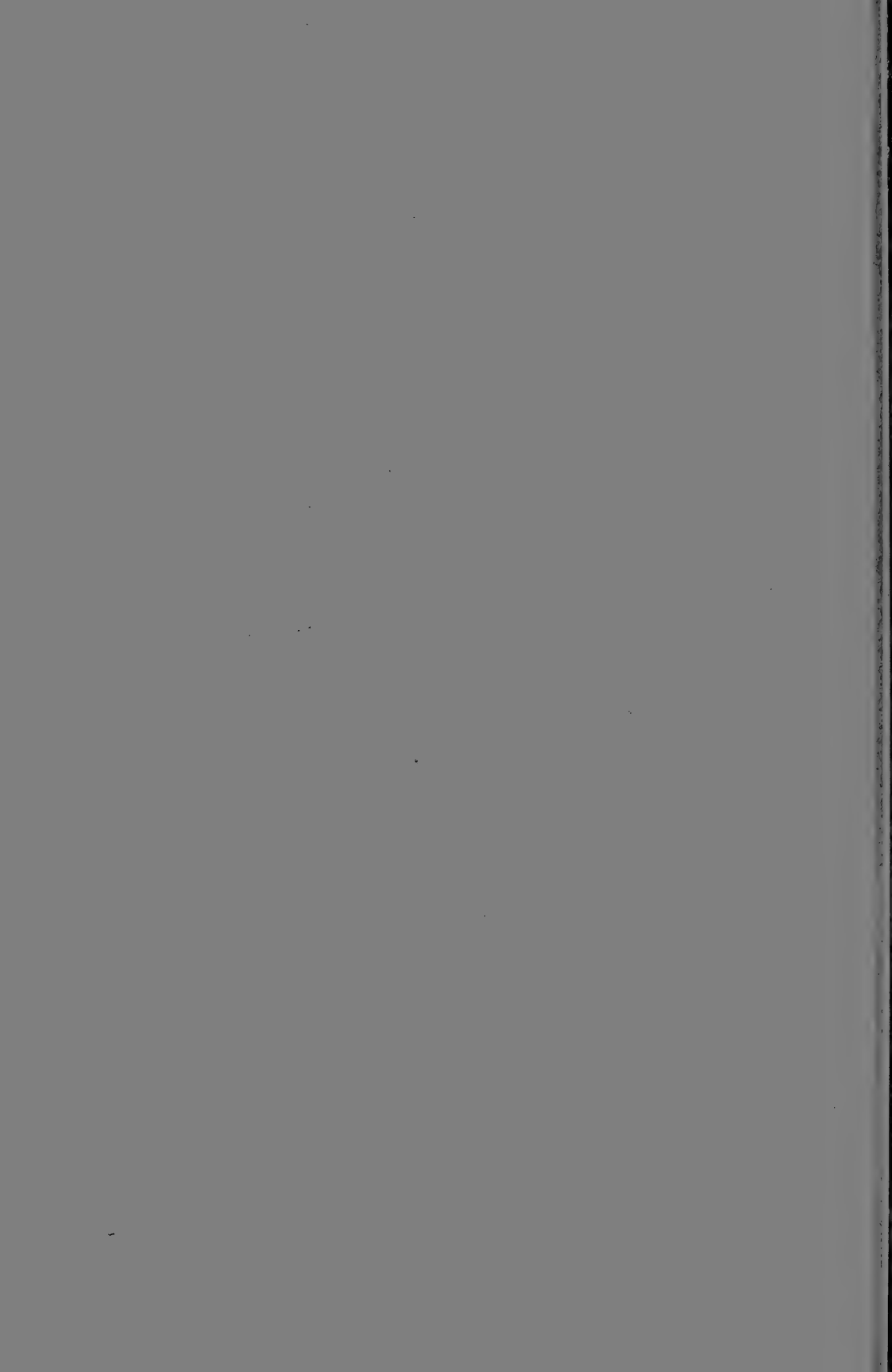

TIJDSCHRIFT VOOR ENTOMOLOGIE

UITGEGEVEN DOOR

DE NEDERLANDSE ENTOMOLOGISCHE VERENIGING

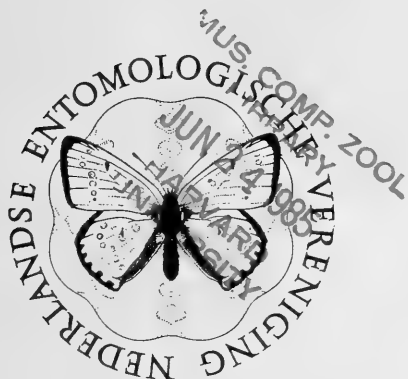

INHOUD

H. J. VLUG. — The types of Platygasteridae (Hymenoptera, Scelionoidea) described by Haliday and Walker and preserved in the National Museum of Ireland and in the British Museum (Natural History). 2. Keys to species, redescription, synonymy, pp. 179—224, figs. 1—98.

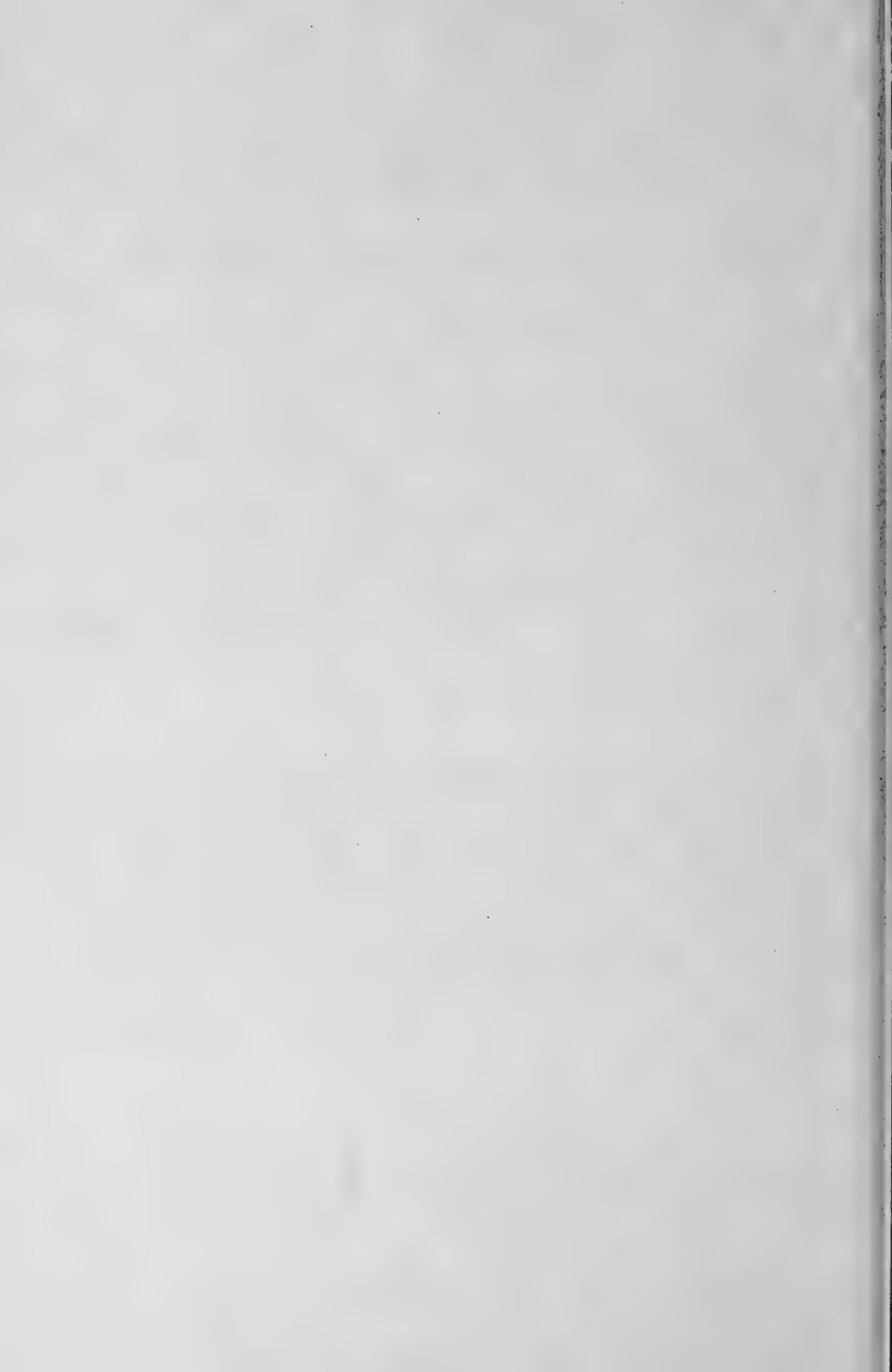

**THE TYPES OF PLATYGASTRIDAE
(HYMENOPTERA, SCELIONOIDEA) DESCRIBED BY
HALIDAY
AND WALKER AND PRESERVED IN THE NATIONAL
MUSEUM OF IRELAND AND IN THE
BRITISH MUSEUM (NATURAL HISTORY).
2. KEYS TO SPECIES, REDESCRIPTIONS, SYNONYMY**

by

H. J. VLUG

Instituut voor Plantenziektenkundig Onderzoek, Binnenhaven 12, Wageningen, The Netherlands

ABSTRACT

Keys are given for 97 Palaearctic species of Platygastriinae, described by Haliday and Walker. They comprise the genera *Platygaster*, *Synoeps*, *Piestopleura*, *Leptacis*, *Trichacis*, *Isocybus* and *Amblyaspis*. Descriptions and illustrations of the type-specimens are provided, mainly based on the lectotypes selected earlier. The following synonymies are proposed: *Platygaster olorus* Walker, 1835 = *P. cebes* Walker, 1835; *P. cratinus* Walker, 1835 = *P. cebes* Walker, 1835; *P. (Urocyclops) ilione* Walker, 1835 = *P. (Urocyclops) vaenia* Walker, 1835; *P. longiventris* Thomson, 1859 = *P. gyge* Walker, 1835; *P. ruborum* (Kieffer, 1916) = *P. pelias* Walker, 1835; *P. evadne* Walker, 1835 = *P. attenuata* Walker, 1835; *P. cleodaeus* Walker, 1835 = *P. abisares* Walker, 1835; *Synoeps mamertes* Kieffer, 1926 = *S. craterus* (Walker, 1835); *S. acco* (Walker, 1835) = *S. rhanis* (Walker, 1835); *Leptacis torispinula* Huggert, 1980 = *L. nydia* (Walker, 1835); *Amblyaspis furius* (Walker, 1835) = *A. scelionoides* (Haliday, 1835).

INTRODUCTION

For a general introduction on the types of Platygastriidae, described by Haliday and Walker I may refer to the paper by Vlug & Graham (1984). In the present paper the types are keyed out and brief redescriptions and figures are given for the species of the subfamily Platygastriinae, comprising the genera *Platygaster*, *Synoeps*, *Piestopleura*, *Leptacis*, *Trichacis*, *Isocybus* and *Amblyaspis*. For a better understanding of this group it is necessary for future workers to consult types. This key is merely an attempt to provide some detailed information about the species and to give a tool for type demands. The figures are kept rather simple and give a general view of the head, antennae and metasoma to support and amplify the descriptions. For the terms of the microsculpture, used in the key, I refer to the paper by Eady (1968).

It has been shown that many species which occur in Great Britain and Ireland are not represented in continental North-Western Europe. They are not well represented in the author's collection. Therefore the descriptions and keys are mainly based on the lectotypes in the National Museum of Ireland (NMI) and the British Museum (Natural History) (BMNH). Where possible, the distribution and hosts are mentioned. Notes on synonymy are given in the keys under the heading "Remarks".

ACKNOWLEDGEMENTS

Thanks are due to Dr. J. P. O'Connor (Dublin, Ireland), Dr. L. Masner (Ottawa, Canada), Dr. M. W. R. de Vere Graham (Oxford, Great Britain) and Dr. L. Huggert (Lund, Sweden) for their useful criticism and to Mr. C. van der Horst (Wageningen, Netherlands) for revising the English text.

Platygaster Latreille

1. Vertex and/or occiput without striae (in *Platygaster sterope* the lectotype has two very short carinae in the middle of the vertex) 2

- Vertex and/or occiput faintly to strongly striated or transversely reticulate 15
- 2. Head and mesoscutum moderately to strongly reticulate-coriaceous; head broadly rounded behind eyes, appearing thick 3
- Head and mesoscutum sometimes reticulate or coriaceous but never regularly and strongly so; head not particularly thick 12
- 3. Pronotum at sides partly coriaceous, lower third longitudinally striated and/or widely punctate with hairs 4
- Pronotum coriaceous in its upper half; lower half more or less smooth. 8
- 4. Pronotum provided with a membraneous-edged flange which covers part of fore coxa *taras* Walker, 1835

Head 2.0 times as broad as long, broadly rounded behind eyes; OOL : POL : LOL = 4 : 9 : 4; frons regularly reticulate-coriaceous, smoother above antennal sockets; occipital region irregularly coriaceous with some short and weak transverse crenulae. Propleurae coriaceous in upper half, lower half sparsely haired; pronotum with a flange which expands posteriorly into an overhanging, more or less membraneous, sclerite which partly covers fore coxa; notauli complete; mesoscutum coriaceous, its midlobe reaching scutellum; scuto-scutellar grooves deep and broad; scutellum strongly convex, well above mesoscutum; propodeal carinae high and strong. T1 crenulated; T2 striated to half of tergite; T3 with a few hairs; T4 with a single row of deeply implanted hairs; T5 partly covered with scattered and deeply implanted hairs; T6 completely covered with long and deeply implanted hairs. Black, shiny species. Antennae preponderantly black, A2 brownish. Fore legs brownish, middle and hind legs dark brown with lighter tarsi. Length female 1.9 mm (figs. 1a—1c).

- Pronotal flange simple, not covering part of coxa and not particularly expanded postero-ventrally 5
- 5. Propleurae striated in lower half, provided with a few weak hairs *otanes* Walker, 1835

Head 1.6 times as broad as long; OOL : POL : LOL = 8 : 17 : 8; head entirely reticulate coriaceous, somewhat smoother between median ocellus and antennal sockets. Mesoscutum entirely reticulate coriaceous except for two smooth lines in front between notauli, and postero-lateral lines outside notauli; notauli complete and deep; mesopleurae with some irregular striation in upper part; midlobe of mesoscutum nearly reaching scutellum, gap between these deep and broad; scutellum strongly convex, well above level of mesoscutum; propodeal carinae long and strong. T1 crenulated; T2 for three-quarter striated, at sides somewhat longer; T3 and T4 smooth with a few hairs; T5 with a single row of deeply implanted hairs; T6 with an irregular row of deeply implanted hairs; T7 with a few hairs. Black, rather dull species. Wings clear. Antennae preponderantly blackish brown. Legs entirely dark brown, fore legs lighter. Length male 1.9 mm (figs. 2a—2c).

- Propleurae smooth in lower part, with widely separated hairs 6
- 6. Occiput elevated in the middle, with some very short carinae on top of the elevation; frons with a smooth line from median ocellus downwards *sterope* Walker, 1835

Head 1.8 times as broad as long; OOL : POL : LOL = 5 : 13 : 4; head reticulate coriaceous, with the exceptions mentioned above, broadly rounded behind eyes. Notauli complete and deep; mesoscutum reticulate coriaceous; scutellum convex, above level of mesoscutum; propodeal carinae long and well apart, their top surface being smooth. T1 reticulate with two, somewhat diverging central keels; central lobe between basal foveae of T2 protruding, striation extending to half of tergite and at sides traceable as a faint wrinkling; T3—T5 with a fine row of hairs; T6 with fine, rather deeply implanted hairs. Black, shiny species. Antennae dark brown, A3 lighter. Wings only slightly infuscated. Legs dark brown, fore femur proximally and all tarsi lighter. Length female 1.4 mm (figs. 3a—3c).

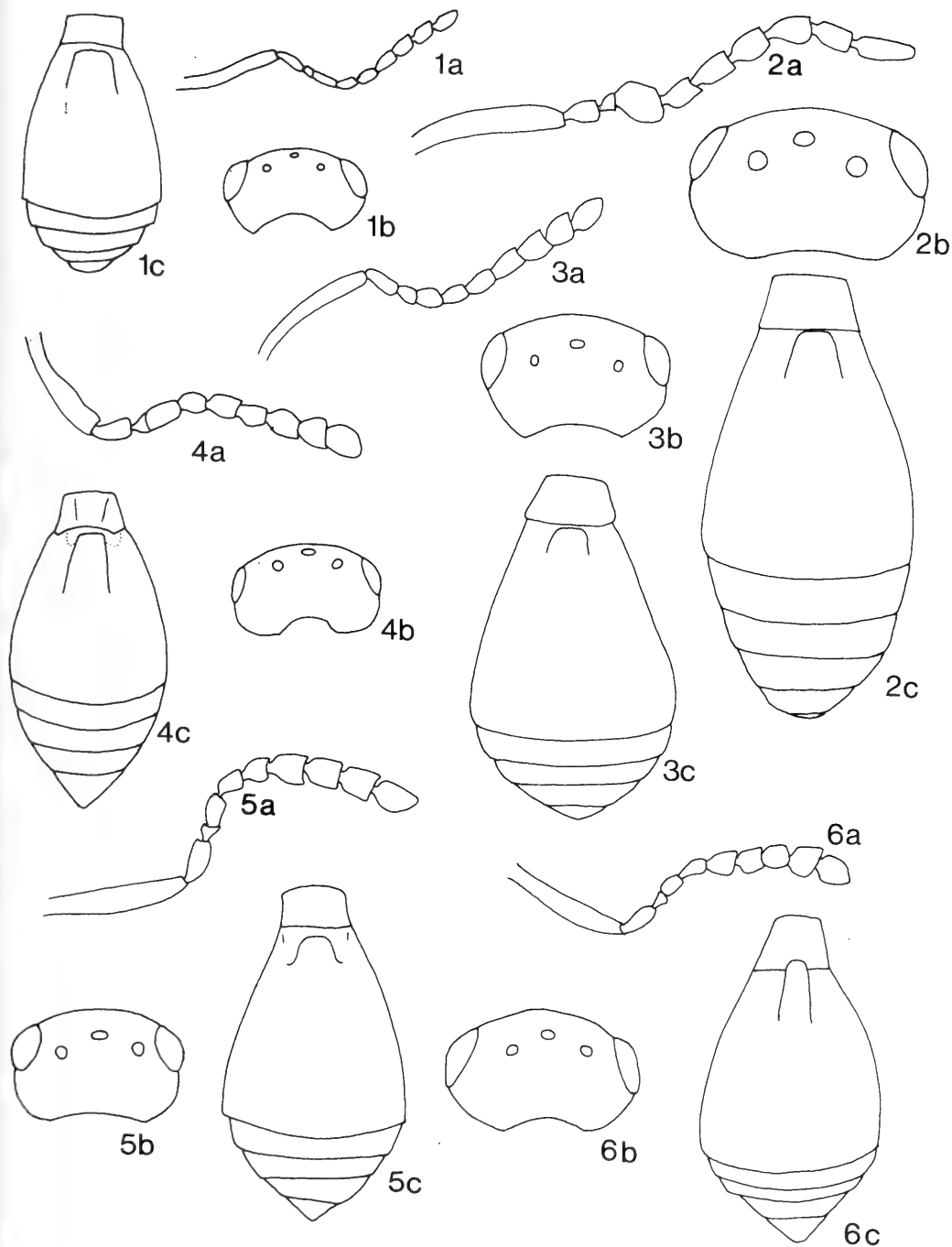

Figs. 1—6. a, antenna; b, head (dorsal view); c, metasoma (dorsal view). 1a—c, *Platygaster taras* (lectotype); 2a—c, *P. otanes* (lectotype); 3a—c, *P. sterope* (lectotype); 4a—c, *P. pleuron* (lectotype); 5a—c, *P. orus* (no. 1104 in NMI); 6a—c, *P. abia* (paralectotype no. 1109 in NMI).

- Occiput not particularly elevated in the middle; head and occiput regularly reticulate coriaceous, without any trace of carinae and smooth lines on frons; sometimes area beneath median ocellus with smoother sculpture 7
- 7. Striation on T2 in basal foveae and on central lobe extending to half of tergite *pleuron* Walker, 1835

Head 1.6 times as broad as long; OOL : POL : LOL = 6 : 9 : 4; entire head regularly reticulate coriaceous, broadly rounded behind eyes. Notauli complete and deep; mesoscutum completely reticulate coriaceous; anteriorly, between notauli, two smooth lines, with two others postero-laterally; propleurae coriaceous in upper two-thirds and smooth with hairs in lower part; scutellum convex, well above level of mesoscutum; propodeal carinae long and strong, with a rather sharp upper ridge. T1 strongly reticulate; T2 striated over whole width in first half of tergite; T3 and T4 smooth, with some lateral hairs; T5 smooth with an irregular row of brown hairs; T6 in posterior two-thirds covered with long, brown hairs. Black, shiny species. Antennae blackish, junction of A2 and A3 being somewhat lighter. Wings slightly infuscated. Fore femora brown, fore tibiae brown but apically lighter; tarsi light brown; middle and hind legs dark brown. Length female 1.7 mm (figs. 4a—4c).

- Striation on T2 only in basal foveae, central lobe being smooth; striation extending to three-quarters of tergite *orus* Walker, 1835

Head 1.7 times as broad as long; OOL : POL : LOL = 4 : 10 : 5; frons reticulate coriaceous, this sculpture being somewhat smoother just beneath median ocellus; occipital region and ocellar area slightly transversely reticulate coriaceous, in posterior middle part slightly rugulose. Mesoscutum and scutellum as in *P. pleuron* (the scutellum and T2 of the type is damaged); propodeal carinae well developed, their top surface flange-like, turned inwards and broadened in posterior part. T1 strongly crenulated; T2 striated in basal foveae to three-quarters of tergite, central lobe rather smooth with some irregular sculpture; T3 and T4 laterally with some fine hairs; T5 with a single row of fine hairs; T6 with some very faint sculpturing and widely separated, deeply implanted hairs. Black, shiny species. Antennae blackish, A2 and A3 somewhat lighter. Fore legs light brown, tibiae dorsally darker; middle legs brown; hind legs dark brown, proximal part of tibiae and tarsal segments being lighter. Length female 2.0 mm (figs. 5a—5c).

- 8. Scape, A2—A4 and all legs entirely reddish or reddish yellow 9
- Antennae and legs darkened, with lighter and darker markings; at most fore legs lighter 10
- 9. Temple as long as eye (in dorsal view); head about 1.8 times as broad as long. *abia* Walker, 1835

OOL : POL : LOL = 8 : 12 : 5; head and mesoscutum entirely, but not very strongly reticulate coriaceous. Notauli complete; scutellum convex, just above level of mesoscutum; propodeal carinae long, but not very prominent, wide apart. T2 with some short striae on central lobe between basal foveae. Black, rather dull species. Scape, A2—A4 and all legs reddish yellow. Length female 1.3 mm (figs. 6a—6c).

- Temple 1.3 times as long as eye (in dorsal view); head about 1.5 times as broad as long *lysicles* Walker, 1835

OOL : POL : LOL = 10 : 17 : 9; head and mesoscutum entirely reticulate coriaceous, fading away at some spots. Scutellum strongly convex, above level of mesoscutum; propodeal carinae wide apart, in between these some cross carinae, forming a turned M. Median lobe between basal foveae of T2 prominent, sparsely striated in one-third of tergite. Black, shiny species. Scape, A2—A4 and all legs reddish. Length female 1.8 mm (figs. 7a—7c).

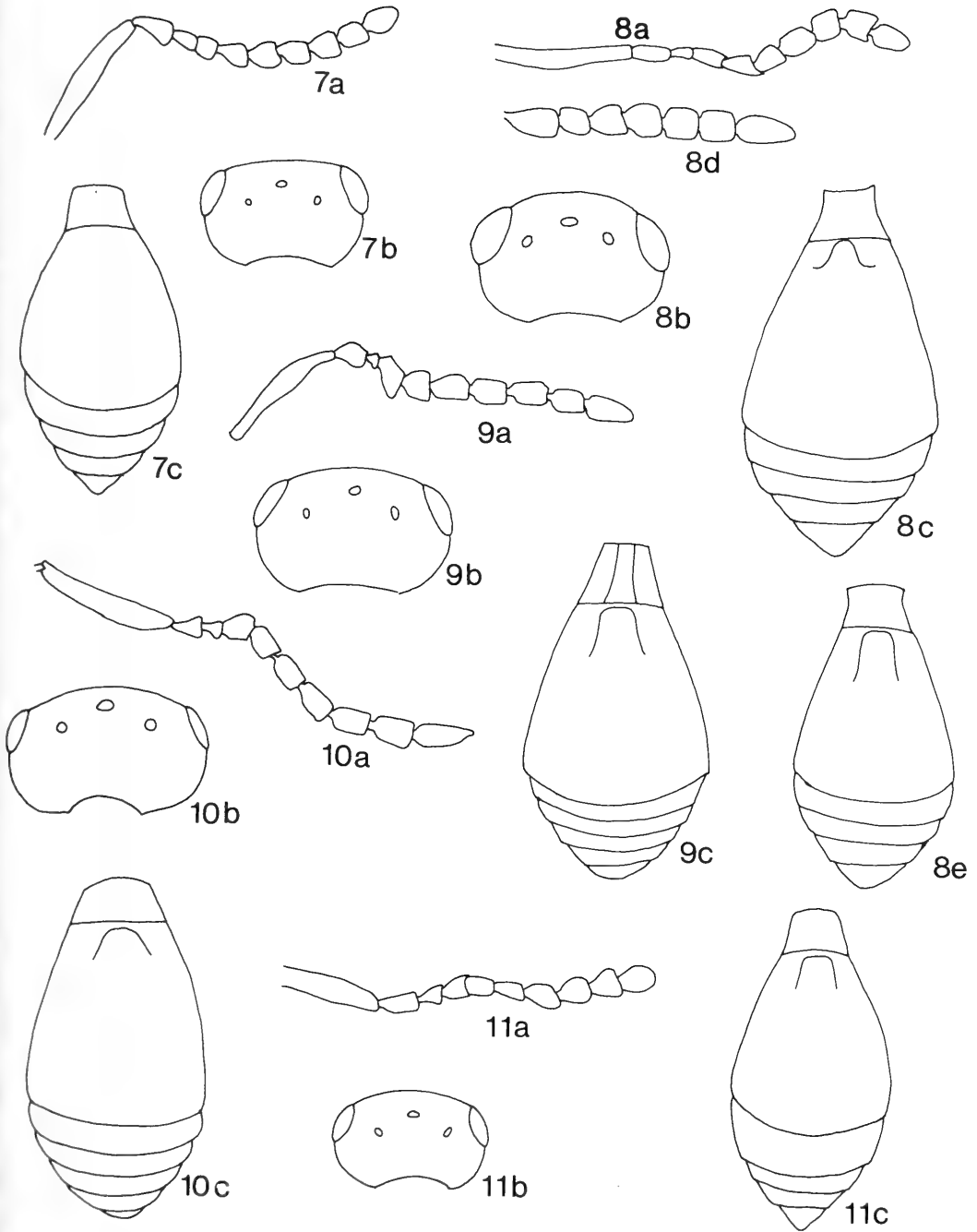

Figs. 7—11. a (d), antenna; b, head (dorsal view); c (e), metasoma (dorsal view). 7a—c, *Platygaster lysicles* (lectotype); 8a—c, *P. sonchis* (lectotype); 8d—e, *P. dictys* (lectotype); 9a—c, *P. cebes* (lectotype); 10a—c, *P. olorus* (paralectotype no. 336 in NMI); 11a—c, *P. cratinus* (lectotype).

- 10. T2 striated to half of tergite. Propodeal carinae prominent, parallel and without transverse connections *sonchis* Walker, 1835

Head 1.7 times as broad as long; OOL : POL : LOL = 5 : 13 : 5; frons faintly coriaceous, shiny; vertex and occiput reticulate coriaceous, occiput more irregularly. Mesoscutum reticulate coriaceous; notauli complete and deep; scutellum strongly convex and steeply sloping to metanotum. Central lobe between basal foveae of T2 prominent. Black, shiny species. Antennae black. Fore legs brown, middle and hind legs black with lighter femora and tarsi. Length female 1.6 mm (figs. 8a—8c).

Remarks. — The male specimen of *P. dictys* Walker, 1835, is very much alike. The type of *P. dictys*, however, is missing head and most part of antennae (figs. 8d—8e). Slight differences may be found in the measurements of the mesoscutum (width × length is 0.36 × 0.36 mm in *P. dictys* and 0.31 × 0.35 mm in *P. sonchis*). Reared series of this species may solve any possible synonymy.

- T2 nearly smooth, somewhat striated in its basal third. Propodeal carinae connected by one or more transverse carinae 11
- 11. T2 faintly striated in basal foveae, rest of tergite smooth *cebes* Walker, 1835

Head 1.7 times as broad as long; OOL : POL : LOL = 8 : 16 : 8; frons faintly coriaceous with some transverse wrinkles above antennal sockets; vertex, occiput and mesoscutum reticulate coriaceous. Scutellum convex, just above level of mesoscutum; propodeal carinae prominent, area in between them roughly crenulated and elevated above the rest of propodeum. Black, shiny species. Antennae dark brown. All legs dark brown, tarsi lighter. Length male 1.4 mm (figs. 9a—9c).

- T2 slightly to moderately striated in and between basal foveae, rest of tergite smooth *olorus* Walker, 1835

Head 1.4 times as broad as long; OOL : POL : LOL = 9 : 17 : 9 (head of the type slightly damaged between lateral ocelli); frons finely coriaceous, faintly striated above antennal sockets; coriaceous on vertex and occiput. Mesoscutum reticulate coriaceous; notauli complete; scutellum convex, just above level of mesoscutum; propodeal carinae with cross carinae, giving the appearance of a butterfly in outline; lateral areas of propodeum densely covered with brown hairs. Black, shiny species. Antennae black. Legs dark brown; all tibiae proximally and distally lighter and all tarsi lighter. Length male 1.5 mm (figs. 10a—10c).

Remarks. — *P. cratinus* Walker, 1835, differs from *P. olorus* by the following characters: Head 1.7 times as broad as long; OOL : POL : LOL = 9 : 18 : 8. Propodeal carinae forming two longitudinal ovals; sides of propodeum sparsely hairy. Length female 1.8 mm (figs. 11a—11c). Despite the differences given for *P. olorus*, *P. cebes* and *P. cratinus*, I consider them to be conspecific. In my collection are some forms intermediate in colour as well as in morphological characters. I select here the name *Platygaster cebes* with *P. olorus* and *P. cratinus* as synonyms (**syn. nov.**).

- 12. Head (except occiput) and mesoscutum smooth, shiny *strato* Walker, 1835

Head 1.6 times as broad as long; OOL : POL : LOL = 6 : 9 : 3. Notauli traceable anteriorly, posteriorly clearly defined; scutellum moderately convex; propodeal carinae high, widely separated and not flattened dorsally. T2 with striated basal foveae, rest of tergite smooth. Dark brown species with darker head. Antennae brown. Fore legs brown, tibiae proximally and distally lighter, tarsi dirty yellow; middle and hind legs brown, tarsi lighter. Length female 1.1 mm (figs. 12a—12c).

- At least frons with microsculpture 13
- 13. Mesoscutum smooth, shiny (*Urocyclops*) *vaenia* Walker, 1835

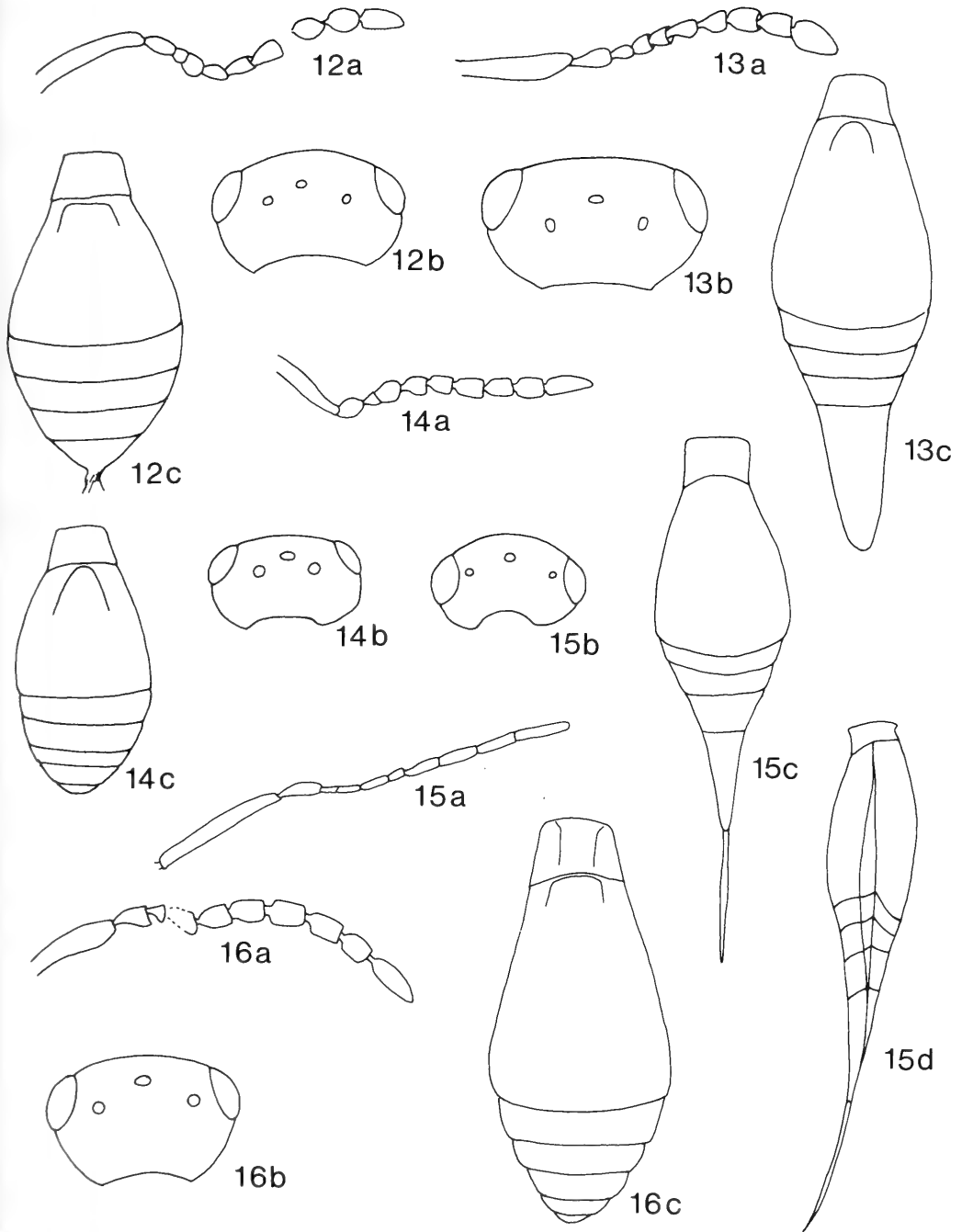

Figs. 12—16. a, antenna; b, head (dorsal view); c, metasoma (dorsal view); d, metasoma (lateral view). 12a—c, *Platygaster strato* (paralectotype no. 384 in NMI); 13a—c, *P. (Urocyclops) vaenia* (lectotype); 14a—c, *P. (Urocyclops) ilione* (lectotype); 15a—d, *P. xeneus* (lectotype); 16a—c, *P. rutubus* (lectotype).

Head 1.7 times as broad as long; OOL : POL : LOL = 9 : 16 : 6; occiput with a few weak wrinkles, vertex and part of frons coriaceous. A modified pronotal structure presented by a semicircular plate in the neck region between collar and mesoscutum; notauli not meeting, becoming more or less parallel posteriorly; scutellum smooth, moderately convex. T2 striated to half of tergite; T6 extremely flattened, twice as long as broad at base, forming a "beaver-tail". Black, shiny species. Antennae dark brown, tip of scape, A2 and A3 lighter. Coxae black, trochantera reddish, all femora proximally reddish, distally darkened; all tibiae dark brown, proximally and distally lighter; tarsi red. Length female 2.0 mm (figs. 13a—13c).

Remarks. — *P. (Urocyclops) ilione* Walker, 1835, differs from *P. (U.) vaenia* by the following characters: OOL : POL : LOL = 6 : 10 : 4. Notauli less deep than in *P. vaenia*. Trochantera darker than in *P. vaenia*; fore tibiae to a greater extent lighter than in *P. vaenia*. Length male 1.1 mm (figs. 14a—14c). *P. ilione* represents the male of *P. vaenia* and may be considered a synonym (**syn. nov.**). *Platygaster vaenia* belongs in the subgenus *Urocyclops* Maneval. Recent material of this subgenus was reared in large quantities for the first time from the gallmidge *Procytiphora gerardi* Meyer on *Juncus gerardii* Lois, by Dr. H. Meyer, Kiel, Germany, and kindly placed at my disposal. Detailed studies and comparison of the specimens with the material mentioned by Huggert (1974) may solve the problems of synonymy associated with these highly polymorphic taxa.

- Mesoscutum with sculpture 14
 14. Head coriaceous, about 2.1 times as broad as long; OOL : POL : LOL = 2 : 16 : 7; antennae long and slender *xeneus* Walker, 1838

Mesoscutum irregularly and weakly reticulate; notauli incomplete; scutellum moderately convex, in dorsal view rounded, apically extended into a small sharp triangle; propodeum with a few long hairs, surface between these hairs smooth; propodeal carinae elevated, with a flattened surface. T1 laterally provided with long hairs; metasoma long oval, gradually tapering apically and with a long and sharply pointed T6 (2.2 times as long as broad at base), for the most part strigose. Length female 1.4 mm (except ovipositor) (figs. 15a—15d).

Remarks. — Antennae of *P. xeneus* remarkably long and slender, with a 4-jointed slender club: (length × width) A1: 0.27 × 0.04 mm; A2: 0.09 × 0.03 mm; A3: 0.04 × 0.02 mm; A4: 0.06 × 0.02 mm; A5: 0.05 × 0.02 mm; A6: 0.03 × 0.02 mm; A7: 0.08 × 0.03 mm; A8: 0.08 × 0.03 mm; A9: 0.08 × 0.03 mm; A10: 0.10 × 0.03 mm. This species combines characters of *Platygaster* and *Synopeas*. It may represent a new genus. A more detailed study is being carried out.

- Head faintly coriaceous, swollen and about 1.4 times as broad as long; OOL : POL : LOL = 6 : 16 : 8; antennae not particularly long and slender *rutubus* Walker, 1835

Epomia strong; mesoscutum partly irregularly coriaceous, rest of mesoscutum smooth; notauli indicated, but evident only in extreme posterior part; scutellum convex, clearly above level of mesoscutum; propodeal carinae wide apart and high. Metasoma long oval, 1.4 times as long as mesosoma; T2 with deep, basal pits, median lobe not developed into a raised tongue; T2 laterally striated to half of its length. Black, shiny species. Antennae brown, scape and A3 red. Mouthparts red. Wings infuscated. Legs entirely yellowish red. Length male 1.6 mm (figs. 16a—16c).

15. No trace of notauli. Median plate, situated between imaginary notaulic courses prolonged into a flange which covers base of scutellum 16
 — Notauli at least traceable in posterior part of mesoscutum; median plate different 19
 16. Scutellum entire, not excavated or prolonged plate-like posteriorly *inermis* Walker, 1835

Head 2.2. times as broad as long; OOL : POL : LOL = 3 : 11 : 5; frons faintly strigose, vertex and occiput striate. Mesoscutum sparsely haired, hair-implantations scale-like; "median plate" of mesoscutum prolonged into a broad flange, which is membranous in its extreme

hind border, covering base of scutellum; scutellum moderately convex, not above level of mesoscutum; propodeal carinae high and wide apart. T2 striated from basal foveae to one-third; T3—T5 equal, T6 longer, as long as broad at base. Black, shiny species. Wings slightly infuscated. Antennae and legs dark brown, tarsi lighter. Length female 1.3 mm (figs. 17a—17c).

- Scutellum excavated from behind, its surface extended into a membranous plate of different structure 17

Remarks. — The species of the “*cochleata* group” key out here. These may belong to *Prosynopeas* Kieffer. Apparently the type of this genus is lost, but rearing may solve the problem. It is also possible that they belong to *Ceratacis* Thomson, the type of which has yet to be examined (Huggert, pers. comm.). Therefore this group has not been properly defined.

17. Median plate of mesoscutum only slightly prolonged, just covering extreme base of scutellum; scutellum moderately convex, in lateral view cut off posteriorly at an angle of 90°; scutellum, seen from behind, clearly excavated, possessing a narrow membranous flange *laricis* Haliday, 1835

Head 2.0 times as broad as long; OOL : POL : LOL = 6 : 10 : 6. Propodeal carinae high and well apart. T2 faintly striated in its basal foveae. Black, shiny species. Antennae yellow, last four segments brownish. Coxae and legs entirely yellow. Length female 1.2 mm (figs. 18a—18c).

- Median plate of mesoscutum prolonged into a broad membranous plate, postero-lateral parts of mesoscutum provided with long hairs, covering base of scutellum; scutellum excavated and dorsally prolonged into a broad plate, high above propodeum, and a second membranous plate under it 18
18. Head 1.7 times as broad as long; OOL : POL : LOL = 3 : 17 : 6; head faintly coriaceous; a small triangular plate between antennal sockets *cochleata* Walker, 1835

Mesoscutum with long hairs; prolongation of scutellum straight apically; propodeum with two widely separated, blunt carinae. T2 with shallow basal foveae, in between these faintly striated. Black, shiny species. Antennae red, last four segments dark. Legs entirely red, coxae darker. Length female 1.7 mm (figs. 19a—19c).

Remarks. — *P. filicornis* Walker, 1835, differs from *P. cochleata* by the following characters: Male. Head 2.2 times as broad as long; OOL : POL : LOL = 3 : 16 : 7; antennae and legs slightly darker than in *P. cochleata*. Length male 1.4 mm (figs. 20a—20c). *Platygaster filicornis* may prove to be the male of *P. cochleatus*, but considering the shape of the head, this is not certain. Rearing may prove the conspecificity of both species, but until then I consider them to be two separate species.

- Head 2.4 times as broad as long; OOL : POL : LOL = 6 : 13 : 7; head entirely but faintly reticulate *vestinus* Walker, 1835

Occipital carina traceable. Median plate of mesoscutum slightly, but very broadly prolonged as a light brown flange, over base of scutellum; postero-lateral parts of mesoscutum sparsely hairy; scutellum long, and slightly convex, at level of mesoscutum, excavated behind and prolonged by a short membrane; mesoscutum faintly coriaceous, sparsely hairy; propodeal carinae high, very close, seemingly fused. Black, shiny species. Antennae brown. Legs brown, tarsi lighter. Length male 1.3 mm (figs. 21a—21c).

Remarks. — *Platygaster leptines* Walker, 1835, differs only slightly from *P. vestinus* Walker, 1835, by the following characters: Frons, vertex and occiput transversely coriaceous. Scutellum ending into a toothed lamella-like structure; propodeal carinae rather close to each other, moderately high and with a blunt surface. Length male 1.2 mm (figs. 22a—22c). *P.*

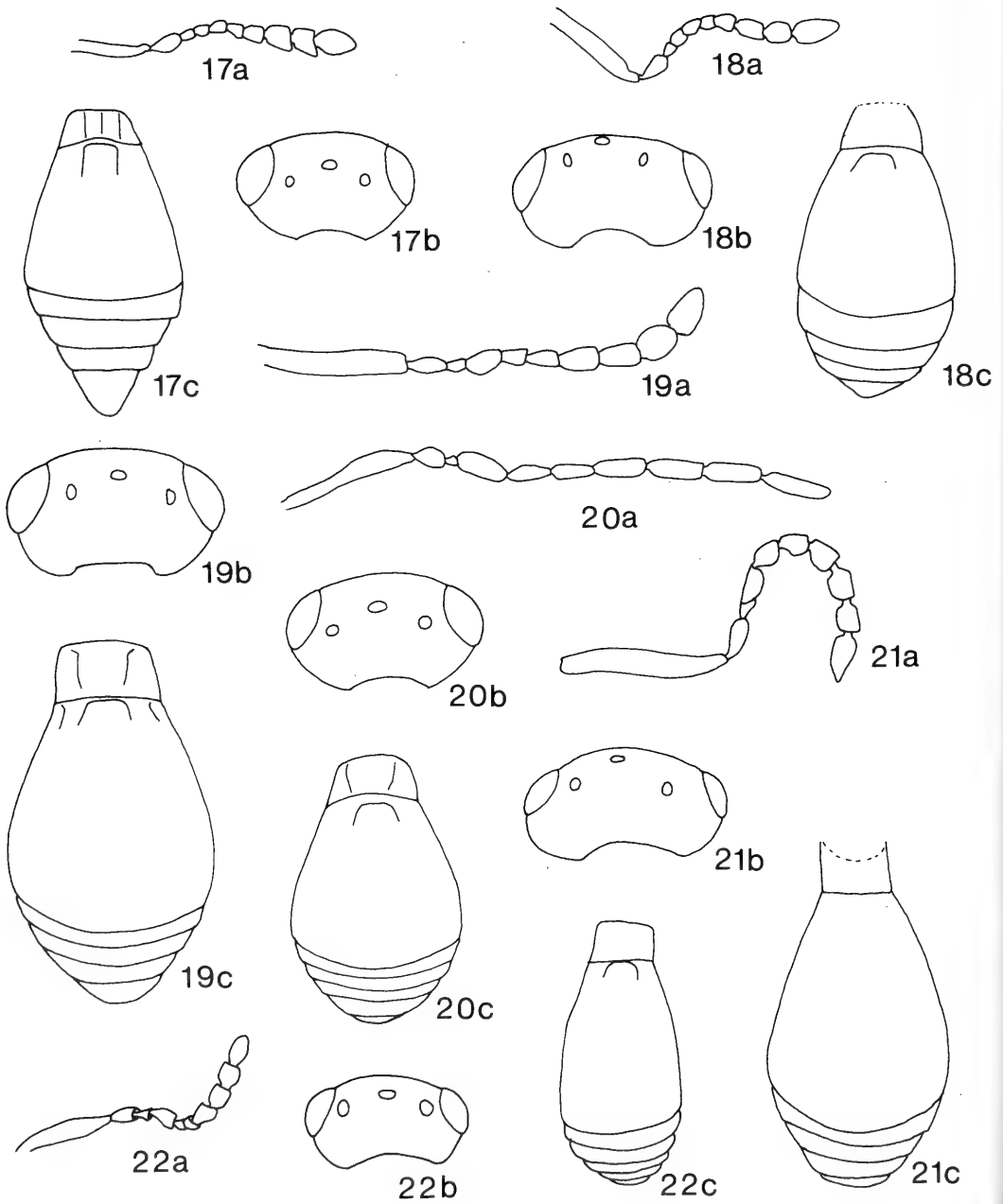

Figs. 17—22. a, antenna; b, head (dorsal view); c, metasoma (dorsal view). 17a—c, *Platygaster inermis* (lectotype); 18a—c, *P. laricis* (lectotype); 19a—c, *P. cochleata* (lectotype); 20a—c, *P. filicornis* (lectotype); 21a—c, *P. vestinus* (lectotype); 22a—c, *P. leptines* (lectotype).

vestinus and *P. leptines* have some characters in common with species of *Leptacis*, *Platygaster* and the "cochleata group" of *Platygaster*. Their systematic position needs further study. In some respects the species are similar, nevertheless I prefer to consider them separate species until rearing results prove their conspecificity.

19. Smooth and shiny species; sometimes faint sculpture in anterior region of mesoscutum 20
 — At least some microsculpture on head and/or mesoscutum 22
 20. Head about 1.9 times as broad as long. Notauli incomplete. *galenus* Walker, 1835

OOl : POL : LOL = 5 : 11 : 3; head smooth, shiny; occiput very weakly transversely striated. Mesoscutum smooth and shiny; median plate between notauli prolonged and just reaching scutellum; scutellum convex, smooth in its centre and haired at its sides; propodeum very short. T2 striated in basal foveae, these very short; rest of T2 smooth shiny; T5 and T6 long, T6 slightly longer than T5; T5 rugulose, 1.2 times as long as broad at base. Black, shiny species. Antennae dark brown. Legs dark brown, fore tarsi lighter. Length female 1.1 mm (figs. 23a—23c).

- Head about 2.3 times as broad as long. Notauli nearly complete 21
 21. Scutellum convex, above level of mesoscutum *cyrsilus* Walker, 1835

Head 2.3 times as broad as long; OOL : POL : LOL = 6 : 12 : 5; occiput transversely striated, rest of head smooth, shiny. Mesoscutum smooth, shiny; scutellum smooth, shiny, rounded, postero-lateral border excavated; propodeum short, carinae high and wide apart. T2 with some striation in and between basal foveae; rest of metasoma smooth, shiny; T4—T6 long, T6 1.4 as long as broad at base. Black, shiny species. Antennae dark brown. Legs blackish, tarsi lighter; fore tibiae proximally and distally lighter. Length female 1.6 mm (figs. 24a—24d).

- Scutellum moderately convex, at level of mesoscutum *dryope* Walker, 1835

Head 2.3 times as broad as long; OOL : POL : LOL = 5 : 13 : 5; occiput transversely striated, rest of head smooth, shiny. Mesoscutum smooth, shiny; scutellum smooth, shiny, its postero-lateral borders entire; propodeum longer than in former species, carinae wide apart and protruding backwards. T2 striated in and between basal foveae; T4—T6 short, T6 0.3 as long as broad at base. Black, shiny species. Antennae brown. All femora brown, all tibiae brown, proximally lighter; fore tarsi yellowish, middle and hind tarsi brown. Length female 1.1 mm (figs. 25a—25c).

22. Scutellum strongly convex, more or less compressed in posterior part and postero-laterally with a strong rounded impression; median plate of mesoscutum prolonged and usually covering base of scutellum 23

- Scutellum slightly to moderately convex, entire or at most with a small roundish impression, never more or less compressed; median plate of mesoscutum at most reaching base of scutellum 24

23. Head about 2.0 times as broad as long; OOL : POL : LOL = 7 : 14 : 5; frons alutaceous
 *athamas* Walker, 1835

Occiput rounded and strongly striated. Mesoscutum rather smooth, in front slightly rugulose; notauli incomplete, median plate between these continuing over base of scutellum; posterior border of median plate broadly rounded; propodeum with high carinae, wide apart and a weak transverse carina between them. T2 striated in basal foveae to half of tergite, median lobe between foveae only striated at base; rest of tergite smooth; hairs on T3—T6 deeply implanted; T6 1.2 as long as broad at base. Black, shiny species. Antennae black. Legs black, tibiae proximally lighter, tarsi light brown. Length female 1.6 mm (figs. 26a—26c).

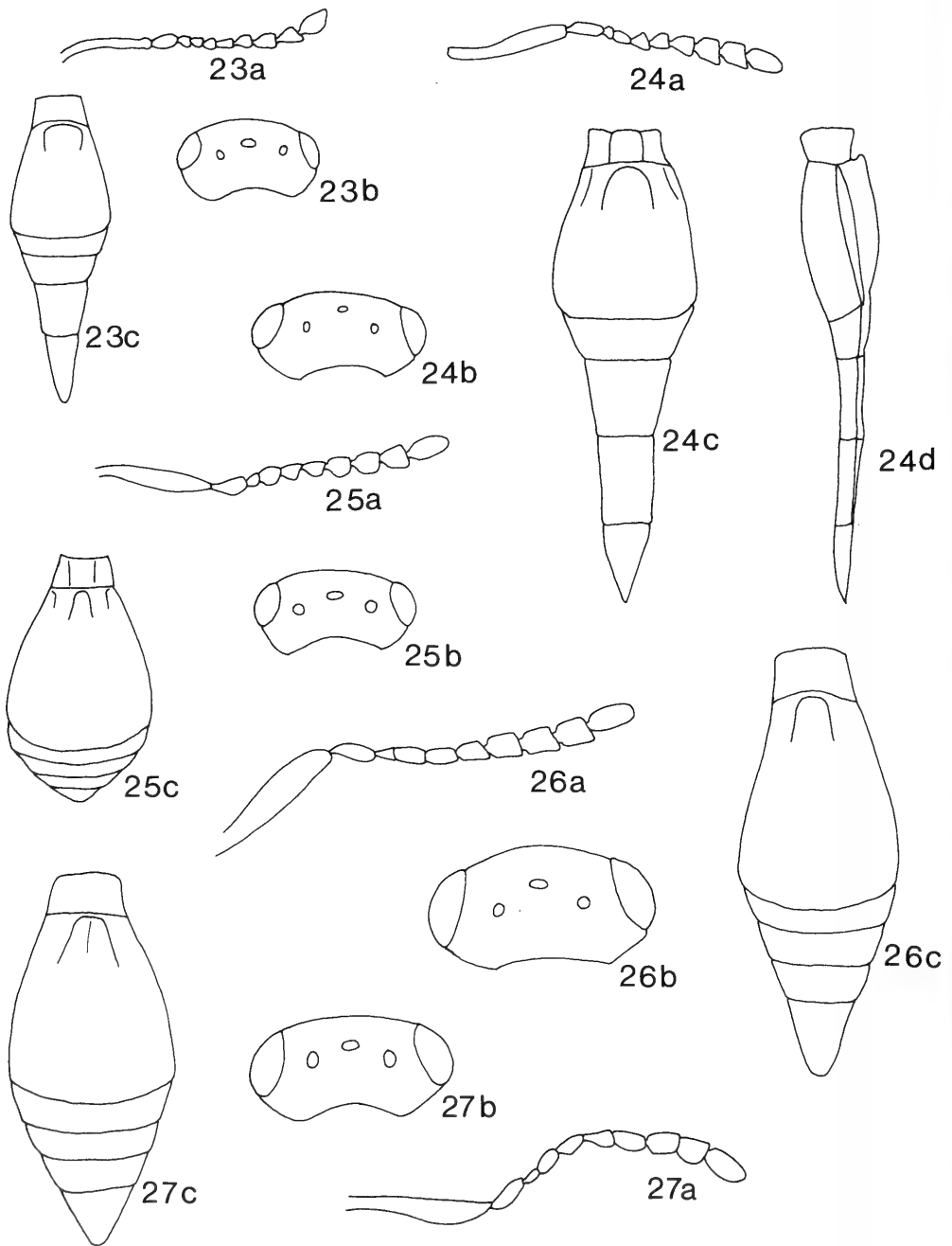

Figs. 23—27. a, antenna; b, head (dorsal view); c, metasoma (dorsal view); d, metasoma (lateral view). 23a—c, *Platygaster galenus* (lectotype); 24a—d, *P. cyrsilus* (lectotype); 25a—c, *P. dryope* (lectotype); 26a—c, *P. atbas* (lectotype); 27a—c, *P. euhemerus* (lectotype).

- Head about 2.5 times as broad as long; OOL : POL : LOL = 4 : 11 : 4; frons faintly fan-like striated *euhemerus* Walker, 1835

Occipital carina present between some transverse striae on vertex, occiput strongly striated. Mesoscutum rather smooth, weakly coriaceous anteriorly; rest of mesosoma as in *P. athamas*. Basal foveae of T2 striated to half of tergite, midlobe between these smooth, except for a short median longitudinal carina; rest of tergites smooth; hairs on T3—T6 less deeply implanted than in *P. athamas*; T6 0.7 times as long as broad at base. Black, shiny species. Antennae black, A2 and A3 lighter. Fore femora black, tibiae light brown, tarsi lighter; middle femora black, tibiae brown, proximally lighter, tarsi light brown; hind femora black, tibiae dark brown, proximally lighter, tarsi brown. Length female 1.5 mm (figs. 27a—27c).

Remarks. — Both *Platygaster athamas* and *P. euhemerus* seem to be rather variable, even in morphological characters, such as the structure of the midlobe of the mesoscutum, the depressions of the scutellum and the striation of T2. A good character seems to be the microsculpture on the propodeum between the carinae: *P. euhemerus* has distinct transverse carinae here, somewhat stronger in females than in males. *P. athamas* was reared from *Bayeria capitigena* Br. on *Euphorbia esula* L. ("The Netherlands, Wessum, August 1971, leg. Vlug") and *Rhabdophaga terminalis* H. Loew on *Salix alba* L. ("The Netherlands, Brandwijk, July 1973, leg. Vlug"). The specimens from *R. terminalis* are larger than those from *B. capitigena*. Other reared material of this species is from *Wachtliella rosarum* Hardy on *Rosa* sp. ("The Netherlands, Cuyk, September 1973, leg. Vlug").

24. Females 25
 — Males 47
 25. T5 either only slightly broader than long or as long as broad at base or longer than broad (cf. figs. 28c—40c) 26
 — T5 strongly transverse (cf. figs. 41c—50c) 38
 26. T4 longer than broad at base (cf. figs. 28c—33c) 27
 — T4 broader than long (cf. figs. 34c—40c) 32
 27. T3—T6 strongly depressed and flattened dorsally; T2 ventrally without a hump between hind coxae 28
 — T3—T6 more or less convex dorsally in transverse section; T2 possessing a hump antero-ventrally between hind coxae 29
 28. Legs red. Tergites without microsculpture *gyge* Walker, 1835

Head 2.3 times as broad as long; OOL : POL : LOL = 5 : 16 : 7; frons transversely coriaceous with a clear midline from median ocellus to clypeus; temple as long as diameter of an eye; occiput weakly and transversely striated. Mesoscutum longitudinally coriaceous; notauli complete and deep; scutellum moderately convex, just above level of mesoscutum; propleurae with microsculpture in its upper half; mesopleurae striated in their upper arc; propodeum at sides densely covered with long hairs, carinae well developed. T1 crenulated; basal foveae of T2 not very deep, possessing striae to half of tergite; rest of tergites smooth, shiny; T3 trapezoidal; T4 tapering gradually, 1.8 as long as broad at base; T5 parallel. Black, shiny species. Antennae dark brown, A2 and base of A3 lighter. Legs red, fore legs lighter. Length female 2.6 mm (figs. 28a—28c).

Remarks. — *Platygaster longiventris* Thomson 1859 (*syn. nov.*) proved to be conspecific with *P. gyge*. I compared the lectotype of *P. gyge* with material of *P. longiventris*, identified by Huggert. A detailed description of this species is given by Huggert (1973).

- Legs dark brown, except distal part of fore legs, which is brownish. T2—T6 with longitudinal microsculpture, tergites at their joints smooth *attenuata* Walker, 1835

Head 2.1 times as broad as long; OOL : POL : LOL = 5 : 15 : 7; frons smooth, except a fine microsculpture towards the eyes and around antennal sockets; around ocelli finely coriaceous; occiput finely transversely striated. Notauli complete; mesoscutum longitudinally coriaceous; scutellum moderately convex, slightly above level of mesoscutum; propodeum at

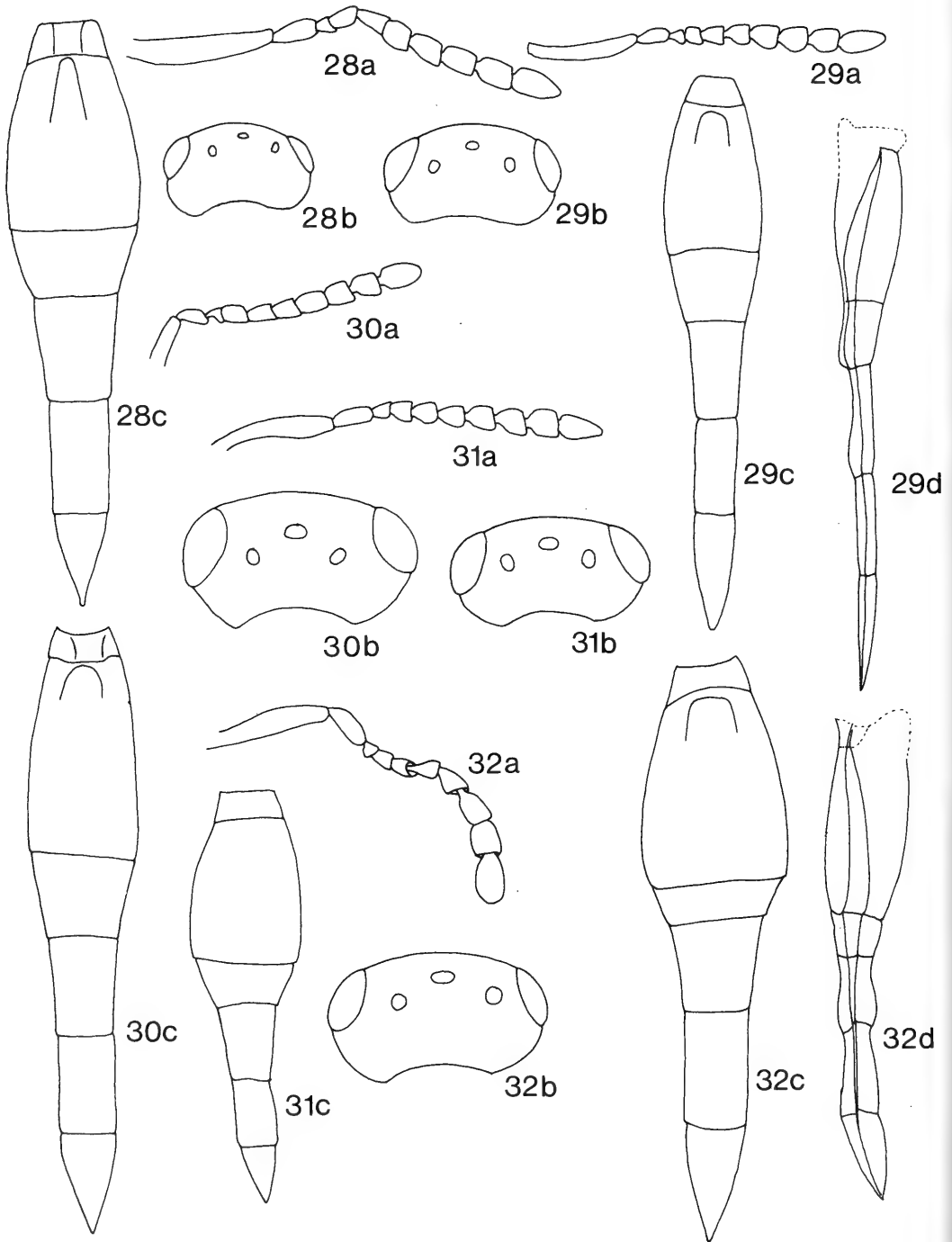

Figs. 28—32. a, antenna; b, head (dorsal view); c, metasoma (dorsal view); d, metasoma (lateral view). 28a—c, *Platygaster gyge* (lectotype); 29a—d, *P. attenuata* (paralectotype no. 1074 in NMI); 30a—c, *P. acrisius* (lectotype); 31a—c, *P. munita* (lectotype); 32a—d, *P. tisiae* (paralectotype no. 288 in NMI).

sides densely covered with hairs, carinae well developed. T1 with two well defined keels, between these two moderately deep pits; T2 densely striated to one-third of tergite; metasoma from middle of second tergite on tapering very gradually, T4 and T5 nearly parallel and T6 sharply pointed; ovipositor of lectotype extruded and as long as abdomen. Black, shiny species. Antennae black. Legs blackish brown; fore tibiae apically and tarsi brownish. Length female 2.4 mm (figs. 29a—29d).

29. Wings clear. T1 with two carinae, in between these smooth; T2 about 1.8 times as long as broad at its widest, posterior part, the sides nearly parallel *acrisius* Walker, 1835

A8 and A9 as long as broad; vertex from behind strongly, half-circularly striated. Head 1.8 times as broad as long; OOL : POL : LOL = 4 : 14 : 6; frons completely irregularly coriaceous. Notauli complete; mesoscutum longitudinally coriaceous; scutellum convex, above mesoscutum; propodeum not particularly hairy, carinae well developed. T1 crenulated, with two sharp keels, smooth in between; T2 with rather deep basal foveae, striated to half of tergite and between these some striae on tongue-like midlobe; T3—T6 with longitudinal microsculpture; joints of tergites thickened, tergites convex in cross-section. Black, shiny species. Antennae black. Legs dark brown, all tarsi lighter. Length female 2.4 mm (figs. 30a—30c).

- Wings infuscated. T1 with two or three carinae. T2 1.2 times as long as broad at its widest part, its sides rounded and tapering backwards 30
30. T3 strongly tapering *munita* Walker, 1835

A8 and A9 slightly longer than broad. Vertex with some incomplete carinae. Head 2.4 times as broad as long; OOL : POL : LOL = 5 : 15 : 7; lower half of frons weakly transversely striated, middle of frons smooth and shiny; coriaceous along eyes and around median ocellus; occiput with strong, transverse carinae. Mesoscutum longitudinally coriaceous; notauli complete; propleurae smooth, shiny, at shoulders weakly coriaceous; scutellum posterolaterally with shallow, roundish impressions. T1 with two strong carinae, anterior lobe between these elevated as a transparent brown lamella; T2 with very deep basal foveae, which are weakly striated to middle of tergite; T4 1.2 times as long as broad at base; T5 1.9 times as long as broad, linear; T4 and T5 with superficial sculpture; T6 pointed apically. Black, shiny species. Antennae black. Legs dark brown, all tibiae distally somewhat lighter. Length female 2.0 mm (figs. 31a—31c).

- T3 gradually tapering (cf. figs. 32c—33c) 31
31. T1 with two carinae. A8 and A9 slightly shorter than broad (2.8 : 3). Head about 1.6 times as broad as long *tisias* Walker, 1835

OOL : POL : LOL = 5 : 14 : 6; frons rather smooth; ocellar region coriaceous, occiput transversely coriaceous. Notauli complete; mesoscutum longitudinally coriaceous; scutellum moderately convex, slightly above level of mesoscutum; propodeum not densely covered with long hairs, carinae high. T1 crenulated; basal foveae of T2 deep and striated, striation continuing to one-third of length; midlobe between basal foveae tongue-like with some striae; rest of metasoma smooth, joints between tergites thickened. Black, shiny species. Antennae dark brown. Wings infuscated. Legs dark brown, fore tibiae apically and all tarsi lighter. Length female 1.6 mm (figs. 32a—32d).

- T1 with three carinae. A8 and A9 clearly longer than broad (4 : 3). Head about 2.3 times as broad as long *chrysiptus* Walker, 1835

OOL : POL : LOL = 3 : 8 : 3; frons smooth in middle part, striated above antennal sockets, transversely striate to coriaceous at both sides of the smooth middle part; ocellar region coriaceous with strong transverse striation between lateral ocelli; occiput striated. Notauli complete, midlobe between them coriaceous, posteriorly longitudinally coriaceous; a coria-

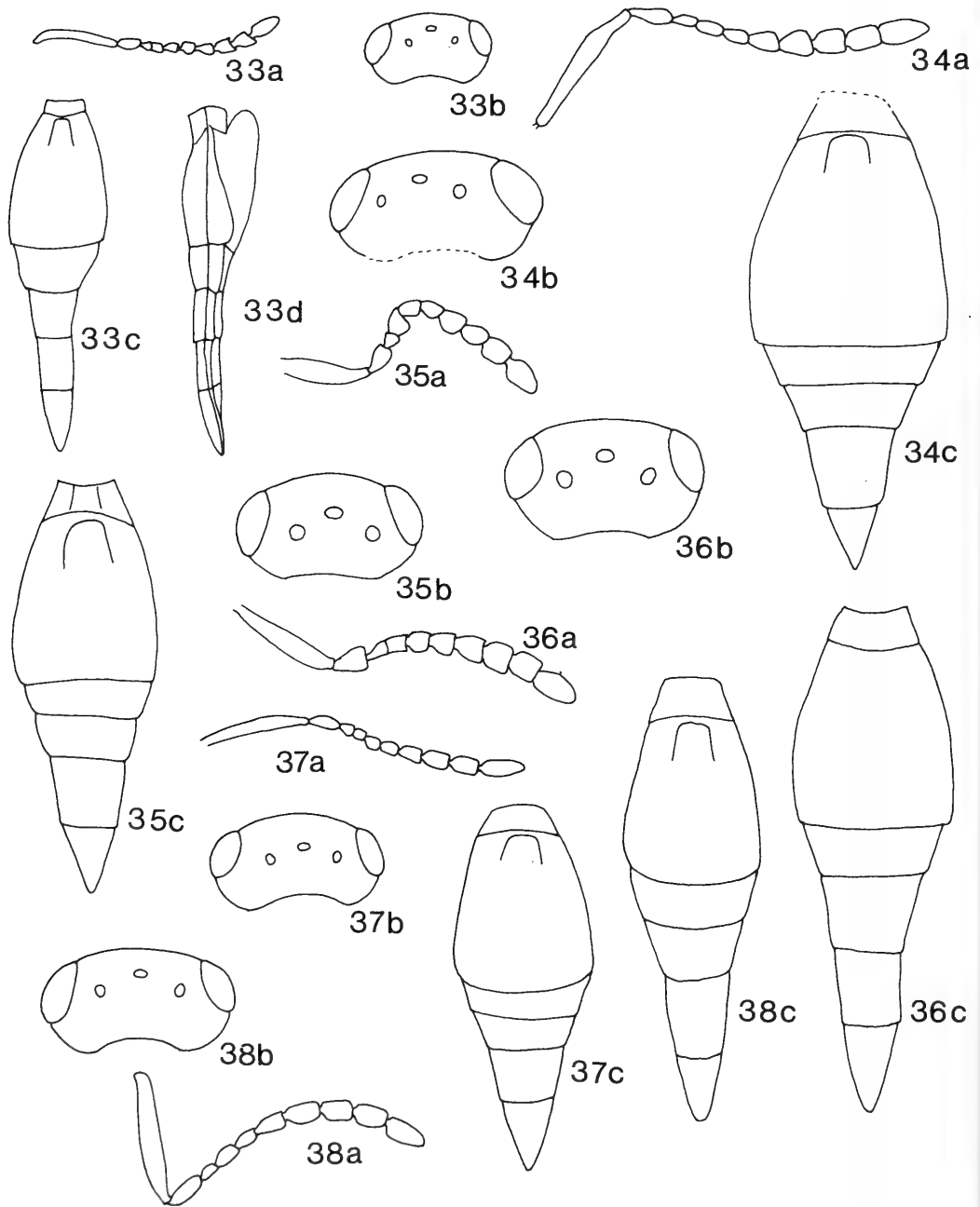

Figs. 33—38. a, antenna; b, head (dorsal view); c, metasoma (dorsal view); d, metasoma (lateral view). 33a—d, *Platygaster chrysippus* (lectotype); 34a—c, *P. oecus* (lectotype); 35a—c, *P. gorge* (lectotype); 36a—c, *P. oebalus* (paralectotype no. 296 in NMI); 37a—c, *P. iolas* (lectotype); 38a—c, *P. demades* (authors collection).

ceous strip at outer side of notauli, then a smooth area and laterally roughly punctate with scaly hair-implantations; propleurae coriaceous with hairs in upper one-third; lower two-thirds smooth with a few hairs; scutellum relatively convex, only slightly above mesoscutum. T1 crenulated with two carinae; basal foveae of T2 smooth, a short striation on the lobe between these, rest of tergite smooth; T3—T6 anterior with faint longitudinal sculpture, becoming stronger posteriorly. Black, shiny species. Antennae dark brown, distal end of A2 and entire A3 lighter. Wings slightly infuscated. Fore legs brown, femur proximally darker, tibiae darker in the middle; middle femora for the larger part dark brown to black, distally lighter, tibiae dark brown, proximally and distally somewhat lighter; hind legs uniformly brown. Length female 1.9 mm (figs. 33a—33d).

32. A6—A9 somewhat broader than long 33
 — A6—A9 somewhat longer than broad 35
 33. A3—A5 longer than broad; A3 and A4 connected as usual; A7—A10 flattened
 *ocelus* Walker, 1835

Head 2.2 times as broad as long; OOL : POL : LOL = 5 : 15 : 5; frons coriaceous, except central part which is smooth; transverse striation above and at sides of antennal sockets; rather strong transverse striation behind ocellar region. Notauli complete and smooth; mesoscutum longitudinally coriaceous; scutellum moderately convex, just above level of mesoscutum. T1 with two strong carinae; T2 with deep, striated, basal foveae, possessing a broad, striated tongue in the middle; striation of T2 extending to one-third, rest of tergite as well as rest of metasoma smooth, except T5 which has a very faint sculpture. Black, shiny species. Wings slightly infuscated. Antennae dark brown. Legs dark brown, fore tibiae apically and fore tarsi lighter. Length female 1.8 mm (figs. 34a—34c).

- A3—A5 broader than long; A3 closely and broadly united with A4; A7—A10 not flattened. . . 34
 34. Legs brownish. Head about 1.9 times as broad as long *gorge* Walker, 1835

OOL : POL : LOL = 5 : 13 : 6; frons faintly coriaceous, ocellar region coriaceous, behind median ocellus and on occiput transversely striated. Notauli complete, midlobe between them longitudinally coriaceous and implantations of hairs scaly; partly smooth at sides of notauli; scutellum convex, posterior part nearly vertically sloping towards propodeum; propodeum with high carinae, their flat surface with sculpture. T1 crenulated with two clear carinae; T2 with deep basal foveae, tongue in between slightly prominent with a few striae; some striae in basal foveae extending to one-third of tergite, rest of T2 smooth; T3—T6 smooth. Black, shiny species. Antennae dark brown, except distal part of A2 and proximal part of A3 which are lighter. Legs brown, all femora and tibiae of hind legs darker, all last tarsal segments dark. Length female 1.5 mm (figs. 35a—35c).

- Legs black. Head about 2.3 times as broad as long *oebalus* Walker, 1835

OOL : POL : LOL = 4 : 14 : 5; frons with a weak midline, at sides of this line faintly fan-like striated, above antennal sockets more strongly transversely striated and upper part of frons and ocellar region irregularly coriaceous (this character is variable; the lectotype has a rather coarse frons and the midline is less distinct); occiput coriaceous and vertex roughly and transversely striated. Notauli complete; mesoscutum entirely longitudinally coriaceous; scutellum convex, above level of mesoscutum, more gradually sloping towards propodeum as in *P. gorge*; propodeal carinae strong and high. T1 roughly crenulated, with two clear carinae; striated basal foveae of T2 possessing a striated tongue, striation of both extending to one-third of tergite and rest of T2 smooth; T3 smooth; T4 and T5 very faintly sculptured; T6 smooth (in some specimens, e.g. the lectotype, there is a tendency to fusion of T5 and T6). Black, shiny species. Antennae black. Legs black. T6 somewhat lighter than rest of tergites. Length female 1.8 mm (figs. 36a—36c).

35. T5 rather smooth *iolas* Walker, 1835

Head 2.4 times as broad as long; OOL : POL : LOL = 4 : 11 : 7; frons apparently smooth but with an impressed line from median ocellus to clypeus and at sides of this line very finely fan-like striated; ocellar region and occiput strongly transversely striated. Notauli incomplete, but evident in posterior part of mesoscutum; mesoscutum smooth, except for the scale-like implantations of hairs; scutellum moderately convex, just above level of mesoscutum; propodeum very short, strip-like in the middle and hidden under scutellum. T1 crenulated in anterior half, posterior half rather smooth; T2 with deep, bare and striated basal foveae; midlobe with a few striae, foveae with striae reaching half the length of tergite, remainder smooth; rest of metasoma smooth, except T5 which has some very faint longitudinal rugosity. Black, shiny species. Antennae black. Legs blackish brown, fore tarsi somewhat lighter. Length female 1.3 mm (figs. 37a—37c).

— T5 with sculpture 36

36. Wings clear *demades* Walker, 1835

Head 2.0 times as broad as long; OOL : POL : LOL = 6 : 13 : 6; frons with a clear midline from median ocellus to clypeus, at both sides with a moderately strong fan-like striation; ocellar region and occiput transversely striated. Notauli incomplete, forming posteriorly a midlobe which reaches the scutellum; midlobe more or less elevated above latero-posterior parts of mesoscutum; these latero-posterior parts depressed and provided with long hairs; mesoscutum rugose-coriaceous; scutellum strongly convex, above level of mesoscutum; propleurae finely longitudinally coriaceous; propodeum with very short and high carinae. T1 strongly crenulated; T2 with bare basal foveae, area in between not conspicuously tongue-like; striation on T2 over whole width, extending to half of tergite; T3 smooth, with a transverse line of deeply implanted hairs which is interrupted in the middle; T4 smooth with two irregular transverse lines of deeply implanted hairs; T5 for the most part longitudinally rugose with some hairs, smooth at extreme anterior and posterior borders; T6 smooth with a few scattered hairs. Antennae black. All femora black; fore tibiae and tarsi reddish brown; middle and hind tibiae dark brown, tarsi lighter. Length of female 1.6 mm (figs. 38a—38c).

Remarks. — This species is frequently reared from various gallmidge hosts and is especially known as an important parasite of *Dasineura mali* Kieffer on apple.

— Wings infuscated 37

37. Head, mesoscutum and scutellum densely covered with long hairs *orcus* Walker, 1835

Antennae less slender than in *P. pelias*; head 2.1 times as broad as long; OOL : POL : LOL = 5 : 15 : 6; frons rather smooth, its upper half finely fan-like coriaceous; ocellar region and occiput strongly transversely striated. Notauli incomplete; mesoscutum densely haired, hair-implantations scale-like; structure of midlobe between notauli as in *P. demades*; scutellum strongly convex, densely hairy, especially at sides; propleurae smooth with very fine sculpture. T1 entirely crenulated; T2 with deep basal foveae; striation of T2 over whole width of tergite and extending over half of tergite; T3 and T4 smooth with a few deeply implanted hairs; T5 as in *P. demades*; T6 smooth. Black, shiny species. Antennae black, A2 apically lighter. Legs blackish brown, tarsi somewhat lighter. Length female 1.6 mm (figs. 39a—39c).

— Scutellum sparsely hairy *pelias* Walker, 1835

Antennae slender; head 2.1 times as broad as long; OOL : POL : LOL = 5 : 12 : 5; frons smooth, very finely alutaceous; ocellar region transversely striated. Notauli incomplete; mesoscutum as in *P. orcus*; propleurae finely coriaceous; scutellum strongly convex, sparsely hairy. T1 crenulated, the two carinae conspicuous; T2 with deep, striated basal foveae, with-

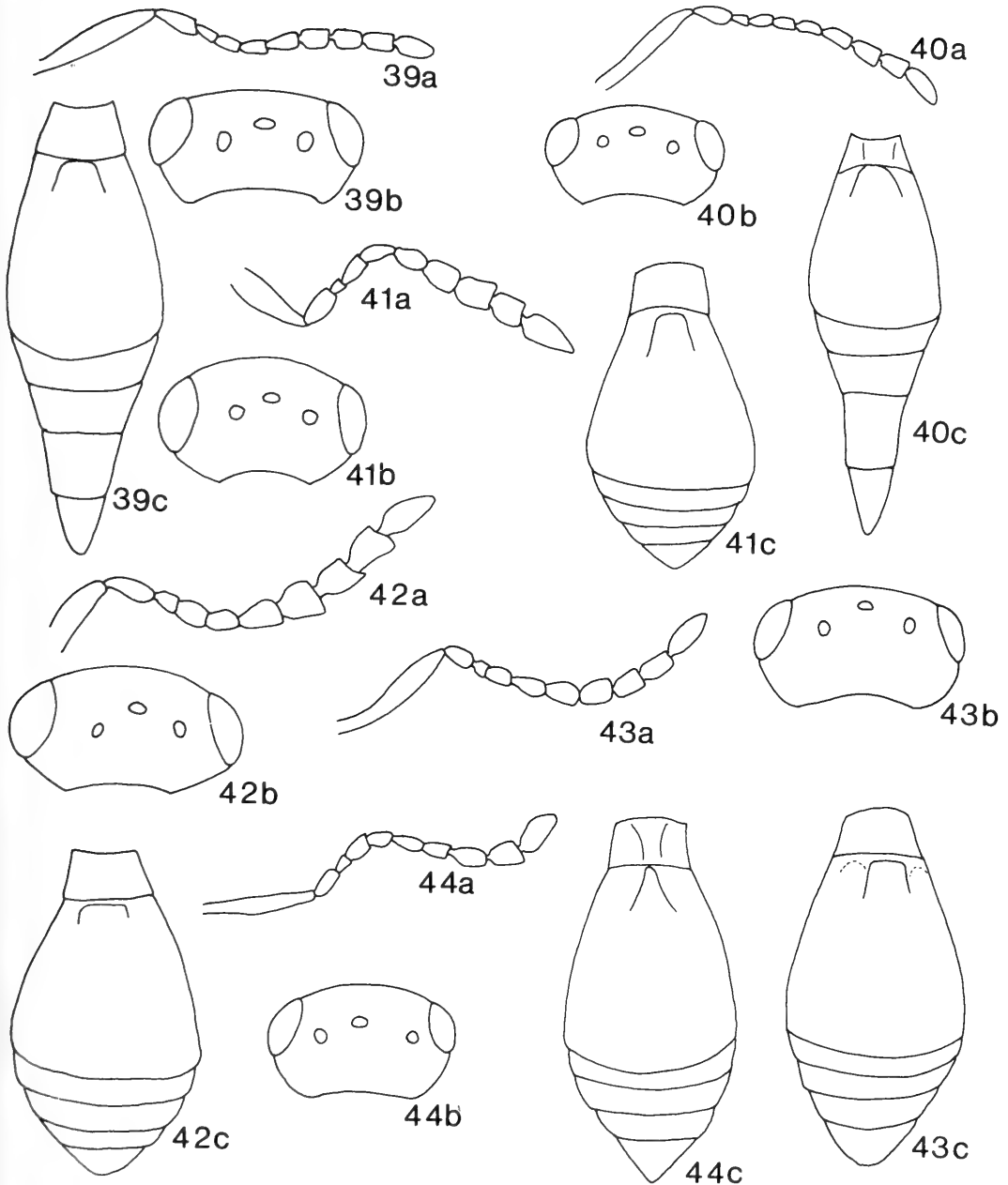

Figs. 39—44. a, antenna; b, head (dorsal view); c, metasoma (dorsal view). 39a—c, *Platygaster orcus* (lectotype); 40a—c, *P. pelias* (lectotype); 41a—c, *P. nisus* (lectotype); 42a—c, *P. manto* (paralectotype no. 1154 in NMI); 43a—c, *P. pedasus* (lectotype); 44a—c, *P. oscus* (lectotype).

out striation on midlobe in between; striation of T2 extending to half of tergite; T3 and T4 with a few hairs, not particularly deeply implanted; T5 as in *P. demades*; T6 smooth. Black, shiny species. Antennae black, A2 somewhat lighter. Fore legs dark brown, tibiae proximally and apically and tarsi lighter; middle and hind legs black, tarsi somewhat lighter. Length female 1.4 mm (figs. 40a—40c).

Remarks. — I have reared series of *P. pelias* from *Lasioptera rubi* Heeg. on *Rubus* sp. collected in Bitsche, France, the type locality of *Platygaster ruborum* Kieffer, 1916 (sensu Huggert, 1973). *P. pelias* is identical with *P. ruborum* (syn. nov.). *P. demades*, *P. orcus* and *P. pelias* are strikingly similar but differ from each other by characters mentioned in the key and by different measurements. The similarity may eventually result in synonymy after detailed study of long series of reared material. Different hosts may affect the size and other characters of specimens. Until further study has been undertaken, I prefer to maintain these three taxa.

38. Notauli absent or only evident at their extreme posterior part 39
 — Notauli complete or nearly so 41
 39. Light coloured species with partially yellow antennae and yellowish legs. Mesoscutum smooth . . .
 *nisis* Walker, 1835

Head 1.8 times as broad as long; OOL : POL : LOL = 5 : 9 : 5; frons nearly smooth; ocellar region transversely alutaceous; occiput transversely striated. Notauli indicated posteriorly, possessing a midlobe which covers base of scutellum; mesoscutum nearly bare, except posterior part which is provided with long hairs, covering groove between mesoscutum and scutellum; scutellum ovoid, smooth, laterally with some hairs; propodeal carinae high and relatively long, somewhat diverging. T1 crenulated; T2 with smooth basal foveae, its midlobe smooth as well as rest of metasoma. Brown, shiny species, head darker. Antennae yellowish, 5-segmented club darker. Legs yellowish, last tarsal segments darker. Length female 0.9 mm (figs. 41a—41c).

Remarks. — The brownish colour may be artificial. In my collection I have a female ("Ireland, Calory Lower, c.o. Wicklow. Irish Grid Reference O.234119. 12-7-1983, leg. Vlug") which is perfectly black, except T1 which is somewhat brownish (Irish specimens tend to be darker than usual; Graham, pers. comm). In my Irish specimen the prolongation of the central mesoscutal part is less prolonged than in the lectotype.

- Dark brown or black species with dark legs and antennae and with at least microsculpture on mesoscutum 40
 40. Head about 2.0 times as broad as long, strongly narrowed behind eyes *manto* Walker, 1835

OOL : POL : LOL = 6 : 9 : 4; frons smooth; ocellar region with faint sculpture; occiput and vertex transversely striated. Notauli very faintly indicated in their posterior part, midlobe between notauli just reaching the somewhat protruded scutellum; mesoscutum nearly smooth, anterior part with superficial sculpture; scutellum moderately convex, smooth; propodeal carinae not particularly high, somewhat diverging. T1 crenulated; T2 with striated basal foveae, midlobe with some short striae; striation of T2 not exceeding one-third of tergite, rest smooth; T3—T6 smooth with some fine hairs. Black, shiny species. Antennae dark brown, scape apically, and A2—A3 lighter. Legs dark brown, all tibiae proximally lighter and all tarsi, except the last segments, light brown. Length female (PLT) 1.0 mm (figs. 42a—42c).

- Head about 1.7 times as broad as long, broadly rounded behind eyes *pedasus* Walker, 1835

OOL : POL : LOL = 5 : 9 : 4; frons finely fan-like alutaceous; occiput with some short transverse striae; occipital region finely coriaceous. Notauli evident in posterior half, oblique and fading in anterior half; midlobe between notauli not quite reaching scutellum; mesoscutum smoothly coriaceous; scutellum moderately convex, smooth; propodeal carinae not par-

ticularly high and long. T1 crenulated; T2 with a broad central lobe, straight and smooth in its anterior part; basal foveae of T2 deep and striated to half of tergite, rest of tergite smooth; T3 and T4 smooth with a few hairs; T5 with a narrow transverse strip of fine rugosity in front of a complete row of deeply implanted hairs; T6 rather smooth with some hairs. Black, shiny species. Antennae brown. All femora brown, all tibiae light brown, all tarsi yellowish except last tarsal segments which are darker. Length female 1.5 mm (figs. 43a—43c).

41. Basal foveae of T2 smooth 42
 — Basal foveae of T2 more or less striated 44
 42. Frons nearly smooth with some superficial striation *oscus* Walker, 1835

Head 1.7 times as broad as long; OOL : POL : LOL = 6 : 13 : 6; ocellar area irregularly coriaceous; occiput strongly transversely striated. Notauli nearly complete; mesoscutum coriaceous; central lobe between notauli rounded posteriorly and just covering base of scutellum; scutellum moderately convex, rather densely haired, especially laterally; propodeal carinae high. T1 with two well defined carinae; T2 with broad, rather deep and smooth basal foveae, tongue between foveae relatively narrow and smooth; rest of tergite smooth with some fine hairs. Black, shiny species. Antennae dark brown, scape brown and A2—A6 lighter. Legs overall light brown, last tarsal segments darker. Length female 1.5 mm (figs. 44a—44c).

- Frons striated or with somewhat coarse sculpture above antennal sockets 43
 43. Frons striated fan-like with transverse striae above antennal sockets *aegeus* Walker, 1835

Head 2.3 times as broad as long; OOL : POL : LOL = 6 : 20 : 8; ocellar region and occiput strongly transversely striated. Notauli deep and nearly complete; mesoscutum for the larger part smooth, anterior part, lateral borders and to some extent along notauli, rugose; midlobe between notauli extending as a broad, nearly straight ending plate over base of scutellum; scutellum moderately convex, roundish, excavated latero-posteriorly; postscutellum clearly visible as a brown lamella; propodeal carinae high, rather long, and wide apart, area in between smooth; lateral parts of propodeum long and densely haired. T1 relatively long with two well defined carinae, area between with two deep pits; T2 with deep and smooth basal foveae, rest of tergite smooth, except hind border which is finely punctate; rest of metasoma finely punctate. Black, shiny species. Antennae dark brown, A2—A3 somewhat lighter. All femora dark brown, all tibiae and tarsi yellowish brown. Length female 2.0 mm (figs. 45a—45c).

- Frons finely fan-like alutaceous-coriaceous; lower half of frons transversely rugose
 *mintbe* Walker, 1835

Head 2.0 times as broad as long; OOL : POL : LOL = 7 : 15 : 5; ocellar region irregularly coriaceous; occiput transversely striated. Notauli nearly complete; mesoscutum for the larger part superficially coriaceous; posterior part of midlobe between notauli smooth, this lobe broadly rounded posteriorly and reaching base of scutellum; scutellum convex, smooth and laterally with some hairs; propodeal carinae strong and high. T1 relatively long with two longitudinal carinae and a crenulated strip over the whole width; anterior part of T1 appearing as an elevated ridge; T2 with deep, broad and smooth basal foveae; tongue between these foveae rather narrow and smooth, rest of T2 smooth; T3—T6 nearly smooth, very finely punctured in posterior part and provided with deeply implanted hairs. Black, shiny species. Antennae black, A2 apically and A3 proximally lighter. All femora brown, proximally lighter; fore tibiae and tarsi yellowish; middle and hind tibiae light brown with dark apical part; middle and hind tarsi yellowish. Length female 1.7 mm (figs. 46a—46c).

44. A7—A9 slightly or distinctly longer than broad 45
 — A7—A9 distinctly broader than long 46

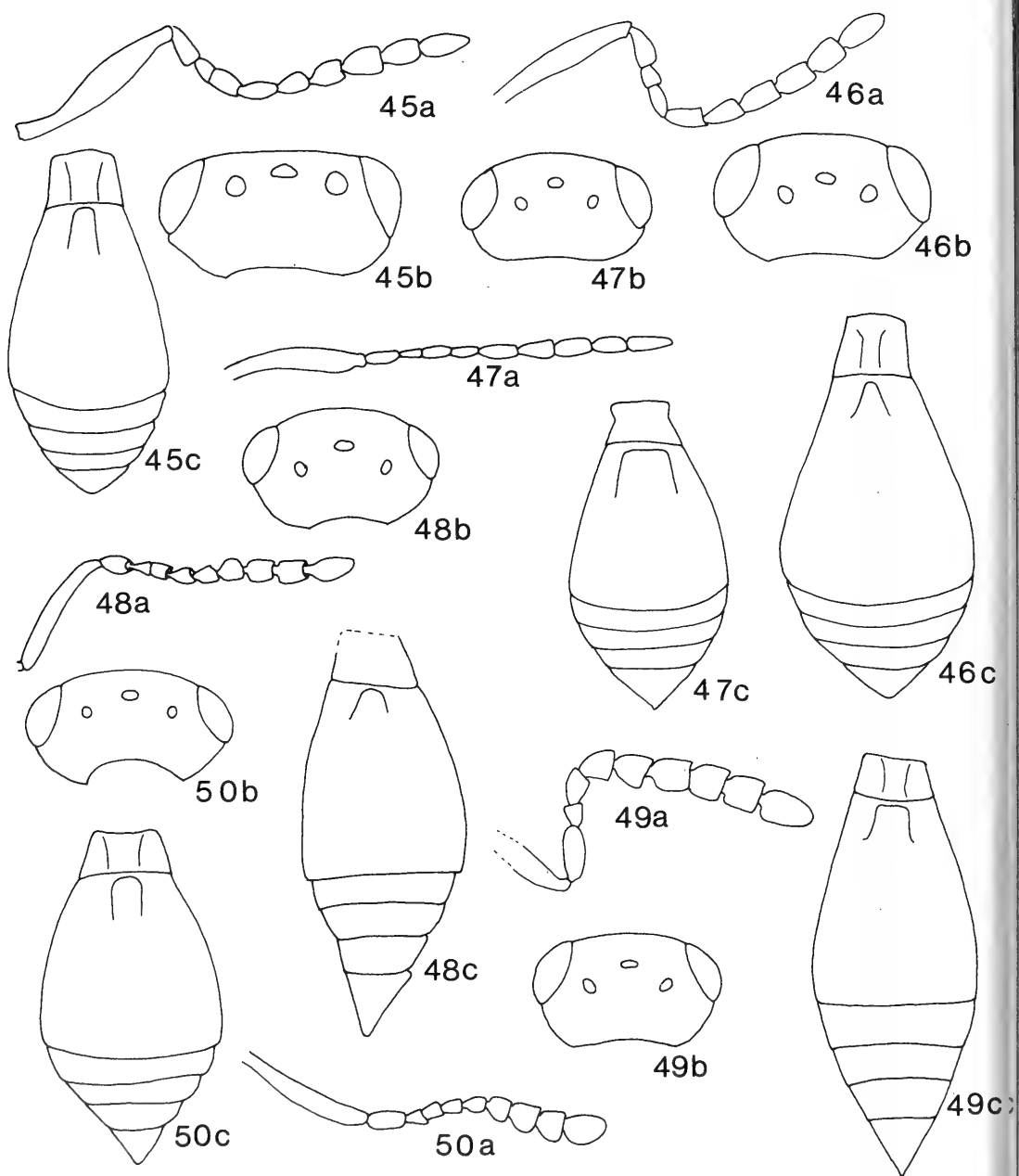

Figs. 45—50. a, antenna; b, head (dorsal view); c, metasoma (dorsal view). 45a—c, *Platygaster aegeus* (lectotype); 46a—c, *P. minthe* (lectotype); 47a—c, *P. ennius* (lectotype); 48a—c, *P. sagana* (paralectotype no. 396 in NMI); 49a—c, *P. philinna* (lectotype); 50a—c, *P. eriphyle* (lectotype).

45. Antennae slender, all segments distinctly longer than broad; A2—A5 yellowish
 *ennius* Walker, 1835

Head 2.2 times as broad as long; OOL : POL : LOL = 6 : 12 : 6; frons with superficial fan-like striation, weak transverse striation above antennal sockets; ocellar region and occiput transversely striated. Notauli nearly complete, rather vague anteriorly; mesoscutum rather smooth, its anterior one-third, lateral margins and along notauli coriaceous; midlobe between notauli rounded posteriorly and not quite reaching scutellum, elevated between depressed lateral and hairy parts of mesoscutum; scutellum smooth, laterally haired, convex; propodeal carinae not particularly high. T1 entirely crenulated; T2 with narrow, striated basal foveae, its midlobe relatively broad and striated in its anterior part; striation of T2 extending to one-third of tergite, rest smooth; T3—T6 smooth, with single rows of deeply implanted hairs. Black, shiny species. Antennae brown, A2—A5 lighter. All femora dark brown; all tibiae and tarsi lighter, last tarsal segments darker. Length female 1.3 mm (figs. 47a—47c).

- Antennae not particularly slender; A8 and A9 slightly longer than broad; antennae entirely blackish brown *sagana* Walker, 1835

Head 1.9 times as broad as long; OOL : POL : LOL = 4 : 11 : 4; frons faintly alutaceous to coriaceous; ocellar region transversely coriaceous; occiput transversely reticulate to coriaceous. Notauli complete; mesoscutum longitudinally coriaceous; midlobe between notauli slightly prolonged, narrowly rounded and not quite reaching scutellum; scutellum moderately convex, coriaceous and bare; propodeal carinae well defined. T1 crenulate, with two carinae; T2 with superficially striated basal foveae, midlobe in between these rounded and smooth; striation not extending one-third of tergite; T3—T6 smooth with some very fine hairs. Black, shiny species. Wings infuscated. Antennae blackish brown. Legs dark brown, fore legs with lighter markings. Length female 1.1 mm (figs. 48a—48c).

46. Frons roughly and strongly coriaceous. Striation of T2 extending over half of tergite
 *philinna* Walker, 1835

Head 1.4 times as broad as long; OOL : POL : LOL = 7 : 18 : 8; ocellar region coriaceous to rugose; occiput strongly transversely striated. Notauli complete and strong; mesoscutum longitudinally coriaceous, anterior part with two smooth longitudinal strips; midlobe between notauli not particularly extended, rather pointed and not reaching scutellum; scutellum moderately convex, coriaceous; propodeal carinae strong and wide apart. T1 with two carinae, crenulate in between and outside these carinae; T2 with broad basal foveae, lobe between these relatively narrow and straight in front; entire width of tergite closely striated, extending over half of tergite; T3—T5 smooth with some deeply implanted hairs laterally; T6 with transverse rugose strip. Black, shiny species. Antennae black. Legs dark brown, fore legs lighter. Length female 2.2 mm (figs. 49a—49c).

- Frons nearly smooth; some transverse wrinkles above antennal sockets. Striation on T2 not reaching half of tergite *eriphyle* Walker, 1835

Head 2.0 times as broad as long; OOL : POL : LOL = 6 : 15 : 5; ocellar region and vertex weakly transversely striate, occiput transversely rugose. Notauli complete; mesoscutum longitudinally coriaceous; midlobe between notauli pointed but not reaching scutellum; scutellum moderately convex, coriaceous, with some hairs laterally; propodeal carinae strong. T1 crenulated with two moderately strong carinae; T2 with deep, striated, basal foveae, moderately striated on lobe in between foveae; striae not extending to half of tergite, rest smooth; T3—T6 smooth with some very fine hairs. Black, shiny species. Antennae blackish brown. Legs dark brown, tarsi somewhat lighter. Length female 1.5 mm (figs. 50a—50c).

47. T1 not crenulated but with two or three longitudinal carinae; area in between smooth 48

- T1 crenulated, carinae not prominent and evident between crenulae 50
 48. Occipital carina incomplete but evident, adjoined by a few transverse striae
 *bucolion* Walker, 1835

Head 2.3 times as broad as long; OOL : POL : LOL = 5 : 12 : 5; frons coriaceous, less so in the middle; some transverse wrinkles above antennal sockets; ocellar region and occiput coriaceous with a clear carina and some adjoining striae. Notauli complete; mesoscutum longitudinally coriaceous; midlobe between notauli slightly prominent, somewhat upcurved apically with a median, short apical carina; scutellum moderately convex, just above level of mesoscutum; propodeal carinae strong, with flattened surface; carinae parallel and slightly longer than gap between them. T1 with three longitudinal carinae, areas between them smooth and lateral of carinae crenulated with some hairs; T2 with moderately deep basal foveae, these sparsely hairy and not particularly striated; midlobe between basal foveae broad, with some striae; rest of tergites smooth. Black, shiny species. Antennae dark brown, scape and A2 proximally lighter. Legs brown, fore legs lighter, all tarsi reddish yellow except the dark apical segments. Length male 1.5 mm (figs. 51a—51c).

Remarks. — *Platygaster bucolion* may very well be the male of *P. munita*. Rearing results may elucidate this problem.

- No occipital carina; occiput not slightly striated 49
 49. Frons smooth. Metasoma short *deipyla* Walker, 1835

Head 1.8 times as broad as long; OOL : POL : LOL = 6 : 11 : 5; ocellar region weak transversely coriaceous, occiput transversely coriaceous to striated. Notauli complete; mesoscutum coriaceous anteriorly, in the middle and posteriorly weakly longitudinally coriaceous; lateral lobes of mesoscutum partly smooth; scutellum slightly convex, weakly coriaceous; propodeal carinae long and high. T1 with two carinae, in between these smooth, laterally somewhat crenulated; T2 with moderately deep basal foveae, which are striated to one-third of tergite, rest of tergite smooth; T3—T7 smooth. Black, shiny species. Antennae brown. Wings infuscated. Legs preponderantly brown, coxae and femora darker, fore legs somewhat lighter. Length male 1.2 mm (figs. 52a—52c).

Remarks. — *Platygaster deipyla* seems to be conspecific with *P. plotina*. There are slight differences in the measurements of the head (in *P. plotina* 1.7 times as broad as long and OOL : POL : LOL = 5 : 13 : 6) and in the form of the metasoma. The metasoma in the lectotype of *P. deipyla*, however, is not fully extracted. The colour of the antennae in *P. plotina* is blackish (for *P. plotina*, see figs. 57a—57c). The female of *P. tisia* might well be conspecific with both *P. deipyla* and *P. plotina*. Reared series of these species may elucidate the question of their synonymy.

- Frons coriaceous, except central part which is smooth; transverse wrinkles above antennal sockets. Metasoma long *evadne* Walker, 1835

Head 1.8 times as broad as long; OOL : POL : LOL = 4 : 15 : 6; ocellar region coriaceous; occiput transversely striated. Notauli complete; mesoscutum coriaceous, posterior part longitudinally coriaceous; scutellum moderately convex, coriaceous; propodeal carinae strong, long and diverging. T1 with two strong keels, with a short median keel between them, lateral parts at a lower level; T2 with deep, superficially striated basal foveae, midlobe with some striae; striation of T2 to one-third of tergite, rest smooth; rest of metasoma appearing smooth, however, with high magnification some fine coriaceous sculpture becomes visible. Black, shiny species. Antennae blackish brown. Legs blackish brown, tarsi somewhat lighter. Length male 1.6 mm (figs. 53a—53c).

Remarks. — *Platygaster evadne* represents the male of *P. attenuata*. I select here the name *P. attenuata* with *P. evadne* as synonym (**syn. nov.**). The male, with its remarkable long metasoma which is curved down apically, seems to be a typical example of the male sex of the "*attenuata* group".

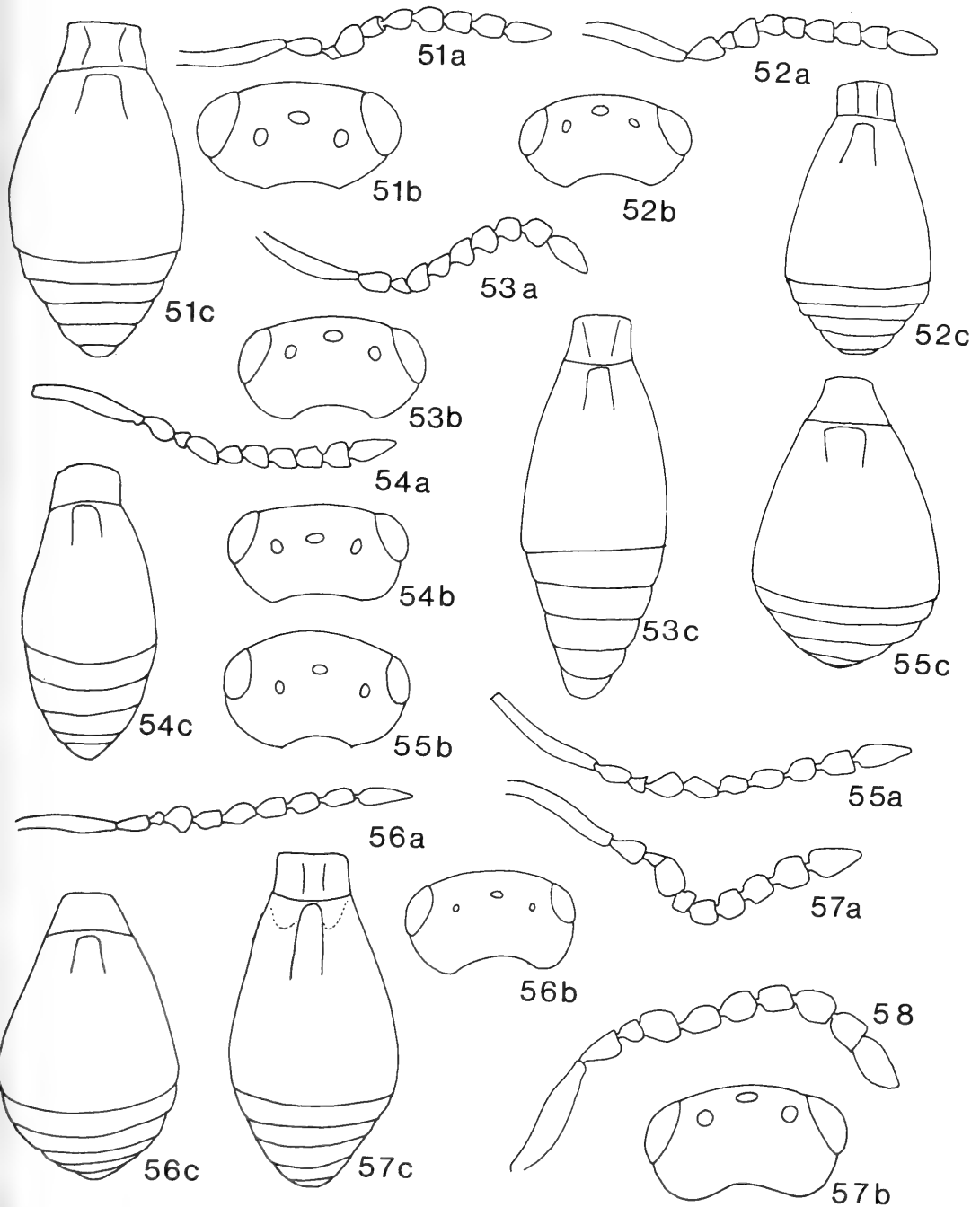

Figs. 51—57. a, antenna; b, head (dorsal view); c, metasoma (dorsal view). 51a—c, *Platygaster bucolion* (lectotype); 52a—c, *P. deipyla* (lectotype); 53a—c, *P. evadne* (paralectotype no. 344 in NMI); 54a—c, *P. zosine* (lectotype); 55a—c, *P. abisares* (lectotype); 56a—c, *P. cleodaeus* (lectotype); 57a—c, *P. plotina* (lectotype); 58, male antenna of *P. manto* (lectotype).

50. Occipital carina present and complete, anteriorly joined by some transverse carinae
 *zosine* Walker, 1835

Head 2.5 times as broad as long; OOL : POL : LOL = 5 : 13 : 4; frons with very weak, fan-like striation, nearly smooth. Notauli incomplete; mesoscutum nearly smooth, hair implantations scaly; scutellum convex with scattered hairs; propodeal carinae short and high. T1 strongly crenulated; T2 with deep basal foveae which are striated, striation extending to half of tergite; lobe between basal foveae of T2 with some short striae; rest of metasoma smooth, T3—T6 with some deeply implanted hairs. Black, shiny species. Antennae black. Wings slightly infuscated. Legs black, fore tibiae and fore tarsi brownish. Length male 1.3 mm (figs. 54a—54c).

- Occipital carina wanting (or not evident between striae; in this case striae rather strong); occiput very weakly transversely striated 51
51. Frons with very fine fan-like alutaceous sculpture, nearly smooth; occiput with some short, superficial striae *abisares* Walker, 1835

Head 2.0 times as broad as long; OOL : POL : LOL = 6 : 13 : 6. Notauli incomplete; mesoscutum with very fine coriaceous sculpture; scutellum moderately convex, nearly smooth; propodeum with well defined carinae. T1 rather strongly crenulated; T2 with short, smooth, basal foveae, sometimes superficially striated; midlobe between basal foveae of T2 with coarse sculpture at its extreme base, rest of tergite smooth (in the case of superficial striae, these extending to one-third of tergite); rest of tergites smooth, with a few, superficially implanted hairs. Black, shiny species. Antennae dark brown. Fore femora distally, fore tibiae apically and tarsal segments light brown; middle and hind legs dark brown, their tibiae apically and distally and their tarsal segments light brown. Length male 1.3 mm (figs. 55a—55c).

Remarks. — There is no reason to treat *P. abisares* and *P. cleodaenus* Walker, 1835, as separate species. The antennae and legs in *P. cleodaenus* are somewhat lighter and the measurements slightly different (for *P. cleodaenus*, see figs. 55a—55c). I select here the species name *P. abisares* with *P. cleodaenus* as synonym (**syn. nov.**).

- Frons smooth, vertex and occiput striated *manto* Walker, 1835

Head 2.0 times as broad as long; OOL : POL : LOL = 4 : 10 : 4. Notauli only clear in their posterior half; mesoscutum rather smooth with some fine hairs; scutellum moderately convex, just above level of mesoscutum; propodeum with short, but strong carinae. T2 with short basal foveae and with a few weak longitudinal striae, rest of tergite smooth; T3—T7 smooth. Black, shiny species. Antennae entirely dark brown. Fore legs dark brown, femora apically, fore tibiae with thickened apical part and tarsi lighter; middle and hind legs dark brown, joints between femora and tibiae somewhat lighter. Length male 0.9 mm (fig. 58).

Synopeas Foerster

1. Occiput with strong carina 2
- Occiput without or with a weak, short carina 4
2. Scutellum with a short, spine-like tubercle *larides* (Walker, 1835)

Head 1.7 times as broad as long; OOL : POL : LOL = 3 : 16 : 7; temples strongly narrowed behind eyes; head entirely pustulated. Mesoscutum pustulated; notauli indicated posteriorly, central lobe in between them ending in a small transparent projection; scutellum with an S-formed, brown transparent lamella from top of scutellar tubercle downwards; propodeum short, carinae fused and protruding backwards. Junction of T1 and T2 thickly haired dorso-laterally; tergites smooth, at their extreme end with microsculpture. All tibiae, especially fore tibiae strongly clubbed, their proximal part being very slender. Black species. Antennae dark brown, scape lighter. Fore legs dirty red; middle and hind legs brown, tibiae proximally red and tarsi red. Length of male 1.2 mm (figs. 59a—59d).

- Scutellum armed with a distinct spine 3
3. Head entirely pustulated. Notauli absent; scutellum with a long, strong spine
 *trebius* (Walker, 1835)

Head 2.3 times as broad as long; OOL : POL : LOL = 2 : 17 : 7; temples strongly narrowed behind eyes; mesoscutum pustulated; central lobe between hypothetical notauli extended into a rounded plate which covers base of scutellum; propodeum long, carinae long and fused. Junction of T1 and T2 with three strong dorsal carinae; tergites smoothly shiny, posteriorly with fine microsculpture. Black species. Antennae black; scape reddish, A2 and A3 darker. Fore and middle legs entirely red; hind legs red, except femora and tibiae which are distally black. Length male 1.2 mm (figs. 60a—60d).

- Head entirely reticulate coriaceous. Notauli present in their posterior half. Scutellum with a short, but distinct spine *velutinus* (Walker, 1835)

Head 2.0 times as broad as long; OOL : POL : LOL = 2 : 15 : 8; temples strongly narrowed behind eyes. Mesoscutum for the larger part rather faintly reticulate coriaceous; notauli-indicated only posteriorly; midlobe between notauli prolonged into a brown, transparent plate which covers base of scutellum; scutellum, seen laterally, not particularly convex and ending in a short, strong spine which has a lamella underneath; propodeal carinae strong and fused, prolonged posteriorly and nearly reaching base of T1; lateral areas of propodeum with long hairs in the postero-lateral triangle. T1 and base of T2 thickly haired, except in the middle; extreme hind border of T2 and T3-T6 with fine microsculpture. Black, shiny species. Antennae yellowish red, scape distally somewhat darker and A7—A10 dark brown. Legs preponderantly reddish yellow, middle and hind femora somewhat darker. Length female 1.1 mm (figs. 61a—61d).

4. Notauli complete 5
- Notauli absent or only posteriorly indicated 6
5. Head about 2.2 times as broad as long *jasius* (Walker, 1835)

OOL : POL : LOL = 6 : 15 : 6; head entirely finely coriaceous, rather dull. Mesoscutum longitudinally coriaceous; midlobe between notauli continuing as a keel over scutellum and forming the spine; scutellum strongly triangular; propodeal carinae strong, separated more or less in their anterior part and fused posteriorly. Junction of T1 and T2 densely haired dorso-laterally, T1 with a hollow area in the middle; T2 smooth, at its extreme end with fine microsculpture; T3—T6 with microsculpture; metasoma as long as mesosoma, broader than high. Black species. Antennae black, scape proximally lighter. Legs brown; fore tibiae and tarsi red; middle tibiae proximally, and tarsi red. Length female 1.4 mm (figs. 62a—62e).

Remarks. — *Synopeas jasius* was often collected by Huggert and Vlug on freshly cut stumps of *Quercus robur* L., *Quercus* sp., *Fraxinus* and *Acer* in Sweden, The Netherlands and Yugoslavia (Huggert, 1980); I observed this species in Reading, Great Britain, in September 1978, ovipositing in a freshly cut stump of (?) *Fraxinus*. In my collection I have also a female from Hungary (leg. Gijswijt).

- Head about 1.8 times as broad as long *craterus* (Walker, 1835)

OOL : POL : LOL = 7 : 14 : 6; head completely reticulate coriaceous. Mesoscutum longitudinally coriaceous; midlobe between notauli touching scutellum but not continued as a keel; scutellum protruding anteriorly, armed posteriorly with a short spine; propodeal carinae fused, its top divided in two overhanging membraneous strips which are curved down apically. Metasoma 2.3 times as long as mesosoma, T2 at its widest point about as wide as high; T1 haired dorso-laterally, these hairs not extending to T2; T2 completely smooth; T3—T6 with microsculpture. Black species. Antennae entirely dark brown. Legs reddish brown, femora darker. Length female 2.0 mm (figs. 63a—63e).

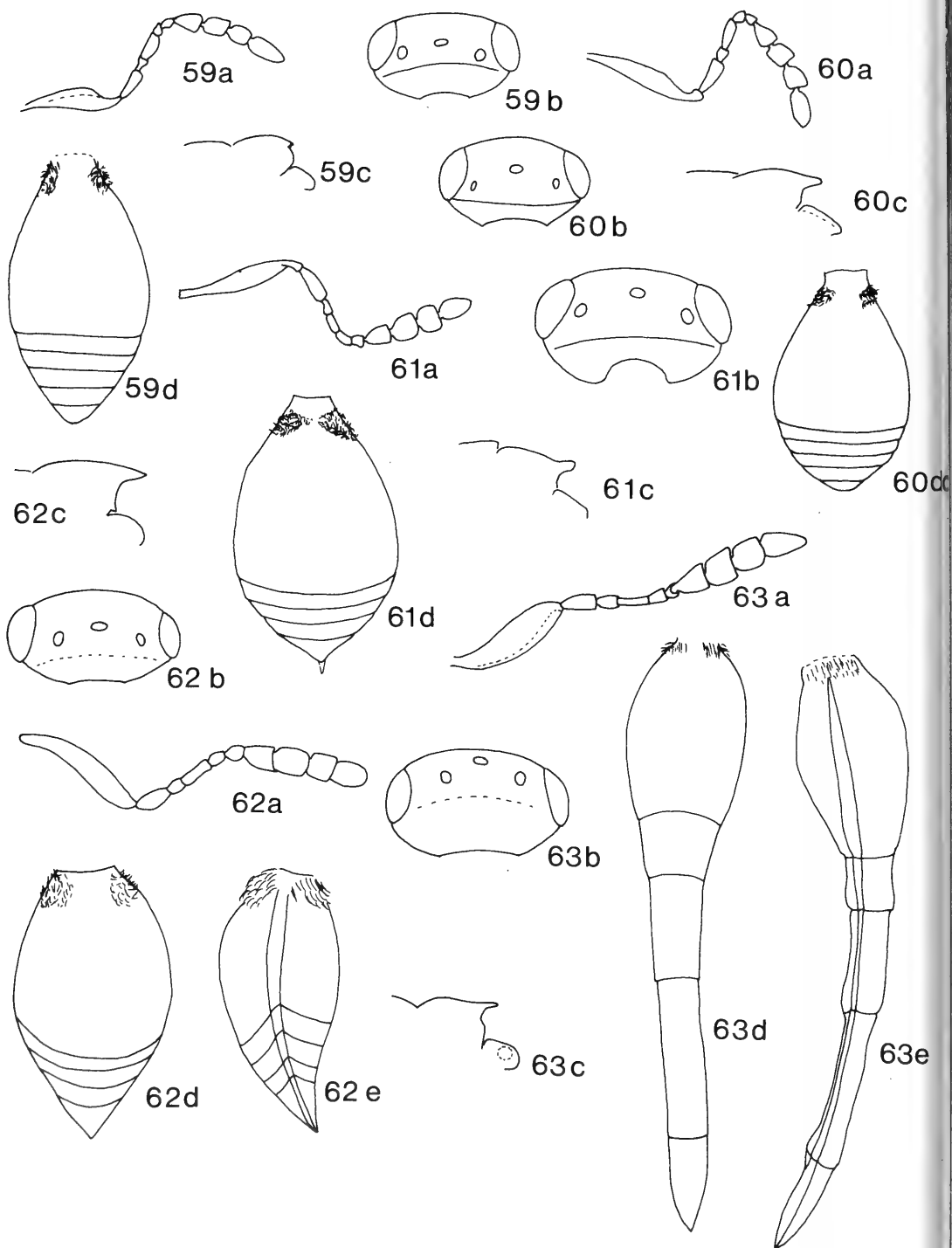

Figs. 59—63. a, antenna; b, head (dorsal view); c, scutellum (lateral view); d, metasoma (dorsal view); e, metasoma (lateral view). 59a—d, *Synopeas larides* (paralectotype no. 211 in NMI); 60a—d, *S. trebius* (lectotype); 61a—d, *S. velutinus* (lectotype); 62a—e, *S. jasius* (lectotype); 63a—e, *S. craterus* (paralectotype no. 185 in NMI).

Remarks. — *Synopeas mamertes* Kieffer, 1926, (syn. nov.) is conspecific with *S. craterus* (Walker). (See figs. 64a—64e).

— Head 1.7 times as broad as long *abaris* (Walker, 1835)

OOL : POL : LOL = 3 : 18 : 5; A4 conspicuously widened; head coriaceous. Mesoscutum longitudinally coriaceous; midlobe between notauli not prolonged and not touching scutellum; scutellum triangular with a short spine; keels of propodeum fused and in lateral view straight. Junction of T1 and T2 densely haired; T2 smooth, except for some superficial microsculpture posteriorly; T3—T7 with microsculpture, T6 with a distinct transverse row of hairs. Black species. Antennae bright red, A6—A10 dark brown. Legs dark brown, fore femora and tibiae and middle tarsi lighter. Length male 1.2 mm (figs. 65a—65d).

6. Scape apically moderately to strongly sinuate, without transparent lamella. T2 not ventrally recessed 7

— Scape not sinuate, on its lower arc with transparent lamella. T2 ventrally recessed 12

7. Scutellar line continuous with line of mesoscutum (no levelled gap present, cf. figs. 66c—69c) 8

— Midlobe of mesoscutum prolonged as a smooth, roundish plate, clearly situated above level of base of scutellum (levelled gap present, cf. figs. 70c—71c) 11

8. Head about 1.6 times as broad as broadest part of mesosoma; mesosoma more or less compressed as in *Piastopleura* *myles* (Walker, 1835)

Head 1.9 times as broad as long; OOL : POL : LOL = 2 : 14 : 6; head weakly pustulated with fine transverse microsculpture above antennal sockets. Mesoscutum with very fine alutaceous sculpture, anteriorly more roughly sculptured; notauli indicated at their extreme posterior part, their midlobe ending in a small roundish plate which covers base of scutellum; mesoscutum 1.5 times as long as at broadest part; scutellum smooth, laterally haired; spine of scutellum of moderate length; propodeal carinae fused, only the top surface divided; lateral areas of propodeum hairy, more densely in their postero-lateral part. Junction of T1 and T2 thickly haired; T2 smooth; T3—T6 with fine microsculpture. Black, shiny species. Antennae brown, scape proximally lighter and A7—A10 darker. Fore femora brown, tibiae reddish and tarsi yellow; middle femora brown, tibiae proximally yellowish red and distally brown, tarsi yellowish red; hind femora brown, tibiae brown, proximally lighter and tarsi brownish. Length female 1.2 mm (figs. 66a—66e).

Remarks. — *Synopeas myles* is here considered a *Synopeas* although it shares some characters with *Piastopleura*. At first sight it looks like a *Piastopleura*, having the somewhat compressed mesosoma.

— Head not much broader than mesosoma; mesosoma not compressed like former species 9

9. Propodeal carinae long and straight *sisis* (Walker, 1835)

Head 2.5 times as broad as long; OOL : POL : LOL = 2 : 15 : 4; frons transversely coriaceous; occipital carina hardly visible. Mesoscutum rather smoothly coriaceous, notauli absent but indicated by longitudinal coriaceous lines; midlobe between hypothetical notauli ending in a smooth, small hump which is membraneous and just covering base of scutellum; scutellum rather convex, smooth in its middle and haired at sides, provided apically with a short spiny lamella; propodeal carinae fused, straight and long. Junction of T1 and T2 haired, except for a narrow, bare gap in the middle; T2 smooth; T3—T6 smooth, each tergite with a narrow strip of microsculpture; T7 very small and smooth. Black, shiny species. Antennae dark brown, scape red. Fore legs red, tarsi yellow with last tarsal segment brownish; middle legs brownish, tibiae proximally yellowish, tarsi yellow, last tarsal segment darker; hind legs as middle legs, but overall slightly darker. Length male 1.2 mm (figs. 67a—67e).

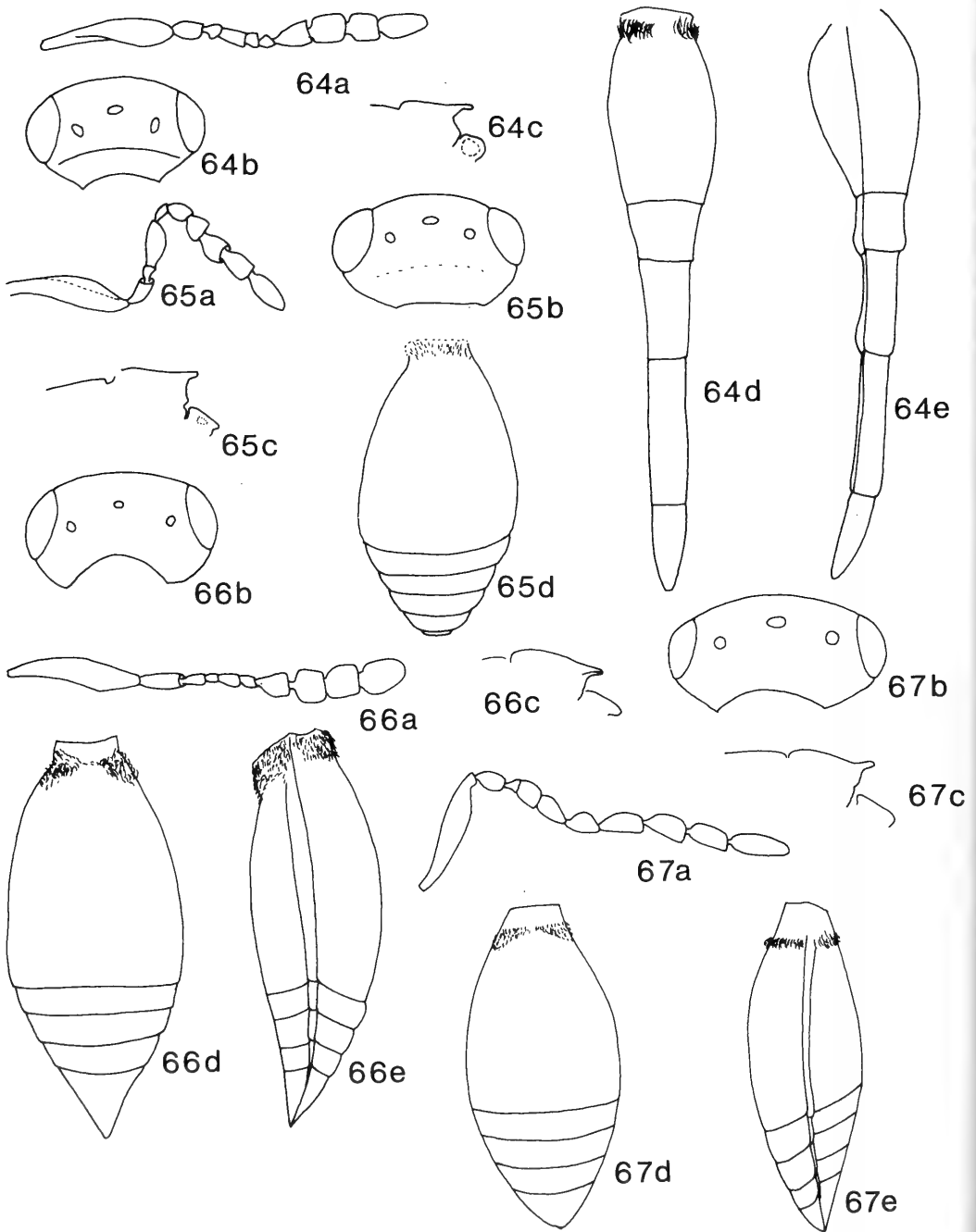

Figs. 64—67. a, antenna; b, head (dorsal view); c, scutellum (lateral view); d, metasoma (dorsal view); e, metasoma (lateral view). 64a—e, *Synopeas mamertes* (lectotype); 65a—d, *S. abaris* (paralectotype no. 197 in NMI); 66a—e, *S. myles* (lectotype); 67a—e, *S. sosis* (lectotype).

- Propodeal carinae short, fused and rounded, in lateral view more or less brown transparent in the middle 10
10. Head about 1.6 times as broad as long *euryale* (Walker, 1835)

OOl : POL : LOL = 4 : 17 : 7; frons completely finely coriaceous; occipital carina present but weak and interrupted in the middle; vertex and occiput sculptured like frons. Mesoscutum coriaceous, its midlobe ending in a small pointed plate, reaching scutellum; scuto-scutellar grooves broadly triangular; scutellum in lateral view not particularly convex, in the middle elevated; this elevation continuing as a broad carina, sloping downwards to propodeal carinae; propodeal carinae strongly curved and fused. Junction of T1 and T2 thickly haired laterally; T2 smooth; T3—T5 with a single row of hairs and with microsculpture; T6 triangular with microsculpture. Black, shiny species. Antennae yellowish red, club dark brown. Fore legs yellowish, femora darker; middle legs reddish, tibiae lighter and tarsi yellowish; hind legs brown, tibiae proximally lighter, tarsi yellowish. Length female 1.4 mm (figs. 68a—68d).

- Head about 2.1 times as broad as long *hyllus* (Walker, 1835)

OOl : POL : LOL = 5 : 16 : 8; head weakly coriaceous with some fine transverse wrinkles above antennal sockets. Mesoscutum finely coriaceous, midlobe prolonged as a smooth, roundish hump, covering base of scutellum; scutellum smooth anteriorly, base below level of mesoscutum; rest of scutellum with rough sculpture, without spine, posteriorly with a short vertical lamella; propodeum very short, not well visible from above. Metasoma compressed, 1.3 times as high as broad and 1.8 times as long as mesosoma; sternites strongly elevated; junction of T1 and T2 densely covered with long greyish hairs, bare in the middle; T2 smooth, T3—T6 with microsculpture. Black species. Antennae entirely black. Legs black; fore tibiae apically and fore tarsi reddish. Length female 1.6 mm (figs. 69a—69e).

11. Antennae entirely dark brown *rhanis* (Walker, 1835)

Head 2.0 times as broad as long; OOl : POL : LOL = 6 : 19 : 9; frons finely coriaceous with some transverse wrinkles above antennal sockets. Mesoscutum finely coriaceous, midlobe continuing as a smooth, roundish plate, high above level of base of scutellum. Junction of T1 and T2 with dense hairs, leaving a narrow, bare gap dorsally; T2 smooth, T3—T6 with microsculpture. Black species. Legs dark brown; fore femora lighter, tibiae reddish and tarsi dirty yellow; middle femora black, tibiae and tarsi reddish; hind legs black, tarsi red. Length female 1.8 mm (figs. 70a—70e).

- Antennae black, A3-A6 reddish *acco* (Walker, 1835)

Head 2.0 times as broad as long; OOl : POL : LOL = 7 : 18 : 8. Black species. Fore legs entirely reddish brown; middle femora brown, tibiae and tarsi red; hind femora brown, tibiae proximally red, distally darker, tarsi red. Rest of characters as in *S. rhanis*. Length female 1.8 mm (figs. 71a—71e).

Remarks. — *S. rhanis* and *S. acco* are conspecific. They differ only slightly in the proportions of the ocellar triangle and different coloration. I select here the name *S. rhanis* with *S. acco* as a synonym (*syn. nov.*). This species is a common parasite of *Dasineura urticae* (Peris) on *Urtica dioica* L.

12. Head about 1.7 times as broad as long; OOl : POL : LOL = 5 : 11 : 14. Head coriaceous with a very weak occipital carina; lamella on scape wide and clearly visible
..... (*Sactogaster*) *tarsa* (Walker, 1835)

Mesoscutum flattened, finely coriaceous; notauli traceable in their posterior one-third; mid-lobe between notauli pointed, prolonged as a bridge over scuto-scutellar groove, reaching basal part of scutellum; scutellar spine rather long and strong; propodeal carinae fused, their surface divided into two overhanging lamellae. Junction of T1 and T2 with long, dense hairs; T2 smooth, T3—T6 with microsculpture; second sternite compressed and recessed ventrally, the complete segment being 1.2 times as high as broad; T5 and T6 long, 6th 1.7 times as long as 5th. Black species. Antennae black, scape proximally red and A2—A5 somewhat lighter. Fore femora and tibiae reddish, tarsi dirty yellowish; middle femora dark brown, tibiae lighter, tarsi dirty yellow; hind femora dark brown, tibiae dark brown but proximally lighter and tarsi dirty yellow. Length female 1.4 mm (figs. 72a—72e).

- Head about 2.0 times as broad as long; OOL : POL : LOL = 3 : 12 : 17; head coriaceous, vertex with a transverse elevation which seems to be a blunt occipital carina; lamellae on scape narrower than in *S. tarsa* (*Sactogaster*) *osaces* (Walker, 1835)

Mesoscutum longitudinally coriaceous; notauli indicated in their posterior one-third; mid-lobe between notauli pointed and somewhat protruding; scutellum as in *S. tarsa*. Junction of T1 and T2 with long, dense hairs; T2 completely smooth, T3—T6 with microsculpture; sternite 2 compressed and recessed ventrally, the complete segment being 1.1 times as high as broad; T5 and T6 long, 6th 2.0 times as long as 5th. Coloration as in *S. tarsa*, overall somewhat lighter. Length female 1.3 mm (figs. 73a—73e).

Piastopleura Foerster

1. T1 smooth, without sculpture *seron* (Walker, 1835)

Mesoscutum, scutellum and metasoma smooth, without hairs. Head 1.8 times as broad as long; OOL : POL : LOL = 1 : 20 : 9; head roundish in front, coriaceous. Mesosoma compressed, length 2.1 times as long as broad at its broadest part; notauli absent; hind border of mesoscutum rounded, just reaching the protruded scutellum; mesoscutum for the larger part smooth with lateral areas of very fine microsculpture; scutellum straight with a long spine; propodeal carinae long, high and fused; lateral areas of propodeum large, more densely haired in its posterior part. T1 smooth, with an impression in its upper third; T2 with indication of basal foveae and some very fine superficial microsculpture posteriorly; T3—T7 with distinct microsculpture. Black, shiny species. Antennae black, scape red. All legs yellowish red, hind femora and tibiae distally darker. Length male 1.6 mm (figs. 74a—74d).

Remarks. — This species resembles *Piastopleura mamertes* in many ways. It differs from it in the sculpturing of T1 and in the coloration of antennae and legs.

- T1 with longitudinal sculpture 2
2. T1 with two lateral grooves and with a crenulate transverse impression in the middle *mamertes* (Walker, 1835)

Head 1.8 times as broad as long; OOL : POL : LOL = 1 : 20 : 10; head in front roundish, somewhat broader than high, coriaceous. Mesosoma compressed, length 2.0 times as long as at broadest part; notauli very faintly indicated; hind border of mesoscutum rounded and not quite reaching the protruded scutellum; mesoscutum with fine microsculpture, medio-laterally with a smooth area; scutellum not particularly convex, with a relatively long spine; propodeal carinae long, high and fused; lateral areas of propodeum large and regularly haired. T2 with shallow lateral foveae, posterior part with fine microsculpture; T2—T7 with fine microsculpture. Blackish brown, shiny species. Antennae dark brown. All femora brown; fore tibiae apically, middle and hind tarsi proximally, yellowish brown, rest darker; all tarsi yellowish, except last tarsal segments which are dark. Length male 1.5 mm (figs. 75a—75d).

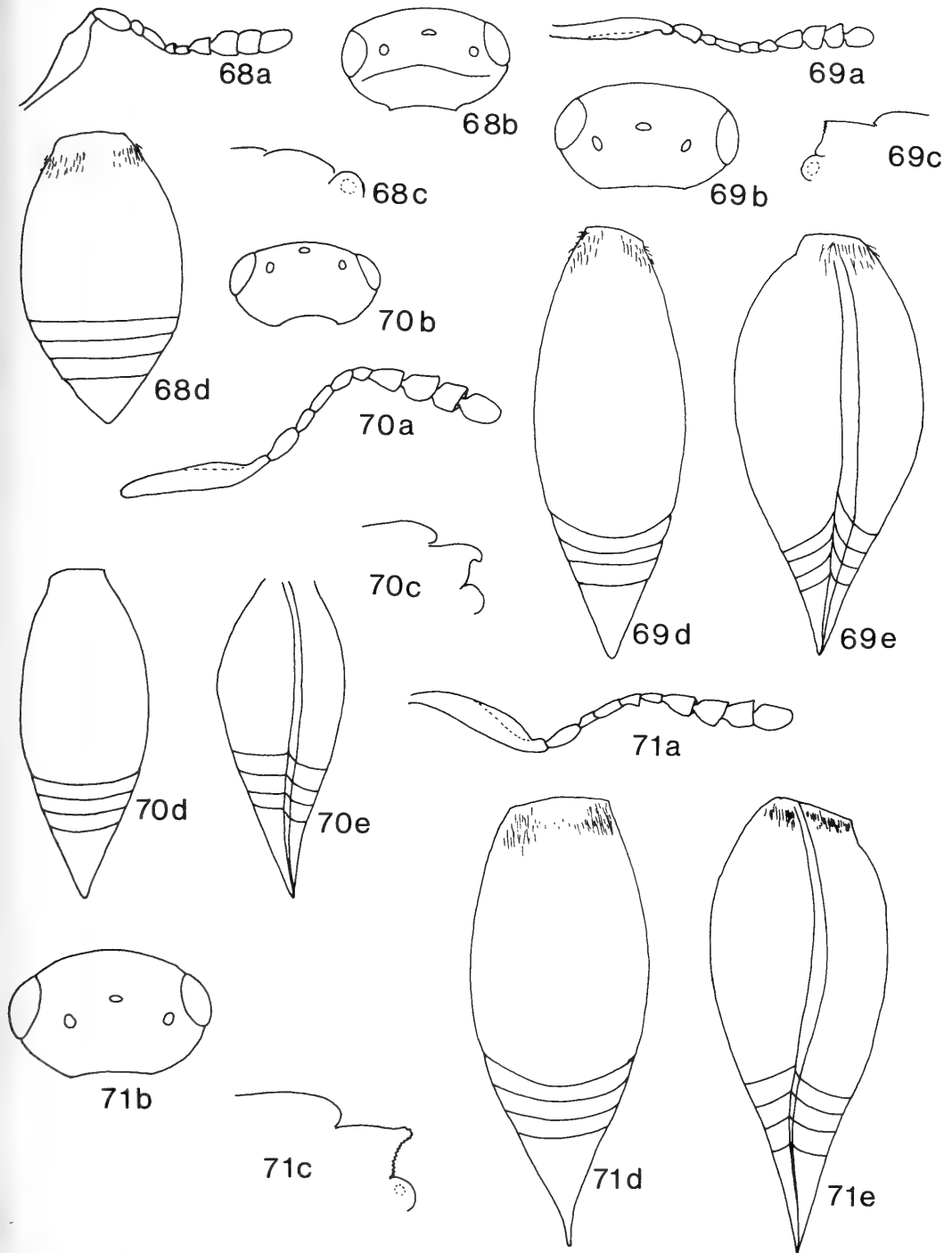

Figs. 68—71. a, antenna; b, head (dorsal view); c, scutellum (lateral view); d, metasoma (dorsal view); e, metasoma (lateral view). 68a—d, *Synopeas euryale* (lectotype); 69a—e, *S. hyllus* (lectotype); 70a—e, *S. rhanis* (lectotype); 71a—e, *S. acco* (lectotype).

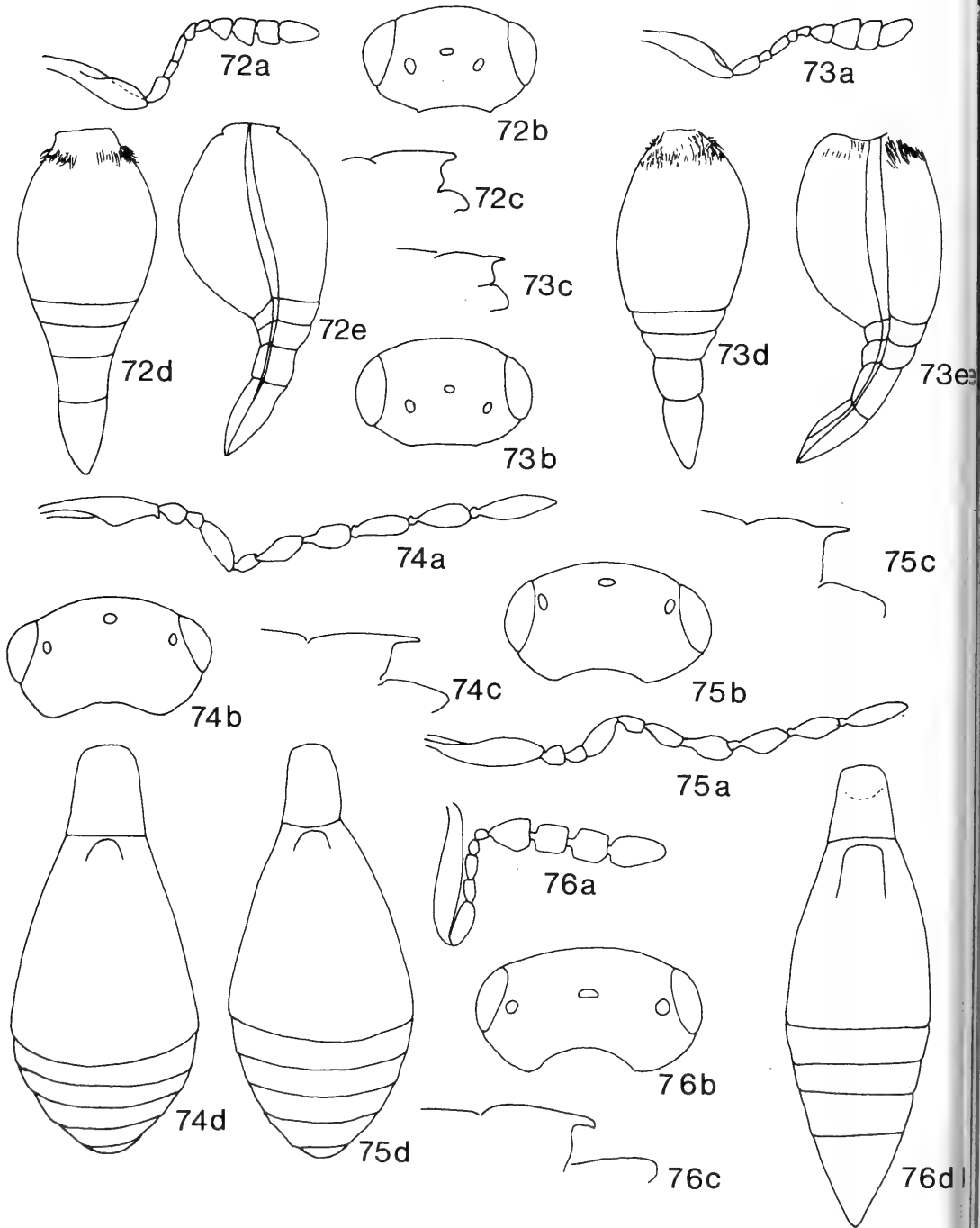

Figs. 72—76. a, antenna; b, head (dorsal view); c, scutellum (lateral view); d, metasoma (dorsal view); e, metasoma (lateral view). 72a—e, *Synoeps (Sactogaster) tarsa* (lectotype); 73a—e, *S. (Sactogaster) osaces* (lectotype); 74a—d, *Piestopleura seron* (lectotype); 75a—d, *P. mamertes* (lectotype); 76a—d, *P. catillus* (authors collection).

- T1 with two lateral grooves, adjoined by longitudinal striae; basal part of T1 elevated *catilla* (Walker, 1835)

Head slightly more than 2.0 times as broad as long; OOL : POL : LOI = 1 : 20 : 8; head in frontal view roundish, 1.2 times as broad as high, with superficial microsculpture, transverse microsculpture above antennal sockets. Thorax and propodeum compressed, combined length nearly three times as long as at broadest part; mesoscutum nearly smooth, in its centre with fine microsculpture; notauli faintly indicated; hind border of mesoscutum nearly straight, just reaching the protruded scutellum; scutellum nail-like and ending in a strong, rather short spine; propodeal carinae close to each other, converging and fused posteriorly; lateral areas of propodeum haired, more densely postero-laterally. T2 with shallow, very finely striated basal foveae, rest of T2 smooth, except for postero-lateral corners which have the same fine microsculpture as on T3—T6. Black, shiny species. Antennae black, A1—A6 somewhat lighter. Legs light brown, hind femur slightly darker. Length female 1.8 mm (figs. 76a—76d).

Leptacis Foerster

1. Scutellum with a long needle-like prolongation or, at least suddenly constricted 2
 — Scutellum with a nail-like prolongation, in dorsal view tapering gradually to apex 3
 2. Head rounded, without occipital carina, entirely finely reticulate, rather dull, except behind eyes *nice* (Walker, 1835)

Head 1.7 times as broad as long; OOL : POL : LOL = 2 : 14 : 6. Notauli vaguely indicated; posterior part of mesoscutum covering base of scutellum as a narrow, semitransparent lamella; scutellum semicircular, convex, provided with a long, narrow spine, 1.5 times as long as broad at base (including spine); propodeal carinae fused and about as long as scutellar spine; lateral areas of propodeum sparsely covered with long hairs; wings densely hairy. T1 1.5 times as long as broad at base, slightly tapering posteriorly, proximally strongly swollen and densely haired at lateral borders; T2 without basal foveae; posterior part of T2 and T3—T7 with fine microsculpture. Light brown species with darkened head and metasoma. Antennae yellowish, A6—A10 darker. Legs yellowish. Length male 1.5 mm (figs. 77a—77d).

- Head rounded, without occipital carina, finely alutaceous; occiput finely transversely reticulate, shiny *halia* (Walker, 1835)

Head 2.0 times as broad as long; OOL : POL : LOL = 2 : 12 : 6. Notauli traceable posteriorly and midlobe in between them just covering base of scutellum; scutellum semi-oval, convex, with a moderately long spine, 1.5 times as long as broad at base (including spine); propodeal carinae close together but not fused and not particularly long. Wings widely haired. T1 1.4 times as long as broad; T2 posteriorly, and T3—T7 with smooth microsculpture. Black, shiny species. A1 and A2 light brown, rest of antennae slightly darker. Legs light brown, middle and hind femora and tibiae darker. Length male 0.8 mm (figs. 78a—78d).

3. Prolongation of scutellum semi-transparent brown, curved, reaching base of T2 and excavated beneath ("hollow") *nydia* (Walker, 1835)

Head with occipital carina, finely reticulate, rather dull; head 1.8 times as broad as long; OOL : POL : LOL = 1 : 13 : 6. Scutellum 1.4 times as long as broad at base; propodeal carinae weak, more or less fused at their base. T1 1.3 as long as broad. Black, shiny species. A1—A6 bright red, A7—A10 black. Legs entirely bright red. Length female 1.4 mm (figs. 79a—79d).

Remarks. — *Leptacis nydia* is conspecific with *Leptacis torispinula* Huggert, 1980 (*syn. nov.*). For a detailed description I refer to the paper of Huggert, 1980. The species is found commonly on the freshly cut ends of oak-logs and other hardwoods.

- Prolongation of scutellum "massive" and rugose, with a vertical lamella from its apex to metanotum 4
4. Head entirely reticulate with a weak occipital carina *ozines* (Walker, 1835)

Head 1.8 times as broad as long; OOL : POL : LOL = 2 : 15 : 7. Pronotum weakly alutaceous with a few hairs in its upper half; notauli incomplete, midlobe between them slightly prolonged and just touching scutellum; scutellum 1.3 times as long as broad at base, its apex not quite reaching base of T1; propodeal carinae clearly separated, not particularly high. T1 and T2 seemingly fused by the presence of dense greyish hairs but definitely separated; T1 with two converging, well defined carinae; T2 with two deep basal foveae, leaving a small, tongue-like structure in the middle; rest of T2 smooth, shiny; T3—T6 with a narrow, transverse strip of microsculpture. Black, shiny species. Scape red, A2—A6 darker, A7—A10 black. Legs brownish, fore legs lighter. Length male 1.0 mm (figs. 80a—80d).

- Head entirely reticulate, vertex and occiput more transversely reticulate; occipital carina present but not strong *laodice* (Walker, 1835)

Head 2.1 times as broad as long; OOL : POL : LOL = 2 : 14 : 6. Pronotum weakly alutaceous in its lower half, upper half regularly hairy; notauli only traceable at their extreme posterior part, midlobe between them forming a short, rounded, membraneous plate, just beyond hind margin of mesoscutum; scutellum as in *L. ozines*; propodeal carinae slightly wider from each other than in *L. ozines*. T1 1.2 times as long as broad, with three longitudinal carinae; basal foveae of T2 less deep than in *L. ozines*, rest of T2 smooth; T3—T6 with a transverse, medial strip of microsculpture. Black, shiny species. A1—A6 red, A7—A10 black. Fore legs brown, tarsi yellow; middle legs brown, tibiae proximally lighter and tarsi yellow; hind legs brown, tarsi yellow. Length female 1.3 mm (figs. 81a—81d).

Remarks. — Three females in my collection ("Ireland. Glen of the Downs, Co. Wicklow [Irish Grid Ref. O. 260112], 12.vii.1983, leg. Vlуг") are slightly darker, especially in the coloration of the legs.

Trichacis Foerster

Walker described three species which fit in the genus *Trichacis*, viz., *T. remulus*, *T. didas* and *T. pisis*. Only superficial characters separate these species. The differences are mainly found in the form of the antennal segments and colour differences of antennae and legs. There seems to be no good reason to treat them as separate species. However, until I have seen more material of this genus, I prefer to maintain the present situation. The material in my collection is far too poor to say anything about variation. There seems to be a tendency that northern specimens (Sweden, Norway and Denmark) have hyaline wings, whereas some of my specimens from Italy, Yugoslavia and Southern France have infuscate wings.

1. A7 and A8 clearly broader than long (0.7 × 0.6 mm). Notauli reaching front margin of mesoscutum *remulus* (Walker, 1835)

Head 1.8 times as broad as long; OOL : POL : LOL = 7 : 18 : 8; frons smooth, with transverse wrinkles above antennal sockets; vertex reticulate coriaceous, this sculpture becoming more transverse towards the weak occipital carina; occipital carina not complete, occiput sloping strongly, having coarse, transverse sculpture. Anterior half of mesoscutum with fine sculpture and hairs, posterior half smooth and less densely haired; propleurae regularly haired, except extreme upper border and hind border; mesopleurae smooth; metapleurae densely haired; scutellum smooth, except the specialized area which has a dense tuft of hairs; propodeal carinae high and strong, lateral areas of propodeum with long hairs. Central part of T1 strongly crenulated, at sides densely haired; basal foveae of T2 deep and densely haired, raised area in between with some short striae, rest of tergite smooth; T3—T7 with fine microsculpture and some long hairs. Black, rather shiny species. Antennae uniformly

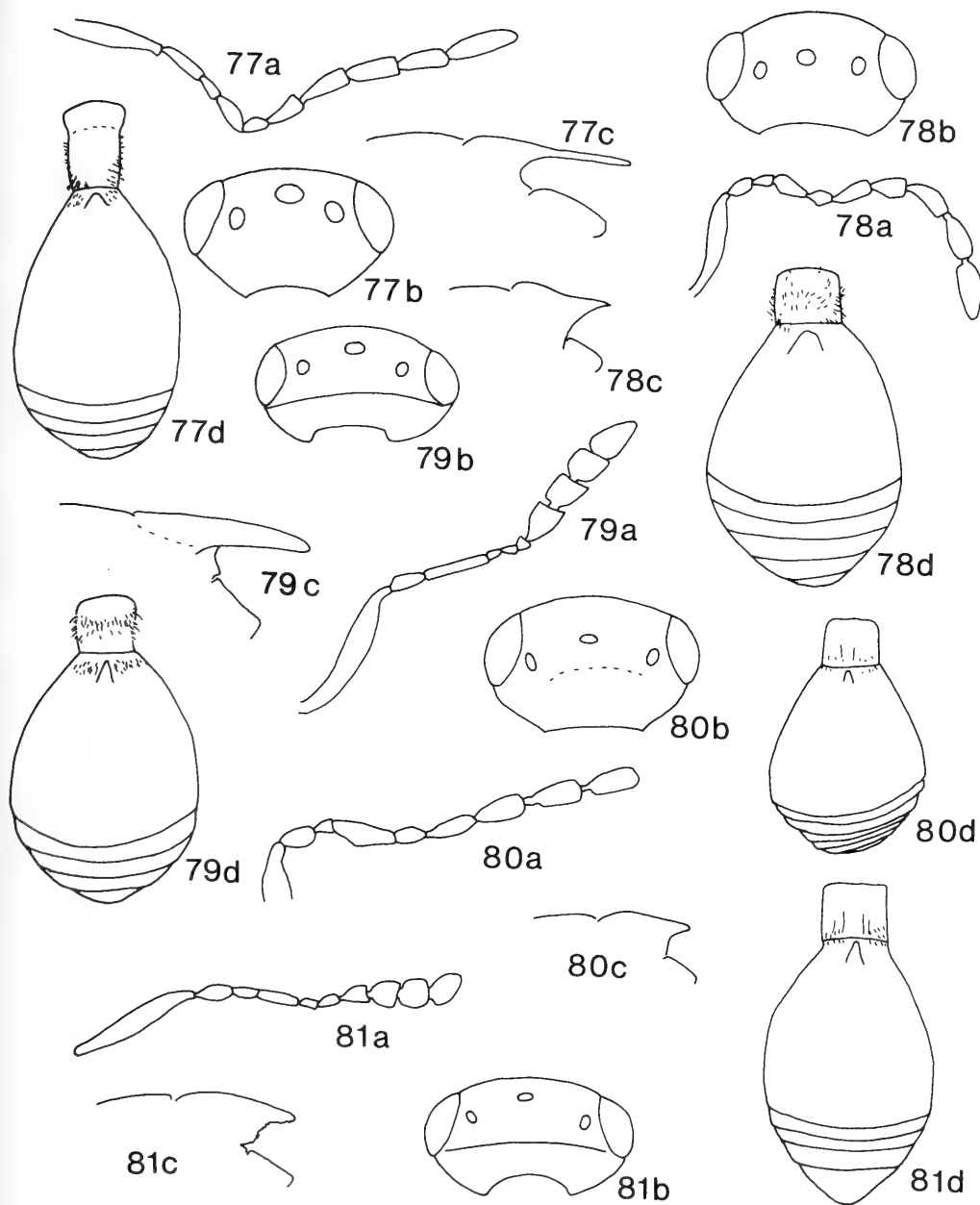

Figs. 77—81. a, antenna; b, head (dorsal view); c, scutellum (lateral view); d, metasoma (dorsal view). 77a—d, *Leptacis nice* (lectotype); 78a—d, *L. halia* (lectotype); 79a—d, *L. nydia* (lectotype); 80a—d, *L. ozines* (lectotype) (last antennal segment missing); 81a—d, *L. laodice* (lectotype).

dark brown, scape proximally lighter. Wings infusate. Legs dark brown, fore tibiae and tarsi lighter. Length male 1.6 mm (figs. 82a—82d).

- A7 and A8 clearly longer than broad (0.6×0.75 mm). Notauli not reaching front margin of mesoscutum. Antennae and legs lighter than in *T. remulus* 2
- 2. A4 about 2.3 times as long as broad *didas* (Walker, 1835)

Head 2.0 times as broad as long; OOL : POL : LOL = 8 : 17 : 8; frons rather smooth, without transverse striae above antennal sockets; vertex and occiput as in *T. remulus*. Mesoscutum as in *T. remulus* but to a greater extent sculptured in the lectotype; notauli incomplete; scutellum smooth with some long hairs except the specialized area with a dense tuft of hairs; propleurae, mesopleurae and metapleurae, propodeum and metasoma as in *T. remulus*. Black, shiny species. Antennae reddish brown, A4—A10 somewhat darker. Wings infusate. Legs dark brown, fore legs entirely reddish brown. Length male 1.8 mm (figs. 83a—83d).

- A4 about 1.6 times as long as broad *pisis* (Walker, 1835)

Head 2.1 times as broad as long; OOL : POL : LOL = 7 : 18 : 8. Rest of characters as in *T. remulus*. Black, shiny species. Antennae reddish brown, scape lighter. Wings infusate. Fore legs reddish, apical tarsal segments darker; middle legs reddish brown, tibiae apically darkened; hind legs dark brown. Length male 1.8 mm (figs. 84a—84d).

Isocybus Foerster

- 1. Vertex broadly excavated 2
- Vertex rounded 3
- 2. T2 entirely roughly striated, except posterior border which is finely punctate *erato* (Walker, 1835)

Head appearing square, 1.5 times as broad as long, eyes clearly forming broadest part; OOL : POL : LOL = 14 : 16 : 7; entire head roughly and wrinkly sculptured. Mesoscutum with same sculpture as head, notauli complete and deep; hairy impression on dorsal surface of scutellum large; postscutellum not exceeding length of scutellum; propodeal carinae strong. T1 carinated; T2 with deep basal pits, entire tergite, except posterior border, longitudinally and irregularly striated (these striae splitting in their second half); T3—T7 finely punctate with scattered, fine long hairs. Black, rather dull species. Antennae red. Wings infusate. Fore legs entirely red; middle femora brown, tibiae brown but proximally lighter and tarsi red; hind legs blackish, tibiae proximally lighter and tarsi dark brown. Length male 3.2 mm (figs. 85a—85d).

Remarks. — In specimens from the Netherlands ("Huizen. "Oud Bussum". 9.viii.1981, leg. Gijswijt"), both males and females tend to have a less extensive striation on T2. In these specimens the legs are somewhat darker and the female antennal club consists of six dark brown to black segments. Fresh material shows clearly that the specialized, roughly sculptured and densely haired area on the scutellum occupies nearly the whole dorsal surface. In all other species this area is smaller and in some cases more or less heart-shaped. Of the four species mentioned in this key, *I. erato* has the strongest infusate wings.

- T2 moderately striated in its proximal two-thirds, rest of tergite, including area between basal foveae smooth *matuta* (Walker, 1835)

Head appearing square, 1.3 times as broad as long, eyes not clearly forming broadest part; OOL : POL : LOL = 13 : 18 : 9; frons irregularly and roughly wrinkled, smoother in the centre; vertex and occiput reticulate coriaceous. Mesoscutum roughly wrinkled, notauli complete and deep; scutellum with more or less triangular, hairy impression on dorsal surface; postscutellum appearing as a semi-transparent crenulated lamella, clearly visible from above;

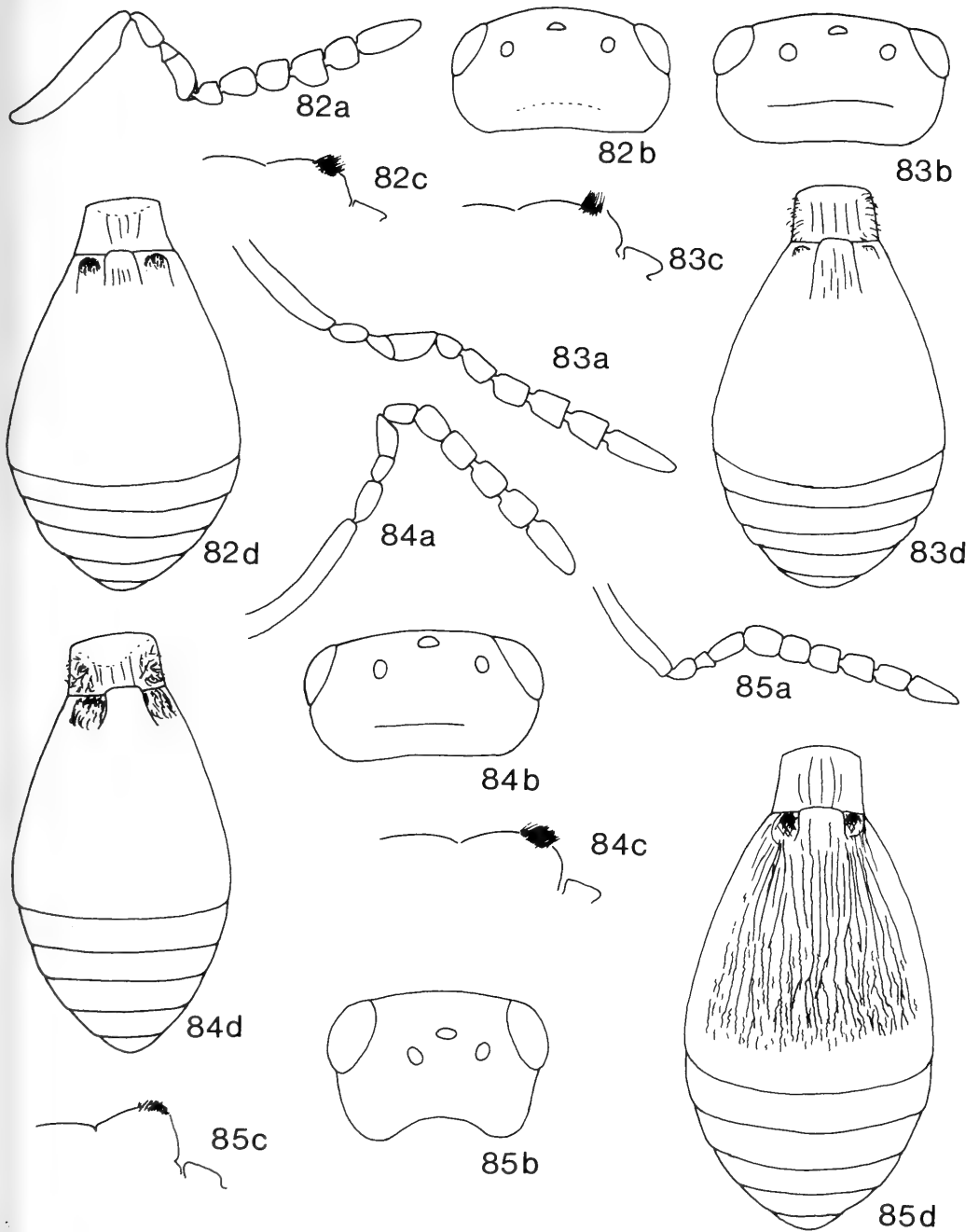

Figs. 82—85. a, antenna; b, head (dorsal view); c, scutellum (lateral view); d, metasoma (dorsal view). 82a—d, *Trichacis remulus* (lectotype); 83a—d, *T. didas* (lectotype); 84a—d, *T. pisis* (lectotype); 85a—d, *Isocybus erato* (lectotype).

propodeal carinae strong, more or less lamelliform and spreading outwards. T1 with central carinated area, at sides roughly sculptured; T3—T7 finely punctate with, especially at sides, long thin hairs. Black, shiny species. Antennae brown, A1 red. Wings somewhat infusate. All legs entirely bright red. Length male 2.6 mm (figs. 86a—86d).

3. Temples, propleurae, scutellum, sides of propodeum and hind coxae densely haired *walkeri* Kieffer, 1926

Head 1.6 times as broad as long; OOL : POL : LOL = 13 : 18 : 8; frons roughly wrinkled, vertex and occiput reticulate coriaceous with some transverse striae. Mesoscutum irregularly and strongly reticulate coriaceous, notauli complete and deep; propleurae with strong punctation and dense brown hairs; mesopleurae with a deep longitudinal impression, with a rather smooth area above and longitudinal striae below; scutellum strongly convex with a densely haired impression; propodeal carinae strong, lateral areas of propodeum with long hairs. T1 with a carinated area in the centre, at sides of it with rough longitudinal sculpture; T2 with deep basal foveae, the tergite striated over its whole width to one-third; lateral part of T2 with long brown hairs, posterior border with fine microsculpture; T3—T7 finely punctate, laterally with hairs. Black, shiny species. Antennae red. Wings, especially proximally, infuscated. Fore legs red; middle legs reddish brown; hind legs dark brown. Length male 3.1 mm (figs. 87a—87d).

- Temples and hind coxae rather bare, propleurae, scutellum and lateral parts of propodeum moderately haired *cotta* (Walker, 1835)

Head 1.7 times as broad as long; OOL : POL : LOL = 12 : 16 : 9; frons roughly sculptured, vertex and occiput reticulate coriaceous. Mesoscutum irregularly reticulate coriaceous, notauli complete and deep; propleurae with strong punctation, moderately densely haired with short fine hairs; mesopleurae with deep longitudinal impression, above as well as beneath with strong longitudinal striae; scutellum with an irregularly shaped impression, sparsely haired; propodeal carinae strong, at sides not particularly hairy. T1 over whole width with longitudinal carinae; T2 with moderate deep, basal foveae, each of them provided with a small round pit; striation of T2 to one-third, rather strong and extending over whole width; hind border of T2 smooth; T3—T6 with fine punctation and some deeply implanted hairs. Black, shiny species. A1 and A2 red, A3 and A4 reddish brown and A5—A10 dark brown. Proximal part of wings infusate, rest clear. Legs uniformly reddish brown, fore legs somewhat lighter. Length female 2.8 mm (figs. 88a—88d).

Amblyaspis Foerster

1. Occipital carina complete; head strongly narrowed behind eyes 2
 — Occipital carina incomplete or absent; head gradually rounded behind eyes 5
 2. Occiput with vertical striae 3
 — Occiput without vertical striae, sometimes with weak transverse striation 4
 3. T2 haired in basal foveae *roboris* (Walker, 1835)

Head 2.2 times as broad as long; OOL : POL : LOL = 6 : 17 : 7; frons finely granulate, above and at sides of antennal sockets roughly sculptured. Hind border of mesoscutum straight; epomia relatively weak and anteriorly not forming an overhanging plate; propodeal carinae fused at base but clearly separated at top. Basal foveae of T2 deep and hairy, rest of T2 smooth; T3—T6 with fine punctation and some long hairs. Black species. Antennae reddish brown, proximally lighter. Wings infusate. Coxae brown, legs dirty yellow; apical parts of middle tibiae, hind femora and hind tibiae darkened. Length female 1.8 mm (figs. 89a—89d).

- T2 bare in basal foveae *nereus* (Walker, 1835)

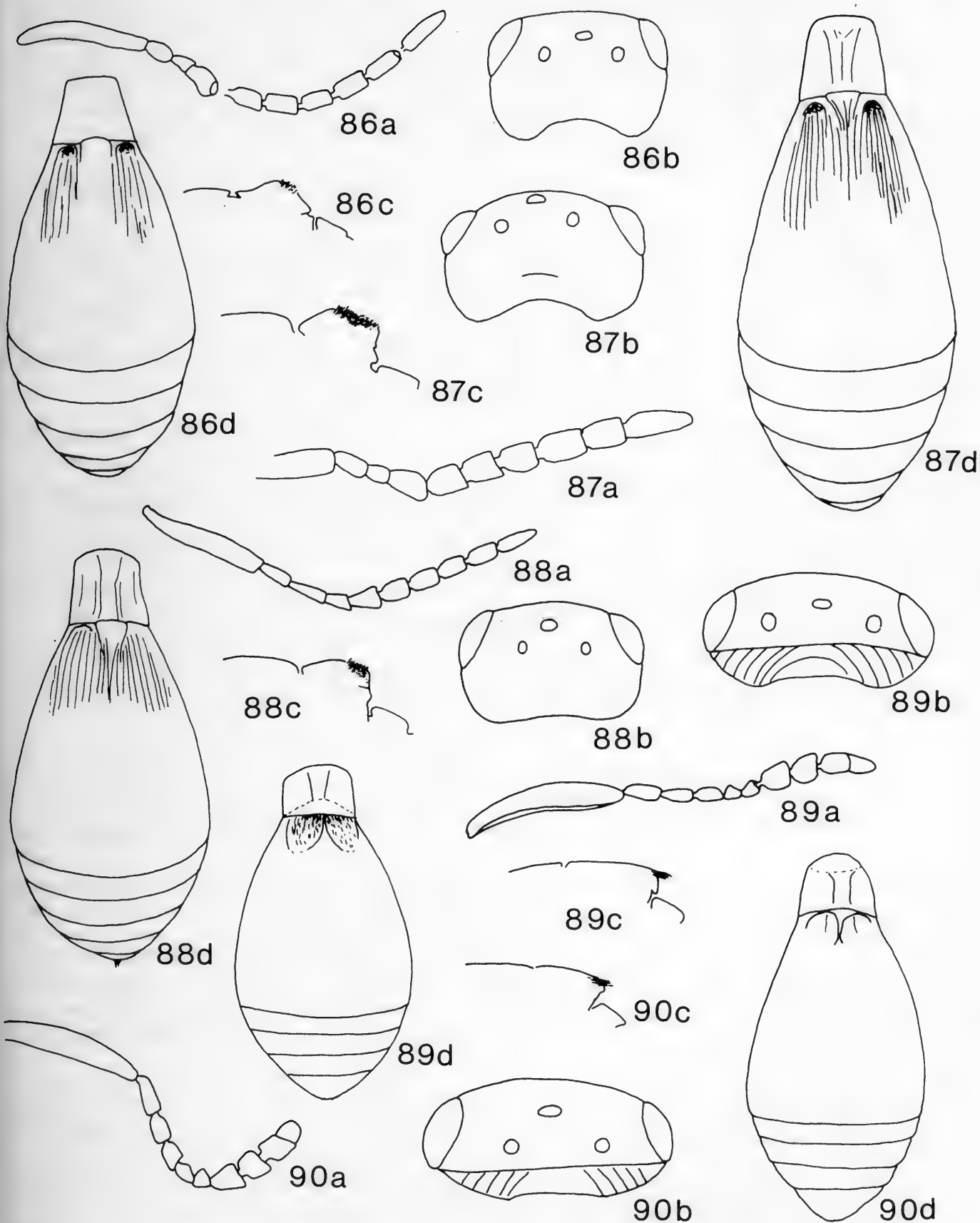

Figs. 86—90. a, antenna; b, head (dorsal view); c, scutellum (lateral view); d, metasoma (dorsal view). 86a—d, *Isocybus matuta* (paralectotype no. 270 in NMI); 87a—d, *I. walkeri* (lectotype); 88a—d, *I. cotta* (lectotype); 89a—d, *Amblyaspis roboris* (lectotype); 90a—d, *A. nereus* (lectotype).

Head 2.3 times as broad as long; OOL : POL : LOL = 10 : 15 : 9; frons granulate, with transverse striation in lower half; head appearing rather dull. Hind border of mesoscutum more or less excavated; epomia strong and anteriorly forming an overhanging plate; propodeal carinae fused at base and separated at top. Basal foveae of T2 bare and not particularly deep, rest of T2 smooth; T3—T6 with fine punctation. Black species. Antennae dark brown, scape reddish brown. Wings strongly infuscated. Fore and middle coxae reddish brown, hind coxae black; legs uniformly reddish brown. Length female 2.1 mm (figs. 90a—90d).

4. Occiput granulate *tritici* (Walker, 1835)

Head 2.0 times as broad as long; OOL : POL : LOL = 8 : 15 : 6; frons granulate with some transverse wrinkles above antennal sockets; mesoscutum coriaceous; notauli weakly indicated; hind border of mesoscutum straight, slightly depressed laterally; propodeal carinae well developed and well separated at top. T1 with two carinae, laterally haired; T2 with rather deep, roundish basal foveae, provided with hairs; rest of T2 smooth; T3—T7 with fine punctation. Black species. Wings strongly infuscated. Coxae black. Legs entirely reddish yellow. Length male 1.5 mm (figs. 91a—91d).

— Occiput transversely reticulate *prorsa* (Walker, 1835)

Head 2.0 times as broad as long; OOL : POL : LOL = 8 : 16 : 8; frons smoothly granulate; some wrinkles above antennal sockets; pronotal collar and epomia well developed; mesoscutum finely coriaceous, without notauli; hind border of mesoscutum straight; propleurae with superficial sculpture in upper part, lower part entirely smooth; propodeal carinae well developed, seemingly fused. T1 with two carinae, laterally haired; T2 with two small, haired basal foveae, rest of T2 smooth; T3—T7 punctate, except a narrow smooth anterior strip. Brownish, shiny species with a blackish head. (The type may have been discoloured to some extent during the 150 years of preservation; darker diffuse markings give rise to this impression.) Antennae light brown. Wings infusate. Legs entirely yellowish. Length male 1.3 mm (figs. 92a—92d).

5. Occipital carina not present, head perfectly rounded 6

— Occipital carina present but not complete, sometimes weak 8

6. Head 1.7 times as broad as long, in frontal view as broad as high, roundish *belus* (Walker, 1835)

OOL : POL : LOL = 5 : 12 : 5; frons nearly smooth, rather shiny and with faint sculpture; occiput faintly coriaceous. Notauli clearly indicated on posterior half of mesoscutum, mid-lobe in between them prolonged over base of scutellum; propodeal carinae strong and high, fused at base but clearly separated at top. Basal foveae of T2 moderately deep and haired, rest of T2 smooth; T3—T6 with fine punctation. Black, rather dull species. Antennae blackish brown. Wings slightly infusate. Legs brown; fore tibiae and tarsi lighter, middle and hind tibiae proximally lighter, middle and hind tarsi lighter. Length female 1.4 mm (figs. 93a—93d).

— Head 2.0 times as broad as long 7

7. Light brown species with yellowish antennae, coxae and legs *abas* (Walker, 1835)

Head 2.0 times as broad as long, slightly broader than high; OOL : POL : LOL = 5 : 13 : 6; head entirely superficially coriaceous. Notauli weakly indicated posteriorly, the mid-lobe in between them slightly prolonged and just reaching scutellum; propodeal carinae strong and high, clearly separated. Basal foveae of T2 moderately deep with a few hairs, rest of T2 smooth; T3—T7 superficially punctate. Reddish brown species with darker head. Wings infusate. Antennae, coxae and legs entirely yellowish. Length male 1.4 mm (figs. 94a—94d).

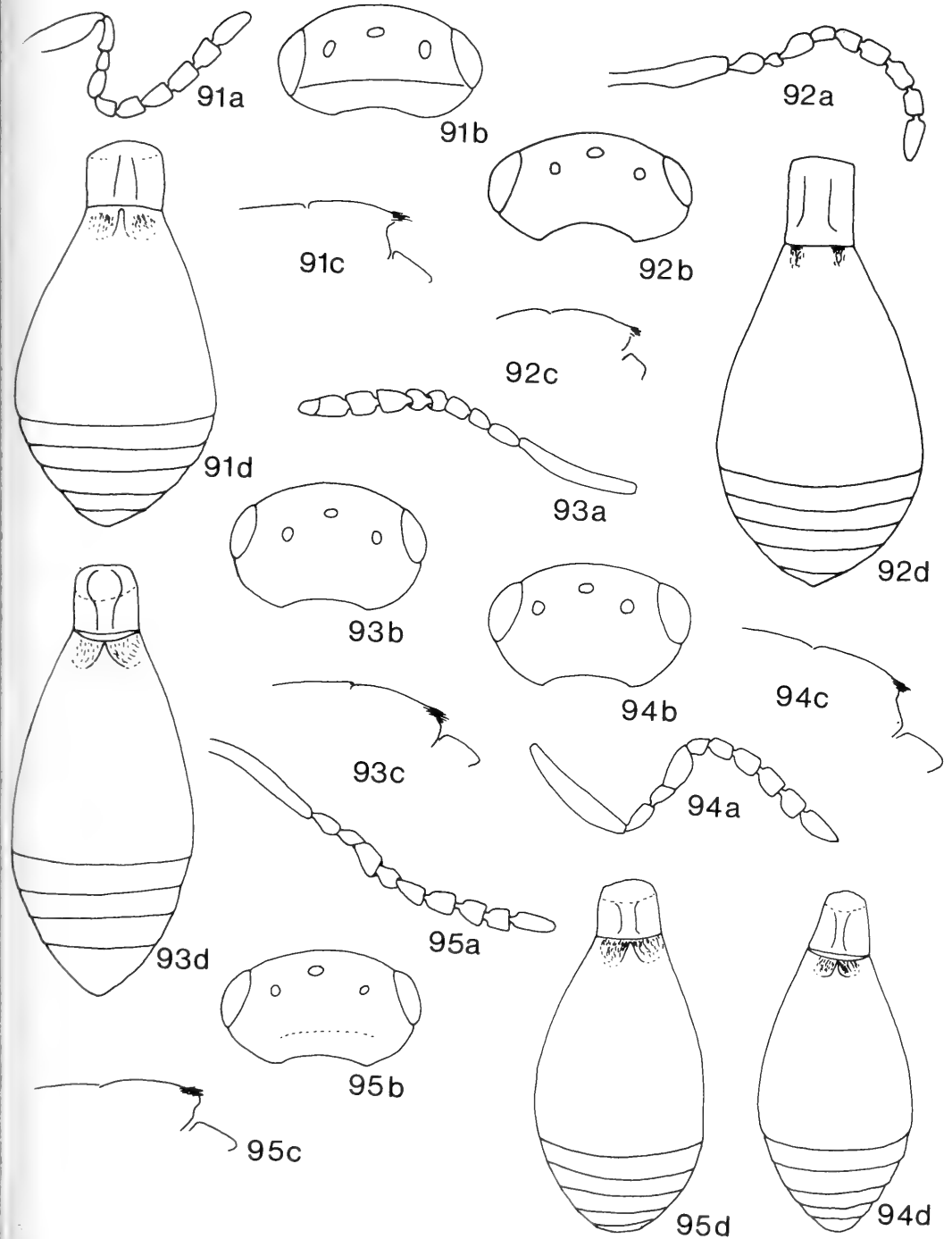

Figs. 91—95. a, antenna; b, head (dorsal view); c, scutellum (lateral view); d, metasoma (dorsal view). 91a—d, *Amblyspis tritici* (lectotype); 92a—d, *A. prorsa* (lectotype); 93a—d, *A. belus* (lectotype); 94a—d, *A. abas* (lectotype); 95a—d, *A. otreus* (lectotype).

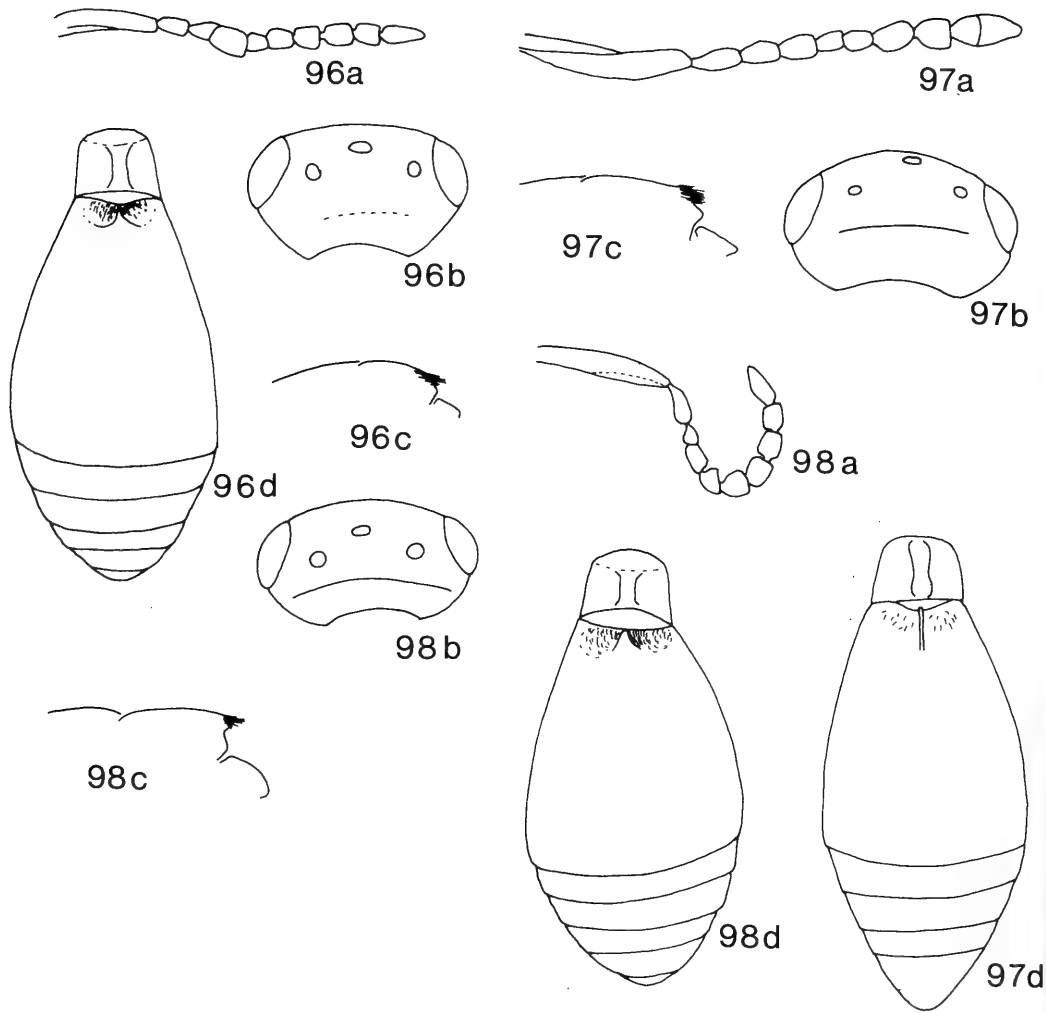

Figs. 96—98. a, antenna; b, head (dorsal view); c, scutellum (lateral view); d, metasoma (dorsal view). 96a—d, *Amblyaspis furius* (lectotype); 97a—d, *A. scelionoides* (lectotype); 98a—d, *A. crates* (lectotype).

— Blackish brown species with dark brown antennae and reddish brown coxae and legs
 *otreus* (Walker, 1835)

Head 2.0 times as broad as long, slightly broader than high; OOL : POL : LOL = 6 : 15 : 6; head entirely superficially coriaceous. Notauli clearly indicated in posterior one-third, mid-lobe between them slightly prolonged over base of scutellum; shallow impressions on meso-scutum, lateral of notauli; propodeal carinae strong and high, clearly separated. Basal foveae of T2 rather deep and thickly haired, rest of T2 smooth; T3—T7 with fine punctation. Wings infusate. Length male 1.6 mm (figs. 95a—95d).

8. Notauli clearly indicated posteriorly, midlobe in between prolonged as a rather narrow flange which covers base of scutellum *furius* (Walker, 1835)

Head 1.7 times as broad as long; OOL : POL : LOL = 6 : 16 : 7; frons and occiput superficially coriaceous. Microsculpture on mesoscutum as on head; propodeal carinae strong and high, clearly separated. Basal foveae of T2 deep and haired, rest of T2 smooth; T3—T7 with fine punctation. Blackish, rather shiny species. Antennae brown, scape somewhat lighter. Wings infusate. Coxae and legs entirely reddish yellow. Length male 1.8 mm (figs. 96a—96d).

Remarks. — *A. scelionoides* (Haliday, 1835) differs from *A. furius* by the following characters: Head 1.6 times as broad as long; mesoscutum coriaceous, lateral parts with a smooth area; shallow impressions on mesoscutum, laterally of notauli. Coxae somewhat darker and legs somewhat lighter than in *A. furius*. Length female 1.8 mm (figs. 97a—97d). Despite the above mentioned characters which are slightly different from those of *A. furius*, I consider both synonymous. I select here the name *A. scelionoides*, with *A. furius* as synonym (**syn. nov.**).

— Notauli absent; hind border of mesoscutum rounded and forming a broad, brownish transparent lamella, covering base of scutellum *crates* (Walker, 1835)

Head 2.0 times as broad as long; OOL : POL : LOL = 7 : 14 : 7; frons superficially coriaceous; occiput weakly reticulate coriaceous. Mesoscutum superficially coriaceous, nearly smooth; major part of scutellum sparsely haired, apex with the usual long hairs; propodeal carinae strong and high. Basal foveae of T2 shallow, sparsely haired, rest of T2 smooth; T3—T7 smooth, with a narrow posterior strip which is finely punctate. Black, shiny species. Antennae dark brown. Wings infusate. Coxae and legs uniformly brown. Length male 1.2 mm (figs. 98a—98d).

REFERENCES

- Eady, R. D., 1968. Some illustrations of microsculpture in the Hymenoptera. — Proc. R. ent. Soc. Lond. (A): 66—72.
 Huggert, L., 1973. Taxonomical studies on Platygastriinae (Hym. Proctotrupoidea). — Ent. Tidskr. 94: 97—108.
 Huggert, L., 1974. Taxonomical studies on the species belonging to *Urocyclops* Maneval (Hym. Proctotrupoidea, Platygastriinae). — Ent. Tidskr. 95: 58—63.
 Huggert, L., 1980. Taxonomical studies on some genera and species of Platygastriinae (Hymenoptera: Proctotrupoidea). — Ent. scand. 11: 97—112.
 Vlug, H. J. and M. W. R. de V. Graham, 1984. The types of Platygastriidae (Hymenoptera, Scelionoidea) described by Haliday and Walker and preserved in the National Museum of Ireland and in the British Museum (Natural History). 1. Designations of lectotypes. — Tijdschr. Ent. 127: 115—135.

INDEX

Amblyaspis abas (Walker)	220	Isocybus matuta (Walker)	216	Platygaster abia Walker	182
Amblyaspis belus (Walker)	220	Isocybus walkeri Kieffer	218	Platygaster abisares Walker	204
Amblyaspis crates (Walker)	223	Leptacis halia (Walker)	213	Platygaster acrisius Walker	193
Amblyaspis furius (Walker)	222	Leptacis laodice (Walker)	214	Platygaster aegaeus Walker	199
Amblyaspis nereus (Walker)	218	Leptacis nice (Walker)	213	Platygaster athamas	
Amblyaspis otreus (Walker)	222	Leptacis nydia (Walker)	213	Walker	189, 191
Amblyaspis prorsa (Walker)	220	Leptacis ozines (Walker)	214	Platygaster attenuata	
Amblyaspis roboris		Leptacis torispinula		Walker	191, 202
(Haliday)	218	(Huggert)	213	Platygaster bucolion Walker	202
Amblyaspis scelionoides		Piestopleura catilla (Walker)	213	Platygaster cebes Walker	184
(Haliday)	223	Piestopleura mamertes		Platygaster chrysippus	
Amblyaspis tritici (Walker)	220	(Walker)	210	Walker	193
Isocybus cotta (Walker)	218	Piestopleura seron (Walker)	210	Platygaster cleodaeus Walker	204
Isocybus erato (Walker)	216			Platygaster cochleata Walker	187
				Platygaster cratinus Walker	184

Platygaster cyrsilus Walker . . .	189	Platygaster minthe Walker . . .	199	Platygaster tisas Walker	193
Platygaster deipyla Walker . . .	202	Platygaster munita Walker	193, 202	Platygaster vaenia Walker	185
Platygaster demades Walker	196, 198	Platygaster nisis Walker	198	Platygaster vestinus Walker . . .	187
Platygaster dictys Walker	184	Platygaster oebalus Walker . . .	195	Platygaster xeneus Walker	186
Platygaster dryope Walker	189	Platygaster oclus Walker	195	Platygaster zosine Walker	204
Platygaster ennius Walker	201	Platygaster olorus Walker	184	Synopeas abaris (Walker)	207
Platygaster eriphyle Walker . . .	201	Platygaster orcus Walker	198	Synopeas acco (Walker)	209
Platygaster euhemerus Walker	191	Platygaster orus Walker	182	Synopeas craterus (Walker) . . .	205
Platygaster evadne Walker	202	Platygaster oscus Walker	199	Synopeas euryale (Walker)	209
Platygaster filicornis Walker . . .	187	Platygaster otanes Walker	180	Synopeas hyllus (Walker)	209
Platygaster galenus Walker	189	Platygaster pedasus Walker . . .	198	Synopeas jasius (Walker)	205
Platygaster gorge Walker	195	Platygaster pelias Walker	196, 198	Synopeas larides (Walker)	204
Platygaster gyge Walker	191	Platygaster philinna Walker . . .	201	Synopeas mamertes Kieffer	210
Platygaster ilione Walker	186	Platygaster pleuron Walker	182	Synopeas myles (Walker)	207
Platygaster inermis Walker	186	Platygaster plotina Walker	202	Synopeas osaces (Walker)	210
Platygaster iolas Walker	196	Platygaster plotina Walker	202	Synopeas rhanis (Walker)	209
Platygaster laricis Haliday	187	Platygaster ruborum (Kieffer)	198	Synopeas sosis (Walker)	207
Platygaster leptines Walker	187	Platygaster rutubus Walker	186	Synopeas tarsa (Walker)	209
Platygaster longiventris Thomson	191	Platygaster sagana Walker	201	Synopeas trebius (Walker)	205
Platygaster lysicles Walker	182	Platygaster sonchis Walker	184	Synopeas velutinus (Walker) . . .	205
Platygaster manto Walker	198, 204	Platygaster sterope Walker	180	Trichacis didas (Walker)	216
		Platygaster strato Walker	184	Trichacis pisis (Walker)	216
		Platygaster taras Walker	180	Trichacis remulus (Walker)	214

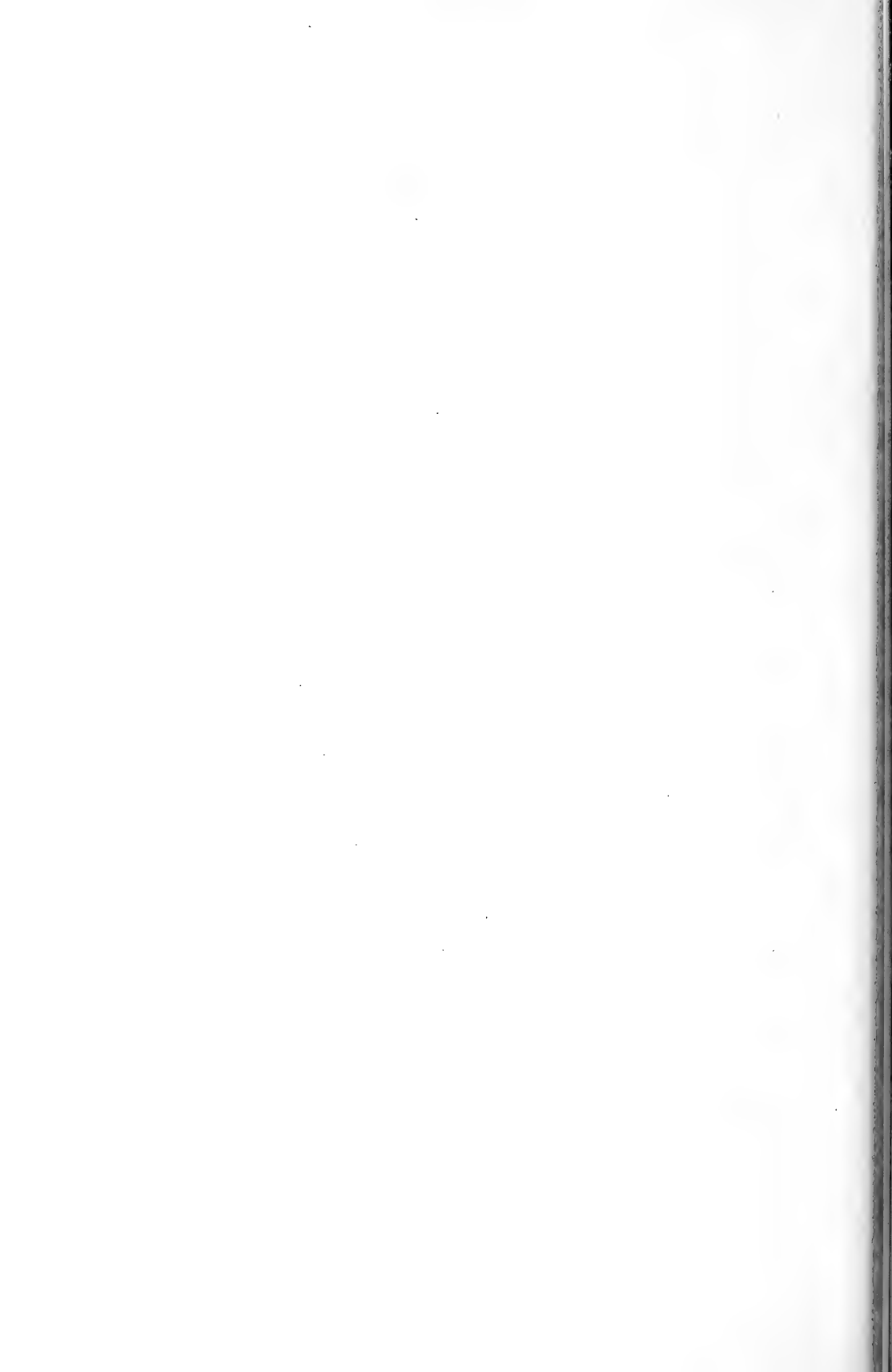



TIJDSCHRIFT VOOR ENTOMOLOGIE

UITGEGEVEN DOOR

DE NEDERLANDSE ENTOMOLOGISCHE VERENIGING

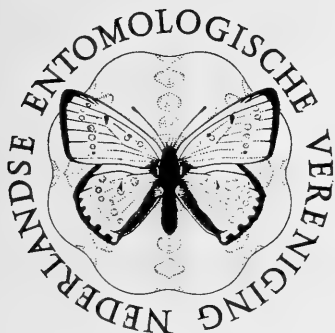

MUS. COMP. ZOOL
LIBRARY
JUN 24 1985
HARVARD
UNIVERSITY

INHOUD

- A. DIAKONOFF, S. A. ULENBERG and L. VÁRI. — A new tortricid of *Nerine* plants originating from Southern Africa (Lepidoptera, Tortricidae), pp. 225—234, figs. 1—21.

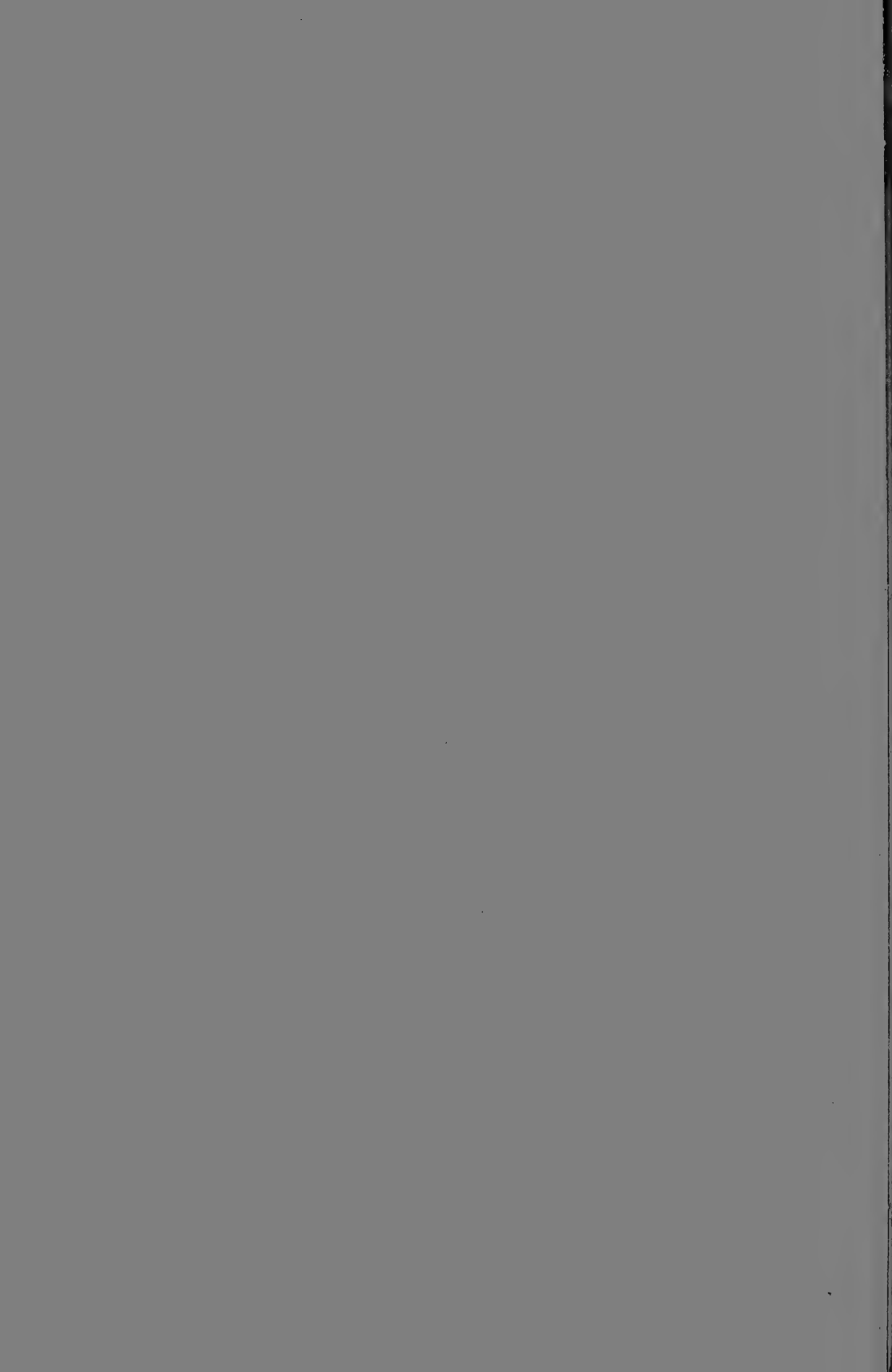

A NEW TORTRICID OF *NERINE* PLANTS ORIGINATING FROM SOUTHERN AFRICA (LEPIDOPTERA, TORTRICIDAE)

by

A. DIAKONOFF

Rijksmuseum van Natuurlijke Historie, Leiden, Netherlands

S. A. ULENBERG

Plantenziektenkundige Dienst, Wageningen, Netherlands

and

L. VÁRI

Transvaal Museum, Pretoria, Republic of South Africa

ABSTRACT

A description is presented of *Phlebozemia sandrinae* Diakonoff, gen. et sp. nov. (Tortricidae, Archipini), a tortricid introduced with plant material from Southern Africa, having caused injury to bulbs, leaves and flowers of *Nerine bowdenii*, a garden flower, grown in glasshouses in the Netherlands. Bionomics, especially host plant acceptance, were studied at the Plantenziektenkundige Dienst, Wageningen, by providing various plant species of Amaryllidaceae to the insects for oviposition. It was shown that the species is not monophagous. The reared material of the insect was compared with authentic Southern African material at the Transvaal Museum, Pretoria, South Africa, and the species proved to occur in that country.

INTRODUCTION

Severe damage was caused to *Nerine bowdenii* Watson, grown in a nursery's glasshouse in the Netherlands in September, 1983. The damage consisted of excavated bulbs and escapes and partly injured flowers (figs. 19—21).

A sample of the affected material was sent to the second author for identification of the insect. The rest of the plants was destroyed and adequate control measures were taken in the glasshouse. The damage appeared to be caused by an unknown tortricid.

Nerine belongs to the plant family Amaryllidaceae and is endemic in South Africa. Since the XVIIth century, *Nerine* is a popular garden flower in Europe, with *Nerine sarniensis* (L.) Herbert, the Guernsey Lily, as the most popular species in England, and for years exclusively cultivated in Guernsey. In other countries of Europe a large number of varieties have been developed from several other *Nerine* species, especially from *Nerine bowdenii* Watson. This species became highly valued in gardens for

their showy, late-autumn flowers and as nursery stock for the production of cut flowers (Van Brenk, 1980).

BIONOMICS

In order to obtain material for taxonomic study and get information on the developmental cycle, the host plant acceptance, and the feeding habits, rearing experiments of the tortricid were carried out by the second author. Three generations were reared indoors on *Nerine bowdenii* at a temperature of 18 °C. These cultures provided the following observations. The moths oviposited upon leaves and flower buds. The larvae started as miners. The later instar larvae bored into bulbs and scapes or fed on leaves which were partly folded lengthwise by webbing, in a way characteristic for Tortricidae.

The following lengths of the different development stages were recorded: egg 10—13 days, larva 19 days, pupa 23 days. The longevity of the individual moths has not been recorded; on average the flying period of the different gener-

ations was three to four weeks.

To determine host plant acceptance, two tests were carried out.

In the first test, *Narcissus cyclamineus* de Candolle ex Redouté was presented as food plant to first instar larvae of the third generation, reared on *Nerine bowdenii*. The larvae accepted *Narcissus* as food plant, developed fully on it, pupated and hatched.

In the second test ovipositing female moths were given the choice between *Nerine bowdenii* and several other Amaryllidaceae, viz., *Crinum powellii* Henderson, *Hippeastrum* Herbert, *Hymenocallis* (×) cv. "Festalis" Hort.¹⁾ and *Sprekelia formosissima* (L.) Herbert. Eggs were deposited on all five plant species. Larvae developed on *Hippeastrum*, *Hymenocallis* and *Sprekelia*, but not on *Crinum*.

Unfortunately, most egg masses of the fourth generation on *Nerine bowdenii* dried out. Simultaneously, the first instar larvae on *Hippeastrum*, *Hymenocallis* and *Sprekelia* died, probably because of extreme temperatures, caused by an error with the heating system in the glasshouse where the tests were carried out. By this abrupt ending of the tests we are not able to say anything about the suitability of the three last mentioned Amaryllidaceae as food plants for this tortricid. However, by the host acceptance, shown by the oviposition behaviour, the full development of the larvae on *Narcissus* and the initial development of the first instar larvae on *Hippeastrum*, *Hymenocallis* and *Sprekelia*, it is suggested that the tortricid in question is polyphagous.

THE INSECT

A preliminary study by the first author of the bred material of the insect revealed that the surmise of its origin must be correct, for it could at once be identified as a member of the large *Epichoristodes* Diakonoff group of the Archipini (a tribe of the subfamily Tortricinae), that is endemic to the Afrotropical Region and Madagascar, a group widely distributed by several, rather uniform, closely interrelated and often extensive genera (Diakonoff, 1960). The present species, however, proved to belong to an apparently undescribed distinct genus and species.

In order to corroborate this preliminary identification, the third author of this paper undertook the comparison of our material with the

authentic Southern African material in the Transvaal Museum at Pretoria. Judging from external characters, it appeared that the present species resembled "*Epichorista*" *geraeas* Meyrick closely, but internally differed entirely by the genital characters and especially the wing venuration, an important criterion, as will be explained in the description below. Besides, he was fortunate to find in the Transvaal Museum collection several male and female specimens of a quite similarly looking, but unnamed species, that showed to be identical with our material of the *Nerine* pest, proving indeed that it is a native of Southern Africa. After having received this information, the first author could proceed with the description of the new genus and species.

Phlebozemia Diakonoff gen. nov.

(φλέψ = vein, ζημύ = loss)

Male. — Head with appressed scales, a dense pointed tuft on face. Ocellus small, posterior. Haustellum short, in rest concealed between palpi. Antenna moderately thickened in male, ciliations 1. Palpus rather long, moderately sinuate, oblong-triangular, closely appressed to face and frontal tuft, with short, appressed scales, terminal segment short, subobtusate. Thorax without a crest. Abdomen long. Posterior tibia simple, smooth.

Fore wing rather long, narrow, oblong-sublanceolate, costa broadly curved along anterior half, slightly sinuate, actually concave posteriorly, apex pointed, termen gently sinuate, strongly oblique. Vein 1b furcate at base, thence running halfway between cell and dorsum, 2 from middle of lower edge of cell, 3 from angle, 4 absent, 3, 5 and 6 parallel and equidistant, 7 free, to termen below apex or to apex, 7 and 8 moderately approximated at base or short-stalked, 11 from slightly before middle of cell, chorda absent.

Hind wing trapezoidal, 1¼, rather pointed, without a cubital pecten. Veins A1—A3 all distinct, 2 from ⅔ of cell, 3 from angle, 4 absent, 5 slightly approximated at base, 6 and 7 stalked.

Female. — Haustellum apparently longer, not altogether concealed. Antenna simple. Palpus longer, less pointed. Wings slightly broader. Abdomen similarly long. Otherwise as male.

Male genitalia. Of the usual and characteristic type of Afrotropical Archipini, resembling

¹⁾ *Hymenocallis* (×) cv. "Festalis" Hort. (common name *Ismene festalis*) is a hybrid of *Hymenocallis narcissiflora* (von Jacquin) Macbride (×) *Elisena longipetala* Herbert (Anonymous, 1975).

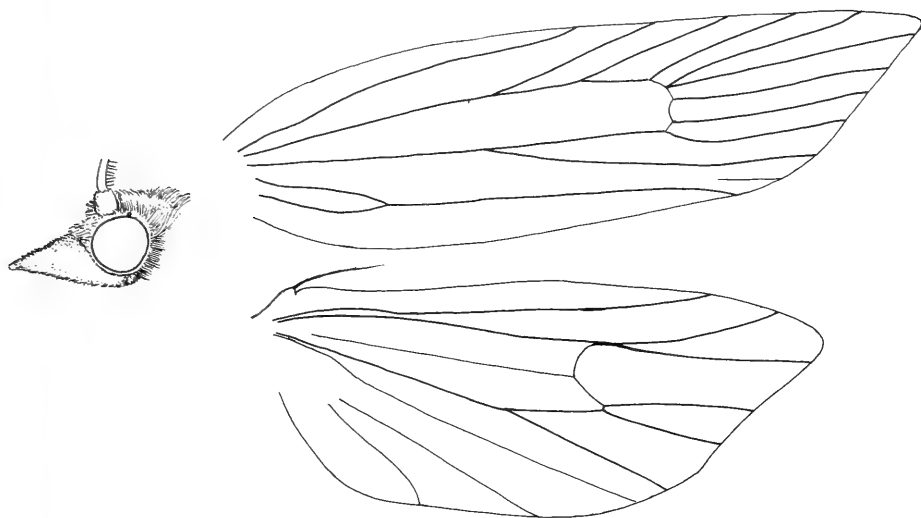

Fig. 1. *Phlebozemia sandrinae* g. & sp. n., sketch of head and wing neuration.

those of *Epichoristodes* Diakonoff. Tegumen moderate, rather conical. Uncus long, little shorter than tegumen, with narrow base, gradually dilated, top truncate, hardly emarginate. Socius moderate, oblong, narrowed, shorter than arm of tegumen. Gnathos robust, sclerotic, arms with dilated bases, hooks strong, moderately long. Vinculum triangular, sclerotic but slender. Transtilla narrow, straight, dilated laterally. Labis moderate, crown-shaped, spiny, little sclerotic. Valva small, hyaline, with an unusually robust and darkly sclerotic basal edge, swollen, constricted below middle; pulvinus proper hyaline, small, with short hairs; sacculus sclerotic, dilated and rounded-prominent in middle; inner rim darkly sclerotic. Aedeagus gradually curved, flattened dorso-ventrally at top; cornutus one, a straight and long, slender spine.

Female genitalia. Lobus analis oblong and slender, triangularly dilated towards top. Ninth segment darkly sclerotic. Apophyses slender and long, postapophyses very long, hyaline, basal furca unusually long. Sterigma transversely oval, moderate, highly sclerotic, with an oval large central orifice, lower rim darkly sclerotic throughout.

Colliculum short, cup-shaped, slight lateral structures above end. Ductus bursae hyaline above, simple throughout, ductus bullae from end of hyaline part, corpus bullae moderate. Corpus bursae simple, without signa.

Type-species: *Phlebozemia sandrinae* spec. nov.

An interesting novel form, externally rather similar to *Epichoristodes* Diakonoff, 1960, but at once recognisable by the absence of vein 4 in both fore and hind wings. The superficially very similar "*Epichorista*" *geraeas* Meyrick differs besides, by shorter labial palpi with especially the terminal segment being shorter, more pointed and drooping; furthermore, by small, almost parietal socii and by an intricate combination of diversely shaped cornuti, while *P. sandrinae* has only one simple cornutus, etc.

The genus belongs to the tribe Archipini and, within it, it may be placed into the large *Epichoristodes* Diakonoff group of genera, with the following synapomorphies.

Valva semioval, submembraneous, with radial wrinkles, a sclerotic sacculus, slender or dilated in middle; dorsal edge of valva more or less sclerotic, with labis. Transtilla narrow. Sterigma with a large, transversely-oval ostium and a moderate, sclerotic colliculum.

The genus *Phlebozemia* has the following autapomorphies: The loss of vein 4 in both the fore and hind wing, strongly sclerotic entire basal edge of valva (with a crown-shaped, dentate labis). Strongly sclerotic, in middle well dilated sacculus, and a short, semioval disc of valva. Gradually curved aedeagus. Ductus bursae with a short, cup-shaped colliculum, below this hyaline for a stretch. Absence of signum

When compared with *Epichoristodes*, especially the neuration, but also the unusually extended sclerotization of the basal edge of the valva are distinct autapomorphies of the genus

2



3



Figs. 2, 3. *P. sandrinae* g. & sp. n. 2, adult male; 3, adult female.

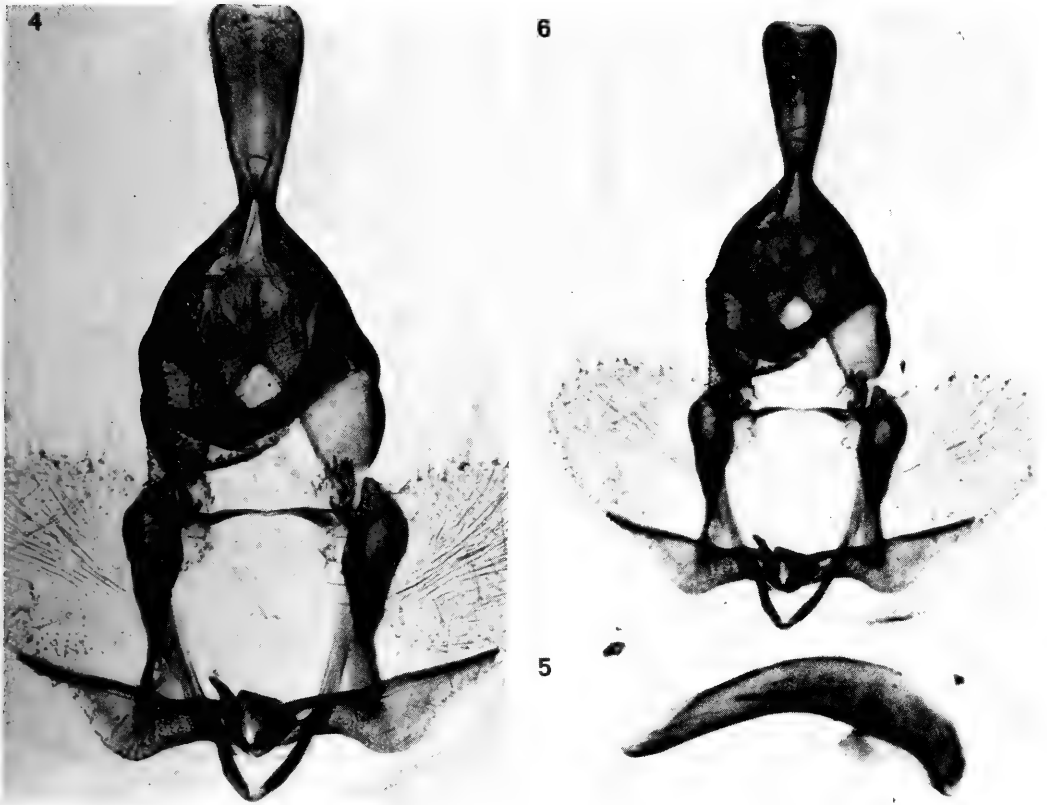

Figs. 4—6. *P. sandrinae* g. & sp. n. 4, male genitalia; 5, aedeagus; 6, general aspect of the genitalia, less magnified.

Phlebozemia; these two characters support one another as autapomorphies in a conspicuous way. On the other hand, the crown-shaped large labis, that is small and mostly rod-like in *Epichoristodes*, is a less trustworthy character, occurring in diverse stages of development in several groups of genera; it might be a parallelism.

***Phlebozemia sandrinae* spec. nov.**
(figs. 1—18)

Male. — Wing span 18 mm. Head brownish-fuscous, antenna fuscous, scape dark brown. Palpus grey-fuscous with lower half throughout white, tinged cinereous, with well-defined edge, terminal segment pale ochreous with fuscous base. Thorax ochreous touched with olive or grey, anteriorly suffused with brown, tegula with basal half brown. Abdomen glossy cinereous.

Fore wing rather long and narrow, costa broadly curved along basal half, almost straight

posteriorly, apex subacute, appearing rather pointed, termen rather sinuate, strongly oblique. Light ochreous, with a strong silky gloss, unicolorous except for narrow streaks of dark brown dusting along upper and lower edges of cell, along all terminal veins, along vein 2 only from end of cell to wing margin and, hardly visible, along vein 1b; a faint blackish point on base of vein 5. Cilia glossy pale ochreous. Hind wing rather glossy anthracite-blackish, paler towards dorsum, darker towards apex. Cilia pale ochreous, grey along anterior half of termen and along dorsum, throughout with a blackish-grey narrow basal band.

Female. — Wing span 20 mm. Palpus rather dusted with dark grey, base white. Head and thorax darker, bronze-tinged. Darker bronze-tawny, densely dusted with blackish-brown along upper half of wing as far as lower edge of cell, and narrowly along terminal veins; additional darkish dusting over dorsal third of wing; a darker brown vertical mark along lower half

7

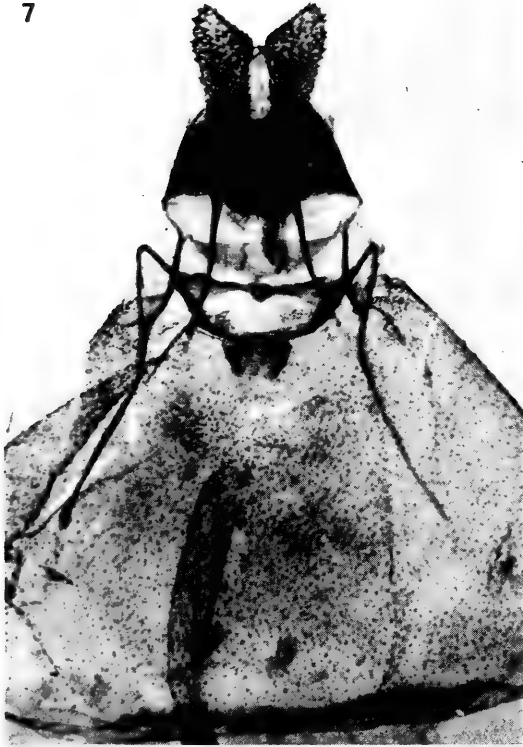

Figs. 7, 8. *P. sandrinae* g. & sp. n. 7, female genitalia, ovipositor and sterigma; 8, bursa copulatrix.

of discoidal vein. Cilia glossy pale ochreous, in tornus and along dorsum glossy cinereous.

Hind wing light anthracite-grey with a silky gloss and narrowly black veins; apical third of wing tinged darker fuscous. Cilia sordid pale ochreous, with a narrow pale grey basal band.

Reared from larvae in bulbs, stalks and leaves of *Nerine bowdenii* Watson, Wageningen, 15—20.xii.1983 (Plantenziektenkundige Dienst, S. A. Ulenberg), ♂ holotype, genit. slide 10640, ♀ allotype genit. slide 10641, 14 ♂, 6 ♀, paratypes (with 2 larvae and 8 pupae).

Southern Africa, Natal, Rietvlei, 1918 (leg. Otto), genit. slide 4584, 1 ♂. Transvaal, Pretoria, 11.ii.'10 (A. J. T. Janse), genit. slide 4677. Pretoria North, 20.iii.1917 (C. J. Swierstra), genit. slide 10716, 1 ♂. Natal, Karkloof, 22.i.1917 (A. J. T. Janse), 1 ♂. All paratypes, in the Transvaal Museum, with hind wings paler, brownish instead of greyish, but otherwise quite similar.

The holo- and allotype with several paratypes will be deposited at the RMNH, Leiden; other paratypes 7 ♂, 3 ♀ (with 2 larvae and 8 pupae),

in the collection of the Plantenziektenkundige Dienst at Wageningen, and 5 ♂, 2 ♀ in the Transvaal Museum, Pretoria.

The following material of "*Epichorista*" *geraeas* Meyrick, from the Transvaal Museum, has been compared: holotype: /40 51/Pretoria 2.10.'07 A. J. T. Janse/G 10759/*Epichorista gaeaeas* M type no. 1051/(male). — Pretoria 15.11.'11 A. J. T. Janse/G 10760/*Epichorista gaeaeas* M./♂. — Pretoria, 15.x.'17, A. J. T. Janse, 1 ♂.

Larva (figs. 9—13)

Length 13 mm. Head hypognathous. Stemmata developed. Adfrontals not reaching vertex. Spinneret robust, thick-walled. Frontal seta one, rather shifted mesad. Fronto-lateral (adfrontal) setae two. Clypeal setae two: Cl₁ shifted mesad and dorsad, Cl₂ marginal. Anterior seta one, minute. Lateral seta L₁ distinct. Posterior setae two, P₂ small, approximated, dorsad and slightly laterad of P₁. Vertical setae not traceable.

Body elongate, integument finely spinulose,

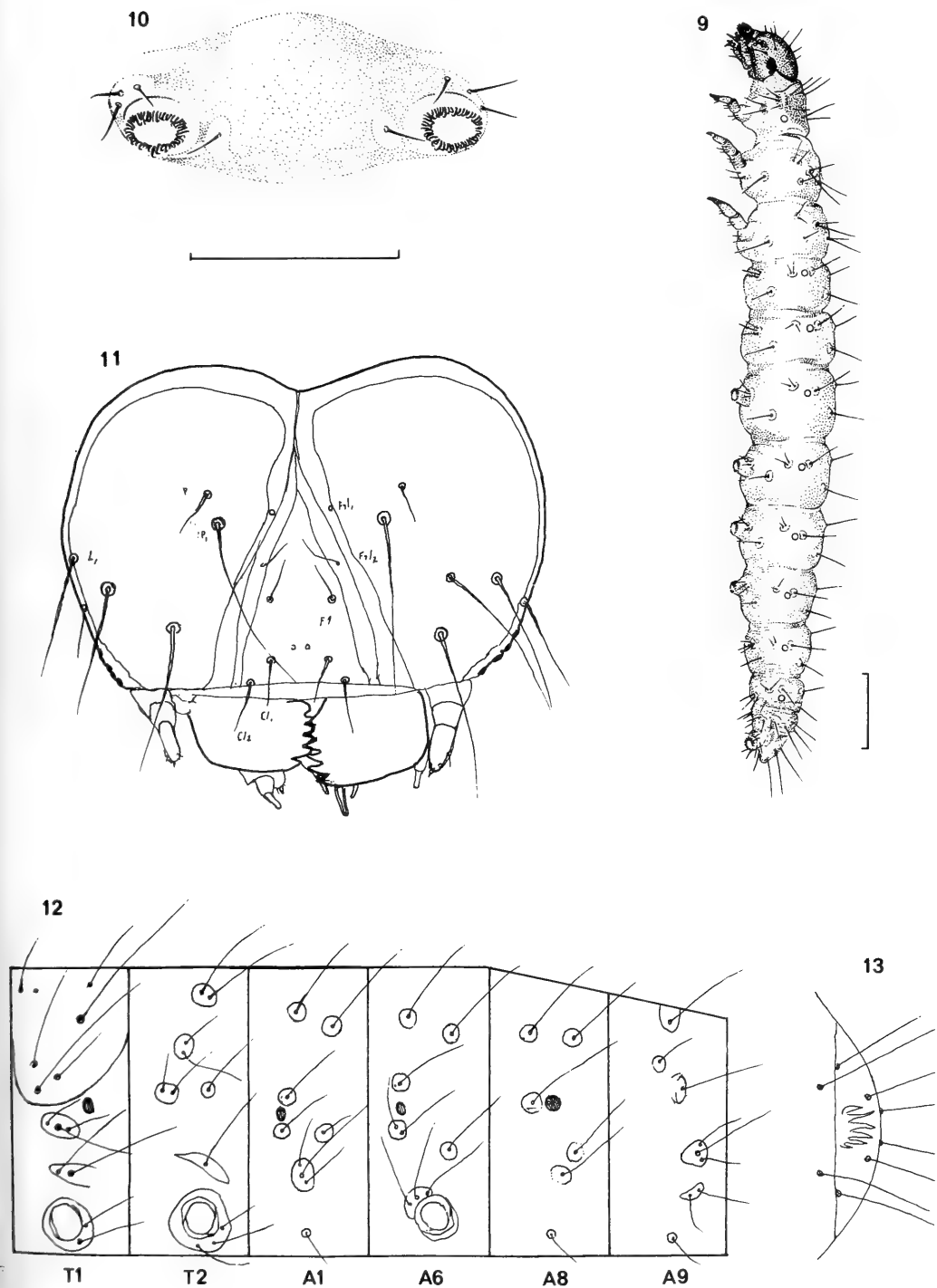

Figs. 9—13. *P. sandrinae* g. & sp. n., larva. 9, lateral aspect; 10, third abdominal segment, ventral aspect; 11, chaetogram of head; 12, chaetogram of body; 13, the same of anal segment (measure, fig. 9: 1 mm, fig. 10: 0.5 mm).

14



15

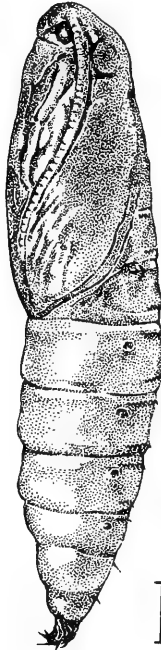

17

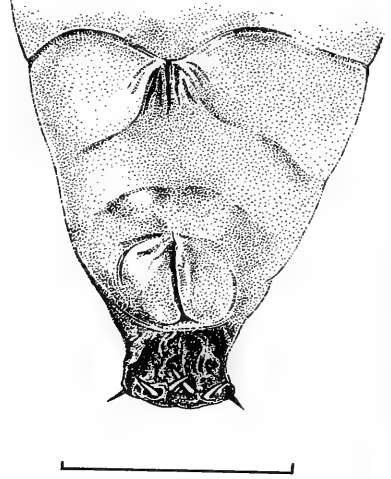

16



18

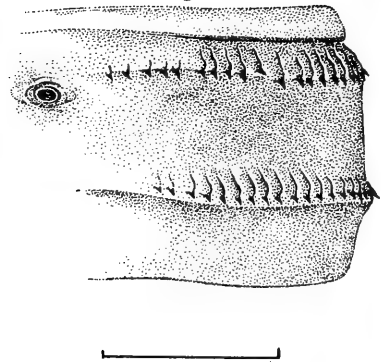

Figs. 14—18. *P. sandrinae* g. & sp. n., pupa. 14, ventral aspect; 15, lateral aspect; 16, cremaster, strongly magnified, ventro-lateral aspect; 17, end of female abdomen and cremaster, strongly magnified, ventral aspect; 18, abdominal tergite in lateral aspect, with bands of crochets (measure = 1 mm).

secondary setae not perceptible. Spiracula rounded-oval, that of prothorax larger, that of segment 8 enlarged, circular, of segment 9 absent. Setal pinnacula large, mostly round and well-defined. Prothorax with prespiracular L group of setae trisetose, on one pinnaculum, L_3 larger than others, L_1 proterodorsal of 2; SV_1 and SV_2 on one pinnaculum, D_1 proterodorso-rostral of D_2 , SD_1 and SD_2 on one pinnaculum; L_1 and L_2 on one pinnaculum, arranged almost

horizontally, L_3 on separate pinnaculum, SV group 2- or 3-setose.

Abdominal segments with right and left D_1 closer together than D_2 , except on segments 6—8. SV_1 hardly postspiracular on segment 1, exactly above spiraculum on segment 2, on segments 3—7 slightly prospiracular, on 8 entirely before spiraculum. SV_2 very small on segments 4—8, on others not traceable; segment 10 with four pairs of setae on dark warts, arranged as in fig.

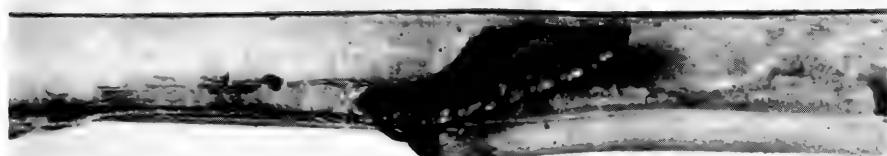

21



20



19

Figs. 19—21. Injury of *Nerine bowdenii* plants by *Phlebozemia sandrinae*. 19, a bulb with damaged shoot; 20, damaged stalks; 21, split stem, showing boring gallery with a mature pupa, partly protruding for the emergence of the moth. (Phot. of Laboratorium voor Bloembollenonderzoek, Lisse.)

13. Anal fork present. Prolegs normally developed, crochets 43—48, uniserial, long and short alternating, on abdominal pseudopods (fig. 10); half a circle of the same kind of alternating crochets on the anal pseudopods.

Pupa
(figs. 14—18)

Length 10 mm. Dark brown. Haustellum short and thick, not reaching to middle of antennae. Labial palpi short. Antenna to just beyond midway between tips of mid- and hind legs, about 5/6 of length of fore wings. Hind legs just beyond fore wing tips. Abdominal segments with a double row of longitudinal ribs, each ending posteriorly in a short spine: a submarginal row of longer ribs and a postmedian row of slightly shorter ribs (fig. 18). Cremaster strongly sclerotic, thick, bent and concave ventrally, with six strong terminal spikes, lateral largest and projecting (figs. 16, 17).

ACKNOWLEDGEMENTS

We like to thank Mr. A. van Frankenhuyzen, Plantenziektenkundige Dienst, Wageningen, for performing the rearing tests, Mr. P. Muller, Laboratorium voor Bloembollenonderzoek, Lisse and G. van Brenk, Vakgroep Tuinbouwplantenteelt, Landbouwhogeschool, Wageningen, for providing the plant material for these experiments. Mr. A. S. J. Noordijk, Plantenziektenkundige Dienst, Wageningen, made most drawings.

REFERENCES

- Anonymous, 1975. Classified list and international register of Hyacinths and other bulbous and tuberous-rooted plants. — Koninklijke Algemene Vereniging voor Bloembollenonderzoek, Hillegom, Holland: 1—277.
- Brenk, G. van, 1980. Historie, groei en bloei van *Nerine bowdenii* (1). — Vakblad voor de Bloemisterij 21: 38—41.
- Diakonoff, A., 1960. Tortricidae from Madagascar (1). — Verh. K. ned. Akad. Wet., Nat. (2) 53 (1): 1—209, figs. 1—90, pls 1—40.

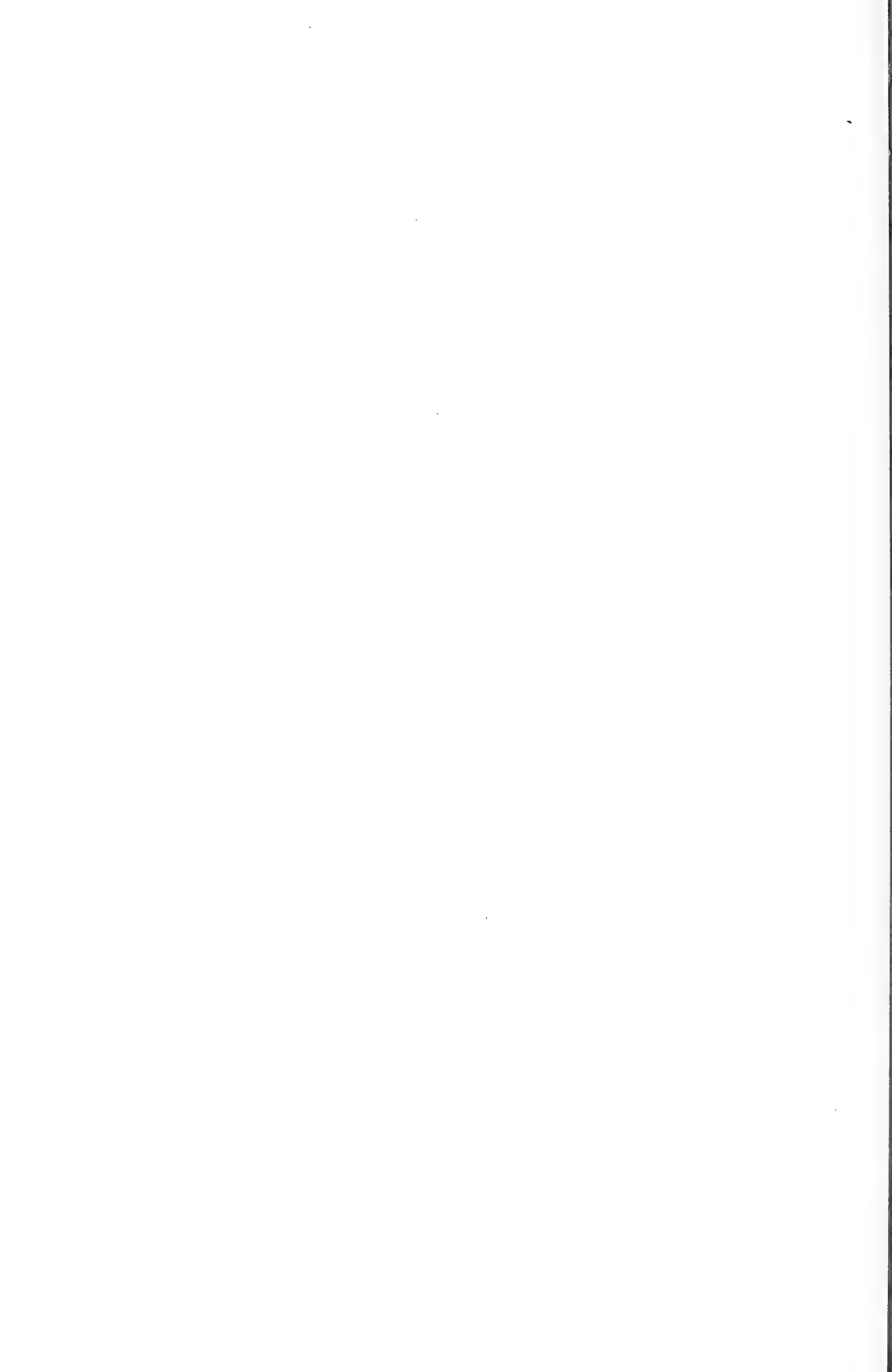



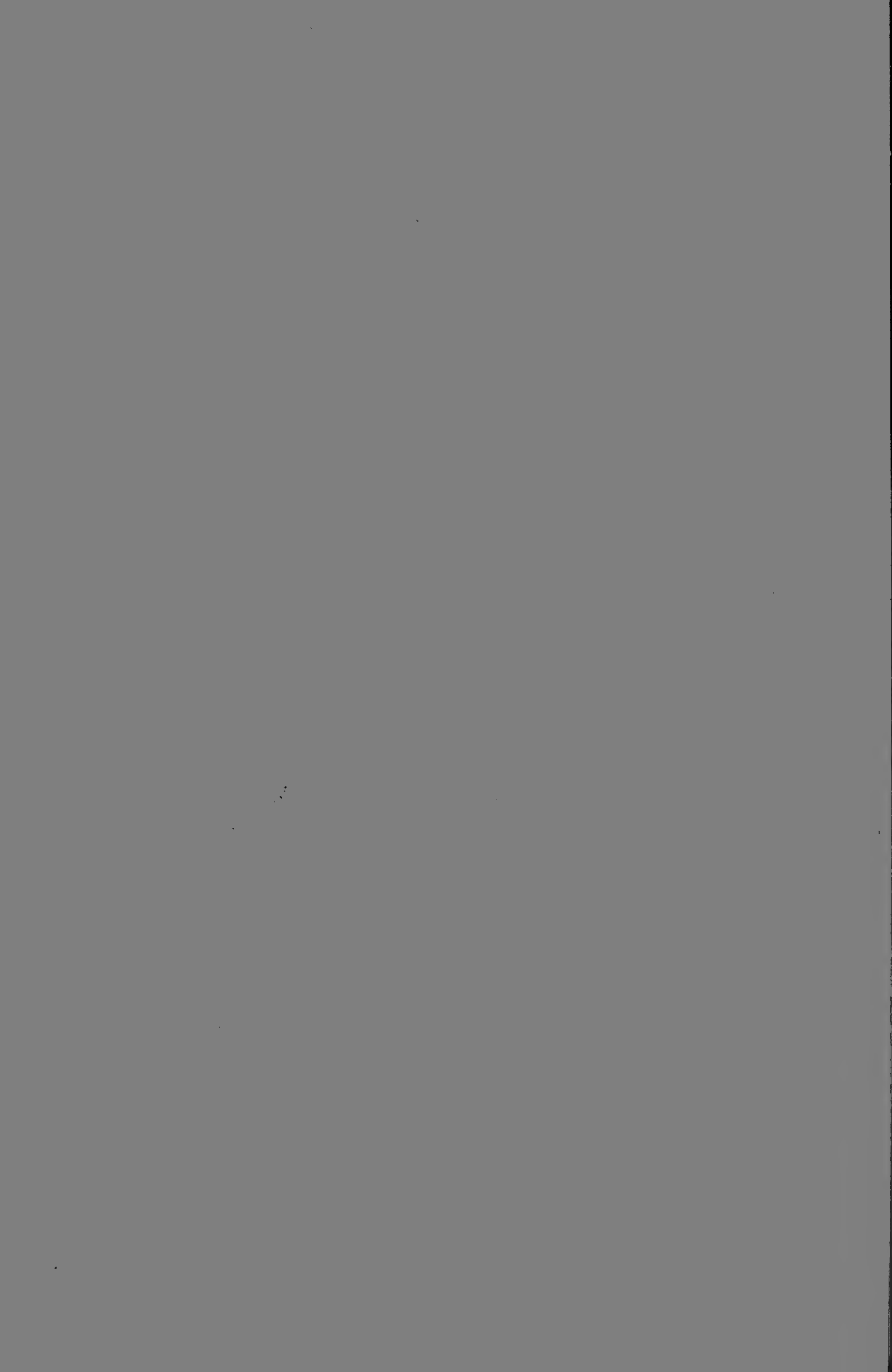

7580

TIJDSCHRIFT VOOR ENTOMOLOGIE

UITGEGEVEN DOOR

DE NEDERLANDSE ENTOMOLOGISCHE VERENIGING

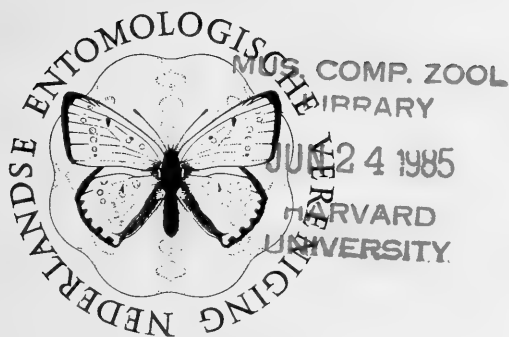

INHOUD

P. OOSTERBROEK. — The *Nephrotoma* species of Japan (Diptera, Tipulidae), pp. 235—278, figs. 1—134.



THE *NEPHROTOMA* SPECIES OF JAPAN (DIPTERA, TIPULIDAE)

by

PJOTR OOSTERBROEK

Instituut voor Taxonomische Zoölogie (Zoölogisch Museum), Plantage Middenlaan 64, Amsterdam

ABSTRACT

Thirty-five Japanese species and subspecies of *Nephrotoma* are discussed. Five taxa, *leeweni*, *vana vana*, *vana nigrovana*, *pallida*, and *medioflava*, are new. Type-material was examined of all species and their synonyms, except two. Eight new synonyms are proposed. A key to the species is presented. The distribution of the species and subspecies is summarized. The total number of species on the main Japanese islands is: Hokkaido 21, Honshu 28, Shikoku and Kyushu 14. Eleven species are endemic to Japan, another four to Japan and the Kurile Islands.

CONTENTS

Introduction	235
The genus <i>Nephrotoma</i>	236
Characters	236
Material	240
Key to the species	240
The species groups	243
<i>cornicina</i> group	243
<i>parvirostra</i> group	247
<i>fuscescens</i> group	251
<i>analis</i> group	256
<i>palloris</i> group	261
<i>crocata</i> group	265
<i>brevipennis</i> group	267
<i>stylacantha</i> group	267
<i>repanda</i> group	270
<i>virgata</i> group	271
<i>sinensis</i> group	274
<i>dorsalis</i> group	274
Acknowledgements	274
References	276

INTRODUCTION

The Japanese species of *Nephrotoma* Meigen, 1803, are revised as part of a revision of the Holarctic members of the genus (Oosterbroek, 1978—1980, 1984; Tangelder, 1983, 1984). With 35 species and subspecies, *Nephrotoma* is the largest tipulid genus in Japan (table 1).

Five taxa are described here for the first time, in addition to the three new species described by Tangelder (1984). The sequence in which the species are discussed and their distribution is given in table 3. A number of species are treated in detail elsewhere (Oosterbroek, 1978—1980: western Palearctic species; Tangelder, 1984:

Table 1. Palearctic (sub)genera of Tipulidae known from Japan (number of Japanese species in brackets, after Theowald & Oosterbroek, 1985).

<i>Dolichozepeza</i> (<i>Dolichozepeza</i>)	(2)
<i>Dolichozepeza</i> (<i>Nesozepeza</i>)	(5)
<i>Dolichozepeza</i> (<i>Orozepeza</i>)	(5)
<i>Macgregoromyia</i>	(4)
<i>Leptotarsus</i> (<i>Longurio</i>)	(2)
<i>Holorusia</i>	(2)
<i>Nephrotoma</i>	(35)
<i>Tipula</i> (<i>Acutipula</i>)	(7)
<i>Tipula</i> (<i>Arctotipula</i>)	(1)
<i>Tipula</i> (<i>Dendrotipula</i>)	(3)
<i>Tipula</i> (<i>Emodotipula</i>)	(1)
<i>Tipula</i> (<i>Indotipula</i>)	(4)
<i>Tipula</i> (<i>Lunatipula</i>)	(8)
<i>Tipula</i> (<i>Nippotipula</i>)	(1)
<i>Tipula</i> (<i>Platytipula</i>)	(16)
<i>Tipula</i> (<i>Pterelachisus</i>)	(19)
<i>Tipula</i> (<i>Savtschenkia</i>)	(3)
<i>Tipula</i> (<i>Schummelia</i>)	(2)
<i>Tipula</i> (<i>Sinotipula</i>)	(1)
<i>Tipula</i> (<i>Tipula</i>)	(1)
<i>Tipula</i> (<i>Tipulodina</i>)	(2)
<i>Tipula</i> (<i>Trichotipula</i>)	(1)
<i>Tipula</i> (<i>Vestitplex</i>)	(6)
<i>Tipula</i> (<i>Yamatotipula</i>)	(15)
<i>Tipula</i> , subg. uncertain	(20)
<i>Ctenophora</i> (<i>Cnemoncosis</i>)	(4)
<i>Ctenophora</i> (<i>Ctenophora</i>)	(4)
<i>Dictenidia</i>	(3)
<i>Phoroctenia</i>	(1)
<i>Pselliophora</i>	(3)
<i>Tanyptera</i> (<i>Protanyptera</i>)	(4)
<i>Tanyptera</i> (<i>Tanyptera</i>)	(2)
<i>Tanyptera</i> , subg. uncertain	(1)

(188)

Table 2. Palaearctic (sub)genera of Tipulidae not known from Japan (number of Palaearctic species in brackets, after Theowald & Oosterbroek, 1985).

<i>Dolichozeza (Sinerozeza)</i>	(1)
<i>Prionocera</i>	(15)
<i>Nigrotipula</i>	(2)
<i>Tipula (Angarotipula)</i>	(4)
<i>Tipula (Beringotipula)</i>	(2)
<i>Tipula (Brithura)</i>	(6)
<i>Tipula (Formotipula)</i>	(9)
<i>Tipula (Lindnerina)</i>	(6)
<i>Tipula (Mediotipula)</i>	(12)
<i>Tipula (Odonatisca)</i>	(7)
<i>Tipula (Triplicitipula)</i>	(4)
<i>Ctenophora (Xiphuromorpha)</i>	(1)

species of the *dorsalis* group) and are only briefly dealt with here.

The total number of Tipulidae known to occur in Japan is 188. They belong to 31 of the in total 43 Palaearctic (sub)genera (tables 1 and 2). It is estimated that the total number of Japanese Tipulidae lies around 230. A historic review on the study of the Japanese tipulids is given by Alexander (1953b). Catalogues are published by Masaki (1933a) and Ishida (1955—1961, 1965). About half the Japanese species of *Nephrotoma* are treated in detail, based on material examined, in Savchenko's revision of the Palaearctic Tipulidae (part 5, 1973, in Russian, under the now suppressed name *Pales* Meigen, 1800).

THE GENUS NEPHROTOMA

Nephrotoma is a large genus, with at present over 400 recognized species and subspecies. It has a world-wide distribution but is especially rich in species in the Holarctic, Oriental and Afrotropical Regions (Oosterbroek & Schuckard, 1976).

The species of *Nephrotoma* can be found in many different landscapes of the world (pine-, deciduous-, mixed-, rain- and monsoon-forests, meadows, steppes, savannas and even tundras as far north as 82°30'), but in general they prefer the temperate climates, which allow the development of deciduous forests and where edges of woods, meadows and banks of streams form the most favourable habitats.

The larvae are usually found in soils rich in humus. In some species they gnaw at the roots of cultivated plants, now and then causing damage to oats, rye, sugarbeets, flax, cabbage and coniferous seedlings. For northern Japan damage to sugarbeets by larvae of *minuticornis* (locally known as the Ao-hoso-gaganbo, sugarbeet

crane-fly) is reported by Kuwayama (1926) and Shiraki (1952), though considered by Alexander (1953d) of minor economic importance.

Very few information is available about the biology of the species. Masaki (1933b) discusses, under the name *virgata*, the biology and all life stages of a species of the *dorsalis* group. For a few species more detailed information is available from the continent (Oosterbroek, Schuckard & Theowald, 1976; Oosterbroek, 1978—1980; Savchenko, 1973).

CHARACTERS (figs. 1—5)

Nephrotoma specimens are usually yellow with dark yellow to black markings on head, thorax and abdomen. Very characteristic are the three broad longitudinal stripes on scutum one and the two such stripes on scutum two. A few species are almost entirely yellow, in others the yellow ground-colour is almost or completely superseded by dark brown or black.

Apart from coloration, *Nephrotoma* is characterized by the wing venation (fig. 2): vein Rs is very short and vein CUA1, or, if present, cross-vein m-cu, meets vein M before or at the anterior corner of the discal cell.

Especially the male copulatory organs (fig. 3) provide important characters for the identification of species and for phylogenetic analysis. Most of the characters necessary to identify species are visible from the outside. The female ovipositor (figs. 4, 5) also possesses many characters and in some instances they are the only reliable clue to separate females of closely related species. However, in dry specimens most of the ovipository characters can not be examined.

During copulation the female hypovalvae enter the dorsal part of the hypopygium. They are kept in position by the embrace of the inner and outer dististyles and the ventrally excavated extension of the ninth tergite. The cerci of the female remain outside the hypopygium, but closely adjusted to the ninth and/or eighth sternites of the male. Depending on the species groups, these sternites show a great variety of shapes, hair- or bristle-tufts, and appendages to guide the cerci. The same applies to the extension of the male tergite nine and the inner and outer dististyles with respect to the hypovalvae. Apart from guiding, practically all the external copulatory organs are equipped with sensory spines, bristles, bristle-like hairs, etc.

The fused valvulae and the furca are two sclerotized plates situated between the cerci and the

Table 3. List of species of *Nephrotoma* with their synonyms and distribution. (+) = types examined by Tangelder, 1984.

Species groups		Type-mat. examined	Hokkaido	Honshu	Shikoku	Kyushu	Tsushima	S Japanese islands	Sado	West Palearctic	Amur obl. + Khabar. kr.	Sakhalin + Moneron	Kurile islands	Northeast China + Korea	South Primorye	East China	Southwest China
Species		New synonymy															
<i>cornicina</i>	<i>aculeata</i>	+		+						+	+	+		+	+		
	(<i>a. atricauda</i>)	+															
	<i>cornicina</i>	+	+	+	+	+	+			+	+	+	+	+	+	+	
	<i>esakii</i>	+	+	+	+	+			+				+				
	<i>saghaliensis</i>	+	+	+							+	+	+	+			
<i>parvirostra</i>	<i>subpallida</i>	+		+	+				+								
	<i>daisensis</i>	+		+	+		+							+	+		
	<i>flammeola</i>	+	+	+	+	+			+				+	+	+		
	<i>parvirostra</i>	+	+	+		+	+			+	+	+	+	+	+		+
	(<i>serristyla</i>)	+	+														
<i>fuscescens</i>	(<i>immemorata</i>)	+	+														
	<i>contrasta</i>	+	+	+													
	<i>flavonota</i>	+		+	+	+	+										+
	<i>fuscescens</i>	+		+	+	+	+								+		
	(<i>iyoensis</i>)	+	+														
<i>analis</i>	(<i>akii</i>)	+	+														
	<i>leeuweni</i>	+		+													
	<i>ozenumensis</i>	+		+									+				
	<i>vana vana</i>	+	+	+									+				
	<i>vana nigrovana</i>	+		+		+											
<i>palloris</i>	<i>pullata</i>	+	+	+	+	+			+	+				+	+		
	(<i>hokkaidensis</i>)	+															
	(<i>mannheimsi</i>)	+	+														
	<i>stygia</i>	+	+	+									+				
	<i>bifusca</i>	+		+	+						+			+	+		
<i>crocata</i>	<i>geminata</i>	+		+													
	<i>pallida</i>	+				+		+									
	<i>palloris</i>	+	+	+								+	+				
	(<i>autumnalis</i>)	+	+														
	<i>neoprattensis</i>	+	+	+	+									+			
<i>brevipennis</i>	<i>hirsuticauda</i>	+	+	+						+	+	+	+	+	+		
	<i>medioflava</i>	+						+									
<i>stylacantha</i>	<i>repanda</i>	+	+	+	+	+	+		+					+	+	+	+
	(<i>grahamiana</i>)	+	+														
<i>virgata</i>	<i>virgata</i>	+	+	+	+	+	+	+	+	+				+	+		+
	(<i>decrepita</i>)	+	+														
<i>dorsalis</i>	(<i>japonica</i>)	+															
	<i>electripennis</i>	(+)			+	+											
	<i>nigricauda</i>	(+)	+	+													
	<i>minuticornis</i>	(+)	+	+	+	+							+	+			
	<i>sachalina</i>	(+)	+									+	+	+			
	<i>difficilis</i>	(+)	+								+	+		+	+		
	<i>angustistria</i>	(+)	+	+													
	<i>cirrata</i>	(+)	+														
	<i>gaganboi</i>	(+)		+													
	<i>microcera</i>	(+)	+	+										+			

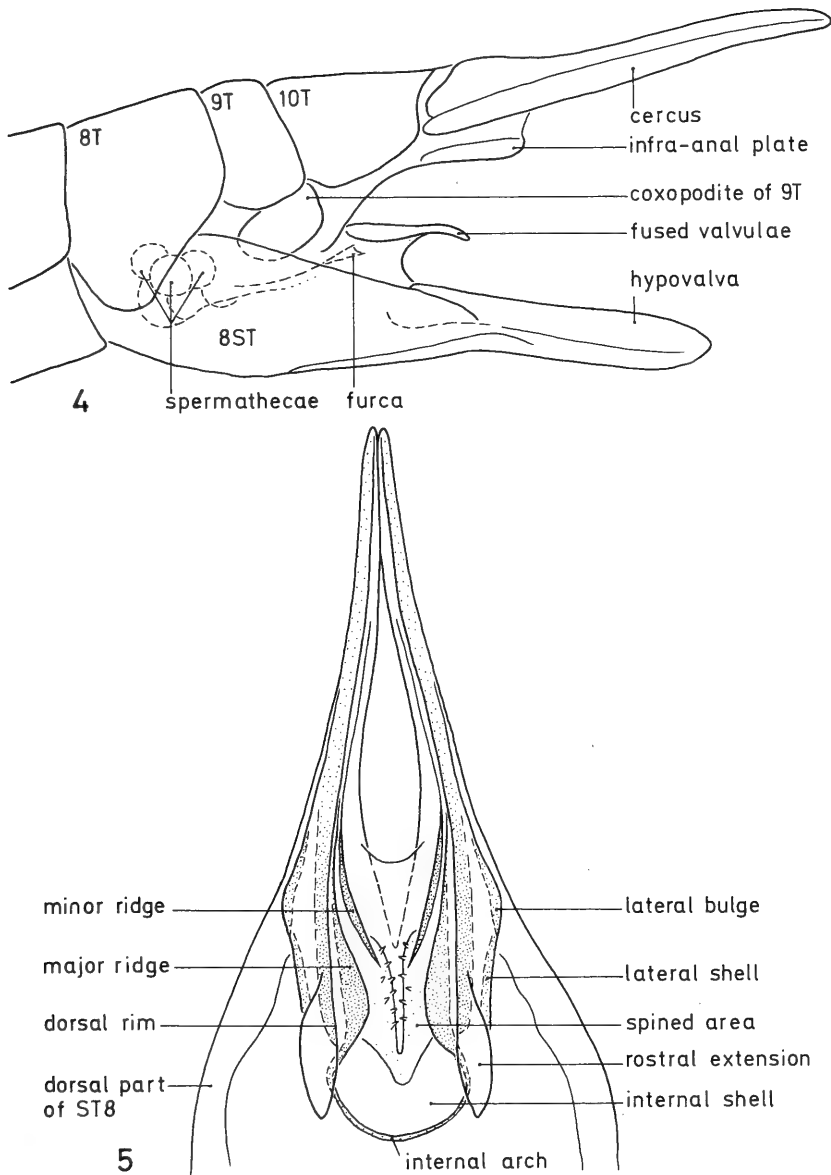

Figs. 4—5. Generalized drawing of ovipositor (fig. 4, lateral view) and hypovalvae (fig. 5, dorsal view); ST, sternite; T, tergite. (Reproduced with kind permission from Tangelder, 1983, *Beaufortia* 33: 113)

hypovalvae. The opening of the bursa copulatrix is situated underneath the fused valvulae. The position of the male intromittent organ is secured during copulation by the adminiculum itself, and by its lateral appendages, the gonapophyses. The intromittent organ is usually a thin tube, running from the semen pump in the direction of the thorax and with a downward loop

back to the adminiculum. Its length varies from about 2 mm to about 40 mm (in *N. helvetica* with the intromittent organ spirally coiled inside the abdomen) and the part towards the adminiculum can show various modifications (bipartite, tripartite, with a serrate membrane or a robust spine), usually characteristic for the species group.

MATERIAL

This study is based on material preserved in the following institutions and, except for ZMA, received on loan:

- ASL Academy of Sciences, Zoological Institute, Leningrad, USSR
- BM(NH) British Museum (Natural History), London, Great Britain
- IPSPK Institut für Pflanzenschutzforschung Kleinmachnow, Eberswalde, East Germany
- KU Kyushu University, Kyushu, Japan
- KURU Kurume University, Kyushu, Japan
- MAK Zoologisches Forschungsinstitut und Museum Alexander Koenig, Bonn, West Germany
- RMNH Rijksmuseum van Natuurlijke Historie, Leiden, the Netherlands
- UKaL University of Kansas, Lawrence, USA
- USNM United States National Museum, Washington DC, USA
- USNMA United States National Museum, Washington DC, USA, C. P. Alexander collection
- ZMA Instituut voor Taxonomische Zoölogie (Zoölogisch Museum), Amsterdam, the Netherlands

Practically all the material is preserved dry. Drawings of the genital structures were made after maceration in KOH and with the aid of a drawing tube on a Wild microscope.

Different localities are separated in the text by a semicolon (;), whereas additional information about a locality is separated from it by a comma.

KEY TO THE SPECIES

- 1. Lateral stripes on scutum 1 very broad, reaching paratergite, and shining. Almost entire thorax shining. Scutellum, mediotergite and lateral thorax chocolate brown to dark brown with the membranous area below paratergite and anterior half of katatergite yellowish. Abdominal segments 5—8(9) blackened. Male with a peculiar shaped appendage at sternite 8 (figs. 12, 16). Female with the cerci and hypovalvae very short (fig. 13) *esakii*
- Not with the above combination of characters 2
- 2. Male with a slender, posteriorly directed appendage at sternite 8 (figs. 9—11). Poste-

- rior margin of outer dististyle in part sclerotized (figs. 10, 11). Female cerci pointed (figs. 5, 6, 7) 3
- Male without or with a differently shaped appendage. Outer dististyle not sclerotized. Female cerci ending blunt or cerci and hypovalvae very short (figs. 17, 51, 53) 5
- 3. Outcurved anterior end of lateral stripe on scutum 1 or mark below anterior end dull. Medial appendage of male sternite 8 knob-shaped (fig. 11) *cornicina*
- Outcurved anterior end of lateral stripe on scutum 1 or mark below anterior end shining. Medial appendage of male sternite 8 very acute (fig. 10) or apically rounded and concave (fig. 9) 4
- 4. Wing usually with numerous macrotrichia in apical cells. Medial appendage of male sternite 8 apically rounded and concave (fig. 9). Outer dististyle abbreviated (fig. 8). Female hypovalvae abbreviated (fig. 6) *saghaliensis*
- Wing without or with few macrotrichia in apical cells. Medial appendage of male sternite 8 very acute (fig. 10). Outer dististyle elongate (fig. 10). Female hypovalvae slender, not abbreviated (fig. 7) *aculeata*
- 5. Mediotergite yellowish on anterior part, at least in the middle (anterior part sometimes transparent in *minuticornis*, characterized by the straight lateral stripes on scutum 1 and the yellow antero-lateral corners of scutum 2) 6
- Antero-medial part of mediotergite with a brown to black longitudinal stripe or mediotergite (almost) entirely darkened ... 26
- 6. Thorax entirely yellowish, including the dorsal stripes. Lateral stripes on scutum 1 straight. Medisternal appendage elongate and strongly hirsute (figs. 38, 41) *flavonota*
- Thorax with at least the scutal stripes in part light brown to black. Lateral stripes on scutum 1 straight, straight with an isolated spot below anterior end, or stripes anteriorly outcurved. Medisternal appendage otherwise 7
- 7. Medial stripe on scutum 1 divided into two by a narrow longitudinal line which is, especially on the anterior part, dull. Medial and lateral stripes on scutum 1 narrowly dull bordered where opposing each other. Anterior end of lateral stripes outcurved and dull. Lateral pronotum darkened on dorsal part only. Inner dististyle with a high, rectangular, dorsal crest (fig. 26).

- Male sternite 8 with a cranially directed appendage (figs. 25, 28) *flammeola*
- Not with the above combination of characters 8
8. Lateral parts of mediotergite distinctly darker coloured than antero-medial part. Male sternite 8 unmodified 9
- Lateral parts of mediotergite concolorous with anteromedial part, sometimes antero-medial part more transparent. Hind margin of male sternite 8 modified except in *subpallida* 17
9. Anterior part of lateral stripes on scutum 1 outcurved and shining. Stripes on scutum 1 and 2 brownish, sometimes vague, rarely partly dark brown. Dorsal surface of abdominal tergite 1 brown with a, usually large and transverse, yellow mark in the middle. Inner dististyle with a low dorsal crest (fig. 108) *medioflava*
- Lateral stripes on scutum 1 straight, with a, usually isolated, dull spot below anterior end. Scutal stripes usually at least partly dark brown or black. Tergite 1 without yellow mark mid-dorsally. Inner dististyle with a posterior crest (fig. 87) or without crest (figs. 76, 80) 10
10. Males (see also characteristics under *palloris*, p. 263) 11
- Females (see also characteristics under *palloris*, p. 264) 14
11. Inner dististyle without crest (figs. 76, 80) 12
- Inner dististyle with a posterior crest (fig. 87) 13
12. Posterior part of inner dististyle blackened (fig. 80) *bifusca*
- Posterior part of inner dististyle not blackened (fig. 76) *geminata*
13. Outer dististyle broad (fig. 77) *palloris*
- Outer dististyle slender (fig. 84) *pallida*
14. Dorsal margin of sternite 8 distinctly upcurved before reaching hypovalva (figs. 88, 91) *bifusca*
- Dorsal margin of sternite 8 more or less straight (figs. 89, 90) 15
15. Cerci slender (fig. 89) *geminata*
- Cerci broad (fig. 90) 16
16. Rostral extensions of hypovalvae broad (fig. 93) *palloris*
- Rostral extensions of hypovalvae narrower (fig. 92) *pallida*
17. Lateral thorax and coxae with large dark brown to black markings. Cerci and hypovalvae shortened (figs. 51—54) 18
- Lateral thorax and coxae yellowish, markings at most light brown. Cerci and hypovalvae not shortened 20
18. Posterior part of inner dististyle with a large, blackened outgrowth (fig. 58). Female unknown *leeuweni*
- Posterior part of inner dististyle without a blackened outgrowth (figs. 45, 49) 19
19. Dorsal margin of inner dististyle posteriorly upcurved (fig. 45). Extension of male tergite 9 with the lateral margins of the medial incision concave (fig. 44). Hypovalvae with a small dorsal notch before apex (fig. 51) *fuscescens*
- Inner dististyle dorsally more or less straight (fig. 49). Medial incision with convex lateral margins (fig. 48). Hypovalvae without dorsal notch before apex (fig. 53) *contrastata*
20. Lateral stripes on scutum 1 straight or anteriorly outcurved and shining 21
- Lateral stripes on scutum 1 anteriorly outcurved, the outcurved part dull 23
21. Antero-lateral corners of scutum 2 yellow in front of stripes. Medial stripe on scutum 1 usually (narrowly) of lighter colour along mid-line. Large species, male 13.5—16 mm, female 17—21.5 mm *minuticornis*
- Antero-lateral corners of scutum 2 with a dull, dark brown to black seam bordering anterior end of stripes. Medial stripe on scutum 1 usually uniformly coloured. Smaller species, male 10—15 mm, females 12—18 mm 22
22. Male sternite 8 with a triangular and laterally compressed medial appendage (fig. 32). Crest of inner dististyle serrate (fig. 35). Stripes on scutum 2 uniformly coloured. Female cerci slender, hypovalvae broad (fig. 31) *parvirostra*
- Male sternite 8 deeply incised, the incision lined with tufts of long yellow hairs (fig. 100). Crest of inner dististyle rounded (fig. 103). Stripes on scutum 2 of lighter colour in the middle. Female cerci moderately broad, hypovalvae moderately slender (fig. 101) *hirsuticauda*
23. Medial stripe on scutum 1 posteriorly dull and prolonged to occupy the central part of the transverse suture *repanda*
- Medial stripe on scutum 1 posteriorly shining and not occupying transverse suture 24
24. Prescutum dull between thoracic stripes. Abdominal end not blackened. Male sternite 8 unmodified *subpallida*

- Prescutum shining between thoracic stripes. Abdominal end blackened. Male sternite 8 modified (figs. 121—124) 25
25. Scutum 2 dull between stripes. Male sternite 8 deeply incised, lateral margins of the incision convex and set with small black spines (figs. 123, 124) *electripennis*
- Scutum 2 shining between stripes. Male sternite 8 with distinctly prolonged lateral corners, apically set with small black spines (figs. 121, 122) *nigricauda*
26. Pterostigma inconspicuous, at most light brown 27
- Pterostigma distinct, brown to dark brown 28
27. Antennae with 11 segments in both sexes. Prescutum shining between thoracic stripes. Abdomen with more or less continuous dark brown stripes dorsally, laterally and ventrally *microcera*
- Antennae 13-segmented in both sexes. Prescutum dull between thoracic stripes. Abdomen usually with triangular dorsal markings, practically unmarked laterally and ventrally *virgata*
28. Lateral thorax without dark brown markings. Prescutum shining between thoracic stripes. Katatergite shining 29
- Lateral thorax with large brown to black markings. Prescutum dull between thoracic stripes. Katatergite dull 33
29. Lateral stripes on scutum 1 anteriorly outcurved and shining. Occipital marking large, basally as broad as dorsal part of pronotum and with convex lateral margins *gaganboi*
- Lateral stripes on scutum 1 straight. Occipital marking shortly triangular, or narrow and elongate 30
30. Antennae with 18—19 segments in the male, 15—16 in the female. Caudal corners of male sternite 8 strongly extended (fig. 120) *sachalina*
- Antennae with 13 segments in both sexes. Caudal corners of male sternite 8 otherwise 31
31. Antero-lateral corners of scutum 2 brownish. Occipital marking shortly triangular, brown *cirrata*
- Antero-lateral corners of scutum 2 dark brown to black. Occipital marking narrow and elongate, dark brown (figs. 126, 127) 32
32. Occipital marking more or less elongate triangular (fig. 126). Medisternal appendage of male sternite 9 directed ventrally (figs. 130, 131). Female cerci rather short and broad (fig. 128) *difficilis*
- Occipital marking a narrow stripe or spot (fig. 127). Medisternal appendage of male sternite 9 directed caudally (fig. 132). Female cerci long and slender (fig. 129) *angustistria*
33. Lateral stripes on scutum 1 with a large and shining, outcurved anterior end. Occipital marking in front narrowly in contact with spots along eye-margin (fig. 21). Inner dististyle with a serrate crest (fig. 23). Male sternite 8 with an elongate, cranially directed appendage (fig. 22) *daisensis*
- Lateral stripes of scutum 1 straight, or anteriorly outcurved and dull. Occipital marking otherwise. Inner dististyle and male sternite 8 otherwise 34
34. Lateral stripes on scutum 1 anteriorly outcurved and dull. Extension of male tergite 9 consisting of two shells (figs. 61, 67) 35
- Lateral stripes on scutum 1 straight or weakly outcurved. Extension of male tergite 9 protruding (figs. 72, 99) 37
35. Thorax almost entirely darkened with the scutal stripes broadly in contact with each other or area between stripes more or less concolorous with the stripes (not dusted grey as in *neoprattensis*). Tergites 2—4 with broadly triangular, transverse markings along hind margins, segments 5—8 blackened *vana nigrovana*
- Thorax yellow between stripes and laterally yellow with large dark brown to black markings. Tergites 2—5 (6) usually with elongate markings which are more triangular towards hind margin, segments 6—7 (8) blackened 36
36. Outer dististyle sinuate with the apical part very slender and elongate (fig. 65) (see also under characteristics of *vana*, p. 256) *ozenumensis*
- Outer dististyle less sinuate (fig. 63) (see also under characteristics of *vana*, p. 256) *vana vana*
37. Occipital marking laterally broadly in contact with the eyes. Dorsal thorax yellow between stripes. Male sternite 8 without appendage *pullata*
- Occipital marking not contacting the eyes. Dorsal thorax heavily dusted grey between and laterad of stripes. Male sternite 8 with a triangular appendage (figs. 96, 98) *neoprattensis*

THE CORNICINA GROUP

Nephrotoma aculeata (Loew, 1871)

(figs. 7, 10)

Pachyrhina aculeata Loew, 1871: 20—22.*Nephrotoma aculeata*; Oosterbroek, 1978: 61—68 (species revision).*Nephrotoma aculeata atricauda* Alexander, 1924: 599.

Material examined. — From Japan: 1♂, Honshu, Nagano, 3.vii.1943 (USNMA).

Characteristics. — *N. aculeata* belongs to the *cornicina* subgroup (Oosterbroek, 1980), the species of which possess a mid-posterior appendage on the semen pump (Oosterbroek, 1980, fig. 18), have the outer dististyle partly sclerotized (figs. 10, 11), and the male sternite 8 with an elongate appendage, very slender and acute in *aculeata* (fig. 10), and the female cerci pointed (figs. 6, 7). *N. aculeata* is closely related to *N. tenuipes* (not Japanese), *saghaliensis* and *cornicina*. In *cornicina* the outcurved anterior part of the lateral scutum one stripe is dull, in the other three species it is shining and in *aculeata* usually isolated from the stripe. Moreover, *tenuipes* and usually also *saghaliensis* possess numerous macrotrichia in the apical wingcells. *N. saghaliensis* is furthermore characterized by the small occipital marking, the peculiar shaped appendage of the male sternite 8 (fig. 9), the short outer dististyle (fig. 8), and the abbreviated hypovalvae (fig. 6), whereas the other three species possess more elongate hypovalvae (fig. 7).

Distribution and period of flight. — *N. aculeata* is distributed throughout the Palaearctic from the British Isles to Sakhalin and Kamchatka. Adults are on the wing from early June to early September. During this study only 1♂ from Japan, Honshu, was examined (see below).

Discussion. — The type-material of *aculeata atricauda* Alexander, 1924 (1♂ holotype, 1♂ 1♀ paratype, all from Sakhalin, Toyohara = Yuzhno-Sakhalinsk) was examined by the present author in 1982 (USNMA). This has confirmed the opinion of Savchenko (1973: 132) that *atricauda* should not be considered a separate subspecies because all the characters mentioned by Alexander fall within the variability of *aculeata*. The species is reported by Ishida (1965) from Hokkaido, Honshu and Shikoku under the name *aculeata atricauda*. In spite of the fact that during this study many *Nephrotoma* material from these islands was examined, only one *aculeata* male from Honshu was

found. For the moment, therefore, it remains questionable whether the species occurs on Hokkaido and Shikoku as well.

Nephrotoma cornicina (Linnaeus, 1758)

(fig. 11)

Tipula cornicina Linnaeus, 1758: 586.*Nephrotoma cornicina*; Oosterbroek, 1978: 100—109 (species revision).

Material examined. — From Japan: 13♂ 18♀, Hokkaido; 23♂ 23♀, Honshu; 3♀, Shikoku; 7♂ 13♀, Kyushu and 1♂, Tsushima.

Characteristics. — See under *aculeata*, male hypopygium as in fig. 11.

Distribution and period of flight. — Wide-spread throughout the Palaearctic from the British Isles and Spain to Sakhalin and the islands bordering Kamchatka, in China as far South as Shanghai. Known from the Japanese islands Hokkaido, Honshu, Shikoku (Tokushima; Ehime), Kyushu and Tsushima. The period of flight in Japan is from mid-May until the end of August.

Nephrotoma esakii Alexander, 1924

(figs. 12—16)

Nephrotoma esakii Alexander, 1924: 596, 597. Alexander, 1925c: 4. Masaki, 1933a: 91. Alexander, 1935b: 226. Alexander, 1953c: 147, 148. Ishida, 1955: 121. Savchenko, 1970: 121.*Pales esakii*; Savchenko & Krivolutzkaya, 1966: 46, 56. Savchenko, 1973: 121, 122.

Material examined. — Holotype ♀, in good condition, labelled "Kamio toineppu, Hokkaido viii-25-1922 Teiso Esaki" "Holotype *Nephrotoma esakii* Alex." (USNMA); other material: 1♀, Kurile (Kunashir); 3♂ 2♀, Sado; 1♂ 1♀, Hokkaido (Sapporo); 23♂ 15♀, Honshu; 2♂ 2♀, Kyushu (Kumamoto; Oita); 1♂ 1♀, Shikoku (without locality).

Characteristics. — Belongs to the *cornicina* subgroup (semen pump with a midposterior appendage, outer dististyle partly sclerotized, hind margin of male sternite 8 with a midventral appendage). *N. esakii* can easily be recognized by coloration (see key), the males by the peculiar shaped midventral appendage of sternite 8 (figs. 12, 16), and the females by the very short ovipositor (fig. 13). The extension of the male tergite 9 possesses a few spines only (fig. 15) and the crest of the inner dististyle is narrow (fig. 14).

Distribution and period of flight. — Known from the islands Kunashir, Sado, Hokkaido,

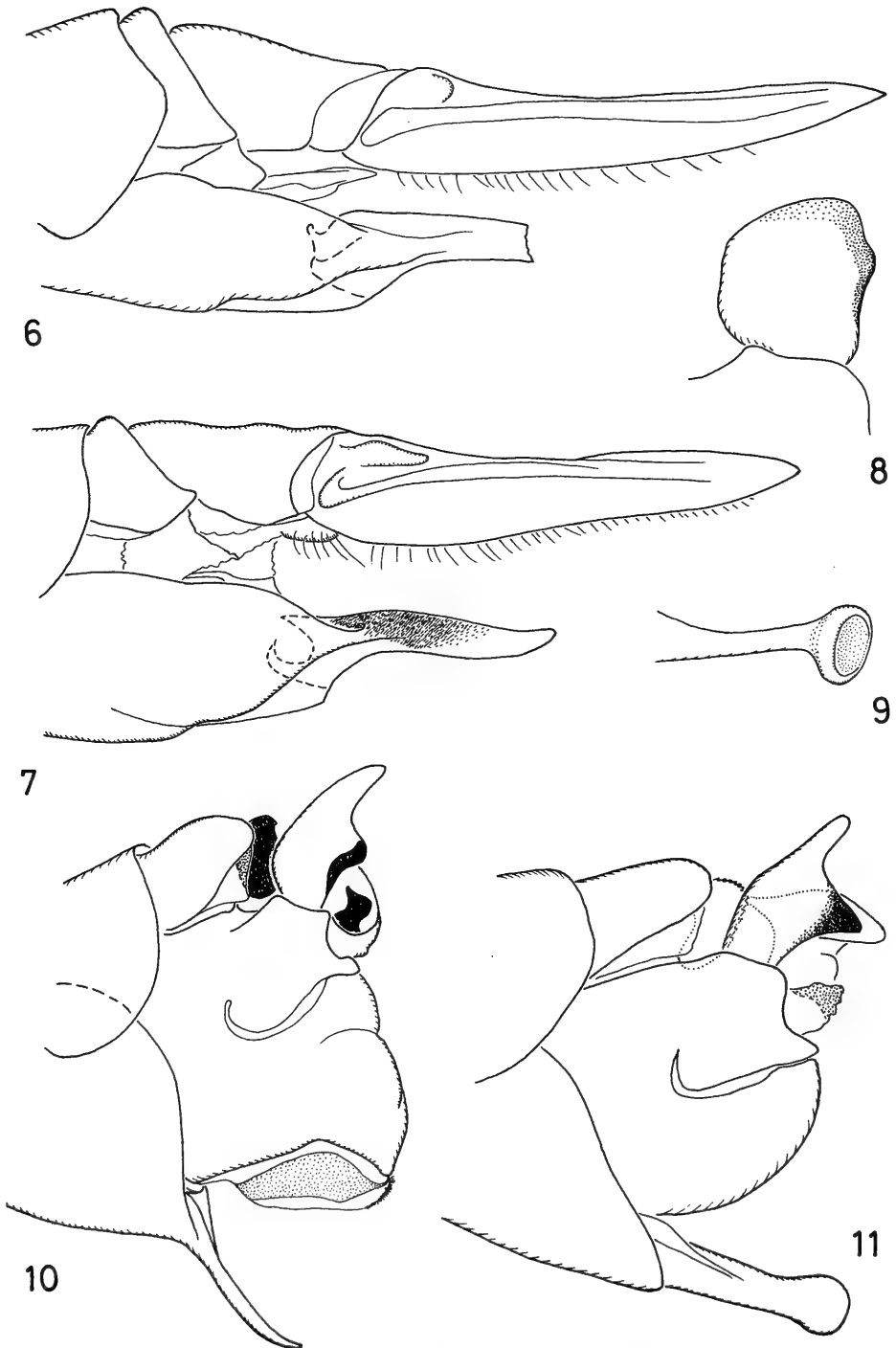
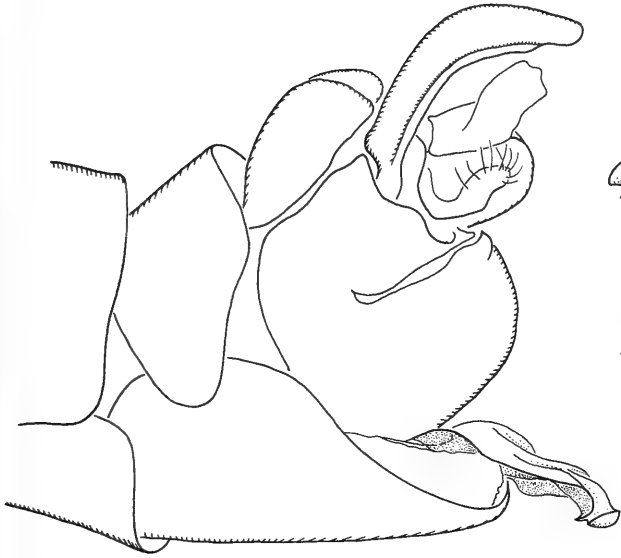
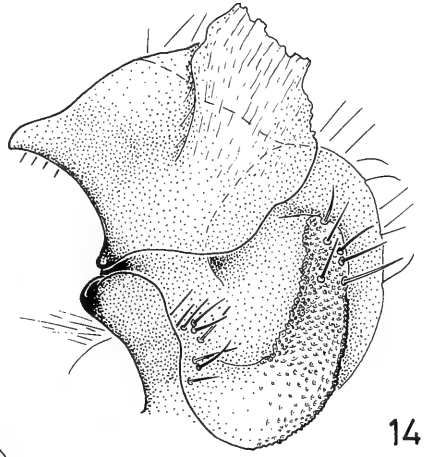

Fig. 6. Ovipositor of *N. saghaliensis*, lateral view. Fig. 7. Ovipositor of *N. aculeata*, lateral view. Fig. 8. Left outer dististyle of *N. saghaliensis*, from outside. Fig. 9. Medial appendage of male sternite 8 of *N. saghaliensis*. Fig. 10. Hypopygium of *N. aculeata*, lateral view. Fig. 11. Hypopygium of *N. cornicina*, lateral view.



12



14

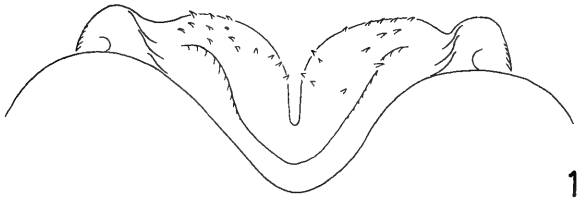

15

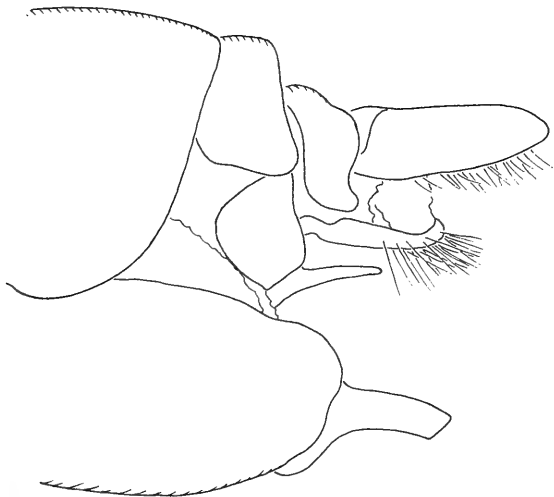

13

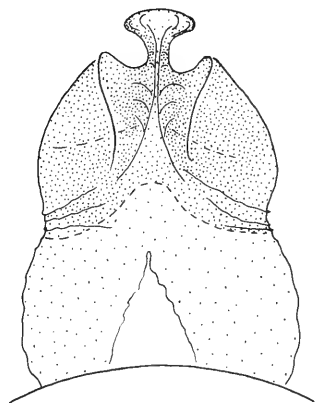

16

Figs. 12—16. *N. esakii*. Fig. 12. Hypopygium, lateral view. Fig. 13. Ovipositor, lateral view. Fig. 14. Left inner dististyle, from outside. Fig. 15. Extension of male tergite 9, dorsal view. Fig. 16. Medial appendage of male sternite 8, ventral view.

Honshu, Kyushu and Shikoku. The species is frequently reported from altitudes up to 1300 m. The period of flight is from the beginning of July to mid-September.

***Nephrotoma saghaliensis* Alexander, 1925**
(fig. 6, 8, 9)

Nephrotoma saghaliensis Alexander, 1925a: 447, 448. Alexander, 1927: 10. Alexander, 1931: 339. Masaki, 1933a: 91. Ishida, 1955: 123. Savchenko, 1970: 121.

Pales saghaliensis; Savchenko & Krivolutzkaya; 1966: 47, 56. Savchenko, 1973: 133, 134.

Material examined. — Holotype ♂, in good condition, one wing on slide 2473, specimen labelled "Toyohara Karafuto Japan viii-29-1921 S. Kuwayana" "Holotype *Nephrotoma saghaliensis* C. P. Alexander" (USNMA; the type-locality Toyohara = Yuhzno-Sakhalinsk); paratype ♂, wing on slide 2473, from Honshu, Yumoto, 5820', 23.vii.1923 (USNMA); other material: 3♂ 1♀, Kamchatka (Dalny); 1♂ 1♀, Sakhalin (Nakano); 1♂, Kunashir; 1♂, Shikotan; 1♂, Yuri (Isl. SW Shikotan); 2♂ 1♀, Hok-

kaido (Iwama; Onpetsu; Sapporo); 12♂ 13♀, Honshu; 2♂ 2♀, North Korea (Puksu Pyaksan in Kankyo Nando, the second highest peak in Korea, appr. 40° 40' N 127° 45' E).

Characteristics. — See under *aculeata*.

Distribution and period of flight. — *N. saghaliensis* is known from Kamchatka, Sakhalin, Moneron, Iturup, Kunashir, Shikotan, Shibotsu, Yuri, Hokkaido, Honshu, Amurskaya oblast and North Korea. Recorded altitudes are up to 2000 m. The period of flight is from early July until mid-September.

***Nephrotoma subpallida* Alexander, 1925**
(figs. 17—20)

Nephrotoma subpallida Alexander, 1925b: 401, 402. Masaki, 1933a: 92. Ishida, 1955: 124.

Pales subpallida; Savchenko, 1973: 163.

Material examined. — Holotype ♂, in good condition, labelled "Mt Minomo Japan vi-22, 1922 T. Esaki" "Holotype *Nephrotoma subpallida* C. P. Alexander" (USNMA; Mt Minomo is on Honshu); paratypes: 1♂ 1♀, labelled as the holotype (♂ with wing and parts of abdomen on

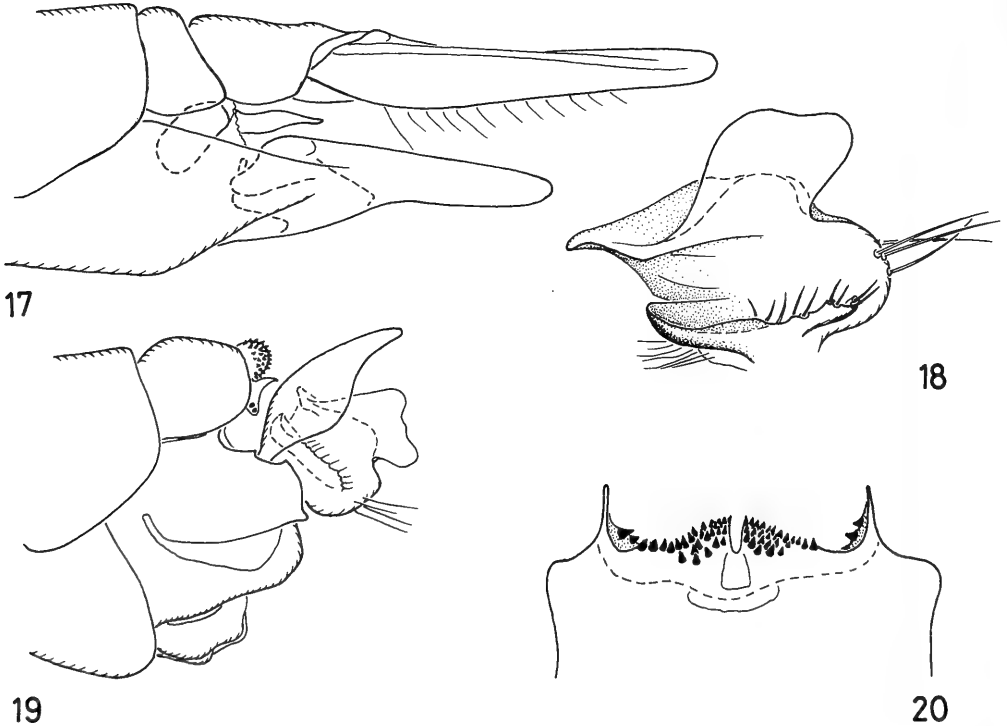

Figs. 17—20. *N. subpallida*. Fig. 17. Ovipositor, lateral view. Fig. 18. Left inner dististyle, from outside. Fig. 19. Hypopygium, lateral view. Fig. 20. Extension of male tergite 9, dorsal view.

slide 2535, USNMA); other material: 11♂ 3♀, Honshu; 2♂, Sado; 1♀, Shikoku (Betssiyama, Ehime); 2♂ 2♀, Kyushu (Shiratoriyama, Kumamoto; Chojabaru, Oita).

Characteristics. — *N. subpallida* can easily be recognized by the characters mentioned in the key. The female cerci are relatively broad and short (fig. 17). The male intromittent organ has the apical two-thirds trifold, a character known from the *flavescens* subgroup of the *cornicina* group only (Oosterbroek, 1980).

Distribution and period of flight. — The species was known from Honshu only, but material was examined now from Sado, Shikoku and Kyushu as well. Adults were collected between

May 28 and August 3, with one record from September 25.

THE PARVIROSTRA GROUP

Nephrotoma daisensis Alexander, 1935
(figs. 21—24)

Nephrotoma daisensis Alexander, 1935b: 236—238.
Alexander, 1953c: 145, 146. Ishida, 1955: 120,
121. Savchenko, 1981: 77.

Pales daisensis; Savchenko, 1973: 161, 162.

Material examined. — Holotype ♀, in good condition, labelled "Mt Daisen Tottori, Japan 800 met. vi-6, '30 Nibi" "Holotype *Nephro-*

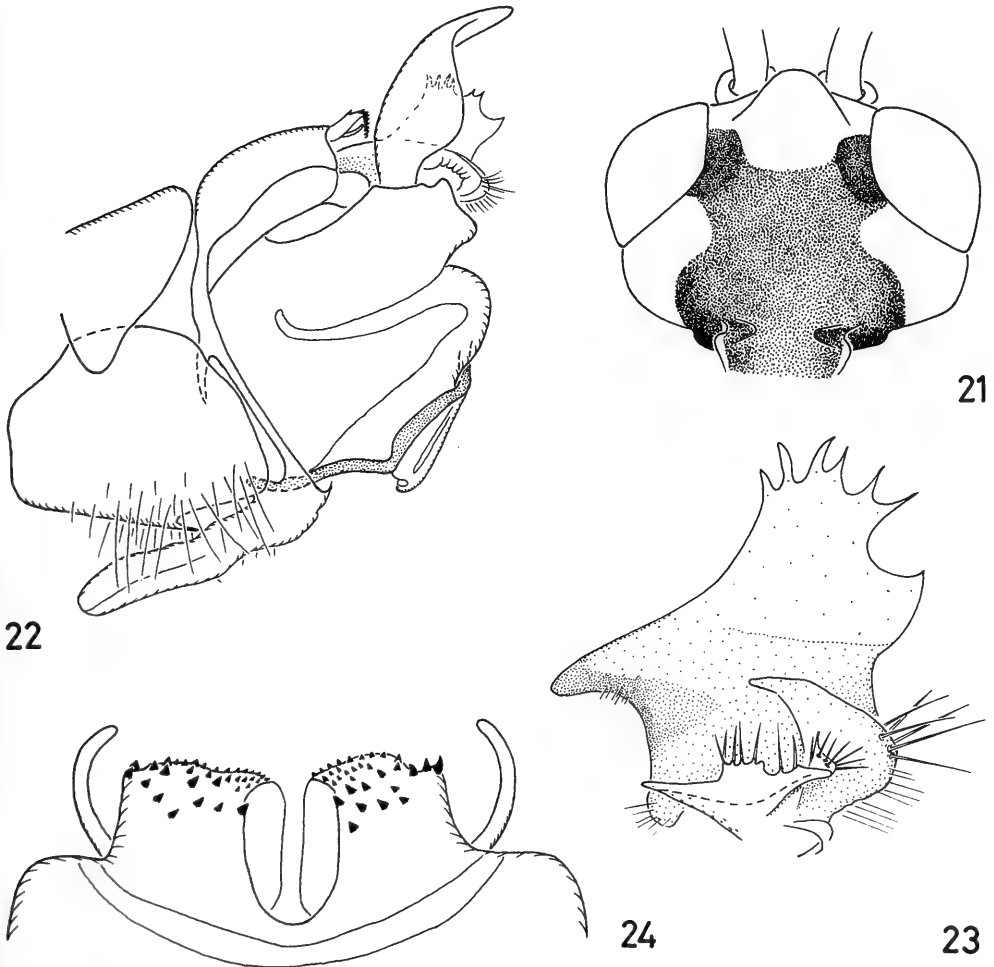

Figs. 21—24. *N. daisensis*. Fig. 21. Head, dorsal view. Fig. 22. Hypopygium, lateral view. Fig. 23. Left inner dististyle, from outside. Fig. 24. Extension of male tergite 9, dorsal view.

ma daisensis C. P. Alexander" (USNMA; Mt Daisen is on Honshu); other material: 1♂ 2♀, Honshu (Rokushosan, Fukui; Kurokawa, Echigo); 1♂, Tsushima (Mt Ariake); 1♀, South Korea (Central Nat. Forest, 18 mi NE Seoul).

Characteristics. — The structures of the extension of the male tergite 9 (fig. 24) and the inner dististyle (fig. 23) clearly show that the species is closely related to *parvirostra*. The coloration, however, is very different from the yellowish *parvirostra*. The occipital marking is large and of a characteristic shape (fig. 21), the thorax is variegated with large dark brown to black markings, the abdominal tergites 2—5 possess large triangular markings on the posterior two-thirds and the segments 6—8 (9) are blackened. The wings are brownish with especially in the females the apex broadly clouded.

Distribution and period of flight. — Known from Honshu, Shikoku (Alexander, 1953c: Mt Tsurugi), Tsushima, South Korea and southern Primorye (Savchenko, 1981: Kedrova Pad). The recorded period of flight is from May 9 to July 7.

Nephrotoma flammeola Alexander, 1925 (figs. 25—28)

Nephrotoma flammeola Alexander, 1925b: 400, 401. Masaki, 1933a: 92. Ishida, 1955: 121. Savchenko, 1970: 121.

Pales flammeola; Savchenko & Krivolutzkaya, 1966: 46, 56. Savchenko, 1973: 160, 161.

Material examined. — Holotype ♂, in fair condition, one wing and abdominal end on slide 2468, specimen labelled "Gifu, Japan v-25 1921 Takeuchi" "Holotype *Nephrotoma flammeola* C. P. Alexander" (USNMA; Gifu is on Honshu); other material: 1♂ 3♀, Hokkaido (Sooukyo; Sapporo; Jozankei); 11♂ 12♀, Honshu; 1♂, Kyushu (Shiratoriyama, Kumamoto); 3♂ 5♀, Shikoku; 1♂, Sado; 7♂ 3♀, South Korea (Central Nat. Forest, 18 mi NE Seoul).

Characteristics. — As given in the key. Occipital marking small, triangular, dark brown to almost absent. Between tubercle and eyes dark brown spots. Transverse suture darkened, especially in the middle. Lateral thorax mainly yellow, anatergite and posterior half of katatergite usually darkened. Hypopygial structures as in figs. 25—28. The species apparently belongs to the *parvirostra* group.

Distribution and period of flight. — The species is known from South Korea, the Japanese

islands Hokkaido, Honshu, Kyushu, Shikoku and Sado, and is reported by Savchenko from Kunashir and southern Primorye. The species is most abundant in July and August with a few records from June and the first half of September. At altitudes up to 1500 m.

Nephrotoma parvirostra Alexander, 1924 (figs. 29—35)

Nephrotoma parvirostra Alexander, 1924: 600, 601. Masaki, 1933a: 92. Ishida, 1955: 123. Alexander, 1966: 120. Savchenko, 1970: 121.

Pales parvirostra; Zinovjev & Savchenko, 1962: 556, 557, 562—569. Savchenko & Krivolutzkaya, 1966: 46, 56.

Pales parvirostra parvirostra; Savchenko, 1973: 116, 117.

Nephrotoma immemorata Alexander, 1935a: 139, 140. (Syn. nov.)

Pales immemorata; Savchenko, 1973: 119.

Nephrotoma serristyla Alexander, 1935b: 226—228. (Syn. nov.)

Pales parvirostra serristyla; Savchenko, 1973: 118, 119.

The references by Mannheims & Savchenko (1967) and Savchenko, Violovich & Narchuk (1972) refer to *relicta*, see under discussion.

Material examined. — Holotype ♂ of *parvirostra*, in good condition, labelled: "Sapporo, Japan M. Hori" "Holotype *Nephrotoma parvirostra* C. P. Alexander" (USNMA); paratypes: 1♂ (wing and hypopygium on slide 2472), Hokkaido, Sapporo, 25.vii.1921 (USNMA); 1♂, Hokkaido, Shikaripetsu, 26.viii.1922 (USNMA); 1♂, Hokkaido, Kamiokoppe, 27.viii.1922 (USNMA) (see for localities Alexander, 1924). Holotype ♂ of *immemorata*, in fair condition, one wing, one antenna and hypopygium on slide 5737, specimen labelled: "Mt Omei Szechwan China Aug. 23, '29" "Holotype *Nephrotoma immemorata* C. P. Alexander" (USNMA) (Alexander, 1935b, fig. 47, does not indicate the serrate dorsal crest of the inner dististyle, but the crest is present in the holotype). Holotype ♂ of *serristyla*, in good condition, labelled: "Chungking 1—2000 ft v.6-27.30" "Szechwan China D C Graham" "Holotype *Nephrotoma serristyla* C. P. Alexander" (USNMA); paratypes (all USNMA): 3♂ 2♀ para(topo)types and 1♂ paratype from Chabarovsk, Amur, Primorye, 26.vii.1927, Stackelberg (apparently the paratype from Ussuri Railway, Alexander, 1924); other material: 2♂, Kunashir; 1♂, Shikotan; 14♂ 10♀, Hokkaido; 10♂ 7♀, Honshu; 2♂, Kyushu (Shiiba, Kuma-

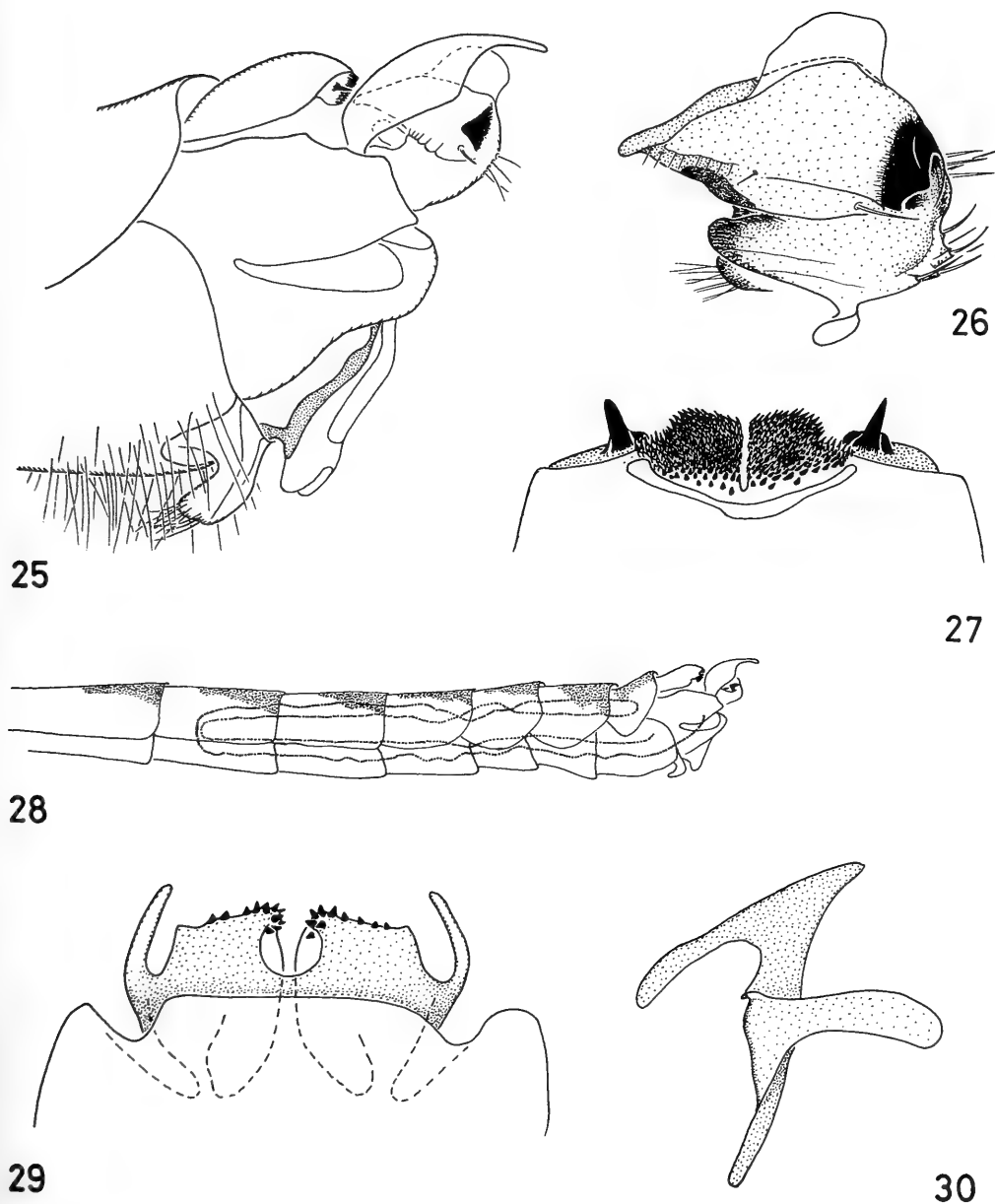

Figs. 25—28. *N. flammeola*. Fig. 25. Hypopygium, lateral view. Fig. 26. Left inner dististyle, from outside. Fig. 27. Extension of male tergite 9, dorsal view. Fig. 28. Male abdomen, showing course of intromittent organ. Figs. 29, 30. *N. parvirostra*. Fig. 29. Extension of male tergite 9, dorsal view. Fig. 30. Adminiculum, lateral view.

moto; Chojabaru, Oita); 1♂, Tsushima; 2♂ 1♀, North Korea (Chonsani near Paiktusan, the highest mountain in Korea, close to the border of Manchuria, appr. 42° N 128° E); 1♂ 4♀, South Korea (16 & 18 mi NE Seoul); 2♂ 4♀,

China (Lichuan and Eastern Tombs, Hupeh).

Characteristics. — *N. parvirostra* forms a species group with *daisensis*, *relicta*, and probably also *flammeola*. Apart from the characters mentioned in the key, *parvirostra* males can be

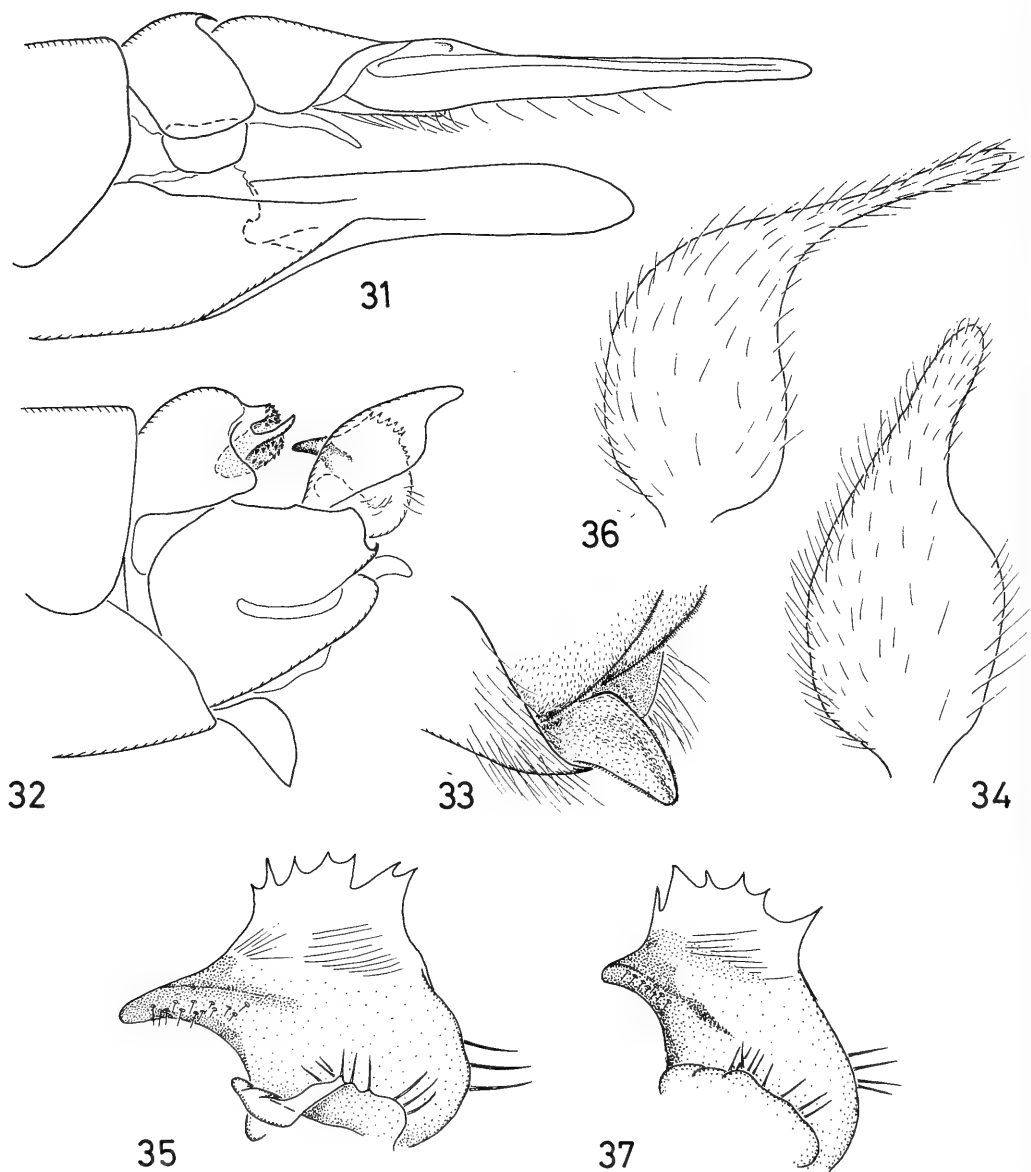

Figs. 31—35. *N. parvirostra*. Fig. 31. Ovipositor, lateral view. Fig. 32. Hypopygium, lateral view. Fig. 33. Medial appendage of male sternite 8, latero-posterior view. Fig. 34. Left outer dististyle, from outside. Fig. 35. Left inner dististyle, from outside. Figs. 36, 37. *N. relictta*. Fig. 36. Left outer dististyle, from outside. Fig. 37. Left inner dististyle, from outside.

easily recognized by the laterally compressed and triangular-shaped midventral appendage of sternite 8 (figs. 32, 33). Outside Japan this character is also found in the closely related species *relictta* (see discussion).

Distribution and period of flight. — Material has been examined from Kunashir, Shikotan,

Hokkaido, Honshu, Kyushu, Tsushima, North and South Korea and China (W. Hupeh). Savchenko, and co-authors, in addition report Amur-Zea interregion, southern Sakhalin, and China, Mao-erh-shan (sub *parvirostra*) and southern Khabarovskiy kray and southern Primorye (sub *serristyla*). Early and late records

are May 23, June 11 and October 25; all other records are between mid-July and mid-September with a distinct peak at the end of August.

Discussion. — Savchenko (1973) recognizes three subspecies of *parvirostra*, the nominal form, *serristyla* Alexander (1935), and *relicta* Savchenko (1973). Examination of type-material revealed that *serristyla* is synonymous with *parvirostra*. The differences are limited to the coloration of the antennae and thorax and, as such, found among specimens throughout the distribution range, apparently due to variation.

Specimens of *relicta* have the anterior beak of the inner dististyle short (fig. 37), and the outer dististyle apically lengthened (fig. 36). Material of *relicta* was examined from North Korea (Ompo, situated a few miles inland from the coast just south of 42° N), Mongolia (80 km SE Semon Chalchingol), China (Mao-erh-shan; Lichuan; Mt Omei) and USSR (near Irkutsk, syntype ♂, ASL). Material of *parvirostra* was examined from a number of these localities or regions as well. Because of the large area of sympatry, *relicta* is best considered a species instead of subspecies. Savchenko (1973) reports *relicta* from the Leningradskaya oblast, Krasnoyarskiy kray (Mina) and the Irkutskaya oblast.

THE *FUSCESCENS* GROUP

Nephrotoma contrasta Alexander, 1920 (figs. 47—50, 53—54)

Nephrotoma contrasta Alexander, 1920: 23, 24. Ishida, 1955: 120.

Pales contrasta; Savchenko, 1973: 164.

Material examined. — Holotype ♂, in fair condition, antennae, one wing, leg fragments and hypopygium on slide 1129, specimen labelled "Saitama, Japan May 29, 1919 R. Takahashi" "Holotype *Nephrotoma contrasta* C. P. Alexander" (USNMA; Saitama is on Honshu); 1 ♀ paratype, Hokkaido, Meguro near Horoizumi, 24.v.1919 (USNMA) (the ♀ para(topo)type, USNMA, specimen and slide 1129, belongs to *fuscescens*); other material: 1 ♀, Hokkaido (Nopporo, Ishikari); 5 ♂ 3 ♀, Honshu (Mt Takao; Kyoto).

Characteristics. — Belongs to the *fuscescens* group. The differentiating characters are discussed under *fuscescens*.

Distribution and period of flight. — Known from Hokkaido and Honshu only. On Honshu the species occurs as far South as Kyoto. The records are from May and June.

Nephrotoma flavonota (Alexander, 1914) (figs. 38—42)

Pachyrhina flavonota Alexander, 1914: 158, 159.

Nephrotoma flavonota; Masaki, 1933a: 90. Alexander, 1940a: 121—123. Alexander, 1953c: 148. Ishida, 1955: 121.

Pales flavonota; Savchenko, 1973: 94.

Material examined. — Holotype ♂, three slides only (one with outer and inner dististyle, one with rest of hypopygium, one with a wing), labelled "Holotype 827 *Nephrotoma flavonota* (Alex.) ♂ Tokyo, Japan Aug, 1912 (Ex Kuwana) 827" (USNMA, specimen lost?); 1 ♀ paratype slide with wing, labelled as the holotype except for „Allotype" and "♀" and not mentioning "(Ex Kuwana)" (USNMA, specimen lost?); other material: 1 ♂ 2 ♀, Hokkaido (Meguro near Horoizumi); 2 ♂ 1 ♀, Tsushima; 21 ♂ 13 ♀, Honshu; 6 ♂ 6 ♀, Kyushu; 4 ♂ 1 ♀, Shikoku; 7 ♂ 1 ♀, China (Chekiang; Fukien).

Characteristics. — Head and thorax entirely yellow to brownish yellow, the latter with the dorsal stripes pale brown and subopaque, area between the stripes dull, medial stripe on scutum 1 sometimes with a narrow dull medial line, lateral stripes on scutum 1 straight. Abdomen with a row of dorsal spots, elongate in the male, more triangular in the female. Male segment 8 and tergite 9 darkened. Male tergite 8 deeply incised, incision lined with long hairs; medisternal appendage of sternite 9 elongate, strongly hirsute and occupying incision of sternite 8 (figs. 38, 41). Extension of male tergite 9 as in fig. 40. Inner dististyle with a high serrate crest (fig. 42). Female ovipositor relatively short (fig. 39).

The species does not clearly belong to a species group but might be allied to the *fuscescens* group with which it shares the lengthened male sternite 8, the hirsute medisternal appendage, and the short ovipositor (extremely short in the *fuscescens* group).

Distribution and period of flight. — Known from the Japanese islands Tsushima, Honshu, Kyushu and Shikoku and from the Chinese provinces Chekiang and Fukien. Japanese records are from May 7 to June 18, Chinese records from April 6 to June 11.

Nephrotoma fuscescens (Riedel, 1910) (figs. 43—46, 51—52)

Pachyrhina fuscescens Riedel, 1910: 422, 423.

Pales fuscescens; Savchenko, 1973: 50, 51.

Nephrotoma iyoensis Alexander, 1953d: 226, 267.
(*Syn. nov.*)

Pales iyoensis; Savchenko, 1973: 51.

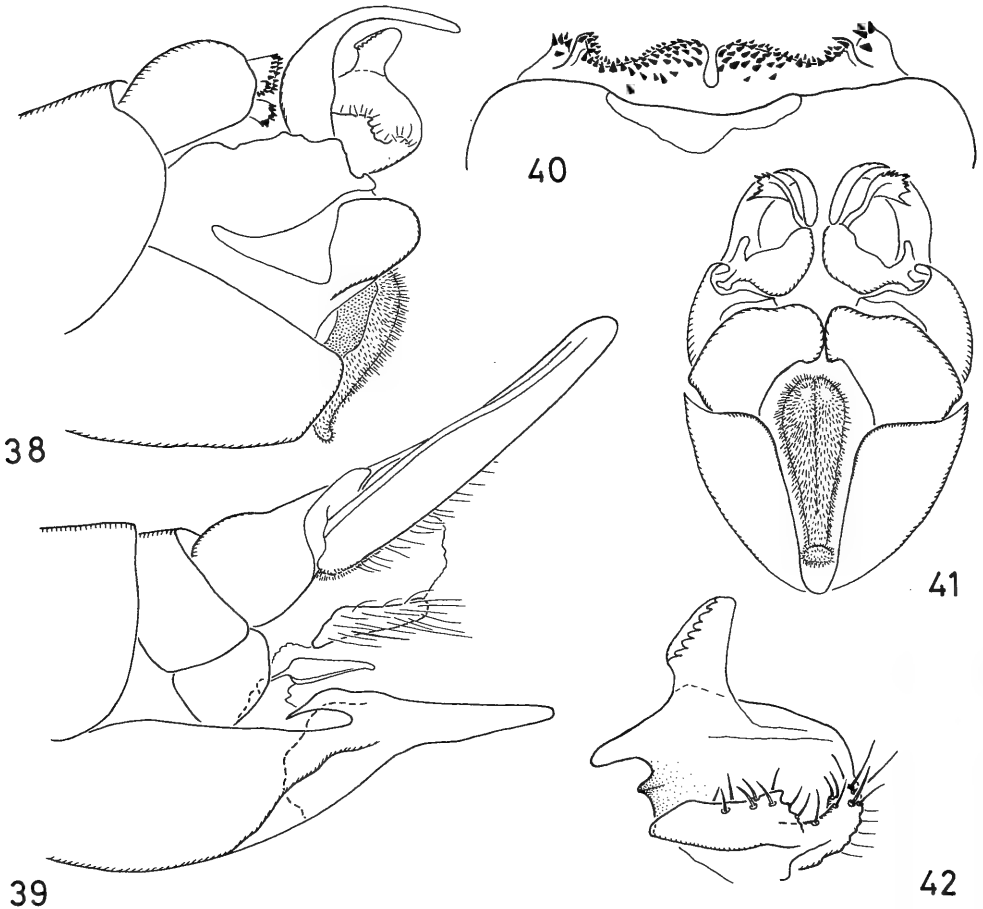

Figs. 38—42. *N. flavonota*. Fig. 38. Hypopygium, lateral view. Fig. 39. Ovipositor, lateral view. Fig. 40. Extension of male tergite 9, dorsal view. Fig. 41. Hypopygium, rear view. Fig. 42. Left inner dististyle, from outside.

Nephrotoma akitaë Alexander, 1955: 366—368. (Syn. nov.)

Material examined. — Holotype ♂ of *iyoen-sis*, in fair condition, hypopygium on slide 9706, specimen labelled: "Japan Shikoku Saragamine 1200 m. vi-3.52 Ishihara" "Holotype ♂ *Nephrotoma iyoensis* C. P. Alexander" (USNMA); 1 ♀ paratype, Shikoku, Saragamine, 1100 m, 3.vi.1952 (USNMA). Holotype ♂ and paratype ♀ of *akitaë* on one pin, abdominal ends lacking (corresponding slides were not found), labelled "Japan Akita Prov. Yuze 250 m, vi-22, 51 Issiki-Ito" "Holotype *Nephrotoma akitaë* C. P. Alexander" "Allotype *Nephrotoma akitaë* C. P. Alexander" (USNMA); other material: 4♂ 2♀, Primorskiy kray (Wladiwostok; Khasan, Ke-

drova Pad); 1♂ 1♀, Tsushima; 3♀, Honshu (Sata; Saitama; Mt Takao); 15♂ 6♀, Kyushu; 1♂ 1♀, Shikoku (Omogo Valley, Iyo).

The type-material of *fuscescens* ("2♂ 4♀, Halbinsel Jankowsky, Süd Ussuri", Museum für Naturkunde, Berlin, East Germany), could not be studied. The species is described from southern Primorye; material from that region was examined during this study.

Characteristics. — *N. fuscescens* and the closely related species *contrastata* and *leeweni* share the following characters: anterior part of mediotergite yellow; lateral thorax with dark brown to black markings; male sternite 8 lengthened and incised (figs. 43, 46, 47, 50, 55, 57); female ovipositor very short (figs. 51—54) (the female of *leeweni* is unknown, the hypo-

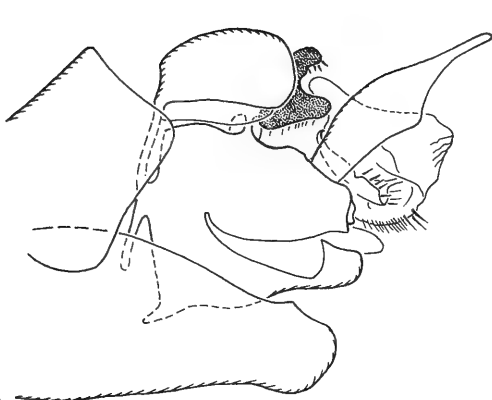

43

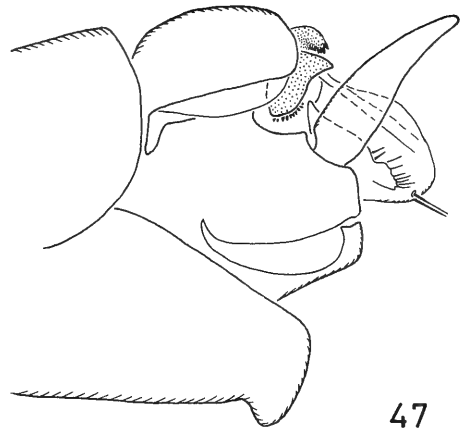

47

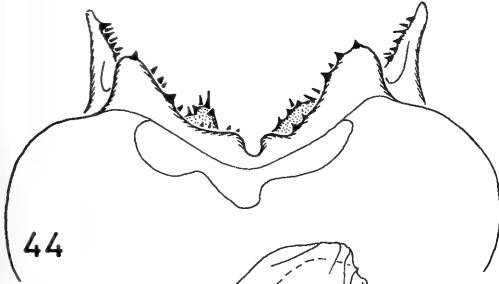

44

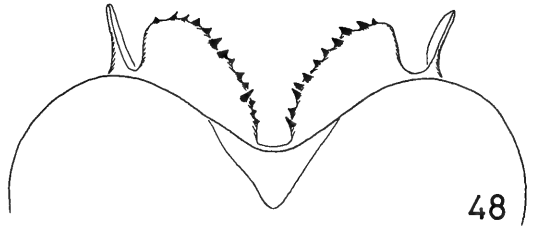

48

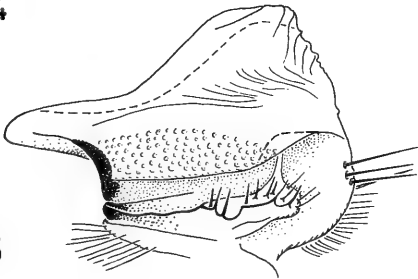

45

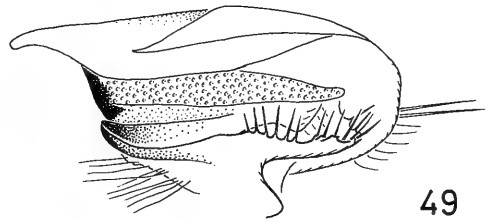

49

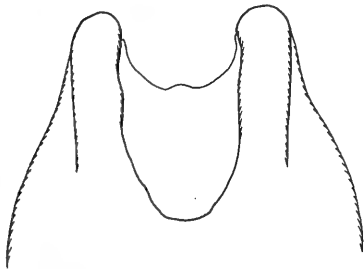

46

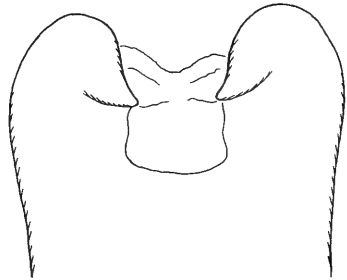

50

Figs. 43—46. *N. fuscescens*. Fig. 43. Hypopygium, lateral view. Fig. 44. Extension of male tergite 9, dorsal view. Fig. 45. Left inner dististyle, from outside. Fig. 46. Male sternite 8, ventral view. Figs. 47—50. *N. contrasta*. Fig. 47. Hypopygium, lateral view. Fig. 48. Extension of male tergite 9, dorsal view. Fig. 49. Left inner dististyle, from outside. Fig. 50. Male sternite 8, ventral view.

pygium of this species is very similar to that of *fuscescens* and *contrasta* and it is assumed that the same applies to the ovipositor).

The species differ among each other as fol-

lows: in *leuweni* the posterior part of the inner dististyle is enlarged and blackened (fig. 58) and the broadly V-shaped extension of the male tergite 9 possesses robust lateral projections (fig.

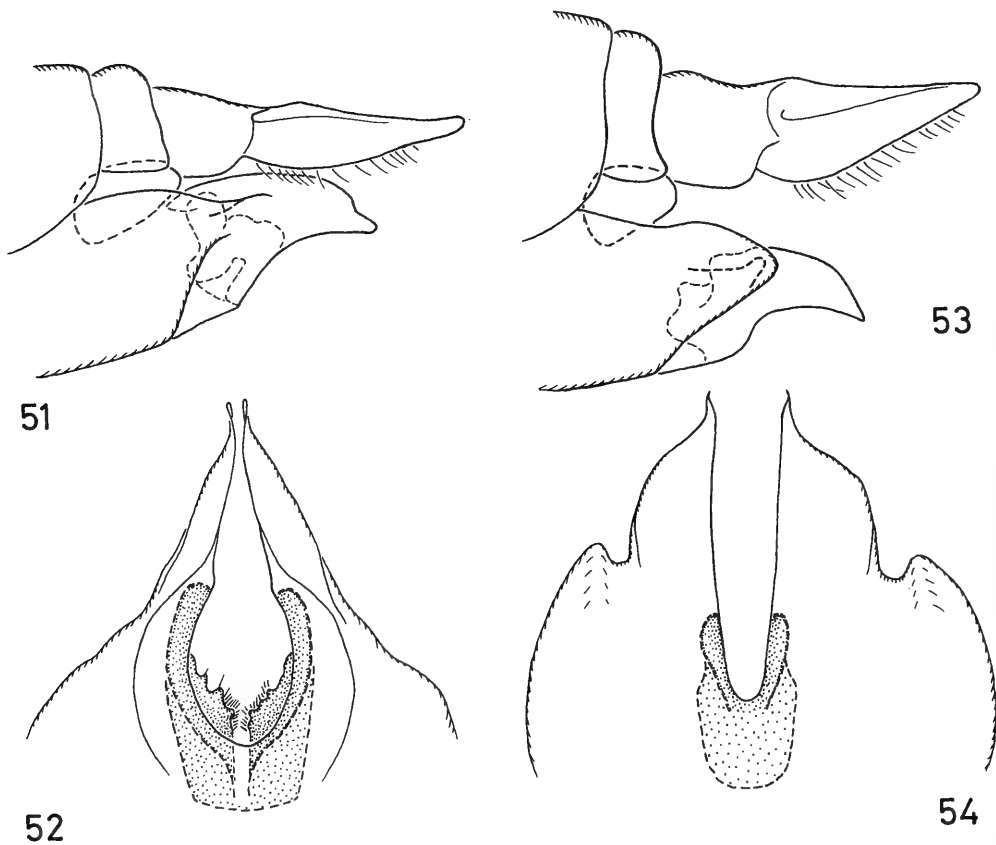

Figs. 51, 52. *N. fuscescens*. Fig. 51. Ovipositor, lateral view. Fig. 52. Female sternite 8 and hypovalvae, ventral view. Figs. 53, 54. *N. contrasta*. Fig. 53. Ovipositor, lateral view. Fig. 54. Female sternite 8 and hypovalvae, ventral view.

56); in *fuscescens* the extension has a concave medial incision (fig. 43); in *contrasta* the medial incision is convex (fig. 48); the inner dististyle of *fuscescens* has a high posterior crest (fig. 45); in *contrasta* the crest is low (fig. 49); furthermore there are some differences in the ventral aspect of the male sternite 8 (figs. 46, 50); females of *fuscescens* and *contrasta* differ in the shape of the short hypovalvae (figs. 51, 53, with a small dorsal notch before apex in *fuscescens*) and by the transition of sternite 8 and the hypovalvae (figs. 52, 54).

Distribution and period of flight. — Known from southern Primorye and the Japanese islands Tsushima, Honshu, Kyushu and Shikoku. On Honshu the species is sympatric with *contrasta* and *leeuweni* and known as far north as Yuze, Akita. Altitudes are up to 1200 metres. Almost all Japanese records are in May, a few

are from June; the records from southern Primorskiy kray are from June and July.

***Nephrotoma leeuweni* spec. nov.**
(figs. 55—58)

Type-material. — Holotype ♂, in good condition, abdomen stored in microvial, labelled "Honshu Nagano Tokyo, 12.v.1922 Esaki" "Holotype *Nephrotoma leeuweni* P. Oosterbroek" (ZMA).

Characteristics. — Belongs to the *fuscescens* group. Differentiating characters are discussed under *fuscescens*. The most salient character is the enlarged and blackened posterior margin of the inner dististyle (fig. 58).

Description.

Body and wing length: 14 mm.

Head. — Yellow with dorsal part of rostrum and occipital marking dark brown. The latter

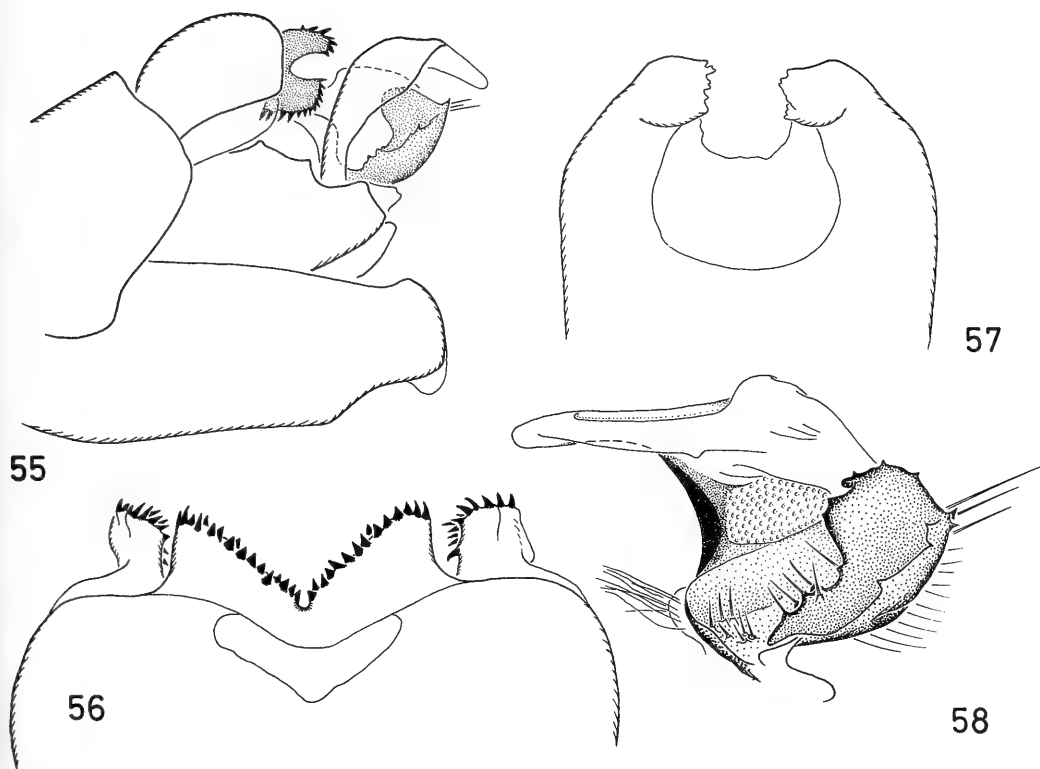

Figs. 55—58. *N. leeuweni*. Fig. 55. Hypopygium, lateral view. Fig. 56. Extension of male tergite 9, dorsal view. Fig. 57. Male sternite 8, ventral view. Fig. 58. Left inner dististyle, from outside.

large, about as broad as dorsal pronotum and reaching base of tubercle. In between tubercle and eye margin rounded, dark brown to black spots. Antennae 13-segmented; scape light brown; pedicel brown; flagellar segments dark brown to black and somewhat reniform beyond first; longest verticillar hairs about as long as segments.

Thorax. — Yellow with dark brown to black dorsal stripes and large lateral markings. Lateral stripes on scutum 1 outcurved, the outcurved part dull and reaching halfway paratergite. Anterior two-thirds of mediotergite yellow, posterior one-third with two rounded dark brown spots. Coxae with dark brown markings basally, largest on coxae one; trochanters yellowish brown; femora basally yellowish brown, gradually darkening towards brown tips; tibiae light brown to dark brown; tarsi dark brown; claw of right front leg toothed, other claws lacking. Wing with a light brown tinge, cells c and sc slightly more brownish; stigma distinct, brown,

with about 6 macrotrichia; crossveins just below stigma with a brown seam; wingtip clouded brown.

Abdomen. — Yellowish brown with a brown to dark brown dorsal stripe on tergites 1—6, stripe about as broad as scutellum and narrowly interrupted on the anterior part of the tergites; segment 7 and 8 largely darkened.

Hypopygium. — Dark reddish brown. Extension of tergite 9 widely V-shaped with robust lateral projections (fig. 56). Outer dististyle slender (fig. 55). Inner dististyle as in fig. 58, with an elongate and slender anterior beak and the posterior part distinctly enlarged and blackened. Medisternal appendage of sternite 9 strongly hirsute and situated between the lateral extensions of the elongate sternite 8.

Distribution. — Known after the holotype ♂ from Honshu only.

Etymology. — The species is named after my friend and colleague Dr. Br. Theowald van Leeuwen.

THE ANALIS GROUP

***Nephrotoma ozenumensis* Alexander, 1925**
(figs. 65—68)*Nephrotoma ozenumensis* Alexander, 1925b: 399, 400. Masaki, 1933a: 92. Ishida, 1955: 122.*Nephrotoma lamellata*; Savchenko, 1970: 120, 121.*Pales ozenumensis*; Savchenko, 1973: 162, 163.*Pales sublamellata*; Savchenko, 1973: 56—58 (in part).

Material examined. — Holotype ♀, in good condition, one wing on slide 2845, specimen labelled: "Ozenuma Japan 6454 ft vii-25.23 T. Esaki" "Holotype *Nephrotoma ozenumensis* C. P. Alexander" (USNMA; Ozenuma is on Honshu); other material: 1♂, Shikotan, 20.viii.1971 (ZMA); 1♂, Honshu, Nikko, Tochigi pref., 26.vii.1973 (KURU).

Characteristics. — See under *N. vana*.

Distribution and period of flight. — Known from Shikotan and Honshu only. Records are from July 17 to August 20.

***Nephrotoma vana* spec. nov.**
(figs. 59—63)

Introduction. — In the literature some confusion exists about the synonymy of *sublamellata* Alexander, 1935, and *lamellata* (Riedel, 1910). Examination of the male holotype of the former (USNMA) revealed that *sublamellata* is at most a subspecies of *lamellata*, differing in the shape of the lateral appendage of the adminiculum only, and replacing *lamellata* in southern Primorye, Sakhalin and North Korea. Examination of specimens from the Kurile and Japan showed that this material belongs to two other species, closely related to *lamellata*. They are *ozenumensis* Alexander, 1925, known from Shikotan and Honshu; and *vana* nov. spec., divided here into two subspecies, the nominal form from Kunashir and Hokkaido, and the subspecies *nigrovana* from Honshu and Kyushu.

Characteristics. — The species *lamellata*, *ozenumensis* and *vana* do not differ in coloration, except for the darker coloured subspecies *nigrovana* (see descriptions of *vana vana* and *vana nigrovana*). The differences are limited to hypopygial characters as follows:

lamellata: gonapophyses of the adminiculum with an acute upright projection (fig. 64); in the subspecies *sublamellata* the downcurved posterior arm is notably shorter;

ozenumensis: gonapophyses of the adminiculum without an acute upright projection and

posterior arm not downcurved (fig. 66); in both *lamellata* and *ozenumensis* the dorsal margin of the appendage is serrate; outer dististyle sinuate with the apical part very slender and elongate (fig. 65);

vana: gonapophyses of the adminiculum more straight and with the dorsal margin not serrate (fig. 62); outer dististyle less sinuate (fig. 63); lateral shells of the extension of tergite 9 in dorsal view largely concealed by the above-lying flanges (fig. 61), in *lamellata* and *ozenumensis* these flanges are less developed (fig. 67); *vana nigrovana* differs from the nominal subspecies in coloration only: the thorax is almost entirely darkened, the scutal stripes are broadly in contact with each other and the abdominal segments (5) 6—8 are entirely black.

Etymology. — The name *vana* refers to the more hollow lateral shells of the extension of the male tergite 9.

***Nephrotoma vana vana* subsp. nov.**
(figs. 59—63)*Pales lamellata*; Savchenko & Krivolutzkaya, 1966: 56.*Pales sublamellata*; Savchenko, 1973: 56—58 (in part).*Nephrotoma lamellata*; Oosterbroek, 1980: 366 (subsp. nov.; distribution only).

Type-material. — Holotype ♂, in good condition, labelled "Japan Murayama Sapporo vi-25.32 Okada (USNMA); paratypes: 1♂, Kunashir, 1.viii.1977 (ZMA); 1♂, Hokkaido, Jozankei, Sapporo, 19.viii.1922 (ZMA); 1♀, idem, 28.vi.1953 (USNMA); 1♀, Hokkaido, Yubari-dake, subalpine z., 14.vii.1967 (KU).

Characteristics. — See under *N. vana*.

Description.

Body length ♂: 12—13 mm, ♀: 18—20 mm; wing length ♂: 12—13 mm, ♀: 15—17 mm.

Head. — Dorsal part of rostrum broadly dark brown, lateral parts yellow. Head pale yellow to yellow, tubercle and vertex sometimes more brownish. Occipital marking large, about as broad as or broader than dorsal part of pronotum, with rounded lateral margins and usually pointed anteriorly, reaching base of tubercle. Next to tubercle large dark brown spots along eye-margin. Antennae with 13 segments; scape yellow with brownish patches on apical half; pedicel light brown; flagellar segments dark brown, in the male somewhat nodulose basally beyond first, in the female cylindrical.

Thorax. — Pronotum dorsally yellow, lateral

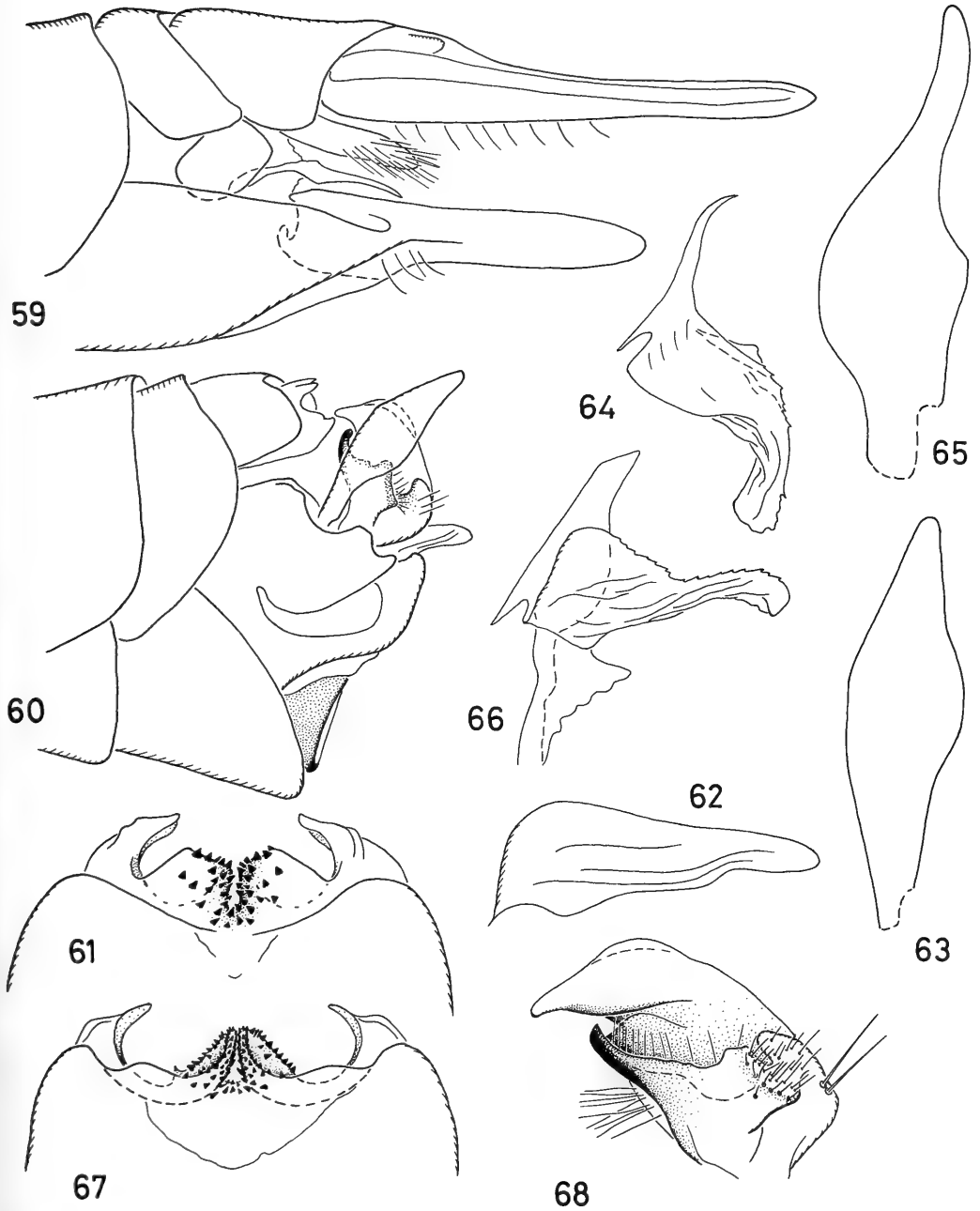

Figs. 59—63. *N. vana vana*. Fig. 59. Ovipositor, lateral view. Fig. 60. Hypopygium, lateral view. Fig. 61. Extension of male tergite 9, dorsal view. Fig. 62. Left gonapophyses, lateral view. Fig. 63. Left outer dististyle, from outside. Fig. 64. *N. lamellata*. Adminiculum and left gonapophysis, lateral view. Figs. 65—68. *N. ozenu-mensis*. Fig. 65. Left outer dististyle, from outside. Fig. 66. Adminiculum and left gonapophysis, lateral view. Fig. 67. Extension of male tergite 9, dorsal view. Fig. 68. Left inner dististyle, from outside.

part anteriorly yellow to light brown, posteriorly dark brown. Scutal stripes dark brown to black, lateral stripes with the outcurved anterior part dull and large, almost or actually reaching paratergite. Dull seam around anterior corners of scutum 2 occupying lateral part of transverse suture and contacting lateral stripes of scutum 1 with stripes of scutum 2. Scutellum yellowish brown with a broad brown to dark brown medial stripe or scutellum entirely darkened. Mediotergite antero-laterally yellowish brown, antero-medially with a broad brown to dark brown stripe which distinctly broadens posteriorly. Lateral parts of thorax yellowish brown, variegated with large dark brown markings. Coxae dorsally darkened; trochanters largely light brown; femora light brown with the apices broadly darkened, front legs with apical half darkened; tibiae and tarsi brown to dark brown; male claws toothed. Wings with a light brownish yellow tinge; stigma dark brown with about 30 macrotrichia; crossveins just below stigma with a broad brown seam; wingtip broadly clouded.

Abdomen. — Tergite 1 with a broad brown to dark brown spot dorsally. Tergites 2—5 (male) or 2—6 (female) with brown to dark brown spots on the posterior part of the tergite, in the male spots about as large as scutellum and on tergite 2 prolonged anteriorly to contact similar spot on anterior half of the tergite, in the female spots broader and more triangular and prolonged anteriorly forming a continuous stripe. Sternites 1—5 or 1—6 yellow. Male with segments 6—8 and female with segments 7—8 dark brown to black. Hypopygium largely darkened. Female tergites 9 and 10 and ovipositor light brown.

Hypopygium and ovipositor. — As in figs. 59—63.

Distribution and period of flight. — Known from Kunashir and Hokkaido only. The records are between June 25 and August 19.

Nephrotoma vana nigrovana subsp. nov.

Type-material. — Holotype ♂, in good condition, abdomen stored in microvial, labelled "Honshu Mt Hirasan Shiga pref. 900—1100 m. 1969.vi.5 K. Kanmiya" (KURU); paratypes: 1♀, Kyushu, Shiratoriyama, Kumamoto, 10.vii.1977 (KU); 1♀, Kyushu, Bogazuru, Kujusan, 13.vi.1968 (ZMA); 1♀, Japan, 1909 (BMNH); 1♀, Honshu, Chugokusanchi, Kamikochi, 5000', 26.vii.1939 (ZMA).

Characteristics. — See under *vana*.

Description.

Body length ♂: 15 mm, ♀: 18—20 mm; wing length ♂: 14 mm, ♀: 16 mm.

Head. — As in the nominal form, pedicel and scape darker.

Thorax. — Thorax and coxae largely dark brown to black. Scutal stripes broadly in contact with each other; lateral stripes of scutum 1 with a large dull outcurved anterior part. Thorax yellow or yellowish brown at dorsal pronotum, on either side of outcurved part of the lateral stripe of scutum 1, at paratergite and with smaller marks around wing base, largest on katapisternite. Wings and legs as in *vana vana*.

Abdomen. — Segment 1 dark brown to black, the tergite laterally somewhat lighter. Segments 2—4 yellow, the tergites with dark brown triangular transverse bands along the hind margin, bands in male relatively narrow, in female broader, dorsally occupying posterior half of tergite; tergite 2 in addition with a rounded dark brown to black spot on anterior half with two smaller spots antero-laterad of it. Anterior part of sternite 5 yellow, remainder of segment 5 dark brown to black. Segments 6—8 and male hypopygium dark brown to black. Female tergites 9 and 10 and ovipositor light brown.

Distribution and period of flight. — Known from Honshu and Kyushu only. Records are from June 5 to July 26.

Nephrotoma pullata (Alexander, 1914)

(figs. 69—72)

Pachyrhina pullata Alexander, 1914: 160—162.

Nephrotoma pullata; Masaki, 1933a: 90. Alexander, 1953a: 73. Alexander, 1953c: 148, 149. Ishida, 1955: 123.

Nephrotoma hokkaidensis Alexander, 1925a: 446, 447. (Synonymy in Alexander, 1953c.)

Nephrotoma mannheimsi Savchenko, 1966: 260—262. (Syn. nov.)

The reference by Savchenko (1973) refers to *neoprattensis*.

Material examined. — Holotype ♂ of *pullata*, three slides containing one wing, left inner and outer dististyle and abdominal end, labelled "Holotype 829 *Nephrotoma pullata* (Alex.) ♂ Tokyo, Japan May 7, 1912 (Ex S. Kuwana) 829" (USNMA, the holotype specimen was not found). Holotype ♂ of *hokkaidensis*, in good condition, labelled "Yoichi, Prov. Shiribeshi, Japan vi-26-1921 S. Kuwayama" "Holotype

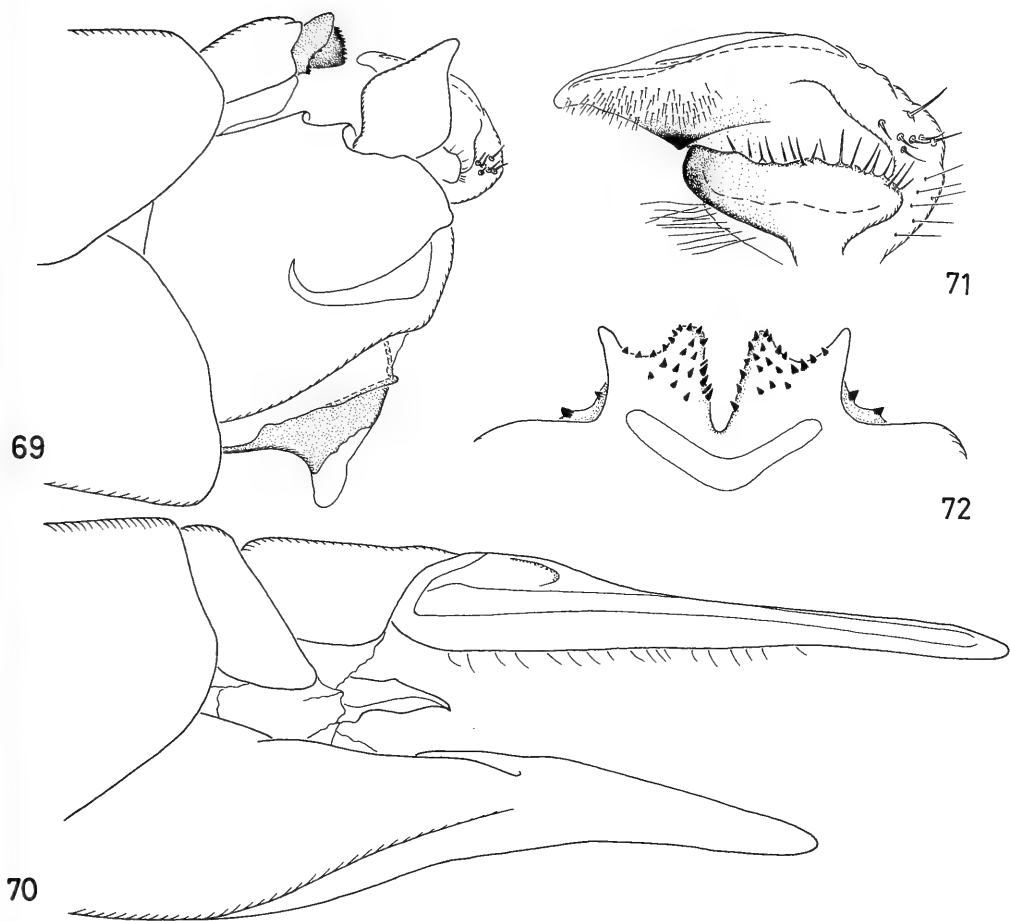

Figs. 69—72. *N. pullata*. Fig. 69. Hypopygium, lateral view. Fig. 70. Ovipositor, lateral view. Fig. 71. Left inner dististyle, from outside. Fig. 72. Extension of male tergite 9, dorsal view.

Nephrotoma hokkaidensis C. P. Alexander" (USNMA; Yoichi is, of course, on Hokkaido); paratypes: 1♂ 1♀, para(topo)types (USNMA); 2♂, Hokkaido, Sapporo. Mt Moiwa, 15.vi.1923 (1♂ USNMA, 1♂ BMNH); 1♂ 1♀, Hokkaido, Sapporo, 15.vi.1921 (USNMA, with slide 829); 1♂, idem, end vi.1921 (USNMA). Holotype ♂ of *mannheimsi*, in good condition, labelled "Maershan, Mandschurei 7.vii.39 W. Alin leg." "Mandschurei, Maoershan 7.vii.39 W. Alin" "*Pales* sp. n. opr. E. N. Savchenko" "Holotypus *Pales mannheimsi*, sp. n. Savtshenko" (MAK; notwithstanding the type-labels, the species was described in *Nephrotoma*); paratypes: 1♂ 1♀, para(topo)types from 23.vi.1939 (MAK); other material: 14♂ 18♀, Hokkaido; 3♂ 4♀, Honshu; 1♂ 1♀, Kyushu (Kagoshima;

Beppu); 1♀, Sado; 3♂ 2♀, North Korea (Ompo, situated a few miles inland from the coast just South of 42° N; Seren Mts); 1♂ 1♀, China (Manchuria: Mao-erh-shan and Erzendjanzsy).

Characteristics. — *N. pullata* is a large species (body length ♂ up to 19 mm, ♀ up to 24 mm). The coloration of the head is characteristic with the yellow eye-ring broadly interrupted by the greyish lateral extension of the occipital marking. The lateral thorax is dusted grey to a variable degree. The male abdominal tergites 2—5 with elongate, brown to black, dorsal spots in front of hind margin, usually about as broad as scutellum and twice as long; posterior segments blackened. Female with a continuous dorsal stripe on tergites 2—7, composed of triangular spots, largest on tergites 4—6; tergites

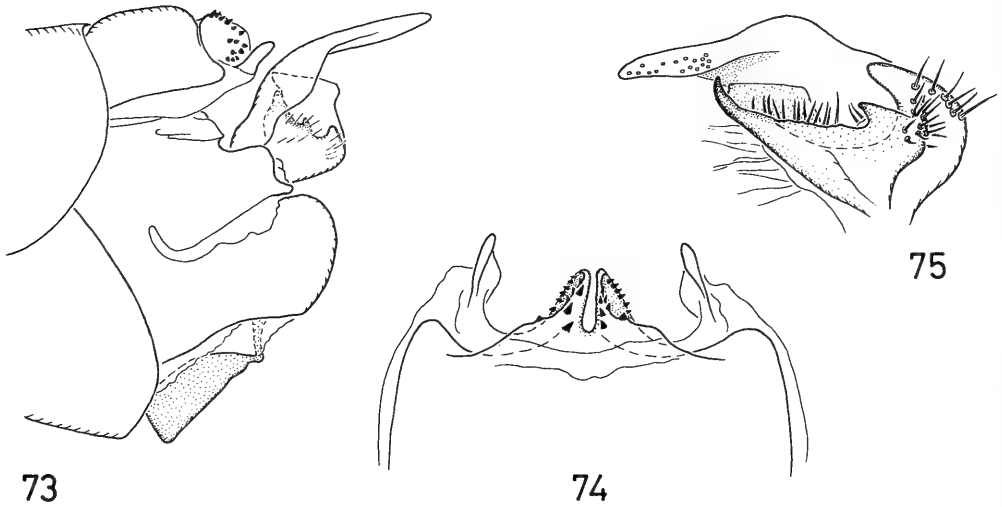

Figs. 73—75. *N. stygia*. Fig. 73. Hypopygium, lateral view. Fig. 74. Extension of male tergite 9, dorsal view. Fig. 75. Left inner dististyle, from outside.

laterally and sternites ventrally with elongate brown to dark brown spots. Specimens from the continent are usually to a much lesser degree variegated with brown to black markings, especially on the abdomen, and they have the thorax not dusted grey. Hypopygium and ovipositor as in figs. 69—72.

Distribution and period of flight. — Material was examined from Hokkaido, Honshu, Sado, Kyushu, Shikoku, North Korea and China (Manchuria). Savchenko (1966) in addition reports Amurskaya oblast and Primorskiy kray. On the continent and on Hokkaido the species is on the wing from the end of May until the end of July, on the other Japanese islands the records are much earlier, from mid-April to mid-June, with one record for August 9.

***Nephrotoma stygia* Alexander, 1921**
(figs. 73—75)

Nephrotoma stygia Alexander, 1921: 131, 132. Alexander, 1925c: 4. Esaki, 1932: 181. Masaki, 1933a: 91. Ishida, 1955: 124.

Pales erebus; Savchenko, 1973: 113 (see discussion).

Material examined. — Holotype ♂, in good condition, one wing on slide 1788, specimen labelled "Ikaho, Japan Gumma-ken, July 7 1920 K. Tanaka" "Holotype *Nephrotoma stygia* C. P. Alexander" (USNMA; Ikaho is on Honshu); paratypes: 1 ♀, in poor condition, one wing on slide 1788, specimen labelled as the holotype;

1 ♀, Honshu, Chuzenji, 9.vii.1920 (both ♀ USNMA); other material: 1 ♂ 5 ♀, Hokkaido (Sounkei; Sapporo; Shizunai); 11 ♂ 15 ♀, Honshu; 1 ♂, Shikoku (Mt Sara).

Characteristics. — *N. stygia* is an almost completely brownish black species with two, clear yellow marks on the lateral thorax, namely the membranous area underneath the paratergite and the anterior half of the katatergite in front of the halter. The genae and frontal tubercle are more brownish yellow than the rest of the head. The abdominal segments are shining with a broad dull ring along the posterior margins. *N. stygia* belongs to the *analis* subgroup (sensu Oosterbroek, 1980), as is shown by the shape of the inner dististyle (fig. 75) and the extension of tergite nine (fig. 74). The basal one-third of the intromittent organ is relatively thick, the apical two-thirds are more slender and consist of a cylindrical filament which is dorsally open, especially at the transition; a similar opening is found in the *flavipalpis* subgroup, the presumed sistergroup of the *analis* subgroup (Oosterbroek, 1980).

Distribution and period of flight. — Known from the islands Hokkaido, Honshu and Shikotan; Masaki and Ishida also mention Kyushu, but no material from that island was examined. The species is recorded from altitudes up to 2000 m and is most frequent from the end of July until the end of August, only a few records are from early July.

Discussion. — Savchenko (1973) considers *stygia* as possibly a junior synonym of *erebus*, but *stygia* is a valid species, not even belonging to the same species-group as *erebus*.

THE *PALLORIS* GROUP

Nephrotoma bifusca Alexander, 1920 (figs. 79—83, 88, 91)

Nephrotoma bifusca Alexander, 1920: 25, 26. Alexander, 1953d: 265, 266. Ishida, 1955: 120.
Pales bifusca; Zinovjev & Savchenko, 1962: 557, 569. Savchenko, 1973: 45, 46.

Material examined. — Holotype ♀, in good condition, one wing on slide 1128, specimen labelled "Kioto, Japan May 27, 1914 A. Nohira" "Holotype *Nephrotoma bifusca* C. P. Alexander" (USNMA); other material: 3♂ 2♀, Honshu (Tottori, Owami, Gifu); 2♂, Shikoku (Minara; Iyo); 2♂, North Korea (Puksu Pyaksan in Kankyo Nando, the second highest peak in Korea, appr. 40° 40' N 127° 45' E; Chonsani near Paiktusan, the highest mountain in Korea, close to the border of Manchuria, appr. 42° N 128° E); 4♂ 6♀, South Korea (Central Nat. Forest, 18 mi NE Seoul; 8 mi SW Kangnung; Tangjok-gok, 38°11'N 128°19'E); 2♂ 3♀, Primorskiy kray (Khasan, Kedrova Pad; Wladivostok); 1♂, Khabarovskiy kray (Khabarovsk); 1♂ Amurskaya oblast (Khor).

Characteristics. — *N. bifusca* belongs to the *palloris* group, of which the Japanese species possess an usually isolated dull mark below the anterior end of the lateral stripes on scutum 1 and which have the lateral parts of the mediotergite darkened and the antero-medial part yellow. Among these species *bifusca* can be easily recognized by the brown seam along the wing cord and apical part of vein CuA2. Males have the posterior margin of the inner dististyle blackened (fig. 80). In females the dorsal margin of sternite 8 is very high towards the hypovalvae, a character easily visible even in unmacerated specimens (figs. 88, 91). A peculiarity of *bifusca* is the swelling of the intromittent organ at about one-third its length from the semen pump (fig. 82). See also under *palloris*.

Distribution and period of flight. — Known from Amurskaya oblast, Khabarovskiy kray, Primorskiy kray, North Korea, South Korea and the Japanese islands Honshu and Shikoku. The period of flight is from the second half of May until the first half of September.

Nephrotoma geminata Alexander, 1920 (figs. 76, 89)

Nephrotoma geminata Alexander, 1920: 24, 25. Ishida, 1955: 121.
Pales geminata; Savchenko, 1973: 64.

Material examined. — Holotype ♂, in fair condition, several parts stored on slide 1127, specimen labelled "Ichikawa Chiba-ken Japan v-17-1919" "Holotype *Nephrotoma geminata* C. P. Alexander" (USNMA). 1♀ paratype with slide 1127, labelled as the holotype except "May 17, 19" and "Allotype" (USNMA); other material: 36♂ 15♀, from Honshu.

Characteristics. — Belongs to the *palloris* group and is compared with the species of this group under *palloris*.

Distribution and period of flight. — Known from Honshu only and on the wing from the second half of April to the end of May, with one record for September 9.

Nephrotoma pallida spec. nov. (figs. 84—87, 90, 92)

Type-material. — Holotype ♂, in good condition, labelled "Kyushu Miyazaki Miyazaki 3.x.1973" J. Emoto (KU); paratypes: 1♀, labelled as the holotype (ZMA); 1♂, Yakushima, Onoaida, 7.x.1968 (ZMA); 1♂ 1♀, Kyushu, Sata Misaki, 19.v.1952 (♀), 21.v.1952 (♂) (USNMA); 1♂, Yunomoto, Isl. Iki NE of Kyushu, 28.v.1957 (ZMA); 1♀, Kyushu, Sata Oshumi, Magome-Hetsuka, 24.v.1952 (USNMA); 1♂, Kyushu, Inunakiyamo, Fukuoka, 18.viii.1965 (KU); 1♀, Kyushu, Inunakiyamo, Fukuoka, 30.ix.1965 (ZMA).

Characteristics. — Closely related to *palloris*, discriminating characters are discussed under that species.

Description.

Body length ♂: 10—11 mm, ♀: 14—16 mm; wing length ♂: 10—11 mm, ♀: 12—13 mm.

Head. — Yellowish, vertex light brown, rostrum usually with a brownish spot dorsally. Occipital marking a small shining triangle with a narrow dark brown frontal prolongation that reaches top of tubercle, frontal prolongation less broad than diameter of flagellomere 1 and sometimes faint or even absent. Antennae 13-segmented; scape, pedicel and first flagellar segment light yellow to brownish yellow; following flagellar segments light brown and somewhat reniform in the male with the basal nodes

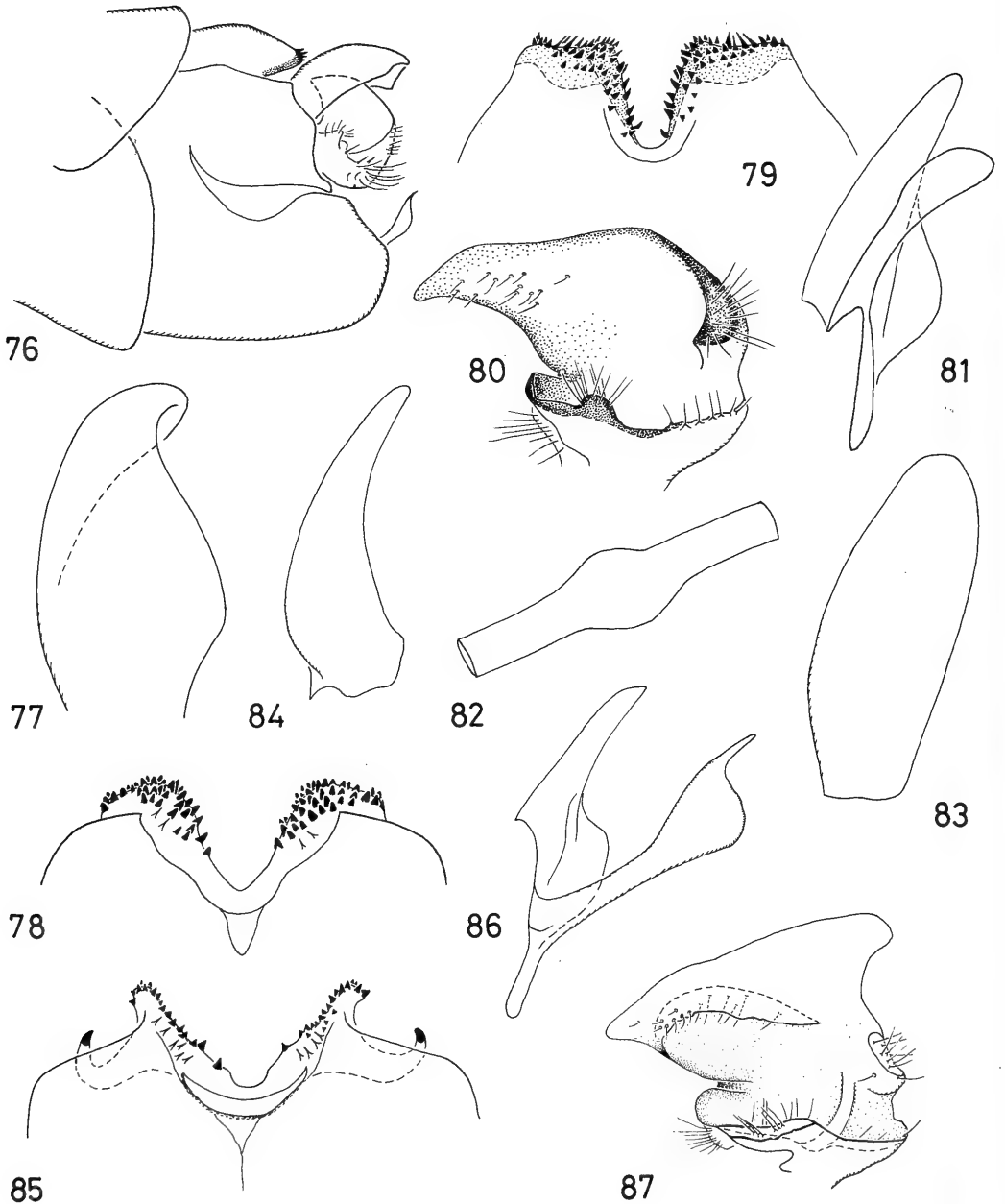

Fig. 76. *N. geminata*. Hypopygium, lateral view. Figs. 77, 78. *N. palloris*. Fig. 77. Left outer dististyle, from outside. Fig. 78. Extension of male tergite 9, dorsal view. Figs. 79—83. *N. bifusca*. Fig. 79. Extension of male tergite 9, dorsal view. Fig. 80. Left inner dististyle, from outside. Fig. 81. Adminiculum and left gonapophysis, lateral view. Fig. 82. Swelling of intromittent organ. Fig. 83. Left outer dististyle, from outside. Figs. 84—87. *N. pallida*. Fig. 84. Left outer dististyle, from outside. Fig. 85. Extension of male tergite 9, dorsal view. Fig. 86. Adminiculum and left gonapophysis, lateral view. Fig. 87. Left inner dististyle, outside view.

blackened; in the female yellowish with the basal nodes of the segments blackened beyond first or second segment.

Thorax. — Pronotum yellowish brown. Lateral thorax pale yellow to yellow, dorsal part of anatergite dark brown. Scutum 1 and 2 pale yellow to yellowish brown between stripes. Scutal stripes dark brown; anterior half of medial stripe of scutum 1 usually paler with a broad brownish yellow mark along mid-line, mark sometimes extending over entire length of stripe; lateral stripes of scutum 1 straight with a large, isolated, rounded or oval, dull black spot below anterior end. A broad dull black seam around antero-lateral corners of scutum 2. Scutellum transparent, yellow to light brown. Mediotergite yellow on antero-medial part, lateral and posterior parts dark brown. Coxae, trochanters and femora light brown, the latter with narrowly darkened tips; tibiae light brown to brown, tips dark brown; tibiae brown to dark brown; male claws toothed. Wings with a light brown tinge, cell c and usually sc dark brown; stigma dark brown with up to 20 macrotrichia; dark coloration of wing margin usually narrowly continued beyond stigma, broadening towards wingtip and reaching vein M2, sometimes even CuA1.

Abdomen. — Brownish yellow with a row of dark brown dorsal and lateral spots. Tergite 1 broadly dark brown dorsally. Tergites 2—7 with elongate dark brown spots which almost reach preceding tergite, spots in the male about as broad as scutellum, in the female somewhat broader, spots sometimes less developed on tergites 5—7. Tergites 2—8 with elongate dark brown spots along lateral margin, almost forming a continuous stripe, especially on the anterior tergites. Sternites yellow, sometimes infuscated, hind margins light yellow.

Hypopygium. — Extension of male tergite 9 widely V-shaped with slender and curved lateral arms (fig. 85). Outer dististyle very narrow (fig. 84). Inner dististyle with a posterior crest (fig. 87). Gonapophyses elongate, the warning-finger-like part usually visible outside hypopygium (fig. 86), but not as distinct as in *geminata* (fig. 76). Hind margin of sternite 8 with a very wide and shallow incision, lined with long golden hairs.

Ovipositor. — Lateral aspect as in fig. 90 and dorsal aspect of hypovalvae as in fig. 92, differing from *palloris* (fig. 93) among others in the shape of the rostral extensions.

Distribution and period of flight. — Known

from the islands Iki, Kyushu and Yakushima only. The species has been collected at the following dates: May 19, 24, 28, August 18, September 30, October 3 and 7.

Etymology. — The name *pallida* has the same meaning as *palloris*, of pale colour. The two species are evidently allopatric sisterspecies.

Nephrotoma palloris (Coquillett, 1898)

(figs. 77, 78, 93)

Pachyrhina palloris Coquillett, 1898: 306. Alexander, 1914: 159, 160.

Nephrotoma palloris; Alexander, 1920: 24. Masaki, 1933a: 90. Ishida 1955: 122. Alexander & Alexander, 1973: 36 (in part).

Pales palloris; Savchenko, 1973: 44, 45.

Pales autumnalis Savchenko, 1973: 106, 107 (**Syn. nov.**)

Nephrotoma autumnalis; Savchenko, 1970: 120, 121 (localities only).

The references by Riedel (1917, 1918) and Alexander & Alexander (1973, in part) apparently refer to *sinensis*, see distribution.

Material examined. — *Nephrotoma palloris*: Holotype ♀, in good condition, flagellar segments lacking, labelled "Japan Mitsukuri" "Type no 3968 USNM" "*Pachyrhina palloris* Coq." (USNM; Mitsukuri is presumably on Honshu). *Nephrotoma autumnalis*: 2♂ 2♀ syntypes from Moneron, Violovich, 23.viii.1956 (1♂) and 26.viii.1956 (1♂ 2♀) (ASL; Savchenko, 1973, described *autumnalis* after 9♂ 8♀ from Moneron and 1♂ from Shikotan, without mentioning type-locality and without designation of a holotype); other material: 5♂ 5♀, Hokkaido; 20♂ 16♀, Honshu; 2♂, Oshima.

Characteristics. — Forming a species group with *geminata*, *bifusca* and *pallida* and closely related to the latter. The species are very similar in coloration. Except *geminata*, they usually have the costal margin of the wing darkened as follows: in *bifusca* cell sc is darkened and in *palloris* and *pallida* cells c and sc; this, however, is not a reliable character to separate the species, while *bifusca* can have both cells dark brown, *palloris* both or sc only or neither of the two and *pallida* only sc. More reliable characters are found in the copulatory organs.

Males: Inner dististyle without crest (figs. 76, 80): *bifusca* and *geminata*. Posterior part of inner dististyle blackened (fig. 80): *bifusca*. Gonapophyses distinctly protruding beyond hypopygium (fig. 76): *geminata*. Inner dististyle with a posterior crest (fig. 87): *palloris* and *pallida*. Outer dististyle broad (fig. 77): *palloris*. Outer

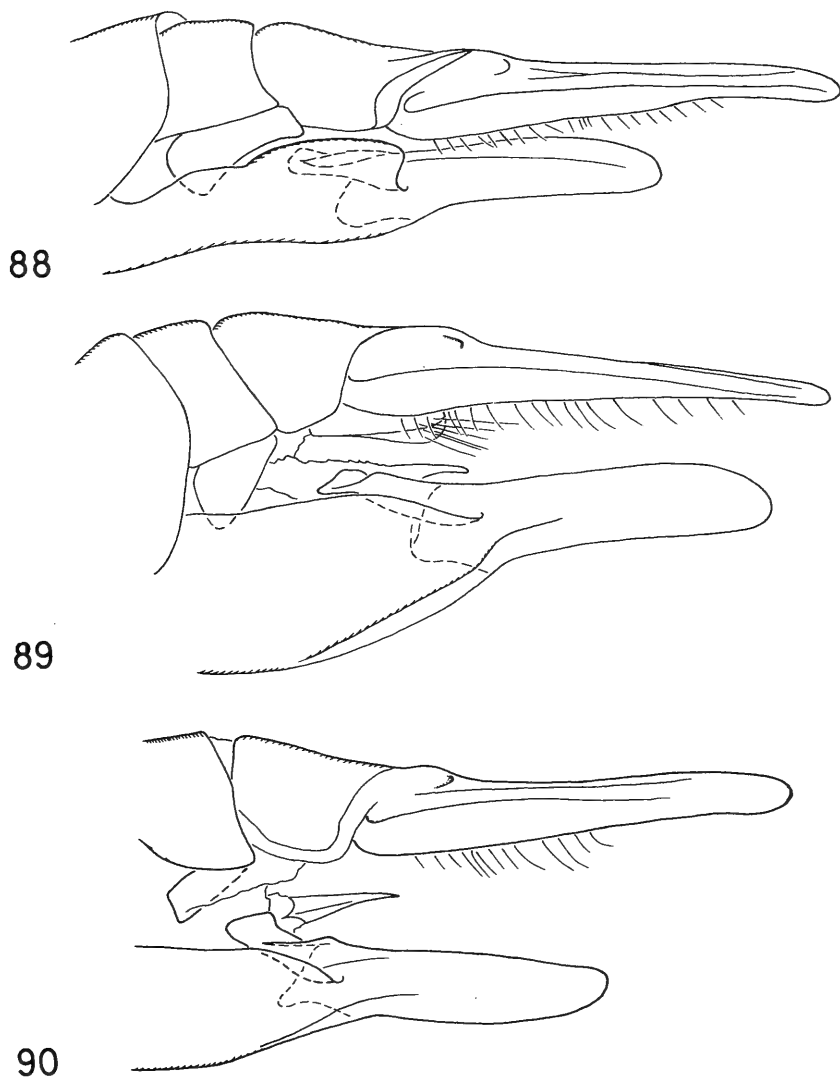

Figs. 88—90. Ovipositor, lateral view. Fig. 88. *N. bifusca*. Fig. 89. *N. geminata*. Fig. 90. *N. pallida*.

dististyle slender (fig. 84): *pallida*.

Females: Dorsal margin of sternite 8 distinctly upcurved before contacting hypovalvae (figs. 88, 91): *bifusca*. Cerci slender (fig. 89): *geminata*. Cerci broad (fig. 90): *palloris* and *pallida*. Rostral extensions of hypovalvae broad (fig. 93): *palloris*. Rostral extensions narrower (fig. 92): *pallida*. The differences in the hypovalvae are the only reliable characters found to separate the females of *palloris* and *pallida*.

Distribution and period of flight. — *N. palloris* is known from the islands Hokkaido,

Honshu and Oshima. Savchenko (1973) described *autumnalis* from the island Moneron near southern Sakhalin and from Shikotan, adding (1970) Kunashir. Riedel (1917, 1918) and Alexander & Alexander (1973) reported *palloris* from Taiwan (Formosa) but these records apparently refer to *sinensis* Edwards. Out of the Riedel collection (IPSFK) Prof. Dr. G. Morge kindly sent me the only *palloris* det. Riedel specimen from Taiwan, which I recognized as *sinensis*.

The species is most abundant in May and ear-

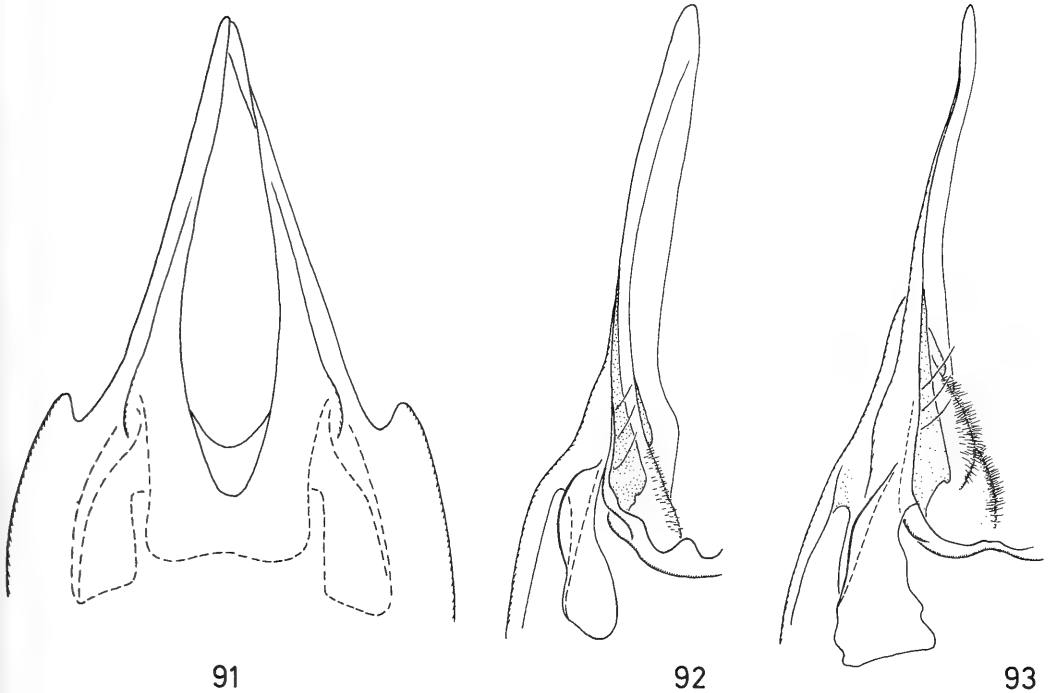

Fig. 91. *N. bifusca*. Female sternite 8 and hypovalvae, ventral view. Figs. 92—93. Right hypovalva, dorsal view. Fig. 92. *N. pallida*. Fig. 93. *N. palloris*.

ly June, but is also frequent in the second half of July until mid-September.

Discussion. — Females of *palloris* and *pallida* can be separated only by internal characters of the hypovalvae. The female holotype of *palloris* (Coquillett) was not investigated by the present author with respect to these characters. Nevertheless it is assumed that *palloris* (Coquillett) is conspecific with *palloris* as presented in this paper and not with *pallida*. The female holotype of *palloris* is labelled “Mitsukuri”, presumably on Honshu, whereas *pallida* is distributed on Kyushu and adjacent smaller islands.

THE CROCATI GROUP

Nephrotoma neoprattensis Alexander, 1921 (figs. 94—99)

Nephrotoma neoprattensis Alexander, 1921: 132, 133.
Alexander, 1925c: 4. Masaki, 1933a: 91. Ishida, 1955: 122.

Pales pullata; Savchenko, 1973: 121—123.

Material examined. — Holotype ♀, in good condition, a wing on slide 1834, specimen la-

belled “Sapporo, Japan May 26, 1916 S. Kuwayama” “Holotype *Nephrotoma neoprattensis* C. P. Alexander” (USNMA); other material: 9♂ 9♀, Hokkaido; 5♂ 5♀, Honshu; 1♂, Shikotan (Misaki, Iyo); 1♂ 1♀, North Korea (Ompo, situated a few miles inland from the coast just South of 42°N); 1♀, South Korea (8 mi SW Kangnung).

Characteristics. — Belongs to the *crocata* subgroup (Oosterbroek, 1980) the species of which have the apex of the adminiculum spined (fig. 97) and possess a spine on the ventral surface of the intromittent organ, usually just in front of the adminiculum, as in *neoprattensis*. *N. neoprattensis* is a large species (body length ♂: up to 16 mm, ♀: up to 20 mm) and mostly resembles *pullata*. The species is characterized as follows. Occipital marking large and rounded with a narrow and short prolongation on tubercle; basally about as broad as prescutum, sometimes narrowly but usually not in contact with the eyes, which are surrounded by yellow. Coxae, abdominal segment 1 and almost entire thorax dusted grey, region below paratergites broadly yellow, as are the parascutella. Scutal

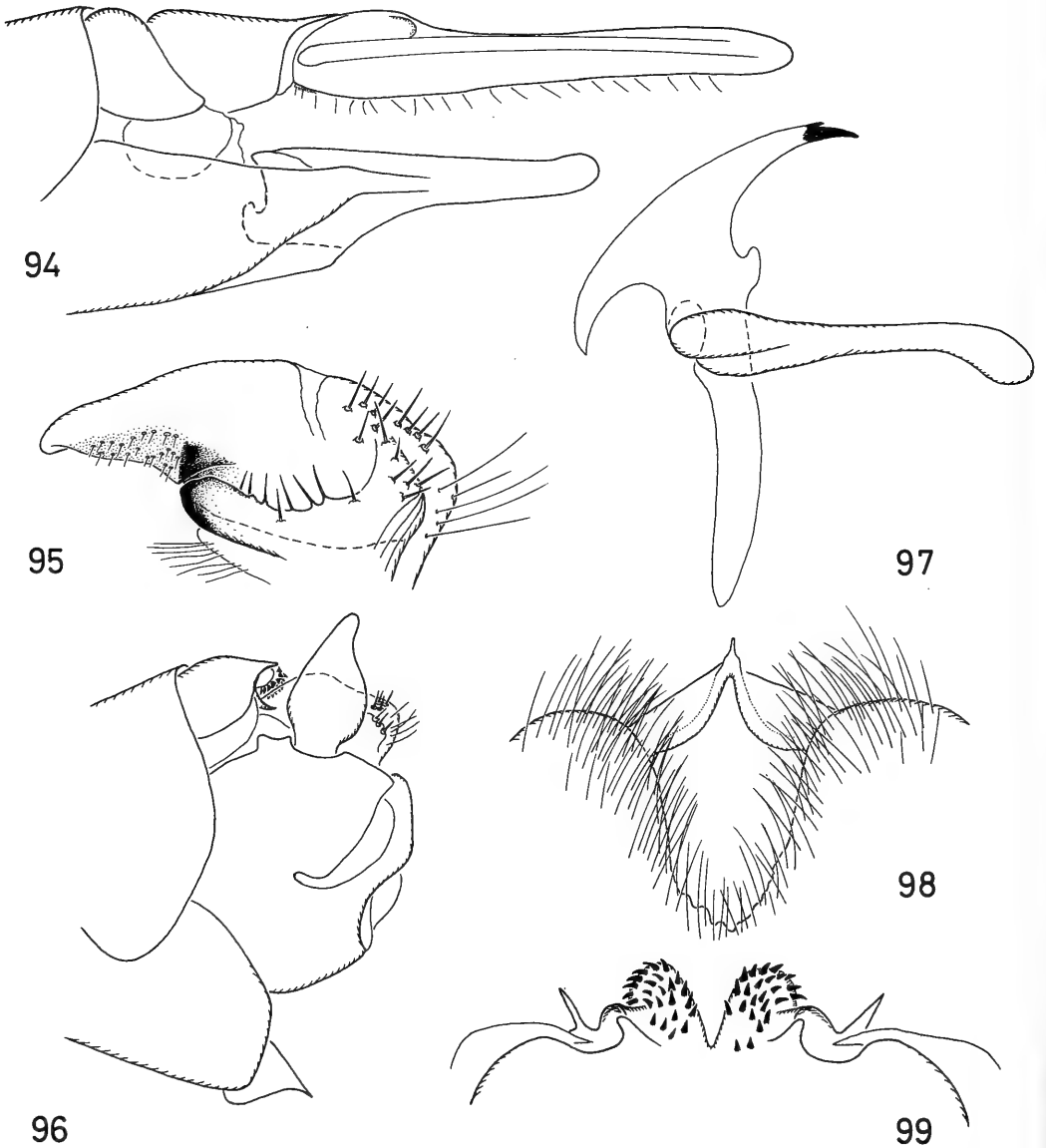

Figs. 94—99. *N. neoprattensis*. Fig. 94. Ovipositor, lateral view. Fig. 95. Left inner dististyle, from outside. Fig. 96. Hypopygium, lateral view. Fig. 97. Adminiculum and left gonapophysis, lateral view. Fig. 98. Medial appendage of male sternite 8, ventral view. Fig. 99. Extension of male tergite 9, dorsal view.

stripes and scutellum blackened, lateral stripes of scutum 1 straight. Abdomen with continuous dorsal and lateral stripes; in the male dorsal stripe about as broad as scutellum, posterior segments and hypopygium blackened and sternites with elongate ventral markings; in the female dorsal stripe broader and individual spots

triangular and along hind margin almost or actually in contact with lateral stripes, sternites with a continuous ventral stripe, segment 8 and tergites 9 and 10 blackened. Male hypopygium as in figs. 95—99, hind margin of sternite 8 with a peculiar shaped medial appendage; ovipositor as in fig. 94.

Distribution and period of flight. — Known from Hokkaido, Honshu, Shikoku (Iyo), South and North Korea. Adults are on the wing during about six weeks, from the end of April until mid-June.

Discussion. — The species is reported by Savchenko (1973) under *pullata*. His *neopratenensis* shows a crest on the inner dististyle and a different colour-pattern and apparently is a not yet described species from Sakhalin.

THE *BREVIENNIS* GROUP

Nephrotoma hirsuticauda Alexander, 1924 (figs. 100—104)

Nephrotoma hirsuticauda Alexander, 1924: 597—599.
Alexander, 1925c: 2, 4. Masaki, 1933a: 91. Ishida, 1955: 121. Savchenko, 1970: 121. Savchenko, Vio-
lovich & Narchuk, 1972: 82.

Pales hirsuticauda; Zinovjev & Savchenko, 1962: 556,
562, 566, 567, 569. Savchenko & Krivolutzkaya,
1966: 46, 56. Savchenko, 1973: 110—112.

Material examined. — Holotype ♂, in good condition, labelled: "Sapporo, Japan July 1921 S. Kuwayama" "Holotype *Nephrotoma hirsuticauda* C. P. Alexander" (USNMA); paratypes: 2♂ 2♀, Sakhalin, Toyohara (= Yuzhno-Sakhalinsk), 20—23.vii.1923 (1♂ 2♀ USNMA, 1♂ BMNH); other material: 1♂ 1♀, Sakhalin (Konusuma; Toyohara = Yuzhno-Sakhalinsk); 4♂ 4♀, Hokkaido; 1♂, Honshu (Tochigi, Nikko); 3♂, Primorskiy kray (Jakovskoye; Kamen Ribolov. Oz. Khanka); 1♀, China (Manchuria, Ha-erh-pin = Charbin).

Characteristics. — *N. hirsuticauda* belongs to the *brevipennis* group, comprising the three species from Madeira (*brevipennis* (Wollaston), *lucida* (Schiner), *antithrix* (Mannheims)), and a number of Nearctic species (*ferruginea* (Fabricius), *abbreviata* (Loew), *suturalis* (Loew), *navajo* Alexander). The group is characterized by the shape of the gonapophyses, of the inner dististyle and of the extension of the male tergite 9. The presence of an oval, serrate membrane at the intromittent organ is known in this group only and is found in the species of Madeira, in *navajo* and in *hirsuticauda*. In general *hirsuticauda* mostly resembles *suturalis*. Males of *hirsuticauda* are easily recognized by the shape of the extension of tergite 9 (fig. 102) and by the tufts of long hairs at sternite 8 (fig. 100).

Females share the following characters. Occipital marking small, triangular, ranging from yellow to dark brown, sometimes with a narrow prolongation on tubercle. Pronotum entirely

yellowish brown. Scutal stripes usually not uniformly coloured but in part dark brown and light or yellowish brown; at least stripes on scutum 2 lighter in the middle; lateral stripes of scutum 1 anteriorly outcurved, outcurved part shining. Scutellum yellow. Mediotergite yellow, posterior part and usually antero-medial part transparent and light brown. Femora and tibiae light brown, tips dark brown. Abdominal tergites 2—7 (8) posteriorly with rounded to oval dorsal spots situated well in front of the hind margins, spots about as large as scutellum; tergites laterally with a continuous dark brown stripe. Cerci and hypovalvae as in fig. 101.

Specimens from the continent are usually much darker coloured (f. *tristis* of Savchenko, 1973), but show no differences in genital characters.

Distribution and period of flight. — *N. hirsuticauda* is known from Krasnoyarskiy kray (Kansk), Irkutskaya oblast, Buryatskaya ASSR, northern Mongolia, Amurskaya oblast, Khabarovskiy kray (Khabarovsk), Primorskiy kray, NE China (Ha-erh-pin), North Korea (Hamgyong nando), Sakhalin, Kunashir, Hokkaido, Honshu (Nikko). The period of flight in Japan and Sakhalin is from mid-June until mid-September, on the continent from mid-May to the end of August.

THE *STYLACANTHA* GROUP

Nephrotoma medioflava spec. nov. (figs. 105—110)

Type-material. — Holotype ♂, in good condition, labelled "Japan Okinawa Shuri 300' 28.ii.1923" "Holotype *Nephrotoma medioflava* P. Oosterbroek" (USNMA); paratypes: 22♂ 6♀, labelled as the holotype except for dates, running from "12.i.1923" to "27.iii.1923" and for "paratype" (17♂ 4♀ USNMA, 5♂ 2♀ ZMA); other material: 1♀, Okinawa, Katsudake, 10.vii.1951 (ZMA); 1♀, Okinawa, Koza, vi.1958 (ZMA).

Characteristics. — As indicated in the key, the transverse yellow spot on the mid-dorsal part of the dorsally brown to dark brown tergite 1 separates this species from all other Japanese species.

Description.

Body length ♂: 11—12 mm, ♀: 14—16 mm; wing length ♂: 11—13 mm, ♀: 12—14 mm.

Head. — Yellowish, dorsal rostrum and vertex more brownish. Occipital marking shining brown, triangular with the base about as broad

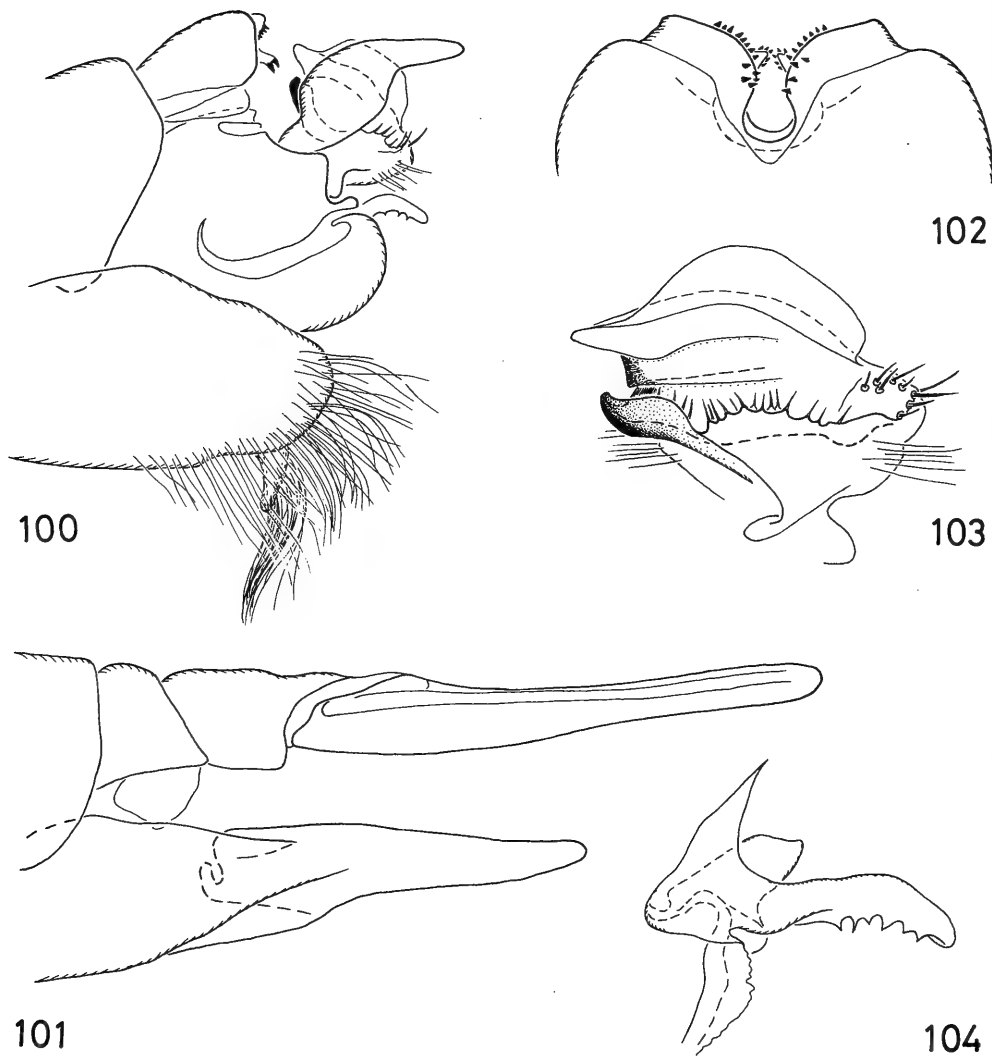

Figs. 100—104. *N. hirsuticauda*. Fig. 100. Hypopygium, lateral view. Fig. 101. Ovipositor, lateral view. Fig. 102. Extension of male tergite 9, dorsal view. Fig. 103. Left inner dististyle, from outside. Fig. 104. Adminiculum and left gonapophyses, lateral view.

as neck and anteriorly reaching halfway tubercle, usually with a narrow, dull brown prolongation to top of tubercle. Between tubercle and eye margin vague brown spots. Antennae 13 segmented; scape and pedicel yellow to light brown; flagellar segments dark brown in the male and distinctly reniform beyond flagel 1; female flagellar segment 1 light brown, following segments light brown to brown with the bases dark brown.

Thorax. — Pronotum dorsally brownish yellow,

lateral brown or in part dark brown coloration continued on coxae 1. Lateral thorax and coxae 2 and 3 yellowish, dorsal part of anatergite dark brown. Dorsal thorax yellow between stripes, sometimes more brownish. Scutal stripes usually not uniformly coloured, ranging from brown to dark brown; medial stripe on scutum 1 usually with a longitudinal, lighter coloured mark on anterior part; lateral stripes on scutum 1 outcurved, the outcurved part shining and usually lighter coloured than stripes

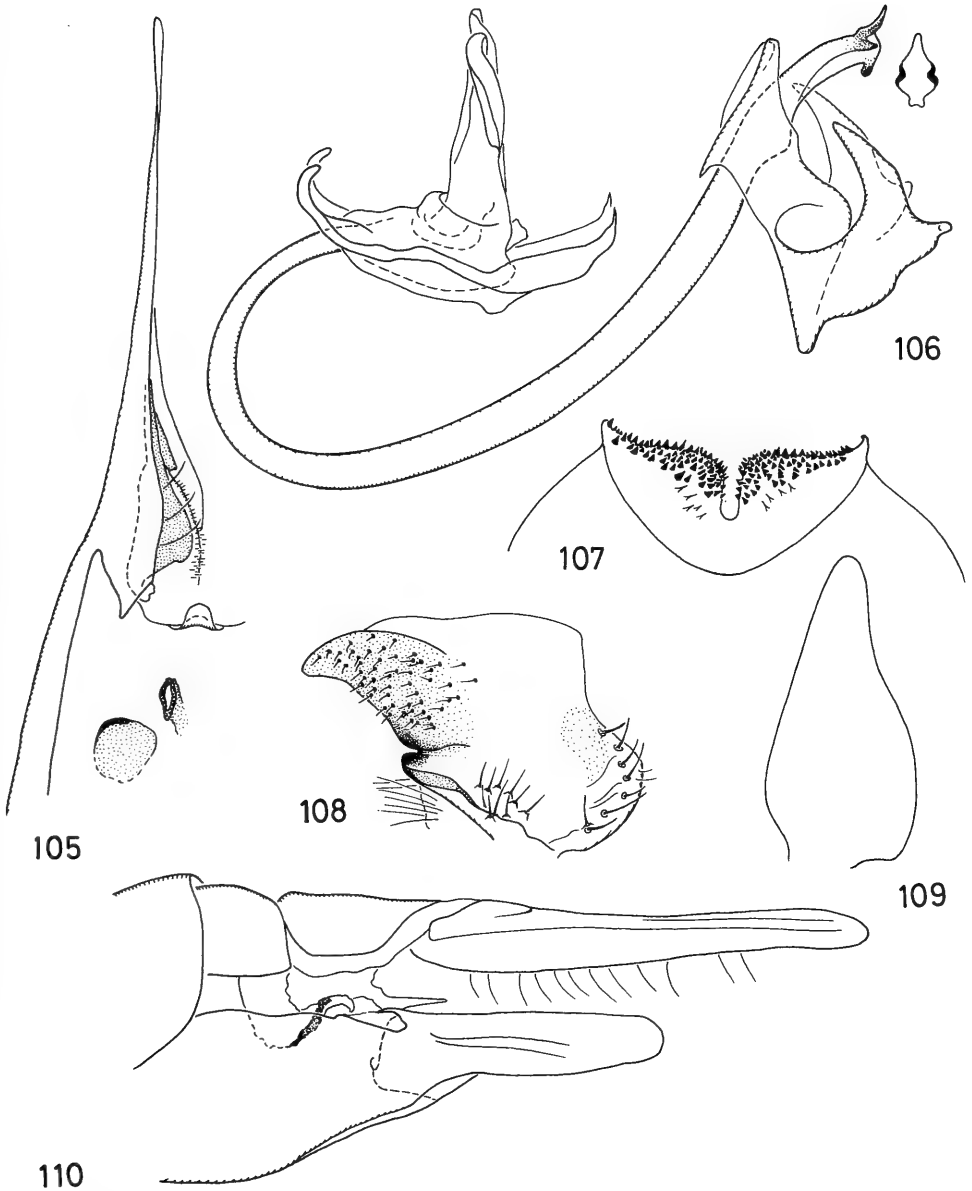

Figs. 105—110. *N. medioflava*. Fig. 105. Right hypovalva, dorsal view. Fig. 106. Semen pump, intromittent organ and adminiculum with gonapophyses, lateral view; top right: rear view of intromittent organ. Fig. 107. Extension of male tergite 9, dorsal view. Fig. 108. Left inner dististyle, from outside. Fig. 109. Left outer dististyle, from outside. Fig. 110. Ovipositor, lateral view.

themselves. Antero-lateral corners of scutum 2 with a dark brown dull seam. Scutellum transparent, yellow to light brown. Mediotergite yellow on antero-medial part, lateral parts brown to dark brown, posterior part ranging from yellow

low to brown. Trochanters brownish yellow; femora basally brownish yellow, growing brown towards apex; tibiae brown; apices of femora and tibiae broadly dark brown; tarsi dark brown; male claws toothed. Wings with a

light brown tinge; stigma distinct, brown to dark brown, with a few or up to 25 macrotrichia; wingtip with a brownish cloud.

Abdomen. — Tergite 1 broadly brown to dark brown with a transverse yellowish spot on the middorsal part, lateral parts pale yellow, hind margin yellow. Tergites 2—6 or 2—7 with a broad brown to dark brown stripe, interrupted on anterior part of tergites, stripe in the male about as broad as scutellum, in the female broader than mediotergite with the individual spots slightly triangular towards hind margin. Tergites 2—6, 2—7 or 2—8 with a dark brown, almost uninterrupted lateral stripe. Male tergite 8 and usually also tergite 7 and sternite 8 largely dark brown; female tergite 8 sometimes largely dark brown.

Hypopygium. — Brownish. Extension of tergite 9 with a small medial incision (fig. 107). Outer dististyle of moderate length (fig. 109). Inner dististyle with a broad anterior beak (fig. 108). Intromittent organ short and robust with the apex differentiated (fig. 106). Gonapophyses upcurved with short posteriorly directed processes (fig. 106). Hind margin of sternite 8 straight, unmodified.

Ovipositor. — Lateral aspect as in fig. 110, dorsal aspect of hypovalvae as in fig. 105, with short rostral extensions and two sclerotized parts on each side in front of hypovalvae.

Distribution and period of flight. — Known from Okinawa only and apparently on the wing from January to July.

Discussion. — *N. medioflava* is related to *stylacantha* Alexander, known from the Chinese provinces Fukien and Kiangsu. They share the following characters. Transverse and yellow dorsal spot on tergite 1, extension of male tergite 9 very similar, intromittent organ short and thick and apically modified. The inner dististyle of *stylacantha* as well as the gonapophyses are very different.

Etymology. — The name *medioflava* refers to the yellow mark on the first abdominal tergite.

THE REPANDA GROUP

Nephrotoma repanda (Alexander, 1914) (figs. 111—114)

Pachyrhina repanda Alexander, 1914: 162, 163.

Nephrotoma repanda; Masaki, 1933a: 90. Alexander, 1954: 277, 278. Ishida, 1955: 123. Savchenko, 1970: 121.

Pales repanda; Savchenko & Krivolutzkaya, 1966: 46, 56. Savchenko, 1973: 62—64.

Nephrotoma grahamiana Alexander, 1940b: 403—405 (hypopygium = fig. 46, not 45). (Syn. nov.)
Pales grahamiana; Savchenko, 1973: 62.

Material examined. — Holotype ♂ of *repanda*, three slides with one wing, left inner and outer dististyle and abdominal end, labelled "Holotype 830 *Nephrotoma repanda* (Alex.) ♂ Tokyo, Japan Aug. 1912 (Ex Kuwana) 830" (USNM, the type-specimen was not found). Holotype ♂ of *grahamiana*, in good condition, labelled "W. China Omei Shuang Fei Chiao 3000' vi—14.35 Graham" "Holotype ♂ *Nephrotoma grahamiana* C. P. Alexander" (USNM); paratypes: 4♂ para(topo)types with dates from 14—22.vi.1935 (2♂ complete USNM, 1♂ USNM with slide USNMA, 1♂ slide only USNMA); other material: 4♀, Hokkaido (Ishikari; Tokachi); 4♂ 3♀, Honshu; 2♂ 1♀, Kyushu (Oita; Kujusan; Kumamoto); 6♂ 2♀, Shikoku: 2♀, Sado; 1♂, Tsushima (Mt Ariake); 1♂, Primorskiy kray (Wladiwostok); 1♂, North Korea (Ompo, situated a few miles inland from the coast just South of 42°N); 4♀, South Korea (16 & 18 mi NE and 6 mi E of Seoul); 5♂, China (Szechwan: Pehlütung and Mt Omei).

Characteristics. — *N. repanda* is closely related to *dutti* Alexander, 1963 (= *condylophora* Alexander, 1970) from the southern Himalayas (Murree; Darjeeling; Bomdila). The species is characterized by the yellow thorax with only the scutal stripes dark brown; the medial stripe on scutum 1 and the stripes on scutum 2 have the posterior ends dull. Head largely yellow, dark brown coloration of dorsal rostrum, of spots on either side of tubercle and of small triangular occipital marking variable in expression. Male tergites 2—6 sometimes with a vague dorsal stripe about as broad as scutellum and sometimes infuscated along lateral margin; tergite 7 or segment 7, segment 8 and hypopygium largely dark brown. Hypopygium, extension of tergite 9 and inner dististyle as in figs. 111—113, the hind margin of sternite 8 with a small medial incision covered by a membrane, sides of incision and membrane covered with longer white hairs. Apex of intromittent organ bifid. Female abdomen with a dark brown dorsal stripe on tergites 2—7, about as broad as scutellum or mediotergite and interrupted in front of hind margin of tergites, lateral margin of tergites usually infuscated or with a dark brown lateral stripe along the margins. Tergite 8 and basal part of sternite 8 darkened, apical part of

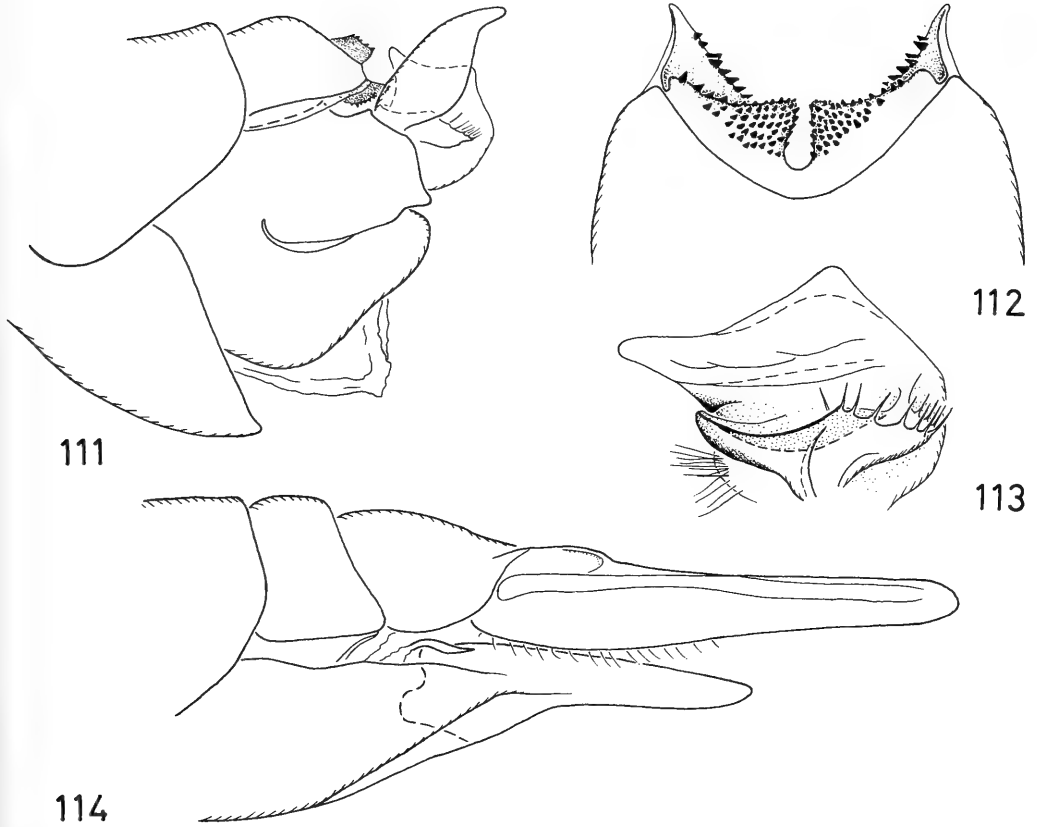

Figs. 111—114. *N. repanda*. Fig. 111. Hypopygium, lateral view. Fig. 112. Extension of male tergite 9, dorsal view. Fig. 113. Left inner dististyle, from outside. Fig. 114. Ovipositor, lateral view.

sternite 8 with large and oval dark brown spots. Cerci relatively short and broad, hypovalvae slender (fig. 114).

Distribution and period of flight. — Known from Kunashir, Hokkaido, Honshu, Sado, Kyushu, Shikotan, Tsushima, southern Primorye, North and South Korea and China (Szechwan). Altitudes in Japan are up to 1200 m, in China up to 2000 m. The period of flight is from the end of May until early August.

THE VIRGATA GROUP

Nephrotoma virgata (Coquillett, 1898) (figs. 115—118)

Pachyrhina virgata Coquillett, 1898: 306. Alexander, 1914: 163, 164.

Nephrotoma virgata; Alexander, 1920: 22, 23. Alexander, 1925c: 20. Esaki, 1932: 148. Masaki, 1933a: 90. Alexander, 1953c: 149, 150. Ishida, 1955: 124

(in part). Alexander & Alexander, 1973: 38 (in part).

Pales virgata; Savchenko, 1973: 51—53.

Nephrotoma decrepita Alexander, 1935a: 140—142. (Syn. nov.)

Pales decrepita; Savchenko, 1973: 53.

Limnophila japonica Esaki, 1957: 1532 (synonymy after Alexander, 1953c).

Pachyrhina serricornis; Brunetti, 1912: 343 (Japanese records only).

The records from Taiwan (Formosa) by Edwards (1916), Riedel (1917), Brunetti (1918, 1920), Ishida (1955) and Alexander & Alexander (1973) probably refer to different species, see under distribution.

Material examined. — Holotype ♂ of *virgata*, in good condition, labelled: "Japan Mitsukuri" "Type no. 3967 U.S.N.M." "*Pachyrhina virgata* Coq." (USNM; Mitsukuri presumably lies on Honshu). Holotype ♂ of *decrepita*, in fair

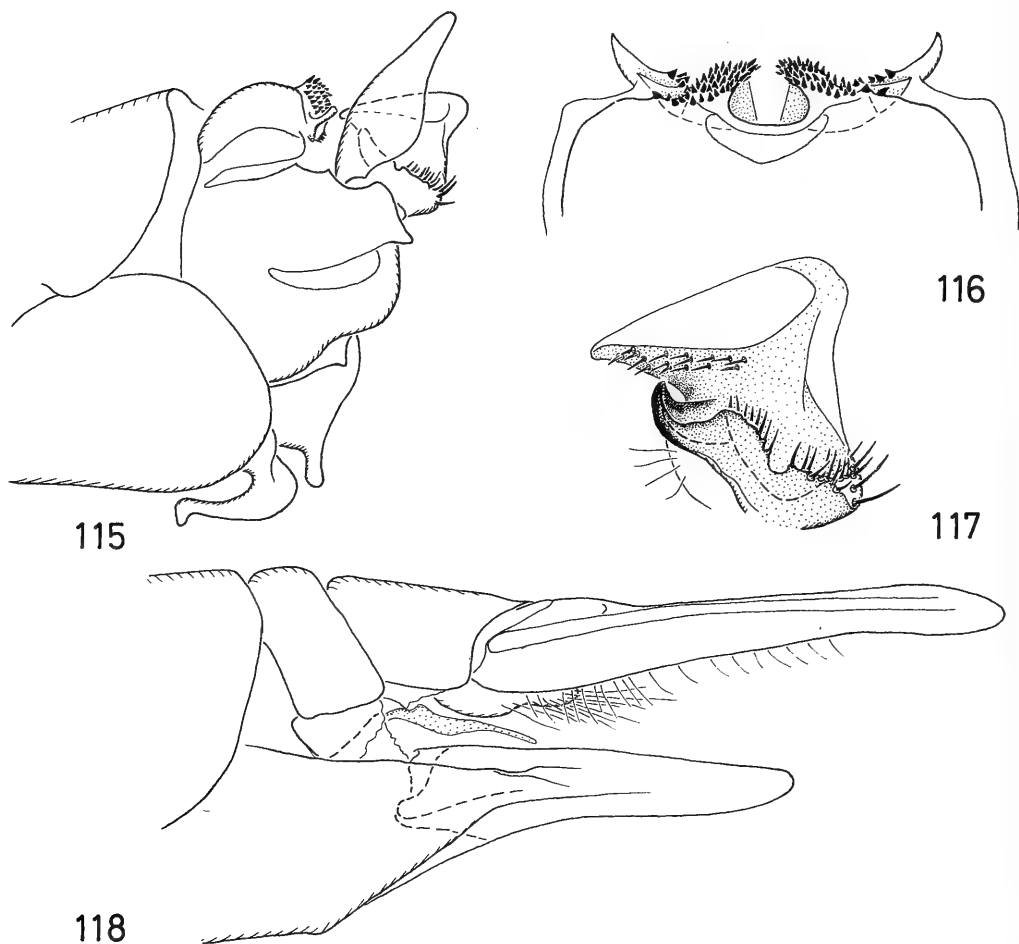

Figs. 115—118. *N. virgata*. Fig. 115. Hypopygium, lateral view. Fig. 116. Extension of male tergite 9, dorsal view. Fig. 117. Left inner dististyle, from outside. Fig. 118. Ovipositor, lateral view.

condition, abdominal end and one wing on slide 5736, specimen labelled: "Mt Omei Szechwan China 4500 ft aug. 15, '29" "Holotype *Nephrotoma decrepita* C. P. Alexander" (USNMA); other material: 20♂ 21♀, Hokkaido; 49♂ 49♀, Honshu; 7♂ 7♀, Shikoku; 15♂ 9♀, Kyushu; 1♀, Sado; 1♂, Tsushima; 1♀, Oshima; 1♂ 1♀, Amami; 1♂, North Korea (Puksu Pyaksan in Kankyo Nando, the second highest peak in Korea, appr. 40°40' N 127°45' E; 2♂ 7♀, South Korea (Ch'unch'ön; 16, 18 & 20 mi NE and 6 mi E of Seoul); 3♂ 9♀, China (Lichuan, Hupeh; Chungching, Mt Omei, Szechwan).

Characteristics. — *N. virgata* males can be easily recognized by the shape of the extension of tergite 9 (fig. 116), of the inner dististyle (fig.

117), and by the backtolded appendage at sternite 8 (fig. 115). Females have the cerci broad and with the blunt ending apical part slightly downcurved (fig. 118). Both sexes have a small occipital marking and the lateral stripes on scutum 1 are usually somewhat outcurved anteriorly, the outcurved part ranges from dull to almost as shining as stripes themselves. The abdominal tergites bear brown to dark brown dorsal markings, the expression of the markings is very variable, ranging from almost absent to occupying the largest part of the tergite but in all instances the hind margins of the tergites are broadly yellow, especially on tergites 2—6; lateral and ventral markings are absent and the abdominal end is not darkened. The species is

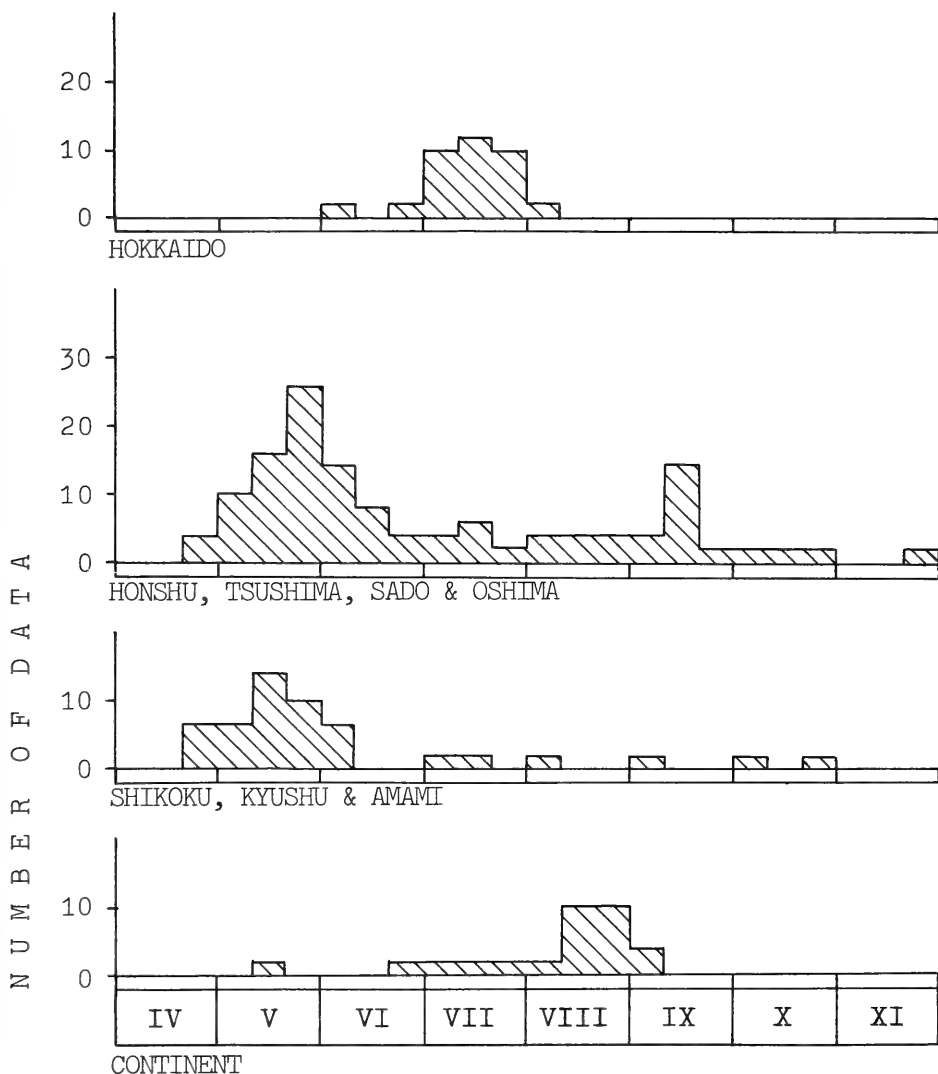

Diagram 1. Period of flight of *N. virgata*. Months divided into periods of 10 days. Number of data relates to number of samples, not to number of specimens.

not closely related to any of the other Japanese species but more to species found in central and southeast Asia (f.e. *consimilis* Brunetti, 1911; *scurroides* de Meijere, 1904).

Distribution and period of flight. — The species is known from the Japanese islands Hokkaido, Honshu, Tsushima, Sado, Oshima, Shikoku, Kyushu and Amami. It is recorded from the eastern USSR by Alexander (1925c) and Savchenko (1973; Khasan, Wladiwostok, Primorskiy kray); Alexander (1925c) also men-

tions Kudia river, Amagu, which could not be traced, and Okeanskaya, a doubtful record as it is South of Kamchatka, far outside the presently known range of *virgata*. During this study material was examined from North Korea and South Korea, other Korean localities are mentioned by Masaki (1933a), but these are doubtful, the figures of *virgata* from Korea in Masaki (1933b) refer to a species of the *dorsalis* group. Material was also examined from China (W Hupah; Szechwan). Out of the Riedel collection

(IPSFK) Prof. Dr. G. Morge kindly sent one specimen det. *virgata* by Riedel from Taiwan. The specimen was identified by me as *definata* Alexander, 1935. In spite of all the records from Taiwan it is most probable that *virgata* does not occur on the island. Other records of *virgata* in SE Asia are based on the synonymy by Edwards (1927) of *scurroides* de Meijere, 1904, with *virgata*, but *scurroides* is a valid species (types in ZMA). Recorded altitudes are up to 2000 m. The period of flight throughout the distribution range is given in diagram 1; on Hokkaido the flight-period is short, June and most frequently July; on the other islands the species is most frequent in spring but adults can be found during quite long a period, from the end of April until the end of October or November; on the continent adults are on the wing from mid-May until early September and are most frequent in August.

THE *SINENSIS* GROUP

Nephrotoma sinensis (Edwards, 1916)

This species is recorded from Japan by Esaki (1932), Masaki (1933a), Alexander (1953a, 1953c) and Savchenko (1973). During this study no *sinensis* material from Japan was encountered. It is almost certain that the above-mentioned records refer to species of the *palloris* group. As in *sinensis*, some members of this group have the costal margin of the wing darkened.

THE *DORSALIS* GROUP

The following species belong to the *dorsalis* group, and are discussed and figured in very detail by Tangelder (1984).

Nephrotoma electripennis Alexander, 1953 (figs. 123, 124)

Endemic to Japan (Shikoku, Kyushu); period of flight: mid-May until mid-June (Tangelder, 1984: 32, 33, figs. 44—56, map 2).

Nephrotoma nigricauda Alexander, 1925 (figs. 121, 122)

Endemic to Japan (Hokkaido, Honshu) and the Kurile (Kunashir); period of flight: mid-May until the end of July (Tangelder, 1984: 33—36, figs. 57—68, map 2).

Nephrotoma minuticornis Alexander, 1921 (fig. 119)

Sugarbeet crane-fly (see p. 236)

Distributed from southern Sakhalin to Kyushu and Shikoku; period of flight: the end of May until early October (Tangelder, 1984: 66—70, figs. 201—210, map 8).

Nephrotoma sachalina Alexander, 1924 (fig. 120)

Distribution: southern Kamchatka, southern Sakhalin, the Kurile and Hokkaido; period of flight: mid-June until the end of August (Tangelder, 1984: 45—48, figs. 88, 101, 103—112, map 4).

Nephrotoma difficilis Tangelder, 1984 (figs. 126, 128, 130, 131)

Distributed from central Asia (Krasnoyarsk and Tuva regions) to southern Primorye, North Korea, southern Sakhalin and Hokkaido; period of flight: mid-June until mid-August (Tangelder, 1984: 53—57, figs. 124, 134, 137—148, map 5).

Nephrotoma angustistria Alexander, 1925 (figs. 127, 129, 132)

Endemic to Japan (Hokkaido, Honshu); period of flight: mid-May until early September (Tangelder, 1984: 59—61, figs. 126, 136, 161—169, map 5).

Nephrotoma cirrata Tangelder, 1984 (fig. 133)

Endemic to Japan (Hokkaido); recorded from June 25/26 and July 6 and 12 (Tangelder, 1984: 61—63, figs. 170, 172—181, map 6).

Nephrotoma gaganboi Tangelder, 1984 (fig. 134)

Endemic to Japan (Honshu); recorded from June 30 only (Tangelder, 1984: 63, 64, figs. 182—189, map 6).

Nephrotoma microcera Alexander, 1921 (fig. 125)

Known from Japan (Hokkaido, Honshu) and South Korea (18 mi NE Seoul); period of flight: mid-May until the end of September (Tangelder, 1984: 64—66, figs. 171, 190—200, map 7).

ACKNOWLEDGEMENTS

Large amounts of unidentified and fairly recently collected specimens were made available through the kindness of K. Kanmiya (Biological Laboratory, Department of General Education, School of Medicine, Kurume University) and T. Saigusa (Biological Laboratory, College of Gen-

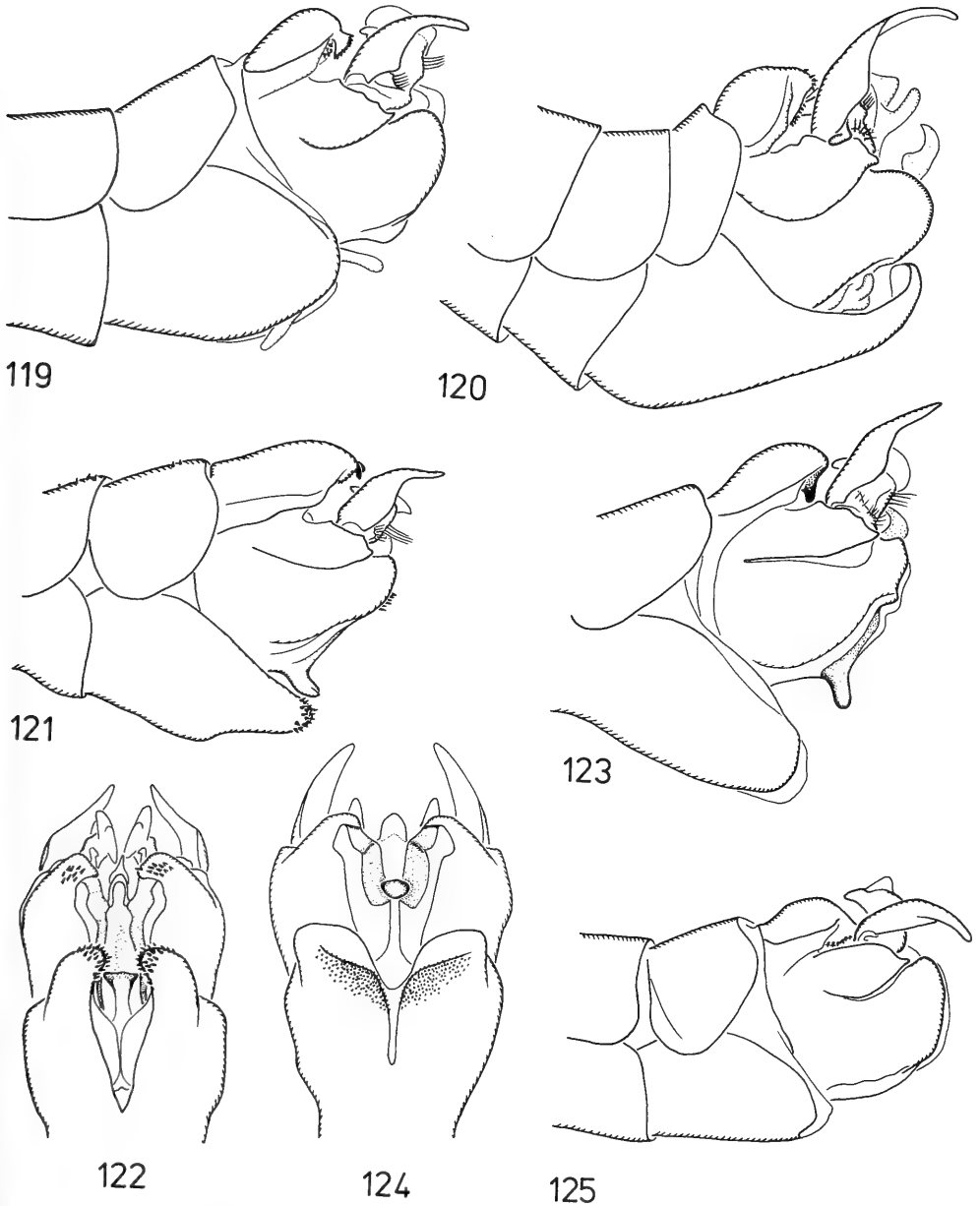

Figs. 119—121, 123, 125. Hypopygium, lateral view. Fig. 119. *N. minuticornis*. Fig. 120. *N. sachalina*. Fig. 121. *N. nigricauda*. Fig. 123. *N. electripennis*. Fig. 125. *N. microcera*. Figs. 122, 124. Hypopygium, ventral view. Fig. 122. *N. nigricauda*. Fig. 124. *N. electripennis*. (With kind permission redrawn from Tangelder, 1984, Beaufortia, 34)

eral Education, Kyushu University). These shipments included material of the new (sub)species *vana vana*, *vana nigrovana* and *pallida*, contained a number of rare species, sev-

eral of which were known from the types only, and added much to our knowledge of the distribution of the species.

The most important C. P. Alexander collec-

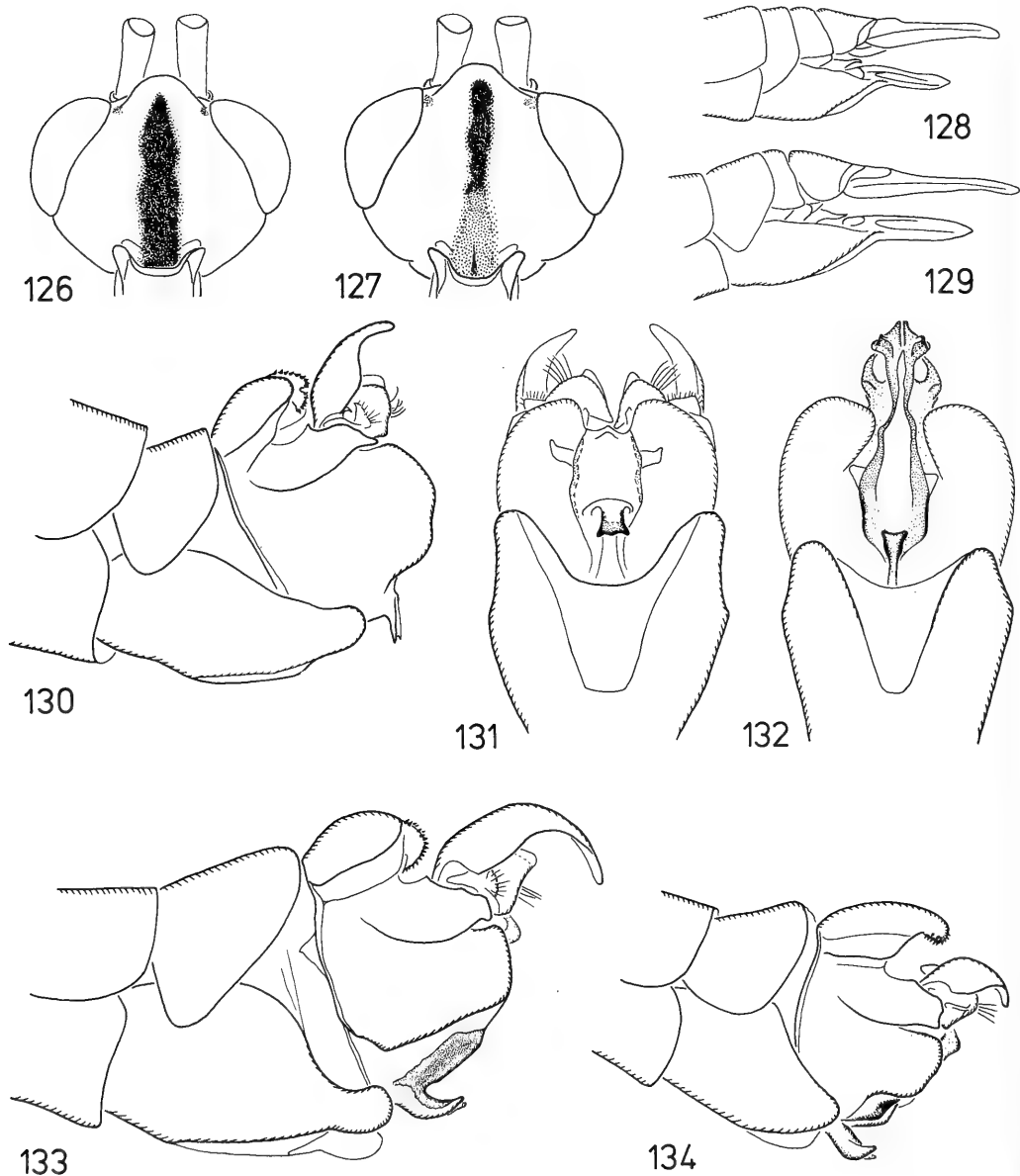

Figs. 126, 127. Head, dorsal view. Fig. 126. *N. difficilis*. Fig. 127. *N. angustistria*. Figs. 128, 129. Ovipositor, lateral view. Fig. 128. *N. difficilis*. Fig. 129. *N. angustistria*. Figs. 130—134. Hypopygium. Fig. 130. *N. difficilis*, lateral view. Fig. 131. *N. difficilis*, ventral view. Fig. 132. *N. angustistria*, ventral view. Fig. 133. *N. cirrata*, lateral view. Fig. 134. *N. gaganboi*, lateral view. (With kind permission redrawn from Tangelder, 1984, Beaufortia 34)

tion could be studied through the generous cooperation of W. N. Mathis (National Museum of Natural History, Smithsonian Institution, Washington, D.C.).

REFERENCES

- Alexander, C. P., 1913—1914. Report on a collection of Japanese crane-flies (Tipulidae) with a key to the species of *Ptychoptera*. — Can. Ent. 45 (1913):

- 197—210, 285—295, 313—322; 46 (1914): 157—164, 205, 211, 236—242.
- Alexander, C. P., 1920. New or little-known crane-flies from Japan (Tipulidae, Diptera). — *Trans. Amer. Ent. Soc.* 46: 1—26.
- Alexander, C. P., 1921. Undescribed species of Japanese crane-flies (Tipulidae, Diptera). Part II. — *Ann. Ent. Soc. Amer.* 14: 111—134.
- Alexander, C. P., 1924. New or little-known crane-flies from northern Japan (Tipulidae, Diptera). — *Philip. J. Sci.* 24: 531—611.
- Alexander, C. P., 1925a. Undescribed species of Japanese crane-flies. Part V. — *Ann. Ent. Soc. Amer.* 17: 431—448.
- Alexander, C. P., 1925b. New or little-known Tipulidae (Diptera). XXVII. Palaearctic species. — *Ann. Mag. Nat. Hist.* (9) 15: 385—408.
- Alexander, C. P., 1925c. Crane-flies from the Maritime Province of Siberia (on the insect fauna of the Maritime Province of Siberia). — *Proc. U.S. Nat. Mus.* 68 (4): 1—21.
- Alexander, C. P., 1927. Entomologische Ergebnisse der Schwedischen Kamchatka-Expedition. 1920—1922. Part 12. Tipulidae. — *Arkiv för Zoologi* 19A (9): 1—10.
- Alexander, C. P., 1931. New or little-known Tipulidae from eastern Asia (Diptera). IX. — *Philip. J. Sci.* 44: 339—368.
- Alexander, C. P., 1935a. New or little-known Tipulidae from eastern Asia (Diptera). XXV. — *Philip. J. Sci.* 57: 81—148.
- Alexander, C. P., 1935b. New or little-known Tipulidae from eastern Asia (Diptera). XXVII. — *Philip. J. Sci.* 58: 213—252.
- Alexander, C. P., 1940a. Studies on the Tipulidae of China (Diptera). IV. New or little-known crane-flies from Tien-mu-shan, Chekiang (cont.). — *Lingnan Sci. J.* 19: 121—132.
- Alexander, C. P., 1940b. New or little-known Tipulidae from eastern Asia (Diptera). XLIII. — *Philip. J. Sci.* 73: 375—420.
- Alexander, C. P., 1945. Undescribed species of crane-flies from northern Korea (Diptera, Tipuloidea). — *Trans. R. Ent. Soc. London* 95: 227—246.
- Alexander, C. P., 1953a. The insect fauna of Mt. Ishizuchi and Omogo Valley, Iyo, Japan. The Tipulidae (Diptera). — *Trans. Shikoku Ent. Soc.* 3: 71—83.
- Alexander, C. P., 1953b. Records and descriptions of Japanese Tipulidae (Diptera). Part I. The crane-flies of Shikoku, I. — *Philip. J. Sci.* 82: 21—75.
- Alexander, C. P., 1953c. Records and descriptions of Japanese Tipulidae (Diptera). Part II. The crane-flies of Shikoku, II. — *Philip. J. Sci.* 82: 141—179.
- Alexander, C. P., 1953d. Records and descriptions of Japanese Tipulidae (Diptera). Part III. The crane-flies of Shikoku, III. — *Philip. J. Sci.* 82: 263—308.
- Alexander, C. P., 1954. Records and descriptions of Japanese Tipulidae (Diptera). Part IV. The crane-flies of Shikoku, IV. — *Philip. J. Sci.* 83: 263—306.
- Alexander, C. P., 1955. Undescribed species of Japanese crane-flies (Diptera: Tipulidae). Part VIII. — *Ann. Ent. Soc. Amer.* 48: 364—374.
- Alexander, C. P., 1963. Some Tipulidae from Tibet and upper Burma in the British Museum (Natural History) (Diptera). — *Bull. British Mus. (Nat. Hist.)*, Ent. 14 (7): 319—340.
- Alexander, C. P., 1966. The crane-fly fauna of the southern Kuriles (Tipulidae, Diptera). — *Mushi* 39 (11): 119—126.
- Alexander, C. P., 1970. New or little-known species of Asiatic Tipulidae (Diptera). III. — *Trans. Amer. Ent. Soc.* 96: 307—352.
- Alexander, C. P. & M. M. Alexander, 1973. Tipulidae. In: Delfinado, M. D. & D. E. Hardy (Eds.), *A Catalog of the Diptera of the Oriental region*, 1: 10—224. — Honolulu.
- Brunetti, E., 1911. New Oriental Nemocera. — *Rec. Indian Mus.* 4: 259—316.
- Brunetti, E., 1912. Diptera Nematocera (excluding Chironomidae and Culicidae). In: Shipley, A. E. (Ed.), *The fauna of British India, including Ceylon and Burma*, 581 pp., 44 figs., 12 pls. — London.
- Brunetti, E., 1918. Revision of the Oriental Tipulidae with descriptions of new species, 2. — *Rec. Indian Mus.* 15: 255—344.
- Brunetti, E., 1920. Catalogue of Oriental and South Asiatic Nemocera. — *Rec. Indian Mus.* 17: 1—300.
- Coquillett, D. W., 1898. Report on a collection of Japanese Diptera, presented to the U.S. National Museum by the Imperial University of Tokyo. — *U.S. Natl. Mus. Proc.* 21: 301—340.
- Edwards, F. W., 1916. New or little-known Tipulidae, chiefly from Formosa. — *Ann. Mag. Nat. Hist.* (8) 18: 245—269.
- Edwards, F. W., 1927. Diptera Nematocera from the Dutch East Indies. — *Treubia* 9: 352—370.
- Esaki, T., 1932. Diptera. In: *Iconographia Insectorum Japonicorum* (first ed.), 7—249. — Tokyo (in Japanese).
- Esaki, T., 1957. Tipulidae. In: *Iconographia Insectorum Japonicorum* (2nd ed.), 1528—1537. — Tokyo (in Japanese).
- Ishida, H., 1955. The catalogue of the Japanese Tipulidae, with the keys to the genera and subgenera. I. Tipulinae (part). — *Ann. Rep. Hyogo Agric. Coll. (Kenkyu Shuroku)* 4: 106—135.
- Ishida, H., 1956. Idem. II. *Tipula* (part) and *Cylindrotominae*. — *Idem* 5: 59—77.
- Ishida, H., 1957. Idem. III. Limoniinae, Tribe Limoniini. — *Idem* 5: 122—149.
- Ishida, H., 1958. Idem. IV. Limoniinae, Tribe Pedicini. — *Sci. Rep. Hyogo Univ. Agric.* 3, Series Natural Sciences: 37—42.
- Ishida, H., 1959. Idem. V. Limoniinae, Tribe Hexatomiini. — *Idem* 4: 3—11.

- Ishida, H., 1960. Idem. VI. Limoniinae, Tribe Eriopterini (1). — Idem 4: 27—34.
- Ishida, H., 1961. Idem. VII. Limoniinae, Tribe Eriopterini (2). — Idem 5: 1—8 (including a supplement to the Tipulidae).
- Ishida, H., 1965. The check-list of the Japanese Tipulidae (Diptera). — Private publication, i-iii, 1—43.
- Kuwayama, S., 1926. A list of the insects injurious to agricultural and horticultural plants in Hokkaido. — Bull. Hokkaido Agric. Expt. Sta. 42: 73 (in Japanese).
- Linnaeus, C., 1758. Systema naturae per regna tria naturae. Ed. 10, Vol. 1, 824 pp. — Holmiae (= Stockholm).
- Loew, H., 1871. Beschreibung europäischer Dipteren. Systematische Beschreibung der bekannten europäischen zweiflügeligen Insekten, von Johann Wilhelm Meigen, 2: Neunter Theil oder dritter Supplementband, 319 pp. — Halle.
- Mannheims, B. & E. N. Savchenko, 1967. 105. Tipulidae. Ergebnisse der zoologischen Forschungen von Dr. Z. Kaszab in der Mongolei (Diptera). — Reichenbachia 9: 147—156.
- Masaki, J., 1933a. On the Tipulinae of the Japanese Empire. — Mushi 6: 74—95.
- Masaki, J. 1933b. Notes sur les Coréen Tipulidae. — Tottori nogakkaiho (= Trans. Tottori Soc. Agric. Sciences) 4: 368—386, 2 pls. (in Japanese).
- Meijere, J. C. H. de, 1904. Neue und bekannte südasiatischen Dipteren. — Bijdr. Dierk. 17—18: 85—115.
- Oosterbroek, P., 1978. The western palaeartic species of *Nephrotoma* Meigen, 1803 (Diptera, Tipulidae). Part 1. — Beaufortia 27: 1—137.
- Oosterbroek, P., 1979a. Idem. Part 2. — Beaufortia 28: 57—111.
- Oosterbroek, P., 1979b. Idem. Part 3. — Beaufortia 28: 157—203.
- Oosterbroek, P., 1979c. Idem. Part 4, including a key to the species. — Beaufortia 29: 129—197.
- Oosterbroek, P., 1980. Idem. Part 5, Phylogeny and Biogeography. — Beaufortia 29: 311—393.
- Oosterbroek, P., 1984. A revision of the crane-fly genus *Nephrotoma* Meigen, 1803, in North America (Diptera, Tipulidae). Part II: the non-*dorsalis* species-groups. — Beaufortia 34: 117—180.
- Oosterbroek, P. & R. Schuckard, 1976. A world check-list of *Nephrotoma* Meigen, 1803 (Diptera, Tipulidae). — Versl. techn. Geg. Inst. Taxon. Zool. Amsterdam 9: 1—35.
- Oosterbroek, P., R. Schuckard & Br. Theowald, 1976. Die *Nephrotoma*-Verbreitung in der Welt (Diptera, Tipulidae). — Bull. Zool. Mus. Univ. Amsterdam 5: 111—123.
- Riedel, M. P., 1910. Die paläarktischen Arten der Dipteren (Nematocera polyneura) Gattung *Pachyrbina* Macq. Suit à Buff. (1834). — Deutsch. ent. Z. 1910: 409—437.
- Riedel, M. P., 1917. Sauter's Formosa-Ausbeute: Nematocera Polyneura (Dipt.), III. — Arch. Naturg. 82(A): 109—116.
- Riedel, M. P., 1918. H. Sauter's Formosa-Ausbeute: Liriopidae (Ptychopteridae) und Nematocera Polyneura (Dipt.), IV. — Ann. Mus. Nat. Hung. 16: 315—320.
- Savchenko, E. N., 1966. Two new eastpalaeartic species of *Nephrotoma* Meig. (Diptera, Tipulidae). — Bonn. Zool. Beitr. 3/4: 260—264.
- Savchenko, E. N., 1970. Additions to the fauna of crane-flies (Diptera, Tipulidae) of the southern Kuriles. — Ent. Obozr. 49: 108—123 (in Russian with English summary).
- Savchenko, E. N., 1973. Tipulidae. — Fauna SSSR, (n.s.), 105 (Diptera, 2) (5): 1—281 (in Russian, date of manuscript: 1965).
- Savchenko, E. N., 1981. A species of the genus *Nephrotoma* new for the fauna of the SSSR. — Vestnik Zool. 3: 77 (in Russian).
- Savchenko, E. N. & G. O. Krivolutzkaya, 1966. On the crane-flies (Diptera, Tipulidae) of the Kuril Islands. — Entomofauna Lesow, Moscow, 1966: 45—58 (in Russian).
- Savchenko, E. N., N. A. Violovich & E. P. Narchuk, 1972. A review of crane-flies (Diptera, Tipulidae) of Altai mountains. — Ent. Obozr. 51: 74—95 (in Russian with English summary).
- Shiraki, T., 1952. Catalogue of injurious insects in Japan (exclusive of animal parasites), 5. — Prelim. Stud. econ. sci. Sect. nat. Res. Div. G.H.Q. Allied Powers Tokyo, no. 71.
- Tangelder, I. R. M., 1983. A revision of the crane-fly genus *Nephrotoma* Meigen, 1803, in North America (Diptera, Tipulidae). Part I: the *dorsalis* species-group. — Beaufortia 33: 111—205.
- Tangelder, I. R. M., 1984. The species of the *Nephrotoma dorsalis*-group in the Palaeartic (Diptera, Tipulidae). — Beaufortia 34: 15—92.
- Theowald, Br. & P. Oosterbroek, 1985. Family Tipulidae. In: Catalogue of the palaeartic Diptera. — Budapest (in preparation).
- Zinovjev, G. A. & E. N. Savchenko, 1962. On the fauna of crane-flies (Diptera, Tipulidae) of the Amur and Zea rivers interarea. — Ent. Obozr. 41: 554—571 (in Russian with English summary).

REGISTER VAN DEEL 127

* Een sterretje duidt aan een naam nieuw voor de wetenschap

* An asterisk denotes a name new to science

The article by W. N. Ellis and P. F. Bellinger is not included in this index.

DIPTERA

- abbreviata*, *Nephrotoma* 267
abyssinica, *Tipula* (*Acutipula*)
 [35, 53, 55
aculeata, *Nephrotoma* 237, 240,
 [243, 244, 246
 ssp. *atricauda* 237, 243
Acutipula 33, 39, 60 sqq, 235
africana, *Lecteria* 49
 ssp. *nigrilinea* 49
akitae, *Nephrotoma* 237, 252
analis, *Nephrotoma* 237, 256,
 [260
Angarotipula 236
angustistria, *Nephrotoma* 237,
 [242, 274, 276
antithrix, *Nephrotoma* 267
Arctotipula 235
atlantica, *Tipula* 35, 58, 71 sqq
autumnalis, *Nephrotoma* 237,
 [263, 264
Bayeria 191
Beringotipula 236
bicolor, *Tipula* 35, 36, 49,
 [58 sqq
bifusca, *Nephrotoma* 237, 241,
 [261 sqq
brevipennis, *Nephrotoma* 237,
 [264
brevisiana, *Tipula* 35, 48 sqq
Brithura 236
brunneinervis, *Tipula* 76
capioneura, *Tipula* 36 sqq
capitigena, *Bayeria* 191
chubbi, *Tipula* 38
cirrata, *Nephrotoma* 237, 242,
 [274, 276
Cnemoncosis 235
condylophora, *Nephrotoma* 270
consimilis, *Nephrotoma* 273
**consobrina*, *Tipula* 38, 39 sqq
contrasta, *Nephrotoma* 237,
 [241, 251 sqq
cornicina, *Nephrotoma* 237,
 [240, 243, 244
crocata, *Nephrotoma* 237, 265
Ctenophora 235, 236
curtipennis, *Tipula* 39 sqq
czizeki, *Tipula* 39, 56
daisensis, *Nephrotoma* 237, 242,
 [247-249
Dasineura 196, 209
decrepita, *Nephrotoma* 237,
 [271, 272
definata, *Nephrotoma* 274
Dendrotipula 235
dichroa, *Tipula* (*Acutipula*) 39,
 [40
Dictenidia 235
difficilis, *Nephrotoma* 237, 242,
 [274, 276
Dolichozepe 235, 236
dorsalis, *Nephrotoma* 236, 237,
 [273, 274
dutti, *Nephrotoma* 270
electricipennis, *Nephrotoma* 237,
 [242, 274, 275
elliotti, *Tipula* 40
Emodotipula 235
erebus, *Pales* 260, 261
esakii, *Nephrotoma* 237, 240,
 [243, 245
eucera, *Nephrotoma* 238
eumecacera, *Tipula* 39, 40 sqq
ferruginea, *Nephrotoma* 267
fimbriata, *Tipula* 41, 49
flagellicurta, *Tipula* 37, 39,
 [41 sqq
flammeola, *Nephrotoma* 237,
 [241, 248, 249
flavescens, *Nephrotoma* 247
flavipalpis, *Nephrotoma* 260
flavolutescens, *Tipula* 42
flavonota, *Nephrotoma* 237,
 [240, 251, 252
Formotipula 236
frater, *Tipula* 38, 39, 42 sqq
fulvipennis, *Tipula* 60, 61
fusca, *Tipula* 43, 56
fuscescens, *Nephrotoma* 237,
 [241, 251-254
gaganboi, *Nephrotoma* 237,
 [242, 274, 276
geminata, *Nephrotoma* 237,
 [241, 261-264
gerardi, *Procystiphora* 186
grahamiana, *Nephrotoma* 237,
 [270
Habromastix 45
helvetica, *Nephrotoma* 239
hirsuticauda, *Nephrotoma* 237,
 [241, 267, 268
 f. *tristis* 267
hokkaidensis, *Nephrotoma* 237,
 [258, 259
hollanderi, *Tipula* 43, 44, 47,
 [66 sqq
Holorusia 235
hungarica, *Tipula* 44, 45, 49
immemorata, *Nephrotoma* 237,
 [248
Indotipula 235
italica, *Tipula* 41, 45, 49, 58,
 [69 sqq
 *ssp. *errans* 41, 45, 58 sqq
iyoenis, *Nephrotoma* 237, 251,
 [252
japonica, *Nephrotoma* 237, 271
jonesi, *Habromastix* 45
jonesi, *Leptotarsus* (*Longurio*)
 [45
jonesi, *Tipula* 45
kleinschmidti, *Tipula* 45, 58, 62,
 [64 sqq
lamellata, *Nephrotoma* 256, 257
Lasioptera 198
Lecteria 49
**leeuweni*, *Nephrotoma* 237,
 [241, 252-255

- Leptotarsus* 45, 235
Lindnerina 236
lobelia, *Tipula* 46, 58, 66 sqq
**loeffleri*, *Tipula* 47, 58, 71 sqq
longidens, *Tipula* 76
Longurio 235
lourensi, *Tipula* 47 sqq
loveridgei, *Tipula* (*Acutipula*)
[33, 60 sqq
lucida, *Nephrotoma* 267
luna, *Tipula* 34
Lunatipula 235
luteipennis, *Tipula* 34
Macgregoromyia 235
mali, *Dasineura* 196
mannheimsi, *Nephrotoma* 237,
[258, 259
mashona, *Tipula* 35, 48 sqq
maxima, *Tipula* 60, 61
**medioflava*, *Nephrotoma* 237,
[241, 267 sqq
Mediotipula 236
mediterranea, *Tipula* 34, 45,
[49 sqq
microcephala, *Lecteria* 49
microcera, *Nephrotoma* 237,
[279
minuticornis, *Nephrotoma*
[236 sqq, 274, 275
moesta, *Tipula* 34
mosambicensis, *Tipula* 45
navajo, *Nephrotoma* 267
neoprattensis, *Nephrotoma* 237,
[242, 258 sqq
Nephrotoma 235 sqq
Nesopeza 235
nigricauda, *Nephrotoma* 237,
[242, 274, 275
Nigrotipula 236
niligena, *Tipula* 35, 49
Nippotipula 235
Odonatisca 236
oleracea, *Tipula* 33 sqq
orientalis, *Tipula* 44 sqq
Oropeza 235
ozenumensis, *Nephrotoma* 237,
[242, 256, 257
Pachyrhina 243 sqq
Pales 236 sqq
**pallida*, *Nephrotoma* 237, 241,
[261-265, 275
palloris, *Nephrotoma* 237, 241,
[261-265, 274
paludosa, *Tipula* 34 sqq
parvirostra, *Nephrotoma* 237,
[241, 248-251
Phoroctenia 235
pilicauda, *Tipula* 76
Platytipula 34, 61, 235
plumbea, *Tipula* 41, 49 sqq
Prionocera 236
Procistophora 186
Protanyptera 235
pruinosa, *Tipula* 34
Pseliophora 235
Pterelachisis 51, 235
pullata, *Nephrotoma* 237, 242,
[258 sqq
pustulata, *Tipula* 76
relicta, *Nephrotoma* 248-251
repanda, *Nephrotoma* 237, 241,
[270, 271
Rhabdophaga 191
rosarum, *Wachtliella* 191
rothschildi, *Savtshenkia* 50, 55
rubi, *Lasioptera* 198
sachalina, *Nephrotoma* 237,
[242, 274, 275
saghaliensis, *Nephrotoma* 237,
[240 sqq
Savtshenkia 50, 51, 235
schulteni, *Tipula* 60
Schummelia 235
scurrioides, *Nephrotoma* 237,
[274
selenitica, *Tipula* 76
serricornis, *Pachyrhina* 271
serristyla, *Nephrotoma* 237,
[248-251
setosipennis, *Yamatotipula* 50,
[51
sinensis, *Nephrotoma* 264, 274
Sinotipula 235
soror, *Tipula* 38 sqq
 ssp. mashona 38, 48, 49
 speiseriana, *Tipula* 52 sqq
strigata, *Tipula* 35 sqq
stygia, *Nephrotoma* 237, 260,
[261
stylacantha 237, 267, 270
subaptera, *Tipula* 55 sqq
subcunctans, *Tipula* 34 sqq
sublamellata, *Nephrotoma* 256
submendosa, *Tipula* 56
subpallida, *Nephrotoma* 237
suturalis, *Nephrotoma* 267
Tanyptera 235
tenuipes, *Nephrotoma* 243
terminalis, *Rhabdophaga* 191
Tipula 33 sqq, 235, 243
Tipulodina 235
Trichotipula 235
Triplicitipula 236
ultima, *Tipula* 34
urticae, *Dasineura* 209
**vana*, *Nephrotoma* 237, 242,
[256
 **ssp. vana* 237, 242, 256, 257,
[275
 **ssp. nigrovana* 237, 242, 256,
[258, 275
venturii, *Tipula* 56
Vestiplex 235
virgata, *Nephrotoma* 236, 237,
[242, 271-274
vittata, *Tipula* 34
Wachtliella 191
wollastoni, *Tipula* 56
Xiphuromorpha 236
Yamatotipula 51, 60, 61, 235
zambiensis, *Tipula* 60
**zimbabwensis*, *Tipula* 35, 56 sqq
HYMENOPTERA
abaris, *Synopeas* 128, 207, 208
abas, *Amblyaspis* 117, 220, 221
abia, *Platygaster* 121, 181, 182
abisares, *Platygaster* 121, 203,
[204
acco, *Synopeas* 129, 209, 211
Acerota 131
Acerotella 131
acrisius, *Platygaster* 121, 192,
[193
aegeus, *Platygaster* 121, 199,
[200
africanus, *Mesitius* 103, 104
 ssp. africanus 104
Allotropa 117, 131
Amblyaspis 117 sqq, 179
Anaylax 101, 102, 103
**Apotosoma* 139 sqq
apterus, *Mesitius* 104
areolatus, *Metaclisus* 133
**Aspidobracon* 137 sqq
athamas, *Platygaster* 121, 189,
[190, 191
atinas, *Isostasius* 133
attenuata, *Platygaster* 120, 121,
[191, 192, 202
basimacula, *Philomacroploea*
[150, 151, 159
**bekkeri*, *Metriorionotus* 105, 106
belus, *Amblyaspis* 118, 220, 221
bimucronatus, *Dioxybracon*
[146, 153
boschi, *Inostemma* 133
boter, *Acerota* 131
boter, *Acerotella* 131
boter, *Inostemma* 117, 131
Brachinostemma 132
Bracon 143, 147
buchaetus, *Inostemma* 117

- bucolion, *Platygaster* 121,
[202, 203
- Caloncoba* 137
- cameroni*, *Mesitius* 104
ssp. *cameroni* 104
- cameroni*, *Philomacroploea* 151
- capensis*, *Sulcomesitius* 109
- carceli*, *Heterocoelia* 108
ssp. *carceli* 108
ssp. *obscura* 108
- Carinibracon* 137
- catillus*, *Piestopleura* 120,
[212, 213
- Catillus* 120
- cebes*, *Platygaster* 121, 183, 184
- Ceratacis* 187
- chrysipus*, *Platygaster* 122,
[193, 194
- cleodaeus*, *Platygaster* 122, 203,
[204
- Cleptes* 109
- Clytrovorus* 102, 103
- cochleata*, *Platygaster* 122, 187,
[188, 189
- consimilis*, *Sulcomesitius* 109
- cotta*, *Isocybus* 119, 218, 219
- craterus*, *Synopeas* 129, 205,
[206, 207
- crates*, *Amblyaspis* 118,
[222, 223
- cratinus*, *Platygaster* 122,
[183, 184
- cyrtilus*, *Platygaster* 122, 189,
[190
- deipyla*, *Platygaster* 122, 202,
[203
- demades*, *Platygaster* 122, 194,
[196, 198
- densepunctatus*, *Pycnomesitius*
[112
- dictys*, *Platygaster* 122, 183, 184
- didas*, *Trichacis* 131, 214, 216,
[217
- Dioxybracon* 139 sqq
- dryope*, *Platygaster* 123, 189,
[190
- Ectadius* 129
- egypticus*, *Metriorionotus* 105
- elongata*, *Platygaster* 116, 123
- emarginata*, *Pedinopleura* 148,
[149, 154
- ennius*, *Platygaster* 123, 200,
[201
- Epyris* 104, 109
- erato*, *Isocybus* 119, 216, 217
- erdoesi*, *Sulcomesitius* 109
- eriphyle*, *Platygaster* 123, 200,
[201
- euhemerus*, *Platygaster* 123,
[190, 191
- europus*, *Allotropa* 131
- europus*, *Inostemma* 117
- Eurostemma* 131
- euryale*, *Synopeas* 129, 209, 211
- Eutropobracon* 139 sqq
- evadne*, *Platygaster* 123, 202,
[203
- favo*, *Inostemma* 116, 117, 132
- filicornis*, *Platygaster* 123, 187,
[188
- furcata*, *Gastrotheca* 140, 141
- furcata*, *Physaraia* 140, 141, 152
- furius*, *Amblyaspis* 118, 222,
[223
- galenus*, *Platygaster* 124, 189,
[190
- Gastrotheca* 140
- ghilianii*, *Mesitius* 103, 104
- gorge*, *Platygaster* 124, 194, 195
- *grahamensis*, *Sulcomesitius* 109,
[111
- gyge*, *Platygaster* 124, 191, 192
- gynomamertes*, *Ectadius* 129
- halia*, *Leptacis* 119, 213, 215
- halidayi*, *Heterocoelia* 109
- *hesperivorus*, *Aspidobracon*
[144, 145, 161
- Heterocoelia* 106, 107, 108, 109
- hispanica*, *Heterocoelia* 109
- hispo*, *Inostemma* 116, 117, 132
- horvathi*, *Clytrovorus* 103, 104
- hungarica*, *Heterocoelia* 108
- *Hyboteles* 139 sqq
- hyllus*, *Synopeas* 129, 209, 211
- ilione*, *Platygaster* 124, 185, 186
- Incertosulcus* 105
- indicus*, *Eutropobracon* 147,
[158
- inermis*, *Platygaster* 124, 186,
[188
- Inostemma* 116, 132
- integer*, *Anaylax* 102
- iolas*, *Platygaster* 124, 194, 196
- Iphitrachelus* 116, 133
- Isocybus* 119 sqq, 179
- Isostasius* 133
- jasius*, *Synopeas* 129, 205, 206
- Kenema* 138
- koshunensis*, *Bracon* 147, 150
- koshunensis*, *Pedinopleura* 149,
[150, 155
- laodice*, *Leptacis* 120, 214, 215
- lar*, *Iphitrachelus* 116, 133
- laricis*, *Platygaster* 124, 187, 188
- larides*, *Synopeas* 129, 204, 206
- *latimarginale*, *Apotosoma* 142,
[156
- Leptacis* 119 sqq, 179, 189
- leptines*, *Platygaster* 125, 187,
[188, 189
- longiventris*, *Platygaster* 191
- lycon*, *Inostemma* 132
- lysicles*, *Platygaster* 125, 182,
[183
- mamertes*, *Piestopleura* 120,
[129, 210, 212
- mamertes*, *Synopeas* 120, 129,
[208
- manto*, *Platygaster* 125, 197,
[198, 203, 204
- masneri*, *Sulcomesitius* 110
- matuta*, *Isocybus* 119, 216, 219
- mecrida*, *Inostemma* 117, 132
- *melateles*, *Apotosoma* 142, 143,
[163
- melicerta*, *Inostemma* 132
- menippus*, *Inostemma* 132
- Mesitius* 103, 104, 108, 109, 112
- Metaclisis* 117, 131 sqq
- Metriorionotus* 105, 106, 108
- minthe*, *Platygaster* 125, 199,
[200
- Misocyclops* 128 sqq
- moczari*, *Anaylax* 102
- Monocrita* 133
- munita*, *Platygaster* 125, 192,
[193, 202
- myles*, *Synopeas* 130, 207, 208
- nagy*, *Heterocoelia* 109
- neruus*, *Amblyaspis* 118, 218,
[219
- nice*, *Leptacis* 120, 213, 215
- nigriventris*, *Heterocoelia* 109
- *nikolskajae*, *Heterocoelia* 106,
[107
- nisus*, *Platygaster* 125, 197, 198
- *noyesi*, *Aspidobracon* 143, 145,
[162
- nydia*, *Leptacis* 120, 213, 215
- ocalea*, *Inostemma* 117, 133
- ocaleus*, *Metaclisis* 133
- oebalus*, *Platygaster* 125, 194,
[195
- oeculus*, *Platygaster* 125, 194, 195
- olorus*, *Platygaster* 126, 183,
[184
- orcus*, *Platygaster* 126, 196, 197,
[198
- orus*, *Platygaster* 126, 181, 182
- osaces*, *Synopeas* 130, 210, 212
- osculus*, *Platygaster* 126, 197, 199
- otanes*, *Platygaster* 126, 180,
[181

- otreus*, *Amblyaspis* 118, 221, [222
ozines, *Leptacis* 120, 214, 215
**pardoi*, *Analyx* 101, 103
Parinostemma 117, 132 sqq
pedasus, *Platygaster* 126, 197, [198
**Pedinopleura* 139 sqq
pelias, *Platygaster* 126, 196, 197, [198
peringueyi, *Pycnomesitius* 112
philinna, *Platygaster* 127, 200, [201
Philomacroploea 140 sqq
Physaraia 137 sqq
**pierrei*, *Aspidobracon* 143, 144, [160
Piestopleura 120, 179, 207
pisis, *Trichacis* 131, 214, 216, [217
Platygaster 116 sqq, 179 sqq
Plesiobracon 137 sqq
pleuralis, *Philomacroploea* 151
pleuron, *Platygaster* 127, 181, [182
plotina, *Platygaster* 127, 202, [203
Polygnotus 126 sqq
Polymecus 129
prorsa, *Amblyaspis* 118, 220, [221
Prosactogaster 121 sqq
Pycnomesitius 112
remulus, *Trichacis* 131, 214, [216, 217
rhanis, *Synopeas* 130, 209, 211
roboris, *Amblyaspis* 118, 218, [219
ruborum, *Platygaster* 198
ruficornis, *Platygaster* 119
rutubus, *Platygaster* 127, 185, [186
Sactogaster 130 sqq, 209
sagana, *Platygaster* 127, 200, [201
scelionoides, *Amblyaspis* 118, [222, 223
scrutator, *Isostasius* 133
seron, *Piestopleura* 120, 210, [212
soikai, *Incertosulcus* 105
sonchis, *Platygaster* 127, 183, [184
sisis, *Synopeas* 130, 207
sterope, *Platygaster* 127, 179, [180, 181
strato, *Platygaster* 127, 184, 185
**suarezi*, *Clytrovorus* 102, 103
Sulcomesitius 109, 110
sumatrana, *Physaraia* 141
Synopeas 119 sqq, 128 sqq, 179, [186
syrinx, *Inostemma* 117
szaboi, *Mesitius* 104
taras, *Platygaster* 128, 180, 181
tarsa, *Synopeas* 130, 209, 210, [212
tisias, *Platygaster* 128, 192, 193
torispinula, *Leptacis* 213
townesianus, *Sulcomesitius* 112
**toxopeusi*, *Hyboteles* 148, 157
trebius, *Synopeas* 130, 205, 206
Trichacis 131 sqq, 179
triticis, *Amblyaspis* 119, 220, 221
ulex, *Inostemma* 117
Urocyclops 128, 184 sqq
vaenia, *Platygaster* 128, 184, [185, 186
velutinus, *Platygaster* 116
velutinus, *Synopeas* 130, 205, [206
vestinus, *Platygaster* 128, 187, [188, 189
walkeri, *Inostemma* 133
walkeri, *Isocybus* 119, 218, 219
walkeri, *Piestopleura* 120
xeneus, *Platygaster* 128, 185, [186
**zambiensis*, *Sulcomesitius* 110, [111
zavadili, *Clytrovorus* 104
zosine, *Platygaster* 128, 203, [204
zuluensis, *Metrionotus* 105
LEPIDOPTERA
Acraea 137, 144
adpersella, *Diptychophora* [17 sqq
allophylica, *Stigmella* 167
**allophylivora*, *Stigmella* 167, [168
**apicella*, *Roxita* 17 sqq
bipunctella, *Modestia* 17 sqq
**birgittae*, *Stigmella* 171, 173
cephus, *Acraea* 137, 144
charistis, *Stigmella* 167
Corynophora 18
Crambus 17, 26
Culladia 17, 19, 26, 27
Diptychophora 17, 22
ECTOEDERMIA 165
Epichorista 226, 227
Epichoristodes 227, 229
Erionota 145
eurydyce, *Roxita* 17 sqq
**ficivora*, *Stigmella* 169
**fletcheri*, *Roxita* 17 sqq
geraeas, *Epichorista* 226, 227, [230
Glaucoccharis 17, 25
glaucophanes, *Tawhitia* 18
mandingella, *Stigmella* 174
**maytenivora*, *Stigmella* 174, 175
modestellus, *Crambus* 17, 26, [27
Modestia 17, 19, 26, 27
**mululella*, *Roxita* 17 sqq
Orocrambus 19
paliurella, *Stigmella* 171
pentadactyla, *Tawhitia* 18
**Phlebozemia* 225 sqq
platyzona, *Stigmella* 170
**reductella*, *Roxita* 17, 19, 20, 25
**rhomboivora*, *Stigmella* 166, 167
Roxita 17 sqq
**sandrinae*, *Phlebozemia* 225, [227 sqq
Stigmella 165 sqq
szetschwanella, *Culladia* 17 sqq
f. modesta 17
Tawhitia 18
thrax, *Erionota* 145
Trifurcula 165
**wollofella*, *Stigmella* 174, 176
**ziziphivora*, *Stigmella* 171, 172
zizyphi, *Stigmella* 171
ODONATA
andromeda, *Phyllogomphoides* [81, 82, 83, 89
angularis, *Phyllogomphoides* [81, 82, 90
annectens, *Phyllogomphoides* [81, 82, 93
Aphylla 80, 94
atlanticus, *Phyllogomphoides* [81, 82, 90
audax, *Phyllogomphoides* [81 sqq
brunneus, *Phyllogomphoides* [81 sqq
calverti, *Phyllogomphoides* 81, [82, 92
camposi, *Phyllogomphoides* 81, [82, 93
cassiopeia, *Phyllogomphoides* [81, 82, 83, 89
cephus, *Phyllogomphoides* 81, [82, 83, 89
cornutifrons, *Phyllogomphoides* 81, 83, 94
cristatus, *Phyllogomphoides* 81, [82, 83, 88, 89

- Cyclophylla* 89, 92, 93
eugeniae, Gomphoides 86
fuliginosus, Phyllogomphoides [81 sqq]
Gomphoides 80 sqq
Idiogomphoides 80
imperator, Phyllogomphoides [81 sqq]
lieftincki, Phyllogomphoides [81, 82, 83, 92]
**major*, Phyllogomphoides [80 sqq]
Negomphoides 88 sqq
**pedunculus*, Phyllogomphoides [80, 81, 82, 90]
Phyllocycla 80, 89, 92, 93
Phyllogomphoides 79 sqq
praedatrix, Phyllogomphoides [81, 83, 87]
Progomphus 80
- *pseudoundulatus*, Phyllogomphoides 80, 81, 82, 91
regularis, Phyllogomphoides 81, [82, 83, 93]
selysi, Phyllogomphoides [80 sqq]
semicircularis, Phyllogomphoides 81, 82, 83, 91
singularis, Phyllogomphoides [81, 93]
undulatus, Phyllogomphoides [81 sqq]
- PLANTAE
Acer 205
Allophylus cf. *africanus* 167
Caloncoba welwitschii 137, 144
Crinum powellii 226
Elisena longipetala 226
- Euphorbia esula* 191
Ficus parasitica 170
Fraxinus 205
Hippeastrum 226
Hymenocallis narcissiflora 226
Juncus gerardii 186
Maytenus senegalensis 174
Narcissus cyclamineus 226
Nerine bowdenii 225, 226, 230
Nerine sarniensis 225
Oryza sativa 145
Quercus robur 205
Rosa sp. 191
Robus sp. 198
Salix alba 191
Sprekelia formosissima 226
Triumfetta rhomboidea 167
Urtica dioica 209
Ziziphus mauritania 171, 174, [179]

ERNST MAYR LIBRARY



3 2044 114 196 397

