

TIN SHEET-IRON AND  
COPPER-PLATE WORKER

---

BLINN

ifornia  
onal  
ty

Southern Branch  
of the  
**University of California**  
Los Angeles

Form L 1

TS  
250  
B61t

This book is DUE on the last date stamped below

JUL 27 1931  
OCT 31 1932

JUL 31 1933

JUL 31 1934

JUL 31 1935

JUL 16 1941

JUL 25 1941

AUG 1 1941

AUG 8 1941

AUG 15 1941

4/24/67

4/13/2006



TIN, SHEET-IRON AND  
COPPER-PLATE WORKER

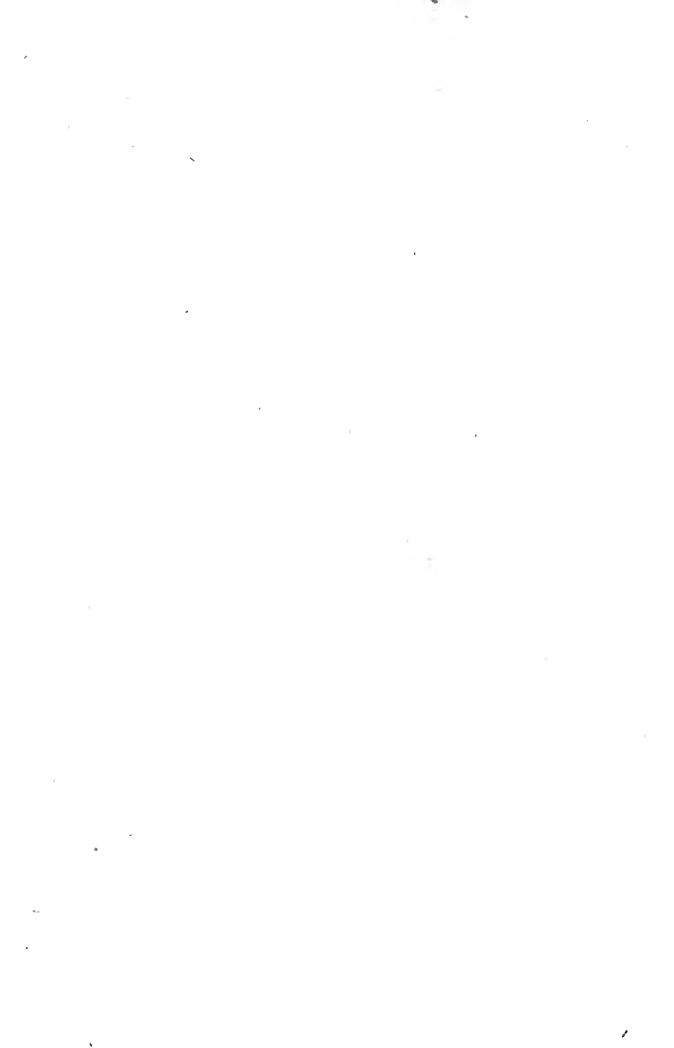

# TIN, SHEET-IRON AND COPPER-PLATE WORKER

A PRACTICAL WORKSHOP COMPANION

CONTAINING

RULES FOR DESCRIBING VARIOUS KINDS OF PATTERNS  
USED BY TIN, SHEET-IRON AND COPPER-PLATE  
WORKERS; PRACTICAL GEOMETRY;

*Mensuration of Surfaces and Solids;*

TABLES OF THE WEIGHTS AND STRENGTHS OF METALS AND  
OTHER MATERIALS; TABLES OF AREAS AND CIRCUM-  
FERENCES OF CIRCLES; COMPOSITION OF METALLIC  
ALLOYS AND SOLDERS; WITH NUMEROUS VAL-  
UABLE RECEIPTS AND MANIPULATIONS FOR  
EVERY-DAY USE IN THE WORKSHOP

---

By LEROY J. BLINN

MASTER MECHANIC

---

NEW ENLARGED EDITION, TO WHICH HAS BEEN ADDED  
MANY NEW PATTERN PROBLEMS

*ILLUSTRATED BY 207 ENGRAVINGS*

NEW YORK  
HENRY CAREY BAIRD & CO., Inc.,

*Publishers of Mechanical and Industrial Books*

2 WEST 45TH STREET

1920

53754

Copyright by HENRY CAREY BAIRD & Co., Inc., 1920

Printed in the U. S. A.



TS  
250  
B61t

## PREFACE

---

THE present is a new and thoroughly revised edition of one of the most popular books on sheet-metal working ever published in this country. It having been found necessary to make a new set of electrotype plates and new engravings—the old ones having been worn out by actual use—it was determined to have the book re-edited and to add to it, in the different departments, new, recent and necessary matter.

Inasmuch as geometrical problems never become obsolete and as pattern cutting is based on that science, the original problems are as correct and useful as ever and have therefore been retained. These have been augmented by the supplementary problems which have been incorporated to emphasize the modern system of triangulation and to give some knowledge of modern skylight work. As a result, that department of the book, valuable heretofore, is now considerably improved.

The portion treating on metallic alloys and solders has been entirely rewritten, so as to have a more systematic arrangement and to bring it abreast with the best modern practice in this interesting and important field. Experts have carefully gone over the recipes and tables to insure their accuracy.

In all the other departments new matter has been added and every effort has been made to render the entire work, in the future, if possible, even more useful to the tin, sheet-iron and copper-plate worker than in the past.

Reference to the many subjects treated will be rendered easy by the very full table of contents and the complete index.

THE PUBLISHERS.

New York, April, 1920.

1920  
1920

300

Howler

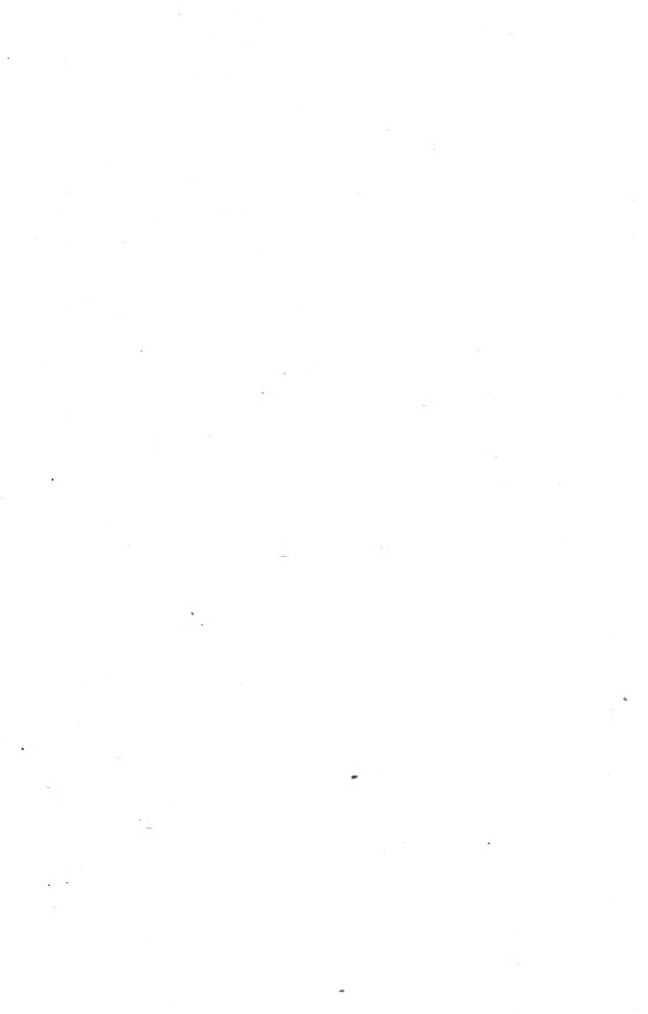

# CONTENTS.

## RULES FOR DESCRIBING PATTERNS.

To describe an envelope for a cone ; To describe a frustum of a cone . . . . .	1
To describe a can top or deck flange . . . . .	2
To describe a pattern for, or an envelope for a frustum of a cone . . . . .	3
To describe a pattern for a tapering oval article, to be in four sections . . . . .	4
To describe a pattern for a tapering oval article, to be in two sections . . . . .	7
To describe a pattern for a tapering oval article, to be in two sections . . . . .	9
To describe a pattern for a tapering oval article (another method) . . . . .	11
To describe a pattern for a tapering oval, or oblong article, the sides to be straight, with quarter-circle corners, to be in two sections . . . . .	13
To describe a pattern for a tapering oval, or oblong article, the sides to be straight, one end to be a semicircle, the other end to be straight, with quarter-circle corners, to be in two sections . . . . .	14
To describe a pattern for a tapering oval, or oblong article, the sides to be straight, with semicircle ends, to be in two sections . . . . .	16
To describe a pattern for a fish-kettle with straight sides . . . . .	17
To draw the plan of an oblong taper bath, the size of the top and bottom, the height, and the slant at the head being given . . . . .	18
To draw the plan of a hip-bath, or of a sitz-bath . . . . .	20
To describe a frustum of an oblique pyramid . . . . .	23
To describe without long radii a frustum of an oblique pyramid, the plan of the frustum and its height being given . . . . .	26

To draw the pattern of a hood . . . . .	28
Covering of circular roofs, etc. ; First method . . . . .	30
Second method ; To cover a dome by the first method . . . . .	31
To cover a dome by the second method . . . . .	32
To ascertain the outlines of a course of covering to a dome without reference to a section of the dome ; Covering of a hipped-roof . . . . .	33
To describe a pattern for a tapering square article . . . . .	40
To describe a pattern for a tapering square article, to be in two sections ; To describe a pattern for a tapering article, the base to be square, and the top a circle, to be in two sections . . . . .	41
To describe a pattern for a tapering article, the base to be a rectangle and the top square, to be in two sections . . . . .	42
To describe a pattern for a tapering article, the base to be a rectangle, and the top a circle, to be in two sections ; To describe a pattern for a tapering article, the top and base to be a rectangle, to be in two sections . . . . .	44
To describe a pattern for tapering octagon top or cover . . . . .	46
To describe a pattern for a miter-joint at right angles for a semicircle gutter . . . . .	47
To describe a pattern for a miter-joint at any angle for a semicircle gutter . . . . .	48
To describe a pattern for a miter-joint for an O G gutter at right angles . . . . .	49
To describe a pattern for a miter-joint for an O G cornice at right angles ; also an offset . . . . .	50
To describe a pattern for an octagon O G lamp top or cover . . . . .	52
To describe a pattern for a stand (aquarium stand, for in- stance) the edge of which is a moulding . . . . .	53
To describe a T pipe at right angles . . . . .	56
To describe a pattern for a T pipe at any angle . . . . .	57
To describe a pattern for a T pipe, the collar to be smaller than the main pipe . . . . .	59
To describe a pattern for a T pipe at any angle, the collar to be smaller than the main pipe . . . . .	61
To describe a pattern for a T pipe at any angle, the collar to be set on one side of the main pipe . . . . .	63

To describe the pattern for a T-piece formed by two equal or unequal circular pipes (cylinders of equal or unequal diameter) which meet at right angles . . . . .	64
To describe the pattern for the T formed by a funnel-shape piece of pipe and a circular piece, the former being square to the latter; the diameter of the circular pipe and the diameters of the ends of the funnel-shape pipe and its length being given . . . . .	68
To describe a pattern for a pipe to fit a flat surface at any angle, as the side of the roof of a building . . . . .	73
To describe a pattern for a pipe to fit two flat surfaces, as the roof of a building . . . . .	74
To describe the form of a "tapering piece" of piping, to join two pieces of piping, which are both vertical, but not in the same axis, and which are of different diameters . . . . .	75
To describe an elbow at right angles . . . . .	78
To describe an elbow pattern at any angle . . . . .	79
To describe a pattern for an elbow in three sections . . . . .	80
To describe a pattern for an elbow in four sections . . . . .	82
To describe a pattern for an elbow in five sections . . . . .	84
To describe a pattern for a tapering elbow . . . . .	87
To describe an oval boiler cover; To describe a pattern for a flange for a pipe that goes on the roof of a building . . . . .	89
To describe an octagon or square top or cover . . . . .	90
To describe a steamer cover . . . . .	91
To describe an ellipse or oval, having the two diameters given; To draw an ellipse with the rule and compasses, the transverse and conjugate diameters being given; that is the length and width . . . . .	92
To draw an egg-shaped oval, having the length and width given . . . . .	93
To find the centre and the two axes of an ellipse . . . . .	94
To find the radius and versed sine for a given frustum of a cone . . . . .	95
To draw a figure having straight sides and semicircular ends . . . . .	96

## PRACTICAL GEOMETRY.

From any given point, in a straight line, to erect a perpendicular; or, to make a line at right angles with a given

line ; When a perpendicular is to be made at or near the end of a given line ; To bisect a given line (divide a line into two equal parts) . . . . .	97
To divide a line into any number of equal parts ; To do the same otherwise ; To bisect any given angle . . . . .	98
To trisect (divide into three equal angles) a right angle ; To describe a triangle in a circle ; To find the centre of a circle ; To find the length of any given arc of a circle . . . . .	99
To find the centre of a circle, or radius, that shall cut any three given points, not in a direct line ; Through any given point, to draw a tangent to a circle ; To draw from or to the circumference of a circle lines tending towards the centre, when the centre is inaccessible . . . . .	100
To describe an arc or segment of a circle of large radii ; Or otherwise ; To describe a parabola, the dimensions being given . . . . .	101
To describe an elliptic arch, the width and rise of span being given ; To obtain by measurement the length of any direct line, though intercepted by some material object . . . . .	102
To inscribe any regular polygon in a given circle ; To describe any regular polygon, the length of one side being given . . . . .	103
To form a circle equal in area to a given ellipse ; To construct a square upon a given right line ; To form a square equal in area to a given triangle . . . . .	104
To form a triangle equal in area to a circle . . . . .	105
To form a square equal in area to a given rectangle ; To find the length for a rectangle, whose area shall be equal to that of a given square, the breadth of the rectangle being also given ; To describe a circle of greatest diameter in a given triangle . . . . .	106
To bisect any given triangle ; To form a rectangle of greatest surface in a given triangle ; To inscribe within a given equilateral triangle three equal semicircles having their diameters adjacent and equal . . . . .	107
To inscribe in a given circle three equal semicircles having their diameters adjacent . . . . .	108
Decimal equivalents to fractional parts of lineal measurement	108

## MENSURATION OF SURFACES.

- Definitions of arithmetical signs used in the following calculations; To measure or ascertain the quantity of surface in any right-lined figure, whose sides are parallel to each other . . . . . 110
- To find the area of a triangle when the base and perpendicular are given; Any two sides of a right-angled triangle being given, to find the third; When the hypotenuse and base are given, to find the perpendicular . . . . . 111
- When the hypotenuse and the perpendicular are given, to find the base; To find the area of a regular polygon; To find the area of a regular polygon, when the side only is given . . . . . 112
- Table of angles relative to the construction of regular polygons with the aid of the sector, and of coefficients to facilitate their construction without it; also, of coefficients to aid in finding the area of the figure, the side only being given . . . . . 113
- The circle and its sections; Observations and definitions . . 113
- General rules in relation to the circle; Application of the rules to practical purposes . . . . . 114
- Any chord and versed sine of a circle being given, to find the diameter; To find the length of any arc of a circle . . 115
- To find the area of the sector of a circle; To find the area of a segment of a circle . . . . . 116
- To find the area of the space contained between two concentric circles or the area of a circular ring; To find the area of an ellipse or oval; To find the circumference of an ellipse or oval . . . . . 117
- To find the convex surface of a cylinder; To find the convex surface of a right cone or pyramid; To find the convex surface of a frustum of a cone or pyramid . . . . . 118
- To find the convex surface of a sphere or globe . . . . . 119

## MENSURATION OF SOLIDS AND CAPACITIES OF BODIES.

- To find the solidity or capacity of any figure in the cubical form; To find the solidity of cylinders . . . . . 119
- To find the contents in gallons of cylindrical vessels; To find

the solidity of a cone or a pyramid ; To find the solidity of the frustum of a cone . . . . .	120
To find the contents in United States standard gallons of the frustum of a cone ; To find the solidity of the frustum of a pyramid . . . . .	121
To find the solidity of a sphere . . . . .	122

#### TABLES OF WEIGHTS, ETC.

Weight of square rolled iron, from $\frac{1}{4}$ inch to 12 inches, and 1 foot in length ; Weight of flat rolled iron, from $\frac{1}{8} \times \frac{1}{2}$ inch to $1 \times 6$ inches . . . . .	123
Weight of round rolled iron, from $\frac{1}{4}$ inch to 12 inches in diameter, and 1 foot in length . . . . .	124
Weight of a square foot of wrought iron, copper and lead, from $\frac{1}{8}$ to 2 inches thick . . . . .	125
Weight of copper bolts, from $\frac{1}{4}$ to 4 inches in diameter and 1 foot in length . . . . .	126

#### TABLES OF THE CIRCUMFERENCE OF CIRCLES, TO THE NEAREST FRACTION OF PRACTICAL MEASUREMENT ; ALSO, THE AREAS OF CIRCLES, IN INCHES AND DECIMAL PARTS ; LIKEWISE IN FEET AND DECIMAL PARTS AS MAY BE REQUIRED.

Rules rendering the tables more generally useful . . . . .	127
Sizes of tinware in form of frustum of a cone ; Pans ; Dish kettles and pails ; Coffee pots ; Dippers . . . . .	135
Measures ; Wash-bowls ; Druggists' and liquor dealers' measures . . . . .	136
Capacity of cylinders in United States gallons . . . . .	137
Decimal equivalents of the fractional parts of a gallon ; Explanation of the tables . . . . .	143
Specific gravity . . . . .	145
Table showing the specific gravities of technically important bodies (metals, stones, varieties of earths, woods, seeds, fluids) . . . . .	146
Heat . . . . .	147
Latent heat of various substances ; Specific heat of different substances ; Fusing points of the principal metals and other elements employed in alloys . . . . .	148



Relative internal heat-conducting power of bodies ; Table of effects of heat upon bodies ; Expansion of metals by heat	149
Comparative radiating or absorbent or reflecting powers of substances ; Tempering . . . . .	150
To temper by the thermometer ; To temper brass or to draw its temper ; To temper drills . . . . .	151
To temper gravers ; Mixtures for tempering . . . . .	152
Water ; Composition of water . . . . .	153
Boiling point of water . . . . .	154
Specific gravity and weight of water . . . . .	155
Effects produced by water in its natural state . . . . .	156
Air ; Effects produced by air in its natural, and also in its rarefied state . . . . .	157
Table of expansion of atmospheric air by heat . . . . .	158
Manufacture of tin plate . . . . .	159
Quality of tin plate ; To recognize a content of lead in tin ; Crystallized tin plate . . . . .	163
Size, length, breadth and weight of tin plates . . . . .	164
Tin roofing and tin work . . . . .	165
Table showing the lengths and diameters of pipes, made from sheets, and also the amount contained in one box ; Semicircular gutters ; Galvanized iron ; Mouldings of galvanized iron . . . . .	166
American lap weld iron boiler flues, manufactured by the Reading Iron Company ; Calibré and weights of fountains or aqueduct pipes . . . . .	169
Calibre and weight of lead pipe ; To ascertain the weights of pipes of various metals, and any diameter required . . . . .	170
Application of the rule ; Weight of a square foot of sheet iron, copper and brass as per Birmingham wire gauge . . . . .	171
Gas pipes ; Table of the diameter and length of gas pipes to transmit given quantities of gas to branch pipes and burners ; Services for lamps . . . . .	172
Weight of a superficial foot of plates of different metals in pounds ; Recapitulation of weights of various substances . . . . .	173
Expansion of cast and wrought iron ; Table showing the figures by which the weight of the pattern has to be multiplied to obtain the weight of the casting . . . . .	174

Shrinkage of castings . . . . .	175
Speed of saws running 10,000 feet per minute on the rim ; Rules for calculating speeds, etc. . . . .	176

## PRACTICAL RECEIPTS.

Japanning and varnishing . . . . .	178
White japan ground . . . . .	179
Gum copal . . . . .	180
To japan or varnish white leather ; Black grounds . . . . .	181
Black japan ; Brunswick black ; Blue japan grounds ; Scar- let japan . . . . .	182
Yellow grounds ; Green japan grounds ; Orange-colored grounds ; Purple japan grounds . . . . .	183
Black japan ; Japan black for leather ; Transparent japan ; Japanners' copal varnish ; Tortoise-shell japan . . . . .	184
Painting japan work ; Japanning old tea trays . . . . .	185
Japan finishing . . . . .	186

## VARNISHES—MISCELLANEOUS.

Chief resins employed in the manufacture of varnishes . . . . .	188
Solvents of the various resins . . . . .	190
Spirit varnishes ; Essence varnishes ; Oil varnishes . . . . .	191
Lacquer . . . . .	192
Copal varnishes . . . . .	193
Cabinet varnish ; Table varnish ; Copal varnish for inside work ; Best body copal varnish for coach makers, etc. . . . .	195
Copal polish ; White spirit varnish ; White hard spirit varnishes ; White varnish . . . . .	196
Soft brilliant varnish ; Brown, hard spirit varnishes ; To prepare a varnish for coating metals ; To varnish articles of iron and steel . . . . .	197
Varnish for iron work ; Black varnish for iron work ; Bronze varnish for statuary ; Amber varnishes . . . . .	198
Amber varnish, black ; Amber varnishes . . . . .	199
Black varnish ; Varnish for certain parts of carriages ; Coach varnish ; Mahogany varnish ; Varnish for cabinet- makers ; Cement varnish for watertight luting ; The var- nish of Watin for gilded articles . . . . .	200
Cheap oak varnish ; Varnish for wood-work ; Dark varnish	

for light wood-work ; Varnish for instruments ; Varnish for the wood toys of Spa ; Varnishes for furniture . . .	201
To French polish . . . . .	202
Furniture polishes ; Furniture gloss ; Furniture cream, oils and pastes . . . . .	203
Etching varnishes ; Varnish for engravings, maps, etc. ; Varnish to fix engravings or lithographs on wood ; Varnishes for oil paintings and lithographs ; Varnish for oil paintings ; Beautiful varnish for paintings and pictures.	204
Milk of wax ; Crystal varnishes . . . . .	205
Italian varnishes ; Size, or varnish, for printers ; Mastic varnishes ; India rubber varnishes . . . . .	206
Black varnish for harness ; Boiled oil or linseed oil varnish ; Dammar varnish ; Common varnish ; Water-proof varnishes . . . . .	208
Varnishes for balloons, gas bags, etc. ; Gold varnish ; Wain-scot varnish for house painting and japanning . . . . .	209
Iron work, black ; Black japan varnish ; Leather varnish ; Varnish for smooth moulding patterns ; Fine black varnish for coaches . . . . .	210

## LACQUERS.

Gold lacquer ; Red spirit lacquer ; Pale brass lacquer ; Lacquer for tin ; Lacquer varnish ; Deep gold-colored lacquer . . . . .	211
Lacquers for pictures, metal, wood or leather ; Directions for making lacquer ; Lacquer for dipped brass and for bronzed brass ; Deep gold-colored lacquer ; Gold-colored lacquer for brass not dipped and dipped . . . . .	212
Good lacquer for brass ; Lacquer for dipped brass ; Good lacquer ; Pale lacquer for tin plate ; Red lacquer for brass ; Pale lacquer for brass ; Best lacquer for brass ; Color for lacquer ; Lacquer for philosophical instruments ; Soap lacquers . . . . .	213
Imitation of Japanese lacquer . . . . .	214

## MISCELLANEOUS CEMENTS.

Armenian or diamond cement . . . . .	215
--------------------------------------	-----

Cement for mending earthen and glassware; Cement for stoneware; Iron rust cement . . . . .	216
Composition for making architectural ornaments in relief; Varley's mastic; Electrical and chemical apparatus cement; Cement for iron tubes, boilers, etc. . . . .	217
Cement for ivory, mother of pearl, etc.; Cement for holes in castings; Cement for coppersmiths and engineers; A cheap cement; Plumbers' cement; Cement for bottle corks; China cement . . . . .	218
Cement for stone structures; Roofing cement; Ammonia-shellac cement . . . . .	219
Cement for leather; Marble cement; A good cement; Cement for marble-workers and coppersmiths; Transparent cement for glass; Cement to mend iron pots and pans . . . . .	220
Cement to render cisterns and casks water-tight; Cement for repairing fractured bodies of all kinds; Cement for cracks in wood . . . . .	221
Cement for joining metals and wood; Gasfitters' cement; Impervious cement for apparatus, corks, etc.; Cement for fastening brass to glass vessels; Cement for fastening blades, files, etc.; Hydraulic cement paint; Sorel's cements; London mastic cement . . . . .	222
Keene's marble cement; Martin's cement; Parian cement; Lowitz's cement for the protection of wood and stone against moisture . . . . .	223

#### IMPORTANT METALLIC ALLOYS.

Alloys of copper and zinc—Brass and similar alloys . . . . .	224
Color of copper-zinc alloys; Composition of various copper-zinc alloys . . . . .	225
Alloys of copper and tin; Gun metal; Steel bronze or Uchatius bronze; Bell metal; Speculum metal; Art bronze . . . . .	226
Phosphor bronze; Silicon bronze; Manganese bronze . . . . .	227
Delta metal; Silveroid; Cobalt bronze . . . . .	228
Aluminium bronze . . . . .	229
Alloys of copper, zinc and nickel, German silver, argentan or pakfong; Britannia metal . . . . .	230

Composition of various kinds of Britannia metal ; Readily fusible alloys . . . . .	231
Alloys of the noble metals ; Various alloys ; Yellow brass for turning ; Red brass for turning ; Red brass to turn freely ; Best red brass for fine castings ; Rolled brass ; Hard brass for casting ; Bell metal ; For bells of clocks ; Metal for journal boxes ; Bearing metals for locomotives	232
Brasses for locomotive side rods ; Brasses for locomotive driving boxes ; Queen's metal ; Hard white metal ; Metal for taking impressions ; Rivet metal ; Bullet metal ; Bath metal ; Cock metal ; White metals . . . . .	233
Expansive metal ; Bronze for gilding ; Blanched copper ; Ormolu ; Stereotype metal ; Type metal ; Artificial gold	234
Solders ; Composition of soft solders . . . . .	235
Hard solders ; Solder for gold ; White solder for raised Britannia ware ; Solder for steel joints ; Solders for aluminium . . . . .	236
Solder for aluminium bronze ; To solder platinum . . . . .	237
Metallic cement ; To color soft solder . . . . .	238
To join small band saws ; To make muriate of zinc ; To prepare borax for brazing ; Soldering iron and steel . . . . .	239
Joints . . . . .	241

## MISCELLANEOUS RECEIPTS.

Paint for coating wire work ; Razor paste ; Cutting glass . . . . .	244
Prepared liquid glue ; Liquid glues ; Marine glue ; Dextrine or British gum ; Liquid glue that keeps for years . . . . .	245
Sealing wax for fruit cans ; Browning gun barrels ; Silvering powder for coating copper ; To prevent rusting ; Quick, bright dipping acid for brass which has been ormolued ; Dipping acid . . . . .	246
Good dipping acid for cast brass ; Dipping acid ; Ormolu dipping acid for sheet brass or cast brass ; To prepare brass work for ormolu dipping ; To repair old nitric acid ormolu dips ; Vinegar bronze for brass . . . . .	247
Brown bronze dip ; Green bronze dip ; Aquafortis bronze dip ; Olive bronze dip for brass ; Brown bronze paint for copper vessels ; Bronze for all kinds of metals ; Bronze	

paint for iron or brass ; To bronze gun barrels ; Silvering by heat . . . . .	248
Mixture for silvering ; To separate silver from copper ; Solvent for gold ; Composition used in welding cast steel ; Cast iron cement ; Beautiful and durable bronze upon tin and tin alloys . . . . .	249
Bronzing gas fixtures . . . . .	250
To bronze plaster of paris figures ; To cleanse plaster of paris busts and statuettes ; Coppering of iron rollers for calico printing . . . . .	251
To tin copper and brass ; To tin iron sauce-pans . . . . .	252
Cold tinning ; To tin small articles . . . . .	253
Galvanizing brass and copper ; Cheap and quick method of coloring metals . . . . .	254
Electroplating pewter surfaces . . . . .	255
Brown tint for iron and steel ; Enamelling metals . . . . .	256
Enamel for watch faces ; To polish gold and silver lace . . . . .	257
Cleaning tinware ; Solvents for rubber . . . . .	258
Etching solution for brass ; Compound for casts . . . . .	259
Imitation gold varnish ; Inks for marking tinware ; Red ink for rubber stamps . . . . .	260
Ink for brass stamps ; Indelible ink for stamps ; Resharp-ening files ; To repair broken belting . . . . .	261

#### STRENGTH OF MATERIALS.

Bar of iron ; Bridges ; Floors ; Roofs ; Beams ; Cast iron beams ; Beams . . . . .	262
Models proportioned to machines . . . . .	264
List of metals arranged according to their strength . . . . .	265
List of woods arranged according to their strength ; Strength of hempen cords ; Rule for finding the weight in pounds which a hempen rope will support . . . . .	266
Method of increasing the suspensive power of timber ; Strength of rectangular columns or timbers in resisting compression . . . . .	268
Cohesive power of bars of metal one inch square, in tons ; Relative strength of cast and malleable iron ; Method of testing metals . . . . .	269

## TABLES OF STRENGTH OF MATERIALS.

Strength of chains; Common close-linked cable chain; Steel-linked cable chain . . . . .	272
Strength and weight of short-linked crane chain . . . . .	273
Strength and weight of steel-linked cable chain . . . . .	274
Strength of iron wire ropes; Strength and weight of hempen ropes . . . . .	275
Strength of drawn lead pipes of the ordinary standard weights . . . . .	276
Strength of timbers to resist crushing strains, in pounds and tons per square inch . . . . .	277
Table of the strength, extensibility and stiffness of metals, cast iron being 1, or unity . . . . .	278
Table of the strength, extensibility and stiffness of woods, cast iron being 1, or unity; Effect of remelt- ing on the strength of cast iron . . . . .	279
Table showing the average crushing load of different materials, or the weight under which they will crum- ble; Table showing the tensile strength, or the strain that will pull different metals asunder on a straight pull . . . . .	280
Table showing the tensile strength of different kinds of wood . . . . .	281

## SUPPLEMENTARY PATTERN PROBLEMS.

Introduction . . . . .	282
Pattern for a chimney base or an article circular at the top and rectangular at the base and both centrally situated to each other . . . . .	283
Pattern of an article circular at the top and rectangular at the base, second case . . . . .	285
Pattern of an article circular at the top and rectangu- lar at the base, third case . . . . .	286
Pattern for an offsetting transition fitting with a square base and round top . . . . .	287

Pattern for a double offsetting transition fitting with a square base and round top . . . . .	289
Pattern for a furnace boot . . . . .	290
Pattern for a square to round roof collar . . . . .	295
Pattern for an offsetting furnace boot . . . . .	296
Pattern for a "Y" branch . . . . .	300
Pattern for a taper joint . . . . .	303
Patterns for flat skylights . . . . .	305
Patterns for hipped skylights . . . . .	310
Index . . . . .	321



# TIN, SHEET-IRON AND COPPER-PLATE WORKER.

## RULES FOR DESCRIBING PATTERNS.

### A CONE.

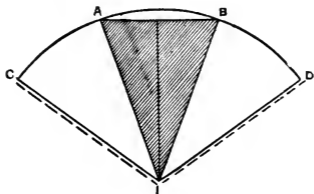

Fig. 1.

*To describe an Envelope for a Cone.*—Let ABI (Fig. 1) be the given cone. From I as centre, with the radius IA, describe the arc CD; make CD equal in length to the circumference of AB (which can be found by a reference to the table of the *Circumferences of Circles*); draw the lines CI and DI; then the figure CDI will be that of the required surface of the cone.

Edges for folding or lapping to be allowed, drawing the lines parallel to CI and DI, as shown by the dotted lines.

*To describe a Frustum of a Cone.*—Let AB (Fig. 2) equal diameter of large end; FH diameter of small end; GK altitude. Produce AF and BH until they meet at E; with E as centre, and the radii EF and EA, describe the arcs CD and IJ; set off CD equal to that portion of the cir-

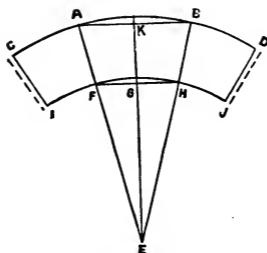

Fig. 2.

cumference of AB required for a pattern ; draw the lines CI and DJ, cutting the centre at E.

Edges for folding or lapping to be allowed, drawing the lines parallel to CI and DJ, as shown by the dotted lines.

OBS.—The term altitude denotes perpendicular height ; as from G to K in Fig. 2.

### CAN TOP OR DECK FLANGE.

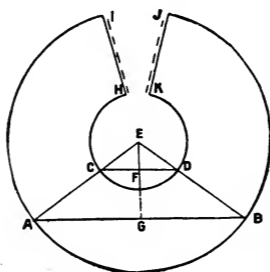

Fig. 3.

*To describe a Can Top or Deck Flange.*—Let AB (Fig. 3)

equal diameter of can, or base of a flange; CD diameter of opening in the top; FG altitude. Produce AC and BD until they meet at E; with E as centre, and the radii ED and EB, describe the curves IJ and HK; set off IJ equal to the circumference of the base AB; draw the lines IH and JK, cutting the centre at E.

Edges to be allowed.

## FRUSTUM OF A CONE.

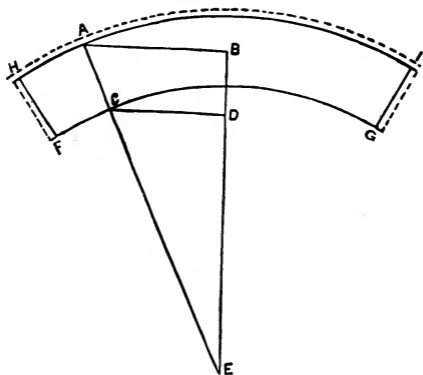

Fig 4

*To describe a Pattern for, or an Envelope for a Frustum of a Cone.*—Describe the right angle ABE (Fig. 4); make BD the altitude; draw the line CD at right angle to BE; make AB equal one-half the diameter of the large end, CD one-half the diameter of the small end; draw a line cutting the points A and C, and the line BE; with E as a centre and the radii EC and EA describe the arcs FG and HI; set off FG equal to that portion of the circumference of

the smallest end required for a pattern, draw the lines HF and IG, cutting the centre at E.

Edges for folding or lapping to be allowed, drawing the lines parallel to HF and IG.

When the work is to be riveted, punch the holes for the rivets on the lines HF and IG.

When the work is to be wired, or a flange laid off, it must be allowed as shown by the dotted lines over the arc HI.

### OVAL.

*To describe a pattern for a Tapering Oval Article, to be in Four Sections.*—Describe the bottom, the length and breadth required as in Fig. 5; describe the sides as in Figs. 6 and 7.

Describe the right angle ABC, Fig. 6; make BF the alti-

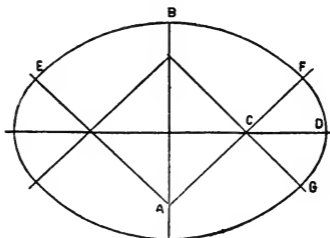

Fig. 5.

tude, draw the line DF at right angle to BC; make DF equal to AB in Fig. 5; make AB equal to DF and the taper required on a side, draw a line cutting the points A and D, and the line BC.

On any right line, as AB in Fig. 7, with the radii CD and CA, describe the arcs EF and CD, set off EF equal to EBF in Fig. 5; draw the lines CE and DF, cutting the centre at B.

Edges to be allowed.

Fig. 6, make EF equal to CD in Fig. 5 ; make GB equal to EF, and the taper required on a side ; draw a line cutting the points G and E, and the line BC.

On any right line, as AB in Fig. 7, with the radii HL

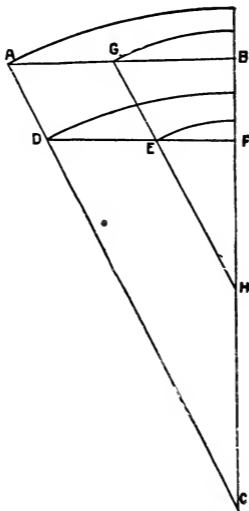

Fig. 6.

and LK, describe the arcs IK and GH ; set off IK equal to FDG in Fig. 5, draw the lines GI and HK, cutting the centre at L.

Edges to be allowed.

The taper must be equal on all sides.

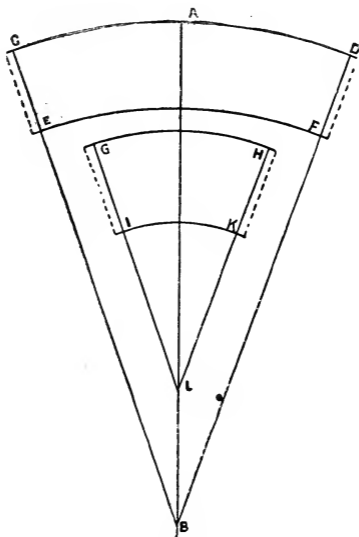

Fig. 7.

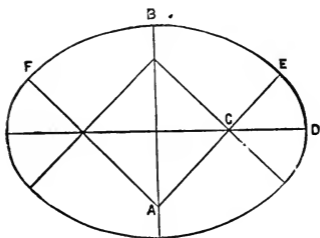

Fig. 8.

*To describe a Pattern for a Tapering Oval Article, to be in Two Sections.*—Describe the bottom, the length and breadth required as in Fig. 8; then describe the body as in Figs. 9 and 10.

Describe the right angle ABC, Fig. 9; make BE the alti-

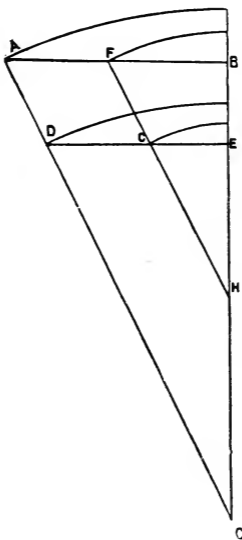

Fig. 9.

tude, draw the line DE at right angle to BC; make DE equal to AB in Fig. 8; make AB equal to DE and the taper required on a side, draw a line cutting the points A and D, and the line BC.

On any right line, as AB in Fig. 10, with the radii CE and CL, describe the arcs EF and CD; set off EF equal

to FBE in Fig. 8; draw the lines CE and DF, cutting the centre at B.

Fig. 9, make GE equal to CD in Fig. 8; make FB equal

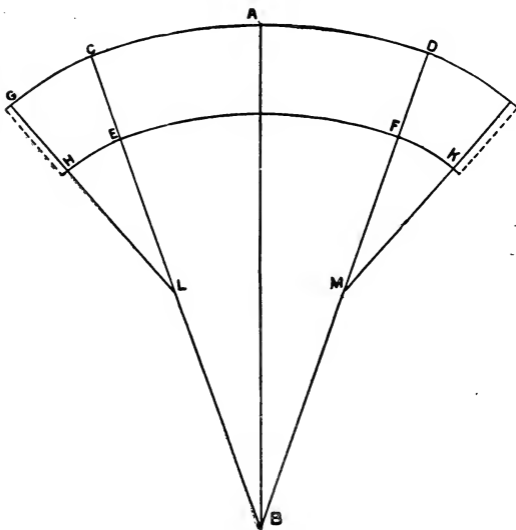

Fig. 10.

to GE, and the taper required on a side; draw a line cutting the points F and G, and the line BC; with the radius HG and, in Fig. 10, E and F as centres, cut the lines CB and DB, as at L and M; with L and M as centres describe the arcs FK and EH; also, the arcs DI and CG; set off FK and EH, equal to ED in Fig. 8; draw the lines IK and GH, cutting the centres at M and L.

Edges to be allowed.

The taper must be equal on all sides.



*To describe a Pattern for a Tapering Oval Article, to be*

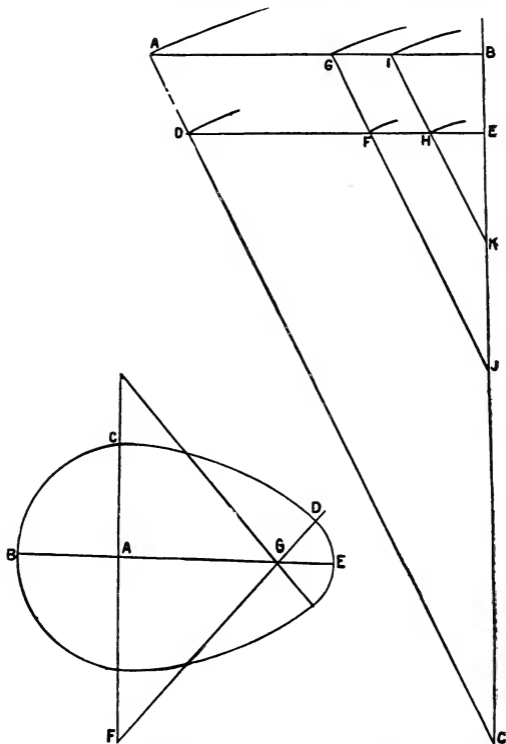

Fig. 11.

Fig. 12.

*in Two Sections.*—Describe the bottom, the length and breadth required as in Fig. 11, then describe the body as

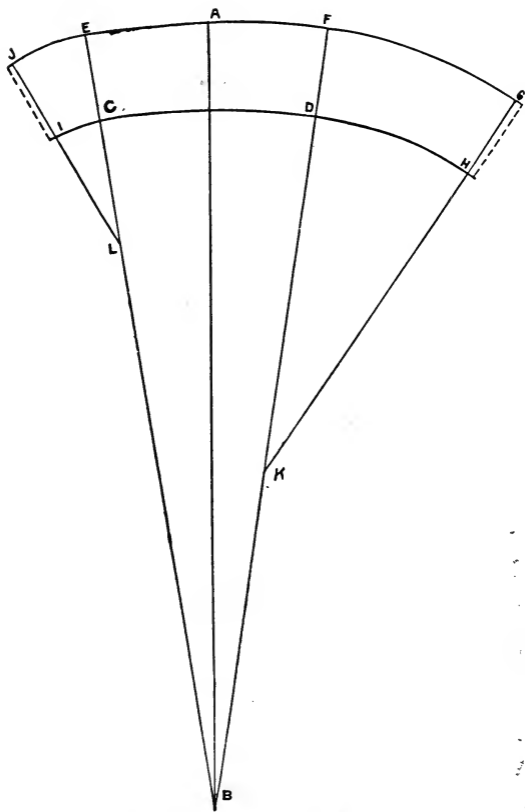

Fig 13.

in Figs. 12 and 13; describe the right angle ABC, Fig. 12; make BE the altitude, draw the line DE at right angle to BC; make DE equal to FC in Fig. 11; make AB equal to DE and the taper required on a side; draw a line cutting the points A and D, and the line BC.

On any right line, as AB in Fig. 13, with the radii CD and CA, describe the arcs CD and EF, set off CD equal to CD in Fig. 11; draw the lines EC and FD, cutting the centre at B.

Fig. 12, make FE equal to AC in Fig. 11; make GB equal to FE, and the taper required on a side, draw a line cutting the points G and F, and the line BC, with the radius JF, and in Fig. 13, D as a centre, cut the line FB, as at K; with K as a centre describe the arc DH; also, the arc FG; set off DH equal to BC in Fig. 11; draw the line GH, cutting the centre at K. Fig. 12, make HE equal to GE in Fig. 11; make IB equal to HE, and the taper required on a side; draw a line cutting the points I and H, and the line BC; with the radius KH, and in Fig. 13, C as a centre, cut the line EB, as at L; with L as a centre, describe the arc IC; also, the arc JE; set off IC equal to DE, in Fig. 11; draw the line JI, cutting the centre at L.

Edges to be allowed.

The taper must be equal on all sides.

*To describe a Pattern for a Tapering Oval Article.*—Describe the bottom, the length and breadth required as in Fig. 14; describe the body as in Figs. 15 and 16; describe the right angle ABC, Fig. 15; make BE the altitude, draw the line DE at right angle to BC; make FE equal HG in Fig. 14; make GB equal to FE and the taper required on a side; draw a line cutting the points G and F, and the line BC.

On any right line, as AB in Fig. 16, with the radii HF and HG, describe the arcs CD and EF, set off CD equal

to IGF in Fig. 14; draw the lines EC and FD, cutting the centre at G.

Fig. 15, make DE equal to AB in Fig. 14; make AB equal to DE, and the taper required on a side; draw a line cutting the points A and D, and the line BC; with the

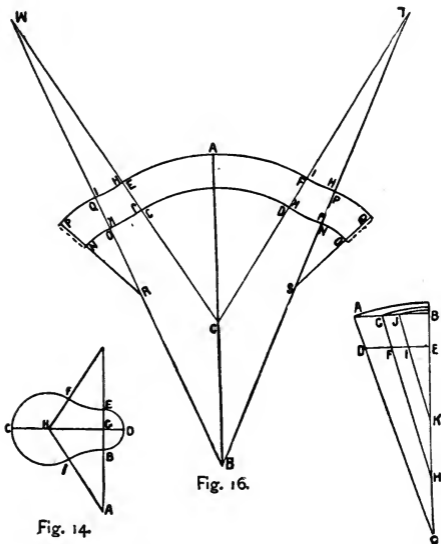

Fig. 16.

Fig. 14.

Fig. 15.

radius CD, and, in Fig. 16, with I and H as centres, cut the lines GL and GM, as at M and L; with M and L as centres, describe the arcs HI and HI; also, the arcs JK and JK; set off HI and HI equal to IB, in Fig. 14; draw the lines JH and KI, cutting the centres at L and M. Fig.

15, make IE equal to CD in Fig. 14; make JB equal to IE, and the taper required on a side, draw a line cutting the points J and I, and the line BC with the radius KI, and in Fig. 16, O and N as centres, cut the lines LB and MB, as at R and S; with R and S as centres, describe the arcs NO and NO, also, the arcs PQ and PQ; set off NO and NO equal to BD in Fig. 14; draw the lines QO and PN, cutting the centres at S and R.

Edges to be allowed.

The taper must be equal on all sides. The pattern can be cut in any number of sections.

Fig. 19.

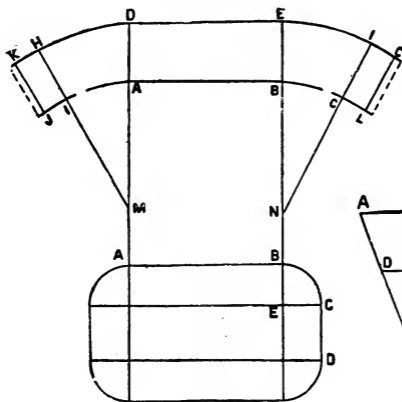

Fig. 17.

Fig. 18.

*To describe a Pattern for a Tapering Oval or Oblong Article, the Sides to be Straight with Quarter Circle Corners, to be in Two Sections.*—Describe the bottom, the length and breadth required as in Fig. 17; the body as in

Figs. 18 and 19; describe the right angle ABC, Fig. 18; make BE the altitude, draw the line DE at right angle to BC; make DE equal to EC in Fig. 17; make AB equal to DE and the taper required on a side, draw a line cutting the points A and D and the line BC.

Fig. 19, make AD and BE equal to AD in Fig. 18; make AB equal to AB in Fig. 17; draw the lines DM and EN, Fig. 18 with the radius CD, and in Fig. 19, A and B as centres, cut the lines DM and EN, as at M and N; with M and N as centres, describe the arcs BC and AI; also, the arcs EF and DH; set off BC and AI equal to BC, in Fig. 17; draw the lines HI and FC, cutting the centres M and N. Draw the lines FG and CL at right angle to FN; also, the line KH and JI at right angle to HM; make CL and JI equal to one-half of CD, in Fig. 17, draw the lines KJ and GL at right angle to KH and FG.

Edges to be allowed.

The taper to be equal on all sides.

*To describe a Pattern for a Tapering Oval or Oblong Article, the Sides to be Straight, one End to be a Semi-circle, the other End to be Straight with quarter Circle Corners, to be in Two Sections.*—Describe the bottom, the length and breadth required as in Fig. 20; the body as in Figs. 21 and 22; describe the right angle ABC, Fig. 21; make BG the altitude, draw the line DG at right angle to BC; make DG equal to AF in Fig. 20; make AB equal to DG and the taper required on a side; draw a line cutting the points A and D, and the line BC; make FG equal to GD in Fig. 20; make EB equal to FG and the taper required on a side; draw a line cutting the points E and F and the line BC.

Fig. 22, make AC and BD equal to DA in Fig. 21; make CD and AB equal to BC in Fig. 20; draw the lines CK and DL in Fig. 21; with the radius CD, and, in Fig. 22, A as a centre, cut the line CK as at K; with K as a centre, de-

scribe the arc AI, also, the arc CJ; set off AI equal to AB, in Fig. 20, draw the line JI, cutting the centre at K.

Fig. 21, with the radius HF, and in Fig. 22, B as a centre, cut the line DL, as at L; with L as a centre, describe the

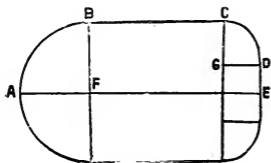

Fig. 20.

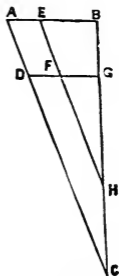

Fig. 21.

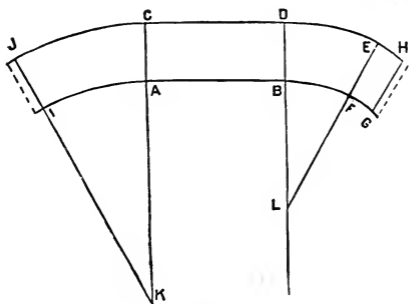

Fig. 22.

arc BF, also the arc DE; set off BF equal to CD, in Fig. 20; draw the line EF, cutting the centre at L; draw the lines FG and EH at right angles to EL; make FG, equal to DE, in Fig. 20; draw the line HG at right angle to EH.

Edges to be allowed.

The taper to be equal on all sides.

*To describe a Pattern for a Tapering Oval or Oblong Article, the Sides to be Straight, with Semi-circle Ends, to be in Two Sections.*—Describe the bottom, the length and

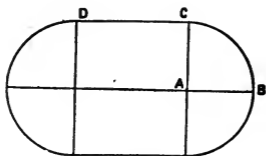

Fig. 23.

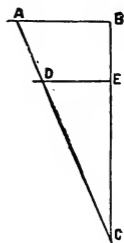

Fig. 24.

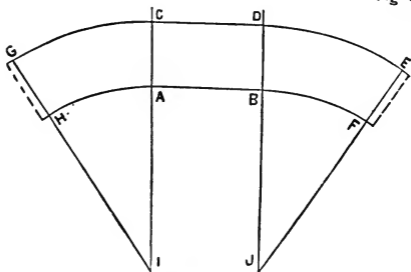

Fig. 25.

breadth required as in Fig. 23; the body as in Figs. 24 and 25.

Describe the right angle ABC, Fig. 24; make BE the altitude; draw the line DE at right angle to BC; make DE equal to AB in Fig. 23; make AB equal to DE and the taper required on a side; draw a line cutting the points A



and D, and the line BC, Fig. 25; make AC and BD equal to AD in Fig. 24.

Make AB and CD equal to DC in Fig. 23; draw the lines CI and DJ, Fig. 25; with the radius CD and, in Fig. 25, A and B as centres, cut the lines CI and DJ as at I and J; with I and J as centres, describe the arcs AH and BF; also, the arcs CG and DE; set off AH and BF equal to CB, in Fig. 23; draw the lines GH and EF, cutting the centre at I and J.

Edges to be allowed.

The taper to be equal on all sides.

In a large article it may be more convenient to lay out the end-pieces to fit the semi-circles, and join them to the sides, as at D and C, in Fig. 23.

*To describe a Pattern for a Fish-kettle with Straight Sides.*—Suppose Fig. 24 to be the shape of hollowing side and end-views, and Fig. 26 the shape of the kettle. Divide the length of curve from centre to end in an indefinite number of equal points, or take the length of curve with a strip of tin (which is the most accurate), then draw a line FG on a sheet of tin; set off the points equal in number to those round the curve at each side of the centre, which will be the length of the cover before it is hollowed (of course edging on must be allowed for). The same process must be gone through with regard to the width, but it is necessary to obtain the length of the curve at A, and the point taken as before and set off, as shown at H (Fig. 26). This done, we find that the sides of the pattern are a little curved, though they are wanted straight when finished. These curves may be made with the compasses, but to be perfectly true there should be a greater number of points, BCDE, taken, and curve drawn through the points by free hand. This process of obtaining a pattern cannot fail; it is certain to be right so long as the hollowing is done right. The same process will answer in describing patterns of

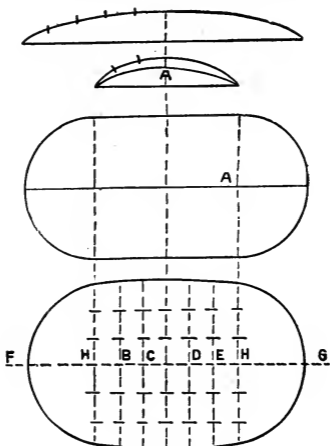

Fig. 26.

kettles with curved sides, *i. e.*, a true oval or ellipse. A round article will also be made the proper size, if the length of curve be taken at which the cover or bottom must be finished.

*To draw the Plan of an Oblong Taper Bath, the Size of the Top and Bottom, the Height, and the Slant at the Head being given.*—To draw DEFC (Fig. 29), the plan of the top: Draw AB equal to the given length of the top, and through A and B draw lines perpendicular to AB. Make AE and AD each equal to half the width of the top at the head of the bath, and BF and BC each equal to half the width of the top at the toe; and join EF and DC. Next from E mark off along EF and ED equal distances EG and EH, according to the size of the round corner required at the head. Through G and H draw lines perpendicular to EF



B' draw lines each perpendicular to AB; make A'E' and A'D' each equal to half the width of the bottom at the head, and B'F' and B'C' equal to half the width of the bottom at the toe. Join E'F' and D'C'. The round corner of the bottom at the head must be drawn in proportion to the round corner of the top at the head, and this is done as follows: Join EE' and produce it to meet AB in P and join HP by a line cutting D'E' in H; make E'G' equal to E'H', and complete the corner from centre O' obtained as was the centre O. Draw the other corners in a similar way, and this will complete the plan required. The D corner is like the E corner; the corners also at F and C correspond. Similarly with the E' and D', and F' and C' corners.

If the length of the bath is given and the length of slant at (but not its inclination) head or toe, the distance AA' can be found by drawing two lines A''A, A'A (Fig. 27) perpendicular to one another and meeting in A, and making AA'' equal to the given height; then, with A'' as centre and A''A', the given length of the slant at the head, as radius, describe an arc cutting AA' in A'. Then AA' is the distance required. Similarly (Fig. 28) the distance BB' can be found.

*To draw the Plan of a Hip-bath or of a Sitz-bath.*— Fig. 30 is a side elevation of the bath, drawn here only to make the problem clearer, not because it is necessary for the working.

The bottom of a hip-bath or a sitz-bath is an ordinary oval. The portion X'F of the top is parallel to the bottom A'B', and the whole XX' top, the portion FXE of the bath being removed, is also an ordinary oval. By the plan of the bath is meant the plan of XX'B'A' portion of it; no more being required for the drawing of the pattern of the bath.

We will first suppose the given dimensions to be those-

of the bottom and the  $XX'$  top of the bath, also height of the bath in front.

First draw  $A'D'B'C'$  (Fig. 31) the plan of the bottom by Fig. 8, p. 6. To draw the plan of the  $XX'$  top (Fig. 30):

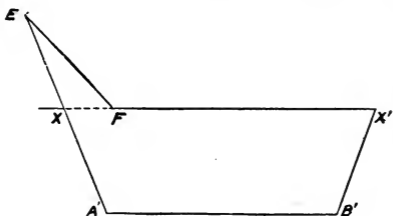

Fig. 30.

set off  $OA$  and  $OB$  each equal to half the given length of that top, and  $OC$  and  $OD$  each equal to half its given width. The plan of the  $XX'$  top can now be drawn as was that of the bottom. This completes, as stated above,

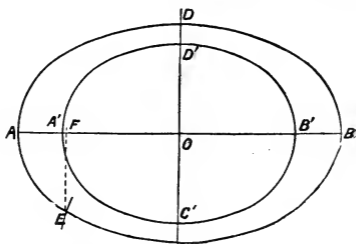

Fig. 31.

all that is necessary of the plan of the bath to enable its pattern to be drawn.

If the length of the  $XX'$  top (Fig. 30) is not given, but the inclination of the slant at front and back, these incli-

nations being the same, the required length can be determined as follows :

Make the angle  $AA'E$  (Fig. 32) equal to the given inclination. Through  $A'$  draw  $A'H$  perpendicular to  $AA'$  and equal to the given height of the bath in front ; through  $H$  draw  $HX$  parallel to  $AA'$  and cutting  $A'E$  in  $X$ , and draw  $XA$  perpendicular to  $AA'$ ; then  $AA'$  will be the distance in plan, at back and front, between the curve of the bottom and the curve of the  $XX'$  top. Make  $AA'$  (Fig. 31) and  $BB'$  each equal to  $AA'$  (Fig. 32); then  $AB$  will be the length required.

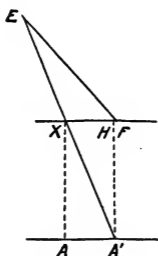

Fig. 32.



Fig. 33.

If the length of the  $XX'$  top of the bath (Fig. 30) is not given, nor the inclination of the slant at front and back, but only the length of the slant at front, the required length can be ascertained as follows :

Draw two lines  $XB$ ,  $B'B$  perpendicular to one another and meeting in  $B$ ; make  $BX$  equal to the given height of the bath in front, and with  $X$  as centre, and radius equal to the length of the slant at the front, describe an arc cutting  $BB'$  in  $B'$ . Make  $A'A$  and  $B'B$  (Fig. 31) each equal to  $BB'$  (Fig. 33), then  $AB$  is the length wanted. The remainder of the plan can be drawn as above described.

By a little addition to Fig. 32 we get at the back portion of the side elevation of the bath. It will be useful to do this. Produce  $A'X$  and make  $A'E$  equal to the slant at back, which must, of course, be given. Then on the plan (Fig. 31),  $E$  being the meeting point of the end and side curves of the oval  $ADBC$ , draw  $EF$  perpendicular to  $AB$ . Make  $XF$  (Fig. 32) equal to  $AF$  (Fig. 31); join  $FE$ ; this completes the elevation required.

*To describe a Frustum of an Oblique Pyramid.—I.* Given the plan of the frustum and its height.

Let  $ABCDD'A'B'C'$  (Fig. 34) be the plan of the frus-

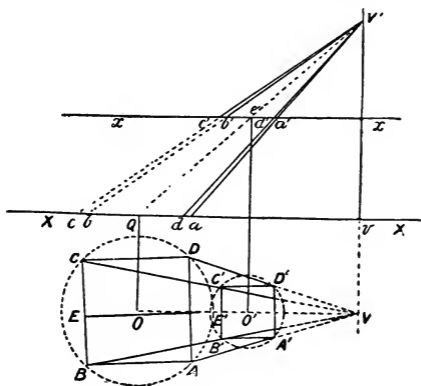

Fig. 34.

tum (here of a square pyramid). Produce  $AA'$ ,  $BB'$ , etc., the plans of the edges to meet in a point  $V$ ; this point is the plan of the apex of the pyramid of which the frustum is a part. Join  $O$ , the centre of the square which is the plan of the large end of the frustum, to  $V$ . The line  $OV$  will pass through  $o'$ , the centre of the plan of the small

end;  $OO'$  will be the plan of the axis of the frustum, and  $OV$  the plan of the axis of the pyramid of which the frustum is a portion.

Draw  $XX$  parallel to  $OV$ ; through  $V$  draw  $VV'$  perpendicular to  $XX$  and cutting it in  $v$ . Make  $vx$  equal to the given height of the frustum, and through  $x$  draw  $xx$  parallel to  $XX$ ; through  $O$  draw  $OQ$  perpendicular to  $XX$

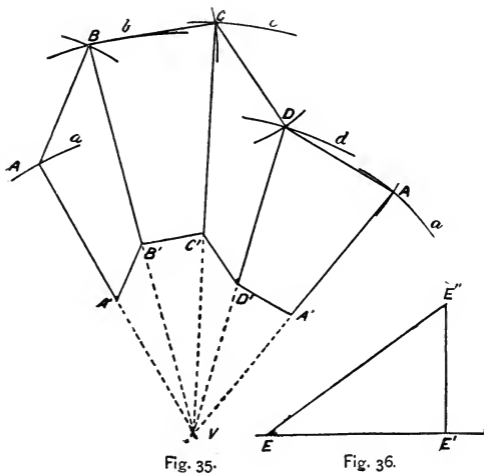

Fig. 35.

Fig. 36.

and meeting it in  $Q$ , and through  $O'$  draw  $O'Q'$  perpendicular to  $XX$  and cutting  $xx$  in  $q'$ . Join  $Qq'$  and produce it to intersect  $vV'$  in  $V'$ . Next make  $va, vb, vc, vd$ , equal to  $VA, VB, VC, VD$  respectively; join  $a, b, c$ , and  $d$  to  $V'$  by lines cutting  $xx$  in points  $d', b', c'$  and  $d$ ;  $ad', bb'$ , etc., are then the lengths of the edges of the frustum.

To draw the pattern with the seam at  $AA'$ : Draw  $VA$



(Fig. 35) equal to  $V'a$  (Fig. 34); with  $V$  as centre and  $V'b$  (Fig. 34) as radius describe an arc  $b$ , and with  $A$  as centre and  $AB$  (Fig. 34) as radius describe an arc intersecting arc  $b$  in  $B$ ; with  $V'c$  (Fig. 34) as radius and  $V$  as centre describe an arc  $c$ , and with  $BC$  (Fig. 34) and  $B'$  as centre describe an arc intersecting the arc  $c$  in  $C$ . Next with  $V'd$  and  $V'a$  (Fig. 34) as radii and  $V$  as centre describe arcs  $d$  and  $a$ ; with  $C$  as centre and radius  $CD$  (Fig. 34) describe an arc intersecting arc  $d$  in  $D$ ; and with  $DA$  (Fig. 34) as radius and  $D$  as centre describe an arc intersecting the arc  $a$  in  $A$ . Join  $A, B, C, D$ , and  $A$  to  $V$ ; make  $AA', BB', CC', DD'$  respectively equal to  $aa', bb', cc', dd'$ , (Fig. 34), and join  $AB, BC, CD, DA, A'B', B'C', C'D'$ , etc. Then  $ABCDA A'D'C'B'A'$  is the pattern required.

The dotted circles (Fig. 34) through the angular points of the plans of the ends show the plans of the ends of the frustum of the oblique cone which would envelop the frustum of the pyramid. From the similarity of the construction above to that for the pattern of a frustum of an oblique cone, it will be evident that the edges of the frustum have been treated as generating lines of the frustum of the oblique cone, in which the frustum of the pyramid could be inscribed.

Should it be inconvenient to draw  $XX$  in conjunction with the plan of the pyramid, draw  $XX$  quite apart, and from any point  $v$  in it draw  $vV'$  perpendicular to  $XX$ ; make  $vx$  equal to the height of the frustum and draw  $xx$  parallel to  $XX$ . Make  $va, vb, vc, vd$  equal to  $VA, VB, VC, VD$  (Fig. 35) respectively; and make  $xa', xb', xc', xd'$  equal to  $VA', VB', VC', VD'$ , (Fig. 34), respectively. Join  $aa', bb', cc'$  and  $dd'$  by lines produced to meet  $vV'$  in  $V'$ , and proceed as above stated.

II. Given the dimensions of the two ends of the frustum, the slant of one face and its inclination (the slant of

the face of a pyramid is a line meeting its end lines and perpendicular to them).

Draw (Fig. 36) a line  $EE''$  equal to the given slant, make the angle  $E''EE'$  equal to the given inclination and let fall  $E''E$  perpendicular to  $EE'$ . Draw  $ABCD$  (Fig. 34), the plan of the large end of the frustum, and let  $BC$  be the plan of the bottom edge of the face whose slant is given. Bisect  $BC$  in  $E$  and draw  $EE'$  perpendicular to  $BC$  and equal to  $EE'$  (Fig. 36). Through  $E'$  draw  $B'C'$  parallel to  $BC$ ; make  $EC'$  and  $E'B'$  each equal to half the length of the top edge of the  $BC$  face, through  $C'$  and  $B'$  draw  $C'D'$  and  $B'A'$  parallel to  $CD$  and  $BA$ ; make  $C'D'$  and  $B'A'$  each equal to  $B'C'$ ; join  $D'A'$ , also  $AA'$ ,  $BB'$ ,  $CC'$  and  $DD'$ : this will complete the plan of the frustum.  $E'E''$  (Fig. 36) is the height of the frustum. The remainder of the construction is now the same as in I.

*To describe without Long Radii a Frustum of an Oblique*

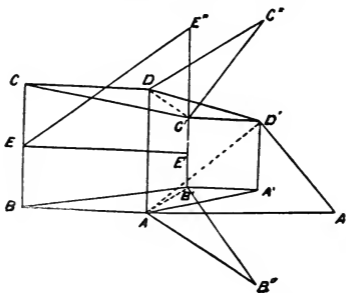

Fig. 37.

*Pyramid, the Plan of the Frustum and its Height being given.*

—Let  $ABCD D'A'B'C'$  (Fig. 37) be the plan of the frustum. From any point  $E$  in  $BC$  draw  $EE'$  perpendicular to  $BC$  and  $B'C'$  of the frustum. Draw  $E'E''$  perpendicular to  $EE'$  and equal to the height (which either is

given or can be found as in II. of last problem), and join  $EE''$ , then  $EE''$  is the true length of a slant of the face  $BCB'C'$  of the frustum. Join  $DC'$  and find its true length ( $DC''$ ) by drawing  $C'C''$  perpendicular to  $DC'$  and equal to the height of frustum and joining  $DC''$ . Next join  $D'A$  and  $B'A$ ; through  $D'$  and  $B'$  draw lines  $D'A''$ ,  $B'B''$  perpendicular to  $D'A$  and  $B'A$  respectively, and make  $D'A''$  and  $B'A''$  each equal to the given height of the frustum; join

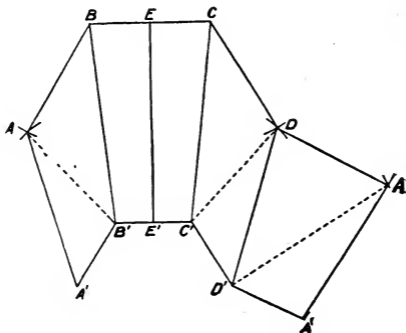

Fig. 38.

$AA''$  and  $AB''$ , then  $AA''$  and  $AB''$  are the true lengths of  $D'A$  and  $B'A$  respectively.

To draw the pattern of the face  $BCB'C'$  draw  $EE'$  (Fig. 38) equal to  $EE''$  (Fig. 37), and through  $E$  and  $E'$  draw  $BC$  and  $B'C'$  perpendicular to  $EE'$ . Make  $EC$ ,  $EB$ ,  $E'C'$  and  $E'B'$  equal to  $EC$ ,  $EB$ ,  $E'C'$  and  $E'B'$  (Fig. 37) respectively; join  $CC'$  and  $BB'$ ; this completes the pattern of the face. The patterns of the other faces are found as follows:

With  $C'$  (Fig. 38) and  $C$  as centres and  $DC''$  and  $CD$  (Fig. 37) as radii respectively, describe arcs intersecting

in D; join CD, draw  $C'D'$  parallel to CD and equal to  $C'D'$  (Fig. 37); and join  $DD'$ . With  $D'$  and D (Fig. 38) as centres and  $AA''$  and DA (Fig. 37) as radii respectively, describe arcs intersecting in A; join DA, draw  $D'A'$  parallel to DA and equal to  $D'A'$  (Fig. 37) as radii respectively, describe arcs intersecting in A; join DA, draw  $D'A'$  parallel to DA and equal to  $D'A'$  (Fig. 37), and join A to  $A'$ . Next with  $B'$  and B as centres and  $AB''$  and BA (Fig. 37) respectively as radii, describe arcs intersecting in A; join BA and draw  $B'A'$  parallel to BA and equal to  $B'A'$  (Fig. 37). Join  $AA'$ , and this will complete the pattern required.

*To draw the Pattern of a Hood.*—The plan of the hood

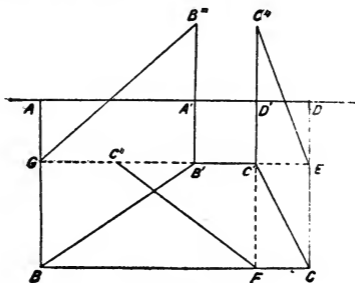

Fig. 39.

is necessarily given, or else the dimensions from which to draw it. Also the height of the hood, or the slant of one of its faces. The hood is here supposed to be a body of unequal taper with top and base parallel, but not a frustum of an oblique pyramid.

Let  $ABCD A' B' C' D'$  (Fig. 39) be the given plan of the hood (a hood of three faces), AD being the "wall line," AB and DC perpendicular to AD and BC parallel to it;

also let the length of  $FC''$ , a slant of face  $BB'C'C$ , be given. Draw  $C'F$  perpendicular to  $BC$  and through  $C'$  draw  $C'C''$  perpendicular to  $C''F$ , and with  $F$  as centre and radius equal to the given length, describe an arc cutting  $C'C''$  in  $C''$ . Join  $FC''$ ; then  $C'C''$  is the height of the hood which we need. If the height of the hood is given instead of the length  $FC''$ , make  $C'C''$  equal to the height and join  $FC''$ , which will be the true length of  $FC'$ . Next, through  $C'$  draw  $C'E$  perpendicular to  $CD$ ; draw  $C'C''$  perpendicular to  $C'E$ , make  $C'C''$  equal to the height and join  $EC''$ . Now produce  $C'B'$  to meet  $AB$  in  $G$ ; draw

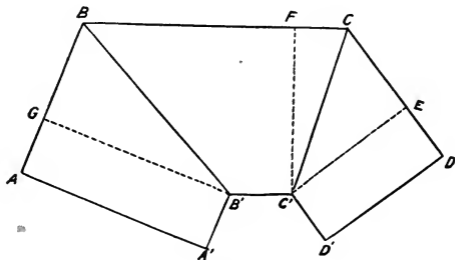

Fig. 40

$B'B''$  perpendicular to  $B'G$  and equal to the height and join  $GB''$ .

To draw the pattern of the hood: Draw  $FC'$  (Fig. 40) equal to  $FC''$  (Fig. 39); through  $F$  and  $C'$  draw  $BC$  and  $B'C'$ , each perpendicular to  $FC'$ ; make  $FB$  equal to  $FB$  (Fig. 39); make  $FC$  equal to  $FC$  (Fig. 39) and  $C'B'$  equal to  $C'B'$  (Fig. 39). Join  $BB'$  and  $CC'$ ; then  $BB'C'C$  will be the pattern of the face, of which  $BB'C'C$  (Fig. 39) is the plan.

To draw the pattern of the face  $C'D'DC$  (Fig. 39): With  $C'$  and  $C$  (Fig. 40) as centres and  $EC''$  and  $CE$  (Fig. 39) as radii respectively, describe arcs intersecting in  $E$ . Join

CE and produce it, making CD equal to CD (Fig. 39), and through C' draw C'D' parallel to CD and equal to C'D' (Fig. 39). Join DD', then C'CDD' is the pattern of the face of which C'CDD' (Fig. 39) is the plan. With B' and B as centres and radii respectively equal to B'G and BG (Fig. 39), describe arcs intersecting in G. Join BG and produce it, making BA equal to BA (Fig. 39), and through B' draw B'A' parallel to BA and equal to B'A' (Fig. 39). Join AA' and the pattern for the hood is complete.

*Covering of Circular Roofs, etc.*—Circular roofs may be covered upon two different principles :

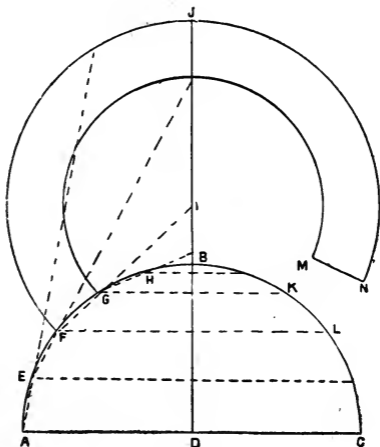

Fig. 41.

*First Method.* Assume the vertical section, or axis, to be divided into a number of equal parts, and the roof, or figure, cut by planes through the points of division par-

allel to the base; and then consider the portions of the figure as so many frustums of a cone; the surface of each frustum can then be determined as by Fig. 41, p. 30.

*Second Method.* Divide the circumference of the base into a number of equal parts, and assume sections to be made perpendicular through these points of division; then estimate the surface of each of these divisions on the surface of the figure.

*To cover a Dome by the First Method.*—Let ABC (Fig. 41) be the section of a dome. Draw the axis DB; produce to J; divide the curve of one-half the figure into

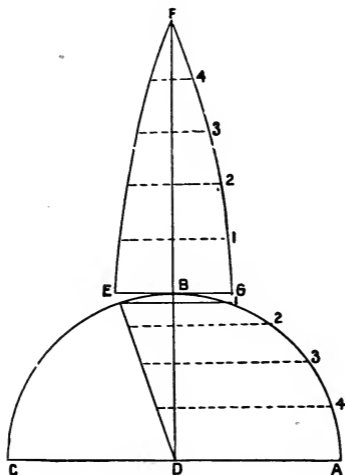

Fig. 42.

equal parts, as EFG and H, the width of these divisions being the width required by that of the metal with which

the dome is to be covered; produce AE, EF, FG, GH and HB severally, until they intersect the axis BD; then [for example] from the point I, with the radii IG and IF, describe the curves GM, FN; then set off that portion of the circumference of the base FL required for a pattern to cover the course FG.

In the same manner, the covering for the other portion can be found.

*To cover a Dome by the Second Method*—Let ABC, Fig. 42, be the section of a dome; then the length of a course

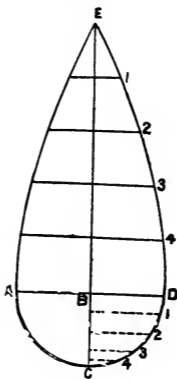

Fig. 43.

or covering is obtained as follows: The length of the course BF is equal to the curve AB, and EG the breadth of it; join ED, and the lines 1, 2, 3 and 4, intersected thereby, will be the half breadth (for the vertical BD) of the course at the corresponding lines on BF, through which points a line can be drawn which will give the form of the course required.



To ascertain the Outlines of a Course of Covering to a Dome, without reference to a Section of the Dome.—Let AB, Fig. 43, be the breadth of the course. Bisect it at B by the perpendicular CE; make BE equal to the length of the arc from the base of the dome to the top of it (which may be found either by measurement or calculation); divide the semi-circle ACD into any number of equal parts, and draw the lines parallel to BD; divide BE into the same number of equal parts, and draw lines parallel to AD; mark ordinates on each side of BE; as 1, 2, 3 and 4 equal to the lines of BCD, and a curve drawn through their terminations 1, 2, 3 and 4 on both sides will give the outline of the course.

Covering of a Hipped Roof.—In Fig. 44, *abcd* is the plan of a building to be covered by a hipped roof. To draw the plan of the roof bisect the angles of the parallelogram, and the bisectors meeting in *e* and *f* will form the plans of the hip-lines, and the line joining *e* and *f* will be the plan of the ridge. Let it now be required to project the elevation from this plan. Draw any horizontal, as AB, Fig. 45, and the perpendiculars from *c*, *e*, *f*, *d*, cutting AB in *g*, *h*, *i*, *j*, and produce *h* and *i* indefinitely. Produce the perpendicular at *e* until it reaches *l*; then it will be clear that *kl* is the width of the roof trusses (at *kl* and *mn*), which would be at right angles to *ab* and *cd*.

Draw *k'l'* (Fig. 46) equal to *kl* in Fig. 44, and at the middle point *O*, draw the perpendicular *op* equal to the real height of the truss, which is, of course, a matter dependent on the taste or defined purpose of the architect. This triangle will then be the shape of the truss at this point, and is the section *across* the roof.

Make *hq* and *ir* in Fig. 45 equal to *op* in Fig. 46, Draw *gq*, *qr* and *rj*, which will complete the elevation, and this will also be the longitudinal section through the ridge.

We now have to find the real length of the hip. To do this, draw  $fs$ , Fig. 44, equal to  $op$ , Fig. 46, and at right

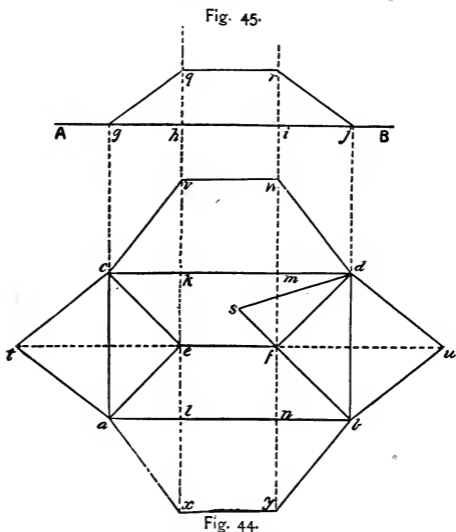

angles to  $fd$ . Join  $ds$ , then the right-angled triangle,  $dfs$ , is the true shape of the hip truss. This will be understood

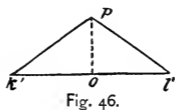

by cutting a piece of cardboard of the shape described and placing it on its edge,  $df$ . Then it will be seen that  $ds$  will be the length of the hip.

*In Developing the Covering of this Roof* it will, of course, be understood that the surface will consist of four planes, which will meet at the hip-lines. Now it has already been shown that the ends are triangles, of which  $a e c$  and  $b f d$  are the plans; the length of lines  $a c$  and  $b d$  remain unaltered, but the real length of  $c e$ ,  $a e$ ,  $b f$ ,  $d f$ , has been proved to be  $d s$ . Therefore on  $d b$  and  $a c$  construct isosceles triangles, having  $d s$  for the two remaining sides; these triangles, then,  $a t c$  and  $b n d$ , are *the true shape of the coverings of the ends of the roof*. Now from  $c$  and  $d$ , with radius  $c t$ , describe arcs cutting the perpendiculars  $k$  and  $m$  in  $v$  and  $w$ . Join  $d w$ ,  $v c$ , and  $w v$ . Then the trapezoid  $c v w d$  is the development of one of the planes forming the side of the roof-covering.

The same length set off on the perpendiculars  $l n$  will give the points  $x y$ , which will complete the fourth plane.

To find the form of the hip when the roof is a groined one: It will be clear that if a spectator stands on the platform of a railroad at the side of a semicircular arch by which a road is carried over it, he will then see that, while the face or elevation of the arch, where it crosses the railroad at right angles, is semicircular, its span being, of course, the diameter of the circle, of which it is half; the length from the springing near which he is standing, to the most distant springing (that is, the one on the opposite of the line at the other end of the arch) will be much longer; yet the arch there is not any higher, although its span, thus taken crosswise, is longer, because the diagonal of a square or other rectangle is longer than any one of its sides. The principle on which to find the curve which would reach from the springing at which the spectator is standing, to the one referred to, is also shown in Fig. 47.

On  $a b$  describe a semicircle, and from the points 1, 2, 3, 4 erect perpendiculars cutting the semicircle in  $1'$ ,  $2'$ ,  $3'$ ,  $4'$ , or mark off any divisions in the diagonal, and from

them draw perpendiculars to  $a b$ . Now from the points where the lines  $1', 2', 3', 4',$  etc., cut  $a c$  draw lines perpendicular to  $a c$ ; make each of these equal in height to those correspondingly lettered in the semicircle, and the

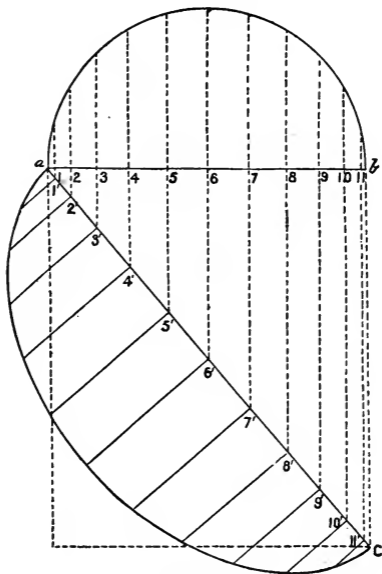

Fig. 47.

curve drawn through their extremities will be the form required.

In Fig. 48 ABCD is the plan of a building to be covered by a groined roof. The arch, the springing of which is AB and CD, is a semicylinder. The arch which has its

springing in AC and BD, being of the same height but of wider span, is semi-cylindroid.

A *cylindroid* is a solid body of the character of a cylinder; but whilst in a cylinder all sections taken at right angles to the axis are circles, in the cylindroid all such sections are ellipses. It is, in fact, a *flattened* cylinder. The

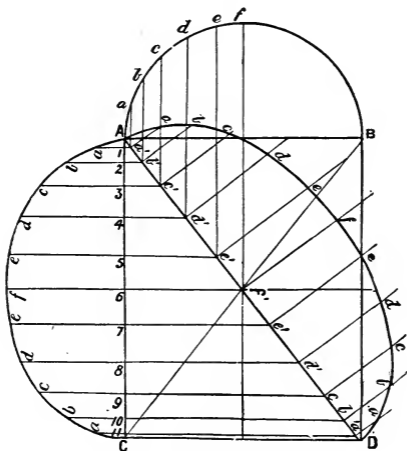

Fig. 48.

curve of the groin is then generated by the penetration of a cylindroid and cylinder.

On AB describe the semicircle which represents the face of the arch, at the ends AB and CD, and divide it into any number of equal parts, *a, b, c*, etc. It is only necessary to use the quadrant, as throughout the working the measurements are the same on each side. Draw the diagonals AD and BC. From *a, b, c, d, e, f* draw lines perpendicular to

AB, cutting the diagonal AD in  $a', b', c', d', e', f'$ , and set off the same distances on the other half of the diagonal.

From these points draw lines at right angles to AC, and passing through it in points 1, 2, 3, 4, 5, 6, 7, 8, 9, 10, 11. Mark off on the perpendicular 6 the height  $6f$ , equal to the height of the semicircle  $f$ , and on the perpendiculars 5, 4, 4, 3, 2, 1, mark off in succession the heights of the perpendiculars  $e, a, f, c, d, a$ , as contained between the semicircle and its diameter AB.

Set off the same heights on the corresponding perpendiculars, on the other side of  $6f$ , and the curve traced through these points will be a semi-ellipse, which is the section of the semi-cylindroid forming the arch of which AC and BD are the springings.

We now proceed to find the curve of the groin; and it will be evident that although the span is still further increased in length, the height of the different points in the curve will be the same as in both the previous elevations. The span then of the arch at the groin is the diagonal AD (or BC) to which the divisions  $a, b, c, d, e, f$ , have already been transferred from the semicircle, and from these the lines were carried at right angles to AC, on which the height of the points in the curve were set off.

These points, viz.,  $a', b', c', d', e', f'$ , in the diagonal, then, will be seen to be common to both arches, since they are the plans of the points in the roof where the cylindrical and cylindroidal bodies penetrate each other. At these points, therefore, draw lines perpendicular to the *diagonal*, and mark off on these the heights of the perpendiculars in the semicircle from which the points on which they stand were deduced. These extremities being connected, the curve so traced is the groin curve, and will give the shape for the centering of the groin, as the semicircle and semi-ellipse will for those used in the elevations of the arches.

It now only remains to develop the surfaces of these

arches; that is, to find the shape of tin, zinc or lead which would cover the roof of a building, when formed as here described.

The student is advised to work this study on a large scale on cardboard, and then to cut out the separate parts, which he can afterwards join at their edges, thus constructing an accurate model of the roof required.

As regards Fig. 49 draw any straight line, and, com-

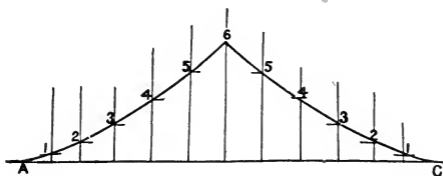

Fig 49

mencing at A, set off on it the distances into which the curve AC (Fig. 48) is divided—(measuring on the *curve*, not on the springing line)—namely, the distances A, *a b c*, etc.

At the points on the straight line thus marked, draw

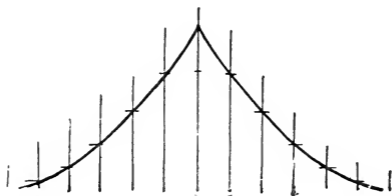

Fig. 50.

perpendiculars; make the middle one equal to  $6f$ ; those on  $ee$  equal to  $5e$ ; those on  $dd$  equal to  $4d$ ; those on  $cc$

equal to  $3c$ ; those on  $b b$  equal to  $2b$ , and those on  $a a$  equal to  $1a$ .

Join the extremities of these perpendiculars, and the curves meeting in a point, and joined by the original straight line, will form the development of the covering of the cylindroidal arch.

Fig. 50 is the development of the semicylindrical arch. As this is worked in precisely the same manner as the last, but taking the measurements from the semicircle, no further instructions are deemed necessary.

### SQUARE.

*To describe a Pattern for a Tapering Square Article.—*

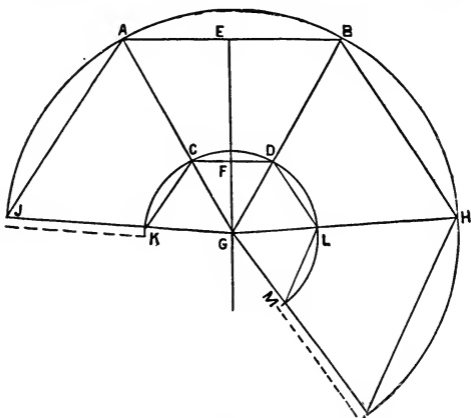

Fig. 51

Erect the perpendicular line  $GE$  (Fig. 51); draw the line  $AB$  at right angle to  $GE$ ; make  $EF$  equal to the slant height, and draw the line  $CD$  parallel to  $AB$ ; make  $AB$  equal in length to one side of the base; make  $CD$  equal in



length to one side of the top or smallest end ; draw the lines AG and BG, cutting the points AC and BD; with G as a centre and the radii GC and GA, describe the arcs KM and JI; set off on the arc JI, JA, BH, and HI equal in length to AB, and draw the lines JG, HG, and IG, also, the lines JA, BH, HI, and KC, DL, LM.

Edges to be allowed.

*To describe a Pattern for a Square Tapering Article, to be in Two Sections.*—Erect the perpendicular line EF (Fig. 52) equal to the slant height of the article ; draw the line

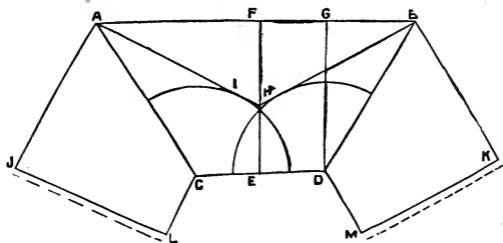

Fig 52.

AB at right angle to EF ; draw the line CD parallel to AB ; make AB equal in length to one side of the base ; make CD equal in length to one side of the top or smaller end ; draw the lines AC and BD ; C and D as centres, with a radius equal to one-half the difference of the two ends, as from B to G, describe the arcs I and H ; draw the right angle lines IAJ and HBK ; set off JA and KB equal to FB, and draw the lines JL and KM at right angles to JA and KB ; also, the lines LC and MD at right angles to LJ and MK.

Edges to be allowed.

#### SQUARE BASE WITH A CIRCULAR TOP.

*To describe a Pattern for a Tapering Article, the Base to*

*be Square, and the Top a Circle, to be in Two Sections.*—Erect the perpendicular line NF (Fig. 53); draw the line AB at right angle to NF; make EF equal to the slant height, and draw the line CD parallel to AB; make a AB

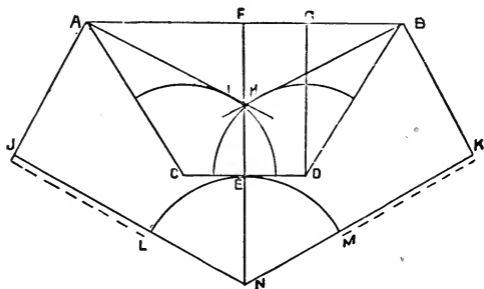

Fig. 53.

equal in length to one side of the base; make CD equal in length to one-fourth the circumference of the top, and draw the lines AC and BD; C and D as centres, with a radius equal to one-half the difference of the two ends describe the arcs I and H; draw the right-angle lines IAJ and HBK; set off JA and KB equal to FB, and draw the lines JN and KN at right angles to JA and KB; N as a centre, with the radius NE, describe the arc LEM.

Edges to be allowed.

#### RECTANGLE BASE WITH A SQUARE TOP.

*To describe a Pattern for a Tapering Article, the Base to be a Rectangle and the Top Square, to be in Two Sections.*—Erect the perpendicular line KC (Fig. 54); draw the line AB at right angle to KC; make KC equal to the slant height, and draw the line DE parallel to AB; make AB equal in length to the longest side of the base; make DE

equal in length to one side of the top ; draw the lines AD and BE ; make CG equal to one-half the shortest side of the base ; D and E as centres, with a radius equal to one-half

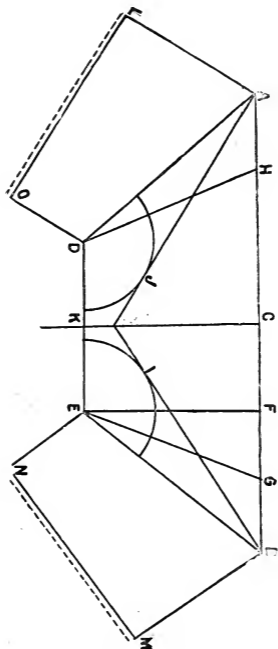

Fig. 54

the difference of the top and the shortest side of the base, as from G to F, describe the arcs J and I ; draw the right-angled lines JAL and IBM ; set off AL and BM equal in

length to CG, and draw the lines MN and LO at right angle to BM and LA; also, the lines NE and OD at right angle to NM and OL.

Edges to be allowed.

#### RECTANGLE BASE WITH A CIRCULAR TOP.

*To describe a Pattern for a Tapering Article, the Base to be a Rectangle, and the Top a Circle, to be in Two Sections.*—Erect the perpendicular line DC (Fig. 55); draw the line AB at right angle to DC; make CE equal to the slant height, and draw the line FG parallel to AB; make AB equal in length to the longest side of the base; make FG equal in length to one-fourth the circumference of the top; draw the lines AF and BG; make CK equal to one-half the shortest side of the base; erect the line LG parallel to EC; F and G as centres, with the radius KL, describe the arcs I and H; draw the right-angled lines HBN and IAM; set off BN and AM equal in length to CK, and draw the lines MD and ND at right angles to MA and NB; D as a centre, with the radius DE, describe the arc OEP.

Edges to be allowed.

#### RECTANGLE.

*To describe a Pattern for a Tapering Article, the Top and Base to be a Rectangle, to be in Two Sections.*—Erect the perpendicular line FE (Fig. 56); draw the line AB at right angle to FE; make FE equal to the slant height of the article, and draw the line CD parallel to AB; make AB equal in length to the longest side of the base; make CD equal in length to the longest side of the top; draw the lines AC and BD; make GH equal in length to the shortest side of the base; make JI equal in length to the shortest side of the top; draw the line HI; also, erect the line KI parallel to FE; C and D as centres, with the radius HK, describe the arcs M and L; draw the right-angled lines LBO



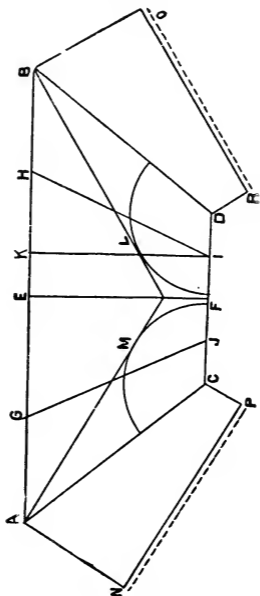

Fig. 56.

## OCTAGON.

*To describe a Pattern for Tapering Octagon Top or Cover.*  
 —Erect the perpendicular line GE (Fig. 57); draw the line AB at right angle to GE; make FE equal to the slant height of the article, and draw the line CD parallel to AB; make AB equal in length to one of the longest sides of the base; make CD equal in length to one of the longest sides of the top, and draw the lines AG and BG, cutting

the points AC and BD; G as a centre, with the radii GC and GA, describe the arcs SO and PN; set off QR, HJ and LN equal to AB; set off PQ, RA, BH and JL equal in length to one of the shortest sides of the base; draw the lines PS, QT, RU, etc., cutting the centre at G; draw the lines PQ, QR, ST, TU, etc.

Edges to be allowed.

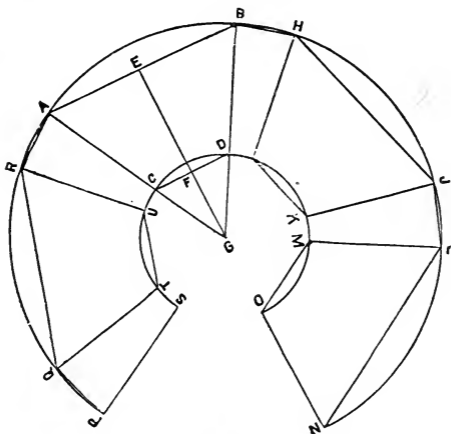

Fig. 57.

### GUTTER MITER JOINTS.

*To describe a Pattern for a Miter Joint at Right Angles for a Semicircle Gutter.*—Let the semicircle ACB (Fig. 58) be the breadth and depth of the gutter; draw the line AB; draw the lines AF and BE at right angle to AB; draw the line DE parallel to AB; make DF equal to AB, and draw the line FE; divide the semicircle into any number of equal parts; from the points draw lines parallel

to AF, as 1, 2, 3, etc., then set off the line AB (Fig. 59) equal in length to the semicircle ACB; erect the lines BD and AC at right angle to AB; set off on the line AB (Fig. 59) the same number of equal distances as in the semi-

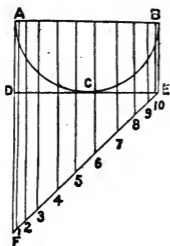

Fig. 58.

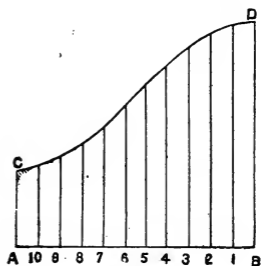

Fig. 59.

circle; from the points draw lines parallel to BD, as 1, 2, 3, etc., make BD equal in length to AF (Fig. 58), and AC equal in length to BE; also, each of the parallel lines bearing the same figure, as 1, 2, 3, etc.; then a line traced through the points will form the pattern required.

### MITER JOINTS.

*To describe a Pattern for a Miter Joint at any Angle for a Semicircle Gutter.*—Let ABC (Fig. 60) be the breadth and depth of the gutter; draw the line AC; draw the lines EG and DH, the angle required; draw the line ED, cutting the points E and D; divide the semicircle into any number of equal parts; from the points draw lines parallel to AE, as 1, 2, 3, etc. Then set off the line AB (Fig. 61) equal in length to the semicircle ABC; erect the lines AC and BD at right angle to AB; set off on the line AB, the same number of equal distances as in the semicircle ABC (Fig. 60); from the points draw lines parallel to BD, as 1, 2, 3, etc.



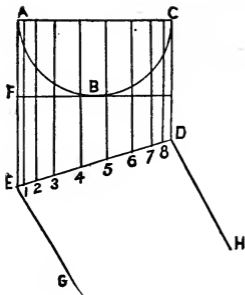

Fig. 60.

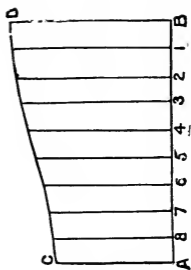

Fig. 61.

Make  $BD$  equal to  $EA$ , and  $AC$  equal to  $DC$ ; also, each of the parallel lines bearing the same figures as 1, 2, 3, etc.; then a line traced through the points will form the pattern.

*To describe a Pattern for a Miter Joint for an O G Gutter at Right Angles.*—Let  $ABCD$  (Fig. 62) be the given gutter; divide the curved line  $BC$  into any number of equal parts; from the points draw lines parallel to  $AD$ , as 1, 2, 3, etc.; then set off the right-angled line  $ABE$  (Fig. 63); make  $BF$  equal to  $AB$  (Fig. 62), and draw the line  $CF$  parallel to  $AB$ ; make  $AB$  and  $CF$  equal in length to  $AD$  (Fig. 62), and draw the line  $AC$ ; make  $FD$  equal in length to the curved line  $BC$  (Fig. 62); set off on the line  $FD$  the same number of equal distances, as in the curved line  $BC$  (Fig. 62); from the points draw lines parallel to  $CF$ , as 1, 2, 3, etc.; make  $CF$  equal to  $BE$  (Fig. 62); also, each of the parallel lines bearing the same figures, as 1, 2, 3, etc.; make  $DE$  equal to  $CD$ ; then a line traced through the points will form the pattern.

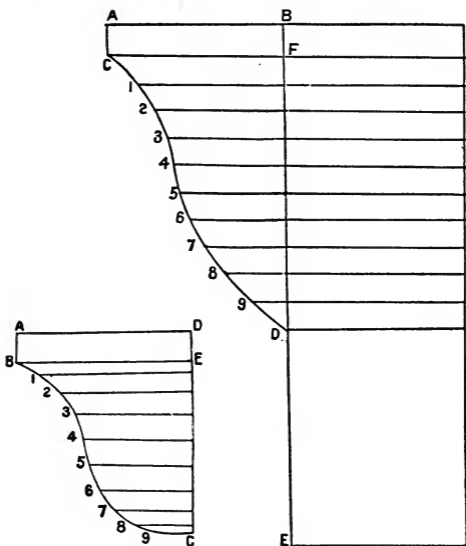

Fig. 62.

Fig. 63.

## CORNICE.

*To describe a Pattern for a Miter Joint for an O G Cornice at Right Angles; also an Offset.*—Describe the right-angled line AFE (Fig. 64); let ABCDE be the given cornice; divide the curved line BCH into any number of equal parts; from the points draw lines parallel to AF, as 1, 2, 3, etc. Then set off the right angle ABCF (Fig. 65); make CD equal to AB (Fig. 64); make DG equal in length to the curved line BCH (Fig. 64); make GE equal to HD (Fig. 64); make EF equal to DE; set off on the line DG

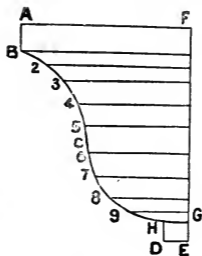

Fig 64.

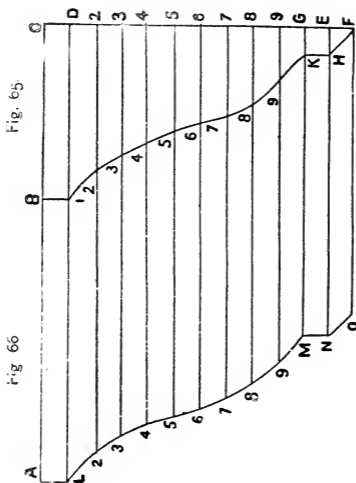

Fig. 65

Fig 66

the same number of equal distances as in the curved line BCH (Fig. 64); from the points draw lines parallel to BC, as 1, 2, 3, K, H, etc. Make BC and ID equal to AF (Fig. 64); also, each of the parallel lines bearing the same figures, as 2, 3, 4, etc.; make KG and HE equal to DE (Fig. 64); then a line traced through the points B, 1, 2, 3, 4, etc., and KHF will form the pattern for a Miter Joint.

When there is to be an offset or projection at right angles, let AB (Fig. 66) be the depth of the offset or projection; make each of the parallel lines the same in length as AB, LI, 2 2, 3 3, etc.; then a line traced through the points will form the pattern.

### OCTAGON.

*To describe a Pattern for an Octagon O G Lamp Top or*

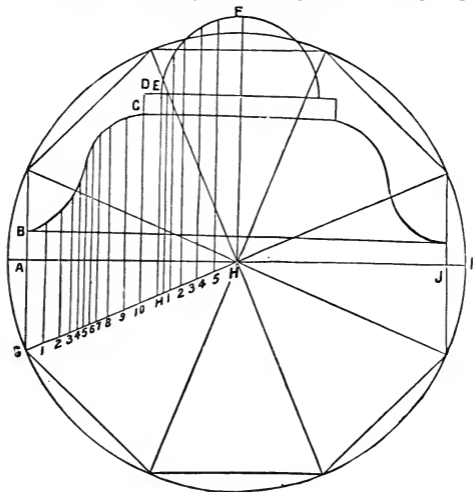

Fig 67.

*Cover.*—Describe a circle that will cut the required Octagon (Fig. 67); draw a line that will cut the centre of two sections, as AI; erect the perpendicular line HF; let ABCDEFJ be the given top or cover; divide the curved lines BC and EF into any number of equal parts; from the points draw lines parallel to FH, as 1, 2, 3, etc., H, 1, 2, 3, etc.

Set off the line AF (Fig. 68); draw the line GE at right angle to AF; make AB equal to AB in Fig. 67; make BC

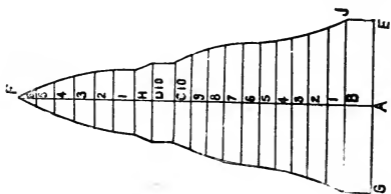

Fig. 68.

equal in length to the curved line BC (Fig. 67); divide BC into the same number of equal distances, as in the curved line BC (Fig. 67); from the points draw lines parallel to GE; make CD equal to CD (Fig. 67), and DH equal to DE (Fig. 67); make HF equal to the curved line EF (Fig. 67); divide HF into the same number of equal distances, as in the curved line EF; from the points draw lines parallel to GE; make AGAE and BIBJ equal to GA; also, each of the parallel lines bearing the same figures as 1, 2, 3, 4, 5, 6, 7, 8, 9, 10, 10, H, 1, 2, 3, 4, 5, 6; then a line traced through the points will form the pattern.

A Top may be described in any number of sections by this rule.

*To describe a Pattern for a Stand (Aquarium Stand, for instance), the Edge of which is a Moulding.*—Let ABCDD

$C'B'A'$  (Fig. 69), be the plan of the stand, and EFGH the front elevation. Through  $D'$  draw  $D'f'$  perpendicular to AD (the line  $D'f'$  will be a continuation of the line  $C'D'$ ); and on it draw  $f'cd''$ , the curve of the moulding,

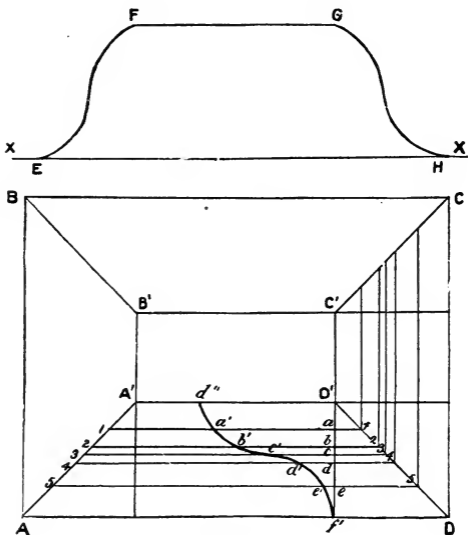

Fig. 69.

which divide into any number of parts, equal or unequal. The division here is into six equal parts, in the points  $a'$ ,  $b'$ ,  $c'$ ,  $d'$  and  $e'$ , but it may sometimes be advantageous that the division shall be into unequal parts. Through the points of division draw lines 1 to 1, 2 to 2, 3 to 3, 4 to 4, and 5 to 5, parallel to AD, the extremities of these lines

terminating in  $A'A$  and  $D'D$ , the "miter" lines of the plan. These "miter" lines  $A'A$  and  $E'D$  bisect respectively the angles  $BAD, CAD$ ; in fact, the "miter" lines of a moulding which is joined at any angle always bisect that angle. From the points 1, 2, 3, 4, and 5 on the line  $D'D$  draw lines parallel to  $DC$  and terminating in  $C'C$ . To draw the pattern for the  $A'DAD$  portion of the mould-

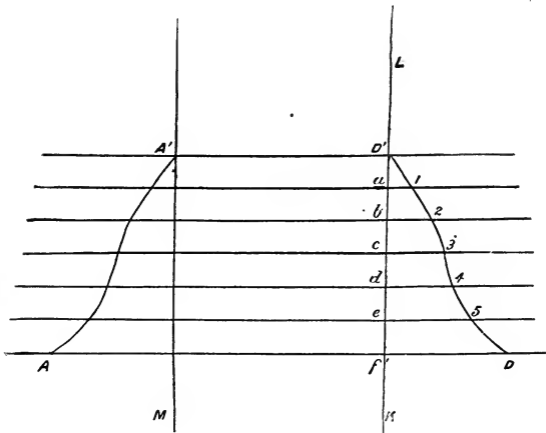

Fig. 70.

ing, draw (Fig. 70) any line  $KL$ , and from any point  $D'$  in it, set off distances  $D'a, ab, bc$ , etc., equal respectively to the distances  $d'a, d'b, d'c$ , etc.; round the curve  $d''d'f'$  (Fig. 69), and through the points  $D', a, b, c$ , etc., draw lines perpendicular to  $KL$ . Make  $a1$  equal to  $a1$  (Fig. 69), and  $b2, c3, d4, e5$ , and  $f'D$  respectively equal to the distances  $b2, c3, d4, e5$  and  $f'D$  (Fig. 69);

and through the points  $D' 1, 2, 3, 4, 5$  and  $D$  draw an unbroken curved line. Now from  $D'$  set off  $D'A'$  equal to  $D'A'$  (Fig. 69), and through  $A'$  draw  $A'M$  parallel to  $KL$ . From the points in  $A'M$ , where the lines through  $a, b, c$ , etc., cut  $A'M$ , set off distances to the left of the line corresponding to the distances  $a 1, b 2, c 3$ , etc., to the right of the line  $KL$ , and through the points thus found draw an unbroken curved line. Then  $A'D'AD$  will be the pattern for the  $A'D'AD$  (Fig. 69) portion of the stand.

To draw the pattern for the  $D'C'DC$  (Fig. 69) portion of the stand: It will be at once seen from the plan that this differs only from the  $A'D'AD$  portion in that the distance  $D'C'$  is less than the distance  $A'D'$ ; and thus, that if in Fig. 69 the lines  $A'M$  and  $LK$  are brought closer together, so that  $A'D'$  is equal to  $D'C'$  (Fig. 69), that the pattern so obtained will be the pattern for the  $D'C'DC$  piece of moulding.

It will be noticed that the elevation  $FGEH$  is not used in the working of the problem, although here drawn; that, indeed, it is unnecessary to draw an elevation.

## PIPES.

*To describe a T Pipe at Right Angles.*—Let  $ABCD$  (Fig. 71), be the length and diameter of the T; describe the semicircle  $CED$ ; divide the semicircle into any number of equal parts; from the points draw lines parallel to  $AC$ , as  $1, 2, 3$ , etc.; then set off the line  $ABC$  (Fig. 72), equal in length to the circumference of the pipe  $AB$ ; erect the lines  $AD, BE$  and  $CF$ ; set off on each side of  $BE$  the same number of equal distances, as in the semicircle  $CED$ ; from the points draw lines parallel to  $BE$ , as  $1 1, 2 2, 3 3$ , etc.; make  $AD, BE$  and  $CF$  equal to  $AC$  (Fig. 71); also, each of the parallel lines, bearing the same numbers as  $1 1$ ,



2 2, 3 3, etc.; then a line traced through the points will form the pattern required.

Edges to be allowed for folding or riveting.

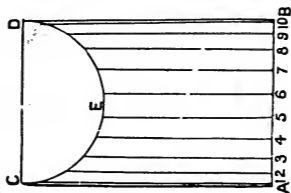

Fig. 71.

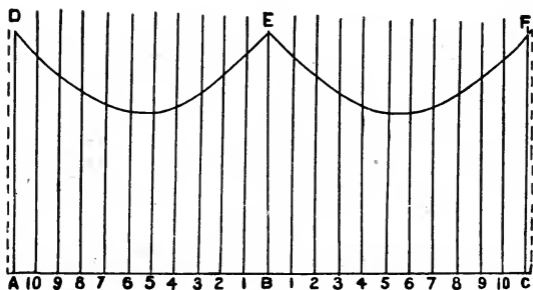

Fig. 72.

*To describe a Pattern for a T Pipe at any Angle.*—Draw the line AE (Fig. 73); erect the line AB, the angle required; also, the line ED parallel to AB; make BD equal to the diameter of the Pipe; describe the semicircle BCD; draw the line FG parallel to BD; divide the semicircle into any number of equal parts; from the points draw lines parallel to AB, as 1, 2, 3, etc.

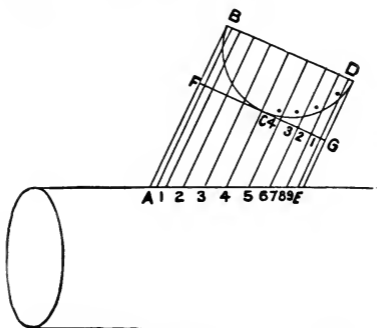

Fig. 73.

Set off the line ABC (Fig. 74) equal in length to the circumference of the Pipe; erect the lines AE, BD and

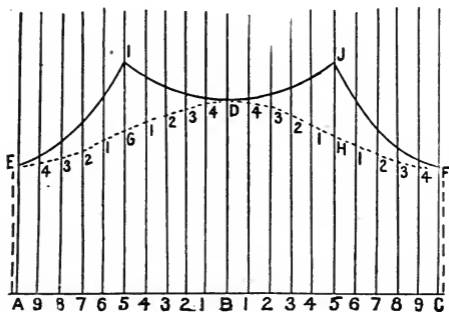

Fig. 74.

CF at right angles to AC; set off on each side of BD the same number of equal distances as in the semicircle BCD

(Fig. 73), and from the points draw lines parallel to BD, as 1 1, 2 2, 3 3, etc. Make BD equal to AB (Fig. 73), and EA and CF equal to ED (Fig. 73); also, each of the parallel lines, bearing the same figures as 1 1, 2 2, 3 3, etc. Make GI and HJ equal to GD (Fig. 73); also, each of the lines bearing the same figures as 1 1, 1 1, 2 2, 2 2, etc.; then a line traced through the points will form the required pattern.

Edges to be allowed.

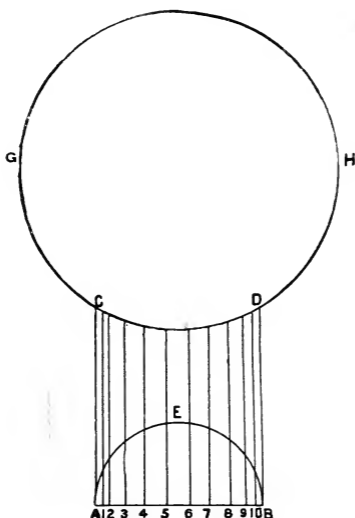

Fig. 75.

*To describe a Pattern for a T Pipe, the Collar to be Smaller than the Main Pipe.*—Let the circle GH (Fig. 75) equal the large pipe, AB, CD, the branch or collar; describe the

semicircle AEB; divide the semicircle into any number of equal parts; from the points draw lines parallel to AC, as 1, 2, 3, etc.

Set off the line ABC (Fig. 76) equal in length to the

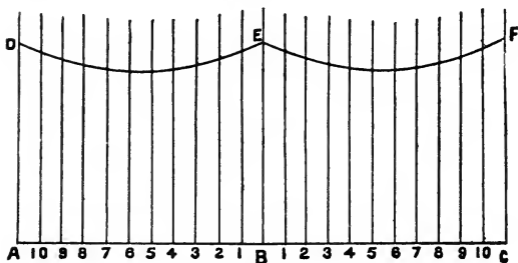

Fig. 76.

circumference of the collar AB; erect the perpendicular lines AD, BE and CF; set off on each side of BE the same

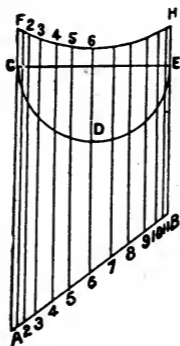

Fig. 77.

number of equal distances as in the semicircle; from the points draw lines parallel to BE, as 1, 1, 2, 2, etc.; make AD, BE and CF equal to AC and BD (Fig. 75); also, each of the parallel lines bearing the same figures, as 1, 1, 2, 2, 3, 3, etc.; then a line traced through the points will form the pattern.

Edges to be allowed.

*To describe a Pattern for a T Pipe at any Angle, the Collar to be Smaller than the Main Pipe.*—Let CE (Fig. 77) be the diameter of the collar, and AB the angle required; describe

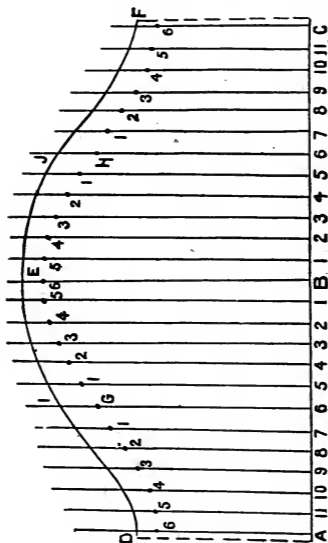

Fig. 78.

the semicircle CDE; make CF and EH of equal length; with a radius equal to one-half the diameter of the large pipe, describe the arc FH; divide the semicircle into any number of equal parts; from the points draw lines parallel to AC, as 1, 2, etc. There must be an odd number of lines, as in the diagram, so that one of the lines runs through the centre of the semicircle.

Set off the line ABC (Fig. 78) equal in length to the circumference of the collar, CE; erect the lines AD, BE

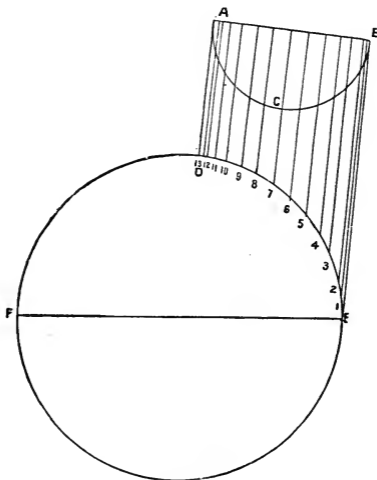

Fig. 79.

and CF; set off on each side of BE the same number of equal distances as in the semicircle, and from the points draw lines parallel to BE, as 1 1, 2 2, etc.; make BE equal

to AC in Fig. 77; make AD and CF equal to BE (Fig. 77); also, each of the parallel lines bearing the same figures; make GI and HJ equal to CF (Fig. 77); also, each of the parallel lines bearing the same figures, as 1 1, 1 1, 2 2, 2 2, etc.

A line traced through the last points will form the pattern.

Edges to be allowed.

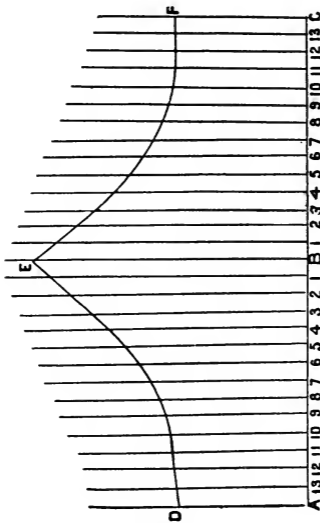

Fig. 80.

*To describe a Pattern for a T Pipe at any Angle, the Collar to be set on one side of the Main Pipe.*—Let the circle FE (Fig. 79) equal a large pipe or boiler; make AB equal to the diameter of the collar or branch pipe, BE the angle

required ; describe the semicircle ACB ; divide the semicircle into any number of equal parts ; from the points draw lines parallel to EB, as 1, 2, 3, etc.

Set off the line ABC (Fig. 80) equal in length to the circumference of the collar AB (Fig. 79) ; erect the perpendicular lines AD, BE and CF (Fig. 79) ; set off on each side of BE the same number of equal distances as in the semicircle ACB (Fig. 79) ; from the points draw lines parallel to BE ; make BE equal to EB (Fig. 79) ; make AD and CF equal to DA (Fig. 79) ; also, each of the parallel lines bearing the same figures, as 1 1, 2 2, 3 3, etc. Then a line traced through the points will form the pattern.

Edges to be allowed.

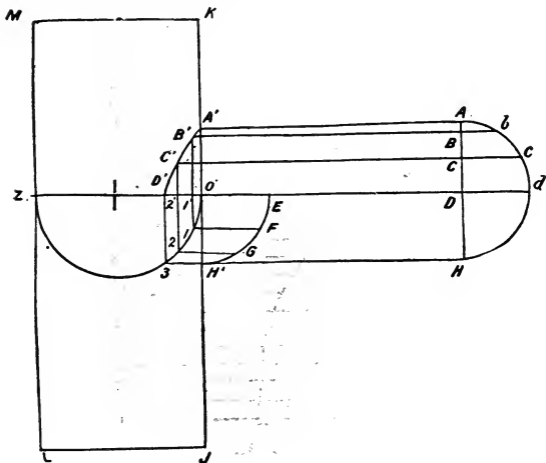

Fig. 81.

*To describe the Pattern for a T-piece formed by two equal or unequal circular Pipes (cylinders of equal or un-*



*equal diameter*), which meet at Right Angles.—First draw (Fig. 81) a side elevation and part-plan of the two circular pieces of pipe, which we will suppose unequal, as follows: Draw two indefinite lines  $Zd$  and  $KJ$ , intersecting each other at right angles in  $O$ . Make  $OZ$  equal to the diameter of the larger pipe, and through  $Z$  draw an indefinite line  $ML$  parallel to  $JK$ . Make  $OA'$  and  $OH'$  each equal to half the diameter of the smaller pipe, and through  $A'$  and  $H'$  draw indefinite lines  $A'A$  and  $H'H$ , each perpendicular to  $KJ$ . In  $A'A$  take any point  $A$ , on  $H'H$  set off  $H'H$  equal to  $A'A$ , and join  $AH$  cutting  $Od$  in  $D$ ; then  $A'A$   $HH'$  will represent, in elevation, a piece of the smaller pipe. Next, in  $A'K$  take any point  $K$ , and through  $K$  draw  $KM$  perpendicular to  $KJ$ , and meeting  $ML$  in  $M$ ; also, in  $H'J$  take any point  $J$ , and through  $J$  draw  $JL$  perpendicular to  $KJ$  and meeting  $ML$  in  $L$ ; then  $MKJL$  will represent, in elevation, a piece of the larger pipe, and  $MKA'AHH'JL$  a side elevation (except the curve of junction) of the T-piece. With  $D$  as centre and radius  $DA$ , that is, half the diameter of the smaller pipe, describe a semicircle  $AaH$ ; divide the quadrant  $Aa$  of it into any number of equal parts, here three, in the points  $b$  and  $c$ ; and through  $b$  and  $c$  draw indefinite lines  $bB'$  and  $cC'$  parallel to  $A'A$ . Now on  $ZO$  describe a semicircle  $Z_3O$  (this will be a part-plan of the large pipe), and with  $O$  as centre and radius  $DA$  describe a quadrant  $H'E$  (this may be regarded as a part-plan of the smaller pipe) which divide, exactly as quadrant  $Aa$  was divided in the points  $F$  and  $G$ ; through  $F$ ,  $G$ , and  $H'$  draw lines  $F_1$ ,  $G_2$ , and  $H'_3$  parallel to  $Zd$  and cutting the semicircle  $Z_3O$  in points 1, 2 and 3. Through point 1 draw a line  $1B'$  parallel to  $KJ$  and meeting  $bB'$  in  $B'$ ; through 2 draw  $2C'$  parallel to  $KJ$  and meeting  $cC'$  in  $C'$ ; and through 3 draw  $3D'$  parallel to  $KJ$  and meeting  $dD'$  in  $D'$ . From  $D'$  to  $A'$  through the points  $C'$  and  $B'$  draw an unbroken curved line, then  $A'C'D'$  is

the elevation of one-half of the curve of junction of the two pipes. In practice it is only necessary to draw the  $A'ODA$  (Fig. 81) portion of the elevation of the smaller pipe. The other half elevation  $H'ODH$  of it is drawn here simply to make the full side elevation of the T-piece clearer.

To get at the whole T-piece it is evident that two patterns are required, one for the smaller piece of pipe, up to

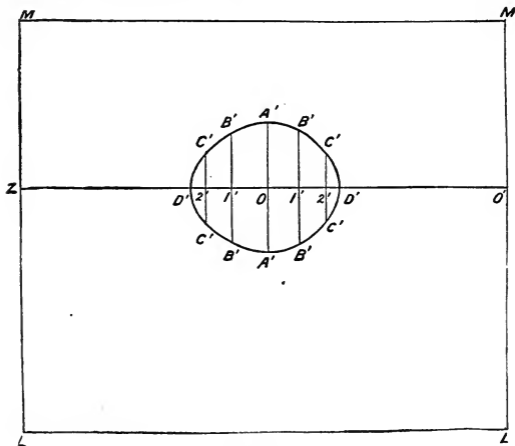

Fig. 82.

its junction with the larger, and one for the larger with the hole in it that the smaller pipe fits to.

To draw the pattern for the larger pipe with the longitudinal seam to correspond with the line  $ML$ , proceed as follows:

First set out, apart from the pipe itself, the shape for the hole in it. Draw (Fig. 82) two indefinite lines  $ZO'$

and  $A'A'$ , intersecting at right angles in  $O$ ; from  $O$ , on  $ZO$ , right and left of  $A'A'$ , set off distances  $O1'$ ,  $1'2'$  and  $2'D$  equal respectively to  $O1$ ,  $12$ , and  $23$  (Fig. 81), that is, to the actual distances on the round curve of the pipe at  $ZO$  that the lines  $1B'$ ,  $2C'$  and  $3D'$  are apart. Through points  $1'$  and  $2'$ , right and left of  $A'A'$ , draw  $B'B'$  and  $C'C'$  perpendicular to  $ZO'$ . Make  $1'B'$  above and below  $ZO$ , and right and left of  $A'A'$ , equal to  $1'B$  (Fig. 81); and make  $2'C'$ , above and below  $ZO'$ , and right and left of  $A'A'$ , equal to  $2'C$  (Fig. 81); and through all the points as above found, namely,  $D'C'B'$ ,  $A'$ ,  $B'C'D'$ ,  $C'$ ,  $B'$ , etc., draw an unbroken curved line; then  $D'A'D'A'D'$  will be the shape of the hole required.

To complete the pattern for the  $MKJL$  (Fig. 81) piece of the larger pipe, make  $OZ$  and  $OO'$  each equal to half its circumference; and through  $Z$  and  $O'$  draw indefinite lines  $ML$  perpendicular to  $ZO'$ . Make  $ZM$  of left-hand line  $ML$ , and  $O'M$  of right-hand line  $ML$ , each equal to  $ZM$  (Fig. 81); similarly make  $ZL$  and  $O'L$  each equal to  $ZL$  (Fig. 81). Then  $MLLM$  will complete the pattern required.

It has been shown how to mark out by itself the hole in the larger pipe, because in cases where the pipe is already made up, it is convenient to be able to mark out the shape of the hole apart from the pipe, on, say, a thin piece of sheet-metal, which shape can then be cut out and used as a template; being applied to the pipe and bent to it, and the shape of the hole marked on it from the template. Even when the pipe is not made up, it is useful when the pipe is large to be able to mark out the hole quite apart from the pipe itself.

To draw the pattern for the smaller piece of pipe, the longitudinal seam to correspond with the line  $A'A$  (Fig. 81), proceed as follows:

Draw (Fig. 83) an indefinite line  $AA$ . In it take any

point D, and from D, right and left, set off distances DC, CB, BA, equal respectively to  $dc$ ,  $cb$ , and  $ba$  (Fig. 81) that is, equal to one another; and from the point D and each of the points C, B, and A, draw lines perpendicular to AA. Make DD' equal to DD' (Fig. 81), and the lines CC', BB', AA', right and left of DD', equal respectively to CC', BB' and AA' (Fig. 81). From either point A to A' on the other side of DD', draw through B'C'D'C', and B', an unbroken curved line; then AA'A'A will be half the required pattern. The other half can be similarly drawn.

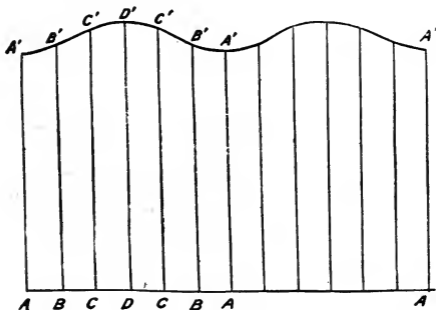

Fig. 83.

*To describe the Pattern for the T formed by a funnel-shape piece of Pipe and a circular piece, the former being square to the latter; the Diameter of the circular Pipe and the Diameters of the ends of the funnel-shape Pipe and its Length being given.*—By “being square” is meant that the axes of the pieces of pipe intersect and are at right angles. The given diameter of the smaller end of the funnel-shape pipe is the diameter in the direction of the length of the circular pipe, and that coincides with its surface.

First draw a side elevation and a part-plan of the T

thus: Draw (Fig. 84) any two indefinite lines  $Zd$  and  $KJ$ , intersecting at right angles at  $O$ . Make  $OZ$  equal to the diameter of the circular pipe, and through  $Z$  draw  $ML$

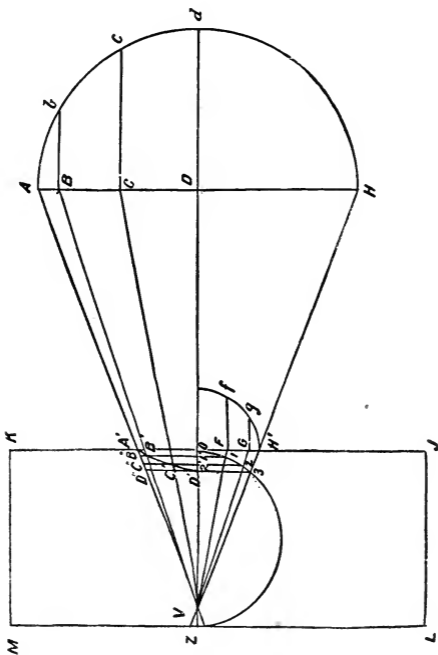

Fig. 84.

parallel to  $KJ$ ; make  $OD$  equal to the length of the funnel-shape pipe, and through  $D$  draw a line  $AH$  perpendicular to  $Od$ . Now make  $DA$  and  $DH$  each equal to half

the given diameter of its smaller end, which small end we will suppose is not let into, but fits against the circular pipe. Join  $AA'$  and  $HH'$ , then  $A'A$  and  $HH'$  will be, in elevation, the main portion of the funnel-shape pipe. Next in  $A'K$  take any point  $K$ , and through  $K$  draw  $KM$  perpendicular to  $KJ$  and meeting  $ML$  in  $M$ ; also, in  $H'J$  take any point  $J$ , and through  $J$  draw  $JL$  perpendicular to  $KJ$  and meeting  $ML$  in  $M$ ; then  $MKJL$  will represent, in elevation, a piece of the circular pipe; and  $MKA'AHH'JL$  a side elevation (except the curve of the junction) of the  $T$ . Produce  $AA'$  and  $HH'$  to intersect  $ZO$  in  $V$ ; with  $D$  as centre and radius  $DA$ , describe a semicircle  $AaH$ , and divide the quadrant  $Aa$  of it into any number of equal parts, here three, in the points  $b$  and  $c$ ; through  $b$  and  $c$  draw  $bB$  and  $cC$ , each perpendicular to  $AH$  and cutting it in  $B$  and  $C$ , and join  $BV$  and  $CV$ ; now on  $ZO$  describe a semicircle  $Z_3O$  (this will be a part-plan of the circular pipe), cutting  $VH'$  in point 3. With  $O$  as centre and radius  $OH'$ , describe a quadrant  $H'E$  (this may be regarded as a part-plan of the funnel-shape pipe), which divide into the same number of equal parts that the quadrant  $Aa$  is divided into, in the points  $f$  and  $g$ . Through  $f$  and  $g$  draw  $fF$  and  $gH$ , each perpendicular to  $A'H'$  and cutting it in  $F$  and  $G$ ; join  $FV$ ,  $GV$ , cutting the semicircle  $Z_3O$  in points 1 and 2 respectively. Through point 1 draw a line  $1B''$  parallel to  $KJ$ , meeting  $AV$  in  $B''$  and cutting  $ZO$  and  $BV$  in  $1'$  and  $B'$  respectively; through 2 draw  $2C''$  parallel to  $KJ$ , meeting  $AV$  in  $C''$ , and cutting  $ZO$  and  $CV$  in  $2'$  and  $C'$  respectively; and through 3 draw  $3D''$  parallel to  $KJ$ , cutting  $ZO$  in  $D'$  and meeting  $AV$  in  $D''$ . From  $D'$  through  $C'$  and  $B'$  to  $A'$  draw an unbroken curved line; then  $A'C'D'$  is the elevation of one-half the curve of junction of the two pipes. In practice it is only necessary to draw the  $OA'AD$  (Fig. 84) portion of the elevation of the smaller pipe. The other half elevation  $OH'HD$  of it is drawn here

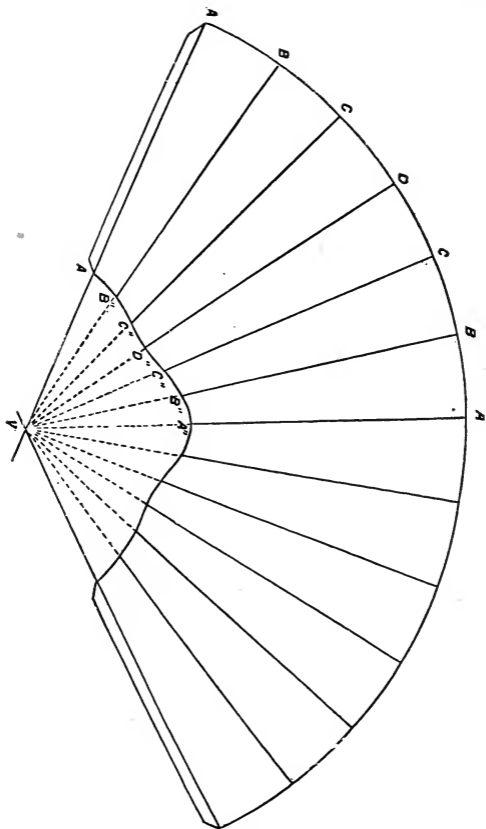

Fig. 85.

simply to make the full side elevation of the T clearer. It is evident that the T requires two patterns, one for the circular pipe with the hole in it that the funnel-shape pipe fits to, and one for the funnel-shape itself.

To draw the pattern for the circular pipe, the longitudinal seam to correspond with the line ML, proceed in exactly similar manner as explained for the pattern of the corresponding pipe in the preceding problem (p. 66).

To draw the pattern for the funnel-shape pipe, the longitudinal seam to correspond with the line AA' (Fig. 84), proceed as follows: With V (Fig. 85) as centre, and VA (Fig. 85) as radius, describe an arc AA, and from any point in it set off along the arc distances AB, BC, CD, DC, BC and BA, each equal to  $A\hat{b}$  (one of the equal parts into which quadrant  $\hat{d}A$  (Fig. 84) is divided). Join AV, BV, CV, DV, CV, BV and AV; and make the extreme lines AA' right and left of DV equal to AC'' (Fig. 85) and

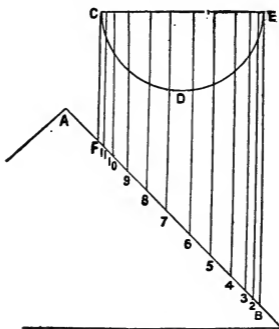

Fig. 86.

DD'' equal to AD'' (Fig. 84). Through points A', B'', C'', D'', C'', B'', A'' draw an unbroken curved line; then AA'





Then set off the line ABC (Fig. 87) equal in length to the circumference of the cylinder CE (Fig. 86); erect the perpendicular lines AD, BE and CF; set off on each side of BE the same number of equal distances, as in the semi-circle CDE (Fig. 86); from the points draw lines parallel to BE; make BE equal to BE (Fig. 86); make AD and CF equal to FC (Fig. 86); also, each of the parallel lines bearing the same number as 2 2, 3 3, 4 4, etc.; then a line traced through the points will form the pattern.

Edges to be allowed.

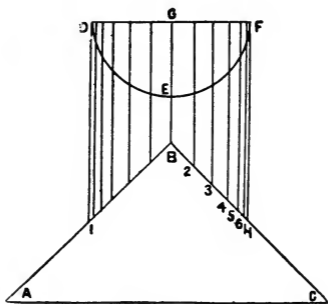

Fig. 88.

*To describe a Pattern for a Pipe to fit two Flat Surfaces, as the Roof of a Building.*—Let ABC (Fig. 88) equal the pitch of a roof; let DF, IH, be the pipe; draw the line BG parallel to HF; draw the line DF at right angle to HF; describe the semicircle DEF; divide one-half of the semicircle into any number of equal parts; from the points draw lines parallel to FH, as 2, 3, 4, etc.

Set off the line ABC (Fig. 89) equal in length to the circumference of the pipe DF; divide the line ABC into

four equal parts, and erect the lines AD, OI, BF, OI, CE; set off on each side of OI, OI, the same number of equal distances as in one-half of the semicircle; from the points draw lines parallel to BF; make AD, BF and CE equal to

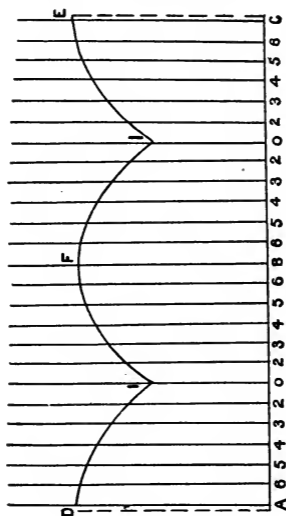

Fig. 89.

HF (Fig. 88); make OI, OI equal to BG (Fig. 88); also, each of the parallel lines bearing the same figures as 2 2, 2 2, 3 3, 3 3, etc.; then a line traced through the points will form the pattern.

Edges to be allowed.

*To describe the Form of a "Tapering Piece" of Piping, to join Two Pieces of Piping, which are both vertical, but not in the same axis, and which are of Different Diameters.—Let*



until they meet in  $O$ ; then if  $OC$  be produced until it is equal to  $OB$ , viz., to  $I$ , and  $IB$  be joined, it will be evident that  $OIB$  is the elevation of a cone placed obliquely on the lower cylinder, and which is cut off at  $BC$  and  $EF$ .

Now draw any diameter to the cylinder, as  $JK$ , and on it describe a semicircle, representing half of the section of the cylinder. Divide this semicircle into any number of equal parts, viz.,  $IMNPQ$ ; through these points draw perpendiculars cutting the line  $BC$  in  $l, m, n, p, q$ , and from  $l, m, n, p, q$ , draw lines to  $O$ .

Now from  $O$ , with radius  $On$ , describe an arc  $N'N''$ , and on this arc set off the lengths into which the semicircle is divided. From  $O$  draw radii through all these points, producing them beyond the arc  $N'N''$ ; from  $O$  as a centre, and with  $OB, Ol, Om, Op, Oq$ , and  $OC$  as radii, describe arcs cutting the radii, in Fig. 91, in  $C', q', p', n, n', l$  and

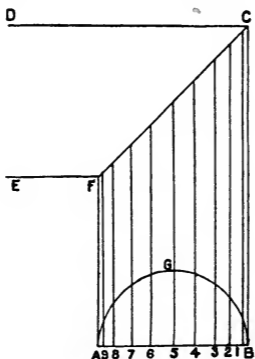

Fig. 92.

$B$ , etc., and the curve being drawn through these points will give the bottom of the tapering piece.

The upper piece is to be drawn in the same manner, and will be understood from the diagram.

## ELBOWS.

*To describe an Elbow at Right Angles.*—Let ABCD (Fig. 92) be the given elbow; draw the line AB at right angles to BC; draw the line FC; describe the semicircle AGB;

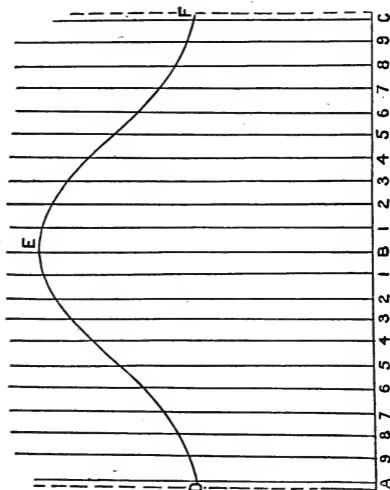

Fig. 93.

divide the semicircle into any number of equal parts; from the points draw lines parallel to BC, as 1, 2, 3, etc.

Set off the line ABC (Fig. 93) equal in length to the circumference of the elbow AB; erect the perpendicular lines AD, BE and CF; set off on each side of BE the

same number of equal distances, as in the semicircle AGB (Fig. 92); from the points draw lines parallel to BE; make BE equal to BC (Fig. 92); make AD and CF equal to AF (Fig. 92); also, each of the parallel lines bearing the same figures as 1 1, 2 2, 3 3, etc.; then a line traced through the points will form the pattern.

Edges to be allowed.

Patterns for Elbows may be described at any angle, by any of the Rules for cutting Elbow patterns; in laying out Elbow patterns let AB equal diameter of the Elbow, and BCD the angle.

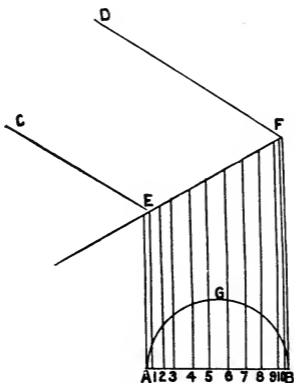

Fig. 94

*To describe an Elbow Pattern at any Angle.*—Let ABCD (Fig. 94) be the given elbow; draw the line AB at right angle to BF; draw the line EF; describe the semicircle AGB; divide the semicircle AGB into any number of equal parts; from the points draw lines parallel to BF, as 1, 2, 3, etc.

Set off the line ABC (Fig. 95) equal in length to the circumference of the elbow AB (Fig. 94); erect the perpendicular lines AF, BE and CD; set off on each side of BE the same number of equal distances, as in the semicircle

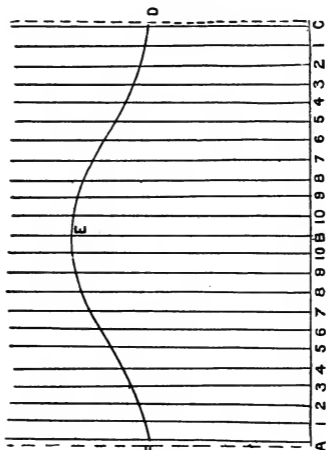

Fig. 95.

AGB (Fig. 94); from the points draw lines parallel to BE, as 1, 1, 2, 2, 3, 3, etc.; make BE equal to BF (Fig. 94); make AF and CD equal to AE; also, each of the parallel lines bearing the same figures as 1, 1, 2, 2, 3, 3, etc.

Then a line traced through the points will form the pattern.

Edges to be allowed.

*To describe a Pattern for an Elbow in Three Sections.*—Let ABED (Fig. 96) be the given elbow; draw the line FC; make FK equal to one-half the diameter of the elbow;





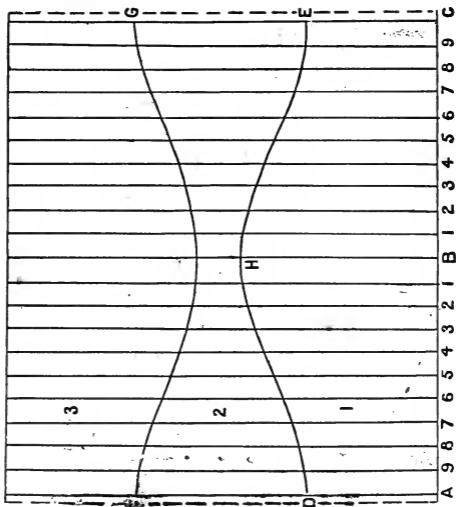

Fig. 97.

*To describe a Pattern for an Elbow in Four Sections.*— Let ABED (Fig. 98) be the given elbow; draw the line FC; make FM equal in length to one-half the diameter of the elbow; with F as a centre, describe the arc KL; divide the arc KL into three equal parts; draw the lines FH and FI; also the line IH; divide the section HK into two equal parts, and draw the line FG; draw the line AB at right angles to BC; describe the semicircle ANB; divide the semicircle into any number of equal parts; from the points draw lines parallel to BC, as 1, 2, 3, etc.

Set off the line ABC (Fig. 99) equal in length to the circumference of elbow AB; erect the lines AF, BD and





parts, and draw the line FK; draw the line AB at right angle to BC; describe the semicircle ANB; divide the semicircle into any number of equal parts; from the points draw lines parallel to BC, as 1, 2, 3, etc.

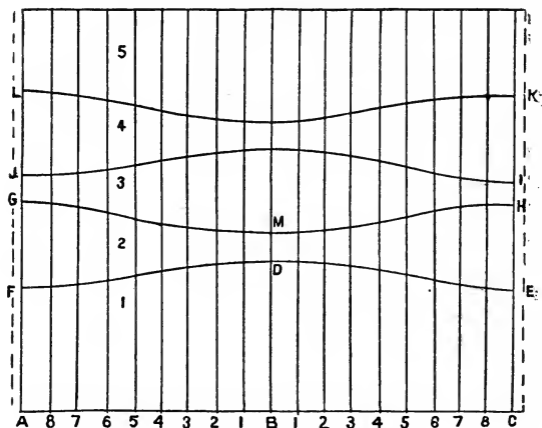

Fig. 101.

Set off the line ABC (Fig. 101) equal in length to the circumference of the elbow AB; erect the perpendicular lines AL, BD and CK; set off on each side of BD the same number of equal distances as in the semicircle ANB (Fig. 100); from the points draw lines parallel to BD, as 1, 1, 2, 2, etc.; make BD equal to BK; make AF and CE equal to AO; also, each of the parallel lines bearing the same number as 1, 1, 2, 2, 3, 3, etc.; then a line traced through the points will form Sec. 1. Make FG and EH equal to HI; reverse Sec. 1, place E at G and F at H, and trace a line from G to H; make GJ and HI

equal DM in Fig. 100; take Sec. 1 and place E at I and F at J, and trace a line from J to I; make JL and IK equal to HI; reverse Sec. 1, and place E at L and F

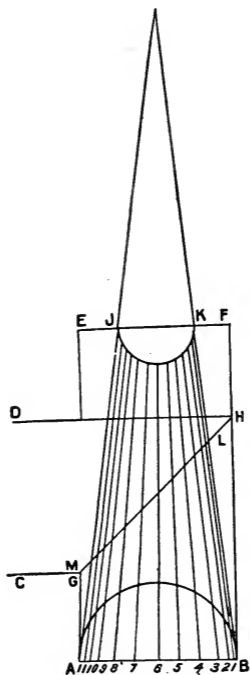

Fig. 102.

at K, and trace a line from L to K. This completes Sections Nos. 4 and 5. This completes the patterns. When

elbows are to be of heavy iron and riveted, punch the holes for the rivets on the lines FE, GH, JI and LK, allowing for the lap each side on Sections Nos. 2, 3, and 4.

*To describe a Pattern for a Tapering Elbow.*—Let AB and CD (Fig. 102) equal large end of elbow, DHB the angle; make HF equal CG, and EF equal AB; make JK

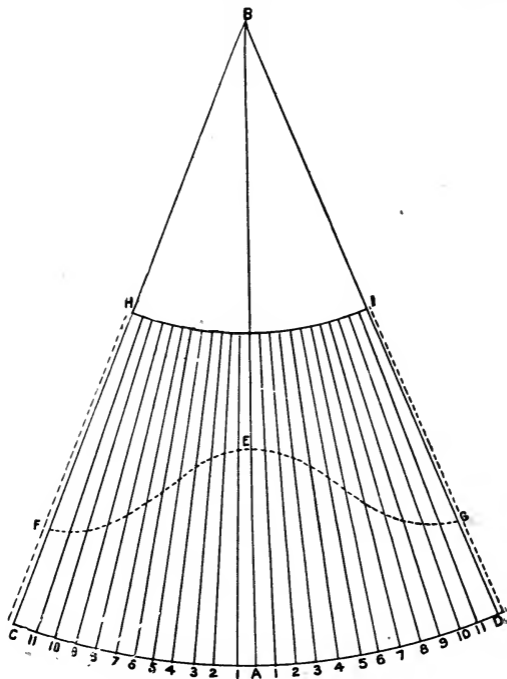

Fig. 103.

equal the small end of the elbow; draw the lines BK and AJ, and continue the lines until they intersect at I; describe the semicircles AB and JK; divide the semicircles into the same number of equal parts; from the points draw lines, as 1, 2, 3, etc.

On any line, as AB (Fig. 103), with the radii IK and IB (Fig. 102), describe the arcs HI and CD; set off CAD equal in length to the circumference of the large end AB; draw the lines CB and DB; set off on each side of AB the same number of equal distances as in the semicircle AB (Fig. 102); from the points draw lines cutting the centre at B; make AE equal to BL (Fig. 102); make CF and DG equal to AM (Fig. 102); also, each of the lines bearing the same figure as 1, 1, 2, 2, 3, 3, etc. Then a line traced through the points will form the pattern.

Edges to be allowed.

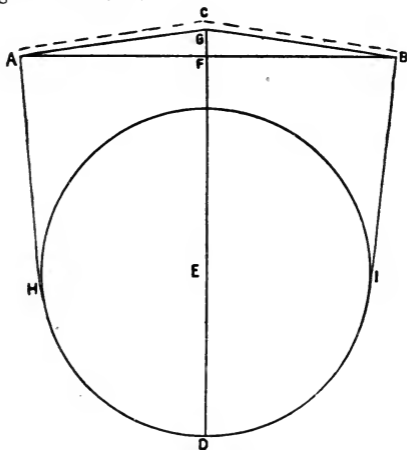

Fig. 104.



## BOILER COVER.

*To describe an Oval Boiler Cover.*—Erect the line DC (Fig. 104); make FD equal to one-half the length of the boiler bottom before the edge is turned; describe the circle HDI one-eighth of an inch larger in diameter than the breadth of the bottom; let FG be three-eighths of an inch; then apply the corner of the square on the line AB, allowing the blade to cut the circle at I and the tongue at the point G; draw the lines GB, BI, also the lines GA, AH; allow one-eighth of an inch for an edge, as shown by the dotted lines. The cover will be the same size as the bottom or pit.

## FLANGE.

*To describe a Pattern for a Flange for a Pipe that goes on the Roof of a Building, as Fig. 88.*—Let ABC (Fig. 105)

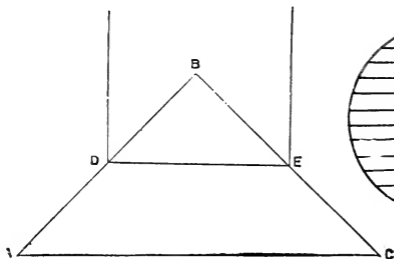

Fig. 105.

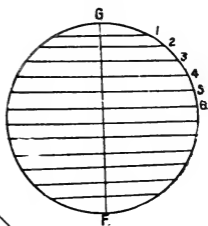

Fig. 106.

be the pitch of the roof; make DE equal to the diameter of the pipe; describe the circle FG (Fig. 106); make FG the same in diameter as the pipe; draw the line FG; set off on the line FG any number of equal parts; from the points draw lines at right angle to FG, as 1, 2, etc.

Set off the line HI (Fig. 107) equal in length to DBE in Fig. 105; set off on the line HI the same number of equal parts as in the line FG (Fig. 106); from the points draw lines at right angle to HI; set off on each side of HI the same distances as on each side of the line FG in Fig.

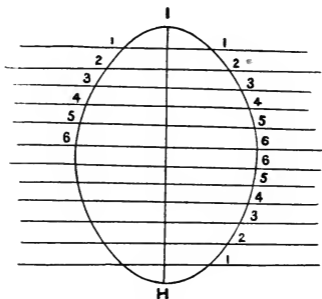

Fig. 107.

106, as 1, 1, 2, 2, etc.; a line traced through the points will form the piece to be cut out; when there is to be an edge turned up, it must be allowed inside of the line traced. The same rule is applied to describe a pattern for a flange for Fig. 86; make HI (Fig. 107) equal BF (Fig. 86), then proceed the same as described above.

### OCTAGON OR SQUARE TOP OR COVER.

*To describe an Octagon or Square Top or Cover.*—Describe a circle, three-quarters of an inch larger in diameter than a circle that will cut each corner of the article the top or cover is for; set off the squares from B to C (Fig. 108); take one-half of the largest square; and with B and C as centres, describe arcs G and H; then with A as centre, describe the arc cutting the square at I and the arc D;

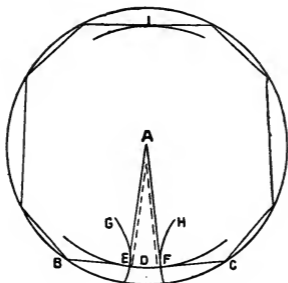

Fig. 108.

where the arcs GD and HD intersect, draw the lines AE and AF, also the lines BE and CF.

#### STEAMER COVER.

*To describe a Steamer Cover.*—Describe a circle one inch larger in diameter than the hoop after the edge is laid off; lay the hoop on the plate, allowing an edge each side, as

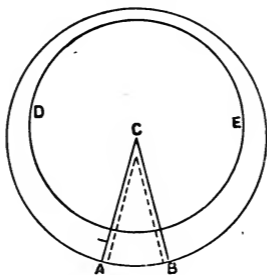

Fig. 109.

shown by the distance between the two circles and the dot on the line AC (Fig. 109), the circle DE representing the hoop; take the distance from A to the dot on the line AC,

and set off three times the distance on the outer circle, as from A to B; draw the lines AC and BC, cutting the centre at C.

Edges to be allowed.

### OVAL.

*To describe an Ellipse or Oval, having the Two Diameters given.*—On the intersection of the two diameters as a centre, with a radius equal to one-half the difference of the two diameters, describe the arc AB (Fig. 110), and from B as a centre, with half the chord ACB, describe the arc

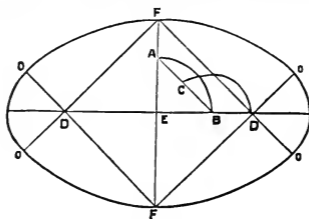

Fig. 110.

CD; from E as a centre with the distance ED cut the diameters at FF and DD; draw the lines FO, FO, FO, FO; then from F and F as centres, describe the arcs OO and OO; also, from D and D as centres, describe the smaller arcs OO and OO, which will complete the ellipse as required.

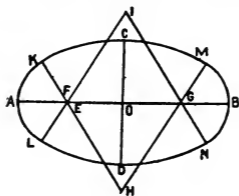

Fig. 111.

*To draw an Ellipse with the Rule and Compasses, the*

*transverse and conjugate Diameters being given; that is, the Length and Width.*—Let AB (Fig. 111) be the transverse or longest diameter; CD the conjugate or shortest diameter, and O the point of their intersection—that is, the centre of the ellipse. Take the distance OC or OD; and, taking A as one point, mark that distance AE upon the line AO; divide OE into three equal parts, and take from AF, a distance EF, equal to one of those parts; make OG equal to OF; with the radius FG, and F and G as centres, strike arcs which shall intersect each other in the points I and H; then draw the lines HFK, HGM, and IFL, IGN; with F as a centre, and the radius AF, describe the arc LAK; and, from G as a centre, with the same radius, describe the arc MBN; with the radius HC, and H as a centre, describe the arc KCM, and from the point I, with the radius ID, describe the arc LMD. The figure ACBD is an ellipse, formed of four arcs of circles.

*To draw an Egg-shaped Oval, having the Length and Width given.*—Make AB (Fig. 112) equal to the length of the oval, and from A set off AO equal to half its width. Through O draw an indefinite line QQ' perpendicular to AB, and with O as centre and OA as radius, describe the semicircle CAD. Join DB; and from D draw DE perpendicular to QQ' and equal to OD. Also, from E draw EG parallel to QQ' and intersecting DB in G, and from G draw GF parallel to DE and intersecting QQ' in F. From B set off BP equal to DF, and join PF. Bisect FP and through the point of bisection draw a line cutting QQ' in Q. Join QP and produce it indefinitely, and with Q as centre and QD as radius describe an arc meeting QP produced in H. Make OQ' equal to OQ, and join QP and produce it indefinitely. With Q' as centre, and Q'C (equal to QD) as radius, describe an arc meeting Q'P produced in H'. And with P as centre and PB as radius describe an



ABCD (Fig. 113) be an ellipse: it is required to find its centre; draw any two lines, as EF and GH, parallel and equal to each other; bisect these lines as in the points I and K, and bisect IK as in L; from L as a centre, draw a circle cutting the ellipse in four points, 1, 2, 3, 4; now L is the centre of the ellipse; but join the points 1, 3, and 2, 4; and bisect these lines as in M and N; draw the line MN, and produce it to A and B, and it will be the transverse axis; draw CD through L, and perpendicular to AB, and it will be the conjugate or shorter axis.

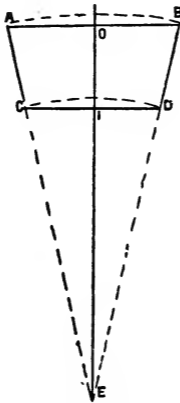

Fig. 114.

*To find the Radius and Versed Sine for a given Frustum of a Cone.*—Multiply the slant height by one-half the diameter of the large end, and divide the product by one-half the difference of the two ends, and the quotient is the radius. The versed sine is found by multiplying the altitude by one-half the diameter of the large end, and dividing

the product by one-half the difference of the two ends; then subtract the quotient from the radius, and the remainder is the versed sine.

The diameter AB (Fig. 114) equals 12 inches; CD equals 8 inches; the slant height DB equals 10 inches; required the radius:  $10 \times 6 = 60 \div 2 = 30$  inches, radius.

The diameter AB equals 12 inches; CD equals 8 inches; the altitude IO, 9.79 inches; required versed sine:  $9.79 \times 6 = 58.74 \div 2 = 29.37$ ;  $30 - 29.37 = .63$ , versed sine.

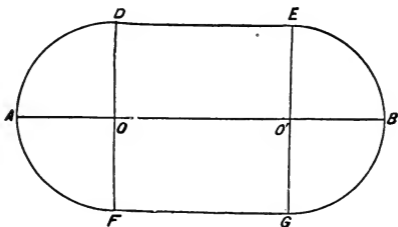

Fig. 115.

*To draw a Figure having Straight Sides and Semicircular Ends.*—Draw a line AB (Fig. 115) equal to the given length; make AO and BO' each equal to half the given width. Through O and O' draw indefinite lines perpendicular to AB; with O and O' as centres and OA as radius describe arcs cutting the perpendiculars through O and O' in DF and GE. Join DE, GF; this will complete the figure required.



## PRACTICAL GEOMETRY.

GEOMETRY is the science which investigates and demonstrates the properties of lines on surfaces and solids; hence, PRACTICAL GEOMETRY is the method of applying the rules of science to practical purposes.

*From any given point, in a straight line, to erect a perpendicular; or, to make a line at right angles with a given line.*—On each side of the point A (Fig. 116) from which the line is to be made, take equal distances, as AB, AC; and from B and C as centres, with any distance greater than BA or CA, describe arcs cutting each other at D; then will the line AD be the perpendicular required.

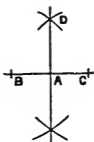

Fig. 116.

*When a perpendicular is to be made at or near the end of a given line.*—With any convenient radius, and with any distance from the given line AB (Fig. 117), describe a portion of a circle, as BAC, cutting the given point in A; draw, through the centre of the circle N, the line BNC; and a line from the point A, cutting the intersection at C, is the perpendicular required.

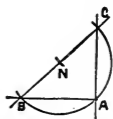

Fig. 117.

*To bisect a given line (divide a line into two equal parts).*—Let AB (Fig. 118) be the given line. With A as a centre and any radius greater than half its length, describe an indefinite arc; and with B as centre and same radius, describe an arc intersecting the former arc in points P and Q. Draw a line through P and Q; this will bisect AB.

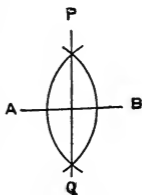

Fig. 118.  
(97)

*To divide a line into any number of equal parts.*—Let AB (Fig. 119) be the given line. From one of its extremities, say A, draw a line A3 at any angle to AB, and on it, from the angular point, mark off as many parts—of any convenient length, but all equal to each other—as AB is to be divided into. Say that AB is to be divided into three equal parts, and that the equal lengths marked off on A3 are A to 1, 1 to 2, and 2 to 3. Then join point 3 to the B extremity of AB, and through the other points of division, here 1 and 2, draw lines parallel to 3B, cutting AB in C and D. Then AB is divided as required.

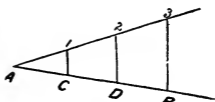

Fig. 119.

*To do the same otherwise.*—From the given point A (Fig. 120), with any convenient radius, describe the arc DCB; from D, cut the arc in C, and from C, cut the arc in B; also, from C and B as centres, describe arcs cutting each other in T; then will the line AT be the perpendicular as required.

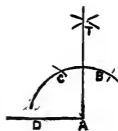

Fig. 120

NOTE.—When the three sides of a triangle are in the proportion of 3, 4, and 5 equal parts, respectively, two of the sides form a right angle; and observe, that in each of these or the preceding problems, the perpendiculars may be continued below the given lines, if necessarily required.

*To bisect any given angle.*—From the point A (Fig. 121) as a centre, with any radius less than the extent of the angle, describe an arc as CD; and from C and D as centres, describe arcs cutting each other at B; then will the line AB bisect the angle as required.

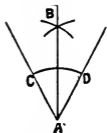

Fig. 121.

*To trisect (divide into three equal angles) a right angle.*—With centre B (Fig. 122) and any radius, describe the arc 1, 2; with the centres 1 and 2 and the same radius, describe the arcs 3 and 4. Draw B3 and B4 and the right angle will be trisected into three equal angles.

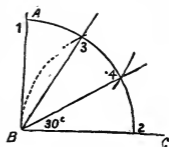

Fig. 122.

*To describe a triangle in a circle.*—From any point of the periphery (Fig. 123) describe with the radius of the circle an arc passing through the centre of the circle. By now joining the intersecting points *a* and *b* by a line, one side of the required triangle is obtained. With this line as a radius, describe arcs from *a* and *b*, intersecting in *c*; then join *a*, *b*, *c*, which will complete the required triangle.

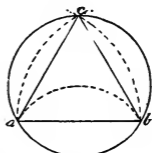

Fig. 123.

*To find the centre of a circle.*—Draw the chord *ab* (Fig. 124). From the terminal points of this chord describe, with any convenient radius, an arc intersecting in *c* and *d*; through the intersection draw a straight line meeting the circle in *e*. This line *ce* now contains a diameter, viz., *ef*, and by dividing this diameter into two equal parts, the centre (*o*) is found.

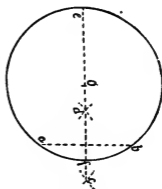

Fig. 124.

*To find the length of any given arc of a circle.*—With the radius AC (Fig. 125) equal to  $\frac{1}{4}$  the length of the chord of the arc AB, and from

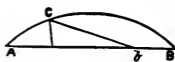

Fig. 125.

As a centre, cut the arc in C; also, from B as a centre, with equal radius, cut the chord in B; draw the line CB;

and twice the length of the line is the length of the arc nearly.

*To find the centre of a circle or radius, that shall cut any three given points, not in a direct line.*—From the middle point B (Fig. 126) as a centre, with any radius, as BC, BD, describe a portion of a circle, as CSD; and from R and T as centres, with an equal radius, cut the portion of the circle in CS and DS; draw lines through where the arcs cut each other; and the intersection of the lines at S is the centre of the circle as required.

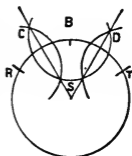

Fig. 126.

*Through any given point, to draw a tangent to a circle.*—Let the given point be at A (Fig. 127); draw the line AC, on which describe the semi-circle ADC; draw the line ADE, cutting the circumference in D, which is the tangent as required.

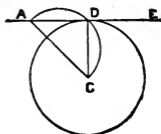

Fig. 127.

*To draw from or to the circumference of a circle lines tending towards the centre, when the centre is inaccessible.*

—Divide the whole or any given portion of the circumference into the desired number of equal parts; then, with any radius less than the distance of two divisions, describe arcs cutting each other, as  $A_1, B_1, C_2, D_2$ , etc. (Fig. 128); draw the lines  $C_1, B_2, D_3$ , etc., which lead to the centre as required.

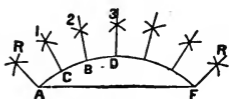

Fig. 128.

*To draw the end lines.*—As AR, FR; from C describe the arc R, and with the radius CI, from A or F as centres, cut the former arcs at R, or R', and the lines AR, FR, will tend to the centre as required.

To describe an arc or segment of a circle of large radii.—Of any suitable material, construct a triangle, as ABC (Fig. 129); make AB, BC, each equal in length to the chord of the arc DE, and in height twice that of the arc

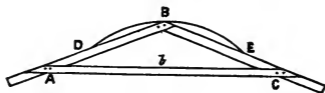

Fig. 129.

BB. At each end of the chord DE fix a pin, and at B, in the triangle, fix a tracer (as a pencil), move the triangle along the pins as guides; and the traces will describe the arc required.

Or otherwise.—Draw the chord ACB (Fig. 130); also, draw the line HDI, parallel with the chord, and equal to the height of the segment;



Fig. 130.

bisect the chord in C, and erect the perpendicular CD; join AD, DB; draw AH perpendicular to AD, and BI perpendicular to BD; erect also the perpendiculars An and Bn; divide AB and HI into any number of equal parts; draw the lines 1, 1, 2, 2, 3, 3, etc.; likewise divide the lines An, Bn, each into half the number of equal parts; draw lines to D from each division in the lines An, Bn, and through where they intersect the former lines describe a curve, which will be the arc or segment required.

To describe a parabola, the dimensions being given.—Let AB (Fig. 131) equal the length, and CD the breadth of

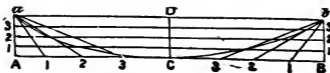

Fig. 131.

the required parabola; divide CA, CB into any number of equal parts; also, divide the perpendiculars A a and B b into the same number of equal parts; then from a and b draw lines meeting each division on the line ACB, and a curve line drawn through each intersection will form the parabola required.

*To describe an elliptic arch, the width and rise of span being given.—*

Bisect with a line at right angles the chord or span AB (Fig. 132); erect the perpendicular A q, and draw the line q D equal and parallel to AC, bisect AC and A q in r and n; make C l equal to CD, and draw the line l r q; draw also the line n s D; bisect s D with a line at right angles, and meeting the line CD in g; draw the line g q, make CP equal to C k, and draw the line g P i; then from g as a centre, with the radius g D, describe the arc s D i; and from k and P as centres, with the radius A k, describe the arcs A s and B i, which completes the arch as required. Or,

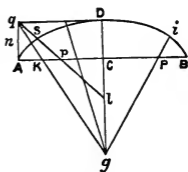

Fig. 132.

Bisect the chord AB (Fig. 133), and fix at right angles any straight guide, as b c; prepare, of any suitable material, a rod or staff, equal to half the chord's length, as d e f; from the end of the staff, equal to the height of the arch, fix a pin e,

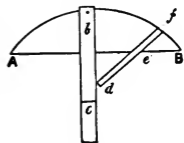

Fig. 133.

and at the extremity a tracer f; move the staff, keeping its end to the guide and the fixed pin to the chord; and the tracer will describe one-half the arc required.

*To obtain by measurement the length of any direct line, though intercepted by some material object.—*Suppose the distance between A and B (Fig. 134) is required, but the

right line is intercepted by the object C. On the point  $d$ , with any convenient radius, describe the arc  $cc$ ; make the arc twice the radius in length, through which draw the line  $dce$ , and on  $e$  describe another arc equal in length to once the radius, as  $eff$ ; draw the line  $efr$  equal to  $efd$ ; on  $r$



Fig. 134

describe the arc  $jj$ , in length twice the radius; continue the line through  $rj$ , which will be a right line, and make  $d e$ , or  $e r$ , equal to the distance between  $d r$ , by which the distance between A and B is obtained as required

To inscribe any regular polygon in a given circle.—Divide any diameter, as AB (Fig. 135), into so many equal parts as the polygon is required to have sides; from A and B as centres, with a radius equal to the diameter, describe arcs cutting each other in C; draw the line CD through the second point of division on the diameter  $e$ , and the line DB is one side of the polygon required.

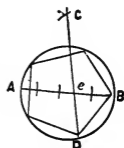

Fig. 135.

To describe any regular polygon, the length of one side being given.—Let AB (Fig. 136) be the given side of, say, a hexagon. With either end, here B, as centre and the length of the given side as radius, describe an arc. Produce AB to cut the arc in X.

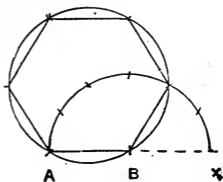

Fig. 136.





ABC (Fig. 139) be the given triangle; let fall the perpendicular  $Bd$ , and make  $Ae$  half the height  $dB$ ; bisect  $eC$ , and describe the semicircle  $enC$ ; erect the perpendicular  $As$ , or side of the square, then  $As tx$  is the square of equal area as required.

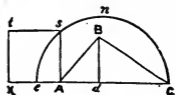

Fig. 139.

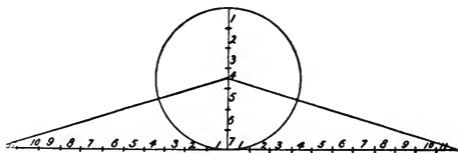

Fig 140.

*To form a triangle equal in area to a circle :*

*Preliminary remarks.*—A cord stretched over the circumference of a disk 7 inches in diameter measures, from end to end, 22 inches. Hence, the diameter is 7 inches, and the circumference 22 inches. This proportion holds good for all circles, no matter how large or how small. Hence, the geometrical rule :

*The diameter of a circle is to the periphery as 7 : 22 ; or, still more accurately, as 100 : 314.*

For the sake of simplicity the proportion 7 : 22 is here used.

The solution of the problem is as follows : Draw a perpendicular diameter (Fig. 140) and divide it into 7 equal parts. Then draw tangentially to the circle a horizontal, and measure off on it 22 such parts, best 11 to the left and 11 to the right. Now, by connecting both points of the horizontal with the centre of the circle a triangle is formed, which is equal in area to the circle, because, by dividing

the periphery into 22 equal parts, and drawing from every point of division a radius towards the centre, the entire area of the circle is divided into 22 triangles having an equal altitude (the radius) and an equal base (the arc of the circle). The correctness of this construction is shown by the application of the rule that triangles of equal bases and equal altitudes are equal to each other.

*To form a square equal in area to a given rectangle.*—Let the line AB (Fig. 141) equal the length and breadth of the given rectangle; bisect the line in  $e$ , and describe the semicircle ADB; then from A with the breadth, or from B with the length, of the rectangle, cut the line AB at C, and erect the perpendicular CD, meeting the curve at D, and CD will equal a side of the square required.

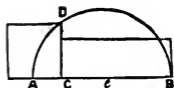

Fig. 141.

*To find the length for a rectangle whose area shall be equal to that of a given square, the breadth of the rectangle being also given.*—Let ABCD (Fig. 142) be the given square, and DE the given breadth of rectangle; continue the line BC to F, and draw the line DF; also, continue the line DC to  $g$ , and draw the line  $A g$  parallel to DF; from the intersection of the lines at  $g$ , draw the line  $g d$  parallel to DE, and  $E d$  parallel to  $D g$ ; then  $ED d g$  is the rectangle as required.

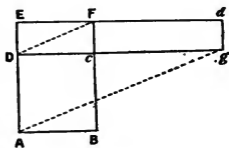

Fig. 142.

*To describe a circle of greatest diameter in a given triangle.*—Bisect the angles A and B (Fig. 143) and draw the intersecting lines AD, BD, cutting each other in D; then

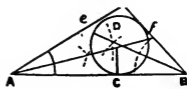

Fig. 143

from  $D$  as centre, with the distance or radius  $DC$ , describe the circle  $Cef$ , as required.

*To bisect any given triangle.*—Suppose  $ABC$  (Fig. 144) the given triangle; bisect one of its sides, as  $AB$  in  $e$ , from which describe the semicircle  $A r B$ ; bisect the same in  $r$ , and from  $B$ , with the distance  $B r$ , cut the diameter  $AB$  in  $v$ ; draw the line  $vy$  parallel to  $AC$ , which will bisect the triangle as required.

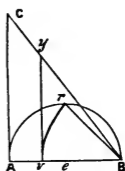

Fig. 144.

*To form a rectangle of greatest surface in a given triangle.*—Let  $ABC$  (Fig. 145) be the given triangle; bisect any two of its sides, as  $AB$ ,  $BC$ , in  $e$  and  $d$ ; draw the line  $ed$ ; also at right angles with the line  $ed$ , draw the lines  $ep$ ,  $dp$ , and  $epdp$  is the rectangle required.

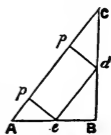

Fig. 145.

*To inscribe within a given equilateral triangle three equal semicircles having their diameters adjacent and equal.*—

Let  $ABC$  (Fig. 146) be the equilateral triangle. Bisect the angles of the triangle by lines  $Aa$ ,  $Bb$ , and  $Cc$ . Join  $ab$ , and on this line describe a semicircle touching the sides of the triangle. To avoid

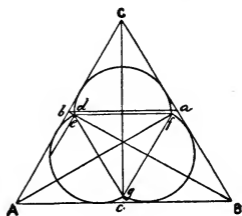

Fig. 146.

confusion of lines, this semicircle is omitted in the figure, only the point ( $d$ ) where it would cut  $ba$  being shown. From  $d$  draw a line parallel to  $cA$ , cutting  $bB$  in  $e$ ; from  $e$  draw a line parallel to  $ba$ , cutting  $Aa$  in  $f$ . Draw  $fg$  parallel to  $CA$ ; join  $ge$  by a line parallel to  $BC$ . Then

*ef, fg* and *ge* will be the adjacent diameters of three semicircles, the curves of which will touch the triangle *ABC*.

*To inscribe in a given circle three equal semicircles having their diameters adjacent.*—Find the centre of the circle *A* (Fig. 147); draw the diameter *BC*, and from *B* and *C* set off the radius of the circle, thus dividing it into six equal parts in *EG, FD*; draw *EF* and *GD*; draw the radius *AH* at right angles to *BC*; from *F* set off *FI* equal to *FH*, thus trisecting the quadrant *HB* in *FI*; from *I* draw a line to *G*, cutting *EF* in *J*; from *A* set off *AK* and *AL* equal to *AJ*; join *JK, KL* and *LJ*, which will give the adjacent diameters of the three required semicircles, the centres of which will be at *M, N, O*.

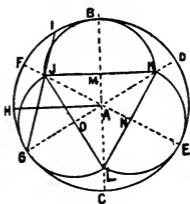

Fig. 147.

## DECIMAL EQUIVALENTS TO FRACTIONAL PARTS OF LINEAL MEASUREMENT.

### *One Inch the Integer or Whole Number.*

.96875 are equal to	and $\frac{3}{32}$	.46875 are equal to	$\frac{3}{8}$ and $\frac{3}{32}$
.9375            "	and $\frac{1}{6}$	.4375            "	and $\frac{1}{6}$
.90625           "	and $\frac{3}{32}$	.40625           "	and $\frac{3}{32}$
.875               "		.375               "	
.84375           "	and $\frac{3}{32}$	.34375           "	and $\frac{3}{32}$
.8125             "	and $\frac{1}{6}$	.3125             "	and $\frac{1}{6}$
.78125           "	and $\frac{1}{32}$	.28125           "	and $\frac{1}{32}$
.75                "		.25                "	
.71875           "	and $\frac{3}{32}$	.21875           "	and $\frac{3}{32}$
.6875             "	and $\frac{1}{6}$	.1875             "	and $\frac{1}{6}$
.65625           "	and $\frac{1}{32}$	.15625           "	and $\frac{1}{32}$
.625               "		.125               "	
.59375           "	and $\frac{3}{32}$	.09375           "	$\frac{3}{32}$
.5625             "	and $\frac{1}{6}$	.0625             "	$\frac{1}{6}$
.53125           "	and $\frac{1}{32}$	.03125           "	$\frac{1}{32}$
.5                 "			

*One Foot or 12 Inches the Integer.*

.9166 are equal to	11 inches.	.1666 are equal to	2 inches.
.8333     "     "	10   "	.0833     "     "	1     "
.75       "     "	9     "	.07291   "     "	7/8   "
.6666     "     "	8     "	.0625     "     "	3/4   "
.5833     "     "	7     "	.05208   "     "	5/8   "
.5         "     "	6     "	.04166   "     "	1/2   "
.4166     "     "	5     "	.03125   "     "	1/3   "
.3333     "     "	4     "	.02083   "     "	2/3   "
.25       "     "	3     "	.01041   "     "	1/4   "

## MENSURATION OF SURFACES.

MENSURATION is that branch of Mathematics which is employed in ascertaining the extension, solidities and capacities of bodies capable of being measured.

### DEFINITIONS OF ARITHMETICAL SIGNS USED IN THE FOLLOWING CALCULATIONS.

= Sign of Equality, as  $4 + 6 = 10$ .

+ Sign of Addition, as  $6 + 6 = 12$ , the Sum.

— Sign of Subtraction, as  $6 - 2 = 4$ , the Remainder.

× Sign of Multiplication, as  $8 \times 3 = 24$ , the Product.

÷ Sign of Division, as  $24 \div 3 = 8$  or  $\frac{24}{3} = 8$ .

√ Sign of Square Root, signifies Evolution or Extraction of Square Root.

<sup>2</sup> Sign of to be Squared, thus  $8^2 = 64$ .

<sup>3</sup> Sign of to be Cubed, thus  $3^3 = 27$ .

*To Measure or Ascertain the quantity of Surface in any Right-lined figure, whose Sides are Parallel to each other, as Figs. 148, 149 and 150.*

Square.



Fig. 148.

Rectangle.

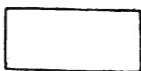

Fig. 149.

Rhomboid.

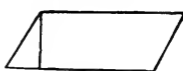

Fig. 150.

RULE.—Multiply the length by the breadth or perpendicular height, and the product will be the area or superficial contents.

#### *Application of the Rule to Practical Purposes.*

The sides of a square piece of iron are  $9\frac{7}{8}$  inches in length, required the area.

Decimal equivalent to the fraction  $\frac{7}{8} = .875$ , (See page 108,) and  $9.875 \times 9.875 = 97.5$ , etc., square inches, the area.

The length of a roof is 60 ft. 4 in., and its width 25 ft. 3 in., required the area of the roof.

4 inches = .333 and 3 inches = .25, (See table of equivalents,) hence,  $60.333 \times 25.25 = 1523.4$  square feet, the area.

### TRIANGLES.

*To find the Area of a Triangle when the base and perpendicular are given.*

RULE.—Multiply the base by the perpendicular height, and half the product is the area.

The base of the triangle (Fig. 151) ADB is 3 feet 6 inches in length, and the height, DC, 1 foot 9 inches, required the area.

6 inches = .5, and 9 inches = .75;

hence,  $\frac{3.5 \times 1.75}{2} = 3.0625$  square feet, the area.

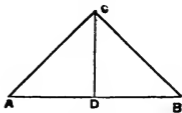

Fig. 151.

*Any two sides of a Right-Angled Triangle being given, to find the third.*

When the base and perpendicular are given, to find the hypotenuse.

Add the square of the base to the square of the perpendicular, and the square root of the sum will be the hypotenuse.

The base of the triangle (Fig. 152) AB is 4 feet, and the perpendicular BC 3 feet, then  $4^2 + 3^2 = 25$ ,  $\sqrt{25} = 5$  feet, the hypotenuse.

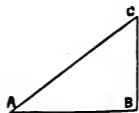

Fig. 152.

*When the Hypotenuse and Base are given, to find the Perpendicular.*

From the square of the hypotenuse subtract the square

of the base, and the square of the remainder will be the perpendicular.

The hypotenuse of the triangle (Fig. 152), AC, is 5 feet, and the base, AB, 4 feet; then  $5^2 - 4^2 = 9$ , and  $\sqrt{9} = 3$ , the perpendicular.

*When the Hypotenuse and the Perpendicular are given, to find the base.*

From the square of the hypotenuse subtract the square of the perpendicular, and the square root of the remainder will be the base.

### OF POLYGONS.

*To find the Area of a Regular Polygon.*

RULE.—Multiply the length of a side by half the distance from the side to the centre, and that product by the number of sides; the last product will be the area of the figure.

EXAMPLE.—The side AB (Fig. 153) of a regular hexagon is 12 inches, and the distance therefrom to the centre of the figure,  $d c$ , is 10 inches; required the area of the hexagon.

$$\frac{10}{2} \times 12 \times 6 = 360 \text{ sq. in.} = 2\frac{1}{2} \text{ sq. feet.} \quad \text{Ans.}$$

*To find the Area of a Regular Polygon, when the Side only is given.*

RULE.—Multiply the square of the side by the multiplier opposite to the name of the polygon in the ninth column of the following table, and the product will be the area.

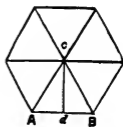

Fig. 153.



TABLE of Angles relative to the construction of Regular Polygons with the aid of the Sector, and of Co-efficients to facilitate their construction without it; also, of Co-efficients to aid in finding the area of the figure, the side only being given.

Names.	No. of sides.	Angle at centre.	Angle at circumference.	Perpendicular side being 1.	Length of side, radius being 1.	Radius of circle, side being 1.	Radius of circle, perpendicular, being 1.	Area, side being -
Triangle,	3	120°	60°	0.28868	1.782	.5773	2.	0.438012
Square,	4	90	90	0.5	1.414	.7071	1.414	1.
Pentagon,	5	72	108	0.6882	1.175	.8506	1.238	1.720477
Hexagon,	6	60	120	0.866	1.	1.	1.156	2.598076
Heptagon,	7	51 $\frac{3}{4}$	128 $\frac{1}{4}$	1.0382	.8672	1.152	1.11	3.633912
Octagon,	8	45	135	1.2071	.7654	1.3065	1.08	4.828427
Nonagon,	9	40	140	1.3737	.684	1.4619	1.06	6.181824
Decagon,	10	36	144	1.5388	.618	1.618	1.05	7.694208
Undecagon,	11	32 $\frac{1}{11}$	147 $\frac{8}{11}$	1.7028	.5634	1.7747	1.04	9.36564
Dodecagon,	12	30	150	1.866	.5176	1.9318	1.037	11.196152

NOTE.—“Angle at centre” means the angle of radii, passing from the centre to the circumference, or corners of the figure. “Angle at circumference” means the angle which any two adjoining sides make with each other.

## THE CIRCLE AND ITS SECTIONS.

### Observations and Definitions.

1. The Circle contains a greater area than any other plane figure bounded by the same perimeter or outline.

2. The areas of Circles are to each other as the squares of their diameters; any Circle twice the diameter of another contains four times the area of the other.

3. The Radius of a circle is a straight line drawn from the centre to the circumference, as BD (Fig. 154).

4. The Diameter of a circle is a straight line drawn through the centre and terminated both ways at the circumference, as ABC.

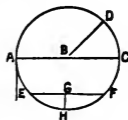

Fig. 154

5. A Chord is a straight line joining any two points of the circumference, as EF (Fig. 154).

6. The Versed Sine is a straight line joining the chord and the circumference, as GH.

7. An Arc is any part of the circumference, as AEH.

8. A Semicircle is half the circumference cut off by a diameter, as AHC.

9. A Segment is any portion of a circle cut off by a chord, as EHF.

10. A Sector is part of a circle cut off by two radii, as CBD.

*General Rules in Relation to the Circle.*

1. Multiply the diameter by 3.1416; the product is the circumference.

2. Multiply the circumference by .31831; the product is the diameter.

3. Multiply the square of the diameter by .7854, and the product is the area.

4. Multiply the square root of the area by 1.12837; the product is the diameter.

5. Multiply the diameter by .8862; the product is the side of a square of equal area.

6. Multiply the side of a square by 1.128; the product is the diameter of a circle of equal area.

*Application of the Rules to Practical Purposes.*

1. The diameter of a circle being 5 feet 6 inches; required its circumference.

$$5.5 \times 3.1416 = 17.27880 \text{ feet, the circumference.}$$

2. A straight line, or the circumference of a circle, being 17.27880 feet; required the circle's diameter corresponding thereto.

$$17.27880 \times .31831 = 5.5000148280 \text{ feet, diameter.}$$

3. The diameter of a circle is  $9\frac{3}{8}$  inches; what is its area in square inches?

$$9.375^2 = 87.89, \text{ etc., } \times .7854 = 69.029, \text{ etc., in., the area.}$$

4. What must the diameter of a circle be to contain an area equal to 69.029296875 square inches?

$$\sqrt{69.02929, \text{ etc.}} = 8.3091 \times 1.12837 = 9.375, \\ \text{etc., or } 9\frac{3}{8} \text{ inches, the diameter.}$$

5. The diameter of a circle is  $15\frac{1}{2}$  inches; what must each side of a square be, to be equal in area to the given circle?

$$15.5 \times .8862 = 13.73, \text{ etc., inches, length of side.}$$

6. Each side of a square is 13.736 inches in length; what must the diameter of a circle be to contain an area equal to the given square?

$$13.736 \times 1.128 = 15.49, \text{ etc., or } 15\frac{1}{2} \text{ inches, the diameter.}$$

*Any Chord and Versed Sine of a circle being given, to find the diameter.*

RULE.—Divide the sum of the squares of the chord and versed sine by the versed sine, and the quotient is the diameter of corresponding circle.

7. The chord of a circle AC (Fig. 155) equals 8 feet, and the versed sine BD equals  $1\frac{1}{2}$  feet; required, the circle's diameter.

$$8^2 + 1.5^2 = 66.25 \div 1.5 = 44.16 \\ \text{feet, the diameter.}$$

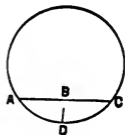

Fig. 155.

8. In the curve of a railway I stretched a line 80 feet in length, and the distance from the line to the curve I found to be 9 inches; required, the circle's diameter.

$$80^2 + .75^2 = 640.5625 \div 2 = 320.28, \text{ etc., feet, the diameter.}$$

*To find the Length of any arc of a circle.*

RULE.—From eight times the chord of half the arc subtract the chord of the whole arc, and one-third of the remainder will be the length nearly.

Required, the length of the arc ABC (Fig. 156), the chord AB of half the arc being  $8\frac{1}{2}$  feet, and the chord AC of the whole arc 16 feet 8 inches.

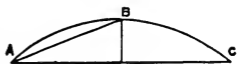

Fig. 156.

$$8.5 \times 8 = 68.0 \text{ and } 68.0 - 16.666 = \frac{41.334}{3} = 13.778$$

feet, the length of the arc.

*To find the area of the Sector of a circle.*

RULE.—Multiply the length of the arc by half the length of the radius.

The length of the arc ABC (Fig. 157) equals  $9\frac{1}{2}$  inches, and the radii DA, DC, equal each 7 inches; required, the area.

$$9.5 \times 3.5 = 33.25 \text{ inches, the area.}$$

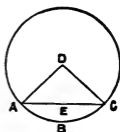

Fig. 157.

*To find the area of a Segment of a circle.*

RULE.—Find the area of a sector whose arc is equal to that of the given segment, and if it be less than a semicircle, subtract the area of the triangle formed by the chord of the segment and radii of its extremities; but if more than a semicircle, add the area of the triangle to the area of the sector, and the remainder or sum is the area of the segment.

Thus, suppose the area of the segment ABCE (Fig. 157) is required, and that the length of the arc ABC equals  $19\frac{1}{2}$  feet, DA and DC each equal 14 feet, and the chord AC equals 16 feet 8 inches; also, the perpendicular ED equals  $7\frac{1}{2}$  feet.

$$19.5 \times 7 = 136.5 \text{ ft., the area of the sector, } \frac{16.666 \times 7.5}{2}$$

$$= 62.49 \text{ ft. the area of the triangle, } 136.5 - 62.49 = 74.01$$

ft., the area of the segment.

*To find the area of the space contained between two Concentric Circles or the area of a Circular Ring.*

RULE 1.—Multiply the sum of the inside and outside diameters by their difference and by .7854; the product is the area.

RULE 2.—The difference of the areas of the two circles will be the area of the ring or of the space required.

Suppose the external circle AD (Fig. 158) equals 4 feet, and the internal circle BC  $2\frac{1}{2}$  feet; required, the area of the space contained between them or area of a ring.

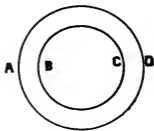

Fig. 158.

$4 + 2.5 = 6.5$  and  $4 - 2.5 = 1.5$ ; hence,  $6.5 \times 1.5 \times .7854 = 7.65$  feet, the area; or,

The area of 4 feet is 12.566; the area of 2.5 is 4.9081. (See table of areas of circles.)

$12.566 - 4.9081 = 7.6579$ , the area.

*To find the area of an Ellipse or Oval.*

RULE.—Multiply the diameters together and their product by .7854.

An oval is 20 inches by 15 inches; what are its superficial contents?  $20 \times 15 \times .7854 = 235.62$  inches, the area.

*To find the circumference of an Ellipse or Oval.*

RULE.—Multiply half the sum of the two diameters by 3.1416; the product will be the circumference.

EXAMPLE.—An oval is 20 inches by 15 inches; what is its circumference?

$\frac{20 + 15}{2} = 17.5 \times 3.1416 = 54.978$  in., the circumference.

## OF CYLINDERS.

*To find the Convex Surface of a Cylinder.*

RULE.—Multiply the circumference by the height or length; the product will be the surface.

EXAMPLE.—The circumference of a cylinder is 6 feet 4 inches, and its length 15 feet; required, the convex surface.

$$6.333 \times 15 = 94.995 \text{ square feet, the surface.}$$

## OF CONES AND PYRAMIDS.

*To find the Convex Surface of a Right Cone or Pyramid.*

RULE.—Multiply the perimeter or circumference of the base by the slant height, and half the product is the slant surface; if the surface of the entire figure is required, add the area of the base to the convex surface.

EXAMPLE.—The base of a cone (Fig. 160) is 5 feet diameter, and the slant height is 7 feet; what is the convex surface?

$$\begin{array}{r} 5 \times 3.1416 = 15.70 \text{ circumference of the base and} \\ 15.70 \times 7 \\ \hline \phantom{15.70 \times 7} 2 \phantom{=} 54.95 \text{ square feet, the convex surface.} \end{array}$$

*To find the Convex Surface of a Frustum of a Cone or Pyramid.*

RULE.—Multiply the sum of the circumference of the two ends by the slant height, and half the product will be the slant surface.

The diameter of the top of a frustum of a cone (Fig. 161) is 3 feet, the base 5 feet, the slant height 7 feet 3 inches; required, the slant surface.

$$9.42 + 15.7 = \frac{25.12 \times 7.25}{2} = 91.06 \text{ sq. ft., slant surface.}$$

## OF SPHERES.

*To find the Convex Surface of a Sphere or Globe (Fig. 159).*

RULE.—Multiply the diameter of the sphere by its circumference, and the product is its surface; or,

Multiply the square of the diameter by 3.1416; the product is its surface.

What is the convex surface of a globe, 6½ feet in diameter?

$6.5 \times 3.1416 \times 6.5 = 132.73$  square feet; or,  $6.5^2 = 42.25 \times 3.1416 = 132.73$  sq. ft., the convex surface.



Fig. 159

## MENSURATION OF SOLIDS AND CAPACITIES OF BODIES.

*To find the Solidity or capacity of any figure in the Cubical Form.*

RULE.—Multiply the length of any one side by its breadth and by the depth or distance to its opposite side; the product is the solidity or capacity in equal terms of measurement.

EXAMPLE.—The side of a cube is 20 inches; what is the solidity?  $20 \times 20 \times 20 = 8000$  cubic inches; or, 4.6296 cubic feet nearly.

A rectangular tank is in length 6 feet, in breadth 4½ feet, and in depth 3 feet; required its capacity in cubic feet; also, its capacity in United States standard gallons.

$6 \times 4.5 \times 3 = 81$  cubic feet,  $81 \times 1728 = 139968 \div 231 = 605.92$  gallons.

## OF CYLINDERS.

*To find the Solidity of Cylinders.*

RULE.—Multiply the area of the base by the height, and the product is the solidity.

EXAMPLE.—The base of a cylinder is 18 inches, and the height is 40 inches; what is the solidity?

$$18^2 \times .7854 \times 40 = 10178.7840 \text{ cubic inches.}$$

*To find the Contents in Gallons of Cylindrical Vessels.*

RULE.—Take the dimensions in inches and decimal parts of an inch. Square the diameter, multiply it by the height, then multiply the product by .0034 for wine gallons, or by .002785 for beer gallons.

EXAMPLE.—How many United States gallons will a cylinder contain, whose diameter is 18 inches and length 30 inches?

$$18^2 \times 30 = 9720 \times .0034 = 33.04, \text{ etc., gallons.}$$

## OF CONES AND PYRAMIDS.

*To find the Solidity of a Cone or a Pyramid.*

RULE.—Multiply the area of the base by the perpendicular height, and  $\frac{1}{3}$  the product will be the solidity.

EXAMPLE.—The base of a cone (Fig. 160) is  $2\frac{1}{4}$  feet, and the height is  $3\frac{3}{4}$  feet; what is the solidity?

$$\frac{2.25^2 \times .7854 \times 3.75}{3} = 4.97 \text{ cubic feet, the solidity.}$$



Fig. 160.

*To find the Solidity of the Frustum of a Cone.*

RULE.—To the product of the diameters of the ends add  $\frac{1}{3}$  the square of the difference of the diameters; multiply the sum by .7854, and the product will be the mean area between the ends, which multiplied by the perpendicular height of the frustum, gives the solidity.

EXAMPLE.—The diameter of the large end of a frustum of a cone (Fig. 161) is 10 feet, that of the smaller end is



6 feet, and the perpendicular height 12 feet; what is the solidity?

10 — 6 = 4<sup>2</sup> = 16 ÷ 3 = 5.333 square of difference of ends; and 10 × 6 + 5.333 = 65.333 × .7854 × 12 = 615.75 cubic feet, the solidity.



Fig. 161.

*To find the Contents in U. S. Standard Gallons of the Frustum of a Cone.*

RULE.—To the product of the diameters in inches, and decimal parts of an inch of the ends, add  $\frac{1}{3}$  the square of the difference of the diameters. Multiply the sum by the perpendicular height in inches and decimal parts of an inch, and multiply that product by .0034 for wine gallons, and by .002785 for beer gallons.

EXAMPLE.—The diameter of the large end of a frustum of a cone (Fig. 161) is 8 feet, that of the smaller end is 4 feet, and the perpendicular height 10 feet; what are the contents in United States standard gallons?

96 — 48 = 48<sup>2</sup> = 2304 ÷ 3 = 768; 96 × 48 + 768 = 5376 × 120 × .0034 = 2193.04 gallons.

*To find the Solidity of the Frustum of a Pyramid.*

RULE.—Add to the areas of the two ends of the frustum the square root of their product, and this sum multiplied by  $\frac{1}{3}$  of the perpendicular height will give the solidity.

EXAMPLE.—What is the solidity of a hexagonal pyramid (Fig. 162), a side of the large end, AB, being 12 feet, and one of the smaller ends 6 feet, and the perpendicular height 8 feet?



Fig. 162.

374.122 + 93.53 =  $\sqrt{34991.63} = 590.811$  374.122 +  
 $1058.463 \times 8$   
 $93.53 \div 590.811 = \frac{\quad}{3} = 2822.568$   
 cubic feet, the solidity.

*To find the Solidity of a Sphere.*

RULE.—Multiply the cube of the diameter by .5236, and the product is the solidity.

EXAMPLE.—What is the solidity of a sphere (Fig. 159), the diameter being 20 inches?

$20^3 = 8000 \times .5236 = 4188.8$  cubic inches, the solidity.

# TABLES OF WEIGHTS, ETC.

*Weight of Square Rolled Iron, from 1-4 Inch to 12 Inches, and 1 Foot in Length.*

Size in Inches.	Weight in Pounds.	Size in Inches.	Weight in Pounds.	Size in Inches.	Weight in Pounds.
1	0.2	3 1/4	35.7	6 1/2	142.8
1 1/8	0.5	3 3/8	38.5	6 3/4	154.0
1 1/4	0.8	3 1/2	41.4	7	165.6
1 3/8	1.3	3 5/8	44.4	7 1/4	177.7
1 1/2	1.9	3 3/4	47.5	7 1/2	190.1
1 5/8	2.6	3 7/8	50.8	7 3/4	203.0
1 3/4	3.4	4	54.1	8	216.3
1 7/8	4.3	4 1/4	57.5	8 1/4	230.1
2	5.3	4 1/2	61.1	8 1/2	244.2
2 1/8	6.4	4 3/4	64.7	8 3/4	258.8
2 1/4	7.6	4 5/8	68.4	9	273.8
2 3/8	8.9	4 1/2	72.3	9 1/4	289.2
2 1/2	10.4	4 3/4	76.3	9 1/2	305.1
2 5/8	11.9	4 7/8	80.3	9 3/4	321.3
2 3/4	13.5	5	84.5	10	337.9
2 7/8	15.3	5 1/8	88.8	10 1/4	355.1
3	17.1	5 1/4	93.2	10 1/2	372.7
3 1/8	19.1	5 3/8	97.7	10 3/4	390.6
3 1/4	21.1	5 1/2	102.2	11	409.0
3 3/8	23.3	5 5/8	107.0	11 1/4	427.8
3 1/2	25.6	5 3/4	111.8	11 1/2	447.0
3 5/8	27.9	5 7/8	116.7	11 3/4	466.7
3 3/4	30.4	6	121.7	12	486.7
3 7/8	33.0	6 1/4	132.0		

*Weight of Flat Rolled Iron, from 1-8 × 1-2 Inch to 1 × 6 Inches.*

Thick.	Width.	Weight in Lbs.	Thick.	Width.	Weight in Lbs.	Thick.	Width.	Weight in Lbs.
1/8	1/2	0.211	1/8	1	0.422	1/4	1 1/2	1.3
1/8	5/8	0.264	1/8	1 1/8	0.475	1/4	1 3/4	1.5
1/8	3/4	0.316	1/4	1	0.8	1/4	2	1.7
1/8	7/8	0.369	1/4	1 1/4	1.1	1/4	2 1/4	1.9

Table Continued.

Thick.	Width.	Weight in Lbs.	Thick.	Width.	Weight in Lbs.	Thick.	Width.	Weight in Lbs.
$\frac{1}{4}$	$2\frac{1}{2}$	2.1	$\frac{3}{8}$	6	7.6	$\frac{5}{8}$	$4\frac{1}{4}$	9.0
$\frac{1}{4}$	$2\frac{3}{4}$	2.3	$\frac{1}{2}$	1	1.7	$\frac{5}{8}$	$4\frac{1}{2}$	9.5
$\frac{1}{4}$	3	2.5	$\frac{1}{2}$	$1\frac{1}{4}$	2.1	$\frac{5}{8}$	$4\frac{3}{4}$	10.0
$\frac{1}{4}$	$3\frac{1}{4}$	2.7	$\frac{1}{2}$	$1\frac{1}{2}$	2.5	$\frac{5}{8}$	5	10.6
$\frac{1}{4}$	$3\frac{1}{2}$	3.0	$\frac{1}{2}$	$1\frac{3}{4}$	3.0	$\frac{5}{8}$	$5\frac{1}{4}$	11.1
$\frac{1}{4}$	$3\frac{3}{4}$	3.2	$\frac{1}{2}$	2	3.4	$\frac{5}{8}$	$5\frac{1}{2}$	11.6
$\frac{1}{4}$	4	3.4	$\frac{1}{2}$	$2\frac{1}{4}$	3.8	$\frac{5}{8}$	$5\frac{3}{4}$	12.1
$\frac{1}{4}$	$4\frac{1}{4}$	3.6	$\frac{1}{2}$	$2\frac{1}{2}$	4.2	$\frac{5}{8}$	6	12.7
$\frac{1}{4}$	$4\frac{1}{2}$	3.8	$\frac{1}{2}$	$2\frac{3}{4}$	4.6	$\frac{3}{4}$	1	2.5
$\frac{1}{4}$	$4\frac{3}{4}$	4.0	$\frac{1}{2}$	3	5.1	$\frac{3}{4}$	$1\frac{1}{4}$	3.2
$\frac{1}{4}$	5	4.2	$\frac{1}{2}$	$3\frac{1}{4}$	5.5	$\frac{3}{4}$	$1\frac{1}{2}$	3.8
$\frac{1}{4}$	$5\frac{1}{4}$	4.4	$\frac{1}{2}$	$3\frac{1}{2}$	5.9	$\frac{3}{4}$	$1\frac{3}{4}$	4.4
$\frac{1}{4}$	$5\frac{1}{2}$	4.6	$\frac{1}{2}$	$3\frac{3}{4}$	6.3	$\frac{3}{4}$	2	5.1
$\frac{1}{4}$	$5\frac{3}{4}$	4.9	$\frac{1}{2}$	4	6.8	$\frac{3}{4}$	$2\frac{1}{4}$	5.7
$\frac{1}{4}$	6	5.1	$\frac{1}{2}$	$4\frac{1}{4}$	7.2	$\frac{3}{4}$	$2\frac{1}{2}$	6.3
$\frac{3}{8}$	1	1.3	$\frac{1}{2}$	$4\frac{1}{2}$	7.6	$\frac{3}{4}$	$2\frac{3}{4}$	7.0
$\frac{3}{8}$	$1\frac{1}{4}$	1.6	$\frac{1}{2}$	$4\frac{3}{4}$	8.0	$\frac{3}{4}$	3	7.6
$\frac{3}{8}$	$1\frac{1}{2}$	1.9	$\frac{1}{2}$	5	8.4	$\frac{3}{4}$	$3\frac{1}{4}$	8.2
$\frac{3}{8}$	$1\frac{3}{4}$	2.2	$\frac{1}{2}$	$5\frac{1}{4}$	8.9	$\frac{3}{4}$	$3\frac{1}{2}$	8.9
$\frac{3}{8}$	2	2.5	$\frac{1}{2}$	$5\frac{1}{2}$	9.3	$\frac{3}{4}$	$3\frac{3}{4}$	9.5
$\frac{3}{8}$	$2\frac{1}{4}$	2.9	$\frac{1}{2}$	$5\frac{3}{4}$	9.7	$\frac{3}{4}$	4	10.1
$\frac{3}{8}$	$2\frac{1}{2}$	3.2	$\frac{1}{2}$	6	10.1	$\frac{3}{4}$	$4\frac{1}{4}$	10.8
$\frac{3}{8}$	$2\frac{3}{4}$	3.5	$\frac{5}{8}$	1	2.1	$\frac{3}{4}$	$4\frac{1}{2}$	11.4
$\frac{3}{8}$	3	3.8	$\frac{5}{8}$	$1\frac{1}{4}$	2.6	$\frac{3}{4}$	$4\frac{3}{4}$	12.0
$\frac{3}{8}$	$3\frac{1}{4}$	4.1	$\frac{5}{8}$	$1\frac{1}{2}$	3.2	$\frac{3}{4}$	5	12.7
$\frac{3}{8}$	$3\frac{1}{2}$	4.4	$\frac{5}{8}$	$1\frac{3}{4}$	3.7	$\frac{3}{4}$	$5\frac{1}{4}$	13.3
$\frac{3}{8}$	$3\frac{3}{4}$	4.8	$\frac{5}{8}$	2	4.2	$\frac{3}{4}$	$5\frac{1}{2}$	13.9
$\frac{3}{8}$	4	5.1	$\frac{5}{8}$	$2\frac{1}{4}$	4.8	$\frac{3}{4}$	$5\frac{3}{4}$	14.6
$\frac{3}{8}$	$4\frac{1}{4}$	5.4	$\frac{5}{8}$	$2\frac{1}{2}$	5.3	$\frac{3}{4}$	6	15.2
$\frac{3}{8}$	$4\frac{1}{2}$	5.7	$\frac{5}{8}$	$2\frac{3}{4}$	5.8	1	$1\frac{1}{2}$	5.1
$\frac{3}{8}$	$4\frac{3}{4}$	6.0	$\frac{5}{8}$	3	6.3	1	2	6.8
$\frac{3}{8}$	5	6.3	$\frac{5}{8}$	$3\frac{1}{4}$	6.9	1	3	10.1
$\frac{3}{8}$	$5\frac{1}{4}$	6.7	$\frac{5}{8}$	$3\frac{1}{2}$	7.4	1	4	13.5
$\frac{3}{8}$	$5\frac{1}{2}$	7.0	$\frac{5}{8}$	$3\frac{3}{4}$	7.9	1	5	16.9
$\frac{3}{8}$	$5\frac{3}{4}$	7.3	$\frac{5}{8}$	4	8.4	1	6	20.3

*Weight of Round Rolled Iron, from 1-4 Inch to 12 Inches in Diameter, and 1 Foot in Length.*

Diamet'r in Inch's.	Weight in Pounds.	Diamet'r in Inch's.	Weight in Pounds.
$\frac{1}{4}$	0.2	$\frac{5}{8}$	1.0
$\frac{3}{8}$	0.4	$\frac{3}{4}$	1.5
$\frac{1}{2}$	0.7	$\frac{7}{8}$	2.0

Table Continued.

Diamet'r in Inch's.	Weight in Pounds.	Diamet'r in Inch's.	Weight in Pounds.
1	2.7	5 $\frac{1}{8}$	69.7
1 $\frac{1}{8}$	3.4	5 $\frac{1}{4}$	73.2
1 $\frac{1}{4}$	4.2	5 $\frac{3}{8}$	76.7
1 $\frac{3}{8}$	5.0	5 $\frac{1}{2}$	80.3
1 $\frac{1}{2}$	6.0	5 $\frac{5}{8}$	84.0
1 $\frac{5}{8}$	7.0	5 $\frac{3}{4}$	87.8
1 $\frac{3}{4}$	8.1	5 $\frac{7}{8}$	91.6
1 $\frac{7}{8}$	9.3	6	95.6
2	10.6	6 $\frac{1}{4}$	103.7
2 $\frac{1}{8}$	12.0	6 $\frac{1}{2}$	112.2
2 $\frac{1}{4}$	13.5	6 $\frac{3}{4}$	121.0
2 $\frac{3}{8}$	15.0	7	130.0
2 $\frac{1}{2}$	16.7	7 $\frac{1}{4}$	139.5
2 $\frac{3}{8}$	18.8	7 $\frac{1}{2}$	149.3
2 $\frac{3}{4}$	20.1	7 $\frac{3}{4}$	159.5
2 $\frac{7}{8}$	21.9	8	169.9
3	23.9	8 $\frac{1}{4}$	180.7
3 $\frac{1}{8}$	25.9	8 $\frac{1}{2}$	191.8
3 $\frac{1}{4}$	28.0	8 $\frac{3}{4}$	203.3
3 $\frac{3}{8}$	30.2	9	215.0
3 $\frac{1}{2}$	32.5	9 $\frac{1}{4}$	227.2
3 $\frac{3}{8}$	34.9	9 $\frac{1}{2}$	239.6
3 $\frac{3}{4}$	37.3	9 $\frac{3}{4}$	252.4
3 $\frac{7}{8}$	39.9	10	266.3
4	42.5	10 $\frac{1}{4}$	278.9
4 $\frac{1}{8}$	45.2	10 $\frac{1}{2}$	292.7
4 $\frac{1}{4}$	48.0	10 $\frac{3}{4}$	306.8
4 $\frac{3}{8}$	50.8	11	321.2
4 $\frac{1}{2}$	53.8	11 $\frac{1}{4}$	336.0
4 $\frac{5}{8}$	56.8	11 $\frac{1}{2}$	351.1
4 $\frac{3}{4}$	60.0	11 $\frac{3}{4}$	366.5
4 $\frac{7}{8}$	63.1	12	382.2
5	66.8		

*Weight of a Square Foot of Wrought Iron, Copper and Lead, from 1-16 to 2 Inches Thick.*

	Wrought Iron, Hard Rolled.	Copper, Hard Rolled.	Lead.
$\frac{1}{16}$	2.517	2.890	3.691
$\frac{1}{8}$	5.035	5.741	7.382
$\frac{3}{16}$	7.552	8.672	11.074
$\frac{1}{4}$	10.070	11.562	14.765

Table Continued.

	Wrought Iron, Hard Rolled.	Copper, Hard Rolled.	Lead.
$\frac{5}{16}$	12.589	14.453	18.456
$\frac{3}{8}$	15.106	17.344	22.148
$\frac{7}{16}$	17.623	20.234	25.839
$\frac{1}{2}$	20.141	23.125	29.530
$\frac{9}{16}$	22.659	26.106	33.222
$\frac{5}{8}$	25.176	28.906	36.913
$\frac{11}{16}$	27.694	31.797	40.604
$\frac{3}{4}$	30.211	34.688	44.296
$\frac{13}{16}$	32.729	37.578	47.987
$\frac{7}{8}$	35.247	40.469	51.678
$1\frac{1}{8}$	37.764	43.359	55.370
1	40.282	46.250	59.061
$1\frac{1}{8}$	45.317	52.03	66.444
$1\frac{1}{4}$	50.352	57.813	73.826
$1\frac{3}{8}$	55.387	63.594	81.210
$1\frac{1}{2}$	60.422	69.375	88.592
$1\frac{5}{8}$	65.458	75.156	95.975
$1\frac{3}{4}$	70.493	80.938	103.358
$1\frac{7}{8}$	75.528	86.719	110.740
2	80.563	92.500	118.128

Weight of Copper Bolts, from 1-4 to 4 Inches in Diameter, and 1 Foot in Length.

Diameter.	Pounds.	Diameter.	Pounds.
$\frac{1}{4}$	.1892	$1\frac{9}{16}$	7.3898
$\frac{5}{16}$	.2956	$1\frac{5}{8}$	7.9931
$\frac{3}{8}$	.4256	$1\frac{3}{4}$	9.2702
$\frac{7}{16}$	.5794	$1\frac{7}{8}$	10.6420
$\frac{1}{2}$	.7567	2	12.1082
$\frac{9}{16}$	.9578	$2\frac{1}{8}$	13.6677
$\frac{5}{8}$	1.1824	$2\frac{1}{4}$	15.3251
$1\frac{1}{8}$	1.4307	$2\frac{3}{8}$	17.0750
$\frac{3}{4}$	1.7027	$2\frac{1}{2}$	18.9161
$1\frac{1}{8}$	1.9982	$2\frac{5}{8}$	20.8562
$\frac{7}{8}$	2.3176	$2\frac{3}{4}$	22.8913
$1\frac{1}{8}$	2.6605	$2\frac{7}{8}$	25.0188
1	3.0270	3	27.2435
$1\frac{1}{16}$	3.4170	$3\frac{1}{8}$	29.5594
$1\frac{1}{8}$	3.8312	$3\frac{1}{4}$	33.9722
$1\frac{3}{16}$	4.2688	$3\frac{3}{8}$	34.4815
$1\frac{1}{4}$	4.7298	$3\frac{1}{2}$	37.0808
$1\frac{5}{16}$	5.2140	$3\frac{5}{8}$	39.7774
$1\frac{1}{2}$	5.7228	$3\frac{3}{4}$	42.5680
$1\frac{7}{16}$	6.2547	$3\frac{7}{8}$	45.4550
$1\frac{1}{2}$	6.8109	4	48.4330

# TABLES

OF THE

## CIRCUMFERENCE OF CIRCLES,

TO THE NEAREST FRACTION OF PRACTICAL MEASUREMENT; ALSO,  
THE AREAS OF CIRCLES, IN INCHES, AND DECIMAL PARTS; LIKE-  
WISE IN FEET AND DECIMAL PARTS, AS MAY BE REQUIRED.

*Rules rendering the following Tables more generally useful.*

1. Any of the areas in inches, multiplied by .04328, or the areas in feet multiplied by 6.232, the product is the number of imperial gallons at 1 foot in depth.

2. Any of the areas in feet, multiplied by .03704, the product equals the number of cubic yards at 1 ft. in depth.

Diameter in Inches.	Circum. in Inches.	Area in Square Inches.	Side of Parallel Square.	Diameter in Inches.	Circum. in Inches.	Area in Square Inches.	Side of Parallel Square.
$\frac{1}{8}$	.196	.0030	.0554	2	$6\frac{1}{4}$	3.141	$1\frac{3}{4}$
$\frac{1}{8}$	.392	.0122	.1107	$2\frac{1}{8}$	$6\frac{5}{8}$	3.546	$1\frac{7}{8}$
$\frac{1}{4}$	.589	.0276	.1661	$2\frac{1}{4}$	7	3.976	2 in.
$\frac{1}{4}$	.785	.0490	.2115	$2\frac{3}{8}$	$7\frac{3}{8}$	4.430	$2\frac{1}{8}$
$\frac{1}{2}$	.981	.0767	.2669	$2\frac{1}{2}$	$7\frac{3}{4}$	4.908	$2\frac{1}{2}$
$\frac{3}{8}$	1.178	.1104	.3223	$2\frac{5}{8}$	$8\frac{1}{4}$	5.412	$2\frac{5}{8}$
$\frac{7}{8}$	1.374	.1503	.3771	$2\frac{3}{4}$	$8\frac{5}{8}$	5.939	$2\frac{7}{8}$
				$2\frac{7}{8}$	9	6.492	$2\frac{7}{8}$
$\frac{1}{2}$	1.570	.1963	.4331	3	$9\frac{3}{8}$	7.068	$2\frac{5}{8}$
$\frac{1}{2}$	1.767	.2485	.4995	$3\frac{1}{8}$	$9\frac{3}{4}$	7.669	$2\frac{3}{4}$
$\frac{3}{8}$	1.963	.3068	.5438	$3\frac{1}{4}$	$10\frac{1}{4}$	8.296	$2\frac{7}{8}$
$\frac{1}{8}$	2.159	.3712	.6093	$3\frac{3}{8}$	$10\frac{5}{8}$	8.946	3 in.
$\frac{3}{4}$	2.356	.4417	.6646	$3\frac{1}{2}$	11	9.621	$3\frac{1}{8}$
$\frac{1}{8}$	2.552	.5185	.7200	$3\frac{5}{8}$	$11\frac{3}{8}$	10.320	$3\frac{1}{4}$
$\frac{7}{8}$	2.748	.6013	.7754	$3\frac{3}{4}$	$11\frac{3}{4}$	11.044	$3\frac{3}{8}$
$\frac{1}{8}$	2.945	.6903	.8308	$3\frac{7}{8}$	$12\frac{1}{8}$	11.793	$3\frac{7}{8}$
1	$3\frac{1}{8}$	.7854	$\frac{7}{8}$	4	Ft. In.	Ar'a sq. i.	Ar'a.s.ft.
$1\frac{1}{8}$	$3\frac{1}{2}$	.9940	$\frac{7}{8}$ & $\frac{3}{32}$	$4\frac{1}{8}$	1 0 $\frac{1}{2}$	12.566	.0879
$1\frac{1}{4}$	$3\frac{3}{8}$	1.227	1 in.	$4\frac{1}{4}$	1 0 $\frac{7}{8}$	13.364	.0935
$1\frac{3}{8}$	$4\frac{1}{4}$	1.485	$1\frac{1}{8}$	$4\frac{3}{8}$	1 1 $\frac{3}{8}$	14.186	.0993
$1\frac{1}{2}$	$4\frac{5}{8}$	1.767	$1\frac{1}{4}$	$4\frac{1}{2}$	1 1 $\frac{3}{4}$	15.033	.1052
$1\frac{5}{8}$	$5\frac{1}{8}$	2.074	$1\frac{1}{2}$	$4\frac{5}{8}$	1 2 $\frac{1}{8}$	15.904	.1113
$1\frac{3}{4}$	$5\frac{1}{2}$	2.405	$1\frac{3}{4}$	$4\frac{3}{4}$	1 2 $\frac{1}{2}$	16.800	.1176
$1\frac{7}{8}$	$5\frac{7}{8}$	2.761	$1\frac{7}{8}$	$4\frac{7}{8}$	1 2 $\frac{7}{8}$	17.721	.1240
					1 3 $\frac{1}{4}$	18.665	.1306

Table Continued.

Diameter in Inches.	Circum. in Feet & Inches.	Area in Square Inches.	Area in Square Feet.	Diameter in Inches.	Circum. in Feet & Inches.	Area in Square Inches.	Area in Square Feet.
5	1 3 <sup>5</sup> / <sub>8</sub>	19.635	.1374	10	2 7 <sup>3</sup> / <sub>8</sub>	78.540	.5497
5 <sup>1</sup> / <sub>8</sub>	1 4 <sup>1</sup> / <sub>8</sub>	20.629	.1444	10 <sup>1</sup> / <sub>8</sub>	2 7 <sup>3</sup> / <sub>8</sub>	80.515	.5636
5 <sup>1</sup> / <sub>4</sub>	1 4 <sup>1</sup> / <sub>2</sub>	21.648	.1515	10 <sup>1</sup> / <sub>4</sub>	2 8 <sup>1</sup> / <sub>8</sub>	82.516	.5776
5 <sup>3</sup> / <sub>8</sub>	1 4 <sup>7</sup> / <sub>8</sub>	22.690	.1588	10 <sup>3</sup> / <sub>8</sub>	2 8 <sup>1</sup> / <sub>2</sub>	84.540	.5917
5 <sup>1</sup> / <sub>2</sub>	1 5 <sup>1</sup> / <sub>4</sub>	23.758	.1663	10 <sup>1</sup> / <sub>2</sub>	2 8 <sup>7</sup> / <sub>8</sub>	86.590	.6061
5 <sup>5</sup> / <sub>8</sub>	1 5 <sup>5</sup> / <sub>8</sub>	24.850	.1739	10 <sup>5</sup> / <sub>8</sub>	2 9 <sup>3</sup> / <sub>8</sub>	88.664	.6206
5 <sup>3</sup> / <sub>4</sub>	1 6	25.967	.1817	10 <sup>3</sup> / <sub>4</sub>	2 9 <sup>3</sup> / <sub>4</sub>	90.762	.6353
5 <sup>7</sup> / <sub>8</sub>	1 6 <sup>3</sup> / <sub>8</sub>	27.108	.1897	10 <sup>7</sup> / <sub>8</sub>	2 10 <sup>1</sup> / <sub>8</sub>	92.855	.6499
6	1 6 <sup>3</sup> / <sub>4</sub>	28.274	.1979	11	2 10 <sup>1</sup> / <sub>2</sub>	95.033	.6652
6 <sup>1</sup> / <sub>8</sub>	1 7 <sup>1</sup> / <sub>4</sub>	29.464	.2062	11 <sup>1</sup> / <sub>8</sub>	2 10 <sup>7</sup> / <sub>8</sub>	97.205	.6874
6 <sup>1</sup> / <sub>4</sub>	1 7 <sup>5</sup> / <sub>8</sub>	30.679	.2147	11 <sup>1</sup> / <sub>4</sub>	2 11 <sup>1</sup> / <sub>4</sub>	99.402	.6958
6 <sup>3</sup> / <sub>8</sub>	1 8	31.919	.2234	11 <sup>3</sup> / <sub>8</sub>	2 11 <sup>3</sup> / <sub>4</sub>	101.623	.7143
6 <sup>1</sup> / <sub>2</sub>	1 8 <sup>3</sup> / <sub>8</sub>	33.183	.2322	11 <sup>1</sup> / <sub>2</sub>	3 0 <sup>1</sup> / <sub>8</sub>	103.869	.7290
6 <sup>5</sup> / <sub>8</sub>	1 8 <sup>3</sup> / <sub>4</sub>	34.471	.2412	11 <sup>5</sup> / <sub>8</sub>	3 0 <sup>1</sup> / <sub>2</sub>	106.139	.7429
6 <sup>3</sup> / <sub>4</sub>	1 9 <sup>1</sup> / <sub>8</sub>	35.784	.2504	11 <sup>3</sup> / <sub>4</sub>	3 0 <sup>5</sup> / <sub>8</sub>	108.434	.7590
6 <sup>7</sup> / <sub>8</sub>	1 9 <sup>1</sup> / <sub>2</sub>	37.122	.2598	11 <sup>7</sup> / <sub>8</sub>	3 1 <sup>1</sup> / <sub>4</sub>	110.753	.7752
7	1 10	38.484	.2693	12	3 1 <sup>5</sup> / <sub>8</sub>	113.097	.7916
7 <sup>1</sup> / <sub>8</sub>	1 10 <sup>3</sup> / <sub>8</sub>	39.871	.2791	12 <sup>1</sup> / <sub>8</sub>	3 2	115.466	.8082
7 <sup>1</sup> / <sub>4</sub>	1 10 <sup>3</sup> / <sub>4</sub>	41.282	.2889	12 <sup>1</sup> / <sub>4</sub>	3 2 <sup>1</sup> / <sub>2</sub>	117.859	.8250
7 <sup>3</sup> / <sub>8</sub>	1 11 <sup>1</sup> / <sub>8</sub>	42.718	.2990	12 <sup>3</sup> / <sub>8</sub>	3 2 <sup>7</sup> / <sub>8</sub>	120.276	.8419
7 <sup>1</sup> / <sub>2</sub>	1 11 <sup>1</sup> / <sub>2</sub>	44.178	.3092	12 <sup>1</sup> / <sub>2</sub>	3 3 <sup>1</sup> / <sub>4</sub>	122.718	.8590
7 <sup>5</sup> / <sub>8</sub>	1 11 <sup>7</sup> / <sub>8</sub>	45.663	.3196	12 <sup>5</sup> / <sub>8</sub>	3 3 <sup>5</sup> / <sub>8</sub>	125.185	.8762
7 <sup>3</sup> / <sub>4</sub>	2 0 <sup>3</sup> / <sub>8</sub>	47.173	.3299	12 <sup>3</sup> / <sub>4</sub>	3 4	127.676	.8937
7 <sup>7</sup> / <sub>8</sub>	2 0 <sup>3</sup> / <sub>4</sub>	48.707	.3409	12 <sup>7</sup> / <sub>8</sub>	3 4 <sup>3</sup> / <sub>8</sub>	130.192	.9113
8	2 1 <sup>1</sup> / <sub>8</sub>	50.265	.3518	13	3 4 <sup>3</sup> / <sub>4</sub>	132.732	.9291
8 <sup>1</sup> / <sub>8</sub>	2 1 <sup>1</sup> / <sub>2</sub>	51.848	.3629	13 <sup>1</sup> / <sub>8</sub>	3 5 <sup>1</sup> / <sub>4</sub>	135.297	.9470
8 <sup>1</sup> / <sub>4</sub>	2 1 <sup>7</sup> / <sub>8</sub>	53.456	.3741	13 <sup>1</sup> / <sub>4</sub>	3 5 <sup>5</sup> / <sub>8</sub>	137.886	.9642
8 <sup>3</sup> / <sub>8</sub>	2 2 <sup>1</sup> / <sub>4</sub>	55.088	.3856	13 <sup>3</sup> / <sub>8</sub>	3 6	140.500	.9835
8 <sup>1</sup> / <sub>2</sub>	2 2 <sup>5</sup> / <sub>8</sub>	56.745	.3972	13 <sup>1</sup> / <sub>2</sub>	3 6 <sup>3</sup> / <sub>8</sub>	143.139	1.0019
8 <sup>5</sup> / <sub>8</sub>	2 3	58.426	.4089	13 <sup>5</sup> / <sub>8</sub>	3 6 <sup>3</sup> / <sub>4</sub>	145.802	1.0206
8 <sup>3</sup> / <sub>4</sub>	2 3 <sup>3</sup> / <sub>8</sub>	60.132	.4209	13 <sup>3</sup> / <sub>4</sub>	3 7 <sup>1</sup> / <sub>8</sub>	148.489	1.0294
8 <sup>7</sup> / <sub>8</sub>	2 3 <sup>7</sup> / <sub>8</sub>	61.862	.4330	13 <sup>7</sup> / <sub>8</sub>	3 7 <sup>1</sup> / <sub>2</sub>	151.201	1.0584
9	2 4 <sup>1</sup> / <sub>2</sub>	63.617	.4453	14	3 7 <sup>7</sup> / <sub>8</sub>	153.938	1.0775
9 <sup>1</sup> / <sub>8</sub>	2 4 <sup>5</sup> / <sub>8</sub>	65.396	.4577	14 <sup>1</sup> / <sub>8</sub>	3 8 <sup>3</sup> / <sub>8</sub>	156.669	1.0968
9 <sup>1</sup> / <sub>4</sub>	2 5	67.200	.4704	14 <sup>1</sup> / <sub>4</sub>	3 8 <sup>3</sup> / <sub>4</sub>	159.485	1.1193
9 <sup>3</sup> / <sub>8</sub>	2 5 <sup>3</sup> / <sub>8</sub>	69.029	.4832	14 <sup>3</sup> / <sub>8</sub>	3 9 <sup>1</sup> / <sub>8</sub>	162.295	1.1360
9 <sup>1</sup> / <sub>2</sub>	2 5 <sup>3</sup> / <sub>4</sub>	70.882	.4961	14 <sup>1</sup> / <sub>2</sub>	3 9 <sup>1</sup> / <sub>2</sub>	165.130	1.1569
9 <sup>5</sup> / <sub>8</sub>	2 6 <sup>1</sup> / <sub>4</sub>	72.759	.5093	14 <sup>5</sup> / <sub>8</sub>	3 9 <sup>7</sup> / <sub>8</sub>	167.989	1.1749
9 <sup>3</sup> / <sub>4</sub>	2 6 <sup>5</sup> / <sub>8</sub>	74.662	.5226	14 <sup>3</sup> / <sub>4</sub>	3 10 <sup>1</sup> / <sub>4</sub>	170.873	1.1961
9 <sup>7</sup> / <sub>8</sub>	2 7	76.588	.5361	14 <sup>7</sup> / <sub>8</sub>	3 10 <sup>3</sup> / <sub>4</sub>	173.782	1.2164



Table Continued.

Diameter in Inches.	Circum. in Feet & Inches.	Area in Square Inches.	Area in Square Feet.	Diameter in Inches.	Circum. in Feet & Inches.	Area in Square Inches.	Area in Square Feet.
15	3 11 $\frac{1}{8}$	176.715	1.2370	20	5 2 $\frac{7}{8}$	314.160	2.1990
15 $\frac{1}{8}$	3 11 $\frac{1}{2}$	179.672	1.2577	20 $\frac{1}{8}$	5 3 $\frac{1}{4}$	318.099	2.2265
15 $\frac{1}{4}$	3 11 $\frac{3}{8}$	182.654	1.2785	20 $\frac{1}{4}$	5 3 $\frac{5}{8}$	322.063	2.2543
15 $\frac{3}{8}$	4 0 $\frac{1}{4}$	185.661	1.2996	20 $\frac{3}{8}$	5 4	326.051	2.2822
15 $\frac{1}{2}$	4 0 $\frac{3}{8}$	188.692	1.3208	20 $\frac{1}{2}$	5 4 $\frac{3}{8}$	330.064	2.3103
15 $\frac{3}{4}$	4 1	191.748	1.3422	20 $\frac{3}{4}$	5 4 $\frac{3}{4}$	334.101	2.3386
15 $\frac{7}{8}$	4 1 $\frac{1}{2}$	194.828	1.3637	20 $\frac{7}{8}$	5 5 $\frac{1}{8}$	338.163	2.3670
15 $\frac{7}{8}$	4 1 $\frac{7}{8}$	197.933	1.3855	20 $\frac{7}{8}$	5 5 $\frac{1}{2}$	342.250	2.3956
16	4 2 $\frac{1}{4}$	201.062	1.4074	21	5 5 $\frac{7}{8}$	346.361	2.4244
16 $\frac{1}{8}$	4 2 $\frac{3}{8}$	204.216	1.4295	21 $\frac{1}{8}$	5 6 $\frac{3}{8}$	350.497	2.4533
16 $\frac{1}{4}$	4 3	207.394	1.4517	21 $\frac{1}{4}$	5 6 $\frac{3}{4}$	354.657	2.4824
16 $\frac{3}{8}$	4 3 $\frac{3}{8}$	210.597	1.4741	21 $\frac{3}{8}$	5 7 $\frac{1}{8}$	358.841	2.5117
16 $\frac{1}{2}$	4 3 $\frac{3}{4}$	213.825	1.4967	21 $\frac{1}{2}$	5 7 $\frac{1}{2}$	363.051	2.5412
16 $\frac{3}{8}$	4 4 $\frac{1}{4}$	217.077	1.5195	21 $\frac{5}{8}$	5 7 $\frac{7}{8}$	367.284	2.5708
16 $\frac{3}{4}$	4 4 $\frac{3}{8}$	220.353	1.5424	21 $\frac{3}{4}$	5 8 $\frac{1}{4}$	371.543	2.6007
16 $\frac{7}{8}$	4 5	223.654	1.5655	21 $\frac{7}{8}$	5 8 $\frac{3}{4}$	375.826	2.6306
17	4 5 $\frac{3}{8}$	226.980	1.5888	22	5 9 $\frac{1}{8}$	380.133	2.6608
17 $\frac{1}{8}$	4 5 $\frac{3}{4}$	230.330	1.6123	22 $\frac{1}{8}$	5 9 $\frac{1}{2}$	384.465	2.6691
17 $\frac{1}{4}$	4 6 $\frac{1}{8}$	233.705	1.6359	22 $\frac{1}{4}$	5 9 $\frac{7}{8}$	388.822	2.7016
17 $\frac{3}{8}$	4 6 $\frac{1}{2}$	237.104	1.6597	22 $\frac{3}{8}$	5 10 $\frac{1}{4}$	393.203	2.7224
17 $\frac{1}{2}$	4 6 $\frac{3}{8}$	240.528	1.6836	22 $\frac{1}{2}$	5 10 $\frac{3}{8}$	397.608	2.7632
17 $\frac{3}{8}$	4 7 $\frac{3}{8}$	243.977	1.7078	22 $\frac{5}{8}$	5 11	402.038	2.7980
17 $\frac{3}{4}$	4 7 $\frac{3}{4}$	247.450	1.7321	22 $\frac{3}{4}$	5 11 $\frac{1}{2}$	406.493	2.8054
17 $\frac{7}{8}$	4 8 $\frac{1}{8}$	250.947	1.7566	22 $\frac{7}{8}$	5 11 $\frac{7}{8}$	410.972	2.8658
18	4 8 $\frac{1}{2}$	254.469	1.7812	23	6 0 $\frac{1}{4}$	415.476	2.8903
18 $\frac{1}{8}$	4 8 $\frac{7}{8}$	258.016	1.8061	23 $\frac{1}{8}$	6 0 $\frac{5}{8}$	420.004	2.9100
18 $\frac{1}{4}$	4 9 $\frac{1}{4}$	261.587	1.8311	23 $\frac{1}{4}$	6 1	424.557	2.9518
18 $\frac{3}{8}$	4 9 $\frac{3}{4}$	265.182	1.8562	23 $\frac{3}{8}$	6 1 $\frac{3}{8}$	429.135	2.9937
18 $\frac{1}{2}$	4 10 $\frac{1}{8}$	268.803	1.8816	23 $\frac{1}{2}$	6 1 $\frac{3}{4}$	433.737	3.0129
18 $\frac{3}{8}$	4 10 $\frac{1}{2}$	272.447	1.9071	23 $\frac{5}{8}$	6 2 $\frac{1}{4}$	438.363	3.0261
18 $\frac{3}{4}$	4 10 $\frac{7}{8}$	276.117	1.9328	23 $\frac{3}{4}$	6 2 $\frac{5}{8}$	443.014	3.0722
18 $\frac{7}{8}$	4 11 $\frac{1}{4}$	279.811	1.9586	23 $\frac{7}{8}$	6 3	447.690	3.1081
19	4 11 $\frac{5}{8}$	283.529	1.9847	Ft. In.			
19 $\frac{1}{8}$	5 0	287.272	1.9941	2 0	6 3 $\frac{3}{8}$	452.390	3.1418
19 $\frac{1}{4}$	5 0 $\frac{1}{2}$	291.039	2.0371	2 0 $\frac{1}{4}$	6 4 $\frac{1}{8}$	461.864	3.2075
19 $\frac{3}{8}$	5 0 $\frac{7}{8}$	294.831	2.0637	2 0 $\frac{1}{2}$	6 4 $\frac{7}{8}$	471.436	3.2731
19 $\frac{1}{2}$	5 1 $\frac{1}{4}$	298.648	2.0904	2 0 $\frac{3}{4}$	6 5 $\frac{3}{4}$	481.106	3.3410
19 $\frac{3}{8}$	5 1 $\frac{5}{8}$	302.489	2.1172	2 1	6 6 $\frac{1}{2}$	490.875	3.4081
19 $\frac{3}{4}$	5 2	306.355	2.1443	2 1 $\frac{1}{4}$	6 7 $\frac{1}{4}$	500.741	3.4775
19 $\frac{7}{8}$	5 2 $\frac{3}{8}$	310.245	2.1716	2 1 $\frac{1}{2}$	6 8 $\frac{1}{8}$	510.706	3.5468
				2 1 $\frac{3}{4}$	6 8 $\frac{7}{8}$	520.769	3.6101

Table Continued.

Diameter in Ft. & In.	Circum. in Ft. & In.	Area in Square Inches.	Area in Square Feet.	Diameter in Ft. & In.	Circum. in Ft. & In.	Area in Square Inches.	Area in Square Feet.
2 2	6 9 <sup>5</sup> / <sub>8</sub>	530.930	3.6870	3 0	9 5	1017.87	7.0688
2 2 <sup>1</sup> / <sub>4</sub>	6 10 <sup>1</sup> / <sub>2</sub>	541.189	3.7583	3 0 <sup>1</sup> / <sub>4</sub>	9 5 <sup>7</sup> / <sub>8</sub>	1032.06	7.1671
2 2 <sup>1</sup> / <sub>2</sub>	6 11 <sup>1</sup> / <sub>4</sub>	551.547	3.8302	3 0 <sup>1</sup> / <sub>2</sub>	9 6 <sup>5</sup> / <sub>8</sub>	1046.35	7.2664
2 2 <sup>3</sup> / <sub>4</sub>	7 0	562.002	3.9042	3 0 <sup>3</sup> / <sub>4</sub>	9 7 <sup>1</sup> / <sub>2</sub>	1060.73	7.3662
2 3	7 0 <sup>3</sup> / <sub>4</sub>	572.556	3.9761	3 1	9 8 <sup>1</sup> / <sub>4</sub>	1075.21	7.4661
2 3 <sup>1</sup> / <sub>4</sub>	7 1 <sup>5</sup> / <sub>8</sub>	583.208	4.0500	3 1 <sup>1</sup> / <sub>4</sub>	9 9	1089.79	7.5671
2 3 <sup>1</sup> / <sub>2</sub>	7 2 <sup>3</sup> / <sub>8</sub>	593.958	4.1241	3 1 <sup>1</sup> / <sub>2</sub>	9 9 <sup>7</sup> / <sub>8</sub>	1104.46	7.6691
2 3 <sup>3</sup> / <sub>4</sub>	7 3 <sup>1</sup> / <sub>8</sub>	604.807	4.2000	3 1 <sup>3</sup> / <sub>4</sub>	9 10 <sup>1</sup> / <sub>2</sub>	1119.24	7.7791
2 4	7 3 <sup>7</sup> / <sub>8</sub>	615.753	4.2760	3 2	9 11 <sup>3</sup> / <sub>8</sub>	1134.12	7.8681
2 4 <sup>1</sup> / <sub>4</sub>	7 4 <sup>3</sup> / <sub>4</sub>	626.798	4.3521	3 2 <sup>1</sup> / <sub>4</sub>	10 0 <sup>1</sup> / <sub>8</sub>	1149.09	7.9791
2 4 <sup>1</sup> / <sub>2</sub>	7 5 <sup>1</sup> / <sub>2</sub>	637.941	4.4302	3 2 <sup>1</sup> / <sub>2</sub>	10 0 <sup>7</sup> / <sub>8</sub>	1164.16	8.0846
2 4 <sup>3</sup> / <sub>4</sub>	7 6 <sup>1</sup> / <sub>4</sub>	649.182	4.5083	3 2 <sup>3</sup> / <sub>4</sub>	10 1 <sup>3</sup> / <sub>4</sub>	1179.32	8.1891
2 5	7 7	660.521	4.5861	3 3	10 2 <sup>1</sup> / <sub>2</sub>	1194.59	8.2951
2 5 <sup>1</sup> / <sub>4</sub>	7 7 <sup>1</sup> / <sub>8</sub>	671.958	4.6665	3 3 <sup>1</sup> / <sub>4</sub>	10 3 <sup>1</sup> / <sub>4</sub>	1209.95	8.4026
2 5 <sup>1</sup> / <sub>2</sub>	7 8 <sup>5</sup> / <sub>8</sub>	683.494	4.7467	3 3 <sup>1</sup> / <sub>2</sub>	10 4	1225.42	8.5091
2 5 <sup>3</sup> / <sub>4</sub>	7 9 <sup>1</sup> / <sub>2</sub>	695.128	4.8274	3 3 <sup>3</sup> / <sub>4</sub>	10 4 <sup>7</sup> / <sub>8</sub>	1240.98	8.6171
2 6	7 10 <sup>1</sup> / <sub>4</sub>	706.860	4.9081	3 4	10 5 <sup>5</sup> / <sub>8</sub>	1256.64	8.7269
2 6 <sup>1</sup> / <sub>4</sub>	7 11	718.690	4.9901	3 4 <sup>1</sup> / <sub>4</sub>	10 6 <sup>3</sup> / <sub>8</sub>	1272.39	8.8361
2 6 <sup>1</sup> / <sub>2</sub>	7 11 <sup>3</sup> / <sub>4</sub>	730.618	5.0731	3 4 <sup>1</sup> / <sub>2</sub>	10 7 <sup>1</sup> / <sub>4</sub>	1288.25	8.9462
2 6 <sup>3</sup> / <sub>4</sub>	8 0 <sup>5</sup> / <sub>8</sub>	742.644	5.1573	3 4 <sup>3</sup> / <sub>4</sub>	10 8	1304.20	9.0561
2 7	8 1 <sup>3</sup> / <sub>8</sub>	754.769	5.2278	3 5	10 8 <sup>3</sup> / <sub>4</sub>	1320.25	9.1686
2 7 <sup>1</sup> / <sub>4</sub>	8 2 <sup>1</sup> / <sub>8</sub>	766.992	5.3264	3 5 <sup>1</sup> / <sub>4</sub>	10 9 <sup>1</sup> / <sub>2</sub>	1336.40	9.2112
2 7 <sup>1</sup> / <sub>2</sub>	8 2 <sup>7</sup> / <sub>8</sub>	779.313	5.4112	3 5 <sup>1</sup> / <sub>2</sub>	10 10 <sup>3</sup> / <sub>8</sub>	1352.65	9.3936
2 7 <sup>3</sup> / <sub>4</sub>	8 3 <sup>1</sup> / <sub>4</sub>	791.732	5.4982	3 5 <sup>3</sup> / <sub>4</sub>	10 11 <sup>1</sup> / <sub>8</sub>	1369.00	9.5061
2 8	8 4 <sup>1</sup> / <sub>2</sub>	804.249	5.5850	3 6	10 11 <sup>7</sup> / <sub>8</sub>	1385.44	9.6212
2 8 <sup>1</sup> / <sub>4</sub>	8 5 <sup>3</sup> / <sub>8</sub>	816.865	5.6729	3 6 <sup>1</sup> / <sub>4</sub>	11 0 <sup>3</sup> / <sub>4</sub>	1401.98	9.7364
2 8 <sup>1</sup> / <sub>2</sub>	8 6 <sup>1</sup> / <sub>8</sub>	829.578	5.7601	3 6 <sup>1</sup> / <sub>2</sub>	11 1 <sup>1</sup> / <sub>2</sub>	1418.62	9.8518
2 8 <sup>3</sup> / <sub>4</sub>	8 6 <sup>7</sup> / <sub>8</sub>	842.390	5.8491	3 6 <sup>3</sup> / <sub>4</sub>	11 2 <sup>1</sup> / <sub>4</sub>	1435.36	9.9671
2 9	8 7 <sup>5</sup> / <sub>8</sub>	855.300	5.9398	3 7	11 3	1452.20	10.084
2 9 <sup>1</sup> / <sub>4</sub>	8 8 <sup>1</sup> / <sub>2</sub>	868.308	6.0291	3 7 <sup>1</sup> / <sub>4</sub>	11 3 <sup>7</sup> / <sub>8</sub>	1469.14	10.202
2 9 <sup>1</sup> / <sub>2</sub>	8 9 <sup>1</sup> / <sub>4</sub>	881.415	6.1201	3 7 <sup>1</sup> / <sub>2</sub>	11 4 <sup>5</sup> / <sub>8</sub>	1486.17	10.320
2 9 <sup>3</sup> / <sub>4</sub>	8 10	894.619	6.2129	3 7 <sup>3</sup> / <sub>4</sub>	11 5 <sup>3</sup> / <sub>8</sub>	1503.30	10.439
2 10	8 10 <sup>3</sup> / <sub>4</sub>	907.922	6.3051	3 8	11 6 <sup>1</sup> / <sub>4</sub>	1530.53	10.559
2 10 <sup>1</sup> / <sub>4</sub>	8 11 <sup>1</sup> / <sub>2</sub>	921.323	6.3981	3 8 <sup>1</sup> / <sub>4</sub>	11 7	1537.86	10.679
2 10 <sup>1</sup> / <sub>2</sub>	9 0 <sup>5</sup> / <sub>8</sub>	934.822	6.4911	3 8 <sup>1</sup> / <sub>2</sub>	11 7 <sup>3</sup> / <sub>4</sub>	1555.28	10.800
2 10 <sup>3</sup> / <sub>4</sub>	9 1 <sup>1</sup> / <sub>8</sub>	948.419	6.5863	3 8 <sup>3</sup> / <sub>4</sub>	11 8 <sup>1</sup> / <sub>2</sub>	1572.81	10.922
2 11	9 1 <sup>7</sup> / <sub>8</sub>	962.115	6.6815	3 9	11 9 <sup>5</sup> / <sub>8</sub>	1590.43	11.044
2 11 <sup>1</sup> / <sub>4</sub>	9 2 <sup>1</sup> / <sub>4</sub>	975.908	6.7772	3 9 <sup>1</sup> / <sub>4</sub>	11 10 <sup>1</sup> / <sub>8</sub>	1608.15	11.167
2 11 <sup>1</sup> / <sub>2</sub>	9 3 <sup>1</sup> / <sub>2</sub>	989.800	6.8738	3 9 <sup>1</sup> / <sub>2</sub>	11 10 <sup>7</sup> / <sub>8</sub>	1625.97	11.291
2 11 <sup>3</sup> / <sub>4</sub>	9 4 <sup>1</sup> / <sub>4</sub>	1003.79	6.9701	3 9 <sup>3</sup> / <sub>4</sub>	11 11 <sup>3</sup> / <sub>4</sub>	1643.89	11.415

Table Continued.

Diameter in Ft. & In.	Circum. in Ft. & In.	Area in Square Inches.	Area in Square Feet.	Diameter in Ft. & In.	Circum. in Ft. & In.	Area in Square Inches.	Area in Square Feet.
3 10	12 0 1/2	1661.90	11.534	4 8	14 7 7/8	2463.01	17.104
3 10 1/4	12 1 1/4	1680.02	11.666	4 8 1/4	14 8 5/8	2485.05	17.257
3 10 1/2	12 2	1698.23	11.793	4 8 1/2	14 9 1/2	2507.19	17.411
3 10 3/4	12 2 7/8	1716.54	11.920	4 8 3/4	14 10 1/4	2529.42	17.565
3 11	12 3 5/8	1734.94	12.048	4 9	14 11	2551.76	17.720
3 11 1/4	12 4 3/8	1753.45	12.176	4 9 1/4	14 11 7/8	2574.19	17.876
3 11 1/2	12 5 1/4	1772.05	12.305	4 9 1/2	15 0 5/8	2596.72	18.033
3 11 3/4	12 6	1790.76	12.435	4 9 3/4	15 1 3/8	2619.35	18.189
4 0	12 6 3/4	1809.56	12.566	4 10	15 2 1/4	2642.08	18.347
4 0 1/4	12 7 1/2	1828.46	12.697	4 10 1/4	15 2 7/8	2664.91	18.506
4 0 1/2	12 8 3/8	1847.45	12.829	4 10 1/2	15 3 3/4	2687.83	18.665
4 0 3/4	12 9 1/8	1866.55	12.962	4 10 3/4	15 4 1/2	2710.85	18.825
4 1	12 9 7/8	1885.74	13.095	4 11	15 5 1/4	2733.97	18.985
4 1 1/4	12 10 1/4	1905.03	13.229	4 11 1/4	15 6 1/8	2757.19	19.147
4 1 1/2	12 11 1/2	1924.42	13.364	4 11 1/2	15 6 7/8	2780.51	19.309
4 1 3/4	13 0 1/4	1943.91	13.499	4 11 3/4	15 7 3/4	2803.92	19.471
4 2	13 1	1963.50	13.635	5 0	15 8 1/2	2827.44	19.635
4 2 1/4	13 1 7/8	1983.18	13.772	5 0 1/4	15 9 1/4	2851.05	19.798
4 2 1/2	13 2 5/8	2002.96	13.909	5 0 1/2	15 10	2874.76	19.963
4 2 3/4	13 3 3/8	2022.84	14.047	5 0 3/4	15 10 3/4	2898.56	20.128
4 3	13 4 1/4	2042.82	14.186	5 1	15 11 5/8	2922.47	20.294
4 3 1/4	13 5	2062.90	14.325	5 1 1/4	16 0 3/8	2946.47	20.461
4 3 1/2	13 5 3/4	2083.07	14.465	5 1 1/2	16 1 1/4	2970.57	20.629
4 3 3/4	13 6 1/2	2103.35	14.606	5 1 3/4	16 1 7/8	2994.77	20.797
4 4	13 7 3/8	2123.72	14.748	5 2	16 2 3/4	3019.07	20.965
4 4 1/4	13 8 1/8	2144.19	14.890	5 2 1/4	16 3 1/2	3043.47	21.135
4 4 1/2	13 8 7/8	2164.75	15.033	5 2 1/2	16 4 1/4	3067.96	21.305
4 4 3/4	13 9 3/4	2185.42	15.176	5 2 3/4	16 5 1/8	3092.56	21.476
4 5	13 10 1/2	2206.18	15.320	5 3	16 5 7/8	3117.25	21.647
4 5 1/4	13 11 1/4	2227.05	15.465	5 3 1/4	16 6 1/4	3142.04	21.819
4 5 1/2	13 0	2248.01	15.611	5 3 1/2	16 7 1/2	3166.92	21.992
4 5 3/4	14 0 7/8	2269.06	15.757	5 3 3/4	16 8 1/4	3191.91	22.166
4 6	14 1 5/8	2290.22	15.904	5 4	16 9	3216.99	22.333
4 6 1/4	14 2 3/8	2311.48	16.051	5 4 1/4	16 9 3/4	3242.17	22.515
4 6 1/2	14 3 1/4	2332.83	16.200	5 4 1/2	16 10 5/8	3267.46	22.621
4 6 3/4	14 4	2354.28	16.349	5 4 3/4	16 11 3/8	3292.83	22.866
4 7	14 4 3/4	2375.83	16.498	5 5	17 0 1/8	3318.31	23.043
4 7 1/4	14 5 1/2	2397.48	16.649	5 5 1/4	17 0 7/8	3343.88	23.221
4 7 1/2	14 6 3/8	2419.22	16.800	5 5 1/2	17 1 3/4	3369.56	23.330
4 7 3/4	14 7 1/8	2441.07	16.951	5 5 3/4	17 2 1/2	3395.33	23.578

Table Continued.

Diameter in Ft. & In.		Circum. in Feet & Inches.		Area in Square Inches.	Area in Square Feet.	Diameter in Ft. & In.		Circum. in Feet & Inches.		Area in Square Inches.	Area in Square Feet.
5	6	17	3 $\frac{3}{8}$	3421.20	23.758	6	4	19	10 $\frac{1}{4}$	4536.47	31.503
5	6 $\frac{1}{4}$	17	4 $\frac{1}{8}$	3447.16	23.938	6	4 $\frac{1}{4}$	19	11 $\frac{1}{2}$	4566.36	31.710
5	6 $\frac{1}{2}$	17	4 $\frac{7}{8}$	3473.23	24.119	6	4 $\frac{1}{2}$	20	0 $\frac{1}{4}$	4596.35	31.919
5	6 $\frac{3}{4}$	17	5 $\frac{3}{8}$	3499.39	24.307	6	4 $\frac{3}{4}$	20	1 $\frac{1}{8}$	4626.44	32.114
5	7	17	6 $\frac{1}{2}$	3525.26	24.483	6	5	20	1 $\frac{7}{8}$	4656.63	32.337
5	7 $\frac{1}{4}$	17	7 $\frac{1}{4}$	3552.01	24.666	6	5 $\frac{1}{4}$	20	2 $\frac{5}{8}$	4686.92	32.548
5	7 $\frac{1}{2}$	17	8	3578.47	24.850	6	5 $\frac{1}{2}$	20	3 $\frac{1}{2}$	4717.30	32.759
5	7 $\frac{3}{4}$	17	8 $\frac{3}{4}$	3605.03	25.034	6	5 $\frac{3}{4}$	20	4 $\frac{1}{4}$	4747.79	32.970
5	8	17	9 $\frac{5}{8}$	3631.68	25.220	6	6	20	5	4778.37	33.183
5	8 $\frac{1}{4}$	17	10 $\frac{3}{8}$	3658.44	25.405	6	6 $\frac{1}{4}$	20	5 $\frac{3}{4}$	4809.05	33.396
5	8 $\frac{1}{2}$	17	11 $\frac{1}{8}$	3685.29	25.592	6	6 $\frac{1}{2}$	20	6 $\frac{1}{2}$	4839.83	33.619
5	8 $\frac{3}{4}$	17	11 $\frac{3}{8}$	3712.24	25.779	6	6 $\frac{3}{4}$	20	7 $\frac{3}{8}$	4870.70	33.824
5	9	18	0 $\frac{3}{4}$	3739.28	25.964	6	7	20	8 $\frac{1}{8}$	4901.68	34.039
5	9 $\frac{1}{4}$	18	1 $\frac{1}{2}$	3766.43	26.155	6	7 $\frac{1}{4}$	20	8 $\frac{7}{8}$	4932.75	34.255
5	9 $\frac{1}{2}$	18	2 $\frac{1}{4}$	3793.67	26.344	6	7 $\frac{1}{2}$	20	9 $\frac{3}{4}$	4963.92	34.471
5	9 $\frac{3}{4}$	18	3 $\frac{1}{8}$	3821.02	26.534	6	7 $\frac{3}{4}$	20	10 $\frac{1}{2}$	4995.19	34.688
5	10	18	3 $\frac{7}{8}$	3848.46	26.725	6	8	20	11 $\frac{1}{4}$	5026.26	34.906
5	10 $\frac{1}{4}$	18	4 $\frac{3}{8}$	3875.99	26.916	6	8 $\frac{1}{4}$	21	0 $\frac{1}{8}$	5058.02	35.125
5	10 $\frac{1}{2}$	18	5 $\frac{1}{2}$	3903.63	27.108	6	8 $\frac{1}{2}$	21	0 $\frac{7}{8}$	5089.58	35.344
5	10 $\frac{3}{4}$	18	6 $\frac{1}{4}$	3931.36	27.301	6	8 $\frac{3}{4}$	21	1 $\frac{5}{8}$	5121.24	35.564
5	11	18	7	3959.20	27.494	6	9	21	2 $\frac{3}{8}$	5153.00	35.784
5	11 $\frac{1}{4}$	18	7 $\frac{3}{4}$	3987.13	27.688	6	9 $\frac{1}{4}$	21	3 $\frac{1}{4}$	5184.86	36.006
5	11 $\frac{1}{2}$	18	8 $\frac{5}{8}$	4015.16	27.883	6	9 $\frac{1}{2}$	21	4	5216.82	36.227
5	11 $\frac{3}{4}$	18	9 $\frac{3}{8}$	4043.28	28.078	6	9 $\frac{3}{4}$	21	4 $\frac{3}{4}$	5248.87	36.450
6	0	18	10 $\frac{1}{8}$	4071.51	28.274	6	10	21	5 $\frac{1}{2}$	5281.02	36.674
6	0 $\frac{1}{4}$	18	10 $\frac{3}{8}$	4099.83	28.471	6	10 $\frac{1}{4}$	21	6 $\frac{3}{8}$	5313.27	36.897
6	0 $\frac{1}{2}$	18	11 $\frac{1}{4}$	4128.25	28.663	6	10 $\frac{1}{2}$	21	7 $\frac{1}{8}$	5345.62	37.122
6	0 $\frac{3}{4}$	19	0 $\frac{1}{2}$	4156.77	28.866	6	10 $\frac{3}{4}$	21	7 $\frac{7}{8}$	5378.07	37.347
6	1	19	1 $\frac{1}{4}$	4185.39	29.065	6	11	21	8 $\frac{3}{4}$	5410.62	37.573
6	1 $\frac{1}{4}$	19	2 $\frac{1}{8}$	4214.11	29.264	6	11 $\frac{1}{4}$	21	9 $\frac{1}{2}$	5443.26	37.700
6	1 $\frac{1}{2}$	19	2 $\frac{7}{8}$	4242.92	29.466	6	11 $\frac{1}{2}$	21	10 $\frac{1}{4}$	5476.00	38.027
6	1 $\frac{3}{4}$	19	3 $\frac{5}{8}$	4271.83	29.665	6	11 $\frac{3}{4}$	21	11	5508.84	38.256
6	2	19	4 $\frac{1}{2}$	4300.85	29.867						
6	2 $\frac{1}{4}$	19	5 $\frac{1}{4}$	4329.95	30.069						
6	2 $\frac{1}{2}$	19	6	4359.16	30.271						
6	2 $\frac{3}{4}$	19	6 $\frac{3}{4}$	4388.47	30.475						
6	3	19	7 $\frac{5}{8}$	4417.87	30.679						
6	3 $\frac{1}{4}$	19	8 $\frac{3}{8}$	4447.37	30.884						
6	3 $\frac{1}{2}$	19	9 $\frac{1}{8}$	4476.97	31.090						
6	3 $\frac{3}{4}$	19	9 $\frac{7}{8}$	4506.67	31.296						

Table Continued.

Diameter in Feet and Inches.	Circumfer- ence in Feet and Inches.	Area in Feet.	Diameter in Feet and Inches.	Circumfer- ence in Feet and Inches.	Area in Feet.
7 0	21 11 $\frac{7}{8}$	38.4846	10 0	31 5	78.5400
1	22 3	39.4060	1	31 8 $\frac{1}{8}$	79.8540
2	22 6 $\frac{1}{8}$	40.3388	2	31 11 $\frac{1}{4}$	81.1795
3	22 9 $\frac{1}{4}$	41.2825	3	32 2 $\frac{3}{8}$	82.5190
4	23 0 $\frac{3}{8}$	42.2367	4	32 5 $\frac{1}{2}$	83.8627
5	23 2 $\frac{1}{8}$	43.2022	5	32 8 $\frac{3}{8}$	85.2211
6	23 6 $\frac{3}{4}$	44.1787	6	32 11 $\frac{3}{4}$	86.5903
7	23 11	45.1656	7	33 2 $\frac{7}{8}$	87.9697
8	24 1 $\frac{1}{8}$	46.1638	8	33 6 $\frac{1}{8}$	89.3668
9	24 4 $\frac{1}{8}$	47.1730	9	33 9 $\frac{1}{4}$	90.7627
10	24 7 $\frac{1}{4}$	48.1926	10	34 0 $\frac{3}{8}$	92.1749
11	24 10 $\frac{3}{8}$	49.2236	11	34 3 $\frac{1}{2}$	93.5986
8 0	25 1 $\frac{1}{2}$	50.2656	11 0	34 6 $\frac{5}{8}$	95.0334
1	25 4 $\frac{5}{8}$	51.6178	1	34 9 $\frac{3}{4}$	96.4783
2	25 7 $\frac{7}{8}$	52.3816	2	35 0 $\frac{7}{8}$	97.9347
3	25 11	53.4562	3	35 4 $\frac{1}{8}$	99.4021
4	26 2 $\frac{1}{8}$	54.5412	4	35 7 $\frac{1}{4}$	100.8797
5	26 5 $\frac{1}{4}$	55.6377	5	35 10 $\frac{3}{8}$	102.3689
6	26 8 $\frac{3}{8}$	56.7451	6	36 1 $\frac{1}{2}$	103.8601
7	26 11 $\frac{1}{2}$	57.8628	7	36 4 $\frac{1}{2}$	105.3794
8	27 2 $\frac{3}{4}$	58.9920	8	36 7 $\frac{3}{4}$	106.9013
9	27 5 $\frac{3}{4}$	60.1321	9	36 10 $\frac{7}{8}$	108.4342
10	27 9	61.2826	10	37 2 $\frac{3}{4}$	109.9772
11	28 0 $\frac{1}{8}$	62.4445	11	37 5 $\frac{1}{4}$	111.5319
9 0	28 3 $\frac{1}{4}$	63.6174	12 0	37 8 $\frac{3}{8}$	113.0976
1	28 6 $\frac{3}{8}$	64.8006	1	37 11 $\frac{1}{2}$	114.6732
2	28 9 $\frac{1}{2}$	65.9951	2	38 2 $\frac{5}{8}$	116.2607
3	29 0 $\frac{5}{8}$	67.2007	3	38 5 $\frac{3}{4}$	117.8590
4	29 3 $\frac{3}{4}$	68.4166	4	38 8 $\frac{7}{8}$	119.4674
5	29 7	69.6440	5	39 0	121.0876
6	29 10 $\frac{1}{8}$	70.8823	6	39 3 $\frac{1}{4}$	122.7187
7	30 1 $\frac{1}{4}$	72.1309	7	39 6 $\frac{3}{8}$	124.3598
8	30 4 $\frac{3}{8}$	73.3910	8	39 9 $\frac{1}{2}$	126.0127
9	30 7 $\frac{1}{2}$	74.6620	9	40 0 $\frac{3}{8}$	127.6765
10	30 11 $\frac{5}{8}$	75.9433	10	40 3 $\frac{3}{4}$	129.3504
11	31 1 $\frac{3}{4}$	77.2362	11	40 6 $\frac{7}{8}$	131.0360

Table Continued.

Diameter in Feet and Inches.		Circumference in Feet and Inches.		Area in Feet.	Diameter in Feet and Inches.		Circumference in Feet and Inches.		Area in Feet.
13	0	40	10	132.7326	16	0	50	3 $\frac{1}{8}$	201.0624
	1	41	1 $\frac{1}{8}$	134.4391		1	50	6 $\frac{1}{4}$	203.1615
	2	41	4 $\frac{3}{8}$	136.1574		2	50	9 $\frac{5}{8}$	205.2726
	3	41	7 $\frac{1}{2}$	137.8867		3	51	0 $\frac{1}{2}$	207.3946
	4	41	10 $\frac{5}{8}$	139.6260		4	51	3 $\frac{1}{4}$	209.5264
	5	42	1 $\frac{5}{8}$	141.3771		5	51	6 $\frac{1}{2}$	211.6703
	6	42	4 $\frac{7}{8}$	143.1391		6	51	10	213.8251
	7	42	8	144.9111		7	52	1 $\frac{1}{8}$	215.9896
	8	42	11 $\frac{1}{8}$	146.6949		8	52	4 $\frac{1}{4}$	218.1662
	9	43	2 $\frac{1}{4}$	148.4896		9	52	7 $\frac{3}{8}$	220.3537
	10	43	5 $\frac{1}{2}$	150.2943		10	52	10 $\frac{1}{2}$	222.5510
11	43	8 $\frac{5}{8}$	152.1109	11	53	1 $\frac{3}{8}$	224.7603		
14	0	43	11 $\frac{3}{4}$	153.9484	17	0	53	4 $\frac{7}{8}$	226.9806
	1	44	2 $\frac{7}{8}$	155.7758		1	53	8	229.2105
	2	44	6	157.6250		2	53	11 $\frac{1}{8}$	231.4625
	3	44	9 $\frac{1}{8}$	159.4852		3	54	2 $\frac{1}{8}$	233.7055
	4	45	0 $\frac{1}{4}$	161.3553		4	54	5 $\frac{3}{8}$	235.9682
	5	45	3 $\frac{1}{2}$	163.2373		5	54	8 $\frac{1}{2}$	238.2430
	6	45	6 $\frac{5}{8}$	165.1303		6	54	11 $\frac{3}{8}$	240.5287
	7	45	9 $\frac{3}{4}$	167.0331		7	55	2 $\frac{7}{8}$	242.8241
	8	46	0 $\frac{7}{8}$	168.9479		8	55	6	245.1316
	9	46	4	170.8735		9	55	9 $\frac{1}{8}$	247.4500
	10	46	7 $\frac{1}{8}$	172.8091		10	56	0 $\frac{1}{4}$	249.7781
11	46	11 $\frac{1}{4}$	174.7565	11	56	3 $\frac{1}{2}$	252.1184		
15	0	47	1 $\frac{1}{2}$	176.7150	18	0	56	6 $\frac{1}{2}$	254.4696
	1	47	4 $\frac{5}{8}$	178.6832		1	56	9 $\frac{3}{8}$	256.8303
	2	47	7 $\frac{3}{4}$	180.6634		2	57	0 $\frac{7}{8}$	259.2033
	3	47	10 $\frac{7}{8}$	182.6545		3	57	4	261.5872
	4	48	2 $\frac{1}{2}$	184.6555		4	57	7 $\frac{1}{8}$	263.9807
	5	48	5 $\frac{1}{8}$	186.6684		5	57	10 $\frac{1}{4}$	266.3864
	6	48	8 $\frac{1}{4}$	188.6923		6	58	1 $\frac{3}{8}$	268.8031
	7	48	11 $\frac{3}{8}$	190.7260		7	58	4 $\frac{1}{2}$	271.2293
	8	49	2 $\frac{5}{8}$	192.7716		8	58	7 $\frac{3}{8}$	273.6678
	9	49	5 $\frac{3}{4}$	194.8282		9	58	10 $\frac{3}{4}$	276.1161
	10	49	8 $\frac{7}{8}$	196.8946		10	59	2	278.5761
11	50	0	198.9730	11	59	5 $\frac{1}{8}$	281.0472		

*Sizes of Tinware in Form of Frustum of a Cone.*

## PANS.

Size.	Diameter of Top.	Diameter of Bottom.	Height.	Size.	Diameter of Top.	Diameter of Bottom.	Height.
20 qts.	19½ In.	13 In.	8 In.	2 qts.	9 In.	6 In.	3¾ In.
16 "	18 "	11¼ "	6¼ "	3 pts.	8¼ "	5¾ "	2¾ "
14 "	15¼ "	9¾ "	6¼ "	1 pt.	6¼ "	4 "	2¾ "
10 "	14¾ "	11 "	4⅞ "	Pie.	9 "	7½ "	1¾ "
6 "	12¾ "	9 "	4 "				

## DISH KETTLES AND PAILS.

Size.	Diameter of Top.	Diameter of Bottom.	Height.	Size.	Diameter of Top.	Diameter of Bottom.	Height.
14 qts.	13 In.	9 In.	9 In.	6 qts.	9¼ In.	5½ In.	6½ In.
10 "	11½ "	7 "	8 "	2 "	6¼ "	4 "	4 "

## COFFEE POTS.

Size.	Diameter of Top.	Diameter of Bottom.	Height.	Size.	Diameter of Top.	Diameter of Bottom.	Height.
1 gal.	4 In.	7 In.	8½ In.	3 qts.	3½ In.	6 In.	8½ In.

## DIPPERS.

Size.	Diam. of Top.	Diam. of Bot.	Height.	Size.	Diam. of Top.	Diam. of Bot.	Height.
½ gal.	6½ In.	4 In.	4 In.	1 pt.	4¼ In.	3¾ In.	2¾ In.

## Tables Continued.

## MEASURES.

Size.	Diameter of Top.	Diameter of Bottom.	Height.	Size.	Diameter of Top.	Diameter of Bottom.	Height.
1 gal.	5½ In.	6⅛ In.	9¼ In.	1 pt.	2½ In.	3¾ In.	4¼ In.
½ " "	4 " "	4⅞ " "	8 " "	½ " "	2⅝ " "	2⅞ " "	3⅞ " "
1 qt.	3½ " "	4 " "	5¾ " "				

## WASH BOWLS.

Size.	Diameter of Top.	Diameter of Bottom.	Height.
Large wash bowl.....	11 In.	5¾ In.	5 In.
Cullender.....	11 " "	5¾ " "	5 " "
Small wash bowl.....	9½ " "	5½ " "	3¾ " "
Milk strainer.....	9½ " "	5½ " "	3¾ " "

## DRUGGISTS' AND LIQUOR DEALERS' MEASURES.



Fig. 163.

Size.	Diameter of Top.	Diameter of Bottom.	Height.	Size.	Diameter of Top.	Diameter of Bottom.	Height.
5 gal.	8 In.	13½ In.	12¾ In.	½ gal.	3½ In.	6⅝ In.	6 In.
3 " "	7 " "	11½ " "	10⅞ " "	1 qt.	2½ " "	5⅞ " "	4⅞ " "
2 " "	6 " "	10½ " "	8¾ " "	1 pt.	2 " "	4 " "	4 " "
1 " "	3¾ " "	8¾ " "	7½ " "	½ " "	1¾ " "	3¾ " "	3½ " "



*Capacity of Cylinders in United States Gallons.*

Dia'r. } Inc's. } Depth.	4	5	6	7	8	9
1 inch.	.0544	.0850	.1224	.1666	.2176	.2754
2 .....	.1088	.1700	.2448	.3332	.4352	.5508
3 .....	.1632	.2550	.3672	.4998	.6528	.8262
4 .....	.2176	.3400	.4896	.6664	.8704	1.1016
5 .....	.2720	.4250	.6120	.8330	1.0880	1.3770
6 .....	.3264	.5100	.7344	.9996	1.3056	1.6524
7 .....	.3808	.5950	.8568	1.1662	1.5232	1.9278
8 .....	.4352	.6800	.9792	1.3328	1.7408	2.2032
9 .....	.4896	.7650	1.1016	1.4994	1.9584	2.4786
10 .....	.5440	.8500	1.2240	1.6660	2.1760	2.7540
11 .....	.5984	.9350	1.3464	1.8326	3.3936	3.0294
12 .....	.6528	1.0200	1.4688	1.9992	2.6112	3.3048
13 .....	.7072	1.1050	1.5912	2.1658	2.8288	5.5802
14 .....	.7616	1.1900	1.7136	2.3324	3.0464	3.8556
15 .....	.8160	1.2750	1.8360	2.4990	3.2640	4.1310
16 .....	.8704	1.3600	1.9584	2.6656	3.4816	4.4064
17 .....	.9248	1.4450	2.0808	2.8322	3.6992	4.6818
18 .....	.9792	1.5300	2.2032	2.9988	3.9168	4.9572
19 .....	1.0336	1.6150	2.3256	3.1654	4.1344	5.2326
20 .....	1.0880	1.7000	2.4480	3.3320	4.3520	5.5080
21 .....	1.1424	1.7850	2.5704	3.4986	4.5696	5.7834
22 .....	1.1968	1.8700	2.6928	3.6652	4.7872	6.0588
23 .....	1.2512	1.9550	2.8152	3.8318	5.0048	6.3342
24 .....	1.3056	2.0400	2.9376	3.9984	5.2224	6.6096
25 .....	1.3600	2.1250	3.0600	4.1650	5.4400	6.8850
26 .....	1.4144	2.2100	3.1824	4.3316	5.6576	7.1604
27 .....	1.4688	2.2950	3.3048	4.4982	5.8752	7.4358
28 .....	1.5232	2.3800	3.4272	4.6648	6.0928	7.7112
29 .....	1.5776	2.4650	3.5496	4.8314	6.3104	7.9866
30 .....	1.6320	2.5500	3.6720	4.9980	6.5280	8.2620
31 .....	1.6864	2.6350	3.7944	5.1646	6.7456	8.5374
32 .....	1.7408	2.7200	3.9168	5.3312	6.9632	8.8128
33 .....	1.7952	2.8050	4.0392	5.4978	7.1808	9.0882
34 .....	1.8496	2.8900	4.1616	5.6644	7.3984	9.3636
35 .....	1.9040	2.9750	4.2840	5.8310	7.6160	9.6390
36 .....	1.9584	3.0600	4.4064	5.9976	7.8336	9.9144
40 .....	2.1760	3.4000	4.8960	6.6640	8.7040	11.0160
44 .....	2.3936	3.7400	5.3856	7.3304	9.5744	12.1176
48 .....	2.6112	4.0800	5.8752	7.9968	10.4448	13.2192
54 .....	2.9376	4.5900	6.6096	8.9964	11.7504	14.8716
60 .....	3.2640	5.1000	7.3440	9.9960	13.0560	16.5240
72 .....	3.9168	6.1200	8.8128	11.9952	15.6672	19.8288

Table Continued.

Dia'r. } Inc's. } Depth.	10	11	12	13	14	15
1 inch.	.3400	.4114	.4896	.5746	.6664	.7650
2 .....	.6800	.8228	.9792	1.1492	1.3328	1.5300
3 .....	1.0200	1.2342	1.4688	1.7238	1.9992	2.2950
4 .....	1.3600	1.6456	1.9584	2.2984	2.6656	3.0600
5 .....	1.7000	2.0570	2.4480	2.8730	3.3320	3.8250
6 .....	2.0400	2.4684	2.9376	3.4476	3.9984	4.5900
7 .....	2.3800	2.8798	3.4272	4.0222	4.6648	5.3550
8 .....	2.7200	3.2912	3.9168	4.5968	5.3312	6.1200
9 .....	3.0600	3.7026	4.4064	5.1714	5.9976	6.8850
10 .....	3.4000	4.1140	4.8960	5.7460	6.6640	7.6500
11 .....	3.7400	4.5254	5.3856	6.3206	7.3304	8.4150
12 .....	4.0800	4.9368	5.8752	6.8952	7.9968	9.1800
13 .....	4.4200	5.3482	6.3648	7.4698	8.6632	9.9450
14 .....	4.7600	5.7596	6.8544	8.0444	9.3296	10.7100
15 .....	5.1000	6.1710	7.3440	8.6190	9.9960	11.4750
16 .....	5.4400	6.5824	7.8336	9.1936	10.6624	12.2400
17 .....	5.7800	6.9938	8.3232	9.7682	11.3288	13.0050
18 .....	6.1200	7.4052	8.8128	10.3428	11.9952	13.7700
19 .....	6.4600	7.8166	9.3024	10.9174	12.6616	14.5350
20 .....	6.8000	8.2280	9.7920	11.4920	13.3280	15.3000
21 .....	7.1400	8.6394	10.2816	12.0666	13.9944	16.0650
22 .....	7.4800	9.0508	10.7712	12.6412	14.6608	16.8300
23 .....	7.8200	9.4622	11.2608	13.2158	15.3272	17.5950
24 .....	8.1600	9.8736	11.7504	13.7904	15.9936	18.3600
25 .....	8.5000	10.2850	12.2400	14.3650	16.6600	19.1250
26 .....	8.8400	10.6964	12.7296	14.9396	17.3264	19.8900
27 .....	9.1800	11.1078	13.2192	15.5142	17.9928	20.6550
28 .....	9.5200	11.5192	13.7088	16.0888	18.6592	21.4200
29 .....	9.8600	11.9306	14.1984	16.6634	19.3256	22.1850
30 .....	10.2000	12.3420	14.6880	17.2380	19.9920	22.9500
31 .....	10.5400	12.7534	15.1776	17.8126	20.6584	23.7150
32 .....	10.8800	13.1648	15.6672	18.3872	21.3248	24.4800
33 .....	11.2200	13.5762	16.1568	18.9618	21.9912	25.2450
34 .....	11.5600	13.9876	16.6464	19.5364	22.6576	26.0100
35 .....	11.9000	14.3990	17.1360	20.1110	23.3240	26.7750
36 .....	12.2400	14.8104	17.6256	20.6856	23.9904	27.5400
40 .....	13.6000	16.4560	19.5840	22.9840	26.6560	30.6000
44 .....	14.9600	18.1016	21.5424	25.2824	29.3216	33.6600
48 .....	16.3200	19.7472	23.5008	27.5808	31.9872	36.7200
54 .....	18.3600	22.2156	26.4384	31.0284	35.9856	41.3100
60 .....	20.4000	24.6840	29.3760	34.4760	39.9840	45.9000
72 .....	24.4800	29.6208	35.2512	41.3712	47.9808	55.0800

Table Continued.

Dia'r. } Inc's. } Depth.	16	17	18	19	20	21
1 inch.	.8704	.9826	1.1016	1.2274	1.3600	1.4994
2 .....	1.7408	1.9652	2.2032	2.4548	2.7200	2.9988
3 .....	2.6112	2.9478	3.3048	3.6822	4.0800	4.4982
4 .....	3.4816	3.9304	4.4064	4.9096	5.4400	5.9976
5 .....	4.3520	4.9130	5.5080	6.1370	6.8000	7.4970
6 .....	5.2224	5.8956	6.6096	7.3644	8.1600	8.9964
7 .....	6.0928	6.8782	7.7112	8.5918	9.5200	10.4958
8 .....	6.9632	7.8608	8.8128	9.8192	10.8800	11.9952
9 .....	7.8336	8.8434	9.9144	11.0466	12.2400	13.4946
10 .....	8.7040	9.8260	11.0160	12.2740	13.6000	14.9940
11 .....	9.5744	10.8086	12.1176	13.5014	14.9600	16.4934
12 .....	10.4448	11.7912	13.2192	14.7288	16.3200	17.9928
13 .....	11.3152	12.7738	14.3208	15.9562	17.6800	19.4922
14 .....	12.1856	13.7564	15.4224	17.1836	19.0400	20.9916
15 .....	13.0560	14.7390	16.5240	18.4110	20.4000	22.4910
16 .....	13.9264	15.7216	17.6256	19.6384	21.7600	23.9904
17 .....	14.7968	16.7042	18.7272	20.8658	23.1200	25.4898
18 .....	15.6672	17.6868	19.8288	22.0932	24.4800	26.9892
19 .....	16.5376	18.6694	20.9304	23.3206	25.8400	28.4886
20 .....	17.4080	19.6520	22.0320	24.5480	27.2000	29.9880
21 .....	18.2784	20.6346	23.1336	25.7754	28.5600	31.4874
22 .....	19.1488	21.6172	24.2352	27.0028	29.9200	32.9868
23 .....	20.0192	22.5998	25.3368	28.2302	31.2800	34.4862
24 .....	20.8896	23.5824	26.4384	29.4576	32.6400	35.9856
25 .....	21.7600	24.5650	27.5400	30.6850	34.0000	37.4850
26 .....	22.6304	25.5476	28.6416	31.9124	35.3600	38.9844
27 .....	23.5008	26.5302	29.7432	33.1398	36.7200	40.4838
28 .....	24.3712	27.5128	30.8448	34.3672	38.0800	41.9832
29 .....	25.2416	28.4954	31.9464	35.5946	39.4400	43.4826
30 .....	26.1120	29.4780	33.0480	36.8220	40.8000	44.9820
31 .....	26.9824	30.4606	34.1496	38.0494	42.1600	46.4814
32 .....	27.8528	31.4432	35.2512	39.2768	43.5200	47.9808
33 .....	28.7232	32.4258	36.3528	40.5042	44.8800	49.4802
34 .....	29.5936	33.4084	37.4544	41.7316	46.2400	50.9796
35 .....	30.4640	34.3910	38.5560	42.9590	47.6000	52.4790
36 .....	31.3344	35.3736	39.6576	44.1864	48.9600	53.9784
40 .....	34.8160	39.3040	44.0640	49.0960	54.4000	59.9760
44 .....	38.2976	43.2344	48.4704	54.0056	59.8400	65.9736
48 .....	41.7792	47.1648	52.8768	58.9152	65.2800	71.9712
54 .....	47.0016	53.0604	59.4864	66.2796	73.4400	80.9676
60 .....	52.2240	58.9560	66.0960	73.6440	81.6000	89.9640
72 .....	62.6688	70.7472	79.3152	88.3728	97.9200	107.9570

Table Continued.

Diameter in } Inches. } Dep'th. } .....	22	23	24	26	28
1 inch.....	1.6456	1.7986	1.9584	2.2984	2.6656
2 .....	3.2912	3.5972	3.9168	4.5968	5.3312
3 .....	4.9368	5.3958	5.8752	6.8952	7.9968
4 .....	6.5824	7.1944	7.8336	9.1930	10.6624
5 .....	8.2280	8.9930	9.7920	11.4920	13.3280
6 .....	9.8736	10.7916	11.7504	13.7904	15.9936
7 .....	11.5192	12.5902	13.7088	16.0888	18.6592
8 .....	13.1648	14.3888	15.6672	18.3872	21.3248
9 .....	14.8104	16.1874	17.6256	20.6856	23.9904
10 .....	16.4560	17.9860	19.5840	22.9840	26.6560
11 .....	18.1016	19.7846	21.5424	25.2824	29.3216
12 .....	19.7472	21.5832	23.5008	27.5808	31.9872
13 .....	21.3928	23.3818	25.4592	29.8792	34.6528
14 .....	23.0384	25.1804	27.4176	32.1776	37.3184
15 .....	24.6840	26.9790	29.3760	34.4760	39.9840
16 .....	26.3296	28.7776	31.3334	36.7744	42.6496
17 .....	27.9752	30.5762	33.2928	39.0728	45.3152
18 .....	29.6208	32.3748	35.2512	41.3712	47.9808
19 .....	31.2664	34.1734	37.2096	43.6696	50.6464
20 .....	32.9120	35.9720	39.1680	45.9680	53.3120
21 .....	34.5576	37.7706	41.1264	48.2664	55.9796
22 .....	36.2032	39.5692	43.0848	50.5648	58.6432
23 .....	37.8488	41.3678	45.0432	52.8632	61.3088
24 .....	39.4944	43.1664	47.0016	55.1616	63.9744
25 .....	41.1400	44.9650	48.9600	57.4600	66.6400
26 .....	42.7856	46.7636	50.9184	59.7584	69.3056
27 .....	44.4312	48.5622	52.8768	62.0568	71.9712
28 .....	46.0768	50.3608	54.8352	64.3552	74.6368
29 .....	47.7224	52.1594	56.7936	66.6536	77.3024
30 .....	49.3680	53.9580	58.7520	68.9520	79.9680
31 .....	51.0136	55.7566	60.7104	71.2504	82.6336
32 .....	52.6592	57.5552	62.6688	73.5488	85.2992
33 .....	54.3048	59.3538	64.6272	75.8472	87.9648
34 .....	55.9504	61.1524	66.5856	78.1456	90.6304
35 .....	57.5960	62.9510	68.5440	80.4440	93.2960
36 .....	59.2416	64.7496	70.5024	82.7424	95.9616
40 .....	65.8240	71.9440	78.3360	91.9360	106.6240
44 .....	72.4064	79.1384	86.1696	101.1300	117.2860
48 .....	78.9888	86.3328	94.0032	110.3230	127.9490
54 .....	88.8624	97.1244	105.7540	124.1140	143.9420
60 .....	98.7360	107.9160	117.5040	137.9040	159.9360
72 .....	118.4830	129.4990	141.0050	165.4850	191.9230

Table Continued.

Diameter in } Inches. } ..... Depth.	30	32	34	36	40
1 inch.....	3.0600	3.4816	3.9304	4.4064	5.4400
2 .....	6.1200	6.9632	7.8608	8.8128	10.8800
3 .....	9.1800	10.4448	11.7912	13.2192	16.3200
4 .....	12.2400	13.9264	15.7216	17.6256	21.7600
5 .....	15.3000	17.4080	19.6520	22.0320	27.2000
6 .....	18.3600	20.8896	23.5824	26.4384	32.6400
7 .....	21.4200	24.3712	27.5128	30.8448	38.0800
8 .....	24.4800	27.8528	31.4422	35.2512	43.5200
9 .....	27.5400	31.3344	35.3736	39.6576	48.9600
10 .....	30.6000	34.8160	39.3740	44.0640	54.4000
11 .....	33.6600	38.2976	43.2344	48.4704	59.8400
12 .....	36.7200	41.7792	47.1648	52.8768	65.2800
13 .....	39.7800	45.2608	51.0952	57.2832	70.7200
14 .....	42.8400	48.7424	55.0256	61.6896	76.1600
15 .....	45.9000	52.2240	58.9560	66.0960	81.6000
16 .....	48.9600	55.7056	62.8864	70.5024	87.0400
17 .....	52.0200	59.1872	66.8168	74.9088	92.4800
18 .....	55.0800	62.6688	70.7472	79.3152	97.9200
19 .....	58.1400	66.1504	74.6776	83.7216	103.3600
20 .....	61.2000	69.6320	78.6080	88.1280	108.8000
21 .....	64.2600	73.1136	82.5384	92.5344	114.2400
22 .....	67.3200	76.5952	86.4688	96.9408	119.6800
23 .....	70.3800	80.0768	90.3992	101.3470	125.1200
24 .....	73.4400	83.5584	94.3296	105.7540	130.5600
25 .....	76.5000	87.0400	98.2600	110.1600	136.0000
26 .....	79.5600	90.5216	102.1900	114.5660	141.4400
27 .....	82.6200	94.0032	106.1210	118.9730	146.8800
28 .....	85.6800	97.4848	110.0510	123.3790	152.3200
29 .....	88.7400	100.9660	113.9820	127.7860	157.7600
30 .....	91.8000	104.4480	117.9120	132.1920	163.2000
31 .....	94.8600	107.9300	121.8420	136.5980	168.6400
32 .....	97.9200	111.4110	125.7730	141.0050	174.0800
33 .....	100.9800	114.8930	129.7030	145.4110	179.5200
34 .....	104.0400	118.3740	133.6340	149.8180	184.9600
35 .....	107.1000	121.8560	137.5640	154.2240	190.4000
36 .....	110.1600	125.3380	141.4940	158.6300	195.8400
40 .....	122.4000	139.2640	157.2160	176.2560	217.6000
44 .....	134.6400	153.1900	172.9380	193.8820	239.3600
48 .....	146.8800	167.1170	188.6590	211.5070	261.1200
54 .....	165.2400	188.0060	212.2420	237.9460	293.7600
60 .....	183.6000	208.8960	235.8240	264.3840	326.4000
72 .....	220.3200	250.6750	282.9890	317.2610	391.6800

Table Continued.

Diameter in } Inches. } Depth. }.....	44	48	54	60	72
1 inch.....	6.5824	7.8336	9.9144	12.2400	17.6256
2.....	13.1648	15.6672	19.8288	24.4800	35.2512
3.....	19.7472	23.5008	29.7432	36.7200	52.8768
4.....	26.3296	31.3344	39.6576	48.9600	70.5024
5.....	32.9120	39.1680	49.5720	61.2000	88.1280
6.....	39.4944	47.0016	59.4864	73.4400	105.7540
7.....	46.0768	54.8352	69.4008	85.6800	123.3790
8.....	52.6592	62.6688	79.3152	97.9200	141.0050
9.....	59.2416	70.5024	89.2296	110.1600	158.6300
10.....	65.8240	78.3360	99.1440	122.4000	176.2560
11.....	72.4064	86.1696	109.0580	134.6400	193.8820
12.....	78.9888	94.0032	118.9730	146.8800	211.5070
13.....	85.5712	101.8370	128.8870	159.1200	229.1330
14.....	92.1536	109.6700	138.8020	171.3600	246.7580
15.....	98.7360	117.5040	148.7160	183.6000	264.3840
16.....	105.3180	125.3380	158.6300	195.8400	282.0100
17.....	111.9010	133.1710	168.5450	208.0800	299.6350
18.....	118.4830	141.0050	178.4590	220.3200	317.2610
19.....	125.0660	148.8380	188.3740	232.5600	334.8860
20.....	131.6480	156.6720	198.2880	244.8000	352.5120
21.....	138.2300	164.5060	208.2020	257.0400	370.1380
22.....	144.8130	172.3390	218.1170	269.2800	387.7630
23.....	151.3950	180.1730	228.0310	281.5200	405.3890
24.....	157.9780	188.0060	237.9460	293.7600	423.0140
25.....	164.5600	195.8400	247.8600	306.0000	440.6400
26.....	171.1420	203.6740	257.7740	318.2400	458.2660
27.....	177.7250	211.5070	267.6890	330.4800	475.8910
28.....	184.3070	219.3410	277.6030	342.7200	493.5170
29.....	190.8900	227.1740	287.5180	354.9600	511.1420
30.....	197.4720	235.0080	297.4320	367.2000	528.7680
31.....	204.0540	242.8420	307.3460	379.4400	546.3940
32.....	210.6370	250.6750	317.2610	391.6800	564.0190
33.....	217.2190	258.5090	327.1750	403.9200	581.6450
34.....	223.8020	266.3420	337.0900	416.1600	599.2710
35.....	230.3840	274.1760	347.0040	428.4000	616.8960
36.....	236.9660	282.0100	356.9180	440.6400	634.5220
40.....	263.2960	313.3440	396.5760	489.6000	705.0240
44.....	289.6260	344.6780	436.2340	538.5600	775.5260
48.....	315.9550	376.0130	475.8910	587.5200	846.0290
54.....	355.4500	423.0140	535.3780	660.9600	951.7820
60.....	394.9440	470.0160	594.8640	734.4000	1057.5400
72.....	473.9330	564.0190	713.8370	881.2100	1269.0400

*The Decimal equivalents of the Fractional parts of a Gallon.*

0.03125 of a gallon.....	equals	1	gill.
0.06250 of a gallon.....	equals	$\frac{1}{2}$	pint.
0.09375 of a gallon.....	equals	3	gills.
0.12500 of a gallon.....	equals	1	pint.
0.15625 of a gallon.....	equals	5	gills.
0.18750 of a gallon.....	equals	$1\frac{1}{2}$	pint.
0.21875 of a gallon.....	equals	7	gills.
0.25000 of a gallon.....	equals	1	quart.
0.28125 of a gallon.....	equals	9	gills.
0.31250 of a gallon.....	equals	$2\frac{1}{2}$	pints.
0.34375 of a gallon.....	equals	11	gills.
0.37500 of a gallon.....	equals	3	pints.
0.40625 of a gallon.....	equals	13	gills.
0.43750 of a gallon.....	equals	$3\frac{1}{2}$	pints.
0.46875 of a gallon.....	equals	15	gills.
0.50000 of a gallon.....	equals	$\frac{1}{2}$	gallon.
0.53125 of a gallon.....	equals	17	gills.
0.56250 of a gallon.....	equals	$4\frac{1}{2}$	pints.
0.59375 of a gallon.....	equals	19	gills.
0.62500 of a gallon.....	equals	5	pints.
0.65625 of a gallon.....	equals	21	gills.
0.68750 of a gallon.....	equals	$5\frac{1}{2}$	pints.
0.71875 of a gallon.....	equals	23	gills.
0.75000 of a gallon.....	equals	3	quarts.
0.78125 of a gallon.....	equals	25	gills.
0.81250 of a gallon.....	equals	$6\frac{1}{2}$	pints.
0.84375 of a gallon.....	equals	27	gills.
0.87500 of a gallon.....	equals	7	pints.
0.90625 of a gallon.....	equals	29	gills.
0.93750 of a gallon.....	equals	$7\frac{1}{2}$	pints.
0.96875 of a gallon.....	equals	31	gills.
1.000 of a gallon.....	equals	1	gallon.

*Explanation of the Tables.*—A very few words are needed to explain the tables given above, and perhaps the simplest method of doing so is to apply it to a practical case. Suppose, for instance, it is desired to find the dimensions of

a cylinder holding 27 gallons. Running down the column headed 19, we find the number 27.0028 and following the line across we come to the number 22; hence a cylinder 19 inches in diameter and 22 inches deep will hold 27 gallons and .0028 gallon. Turning to the supplementary table we find a gill is equal to .03125 gallon; so the capacity of the cylinder in question is about  $\frac{1}{10}$  gill more than 27 gallons.

Again, if it is desired to find the depth of a 15-inch cylinder that shall hold 27 gallons, we run down the column headed 15 till we come to the number 27.54, and following the line across we find the depth to be 36 inches. The decimal .54 we find, on consulting the supplementary table, is equivalent to between 1 and 2 pints, therefore a 15 inch cylinder 36 inches deep will hold between 1 and 2 pints more than 27 gallons. Similarly, to find the diameter of a cylinder 15 inches deep that shall hold 27 gallons, we run across the line opposite 15 till we come to the number 26.976 under the column headed 23. The decimal part according to the small table is equivalent to between 31 gills and 1 gallon, so the capacity of a cylinder 15 inches deep and 23 inches in diameter is about  $\frac{1}{2}$  gill less than 27 gallons. Where it is desired to find the capacity of a cylinder, both dimensions of which are given, it is only necessary to run down the column headed with the diameter till we come to the line across from the given depth, where the number found will be the capacity of the cylinder in gallons. To illustrate: What is the capacity of a cylinder 29 inches deep and 32 inches in diameter? Consulting the table in the manner described, we find the number 100.966, the decimal part of which according to the second table is about 31 gills, or 3 quarts, 1 pint, 3 gills; the given cylinder, therefore, holding 100 gallons, 3 quarts, 1 pint, 3 gills. These examples, we think, fully illustrate the uses of the table, and serve to show its wide



application to the determination of the capacities and dimensions of cylindrical vessels. (The Metal Worker.)

### SPECIFIC GRAVITY.

The specific gravity of a body is the ratio of its weight to an equal volume of some other body assumed as a conventional standard. The standard usually adopted for solids and liquids is rain or distilled water at a common temperature. In bodies of equal magnitudes the specific gravities are directly as the weights or as their densities. In bodies of the same specific gravity the weights will be as the magnitudes. In bodies of equal weights the specific gravities are inversely as the magnitudes. The weights of different bodies are to each other in the compound ratio of their magnitudes and specific gravities. Hence, it is obvious that speaking of the magnitude, weight and specific gravity of a body, if any two of them are given, the third may be found. A body immersed in a fluid will sink if its specific gravity be greater than that of the fluid; if it be less, the body will rise to the top, and be only partly immersed; and if the specific gravity of the body and fluid be equal, it will remain at rest in any part of the fluid in which it may be placed. When a body is heavier than a fluid it loses as much of its weight when immersed as is equal to a quantity of the fluid of the same bulk or magnitude. If the specific gravity of the fluid be greater than that of the body, then the quantity of fluid displaced by the part immersed is equal to the weight of the whole body. And hence, as the specific gravity of the fluid is to that of the body, so is the whole magnitude of the body to the part immersed. The specific gravities of equal solids are as their parts immersed in the same fluid.

A knowledge of the specific gravities of bodies of technical and economic importance is of interest in so far as it,

1. Furnishes a means of finding the absolute weight of bodies whose volumes are known.

2. In that it permits the approximate quantitative proportions of the constituents of a mixture; and

3. As it serves as a sign of genuineness.

Hence, in the following table, the specific gravities of 119 bodies, used for technical and scientific purposes, are given.

*Table showing the Specific Gravities of Technically Important Bodies.*

I.— <i>Metals.</i>			
		Asphalt.....	1.66
		Basalt.....	2.79
Aluminium.....	2.67	Brick.....	1.53
Antimony.....	6.72	Chalk.....	2.45
Bell-metal(78copper, 22 tin)	8.82	Clay.....	1.66
Brass.....	8.40	Clay, potters'.....	2.20
Brass wire.....	8.54	Coal.....	1.53
Copper, cast.....	8.76	Earth, clayey, dry.....	1.9
Copper, hammered.....	8.88	Earth, clayey, fresh.....	2.1
German silver.....	8.6	Feldspar.....	2.28
Gold, cast.....	19.5	Glass, bottle.....	2.76
Gold, hammered.....	19.6	Glass, window.....	2.64
Gun-metal.....	8.79	Granite.....	2.70
Iron, cast.....	7.25	Gypsum, burnt.....	1.80
Iron, wrought.....	7.79	Gypsum, cast and dried....	0.97
Lead.....	11.35	Gypsum, crude.....	2.20
Mercury.....	13.6	Lignite.....	1.25
Nickel.....	8.28	Lime mortar, dry.....	1.64
Platinum, hammered.....	21.25	Lime mortar, fresh.....	1.79
Steel, cast.....	7.92	Limestone.....	2.46
Steel, hammered.....	7.84	Marble (Carrara).....	2.72
Steel, hardened in water...	7.82	Masonry of bricks, dry....	1.53
Steel, soft.....	7.63	Masonry of quarrystone, dry	2.40
Silver, cast.....	10.47	Porcelain (Berlin).....	2.30
Silver, hammered.....	10.62	Porcelain (China).....	2.39
Tin (English), cast.....	7.30	Porcelain (Meissen).....	2.49
Tin (English), hammered..	7.48	Porcelain (Sèvres).....	2.15
Zinc, cast.....	6.86	Pumice stone.....	0.92
Zinc, rolled.....	7.04	Quarrystone.....	2.46
		Quarrystone, soft.....	1.98
		Quartz.....	2.65
		Sand, dry.....	1.64
		Sandstone.....	2.35
		Slate.....	2.76
II.— <i>Stones and Varieties of Earths.</i>			
Alabaster.....	2.63		
Asbestos.....	2.6		

III.—*Woods.*

Alder.....	0.68
Ash, from the trunk.....	0.85
Basswood.....	0.60
Beech.....	0.85
Boxwood (Dutch).....	1.03
Boxwood (French).....	0.91
Cedar (American).....	0.56
Cedar (Indian).....	1.32
Cherry, dry.....	0.74
Cork.....	0.24
Ebony (Antilles).....	1.35
Ebony (Madagascar).....	1.21
Ebony (Mexican).....	0.80
Fir, from the heart, dry.....	0.62
Fir, from the trunk, green..	0.72
Hickory.....	0.68
Lignum vitæ.....	1.26
Mahogany (African).....	0.95
Mahogany (Cuba).....	0.56
Mahogany (Domingo).....	0.79
Maple.....	0.75
Oak, from the heart, green..	1.17
Oak, from the trunk, dry...	0.72
Oak, from the trunk, green..	0.84
Oak, sap-wood, dry.....	0.61
Pear.....	0.66
Pine, pitch.....	0.47
Pine, white.....	0.55
Poplar.....	0.38
Willow.....	0.58

IV.—*Seeds.*

Barley.....	0.65
Beans.....	0.76
Buckwheat.....	0.64
Clover.....	0.80
Flaxseed.....	0.70
Hempseed.....	0.53
Indian corn.....	0.76
Lentils.....	0.77
Millet.....	0.75
Oats.....	0.45
Peas.....	0.77
Poppy.....	0.62
Rape.....	0.68
Rye.....	0.70
Vetches.....	0.84
Wheat.....	0.75

V.—*Fluids.*

Beer.....	1.023 to 1.034
Hydrochloric acid, at 59°F.	1.192
Linseed oil.....	0.94
Milk.....	1.02 to 1.04
Nitric acid, at 53.5° F.....	1.522
Rapeseed oil.....	0.92
Sulphuric acid, anhydrous, at 68° F.....	1.970
Water.....	1.00
Wine (Rhine).....	0.992 to 1.002

## HEAT.

One of the remarkable effects of the application of heat to matter is, that the same amount will affect equal weights of dissimilar kinds in different degrees. Thus the amount of heat that will raise 1 pound of water from 100° F. to 200° F., will raise 30 pounds of mercury through the same range. The amount that will raise 1 pound of water 1°, will raise 14 pounds of air 1° F.

The capacity of a body for heat is termed its *specific heat*, and may be defined as the number of units of heat necessary to raise the temperature of 1 pound of that body 1° F.

The thermal unit, *or unit of heat*, is the quantity of heat

that will raise 1 pound of pure water 1° F., or from 39° to 40° F.

*Latent heat* is the quantity of heat which has disappeared from a body owing to an increase of temperature. The *sensible heat* is that which is sensible to the touch or measurable by the thermometer.

*Latent Heat of Various Substances.*

	Deg. Fahr.		Deg. Fahr.
Alcohol .....	442	Lead.....	162
Ammonia.....	860	Sulphur.....	144
Beeswax.....	176	Steam.....	990
Ether.....	301	Vinegar.....	875
Ice.....	140	Zinc.....	493

*Specific Heat of Different Substances.*

<i>Solids.</i>		<i>Liquids.</i>	
Copper.....	0.0951	Alumina.....	0.1970
Gold.....	0.0324	Stones, bricks, etc., about.	0.2200
Iron.....	0.1138		
Lead.....	0.0314	Water.....	1.0000
Platinum.....	0.0324	Lead, melted.....	0.0402
Silver.....	0.0570	Sulphur, melted.....	0.2340
Tin.....	0.0562	Bismuth, melted.....	0.0363
Zinc.....	0.0955	Tin, melted.....	0.0637
Brass.....	0.0939	Mercury.....	0.0332
Glass.....	0.1977	Alcohol.....	0.6150
Ice.....	0.5040	Fusel oil.....	0.5640
Sulphur.....	0.2020	Benzine.....	0.4500
Charcoal.....	0.2410	Ether.....	0.5034

*Fusing Points of the Principal Metals and other Elements employed in Alloys.*

	Deg. Fahr.		Deg. Fahr.
Aluminium.....	1292	Lead.....	626
Antimony.....	797	Mercury.....	40
Arsenic.....	773	Nickel.....	2732 to 2912
Bismuth.....	504	Phosphorus.....	111
Cadmium.....	608	Platinum.....	4712
Copper.....	1922	Silver.....	1832
Gold.....	2282	Sulphur.....	239
Iron, cast.....	1922 to 2192	Tellurium.....	716
Iron, steel.....	2372 to 2552	Tin.....	455
Iron, wrought.....	2732 to 2912	Zinc.....	773

*Relative Internal Heat-Conducting Power of Bodies.*

Substance.	Relative Conducting Power.	Substance.	Relative Conducting Power.
Gold.....	1000	Zinc . . . . .	363
Platinum . . . . .	981	Tin . . . . .	304
Silver . . . . .	973	Lead.....	180.
Copper.....	892	Marble.....	24
Brass . . . . .	749	Porcelain.....	12
Cast iron.....	562	Terra-cotta.....	11
Wrought iron . . . . .	374		

*Table of Effects of Heat upon Bodies.*

Cast iron thoroughly melts at . . . . .	2754°	Fahrenheit.
Fine gold melts at.....	1983°	“
Fine silver melts at . . . . .	1850°	“
Copper melts at.....	2160°	“
Brass melts at.....	1900°	“
Zinc melts at.....	740°	“
Lead melts at . . . . .	594°	“
Bismuth melts at.....	476°	“
Tin melts at.....	421°	“
Tin and bismuth (equal parts) melt at.....	283°	“
Tin 3 parts, bismuth 5, and lead 2, melt at.....	212°	“
Mercury boils at . . . . .	630°	“
Linseed oil boils at.....	600°	“
Alcohol boils at.. . . .	174°	“
Ether boils at.....	98°	“
Mercury melts at.....	39°	“

*Expansion of Metals by Heat.*

In raising the temperature of bars of various metals from 32° Fahr. to 212° Fahr., they are found to expand nearly as follows :

Platinum.....	1 in 1097	Copper.....	1 in 557
Palladium.....	“ 1000	Gunmetal (copper 8, tin 1)	“ 550
Antimony.....	“ 923	Brass.....	“ 524
Cast iron.....	“ 901	Speculum metal.....	“ 517
Steel.....	“ 824	Silver.....	“ 499
Wrought iron.....	“ 801	Tin.....	“ 424
Bismuth.....	“ 718	Lead.....	“ 350
Gold.....	“ 667	Zinc..	“ 336

*Comparative Radiating or Absorbent and Reflecting Powers of Substances.*

Substance.	Power.	
	Radiating or Absorbing.	Reflecting.
Lamp black . . . . .	100	0
Water . . . . .	100	0
Carbonate of lead . . . . .	100	0
Writing paper . . . . .	98	2
Ivory, jet, marble . . . . .	93 to 98	7 to 2
Isinglass . . . . .	91	9
Ordinary glass . . . . .	90	10
China ink . . . . .	85	15
Ice . . . . .	85	15
Gum lac . . . . .	72	28
Silver leaf on glass . . . . .	27	73
Cast iron, brightly polished . . . . .	25	75
Mercury, about . . . . .	23	77
Wrought iron, polished . . . . .	23	81
Zinc, polished . . . . .	19	81
Steel, polished . . . . .	17	83
Platinum, a little polished . . . . .	24	76
Platinum, deposited on copper . . . . .	17	83
Platinum, in sheet . . . . .	17	83
Tin . . . . .	15	85
Brass, cast, dead polished . . . . .	11	89
Brass, hammered, dead polished . . . . .	9	91
Brass, cast, bright polished . . . . .	7	93
Brass, hammered, bright polished . . . . .	7	93
Copper, varnished . . . . .	14	86
Copper, deposited on iron . . . . .	7	93
Copper, hammered or cast . . . . .	7	93
Gold, plated . . . . .	5	95
Gold, deposited on polished steel . . . . .	3	97
Silver, hammered, polished bright . . . . .	3	97
Silver, cast, polished bright . . . . .	3	97

## TEMPERING.

The article, after being completed, is hardened by being heated gradually to a bright red, and then plunged into cold water; it is then tempered by being warmed gradually and equably, either over a fire or on a piece of heated

metal, till of the color corresponding to the purpose for which it is required, as per table below, when it is again plunged into water.

Corresponding Colors and Temperatures.

A very pale straw	- -	430°	Lancets	}	} All kinds of wood tools, screw taps.
Straw	- - - -	450°	Razors		
Darker straw	- - - -	470°	Penknives	}	
Yellow	- - - -	490°	Scissors		
Brown yellow	- - - -	500°	} Hatchets, chipping chisels, saws.		
Slightly tinged purple	- - - -	520°			
Purple	- - - -	530°	} All kinds of percussive tools.		
Dark purple	- - - -	550°			
Blue	- - - -	570°		} Springs.	
Dark blue	- - - -	600°	Soft for saws.		

*To Temper by the Thermometer.*—Put the articles to be tempered into a vessel containing a sufficient quantity to cover them of oil or tallow, sand, or a mixture of 8 parts bismuth, 5 of lead, and 3 of tin; the whole to be brought up to, and kept up at, the heat corresponding to the hardness required, by means of a suitable thermometer, till heated equally throughout. The articles are then withdrawn and plunged into cold water.

If no thermometer is available, it may be observed that oil or tallow begins to smoke at 430°, or straw color, and that it takes fire on a light being presented, and goes out when the light is withdrawn, at 570°, or blue.

*To Temper Brass or to Draw its Temper.*—Brass is rendered hard by hammering or rolling; therefore, when you make a thing of brass necessary to be in temper, you must prepare the material before shaping the article. Temper may be drawn from brass by heating it to a cherry red, and then simply plunging it into water, the same as though you were going to temper steel.

*To Temper Drills.*—Select none but the finest and best steel for your drills. In making them never heat higher than a cherry red, and always hammer till nearly cold.

Do all your hammering in one way, for if, after you have flattened your piece out, you attempt to hammer it back to a square or a round, you spoil it. When your drill is in proper shape heat it to a cherry red and thrust it into a piece of resin, or into quicksilver.

Some use a solution of potassium cyanide and rain water for tempering their drills; but for my part I have always found the resin or quicksilver to work best.

*To Temper Gravers.*—Gravers and other instruments larger than drills may be tempered in quicksilver, as above; or, you may use lead instead of quicksilver. Cut down into the lead, say half an inch; then, having heated your instrument to a light cherry heat, press it firmly into the cut. The lead will melt around it, and an excellent temper will be imparted. It is said that the engravers and watch-makers of Germany harden their tools in sealing wax. The tool is heated to whiteness and plunged into the wax, withdrawn after an instant and plunged in again—the process being repeated until the steel is too cold to enter the wax. The steel is said to become, after this process, almost as hard as the diamond, and when touched with a little oil of turpentine, the tools are excellent for engraving and for piercing the hardest metals.

*Mixtures for Tempering.*—By melting together about 1 gallon of spermaceti oil, 2 pounds of tallow and  $\frac{1}{4}$  pound of wax, a mixture is obtained very convenient for tempering any kind of steel articles of small size. Adding 1 pound of resin it is used for the tempering of larger articles. The addition of resin must be made with care, for an excess of this material renders the steel too hard and brittle. After several months' use the mass loses its energy; it must then be wholly renewed, taking care to thoroughly cleanse the bottom of the vessel which contained it.

Another mixture, the efficiency of which has likewise



been proved in practice, consists of 20 gallons of spermaceti oil, 20 pounds of tallow, 10 gallons neatsfoot oil, 1 pound of pitch and 3 pounds of resin. The pitch and resin are melted together, then the three other materials are successively added, and the whole is heated in an iron pot till all the water is evaporated. This is ascertained when the mass takes fire at the approach of a burning chip of wood; the flame is immediately put out by hermetically shutting the pot with a cover. The tempering is in both cases effected as follows: Saw-blades, for instance, are heated in special ovens, and when they have reached the required temperature, are dipped in the mass contained in tubs arranged side by side. For a continuous manufacture a certain number of tubs are used, so as to allow the mass time for cooling during the progress of the operation. As soon as the blade is cooled, it is withdrawn from the bath and cleaned with a piece of leather, so that there remains still on it a thin layer of grease. It is then passed over a coke fire till the grease catches fire and burns with a clear smoke. In this way the blade acquires elasticity. If it is desired very hard, a part only of the grease is allowed to be burned; the more softness is desired, the more the burning is completed. For springs, the flame is left to burn itself out. If the objects are of various forms and sizes, the burning is repeated on the several parts till all are deemed equally tempered. The blades are finished by hammering and heating them again on a clear coke fire till they return to a straw-yellow hue. The coloration is then taken away by washing in dilute hydrochloric acid, and afterwards in plenty of water.

## WATER.

Pure water is composed of hydrogen and oxygen in the proportion of 2 measures of hydrogen to 1 of oxygen, or 7 part of hydrogen to 8 of oxygen; or oxygen, 89 parts

by weight, and by measure 1 part ; hydrogen by weight, 11 parts, and by measure 2 parts. But pure water is not attainable, nor is it to be found in the laboratory of the chemist.

With the barometer at  $30^{\circ}$  water boils in the open air, at sea-level at  $212^{\circ}$  Fahr., and in vacuum at  $88^{\circ}$  F. The less the pressure of the atmosphere, the lower is the temperature at which water will boil. The pressure of the atmosphere at sea-level is 14.7 pounds per square inch, pressing equally and in all directions. A cubic foot of water evaporated under a pressure of one atmosphere, or 15 pounds per square inch, occupies a space of 1,700 cubic feet.

Salt water boils at a higher temperature than fresh, owing to its greater density, and because the boiling-point of water is increased by any substance that enters into chemical combination with it. Mud and other substances, so long as they are kept in mechanical solution, will not increase the boiling-point of water ; when these substances settle, and burn to the interior of the boilers, the boiling-point will be increased. The density of water decreases as the temperature increases, since heat destroys cohesion and expands the particles, causing them to occupy greater space. The power of water to hold chemical substances, such as salts of lime, in solution, decreases as the temperature increases.

The law of expansion by heat and contraction by cold is true as relating to water, with this exception, that as hot water cools down from the boiling-point it contracts until  $45^{\circ}$  F. is reached ; but if cooled down from this point, it expands again.

When a substance solidifies or freezes, there is always a change of volume, which usually is contraction ; but, in the case of water, an expansion takes place. The expansion of water at the freezing-point is by no means gradual,

but takes place almost instantaneously, and the amount of force exerted at the time is enormous. It has been demonstrated by actual experiments, that in freezing, water exerts a pressure of about 30,000 pounds per square inch.

The specific gravity of all waters is not the same. Sea water varies from 1.0269 to 1.0285—the mean being 1.0277, thus requiring 34.9741 cubic feet of sea water to make one ton, and about 35 cubic feet of fresh water. Water is heavier at night than during the day, owing to the atmosphere being more dense and the additional weight of the dew.

*Weight of Water.*

1	Cubic inch.....equal to.....	.03617	pounds.
12	Cubic inches.....equal to.....	.434	pounds.
1	Cubic foot.. ..equal to.....	62.5	pounds.
1	Cubic foot.....equal to.....	7.50	U. S. gallons.
1.8	Cubic foot.....equal to.....	112.00	pounds.
35.84	Cubic feet.....equal to.....	2240.00	pounds.
1	Cylindrical inch.....equal to.....	.02842	pounds.
12	Cylindrical inches....equal to.....	.341	pounds.
1	Cylindrical foot.....equal to.....	49.10	pounds.
1	Cylindrical foot.....equal to. ...	6.00	U. S. gallons.
2.282	Cylindrical feet.....equal to. ...	112.00	pounds.
45.64	Cylindrical feet.....equal to....	2240.00	pounds.
11.2	Imperial gallons..... equal to.....	112.00	pounds.
224	Imperial gallons.....equal to.....	2240.00	pounds.
13.44	United States gallons..equal to.....	112.00	pounds.
268.8	United States gallons..equal to.....	2240.00	pounds.

Centre of pressure is at two-thirds depth from surface.

Water has the greatest specific heat of all known liquids except hydrogen, and is therefore taken as the standard for all solids and fluids. The latent heat of water is 143° F., and that of ice 140°, as it absorbs that amount of heat in changing from a liquid to a solid state.

When water in a vessel is subjected to the action of fire it readily imbibes the heat, or fluid principle of which the

fire is the immediate cause, and sooner or later, according to the intensity of the heat, attains a temperature of  $212^{\circ}$  F. If, at this point of temperature, the water be not inclosed, but exposed to atmospheric pressure, ebullition will take place, and steam or vapor will ascend through the water, carrying with it the superabundant heat, or that which the water cannot, under such circumstances of pressure, absorb, to be retained, and to indicate a higher temperature.

Water, in attaining the aëriform state, is thus uniformly confined to the same laws, under every degree of pressure; but, as the pressure is augmented, so is the indicated temperature proportionately elevated. Hence the various densities of steam, and corresponding degrees of elastic force.

*Effects Produced by Water in its Natural State.*

Because of liquids possessing the properties of gravity and capability of flowing freely in every direction, sides of vessels, flood-gates, sluices, etc., sustain a pressure equal to the product of the area multiplied by half the depth of the fluid, and by its gravity in equal terms of unity.

But when a sluice or opening through which a liquid may issue is under any given continued head, the pressure is equal to the product of the area multiplied into the height from the centre of the opening to the surface of the fluid.

EXAMPLE 1.—Required the pressure of water on the sides of a cistern 18 feet in length, 13 in width, and 9 in depth.

The terms of measurement or unity are in feet; 1 cubic foot of water = 62.5 lbs.; hence,

$$18 \times 9 \times 2 + 13 \times 9 \times 2 = 558 \times 4.5 \times 62.5 = 156937.5 \text{ lbs. ; weight of water on bottom} = 18 \times 13 \times 9 \times 62.5 = 131625 \text{ lbs.}$$

EXAMPLE 2.—Required the pressure on a sluice 3 feet square, and its centre 30 feet from the surface of the water.

$$3 \times 3 \times 30 \times 62.5 = 16875 \text{ lbs. pressure.}$$

## AIR.

*Effects Produced by Air in its Natural, and also in its Rarefied State.*—The mean pressure of the atmosphere at the level of the sea is equal to 14.7 lbs. per square inch, or 2116.4 lbs. per square foot. This is called one atmosphere of pressure. The following are measures of pressures :

One atmosphere of pressure : 1. A column of air at 32° F., 27,801 feet, or about  $5\frac{1}{4}$  miles high, of uniform density equal to that of air at the level of the sea. 2. A column of mercury at 32° F., 29.922 inches or 76 centimetres high ; nearly 30 inches. At 62° F. the height is 30 inches. 3. A column of water at 62° F., 33.947 feet high ; nearly 34 feet.

A pressure of 1 lb. per square inch : 1. A column of air at 32° F., 1891 feet high, of uniform pressure as above. 2. A column of mercury at 32° F., 2.035 inches high. At 62° F. the height is 2.04 inches. 3. A column of water at 62° F., 0.1925 inch high.

The density or weight of one cubic foot of pure air, under a pressure of one atmosphere, or 14.7 lbs. per square inch, is,

At 32° F. = 0.080728 lb., or 1.29 oz., or 565.1 grains.  
 At 62° F. = 0.076097      “    1.217      “    532.7      “

The weight of a litre of pure air, under one atmosphere, at 32° F., is 19.955 grains.

The weight of air, compared with that of water at three notable temperatures, and at 52.3°, under one atmosphere, is as follows :

Weight of water at 32° F.,	773.2	times the weight of air at 32° F.
“    “    “    39.1° F.,	773.27	“    “    “    32° F.
“    “    “    62° F.,	772.4	“    “    “    32° F.
“    “    “    62° F.,	819.4	“    “    “    62° F.
“    “    “    52.3° F.,	820	“    “    “    62° F.

The volume of 1 lb. of air at 32° F., and under one

atmospheric pressure, is 12.387 cubic feet. The volume at 62° F. is 13.141 cubic feet.

The specific heat of air, at constant pressure, is 0.2377; and at constant volume, 0.1688, that of water being = 1.

Air, like all other gases, is rendered lighter by the application of heat, for then the particles of the mass are repelled from each other, or rarefied, and occupy a greater space. Rarefied air, being specifically lightest, mounts above that of common density; hence change of temperature, and the principal cause of winds.

*Table of the Expansion of Atmospheric Air by Heat.*

Degrees of Fahrenheit.	Bulk.	Degrees of Fahrenheit.	Bulk.	Degrees of Fahrenheit.	Bulk.
32°	1000	65°	1077	100°	1152
35°	1007	70°	1089	120°	1194
40°	1021	75°	1099	140°	1235
45°	1032	80°	1110	160°	1275
50°	1043	85°	1121	180°	1315
55°	1055	90°	1132	200°	1364
60°	1066	95°	1142	212°	1376

The pressure or gravity of the atmosphere, being equal to a column of water 34 feet in height, is the means or principle on which rests the utility of the common pump, also of the siphon and all other such hydraulic applications. In a pump, the internal pressure on the surface of the liquid is removed by the action of the bucket; and as by degrees the density becomes lessened, so the water rises by the external pressure to the above-named height; and at such height it will remain, unless, by some derangement of construction taking place, the atmospheric fluid is allowed to enter and displace the liquid column. But observe, if the temperature of the water or other liquid be so elevated that steam or vapor arise through it, then, accord-

ing to the vapor's accumulation of density, may the action of the pump be partially or wholly destroyed; and the only means of evasion in such cases is, to place the working bucket beneath the surface of the liquid which is required to be raised.

### MANUFACTURE OF TIN PLATE.

The first step in the manufacture is to cleanse the surface of the sheet-iron from oxide, dust and grease. This is effected by dipping the sheets in a pickle of dilute sulphuric acid (1 acid to 16 to 20 water). The pickle is prepared by pouring the acid in a thin stream into the water, keeping the latter constantly agitated. The sheets remain in the pickle until all the oxide is dissolved and the surface shows a dead-gray color. Pickling is frequently succeeded by scouring with fine, hard sand and water, the numerous scratches produced thereby upon the surface of the sheets promoting the adhesion of the coating of tin to be applied later on.

In order to obtain sheets of sufficient softness, they have to be annealed; but to prevent them from becoming again coated with a layer of oxide when exposed to a red heat, the air has to be excluded during the annealing process. For this purpose the plates are placed, to the number of about 1,800—for common sizes—in piles, within a cast-iron box about 2 feet square, the lid carefully luted on to prevent air entering, and then placed with several similarly filled boxes in a stove constructed very much in the shape of a reverberatory furnace, but considerably larger and having its bed on a level with the ground. The fire-bridge being tolerably high, the flame from the grate rolls slowly over the boxes and raises them gradually to a cherry-red heat, at which temperature they are maintained during 12 hours, and then withdrawn. When quite cold the covers are taken off, the plates taken out, carefully examined, and

sorted. If the heat has been too high, some of the plates will be found adhering to one another ; if too mild, they will not be much improved by the operation ; and if air should have entered, they will be either partially or completely converted into scale or oxide of iron. After being subjected to this process the plates have a deep, plum-color bloom on their surfaces, due to a very thin film or coating of oxide that has formed upon them. They are now passed three times through a pair of rolls placed in close proximity so that the plates passing between them are subjected to great pressure, but not sufficient to enlarge them. After having been thus cold-rolled, as it is termed, the plates are extremely smooth and possessed of a lustrous and dappled appearance, still owing to the thin oxidation. One effect of this rolling is to make the plates brittle once more, and therefore to necessitate a second annealing, which is performed in the same way as the preceding ; but the heat is milder and the time reduced to 5 or 6 hours. Another sorting follows, when the good plates are sent to the *tin house*. In the tin house the plates are again pickled in a warm but more dilute bath of sulphuric acid than that already used, during ten minutes ; then removed and well rubbed with sand and water, to remove all dirt and scale. They should now have a smooth, perfectly clean, grayish metallic surface, in which state they can be kept for some time in cold water without injury, and are ready for *tinning*.

The apparatus for this process consists of a series of baths, set side by side, for the convenience of the workmen, each bath having a fire beneath it, to keep the materials they contain in a fluid state. These baths or *pots* are six in number, namely: 1, the tinman's pot ; 2, the tin pot ; 3, the washing or dipping pot ; 4, the grease pot ; 5, the cold pot, and 6, the list pot. The tinman's pot is full of melted grease, and in this the plates are immersed and



left till all the moisture upon them is evaporated and they become completely covered with the grease. From the tinman's pot the plates are removed to the tin pot and plunged into the bath of melted tin, protected with a layer of grease, which it contains, and remain in it for about 20 minutes. In the first dipping the alloy is imperfect, and the surface not uniformly coated; consequently, the plates are removed to the dipping and washing pot, which is divided into two compartments. The first immersion takes place in the larger division, which contains melted tin covered with grease, like the last, and here the plate is left sufficiently long to make the alloy complete, and to separate any superfluous tin which might have adhered to the surface. The workman then takes out each plate separately to a table between the wash pot and the grease pot, and wipes it on each side with a brush of hemp to remove any excess of tin; to obliterate the marks of the brush, he quickly dips the plate into the second compartment of the wash pot, and then at once into the grease pot. This second compartment of the wash pot always contains the purest tin; and as it becomes alloyed with iron, it is removed to the first compartment of the same, and thence to the tin pot. The grease pot is filled with melted grease, and great care is necessary to maintain it at the proper temperature. Its purposes are to allow any superfluous tin to run off, and especially to prevent the alloy on the surface of the plate cooling more rapidly than the iron. If this were neglected its surface would be cracked. After 10 minutes' immersion in the grease pot, the plate is removed to the cold pot, which is filled with tallow heated to a comparatively low temperature. The pots 4 and 5 serve the purpose of annealing the plates, and of cooling them down to a low temperature. The last one in the series is the list pot, and is a small cast-iron bath kept at a sufficiently high temperature, its bottom covered with tin to the depth of a

quarter of an inch. In this the edges of the plates are dipped, and left in it till the wire of tin, which usually forms on them in the course of the foregoing processes, melts, and is removed by a quick blow on the plate with a stick.

The articles are now tin plates; but before they are sent to market, they undergo some further treatment. They are first carefully rubbed with bran to clean them from grease and dirt; they then receive another rubbing with a pad of sheep-skin, retaining its wool, and finally they are sent to the sorter whose duty it is to pick out defective plates and to arrange the good ones in piles according to their size and quality. According to experience, for a box of tin-plate, as furnished by the English factories, and which contains from 119 to 126 lbs. of tin plate,  $7\frac{1}{2}$  to  $9\frac{1}{4}$  lbs. of tin, about 2 lbs. of palm oil or tallow and 9 to 11 lbs. of sulphuric acid are required. It will be seen that the above-described method of making tin plate, which is the one used in England, is rather tedious and expensive, but the product obtained is an excellent one.

In Germany the preparation of the plates for tinning is the same as that used in England, but the operation of tinning differs essentially. The first step in the process is the so-called *burning-in* of plates, which is effected in the *burning-in* pot. The latter is about  $18\frac{1}{2}$  inches long,  $14\frac{1}{2}$  inches wide and  $18\frac{1}{2}$  inches deep, and is filled with melted tin covered with a layer of fat.

The plates are placed to the number of about 200 within the pot, then taken out in lots of about 25 each and cooled in water. When all the plates have been removed, the pot is divided into two compartments, one larger than the other, by inserting an iron plate in grooves in the sides of the pot. A portion of the burnt-in plates are now placed in the larger compartment and after remaining for some time in the tin bath, they are taken out separately and placed upon iron frames to drain off. This operation is

called *burning off*. The burnt-off plates are then separately plunged into the smaller compartment of the pot. After removal from this compartment and draining off, they are considered sufficiently tinned and the wire of tin formed in the course of the operation is removed in a manner similar to that as in the English process.

*Quality of Tin Plate.*—The tests for tin plates are ductility, strength and color, and to possess these, the iron must be of the best quality, and all the process be conducted with care and skill. The following conditions are inserted in some specifications, and will serve to indicate the strength and ductility of first-class tin plates:

1. They must bear cutting into strips of a width equal to ten times the thickness of the plate, both with and across the fibre, without splitting; the strips must bear, while hot, being bent upon a mould to a sweep equal to four times the width of the strip.

2. While cold, the plates must bear bending in a heading machine, in such a manner as to form a cylinder, the diameter of which shall at most be equal to sixty times the thickness of the plate. In these tests, the plate must show neither flaw nor crack of any kind.

*To Recognize a Content of Lead in Tin.*—Make a solution of potassium chromate in water. Then apply a few drops of pure acetic acid to the tin to be examined, and a whitish coating will appear. To this whitish coating apply a few drops of the potassium chromate solution; if the coating turns yellow, the tin contains lead, and the more the greater the intensity of the yellow color. The reaction is so sharp as to indicate  $\frac{1}{100000}$  part of lead.

*Crystallized Tin Plate.*—Crystallized tin plate is a variegated primrose appearance produced upon the surface of tin plate by applying to it in a heated state some dilute nitro-muriatic acid for a few seconds, then washing it with water, drying and coating it with lacquer. The figures are

more or less beautiful and diversified, according to the degree of heat and relative dilution of the acid. Place the tin plate, slightly heated, over a tub of water, and rub its surface with a sponge dipped in a liquor composed of 4 parts of aquafortis and 2 of distilled water, holding 1 of common salt or sal ammoniac in solution. Whenever the crystalline spangles seem to be thoroughly brought out, the plate must be immersed in water, washed either with a feather or a little cotton (taking care not to rub off the film of tin that forms the feathering), forthwith dried with a low heat, and coated with a lacquer varnish; otherwise it loses its lustre in the air. If the whole surface is not plunged at once in cold water, but if it be partially cooled by sprinkling water on it, the crystallization will be finely variegated with large and small figures. Similar results will be obtained by blowing cold air through a pipe on the tinned surface while it is just passing from the fused to the solid state.

*Size, Length, Breadth and Weight of Tin Plates.*

Brand Mark.	No. of Sheets in Box.	Length and Breadth.		Weight per Box.		
I C.....	225	14 in.	by 10	1 cwt	0 qr	0 lb
I x.....	225	14	by 10	1	1	0
I xx.....	225	14	by 10	1	1	21
I xxx.....	225	14	by 10	1	2	14
I xxxx.....	225	14	by 10	1	3	7
I xxxxx.....	225	14	by 10	2	0	0
I xxxxxx.....	225	14	by 10	2	0	21
D C.....	100	17	by 12½	0	3	14
D x.....	100	17	by 12½	1	0	14
D xx.....	100	17	by 12½	1	1	7
D xxx.....	100	17	by 12½	1	2	0
D xxxx.....	100	17	by 12½	1	2	21
D xxxxx.....	100	17	by 12½	1	3	14
D xxxxxx.....	100	17	by 12½	2	0	7
S D C.....	200	15	by 11	1	1	27
S D x.....	200	15	by 11	1	2	20
S D xx.....	200	15	by 11	1	3	13
S D xxx.....	200	15	by 11	2	0	6
S D xxxx.....	200	15	by 11	2	0	27
S D xxxxx.....	200	15	by 11	2	1	20
S D xxxxxx.....	200	15	by 11	2	2	13

*Tin Roofing and Tin Work.*—Tin roofing is measured by the square of 100 superficial feet; hips, valleys and flashings, by the foot lineal. Gutters and down-spouts (or conductors and leaders) are measured by the foot lineal, and are rated generally by their diameters, but sometimes by their girt.

A box of roofing tin contains 112 sheets,  $14 \times 20$  inches, and weighs from 110 to 145 lbs. per box—the Ponty-miester MF, and other good brands of IC charcoal tin, weighing an average of 112 lbs. per box, or 1 lb. per sheet, and X tin, 140 lbs. per box, or  $1\frac{1}{4}$  lb. per sheet. Roofing tin can now be had *double size*, or  $20 \times 28$  inches, weighing IC 125 lbs. per box, and X tin 283 lbs. per box. This latter size is the most economical in its use, saving the material and labor of one-fourth of the seams and ribs.

One sheet of tin,  $14 \times 20$  inches, will cover  $235\frac{3}{8}$  inches superficial, or 1 foot  $7\frac{1}{2}$  inches superficial of standing-joint roof; and a box of 112 sheets will cover 182 feet 14 inches of roof, allowing 1 inch and  $1\frac{1}{4}$  inches for the two side ribs, and  $\frac{1}{4}$  inch for top and  $\frac{1}{2}$  inch for bottom laps.

One sheet,  $14 \times 20$  inches, will cover, of flat-lock roofing, 255 superficial inches, or 1 foot  $9\frac{1}{4}$  inches; and a box of 112 sheets, 198 feet 3 inches, allowing  $\frac{3}{8}$  inch all around for joints;  $61\frac{1}{4}$  sheets,  $14 \times 20$  inches, will cover one square of 100 feet superficial; and weigh IC tin  $61\frac{1}{4}$  lbs., and X tin  $76\frac{1}{2}$  lbs.

In these calculations there is no allowance for wastage on hips, valleys, flashings, combings, etc., which are controlled partly by the shape and size of the roof, but mostly by the skill and care of the workman.

The following sizes work the tin plates without any waste, and with a single seam in the pipes. Intermediate and larger sizes either leave a waste strip of tin on every sheet, or require additional work in seaming the pieces together.

*Table showing the Lengths and Diameters of Pipes, made from Sheets, and also the amount contained in one Box.*

Sheets.				Boxes.	
Diameter of Pipe.	Number of Sheets.	Size of Sheets.	Length of Pipe.	Number in Boxes.	Length of Pipe.
Inches.		Inches.	Ft. In.	Sheets.	Feet.
6 $\frac{1}{8}$	One sheet.	14 X 20	1 1 $\frac{1}{2}$	112	126
4 $\frac{1}{3}$	One sheet.	14 X 20	1 7 $\frac{1}{2}$	112	182
4	Two sheets.	14 X 20	3 4 $\frac{1}{2}$	112	189
3 $\frac{1}{8}$	One sheet.	14 X 20	2 3	112	252
2 $\frac{1}{8}$	One sheet.	14 X 20	3 3	112	364

*Semicircular Gutters.*

Sheets.				Boxes.	
Girt.	Number of Sheets.	Size of Sheets.	Length of Gutter.	Number in Boxes.	Length of Gutter.
Inches.		Inches.	Ft. In.	Sheets.	Feet.
19	One sheet.	14 X 20	1 1 $\frac{1}{2}$	112	126
13	One sheet.	14 X 20	1 7 $\frac{1}{2}$	112	182

*Galvanized Iron.*—This material, which is of comparatively recent origin, is much used in this country for rain-water guttering and cornices for architectural purposes. Some of these cornices, when containing many members of moulding, especially if they are circular in plan, need much skill. In general principle the metal is bent over the hatchet-stake with mallet or hammer, much as in making other guttering, assisting with swages where necessary. The following observations on circular work are by Mr. C. A. Vaile.

In making up circular mouldings, it is necessary to have the material sufficiently heavy to bear shrinking and stretching without breaking or becoming brittle. The best plan to bring mouldings to the required shape is as follows:

Take a piece of hard wood (oak)  $4 \times 4$  inches and 12

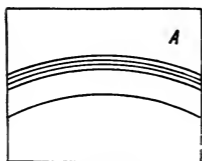

Fig. 164.



Fig. 165.

inches long, make a profile of work intended, and on one end of this piece make a die of the desired shape ; to this must

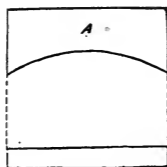

Fig. 166.

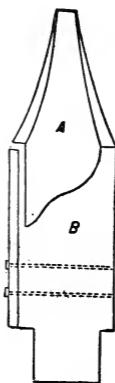

Fig. 167.

be fitted a plunger, allowing the thickness of iron to inter-

vene. The die is shown in the annexed figures: Fig. 164 is the top; Fig. 165 the sectional view of the plunger and die for a half-round mould. Fig. 164 is to be made in the same circle as the work. Figs. 166 and 167 are the same

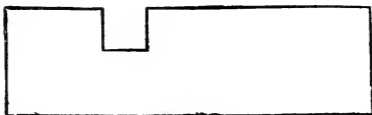

Fig. 168.

of a different moulding. Fig. 164 or 167 is to be placed in an oak block as Fig. 168. The right hand portion should be of sufficient length to answer for a seat to the operator. Fig. 169 is a mallet about 12 inches long. To

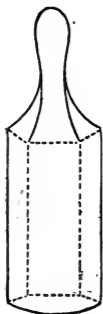

Fig. 169.

make these dies imagine the cap to be stamped from one piece, and get out the die and plunger accordingly. The tools required will be a saw, brace and  $\frac{1}{2}$  inch bit, a straight chisel, two or three sizes of gouges and a rasp curved at one end. When the iron is cut to the required pattern it is raised in these dies; shifting the mould to and fro each time it is forced into the die with a blow on the plunger from the mallet, until it is brought to the required shape. A little practice will soon demonstrate the utility of this method, and also its superiority over the hammering process.

When work is to be joined, never place two raw edges together. On one of the members turn  $\frac{1}{8}$  of an inch edge, and lap the member on this, and soak the solder in well, so as to firmly unite the pieces, and on the top strip that is to be built in the wall turn a half-inch



edge, to stiffen and answer the purpose of straps to hold the cap in position. An edge of the same kind should also be turned on bottom strip, to extend over the frame; and if the cap is to have a drop or corbel, let the inside of the drop or corbel extend back past the frame at least one inch, to secure the corbel to the frame, and the other side of corbel have a half-inch edge to fit against the wall.

Should the work be for a building already up, the strip should have an edge sufficient to nail through into mortar joints. Good judgment is required in putting up work of this character, to make it a success.

*American Lap Weld Iron Boiler Flues, Manufactured by the READING IRON COMPANY.*

Outside Diameter	W. G. Nos.	Weight per Foot, About	Outside Diameter.	W. G. Nos.	Weight per Foot, About
1¼ in.	16	1 lb.	3¼	11	4
1½	15	1 1-10	3½	10	4¾
1¾	14	1½	4	10	5½
2	13	2	5	9	7½
2¼	12	2½	6	8	10
2½	12	2¾	7	7	13
2¾	11	3⅛	8	6	
3	11	3½			

*Calibre and Weights of Fountains or Aqueduct Pipes.*

Very light Lead Pipes for Hydraulic Rams, and for conducting water at long distances, under slight pressure or head of water.

Calibre.	Weight per foot.	Av. length.	Calibre.	Weight per foot.	Av. length.
	oz.	ft.		lbs. oz.	ft.
¼ inch.....	6	1600	¾ inch.....	1 2	550
⅜ inch.....	8	1200	1 inch.....	1 12	400
½ inch.....	10	1000	1¼ inch.....	2	250
⅝ inch.....	12	900	1½ inch.....	2 4	200

*Calibre and Weight of Lead Pipe.*

Calibre.	Weight per ft.		Av. length.	Calibre.	Weight per foot.		Av. length.
	lbs.	oz.			lbs.	oz.	
$\frac{1}{4}$ in. light.....		8	300	$1\frac{1}{2}$ in. medium..	5	4	28
strong....		12	225	strong....	6	4	24
ex. strong	1	4	120	ex. strong	7	2	21
$\frac{3}{8}$ in. light.....		12	225	$1\frac{3}{4}$ in. ex. light..	3	12	42
medium..	1		150	light....	4	8	33
strong....	1	8	100	medium..	5	8	27
ex. strong	2		75	strong....	6	8	23
$\frac{1}{2}$ in. light.....	1		150	ex. strong	8	4	18
medium..	1	4	120	2 in. ex. light..	4	8	33
strong....	1	12	85	light....	5	8	27
ex. strong	2	7	60	medium..	7		21
$\frac{5}{8}$ in. ex. light..	1	4	120	strong....	8		18
light....	1	12	85	ex. strong	9	8	15
medium..	2	4	65	$2\frac{1}{2}$ in. $\frac{3}{16}$ thick..	7	13	15
strong....	2	8	60	$\frac{1}{4}$ thick..	8	13	15
ex. strong	3		50	$\frac{5}{16}$ thick..	13	11	15
$\frac{3}{4}$ in. ex. light..	1	8	100	$\frac{3}{8}$ thick..	16	12	15
light.....	2		75	3 in. waste....	5		15
medium..	2	8	60	$\frac{3}{16}$ thick..	9	5	15
strong....	3		50	$\frac{1}{4}$ thick..	12	10	15
ex. strong	3	10	43	$\frac{1}{8}$ thick..	16		15
1 in. ex. light..	2	4	65	$\frac{3}{8}$ thick..	19	11	15
light.....	2	12	55	$3\frac{1}{2}$ in. $\frac{1}{4}$ thick..	15		15
medium..	3	8	45	$\frac{5}{16}$ thick..	18	5	15
strong....	4		38	$\frac{3}{8}$ thick..	21	12	15
ex. strong	3	12	42	$\frac{7}{16}$ thick..	26	13	15
$1\frac{1}{4}$ in. ex. light..	2	12	55	4 in. waste....	5	5	15
light.....	3	4	46	$\frac{1}{4}$ thick..	16	12	15
medium..	4		38	$\frac{5}{16}$ thick..	21		15
strong....	4	8	33	$\frac{3}{8}$ thick..	25	4	15
ex. strong	6		25	$\frac{7}{8}$ thick..	30		15
$1\frac{1}{2}$ in. ex. light..	3	8	45	$4\frac{1}{2}$ in. waste....	5	12	15
light.....	4	4	35	5 in. waste....	8		15

*To ascertain the Weights of Pipes of various Metals, and any Diameter required.*

RULE.—To the interior diameter of the pipe, in inches, add the thickness of the metal; multiply the sum by the decimal number opposite the required thickness and under

the metal's name; also by the length of the pipe in feet; and the product is the weight of the pipe in pounds.

Thick. inch.	Wr'ght Iron.	Copper	Lead.	Thick. inch.	Wr'ght Iron.	Copper	Lead.
$\frac{1}{8}$	.326	.38	.483	$\frac{5}{8}$	1.627	1.9	2.417
$\frac{1}{6}$	.653	.76	.967	$\frac{3}{4}$	1.95	2.28	2.9
$\frac{3}{8}$	.976	1.14	1.45	$\frac{7}{8}$	2.277	2.66	3.383
$\frac{1}{2}$	1.3	1.52	1.933	$\frac{1}{2}$	2.6	3.04	3.867

*Application of the Rule.*—Required the weight of a copper pipe, whose interior diameter is  $2\frac{1}{4}$  inches, its length 20 feet, and the metal  $\frac{1}{8}$  of an inch in thickness.

$$2.25 + .125 = 2.375 \times 1.52 \times 20 = 72.2 \text{ lbs.}$$

*Weight of a Square Foot of Sheet-Iron, Copper, and Brass,  
as per Birmingham Wire Gauge.*

No. of Gauge.	Iron.	Copper	Brass.	No. of Gauge.	Iron.	Galv. Iron.	Copper	Brass.
1	12.5	14.5	13.75	16	2.62	3.	2.9	2.75
2	12.	13.9	13.2	17	2.20	2.69	2.52	2.4
3	11.	12.75	12.1	18	1.92	2.31	2.15	2.04
4	10.5	11.6	11.	19	1.75	2.07	1.97	1.87
5	9.	10.1	9.61	20	1.54	1.75	1.78	1.69
6	8.34	9.4	8.93	21	1.4	1.5	1.62	1.54
7	7.5	8.7	8.25	22	1.25	1.32	1.45	1.37
8	6.86	7.9	7.54	23	1.13	1.19	1.3	1.23
9	6.29	7.2	6.86	24	1.02	1.06	1.16	1.1
10	5.62	6.5	6.18	25	.9	1.	1.04	.99
11	5.	5.8	5.5	26	.8	.96	.92	.88
12	4.5	5.08	4.81	27	.75	.88	.83	.79
13	4.	4.34	4.12	28	.65	.75	.74	.7
14	3.23	3.6	3.43	29	.58	.69	.64	.61
15	2.97	3.27	3.1					

## GAS PIPES.

*Table of the Diameter and Length of Gas Pipes to Transmit Given Quantities of Gas to Branch Pipes and Burners.*

No. of cubic feet of gas.	Length of pipe.	Diameter of pipe.	No. of cubic feet of gas.	Length of pipe.	Diameter of pipe.
per hour.	feet.	inches.	per hour.	feet.	inches.
50	100	0.40	2000	2000	5.32
250	200	1.00	2000	4000	6.33
500	600	1.97	2000	6000	7.00
700	1000	2.65	6000	1000	7.75
1000	1000	3.16	6000	2000	9.21
1500	1000	3.87	8000	1000	8.95
2000	1000	4.47	8000	2000	16.65

These dimensions are applicable to the mains which conduct the gas to the places where it is to be used. If they send off branches for burners, the diameter may be reduced or the length may be greater. For example, if a pipe of 5.32 inches, which transmits 2000 cubic feet through a length of 2000 feet gives off, in this space, 2000 cubic feet of gas, then the same diameter can continue to transmit the gas through a length of 2450 feet.

## SERVICES FOR LAMPS.

2 Lamps	40 feet	from Main	require pipe	$\frac{3}{8}$ inch	Bore.
4 "	" "	" "	" "	$\frac{1}{2}$ "	" "
6 "	50 "	" "	" "	$\frac{5}{8}$ "	" "
10 "	100 "	" "	" "	$\frac{3}{4}$ "	" "
15 "	130 "	" "	" "	1 "	" "
20 "	150 "	" "	" "	$1\frac{1}{4}$ "	" "
25 "	180 "	" "	" "	$1\frac{3}{8}$ "	" "
30 "	200 "	" "	" "	$1\frac{1}{2}$ "	" "

*Weight of a Superficial Foot of Plates of Different Metals  
in Pounds.*

Thickness. Inches.	Iron.	Brass.	Copper.	Lead.	Zinc.	Thickness.
$\frac{1}{16}$	2.5	2.7	2.9	3.7	2.3	.0625 in. = 16 Bir-
$\frac{1}{8}$	5.0	5.5	5.8	7.4	4.7	.1250 " = 11 ming-
$\frac{3}{16}$	7.5	8.2	8.7	11.1	7.0	.1875 " = 7 ham
$\frac{1}{4}$	10.0	11.0	11.6	14.8	9.4	.2500 " = 4 wire
$\frac{5}{16}$	12.5	13.7	14.5	18.5	11.7	.3125 " = 1 gauge
$\frac{3}{8}$	15.	16.4	17.2	22.2	14.0	.3750
$\frac{7}{16}$	17.5	19.2	20.0	25.9	16.4	.4375
$\frac{1}{2}$	20.0	21.9	22.9	29.5	18.7	.5000
$\frac{9}{16}$	22.5	24.6	25.7	33.2	21.1	.5625
$\frac{5}{8}$	25.0	27.4	28.6	36.9	23.4	.6250
$\frac{11}{16}$	27.5	30.1	31.4	40.6	25.7	.6875
$\frac{3}{4}$	30.0	32.9	34.3	44.3	28.1	.7500
$\frac{13}{16}$	32.5	35.6	37.2	48.0	30.4	.8125
$\frac{7}{8}$	35.0	38.3	40.0	51.7	32.8	.8750
$\frac{15}{16}$	37.5	41.2	42.9	55.4	35.1	.9375
1	40.0	43.9	45.8	59.1	37.5	1.0000

*Recapitulation of Weights of Various Substances.*

Names.	Cubic feet in lbs.	Cubic inch in lbs.
Cast iron . . . . .	450.55	.2607
Wrought iron . . . . .	486.65	.2816
Steel . . . . .	489.8	.2834
Copper . . . . .	555.	.32118
Lead . . . . .	708.85	.4101
Brass . . . . .	537.75	.3112
Tin . . . . .	456.	.263
White pine . . . . .	29.56	.0171
Salt water (sea) . . . . .	64.3	.03721
Fresh water . . . . .	62.5	.03616
Air . . . . .	.07529	
Steam . . . . .	.03689	

Cast iron expands  $\frac{1}{112000}$  of its length for one degree of heat; greatest change in the shade, in this climate,  $\frac{1}{1170}$  of its length; exposed to the sun's rays,  $\frac{1}{1000}$ ; shrinks in cooling from  $\frac{1}{85}$  to  $\frac{1}{98}$  of its length; is crushed by a force of 93,000 lbs. upon a square inch; will bear, without permanent alterations, 15,300 lbs. upon a square inch, and an extension of  $\frac{1}{200}$  of its length. Weight of modulus of elasticity for a base of an inch square, 18,400,000 lbs.; height of modulus of elasticity, 5,750,000 feet.

Wrought iron expands  $\frac{1}{113000}$  of its length for one degree of heat; will bear on a square inch, without permanent alterations, 17,800 lbs., and an extension in length of  $\frac{1}{1400}$ ; cohesive force is diminished  $\frac{1}{3000}$  by an increase of one degree of heat. Weight of modulus of elasticity for a base of an inch square, 24,920,000 lbs.; height of modulus of elasticity, 7,550,000 feet.

*Table Showing the Figures by which the Weight of the Pattern has to be Multiplied to Obtain the Weight of the Casting (According to Karmarsch).*

Material of the pattern.	Material of the casting.						
	Cast iron.		Brass.	Tom-bac.	Bronze.	Zinc.	Bell or gun metal.
	a	b					
Pine.....	14.	17.5	15.8	16.7	16.3	13.5	17.1
Oak.....	9.	10.9	10.1	10.4	10.3	8.6	10.9
Beech.....	9.7	11.1	10.9	11.4	11.3	9.4	11.9
Bass.....	13.4	—	15.1	15.7	15.5	12.9	16.3
Pear.....	10.2	13.0	11.5	11.9	11.8	9.8	12.4
Birch.....	10.6	13.5	11.9	12.3	12.2	10.2	12.9
Alder.....	12.8	13.5	14.3	14.9	14.7	12.2	15.5
Mahogany.....	11.7	—	13.2	13.7	13.5	11.2	14.2
Brass.....	0.84	0.95	0.95	0.99	0.98	0.81	1.

Table Continued.

Material of the pattern.	Material of the casting.						
	Cast iron.		Brass.	Tombac.	Bronze.	Zinc.	Bell or gun metal.
	a	b					
Zinc.....	1.	—	1.13	1.17	1.16	0.96	1.22
Tin (with $\frac{1}{3}$ to $\frac{1}{4}$ lead).....	0.89	1.11	1.	1.03	0.03	0.85	1.12
Lead.....	0.64	0.79	0.72	0.74	0.74	0.61	0.78
Cast iron.....	0.97	—	1.09	1.13	1.12	0.93	1.18

	Linear $\frac{1}{a}$	If the cubic content of the pattern = 1, that of the casting is = $1 - \frac{1}{a} 3$ .
Cast iron.....	$\frac{1}{96} = 0.0104$	$\frac{3}{96} = 0.9688$
Cast steel.....	$\frac{1}{72} = 0.0139$	$\frac{3}{72} = 0.9584$
Malleable casting.....	$\frac{1}{48} = 0.0208$	$\frac{3}{48} = 0.9376$
Brass and tombac.....	$\frac{1}{65} = 0.0154$	$\frac{3}{65} = 0.9545$
Gun metal.....	$\frac{1}{134} = 0.0075$	$\frac{3}{134} = 0.9776$
Bell metal.....	$\frac{1}{63} = 0.0159$	$\frac{3}{63} = 0.9545$
Zinc.....	$\frac{1}{62} = 0.0161$	$\frac{3}{62} = 0.9524$
Tin.....	$\frac{1}{28} = 0.0078$	$\frac{3}{28} = 0.9766$
Lead.....	$\frac{1}{92} = 0.0109$	$\frac{3}{92} = 0.9678$

The weight of larger castings can be approximately determined by the formula  $G = \frac{a-1}{a} \frac{S}{s} M$ , when  $s$  indicates the specific gravity of the pattern,  $S$  that of the casting,  $M$  the absolute weight of the pattern, and  $a$  the proportion of shrinkage (see the above table).

*Shrinkage of Castings.*—In making castings of determined size the shrinkage of the metals in passing from the melted into the solid and cold state must be taken into consideration. The table given above shows the shrinkage

of the metals and the proportions of volumes between the pattern and casting.

By  $a$  is expressed the proportion of shrinkage, *i. e.*, the quotient from the volume of the model = 1 and the bodily shrinkage of the cast metal. The areas and bodily shrinkage are obtained by multiplying the separate values of  $\frac{1}{a}$  by 2 or 3, as the case may be.

*Speed of Saws Running 10,000 Feet per Minute on the Rim.*

72 inches.....	530 revolutions per minute.		
68 " .....	560	"	"
64 " .....	600	"	"
60 " .....	640	"	"
56 " .....	700	"	"
52 " .....	750	"	"
48 " .....	815	"	"
44 " .....	890	"	"
40 " .....	980	"	"
36 " .....	1080	"	"
32 " .....	1225	"	"
28 " .....	1400	"	"
24 " .....	1630	"	"
20 " .....	1960	"	"
16 " .....	2450	"	"
12 " .....	3260	"	"
10 " .....	3920	"	"
8 " .....	4600	"	"

*Rules for Calculating Speeds, etc.*

*Problem 1.*—The diameter of driving and driven pulleys and the speed of driver being given, find the speed of driven.

*Rule.*—Multiply the diameter of driver by its number of revolutions and divide the product by the diameter of the driven; the quotient will be the number of revolutions of driven.



*Problem 2.*—The diameter and revolutions of driver and the revolutions being given, to find the diameter of the driven.

*Rule.*—Multiply the revolutions of driven by its diameter and divide the product by the revolutions of the driver; the quotient will be the diameter of driven.

# PRACTICAL RECEIPTS.

---

## JAPANNING AND VARNISHING.

JAPANNING is the art of covering bodies by grounds of opaque colors in varnish, which may be afterwards decorated by printing or gilding, or left in a plain state. It is also to be looked upon in another sense, as that of ornamenting coaches, snuff-boxes, screens, etc. All surfaces to be japanned must be perfectly clean, and leather should be stretched on frames. Paper should be stiff for japanning.

The French prime all their japanned articles, the English do not. This priming is generally of common size. Those articles, that are primed thus, never endure as well as those that receive the japan coating on the first operation, and thus it is that those articles of japan work that are primed with size, when they are used for some time, crack, and the coats of japan fly off in flakes.

A solution of strong isinglass size and honey, or sugar candy, makes a good japan varnish to cover water colors on gold grounds.

A pure white priming for japanning, for the cheap method, is made with parchment size, and one-third of isinglass, laid on very thin and smooth. It is the better for three coats, and when the last coat is dry, it is prepared to receive the painting or figures. Previous to the last coat, however, the work should be smoothly polished. When wood or leather is to be japanned, and no priming used, the best plan is to lay on two or three coats of varnish made of seed-lac and resin, two ounces each, dissolved in alcohol and strained through a cloth. This varnish should be put on in a warm place, and the work to be varnished

should, if possible, be warm also, and all dampness should be avoided, to prevent the varnish from being chilled. When the work is prepared with the above composition, and dry, it is fit for the proper japan to be laid on. If the ground is not to be white the most suitable varnish now to be used is made of shellac, as it is the best vehicle for all colors. This is made in the following proportions: The best shellac, five ounces, made into powder, steeped in a quart of alcohol, and kept at a gentle heat for two or three days and shaken frequently, after which the solution must be filtered through a flannel bag, and kept in a well-corked bottle for use. This varnish for hard japanning on *copper* or *tin* will stand for ever, unless fire or hammer be used to burn or beat it off.

The color to be used with shellac varnish may be of any pigments whatever to give the desired shade, as this varnish will mix with any color.

*White Japan Ground.*—To form a hard, perfectly white ground is no easy matter, as the substances which are generally used to make the japan hard, have a tendency, by a number of coats, to look or become dull in brightness. One white ground is made by the following composition: White flake or lead washed over and ground up with a sixth of its weight of starch, then dried and mixed with the finest gum, ground up in the proportion of one ounce gum to half an ounce of rectified turpentine, mixed and ground thoroughly together. This is to be finely laid on the article to be japanned, dried, and then varnished with five or six coats of the following: Two ounces of the whitest seed-lac to three ounces of gum anime reduced to a fine powder and dissolved in a quart of alcohol. This lac must be carefully picked. For a softer varnish than this, a little turpentine should be added, and less of the gum. A very good varnish and not brittle, may be made by dissolving gum anime in nut oil, boiling it gently as the gum is added, and giving

the oil as much gum as it will take up. The ground of white varnish may of itself be made of this varnish, by giving two or three coats of it, but when used it should be diluted with pure turpentine. Although this varnish is not brittle it is liable to be indented with brush-strokes, and it will not bear to be polished, but if well laid on it will not need polishing afterwards. It also takes some time to dry. Heat applied to all oils, however, darkens their color, and oil varnishes for white grow very yellow if not exposed to a full clear light.

*Gum Copal.*—Copal varnish is one of the very finest varnishes for japanning purposes. It can be dissolved by linseed oil, rendered dry by adding some quicklime at a heat somewhat less than will boil or decompose the oil.

This solution, with the addition of a little turpentine, forms a very transparent varnish, which, when properly applied and slowly dried is very hard and durable. This varnish is applied to snuff boxes, tea trays and other utensils. It also preserves paintings and renders their surfaces capable of reflecting light more uniformly.

If powdered copal be mixed in a mortar with camphor, it softens and becomes a coherent mass, and if camphor be added to alcohol it becomes an excellent solvent of copal by adding the latter, ground well, and employing a tolerable degree of heat, using a well-corked vessel, with a long neck to allow of expansion. The vessel must only be about one-fourth filled with the mixture. Copal can also be incorporated with turpentine, with one part of powdered copal to twelve parts of pure turpentine, subjected to the heat of a sand-bath for several days in a long-necked matrass, shaking it frequently.

Copal is a good varnish for metals, such as *tin*; the varnish must be dried in an oven, each coat, and it can be colored with some substances, but alcohol varnish will mix with any coloring matter. For white japans or varnishes,

we have already shown that fine chalk or white lead is used as a basis, and the varnishes coated over it.

To japan or varnish white leather, so that it may be elastic, is altogether a different work from varnishing or japanning wood or metal, or papier-maché.

For white leather oil is the principal ingredient, as it is well known that chalk is extensively used to give white leather its pure color, or speaking more philosophically, its fair colorless whiteness. White leather having already the basis of white varnish, it should get a light coat of the pure varnish, before mentioned, and be dried well *in the oven*, or a coat of the oil copal will answer very well. This being well dried, boiled nut oil carefully laid on and successively dried, will make a most beautiful white varnish for leather, not liable to crack. This quality takes a long time to dry, and of course is more expensive. Coarse varnish may be made of boiled linseed oil, to which is added gradually the acetate of lead as a drier. This addition must be made very cautiously, as the oil will be very apt to foam over.

A better and more safe drying mixture than the mere acetate of lead, is made by dissolving the acetate of lead in a small quantity of water, neutralizing the acid with the addition of pipe clay, evaporating the sediment to perfect dryness, and feeding the oil while gently boiling, gradually to it.

These *varnishes* or *japans*, as far as described, have only reference to white grounds.

There is some nice work to be observed, and there is much in applying the varnishes at the right time, knowing by the eye the proper moment when the mixture is perfect, or when to add any ingredients. These things require practice.

*Black Grounds.*—Black grounds for japans may be made by mixing ivory black with shellac varnish; or for coarse work, lamp black and the top coating of common seed-lac

varnish. A common black japan may be made by painting a piece of work with drying oil (oil mixed with lead), and putting the work into a stove, not too hot, but of such a degree, gradually raising the heat and keeping it up for a long time, so as not to burn the oil and make it blister. This process makes very fair japan and requires no polishing.

*Black Japan.*—Asphaltum 50 lbs., dark gum-anime 8 lbs., fuse; add linseed oil 12 gallons, boil, add dark gum amber 10 lbs., previously fused and boiled with linseed oil 2 gallons, add the driers; put the work into a stove as above. *Used* for wood or metals.

*Brunswick Black.*—1. Asphaltum 45 lbs., drying oil 6 gallons, litharge 6 lbs., boil as last, and thin with 25 gallons of oil of turpentine. *Used* for ironwork, etc.  
2. Black pitch and gas tar asphaltum, of each 25 lbs., boil gently for 5 hours, then add linseed oil 8 gallons, litharge and red lead, of each 10 lbs., boil as before, and thin with oil of turpentine 20 gallons. Inferior to the last, but cheaper.

*Blue Japan Grounds.*—Blue japan grounds may be formed of bright Prussian blue. The color may be mixed with shellac varnish, and brought to a polishing state by 5 or 6 coats of varnish of seed-lac. The varnish, however, is apt to give a greenish tinge to the blue, as the varnish has a yellowish tinge, and blue and yellow form a green. Whenever a light blue is desired, the purest varnish must always be used.

*Scarlet Japan.*—Ground vermilion may be used for this, but being so glaring it is not beautiful unless covered over with rose-pink or lake, which have a good effect when thus used. For a very bright crimson ground, safflower or Indian lake should be used, always dissolved in the alcohol of which the varnish is made. In place of this lake, carmine may be used, as it is more common. The top coat

of varnish must always be of the white seed-lac, which has been before described, and as many coats given as may be thought proper; it is easy to judge of this.

*Yellow Grounds.*—If turmeric be dissolved in spirit of wine and strained through a cloth, and then mixed with pure seed-lac varnish, it makes a good yellow japan. Saffron will answer for the same purpose in the same way, but the brightest yellow ground is made by a primary coat of pure chrome yellow, and coated successively with the varnish. Dutch pink is used for a kind of cheap yellow japan ground. If a little dragon's blood be added to the varnish for yellow japan, a most beautiful and rich salmon-colored varnish is the result, and by these two mixtures all the shades of flesh-colored japans are produced.

*Green Japan Grounds.*—A good green may be made by mixing Prussian blue along with the chromate of lead, or with turmeric, or orpiment (sulphuret of arsenic), or ochre, only the two should be ground together and dissolved in alcohol, and applied as a ground, then coated with four or five coats of shellac varnish, in the manner already described. A very bright green is made by laying on a ground of Dutch metal, or gold leaf, and then coating it over with distilled verdigris dissolved in alcohol, then the varnishes on the top. This is a splendid green, brilliant and glowing.

*Orange-colored Grounds.*—Orange grounds may be made of yellow mixed with vermilion or carmine, just as a bright or rather inferior color is wanted. The yellow should always be in quantity to make a good full color, and the red added in proportion to the depth of shade. If there is not a good full body of yellow, the color will look watery, or bare, as it is technically termed.

*Purple Japan Grounds.*—These are made by a mixture of lake and Prussian blue or carmine, or for an inferior color vermilion, and treated as the foregoing. When the ground

is laid on and perfectly dried, a thin coat of pure boiled nut oil then laid on and also dried, is a good method for a japan not liable to crack. But a better plan is to use this oil in the varnish, which should contain considerable pure turpentine, giving the first coat after the ground is laid on. In every case where oil is used for any purpose for varnish, it is all the better if turpentine is mixed with it. Turpentine enables oils to mix with either alcohol or water. Alkalies have this property also.

*Black Japan.*—1. Asphaltum, 3 oz.; boiled oil, 4 quarts; burnt umber, 8 oz. Mix by heat, and when cooling thin with turpentine. 2. Amber, 12 oz.; asphaltum, 2 oz.; fuse by heat, add boiled oil, half a pint, resin 2 oz. When cooling, add 16 oz. oil of turpentine. Both are used to varnish metals.

*Japan Black for Leather.*—1. Burnt umber, 4 oz.; true asphaltum, 2 oz.; boiled oil, 2 quarts. Dissolve the asphaltum by heat in a little of the oil, add the burnt umber ground in oil, and the remainder of the oil, mix, cool and thin with turpentine; flexible. 2. Shellac, 1 part; wood naphtha, 4 parts; dissolve, and color with lampblack; inflexible.

*Transparent Japan.*—Oil of turpentine, 4 oz.; oil of lavender, 3 oz.; camphor,  $\frac{1}{2}$  drachm; copal, 1 oz; dissolve. Used to japan tin, but quick copal varnish is mostly used instead.

*Japanners' Copal Varnish.*—Pale African copal, 7 lbs.; fuse; add clarified linseed oil,  $\frac{1}{2}$  gallon; boil for 5 minutes; remove it into the open air; add boiling oil of turpentine, 3 gallons; mix well, strain it into the can, and cover it up immediately. Used to varnish furniture, and by japanners, coachmakers, etc. Dries in 15 minutes, and may be polished as soon as hard.

*Tortoise-shell Japan.*—This varnish is prepared by taking of good linseed oil 1 gallon, and of umber  $\frac{1}{2}$  lb., and



boiling them together until the oil becomes very brown and thick, when they are strained through a cloth and boiled again until the composition is about the consistence of pitch, when it is fit for use. Having prepared this varnish, clean well the copper or iron plate, or vessel, that is to be varnished (japanned), and then lay vermilion, mixed with shellac varnish, or with drying oil diluted with turpentine, very thinly on the places intended to imitate the clear parts of the tortoise shell. When the vermilion is dry, brush over the whole with the above umber varnish, diluted to a due consistence, with turpentine, and when it is set and firm, it must be put into a stove and undergo a strong heat for a long time—even two weeks will not hurt it. This is the ground for those beautiful snuff-boxes and tea trays which are so much admired, and those grounds can be decorated with all kinds of paintings that fancy may suggest, and the work is all the better to be finished in an annealing oven.

*Painting Japan Work.*—The colors to be painted are tempered, generally in oil, which should have at least one-fourth of its weight of gum sandarach, or mastic, dissolved in it, and it should be well diluted with turpentine, that the colors may be laid on thin and evenly. In some instances it does well to put on water colors or grounds of gold, which a skilful hand can do and manage so as to make the work appear as if it were embossed. These water colors are best prepared by means of isinglass size, mixed with honey or sugar candy. These colors, when laid on, must receive a number of upper coats of the varnish we have described before.

*Japanning old Tea Trays.*—First clean them thoroughly with soap and water and a little rotten stone; then dry them by wiping and exposure at the fire. Now, get some good copal varnish, mix it with some bronze powder, and apply with a brush to the denuded parts; after which set

the tea tray in an oven at a heat of  $212^{\circ}$  or  $300^{\circ}$ , until the varnish is dry. Two coats will make it equal to new.

*Japan Finishing.*—The finishing part of jpanning lies in laying on and polishing the outer coats of varnish, which is necessary in all painted or simply ground-colored japan work. When brightness and clearness are wanted, the white kind of varnish is necessary, for seed-lac varnish, which is the hardest and most tenacious, imparts a yellow tinge. A mixed varnish, we believe, is the best for this purpose, that is, for combining hardness and purity. Take then 3 oz. of seed-lac, picked very carefully from all sticks and dirt, washing it well with cold water, stirring it up, pouring it off, and continuing the process until the water runs off perfectly pure. Dry it and then reduce it to powder, and put it with a pint of alcohol into a bottle, of which it must occupy only two-thirds of the space. This mixture must be shaken well together and the bottle kept at a gentle heat (being corked) until the lac is dissolved. When this is the case, the clear must be poured off, and the remainder strained through a cloth, and all the clear, strained and poured, must be kept in a well-stoppered bottle. The manner of using this seed-lac varnish is the same as that before described, and a fine polishing varnish is made by mixing this with pure white varnish. The pieces of work to be varnished for finishing should be placed near a stove, or in a warm, dry room, and one coat should be perfectly dry before the other is applied. The varnish is applied by proper brushes, beginning at the middle, passing the stroke to one end and with the other stroke from the middle to the other end. Great skill is necessary in laying on these coats of varnish. If possible the same place should never be crossed or twice passed over in giving one coat. When one coat is dry another must be laid over it, and so on successively for a number of coats, so that the coating shall be sufficiently thick to bear the polishing, without lay-

ing bare the surface of the painting or ground work beneath. When a sufficient number of coats are thus laid on, the work is fit to be polished, which, in common cases, is done with a rag dipped in finely powdered rotten stone ; but towards the end of the rubbing a little oil should be used along with the powder, and when the work appears fine and glossy a little oil must be used alone to clean off the powder and give the work a still brighter hue. In very fine work, French whiting should be used, which should be washed in water to remove any sand that might be in it. Pumice stone ground to a very fine powder is used for the first part of the polishing, and the finishing is done with whiting. It is always best to dry the varnish of all japan work by heat. For wood work, heat must be sparingly used, but for metals the varnish should be dried in an oven, also for papier-maché and leather. The metal will stand the greatest heat, and care must be taken not to darken by too high a temperature. When gold size is used in gilding for japan work, where it is desired not to have the gold shine, or appear burnished, the gold size should be used with a little of the spirits of turpentine and a little oil, but when a considerable degree of lustre is wanted without burnishing and the preparation necessary for it, a little of the size along with oil alone should be used.

#### VARNISHES—MISCELLANEOUS.

Different substances are employed for making varnish, the object being to produce a liquid easily applied to the surface of cloth, paper or metal, which, when dry, will protect it with a fine film. Gums and resins are the substances employed for making varnishes ; they are dissolved either in turpentine, alcohol, or oil, in a close stone-ware, glass or metal vessel, exposed to a low heat, as the case may require, or cold. The alcohol or turpentine dissolves the gum or resin, and holds them in solution, and after the application

of the varnish, this mixture being mechanical, the moisture of the liquid evaporates, and the gum adheres to the article to which it is applied.

The choice of linseed oil is of peculiar consequence to the varnish maker. Oil from fine full-grown ripe seed, when viewed in a vial, will appear limpid, pale, and brilliant; it is mellow and sweet to the taste, has very little smell, is specifically lighter than impure oil, and, when clarified, dries quickly and firmly, and does not materially change the color of the varnish when made, but appears limpid and brilliant.

*The following are the chief Resins employed in the manufacture of Varnishes.*

*Amber.*—This resin is most distinguished for durability. It is usually of some shade of yellow, transparent, hard and moderately tough. Heated in air, it fuses at about 549°; it burns with a clear flame, emitting a pleasant odor.

*Anime.*—This is imported from the East Indies. The large, transparent, pale-yellow pieces, with vitreous fracture, are best suited for varnish. Inferior qualities are employed for manufacturing gold-size or japan-black. Although superior to amber in its capacity for drying, and equal in hardness, varnish made from anime deepens in color on exposure to air, and is very liable to crack. It is, however, much used for mixing with copal varnish.

*Benzoin.*—This is a gum resin, but little used in varnishes on account of its costliness.

*Colophony.*—This resin is synonymous with arcanson and rosin. When the resinous juice of *Pinus sylvestris* and other varieties is distilled, colophony remains in the retort. Its dark color is due to the action of the fire. Dissolved in linseed oil, or in turpentine by the aid of heat, colophony forms a brilliant, hard, but brittle varnish.

*Copal.*—This is a gum resin of immense importance to the varnish maker. It consists of several minor resins of

different degrees of solubility. In durability, it is only second to amber. When made into varnish, the better sorts become lighter in color by exposure to air.

Copal is generally imported in large lumps about the size of potatoes. The clearest and palest are selected for what is called *body gum*; the second best forms *carriage gum*; whilst the residue, freed from the many impurities with which it is associated, constitutes the *worst quality*, fitted only for japan black or gold size.

In alcohol, copal is but slightly soluble; but it is said to become more so by reducing it to a fine powder and exposing it to atmospheric influences for twelve months. Boiling alcohol or spirit of turpentine, when poured upon *fused* copal, accomplishes its complete solution, provided the solvent be not added in too large proportions at a time. The addition of camphor also promotes the solubility of copal; so likewise does oil of rosemary.

*Dammar*.—This is a tasteless, inodorous, whitish resin, easily soluble in oils. It is not so hard as mastic, with which it forms a good admixture.

*Elemé*.—This is a resin of a yellow color, semi-transparent and of faint fragrance. Of the two resins which it contains, one is crystallizable and soluble in cold alcohol.

*Lac*.—This constitutes the basis of spirit varnish. The resin is soluble in strong alcohol aided by heat. Its solution in ammonia may be used as a varnish, when the articles coated with it are not to be exposed more than an hour or two at a time to water.

*Mastic*.—This is a soft resin of considerable lustre. The two sorts in commerce are, *in tears* and the *common mastic*; the former is the purer of the two. It consists of two resins, one of which is soluble in dilute alcohol. With oil of turpentine it forms a very pale varnish of great lustre, which flows readily and works easily. Moreover, it can

be readily removed by friction with the hand; hence its use for delicate work of every description.

*Sandarach.*—This is a pale, odorous resin, less hard than lac, with which it is often associated as a spirit varnish. It consists of three resins differing as to solubility in alcohol, ether and turpentine. It forms a good pale varnish for light-colored woods; when required to be polished, Venice turpentine is added to give it body.

Of the solvents of these various resins little need be said. In the manufacture of varnishes, great care, as well as cleanliness, is required. The resins should be washed in hot water, to free them from particles of dust and dirt; they should be dried and assorted according to their color, reserving the lightest shades for the best kinds of varnish.

The *linseed oil* should be as pale colored and as well clarified as possible. New oil always contains mucilage, and more or less of foreign matters; as these prevent the regular absorption of oxygen, the oil requires preliminary treatment. The common plan is to boil it with litharge; but such *oil varnish* is inferior to that prepared with sulphate of lead.

The best method is to rub up linseed oil with dry sulphate of lead, in sufficient quantity to form a milky mixture. After a week's exposure to the light, and frequent shaking, the mucus deposits with the sulphate of lead, and leaves the oil perfectly clear. The precipitated slime forms a compact membrane over the lead, hardening to such an extent that the clarified oil may be readily poured off.

*Turpentine.*—This is of very extensive use. The older it is, the more ozonized, the better it is. Turpentine varnishes dry much more readily than oil varnishes, are of a lighter color, more flexible and cheap. They are, however, neither so tough nor so durable.

*Alcohol.*—This is employed as the solvent of sandarach and of lac. The stronger, *ceteris paribus*, the better.

*Naphtha and Methylated Spirit of Wine.*—These are used for the cheaper varnishes. Their smell is disagreeable. The former is, however, a better solvent of resins than alcohol.

*Spirit Varnishes.*—These varnishes may be readily colored—*red*, by dragon's blood; *yellow*, by gamboge. If a colored varnish is required, no account need be taken of the color of the resins. Lac varnish may be bleached by Mr. Lemming's process:—Dissolve five ounces of shellac in a quart of spirit of wine; boil for a few minutes with ten ounces of well-burnt and recently-heated animal charcoal, when a small quantity of the solution should be drawn off and filtered: if not colorless, a little more charcoal should be added. When all tinge is removed, press the liquor through silk, as linen absorbs more varnish; and afterwards filter it through fine blotting-paper. Dr. Hare proceeds as follows:—Dissolve in an iron kettle about one part of pearlsh in about eight parts of water, add one part of shell or seed-lac, and heat the whole to ebullition. When the lac is dissolved, cool the solution, and impregnate it with chlorine gas till the lac is all precipitated. The precipitate is white, but the color deepens by washing and consolidation. Dissolved in alcohol, lac bleached by this process yields a varnish which is as free from color as any copal varnish.

One word in conclusion with reference to all spirit varnishes. A damp atmosphere is sufficient to occasion a milky deposit of resin, owing to the diluted spirit depositing a portion: in such case the varnish is said to be *chilled*.

*Essence Varnishes.*—They do not differ essentially in their manufacture from spirit varnishes. The polish produced by them is more durable, although they take a longer time to dry.

*Oil Varnishes.*—The most durable and lustrous of var-

nishes are composed of a mixture of resin, oil, and spirit of turpentine. The oils most frequently employed are linseed and walnut; the resins chiefly copal and amber.

The drying powder of the oil having been increased by litharge, red lead, or by sulphate of lead, and a judicious selection of copal having been made, it is necessary, according to Booth, to bear in mind the following precautions before proceeding to the manufacture of varnish:—1. That oil varnish is not a solution, but an intimate mixture of resin in boiled oil and spirit of turpentine. 2. That the resin must be completely fused previous to the addition of the boiled or prepared oil. 3. That the oil must be heated from  $250^{\circ}$  to  $300^{\circ}$ . 4. That the spirit of turpentine must be added gradually, and in a thin stream, while the mixture of oil and resin is still hot. 5. That the varnish be made in dry weather, otherwise moisture is absorbed, and its transparency and drying quality impaired.

The heating vessel must be of copper, with a riveted and not a soldered bottom. To promote the admixture of the copal with the *hot* oil, the copal—carefully selected, and of nearly uniform fusibility—is *separately* heated with continuous stirring over a charcoal fire. Good management is required to prevent the copal from burning or becoming even high colored. When completely fused, the heated oil should be gradually poured in with constant stirring. The *exact* amount of oil required must be determined by experiment. If a drop upon a plate, on cooling, assumes such a consistency as to be penetrated by the nail without cracking, the mixture is complete; but if it cracks, more oil must be added.

The spirit of turpentine *previously heated* is added in a thin stream to the former mixture, care being taken to keep up the heat of all the parts.

*Lacquer*.—This is used for wood or brass work, and is also a varnish. For brass, the proportions are half a pound



of pale shellac to one gallon of spirit of wine. It is better prepared without the aid of heat by simple and repeated agitation. It should then be left to clear itself, and separated from the thicker portions and from all impurities by decantation. As it darkens on exposure to light, the latter should be excluded. It need scarcely be said that the color will also be modified by that of the lac employed.

*I. Copal Varnishes.*—1. Oil of turpentine one pint. Set the bottle in a water bath, and add in small portions at a time, three ounces of powdered copal that has been previously melted by a gentle heat, and dropped into water; in a few days decant the clear. *Dries* slowly, but is very pale and durable. *Used* for pictures, &c. 2. Pale hard copal two pounds; fuse, add hot drying oil one pint, boil as before directed, and thin with oil of turpentine three pints, or as much as sufficient. Very pale. *Dries* hard in 12 to 24 hours. 3. Clearest and palest African copal eight pounds; fuse, add hot and pale drying oil two gallons, boil till it strings strongly, cool a little, and thin with hot rectified oil of turpentine three gallons, and immediately strain into the store can. Very fine. Both the above are used for pictures. 4. Coarsely-powdered copal and glass, of each four ounces, alcohol of 90 per cent. one pint, camphor one-half ounce; heat it in a water-bath so that the bubbles may be counted as they rise, observing frequently to stir the mixture; when cold decant the clear. *Used* for pictures. 5. Copal melted and dropped into water three ounces, gum sandarach six ounces, mastic and Scio turpentine, of each two and one-half ounces, powdered glass four ounces, alcohol of 85 per cent. one quart; dissolve by a gentle heat. *Used* for metal, chairs, &c.

All copal varnishes are hard and durable, though less so than those made of amber, but they have the advantage over the latter of being paler. They are applied on coaches,

pictures, polished metal, wood, and other objects requiring good durable varnish.

*II. Copal Varnish.*—Hard copal, 300 parts; drying linseed or nut oil, from 125 to 250 parts; oil of turpentine, 500. These three substances are to be put into three separate vessels; the copal is to be fused by a somewhat sudden application of heat; the drying oil is to be heated to a temperature a little under ebullition, and is to be added, by small portions at a time, to the melted copal. When this combination is made, and the heat a little abated, the oil of turpentine, likewise previously heated, is to be introduced by degrees; some of the volatile oil will be dissipated at first, but more being added, the union will take place. Great care must be taken to prevent the turpentine vapor from catching fire, which might occasion serious accidents to the operator. When the varnish is made and has cooled down to about 130 degrees Fahr., it may be strained through a filter, to separate the impurities and undissolved copal. Almost all varnish makers think it indispensable to combine the drying oil with the copal before adding the oil of turpentine, but in this they are mistaken. Boiling oil of turpentine combines very readily with fused copal; and, in some cases, it would probably be preferable to commence the operation with it, adding it in successive small quantities. Indeed, the whitest copal varnish can be made only in this way; for if the drying oil has been heated to nearly its boiling point, it becomes colored, and darkens the varnish.

This varnish improves in clearness by keeping. Its consistence may be varied by varying the proportions of the ingredients within moderate limits. Good varnish, applied in summer, should become so dry in 24 hours that the dust will not stick to it, and so hard as not to receive an impression from the fingers. To render it sufficiently dry and hard

for polishing, it must be subjected for several days to the heat of a stove.

*III. Copal Varnishes.*—1. Melt in an iron pan at a slow heat, copal gum powdered, 8 parts, and add balsam copaiva, previously warmed, 2 parts. Then remove from the fire, and add spirits of turpentine, also warmed beforehand, 10 parts, to give the necessary consistence. 2. Prepared gum copal 10 parts, gum mastic 2 parts, finely powdered, are mixed with white turpentine and boiled linseed oil, of each 1 part, at a slow heat, and with spirits of turpentine 20 parts. 3. Prepared gum-copal 10 parts, white turpentine 2 parts; dissolve in spirits of turpentine.

Gum-copal is *prepared* or made more soluble in spirits of turpentine, by melting the powdered crude gum, afterwards again powdering, and allowing to stand for some time loosely covered.

*Cabinet Varnish.*—Copal, fused, 14 lbs.; linseed oil, hot, 1 gallon; turpentine, hot, 3 gallons. Properly boiled, such a varnish will dry in 10 minutes.

*Table Varnish.*—Dammar resin, 1 lb.; spirits of turpentine, 2 lbs.; camphor, 200 grains. Digest the mixture for 24 hours. The decanted portion is fit for immediate use.

*Common Table Varnish.*—Oil of turpentine, 1 lb.; bees' wax, 2 oz.; colophony, 1 drachm.

*Copal Varnish for Inside Work.*—1. Pounded and oxidized copal, 24 parts; spirit of turpentine, 40 parts; camphor, 1 part.—2. *Flexible Copal Varnish.* Copal in powder, 16 parts; camphor, 2 parts; oil of lavender, 90 parts.

Dissolve the camphor in the oil, heat the latter, and stir in the copal in successive portions until complete solution takes place. Thin with sufficient turpentine to make it of proper consistence.

*Best Body Copal Varnish for Coach Makers, etc.*—This is intended for the body parts of coaches and other similar

vehicles, intended for polishing. Fuse eight lbs. of fine African gum copal, and two gallons of clarified oil, boil it very slowly for four or five hours, until quite stringy, mix with three gallons and a half of turpentine; strain off and pour it into a can. If this is too slow in drying, coach-makers, painters and varnish-makers have introduced to two pots of the preceding varnish, one made as follows: Eight lbs. of fine pale gum-anime, two gallons of clarified oil and three and a half gallons of turpentine. To be boiled four hours.

*Copal Polish.*—Digest or shake finely powdered gum copal four parts, and gum camphor one part, with ether to form a semi-fluid mass, and then digest with a sufficient quantity of alcohol.

*White Spirit Varnish.*—Sandarach, 250 parts; mastic, in tears, 64; elemi resin, 32; turpentine, 64; alcohol of 85 per cent., 1000 parts, by measure. The turpentine is to be added after the resins are dissolved. This is a brilliant varnish, but not so hard as to bear polishing.

*White Hard Spirit Varnishes.*—1. Gum sandarach five pounds, camphor one ounce, rectified spirit 65 over proof two gallons, washed and dried coarsely-pounded glass two pounds; proceed as in making mastic varnish. When strained add one quart of very pale turpentine varnish. Very fine. 2. Picked mastic and coarsely-ground glass, of each four ounces, sandarach and pale clear Venice turpentine, of each three ounces, alcohol two pounds; as last. 3. Gum sandarach one pound, clear Strasburg turpentine six ounces, rectified spirit (65 over proof) three pints; dissolve. 4. Mastic in tears two ounces, sandarach eight ounces, gum elemi one ounce, Strasburg or Scio turpentine (genuine) four ounces, rectified spirit (65 over proof) one quart. *Used* on metals, etc. Polishes well.

*White Varnish.*—1. Tender copal seven and one-half ounces, camphor one ounce, alcohol of 95 per cent. one

quart; dissolve; then add mastic two ounces, Venice turpentine one ounce; dissolve and strain. Very white, drying and capable of being polished when hard. *Used* for toys. 2. Sandarach eight ounces, mastic two ounces, Canada balsam four ounces, alcohol one quart. *Used* on paper, wood or linen.

*Soft Brilliant Varnish.*—Sandarach six ounces, elemi (genuine) four ounces, anise one ounce, camphor one-half ounce, rectified spirit one quart; as before.

The above spirit varnishes are chiefly applied to objects of the toilet, work boxes, card cases, etc., but are also suitable for other articles, whether of paper, wood, linen, or metal, that require a brilliant and quick-drying varnish. They mostly dry almost as soon as applied, and are usually hard enough to polish in 24 hours. Spirit varnishes are less durable and more liable to crack than oil varnishes.

*Brown, hard Spirit Varnishes.*—1. Sandarach four ounces, pale seed lac two ounces, elemi (true) one ounce, alcohol one quart; digest with agitation till dissolved, then add Venice turpentine two ounces. 2. Gum sandarach three pounds, shellac two pounds, rectified spirit (65 over proof), two gallons; dissolve; add turpentine varnish one quart; agitate well and strain. Very fine. 3. Seed lac and yellow resin, of each one and one-half pounds, rectified spirit two gallons.

*To Prepare a Varnish for Coating Metals.*—Digest one part of bruised copal in two parts of absolute alcohol; but as this varnish dries too quickly it is preferable to take one part of copal, one part of oil of rosemary, and two or three parts of absolute alcohol. This gives a clear varnish as limpid as water. It should be applied hot, and when dry it will be found hard and durable.

*To Varnish Articles of Iron and Steel.*—Dissolve ten parts of clear grains of mastic, five parts of camphor, fifteen parts of sandarach, and five of elemi, in a sufficient

quantity of alcohol, and apply this varnish without heat. The articles will not only be preserved from rust, but the varnish will retain its transparency and the metallic brilliancy of the articles will not be obscured.

*Varnish for Iron Work.*—Dissolve, in about two pounds of tar oil, half a pound of asphaltum, and a like quantity of pounded resin, mix hot in an iron kettle, care being taken to prevent any contact with the flame. When cold, the varnish is ready for use. This varnish is for out-door wood and iron work, not for japanning leather or cloth.

*Black Varnish for Iron Work.*—Asphaltum forty-eight pounds; fuse; add boiled oil ten gallons, red lead and litharge, of each seven pounds, dried and powdered white copperas three pounds; boil for two hours; then add dark gum amber (fused) eight pounds, hot linseed oil two gallons; boil for two hours longer, or till a little of the mass, when cooled, may be rolled into pills; then withdraw the heat, and afterwards thin down with oil of turpentine thirty gallons. *Used* for the iron work of carriages and other nice purposes.

*Bronze Varnish for Statuary.*—Cut best hard soap fifty parts into fine shavings; dissolve in boiling water two parts, to which add the solution of blue vitriol fifteen parts, in pure water sixty parts. Wash the copper-soap with water, dry it at a very slow heat, and dissolve it in spirits of turpentine.

*Amber Varnishes.*—1. Amber one pound, pale boiled oil ten ounces, turpentine one pint. Render the amber, placed in an iron pot, semi-liquid by heat; then add the oil, mix, remove it from the fire, and when cooled a little, stir in the turpentine. 2. To the amber, melted as above, add two ounces of shellac, and proceed as before.

This varnish is rather dark, but remarkably tough. The first formula is the best. It is used for the same purposes as copal varnish, and forms an excellent article for covering

wood, or any other substance not of a white or pale color. It dries well, and is very hard and durable.

*Amber Varnish, Black.*—Amber one pound, boiled oil one-half pint, powdered asphaltum; six ounces, oil of turpentine one pint. Melt the amber, as before described, then add the asphaltum, previously mixed with the cold oil, and afterwards heated very hot; mix well, remove the vessel from the fire, and when cooled a little, add the turpentine, also made warm.

Each of the above varnishes should be reduced to a proper consistence with more turpentine if required. The last formula produces the *beautiful black varnish* used by the coachmakers. Some manufacturers omit the whole or part of the asphaltum, and use the same quantity of clear black rosin instead, in which case the color is brought up by lampblack reduced to an impalpable powder, or previously ground very fine with a little boiled oil. The varnish made in this way lacks, however, that richness, brilliancy, and depth of blackness imparted by asphaltum.

*Amber Varnishes.*—1. (*Pale.*) Amber pale and transparent six pounds; fuse; add hot clarified linseed oil two gallons; boil till it strings strongly, cool a little and add oil of turpentine four gallons. Pale as copal varnish; soon becomes very hard, and is the most durable of oil varnishes; but requires time before it is fit for polishing. When wanted to dry and harden more quickly, “drying” oil may be substituted for linseed, or “dryers” may be added during the boiling. 2. Amber one pound; melt, add Scio turpentine one-half pound, transparent white resin two ounces, hot linseed oil one pint, and afterwards oil of turpentine as much as sufficient; as above. Very tough. 3. (*Hard.*) Melted amber four ounces, hot boiled oil one quart; as before. 4. (*Pale.*) Very pale and transparent amber four ounces, clarified linseed oil and oil of turpentine, of each one pint; as before.

Amber varnish is suited for all purposes, where a very hard and durable oil varnish is required. The paler kind is superior to copal varnish, and is often mixed with the latter to increase its hardness and durability.

*Black Varnish.*—Heat to boiling linseed oil, varnish ten parts, with burnt amber two parts, and powdered asphaltum one part, and when cooled, dilute to the required consistence, with spirits of turpentine.

*Varnish for certain parts of Carriages.*—Sandarach 190 parts, pale shellac 95, resin 125, turpentine 190, alcohol (at 85 per cent.) 1000 parts, by measure.

*Coach Varnish.*—Mix shellac sixteen parts, white turpentine three parts, lampblack a sufficient quantity, and digest with alcohol ninety parts, oil of lavender four parts.

*Mahogany Varnish.*—Sorted gum anime eight pounds, clarified oil three gallons, litharge and powdered dried sugar of lead, of each one-fourth pound; boil till it strings well, then cool a little, thin with oil of turpentine five and one-half gallons, and strain.

*Varnish for Cabinetmakers.*—Pale shellac 750 parts, mastic 64, alcohol (of 90 per cent.) 1000 parts by measure. The solution is made in the cold, with the aid of frequent stirring. It is always muddy, and is employed without being filtered. With the same resins and proof spirit a varnish is made for bookbinders, for applying to morocco leather.

*Cement Varnish for water-tight Luting.*—White turpentine fourteen parts, shellac eighteen parts, resin six parts, digest with alcohol eighty parts.

*The Varnish of Watin for Gilded Articles.*—Gum lac (in grains) 125 parts, gamboge 125, dragon's blood 125, annotto 125, saffron 32. Each resin must be dissolved in 1000 parts (by measure) of alcohol of 90 per cent.; two separate tinctures must be made with the dragon's blood and annotto, in 1000 parts of such alcohol; and a proper



portion of each should be added to the varnish—according to the shade of golden color wanted.

*Cheap Oak Varnish.*—Clear pale resin three and one-half pounds, oil of turpentine one gallon; dissolve. It may be colored darker by adding a little fine lampblack.

*Varnish for Woodwork.*—Powdered gum sandarach eight parts, gum mastic two parts, seed lac eight parts, and digest in a warm place for some days with alcohol twenty-four parts; and finally, dilute with sufficient alcohol to the required consistence.

*Dark Varnish for Light Woodwork.*—Pound up and digest shellac sixteen parts, gum sandarach thirty-two parts, gum mastic (juniper) eight parts, gum elemi eight parts, dragon's blood four parts, annotto one part, with white turpentine sixteen parts, and alcohol 256; dilute with alcohol if required.

*Varnish for Instruments.*—Digest seed lac one part, with alcohol seven parts, and filter.

*Varnish for the Wood Toys of Spa.*—Tender copal, 75 parts; mastic, 12.5; Venice turpentine, 6.5; alcohol (of 95 per cent.), 100 parts (by measure, water ounces, for example, if the other parts be taken in ounces). The alcohol must be first made to act upon the copal, with the aid of a little oil of lavender or camphor, if thought fit; and the solution being passed through a linen cloth, the mastic must be introduced. After it is dissolved, the Venice turpentine, previously melted in a water bath, should be added; the lower the temperature at which these operations are carried on, the more beautiful will the varnish be. This varnish ought to be very white, very drying, and capable of being smoothed with pumice stone and polished.

*Varnishes for Furniture.*—The simplest, and perhaps the best, is the solution of shellac only; but many add gums and sandarach, mastic, copal, arabic, benzoin, etc., from the idea that they contribute to the effect. Gum arabic is

certainly never required if the solvent be pure, because it is insoluble in either rectified spirit or rectified wood naphtha, the menstrua employed in dissolving the gums. As spirit is seldom used on account of its expense, most of the following are mentioned as solutions in naphtha, but spirit can be substituted when thought proper.

1. Shellac one and a half pounds, naphtha one gallon; dissolve, and it is ready without filtering. 2. Shellac twelve ounces, copal three ounces (or an equivalent of varnish); dissolve in one gallon of naphtha. 3. Shellac one and a half pounds, seed lac and sandarach each four ounces, mastic two ounces, rectified spirit one gallon; dissolve. 4. Shellac two pounds, benzoin four ounces, spirit one gallon. 5. Shellac ten ounces, seed lac, sandarach and copal varnish, of each, six ounces; benzoin three ounces, naphtha one gallon.

To darken polish, benzoin and dragon's blood are used, turmeric and other coloring matters are also added; and to make it lighter it is necessary to use bleached lac, though some endeavor to give this effect by adding oxalic acid to the ingredients; however, it, like gum arabic, is insoluble in rectified spirit or naphtha. For all ordinary purposes the first formula is best and least troublesome, while the result obtained is equal to any other.

*To French Polish.*—The wood must be placed level and sandpapered until it is *quite smooth*, otherwise it will *not polish*. Then provide a rubber of cloth, list or sponge; wrap it in a soft rag, so as to leave a handle at the back for your hand; shake the bottle against the rubber, and in the middle of the varnish on the rag place with your finger a little raw linseed oil. Now commence rubbing, in small circular strokes, and continue until the pores are filled, charging the rubber with varnish and oil as required, until the whole wood has had one coat. When dry repeat the process once or twice until the surface appears even and fine, between

each coat using fine sandpaper to smooth down all irregularities. Lastly, use a clean rubber with a little strong alcohol only, which will remove the oil and the cloudiness it causes; when the work will be complete.

*Furniture Polishes.*—New wood is often French-polished. Or the following may be tried:

Melt three or four pieces of sandarach, each the size of a walnut; add one pint of boiled oil, and boil together for one hour. While cooling add one drachm of Venice turpentine, and if too thick a little oil of turpentine also. Apply this all over the furniture, and after some hours rub it off; rub the furniture daily, without applying fresh varnish, except about once in two months. Water does not injure this polish, and any stain or scratch may be again covered, which cannot be done with French polish.

*Furniture Gloss.*—To give a gloss to household furniture various compositions are used, known as wax, polish, creams, pastes, oils, etc. The following are some of the formulæ used:

*Furniture Cream.*—Beeswax one pound, soap four ounces, pearlash two ounces, soft water one gallon; boil together until mixed.

*Furniture Oils.*—1. Acetic acid two drachms, oil of lavender one-half drachm, rectified spirit one drachm, linseed oil four ounces. 2. Linseed oil one pint, alkanet root two ounces; heat, strain and add lac varnish one ounce. 3. Linseed oil one pint, rectified spirit two ounces, butter of antimony four ounces.

*Furniture Pastes.*—1. Beeswax, spirit of turpentine and linseed oil, equal parts; melt and cool. 2. Beeswax four ounces, turpentine ten ounces, alkanet root to color; melt and strain. 3. Beeswax one pound, linseed oil five ounces, alkanet root one-half ounce; melt, add five ounces of turpentine, strain and cool. 4. Beeswax four ounces, resin one ounce, oil of turpentine two ounces, Venetian red to color.

*Etching Varnishes.*—1. White wax two ounces, black and Burgundy pitch, of each one-half ounce; melt together; add, by degrees, powdered asphaltum two ounces, and boil till a drop taken out on a plate will break when cold by being bent double two or three times between the fingers; it must then be poured into warm water and made into small balls for use. 2. (*Hard Varnish.*) Linseed oil and mastic, of each four ounces; melt together. 3. (*Soft Varnish.*) Soft linseed oil four ounces, gum benzoin and white wax, each one-half ounce; reduced by boiling to two-thirds.

*Varnish for Engravings, Maps, etc.*—Digest gum sandarach twenty parts, gum mastic eight parts, camphor one part, with alcohol forty-eight parts. The map or engraving must previously receive one or two coats of gelatine.

*Varnish to fix Engravings or Lithographs on Wood.*—For fixing engravings or lithographs upon wood, a varnish called mordant is used in France, which differs from others chiefly in containing more Venice turpentine, to make it sticky. It consists of sandarach 250 parts, mastic in tears 64, rosin 125, Venice turpentine 250, alcohol 1000 parts (by measure).

*Varnishes for Oil Paintings and Lithographs.*—1. Dextrine two parts, alcohol one part, water six parts. 2. Varnish for drawings and lithographs: dextrine two parts, alcohol one-half part, water two parts. These should be prepared previously with two or three coats of thin starch, or rice, boiled and strained through a cloth.

*Varnish for Oil Paintings.*—Digest at a slow heat gum sandarach two parts, gum mastic four parts, balsam copaiba two parts, white turpentine three parts, with spirits of turpentine four parts, alcohol (95 per cent.) 50 to 56 parts.

*Beautiful Varnish for Paintings and Pictures.*—Honey one pint, the white of two dozen fresh hens' eggs, one ounce of good clean isinglass, twenty grains of hydrate of potassium, one-half ounce of chloride of sodium. Mix to-

gether over a gentle heat of eighty or ninety degrees Fahrenheit. Be careful not to let the mixture remain long enough to coagulate the albumen of the eggs. Stir the mixture thoroughly, then bottle. It is to be applied as follows: one tablespoonful of the varnish added to half a tablespoonful of good oil of turpentine; then spread on the picture as soon as mixed.

*Milk of Wax.*—Milk of wax is a valuable varnish, which may be prepared as follows: Melt in a porcelain capsule a certain quantity of white wax, and add to it, while in fusion, an equal quantity of spirit of wine (of specific gravity 0.830); stir the mixture and pour it upon a large porphyry slab. The granular mass is to be converted into a paste by the muller, with the addition, from time to time, of a little alcohol; and as soon as it appears to be smooth and homogeneous, water is to be introduced in small quantities successively, to the amount of four times the weight of the wax. This emulsion is to be then passed through canvas, in order to separate such particles as may be imperfectly incorporated. The milk of wax, thus prepared, may be spread with a smooth brush upon the surface of a painting, allowed to dry, and then fused by passing a hot iron over its surface. When cold, it is to be rubbed with a linen cloth to bring out the lustre. It is to the unchangeable quality of an encaustic of this nature that the ancient paintings upon the walls of Herculaneum and Pompeii owe their freshness at the present day.

*Crystal Varnishes.*—1. Genuine pale Canada balsam and rectified oil of turpentine equal parts; mix, place the bottle in warm water, agitate well, set it aside in a moderately warm place, and in a week pour off the clear. *Used* for maps, prints, drawings and other articles of paper, and also to prepare tracing paper, and to transfer engravings. 2. Mastic three ounces, alcohol one pint; dissolve. *Used* to fix pencil drawings.

*Italian Varnishes.*—1. Boil Scio turpentine till brittle ; powder, and dissolve in oil of turpentine. 2. Canada balsam and clear white resin, of each six ounces, oil of turpentine one quart ; dissolve. *Used* for prints, etc.

*Size, or Varnish, for Printers, etc.*—Best pale glue and white curd soap, of each 4 ounces ; hot water 3 pints ; dissolve, then add powdered alum 2 ounces. *Used* to size prints and pictures before coloring them.

*Mastic Varnishes.*—1. (*Fine.*) Very pale and picked gum mastic five pounds, glass pounded as small as barley, and well washed and dried, two and one-half pounds, rectified turpentine two gallons ; put them into a clean four gallon stone or tin bottle, bung down securely, and keep rolling it backwards and forwards pretty smartly on a counter or any other solid place for at least four hours ; when, if the gum is all dissolved, the varnish may be decanted, strained through muslin into another bottle, and allowed to settle. It should be kept for six or nine months before use, as it thereby gets both tougher and clearer. 2. (*Second Quality.*) Mastic eight pounds, turpentine four gallons ; dissolve by a gentle heat, and add pale turpentine varnish one-half gallon. 3. Gum mastic six ounces, oil of turpentine one quart ; dissolve.

Mastic varnish is used for pictures, etc. ; when good, it is tough, hard, brilliant, and colorless. Should it get "*chilled,*" one pound of well-washed siliceous sand should be made moderately hot, and added to each gallon, which must then be well agitated for five minutes, and afterwards allowed to settle.

*India Rubber Varnishes.*—1. Cut up one pound of India rubber into small pieces and diffuse in half a pound of sulphuric ether, which is done by digesting in a glass flask on a sand bath. Then add one pound pale linseed oil varnish, previously heated, and after settling, one pound of oil of

turpentine, also heated beforehand. Filter, while yet warm, into bottles. Dries slowly.

2. Two ounces India rubber finely divided and digested in the same way, with a quarter of a pound of camphene, and half an ounce of naphtha or benzole. When dissolved add one ounce of copal varnish, which renders it more durable. Principally for gilding.

3. In a wide-mouthed glass bottle, digest two ounces of India rubber in fine shavings, with one pound of oil of turpentine, during two days, without shaking; then stir up with a wooden spatula. Add another pound of oil of turpentine, and digest, with frequent agitation, until all is dissolved. Then mix a pound and a half of this solution with two pounds of very white copal-oil varnish, and a pound and a half of well boiled linseed oil; shake and digest in a sand bath, until they have united into a good varnish.—For morocco leather.

4. Four ounces India rubber in fine shavings are dissolved in a covered jar by means of a sand bath, in two pounds of crude benzole, and then mixed with four pounds of hot linseed oil varnish, and half a pound of oil of turpentine. Dries very well.

5. *Flexible Varnish*.—Melt one pound of rosin, and add gradually half a pound of India rubber in very fine shavings, and stir until cold. Then heat again, slowly, add one pound of linseed oil varnish, previously heated, and then filter.

6. *Another*.—Dissolve one pound of gum dammar, and a half pound of India rubber, in very small pieces, in one pound of oil of turpentine, by means of a water bath. Add one pound of hot oil varnish and filter.

7. India rubber in small pieces, washed and dried, is fused for three hours in a close vessel, on a gradually heated sand bath. On removing from the sand bath, open the vessel and stir for ten minutes, then close again, and

repeat the fusion on the following day, until small globules appear on the surface. Strain through a wire sieve.

8. *Varnish for Waterproof Goods*.—Let a quarter of a pound of India rubber, in small pieces, soften in a half pound of oil of turpentine, then add two pounds of boiled oil, and let the whole boil for two hours over a slow coal fire. When dissolved, add again six pounds of boiled linseed oil and one pound of litharge, and boil until an even liquid is obtained. It is applied warm,

9. *Gutta Percha Varnish*.—Clean a quarter of a pound of gutta percha from adhering impurities in warm water, dry well, dissolve in one pound of rectified rosin oil, and add two pounds of linseed oil varnish, boiling hot. Very suitable to prevent metals from oxidation.

*Black Varnish for Harness*.—Digest shellac twelve parts, white turpentine five parts, gum sandarach two parts, lamp-black one part, with spirits of turpentine four parts, alcohol ninety-six parts.

*Boiled Oil or Linseed-Oil Varnish*.—Boil linseed oil sixty parts, with litharge two parts, and white vitriol one part, each finely powdered, until all water is evaporated. Then set by.

*Dammar Varnish*.—Gum dammar ten parts, gum sandarach five parts, gum mastic one part; digest at a low heat, occasionally shaking, with spirits of turpentine twenty parts. Finally, add more spirits of turpentine to give the consistence of syrup.

*Common Varnish*.—Digest shellac one part, with alcohol seven or eight parts.

*Waterproof Varnishes*.—Take one pound of flowers of sulphur and one gallon of linseed oil, and boil them together until they are thoroughly combined. This forms a good varnish for waterproofing textile fabrics. Another is made with four pounds oxide of lead, two pounds of lamp-black, five ounces of sulphur, and ten pounds of India rub-



ber dissolved in turpentine. These substances, in the proportions given, are boiled together until they are thoroughly combined. Coloring matters may be mixed with them. Twilled cotton may be rendered waterproof by the application of the oil-sulphur varnish. It should be applied at two or three different times, and dried after each operation.

*Varnishes for Balloons, Gas Bags, etc.*—1. India rubber in shavings one ounce; mineral naphtha two lbs.; digest at a gentle heat in a close vessel till dissolved, and strain. 2. Digest one pound of Indian rubber, cut small, in six pounds of oil of turpentine for 7 days. in a warm place. Put the mixture in a water bath, heat until thoroughly mixed, add one gallon of warm boiled drying oil, mix, and strain when cold. 3. Linseed oil one gallon; dried white copperas and sugar of lead, each three ounces; litharge eight ounces; boil with constant agitation till it strings well, then cool slowly and decant the clear. If too thick, thin it with quicker-drying linseed oil.

*Gold Varnish.*—Digest shellac sixteen parts, gum sandarach, mastic, of each three parts, crocus one part, gum gamboge two parts, all bruised, with alcohol one hundred and forty four parts. Or, digest seed-lac, sandarach, mastic, of each eight parts, gamboge two parts, dragon's blood one part, white turpentine six parts, turmeric four parts, bruised, with alcohol one hundred and twenty parts.

*Wainscot Varnish for House Painting and Japanning.*—Anime eight pounds; clarified linseed oil three gallons; litharge one-fourth pound; acetate of lead one-half pound; sulphate of copper one-fourth pound.

All these materials must be carefully but thoroughly boiled together until the mixture becomes quite stringy, and then five and a half gallons of heated turpentine stirred in. It can be easily deepened in color by the addition of a little gold-size.

*Iron Work Black.*—Put 48 lbs. asphaltum into an iron pot, and boil for 4 hours; during the first 2 hours introduce 7 lbs. litharge, 3 lbs. dried copperas, and 10 galls. boiled oil; add  $\frac{1}{8}$  lb. run of dark gum, with 2 galls. hot oil. After pouring the oil and gum, continue the boiling 2 hours, or until it will roll into hard pills, like Japan. When cool, thin it off with 30 galls. of turpentine, or until it is of proper consistence.

*Black Japan Varnish.*—Bitumen, 2 ounces; lampblack, 1 ounce; acetate of lead  $\frac{1}{2}$  ounce; Venice turpentine,  $\frac{1}{2}$  ounce; boiled oil, 12 ounces. Melt the turpentine and oil together, carefully stirring in the rest of the ingredients, previously powdered. Simmer all together for ten minutes.

Tinware is japanned with Colored Copal Varnish, and then baked in an oven until the varnish becomes perfectly dry and hard. Varnishes may be colored with any of the pigments used in oil painting.

*Leather Varnish.*—Durable leather varnish is composed of boiled linseed oil, in which a drier, such as litharge, has been boiled. It is colored with lampblack. This varnish is used for making enamelled leather. Common leather varnish, which is used as a substitute for blacking, is made of thin lac-varnish colored with ivory black.

*Varnish for Smooth Moulding Patterns.*—Alcohol, 1 gall.; shellac, 1 lb.; lamp or ivory black sufficient to color it.

*Fine Black Varnish for Coaches.*—Melt in an iron pot, amber, 32 ozs.; resin, 6 ozs.; asphaltum, 6 ozs.; drying linseed oil, 1 pt.; when partly cooled add oil of turpentine, warmed, 1 pt.

## LACQUERS.

*Gold Lacquer.*—Put into a clean four-gallon tin, one pound of ground turmeric, one and a half ounces of gamboge, three and a half pounds of powdered gum sandarach, three-quarters of a pound of shellac, and two gallons of spirits of wine. When shaken, dissolved, and strained, add one pint of turpentine varnish, well mixed.

*Red Spirit Lacquer.*—Made exactly as the gold lacquer with these ingredients: Two gallons of spirits of wine, one pound of dragon's blood, three pounds of Spanish annotto, three and a quarter pounds of gum sandarach, and two pints of turpentine.

*Pale Brass Lacquer.*—Two galls. spirits of wine; 3 oz. Cape aloes cut small; 1 lb. fine pale shellac; 1 oz. gamboge, cut small; no turpentine; varnish made exactly as before. But observe, that those who use lacquers frequently want some paler and some darker; and sometimes inclining more to the particular tint of certain of the component ingredients. Therefore, if a 4 oz. phial of a strong solution of each ingredient be prepared, a lacquer of any tint can be produced at any time.

*Lacquer for Tin.*—Any good lacquer laid upon tin gives it the appearance of copper or brass. It is made by coloring lac-varnish with turmeric to impart the color of brass to it, and with annotto, to give it the color of copper. If a tin plate is dipped into molten brass, the latter metal will adhere to it in a coat.

*Lacquer Varnish.*—A good lacquer is made by coloring lac-varnish with turmeric and annotto. Add as much of these two coloring substances to the varnish as will give it the proper color; then squeeze the varnish through a cotton cloth, when it forms lacquer.

*Deep Gold-colored Lacquer.*—Seed-lac three ounces, turmeric one ounce, dragon's blood one-fourth ounce, al-

cohol one pint; digest for a week, frequently shaking, decant and filter.

Lacquers are used upon polished metals and wood to impart the appearance of gold. If yellow is required, use turmeric, aloes, saffron, or gamboge; for red, use annotto, or dragon's blood, to color. Turmeric, gamboge and dragon's blood, generally afford a sufficient range of colors.

*Lacquers for Pictures, Metal, Wood or Leather.*—1. Seed-lac, eight ounces, alcohol one quart; digest in a close vessel in a warm situation for three or four days, then decant and strain. 2. Substitute lac bleached by chlorine for seed-lac. Both are very tough, hard and durable; the last almost colorless.

*Directions for Making Lacquer.*—Mix the ingredients and let the vessel containing them stand in the sun, or in a place slightly warmed three or four days, shaking it frequently till the gum is dissolved, after which let it settle from twenty-four to forty-eight hours, when the clear liquor may be poured off for use. Pulverized glass is sometimes used in making lacquer, to carry down the impurities.

*Lacquer for Dipped Brass.*—Alcohol, proof specific gravity not less than 95-100ths, 2 galls.; seed-lac, 1 lb.; gum copal, 1 oz.; English saffron, 1 oz.; annotto, 1 oz.

*Lacquer for Bronzed Brass.*—To one pint of the above lacquer, add, gamboge, 1 oz.; and after mixing it add an equal quantity of the first lacquer.

*Deep Gold-colored Lacquer.*—Best alcohol, 40 oz.; Spanish annotto, 8 grs.; turmeric, 2 drs.; shellac,  $\frac{1}{2}$  oz.; red sanders, 12 grs.; when dissolved add spirits of turpentine, 30 drops.

*Gold-colored Lacquer for Brass not Dipped.*—Alcohol, 4 gals.; turmeric, 3 lbs.; gamboge, 3 oz.; gum sandarach, 7 lbs.; shellac,  $1\frac{1}{2}$  lb.; turpentine varnish, 1 pint.

*Gold-colored Lacquer for Dipped Brass.*—Alcohol, 36-

oz. ; seed lac, 6 oz. ; amber, 2 oz. ; gum gutta, 2 oz. ; red sandal wood, 24 grs. ; dragon's blood, 60 grs. ; Oriental saffron, 36 grs. ; pulverized glass, 4 oz.

*Good Lacquer for Brass.*—Seed-lac, 6 oz. ; amber or copal, 2 oz. ; best alcohol, 4 gals. ; pulverized glass, 4 oz. ; dragon's blood, 40 grs. ; extract of red sandal wood obtained by water, 30 grs.

*Lacquer for Dipped Brass.*—Alcohol, 12 gals. ; seed-lac, 9 lbs. ; turmeric, 1 lb. to a gallon of the above mixture ; Spanish saffron, 4 oz.

The saffron is to be added for bronze work.

*Good Lacquer.*—Alcohol, 8 oz. ; gamboge, 1 oz. ; shellac, 3 oz. ; annotto, 1 oz. ; solution of 3 oz. of seed-lac in 1 pint of alcohol ; when dissolved add one-half ounce Venice turpentine. One-quarter ounce dragon's blood will make it dark. Keep it in a warm place four or five days.

*Pale Lacquer for Tin Plate.*—Best alcohol, 8 oz. ; turmeric, 4 drs. ; hay saffron, 2 scruples ; dragon's blood, 1½ scruples ; red sanders, 1 scruple ; shellac, 1 oz. ; gum sandarach, 2 drs. ; gum mastic, 2 drs. ; Canada balsam, 2 drs. ; when dissolved, add spirits of turpentine, 80 drops.

*Red Lacquer for Brass.*—Alcohol, 8 gals. ; dragon's blood, 4 lbs. ; Spanish annotto, 12 lbs. ; gum sandarach, 13 lbs. ; turpentine, 1 gal.

*Pale Lacquer for Brass.*—Alcohol, 2 gals. ; Cape aloes, cut small, 3 oz. ; pale shellac, 1 lb. ; gamboge, 1 oz.

*Best Lacquer for Brass.*—Alcohol, 4 gals. ; shellac, 2 lbs. ; amber gum, 1 lb. ; copal, 20 oz. ; seed-lac, 3 lbs. ; saffron, to color ; pulverized glass, 8 oz.

*Color for Lacquer.*—Alcohol, 1 qt. ; annotto, 4 ozs.

*Lacquer for Philo-sophical Instruments.*—Alcohol, 80 oz. ; gum gutta, 3 ozs. ; gum sandarach, 8 oz. ; gum elemi, 8 oz. ; dragon's blood, 4 oz. ; seed-lac, 4 oz. ; terra merita, 3 oz. ; saffron, 8 grs. ; pulverized glass, 12 oz.

*Soap Lacquers.*—Soap lacquer possesses several properties

making it valuable for certain purposes. It can be prepared very cheaply, remains entirely unchanged in water, and has a considerable degree of elasticity. The simplest method of preparation is as follows: Boil good tallow soap in rain water, so that a clear solution is formed, and filter this, while still hot, through several close cloths. Then again heat the solution and dilute with an equal volume of rain water. Next add a boiling-hot solution of alum as long as a precipitate is formed. This precipitate is allowed to settle, the supernatant fluid is then poured off and the precipitate washed several times with boiling water. It is then dried and heated in a pot standing in a vessel filled with boiling water, until it becomes transparent. To prepare lacquer heat oil of turpentine in a pot nearly to the boiling-point, and add a sufficient quantity of the prepared precipitate to form a solution of the consistency of thick varnish. Should this prove too viscid when cold, it can be readily reduced by adding hot oil of turpentine.

Articles coated with this lacquer should be placed near a hot stove, so that they will dry quickly. The lacquer is not acted upon by water, and, as it is perfectly flexible, can be advantageously used for many purposes.

Another mode of preparation is as follows: Dissolve green vitriol in water, add to this a solution of soap, and collect the precipitate formed. When dry, dissolve the precipitate in sulphide of carbon or benzine, so as to form a fluid of the consistency of varnish.

*Imitation of Japanese Lacquer.*—Take 90 parts of oil of turpentine and 120 of oil of lavender, and after freeing it from any water which may be present by adding a small quantity of calcined calcium chloride, and then carefully pouring off the oil, combine it in a bottle with 2 parts of camphor and 30 parts of copal. Place the bottle for 24 hours in hot ashes, shaking it occasionally, and finally filter the contents through a cloth. The filtrate is again

allowed to stand for 24 hours, when the clear, supernatant fluid is poured off from the sediment.

### MISCELLANEOUS CEMENTS.

*Armenian or Diamond Cement.*—This article, so much esteemed for uniting pieces of broken glass, for repairing precious stones, and for cementing them to watch cases and other ornaments, is made by soaking isinglass in water until it becomes quite soft, and then mixing it with spirit in which a little gum mastic and ammoniac have been dissolved.

The jewellers of Turkey, who are mostly Armenians, have a singular method of ornamenting watch cases, etc., with diamonds and other precious stones, by simply gluing or cementing them on. The stone is set in silver or gold, and the lower part of the metal made flat, or to correspond to the part to which it is to be fixed; it is then warmed gently, and has the glue applied, which is so very strong that the parts so cemented never separate. This glue, which will strongly unite bits of glass, and even polished steel, and may be applied to a variety of useful purposes, is thus made in Turkey:

Dissolve five or six bits of gum mastic, each the size of a large pea, in as much spirits of wine as will suffice to render it liquid; and in another vessel dissolve as much isinglass, previously a little softened in water (though none of the water must be used), in French brandy or good rum, as will make a two-ounce vial of very strong glue, adding two small bits of gum albanum, or ammoniac, which must be rubbed or ground till they are dissolved. Then mix the whole with a sufficient heat. Keep the glue in a vial closely stoppered, and when it is to be used, set the vial in boiling water. A composition under the name of Armenian cement has been made and sold; but this

composition is badly made ; it is much too thin, and the quantity of mastic is much too small.

The following are good proportions : Isinglass, soaked in water and dissolved in spirit, two ounces (thick) ; dissolve in this ten grains of very pale gum ammoniac (in tears), by rubbing them together ; then add six large tears of gum mastic, dissolved in the least possible quantity of rectified spirit.

Isinglass, dissolved in proof spirit, as above, three ounces ; bottoms of mastic varnish (thick but clear), one and a half ounces ; mix well.

When carefully made, this cement resists moisture, and dries colorless. As usually met with, it is not only of a very bad quality, but sold at exorbitant prices.

*Cement for Mending Earthen and Glassware.*—1. Heat the article to be mended to little above boiling-water heat, then apply a thin coating of gum shellac on both surfaces of the broken vessel, and when cold it will be as strong as it was originally. 2. Dissolve gum shellac in alcohol, apply the solution, and bind the parts firmly together until the cement is perfectly dry.

*Cement for Stoneware.*—Another cement in which an analogous substance, the curd or caseine of milk, is employed, is made by boiling slices of skim-milk cheese into a gluey consistence in a great quantity of water, and then incorporating it with quicklime on a slab with a muller, or in a marble mortar. When this compound is applied warm to broken edges of stoneware, it unites them very firmly after it is cold.

*Iron-rust Cement.*—The iron-rust cement is made of from 50 to 100 parts of iron borings, pounded and sifted, mixed with 1 part of sal-ammoniac, and when it is to be applied moistened with as much water as will give it a pasty consistency. Formerly flowers of sulphur were used, and much more sal-ammoniac in making this cement, but with no de-



cided advantage, as the union is effected by oxidation, consequent expansion and solidification of the iron powder, and any heterogeneous matter obstructs the effect. The best proportion of sal-ammoniac is, I believe, one per cent. of the iron borings. Another composition of the same kind is made by mixing 4 parts of fine borings or filings of iron, 2 parts of potters' clay, and 1 part of pounded potsherds, and making them into a paste with salt and water. When this cement is allowed to concrete slowly on iron joints, it becomes very hard.

*For making Architectural Ornaments in Relief.*—For making architectural ornaments in relief, a moulding composition is formed of chalk, glue and paper paste. Even statues have been made with it, the paper aiding the cohesion of the mass.

Mastics of a resinous or bituminous nature, which must be softened or fused by heat, are the following:

*Varley's Mastic.*—Mr. S. Varley's consists of 16 parts of whiting sifted and thoroughly dried by a red heat, adding when cold a melted mixture of 16 parts of black rosin and 1 of beeswax, and stirring well during the cooling.

*Electrical and Chemical Apparatus Cement.*—Electrical and chemical apparatus cement consists of 5 lbs. of rosin, 1 of beeswax, 1 of red ochre, and 2 tablespoonfuls of Paris plaster, all melted together. A cheaper one for cementing voltaic plates into wooden troughs, is made with 6 pounds of rosin, 1 pound of red ochre, half a pound of plaster of Paris, and one-quarter of a pound of linseed oil. The ochre and the plaster of Paris should be calcined beforehand, and added to the other ingredients in their melted state. The thinner the stratum of cement that is interposed, the stronger, generally speaking, is the junction.

*Cement for Iron Tubes, Boilers, etc.*—Finely powdered iron 66 parts, sal-ammoniac 1 part, water a sufficient quantity to form into paste.

*Cement for Ivory, Mother of Pearl, etc.*—Dissolve one part of isinglass and two of white glue in thirty of water; strain and evaporate to six parts. Add one-thirtieth part of gum mastic, dissolved in half a part of alcohol, and one part of white zinc. When required for use, warm and shake up.

*Cement for Holes in Castings.*—The best cement for this purpose is made by mixing one part of sulphur in powder, two parts of sal-ammoniac, and eighty parts of clean, powdered iron turnings. Sufficient water must be added to make it into a thick paste, which should be pressed into the holes or seams which are to be filled up. The ingredients composing this cement should be kept separate, and not mixed until required for use. It is to be applied cold, and the casting should not be used for two or three days afterwards.

*Cement for Coppersmiths and Engineers.*—Boiled linseed oil and red lead, mixed together into a putty, are often used by coppersmiths and engineers to secure joints. The washers of leather or cloth are smeared with this mixture in a pasty state.

*A Cheap Cement.*—Melted brimstone, either alone or mixed with rosin and brick dust, forms a tolerably good and very cheap cement.

*Plumbers' Cement.*—Plumbers' cement consists of black rosin one part, brick dust two parts, well incorporated by a melting heat.

*Cement for Bottle Corks.*—The bituminous or black cement for bottle corks, consists of pitch hardened by the addition of rosin and brick dust.

*China Cement.*—Take the curd of milk, dried and powdered, ten ounces; quicklime one ounce, camphor two drachms. Mix and keep in closely stoppered bottles. For use, a portion is to be mixed with a little water into a paste, to be applied quickly.

*Cement for Stone Structures.*—The repairs of some of the most important stone structures in Paris, including the Pont Neuf, the Colonnade of the Louvre, and that of the Conservatoire des Arts et Metiers, have, it is said, been carried out with a cement by Prof. Brune. This is made from 2 parts (by weight) of oxide of zinc, 2 of crushed limestone and 1 of crushed grit, mixed and ground together into a powder. To this is added a liquid consisting of a saturated solution of zinc chloride, to which is added an amount of ammonium chloride equal to one-sixth of the zinc. The liquid is then diluted with two-thirds its bulk of water, and one pound of the powder is mixed with two and a half pints of the above liquid.

*Roofing Cement.*—Mix ordinary red oxide of iron and boiled linseed oil so as to form a paint; add to every quart one gill of Japan dryer; then add equal parts of Roman water lime and Venetian red, until the mixture is as thick as desired for the work to be done. This cement will be found very useful for flashings, or for repairing leaky roofs, as it dries quickly and can be applied by means of a small brush to leaks on a standing seam roof, where it would be impossible to solder. It is also useful for repairing cracked seams, where the tin has become too rusty to be soldered.

*Ammonia Shellac Cement.*—The annoyance often experienced by the impossibility or imperfection of an air-tight connection in using rubber plates and rings for making connections between steam and other pipes and apparatus, is entirely obviated by employing a cement which fastens alike well to the rubber and to the metal or wood. Such cement is prepared by a solution of shellac in ammonia. This is best made by soaking pulverized gum shellac in ten times its weight of strong ammonia, when a slimy mass is obtained, which in three to four weeks will become liquid without the use of hot water. This softens the rubber, and

becomes, after the volatilization of the ammonia, hard and impermeable to gases and fluids.

*Cement for Leather.*—A mixture of India rubber and shellac varnish makes a very adhesive leather cement. A strong solution of common isinglass, with a little diluted alcohol added to it, makes an excellent cement for leather.

*Marble Cement.*—Take plaster of Paris and soak it in a saturated solution of alum; then bake the two in an oven, the same as gypsum is baked to make it plaster of Paris; after which they are ground to powder. It is then used as wanted, being mixed up with water, like plaster, and applied. It sets into a very hard composition capable of taking a very high polish. It may be mixed with various coloring minerals to produce a cement of any color capable of imitating marble.

*A Good Cement.*—Shellac dissolved in alcohol, or in a solution of borax, forms a pretty good cement.

*Cement for Marble-workers and Coppersmiths.*—White of egg alone, or mixed with finely sifted quicklime, will answer for uniting objects which are not exposed to moisture. The latter combination is very strong, and is much employed for joining pieces of spar and marble ornaments. A similar composition is used by coppersmiths to secure the edges and rivets of boilers—only bullock's blood is the albuminous matter used instead of white of egg.

*Transparent Cement for Glass.*—Dissolve one part of India rubber in 64 of chloroform; then add gum mastic in powder 14 to 24 parts, and digest for two days with frequent shaking. Apply with a camel-hair brush.

*Cement to Mend Iron Pots and Pans.*—Take two parts of sulphur and one part (by weight) of fine black lead; put the sulphur in an old iron pan, holding it over the fire until it begins to melt; then add the lead; stir well until all is mixed and melted; then pour out on an iron plate, or smooth stone. When cool, break into small pieces. A

sufficient quantity of this compound being placed upon the crack of the iron pot to be mended, can be soldered by a hot iron in the same way as a tinsmith solders his sheets. If there is a small hole in the pot, drive a copper rivet in it and then solder over it with this cement.

*Cement to Render Cisterns and Casks Water-tight.*—An excellent cement for resisting moisture is made by incorporating thoroughly eight parts of melted glue, of the consistence used by carpenters, with four parts of linseed oil, boiled into varnish with litharge. This cement hardens in about forty-eight hours, and renders the joints of wooden cisterns and casks air and water tight. A compound of glue with one-fourth its weight of Venice turpentine, made as above, serves to cement glass, metal and wood, to one another. Fresh-made cheese curd and old skim-milk cheese, boiled in water to a slimy consistence, dissolved in a solution of bicarbonate of potash, are said to form a good cement for glass and porcelain. The gluten of wheat, well prepared, is also a good cement. White of eggs, with flour and water, well mixed, and smeared over linen cloth, forms a ready lute for steam joints in small apparatus.

*Cement for Repairing Fractured Bodies of all Kinds.*—White lead ground upon a slab with linseed oil varnish, and kept from contact with the air, affords a cement capable of repairing fractured bodies of all kinds. It requires a few weeks to harden. When stone or iron is to be cemented together, a compound of equal parts of sulphur with pitch answers very well.

*Cement for Cracks in Wood.*—Make a paste of slacked lime one part, rye meal two parts, with a sufficient quantity of linseed oil. Or, dissolve one part of glue in sixteen parts of water, and when almost cool stir in sawdust and prepared chalk a sufficient quantity; or, oil varnish,

thickened with a mixture of equal parts of white lead, red lead, litharge and chalk.

*Cement for Joining Metals and Wood.*—Melt rosin and stir in calcined plaster until reduced to a paste, to which add boiled oil a sufficient quantity to bring it to the consistence of honey; apply warm. Or, melt rosin 180 parts, and stir in burnt umber 30, calcined plaster 15, and boiled oil 8 parts.

*Gasfitters' Cement.*—Mix together, resin four and one-half parts, wax one part, and Venetian red three parts.

*Impervious Cement for Apparatus, Corks, etc.*—Zinc white rubbed up with copal varnish to fill up the indentures; when dry, to be covered with the same mass, somewhat thinner, and lastly, with copal varnish alone.

*Cement for Fastening Brass to Glass Vessels.*—Melt rosin 150 parts, wax 30, and add burnt ochre 30, and calcined plaster 2 parts. Apply warm.

*Cement for Fastening Blades, Files, etc.*—Shellac two parts, prepared chalk one, powdered and mixed. The opening for the blade is filled with this powder, the lower end of the iron heated and pressed in.

*Hydraulic Cement Paint.*—If hydraulic cement be mixed with oil, it forms a first-rate anti-combustible and excellent water-proof paint for roofs of buildings, outhouses, walls, etc.

*Sorel's Cement* is obtained by mixing oxide of zinc with a concentrated solution of zinc chloride. This cement is very hard and not readily attacked by acids.

*Sorel's Magnesia Cement* is obtained by mixing a concentrated solution of magnesium chloride with calcined magnesia. In using the cement, sand, silica, barium sulphate, etc., are frequently added. It is very hard and almost insoluble in water.

*London Mastic Cement* is a mixture of 35 parts of quartz sand with 62 of pulverized limestone or sandstone and 3

of litharge. The mixture is made into a paste by kneading with seven parts of linseed oil. In one month the mass becomes so hard that it throws out sparks when struck with a steel.

*Keene's Marble Cement* consists of gypsum burnt and ground, which previous to burning has been moistened with alum solution. For use it is made into a paste with alum solution.

*Martin's Cement* is a solution of alum and potassium carbonate made into a paste with strongly-burnt gypsum.

*Parian Cement* consists of gypsum saturated with borax solution (1 part borax to 11 water). The gypsum is to be thoroughly burnt and after grinding made into a paste with solution of tartar (1 part tartar to 11 water).

*Lowitz's Cement for the Protection of Wood and Stone against Moisture* is a mixture of 65 parts of chalk, 34 of colophony, 1 of oil of turpentine, to which, after melting together, add 200 parts of sand and 8 of coal tar.

## IMPORTANT METALLIC ALLOYS.

Most metals are capable of existing in a state of combination with each other in every proportion, or at least in definite proportions, and thus form alloys. The melting-point of an alloy is, as a rule, lower than that of its separate constituents. Many alloys possess the characteristics of a mixture and the mean properties of their constituent metals, while others approach chemical combinations and partly show other properties than their components. The formation of actual chemical compounds, in some cases, when two metals are melted together, is indicated by several phenomena, viz.: The evolution of heat, as in the case of platinum and tin, copper and zinc, etc. In the solidification of alloys, the temperature does not always fall uniformly, but often remains stationary at particular

degrees, which may be regarded as the solidifying points of the compounds then crystallizing. Tin and lead melted together in any proportion always form a compound which solidifies at 187° Fahrenheit.

Generally speaking, alloys are more readily destroyed by external influences than the pure metals, though there are exceptions to this rule.

Many alloys, when in a melted state and slowly cooling, successively separate definite combinations, which frequently are crystalline and show a different chemical combination; technically, such a separation is called *liquation*.

*Alloys of Copper and Zinc—Brass and Similar Alloys.*—Brass is an alloy of copper and zinc in quite varying proportions. Ordinary brass contains from 18 to 50 per cent. of zinc (on an average, 1 part of zinc to 2 of copper). With a higher content of copper, the alloy acquires a reddish color, and is then called tombac. Tombac contains at the utmost 18 per cent. of zinc, and is chiefly used where great ductility, flexibility and moderate hardness are required: or instance, for fine works of wire and sheet, and where a reddish color is desired, as in articles which are to be gilded. For most technical purposes, however, brass more rich in zinc is used, because it is cheaper, and besides, fuses more readily. Brass for the manufacture of ordinary, coarser articles, consists generally of very zinciferous, and therefore cheap, alloys, which, moreover, are frequently prepared from impure raw materials. On the other hand, brass for sheet and wire is made of very pure materials and contains somewhat less zinc than ordinary brass—generally 25 to 35 per cent., and only exceptionally up to 37 per cent. Besides copper and zinc, brass frequently contains small quantities of other metals (tin, lead, iron), which are seldom intentionally added, but are generally contained in the metals used. With brass are classed a number of copper-zinc alloys (Aich-metal, Muntz-metal,



oreide, etc.), which are prepared for certain purposes. The composition of these alloys is given below.

The color of copper-zinc alloys varies according to the content of zinc, as shown in the following table:

*Color of Copper-zinc Alloys.*

Content of Zinc.	Color.	Content of Zinc.	Color.
5 per cent....	Red.	35 per cent....	Deep-yellow.
10 " ....	Red-brownish.	38 " ....	Deep-yellow.
16 " ....	Red-yellow.	41 " ....	Reddish-yellow.
20 " ....	Reddish-yellow.	50 " ....	Golden-yellow.
22 " ....	Reddish-yellow.	60 " ....	Bismuth-gray.
25 " ....	Pale-yellow.	70 " ....	Antimony-gray.
27 " ....	Yellow.	80 " ....	Zinc-gray.
30 " ..	Yellow.	90 " ....	Zinc-gray.

*Composition of Various Copper-zinc Alloys.*

Name.	Copper.	Zinc.	Tin.	Lead.	Various metals.
Tombac, English.....	86.4	13.6			
Tombac, Nüremberg.....	84.6	15.4			
Chrysochalk.....	90	7.9		1.6	
Tombac, resembling gold...	89.97	9.96	0.05		
Tombac, for buttons.....	99.15	0.85			
Pinchbeck.....	93.6	6.4			
Oreide, resembling gold....	90	10			
Talmi-gold*.....	86.4	12.2	1.1		0.3 iron.
Manheim gold, or similor..	89.44	9.93	0.62		
Muntz-metal or yellow-metal.	60	40			
Aich, or sterro-metal, malleable in the heat.....	60	38.2			1.8 iron.
Chryсорin.....	72	28			
Sterling-metal..	66.2	33.1			0.7 iron.
Prince-metal or Bristol-metal.	75.5	24.5			
Mosaic gold.....	65.3	34.7			

\* Genuine Talmi-gold consists of plated sheet-tombac; it contains about 1 per cent of gold.

*Alloys of Copper and Tin.*—*Bronze* is an alloy of copper and tin, with or without the addition of other metals, it being generally composed of 73 to 92 per cent. of copper, and 6.7 to 26.7 per cent. of tin. It is used for statues, ornamentations, etc. By quenching in cold water bronze becomes ductile. By frequent melting and subsequent slow cooling the tin liquates.

*Gun-metal* contains on an average 90 to 91 per cent. of copper and 9 to 10 per cent. of tin, and sometimes a small quantity of lead and zinc. In cooling the melted alloy, liquation takes place, a more readily fluid, very hard alloy, richer in tin, separating from a tougher alloy, poorer in tin. This inclination of the alloy towards liquation is very injurious in casting.

*Steel-bronze or Uchatius-bronze* contains 8 per cent. of tin, and is chiefly used for ordnance. In casting, a copper rod about  $1\frac{3}{4}$  inches in diameter is set as a core in the centre of the thick iron mould. This conductor serves as a conductor of heat, the same as the chill in chilled castings, and is later on removed by drilling. The alloy is crystalline and has a golden-yellow color. To increase the strength, steel bolts varying in diameter from 0.39 to 1.95 inch are forced into the bored barrel by means of a hydraulic press.

*Bell-metal* consists on an average of 78 per cent. copper and 22 per cent. tin.

*Speculum-metal* contains on an average 30 to 35 per cent. tin, and 64 to 69 per cent. copper. To increase the white color, a small quantity of arsenic or antimony is sometimes added.

*Art-bronze*, as at present used for monuments, etc., contains on an average 86.6 per cent. of copper, 6.6 per cent. of tin, 3.3 per cent. of lead and 3.3 per cent. of zinc. By the action of the air the bronze becomes in time coated with patina.

*Phosphor-bronze* consists of about 90 per cent. of copper, 9 per cent. of tin, and from 0.5 to 0.75 per cent. of phosphorus. With a content of over 5 per cent. of phosphorus the alloy acquires a color similar to gold. The melted metal is very thinly fluid and fills the mould well. By changing the proportions of the constituents the alloy acquires different properties. It can be made as soft as copper, as tenacious as iron, and as hard as steel. The composition of alloys intended for rolling and drawing processes differs from that of alloys for castings. For articles requiring strength, ductility and durability, phosphor-bronze is superior to gun metal and brass. It does not become crystalline by shocks, nor does it break when repeatedly bent. It is employed for many purposes, chiefly for wire, tubes, art castings, ships' screws, cylinders, valves, bearings, and as anti-friction metal.

*Silicon bronze* is a combination of copper with silicon. Its breaking strength is as great as that of phosphor-bronze, and it possesses besides greater power of conducting electricity. It is principally used for telephone and telegraph wires, the composition of wires as manufactured by Lazare Weilers, of Angoulême, France, being as follows:

*Silicon telephone wire, A*: Copper, 99.94 per cent. ; tin, 0.03 ; silicon, 0.02 ; iron, a trace.

*Silicon telegraph wire, A*: Copper, 97.12 per cent. ; tin, 1.14 ; silicon, 0.05 ; zinc, 1.62 ; iron, a trace.

*Manganese bronze* is prepared by addition of ferro-manganese either to copper alone or to copper and zinc, or, finally, to copper, zinc and tin. The Bronze Company, in England, manufactures five varieties: In quality I, the zinc added to the copper preponderates considerably over the tin ; quality II very much resembles the mixture of quality I, the principal difference being that the materials are melted in the crucible. Quality III is made of copper and tin in the proportion customary for gun metal (83 to

82 parts of copper, 17 to 18 of tin), to which a quantity of ferro-manganese is added.

*Delta metal* is an alloy of zinc, iron and copper, to which during fusing phosphorus and, according to the desired properties, tin, manganese and lead are added. It has the color of a gold-silver alloy, and can be worked cold as well as warm; it is not weldable, but with some care can be soldered, and does not rust. On account of its great strength it is used as a substitute for steel in torpedoes, bicycles, ships' cables, in the construction of steam vessels, etc. The following table shows some compositions of Delta metal:

	Cast, per cent.	Wrought, per cent.	Rolled, per cent.	Hot Punched, per cent.
Copper.....	55.94	55.80	55.82	54.22
Lead.....	0.72	1.82	0.76	1.10
Iron .....	0.87	1.28	0.86	0.99
Manganese.....	0.81	0.96	1.38	1.09
Zinc .....	41.61	40.07	41.41	42.25
Nickel.....	trace.	trace.	0.06	0.16
Phosphorus.....	0.013	0.011	trace.	0.02
	99.963	99.941	100.29	99.83

*Silveroid* consists of copper and nickel, to which, according to the purpose for which it is intended, zinc, tin and lead are added. The alloy is very white, lustrous, fine-grained and of great strength; it is employed as a substitute for gun metal and brass where lustrous color and polish are required.

*Cobalt bronze* is still more lustrous than silveroid, but also more expensive. The alloy contains only a small quantity of cobalt. On account of its taking a very fine

polish, and its hardness and strength, it is used in the manufacture of fine ornamental articles and instruments.

*Aluminium bronze* is an alloy of aluminium and copper. It comes into commerce in various qualities, the usual alloys being those containing 1, 2, 5, 7.5 and 10 per cent. of aluminium. The 5 per cent. bronze is golden in color, polishes well, casts beautifully, is very malleable cold or hot, and has great strength, especially after hammering. The 7.5 per cent. bronze has a peculiar greenish-gold color, which makes it very suitable for decoration. All these good qualities are possessed by the 10 per cent. bronze. It is bright-golden, keeps its polish in the air, may be easily engraved, shows a greater elasticity than steel, and can be soldered with hard solder.

Aluminium bronze is, in every respect, considered the best bronze yet known. Its high cost alone prevents its extensive use, but since the perfection of the reduction of aluminium by electric furnaces, the cost of manufacture has been greatly reduced, and promises to be still lower in the near future. For making small quantities of aluminium bronze the following directions are given: Melt the copper in a plumbago crucible, and heat it somewhat hotter than its melting-point. When quite fluid and the surface clean, sticks of aluminium of a suitable size are taken in tongs and pushed down under the surface, thus protecting the aluminium from oxidation. The first effect is necessarily to chill the copper more or less in contact with the aluminium; but if the copper was at a good heat to start with, the chilled part is speedily dissolved and the aluminium attacked. The chemical action of the aluminium is then shown by a rise of temperature which may even reach a white heat. Considerable commotion may take place at first, but this gradually subsides. When the required amount of aluminium has been introduced, the bronze is let stand for a few minutes, and then well stirred, taking

care not to rub or scrape the sides of the crucible. By the stirring, the slag—which commences to rise even during the alloying—is brought almost entirely to the surface. The crucible is then taken out of the furnace, the slag removed with a skimmer, the melted metal again stirred to bring up what little slag still remains in it, and is then ready for casting. It is very injurious to leave it longer in the fire than is absolutely necessary. No flux is necessary, the bronze needing only to be covered with charcoal powder. The particular point to be attended to in melting these bronzes is to handle as quickly as possible when once melted. As with ordinary brass and bronze, two or three remeltings are needed before the combination of the metal appears to be perfect and the bronze takes on its best qualities.

*Alloys of Copper, Zinc and Nickel, German Silver, Argentan or Pakfong.*—The composition of German silver varies within the following limits: Copper, 50 to 66 per cent.; zinc, 19 to 31; nickel, 13 to 18.5.

*a. Ordinary German Silver:* Copper, 8 parts; zinc, 3.5; nickel, 2; yellow, used for ordinary articles, wire, etc.

*b. White German Silver:* Copper, 8; zinc, 3.5; nickel, 3; color, white.

*c. Electrum:* Copper, 8; zinc, 3.5; nickel, 4; takes a very high polish and very much resembles silver.

*d. Tutenag (Pakfong):* Copper, 8; zinc, 6.5; nickel, 3.

German silver, being less attacked by acid fluids than brass or copper, is much used for forks and spoons, and other household utensils. Tested by the touchstone, German silver can only be distinguished from genuine silver by its streak being more rapidly dissolved on moistening with nitric acid.

*Britannia Metal* is an alloy of tin 65 to 97 per cent., antimony 1 to 24, copper 1 to 5. It is of a silver-white

color and is used for coffee-pots, tea-pots, etc. By polishing, the alloy acquires great lustre. It can be rolled out into thin sheets, tarnishes but slightly on exposure to the air, and is less attacked by organic acids than tin. The melting-point of an alloy with 10 per cent. antimony is 456.8° Fahr., and with 18 per cent. antimony 482° F. Its specific gravity is the higher the greater the content of tin, an alloy of 97.9 per cent. tin and 2.1 per cent. antimony having a specific gravity of 7.279, and one of 74 per cent. tin and 26 per cent. antimony only one of 7.100.

*Composition of Various Kinds of Britannia Metal.*

	Contents in per cent.			
	Tin.	Antimony.	Copper.	Zinc .
Britannia sheet.....	92.0	6	2	
Britannia sheet (Birmingham)	91.5	7	1.4	
Britannia metal, for spoons..	88.4	8.7	2.9	
Britannia metal, cast.....	90.71	9.20	0.09	
Britannia metal, for turning..	93.7	3.8	2.5	2.9

*Readily Fusible Alloys.*

	Bismuth.	Lead.	Tin.	Cadmium.	Melting-point, degrees Fahr.
Rose's metal.....	2	1	1		200.6
Rose's alloy, according to W. Spring.....	7	1	6		194.3
Wood's alloy, according to W. Spring.....	4	2	2	2	149 to 158
Lipowitz's alloy, according to W. Spring.....	11	6	5	4	176 to 185

*Alloys of the Noble Metals.*—*Gold* is alloyed with copper or silver, or with both metals. *Silver* is always alloyed with copper.

*Various Alloys.*—Copper and silver, in equal parts, with 2 per cent. of arsenic, form an alloy similar to silver, with the exception of being a little harder, although of almost equal tenacity and malleability.

Antimony imparts a beautiful red color to copper, varying from a rose-red where much antimony is added, to a crimson or violent tinge with smaller quantities of antimony.

*Yellow Brass for Turning.*—Copper, 20 lbs.  $\frac{1}{2}$ ; zinc, 10 lbs.; lead, from 1 to 5 oz. Put in the lead last, before pouring out.

*Red Brass for Turning.*—Copper, 24 lbs.; zinc, 5 lbs.; lead, 8 oz. Put in the lead last, before pouring out. *Or*, copper, 32 lbs.; zinc, 10 lbs.; lead, 1 lb.

*Red Brass to Turn Freely.*—Copper, 160 lbs.; zinc, 150 lbs.; lead, 10 lbs.; antimony, 44 oz.

*Best Red Brass for Fine Castings.*—Copper, 24 lbs.; zinc, 5 lbs.; bismuth, 1 oz. Put in the bismuth last, before pouring out.

*Rolled Brass.*—Copper, 32; zinc, 10; tin, 1.5.

*Hard Brass for Casting.*—Copper, 25; zinc, 2; tin, 4.5.

*Bell Metal.*—*Fine*: Copper, 71; tin, 26; zinc, 2; iron, 1. *For large bells*: Copper, 100 lbs.; tin, 20 to 25 lbs. *For small bells*: Copper, 3 lbs.; tin, 1 lb.

*For Bells of Clocks.*—Copper, 72 parts; tin, 26.56; iron, 1.44.

*For Journal Boxes.*—Copper, 24 lbs.; tin, 24 lbs.; antimony, 8 lbs. Melt the copper first, then add the tin, and lastly the antimony. It should first be run into ingots, then melted and cast in the required form. *Another mixture* is as follows; Copper, 10 lbs.; tin, 1 lb.; zinc, 10 oz.

*Bearing Metals for Locomotives.*—1. Copper, 86 parts;



tin, 14. 2. Copper, 85.25 parts; tin, 127.5; zinc, 2. 3. Copper, 80 parts; tin, 16; lead, 2; antimony, 2.

*Brasses for Locomotive Side-rods.*—Copper, 6 lbs.; tin, 1 lb.; to every 100 lbs. of this mixture add one-half lb. each of zinc and lead.

*Brasses for Locomotive Driving-boxes.*—The same as for side-rod brasses, though some prefer harder brasses, and call for 10 lbs of copper, 2 of tin, and 1 lb. each of zinc and lead.

*Queen's Metal.*—Tin, 100 lbs.; regulus of antimony, 8; bismuth, 1; copper, 4.

*Hard White Metal.*—Grain copper, 3 lbs.; tin, 90 lbs.; antimony, 70 lbs.

*Metal for Taking Impressions.*—Lead, 6 lbs.; tin, 4 lbs.; bismuth, 10 lbs.

*Rivet Metal.*—Copper, 4 lbs.; tin, 4 oz.; zinc, 2 oz.

*Rivet Metal for Hose, Belting, etc.*—Copper, 32 lbs.; tin, one-half lb.

*Bullet Metal.*—Lead, 98 parts; arsenic, 2.

*Bath Metal.*—Brass, 32 parts; zinc, 9.

*Cock Metal.*—Copper, 20 lbs.; lead, 8 lbs.; litharge, 1 oz.; antimony, 3 oz.

### White Metals.

Tin.	Lead.	Copper.	Bismuth.	Antimony.	Brass.	Iron.	Zinc.	Mercury.	Alloys.
89		2	2	7					Plate pewter.
75	9		8	8					Queen's metal.
89		2		6	2	1			Britannia metal.
4	1								Pewter.
80				20					Music metal.
50							50		Silver leaf.
90	10								Organ pipes.
100		2	2	8					Best plate pewter.
29	19								Reflector metal.

The last two alloys are used for coating the insides of glass globes and many other similar purposes. A little of the metal is poured into the globe, or other vessel, which, being turned about, receives a thin film of a brilliant, silvery appearance, the excess of metal being poured back into the ladle.

*Expansive Metal.*—Lead, 9 parts; antimony, 2; bismuth, 1. This alloy expands on cooling, and is used for filling small holes or defects in castings.

*Bronze for Gilding.*—This should be fusible at a low temperature, compact and close-grained. Copper, 82.25; zinc, 17.50, and tin, 0.25; gilds well.

*Blanched Copper.*—Fuse 1 lb. of copper and 1 oz. of neutral arsenical salt with a flux made of calcined borax, charcoal dust and powdered glass.

*Ormolu.*—The ormolu of the brass founder, which is an imitation of red gold, is extensively used in ornamenting iron work, as well as in many other branches of artistic trade. It is composed of more copper and less zinc than ordinary brass; it is readily cleaned by acid, and can be easily burnished. To make it more brilliant, it may be brightened up after dipping by means of a scratch-brush. To protect it from tarnish, it should be lacquered.

*Stereotype Metal.*—Tin, 1; antimony, 1; lead, 4 parts.

*Type Metal.*—Lead 9 parts to antimony 1 forms common type metal; lead 7 to 1 of antimony is used for large and soft type; lead 6 and antimony 1 for large type; lead 5 and antimony 1 for middle type; lead 4 and antimony 1 for small type, and lead 3 to antimony 1 for the smallest and hardest kinds of type.

*Artificial Gold.*—Pure copper, 100 parts; zinc (or preferably tin), 17 parts; magnesia, 6 parts; sal-ammoniac, three-sixth part; quicklime, one-eighth part; tartar of commerce, 9 parts; are mixed as follows: The copper is first melted; then the magnesia, sal-ammoniac, lime,

and tartar are added, separately and by degrees, in the form of powder; the whole is now briskly stirred for about half an hour, so as to mix thoroughly; and then the zinc is added in small grains by throwing it on the surface and stirring till it is entirely fused; the crucible is then covered and the fusion maintained for about 35 minutes. The surface is then skimmed and the alloy is ready for casting. It has a fine grain, is malleable and takes a splendid polish. It does not corrode readily, and for many purposes is an excellent substitute for gold. When tarnished, its brilliancy can be restored by a little acidulated water. If tin be employed instead of zinc, the alloy will be more brilliant. It is very much used in France, and must ultimately attain equal popularity here.

## SOLDERS.

The following table gives the composition of soft solders and their melting-points:

Number.	Tin.	Lead.	Deg's Fahr't.	Number.	Tin.	Lead.	Bismuth.	Deg's Fahr't.
1	1	25	558	10	4	1	0	365
2	1	10	541	11	5	1	0	378
3	1	5	511	12	6	1	0	381
4	1	3	482	13	4	4	1	320
5	1	2	441	14	3	3	1	310
6	1	1	370	15	2	2	1	392
7	1½	1	334	16	1	1	1	354
8	2	1	340	17	2	1	2	336
9	3	1	356	18	3	5	8	202

By the addition of 3 parts of mercury to No. 18, it melts at 122° Fahrenheit.

*Hard Solders.*

	Copper.	Zinc.	Silver.	Uses.
Spelter, hardest.....	2	1	0	For iron work, gun metal, etc.
Spelter, hard.....	1½	1	0	For copper and iron.
Spelter, soft.....	1	1	0	For ordinary brass work.
Spelter, finer.....	2	2	0¼	For finer kinds of brass work.
Silver solder.....	1	0	4	{ Hardest, but makes a very neat joint. { Makes a sound joint, but will not burn. { For general use.
Silver solder, hard..	1	0	1	
Silver solder, soft...	1	0	2	

*Solder for Gold.*—Gold, 6 parts; silver, 1; copper, 1.

*White Solder for Raised Britannia Ware.*—Tin, 100 lbs.; copper, 3 oz.; to make it free, add lead, 3 oz.

*Solder for Steel Joints.*—Silver, 19 parts; copper, 1; brass, 2. Melt under a coat of charcoal dust.

*Solders for Aluminium.*—1. Col. Frishmuth, of Philadelphia, recommends a solder of 10 parts of silver, 10 of copper, 20 of aluminium, 60 of tin and 30 of zinc. This solder is especially suitable for ornamental chains, etc. For solder to be used with the ordinary soldering iron, either 95 parts of tin and 5 parts of bismuth, or 97 parts of tin and 3 of bismuth, may be taken, paraffin, stearin, vaseline, copaiba balsam or benzine being in all cases employed as a flux. The articles to be soldered must be thoroughly cleansed, and the parts to be united just sufficiently heated for the solder to adhere to them. 2. Zinc, 80 parts by weight; copper, 8; aluminium, 12. 3. Zinc, 85; copper, 6; aluminium, 9. 4. Zinc, 88; copper, 5; aluminium, 7. 5. Zinc, 90; copper, 4; aluminium, 6. 6. Zinc, 94; copper, 2; aluminium, 4. The solders are prepared as follows: Melt the copper and gradually introduce

the aluminium in three or four portions. The specific gravity of the two metals varying very much, as perfect a union as possible should be brought about by stirring with a clay rod. Immediately after the last portion of aluminium has combined with the copper, add the zinc, throwing at the same time a small quantity of fat or resin into the crucible, and after quickly stirring pour the alloy into iron moulds, previously coated with coal tar, oil or benzine.

The zinc used should be perfectly free from iron, since even a very minute quantity of the latter has an injurious effect upon the strength and fusibility of the alloys.

*Solder for Aluminium Bronze.*—Ordinary soft solder, 2 parts; zinc amalgam, 1; *or*, ordinary soft solder, 4; zinc amalgam, 1; *or*, ordinary soft solder, 8; zinc amalgam, 1. Zinc amalgam is an alloy of zinc and mercury. It is prepared by adding to 2 parts of melted zinc 1 of mercury, and after vigorously stirring, cooling it off as quickly as possible. When cold, it forms a very brittle alloy of a silver-white color.

To prepare the solder for aluminium bronze, melt the ordinary solder, and after adding the finely powdered zinc amalgam, pour the solder at once into the moulds.

*To Solder Platinum.*—Heat the platinum on the place to be soldered to a red heat over a Bunsen burner, and lay a small piece of sheet-platinum upon the crack. For soldering, an oxyhydrogen blow-pipe is required. The flame is so regulated that, before the entrance of the oxygen, it is about  $4\frac{3}{4}$  inches, and that after the admission of the current of oxygen, the inner cone of flame has a length of about 0.31 inch. This flame is gradually brought near the place to be soldered. In the white heat the piece of sheet-platinum placed upon the crack melts to a ball, and soon spreads over the crack, when the flame is to be removed. If necessary, repeat the melting. It is advisable

to protect the eyes by smoked glasses from the light of the dazzling white heat of the platinum.

*Metallic Cement.*—An alloy of copper and mercury, useful when metals are to be soldered together at a low temperature, can be made as follows: From 20 to 30 parts of finely divided copper, obtained by the reduction of oxide of copper with hydrogen; or by precipitating from solution of its sulphate with zinc, are made into a paste with oil of vitriol and 70 parts of mercury added; the whole being well triturated. When amalgamation is complete, the acid is removed by washing with boiling water, and the compound allowed to cool. In ten or twelve hours it becomes sufficiently hard to receive a brilliant polish, and to scratch the surface of tin or gold. To use the alloy for soldering, it is warmed till it is about the consistency of wax, and in this state it is applied to the joint, to which, on cooling, it adheres very firmly.

*To Color Soft Solder.*—The following method for coloring soft solder so that when it is used for uniting brass the colors may be about the same, has been recommended. In making the solutions, care should be had to use glass or earthen dishes. First prepare a saturated solution of sulphate of copper (blue vitriol) in water, and apply some of this on the end of a stick or small brush to the solder. On touching it then with an iron or steel wire it becomes coppered, and by repeating the experiment the deposit may be made thicker and darker. To give the solder a yellow color, mix in part of a saturated solution of sulphate of zinc with two of sulphate of copper; apply this to the coppered spot and rub with a zinc rod. The color may still be improved by applying gilt powder and polishing. On gold jewelry, or colored gold, the solder is first colored yellow, as above described; then a thin coat of gum or isinglass solution is laid on, and bronze powder dusted

over it, making a surface which can be polished smooth and brilliant when the gum is dry.

*To Join Small Band Saws.*—The parts to be joined must be bevelled to a nice fit. Secure the saw at both ends in clamps. See that the edges are parallel, or a short and a long edge will be the result, which will cause the saw to run badly and when strained to break on the short edge. Put on the filed parts a thin coat of borax paste. Cut a piece of very thin sheet-silver solder of the same size as joint to be made, which place between the lap. Take a pair of tongs having suitably-sized jaws for the joint, and that have been heated to a bright red, sufficiently to melt the solder. Scrape all the scale off between the jaws with an old file; hold the joint with the hot tongs until the solder has thoroughly melted; remove the hot tongs carefully, and follow up with another pair heated to a dull red, which will set the solder and prevent the joint from being chilled too suddenly. The joint can then be dressed to thickness of the saw blade. It would be as well to have a pair of cold tongs to clamp the hot jaws firmly to the joint, as the hot iron must fit nicely over the whole width of the saw. In joining, do not make the lap longer than is absolutely necessary; one-half inch is sufficient for scroll saws, and three-quarter inch for saws two to eight inches wide.

*To Make Muriate of Zinc.*—Feed into muriatic acid small pieces of zinc until the mixture ceases to boil, after which dilute with an equal portion of rain or distilled water.

*To Prepare Borax for Brazing.*—Roast the borax until all the moisture is driven off; pulverize and mix with distilled water to a thin paste.

*Soldering Iron and Steel.*—For large and heavy pieces of iron and steel, copper or brass is used. The surfaces to be united are first filed off, in order that they may be clean; they are then bound together with wire, a thin layer of

copper or brass laid along the junction, and the whole covered with a layer (1 inch in thickness) of clay free from sand. After drying, the pieces to be united are brought to a white heat, and then plunged into cold water, in the case of iron being soldered to iron; or allowed slowly to cool if iron be soldered to steel, or steel soldered to steel. The vitrified clay is then broken off. If brass instead of copper is used, it is not necessary to heat so strongly; the former, therefore, recommends itself for steel. Articles of iron and steel of medium size are best united with hard or soft brass solders. In both cases the seams are cleanly filed and spread over with solder and borax, when the soldering seam is heated. *Hard solder* is prepared by melting in a crucible 8 parts of brass, and adding 1 part of previously heated zinc. The crucible is then covered and exposed to a glowing heat for a few minutes; then emptied into a pail with cold water, the water being strongly agitated with a broom. Thus the metal is obtained in small grains or granules. *Soft brass solder* is obtained by melting together 6 parts of brass, 1 of zinc, and 1 of tin. The granulation is carried out as indicated above. Small articles are best soldered with hard silver solder or soft solder. The former is obtained by alloying equal parts of fine silver and soft brass. In fusing, the mass is covered with borax, and, when cold, the metal is beaten out to a thin sheet, of which a sufficiently large and previously annealed piece is placed, with borax, upon the seams to be united and heated. Soft solder differs from hard silver solder only in that it contains one-sixteenth of tin, which is added to it during fusion. Very fine articles of iron and steel are soldered with gold, namely, either with pure gold or hard gold solder. The latter can be obtained by fusion of 1 part gold, 2 parts silver, and 3 copper. Fine steel wire can also be soldered with tin, but the work is not very durable. Hard and soft brass solder



are used for uniting brass to iron and steel, silver solder for silver, hard gold solder for gold.

## JOINTS.

The following are the more important seams or joints used in metal plate work.

Fig. 170 shows the various methods of making joints at

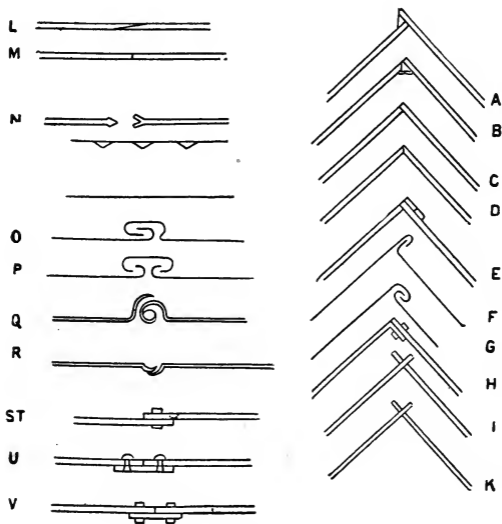

Fig. 170.

angles of sheet-metal. *A* and *B* are for the thinnest metals, such as tin, which require a film of soft solder on one or the other side. Sheet lead is similarly joined, and both are usually soldered from within.

*C* and *D* are the *butt* and *mitre* joints used for thicker metals with hard solders. Sometimes *D* is dovetailed together, the edges being filed to correspond coarsely; sometimes they are partly riveted before being soldered from within. These joints are very weak when united with soft solder.

*E* is the *lap* joint, the metal being creased over the hatchet-stake. Tin plate requires an external layer of solder; spelter solder runs through the crack and does not project.

*F* is folded by means of the hatchet-stake; the two are then hammered together, but require a film of solder to prevent their sliding asunder.

*G* is the *folded angle* joint used for fire-proof deed boxes and other strong work in which solder would be inadmissible. It is common in tin and copper work, but less so in iron and zinc, which do not bend so readily.

*H* is a *riveted* joint, which is very commonly used in strong iron plate and copper work, as in boilers, etc. Generally a rivet is inserted at each end, then the other holes are punched through the two thicknesses. The head of the rivet is put within, the metal is flattened around it, by placing the small hole of a riveting set over the pin of the rivet, and giving a blow; the rivet is then clinched, and is finished to circular form by the concave hollow in the riveting set.

In *IK* one plate is punched with a long mortise, the other being formed into tenons, which are inserted and riveted. *K*, however, has tenons with transverse keys, which can be taken out and the plate released.

Fig. 170 also illustrates straight joints. *L* is the *lap* joint employed with solder for tin-plates, sheet-lead, etc., and for tubes bent of these materials.

*M* is the *butt* joint used for plates and small tubes of the various metals. When united by hard solder or brazed,

such joints are moderately strong, but with soft solder they are very weak from the limited superficies of the adhering surface.

*N* is the *cramp* joint. The edges are thinned by the hammer, the one is left plain, while the other is notched obliquely with shears for one-eighth of an inch deep, each alternate cramp is bent up, the other down, for insertion of the plain edge. They are then hammered together and brazed, after which they may be made nearly flat by the hammer, and quite so by the file. The cramp joint is used for thin work requiring *strength*. Sometimes the lap joint (*L*) is feather-edged. This improves it, but it is still inferior to the cramp joint in strength.

*O* is the lap joint, without solder for tin, copper, iron, etc. It is set down flat with a seam set, and is used for smoke-pipes, and numerous works not required to be steam and water tight.

*P* is used for zinc works and others. It saves the double bend of the preceding. It is sometimes called the "patent strip over lap."

*Q* is the roll joint, used for lead roofs.

*R* is a hollow crease, used till recently for vessels and chambers for making sulphuric acid. The metal is scraped perfectly clean, filled with lead heated nearly to redness, and the whole united by burning with an iron also heated to redness. Solder which contains tin would be attacked by the acid. This method of soldering is now superseded by autogenous soldering.

*ST* are joints united by screw bolts or rivets, for iron and copper boilers, etc.

*U*, united with rivets in ordinary manner of uniting the plates of marine boilers, and other work requiring to be flush externally.

*V* is a similar case, used of late years for constructing the largest iron steam-ships, etc. The ribs of the vessel

are made of T iron, varying from about 4 to 8 inches wide, which is bent to the curves by the employment of very large surface plates cast full of holes, upon which the wood-model of the rib is laid down, and a chalk mark is made around its edge. Dogs or pins are wedged at short intervals in all these holes, which intersect the course. The rib heated to redness in a reverberatory furnace, is wedged fast at one end, and bent around the pins by sets, and sledge-hammers, and as it yields to the curve each pin is secured by wedges until the whole is completed.

#### MISCELLANEOUS RECEIPTS.

*Paint for Coating Wire Work.*—Boil good linseed oil with as much litharge as will make it of the consistency to be laid on with the brush; add lampblack at the rate of one part to every ten, by weight, of the litharge; boil three hours over a gentle fire. The first coat should be thinner than the following coats.

*Razor Paste.*—1. Levigated oxide of tin (prepared putty powder) 1 oz.; powdered oxalic acid  $\frac{1}{4}$  oz.; powdered gum 20 grs.; make it into a stiff paste with water, and evenly and thinly spread it over the strop. With very little friction, this paste gives a fine edge to the razor, and its efficiency is still further increased by moistening it.

2. Emery reduced to an impalpable powder 2 parts; spermaceti ointment 1 part; mix together, and rub it over the strop.

3. Jewellers' rouge, blacklead, and suet, equal parts; mix.

*Cutting Glass.*—To cut bottles, shades, or other glass vessels neatly, heat a rod of iron to redness, and having filled your vessel the exact height you wish it to be cut, with oil of any kind, you proceed very gradually to dip the red hot iron into the oil, which, heating all along the surface, suddenly the glass chips and cracks right round,

when you can lift off the upper portion clean by the surface of the oil.

*Prepared Liquid Glue.*—Take of best white glue 16 oz. ; white lead, dry, 4 oz. ; rain water 2 pts. ; alcohol 4 oz. With constant stirring dissolve the glue and lead in the water by means of a water-bath. Add the alcohol, and continue the heat for a few minutes. Lastly pour into bottles while it is hot.

*Liquid Glues.*—Dissolve 33 parts of best glue on the steam bath in a porcelain vessel, in 36 parts of water. Then add gradually, stirring constantly, 3 parts of aqua fortis, or as much as is sufficient to prevent the glue from hardening when cool. Or dissolve one part of powdered alum in 120 of water, add 120 parts of glue, 10 of acetic acid and 40 of alcohol, and digest.

*Marine Glue.*—Dissolve 4 parts of India rubber in 34 parts of coal tar naphtha—aiding the solution with heat and agitation ; add to it 64 parts of powdered shellac, which must be heated in the mixture, till the whole is dissolved. While the mixture is hot it is poured upon metal plates in sheets like leather. When required for use, it is heated in a pot, till soft, and then applied with a brush to the surfaces to be joined. Two pieces of wood joined with this glue can scarcely be sundered.

*Dextrine, or British Gum.*—Dry potato-starch heated from 300° to 600° until it becomes brown, soluble in cold water, and ceases to turn blue with iodine. Used by calico printers and others, instead of gum arabic.

*A Liquid Glue that Keeps for Years.*—Dissolve 2 pounds good glue in 2 and one-ninth pints hot water ; add gradually 7 oz. nitric acid, and mix well.

An excellent liquid glue is also made by dissolving glue in nitric ether ; this fluid will only dissolve a certain amount of glue, consequently the solution cannot be made too thick. The glue solution obtained has about the consist-

ency of molasses, and is doubly as tenacious as that made with hot water. If a few pieces of caoutchouc, cut into scraps the size of buck-shot, be added, and the solution allowed to stand a few days, being frequently stirred, it will be all the better, and will resist dampness twice as well as glue made with water.

*Sealing-wax for Fruit-cans.*—Beeswax, one-half oz. ; English vermilion,  $1\frac{1}{2}$  oz. ; gum shellac,  $2\frac{1}{2}$  oz. ; rosin, 8 oz. Take some cheap iron vessel that you can always keep for the purpose, and put in the rosin and melt it, and stir in the vermilion. Then add the shellac, slowly, and stir that in, and afterward the beeswax. When wanted for use at any after time, set it upon a slow fire and melt it so you can dip bottle-nozzles in. For any purpose, such as an application to trees, where you want it tougher than the above preparation will make it, add a little more beeswax, and leave out the vermilion.

If the vermilion is left out in the above, the wax will be all the better for it, as it is merely used for coloring purposes.

*Browning Gun Barrels.*—The tincture of iodine diluted with one-half its bulk of water, is a superior liquid for browning gun barrels.

*Silvering Powder for Coating Copper.*—Nitrate of silver, 30 grains ; common salt, 30 grains ; cream of tartar,  $3\frac{1}{2}$  drachms ; mix, moisten with water, and apply.

*To Prevent Rusting.*—Boiled linseed oil will keep polished tools from rusting if it is allowed to dry on them. Common sperm oil will prevent them from rusting for a short period. A coat of copal varnish is frequently applied to polished tools exposed to the weather.

*Quick, Bright Dipping Acid, for Brass which has been Ormolued.*—Sulphuric acid, 1 gal. ; nitric acid, 1 gal.

*Dipping Acid.*—Sulphuric acid, 12 lbs. ; nitric acid, 1 pint ; nitre, 4 lbs. ; soot, 2 handfuls ; brimstone, 2 oz.

Pulverize the brimstone and soak it in water for an hour. Add the nitric acid last.

*Good Dipping Acid, for Cast Brass.*—Sulphuric acid, 1 qt. ; nitre, 1 qt. ; water, 1 qt. A little muriatic acid may be added or omitted.

*Dipping Acid.*—Sulphuric acid, 4 gals. ; nitric acid, 2 gals. ; saturated solution of sulphate of iron (copperas), 1 pt. ; solution of sulphate of copper, 1 qt.

*Ormolu Dipping Acid, for Sheet Brass.*—Sulphuric acid, 2 gals. ; muriatic acid, 1 pt. ; water, 1 pt. ; nitre, 12 lbs. Put in the muriatic acid last, a little at a time, and stir the mixture with a stick.

*Ormolu Dipping Acid, for Sheet or Cast Brass.*—Sulphuric acid, 1 gal. ; sal ammoniac, 1 oz. ; sulphur (in flour), 1 oz. ; blue vitriol, 1 oz. ; saturated solution of zinc in nitric acid, mixed with an equal quantity of sulphuric acid, 1 gal.

*To Prepare Brass Work for Ormolu Dipping.*—If the work is oily, boil it in lye ; and if it is finished work, filed or turned, dip it in old acid, and it is then ready to be ormolued ; but if it is unfinished, and free from oil, pickle it in strong sulphuric acid, dip in pure nitric acid, and then in the old acid, after which it will be ready for ormoluing.

*To Repair Old Nitric Acid Ormolu Dips.*—If the work, after dipping, appears coarse and spotted, add vitriol until it answers the purpose. If the work, after dipping, appears too smooth, add muriatic acid and nitre till it gives the right appearance.

The other ormolu dips should be repaired according to the recipes, putting in the proper ingredients to strengthen them. They should not be allowed to settle, but should be stirred often while using.

*Vinegar Bronze for Brass.*—Vinegar, 10 gals. ; blue

vitriol, 3 lbs. ; muriatic acid, 3 lbs. ; corrosive sublimate, 4 grs. ; sal ammoniac, 2 lbs. ; alum, 8 oz.

*Brown Bronze Dip.*—Iron scales, 1 lb. ; arsenic, 1 oz. ; muriatic acid, 1 lb. ; zinc (solid), 1 oz. Let the zinc be kept in only while it is in use.

*Green Bronze Dip.*—Wine vinegar, 2 qts. ; verditer green, 2 oz. ; sal ammoniac, 1 oz. ; salt, 2 oz. ; alum, one-half oz. ; French berries, 8 oz. ; boil the ingredients together.

*Aquafortis Bronze Dip.*—Nitric acid, 8 oz. ; muriatic acid, 1 qt. ; sal ammoniac, 2 oz. ; alum, 1 oz. ; salt, 2 oz. ; water, 2 gals. Add the salt after boiling the other ingredients, and use it hot.

*Olive Bronze Dip for Brass.*—Nitric acid, 3 oz. ; muriatic acid, 2 oz. ; add titanium or palladium ; when the metal is dissolved, add 2 gals. pure soft water to each pint of the solution.

*Brown Bronze Paint for Copper Vessels.*—Tincture of steel, 4 oz. ; spirits of nitre, 4 oz. ; essence of dendi, 4 oz. ; blue vitriol, 1 oz. ; water, one-half pint. Mix in a bottle. Apply it with a fine brush, the vessel being full of boiling water ; varnish after the application of the bronze.

*Bronze for All Kinds of Metals.*—Muriate of ammonia (sal ammoniac), 4 drachms ; oxalic acid, 1 dr. ; vinegar, 1 pint. Dissolve the oxalic acid first. Let the work be clean. Put on the bronze with a brush, repeating the operation as many times as may be necessary.

*Bronze Paint for Iron or Brass.*—Chrome green, 2 lbs. ivory black, 1 oz. ; chrome yellow, 1 oz. ; good japan, 1 gill. Grind all together and mix with linseed oil.

*To Bronze Gun Barrels.*—Dilute nitric acid with water and rub the gun barrels with it ; lay them by for a few days, then rub them with oil and polish them with beeswax.

*Silvering by Heat.*—Dissolve 1 oz. of silver in nitric acid ; add a small quantity of salt ; then wash it and add



some sal ammoniac, or 6 oz. of salt and white vitriol ; also one-quarter oz. of corrosive sublimate ; rub them together till they form a paste ; rub the piece which is to be silvered with the paste, heat it till the silver runs, after which dip it in a weak vitriol pickle to clean it.

*Mixture for Silvering.*—Dissolve 2 oz. of silver with 3 grains of corrosive sublimate ; add tartaric acid, 4 lbs ; salt, 8 qts.

*To Separate Silver from Copper.*—Mix sulphuric acid, 1 part ; nitric acid, 1 part ; water, 1 part ; boil the metal in the mixture till it is dissolved, and throw in a little salt to cause the silver to precipitate.

*Solvent for Gold.*—Mix equal quantities of nitric and muriatic acids.

*Composition used in Welding Cast Steel.*—Borax, 10 ; sal ammoniac, 1 part. Grind or pound them roughly together ; then fuse them in a metal pot over a clear fire, taking care to continue the heat until all scum has disappeared from the surface. When the liquid appears clear, the composition is ready to be poured out to cool and concrete ; afterwards, being ground to a fine powder, it is ready for use. To use this composition, the steel to be welded is raised to a heat which may be expressed by “bright-yellow.” It is then dipped among the welding powder, and again placed in the fire until it attains the same degree of heat as before. It is then ready to be placed under the hammer.

*Cast-Iron Cement.*—Clean borings, or turnings, of cast iron, 16 ; sal ammoniac, 2 ; flour of sulphur, 1 part. Mix them well together in a mortar and keep them dry. When required for use, take of the mixture 1 ; clean borings, 20 parts. Mix thoroughly and add a sufficient quantity of water. A little grindstone dust added improves the cement.

*Beautiful and Durable Bronze upon Tin and Tin Alloys.*—After carefully cleansing the article from dirt and grease, coat it lightly with a solution of 1 part of sulphate of cop-

per (blue vitriol), and 1 part of copperas, in 20 parts of water, and after drying, with a solution of 1 part of verdigris in 4 of vinegar. After again drying, impart lustre to the article by rubbing with a soft brush dipped at first into jewellers' rouge, and frequently breathing upon it. The places in relief are then rubbed with a piece of soft leather moistened with solution of wax in turpentine, and finally rubbed with a dry leather.

*Bronzing Gas Fixtures.*—Boil the fixture in strong lye and scour it free from all grease or old lacquer. Next pickle it in dilute nitric acid till it is quite clean (not bright); then dip in strong acid, and rinse through four or five waters. Repeat the dipping, if necessary, till it is bright. Next bind it very loose with thin iron wire, and lay it in the strongest of the waters used for rinsing. This will deposit a coat of copper all over it if the water or pickle be not too strong; if such is the case, the copper will only be deposited just round where the wire touches. When the copper is of sufficient thickness, wash the article again in the waters and dry it with a brush in some hot sawdust, boxwood dust being best; but if this cannot be had, oak, ash or beech will do. The fixture is now ready for bronzing. The bronze is a mixture of black lead and red bronze, varied according to the shade required, mixed with boiling water. The work is to be painted over with this, and dried; then brushed until it polishes. If there are any black spots or rings on the work, another coat of the bronze will remove them. Lacquer the work with pale, or but very-little-colored lacquer, for if it is of too deep a color it will soon chip off.

*Another Method* is to mix vinegar or dilute sulphuric acid (1 acid to 12 water) with powdered black lead in a saucer or open vessel. Apply this to the brass with a soft brush by gentle brushing. This will soon assume a polish, and is fit for lacquering. The brass must be made slightly

warmer than for lacquering only. The color, black or green, varies with the thickness of black lead.

*To Bronze Plaster of Paris Figures.*—Lay the figure over with isinglass size, without, however, allowing any part of its surface to become dry. Then, with a brush—such as is termed by painters a sash tool—go over the whole, taking care to remove, while it is yet soft, any part of the size that may lodge on the delicate parts of the figure. When it is dry, take a very little, thin, oil gold size, and with as much as just dampens the brush go over the figure with it, allowing no more to remain than causes it to shine. Set it aside in a dry place free from smoke, and in 48 hours the figure is ready to receive the bronze.

After having touched over the whole figure with the bronze powder, let it stand another day, and then with a soft dry brush rub off all the loose powder, particularly from the more prominent parts.

*To Cleanse Plaster of Paris Busts and Statuettes.*—If it is not desired to bronze or paint them, the figures may be cleansed by dipping them in a thick liquid starch and drying, and when the starch is brushed off, the dirt is brushed off with it.

*Coppering of Iron Rollers for Calico Printing.*—First cleanse the iron cylinders with a concentrated alkaline lye, then wash thoroughly in water and go over the whole surface with the file. The surface is then very bright, and is not to be touched with the finger or soiled with the breath. It is then plunged into an alkaline bath composed of sulphate of copper 1 part, dissolved in water 12 parts; cyanide of potassium, 3 parts; carbonate of soda, 4 parts; sulphate of soda, 2 parts, dissolved in water, 16 parts. Or, ammonia, 3 parts; acetate of copper, 2 parts, dissolved in water 10 parts. The cylinder is allowed to remain 24 hours in one of these baths, subject to the action of a battery of four or six pairs, till the surface is coated with a

slender but firmly-adhering layer of copper. It is washed and cleansed with pumice stone. If, in this operation, the iron should be laid bare in any part, the cylinder must be submitted to the alkaline bath anew. As soon as the coating of copper is uniform, it is washed in acidulated water and immersed in an acid bath of sulphate of copper. This bath is composed of solution of copper at 20° B., to which  $\frac{1}{3}$  of its volume of sulphuric acid is added to facilitate the solution of some metallic copper, which is also immersed in the bath for the purpose of maintaining the solution in a uniform state of concentration. Here the cylinder is left until the layer of copper has attained the desired thickness, a galvanic current being kept up by a battery of four pairs. If the temperature is between 60° and 65° F., three to four weeks are required to produce a deposit of  $\frac{1}{3}$  inch in thickness. The cylinder is turned one-quarter round daily, to change the portion of its surface which faces the sheet of copper used as a positive electrode.

*To Tin Copper and Brass.*—Boil 3 lbs. of cream of tartar, 4 lbs. of granulated tin or tin shavings, and 2 gallons of water. After boiling for a sufficient time, place the articles to be tinned in the mixture, and the boiling being continued, the tin is precipitated in its metallic form.

*To Tin Iron Sauce-pans.*—If the sauce-pan is an old one, it must be put on the fire and allowed to get nearly red hot, which will get rid of all the grease. Then make a pickle of the following proportions: Sulphuric acid, one-quarter lb.; muriatic acid, 2 oz.; water, 1 pt. If the sauce-pan can be filled, so much the better; if not, keep the pickle flowing over it for five minutes; then rinse off with water, scour well with sand or coke dust, and rinse thoroughly with water. If the pan is clean, it will be of a uniform gray color; but if there are any red or black spots, it must be pickled and scoured again until thoroughly

clean. Have ready chloride of zinc, *i. e.*, muriatic acid, in which sheet zinc has been dissolved, some powdered sal ammoniac, about 18 inches of iron rod about one-quarter or three-eighths inch thick, one end flattened out and bent up a little, and filed clean, and some bar tin. Dip a wisp of tow in the chloride of zinc, then into the powdered sal ammoniac, taking up a good quantity, and rub well all over the inside. This must be done directly after the scouring, for, if allowed to stand, it will oxidize. Now put the pan over the fire until it is hot enough to melt tin, and then brush the end of a bar of tin over the heated part until melted. Rub the tin well over the surface with the flattened end of the iron rod. Care should be had not to heat too large a surface at once, nor to let it get too hot, which may be known by the tin getting discolored, when some dry sal ammoniac must be thrown in. Having gone all over it, wipe lightly with a wisp of tow, made just warm enough to prevent the tin from sticking to it. When cold, scour well with sand and tow, rinsing with plenty of water.

*Cold Tinning.*—Block tin dissolved in muriatic acid with a little mercury forms a very good amalgam for cold tinning; or 1 part of tin, 2 of zinc, and 6 of mercury. Mix the tin and mercury together until they form a soft paste. Clean the metal to be tinned, taking care to free it from greasiness. Then rub it with a piece of cloth moistened with muriatic acid and immediately apply a little of the amalgam to the surface, rubbing it with the same rag. The amalgam will adhere to the surface and thoroughly tin it. Cast-iron, wrought-iron, steel and copper may be tinned in this manner. Those who find it difficult to make soft solder adhere to iron with sal ammoniac, will find no difficulty if they first tin the surfaces in this manner, and then proceed as with ordinary tin plate.

*To Tin Small Articles.*—Place them in warm water,

with a little sulphuric acid added to it, which will clean them. Then powder some sal ammoniac, and mix it in the water, stirring vigorously until all is dissolved. After washing the articles in clean water, place them in the solution for a few minutes and then place them near the fire to dry. Procure a pan resembling a frying pan in shape, the bottom of which must be full of small holes. The pot for melting the tin must be large enough to admit the pan for holding the articles. Cover the bottom of the pan with the articles to be tinned, and after sprinkling a little powdered sal ammoniac over the surface of the molten tin to clear it from dross, dip the pan containing the articles into it; after all smoke has disappeared, lift it out and shake well over the pot, sprinkling a little sal ammoniac over the goods to prevent them from having too thick a coat, and then cool them quickly in cold water to keep them bright.

*Galvanizing Brass and Copper.*—Copper and brass may be coated with metallic zinc in the following way: Finely divided zinc, in a non-metallic vessel, is covered with a concentrated solution of sal ammoniac; this is heated to boiling, and the articles of copper or brass, properly cleansed, are introduced. A few minutes then suffice to produce a firm and brilliant coating. The requisite fineness of the zinc is produced by pouring the melted metal into a mortar and triturating it until it solidifies.

*Cheap and Quick Method of Coloring Metals.*—Metals may be colored quickly and cheaply by forming on their surface a coating of a thin film of a sulphide. In 5 minutes brass articles may be coated with any color varying from gold to copper red, then to carmine, dark red, and from light aniline blue to a blue white, like sulphide of lead, and at last a reddish white according to the thickness of the coat, which depends on the length of time the metal remains in the solution used. The colors possess a very good lustre; and if the articles to be colored have

been previously thoroughly cleansed by means of acid and alkalis, they adhere so firmly that they may be operated upon by the polishing steel.

To prepare the solution dissolve  $1\frac{1}{2}$  oz. of hyposulphite of soda in 1 lb. of water, and add  $1\frac{1}{2}$  oz. of acetate of lead, dissolved in half a pound of water. When this clear solution is heated to from  $190^{\circ}$  to  $210^{\circ}$  F., it decomposes slowly and precipitates sulphide of lead in brown flakes. If metal be now present, a part of the sulphide of lead is deposited thereon, and according to the thickness of the deposited sulphide of lead, the above-mentioned colors are produced. To produce an even coloring, the articles must be evenly heated. Iron treated with this solution takes a steel-blue color; zinc a brown color; in the case of copper objects, the first gold color does not appear.

If, instead of the acetate of lead, an equal weight of sulphuric acid is added to the hyposulphite of soda, and the process carried on as before, the brass is covered with a very beautiful red, which is followed by a green (which is not in the first mentioned scale of colors), and changes finally to a splendid brown with green and red iris glitter. This last is a very durable coating. Very beautiful marble designs can be produced by using a lead solution, thickened with gum tragacanth, on brass which has been heated to  $210^{\circ}$  F., and is afterwards treated by the usual solution of sulphide of lead. The solution may be used several times.

*Electroplating Pewter Surfaces.*—Take 1 oz. of nitric acid and drop pieces of copper in it until effervescence ceases; then add one-half oz. of water, and the solution is ready for use. Place a few drops of the solution on the desired surface and touch it with a piece of steel, and there will be a beautiful film of copper deposited. The application may be repeated, if necessary, though once is generally sufficient. The article must now be washed and

immediately placed in the plating bath, when deposition will take place with perfect ease.

*Brown Tint for Iron and Steel.*—Dissolve in 4 parts of water, 2 of crystallized chloride of iron, 2 of chloride of antimony, and 1 of gallic acid, and apply the solution with a sponge or cloth to the article, and dry it in the air. Repeat this any number of times, according to the depth of color which it is desired to produce. Wash with water and dry, and finally rub the articles over with boiled linseed oil. The metal thus receives a brown tint and resists moisture. The chloride of antimony should be as little acid as possible.

*Enamelling Metals.*—Enamel is simply glass, composed of lead and sand. When transparent, oxide of tin renders the transparent glass opaque; mixed with oxide of gold it changes the clear or opaque glass into purple; red is produced by the addition of sulphate of iron; oxide of copper produces green; violet is produced by manganese, and blue by oxide of cobalt.

The enamel is poured from the crucible in which it is melted into flat cakes. These cakes are broken up and reduced to a fine granular condition in a mortar, or to a fine impalpable powder by grinding with a muller on a slab. It is applied on metal which will stand a red heat without changing its form or fusing. Gold, silver, copper, brass or iron can be enamelled. There is no true enamel which has not been fused at a red heat. The modes of application vary. Applied on a flat plate, or plaque, it is worked with a brush. Of this class are the Limoges enamels. Other methods of application consist in incising or cutting small troughs in the surface of the metallic object intended to be enamelled. In these the enamel is placed or applied. This method is called the *champ-levé*. Another method of reproducing is by means of electro-deposition.

The next variety of enamels is the partitioned or *clois-*



*sonné* ; in this variety the cells are formed by bending a flat narrow strip of metal, in such a manner as to constitute the retaining walls. These, after being prepared, are arranged on the object and soldered to it. The various colors of enamel are then applied in the cells, and fired by subjecting the object to be enamelled to the heat of a muffle. Repeated applications of enamel with repeated firings are required to fill the cells. The superfluous enamel is finally removed by grinding it away with pumice stone, and smoothing it with stones of different degrees of fineness. Apart from the labor of forming and placing the minute cells, there are difficulties attending the firing operation. Should one part of the muffle be too hot, and the solder become melted which holds the cells, the colors mingle, and the more so, the more the enamel is in a fluid condition, and a confluent mixture of colors is the result.

*Enamel for Watch Faces.*—The faces are prepared with a backing of sheet-iron, having raised edges to receive the enamel in powder, which is fused. After cooling, the lettering and figuring are printed on the plate with soft black enamel by transferring, the plate being then again placed in a muffle to fuse the enamel of the lettering or figuring. The enamel used is composed of white lead, arsenic, flint glass, saltpetre, borax, and ground flint reduced to powder, fused and formed into cakes and ground up for use.

*To Polish Gold and Silver Lace.*—Treat  $1\frac{1}{2}$  oz. of shellac, half a drachm of dragon's blood, and half a drachm of turmeric root with strong alcohol and decant the ruby-red-colored solution. The objects to be restored or brightened (either gold lace, spangles, clasps or knobs) are then brushed over with some of the color by a camel's-hair brush, and then a hot flat iron is passed over, so that the objects shall only be gently warmed. Gold embroidery is treated in the same manner. Detached gold knobs are

fastened on a stand, brushed over with the color, and then dried over red-hot coals, with the above-mentioned precaution. Silver lace or embroidery is polished with a powder obtained as follows: Alabaster is strongly heated and while hot is placed in corn whiskey. A white powder is obtained, which is gently heated over the flame of a spirit lamp. The powder is placed in a linen bag and the lace, etc., are dusted over with it, and then brushed off.

*Cleaning Tinware.*—Ordinary tinware is made of sheet-iron, coated with tin. Acids should never be employed to clean such articles, because they attack the metal and remove it from the iron. Rub the articles to be cleaned first with rotten stone and sweet oil, then finish with whitening and a piece of soft leather. Articles made of solid tin should be cleaned in the same manner. In a dry atmosphere planished tin will remain bright for a long period, but it soon becomes tarnished in moist air.

*Solvents for Rubber.*—The proper solvents for caoutchouc are ether (free from alcohol), chloroform, bisulphide of carbon, coal naphtha and rectified oil of turpentine. By long boiling in water, rubber softens, swells and becomes more soluble in its peculiar menstruum; but when exposed to the air, it speedily resumes its pristine consistency and volume. Industrially, the ethereal solution of caoutchouc is useless because it contains hardly more than a trace of that substance. Oil of turpentine dissolves caoutchouc only when the oil is very pure and with the application of heat. The ordinary oil of turpentine of commerce causes India rubber to swell rather than to become dissolved. In order to prevent the viscosity of the India rubber when evaporated from its solution, 1 part of caoutchouc is worked up with 2 parts of turpentine into a thin paste, to which is added half a part of a hot concentrated solution of sulphuret of potassium in water; the yellow liquid formed leaves the caoutchouc perfectly elastic and without any viscosity.

The solutions of caoutchouc in coal tar, naphtha and benzine are most suited to unite pieces of caoutchouc, but the odor of the solvents is perceptible for a long time. A chloroform is too expensive for common use, sulphide of carbon is the most usual and also the best solvent for caoutchouc. This solution, owing to the volatility of the menstruum, soon dries, leaving the rubber in its natural state. When alcohol is mixed with sulphide of carbon, the latter does no longer dissolve the caoutchouc, but simply softens it and renders it capable of being more readily vulcanized. Alcohol also precipitates solutions of caoutchouc. When caoutchouc is treated with hot naphtha distilled from native petroleum or coal tar, it swells to thirty times its former bulk; and if then triturated with a pestle and pressed through a sieve, it affords a homogeneous varnish, the same that is used in preparing the patent water-proof cloth of Mackintosh. Caoutchouc dissolves in the fixed oils, such as linseed oil, but the varnish has not the property of becoming concrete on exposure to the air. Caoutchouc melts at a heat of about  $256^{\circ}$  or  $260^{\circ}$  F.; after it has been melted it does not solidify on cooling, but forms a sticky mass which does not become solid even when exposed to the air for months. Owing to this property it forms a valuable material for the lubrication of stop-cocks and joints intended to remain air-tight and yet be movable.

*Etching Solution for Brass.*—Prepare a mixture of 8 parts of nitric acid (of specific gravity 1.40), and furthermore dissolve 3 parts of potassium chlorate in 50 parts of water. Mix the two fluids thus obtained, and use the mixture for etching. For covering the ordinary etching ground is used.

*Compound for Casts.*—A compound said to present a beautiful, semi-transparent white appearance, well suited for forming casts of fancy articles, consists of unbaked

gypsum 2 parts; bleached beeswax 1, and paraffine 1. This compound becomes plastic at a temperature of about 120° F., and articles cast from it retain a certain degree of toughness, owing to the beeswax contained in them.

*Imitation Gold Varnish.*—As a substitute for the expensive “gold varnish” used on ornamental tinware, the following compound has been proposed: Turpentine half a gallon; asphaltum half a gill; yellow aniline 2 ozs.; umber 4 ozs.; turpentine varnish 1 gal., and gamboge half a pound, mixed and boiled for 10 hours. This, it is said, will have as good an effect as the gold varnish, and is very cheap.

*Ink for Marking Tinware.*—A good ink for marking tinware is made by reducing asphalt or black varnish with turpentine to the desired consistency. It is to be kept in a corked bottle. When wanted for use the bottle is shaken, when the cork can be withdrawn and held varnish side up, and the pen filled from the varnish on the cork. The ink is recommended for marking cutlery and other bright articles as well as tinware. It can be removed by means of rag dipped in coal oil or turpentine.

*Another Ink* can be made by reducing shellac varnish with alcohol, and adding a sufficient quantity of the finest lamp black. This forms a jet black, lustreless ink, which is insoluble in water, but can be removed by a drop of alcohol. It should be kept in a tightly corked bottle, and can be reduced at any time by adding alcohol.

The following is recommended for *marking on tin plates*: Mix together without the use of heat, 1 part of pine soot with 60 parts of solution of nitrate of copper in water.

*Red Ink for Rubber Stamps.*—Pour over 45 parts of aniline red 150 parts of boiling water, stir the mixture, and after allowing it to stand for some time, strain off the supernatant clear fluid. To the sediment add as much glycerine as necessary, to give it the desired consistency.

*Ink for Brass Stamps.*—Dissolve 16 parts of aniline (red, blue, etc.) in 80 parts of boiling water, and then add with vigorous stirring 7 parts of glycerine and 3 of molasses.

*Indelible Ink for Stamps.*—Mix intimately 16 parts of linseed oil varnish, 6 of the finest quality of lamp black, and 5 of chloride of iron.

*Resharpening Files.*—Well-worn files are first carefully cleaned with hot water and soda; they are then placed in connection with the positive pole of a battery, in a bath composed of 40 parts of sulphuric acid and 1,000 of water. The negative is formed of a copper spiral surrounding the files, but not touching them; the coil terminates in a wire which rises towards the surface. When the files have been in the bath 10 minutes, they are taken out, washed and dried, when the whole of the hollows will be found to have been attacked in a very sensible manner; but should the effect not be sufficient, they are replaced in the bath for the same period as before. Sometimes two operations are necessary, but seldom more. The files thus treated are to all appearances like new ones, and are said to be good for 60 hours' work. Twelve medium Bunsen elements are employed for the batteries.

*To Repair Broken Belting.*—Broken belting can be reunited by the use of chrome glue. With a lap of 4 or 5 inches, the reunited part is apparently as firm as any part of the band, though it is well to take the precaution to tack down the ends of the lapped pieces with a few stitches of stout thread. The chrome glue is prepared as follows: Take 100 parts glue, soaked 12 hours in water, then pour off the remaining water, melt the glue, add 2 per cent. of glycerine and 3 per cent. of red chromate of potash, melting them with the glue. This mixture, thinned by warming, is applied to the lapped ends after having been roughened with a rasp, and then placed between two hard wood

strips in a vice and well pressed. Leave the lapped ends for 24 hours in the vice to become thoroughly dried.

### STRENGTH OF MATERIALS.

*Bar of Iron.*—The average breaking weight of a bar of wrought iron, 1 inch square, is 25 tons; its elasticity is destroyed, however, by about two-fifths of that weight, or 10 tons. It is extended within the limits of its elasticity, .000096, or one-tenthousandth part of an inch for every ton of strain per square inch of sectional area. Hence, the greatest constant load should never exceed one-fifth of its breaking weight or 5 tons for every square inch of sectional area.

The lateral strength of wrought iron, as compared with cast iron is as 14 to 9. Mr. Barlow finds that wrought iron bars, 3 inches deep, 11.2 inches thick, and 33 inches between the supports, will carry  $4\frac{1}{2}$  tons.

*Bridges.*—The greatest extraneous load on a square foot is about 120 pounds.

*Floors.*—The least load on a square foot is about 160 pounds.

*Roofs.*—Covered with slate, on a square foot,  $51\frac{1}{2}$  pounds.

*Beams.*—When a beam is supported in the middle and loaded at each end, it will bear the same weight as when supported at both ends and loaded in the middle; that is, each end will bear half the weight.

*Cast Iron Beams* should not be loaded to more than one-fifth of their ultimate strength.

The strength of similar *beams* varies inversely as their lengths; that is, if a beam 10 feet long will support 1,000 pounds, a similar beam 20 feet long would support only 500 pounds.

A *beam* supported at one end will sustain only one-fourth part the weight which it would if supported at both ends.

When a *beam* is fixed at both ends, and loaded in the middle, it will bear one-half more than it will when loose at both ends. When the beam is loaded uniformly throughout it will bear double. When the beam is fixed at both ends, and loaded uniformly, it will bear triple the weight.

In any *beam* standing obliquely, or in a sloping direction, its strength or strain will be equal to that of a beam of the same breadth, thickness, and material, but only of the length of the horizontal distance between the points of support.

In the construction of *beams*, it is necessary that their form should be such that they will be equally strong throughout. If a beam be fixed at one end, and loaded at the other, and the breadth uniform throughout its length, then, that the beam may be equally strong throughout, its form must be that of a parabola. This form is generally used in the beams of steam engines.

When a *beam* is regularly diminished towards the points that are least strained, so that all the sections are similar figures, whether it be supported at each end and loaded in the middle, or supported in the middle and loaded at each end, the outline should be a cubic parabola.

When a beam is supported at both ends, and is of the same breadth throughout, then, if the load be uniformly distributed throughout the length of the beam, the line bounding the compressed side should be a semi-ellipse.

The same form should be made use of for the rails of a wagon-way, where they have to resist the pressure of a load rolling over them.

Similar *plates* of the same thickness, either supported at the ends or all round, will carry the same weight, either uniformly distributed or laid on similar points, whatever be their extent.

The lateral strength of any *beam*, or *bar* of *wood*, *stone*, *metal*, *etc.*, is in proportion to its breadth multiplied by

two-thirds of its depth. In square beams the lateral strengths are in proportion to the cubes of the sides, and in general of like-sided beams as the cubes of the similar sides of the section.

The lateral strength of any *beam* or *bar*, one end being fixed in the wall and the other projecting, is inversely as the distance of the weight from the section acted upon; and the strain upon any section is directly as the distance of the weight from that section.

The absolute strength of *ropes* or *bars*, pulled lengthwise, is in proportion to the squares of their diameters. All cylindrical or prismatic rods are equally strong in every part, if they are equally thick; but if not, they will break where the thickness is least.

The strength of a *tube*, or *hollow cylinder*, is to the strength of a solid one as the difference between the fourth powers of the exterior and the interior diameters of the tube, divided by the exterior diameter, is to the cube of the diameter of a solid cylinder—the quantity of matter in each being the same. Hence, from this it will be found, that a hollow cylinder is one-half stronger than a solid one having the same weight of material.

The strength of a column to resist being crushed is directly as the square of the diameter, provided it is not so long as to have a chance of bending. This is true in metals or stone, but in timber the proportion is rather greater than the square.

*Models Proportioned to Machines.*—The relation of models to machines, as to strength, deserves the particular attention of the mechanic. A model may be perfectly proportioned in all its parts as a model; yet the machine, if constructed in the same proportion, will not be sufficiently strong in every part; hence, particular attention should be paid to the kind of strain the different parts are



exposed to; and from the statements which follow, the proper dimensions of the structure may be determined.

If the strain to draw asunder in the model be 1, and if the structure is 8 times larger than the model, then the stress on the structure will be  $8\frac{3}{4}$  equal 512. If the structure is 6 times as large as the model, then the stress on the structure will be  $6\frac{3}{4}$  equal 216, and so on; therefore, the structure will be much less firm than the model; and this the more, as the structure is cube times greater than the model. If we wish to determine the greatest size we can make a machine of which we have a model, we have—

The greatest weight which the beam of the model can bear, divided by the weight which it actually sustains, equals a quotient which, when multiplied by the size of the beam in the model, will give the greatest possible size of the same beam in the structure.

Ex.—If a beam in the model be 7 inches long, and bears a weight of 4 lbs., but is capable of bearing a weight of 26 lbs., what is the greatest length which we can make the corresponding beam in the structure? Here

$$26 \div 4 = 6.5; \text{ therefore, } 6.5 \times 7 = 45.5 \text{ inches.}$$

The strength, to resist crushing, increases from a model to a structure, in proportion to their size; but, as above, the strain increases as the cubes; wherefore, in this case, also, the model will be stronger than the machine, and the greatest size of the structure will be found by employing the square root of the quotient in the last rule, instead of the quotient itself; thus:

If the greatest weight which the column in a model can bear is 3 cwt., and if it actually bears 28 lbs.; then, if the column be 18 inches high, we have:

$$\sqrt{\left(\frac{336}{28}\right)} = 3.464; \text{ wherefore } 3.464 \times 18 = 62.352 \text{ inches, the length of the column in the structure.}$$

*List of Metals, arranged according to their Strength. —*

Steel, wrought iron, cast iron, platinum, silver, copper, brass, gold, tin, bismuth, zinc, antimony, and lead.

According to Tredgold's and Duleau's experiments, a piece of the best bar iron 1 square inch across the end, would bear a weight of about 77,363 lbs., while a similar piece of cast iron would be torn asunder by a weight of from 16,243 to 19,464 lbs. Thin iron wires, arranged parallel to each other, and presenting a surface at their extremity of 1 square inch, will carry a mean weight of 126,340 lbs.

*List of Woods, Arranged According to their Strength.*—Oak, alder, lime, box, pine (*sylv.*), ash, elm, yellow pine, and fir.

A piece of well-dried pine wood, presenting a section of 1 square inch, is able, according to Eytelwein, to support a weight of from 15,646 lbs. to 20,408 lbs., whilst a similar piece of oak will carry as much as 25,850 lbs.

Hempen cords, twisted, will support the following weights to the *square inch* of their section :

One-quarter to one inch thick, 8,746 lbs. ; 1 to 3 inches thick, 6,800 lbs. ; 3 to 5 inches thick, 5,345 lbs. ; 5 to 7 inches thick, 4,860 lbs.

Tredgold gives the following rule for finding the weight in pounds which a hempen rope will be capable of supporting: Multiply the square of the circumference in inches by 200, and the product will be the quantity sought.

In the practical application of these measures of absolute strength, that of metals should be reckoned at one-half, and that of woods and cords at one-third of their estimated value.

In a parallelopipedon of uniform thickness, supported on two points and loaded in the middle, *the lateral strength is directly as the product of the breadth into the square of the depth, and inversely as the length.* Let *W* represent the lateral strength of any material, estimated by the weight,

$b$  the breadth, and  $d$  the depth of its end, and  $l$  the distance between the points of support; then  $W = f d^2 b \div 4 l$ .

If the parallelopipedon be fastened only at one end in a horizontal position, and the load be applied at the opposite end,  $W = f d^2 b \div 4 l$ .

It is to be observed that the three dimensions,  $b$   $d$  and  $l$ , are to be taken in the same measure, and that  $b$  be so great that no lateral curvature arise from the weight;  $f$  in each formula represents the lateral strength, which varies in different materials, and which must be learned experimentally.

A beam having a rectangular end, whose breadth is two or three times greater than the breadth of another beam, has a power of suspension respectively two or three times greater than it; if the end be two or three times deeper than the end of the other, the suspension power of that which has the greater depth exceeds the suspension power of the other four or nine times; if its length be two or three times greater than the length of another beam, its power of suspension will be one-half and one-third, respectively, that of the other; provided, that in each case, the mode of suspension, the position of the weight, and other circumstances be similar. Hence it follows that a beam, one of whose sides tapers, has a greater power of suspension if placed on the slant than on the broad side, and that the powers of suspension in both cases are in the ratio of their sides; so, for instance, a beam, one of whose sides is double the width of the other, will carry twice as much if placed on a narrow side, as it would if laid on the wide one.

In a piece of round timber (a cylinder) the power of suspension is in proportion to the diameters cubed, and inversely as the length; thus a beam with a diameter two or three times longer than that of another, will carry a weight of 8 or 27 times heavier, respectively, than that whose

diameter is unity, the mode of fastening and loading it being similar in both cases.

The lateral strength of square timber is to that of a tree whence it is hewn as 10 : 17 nearly.

A considerable advantage is frequently secured by using hollow cylinders instead of solid ones, which, with an equal expenditure of materials, have far greater strength, provided only that the solid part of the cylinder be of a sufficient thickness, and that the workmanship be good; especially that in cast metal beams the thickness be uniform, and the metal free from flaws. According to Eytelwein, such hollow cylinders are to solid ones of equal weight of metal, as 1.212 : 1, when the inner semi-diameters are to the outer as 1 : 2; according to Tredgold as 17 : 10, when the two semi-diameters are to each other as 15 : 25; and as 2 : 1, when they are to each other as 7 : 10.

A method of increasing the suspensive power of timber supported at both ends, is to saw down from one-third to one-half of its depth, and forcibly drive in a wedge of metal or hard wood, until the timber is slightly raised at the middle out of the horizontal line. By experiment it was found that the suspensive power of a beam thus cut one-third of its depth was increased 1-19th, when cut one-half it was increased 1-29th, and when cut three-fourths through it was increased 1-87th.

The force required to crush a body increases as the section of the body increases; and this quantity being constant, the resistance of the body diminishes as the height increases.

According to Eytelwein's experiments, the strength of columns or timbers of rectangular form in resisting compression is as:

1. The cube of their thickness (the lesser dimension of their section).
2. As the breadth (the greater dimension of their section).
3. Inversely as the square of their length.

*Cohesive Power of Bars of Metal One Inch Square, in Tons.*

Iron, Swedish bar.....	29.20	Copper, wrought.....	15.80
Iron, Russian bar.....	26.70	Gun metal.....	16.23
Iron, English bar.....	25.00	Copper, cast.....	8.51
Steel, cast.....	59.93	Brass, cast, yellow.....	8.01
Steel, blistered.....	59.43	Iron, cast.....	7.87
Steel, sheer.....	56.97	Tin, cast.....	2.11

*Relative Strength of Cast and Malleable Iron.*—It has been found, in the course of the experiments made by Mr. Hodgkinson and Mr. Fairbairn, that the average strain that cast iron will bear in the way of tension, before breaking, is about  $7\frac{1}{2}$  tons per square inch; the weakest in the course of sixteen trials, on various descriptions, bearing 6 tons, and the strongest  $9\frac{3}{4}$  tons. The experiments of Telford and Brown show that malleable iron will bear, on an average, 27 tons; the weakest bearing 24, and the strongest 29 tons. On approaching the breaking point, cast iron may snap in an instant, without any previous symptom, while wrought iron begins to stretch, with half its breaking weight, and so continues to stretch till it breaks. The experiments of Hodgkinson and Fairbairn show also that cast iron is capable of sustaining compression to the extent of nearly 50 tons on the square inch—the weakest bearing  $36\frac{1}{2}$  tons, and the strongest 60 tons. In this respect, malleable iron is much inferior to cast iron. With 12 tons on the square inch it yields, contracts in length, and expands laterally; though it will bear 27 tons, or more, without actual fracture.

*Method of Testing Metals*—The method is, in general, as follows: Cut from the bar or mass to be tested, pieces about  $3\frac{1}{2}$  or 4 inches long, and turn them off in the middle to a diameter of one-half inch for iron and brass, and three-eighths if of steel; make this neck 1 inch long. A square head is left at each end. Secure the piece vertically and firmly by one end in a strong vise; fit a solid-ended wrench to the other end of the test-piece; and to the ex-

tremity of the handle—which should be, for convenience, about five feet long—attach a spring-balance capable of recording with accuracy up to 50 or 60 lbs.

Paint the scale of the balance with white lead or tallow, and spring the pointer so as to just touch the painted surface. The mark traced by the pointer then indicates the maximum force applied.

Commence pulling steadily on the balance, keeping the direction of pull at right angles to the wrench-handle.

An apparently unyielding resistance will be felt up to a certain point, when the test-piece will commence observably to give way. Note the indication of the spring-balance at this point, which is the *limit of elasticity*, and record both that reading and, if possible, the distance through which the piece has twisted—the latter measure being an indication of its stiffness. Continue twisting the piece until it has gone some distance beyond the limit of its elasticity; then stop and notice how far the arm springs back while gradually taking off the twisting force.

This distance is a measure of the *elasticity* of the metal, and is usually, if not invariably, the same, however great the set, even up to the point of rupture.

Renew the twisting force and break off the piece, noting the maximum angle which the piece has been twisted through and the maximum resistance, as indicated by the spring-balance.

The *stiffness* of the metal is measured by the force required to twist it through the first small angle, say  $5^{\circ}$ , should it yield so far without set. For one-half inch iron, this should be about 50 lbs., on the end of a lever five feet long. For tool steel it should be about 30 lbs., where the neck has a diameter of three-eighths inch.

The *limit of elasticity* is determined by the force required to give it its earliest set.

The *degree of elasticity* is measured by the distance

through which the wrench springs back when the force is removed after producing set.

The *ultimate tensile strength* is approximately proportioned to the force producing *rupture* by torsion.

The *limit of elasticity for tensile strength* is proportioned to the force producing *set* by torsion.

The *ductility of the metal* is measured by the *angle* through which the piece twists before breaking.

The power of resisting shock, or *resilience*, as it is called by engineers, is nearly proportioned to the product obtained by multiplying the breaking force by the maximum angle of torsion.

The *homogeneity* of the metal is determined by the regularity with which the resistance of the piece increases when passing its limit of elasticity.

By taking samples of well-known brands of metals, and pursuing this course, a standard is easily obtained, by reference to which a little practice will enable the experimenter to learn readily, and quite accurately, the relative value of such other metals as he wishes to test. Next, taking the fractured pieces, a careful inspection will assist in pronouncing a correct judgment.

# TABLES OF STRENGTH OF MATERIALS.

## Strength of Chains.

### Common Close-linked Cable Chain.

Number.	Material.	Diameter.	Breaking weight, in tons.				No. of experiments.
			Maxim im.	Minimum.	Mean.		
					Tons.	Per square Inch.	
1	Wrought iron.....	$\frac{1}{4}$	1.8	1.40	1.60	16.32	2
2	" .....	$\frac{3}{8}$	4.4	3.00	3.78	17.12	4
3	" .....	$\frac{7}{8}$	6.8	6.15	6.48	21.55	2
4	" .....	$\frac{1}{2}$	8.4	7.50	7.91	20.15	4
5	" .....	$\frac{5}{8}$	13.0	11.20	12.10	19.72	3
6	" .....	$\frac{1}{3}$	14.9	14.00	14.45	18.46	2
7	" .....	$\frac{3}{4}$	16.5	15.25	15.87	17.96	2
8	" .....	$\frac{1}{2}$	21.4	19.5	20.60	19.86	3
9	" .....	$\frac{3}{8}$	27.5	21.0	25.14	20.90	32
10	" .....	I	38.6	26.0	31.81	20.15	61
11	" .....	$I\frac{1}{8}$	35.0	28.5	31.30	17.66	3
12	" .....	$I\frac{1}{4}$	52.0	35.0	46.19	18.82	3
13	" .....	$I\frac{1}{2}$	63.5	55.5	60.62	17.15	4

### Steel-linked Cable Chain.

14	Wrought iron.....	$\frac{5}{8}$			9.58	15.60	6
15	" .....	$\frac{3}{4}$			13.51	15.30	6
16	" .....	$\frac{3}{4}$	18.0	15.5	16.75	18.91	2
17	" .....	$\frac{7}{8}$	27.0	20.0	22.75	18.91	6
18	" .....	$\frac{7}{8}$			20.38	16.90	20
19	" annealed ....	$\frac{7}{8}$	20.25	19.0	19.65	16.34	10
20	" not annealed.	$\frac{7}{8}$	21.75	20.5	21.10	17.54	10
21	" .....	I	37.5	32.5	34.20	21.77	5
22	" .....	I			24.25	15.40	6
23	" .....	I	34.5	26.0	30.70	19.54	3
24	" .....	$I\frac{1}{8}$			29.54	14.90	6
25	" Lowmoor....	$I\frac{1}{8}$			41.25	20.75	



Table Continued.

Number.	Material.	Diameter.	Breaking weight, in tons.				No. of experiments.
			Maximum.	Minimum.	Mean.		
					Tons.	Per square Inch.	
26	Wrought iron, Trinity.....	1 1/8			40.38	20.31	
27	“ “ .....	1 1/8			41.50	20.87	
28	“ .....	1 1/2			59.58	16.90	6
29	“ .....	1 3/4			74.12	15.40	6
30	“ .....	1 3/4	94.0	83.0	88.50	18.40	9
31	“ .....	1 3/4	90.7	82.5	84.50	17.56	6
32	“ .....	1 3/4	83.6	72.2	80.10	16.65	12
33	“ .....	1 3/4	100.0	74.0	84.53	17.75	7
34	“ .....	1 7/8			92.88	16.80	6
35	“ .....	2			99.54	15.80	3
36	“ .....	2 1/8	123.0	100.7	113.90	16.60	8
37	“ .....	2 1/4	133.0	119.5	125.20	15.74	3
38	Puddled steel, Firth's.....	1 1/8			41.00	20.62	
39	“ Howell's.....	1 1/8			39.75	20.00	
40	“ Mersey.....	1 1/8			29.75	14.96	
41	Mild steel.....	1 1/8			37.75	18.98	
42	Cast steel, Mushet's.....	1 1/8			33.0	16.60	
43	“ Bessemer.....	1 1/8			35.0	17.61	

Strength and Weight of Short-linked Crane Chain.

Diameter in Inches.	Breaking weight, tons.	Admiralty proof-strain, tons.	Maximum safe-strain, tons.	Working-strain for Cranes, etc., tons.	Weight per fathom, lbs.
1/4.....	1.87	.75	.56	.37	4.5
5/16.....	2.93	1.17	.88	.58	6.0
3/8.....	4.22	1.69	1.26	.84	10.5
7/16.....	5.74	2.30	1.72	1.15	12.0
1/2.....	7.50	3.00	2.25	1.50	18.0
9/16.....	9.49	3.80	2.84	1.90	21.0
5/8.....	11.72	4.69	3.51	2.34	27.9
3/4.....	14.18	5.67	4.25	2.83	31.3
7/8.....	16.87	6.75	5.06	3.37	36
1.....	19.80	7.92	5.94	3.96	42

Table Continued.

Diameter in Inches.	Breaking weight, tons.	Admiralty proof-strain, tons.	Maximum safe-strain, tons.	Working- strain for Cranes, etc., tons.	Weight per fathom, lbs.
$\frac{7}{8}$ .....	22.97	9.19	6.89	4.59	50
$\frac{15}{16}$ .....	26.37	10.55	7.91	5.27	57
1.....	30.00	12.00	9.00	6.00	65
$1\frac{1}{16}$ .....	33.87	13.54	10.16	6.77	73
$1\frac{1}{8}$ ....	37.97	15.18	11.39	7.59	82
$1\frac{1}{4}$ .....	42.30	16.92	12.69	8.46	91
$1\frac{3}{8}$ .....	46.87	18.75	14.06	9.37	101
$1\frac{1}{2}$ .....	51.68	20.67	15.50	10.33	110
$1\frac{3}{4}$ .....	56.72	22.68	17.01	11.34	120
$1\frac{7}{8}$ .....	62.00	24.80	18.60	12.40	130
$1\frac{1}{2}$ .....	67.50	27.00	20.25	13.50	140
Ratios=	5.0	2.0	1.5	1.0	

Strength and Weight of Steel-linked Cable Chain.

Diameter in Inches.	Breaking weight, tons.	Admiralty proof-strain, tons.	Maximum safe-strain, tons.	Weight per fathom, lbs.
$\frac{1}{2}$ .....	6.75	4.50	2.25	15
$\frac{9}{16}$ .....	8.54	5.75	2.84	19
$\frac{5}{8}$ .....	10.55	7.03	3.51	24
$\frac{11}{16}$ .....	12.76	8.52	4.25	28
$\frac{3}{4}$ .....	15.18	10.10	5.06	32
$1\frac{1}{16}$ .....	17.82	11.9	5.94	37
$1\frac{1}{8}$ .....	20.67	13.9	6.89	44
$1\frac{1}{4}$ .....	23.73	15.8	7.91	49
1.....	27.00	18.0	9.00	58
$1\frac{1}{8}$ .....	30.48	22.9	11.45	72
$1\frac{1}{4}$ .....	42.19	28.1	14.05	90
$1\frac{3}{8}$ .....	51.05	34.1	17.05	110
$1\frac{1}{2}$ .....	60.75	40.6	20.30	125
$1\frac{5}{8}$ .....	71.30	47.6	23.8	145
$1\frac{3}{4}$ .....	82.68	55.4	27.7	170
$1\frac{7}{8}$ .....	94.92	63.3	31.6	195
2.....	108.00	72.0	36.0	230
$2\frac{1}{8}$ .....	121.92	81.3	40.6	256
$2\frac{1}{4}$ .....	136.68	91.2	45.6	285
$2\frac{3}{8}$ .....	141.75	101.7	50.8	320
$2\frac{1}{2}$ .....	168.75	112.5	56.2	360
Ratios= ..	3	2	1	

*Strength of Iron Wire Ropes.*

Circumference.	Breaking weight, cwt.	Working load, cwt.	Weight per fathom, lbs.
1	40	6	1
1 $\frac{5}{8}$	80	12	2
1 $\frac{7}{8}$	120	18	3
2 $\frac{1}{8}$	160	24	4
2 $\frac{3}{8}$	200	30	5
2 $\frac{5}{8}$	240	36	6
2 $\frac{7}{8}$	280	42	7
3 $\frac{1}{8}$	320	48	8
3 $\frac{1}{2}$	400	60	10
3 $\frac{3}{4}$	480	72	12
4	560	84	14
4 $\frac{3}{8}$	640	96	16
4 $\frac{5}{8}$	800	120	20

*Sizes.**Flat Wire Ropes.*

2 $\frac{1}{2}$ × $\frac{1}{2}$	400	44	11
2 $\frac{3}{4}$ × $\frac{5}{8}$	540	60	15
3 $\frac{1}{4}$ × $\frac{3}{8}$	640	72	18
3 $\frac{3}{4}$ × $\frac{1}{8}$	800	88	22
4 $\frac{1}{4}$ × $\frac{3}{4}$	1,000	112	28
4 $\frac{5}{8}$ × $\frac{3}{4}$	1,200	136	34

*Strength and Weight of Hempen Ropes.*

Girth in Inches.	Weight per fathom, lbs.	Ropes made with Register.			
		Breaking weight, cwt.	Proof strain, cwt.	Safe loads, cwt.	
				Ordinary.	Hoists, etc.
1 $\frac{1}{2}$	0.50	16.5	5.5	4.1	2.4
2	0.88	29.3	9.8	7.3	4.9
2 $\frac{1}{2}$	1.38	45.7	15.2	11.4	7.6
3	1.98	66	22	16.5	11.0
3 $\frac{1}{2}$	2.70	90	30	22.5	15.0
4	3.52	117	39	29.2	19.5
4 $\frac{1}{2}$	4.46	148	49	37.0	24.7
5	5.50	183	61	45.7	30.5
5 $\frac{1}{2}$	6.66	221	70	55.2	37.0
6	8.00	263	88	66	44.0
6 $\frac{1}{2}$	9.3	309	103	77	51.5
7	10.8	358	119	89	59.7

Table Continued.

Girth in Inches.	Weight per fathom, lbs.	Ropes made with Register.			
		Breaking weight, cwt.	Proof strain, cwt.	Safe loads, cwt.	
				Ordinary.	Hoists, etc.
7½	12.4	412	137	103	69
8	14.1	468	156	117	78
9	17.8	593	198	148	99
10	22.0	732	244	183	122
11	26.6	886	295	221	144
12	31.7	1054	351	264	176
Hand-laid Ropes.					
1½	0.50	11.3	3.8	2.8	1.9
2	0.88	20.0	6.7	5.0	3.3
2½	1.38	31.3	10.4	7.8	5.2
3	1.98	45.1	15.0	11.3	7.5
3½	2.70	60.6	20.2	15.1	10.1
4	3.52	78	26.0	19.5	13.0
4½	4.46	92	30.7	23.0	15.3
5	5.50	118	39.3	29.5	19.7
5½	6.66	138	46	34.5	23.0
6	8.00	162	54	40.5	27.0
6½	9.3	183	61	45.7	30.5
7	10.8	205	68	51.2	34.1
7½	12.4	223	74	56.0	37.2
8	14.1	240	80	60.0	40.0
Ratios.		6	2	1.5	1

*Strength of Drawn Lead Pipes of the Ordinary Standard Weights.*

Diameter.	Thickness.	Weight in lbs.		Pressure in feet of Water.		
		Per 15 feet.	Per foot.	Bursting.	Working head.	
					Ordinary.	With shock.
½	.0881	12	0.800	1700	170	85
½	.1067	15	1.000	1978	198	100
½	.1356	20	1.330	2367	236	118
½	.1486	22	1.467	2525	252	126
¾	.1060	18	1.200	1649	165	82

Table Continued.

Diameter.	Thickness.	Weight in lbs.		Pressure in feet of Water.		
		Per 15 feet.	Per foot.	Bursting.	Working head.	
					Ordinary.	With shock.
$\frac{5}{8}$	.1264	22	1.467	1898	190	95
$\frac{5}{8}$	.1503	27	1.800	2169	217	108
$\frac{3}{4}$	.1105	22	1.467	1466	147	73
$\frac{3}{4}$	.1236	25	1.667	1610	161	80
$\frac{3}{4}$	.1365	28	1.867	1745	174	87
$\frac{3}{4}$	.1525	32	2.133	1906	191	96
$\frac{3}{4}$	.1695	36	2.400	2068	207	104
$\frac{3}{4}$	.1810	39	2.600	2173	217	109
I	.1370	36	2.400	1378	138	69
I	.1570	42	2.800	1545	155	78
I	.2010	56	3.733	1888	189	95
		per 12 ft.				
$1\frac{1}{4}$	.1610	42	3.500	1307	131	66
$1\frac{1}{4}$	.1945	52	4.333	1535	154	77
$1\frac{1}{4}$	.2300	63	5.250	1760	176	88
$1\frac{1}{2}$	.1625	50	4.167	1123	112	56
$1\frac{1}{2}$	.1800	56	4.667	1228	123	62
$1\frac{1}{2}$	.2250	72	6.000	1488	149	75
$1\frac{1}{2}$	.2580	84	7.000	1672	167	84
$1\frac{3}{4}$	.1940	70	5.833	1146	115	58
$\frac{3}{4}$	.2220	81	6.750	1290	129	65
$1\frac{3}{4}$	.2435	90	7.500	1396	140	70
2	.2055	84	7.000	1067	107	54
2	.2320	96	8.000	1193	119	60
2	.2670	112	9.333	1347	135	68

Strength of Timbers to Resist Crushing Strains, in Pounds and Tons, per Square Inch.

Kind of Timber.	Maxim'm dry, lbs.	Minim'm ordinary state, lbs.	Mean.		Ratio of column 1 to col. 2.
			lbs.	tons.	
Alder .....	6,960	6,831	6,896	3.08	1.02
Ash .....	9,363	8,683	9,023	4.03	1.08
Baywood .....	7,518	7,518	7,518	3.36	1.00
Beech .....	9,363	7,733	8,548	3.81	1.21
Birch, English.....	6,402	3,297	4,850	2.16	1.94

Table Continued.

Kind of Timber.	Maxim'm dry, lbs.	Minim'm ordinary state, lbs.	Mean.		Ratio of column 1 to col. 2.
			lbs.	tons.	
Birch, American...	11,663	8,970*	10,316	4.60	1.30
Box.....	9,971	7,670*	8,820	3.94	1.30
Cedar...	5,863	5,674	5,768	2.58	1.03
Crab-tree...	7,148	6,499	6,824	3.05	1.10
Deal, red.....	6,586	5,748	6,167	2.75	1.15
Deal, white.....	7,293	6,781	7,037	3.14	1.08
Elder.....	9,973	7,451	8,712	3.89	1.34
Elm.....	10,331	7,950*	9,140	4.08	1.30
Fir, spruce.....	6,819	6,499	6,659	2.97	1.05
Hornbeam.....	7,289	4,533	5,911	2.64	1.60
Mahogany.....	8,198	8,198	8,198	3.66	1.00
Oak, English.....	10,058	6,484	8,271	3.69	1.55
Oak, Quebec.....	5,982	4,231	5,106	2.28	1.41
Oak, Dantzic.....	7,731	5,950*	6,840	3.05	1.30
Pine, pitch.....	6,790	6,790	6,790	3.03	1.00
Pine, yellow.....	5,445	5,375	5,410	2.41	1.01
Pine, red.....	7,518	5,395	6,457	2.88	1.40
Plum.....	10,493	8,241	9,367	4.18	1.27
Poplar.....	5,124	3,107	4,116	1.84	1.65
Sycamore.....	9,207*	7,082	8,144	3.67	1.30
Teak.....	12,101	9,310*	10,706	4.78	1.30
Larch.....	5,568	3,201	4,385	1.96	1.74
Walnut.....	7,227	6,063	6,645	2.97	1.19
Willow.....	6,128	2,898	4,513	2.02	2.11

\* Calculated from the general ratio of the experiments in columns 1 and 2, which is 1.3 to 1.0.

*Table of the Strength, Extensibility and Stiffness of Metals,  
Cast Iron being 1, or Unity.*

Metals.	Strength.	Extensibility.	Stiffness.
Iron, wrought.....	1.12	0.86	1.3
Gun metal.....	0.65	1.25	0.535
Brass.....	0.435	0.9	0.49
Zinc.....	0.365	0.5	0.76
Tin.....	0.182	0.75	0.25
Lead.....	0.096	2.5	0.385

*Table of the Strength, Extensibility and Stiffness of Woods,  
Cast Iron being 1, or Unity.*

Woods.	Strength.	Extensibility.	Stiffness.
Oak.....	0.25	2.8	0.093
Ash.....	0.23	2.6	0.089
Elm.....	0.21	2.9	0.073
Pine, yellow.....	0.3	2.6	0.1154
Beech.....	0.15	2.1	0.073
Mahogany, Honduras....	0.24	2.9	0.487

*Effect of Remelting on the Strength of Cast Iron.*

Number of Melting.	Transverse strength, $4\frac{1}{2}$ ft. bars, 1 inch square.	Crushing strength per square inch.	Calculated tensile strength per square inch.
	Tons.	Tons.	Tons.
1.....	.2187	44.0	9.502
2.....	.1973	43.6	8.217
3.....	.1793*	41.1	7.351*
4.....	.1846	40.7*	7.697
5.....	.1927	41.1	8.151
6.....	.1959	41.1	8.349
7.....	.2005	40.9	8.655
8.....	.2192	41.1	9.847
9.....	.2440	55.1	10.07
10.....	.2531	57.7	10.40
11.....	.2910	69.8	11.71
12.....	.3090*	73.1	12.51*
13.....	.2834	66.0	11.54
14.....	.2700	95.9*	9.154
15.....	.1657	76.7	5.366
16.....	.1568	70.5	5.116
17.....			
18.....	.1396	88.0	4.196

NOTE.—Maximum and minimum results marked \*.

It would seem from all this that the method of obtaining increased strength by remelting cast iron is very uncertain. It will also be expensive in fuel, labor and waste of metal. With iron such as that in 5, where the mean tensile strength was increased from 1 to  $18.26 \div 5.6 = 3.26$  at the fourth

melting, it would no doubt be commercially advantageous. In such a case experiments should be especially made on the iron to be used.

By maintaining cast iron in a state of fusion for lengthened periods, the tensile strength is greatly increased; thus with iron twice remelted and kept in fusion for

0	1	2	3 hours,
the tensile strength was			
15,861	20,420	24,383	25,733 lbs.
per square inch. In another experiment, the time being =			
$\frac{1}{2}$	1	$1\frac{1}{2}$	2 hours;
the tensile strength =			
17,843	20,127	24,387	34,496 lbs.

*Table Showing the Average Crushing Load of Different Materials, or the Weight under which they will Crumble.*

	Lbs. per sq. inch.		Lbs. per sq. inch.
Alder.....	6,900	Walnut .....	6,000
Ash.....	8,600	Willow .....	2,900
Beech.....	7,600	Cast iron, American.....	174,803
Cedar.....	5,700	Low Moor, English.....	62,450
Elm.....	10,000	Wrought iron.....	38,000
Fir-spruce .....	6,500	Steel, cast.....	225,000
Hickory, white.....	8,925	Steel, tempered.....	337,800
Hornbeam.....	4,500	Copper, cast.....	117,000
Larch .....	3,200	Brass, cast.....	164,800
Locust.. ..	9,113	Tin, cast.....	15,500
Maple.....	8,150	Lead .....	7,730
Oak.....	4,200	Hard brick.....	2,000
Oak, English.....	6,500	Crown glass.....	51,000
Pine, pitch .....	6,800	Granite, English.....	10,360
Pine, American yellow...	5,300	Portland cement.....	15,000
Poplar.....	5,100	Freestone, Conn.....	3,522
Plum .....	3,700	Marble, American.....	18,061
Sycamore.....	7,000	Roman cement.....	342
Teak .....	12,000		

*Table Showing the Tensile Strength, or the Strain that will Pull Different Metals Asunder on a Straight Pull.*

	Lbs. per sq. inch.		Lbs. per sq. inch.
Antimony .....	1,000	Gun metal.....	96,000
Bismuth.....	3,200	Iron, cast.....	17,900
Brass, cast.....	18,000	Wrought iron, bar.....	57,500
Copper, cast .....	19,000	Wrought iron, good.....	60,000



*Table Showing the Tensile Strength or the Strain that will Pull Different Metals Asunder on a Straight Pull.*

Lbs. per sq. inch.	Lbs. per sq. inch.
Wrought iron, superior... 70,000	Steel, bar—Black Diamond,
Wrought iron, best Amer'n. 76,160	American... 120,700
Wrought iron, Low Moor. 60,000	Steel, tempered... 214,400
Wrought iron, boiler plate. 45,000	Chrome steel, American.. 180,000
Steel plates, English... 78,000	Silver, cast... 41,000
Steel plates, American... 94,450	Tin, block... 4,600
Steel plates, Bessemer,	Zinc, cast... 2,800
American... 98,600	Zinc, sheet... 16,000
Bessemer steel, tool... 112,000	Zinc, wire... 22,000

*Table Showing the Tensile Strength of Different Kinds of Wood.*

Lbs. per sq. inch.	Lbs. per sq. inch.
Alder... 14,000	Hickory... 11,000
Ash... 16,000	Lignum-vitæ... 11,000
Birch... 15,000	Larch... 7,000
Baywood... 12,000	Locust... 18,000
Beech... 11,500	Maple... 10,000
Bamboo... 6,000	Mahogany... 8,000
Boxwood... 20,000	Oak... 10,000
Cedar... 7,000	Pear... 10,000
Chestnut... 13,000	Pine... 10,000
Cypress... 6,000	Poplar... 7,000
Elder... 10,000	Sycamore... 12,000
Elm... 6,000	Teak... 15,000
Fir or Spruce... 10,000	Walnut... 8,000
Hazel... 18,000	Yew... 8,000
Holly... 16,000	

# SUPPLEMENTARY PATTERN PROBLEMS

---

## INTRODUCTION.

THERE are three distinct methods of cutting patterns for sheet metal objects and are based on the geometrical science of developing the surfaces of solids. The first method is termed parallel line development and is the simplest of the three. The second is the radial line method and comprehends conical problems and the like. The patterns of all regular objects of sheet metal can be developed by either of these two methods. The majority of sheet metal articles are irregular in shape and an accurate pattern could not be developed for them by either of these two methods.

The geometrical truth that if you possess the lengths of the base and altitude of a right angled triangle you can then readily determine the length of the hypotenus, that is to say, the third side of the right angled triangle, has been used for these irregular objects and is the third method of cutting patterns and is termed triangulation.

Such problems like the one labelled Fig. 67 or Fig. 71, or again Fig. 77, are developed by the first system, that is, parallel line development. Such problems as Fig. 1 or Fig. 85 are developed by the radial line system. Such problems as Fig. 38 are truly triangulation problems and are so solved, although the text does not mention this important fact. Triangulation, by reason of its tremendous value to sheet metal pattern cutters is especially emphasized in this section of the book by selecting most of the problems solved by that method.

Before leaving the subject of the three methods, it is to be understood that there are some objects, the surfaces of which have double curvature, and their surfaces cannot be laid flat, so to speak, like the surface of a cylinder, that is a pipe. A ball is an object of double surface curvature and a true pattern cannot be cut for it. However, an approximate pattern may be developed for such objects by some one, or perhaps a combination of the three systems. In Fig. 41 a ball or a dome pattern is developed by the radial line system, while in Fig. 42 the pattern has been developed by the parallel line system.

#### PATTERN FOR A CHIMNEY BASE.

*To describe the pattern for a transitional object the base of which is a rectangle and the top circular and situated centrally in respect to the base.*—The object is similar to Fig. 53 and is here solved by triangulation. Let ABCD of Fig. 171 be the plan view of rectangular part of the base to fit over the chimney, and EFGH the circular top to which is attached the cylindrical smoke stack. Divide quarter circle FG into say four equal spaces as shown. Connect F, 1, 2, 3 and G with B. With B as center swing these points to line AB. Also project point G upwards as shown by G''. Assume that BJ is the height of the object. Then BJ is the altitude of the triangles as mentioned in the introduction to this section of the book, and F', I', G', 2', 3' and G'' are the bases of the triangles. Then such lines, as F'J, are the sought for hypotenuses or true lengths of such lines as FB.

With these data the pattern is developed by drawing anywhere a line equal in length to G''J as G4 in Fig. 172. With G, Fig. 172, as center and distance G'J of Fig. 171 as radius, describe an arc which intersect by an arc (of a radius equal to distance 4B of Fig. 171), using 4 as center. Connect G4B with lines. Using always B as center, in Fig. 172, and with radii 3'J, 2'J, 1'J and F'J of

Fig. 171, describe short arcs. Set the dividers to space G3 of Fig. 171, and beginning at G in Fig. 172, step successively to each arc locating thus, points 3, 2, 1 and F. Trace a line through these points. Still using B of Fig. 172 as center, describe an arc of a radius equal to AB of Fig. 171. With F of Fig. 172 as center and a radius equal to FB, describe an arc to intersect the one described with B as center, locating thereby point A. Connect

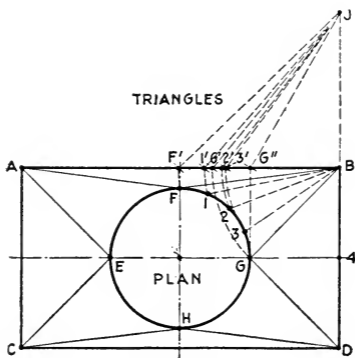

Fig. 171.

ABF and then repeat the first part of the pattern, using always A as center. This will be the net one-half pattern for the object and allowances must be made for edges and the like for all seams. Slight bends are made on those lines indicated with small circles.

This object is known as a quarter symmetrical object because each quarter or section as AEF, DHG, CHE and BGF are exactly similar so that the pattern for one will do for the patterns of the others. Now, such objects can

have the circular top much different in respect to its size with the base, providing that always the circle is de-

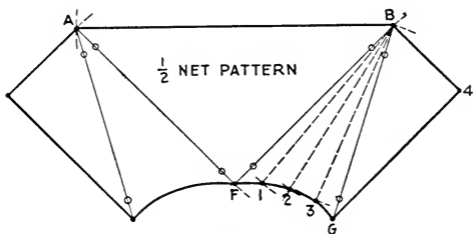

Fig. 172.

scribed with its center also the center of the rectangle. Fig. 173 shows an object the circular top of which ex-

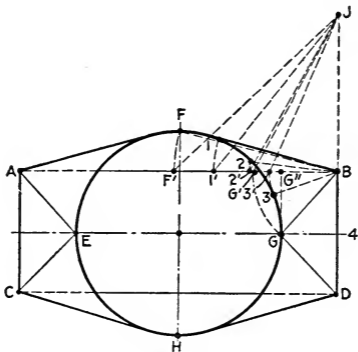

Fig. 173.

tends beyond the sides of the rectangle. This diagram also shows the system of triangulation and Fig. 174 is

the developed pattern. Again, Fig. 175 shows an object with circular base extending all around the rectangle

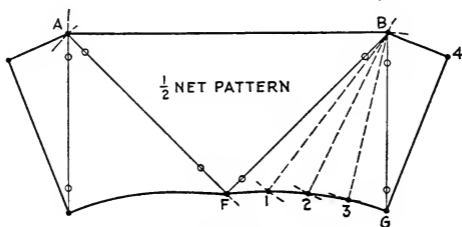

Fig. 174.

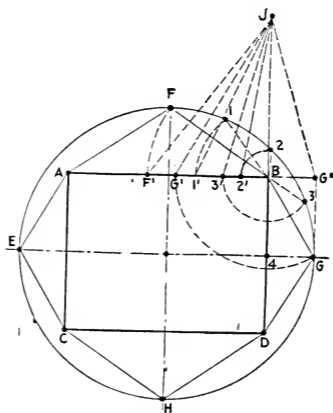

Fig. 175.

top. This diagram also shows the triangulation and Fig. 176 shows the half pattern. Thus it will be seen that the

foregoing explanatory text applies to three problems because of their similarity.

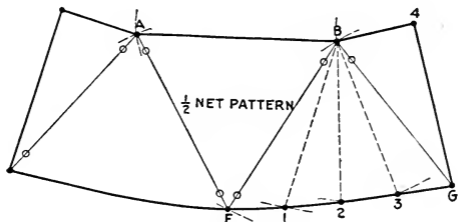

Fig. 176.

### PATTERN FOR AN OFFSETTING TRANSITION FITTING WITH A SQUARE BASE AND ROUND TOP.

To describe the pattern for a transitional object the base of which is a rectangle and the top a circle situated off center one way in respect to the base.—The object shown in Fig. 177 is termed an object of symmetrical halves because the parts separated by the line HF are exactly alike. This means that two sets of triangles must be constructed as shown before the pattern can be developed. However, the procedure is similar to that for the preceding problems and should be readily understood by an inspection of Figs. 177 and 178, except to say that the pattern is started by making line H<sup>\*</sup>H in Fig. 178 the length of DJ<sup>o</sup> in Fig. 177. In Fig. 178, HD equals HD of Fig. 177, and H<sup>\*</sup>D, Fig. 178, is the same length as HJ<sup>o</sup> of Fig. 177. Also, distance FK of Fig. 177 is set from B as K', by coincidence falling on point 2', then FK of Fig. 178 equals length JK' of Fig. 177.

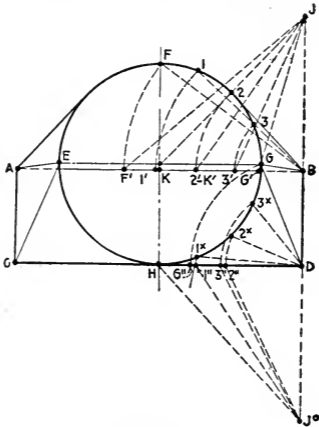

Fig. 177.

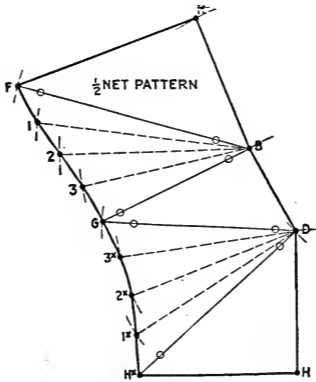

Fig. 178.



Like the other three examples mentioned, the relative sizes of the rectangle and circle have nothing to do with the symmetry of the object, providing that always the center of the rectangle and the center of the circle are on line HF of Fig. 177.

### PATTERN FOR A DOUBLE OFFSETTING TRANSITION FITTING WITH A SQUARE BASE AND ROUND TOP.

*To describe the pattern for a transitional object the base of which is a rectangle and the top a circle situated off center both ways in respect to the base.—A non-sym-*

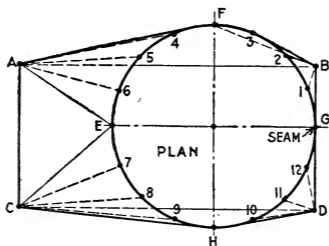

Fig. 179.

metrical of this kind is one that no quarters of it are alike as shown by Fig. 179. Following the principles as explained in the foregoing, diagrams of triangles are constructed, in this case, for all quarters. If the triangles were drawn in Fig. 179 as was done by the other problems, there would be quite a mix-up of lines, so they were drawn elsewhere as in Figs. 180 to 183; by, as for the quarter GBF of Fig. 179, for instance, taking the distances from B to F, to 3, to 2, to 1 and to G and placing them from B on a line as shown in Fig. 180. A vertical line is

drawn from B to J the height of the object which completes the diagram of triangles, and so forth. The pattern, Fig. 184, is then laid out as before explained.

By the principles expounded in the foregoing, it is possible to develop patterns for objects having a base any shape and not necessarily a rectangle and a top of any other shape than a circle, subject to the condition that base and top must always be parallel to each other.

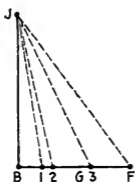

Fig. 180.

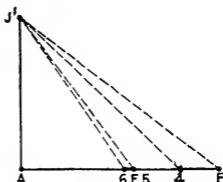

Fig. 181.

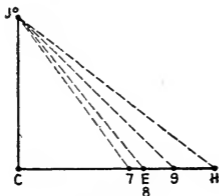

Fig. 182.

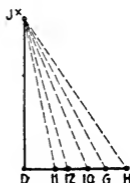

Fig. 183.

#### PATTERN FOR A FURNACE BOOT.

To describe the pattern for an object the base of which is a circle and the top an oval.—The object shown in Fig. 185 has its pattern developed by the same principle expounded in the foregoing. There is, though, no corner acting as the center for numerous arcs, as, for instance,

B in Fig. 171, which requires a slightly different procedure for constructing the triangle and for developing the patterns. Like the others, these problems can be symmetri-

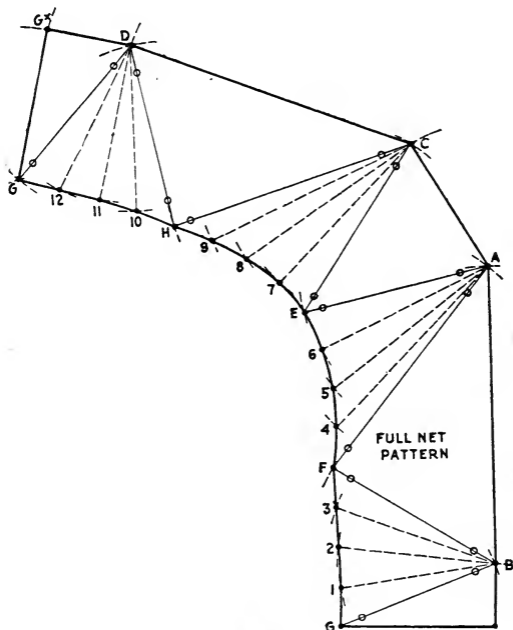

Fig. 184.

cal quarters, symmetrical halves or non-symmetrical. As, however, the basic principles are identical, only one problem is here demonstrated.

Let ABCD be the circular top and JHEKFG the out-

line of the base, mistakenly called oval in the sheet metal trade. It will be seen that this so-called oval has a rectangular center, HEFG, with semi-circular ends, EKF

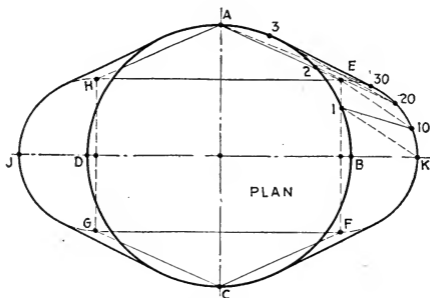

Fig. 185.

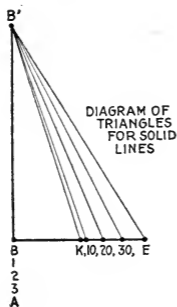

Fig. 186.

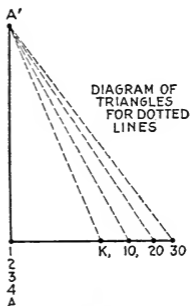

Fig. 187.

and HJG. Divide the quarter-circle AB of the top into, say, four equal spaces, B, 1, 2, 3 and A. Also divide the quarter-circle EK of the base into the same number of

spaces, as K, 10, 20, 30 and E. Connect with solid lines B to K, 1 to 10, 2 to 20, 3 to 30 and A to E. Then connect with dotted lines, K to 1, 10 to 2, 20 to 30 and 30 to E. These are the systems of triangles and are bases of right-angled triangles, the altitudes being the height of the object, or  $BB'$  of Fig. 186 and  $AA'$  of Fig. 187. Take the distances from B to K, and so forth, and place them on the horizontal line in Fig. 186, measuring always from point B, as shown. Do the same with the dotted lines like K1 and place them in Fig. 187. In Fig. 186  $KB'$  is the true length of line BK of Fig. 185, and so on, and in Fig.

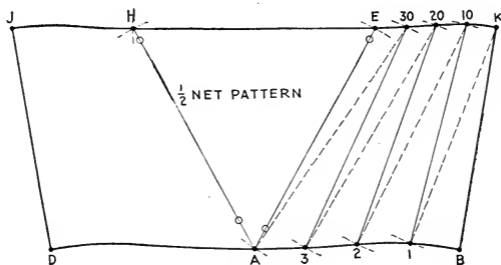

Fig. 188.

187  $KA'$  is the true length of line K1 of Fig. 186, and so on.

Having these data the pattern is developed by drawing a line equal in length to  $KB'$  of Fig. 186, as BK of Fig. 188. With K as center and radius equal to  $KA'$  of Fig. 187, describe a short arc. With the dividers set to space B1 of Fig. 185 and one point at B, Fig. 188, step off point 1. With point 1 as center and radius equal in length to  $10B'$  of Fig. 186, describe a short arc. Set dividers to space K10 of Fig. 185, and with one point of dividers at K of Fig. 188, step off point 10. With 10 as center and radius  $10A'$  of Fig. 187, describe arc as before and step off on

it space 1 to 2 of Fig. 185, giving thus point 2 of Fig. 188. With 2 as center and radius  $20B'$  of Fig. 186, describe arc and intersect with space same as  $K10$ , giving point 20 in Fig. 188, and so forth, until points A and E are located. With same radius AE and E as center, describe an arc which intersects with an arc having E as center and radius equal in length to EH of Fig. 185, thus locating point H of Fig. 188. The balance of the pattern, ADJH, is a duplication of ABKE. As was stated, this is a figure of symmetrical quarters and following these principles, objects having symmetrical halves or non-symmetrical can have their patterns developed, as explained in connection with the other problems.

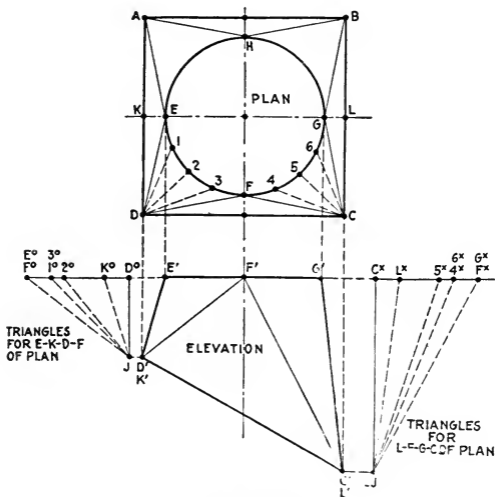

Fig. 180.

## PATTERN FOR A SQUARE TO ROUND ROOF COLLAR.

To describe the pattern for an object with a rectangular base and circular top situated at an angle in respect to base.—The plan of the object as shown in Fig. 189 is much the same as Fig. 171. The elevation, however, shows that the top is not parallel with the base. This means that although the object has symmetrical quarters, two sets of

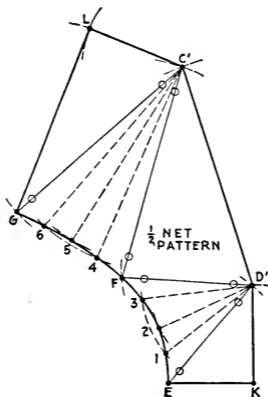

Fig. 190.

triangles must be constructed because, as can be seen in the elevation, the altitudes of the triangles are not alike due to the base being inclined from the horizontal. Such objects are frequently used to make a finish at the roof for smoke stacks or ventilators, and the procedure for constructing the triangles and developing the pattern should be obvious by an inspection of Fig. 189 and Fig. 190. Suffice to say that owing to the EFGH being situated cen-

trally, in plan, in a square, the base line DE is of the same length as DF, and so forth. The only difference in the process of developing the pattern from the foregoing is that length D'C' of Fig. 190 is not DC in plan of Fig. 189 but D'C' in elevation of Fig. 189. Following these principles, patterns can be developed for similar objects of symmetrical halves or non-symmetrical, just as was done for Figs. 173, 175, 177 and 179.

### PATTERN FOR AN OFFSETTING FURNACE BOOT.

*To describe the pattern for an offsetting three-piece transitional object, round at the base and oval at the top.*

This article is a common fitting for hot air furnace work, and the problem of pattern development embodies principles of triangulation that are applicable to innumerable problems. There are several systems of triangulating such objects, but the one explained here is about the shortest and best yet devised.

As shown in Fig. 191, the object consists of an oval collar No. 1, a cylindrical collar No. 3, the profile or section of which is parallel to, but not situated centrally in respect to the profile of collar No. 1. To join these two collars there is an offsetting and transitional piece of irregular shape, labelled No. 2.

Assume that collar No. 1 is to be placed where shown, and that form  $C^o$  to  $C^2$  is to be the size of the throat of the collar. Again, assume that collar No. 3 is to be placed where shown and that  $C^T C^{ox}$  is to be the length of the heel. Connect  $C^o$  and  $C^{ox}$  and bisect the angle  $C^2 C^o C^{ox}$  by the rule given in Fig. 121, thus obtaining the miter line  $C^o B^o$ . Bisect angle  $C^o C^{ox} C^T$ , obtaining thereby miter line  $B^{ox}$ . Join  $B^o B^{ox}$ , which completes the elevation. It is not necessary to draw a complete plan. All that is needed is a half profile of collar No. 1, placed as shown by half profile W and a half profile of collar No. 3, placed as shown by half profile X. It will be seen that this is a flexible de-



sign of furnace fitting, and can be modified at pleasure to suit existing conditions.

Divide half profile X into, say, six equal spaces. Also

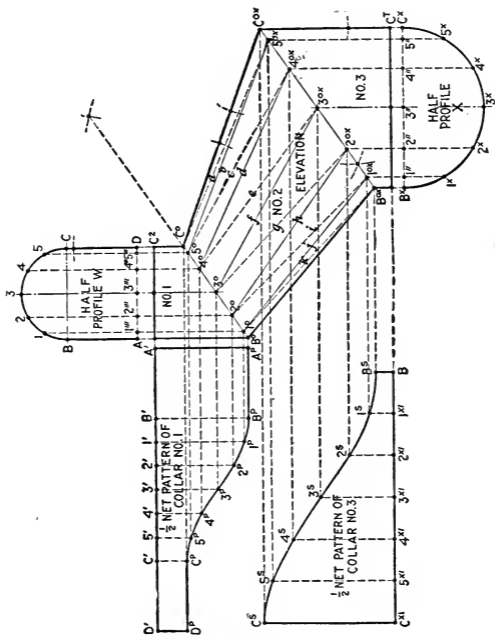

Fig. 191.

divide the round portion of half profile W into six equal spaces. Project the points in half profile X up to miter line B<sup>ox</sup>C<sup>ox</sup>, and indicate where they intersect this line,

also where the cross line  $B^x C^x$ , as shown. Do the same with half profile  $W$  and then join like numbers on both miter lines with solid lines. Then, beginning at  $C^o$ , join  $5^o x$ , and so on, with dotted lines.

Collars No. 1 and No. 3 have their patterns developed by the parallel line system, therefore extend line from point  $C^2$  and place thereon the girth of half profile  $W$  as

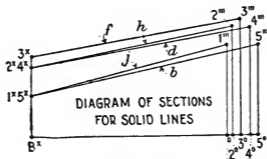

Fig. 192.

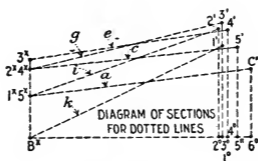

Fig. 193.

shown by points  $A'$  to  $D'$ . Project lines from these points and intersect them with lines projected from like numbered points on miter line  $B^o C^o$  as shown. Sketch a line through these points from  $D^P$  to  $A^P$  which completes the half pattern of collar No. 1. Repeat these operations for collar No. 3, then  $C^x B B^S C^S$  is the half pattern for collar No. 3.

Those dotted and solid lines in piece No. 2 are not shown in their true lengths and a modified system of right-angled triangles is constructed for each set of dotted and solid lines. This system is shown in Figs. 192 and 193, and are

called diagrams of sections. Proceed to construct these diagrams by drawing a horizontal line and locating thereon point  $B^x$  as in Fig. 192. Take the lengths of the solid lines in Fig. 191, and measuring from point  $B^x$  in Fig. 192 place them on this line, like length  $5^o \times 5^o$  of Fig. 191 is  $B^x 5^o$  of Fig. 192, and so on. Erect vertical lines from these points and on the line from  $B^x$  place the lengths of the lines of half profile X of Fig. 191, like  $1 \times 1''$ ,  $2 \times 2''$  and  $3 \times 3''$ . On like numbered lines in Fig. 192 place the lengths

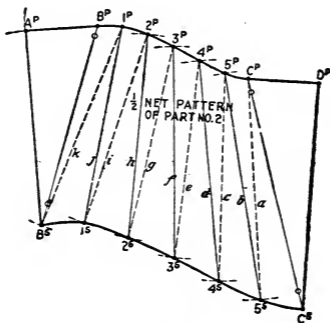

Fig. 194.

of the half profile X, like line  $33''$  of Fig. 191 is  $3^s''$  of Fig. 192. Connect proper points with lines, and to better distinguish them the solid and dotted lines have individual designators, as shown by the letters  $a$  to  $k$ . The sections for the dotted lines are constructed in the same manner and should be understood by referring to like numbers or letters in all the illustrations.

The half profiles X and W do not give the girth of piece No. 2 on the miter lines, and to find that girth it was customary to develop the true shapes of the piece on these

miter lines. However, as only the girths are required and as it is obvious that the miter cuts of the both collars must fit at the respective miters of piece No. 2, it is usual now to dispense with obtaining these true shapes and to measure the required girth from the miter cuts in the patterns of the collars, as explained later.

The pattern can now be developed by drawing, where convenient, a line equal in length to  $C^o \times C^o$  of Fig. 191, as  $C^S D^P$  of Fig. 194. At right angle to this draw a line from point  $D^P$  equal in length to  $DC$  of half profile  $W$  in Fig. 191. Draw line  $C^S C^P$ . With  $C^P$  as center and  $C'' 5^x$  of Fig. 193 as radius, describe a short arc which intersect by one described from point  $C^S$  of Fig. 194 as center and a radius equal to distance  $C^S 5^S$  of the pattern for collar No. 3 in Fig. 191, establishing point  $5^S$ . With point  $5^S$  as center and radius  $5^x 5'''$  of Fig. 192, describe short arc. Intersect this with one described with point  $C^P$  of Fig. 194 as center and a radius equal to  $C^P 5^P$  of the pattern of collar No. 1 in Fig. 191. Continue in this manner until point  $A^P B^S$  is reached, which completes the half pattern, always being sure to measure like spaces in the collar patterns for the spaces in the pattern Fig. 194, because they are all different, and observe that the length of the final line  $A^P B^S$  is taken from  $B^o \times$  to  $B^o$  of the elevation in Fig. 191, all as shown.

### PATTERNS FOR A Y BRANCH.

*To describe the pattern for a bifurcated object, circular at one end and branching into two smaller circular openings.*—These fittings are used quite extensively in the sheet metal trade, and of course the design can be adjusted to suit requirements or the taste of the designer. The same system of triangulation is used as for the preceding problem. A collar is shown at the larger end—collar  $S$ —but none at the branches; oftentimes collars are attached to these branches to facilitate the connecting of

the pipes to them. As the collars are merely circular bands the pattern for collar S is not shown, the pattern being just a rectangular sheet, its width  $1\phi S$  and its length the girth of the half profile W, Fig. 195.

As was stated, these designs are more or less arbitrarily

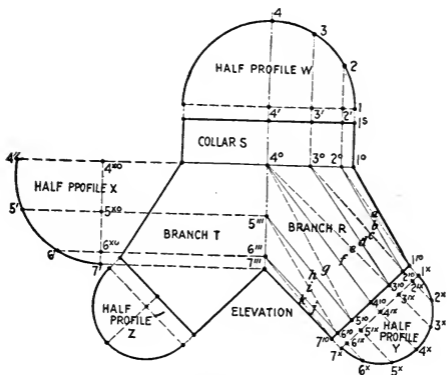

Fig. 195.

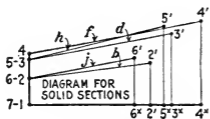

Fig. 196.

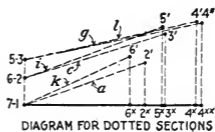

Fig. 197.

drawn. Therefore, assume that the collar S is as wanted in the matter of size and position and that branches T and R turn off at the angle required and that the half profiles Y and Z show the desired sizes and locations of the termini of the branches.

In this case both branches are alike and the object is of symmetrical halves, but these principles of pattern development, with but slight adjustment, are applicable to problems that have unlike branches and to problems that are non-symmetrical. Divide the half profile *W* into equal spaces from 1 to 4 as shown. Also divide the entire half profile *Y* into equal spaces, from 1<sup>x</sup> to 7<sup>x</sup>. Project these spaces in both half profiles to lines 4<sup>o</sup>1<sup>o</sup> and 7<sup>10</sup>1<sup>10</sup> as shown. Project lines from 4<sup>o</sup> and 7<sup>10</sup> to the left and erect a line as 7' 4<sup>xo</sup>. Also establish point 4'' as far from 4<sup>xo</sup> that 4' is from 4 in the half profile *W*. Sketch half profile *X* from 4'' to 7' at pleasure, as there are no geometrical restrictions

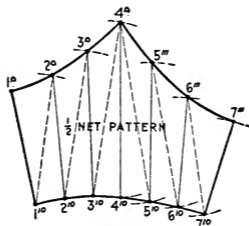

Fig. 198.

in its design other than that distance 4'' 4<sup>xo</sup> must equal 4 4', and distance 4<sup>xo</sup>7' must equal 4<sup>o</sup>7<sup>10</sup>. Divide profile *X* into three equal spaces and project them across locating, thus points 5''' and 6'''. Connect all the points as shown with dotted and solid lines as *a* to *k*.

Construct the diagrams of sections as heretofore, which will give the true lengths of the lines *a* to *k*. That is, all the lengths of the solid lines in branch *R*, Fig. 195, are placed on a horizontal line in Fig. 196. Then the spaces in profiles *W* and *Y* are placed on the vertical lines from these points; for instance, length of line 4<sup>10</sup> 4<sup>o</sup> in Fig. 195 is placed in Fig. 196 as 7-1 to 4<sup>x</sup>. Then space 4<sup>1x</sup>

4<sup>r</sup> of profile Y in Fig. 195 in space 1 to 4 of Fig. 196 and space 4 to 4' of profile W, Fig. 195 is space 4<sup>r</sup> 4' of Fig. 196, and so on. Do likewise for the dotted lines in Fig. 197 noting that the direction of the dotted lines change at 4<sup>o</sup> of Fig. 195, which was done to facilitate laying out the pattern, and be very careful that from 4 to 7 the spaces are taken from profile X from 4" to 4<sup>r</sup>, and so forth.

The pattern is developed in Fig. 198 by drawing line 1<sup>o</sup>1<sup>10</sup> equal in length to 1<sup>o</sup>1<sup>10</sup> of Fig. 195, then proceeding as explained in connection with the other problems. Spaces 1<sup>o</sup> to 2<sup>o</sup>, 2<sup>o</sup> to 3<sup>o</sup>, and 3<sup>o</sup> to 4<sup>o</sup> are taken from half profile W in Fig. 195, while spaces 4<sup>o</sup> to 5<sup>o</sup>", 5<sup>o</sup>" to 6<sup>o</sup>", and 6<sup>o</sup>" to 7<sup>o</sup>" in Fig. 198 are taken from half profile X in Fig. 195. The spaces 1<sup>10</sup> to 2<sup>10</sup>, and so forth, of Fig. 198 are all taken from the half profile Y in Fig. 195. Line 7<sup>o</sup>" 7<sup>10</sup> of Fig. 198 equals in length line 7<sup>o</sup>" 7<sup>10</sup> of Fig. 195, which completes the one-half net pattern of the branches, there being four like this required for the object.

### PATTERN FOR A TAPER JOINT.

*To describe the pattern of a frustum of scalene cone.*—Another system of triangulation is that used for developing the pattern of a scalene cone, and by scalene cone is meant an object similar to a cone, but having its apex (A of Fig. 199) not centrally located in respect to the center of the base (3', Fig. 199) like in a true cone. Being like a cone, though, the system for developing the pattern resembles the radical line system of developing cone patterns. One of the common articles made of sheet metal that can have their pattern developed by this process is the taper joint with a straight back, or as some call it, a reducing joint which is used for changing the diameter in piping. Should the difference in the two diameters be slight, however, this system would be impractical owing to the remoteness of apex A which would give a radius so long that it could not be swung within a reasonable

distance, in which case the system explained in connection with Fig. 185 would be employed.

Assume that 1 to 7 is a half plan view of the largest end of the joint and that  $1^x7^x$  is the diameter of the smallest end and that 1 to  $1^x$  is the height along the straight

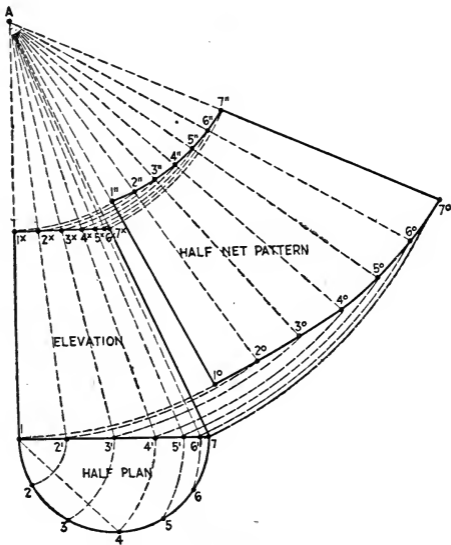

Fig. 199.

side. Then  $1^x, 7^x, 7, 1$  is the outline of the joint in elevation constituting a frustum of a cone in geometrical parlance. Continue lines  $11^x$  and  $77^x$  until they meet at the apex A. Divide the half plan into equal spaces as shown and using point one as center swing these points up to line 17. Then from 1 to  $2'$  and so forth are the bases of the



right-angled triangles and 1 to A the altitude, and therefore 2' to A the apex or the desired true length of the element line. To explain what is meant, refer to the plan where it will be seen that 1 to 4 is the plan view of that element of the scalene cone and is the base line mentioned. To save transferring it elsewhere and constructing a diagram of triangles, it is simply swung up to line 17 as shown.

Draw the element lines to the apex as shown, then with A as center swing arcs of indefinite lengths from points 1, 2' and so on. On the arc described from the point 1 establish the point 1°. With the dividers spaced to distance 1 to 2 of the plan and beginning at point 1°, step off to each succeeding arc the points 2°, 3°, 4°, 5°, 6° and 7°. Trace a line through these points which will be the bottom outline of the pattern. From these points draw lines as shown, to apex A. Indicate on line 1<sup>x</sup>7<sup>x</sup> in the elevation where the element lines cross, as 2<sup>x</sup> and so forth. Again using A as center, describe arcs from these points to intersect like numbered element lines in the pattern, thereby locating points 1'', 2'', and so forth. A line traced through these points will be the outline of the top of the pattern and completes the one-half net pattern of the object.

### FLAT SKYLIGHTS.

*To describe the patterns for a square framed object, with cross ribs for the support of glass, to admit light through a roof opening.*—One of the most important branches of the sheet metal industry is the making of skylights. There are numerous types of skylight, the simplest of which is one that is termed a flat skylight because it sets flat on the roof, the pitch of which coincides with the pitch of the skylight, so that proper drainage of the skylight perforces a slope in the roof adequate for this. This type of skylight is most always set on a raised roof curb, and it is possible to make the back, or rather, top curb a little higher than the bottom curb in case the slope

of the roof is not sufficient for drainage. Of course, this difference in height must not be much, or this type of skylight will not then fit the roof curb.

For flat skylights the pattern development is simple, but as the designs become more intricate, just so do the pattern problems become more complicated; still, in all types, the construction features present more formidable problems than the pattern development. A flat skylight, the dimensions of which are three feet by five feet has been chosen as an example, and in Fig. 200 is shown a scale

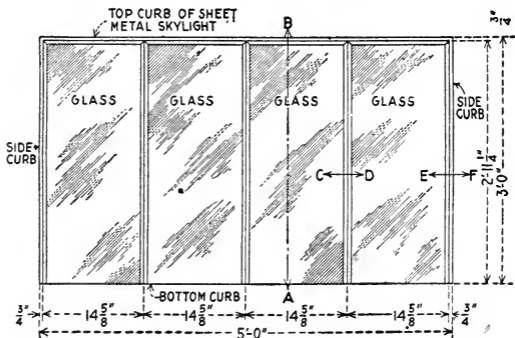
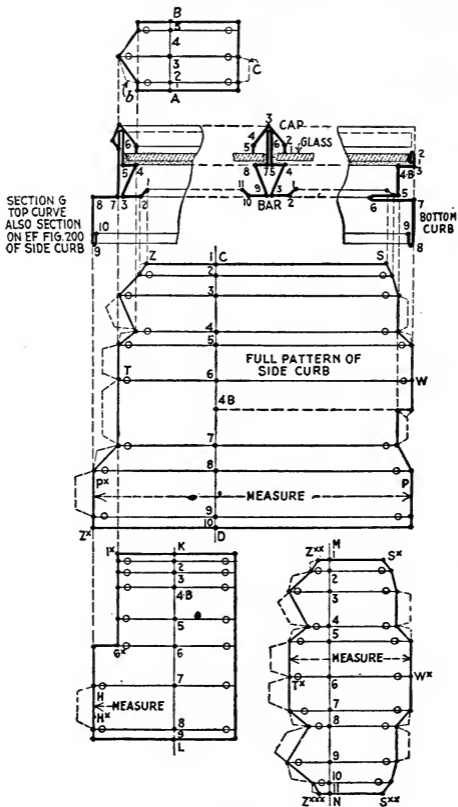

Fig. 200.

layout giving the spacing of the bars and such needed data. As will be seen, glass fourteen inches wide divides this skylight into suitable spaces so that the bars are spaced fourteen and five-eighth inches on center which allows the necessary play room of about one-quarter inch for the glass. Note that there is a three-quarter inch shoulder on the three sides of the skylight which accounts for the measurements as shown, and therefore the bar lengths would be thirty-five and one-quarter inches and the lights of glass fourteen by thirty-five inches.



The design of the skylight is shown in Fig. 201, and it should be understood that for very large skylights these parts would be reinforced by structural steel like, say, a flat band iron core within the bar. When designing the shapes of all types of skylights it is advisable, for economical reasons, to calculate the sizes of the various members so that the entire girth of the part will cut from the sheets without undue waste. The sections shown in Fig. 201 are a view of the skylight on line AB of Fig. 200 with the profile of the bar, which is a section on the line CD, Fig. 200, interposed between the profiles of the top and bottom curbs to show its relation to these, in the matter of glass rest lines, and so forth. It will be seen that these profiles have shoulders on which putty is spread for a bed for the glass and that the joint between the glass and sheet metal is further protected from the weather by sheet metal caps, shaped as shown.

The pattern of these caps is obtained by placing their girth—as 1 to 5—on line AB. The bottom cut of the bar cap is straight as per the solid line and the top cut also as per solid line. The cap for the side curb is the same pattern with the addition of the lap *b* (but not *c*). The cap for the top curb is also the same, except that its length is the distance between bars, and that both ends have a straight cut with the lap *c* on one end for connection to each other at the back. The top caps are held in place by soldering to the curb, while the side curb and bar caps are soldered to these, and at the bottom, say about six inches from the end, sheet copper cleats one inch wide and about two inches long are first soldered to the bar or side curb and then passed through a chiseled opening in the cap and then folded over.

The pattern of the side curb is obtained by placing the girth of section G on line CD as shown. Take the distance also from 5 to 4B of the bottom curb and place it from 7 to 4B on line CD. Draw parallel lines through these points and intersect with line dropped from the profiles, as shown.

This, then, with the laps as shown by dotted lines, is the pattern for the side curbs and for the skylight of Fig. 200, the distance on measuring points  $PP^x$  should be three feet. The pattern for the top curb has the miter cut at  $P^x$  of Fig. 201 on both ends, but without laps; that is, the solid line from  $Z$  to  $Z^x$  and the length between miters in the measuring point  $P^x$  (to  $P^x$ ) for the skylight of Fig. 200 will be five feet.

The pattern for the bottom curb is obtained by placing its girth on a line, as 1 to 9 on line  $KL$  of Fig. 201, and the parallel lines through these figures intersected by lines dropped from the section  $G$  of top curb. Observe that from  $1^x$  to  $6^x$  is a straight notch and that the rest of the miter is also a straight cut with but one lap as shown dotted; this is not exactly the way the miter cut is, according to the intersection of the bottom curb with the side curb, but is so cut because it makes a more rigid and easily assembled joint. Again observe that the miter cut is the same at both ends just like the top curb, and for the skylight of Fig. 200 the distance between miter cuts on point  $H$  (to  $H^x$ ) would be five feet.

The pattern for the bars is shown with its girth 1 to 11 on line  $MN$ . The miter cut (as well as the girth) from  $Z^{xx}$  to  $T^x$  to  $Z^{xxx}$  is the same as the miter cut from  $Z$  to  $T$  in the pattern of the side curb; this is for the miter of the bar to the top curb. The miter cut for the joint between the bar and the bottom curb is  $S^x$  to  $W^x$  to  $S^{xx}$ , and is the same as  $S$  to  $W$  in the pattern of the side curb. The length of this bar for the skylight of Fig. 200 would be thirty-five and one-quarter inches on the measuring line. Note that the length of the cap should be about one-eighth of an inch longer than the bars. This is all the patterns required and it should be understood that these patterns will answer for any size skylight by simply extending the distance between miter cuts as specified by a similar layout as Fig. 200.

## PATTERNS FOR A HIPPED SKYLIGHT.

To describe the patterns for a pyramid-shaped object the sides of which consist of sheet metal ribs and glass, for the admission of light and air through roofs.—Next to flat skylights, hipped skylights are the most important. Like the flat skylight they have a square frame or curb, but the sides are slanted so that these skylights can be placed on a perfectly flat roof. Just ordinary sheet metal shaped to the required profiles is strong enough for sky-

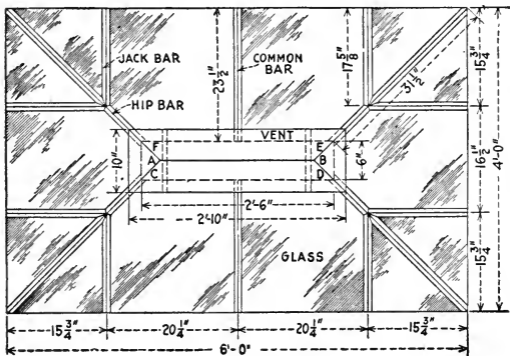

Fig. 202.

lights of medium size, and if they are exceptionally large the parts can be reinforced with structural steel shapes..

To allow ventilation of the inside of the building these skylights can be made with a ventilator like the scale layout of Fig. 202. If a greater amount of ventilation is wanted these skylights are superimposed on a turret frame of suitable height, the sides of which have either louver slats or pivoted sashes. Of course, these glass spaces of Fig. 202 can be made to suit the glass or hand, but the

layout shown is symmetrical and economical in glass. If there was a ridge bar (as line AB), all the bars would terminate against it and its length would be found by deducting the width of the skylight from its length, so that four feet from six feet means that this ridge bar (AB) would be two feet long. However, in this case there is a ventilator six inches wide and the bars terminate against its four sides which are the dotted lines CDEF. To find the length of this ventilator add six inches to the difference between the side and length of the skylight which, as stated for the ridge bar, is two feet, so two feet and six inches equal thirty inches, which is the length of the ventilator. Over this ventilator there is a hood to keep out the rain and snow, and this hood has two inches more projection all around than the ventilator, so that its dimensions are as shown.

By mathematical calculations it has been determined that for the pitch of a skylight used here for an example; that is, a pitch of six inches to a foot, for every inch shown in the plan layout, the actual length of the bar is 1.118 of an inch. Therefore, to find the true length of the common bar take one-half the width of the skylight, which is twenty-four inches, and multiply it by this factor. In this case, however, there is a ventilator, so three inches, or half the width of the ventilator, is subtracted from this twenty-four inches, which leaves twenty-one inches, and this times 1.118 is 23.478, or practically twenty-three and one-half inches. For the true length of the jack bar, multiply this factor by fifteen and three-quarter inches which is 17.6085, or practically seventeen and five-eighth inches. By the same mathematical calculation it was found that the hip bar is one-half inch more on the slant per inch than shown on the flat line of the common bar in plan, so that the factor for the hip bar is 1.5. Therefore, if a ridge bar is used instead of a ventilator, multiply this factor by twenty-four inches, but in this case there is a ventilator, so like for the common bar multiply by twenty-one inches

which is 31.5, or thirty-one and one-half inches, the true length of the hip bar.

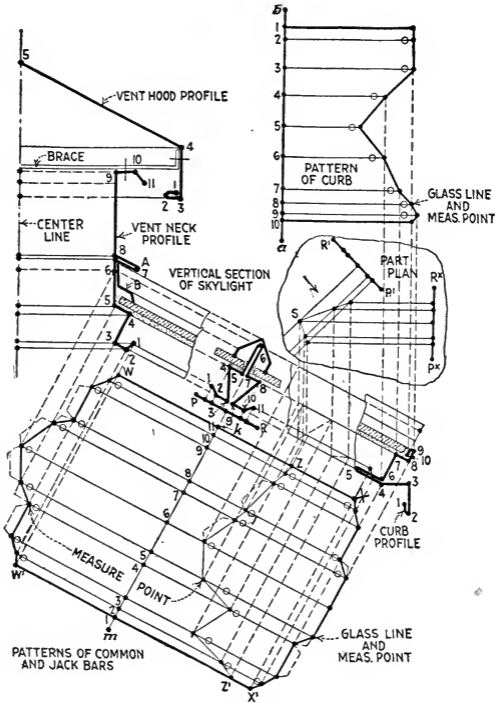

Fig. 203.

A section of the skylight is given in Fig. 203. Note the profile of the curb and how it is bent to conform to the



pitch of the skylight. Also see the relation of the bar and its cap to the curb and to the ventilator. This ventilator is essentially a half bar with an integral protection cap, A, which passes over both the bar and its cap and the half cap B, which is held in place by the thrust of the bar cap. The vent extends considerable above cap A to give space for a swinging damper inside of it and is a neck, so to speak, with the weather baffle edge on which is bolted a 1-8x1 inch band iron brace which is bent as shown and is

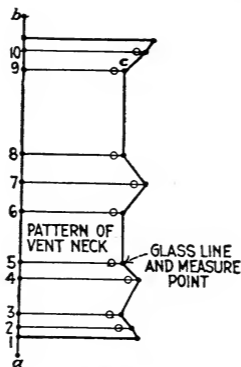

Fig. 204.

also bolted to the hood, the shape of which is clearly shown in the section.

In laying out the patterns for skylights and to measure the various parts, a certain line termed the glass line is taken as a basis to work on. This line passes through the different profiles and occurs in the curb profile at 8 and 7, in the bar profile at 4, 5, 7 and 8, and in the ventilator profile at 4 and 5.

With this understood, the patterns can be developed as

follows: For the curb place its stretchout 1 to 10 on a vertical line as *a, b*. Draw horizontal lines through these numbered points which intersect by lines projected up from

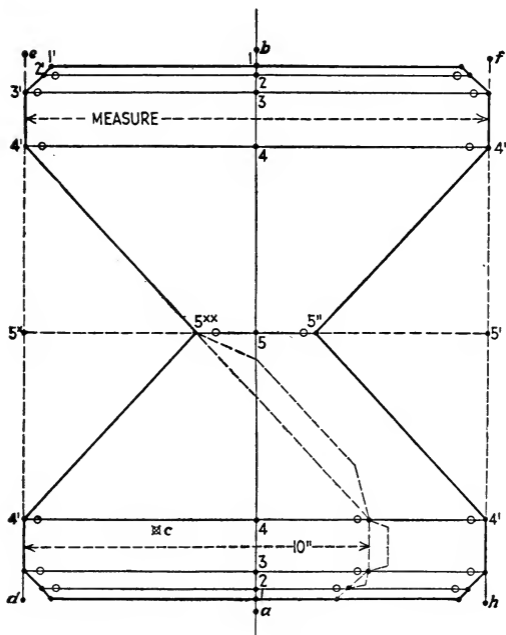

Fig. 205.

like numbered points in the profile, as shown. Note that the glass line and measuring point is on line 8 and for the layout of Fig. 202; two curbs would be cut with this miter

at both ends and six feet apart between the measuring points. Also two curbs four feet long, with laps provided all along the miter cut.

Sometimes for the want of room, patterns cannot be projected like this directly from the profile and must be developed elsewhere. Of course, a piece of paper could be tacked over the drawing and near the profile, but in this case the stretchout of the ventilator was placed on line *a b* in Fig. 204, and the projection distances from the center line in Fig. 203 carried to and placed from the line *a b* in Fig. 204. This, then, is the one-half pattern for the six-inch ends of the ventilator, and by doubling over on line *a b* the full pattern is produced. For the two ends laps should be allowed all along the miter cuts, and for the sides of the vent cut two of these patterns without laps and two feet, six inches between miter cuts on the measuring point shown on line 5. Also on this line indicate by a sharp punch mark the position of the common bars which happens to be in the center, according to the layout of Fig. 202. Again, locate and punch the holes for the braces as at *c* of Fig. 204, and speaking once more of the curb patterns always locate the position of the bars on the glass line by sharp punch marks.

The hood pattern is shown in Fig. 205 and is developed by placing its girth or stretchout on a line as *a b*, 1 to 5 and back to 1. Parallel to this line and at convenient distances from line *a b* draw two lines as *d e* and *f h*. Take the distance from the center line in Fig. 203 to point 4 and place it from these two lines *d e* and *f h* in Fig. 205 as  $5^x$  to  $5^x$  and  $5'$  to  $5''$ . Indicate points  $4'$  and draw the solid lines as shown. The rest of the miter cut as  $4'$  to  $3'$  is a straight line, then a line at 45 degrees from this point to  $2'$  and  $1'$ , as shown. This, then, is the pattern for the hood and brace holes should be located as at *c* and the distance between measuring points, for the layout of Fig. 202 should be two feet ten inches. The two heads or ends are devel-

oped by reversing the miter at  $4' 5^{xx}$  and should measure ten inches between miter cuts, and laps should be allowed all around as shown dotted.

Before the common bar pattern is developed, it is necessary to indicate on the vertical section the intersection of the jack bar with the hip bar. Therefore, in Fig. 203 place a line as PR below the bar profile and project the points of the bar down to it so as to have the widths of the bar. This line PR with these points is placed in a vertical position as at  $P^xR^x$ , also at  $P'R'$ , at an angle of 45 degrees as shown. Draw lines from  $P'R'$  at an angle of 45 degrees, which represents the hip bar in plan (only half is needed). Intersect these lines by like lines drawn horizontally from  $P^xR^x$  and project these intersection points to the vertical section which will indicate the intersection of the jack bar with the hip bar in elevation. Place the girth of the bar on line  $km$  drawn at right angles to the glass line in elevation and intersect the parallel lines drawn at right angle to line  $km$  and through the point 1 to 11, by lines projected as shown, from the vent profile, the jack bar intersection and the curb profile. Then the miter cut (with the laps shown dotted) X to X' is the bottom cut for both the jack and the common bars, and the cut Z to Z' is the miter cut of the jack bars to the hip bars, while the miter cut W to W' is for the common bar connection to the ventilator. For the layout of Fig. 202, extend the miter cuts on the measuring cuts as much as directed by the indicated lengths of the bars. Cap B has no miter cuts and the caps over the jacks and common bars would be laid out in the same manner as the bar patterns were.

To lay out the hip bar patterns a view of it must be obtained looking square at it along the arrow S in the part plan of Fig. 203. To do that in the diagram of Fig. 203 would criss-cross so many lines that it would be confusing, so a new elevation is drawn; that is, just as much

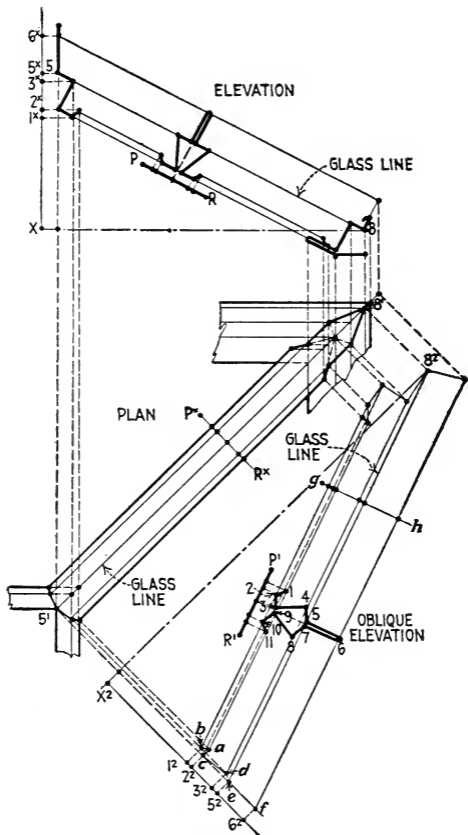

Fig. 206.

as needed, in Fig. 206. From the glass line point 8, in the curb profile, draw the horizontal line 8X, and then at an angle of 45 degrees draw this glass line in elevation 8, 5, as 8' 5', and by projecting lines to this from the different points in the profiles of the ventilator and curb a plan view of these parts is obtained, as shown. Place the line PR (shown in elevation) in the plan as P<sup>x</sup>R<sup>x</sup>, and draw lines through its points to intersect the curb and ventilator as shown, which will complete the plan view of the hip bar.

Parallel to the glass line in plan 8' 5', draw the base line

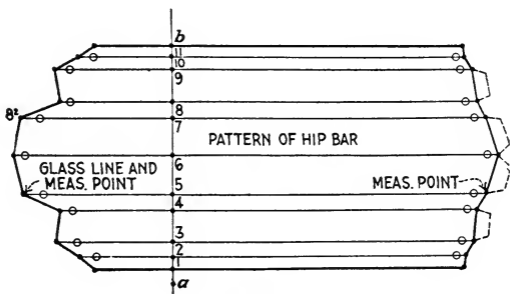

Fig. 207.

of the elevation X8 as X<sup>2</sup>8<sup>2</sup>, and erect a line at right angles to it from point X<sup>2</sup> as shown. On this line place the heights in elevation as X to 1<sup>x</sup>, X to 2<sup>x</sup> and so forth and as shown by X<sup>2</sup> to 1<sup>2</sup>, to 2<sup>2</sup> and so forth. At right angles to line X<sup>2</sup> 6<sup>2</sup> draw lines from the points on it to intersect like lines from the plan. Indicate these intersection points by the characters a to b, and so forth. Draw glass line 8<sup>2</sup> to e, and parallel to it draw lines from points a to f which intersect by projector line from the curb point of the hip bar in plan which completes the oblique elevation of hip bar and is a view of it along arrow S in Fig. 203.

The profile of the hip bar is modified in its relationship to the profile of the common bar and its true profile is obtained by this procedure. Place PR in elevation as P'R' in the oblique elevation, and project lines upward to intersect the proper lines as shown. Then, where these lines intersect as 1 to 11, draw lines which will be the true profile of the hip bar.

The pattern for the hip bar can now be laid out from this oblique elevation by projecting to a stretchout as was done for the common and jack bar, but for the want of room it is developed in Fig. 207 by placing the stretchout 1 to 11 of the true profile in the oblique elevation, in line *ab* and the usual parallel lines drawn through these points. Draw a line as *gh* in the oblique elevation of Fig. 206, and then measuring from it to the end, as, say, to 8<sup>2</sup>, carry the distances and place them from line *ab* in Fig. 207 as, say, 8 to 8<sup>2</sup>, and do the same for the upper miter cut. Fig. 207 is then the pattern for the hip bar, and only those laps need be provided which are shown dotted. Note where the glass line and measuring points are, and according to the layout of Fig. 202, the distance between these two measuring points is to be thirty-one and one-half inches. The cap for the hip bar is developed precisely as per the process for the hip bar.

It is well to remark that that part of the bar as 1, 2, 3 and 9, 10, 11 of Fig. 203, and 1, 2, 3 of the ventilator, and 4, 5, 6 of the curb, and 1, 2, 3 and 9, 10, 11 of the hip bar of Fig. 206 are utilized to catch the drip from the condensation on the glass or a possible leakage of the putty joint. Any water falling into this part of the bar will flow to the curb, and holes should be punched at intervals between the bars at 6 of the curb so that these waters will drain to the outside.

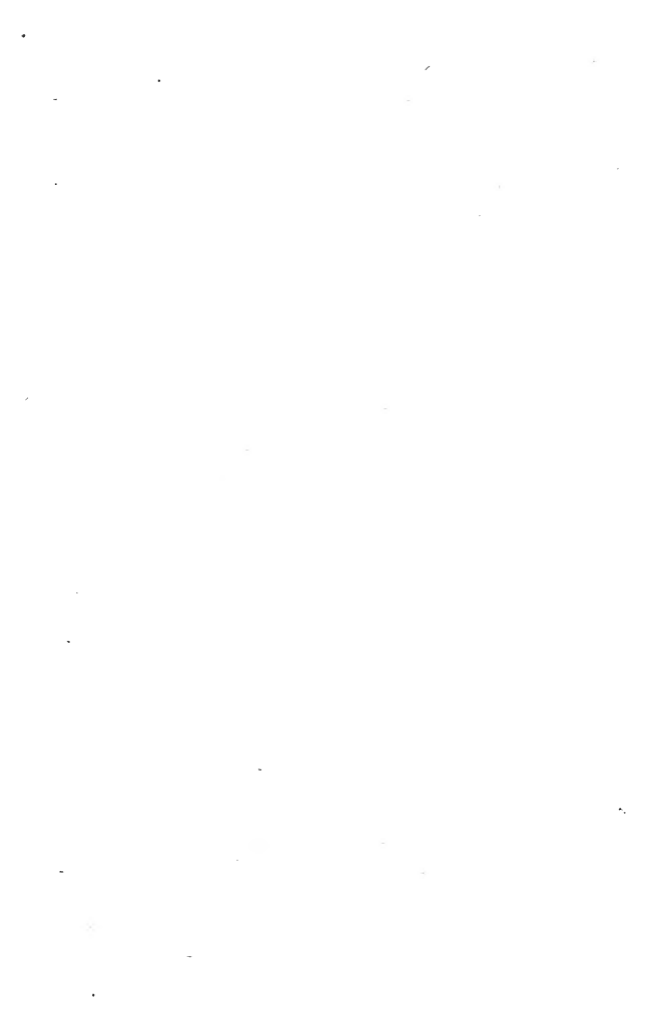



# INDEX

---

- Absorbent or radiating and reflecting powers of substances, 150.  
Acid, dipping, 246, 247.  
Addition, sign of, 110.  
Aich or sterro-metal, 225.  
Air, 157-159.  
    density or weight of, 157, 158.  
    effects produced by, 157.  
    pressure of, 157.  
    specific heat of, 158.  
    table of the expansion of by heat, 158.  
Alcohol, 190.  
Alloy, melting point of an, 223.  
Alloys, characteristics of, 223.  
    fusing points of metals and other elements employed in, 148.  
    important metallic, 223-235.  
    of copper and tin, 226-230.  
    of copper and zinc, 224, 225.  
    of copper, zinc and nickel, 230.  
    of the noble metals, 232.  
    readily fusible, 231.  
    various, 232-235.  
Aluminium bronze, 229, 230.  
    bronze, solder for, 237.  
    solders for, 236, 237.  
Amber, 188.  
    varnishes, 198-200.  
American lap weld iron boiler flues, 169.  
Ammonia-shellac cement, 219, 220.  
Angle at centre, definition of, 113.  
    at circumference, definition of, 113.  
    right, to trisect a, 99.  
    to bisect any given, 98.  
Angles, table of, relative to the construction of regular polygons, 113.  
Anime, 188.  
Apparatus, impervious cement for, 222.  
Aquarium stand, pattern for an, 53-56.  
Aqueduct pipes or fountains, calibre and weights of, 169.  
Arc, definition of an, 114.  
    of a circle, to find the length of any, 115, 116.  
    or segment of a circle of large radii, to describe an, 101.  
Arch, elliptic, to describe an, 102.  
Architectural ornaments, cement for making, 217.  
Area and circumferences of circles, 127-134.  
Argentan, 230.  
Arithmetical signs, definition of, 110.  
Armenian or diamond cement, 215, 216.  
Art-bronze, 226.  
Atmosphere, pressure of one, 157.  
Balloons, varnish for, 209.  
Band saws, small, to join, 239.  
Bar for hipped skylight, design and patterns for, 312.  
Bars, absolute strength of, 264.  
    in hipped skylight, finding length of, 310.  
    of metal, cohesive power of, 269.  
Base, chimney, pattern for, 283.  
    to find the, 112.  
Bath, hip or sitz, plan of a 20-23. metal, 233.  
    oblong taper, plan of a, 18-20.  
Beam, power of suspension of a, 267.  
Beams, strength of, 262-264.  
Bearing metals for locomotives, 232, 233.  
Bell metal, 226, 232.  
Bells of clocks, metal for, 232.  
Belting, broken, to repair, 261, 262.  
    hose, etc., rivet metal for, 233.  
Benzoin, 188.  
Bifurcated object, circular at one end and branching into two smaller circular openings, pattern for, 300.  
Black grounds, 181, 182.  
    japan, 182, 184.  
    japan varnish, 210.

- Black varnish, 200.  
 Blades, cement for fastening, 222.  
 Blanched copper, 234.  
 Blue japan grounds, 182.  
 Bodies, mensuration of solids and capacities of, 119-122.  
     specific gravities of technically important, 146, 147.  
 Boiled oil or linseed-oil varnish, 208.  
 Boiler cover, oval, 89.  
     flues, American lap weld iron, 169.  
 Boilers, cement for, 217.  
 Boot, furnace, pattern for, 290.  
     offsetting furnace, pattern for, 296.  
 Borax for brazing, to prepare, 239.  
 Bottle corks, cement for, 218.  
 Branch "Y", pattern for, 300.  
 Brass and copper, galvanizing of, 254.  
     and copper, to tin, 252.  
     and similar alloys, 224, 225.  
     best lacquer for, 213.  
     best red, for fine castings, 232.  
     bronzed, lacquer for, 212.  
     cast, dipping acid for, 247.  
     cement for fastening, to glass vessels, 222.  
     cohesive power of bars of, 269.  
     dipped, gold-colored lacquer for, 212, 213.  
     dipped, lacquer for, 212.  
     etching solution for, 259.  
     good lacquer for, 213.  
     hard, for casting, 232.  
     lacquer, pale, 211.  
     not dipped, gold colored lacquer for, 212.  
     olive bronze dip for, 248.  
     or iron, bronze paint for, 248.  
     ormolu dipping acid for, 247.  
     ormolued, dipping acid for, 246.  
     pale lacquer for, 213.  
     red, for turning, 232.  
     red lacquer for, 213.  
     rolled, 232.  
     solder, soft, 240.  
     stamps, ink for, 261.  
     to temper or to draw its temper, 151.  
     vinegar-bronze for, 247, 248.  
     weight of a square foot of, 171.  
     work, to prepare for ormolu dipping, 247.  
 Brass, yellow, for turning, 232.  
 Brazing, borax to prepare for, 239.  
 Bridges, greatest load on, 262.  
 Bristol metal or Prince metal, 225.  
 Britannia metal, 230, 231, 233.  
     ware, raised, white solder for, 236.  
 British gum, or dextrine, 245.  
 Bronze, 226.  
     aluminium, 229, 230.  
     aluminium, solder for, 237.  
     art, 226.  
     cobalt, 228, 229.  
     dip, aquafortis, 248.  
     dip, brown, 248.  
     dip, green, 248.  
     dip, olive, for brass, 248.  
     for all kinds of metals, 248.  
     for gilding, 234.  
     manganese, 227, 228.  
     paint for iron or brass, 248.  
     paint, brown, for copper vessels, 248.  
     phosphor, 227.  
     silicon, 227.  
     steel or Uchatius, 226.  
     upon tin and tin alloys, 249, 250.  
     vinegar, for brass, 247, 248.  
 Bronzing gas fixtures, 250, 251.  
     gun-barrels, 248.  
     plaster of Paris figures, 251.  
 Brown and Telford, experiments by, 269.  
     hard spirit varnishes, 197.  
 Brunswick black, 182.  
 Building, pipe to fit the side of the roof of a, 74, 75.  
 Bullet metal, 233.  
 Busts and statuettes, plaster of Paris, to cleanse, 251.  
 Butt and mitre joints, 242.  
 Cabinet makers, varnish for, 200.  
     varnish, 195.  
 Cable chain, steel-linked, strength and weight of, 274.  
     chains, breaking weight of, 272, 273.  
 Calico printing, coppering of iron rollers for, 251, 252.  
 Can top or deck flange, to describe a, 2, 3.  
 Carriages, varnish for certain parts of, 200.

- Casks and cisterns, cement for, 221.
- Casting, hard brass for, 232.  
to obtain the weight of the,  
from that of the pattern,  
174, 175.
- Castings, cement for holes in, 218.  
fine, best red brass for, 232.  
shrinkage of, 175, 176.
- Cast-iron cement, 249.  
-iron, effect of remelting on  
the strength of, 279, 280.  
-iron, expansion of, 174.  
-steel, composition used in  
welding, 249.
- Casts, compound for, 259, 260.
- Cement, Armenian or diamond,  
215, 216.  
cheap, 218.  
china, 218.  
for bottle corks, 218.  
for cast-iron, 249.  
for cisterns and casks, 221.  
for copper-smiths and engi-  
neers, 218.  
for cracks in wood, 221, 222.  
for earthen and glassware,  
216.  
for electrical and chemical ap-  
paratus, 217.  
for fastening blades, files, etc.,  
222.  
for fastening brass to glass  
vessels, 222.  
for fractured bodies of all  
kinds, 221.  
for holes in castings, 218.  
for iron pots and pans, 220,  
221.  
for iron tubes, boilers, etc.,  
217.  
for ivory, mother of pearl, etc.,  
218.  
for joining metal and wood,  
222.  
for leather, 220.  
for making architectural orna-  
ments, 217.  
for marble workers and cop-  
per-smiths, 220.  
for stoneware, 216.  
for stone structures, 219.  
gasfitters', 222.  
good, 220.  
impervious for apparatus,  
corks, etc., 222.
- Cement, iron-rust, 216, 217.  
Keene's marble, 223.  
London mastic, 222, 223.  
Lowitz's, 223.  
marble, 220.  
Martin's, 223.  
metallic, 238.  
paint, hydraulic, 222.  
Parian, 223.  
plumbers', 218.  
roofing, 219.  
Sorel's, 222.  
Sorel's magnesia, 222.  
transparent, for glass, 220.  
varnish for water-tight luting,  
200.
- Cements, miscellaneous, 215-223.
- Chains, strength of, 272-274.
- Chemical and electrical apparatus  
cement, 217.
- Chimney base, pattern for, 283.
- China cement, 218.
- Chord, definition of a, 114.
- Chrysochalk, 225.
- Chryсорin, 225.
- Circle, general rules in relation to  
the, 114, 115.  
of greater diameter in a tri-  
angle, 106, 107.  
of large radii, to describe an  
arc or segment of a, 101.  
or radius, to find the centre of  
a, 100.  
the, and its sections, 113, 114.  
to draw a tangent to a, 100.  
to draw lines tending towards  
the centre of a, 100.  
to describe a triangle in a, 99.  
to inscribe any in a, 103.  
to inscribe semicircles in a, 108.  
to find the area of a segment  
of a, 116.  
to find the area of the sector  
of a, 116.  
to find the centre of a, 99.  
to find the length of any arc  
of a, 99, 100, 115, 116.  
to find the diameter of a, 115.  
to form a, equal in area to an  
ellipse, 104.  
to form a triangle, equal in  
area to a, 105, 106.
- Circles, concentric, area of space  
between two, 117.  
tables of the circumference  
and area of, 127-134.

- Circular ring, to find the area of a, 117.  
 roofs, etc., covering of, 30, 31.  
 top and rectangle base, pattern for a tapering article with, 44.  
 top and square base, pattern for a tapering article with, 41, 42.
- Circumference and area of circles, tables of the, 127-134.
- Cisterns and casks, cement for, 221.
- Clocks, metal for bells of, 232.
- Coach varnish, 200.
- Coaches, fine black varnish for, 210.
- Coachmakers, best body copal varnish for, 195, 196.
- Cobalt bronze, 228, 229.
- Cock metal, 233.
- Coffee pots, sizes of, 135.
- Collar, roof, square to round, pattern for, 285.
- Colophony, 188.
- Coloring metals, cheap and quick method of, 254, 255.
- Colors and temperature in tempering, 151.
- Column, strength of a, 264.
- Columns, strength of, 268.
- Compasses and rule, to draw an ellipse with the, 92, 93.
- Cone, contents in U. S. standard gallons of the frustum of a, 121.  
 frustum of a, sizes of tinware in the form of, 135, 136.
- Cone, frustum of scalene, pattern for, 303.  
 or pyramid, to find the convex surface of a frustum of a, 118.  
 or pyramid, to find the solidity of a, 120.  
 pattern or envelope for a frustum of a, 3, 4.  
 right, or pyramid, to find the convex surface of a, 118.  
 to describe a frustum of a, 1, 2.  
 to describe an envelope for a, 1.  
 to find the radius and versed sine for a frustum of a, 95, 96.  
 to find the solidity of a frustum of a, 120, 121.
- Copal, 188, 189.
- Copal polish, 196.  
 varnish, 180, 181.  
 varnish, best body, for coach-makers, etc., 195, 196.  
 varnish for inside work, 195.  
 varnish, japanners', 184.  
 varnishes, 193-195.
- Copper and brass, galvanizing of, 254.  
 and brass, to tin, 252.  
 blanched, 234.  
 bolts, weight of, 126.  
 cohesive power of bars of, 269.  
 silvering powder for, 246.  
 -tin alloys, 226-230.  
 to separate silver from, 249.  
 vessels, brown bronze paint for, 248.  
 weight of, 125, 126.  
 weight of a square foot of, 171.  
 -zinc alloys, 224, 225.  
 -zinc alloys, color of, 225.  
 -zinc alloys, composition of various, 225.  
 zinc and nickel, alloys of, 230.
- Coppering of iron rollers for calico printing, 251, 252.
- Coppersmiths and engineers, cement for, 218.  
 and marble-workers, cement for, 220.
- Cords, hempen, strength of, 266.
- Corks, impervious cement for, 222.
- Cornice, OG, pattern for a mitre joint for a, 50-52.
- Cover or lamp top, octagon OG, pattern for a, 52, 53.  
 or top, octagon or square, 90, 91.  
 or top, tapering octagon, pattern for, 46, 47.  
 steamer, to describe a, 91, 92.
- Cramp joint, 243.
- Crane chain, strength and weight of, 273, 274.
- Crushing load, average of different materials, 280.
- Crystal varnishes, 205.
- Cubed, to be, sign of, 110.
- Cubical form, solidity and capacity of any figure in the, 119.
- Curb for skylight, design and pattern for, 312.
- Cylinder, hollow, strength of a, 264.  
 power of suspension of a, 267, 268.

- Cylinder, to find the convex surface of a, 118.
- Cylinders, capacity of, in U. S. gallons, 137-145.  
to find the solidity of, 119, 120.
- Cylindroid, definition of a, 37.
- Dammar, 189.  
varnish, 208.
- Decimal equivalents of the fractional parts of a gallon, 143.  
equivalents to fractional parts of lineal measurement, 108, 109.
- Deck flange or can top, to describe a, 2, 3.
- Delta metal, 228.
- Dextrine or British gum, 245.
- Diameter of a circle, 113.
- Diamond or Armenian cement, 215, 216.
- Dippers, sizes of, 135.
- Dipping acid, 246, 247.
- Dish kettles and pails, sizes of, 135.
- Division, sign of, 110.
- Dome, to ascertain the outlines of a course of covering to a, 33.  
to cover a, 31, 32.
- Double offsetting transition fitting with square base and round top, pattern for, 289.
- Drills, to temper, 151, 152.
- Driving boxes, locomotive brasses for, 233.
- Druggists' and liquor dealers' measures, 136.
- Duleau's and Tredgold's experiments, 266.
- Earthenware, cement for, 216.
- Earths and stones, specific gravity of, 146.
- Elbow at right angles, 78, 79.  
in five sections, pattern for an, 84-87.  
in four sections, pattern for an, 82-84.  
in three sections, pattern for an, 80, 81.  
pattern at any angle, 79, 80.  
tapering, pattern for an, 87, 88.
- Elbows, 78-88.
- Electrical and chemical apparatus cement, 217.
- Electro-plating pewter surfaces, 255, 256.
- Electrum, 230.
- Elemi, 189.
- Elements and metals, fusing points of, 148.
- Ellipse or oval, to describe an, 92.  
or oval, to find the area of an, 117.  
or oval, to find the circumference of an, 117.  
to draw an, with the rule and compasses, 92, 93.  
to find the centre and the two axes of an, 94, 95.  
to form a circle equal in area to an, 104.
- Elliptic arch, to describe an, 102.
- Enamel for watch faces, 257.
- Enameling metals, 256, 257.
- Engineers and copper-smiths, cement for, 218.
- England, manufacture of tin plate in, 159-162.
- Engravings, maps, etc., varnishes for, 204.  
or lithographs, varnish to fix, on wood, 204.
- Envelope for a cone, 1.
- Equality, sign of, 110.
- Essence varnishes, 191.
- Etching solution for brass, 259.  
varnishes, 204.
- Expansive metal, 234.
- Eytelwein's experiments on the strength of columns, 268.
- Fairbairn and Hodgkinson, experiments by, 269.
- Figure having straight sides and semicircular ends, to draw a, 96.  
right-lined, quantity of surface in, 110, 111.
- Files, cement for fastening, 222.  
resharpening of, 261.
- Fish-kettle, pattern for, 17, 18.
- Fitting, double offsetting transitional, with square base and round top, pattern for, 289.  
furnace boot, top an oval and base a circle, pattern for, 290.  
offsetting transition, with square base and round top, pattern for, 287.  
transitional, having base rectangular and top circular, situated off centre in respect to base, pattern for, 287.

- Flange for a pipe, pattern for a, 89, 90.
- Flat skylights, 305.
- Flexible varnish, 207.
- Floors, least load on, 262.
- Fluids, specific gravity of, 147.
- Folded angle joint, 242.
- Fountains or aqueduct pipes, calibre and weights of, 169.
- French polish, to, 202, 203.
- Fruit cans, sealing wax for, 246.
- Frustum of a cone, 1, 2.
- of a cone, contents in U. S. standard gallons of the, 121.
  - of a cone or pyramid, to find the convex surface of a, 118.
  - of a cone, pattern or envelope for a, 3, 4.
  - of a cone, sizes of tinware in the form of, 135, 136.
  - of a cone, to find the radius and versed sine for a, 95, 96.
  - of a cone, to find the solidity of a, 120, 121.
  - of an oblique pyramid, to describe a, 23-28.
  - of a pyramid, solidity of the 121.
  - of a scalene cone, pattern for, 303.
- Fusing points of metals and other elements, 148.
- Furnace boot, offsetting, pattern for, 296.
- pattern for, 290.
- Furniture cream, 203.
- gloss, 203.
  - oils, 203.
  - pastes, 203.
  - polishes, 203.
  - varnishes for, 201, 202.
- Gallon, decimal equivalents of the fractional parts of a, 143.
- Gallons, capacity of cylinders in 137-145.
- Galvanized iron, 166-169.
- Galvanizing brass and copper, 254.
- Gas bags, varnish for, 209.
- fitters' cement, 222.
  - fixtures, to bronze, 250, 251.
  - pipes, diameter and length of, 172.
- Geometry, practical, 97-109.
- German silver, 230.
- Germany, manufacture of tin plate in, 162, 163.
- Gilded articles, Watin's varnish for, 200, 201.
- Gilding, bronze for, 234.
- Glass, cutting of, 244, 245.
- transparent cement for, 220.
  - vessels, cement for fastening brass to, 222.
- Glassware, cement for, 216.
- Globe or sphere, to find the convex surface of a, 119.
- Glue, marine, 245.
- Glues, liquid, 245, 246.
- Gold and silver lace, to polish, 257, 258.
- Gold, artificial, 234, 235.
- lacquer, 211.
  - solder for, 236.
  - solvent for, 249.
  - varnish, 209.
  - varnish, imitation of, 260.
- Gravers, to temper, 152.
- Gravity, specific, 145-147.
- Green japan grounds, 183.
- Gum copal, 180, 181.
- Gun-barrels, browning of, 246.
- barrels, to bronze, 248.
  - metal, 226.
  - metal, cohesive power of bars of, 269.
- Gutta-percha varnish, 208.
- Gutters, patterns for a mitre joint for, 47-50.
- semicircular, 166.
- Harness, black varnish for, 208.
- Heat, 147-150.
- conducting power, internal, of bodies, 149.
  - expansion of metals by, 149.
  - latent, 148.
  - specific, definition of, 147.
  - specific, of air, 158.
  - specific, of water, 156.
  - table of effects of, upon bodies, 149.
  - table of the expansion of air by, 158.
  - unit of, 147, 148.
- Hempen cords, strength of, 266.
- rope, rule for finding the weight capable of being supported by a, 266.
  - ropes, strength and weight of 275, 276.
- Hip bar for skylight, true elevation of, 317.
- Hip-bath or sitz-bath, plan of a, 20-23.
- Hipped-roof, covering of a 33-40.
- skylight, patterns for, 310.
  - skylight, scale layout of, 310.

- Hodgkinson and Fairbairn, experiments by, 269.
- Hood, pattern of a, 28-30.
- Hose, belting etc., rivet metal for, 233.
- House painting and japanning; wainscot varnish for, 209.
- Hydraulic applications, principle of, 158.
- Impressions, metal for taking, 233.
- India-rubber varnishes, 206-208.
- Ink for brass stamps, 261.  
indelible, for stamps, 261.  
red, for rubber stamps, 260.
- Inks for marking tinware, 260.
- Instruments, varnish for, 201.  
philosophical, lacquer for, 213.
- Iron and steel, brown tint for, 256.  
and steel, soldering of, 239-241.  
and steel, varnishing articles of, 197, 198.  
cast and malleable, relative strength of, 269.  
cast, effect of remelting on the strength of, 279, 280.  
cast, expansion of, 174.  
cast, strength of beams of 262.  
cohesive power of bars of, 269.  
flat rolled, weight of, 123, 124.  
galvanized, 166-169.  
or brass, bronze paint for, 248.  
pots and pans, cement for, 220, 221.  
rollers for calico printing, coppering of, 251, 252.  
round rolled, weight of, 124, 125.  
-rust cement, 216, 217.  
saucepans, to tin, 252, 253.  
sheet, weight of a square foot of, 171.  
square rolled, weight of, 123.  
tubes, cement for, 217.  
wire ropes, strength of, 275.  
work, black, 210.  
work, black varnish for, 198.  
work, varnish for, 198.  
wrought, expansion of, 174.  
wrought, strength of a bar of, 262.  
wrought, weight of, 125, 126.
- Ivory, cement for, 218.
- Japan, black, 182-184.  
black, for leather, 184.  
finishing, 186, 187.
- Japan, ground, white, 179, 180.  
grounds, blue, 182.  
grounds, green, 183.  
grounds, purple, 183, 184.  
scarlet, 182, 183.  
19.
- Japan, tortoise-shell, 184, 185.  
transparent, 184.  
work, painting of, 185.
- Japanese lacquer, imitation of, 214, 215.
- Japanners' copal varnish, 184.
- Japanning and house painting, wainscot varnish for, 209.  
and varnishing, 178-187.
- Joint, taper, pattern for, 303.
- Joints, 241-244.
- Journal boxes, metal for, 232.
- Keene's marble cement, 223.
- Lac, 189.
- Lace, gold and silver, to polish, 257, 258.
- Lacquer, 192, 193.  
best, for brass, 213.  
color for, 213.  
deep gold-colored, 211, 212.  
directions for making, 212.  
for bronzed brass, 212.  
for dipped brass, 212.  
for philosophical instruments, 213.  
for tin, 211.  
gold, 211.  
gold-colored, for dipped brass, 212, 213.  
gold-colored, for brass not dipped, 212.  
good, 213.  
good, for brass, 213.  
Japanese, imitation of, 214, 215.  
pale, for brass, 211, 213.  
pale, for tin plate, 213.  
red, for brass, 213.  
red spirit, 211.  
varnish, 211.
- Lacquers, 211-215.  
for pictures, metal, wood or leather, 212.  
soap, 213, 214.
- Lamp top or cover, octagon OG, pattern for, 52, 53.
- Lamps, pipes for services for, 172.
- Lap joint, 242, 243.  
weld iron boiler flues, 169.

- Latent heat, 148.  
heat of various substances, 148.
- Lead pipe, calibre and weight of, 170.
- Lead pipes, drawn, strength of, 276, 277.  
to recognize a content of, in tin, 163.  
weight of, 125, 126.
- Leather, cement for, 220.  
japan black for, 184.  
lacquers for, 212.  
varnish, 210.
- Line, direct, to obtain the length of any, 102, 103.  
to bisect a, 97.  
to divide a, into equal parts, 98.
- Lineal measurement, decimal equivalents to fractional parts of, 108, 109.
- Linseed oil, 190.  
oil or boiled oil varnish, 208.
- Lipowitz's alloy, 231.
- Liquation, 224.
- Liquor dealers' and druggists' measures, 136.
- Lithographs and paintings, varnishes for, 204.  
or engravings, varnish to fix, on wood, 204.
- Load, average crushing, of different materials, 280.
- Locomotive driving boxes, brasses for, 233.  
side rods, brasses for, 233.
- Locomotives, bearing metals for, 232, 233.
- London mastic cement, 222, 223.
- Lowitz's cement, 223.
- Luting, water-tight, cement varnish for, 200.
- Machines, models proportioned to, 264, 265.
- Mahogany varnish, 200.
- Manganese bronze, 227, 228.
- Mannheim gold, or similor, 225.
- Manufacture of tin plate, 159-163.
- Maps, engravings, etc., varnishes for, 204.
- Marble cement, 220.  
workers and coppersmiths, cement for, 220.
- Marine glue, 245.
- Martin's cement, 223.
- Mastic, 189, 190.  
cement, London, 222, 223.  
Varley's, 217.
- Mastic varnishes, 206.
- Materials, different, table showing the average crushing load of, 280.  
strength of, 262-281.  
tables of strength of, 272-281.
- Measurement, lineal, decimal equivalents to fractional parts of, 108, 109.
- Measures, druggists' and liquor dealers', 136.  
sizes of, 136.
- Mensuration of solids and capacities of bodies, 119-122.  
of surfaces, 110-119.
- Metal and wood, cement for joining, 222.  
cohesive power of bars of, 269.  
expansive, 234.  
for taking impressions, 233.  
lacquers for, 212.  
lateral strength of a beam or bar of, 263, 264.  
plate work, seams or joints used in, 241-244.
- Metallic alloys, 223-235.
- Metals and other elements, fusing points of, 148.  
bronze for all kinds of, 248.  
cheap and quick method of coloring, 254, 255.  
determination of the homogeneity of, 271.  
enamelling of, 256, 257.  
expansion of, by heat, 149.  
list of, according to their strength, 265, 266.  
measuring the ductility of, 270, 271.  
measuring the elasticity of, 270, 271.  
measuring the stiffness of, 270.  
method of testing, 269-271.  
noble, alloys of the, 232.  
pipes of various, to ascertain weights and diameter of, 170, 171.  
resilience of, 271.  
specific gravity of, 146.  
table of the strength, extensibility and stiffness of, 278.  
table showing the tensile strength of, 280, 281.



- Metals, ultimate tensile strength** of, 271.  
 varnish for, 197.  
 weight of plates of, 173.
- Methylated spirit of wine and naphtha**, 191.
- Milk of wax**, 205.
- Mitre and butt joints**, 242.  
 joint for an OG cornice, pattern for a 50-52.  
 joint for gutters, patterns for a, 47-50.
- Models proportioned to machines**, 264, 265.
- Mosaic gold**, 225.
- Mother of pearl, cement for**, 218.
- Mouldings, circular, of galvanized iron**, 166-169.
- Multiplication, sign of**, 110.
- Muntz metal, or yellow metal**, 225.
- Muriate of zinc, to make**, 239.
- Music metal**, 233.
- Naphtha and methylated spirit of wine**, 191.
- Oak, strength of**, 266.  
 varnish, cheap, 201.
- Object, base a circle and top an oval, pattern for**, 290.  
 bifurcated, circular at one end and branching into two smaller circular openings, pattern for, 300.  
 offsetting three-piece transitional, round at base and oval at top, pattern for, 296.  
 transitional, with base a rectangle and top a circle situated off center one way in respect to base, 287.  
 transitional, with rectangular base and circular top situated off center both ways in respect to top, pattern for, 289.  
 with rectangular base and circular top situated at an angle in respect to the base, pattern for, 295.
- Objects, transitional, with base a rectangle and top a circle, situated centrally in respect to base, patterns for**, 283-287.
- Oblique elevation of hipped-sky-light bar**, 317.  
 pyramid, to describe a frustum of an, 23-26.
- Oblong or oval article, tapering, patterns for an** 13-17.  
 taper bath, plan of an, 18-20.
- Octagon OG lamp top or cover, pattern for an** 52-53.  
 or square top or cover, 90, 91.  
 top or cover, pattern for a tapering, 46, 47.
- Offset, pattern for an** 50-52.
- Offsetting furnace boot, pattern for**, 296.  
 transitional fitting, double, with square base and round top, pattern for, 289.  
 transitional fitting, with square base and round top, pattern for, 287.
- OG cornice, pattern for a mitre joint for an**, 50-52.
- Oil paintings, varnish for**, 204.  
 varnishes, 191, 192.
- Orange-colored grounds**, 183.
- Oreide**, 225.
- Organ pipes, metal for**, 233.
- Ormolu**, 234.  
 dipping acid for brass, 247.  
 dipping, to prepare brass work for, 247.  
 dips, old nitric acid, to repair, 247.
- Oval article, tapering, patterns for**, 4-13.
- Oval boiler cover**, 89.  
 egg-shaped, to draw an, 93, 94.  
 or ellipse, to describe an, 92.  
 or ellipse, to find the area of an, 117.  
 or ellipse, to find the circumference of an, 117.  
 or oblong article, tapering, patterns for, 13-17.
- Pails and dish kettles, sizes of**, 135.
- Paint for coating wire work**, 244.
- Paintings and lithographs, varnishes for**, 204.  
 and pictures, beautiful varnish for, 204, 205.
- Pakfong**, 230.
- Pans, sizes of**, 135.
- Parabola, to describe a**, 101, 102.

- Parallelopipedom, rule for finding the lateral strength of, 266, 267.
- Parian cement, 223.
- Paste, razor, 244.
- Patent strip over lap, 243.
- Pattern, to obtain the weight of the casting from that of the, 174, 175.
- Patterns, rules for describing, 1-96.  
smooth moulding, varnish for, 210.
- Perpendicular, to erect a, 97.  
to find the, 111, 112.
- Pewter, 233.  
plate, 233.  
surfaces, electroplating of, 255, 256.
- Phosphor bronze, 227.
- Pictures and paintings, beautiful varnish for, 204, 205.  
lacquers for, 212.
- Pinchbeck, 225.
- Pine wood, strength of, 266.
- Pipe at any angle, the collar to be set on side of the main pipe, 63, 64.  
at any angle, collar to be smaller than the main pipe, 61-63.  
at any angle, 57-59.  
at right angles, 56, 57.  
pattern for a flange for a, 89, 90.
- Pipe, pattern for the T formed\* by a funnel-shape piece of a, 68-73.  
reducing joint, pattern for, 303.  
the collar to be smaller than the main pipe, 59-61.  
to fit a flat surface at any angle, 73, 74.  
to fit two flat surfaces, 74, 75.
- Pipes, drawn lead, strength of, 276, 277.  
for services for lamps, 172.  
gas, diameter and length of 172.  
lengths and diameters of, made from tin-sheets, 166.  
of various metals, to ascertain weights and diameter of, 170, 171.  
pattern for a T piece formed by two, 64-68.  
patterns for, 56-78.
- Piping, tapering piece of, 75-78.
- Plaster of Paris busts and statuettes, to cleanse, 251.  
of Paris fixtures, to bronze, 251.
- Plates, butt joint for, 242, 243.
- Platinum, to solder, 237, 238.
- Plumbers' cement, 218.
- Polish, copal, 196.
- Polishes, furniture, 203.
- Polygon, regular, to find the area of a, 112.  
to describe any, 103, 104.  
to inscribe any, in a circle, 103.
- Polygons, regular, table of angles relative to the construction of, 113.
- Practical geometry, 97-109.  
receipts, 178-262.
- Pressure of air, 157.  
of water, rule for finding the, 156.  
one atmosphere of, 157.
- Priming, pure white, for japaning, 178, 179.
- Prince metal or Bristol metal, 225.
- Printers, size or varnish for, 206.
- Pump, common, principle of the, 158, 159.
- Purple japan grounds, 183, 184.
- Pyramid, oblique, to describe a frustum of an, 23-28.
- Pyramid or cone, to find the convex surface of a frustum of a, 118.  
or cone, to find the solidity of a, 120.  
or right cone, to find the convex surface of a, 118.  
solidity of the frustum of a, 121.
- Queen's metal, 233.
- Radiating or absorbent and reflecting powers of substances, 150.
- Radius of a circle, 113.  
or circle, to find the centre of a, 100.
- Razor paste, 244.
- Reading Iron Co., American lap weld iron boiler flues, manufactured by the, 169.
- Receipts, miscellaneous, 244-262.  
practical, 178-262.

- Rectangle base and circular top, pattern for a tapering article with, 44.  
   base and square top, pattern for a tapering article with, 42-44.  
   to find the length for a, equal to a square, 106.  
   to form a, in a triangle, 107.  
   to form a square equal in area to a, 106.  
   top and base, pattern for a tapering article with, 44, 45.
- Reducing joint, pattern for, 303.
- Reflecting and radiating or absorbent powers of substances, 150.
- Reflector metal, 233.
- Resilience of metals, 271.
- Resins employed in the manufacture of varnishes, 188-190.
- Rivet metal, 233.
- Riveted joint, 242.
- Roof collars, square to round, pattern for, 295.  
   hipped, covering of a, 33-40.  
   pipe to fit the side of a, 74, 75.
- Roofing cement, 219.
- Roofs, circular, etc., covering of, 30, 31.  
   least load on, 262.
- Roll joint, 243.
- Ropes, absolute strength of, 264.  
   hempen, strength and weight of, 275, 276.
- Ropes, iron wire, strength of, 275.
- Rose's metal, 231.
- Rubber, solvents for, 258, 259.  
   stamps, red ink for, 260.
- Rule and compasses, to draw an ellipse with the, 92, 93.
- Rules for describing patterns, 1-96.
- Rusting, to prevent, 246.
- Sandarach, 190.
- Saucepans, iron, to tin, 252, 253.
- Saws, small band, to join, 239.  
   speed of, 176.
- Scalene cone, frustum of, pattern for, 303.
- Scarlet japan, 182, 183.
- Sealing wax for fruit cans, 246.
- Sector, definition of a, 114.  
   of a circle, to find the area of the, 116.
- Seeds, specific gravity of, 147.
- Segment, definition of a, 114.  
   or arc of a circle of large radii, to describe a, 101.  
   to find the area of a, of a circle, 116.
- Semicircle, definition of a, 114.
- Semicircles, to inscribe in a circle, 108.  
   to inscribe within an equilateral triangle, 107, 108.
- Semicircular gutters, 166.
- Sheet-iron, weight of a square foot of, 171.  
   -lead, lap joint for, 242.
- Shrinkage of castings, 175, 176.
- Side rods, locomotive, brasses for, 233.
- Silicon bronze, 227.  
   telegraph wire, 227.  
   telephone wire, 227.
- Silver and gold lace, to polish; 257, 258.  
   German, 230.  
   leaf, 233.  
   solder, 236.  
   to separate, from copper, 249.
- Silvering by heat, 248, 249.  
   mixture for, 249.  
   powder for copper, 246.
- Silveroid, 228.
- Similar, or Mannheim gold, 225.
- Siphon, principle of the, 158.
- Sitz-bath or hip-bath, plan of a; 20-23.
- Size or varnish for printers, 206.
- Skylights, flat, 305.  
   flat, design and patterns of 307.  
   flat, scale layout of, 306.  
   hipped, patterns for, 310.  
   hipped, scale layout of, 310.
- Soap lacquers, 213, 214.
- Soft brilliant varnish, 197.
- Solder, hard, 240.  
   soft brass, 240.  
   soft, to color, 238, 239.
- Solders, 235-241.  
   hard, 236.  
   soft, 235.
- Solids and capacities of bodies, mensuration of, 119-122.
- Sorel's cement, 222.  
   magnesia cement, 222.
- Specific gravity, 145-147.  
   heat, definition of, 147.  
   heat of different substances, 148.
- Speculum metal, 226.

- Speed of saws, 176.  
 Speeds, etc., rules for calculating, 176, 177.  
 Spelter, 236.  
 Sphere or globe, to find the convex surface of a, 119.  
   to find the solidity of a, 122.  
 Spirit of wine, methylated, and naphtha, 191.  
   varnish, white, 196.  
   varnishes, 191.  
   varnishes, brown, hard, 197.  
   varnishes, white, hard, 196.  
 Square article, tapering, patterns for a, 40, 41.  
   base and circular top, pattern for a tapering article with, 41, 42.  
   or octagon top or cover, 90, 91.  
   root, sign of, 110.  
   to construct a, upon a right line, 104.  
   to find the length for a rectangle equal to a, 106.  
   to form a, equal in area to a rectangle, 106.  
   to form a, equal in area to a triangle, 104, 105.  
   top and rectangle base, pattern for a tapering article with, 42-44.  
 Squared, to be, sign of, 110.  
 Stamps, brass, ink for, 261.  
   indelible ink for, 261.  
   rubber, red ink for, 260.  
 Stand, pattern for a, 53-56.  
 Statuary, bronze varnish for, 198.  
 Statuettes and busts, plaster of Paris, to cleanse, 251.  
 Steamer cover, to describe a, 91, 92.  
 Steel and iron, brown tint for, 256.  
   and iron, soldering of, 239-241.  
   and iron, varnishing articles of, 197, 198.  
 -bronze or Uchatius bronze, 226.  
   cast, composition used in welding, 249.  
   cohesive power of bars of, 269.  
   joints, solder for, 236.  
 Sterotype metal, 234.  
 Sterling metal, 225.  
 Sterro or Aich metal, 225.
- Stone, lateral strength of a beam or bar of, 263, 264.  
   structures, cement for, 219.  
 Stones and varieties of earths, specific gravity of, 146.  
 Stoneware, cement for, 216.  
 Straight joints, 242.  
 Strength of materials, 262-281.  
   of materials, tables of, 272-281.  
   tensile, of metals, 280, 281.  
   tensile, of woods, 281.  
 Substances, radiating or absorbent and reflecting powers of, 150.  
   various, weights of, 173.  
 Subtraction, sign of, 110.  
 Surfaces, mensuration of, 110-119.
- Table varnish, 195.  
 Tables of strength of materials, 272-281.  
   of the circumference and area of circles, 127-134.  
   of weights, etc., 123-126.  
 Talmi gold, 225.  
 Tangent, to draw a, to a circle, 100.  
 Taper joint, pattern for, 303.  
 Tapering article with rectangle base and circular top, 44.  
   article with rectangle base and square top, 42-44.  
   article with rectangle top and base, 44, 45.  
   article with square base and circular top, 41, 42.  
   elbow, pattern for a, 87, 88.  
   octagon top or cover, pattern for, 46, 47.  
 Tapering oval article, patterns for a, 4-13.  
   oval or oblong article, patterns for, 13-17.  
   piece of piping, 75-78.  
   square article, patterns for a, 40, 41.
- Tea trays, japanning old, 185, 186.  
 Telegraph wire, silicon, 227.  
 Telephone wire, silicon, 227.  
 Telford and Brown, experiments by, 269.  
 Temperatures and colors in tempering, 151.  
 Tempering, 150-153.  
   mixtures for, 152, 153.

- Tensile strength of metals, 280, 281.  
strength of woods, 281.
- Testing metals, method of, 269-271.
- Thermometer, to temper by the, 151.
- Timber, method of increasing the suspensive power of, 268.  
round, power of suspension of, 267, 268.  
square, lateral strength of, 268.
- Timbers, rectangular, strength of, 268.  
strength of, to resist crushing strains, 277, 278.
- Tin and tin alloys, bronze upon, 249, 250.  
cohesive power of bars of, 269.  
lacquer for, 211.  
plate, crystallized, 163, 161.  
plate, manufacture of, 159-163.  
plate, pale lacquer for, 213.  
plate, quality of, 163.  
plates, lap joint for, 242.  
plates, size, length, breadth and weight of, 164.  
roofing and tin work, 165.  
sheets, lengths and diameters of pipes made from, 166.  
to recognize a content of lead in, 163.  
-ware, cleaning of, 258.  
in form of frustum of a cone, sizes of, 135, 136.  
inks for marking, 260.
- Tin work and tin roofing, 165.
- Tinning, cold, 253.  
small articles, 253, 254.
- Tombac, 225.
- Top or cover, octagon or square, 90, 91.  
or cover, tapering octagon, pattern for a, 46, 47.
- Tortoise-shell japan, 184, 185.
- Transparent japan, 184.
- Tredgold's and Duleau's experiments, 266.
- Triangle, a circle of greatest diameter in a, 106, 107.  
equilateral, to inscribe semi-circles within a, 107, 108.  
to bisect a, 107.  
to describe a, in a circle, 99.  
to find the area of a, 111.
- Triangle, to form a, equal in area to a circle, 105, 106.  
to form a rectangle in a, 107.  
to form a square equal in area to a, 104, 105.  
right-angled, to find the third side of a, 111.
- Transitional object having base a rectangle and round top situated off center one way in respect to base, pattern for, 287.  
objects, with base a rectangle and top a circle situated centrally in respect to base, patterns for, 283-287.  
three-piece offsetting object round at base and oval at top, pattern for, 296.
- Triangles, diagrams of systems for triangulation in pattern cutting, 290.  
diagrams of systems of sections for triangulation patterns, 298.
- Triangulation, problems in pattern cutting solved by, 283-305.
- Tube, strength of a, 264.
- Tubes, small, butt joints for, 242, 243.
- Turpentine, 190.
- Tutenag, 230.
- Type metal, 234.
- Uchatius or steel-bronze, 226.
- Unit of heat, 147, 148.
- Varley's mastic, 217.
- Varnish, beautiful, for paintings and pictures, 204, 205.  
best body copal, for coach-makers, etc., 195, 196.  
black, 200.  
black, for harness, 208.  
black, for iron work, 198.  
black japan, 210.  
boiled oil or linseed oil, 208.  
bronze, for statuary, 198.  
cabinet, 195.  
cheap oak, 201.  
coach, 200.  
common, 208.  
common table, 195.  
copal, for inside work, 195.  
dammar, 208.  
dark, for light woodwork, 201.

- Varnish, fine black, for coaches, 210.  
flexible, 207.  
for cabinet-makers, 200.  
for certain parts of carriages, 200.  
for coating metals, 197.  
for instruments, 201.  
for iron work, 198.  
for leather, 210.  
for oil paintings, 204.  
for smooth moulding patterns, 210.  
for the wood toys of Spa, 201.  
for waterproof goods, 208.  
for woodwork, 201.  
gold, 209.  
gold, imitation of, 260.  
gutta-percha, 208.  
mahogany, 200.  
or size for printers, 206.  
soft brilliant, 197.  
table, 195.  
to fix engravings or lithographs on wood, 204.  
Watin's, for gilded articles, 200, 201.  
white, 196, 197.  
white spirit, 196.
- Varnishes, amber, 198-200.  
copal, 193-195.  
crystal, 205.  
essence, 191.  
etching, 204.  
for ballons, gas bags, etc., 209.  
for engravings, maps, etc., 204.  
for furniture, 201, 202.  
for oil paintings and lithographs, 204.  
India-rubber, 206-208.  
Italian, 206.  
mastic, 206.  
miscellaneous, 187-210.  
oil, 191, 192.  
spirit, 191.  
waterproof, 208, 209.  
white, hard spirit, 196.
- Varnishing and japanning, 178-187.  
iron and steel, 197, 198.
- Ventilator for skylight, design and patterns for, 312.
- Versed sine, 114.
- Vinegar bronze for brass, 247, 248.
- Wainscot varnish, 209.
- Wash bowls, sizes of, 136.
- Watch faces, enamel for, 257.
- Water, 153-156.  
boiling points of, 154.  
composition of, 153, 154.  
expansion and contraction of, 154, 155.  
in its natural state, effects produced by, 156.  
-proof varnishes, 208, 209.  
rule for finding the pressure of, 156.  
specific gravity of, 155.  
specific heat of, 155.  
weight of, 155.
- Watin's varnish for gilded articles, 200, 201.
- Wax, milk of, 205.
- Weights, etc., tables of, 123-126.
- Welding cast-steel, composition used in, 249.
- White, hard spirit, varnishes, 196.  
japan ground, 179, 180.  
metal, hard, 233.  
metals, 233.  
spirit varnish, 196.
- White varnish, 196, 197.
- Wire work, paint for coating, 244.
- Wood and metal, cement for joining, 222.  
cement for cracks in, 221, 222.  
lacquers for, 212.  
lateral strength of a beam or bar of, 263, 264.  
toys of Spa, varnish for, 201.
- Wood's alloy, 231.
- Woods, list of, according to their strength, 266.  
specific gravity of, 147.  
table of the strength, extensibility and stiffness of, 279.  
table showing the tensile strength of, 281.
- Woodwork, light, dark varnish for, 201.  
varnish for, 201.
- Wrought iron, expansion of, 174.
- "Y" branch, pattern for, 300.
- Yellow grounds, 183.  
metal or Muntz metal, 225.
- Zinc, to make muriate of, 239.

# CATALOGUE

OF

## Practical Scientific, Mechanical and Industrial Books

PUBLISHED BY

HENRY CAREY BAIRD & CO., Inc.

2 West 45th Street

NEW YORK, N. Y.

Any of the books listed in this catalogue will be forwarded, transportation charges prepaid, to any address in the world, at the published price.

---

*Our large descriptive catalogue will be sent free on request.*

---

### AGRICULTURE

**Guide to the Scientific Examination of Soils.** By Felix Wahnschaffe.

This volume will prove of interest to those engaged in scientific agriculture and the investigation of agricultural problems, and contains select methods of mechanical and chemical analysis of soils and their physical investigation. Only those methods yielding scientifically useful results and of comparatively easy and rapid execution have been selected. 5¼ by 7½ Inches. Cloth Binding. 177 Pages. 25 Illustrations. Price .....\$1.50

### ALCOHOL

**Practical Treatise on Distillation and Rectification of Alcohol.** By William T. Brannt.

Covers the raw materials; production of malt; preparation of mashes and of yeast; fermentation; distillation and rectification

and purification of alcohol; preparation of alcoholic liquors; liqueurs, cordials, bitters, fruit essences, vinegar, etc.; examination of materials for the preparation of malt, as well as of the malt itself; examination of mashies before and after fermentation; alcoholometry, with numerous comprehensive tables, and an appendix on the manufacture of compressed yeast and the examination of alcohol and alcoholic liquors for fusel oil and other impurities.

(New edition preparing.)

## ALLOYS

**Metallic Alloys.** By William T. Brannt.

This volume is a complete and practical guide for the manufacture of all kinds of alloys, amalgams and solders used by metalworkers, and describes their chemical and physical properties and their application in the arts and industries. An appendix on the coloring of alloys and the recovery of waste metals is included. In the preparation of this work it has been endeavored to make it popular in character so that it can be easily understood by those readers who have not made metallurgy and its kindred arts subjects of special study. The object aimed at has been to present a reliable guide to all persons professionally interested in the manufacture and use of alloys, amalgams and solders. The present edition, which is the third, has been revised and rewritten and considerable new matter added, including the composition of a number of new alloys. It is the most complete and practical book published on alloys in any language. 6¼ by 9¼ Inches. Cloth Binding. 549 Pages. 45 Illustrations. Price .....\$6.00

## ALUMINIUM

**Aluminium.** By Joseph W. Richards.

The most complete and authoritative book published on aluminium in any language. It covers its history, occurrence, properties, metallurgy and applications including its alloys. A new fourth revised and enlarged edition is in course of preparation.

## ARCHITECTURE AND BUILDING

**Architect's and Builder's Pocket Companion and Price Book.** By Frank W. Vogdes.

A compact and handy volume, consisting of a short but comprehensive epitome of decimals, duodecimals, geometry, and mensuration; with tables of U. S. measures, sizes, weights, strengths, etc., of iron, wood, stone, brick, cement and concretes, quantities of materials in given sizes and dimensions of wood, brick and stone; and full and complete bills of prices for carpenter's work and painting, also rules for computing and valuing brick and brick work, stone work, painting, plastering, with a vocabulary of technical terms, etc. 5½ by 3½ Inches. Cloth Binding. 368 Pages. Illustrated. Price .....\$1.50



ASSAYING

**Assayer's Guide.** By Oscar M. Lieber.

A practical guide in the art of assaying, containing full directions to assayers, miners and smelters for the tests and assays, by heat and by wet processes, of the ores of all of the principal metals; of gold and silver coins and alloys; and of coal, etc. The implements and utensils used are fully described, and approved methods given. 5¼ by 7½ Inches. Cloth Binding. 283 Pages. Illustrated. Price .....\$1.75

CABINET MAKING

**Cabinet-Maker and Upholsterer's Companion.** By J. Stokes.

A book of useful information to the apprentice, of real utility to the workman and experimental reference to the trade generally. Contains instructions on the art of drawing as applicable to cabinet work; veneering, inlaying and buhl-work; the art of dyeing and staining wood, ivory, bone, tortoise-shell, etc.; directions for lacquering, japanning, and varnishing; to make French polish, glues, cements and compositions; with numerous receipts, useful to workmen generally. An appendix upon French polishing, staining, imitating, varnishing, etc., has been added to the present edition. 5¼ by 8 Inches. Cloth Binding. 190 Pages. Illustrated. Price .....\$1.50

CELLULOSE

**Cellulose, Cellulose Products and Artificial Rubber.** By Joseph Bersch.

Comprising the preparation of cellulose from wood and straw; manufacture of parchment; methods of obtaining sugar and alcohol, and oxalic acid; production of viscose and viscid, nitro-celluloses and cellulose esters, artificial silk, celluloid, rubber substitutes, oil-rubber and factis. Authorized translation by William T. Brannt.

(New edition preparing.)

CHEMISTRY

**Chemistry Simplified.** By George A. Koenig.

This volume, which is designed primarily for engineers, consists of a course of lectures on the non-metals, based upon the natural evolution of chemistry, and opens a new era in the study of chemistry. The fundamental idea has been to unroll before the student the knowable nature of bodies as an ever-growing and spreading picture, and in following this idea the usual systematic classification had to be abandoned. The beginning is made with bodies of familiar acquaintance, such as the common metals, as objects of experimentation in allowing the equally familiar bodies of air and water to act upon them under the familiar impulse of heat. In the

chapters on green vitriol and on common salt, as well as on potash, the reader will find the fundamental idea fully elaborated.  $5\frac{1}{4}$  by  $7\frac{1}{2}$  Inches. Cloth Binding. 430 Pages. 103 Illustrations. Price .....\$1.75

## COAL MINING

**Mine Foreman's Handbook.** By Robert Mauchline and F. Ernest Brackett.

This volume, which is arranged in question and answer form, contains much practical and theoretical information on the opening, ventilating and working of collieries and is designed to assist students and others in passing examinations for mine foremanships. To the third edition, which has been thoroughly revised and enlarged, much new matter has been added on safety lamps, coal dust explosions, size of ventilating fans, boilers, haulage, flow of water in pipes, culm flushing, etc. Those whose ambition is to become mine foremen will find in this volume much that would be of assistance to them.  $6\frac{1}{4}$  by  $9\frac{1}{4}$  Inches. Cloth Binding. 360 Pages. 134 Illustrations. Price .....\$3.75

**Coal Mining: Described and Illustrated.** By Thomas H. Walton.

Prepared for students of coal mining, operators of coal mines, owners of coal lands and the general reader. It describes and illustrates the methods of coal mining as practiced in this country and abroad.  $9\frac{3}{4}$  by 12 Inches. Cloth Binding. 175 Pages. 24 Full-Page Plates. Price .....\$3.00

## CONFECTIONERY

**Treatise on the Art of Sugar Boiling.** By Henry Weatherley.

A useful book on confectionery, to the latest edition of which has been added an appendix in which have been included some of the most popular confections of the day. It contains full instructions on crystallizing, lozenge-making, comfits, gum goods and other processes for confectionery, etc., including the various methods of manufacturing raw and refined sugar goods. The appendix treats on cocoa, its varieties and their characteristics; chocolate and its manufacture, including chocolate confections; caramels; nougats, marshmallows, burnt almonds, candied nuts and other confections. Receipts and processes of manipulation are given. 5 by 8 Inches. Cloth Binding. 196 Pages. 8 Illustrations. Price.....\$1.50

## DRAWING

**Mechanical Drawing Self-Taught.** By Joshua Rose.

The object of this book is to enable the beginner to learn to make simple mechanical drawings without the aid of an instructor and to create an interest in the subject by giving examples such as the machinist meets with in every-day workshop practice. Full

practical instructions in the selection and preparation of drawing instruments and elementary instruction in practical mechanical drawing are given, together with examples in simple geometry and elementary mechanism, including screw threads, gear wheels, mechanical motions, engines and boilers. By a careful study of this volume the learner can obtain an excellent practical knowledge of the subject.  $6\frac{1}{4}$  by  $9\frac{1}{4}$  Inches. Cloth Binding. 303 Pages. 330 Illustrations. Price .....\$3.50

### DRY CLEANING

**Practical Dry Cleaner, Scourer and Garment Dyer.** By William T. Brannt, New revised edition, edited by J. B. Gray.

The manner in which this volume has been received by those engaged in the cleaning and dyeing industry is evidenced by the rapid sale of the previous editions and necessitated the preparation of a new fifth revised and enlarged edition. The new edition has been brought strictly up to date, all discoveries and improvements in cleaning and garment dyeing since the fourth edition was published being incorporated in it. It treats fully on cleaning plant design and construction; purification of benzine; dry cleaning; spot and stain removal; wet cleaning, including the cleaning of Palm Beach suits and other summer fabrics; finishing cleaned fabrics; cleaning and dyeing fur skins, rugs and mats; cleaning and dyeing feathers; cleaning, dyeing and blocking straw, felt and Panama hats; cleaning and dyeing rugs and carpets; bleaching and stripping garments; bleaching and dyeing straw and straw hats; cleaning and dyeing gloves; garment dyeing; analysis of textile fabrics; practical chemistry for the dry cleaner and garment dyer. It is the most comprehensive and complete reference and text-book for cleaners and dyers now on the market.  $5\frac{1}{4}$  by  $7\frac{1}{2}$  Inches. Cloth Binding. 375 Pages. 41 Illustrations. Price .....\$3.00

### DYEING

**Wool Dyeing.** By Walter M. Gardner.

2 Volumes. 8 by 11 Inches. Cloth Binding.

Part I.—Covers wool fibre; wool scouring; bleaching of wool; water; mordants; assistants and other chemicals. 91 Pages. 13 Illustrations. Price .....\$5.00

Part II.—Explains the natural and artificial dyestuffs as well as practical dyeing complete. 140 Pages. Price .....\$3.00

### ELECTRO-PLATING

**Complete Treatise on the Electro-Deposition of Metals.** By George Langbein and William T. Brannt.

A comprehensive and complete treatise, written from a scientific as well as practical standpoint and especially intended for the practical workman, wherein he can find advice and information

regarding the objects to be plated while in the bath as well as before and after electro-plating. It is the foremost book on the subject in the English language and covers electro-plating and galvanoplastic operations, the deposition of metals by the contact and immersion processes, the coloring of metals, lacquering and the methods of grinding and polishing, as well as descriptions of the voltaic cells, dynamo-electric machines, thermopiles, and of the materials and processes used in every department of the art. Particular attention has been paid to all important innovations, and it has been endeavored to include all of the latest practical methods of plating, as well as the most recent machinery and apparatus. In this, the seventh edition, a thorough revision has been made and considerable new matter added. It is a ready book of reference and a practical guide to the workshop.  $6\frac{1}{4}$  by  $9\frac{1}{4}$  Inches. Cloth Binding. 720 Pages. 155 Illustrations. Price.....\$6.00

### FATS AND OILS

**Practical Treatise on Animal and Vegetable Fats and Oils.** By William T. Brannt.

This most complete and exhaustive work, which comprises both fixed and volatile oils, treats of their physical and chemical properties and uses, the manner of extracting and refining them and practical rules for testing them. The manufacture of artificial butter and lubricants is also described. The book is divided into three parts—Part I, dealing with fixed fats and oils; Part II, containing volatile or essential oils, and Part III, the appendix devoted to lubricants. The object aimed at in the preparation of this second revised and enlarged edition has been to make it useful to all persons in any way interested in fats and oils, and especially so to analysts, pharmacutists, chemists, manufacturers and chemical students. 2 Volumes.  $6\frac{1}{4}$  by  $9\frac{1}{4}$  Inches. Cloth Binding. 1256 Pages. 302 Illustrations. Price, the set .....\$10.00

**Practical Treatise on Friction, Lubrication, Fats and Oils.** By Emil F. Dieterichs.

A practical up-to-date book by a practical man, treating in condensed and comprehensive form the manufacture of lubricating oils, leather oils, paint oils, solid lubricants and greases, together with numerous formulas, modes of testing oils and the application of lubricants. It is written for the mechanic and manufacturer in language easily understood, technical terms and theories being avoided.  $5\frac{1}{4}$  by  $7\frac{1}{2}$  Inches. Cloth Binding. 137 Pages. Price, \$1.50

### GEARS AND GEARING

**Treatise on Gear Wheels.** By George B. Grant.

The object of this volume is a practical one, to reach and interest all those who make the gear wheels, as well as the draftsman or foreman who directs the work. First, the odontoid or pure

tooth curve as applied to spur gears is taken up, then are described the involute, cycloid and pin tooth, special forms in which it is found in practice; the modifications of the spur gear, known as the spiral gear and elliptic gear; bevel gear and skew bevel gear. The subject is treated in as simple and direct a manner as possible, the method that is plainest to the average intelligent and educated mechanic having been selected. 6¼ by 9 Inches. Cloth Binding. 105 Pages. 169 Illustrations. Price .....\$1.00

## GLUE

**Glue, Gelatine, Animal Charcoal, Phosphorus, Cements, Pastes and Mucilages.** By F. Dawidowsky and William T. Brannt.

The progress that has been made in the manufacture of glue and allied products since the first edition of this volume was issued has necessitated the preparation of a new second revised edition, which has been largely rewritten. Old and wasteful methods have been replaced by more approved processes and in the present edition it has been endeavored to place before those interested in these industries a practical and comprehensive account of modern methods of operation. This volume covers fully the raw materials and manufacture of skin and bone glue, different varieties of glue, animal charcoal, phosphorus, gelatine and products prepared from it; isinglass and fish-glue, methods of testing glue and gelatine, and the preparation and application of cements, pastes and mucilages for use in the workshop, laboratory and office. 6 by 9¼ Inches. Cloth Binding. 282 Pages. 66 Illustrations. Price .....\$3.00

## HOROLOGY

**Watch-Repairer's Hand-Book.** By F. Kemlo.

A guide for the young watch-repairer and the watch owner, containing clear and concise instructions on taking apart, putting together and thoroughly cleaning American watches, the English lever and other foreign watches. 5 by 8 Inches. Cloth Binding. 93 Pages. Illustrated. Price.....\$1.25

## INK

**Manufacture of Ink.** By Sigmund Lehner.

Most of the receipts in this volume have been practically tested so that good results should be obtained if the work is carried on strictly in accordance with the directions. A detailed account of the raw materials required and their properties have been given, together with formulas and instructions for the preparation of writing, copying and hektograph inks, safety inks, ink extracts and powders, colored inks, solid inks, lithographic inks and crayons, printing ink, ink or aniline pencils, marking inks, ink specialties, sympathetic inks, stamp and stencil inks, wash blue, etc. 5¼ by 7½ Inches. Cloth Binding. 229 Pages. Price.....\$2.00

## LATHE WORK

**Manual of the Hand Lathe.** By Egbert P. Watson.

Contains concise directions for working in the lathe all kinds of metals, ivory, bone and precious woods; dyeing, coloring and French polishing; inlaying by veneers, and various methods practiced to produce elaborate work with despatch and at small expense. 5 by 8 Inches. Cloth Binding. 136 Pages. 78 Illustrations. Price .....\$1.25

**Turner's Companion.**

The primary object of this volume is to explain in a clear, concise and intelligent manner the rudiments of turning. It contains instructions in concentric, elliptic and eccentric turning, with directions for using the eccentric cutter, drill, vertical cutter and circular rest. Patterns and instructions for working them, are included. 5 by 8 Inches. Cloth Binding. 135 Pages. 14 Plates. Price .....\$1.25

## LEATHER

**Practical Tanning.** By Louis A. Flemming.

As its title indicates, this volume is a practical and not a theoretical or technical treatise, and the tannery processes are so clearly described and with such precision that nothing further in the way of explanation is required. It is the foremost book on that subject published in any language, and describes fully the American practice for the treatment of hides, skins and pelts of every description. It is a veritable cyclopedia of helpful and reliable information on all branches of tanning, dressing and dyeing leather and furs and allied subjects. 6¼ by 9¼ Inches. Cloth Binding. 594 Pages. 6 Full-Page Plates. Price.....\$6.00

## LOCOMOTIVES

**American Locomotive Engines.** By Emory Edwards.

This volume is a compilation of information and data on the design, construction and management of the locomotive. It is a practical book for the practical man. 5¼ by 8 Inches. Cloth Binding. 383 Pages. 78 Illustrations. Price.....\$1.50

## MARBLE WORKING

**Marble-Workers' Manual.** By M. L. Booth.

Designed for the use of marble-workers, builders and owners of houses. Containing practical information respecting marbles in general; their cutting, working and polishing; veneering of marble; painting upon and coloring of marble; mosaics; composition and use of artificial marble, stuccos, cements; receipts, secrets, etc. 5¼ by 7½ Inches. Cloth Binding. 254 Pages. 1 Folding Plate containing 77 Illustrations. Price.....\$1.75

**MARINE ENGINEERING**

**American Marine Engineer.** By Emory Edwards.

The writer of this volume has endeavored to prepare a clear, concise and thoroughly practical work for marine engineers and students; to treat each subject in as brief and concise a manner as possible, and yet preserve that clearness and fullness of statement so desirable in a work of this description. 5¼ by 8 Inches. Cloth Binding. 440 Pages. 85 Illustrations. Price.....\$2.00

**Catechism of the Marine Steam Engine.** By Emory Edwards.

A practical work for marine engineers and firemen, written in simple, concise language by one of their number, who, knowing from his own experience what they needed, knew also how to supply that want. 5¼ by 8 Inches. Cloth Binding. 414 Pages. 60 Illustrations. Price .....\$2.00

**MECHANICS**

**English and American Mechanic.** By B. Frank Van Cleve and Emory Edwards.

The purpose of this volume is to serve as a handy reference book for the manufacturer and to supply the intelligent workman with information required to conduct a process foreign, perhaps, to his habitual labor, but which at the time it may be necessary to practice. It is an every-day handbook for the workshop and factory, containing several thousand receipts, rules and tables indispensable to the mechanic, the artisan and the manufacturer. It is, in fact, an encyclopedia of useful technical knowledge, its pages presenting an array of information indispensable not only to the practical manufacturer and mechanic, but also to the amateur workman. 5½ by 7½ Inches. Cloth Binding. 476 Pages. 85 Illustrations. Price .....\$2.50

**METAL-WORKING**

**Complete Practical Machinist.** By Joshua Rose.

One of the best-known books on machine shop work, now in its nineteenth edition, and written for the practical workman in the language of the workshop. It gives full practical instructions on the use of all kinds of metal-working tools, both hand and machine, and tells how the work should be properly done. It covers lathe work, vise work, drills and drilling, taps and dies, hardening and tempering, the making and use of tools, tool grinding, marking out work, machine tools, etc. No machinist's library is complete without this volume. 5¼ by 8 Inches. Cloth Binding. 504 Pages. 395 Illustrations. Price .....\$3.00

**Metal Worker's Handy-Book of Receipts and Processes.** By William T. Brannt.

A valuable reference book for all engaged in the working of

metals, being a collection of formulas and practical manipulations for the working of all the metals and alloys, including the decoration and beautifying of articles manufactured therefrom, as well as their preservation. It treats on alloys and amalgams; hardening, tempering, annealing; bronzing and coloring; casting and founding; cements; cleansing, grinding, pickling, polishing; decorating, enameling, engraving, etching; electro-plating, brassing, coppering, galvanizing, gilding, nickling, silvering, tinning, etc.; fluxes and lutes; lacquers, paints and varnishes; solders and soldering; welding and welding compounds. To the new edition has been added several new chapters on die-casting, thermit, oxyacetylene and electric welding, galvanizing, sherardizing, etc.. 5½ by 7½ Inches. Cloth Binding. 575 Pages. 82 Illustrations. Price...\$3.00

**Practical Metal-Worker's Assistant.** By Oliver Byrne.

Comprising metallurgic chemistry, the arts of working all metals and alloys, forging of iron and steel, hardening and tempering, melting and mixing, casting and founding, works in sheet metal, the processes dependent on the ductility of the metals, soldering and the most improved processes, and tools employed by metal workers, with the application of the art of electro-metallurgy to manufacturing processes. An appendix, describing the manufacture of Russian sheet iron, manufacture of malleable iron castings and improvements in Bessemer steel, is included. 6½ by 9¼ Inches. Cloth Binding. 683 Pages. 609 Illustrations. Price.....\$3.50

**Practical Tool-Maker and Designer.** By Herbert S. Wilson.

An elementary treatise upon the designing of tools and fixtures for machine tools and metal working machinery, comprising modern examples of machines with fundamental designs for tools for the actual production of the work. The almost limitless variations in tool construction are based on a few fundamental forms, and an effort has been made to present basic ideas in the design of dies, jigs, special fixtures, etc., to serve as a groundwork for elaboration and variation according to conditions. 6¼ by 9¼ Inches. Cloth Binding. 209 Pages. 189 Illustrations. Price..\$2.50

**Modern Practice of American Machinists and Engineers.** By Egbert P. Watson.

Including the construction, application and use of drills, lathe tools, cutters for boring cylinders and hollow work generally, with the most economical speed for the same; the results verified by actual practice at the lathe, the vise, and on the floor. 5¼ by 8 Inches. Cloth Binding. 276 Pages. 86 Illustrations. Price...\$2.00

## MINERALOGY

**Mineralogy Simplified.** By Henry Erni and Amos P. Brown.

A handy volume, pocket size and form, for the prospector and general mineralogist, giving easy methods of identifying minerals, including ores, by means of the blowpipe, by flame reactions, by



humid chemical analysis and by physical tests. To the fourth revised edition has been added much entirely new matter, including crystallography, tables for the determination of minerals by chemical and pyrognostic characters and by physical characters. 4½ by 6¾ Inches. Flexible Leather. 414 Pages. 123 Illustrations. Price .....\$2.50

## MINING AND PROSPECTING

**Prospector's Field Book and Guide.** By H. S. Osborn.

The remarkable sale of this volume, now in its eighth edition, indicates unmistakably the firm hold which it has on the confidence of prospectors. It is a complete and thoroughly reliable guide and companion to the intelligent and enterprising searcher after ores and useful minerals, including gems and gem stones. Instructions on the blowpipe and its uses and the analysis of ores are given. A chapter on petroleum, ozokerite, asphalt and peat is included, together with a glossary of terms used in connection with prospecting, mining, mineralogy, geology, etc. It is the best book that has been published on prospecting in any language. 5¼ by 7½ Inches. Cloth Binding. 377 Pages. 66 Illustrations. Price...\$3.00

**Underground Treasures: How and Where to Find Them.** By James Orton.

This little work was written expressly for the landholder, the farmer, the mechanic, the miner, the laborer, and even the most unscientific. It is designed to enable such persons to discover for themselves minerals and ores and thus develop the resources and ascertain the value of any particular farm or region. To enhance the value and popularity of the book an appendix on ore deposits and testing minerals with the blowpipe has been added to the present edition. 5 by 6½ Inches. Cloth Binding. 211 Pages. Illustrated. Price .....\$1.50

**Practical Manual of Minerals, Mines and Mining.** By H. S. Osborn.

A practical manual for the mineralogist and miner, containing suggestions as to the localities and associations of all the useful minerals, full descriptions of the most effective methods for both the qualitative and quantitative analyses of each of these minerals and instructions on the various methods of excavating and timbering, including all brick and masonry work during driving, lining, bracing and other operations. The practical work of digging and boring artesian and other deep wells is fully described in an appendix. 6¼ by 9¼ Inches. Cloth Binding. 369 Pages. 171 Illustrations. Price .....\$4.50

## MOLDING AND FOUNDING

**Practical Treatise on Foundry Irons.** By Edwark Kirk.

In this volume it has been endeavored to give all useful, up-

to-date data on the manipulation of foundry irons as actually practiced in foundries by both the old and new methods, and thus place before the foundry, foundry foreman, molder and melter such a variety of methods that he cannot fail to obtain the desired results under any and all of the various conditions met with in the manipulation of these irons. It is a practical book for foundrymen, treating fully on pig iron and fracture grading of pig and scrap irons; scrap irons, mixing irons, elements of metalloids, grading iron by analysis, chemical standards for iron castings, testing cast iron, semi-steel, malleable iron, etc.  $6\frac{1}{4}$  by  $9\frac{1}{4}$  Inches. Cloth Binding. 276 Pages. Illustrated. Price .....\$3.00

**Practical Brass and Iron Founder's Guide.** By James Larkin.

A handy book for the use of the practical workman, treating on brass founding, molding the metals and their alloys, etc. The subjects covered include the properties of metals; behavior of metals and alloys in melting and congealing; malleable iron castings; wrought iron castings; manufacture of steel castings; casting of brass; casting of bronze; modern methods of founding statues; bell founding; chill-casting; new process of casting; autogenous soldering; some modern bronzes. A complete and useful guide for the workshop.  $5\frac{1}{2}$  by  $7\frac{1}{2}$  Inches. Cloth Binding. 394 Pages. 11 Illustrations. Price .....\$2.50

**Moulder's and Founder's Pocket Guide.** By Fred Overman.

A practical treatise on molding and founding in green-sand, dry-sand, loam and cement; the molding of machine frames, mill-gear, hollow ware, ornaments, trinkets, bells and statues; description of molds for iron, bronze, brass and other metals; plaster of Paris, sulphur, wax, etc.; the construction of melting furnaces; the melting and founding of metals; the composition of alloys and their nature, etc. To the latest edition has been added a supplement on statuary and ornamental molding, ordnance, malleable iron castings, etc., by A. A. Fesquet.  $5\frac{1}{4}$  by  $7\frac{1}{2}$  Inches. Cloth Binding. 342 Pages. 44 Illustrations. Price .....\$2.00

**Cupola Furnace.** By Edward Kirk.

A practical treatise on the construction and management of foundry cupolas; comprising improvements on cupolas and methods of their construction and management; tuyeres; modern cupolas; cupola fuels; fluxing of iron; getting up cupola stocks; running a continuous stream; scientifically designed cupolas; spark-catching devices; blast-pipes and blast; blowers; foundry tram rail, etc.  $6\frac{1}{4}$  by  $9\frac{1}{4}$  Inches. Cloth Binding. 459 Pages. 106 Illustrations. Price .....\$4.00

## PAINING AND PAPER HANGING

**Painter, Gilder and Varnisher's Companion.** By William T. Brannt.

This volume gives a clear, concise and comprehensive view of

the principal materials to be used and the operations to be conducted in the practice of the various trades of painting, gilding, varnishing, etc. It describes the manufacture and test of pigments, the arts of painting, graining, marbling, staining, lacquering, japaning, bronzing, polishing, sign-writing, varnishing, glass-staining and gilding on glass, together with coach painting and varnishing and the principles of the harmony and contrast of colors. Many useful receipts on miscellaneous related subjects are included. 5¼ by 7½ Inches. Cloth Binding. 395 Pages. 9 Illustrations. Price .....\$1.75

**Paper-Hanger's Companion.** By James Arrowsmith.

A very useful and practical handbook for the householder, as well as for the paper-hanger, treating fully on the tools and pastes required for paper hanging; preparatory work; selection and hanging of wall papers; distemper painting and cornice-tinting; stencil work; replacing sash-cord and broken window-panes, and useful wrinkles and receipts. A new, thoroughly revised and much enlarged edition. 5 by 7½ Inches. Cloth Binding. 150 Pages. 25 Illustrations. Price .....\$1.25

**Complete Guide for Coach Painters.** By M. Arlot.

A practical guide for the practical man, containing full instructions on the painting and varnishing of coaches, cars, etc., as practiced in this country and abroad.

(New edition preparing.)

## PERFUMERY

**Practical Treatise on the Manufacture of Perfumery.** By C. Deite.

Contains directions for making all kinds of perfumes, sachet powders, fumigating materials, dentrifices; hair pomades, tonics, dyes, etc.; cosmetics and other toilet preparations, together with a full account of the volatile oils and their testing; balsams, resins and other natural and artificial perfume-substances, including the manufacture of fruit ethers and tests of their purity. 5¼ by 7½ Inches. Cloth Binding. 358 Pages. 28 Illustrations. Price....\$3.00

## RAILROADS

**Pocket-Book for Railroad and Civil Engineers.** By Oliver Byrne.

Contains exact and concise methods for laying out railroad curves, switches, frog angles and crossings; the staking out of work, leveling; the calculation of cuttings and embankments, earthwork, etc. 4 by 6¼ Inches. Flexible Leather. 163 Pages. 79 Illustrations. Price .....\$1.75

**Street Railway Motors.** By Herman Haupt.

A brief review of plans proposed for motive power on street railways, their merits and defects, with data on the cost of plants

and operation of the various systems in use.  $5\frac{1}{4}$  by  $7\frac{1}{2}$  Inches. Cloth Binding. 213 Pages. Price .....\$1.50

## RECEIPTS

**Techno-Chemical Receipt Book.** By William T. Brannt and William H. Wahl.

The principal aim in preparing this volume has been to give an accurate and compendious collection of approved receipts and processes of practical application in the industries and for general purposes. In the laborious task of compilation only the latest and best authorities have been resorted to, and whenever different processes of apparently equal value of attaining the same end have been found more than one has been introduced. Every care has been taken to select the very best receipts of each kind and there are few persons, no matter in what business or trade they may be engaged, who will not find in this volume something of use and benefit to them.

It is a compact repository of practical and scientific information, containing thousands of receipts and processes covering the latest and most useful discoveries in chemical technology and their practical application in the useful arts and industries. Most of the receipts have been practically tested by competent men before being given to the public.

It is one of the most valuable handbooks of the age and indispensable for every practical man.  $5\frac{1}{4}$  by  $7\frac{1}{2}$  Inches. Cloth Binding. 495 Pages. 78 Illustrations. Price .....\$2.50

## RUBBER

**India Rubber, Gutta-Percha and Balata.** By William T. Brannt.

Covers the occurrence, geographical distribution, and cultivation of rubber plants; manner of obtaining and preparing the raw materials; modes of working and utilizing them, including washing, loss in washing, maceration, mixing, vulcanizing, rubber and gutta-percha compounds, utilization of waste, balata and statistics of commerce.

(New edition preparing.)

## SCIENCE

**Home Experiments in Science.** By T. O'Connor Sloane.

The experiments in this volume are such as can be performed, with but few exceptions, with home-made apparatus. The book is intended for both the young and old, and the experiments, which are entertaining and instructive, cover mechanics, general and molecular physics, soap bubbles and capillarity. Detailed instructions in the necessary mechanical operations and illustrations of the experiments and apparatus are given.  $5\frac{1}{4}$  by  $7\frac{1}{2}$  Inches. Cloth Binding. 261 Pages. 96 Illustrations. Price .....\$1.50

## SHEET-METAL WORKING

**Practical Work-Shop Companion for Tin, Sheet-Iron and Copper-Plate Workers.** By Leroy J. Blinn.

This is one of the most popular books on sheet-metal working that has ever been published. It is a practical work of instruction and reference and contains rules for describing various kinds of patterns used by tin, sheet-iron and copper-plate workers; practical geometry; mensuration of surfaces and solids; tables of the weights and strength of metals and other materials; tables of areas and circumferences of circles; composition of metallic alloys and solders, with numerous valuable receipts and manipulations for every-day use in the workshop. 5¼ by 7¾ Inches. Cloth Binding. 296 Pages. 170 Illustrations. Price.....\$3.00

**Sheet Metal Worker's Instructor.** By Reuben H. Warn.

This volume, which has been well tried and well proven, still enjoys great popularity among zinc, sheet iron, copper and tinplate workers and others. It contains a selection of geometrical problems, also practical and simple rules for describing the various patterns required in the different branches of the above trades. To the latest edition has been added considerable new matter of great practical value on sheet metal work processes, including tools, joints, solders, fluxes, etc., as well as geometry applied to sheet metal work, which increases very much the usefulness of the book. The appendix contains instructions for boiler making; mensuration of surfaces and solids; rules for calculating the weight of different figures of iron and steel; tables of the weights of iron, steel, etc., and much other valuable data. 6 by 9¼ Inches. Cloth Binding. 252 Pages. 32 Plates. 96 Illustrations. Price .....\$2.50

## SIGN WRITING

**Sign Writing and Glass Embossing.** By James Callingham.

A complete, practical, illustrated manual of the art as practiced by the leading sign writers. The chief object of the book is to assist the beginner in acquiring a thorough knowledge of sign writing and glass embossing and to aid, with suggestions and information, those who, having had some practice, fall short of that excellence which it is desirable to attain. The latest edition has been enlarged by the addition of a new chapter on "The Art of Letter Painting Made Easy," by James G. Badenoch, in which all the necessary details in drawing letters are given with care and precision. 5¼ by 7½ Inches. Cloth Binding. 258 Pages. Fully Illustrated. Price .....\$1.75

## SOAP

**Soap Maker's Hand Book.** By William T. Brannt.

The latest and most complete book published in the English language on the art of soap making, and covers the materials,

processes and receipts for every description of soap. Practical and comprehensive instructions on the modern methods employed in their manufacture are given. In addition to the exhaustive directions for the manufacture of all kinds of soap both by boiling and the cold and semi-warm processes, numerous formulas of stocks available for the purpose are also included, as well as receipts for washing powders, liquid soaps, medicated soaps and other soap specialties. Nothing has been omitted in the preparation of this comprehensive and exhaustive work. Everyone connected in any way with the soap and allied industries should have this volume.  $6\frac{1}{4}$  by  $9\frac{1}{4}$  Inches. Cloth Binding. 512 Pages. 54 Illustrations. Price .....\$6.00

### STEAM BOILERS

**Steam Boilers.** By Joshua Rose.

A practical treatise on boiler construction and examination for the use of practical boiler makers, boiler users and inspectors, and embracing in plain figures all the calculations necessary in designing and classifying steam boilers. A study of this book will enable any engineer, having an ordinary knowledge of decimal fractions, to thoroughly understand the proper construction and determine the strength of a modern steam boiler.  $6\frac{1}{4}$  by  $9\frac{1}{4}$  Inches. Cloth Binding. 258 Pages. 73 Illustrations. Price .....\$2.50

### STEAM ENGINEERING

**Practical Steam Engineer's Guide.** By Emory Edwards.

A practical guide and ready reference for engineers, firemen and steam users, treating on the design, construction and management of American stationary, portable and steam fire engines, steam pumps, boilers, injectors, governors, indicators, pistons and rings, safety valves and steam gauges.  $5\frac{1}{4}$  by 8 Inches. Cloth Binding. 420 Pages. 119 Illustrations. Price .....\$2.50

**900 Examination Questions and Answers for Engineers and Firemen.** By Emory Edwards.

This little book was not gotten up for the use of "experts" or educated engineers, but, on the contrary, it was written for the use and benefit of that great number of worthy and ambitious men of limited education who run steam engines and desire to increase their knowledge and better their positions by obtaining a U. S. Government or State License. The author has used the plain, everyday language of the engine and fire-room in a conversational way so that anyone can understand it.  $3\frac{1}{2}$  by  $5\frac{1}{2}$  Inches. Flexible Cloth. 240 Pages. 15 Illustrations. Price .....\$1.50

**American Steam Engineer.** By Emory Edwards.

A theoretical and practical treatise for the use of engineers, machinists, boiler makers and students, containing much information and data on the design and construction of engines and boilers.

5¼ by 8 Inches. Cloth Binding. 419 Pages. 77 Illustrations.  
 Price .....\$2.00

**Slide Valve Practically Explained.** By Joshua Rose.

Contains simple and complete practical demonstrations of the operation of each element in a slide-valve movement, and illustrating the effects of variations in their proportions, by examples carefully selected from the most recent and successful practice. The object of this book is to present to practical men a clear explanation of the operations of a slide valve under the conditions in which it is found in actual practice. 5¼ by 7½ Inches. Cloth Binding. 100 Pages. 35 Illustrations. Price .....\$1.25

## STEEL AND IRON

**Tool-Steel.** By Otto Thallner.

A concise handbook on tool-steel in general, its treatment in the operations of forging, annealing, hardening, tempering, etc., and the appliances therefor. It is chiefly intended as a guide to the master-workman and the intelligent tool-maker, and, in accordance with this object, is exclusively adapted to practical needs. The directions and working appliances collected in this volume have all been taken from actual practice and tell exactly how the work is to be done. 6¼ by 9¼ Inches. Cloth Binding. 180 Pages. 69 Illustrations. Price .....\$2.00

**Tables Showing the Weight of Different Lengths of Round, Square and Flat Bar Iron, Steel, etc.**

This little book gives tables showing the weight of square iron from ¼ inch to 5 inches square, 1 to 18 feet long; weight of round iron ¼ inch to 5 inches diameter, 1 to 18 feet long; weight of flat iron ¼ inch to 1 inch thick, 1 to 18 feet long, and other tables. 5¾ by 3¼ Inches. Cloth Binding. 83 Pages. Price....75c

## SURVEYING

**Practical Surveyor's Guide.** By Andrew Duncan.

A concise and practical work containing the necessary information to make any person of common capacity a finished land surveyor without the aid of a teacher. It gives to the learner the required instructions in a clear and simple manner, unburdened with unnecessary matter. 5¼ by 7½ Inches. Cloth Binding. 214 Pages. 72 Illustrations. Price .....\$1.75

## TEXTILES

**Manufacture of Narrow Woven Fabrics.** By E. A. Posselt.

Gives description of the various yarns used, the construction of weaves and novelties in fabric structure, descriptive matter as to looms, etc. 5 by 7½ Inches. Cloth Binding. 198 Pages. 247 Illustrations. Price .....\$2.00

**Recent Improvements in Textile Machinery Relating to Weaving.**  
By E. A. Posselt.

A treatise giving descriptive illustrations of the construction and operation of various looms, jacquards, warpers, beamers, slashers, spoolers, etc., also illustrating and explaining different makes of shuttles, temples, pickers, reeds, heddles, harness, etc. Designed for the use of manufacturers, mill managers, designers, boss weavers, loom fixers, students and inventors. 2 Volumes. 8 by 11 Inches. Cloth Binding. Part I, 184 Pages. 600 Illustrations. Part II, 174 Pages. 600 Illustrations. Price, per volume.....\$3.00

**Wool, Cotton, Silk.** By E. A. Posselt.

This work contains detail information as to the various machines and processes used in the manufacture of either wool, cotton or silk from the raw material to the finished fabric, and covers both woven and knit goods. 8 by 11 Inches. Cloth Binding. 409 Pages. Fully Illustrated. Price .....\$5.00

**Textile Calculations.** By E. A. Posselt.

A complete guide to calculations relating to the construction of all kinds of yarns and fabrics, the analysis of cloth, speed, power and belt calculations. 8 by 11 Inches. Cloth Binding. 138 Pages. 74 Illustrations. Price .....\$2.00

**Dictionary of Weaves. Part I.** By E. A. Posselt.

A collection of all weaves from four to nine harness. The weaves, which number two thousand, are conveniently arranged for handy use. 5 by 7½ Inches. Cloth Binding. 85 Pages. Fully Illustrated. Price .....\$2.00

**Technology of Textile Design.** By E. A. Posselt.

A practical treatise on the construction and application of weaves for all kinds of textile fabrics, giving also full particulars as to the analysis of cloth. 8 by 11 Inches. Cloth Binding. 324 Pages. 1,500 Illustrations. Price .....\$5.00

**Cotton Manufacturing.** By E. A. Posselt.

A complete treatise on modern processes and machinery used in connection with cotton spinning, including all calculations.

Part I.—Gives a complete description of the manufacture of cotton yarns from planting the seed to the sliver, ready for the drawing or combing; covering; fibre, ginning, mixing, picking, scutching and carding. 190 Pages. 104 Illustrations.

Part II.—Covers combing, drawing, roller covering and fly frames. 292 Pages. Fully Illustrated.

6½ by 9½ Inches. Cloth Binding. Price, per volume.....\$3.00



## VARNISHES

**Varnishes, Lacquers, Printing Inks and Sealing-Waxes.** By William T. Brannt.

The manufacturer, skilled mechanic, amateur and others desiring detailed and reliable information regarding the preparation of fat and volatile varnishes, lacquers, printing inks and sealing-waxes will find the required instructions in this volume. A description of the properties of the raw materials used and simple methods of testing them are given. An appendix on the art of varnishing and lacquering has also been added in which will be found a large number of valuable receipts for putties, stains for wood, bone, ivory, etc.  $5\frac{1}{4}$  by  $7\frac{1}{2}$  Inches. Cloth Binding. 338 Pages. 39 Illustrations. Price .....\$3.00

## VINEGAR

**Practical Treatise on the Manufacture of Vinegar.** By William T. Brannt.

In this, the third edition, while the same arrangement of the book has been adhered to as in the previous edition, it has been thoroughly revised and largely rewritten, obsolete matter having been entirely eliminated and new matter introduced. It is the most complete and up-to-date book published on the subject, and describes fully and in detail the various present-day processes for the manufacture of vinegar, with special reference to wood vinegar and other by-products obtained in the destructive distillation of wood, as well as the preparation of acetates. It also treats fully on the manufacture of cider and fruit-wines; preservation of fruits and vegetables by canning and evaporation; preparation of fruit-butters, jellies, marmalades, pickles, mustards, etc., and the preservation of meat, fish and eggs. A practical and indispensable book for everyone connected in any way with these industries.  $6\frac{1}{4}$  by  $9\frac{1}{4}$  Inches. Cloth Binding. 543 Pages. 101 Illustrations. Price...\$6.00



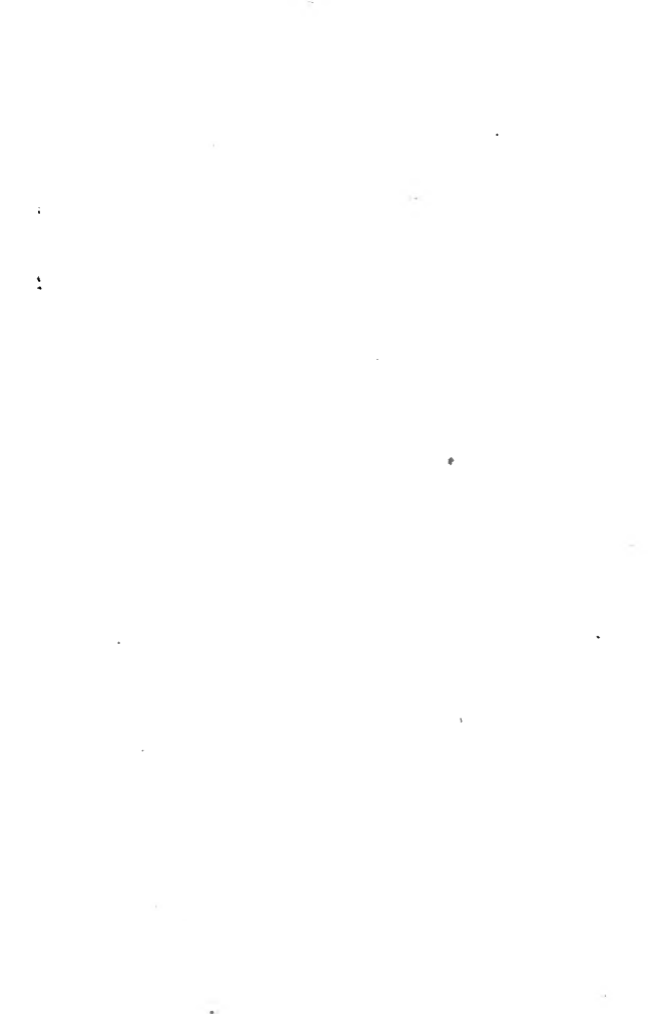





University of California  
SOUTHERN REGIONAL LIBRARY FACILITY  
305 De Neve Drive - Parking Lot 17 • Box 951388  
LOS ANGELES, CALIFORNIA 90095-1388

Return this material to the library from which it was borrowed.

4/13/2006

UC SOUTHERN REGIONAL LIBRARY FACILITY



A 000 506 136 1

SOUTHERN BRANCH,  
UNIVERSITY OF CALIFORNIA,  
LIBRARY,  
LOS ANGELES, CALIF.

U