

UNIVERSITY OF TORONTO

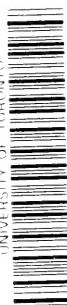

3 1761 01418957 5

UNIV. OF
TORONTO
LIBRARY



Digitized by the Internet Archive
in 2009 with funding from
University of Toronto



*P
Sci
C*

TRANSACTIONS

OF THE

CONNECTICUT ACADEMY

OF

ARTS AND SCIENCES.

VOLUME VI.

12686



NEW HAVEN:
PUBLISHED BY THE ACADEMY.
1882 TO 1885.

TUTTLE, MOREHOUSE & TAYLOR, PRINTERS.

12686

Q

11

C9

v. 6

CONTENTS.

	PAGE
LIST OF ADDITIONS TO THE LIBRARY,	v
ART. I.—NEW ENGLAND SPIDERS OF THE FAMILY THERIDIDÆ. By J. H. EMERTON. Plates 1-24,	1
ART. II.—DIPTEROUS LARVÆ FROM THE WESTERN ALKALINE LAKES, AND THEIR USE AS HUMAN FOOD. By S. W. WILLISTON,	87
ART. III.—NORTH AMERICAN CONOPIDÆ. By S. W. WILLISTON,	91
ART. IV.—ON THE ANATOMY OF <i>Libinia emarginata</i> Leach, THE SPIDER CRAB. By E. A. ANDREWS. Plates 25-27,	99
ART. V.—ON AN UNSYMMETRICAL LAW OF ERROR IN THE POSITION OF A POINT IN SPACE. By E. L. DEFOREST,	123
ART. VI.—SECOND CATALOGUE OF MOLLUSCA RECENTLY ADDED TO THE FAUNA OF THE NEW ENGLAND COAST AND THE ADJACENT PARTS OF THE ATLANTIC, CONSISTING MOSTLY OF DEEP SEA SPECIES, WITH NOTES ON OTHERS PREVIOUSLY RECORDED. By A. E. VERRILL. Plates 28-32,	139
ART. VII.—NEW ENGLAND SPIDERS OF THE FAMILY EPEIRIDÆ. By J. H. EMERTON. Plates 33-40,	295
ART. VIII.—THE DIASTATIC ACTION OF SALIVA, AS MODIFIED BY VARIOUS CONDITIONS STUDIED QUANTITATIVELY. By R. H. CHITTENDEN and HERBERT E. SMITH,	343
ART. IX.—NORTH AMERICAN CONOPIDÆ: <i>Conclusion</i> . By S. W. WILLISTON. Plate 41,	377
ART. X.—THIRD CATALOGUE OF MOLLUSCA RECENTLY ADDED TO THE FAUNA OF THE NEW ENGLAND COAST AND THE ADJACENT PARTS OF THE ATLANTIC, CONSISTING MOSTLY OF DEEP-SEA SPECIES, WITH NOTES ON OTHERS PREVIOUSLY RECORDED. By A. E. VERRILL. Plates 42-44,	395
ART. XI.—ADDITIONS TO THE SHALLOW-WATER MOLLUSCA OF CAPE HATTERAS, N. C., DREDGED BY THE U. S. FISH COMMISSION STEAMER "ALBATROSS" IN 1883 AND 1884. By KATHERINE J. BUSH. Plate 45,	453
ART. XII.—NEW ENGLAND LYCOSIDÆ. By J. H. EMERTON. Plates 46-49,	481

OFFICERS OF THE ACADEMY, 1884-85.

President.

ADDISON E. VERRILL.

Vice-President.

WILLIAM H. BREWER.

Corresponding Secretary.

ADDISON VAN NAME.

Recording Secretary.

LEONARD WALDO.

Librarian.

ADDISON VAN NAME.

Treasurer.

HENRY C. KINGSLEY.

Publishing Committee.

HUBERT A. NEWTON, ELIAS LOOMIS,
GEORGE J. BRUSH, ADDISON E. VERRILL,
EDWIN S. WHEELER, WILLIAM D. WHITNEY,
ADDISON VAN NAME.

Auditing Committee.

ADDISON E. VERRILL, HUBERT A. NEWTON,
ADDISON VAN NAME.

ADDITIONS TO THE LIBRARY
OF THE
Connecticut Academy of Arts and Sciences,
BY GIFT AND EXCHANGE, FROM AUG. 1, 1884, TO JULY 1, 1885.

- ALBANY.—*New York State Library.*
Annual report. LXIV, LXV, 1882-83. 8°.
- New York State Museum of Natural History.*
Annual report. XXVIII, XXXIII-XXXVII, 1879-84. 8°.
- ANNAPOLIS.—*United States Naval Institute.*
Proceedings. Vol. X. 4, XI. 1, 2, 1884-85. 8°.
- BALTIMORE.—*Johns Hopkins University.*
American chemical journal. Vol. VI. 3-6, VII. 1, 1884-85. 8°.
Studies from the biological laboratory. Vol. III. 2, 3, 1884-85. 8°.
- BOSTON.—*Amateur Scientific Society.*
Science observer. Vol. IV. 9-11, 1884-85. 8°.
- Society of Natural History.*
Memoirs. Vol. III. 10, 11, 1884-85. 4°.
Proceedings. Vol. XXII. 4, 1883. 8°.
- BROOKLYN.—*Entomological Society.*
Bulletin. Vol. I-VII, 1878-84. 8°.
Entomologica Americana. Vol. I. 1, 2, 1885. 8°.
Papilio. Vol. I-III. New York, 1881-83. 8°.
- CAMBRIDGE.—*Harvard College.*
Annual report of the president and treasurer. 1883-84. 8°.
- Astronomical Observatory of Harvard College.*
Annals. Vol. XIV. 2, 1885. 4°.
- Museum of Comparative Zoology.*
Memoirs. Vol. IX. 3, XI. 1, XII, XIII, 1884. 4°.
Bulletin. Vol. VII. 2-11, XI. 10, 1881-84. 8°.
Annual report. 1883-84. 8°.
- Entomological Club.*
Psyche. No. 121-129, 1884. 8°.
- CHAMPAIGN.—*Illinois State Laboratory of Natural History.*
Bulletin. Vol. II. 1, 1884. 8°.
- CHICAGO.—*Dearborn Observatory.*
Annual report. 1884. 8°.
- The American antiquarian and oriental journal.* Vol. VI. 5, 6, VII. 1-3, 1881-85. 8°.
- CINCINNATI.—*Society of Natural History.*
Journal. Vol. VII. 3, 4, VIII. 1, 1884-85. 8°.

DAVENPORT.—*Academy of Natural Sciences.*

A vindication of the elephant pipes and inscribed tablets in the museum of the Davenport Academy of Natural Sciences from the accusations of the Bureau of Ethnology of the Smithsonian Institution. By Charles E. Putnam. 1885. 8°.

DENVER.—*Colorado Scientific Society.*

The artesian wells of Denver. 1884. 8°.

DES MOINES.—*Academy of Science.*

Bulletin. Vol. I, 1, 1885. 8°.

MADISON.—*Washburne Observatory.*

Publications. Vol. II, 1884. 8°.

MERIDEN.—*Scientific Association.*

Transactions. Vol. I, 1884. 8°.

MINNEAPOLIS.—*Geological and Natural History Survey of Minnesota.*

Annual report. I (2d ed.), X, XII, 1872-83. 8°.

NEW YORK.—*American Geographical Society.*

Journal. Vol. I, II, 1, III-XIII, 1859-81. 8°.

Bulletin. Vol. I (1852), II (1856), 1882, 1883, 1884 i-iv. 8°.

———*American Museum of Natural History.*

Annual report. XVI, 1884-85.

———*Linnean Society.*

Transactions. Vol. II, 1884. 8°.

———*Torrey Botanical Club.*

Bulletin. Vol. XI, 7-12, XII, 1-5, 1884-85. 8°.

PAWTUCKET.—*The Ornithologist and Oologist.* Vol. X, 1-6, 1885. 8°.PHILADELPHIA.—*Franklin Institute.*

Journal. Vol. CXVIII, 2-6, CXIX, CXX, 1, 1884-85. 8°.

POUGHKEEPSIE.—*Vassar Brothers Institute.*

Transactions. Vol. II, 1883-84. 8°.

ST. LOUIS.—*Academy of Science.*

Transactions. Vol. IV, 3, 1884. 8°.

SALEM.—*Essex Institute.*

Bulletin. Vol. XV, 1-6, 10-12, XVI, 1-3, 7-12, 1883-84. 8°.

SAN FRANCISCO.—*California Academy of Sciences.*

Bulletin. No. 2, 3, 1885. 8°.

SPRINGFIELD.—*Illinois Department of Agriculture.*

Transactions. Vol. XVII, 1880. 8°.

Circular 118, 120, 122, 1885. 8°.

WASHINGTON.—*Bureau of Education.*

Report of the Commissioner of Education. 1881, 1882-83. 8°.

———*Bureau of Ethnology, Smithsonian Institution.*

Annual report. II, 1880-81. 8°.

———*Chief Signal Officer.*

Annual report. 1883. 8°.

Professional papers. No. XV, XVI, 1884-85. 4°.

———*U. S. Geographical and Geological Survey of the Rocky Mountain Region.*

Contributions to North American ethnology. Vol. V, 1882. 4°.

———*United States Geological Survey.*

Annual report. III, 1881-82. 8°.

- WASHINGTON.—*United States Geological Survey.*
 Monographs. Vol. III-VII, 1882-84. 4°.
 Bulletin. No. 1-6, 1883-84. 8°.
 Mineral resources of the United States. By Albert Williams, Jr. 1883. 8°. —
 ——— *United States Naval Observatory.*
 Astronomical and meteorological observations for 1880. 4°.
- WORCESTER.—*American Antiquarian Society.*
 Proceedings. New series, vol. III. 2, 3, 1884. 8°.
-
- AMSTERDAM.—*Kon. Akademie van Wetenschappen.*
 Jaarboek, 1882. 8°.
 Verslagen en mededeelingen. Afd. natuurl. 2de reeks. Deel XVIII, 1883. 8°.
- AUXERRE.—*Société des Sciences Historiques et Naturelles de l'Yonne.*
 Bulletin. Tome XXXVII. 2, XXXVIII, 1883-84. 8°.
- BAMBERG.—*Naturforschende Gesellschaft.*
 Bericht. XIII, 1883. 8°.
- BASEL.—*Naturforschende Gesellschaft.*
 Verhandlungen. Theil VII. 2 and Anhang, 1884. 8°.
- BATAVIA.—*Kon. Naturkundige Vereeniging in Nederlandsch-Indië.*
 Naturkundige tijdschrift. Deel XLII, 1883. 8°.
- BERLIN.—*Königl. Sternwarte.*
 Berliner astronomisches Jahrbuch. 1887. 8°.
- BERN.—*Naturforschende Gesellschaft.*
 Mittheilungen. No. 1064-1082, 1883-84. 8°.
- BOLOGNA.—*Accademia delle Scienze dell' Istituto di Bologna.*
 Rendiconto. 1884-85. 8°.
- BOMBAY.—*Bombay Branch of the Royal Asiatic Society.*
 Journal. No. XLII, XLIV, 1883. 8°.
 ——— *Government Observatory.*
 Magnetical and meteorological observations, 1879-82 and appendix, 1883. 1°.
- BONN.—*Naturhistorischer Verein der preussischen Rheinlande und Westphalens.*
 Verhandlungen. Jahrg. XL. 2, XLI, 1883-84. 8°.
- BREMEN.—*Naturwissenschaftlicher Verein.*
 Abhandlungen. Bd. VIII. 2, IX. 1, 1884-85. 8°.
- BRESLAU.—*Schlesische Gesellschaft für vaterländische Cultur.*
 Jahres-Bericht. LXI, 1883. 8°.
- BRÜNN.—*Naturforscher Verein.*
 Verhandlungen. Bd. XXII, 1883. 8°.
 Bericht der meteorologischen Commission. 1882. 8°.
- BRUXELLES.—*Observatoire Royal.*
 Annales. Nouv. sér. Annales astronomiques. Tome III, IV, V. 1. 2, 1880-84. 4°.
 ——— ——— Annales météorologiques. Tome I, 1881. 4°.
 Observations météorologiques faites aux stations internationales de la Belgique et des Pays-Bas. Année II-IV, 1878-80. 4°.
 Diagrammes du météorographe Van Rysschberghe. Année, 1879-83. f°. —
 Annuaire. Année XLVII-LI, 1880-84. 16°.

BRUXELLES.—*Observatoire Royal.*

Bibliographie générale de l'Astronomie. Par J. C. Houzeau et A. Lancaster.
Tome II, 1882. 8°.

Vade-mecum de l'Astronomie. Par J. C. Houzeau. 1882. 8°.

Exposition critique de la méthode de Wronski pour la résolution des problèmes de mécanique céleste. 1^{re} partie. 1882. 4°.

———*Musée d'Histoire Naturelle.*

Bulletin. Tome III. 1-3, 1884. 8°.

———*Société Royale Belge de Géographie.*

Bulletin. Année VIII, 1884. 8°.

———*Société Malacologique de Belgique.*

Annales. Tome XVIII, 1883. 8°.

———*Société Royale de Botanique.*

Bulletin. Tome XXIII, 1884. 8°.

———*Université.*

L'Université de Bruxelles, 1834-1884. Notice historique. Par L. Vanderkindere. 1884. 8°.

BUENOS AIRES.—*Sociedad Científica Argentina.*

Anales. Tome VI. 2, VII. 4, XIV. 4, XIX. 1-3, 1878-85. 8°.

CALCUTTA.—*Asiatic Society of Bengal.*

Journal. Vol. LIII, pt. i, no. 2 and special no.; pt. ii, no. 1, 2, 1884. 8°.

Proceedings. 1884, no. 2-11. 8°.

———*Geological Survey of India.*

Palaontologia Indica. Series IV. i. 4; X. iii. 2-5; XIII. i. 4 (fasc. 3, 4);
XIV. i. 3 (fasc. 3, 4); 1884. 4°.

Memoirs. Vol. XX, XXI. 1, 2, 1883-84.

Records. Vol. XVII. 3, 4, XVIII. 1, 2, 1883-84. 8°.

———*Meteorological Department of the Government of India.*

Report on the meteorology of India. 1882. f°.

Meteorological observations recorded at six stations in India. 1884. f°.

CAMBRIDGE.—*Philosophical Society.*

Transactions. Vol. XIV. 1, 1885. 4°.

Proceedings. Vol. V. 1-3, 1883-84. 8°.

CATANIA.—*Accademia Gioenia di Scienze Naturali.*

Atti. Ser. III. Tomo XVII, 1883. 4°.

CHRISTIANIA.—*Norwegian North-Atlantic Expedition, 1876-78.*

Report. XI-XIII, 1884-85. 4°.

CHUR.—*Naturforschende Gesellschaft Graubündens.*

Jahresbericht. Neue Folge. Jahrg. XXVII, 1882-83. 8°.

COIMBRA.—*Jornal de sciencias mathematicas e astronomicas.* Vol. III, 1881. 8°.CORDOBA.—*Academia Nacional de Ciencias.*

Boletín. Tomo VI. 4, VII, VIII. 1, 1884-85. 8°.

DANZIG.—*Naturforschende Gesellschaft.*

Schriften. Neue Folge. Bd. VI. 1, 1884. 8°.

DORPAT.—*Gelehrte Estnische Gesellschaft.*

Sitzungsberichte. 1884. 8°.

Verhandlungen. Bd. XII, 1884. 8°.

- DORPAT.—*Naturforscher-Gesellschaft.*
 Archiv für die Naturkunde Liv-Ehst- und Kurlands. Ser. II. Bd. IX. 5,
 X. 1, 1884. 8°.
 Sitzungsberichte. Bd. VI. 2, 3, VII. 1, 1884. 8°.
 Schriften. I, 1884. 8°.
- DRESDEN.—*Naturwissenschaftliche Gesellschaft Isis.*
 Sitzungsberichte. 1884. 8°.
 Festschrift zur Feier ihres 50jährigen Bestehens. 1885. 8
- DUBLIN.—*Royal Irish Academy.*
 Transactions. Vol. XXVIII. 14-16, 1883-84. 4°.
 Proceedings. Ser. II. Science, vol. IV. 1, 2; Polite Literature and Antiqui-
 ties, vol. II. 5; 1884. 8°.
- EDINBURGH.—*Royal Society.*
 Proceedings. Session 1881-82, 1882-83. 8°.
 ————*Royal Physical Society.*
 Proceedings. Vol. I. 2, II-VII, VIII. 1, 1856-84. 8°.
- EMDEN.—*Naturforschende Gesellschaft.*
 Jahresbericht. LXIX, 1883-84. 8°.
- ERFURT.—*Königl. Akademie gemeinnütziger Wissenschaften.*
 Jahrbücher. Neue Folge. Heft XII, XIII, 1884-85. 8°.
- FRANKFURT A. M.—*Deutsche malakologische Gesellschaft.*
 Nachrichtenblatt. Jahrg. XVI. 6-12, XVII. 1-6, 1884-85. 8
 ————*Senckenbergische naturforschende Gesellschaft.*
 Abhandlungen. Bd. XIII. 4. 4°.
 Bericht. 1884. 8°.
- FREIBURG I. BR.—*Naturforschende Gesellschaft.*
 Berichte. Bd. VIII. 2, 1884. 8°.
- GENÈVE.—*Institut National Genevois.*
 Bulletin. Tome XXV, 1883. 8°.
 ————*Société de Physique et d'Histoire Naturelle.*
 Mémoires. Tome XXVIII. 2, 1883-84. 4°.
- GIESSEN.—*Oberhessische Gesellschaft für Natur- und Heilkunde.*
 Bericht. XXIII, 1884. 8°.
- GLASGOW.—*Natural History Society.*
 Proceedings. Vol. V. 3, 1884. 8°.
 Proceedings and Transactions. New Series. Vol. I. 1, 1885. 8
 ————*Philosophical Society.*
 Proceedings. Vol. XV, 1883-84. 8°.
- GÖRLITZ.—*Naturforschende Gesellschaft.*
 Abhandlungen. Bd. XVIII, 1884. 8°.
- GÖTEBORG.—*Konigl. Vetenskaps- och Vitterhets Samhälle.*
 Handlingar. Ny tidsf. Häft. XIX, 1884. 8°.
- GÖTTINGEN.—*Königl. Gesellschaft der Wissenschaften.*
 Nachrichten. 1884. 8°.
- GÜSTROW.—*Verein der Freunde der Naturgeschichte in Mecklenburg.*
 Archiv. Jahrg. XXXVIII, 1884. 8°.
- HABANA.—*Real Colegio de Belen.*
 Observaciones magneticas y meteorologicas. Año. 1875, 1876 i. 4

- HALLE.—*Kais. Leopoldinisch-Carolinische deutsche Akademie der Naturforscher.*
Leopoldina. Heft XVIII–XX, 1882–84. 4°.
- Naturforschende Gesellschaft.*
 Abhandlungen. Bd. XVI. 2, 1884. 4°.
 Bericht. 1883. 4°.
- Naturwissenschaftlicher Verein für Sachsen und Thüringen.*
 Zeitschrift für Naturwissenschaften. Bd. LV. 6, LVII, LVIII. 1, 1883–85. 8°.
- HAMBURG.—*Deutsche Seewarte.*
 Archiv. Jahrg. IV, V, 1881–82. 8°.
 Meteorologische Beobachtungen in Deutschland. Jahrg. II–V, 1879–82. 4°
 Monatliche Uebersicht der Witterung. 1884 Jan.–Okt. 8°.
- Naturwissenschaftlicher Verein.*
 Abhandlungen. Bd. VIII. 1–3, 1884. 4°.
- Wissenschaftliche Anstalten.*
 Jahrbuch. Jahrg. I, 1884. 8°.
- HARLEM.—*Musée Teyler.*
 Archives. Sér. II, pt. 3, 4, 1882–83. 8°.
- Société Néerlandaise des Sciences Exactes et Naturelles.*
 Archives. Tome XVIII. 4, XIX. 2, 4, 5, 1883–84. 8°.
- HELSINGFORS.—*Societas Scientiarum Fennica.*
 Acta. Tom. XIII, 1884. 4°.
 Ofversigt af förhandlingar. XXV, 1882–83. 8°.
- Societas pro Fauna et Flora Fennica.*
 Meddelanden. Häft. IX–XI, 1883–85. 8°.
- HOBART TOWN.—*Royal Society of Tasmania.*
 Papers and proceedings and report. 1882, 1883, 1884. 8°.
- JENA.—*Medicinisch-naturwissenschaftliche Gesellschaft.*
 Jenaische Zeitschrift für Naturwissenschaft. Bd. XVII. 3, 4, XVIII. 1–3
 1884–85. 8°.
 Sitzungsberichte. 1883. 8°.
- KIEL.—*Naturwissenschaftlicher Verein für Schleswig-Holstein.*
 Schriften. Bd. V 2, 1884. 8°.
- Universität.*
 Schriften. 43 Dissertationen etc., 1883–84. 8° and 4°.
- KJØBENHAVN.—*Kon. Danske Videnskabernes Selskab.*
 Oversigt over forhandlingar. 1883 ii, iii, 1884 i, ii. 8°.
- KÖNIGSBERG.—*Königl. physikalisch-ökonomische Gesellschaft.*
 Schriften. Jahrg. XXIV, 1883. 4°.
- KRAKÓW.—*K. k. Sternwarte.*
 Materyaly do klimatografii Galicyi. Rok 1883. 8°.
- LAUSANNE.—*Société Vaudoise des Sciences Naturelles.*
 Bulletin. 2^e sér. No. 90, 91, 1884–85. 8°.
- LEIDEN.—*Nederlandsche Dierkundige Vereeniging.*
 Tijdschrift. Deel VI. 2–4, Supplement I. 2, 1882–85. 8°.
- LEIPZIG.—*Astronomische Gesellschaft.*
 Vierteljahrsschrift. Jahrg. XIX. 2–4, 1884. 4°.
- Naturforschende Gesellschaft.*
 Sitzungsberichte. Jahrg. X, 1883. 8°.

- LEIPZIG.—*Zoologischer Anzeiger.* No. 172-197, 1884-85. 8
- LIÉGE.—*Société Géologique de Belgique.*
Annales. Tome IX, XI, 1881-82; 1883-84. 8°.
- LISBOA.—*Sociedade de Geographia.*
Boletim. Serie IV. 7-11. 8°.
Le Zaire et les contrats de l'association internationale. Par C. Magalhaes. 1884. 8°.
Resposta a sociedade anti-esclavista de Londres. Por J. A. Corte Real. 1884. 8°.
- LONDON.—*Geological Society.*
Quarterly journal. Vol. XL. 3, 4, XLI. 1, 2, 1884-85. 8°.
List. 1884. 8°.
- Linnean Society.*
Journal. Zoology. no. 101-2; Botany, no. 130-33; 1883-84. 8°.
Proceedings. Nov. 1882-June 1883. 8°.
List. 1883. 8°.
- Mathematical Society.*
Proceedings. No. 189-90, 219-39. 8°.
- Royal Meteorological Society.*
Quarterly journal. New series. No. 51-54, 1884-85. 8°.
List of fellows. 1885. 8°.
- Royal Historical Society.*
Transactions. New series. Vol. II. 2-4, 1884-85. 8°.
- Royal Microscopical Society.*
Journal. Ser. II. Vol. IV. 4-6, V. 1, 2, 1884-85. 8°.
- Royal Society.*
Philosophical transactions. Vol. CXXXVI. 4, CLXII. 2, CLXXXIV. 2, 3, 1846-83. 4°.
Alphabetical Index to vol. CXI-CXX. 1823. 8°.
Proceedings. No. 227-231, 1883-84. 8°.
List of council and members. 1883. 4°.
- LUND.—*Universitet.*
Ars-Skrift. Tom. XX, 1883-84. 4°.
Universitets-biblioteks accessions-katalog. 1884. 8°.
- LUXEMBOURG.—*Institut Royal Grand-Ducal.*
Publications. Section des sciences naturelles et mathématiques. Tome XIX. 1883. 8°.
- LYON.—*Académie des Sciences, Belles-Lettres et Arts.*
Mémoires. Classe des sciences. Tome XXVI, 1883-84. 8°.
- Musée Guimet.*
Annales. Tome VII, 1884. 4°.
Revue de l'histoire des religions. Tome VIII. 6, IX, X, XI. 1, 1883-85. 8°.
- MADRAS.—*Administration report of the meteorological reporter for 1883-84.* 8°.
- MADRID.—*Ateneo Científico, Literario y Artístico.*
Discursos academicos del Señor D. José Moreno Nieto. 1882. 8°.
Obras de D. Manuel de la Revilla. 1883. 8°.
El Ateneo de Madrid en el centenario de Calderon. 1881. 8°.
Discurso pronunciado por el Señor Marques de Molins el 18 Nov. 1874. 8°.
Curso de historia universal. Conferencias durante el curso de 1882. 8°.

- MADRID.—*Ateneo Científico, Literario y Artístico.*
 Curso de ciencias naturales. Conferencias durante el curso de 1882. 8°.
 Discursos leídos en el Ateneo con motivo de la apertura del curso de 1884. 8°.
 Velada en honor del Señor D. José Moreno Nieto celebrada el 4 Marzo 1882. 8°.
 Catalogo de las obras existentes en la biblioteca. 1873. 8°.
 ————*Comisión del Mapa Geológico de España.*
 Boletín. Tomo XI. 1, 1885. 8°.
 Terremotos de Andalucía. Informe de la comisión nombrada para su estudio. 1885. 8°.
 ————*Observatorio.*
 Anuario. Año XVIII, 1880. 8°.
 Observaciones meteorológicas. 1876–1881. 8°.
 Resumen de las observaciones meteorológicas efectuadas en la Península 1876–80, 1882. 8°.
 ————*Sociedad Española de Historia Natural.*
 Anales. Tomo XIII. 2, 3, XIV. i, 1884–85. 8°.
- MANCHESTER.—*Literary and Philosophical Society.*
 Memoirs. Series III. Vol. VII, IX, 1881–83. 8°.
 Proceedings. Vol. XX–XXII, 1880–83. 8°.
- METZ.—*Académie.*
 Mémoires. Seconde période. Année LXII, 1880–81. 8°.
- MEXICO.—*Museo Nacional.*
 Anales. Tomo III. 6, 1884. 4°.
 ————*Ministerio de Fomento.*
 Boletín. Tomo IX. 65–80, X. 1–42, 1884–85. 4°.
 ————*Sociedad Mexicana de Historia Natural.*
 La naturaleza. Tomo VI. 21–24, VII. 1, 1883–84. 4°.
- MIDDELBURG.—*Zeeuwsch Genootschap der Wetenschappen.*
 Archief. Deel V. 3, 1883. 8°.
- MILANO.—*Reale Istituto Lombardo di Scienze e Lettere.*
 Rendiconti. Serie II. Vol. XVI, 1883. 8°.
 ————*Reale Osservatorio di Brera.*
 Pubblicazioni. No. XVII, XVIII, XXII, XXIV–XXVI, 1882–85. 4°.
- MODENA.—*Regia Accademia delle Scienze, Lettere ed Arti.*
 Memorie. Serie II. Tomo II, 1884. 4°.
- MONTPELLIER.—*Académie des Sciences et Lettres.*
 Mémoires. Section de médecine. Tome V. 3, 1884. 4°.
- MONTREAL.—*Natural History Society.*
 The Canadian record of science. Vol. I. 1, 2, 1884. 8°.
- MOSCOW.—*Société Impériale des Naturalistes.*
 Nouveaux mémoires. Tome XIV. 4, 1883. 4°.
 Bulletin. 1883 ii, iv, 1884 i. 8°.
 Meteorologische Beobachtungen am Observatorium der landwirth. Akademie zu Moskau. Jahrg. 1883. 4°.
- MÜNCHEN.—*Kön. bayerische Akademie der Wissenschaften.*
 Sitzungsberichte. Philosoph.-philolog. und histor. Classe. 1884. 8°.
 ———— Mathemat.-physikal. Classe. 1884. 8°.

- MÜNCHEN.—*Kön. bayerische Akademie der Wissenschaften.*
 Gedächtnissrede auf Theodor L. W. von Bischoff. Von Carl Kupfler.
 1884. 4°.
 Franz von Kobell. Eine Denkschrift von E. Haushofer. 1884. 4°.
 Rudolf Agricola ein deutscher Vertreter der italienischen Renaissance.
 Festsrede von F. von Bezold. 1884. 4°.
- Königliche Sternwarte.*
 Annalen. Supplbd. X, XIV, 1871-84. 8°.
- MÜNSTER.—*Westfälischer Verein für Wissenschaft und Kunst.*
 Jahresbericht. XII, 1883. 8°.
- NAPOLI.—*Circolo degli Aspiranti Naturalisti.*
 Rivista Italiana di scienze naturali. Anno. I. 1, 1885. 8°.
- Zoologische Station.*
 Mittheilungen. Bd. IV. 4, V, VI. 1, 1883-85. 8°.
- NEUCHÂTEL.—*Société des Sciences Naturelles.*
 Bulletin. Tome XIV, 1884. 8°.
- NEWCASTLE-UPON-TYNE.—*North of England Institute of Mining and Mechanical Engineers.*
 Transactions. Vol. XXXIII. 6, XXXIV. 1, 2, 3, 1884-85. 8°.
 An account of the strata of Northumberland and Durham, as proved by
 borings and sinkings. F-K. 1885. 8°.
- ODESSA.—*Société des Naturalistes de la Nouvelle Russie.*
 Zapiski. T. VIII, IX. 1, 1882-84. 8°.
- OSNABRÜCK.—*Naturwissenschaftlicher Verein.*
 Jahresbericht. VI, 1883-84. 8°.
- OTTAWA.—*Geological and Natural History Survey of Canada.*
 Report of progress, 1882-83-84, with maps.
 Catalogue of Canadian plants. Pt. ii. Gamopetalae. By John Macoun.
 Montreal, 1884. 8°.
 Map of the Dominion of Canada geologically colored from surveys 1842 to
 1882, with descriptive sketch of the physical geography and geology by
 A. R. C. Selwyn and G. M. Dawson. Montreal, 1884.
 Comparative vocabularies of the Indian tribes of British Columbia, with a
 map illustrating distribution. By W. Fraser Tolmie and G. M. Dawson.
 Montreal, 1884. 8°.
- PALERMO.—*Reale Osservatorio Meteorologico Valverde.*
 Osservazioni meteorologiche. Anno I, V. 1, 1880-84. 8°.
- PARIS.—*École Polytechnique.*
 Journal. Cahier LIV, 1884. 4°.
- Société Nationale d'Acclimatation de France.*
 Bulletin. 4^e sér. Tome I. 2-12, II. 1-5, 1884-85. 8°.
- Société Géologique de France.*
 Bulletin. 3^e sér. Tome IX. 7, X. 7, XI. 8, XII. 4-8, XIII. 1-4, 1882-85. 8°.
- Société Mathématique de France.*
 Bulletin. Tome XII. 2-6, XIII. 1-4, 1884-85. 8°.
- PENZANCE.—*Royal Geological Society of Cornwall.*
 Transactions. Vol. X. 7, 1885. 8°.
- PISA.—*Società Toscana di Scienze Naturali.*
 Processi verbali. Vol. IV. pp. 73-146, 167-230, 1884-85. 8°.

- PRAG.—*Kön. böhmische Gesellschaft der Wissenschaften.*
 Abhandlungen. 6te Folge. Bd. XII, 1883–84. 4°.
 Sitzungsberichte. 1882, 1883, 1884. 8°.
 Jahresbericht. 1882, 1883, 1884. 8°.
 Generalregister zu den Schriften, 1784–1884. 8°.
 Verzeichniß der Mitglieder, 1784–1884. 8°.
 Geschichte der kön. böhm. Gesellschaft der Wissenschaften, sammt einer
 kritischen Übersicht ihrer Publicationen aus dem Bereiche der Philosophie,
 Geschichte und Philologie. Heft I. 1884. 8°.
 Bericht über die mathematischen und naturwissenschaftlichen Publikationen.
 Heft I. 1884. 8°.
- REGENSBURG.—*Naturwissenschaftlicher Verein.*
 Correspondenz-Blatt. Jahrg. XXXVII, XXXVIII. 1883–84. 8°.
- RIGA.—*Naturforscher Verein.*
 Correspondenzblatt. Jahrg. XXVI, 1883. 8°.
- ROMA.—*Reale Accademia dei Lincei.*
 Transunti. Vol. VIII, 13–16, 1884. 4°.
 Rendiconti. Vol. I, 1–12, 1884–85. 8°.
- Reale Comitato Geologico d'Italia.*
 Bolletino. Vol. XIV, 1883. 8°.
- ST. GALLEN.—*Naturwissenschaftliche Gesellschaft.*
 Bericht. 1882–83. 8°.
- ST. PETERSBURG.—*Hortus Petropolitanus.*
 Acta. Tom. VIII, 3, IX, 1, 1884. 8
- Imp. Russ. Geograf. Obshtchestvo.*
 Otchet. God 1883, 1884. 8°.
- Physikalisches Centralobservatorium.*
 Annalen. Jahrg. 1882, ii, 1883. 4°.
- Schweizerische naturforschende Gesellschaft.*
 Verhandlungen. Jahresversammlung LXV, in Zürich, 1883. 8°.
- STOCKHOLM.—*Entomologisk Förening.*
 Entomologisk tidskrift. Arg. V, 1884. 8°.
- STUTTGART.—*Verein für vaterländische Naturkunde in Württemberg.*
 Jahreshefte. Jahrg. XI, 1884. 8°.
- SYDNEY.—*Observatory.*
 Results of rain and river observations, 1883, 1884. 8°.
 Physical geography and climate of New South Wales. By H. C. Russell.
 1884. 8°.
 New double stars. By H. C. Russell. 8°.
- Royal Society of New South Wales.*
 Journal and proceedings. Vol. XVI, XVII, 1882–83. 8°.
- TACUBAYA.—*Observatorio Astronómico Nacional.*
 Anuario. Año V, 1885. 8°.
- THRONDHJEM.—*Kon. Norske Videnskabers Selskab.*
 Skrifter. 1882. 8°.
- TOKIO.—*University.*
 Abhandlungen. No. 10, 1883. 8°.
- TORONTO.—*Canadian Institute.*
 Proceedings. Third series. Vol. II, 3, III, 1, 1884–85. 8°.

- TORONTO.—*Meteorological Service of the Dominion of Canada.*
Report. 1882. Ottawa, 1884. 8°.
- TOULOUSE.—*Société d'Histoire Naturelle.*
Bulletin. Année XVIII. 3, 4, 1884. 8°.
- UPSALA.—*Regia Societas Scientiarum.*
Nova acta. Ser. III. Vol. XII. i, 1884. 4°.
- UTRECHT.—*Kon. Nederlandsch Meteorologisch Instituut.*
Nederlandsch meteorologisch jaarboek. 1883. 4°.
— *Provincial Utrechtsch Genootschap van Kunsten en Wetenschappen.*
Verslag van het verhandelde in de algemeene vergadering. 1882, 1883, 1884. 8°.
Aanteekeningen van het verhandelde in de sectie-vergaderingen. 1882, 1883. 8°.
- VENEZIA.—*Istituto Veneto di Scienze, Lettere ed Arti.*
Atti. Ser VI. Vol. I. 4-10, II. 1, 2, 1882-84. 8°.
- VICENZA.—*Accademia Olimpica.*
Atti. Vol. XVI, XVII, 1881-82. 8°.
Il Dottor Beggiato. Commemorazione da Paolo Liroy. 1883. 8°.
- WIEN.—*Kais. Akademie der Wissenschaften.*
Sitzungsberichte. Mathemat.-naturwiss. Classe. Abth. I. Bd. LXVIII, LXIX, 1883-84. 8°.
— *K. k. Central-Anstalt für Meteorologie und Erdmagnetismus.*
Jahrbücher. Neue Folge. Bd. XVIII. 2, XIX, 1881-82. 4°.
— *K. k. geologische Reichsanstalt.*
Abhandlungen. Bd. XI. 1, 1885. 4°.
Jahrbuch. Bd. XXXIV. 2-4, 1884. 8°.
Verhandlungen. Jahrg. 1884, No. 4-18. 8°.
— *K. k. zoologisch-botanische Gesellschaft.*
Verhandlungen. Bd. XXXIII and Beiheft, 1883. 8°.
— *Oesterreichische Gesellschaft für Meteorologie.*
Zeitschrift. Bd. XIX. 8-12, XX. 1-6, 1884-85. 8°.
- WIESBADEN.—*Nassauischer Verein für Naturkunde.*
Jahrbücher. Jahrg. XXXVII, 1884. 8°.
- WÜRZBURG.—*Physikalisch-medicinische Gesellschaft.*
Sitzungsberichte. Jahrg. 1883, 1884. 8°.

-
- Bredichin, Th. Sur les têtes des comètes. Moscou, 1885. 8°. *From the Author.*
- Brinton, D. G. The lineal measures of the semi-civilized nations of Mexico and Central America. Philad., 1885. 8°. *From the Author.*
- Collin, Jonas. Om Linnfjordens tidligere og nuværende marine fauna med særligt hensyn til Bloddyrfaunen. Kjøbenhavn, 1884. 8°. *From the Author.*
- Guthrie, Malcolm. On Mr. Spencer's Data of Ethics. Lond., 1884. 8°. *From the Author.*
- Report of the department of mines of Nova Scotia for 1884. Halifax, 1885. 8°. *From Mr. Edwin Gilpin, Jr.*
- Smellie, T. D. Ocean and air currents. Glasgow, 1885. 8°. *From the Author.*



ADDITIONS TO THE LIBRARY
OF THE
Connecticut Academy of Arts and Sciences,

BY GIFT AND EXCHANGE, FROM JULY 1, 1882, TO AUG. 1, 1884.

- ALBANY.—*New York State Library.*
Annual report. LXI, LXII, LXIII, 1880-82. 8°.
———*New York State Museum of Natural History.*
Annual report. XXXI, 1878. 8°.
American Association for the Advancement of Science.
Proceedings. Thirtieth, thirty-first, thirty-second meeting, 1881-83. Salem,
1882-84. 8°
- ANNAPOLIS.—*United States Naval Institute.*
Proceedings. Vol. X. 1-3, 1884. 8°.
- BALTIMORE.—*Johns Hopkins University.*
American chemical journal. Vol. IV. 3-6, V. 1, 3-6, VI. 1, 2, 1882-84. 8°.
Studies from the biological laboratory. Vol. II. 3, 4, III. 1, 1882-84. 8°.
- BOSTON.—*Amateur Scientific Society.*
Science observer. Vol. IV. 1-8, 1882-84. 8°.
———*American Academy of Arts and Sciences.*
Proceedings. Vol. XVII-XIX, 1881-84. 8°.
———*Society of Natural History.*
Memoirs. Vol. III. 6-9, 1883-84. 4°.
Proceedings. Vol. XXI. 4, XXII. 1-3, 1882-83. 8°.
- BUFFALO.—*Society of Natural Sciences.*
Bulletin. Vol. IV. 3, 4, 1882-83. 8°.
- CAMBRIDGE.—*Astronomical Observatory of Harvard College.*
Annals. Vol. XIII. 1, XIV, 1882-84. 4°.
Annual report. XXXVII, XXXVIII, 1881-82, 1882-83. 8°.
Observations on the transit of Venus, Dec. 5 and 6, 1882. 8°.
———*Museum of Comparative Zoology.*
Memoirs. Vol. VII. 2, pt. 2, 3, VIII, IX. 1, 2, X. 1, 3, 1881-84. 4°.
Bulletin. Vol. X, XI. 1-9, 1882-83. 8°.
Annual report. 1881-82, 1882-83. 8°.
———*Entomological Club.*
Psyche. No. 1-102, 105-120, 1874-84. 8°.
- CHICAGO.—*Astronomical Society.*
Annual report. 1882, 1883. 8°.
———*The American antiquarian and oriental journal.* Vol. IV. 4, V, VI. 1-4
1882-84. 8°.
- CINCINNATI.—*Observatory.*
Publications. No. 7, 1880-82. 8°.

- CINCINNATI.—*Society of Natural History.*
Journal. Vol. V. 3, 4, VI, VII. 1, 2, 1882-84. 8°.
- DAVENPORT.—*Academy of Natural Sciences.*
Proceedings. Vol. III. 2, 1882. 8°.
- FRANKFORT.—*Kentucky Geological Survey.*
Carr, L. The mounds of the Mississippi valley historically considered. 4°.
- MADISON.—*State Historical Society of Wisconsin.*
Report and collections. Vol. IX, 1880-82. 8°.
———*Washburne Observatory.*
Publications. Vol. I, 1882. 8°.
- MIDDLETOWN.—*Museum of Wesleyan University.*
Annual report. XII, 1883. 8°.
- MILWAUKEE.—*Naturhistorischer Verein von Wisconsin.*
Jahres-Bericht. 1881-82. 8°.
- MINNEAPOLIS.—*Minnesota Academy of Natural Sciences.*
Bulletin. Vol. II. 4, 1882. 8°.
- NEW YORK.—*American monthly microscopical journal.* Vol. III. 1-7, 12, IV, 1882-83. 8°.
———*American Museum of Natural Sciences.*
Bulletin. Vol. I. 1-5, 1881-84. 8°.
Annual report. XIV, XV, 1883-84. 8°.
———*Linnæan Society.*
Transactions. Vol. I, 1882. 8°.
———*Torrey Botanical Club.*
Bulletin. Vol. VIII-X, XI. 1-6, 1881-84. 8°.
- PHILADELPHIA.—*Franklin Institute.*
Journal. Vol. CXIV. 2-6, CXV-CXVII, CXVIII. 1, 1882-84. 8°.
- POUGHKEEPSIE.—*Vassar Brothers Institute.*
Transactions. Vol. I, 1881-83. 8°.
- PRINCETON.—*E. M. Museum of Geology and Archaeology of Princeton College.*
Bulletin. No. 3, 1883. 8°.
- ST. LOUIS.—*Missouri Historical Society.*
Publications. No. 7, 1883. 8°.
- SALEM.—*Essex Institute.*
Bulletin. Vol. XIV, 1882. 8°.
- SAN FRANCISCO.—*California Academy of Sciences.*
Bulletin. No. 1, 1884. 8°.
- WASHINGTON.—*Bureau of Education.*
Report of the Commissioner of Education. 1880. 8°.
———*Bureau of Ethnography.*
Annual report. I, 1879-80. 8°.
———*Chief Signal Officer.*
Annual report. 1879. 8°.
Professional papers. No. 1, 2, 3, 6, 7, 13, 1881-84. 4°.
———*Surgeon General, U. S. A.*
Medical and surgical history of the war of the rebellion. Pt. III, vol. II, 1883. 4°.
———*United States Geographical Survey West of the One Hundredth Meridian.*
Report. Vol. III, supplement, 1881. 4°.

- WASHINGTON.—*United States Geological Survey.*
 Annual report. I, II, 1879–80, 1880–81. 8°.
 Tertiary history of the Grand Cañon district, with atlas. By Clarence Dutton.
 1882. 4° and f°.
- United States Naval Observatory.*
 Astronomical and meteorological observations for 1878, and appendix I. 4°.
 Instructions for observing the transit of Venus, Dec. 6, 1882. 4°.
- WORCESTER.—*American Antiquarian Society.*
 Proceedings. No. 73. New series, vol. I. 2, II, III. 1, 1879–84. 8°.
-
- AMIENS.—*Société Linnéenne du Nord de la France.*
 Mémoires. Année 1883. 8°.
 Bulletin. No. 99–122, 1880–82. 8°.
- AMSTERDAM.—*Kon. Akademie van Wetenschappen.*
 Jaarboek, 1880, 1881. 8°.
 Verslagen en mededeelingen. Afdel. natuurkunde. 2de reeks. Deel XVI,
 XVII, 1881–82. 8°.
- AUGSBURG.—*Naturhistorischer Verein.*
 Bericht. XXVII, 1883. 8°.
- AUXERRE.—*Société des Sciences Historiques et Naturelles de l'Yonne.*
 Bulletin. Tome XXXV. 2, XXXVI, XXXVII. 1, 1881–83. 8°.
 Tables analytiques. 2^e série, 1867–78. 8°.
- BAMBERG.—*Naturforschende Gesellschaft.*
 Bericht. XII, 1882. 8°.
- BASEL.—*Naturforschende Gesellschaft.*
 Verhandlungen. Theil VII. 1, 1882. 8°.
- BATAVIA.—*Kon. Natuurkundige Vereeniging in Nederlandsch-Indië.*
 Natuurkundige tijdschrift. Deel XLI, 1882. 8°.
- BERGEN.—*Museum.*
 Nye Aleyonider, Gorgonider og Pennatulider tilhørende til Norges fauna.
 Ved Johan Koren og D. C. Daniellssen. 1883. 4°.
- BERLIN.—*Königl. Sternwarte.*
 Berliner astronomisches Jahrbuch. 1885, 1886. 8°.
- BOLOGNA.—*Accademia delle Scienze dell' Istituto di Bologna.*
 Rendiconto. 1881–82, 1882–83. 8°.
- Congrès Géologique International.*
 Compte rendu. 2^e sess. 1881. 8°.
- BOMBAY.—*Bombay Branch of the Royal Asiatic Society.*
 Journal. No. XL, XLI, 1882–83. 8°.
- BONN.—*Naturhistorischer Verein der preussischen Rheinlande und Westphalens.*
 Verhandlungen. Jahrg. XXXVIII. 2, XXXIX, XL. 1, 1881–83. 8°.
- BORDEAUX.—*Académie Nationale des Sciences, Belles-Lettres et Arts.*
 Actes. Année XLII, XLIII, 1878–81. 8°.
 Table historique et méthodique, 1712–1875. Documents historiques, 1711–1713.
 Catalogue des manuscrits de l'ancienne Académie, 1712–1793. 1879. 8°.
- Société Linnéenne.*
 Actes. Tome XXXV, XXXVI, 1881–82. 8°.
- Société des Sciences Physiques et Naturelles.*
 Mémoires. 2^e sér. Tome IV. 3, V, 1881–83. 8°.

- BREMEN.—*Naturwissenschaftlicher Verein.*
Abhandlungen. Bd. VII. 3, VIII. 1, 1882-83. 8°.
- BRESLAU.—*Schlesische Gesellschaft für vaterländische Cultur.*
Jahres-Bericht. LIX, LX, 1881-82. 8°.
- BRIGHTON.—*Health Congress.*
Transactions. 1881. 8°.
- BRÜNN.—*Naturforscher Verein.*
Verhandlungen. Bd. XIX-XXI, 1881-82. 8°.
Bericht der meteorologischen Commission. 1881. 8°.
- BRUXELLES.—*Académie Royale des Sciences, des Lettres et des Beaux-Arts de Belgique.*
Mémoires. Tome XLIII. 2, XLIV, 1882. 4°.
Mémoires couronnés et mémoires des savants étrangers. Tome XLIV, 1882. 4°.
Mémoires couronnés et autres mémoires. Tome XXXI, XXXIII-XXXV, 1881-83. 8°.
Bulletins. 2^e sér. Tome L. 3^e sér. Tome I-V, 1880-83. Tables générales, 2^e sér., t. 21-50. 8°.
Annuaire. 1881, 1882, 1883. 8°.
- Société Belge de Géographie.*
Bulletin. Année V. 5, 6, VI, VII, 1881-83. 8°.
- Société Entomologique de Belgique.*
Annales. Tome XXV-XXVII, 1881-83. 8°.
- Société Malacologique de Belgique.*
Annales. Tome XIV, XVI, XVII, 1879-82. 8°.
- Société Royale de Botanique.*
Bulletin. Tome XXI, XXII, 1883. 8°.
- BUENOS AIRES.—*Sociedad Científica Argentina.*
Anales. Tome I-V, VI. 3, 6, VII. 1-3, 5, 6, VII, IX, X. 1-3, XIII. 4-6, XIV, XV, XVI. 1-3, 5, 6, XVII. 1-5, 1876-84. 8°.
Censo general de la provincia de Buenos Aires. 1883. f.° (2 copies).
Sistema de medidas y pesas. 1881. 8°.
Rectificación de medidas de longitud y de superficie de la provincia de Tucuman. 1883. 8°.
The Argentine Republic as a field for European emigration. By F. Latzina. 1883. 8°.
- CAEN.—*Société Linnéenne de Normandie.*
Bulletin. 3^e sér. Tome V, VI, 1880-82. 8°.
- CALCUTTA.—*Asiatic Society of Bengal.*
Journal. Vol. LI. i, 2-4 and extra no., ii, LII. i, ii, LIII. i, 1, 1882-84. 8°.
Proceedings. 1882, no. 3-10; 1883; 1884, no. 1. 8°.
Descriptions of new Indian lepidopterous insects from the collection of the late Mr. W. S. Atkinson. Pt. 2. 1882. 4°.
- Geological Survey of India.*
Palaeontologia Indica. Series X, vol. ii. iii. 1; XII, vol. iii. 2, 3, iv. 1; XIII, vol. i. 4 (fasc. 1, 2); XIV, vol. i. 3 (fasc. 2); 1881-84. 4°.
Memoirs. Vol. XIX, XXII, 1882-83. 8°.
Records. Vol. XV, XVI, XVII. 1, 2, 1882-84. 8°.

- CALCUTTA.**—*Meteorological Department of the Government of India.*
 Indian meteorological memoirs. Vol. I. 6, II. 1, 2, 1881-83. f°.
 Report on the meteorology of India. 1879, 1880, 1881. f°.
 Report on the administration of the meteorological department. 1880-81,
 1881-82, 1882-83. f°.
 Meteorological observations recorded at six stations in India. 1880 Aug.-
 Dec.; 1881 Jan., Feb., Oct.-Dec.; 1882; 1883. f°.
- CAMBRIDGE.**—*Philosophical Society.*
 Transactions. Vol. XIII. 2, 3, 1882-83. 4°.
 Proceedings. Vol. IV. 2-6, 1881-83. 8°.
- CASSEL.**—*Verein für Naturkunde.*
 Bericht. XXIX-XXX, 1881-83. 8°.
- CATANIA.**—*Accademia Gioenia di Scienze Naturali.*
 Atti. Ser. III. Tomo XVI, 1882. 4°.
- CHAPULTEPEC.**—*Observatorio Astronomico.*
 Anuario. 1883. 8°.
- CHEMNITZ.**—*Naturwissenschaftliche Gesellschaft.*
 Bericht. VII, VIII, 1878-82. 8°.
- CHERBOURG.**—*Société Nationale des Sciences Naturelles.*
 Mémoires. Tome XXIII, 1881. 8°.
 Catalogue la bibliothèque. 1^{re} partie. 2^e éd. 1881. 8°.
- CHRISTIANIA.**—*Norwegische Commission der Europäischen Gradmessung.*
 Geodätische Arbeiten. Heft I-III, 1880-82. 4°.
 Vandstands observationer. Heft I, II, 1882.
 ————*Norwegian North-Atlantic Expedition, 1876-78.*
 Report. VI-X, 1882-83. 4°.
- CHUR.**—*Naturforschende Gesellschaft Graubündens.*
 Jahresbericht. Neue Folge. Jahrg. XXV, XXVI, 1880-81, 1881-82. 8°.
- CORDOBA.**—*Academia Nacional de Ciencias.*
 Actas. Tomo V. 1. Buenos Aires, 1884. 4°.
 Boletin. Tomo VI. 1, 1884. 8°.
- DANZIG.**—*Naturforschende Gesellschaft.*
 Schriften. Neue Folge. Bd. V. 3, 4, 1882-83. 8°.
- DIJON.**—*Académie des Sciences, Arts et Belles-Lettres.*
 Mémoires. 3^e sér. Tome VII, 1881-82. 8°.
- DORPAT.**—*Gelehrte Estnische Gesellschaft.*
 Sitzungsberichte. 1882, 1883. 8°.
 Verhandlungen. Bd. XI, 1883. 8°.
 ————*Naturforscher-Gesellschaft.*
 Archiv für die Naturkunde Liv-Ehst- und Kurlands. Ser. I. Bd. IX. 1, 2.
 Ser. II. Bd. VIII. 4, 1882. 8°.
 Sitzungsberichte. Bd. VI. 1, 1881. 8°.
- DRESDEN.**—*Naturwissenschaftliche Gesellschaft Isis.*
 Sitzungsberichte. 1881 Juli-Dec., 1882, 1883. 8°.
 ————*Verein für Erdkunde.*
 Jahresbericht. XVIII-XX, 1880-83. 8°.
- DUBLIN.**—*Royal Geological Society of Ireland.*
 Journal. Vol. XVI. 2, 1881-82. 8°.

DUBLIN.—*Royal Irish Academy.*

Transactions. Vol. XXVII. 5, XXVIII. 6-13, 1881-83. 4°.

Proceedings. Ser. II. Vol. II. 4, III. 9, 10, 1882-83. 8°.

EDINBURGH.—*Geological Society.*

Transactions. Vol. I, II. 1, IV. 2, 1868-72. 8°.

———*Royal Society.*

Proceedings. Session 1880-81. 8°.

EMDEN.—*Naturforschende Gesellschaft.*

Jahresbericht. LXVIII, 1882-83. 8°.

ERFURT.—*Königl. Akademie gemeinnütziger Wissenschaften.*

Jahrbücher. Neue Folge. Heft XI, 1882. 8°.

FALMOUTH.—*Royal Cornwall Polytechnic Society.*

Annual report. XLIX, 1881. 8°.

FIRENZE.—*R. Istituto di Studi Superiori.*

Pubblicazioni: Sezione di filosofia e filologia.

Il commento medio di Averroè alla Retorica di Aristotele, pub. dal Prof. F. Lasinio. Fasc. 2, 3, 1877-78. 8°.

Intorno ad alcuni luoghi della Ifigenia in Aulide di Euripide. Osservazioni di G. Vitelli. 1877. 8°.

La ribellione di Masacalo e di Sumitomo. Testo Giapponese riprodotto e tradotto da L. Nocentini. 1878. 2 pts. 8°.

Del papiro. Memoira del Prof. C. Paoli. 1878. 8°.

Il mito di Filottete. Studio monografico di L. A. Milani. 1879. 8°.

—Sezione di scienze fisiche e naturali.

Sulla teoria fisica dell'elettrotono nei nervi. Esperienze del Dott. A. Eccher. 1877. 8°.

Sulle forze elettromotrici sviluppate dalle soluzioni saline. Del Dott. A. Eccher. 1878. 8°.

Il globo celeste Arabico del secolo XI nel gabinetto del R. Istituto, illustrato da F. Meucci. 1878. 8°.

Ricerche sulle formole di costituzione dei composti ferrici. Parte I. Nota del Dott. D. Tommasi. 1879. 8°.

Ancora sulla Polimelia nei Batraci anuri. Sopra alcuni visceri del Gallo cedrone. Del Dott. G. Cavanna. 1879. 8°.

FRANKFURT A. M.—*Deutsche malakologische Gesellschaft.*

Nachrichtsblatt. Jahrg. XIV. 8-12, XV, XVI. 1-5, 1882-84. 8°.

———*Senckenbergische naturforschende Gesellschaft.*

Abhandlungen. Bd. XII. 3, 4, XIII. 1-3, 1881-84. 4°.

Bericht. 1880-81, 1881-82, 1882-83. 8°.

FRAUENFELD.—*Thurgauische Naturforschende Gesellschaft.*

Mittheilungen. Heft V, VI, 1882-84. 8°.

FREIBURG I. BR.—*Naturforschende Gesellschaft.*

Berichte. Bd. VIII. 1, 1882. 8°.

Festschrift der sechs und fünfzigsten Versammlung deutscher Naturforscher und Aerzte gewidmet. 1883. 8°.

GENÈVE.—*Institut National Genevois.*

Bulletin. Tome XXIV, 1882. 8°.

———*Société de Physique et d'Histoire Naturelle.*

Mémoires. Tome XXVII. 2, XXVIII. 1, 1881-83. 4°.

- GIESSEN.—*Oberhessische Gesellschaft für Natur- und Heilkunde.*
Bericht. XXI, XXII, 1882–83. 8°.
- GLASGOW.—*Natural History Society.*
Proceedings. Vol. I, II, III. 1, 3, IV. 1, V. 1, 2, 1859–82. 8°.
- Philosophical Society.*
Proceedings. Vol. XIII. 2, XIV. 1881–83. 8°.
- GÖTEBORG.—*Kongl. Vetenskaps- och Vitterhets Samhälle.*
Handlingar. Ny tidsf. Häft. XVII, XVIII, 1882. 8°.
- GÖTTINGEN.—*Königl. Gesellschaft der Wissenschaften.*
Nachrichten. 1882, 1883. 8°.
- Königliche Sternwarte.*
Klikerfues'sche Constanten zur Reduction auf den scheinbaren Ort für die
mittleren Tage 1884, berechnet von H. Kobold. 1883. 8°.
- GREIFSWALD.—*Geographische Gesellschaft.*
Jahresbericht. I, 1882–83. 8°.
- HALIFAX.—*Nova Scotia Institute of Natural Science.*
Proceedings and transactions. Vol. VI. 1, 1882–83. 8°.
- HALLE.—*Kais. Leopoldinisch-Carolinische deutsche Akademie der Naturforscher.*
Leopoldina. Heft XVII, 1881. 4°.
- Naturforschende Gesellschaft.*
Abhandlungen. Bd. XV. 2–4, XVI. 1, 1881–83. 4°.
Bericht. 1880, 1881, 1882. 4°.
- Naturwissenschaftlicher Verein für Sachsen und Thüringen.*
Zeitschrift für die gesammten Naturwissenschaften. Bd. LIV, LV, LVI.
1–5, 1881–83. 8°.
- HAMBURG.—*Deutsche Seewarte.*
Monatliche Uebersicht der Witterung. 1882 Jan.–Juni, Sept.–Dez.; 1883. 8°.
- HAMBURG–ALTONA.—*Naturwissenschaftlicher Verein.*
Verhandlungen. Neue Folge. No. I, II, 1875–77. 8°.
Abhandlungen. Bd. V. 1, VII. 2, 1866–73. 4°.
- HANNOVER.—*Naturhistorische Gesellschaft.*
Jahresbericht. XXXI, XXXII, 1877–80, 1880–82. 8°.
- HARLEM.—*Musée Teyler.*
Archives. Vol. III. 1–3, V. 1; serie II, pt. 1, 2; 1874–82. 8°.
- Société Néerlandaise des Sciences Exactes et Naturelles.*
Archives. Tome XVII, XVIII. 1–3, 5, XIX. 1, 1882–84. 8°.
- HEIDELBERG.—*Naturhistorisch-medicinischer Verein.*
Verhandlungen. Neue Folge. Bd. III. 2, 1882. 8°.
- HELSINGFORS.—*Societas Scientiarum Fennica.*
Acta. Tom. XII, 1883. 4°.
Öfversigt af förhandlingar. XXIII, XXIV, 1880–82. 8°.
Bidrag till kännedom af Finlands natur och folk. Häft. XXXV–XXXVIII,
1881–82. 8°.
Observations météorologiques. Vol. VIII, 1880. 8°.
Katalog öfver societetens bibliothek. 1881. 8°.
- Societas pro Fauna et Flora Fennica.*
Notiser. Häft. VIII, 1882. 8°.
- HERMANNSTADT.—*Siebenbürgischer Verein für Naturwissenschaften.*
Verhandlungen und Mittheilungen. Jahrg. XXXII–XXXIV, 1882–84. 8°.

- HOBART TOWN.—*Royal Society of Tasmania.*
Papers and proceedings and report. 1880, 1881. 8°.
- JENA.—*Medicinisch-naturwissenschaftliche Gesellschaft.*
Jenaische Zeitschrift für Naturwissenschaft. Bd. XV. 4, XVI, XVII. 1, 2,
1881-84. 8°.
Sitzungsberichte. 1881, 1882. 8°.
- KIEL.—*Naturwissenschaftlicher Verein für Schleswig-Holstein.*
Schriften. Bd. IV. 2, V. i, 1882-83. 8°.
———*Universität.*
Schriften. Bd. XXVIII, 1881-82. 4°.
Dissertationen (40). 1881-82, 1882-83. 8°.
- KJOBENHAVN.—*Kon. Danske Videnskabernes Selskab.*
Oversigt over forhandlinger. 1881, iii, 1882, 1883, i. 8°.
- KÖNIGSBERG.—*Königl. physikalisch-ökonomische Gesellschaft.*
Schriften. Jahrg. XXI. 2, XXII, XXIII, 1880-82. 4°.
- KRAKÓW.—*K. k. Sternwarte.*
Materjaly do klimatografii Galicyi. Rok 1881, 1882. 8°.
- LAUSANNE.—*Société Vaudoise des Sciences Naturelles.*
Bulletin. 2^e sér. No. 85-89, 1881-83. 8°.
- LEEDS.—*Geological and Polytechnic Society of the West Riding of Yorkshire.*
Proceedings. New series. Vol. VIII. 1, 2, 1882-84. 8°.
- LEIDEN.—*Nederlandsche Dierkundige Vereeniging.*
Tijdschrift. Deel VI. 1, supplement I. 1, 1882-83. 8°.
- LEIPZIG.—*Astronomische Gesellschaft.*
Vierteljahrsschrift. Jahrg. XVII. 1, 3, 4, XVIII, XIX. 1, 1882-84. 8°.
Publication. XVII, 1883. 4°.
———*Naturforschende Gesellschaft.*
Sitzungsberichte. Jahrg. VIII, IX, 1881-82. 8°.
———*Zoologischer Anzeiger.* No. 115-171, 1882-84. 8°.
- LIÈGE.—*Société Géologique de Belgique.*
Annales. Tome VII, VIII, 1879-81. 8°.
———*Société Royale des Sciences.*
Mémoires. 2^e sér. Tome X and supplément, 1883. 8° and 4°.
- LINZ.—*Museum Francisco-Carolinum.*
Bericht. XLI, 1882. 8°.
- LISBOA.—*Academia Real das Sciencias.*
Classe de sciencias mathematicas, physicas e naturaes. Memorias. N. S.
Tomo V. 2, VI. 1, 1878-81. 4°.
Classe de sciencias moraes, politicas e bellas-lettas. Historia e memorias.
N. S. Tomo V. 1, 1879. 4°.
Sessão publica. 9 Junho, 1880. 8°.
Jornal de sciencias mathematicas, physicas e naturaes. No. 24-32,
1877-82. 8°.
Shakespeare, W. Hamlet; O Mercado de Veneza. Tradução de Bulhão
Pato. 1879-81. 8°.
Ribeiro, J. S. Don Pedro Calderon de la Barca. 1881. 8°.
Barros Arana, D. de. Vida e viagens de Fernão de Magalhães. 1881. 8°.
Ficalho, Conde de. Flora dos Lusíadas. 1880. 8°.
Motta, E. A. Elementos de histologia geral e histophysiologia. 1880. 8°.

LISBOA.—*Sociedade de Geographia.*

- Boletin. Serie II. 11, 12, III. 1-10, 12, IV. 1-5, 1882-84. 8°.
 Expedição scientifica á serra da Estrella.
 Secção de Archeologia. Relatorio do Sr. Dr. F. M. Sarmiento. 1883. 4°.
 Secção de Botanica. Relatorio do Sr. Dr. J. A. Henriques. 1883. 4°.
 Secção de Meteorologia. Relatorio do Sr. A. C. da Silva. 1883. 4°.
 Secção de Medicina (Hydrologia Mineraria-Medicina). Relatorios dos Srs. Drs. L. Torres e J. A. Medina. 1883. 4°.
 ———(Ophthalmologia). Relatorio do Sr. Dr. F. L. da Fonseca, Jr. 1883. 4°.
 A questão do meridiano universal. 1883. 8°.
 La question du Zaire. Le Portugal et la traite des noirs. 1883. 8°.
 La question du Zaire. Lettre à M. Behagel par M. L. Cordeiro. 1883. 8°.
 La question du Zaire. Droits de Portugal. 1883. 8°.
 Stanley's first opinions. Portugal and the slave trade. 1883. 8°.
 Direitos de padroado de Portugal em Africa. 1883. 8°.
 Terrenos adjacentes aos rios Zambeze e Chire. Mappa coordenado por A. de Moraes Sarmiento. 2 sheets.

LIVERPOOL.—*Literary and Philosophical Society.*

- Proceedings. No. XXXV-XXXVII, 1880-83. 8°.

LONDON.—*Geological Society.*

- Quarterly journal. Vol. XXXVIII. 3, 4, XXXIX, XL. 1, 2. 1882-84. 8°.
 List. 1883. 8°.

———*Linnean Society.*

- Journal. Zoology, no. 86-100; Botany, no. 114-129. 1881-83. 8°.
 List, 1882. 8°.

———*Mathematical Society.*

- Proceedings. No. 184-188, 191-218, 1881-83. 8°.

———*Royal Meteorological Society.*

- Quarterly journal. New series. No. 41-50, 1882-84. 8°.
 Meteorological record. 1881, no. 1, 2. 8°.
 List of fellows. 1882. 8°.

———*Royal Historical Society.*

- Transactions. Vol. X. New series. Vol. I. 1, 4, II. 1, 1882-84. 8°.

———*Royal Microscopical Society.*

- Journal. Ser. II. Vol. II. 4-6, III. 1-4, 6, IV. 1-3, 1882-84. 8°.

———*Royal Society.*

- Philosophical transactions. Vol. CLXXII. 3, CLXXIII, CLXXIV. 1, 1881-83. 4°.
 Proceedings. No. 214-226, 1881-83. 8°.
 List of council and members. 1881, 1882. 4°.

LÜNEBURG.—*Naturwissenschaftlicher Verein.*

- Jahreshefte. VIII, 1879-82. 8°.

LUND.—*Universitet.*

- Ars-Skrift. Tom. XV, XVI, XVII, XVIII. 2, 1878-82. 4°.
 Universitets-biblioteks accessions-katalog. 1879, 1880, 1881. 8°.

LYON.—*Académie des Sciences, Belles-Lettres et Arts.*

- Mémoires. Classe des sciences. Tome XXV, 1881-82. 8°.
 ———Classe des lettres. Tome XX, 1881-82. 8°.

- LYON.—*Musée Guimet.*
 Annales. Tome IV, V, VI, 1882-84. 4°.
 Revue de l'histoire des religions. Année II. 5, 6, III, IV. 1-5, 1881-83. 8°.
 Catalogue du musée. 1^{re} partie. 1883. 16°.
- MADRID.—*Comision del Mapa Geologico de España.*
 Boletín. Tomo IX, X, 1882-83. 8°.
 Memorias. Descripción física, geológica y minera de la provincia de Barcelona. Por D. José Maureta y D. Silvino Thos y Codina. 1881. 8°.
 ————Descripción física geológica y agrologica de la provincia de Valencia. Por Daniel de Cortazar y Manuel Pato. 1882. 8°.
- Sociedad Española de Historia Natural.*
 Anales. Tomo XII, XIII. 1, 1883-84. 8°.
- MARBURG.—*Gesellschaft zur Beförderung der gesammten Naturwissenschaften.*
 Sitzungsberichte. Jahrg. 1880-83. 8°.
- METZ.—*Académie.*
 Mémoires. Année LX, LXI, 1878-79, 1879-80. 8°.
- MEXICO.—*Museo Nacional.*
 Anales. Tomo II. 7, III. 1-5, 1882-83. f°.
 Revista científica Mexicana. Tomo I. 20-25, II. 1, 1882-83. 4°.
- Ministerio de Fomento.*
 Anales. Tomo VII, 1882. 8°.
 Boletín. Tomo VII. 23-124, VIII, IX. 1-64, 1882-84.
- Sociedad de Geografía y Estadística.*
 Boletín. Epoca III. Tomo I, II. 1-4, 7, 1873-75. 8°.
- Sociedad Mexicana de Historia Natural.*
 La naturaleza. Tomo V. 9, 10, 19, VI. 1-16, 18-20, 1881-83. 4°.
- MIDDELBURG.—*Zeeuwsch Genootschap der Wetenschappen.*
 Archief. Deel V. 2, 1881. 8°.
 Catalogus der bibliotheek. 2^{de} druk. I. 1882. 8°.
- MILANO.—*Real Istituto Lombardo di Scienze e Lettere.*
 Rendiconto. Serie II. Vol. XIV, XV, 1882. 8°.
- Real Osservatorio di Brera.*
 Pubblicazioni. No. VII. 1, XV, XX, XXI, XXIII, 1880-83. 4°.
 Schiaparelli, G. V. Misure di alcune stelle doppie. 1882. 8°.
- Società Italiana di Scienze Naturali.*
 Atti. Vol. XXII. 3, 4, XXIII, 1880-81. 8°.
- MODENA.—*Regia Accademia delle Scienze, Lettere ed Arti.*
 Memorie. Tomo XX. Serie II. Tomo I, 1880-83. 4°.
- Società dei Naturalisti.*
 Anuario. Anno XV, 1882. 8°.
 Atti. Anno XVI, 1883. 8°.
- MONTPELLIER.—*Académie des Sciences et Lettres.*
 Mémoires. Section des lettres. Tome VII. 1, 1882. 4°.
 ————Section des sciences. Tome X. 2, 1881. 4°.
- MONTREAL.—*Geological Survey of Canada.*
 Report of progress, 1880-81-82, with maps. 8°.
- Natural History Society.*
 The Canadian record of natural history and geology. Vol. I. 1, 1884. 8°.

- MOSCOW.—*Société Impériale des Naturalistes.*
 Nouveaux mémoires. Tome XIV. 2, 1881. 4°.
 Bulletin. 1881 ii-iv, 1882, 1883 i, ii. 8°.
 Table générale et systématique des matières. 1829-1881. 8°.
 Meteorologische Beobachtungen am Observatorium der landwirth. Akademie zu Moskau. Jahrg. 1882. 4°.
- MÜNCHEN.—*Kön. bayerische Akademie der Wissenschaften.*
 Sitzungsberichte. Philosoph.-philolog. und histor. Classe. 1881 Bd. II. 4, 5; 1882; 1883. 8°.
 ——— Mathemat.-physikal. Classe. 1882 Heft 2-5; 1883. 8°.
 Churfürst Maximilian I von Bayern. Festrede von F. Stieve. 1882. 4°.
 Gedächtnissrede auf Otto Hesse, von Gustav Bauer. 1882. 4°.
 Ueber die Methoden in der botanischen Systematik. Festrede von L. Radlkofer. 1883. 4°.
 Ueber Herkunft und Sprache der transgangetischen Völker. Festrede von E. Kuhn. 1883. 4°.
 Gedächtnissrede auf Karl von Halm, von E. Wölflin. 1883. 4°.
- Königliche Sternwarte.*
 Annalen. Bd. I-VI; Supplbd. I-IV, 1848-69. 8°.
 Meteorologische und magnetische Beobachtungen. Jahrg. 1881, 1882. 8°.
- MÜNSTER.—*Westfälischer Provincial-Verein.*
 Jahresbericht. XI, 1882. 8°.
- NAPOLI.—*R. Accademia delle Scienze Fisiche e Matematiche.*
 Atti. Vol. VII-IX, 1878-82. 4°.
 Rendiconto. Anno XV-XXII, 1876-82. 4°.
- Società Africana d'Italia.*
 Bolletino. Anno I. 3, 5, 6, 1882. 8°.
- Zoologische Station.*
 Mittheilungen. Bd. I, III. 3, 4, IV. 1-3, 1878-83. 8°.
- NEU BRANDENBURG.—*Verein der Freunde der Naturgeschichte in Mecklenburg.*
 Archiv. Jahrg. XXXIV-XXXVII, 1881-83. 8°.
- NEUCHÂTEL.—*Société des Sciences Naturelles.*
 Bulletin. Tome XII. 3, XIII, 1882-83. 8°.
- NEWCASTLE-UPON-TYNE.—*North of England Institute of Mining and Mechanical Engineers.*
 Transactions. Vol. I, II, VIII-XVII, XIX, XX, XXII-XXXII, XXXIII. 1-5, 1852-84. 8°.
 Illustrations of fossil plants, being an autotype reproduction of selected drawings prepared under the direction of the late Dr. Lindley and Mr. W. Hutton. Edited by G. A. Lebour. 1877. 8°.
 Catalogue of the Hutton collection of fossil plants. By G. A. Lebour. 1878.
 An account of the strata of Northumberland and Durham, as proved by borings and sinkings. A-E. 1878-81. 2v. 8°.
- OTTAWA.—*Royal Society of Canada.*
 Proceedings and transactions. Vol. I, 1882-83. 4°.
- PARIS.—*École Polytechnique.*
 Journal. Cahier 50-53, 1881-83. 4°.
- Société d'Acclimatation.*
 Bulletin. 3^e sér. Tome IX. 5-12, X. 2-9, 12, XI. 1-4, 1882-84. 8°.

- PARIS.—*Société Géologique de France.*
Bulletin. 3^e sér. Tome VII. 11, X. 1-6. XI. 1-7, XII. 1-3, 1879-84. 8°.
- Société Mathématique de France.*
Bulletin. Tome X. 4-7, XI. 1, 2, 4, XII. 1, 1882-84. 8°.
- PENZANCE.—*Royal Geological Society of Cornwall.*
Transactions. Vol. X. 4-6, 1882-84. 8°.
Catalogue of the library. Plymouth, 1882. 8°.
- PISA.—*Società Toscana di Scienze Naturali.*
Memorie. Vol. V. 2, VI. 1, 1883-84. 8°.
Processi verbali. Vol. III. pp. 137-196, 273-290, IV. pp. 1-70, 1882-84. 8°.
- POTSDAM.—*Astrophysikalisches Observatorium.*
Publicationen. Bd. III, 1883. 4°.
- PRAG.—*Kön. böhmische Gesellschaft der Wissenschaften.*
Abhandlungen. 6te Folge. Bd. XI, 1882. 4°.
Sitzungsberichte. 1881. 8°.
Jahresbericht. 1881. 8°.
- K. k. Sternwarte.*
Astronomische, magnetische und meteorologische Beobachtungen. Jahrg. XLIII, XLIV, 1882-83. 4°.
- PULKOVA.—*Nicolai-Hauptsternwarte.*
Jahresbericht. 1882. 8°.
- QUEBEC.—*Literary and Historical Society.*
Transactions. Session 1882-83. 8°.
- REGENSBURG.—*Zoologisch-mineralogischer Verein.*
Correspondenz-Blatt. Jahrg. XXXV, XXXVI, 1881-82. 8°.
- Historischer Verein von Oberpfalz und Regensburg.*
Verhandlungen. Bd. XXXVI, XXXVII, 1882-83. 8°.
- RIGA.—*Naturforscher Verein.*
Correspondenzblatt. Jahrg. XXV, 1882. 8°.
- RIO DE JANEIRO.—*Instituto Historico, Geographico e Ethnographico do Brasil.*
Revista trimensal. Tomo XLIV, XLV, 1882. 8°.
- Museu Nacional.*
Archivos. Vol. III. 3, 4, IV, V, 1878-80. 4°.
- ROMA.—*Reale Accademia dei Lincei.*
Atti. Serie II. Vol. V-VIII, 1875-77. 4°.
Serie III. Memorie della classe di scienze morali, storiche e filologiche.
Vol. VI, VII, IX, 1880-81. 4°.
Memorie della classe di scienze fisiche, matematiche e naturali. Vol. IX-XIII, 1880-82. 4°.
Transunti. Vol. VI. 13, 14, VII, VIII. 1-6, 9-12, 1882-84. 4°.
- Reale Comitato Geologico d'Italia.*
Bolletino. Vol. I, II, IX-XIII, 1871-81. 8°.
- Società Italiana delle Scienze.*
Memorie di matematica e di fisica. Ser. III. Tomo III, 1879. 4°.
- ROTTERDAM.—*Batavisch Genootschap der Proefondervindelijke Wijsbegeerte.*
Nieuwe Verhandelingen. 2de reeks. Deel III. 1, 1882. 4°.
- ST. GALLEN.—*Naturwissenschaftliche Gesellschaft.*
Bericht. 1880-81, 1881-82. 8°.

- ST. PETERSBURG.—*Hortus Petropolitanus*.
 Acta. Tom. VIII, 1883. 8°.
- Imp. Russ. Geograf. Obshtchestvo*.
 Izvestiya. Tom. XVII. 3, 4, XVIII. 1-4, 1881-82. 8°.
 Otchet. God 1881, 1882. 8°.
- Kais. Akademie der Wissenschaften*.
 Repertorium der Meteorologie. Bd. VIII, 1883. 4°.
- Physikalisches Centralobservatorium*.
 Annalen. Jahrg. 1881, 1882, i. 4°.
- Schweizerische naturforschende Gesellschaft*.
 Verhandlungen. Jahresversammlung LXIV, LXV, 1881-82. 8°.
- STOCKHOLM —*Entomologisk Forening*.
 Entomologisk tidskrift. Arg. II-IV, 1881-83. 8°.
- Kong. Svenska Vetenskaps Akademien*.
 Handlingar. Ny följd. Bd. XIV. 2, XV-XVII, 1876-79. 4°.
 Bihang. Bd. IV, V, 1876-80. 8°.
 Ofversigt. Arg. XXXIV-XXXVII, 1877-80. 8°.
 Meteorologiska iagttagelser. Bd. XVII-XIX, 1875-77. 4°.
 Lefnadsteckningar. Bd. II. 1, 1878. 8°.
 Minnesteckning öfver Carlander, Bjerkén, Hallenberg, Linné, Sundevall. 8°.
- STUTTGART.—*Verein für vaterländische Naturkunde in Württemberg*.
 Jahreshette. 'Jahrg. XXXVIII, XXXIX, 1882-83. 8°.
- SYDNEY.—*Observatory*.
 Results of double star measures, 1871-81. 8°.
 Results of rain and river observations, 1882. 8°.
 The spectrum and appearance of the recent comet. By H. C. Russell.
 1881. 8°.
 Anniversary address before the Royal Society of New South Wales, 3 May,
 1882. By H. C. Russell. 8°.
- Royal Society of New South Wales*.
 Journal and proceedings. Vol. XV, 1881. 8°.
 Annual report of the department of mines, New South Wales. 1881. 4°.
 The minerals of New South Wales. By A. Liversidge. 2d ed. 8°.
 New South Wales in 1881. 2d issue. 8°.
- THRONHJEM.—*Kon. Norske Videnskabers Selskab*.
 Skrifter. 1881. 8°.
- TOKIO.—*University*.
 Calendar. 1881-82. 8°.
 Memoirs of the science department. No. 9, 1883. 8°.
- TORONTO.—*Canadian Institute*.
 Canadian journal of industry, science and art. New series. Vol. IV-XV,
 1859-78.
 Proceedings. Vol. I, II. 1, 2, 1879-84.
- Meteorological Service of the Dominion of Canada*.
 Report. 1881. Ottawa, 1883. 8°.
- TOULOUSE.—*Académie des Sciences, Inscriptions et Belles-Lettres*.
 Mémoires. 8° sér. Tome IV, V, 1882-83. 8°.
- Société d'Histoire Naturelle*.
 Bulletin. Année XV, XVI, 1881-82. 8°.

- UPSALA.—*Regia Societas Scientiarum.*
Nova acta. Ser. III. Vol. XI, 1881–83. 4°.
- UTRECHT.—*Kon. Nederlandsch Meteorologisch Instituut.*
Nederlandsch meteorologisch jaarboek. 1881, 1882. 4°.
—*Provinciaal Utrechtsch Genootschap van Kunsten en Wetenschappen.*
Verslag van het verhandelde in de algemeene vergadering. 1881. 8°.
Aanteekeningen van het verhandelde in de sectie-vergaderingen. 1880–81. 8°.
- VENEZIA.—*Istituto Veneto di Scienze, Lettere ed Arti.*
Atti. Ser. V. Vol. VI. 10, VII. 10 and appendice, VIII. Ser. VI. Vol. I. 1–3. 1880–83. 8°.
- VICENZA.—*Accademia Olimpica.*
Atti. 1879, 1880. 8°.
Terzo centenario di Andrea Palladio. Discorso di C. Boito, 29 Agosto. 1880. 8°.
- WIEN.—*Kais. Akademie der Wissenschaften.*
Sitzungsberichte. Mathemat.-naturwiss. Classe. Abth I. Bd. LXXXIII. 5, LXXXIV–LXXXVII, 1881–83. 8°.
—*K. k. Central-Anstalt für Meteorologie und Erdmagnetismus.*
Jahrbücher. Neue Folge. Bd. XV. 2, XVI. 2, XVII, XVIII. 1, 1878–81. 4°.
—*K. k. geologische Reichsanstalt.*
Abhandlungen. Bd. VII. 6, X, XII. 3, 1882. 4°.
Jahrbuch. Bd. XXXII, XXXIII, XXXIV. 1, 1882–84. 8°.
Verhandlungen. Jahrg. 1882, 1883, 1884, No. 1–3. 8°.
—*K. k. zoologisch-botanische Gesellschaft.*
Verhandlungen. Bd. XXXI, XXXII, 1881–82. 8°.
—*Oesterreichische Gesellschaft für Meteorologie.*
Zeitschrift. Bd. XVII. 7–12, XVIII. 2–12, XIX. 1–7, 1882–84. 8°.
- WIESBADEN.—*Nassauischer Verein für Naturkunde.*
Jahrbücher. Jahrg. XXXIII–XXXVI, 1881–83. 8°.
- WÜRZBURG.—*Physikalisch-medicinische Gesellschaft.*
Sitzungsberichte. Jahrg. 1881, 1882. 8°.

- Annual addresses before the American Academy of Medicine, 1879, 1881–83. 8°.
From R. J. Dunglison, M.D.
- Ballard, R. The solution of the pyramid problem. New York, 1882, 8°.
From the Author.
- Barrande, J. Acéphalés. Études locales et comparatives. Prague, 1881. 8°.
From the Author.
- Carvill, L. H. The great terminal moraine across Pennsylvania. Salem, 1882. 8°.
From the Author.
- Clapp, H. C. Is consumption contagious, and can it be transmitted by means of food?
2d ed. Boston, 1882. 12°.
From Mr. R. J. Everett.
- Dimmock, G. The anatomy of the mouth-parts and sucking apparatus of some diptera. Boston, 1881. 8°.
— Special bibliography. Nos. 1–3. 8°.
— Seven entomological papers. Cambridge, 1877–79. 8°. *From the Author.*

- Bibliotheca historico-naturalis et mathematica. Lager-Catalog von R. Friedländer & Sohn. Berlin, 1883. 8°. *From Messrs. R. Friedländer & Sohn.*
- Gauche, V. Conference sur l'application du mouvement de la mer. Bruxelles, 1881. 8°. *From the Author.*
- Gilpin, E., Jr. The gold fields of Nova Scotia. Newcastle-upon-Tyne, 1882. 8°. Report of the department of mines, Nova Scotia, for 1883. Halifax, 1884. *From Mr. E. Gilpin, Jr.*
- Mason, J. J., M.D. Minute structure of the central nervous system of certain reptiles and batrachians of North America. Illustrated by permanent photo-micrographs. Series A. Newport, 1879-82. 4°. *From the Author.*
- The palaeontologist. No. 6. Cincinnati, 1882. 8°. *From Mr. U. P. James, the Editor.*
- Newberry, J. S. The origin of carbonaceous matter in bituminous shales. 1883. 8°. ——— Physical conditions under which coal was formed. 1883. 8°. *From the Author.*
- Newlands, J. A. R. On the discovery of the periodic law and on relations among the atomic weights. London, 1884. 8°. *From the Author.*
- Saussure, H. de. Coup d'œil sur l'hydrologie du Mexique. 1^{re} partie. Genève, 1862. 8°. *From the Author.*
- Smyth, C. Piazz. Madeira spectroscopic. Edinburgh, 1882. 4°. ——— Madeira meteorologic. Edinburgh, 1882. 4°. *From the Author.*
- Watson, S. Contributions to American botany. XI. Boston, 1883. 8°. *From the Author.*
- Zincken, C. F. Die Fortschritte der Geologie der Tertiärkohle, Kreidekohle, Jurakohle und Triaskohle. Leipzig, 1878. 8°. *From the Author.*



I.—NEW ENGLAND SPIDERS OF THE FAMILY THERIDIIDÆ.

BY J. H. EMERTON.

OF the 134 species here described, 89 species are from Eastern Massachusetts, collected in Boston and the towns west and south of it, in Lynn, Salem, Beverly and the adjoining towns. In this neighborhood I collected for several years at all seasons, so that this number probably includes nearly all the common and larger species, but of the smaller spiders, *Ceratinella*, *Lophocarenum*, *Tmeticus* and *Microneta*, new kinds are found in almost every new locality explored, and it is probable that twice as many species of this family will sooner or later be found here. Farther east I have spiders from Portland and Eastport, Maine, and farther west from Mt. Tom in Holyoke, Mass., and Albany, N. Y., nearly all of them the same species as found in Eastern Massachusetts. Farther north I have a few from Montreal, Canada, and 43 species from the White Mountains, N. H., where I made large collections in the summers of 1874 and 1877. Of these, 23 species have not been found elsewhere in New England. They nearly all belong to the smaller genera and live in the damp moss on the slopes of the higher mountains. The spiders found in the valleys of the White Mountains differ but little from those of Massachusetts. I have hardly any spiders from the other parts of New Hampshire, Vermont, or the north of Maine. From the southern part of New England I have a few from Wood's Holl and Martha's Vineyard, Mass., and Newport and Providence, R. I., and 68 species from New Haven, Conn., of which 13 species have not been found elsewhere. I have seen but few spiders of this family from other parts of the country, most collections containing very few species of them, so that I am not sure of the range of a single species. Many New England species were found by Hentz in the Southern States, and other localities are mentioned under the various species, as far as I know them.

The principal descriptive work on North American spiders is that of Hentz in the Journal of the Boston Society of Natural History, vols. iv, v and vi, reprinted in occasional papers of Boston Soc. of Nat. Hist., No. 2, 1875. In these papers a considerable number of

species of this family are described, of which I have found the following in New England:

<i>Theridion vulgare</i> Hentz	= <i>Theridium tepidariorum</i> .
<i>Theridion serpentinum</i> Hentz	= <i>Steatoda triangulosa</i> .
<i>Theridion marmoratum</i> Hentz	= <i>Steatoda marmorata</i> .
<i>Theridion boreale</i> Hentz	= <i>Steatoda borealis</i> .
<i>Theridion frondeum</i> Hentz	= <i>Theridium frondeum</i> .
<i>Theridion funebre</i> Hentz	= <i>Euryopsis funebris</i> .
<i>Theridion leoninum</i> Hentz	= <i>Ero thoracica</i> .
<i>Theridion cancellatum</i> Hentz	= <i>Lasciola cancellata</i> .
<i>Theridion sphaerula</i> Hentz	= <i>Theridula sphaerula</i> .
<i>Theridion globosum</i> Hentz	= <i>Theridium globosum</i> .
<i>Theridion trigonum</i> Hentz	= <i>Argyrodes trigonum</i> .
<i>Theridion fictitium</i> Hentz	= <i>Argyrodes fictitium</i> .
<i>Linyphia communis</i> Hentz	= <i>Linyphia communis</i> .
<i>Linyphia costata</i> Hentz	= <i>Linyphia phrygiana</i> .
<i>Linyphia scripta</i> Hentz	= <i>Linyphia marginata</i> .
<i>Linyphia marmorata</i> Hentz	= <i>Linyphia marginata</i> .
<i>Mimetus interfector</i> Hentz	= <i>Mimetus interfector</i> .
<i>Spintharus flavidus</i> Hentz	= <i>Spintharus flavidus</i> .
<i>Pholcus atlanticus</i> Hentz	= <i>Pholcus phalangioides</i> .
<i>Spermophora meridionalis</i> Hentz	= <i>Spermophora meridionalis</i> .
<i>Scytodes cameratus</i> Hentz	= <i>Scytodes thoracica</i> .

The following New England species are also found in Europe and have been described there. The names used for these species are in most cases those adopted by Thorell in "Synonyms of European Spiders," Upsala, 1873, in which a full account of their synonyms is given.

Theridium tepidariorum C. Koch.

Theridium lineatum (Clerck.)

Ero thoracica (Reuss.)

Mimetus interfector Hentz.

Steatoda guttata (Reuss.)

Steatoda corollata (Linn.)

Steatoda triangulosa (Wlk.)

Pholcus phalangioides (Fuessl.)

Scytodes thoracica (Latr.)

Lophomma cristata (Blk.)

Diplostyla concolor (Reuss.)
Diplostyla nigrina (Westr.)
Linyphia marginata (C. Koch.)
Linyphia clathrata (Sund.)
Linyphia phrygiana (C. Koch.)
Stemonyphantes bucculentus (Clerek.)
Bathypantes nebulosa (Sund.)
Bathypantes minuta (Blk.)
Helophora insignis (Blk.)
Drapetisca socialis (Sund.)
Microneta viaria (Blk.)
Erigone longipalpis.

In 1874 and 1875, Mr. O. P. Cambridge described in Proceedings of the Zoological Society of London, under the name of *Erigone*, a number of small spiders, from my collection, which were returned to me and are nearly all redescribed here under the same specific names. The following is a list of these species with the names here used :

1874.

<i>Erigone atra</i>	= <i>Erigone longipalpis</i> .
<i>Erigone dentigera</i>	= <i>Erigone longipalpis</i> .
<i>Erigone interpres</i>	= <i>Ceratinopsis interpres</i> .
<i>Erigone probata</i>	= <i>Tmeticus probatus</i> .
<i>Erigone spinifera</i>	= <i>Lophocarenum spiniferum</i> .
<i>Erigone lœta</i>	= <i>Ceratinella lœta</i> .
<i>Erigone lœtabilis</i>	= <i>Ceratinella lœtabilis</i> .
<i>Erigone emertoni</i>	= <i>Ceratinella emertoni</i> .
<i>Erigone atriceps</i>	= <i>Ceratinella atriceps</i> .
<i>Erigone cristata</i>	= <i>Lophomma cristata</i> .
<i>Erigone fissiceps</i>	= <i>Ceratinella fissiceps</i> .
<i>Erigone directa</i>	= <i>Cornicularia directa</i> .
<i>Erigone indirecta</i>	= <i>Cornicularia indirecta</i> .

1875.

<i>Erigone persimilis</i>	= <i>Erigone longipalpis</i> .
<i>Erigone dentigera</i>	= <i>Erigone longipalpis</i> .
<i>Erigone ornata</i>	= <i>Grammonota ornata</i> .
<i>Erigone pictilis</i>	= <i>Grammonota pictilis</i> .
<i>Erigone provida</i>	= <i>Cornicularia directa</i> ♀.
<i>Erigone pertinens</i>	= <i>Tmeticus pertinens</i> .

<i>Erigone persoluta</i>	= <i>Miconeta persoluta</i> .
<i>Erigone cornupalpis</i>	= <i>Miconeta cornupalpis</i> .
<i>Erigone multissima</i> .	
<i>Erigone viaria</i>	= <i>Miconeta viaria</i> .
<i>Erigone florens</i>	= <i>Lophocarenum florens</i> .

Lately, Keyserling has described several American spiders of this family from the Museum of Comp. Zool., at Cambridge, but, as far as I know, these descriptions have not been published. I have, however, seen the types which have been returned to Cambridge, and have used Keyserling's names for those species which seem to me to be new. The following species of this family are named by Keyserling in the Cambridge collection:

<i>Steatoda borealis</i>	= <i>Theridion boreale</i> Hentz.
<i>Theridium tepidariorum</i> .	
<i>Steatoda ruralis</i>	= <i>Theridion marmoratum</i> Hentz.
<i>Steatoda triangulosa</i>	= <i>Theridion serpentinum</i> Hentz.
<i>Theridium punctis-sparsum</i> .	
<i>Asagena americana</i> .	
<i>Theridium zelotypum</i> .	
<i>Linyphia nebulosa</i> .	
<i>Phyllonethis placens</i>	= <i>Theridion frondeum</i> Hentz.
<i>Phyllonethis lineata</i>	= <i>Theridion frondeum</i> Hentz, young.
<i>Mimetus intersector</i> Hentz.	

Therididæ.

The *Therididæ* are small, slender spiders, spinning webs, often of large size, and living in them, hanging by their claws back downward, and catching and eating the insects which become entangled among the threads. Their markings are under the skin, and do not depend to any great extent on colored hairs or scales. Fine hairs are, however, usually present, thinly scattered all over the body, and the colors are sometimes modified by them. In many species the colors are plain, without any markings on the legs or abdomen. This is usually the case in *Tincticus*, *Lophocarenum* and the smaller *Linyphiinæ*, in which nearly all the species have the cephalothorax and legs dull yellow brown and the abdomen gray. The amount of color varies greatly in individuals of the same species, some being nearly white and others nearly black. In other genera the colors are bright and distinct, and several of the larger species of *Theridium*

and *Linyphia* have distinct colored patterns on the abdomen, and dark and light rings on the legs. In some species there is great variation in the markings, as *Theridium frondeum* and *Steatoda marmorata*.

The legs of the *Therididae* are usually slender. Their relative length 1, 2, 4, 3, or 1, 4, 2, 3, though there are exceptions to this proportion. In *Theridium* and the neighboring genera the spines on the legs are small and resemble the other hairs except in *Mimetus* and *Ero*, where they are usually large, especially on the two front pairs of legs.

The feet have three claws, the lateral ones with five or six teeth, and the middle, one or two. The spines under the claws are sometimes toothed as in *Epeiridae*. The female palpus has usually a single claw, but this is sometimes wanting. The maxillæ are usually as short as wide, not rounded at the end as in *Epeira*, but either ending in a straight edge, or a point at the inner corner.

The eyes are in two rows, slightly curved together at the ends so that the lateral pairs nearly or quite touch each other. The variations in size and position of the eyes are mostly in the middle pairs.

In most species there is considerable difference between the sexes. The males have the abdomen smaller, the legs longer, and the head higher than the females. The colors of the males are usually darker and the light markings less distinct than in the females, and sometimes the colors of the two sexes are very different, but usually the markings and shape of the body are so much alike that the males and females of the same species can be readily recognized.

The palpal organs of the males and the epigynum of the females are usually large and complicated in this family, and are the most convenient means of distinguishing many species, especially in *Linyphiinae* and the smaller *Erigoninae*.

The epigynum consists of two round spermathecae near the genital opening of the female, from each of which run two tubes, one, usually the larger and longer, to a hole outside the body, the other, usually small and short, into the oviduct near its mouth. The spermathecae can sometimes be seen through the skin, but they vary but little, while the hard parts, by which their outer openings are surrounded, differ greatly, according to the species. The internal structure of the epigynum is shown in the figures on Pl. 1. The oviduct opens in the middle of a transverse fold under the front part of the abdomen, and the openings of the epigynum are near the edge of this fold, usually on the outer side and just in front of it. Sometimes

they are simple round holes or are united into a single hole. Grooves or notches often extend from the holes to the edge of the fold, dividing it into three lobes, the outer of which usually overlap the middle one and partly conceal the grooves and openings. Various modifications of the shape of these lobes give the peculiar forms of the epigynum in many species, see figures of *Tmetiscus*, Pl. XV. In some species a long flexible process extends backward from the middle of the epigynum along the under side of the abdomen, and in *Bathyphantes* and *Microneta* the whole epigynum is lengthened out nearly as long as the abdomen, and folded up in two folds, so that the tip is nearly covered. Pl. XXI, XXII, XXIII.

The palpal organ is a smooth bulb on the end of the male palpus, from which projects a fine tube that fits into the epigynum of the female. Inside the bulb is a sac, from which a fine duct extends to the end of the tube, through which the spermatozoa are discharged into the epigynum. In this family the palpal organ is usually partly concealed in a hollow in the tarsus. The tube, even when short, is almost always accompanied by two processes, one hard and the other soft and flexible, and most of the complications of the palpal organs are produced by modifications of these three parts. The tube itself varies greatly in length, in some species being long enough to wind two or three times around the palpal organ, and is then supported at the end by some of the appendages of the bulb. In *Bathyphantes* the tube is short and thick, and surrounded by long and complicated appendages. Besides the palpal organ itself, the terminal joints of the palpus are modified in various ways. The tarsus is hollowed out on one side, and the edges of this hollow are of various shapes to support the parts within. At the base of the tarsus is an appendage, which I call the tarsal hook, jointed to the tarsus at one end, and extending sidewise around the base of the palpal organ. This part varies greatly in shape, and is one of the most useful in the identification of the smaller species. In the *Theridiinae* the tarsal hook is absent. The tibia of the male palpus is usually more or less modified in shape, having often a spine or hook on the upper part, extending over the tarsus. Sometimes the patella is also modified.

The webs of the *Theridiidae* consist usually of a flat or curved sheet under which the spider stands, and which is supported by threads running in all directions to the neighboring objects. In some species these threads form a large mass over the web, and serve to stop insects flying between them and make them drop to the flat web below, where they are caught by the spider. The webs of

Theridium have, in place of the flat sheet, only a small tent or thickened part of the web, under which the spider stands and near which she hangs her cocoons of eggs.

I include in this family the *Theridioidæ* of Thorell, leaving out *Pachygnatha*, which belongs with *Tetragnatha* in another family, but including the *Scytodoïdæ*. It is very difficult to divide this family into smaller groups, but the division of the larger species into *Theridiidæ* and *Linyphiidæ*, as has been done by Blackwall and Menge, seems to me a natural one, and *Pholcus* and *Scytodes* evidently form a natural group by themselves. The other small spiders, usually included in *Erigone*, or by Blackwall and Cambridge in *Neriene* and *Walckenaera*, I include in another group, though the limits between it and the other sub-families are very uncertain. This divides the family into the following four sub-families:

1. Theridinæ.

The maxillæ in this group are pointed at the inner corner, and turned inward toward the lip. The palpi of the male do not have the tarsal hook. The thorax is usually short and wide and the abdomen large. The following genera are in this group:

<i>Theridium</i> ,	<i>Argyrodes</i> ,	<i>Spintharus</i> ,
<i>Ero</i> ,	<i>Ulesanis</i> ,	<i>Steatoda</i> ,
<i>Mimetus</i> ,	<i>Euryopsis</i> ,	<i>Asagena</i> ,
<i>Theridula</i> ,	<i>Lasceola</i> ,	<i>Pholcomma</i> .

2. Scytodinæ.

These are pale, long-legged spiders, with short round thorax, and six eyes, or eight with the front pair very small. The palpal organ is not enclosed in a hollow of the tarsus, and in *Scytodes* is very simple, as in the *Mygalidæ*, while in *Pholcus* it has several large appendages from the base. The maxillæ are turned inward over the lip. The genera are

<i>Pholcus</i> ,	<i>Spermophora</i> ,	<i>Scytodes</i> .
------------------	----------------------	-------------------

3. Erigoninæ.

This group includes most of the old genus, *Erigone*. All the species are small, 1^{mm} or 2^{mm} long. The abdomen is usually long and oval, not thick or rounded as in *Theridinæ*, and the cephalothorax is usually longer and the legs shorter, as in *Drassidæ*. The maxillæ are short and straight on the ends, not pointed inward. The males of

many species have horns or humps on the head, but otherwise differ little from the females. The palpi of the males are large and complicated. The tarsal hook is present but usually small and smooth. The tube is of various lengths, but the supporting appendages are usually small and not so complicated as in *Linyphiinæ*. The tibial hook is usually large and of a great variety of shapes. Most of these spiders live under leaves or near the ground. The webs of most are unknown, but some species make a flat web under leaves like *Linyphiinæ*. This group connects with *Theridiinæ* through *Ceratinella* and *Pholcomma*, and with *Linyphiinæ* through *Tmeticus* and *Microneta*. The following are the genera of this sub-family:

<i>Ceratinella</i> ,	<i>Spiropalpus</i> ,	<i>Lophocarenum</i> ,
<i>Ceratinopsis</i> ,	<i>Lophomma</i> ,	<i>Gonatium</i> ,
<i>Grammonota</i> ,	<i>Cornicularia</i> ,	<i>Erigone</i> .

4. Linyphiinæ.

The smaller species of this group, forming the genus *Microneta*, resemble closely *Tmeticus* of the last sub-family, in the shape of the body, and size and colors. The palpal organs show their relations to *Bathypantes*. In the larger *Linyphiinæ* the legs are long and have long and conspicuous spines. The abdomen is thick and flattened above, or high in front and pointed behind. The male palpi are large and complicated. The tibia is usually short but otherwise not much modified. The tarsal hook is large and varies greatly in shape according to the species. The epigynum is large and in many species folded. The webs consist of a flat sheet supported by irregular threads. The following genera belong to this sub-family:

<i>Linyphia</i> ,	<i>Helophora</i> ,	<i>Bolyphantes</i> ,
<i>Diplostyla</i> ,	<i>Drapetisca</i> ,	<i>Microneta</i> .
<i>Stemonyphantes</i> ,	<i>Bathypantes</i> ,	

Theridium Walek.

Steatoda Menge, Preussische spinnen.

The cephalothorax is broad oval, usually with a dark line along the middle. The abdomen is either nearly spherical or else high in the middle and flattened behind. Pl. XVII. The usual markings of the abdomen are a scalloped or herring-bone stripe in the middle and dark oblique marks at the sides, but in several species these are partly or entirely absent and replaced by other markings. The legs are usually 1, 4, 2, 3, but in long-legged males are often 1, 2, 4, 3.

The legs are long and slender and the spines are small. The eyes are nearly of the same size and at nearly equal distances from each other, except the lateral pairs which are close together. The maxillæ are longer than wide and pointed at the inner corners. The mandibles are small and differ in the sexes in several species, those of the males being much longer, with a long claw and large teeth on the inner side. The males are usually darker colored and more slender than the females, and in some species differ greatly from them. The webs of this genus consist of a small, closely woven portion, sometimes forming a tent and covered with dirt and pieces of plants, and a large loose part composed of threads radiating irregularly from the first in all directions. The spider usually stands back downward under the tent or close portion of the web. The eggs are laid in round cocoons, which hang in the web or are concealed under the thickest part of it.

Theridium differens, new.

PLATE I, FIGURES 1 TO 1d.

Length of female, about 3^{mm}; male 2^{mm}; a little smaller than *mararium*. The herring-bone stripe on the abdomen of females is often very brightly colored, white at the edges and red in the middle. The rest of the abdomen is reddish brown, darkest next the white edges of the stripe; there are no distinct spots on the under side. In males the stripe on the abdomen is obscure and the whole abdomen dark reddish brown. These colors vary greatly, and especially with young individuals, the abdomen is often entirely yellow with indistinct brown markings. The cephalothorax is orange brown without dark stripes. The legs and palpi yellow in females and orange brown in males, slightly darker at the ends of the joints. Sternum orange without markings. The difference in size and color between the sexes is greater than in the other species of this genus. The epigynum has no opening on the outside. Fig. 1c. The palpal organ is large, the end of the tube supported by a soft appendage, opposite to which the bulb has a conical process covered with short scale-like teeth. Fig. 1b. This spider lives on grass and low bushes where it is taken abundantly throughout the summer. In winter the young are found under leaves. The webs are seen to the best advantage on the horizontal branches of spruce trees. The spider spins a small tent under the twigs from which the web spreads irregularly according to the shape of the branch.

From Mt. Washington, N. H.; Portland, Me.; Eastern Massachusetts; Mt. Tom, Mass.; New Haven, Conn.

Theridium spirale, new.

PLATE I, FIGURES 2 TO 2d.

Length of female 3^{mm}; male 2½^{mm}. Cephalothorax of female brownish orange above and below, with an indistinct dark stripe above as wide as the eyes at the forward end. In the male this stripe is much more distinct. Legs of female yellow, with dark rings at the ends of the joints. In the male the legs are yellow at the base, and become darker toward the tip. The abdomen has less red color than in *differens*. The middle stripe is distinctly marked, especially in the male, and is sometimes slightly reddish in the middle, but oftener gray with a dark spot near the front end. The rest of the abdomen is yellowish gray, almost black near the middle stripe, in well marked specimens. The females are much like those of *differens*, but the males of these two species are very distinct in color and markings. Fig. 3, 3a. The epigynum has two openings outside the edge. Fig. 2c. The palpal organ has a very long tube which goes twice round the top of the bulb. Fig. 2b. The inner tubes of the epigynum correspond in length with those of the palpal organs. Fig. 2d.

This does not seem to be as common as *fusca*. I have it from several localities near Boston and Salem, Mass.; from Williamstown, Mass., J. S. Kingley; and New Haven, Conn.

Theridium montanum, new.

PLATE I, FIGURES 3 TO 3c.

This species I have found on various parts of Mt. Washington, N. H., in the summers of 1874 and 1877, in webs in spruce trees. It is a little larger than *spirale* and resembles it in color, though the markings are different. The legs in both sexes are yellow, browner toward the tips, and with indistinct dark rings at the ends and middle of the joints. The thorax orange, with a plain dark stripe as wide as the eyes in front, and black edges. The light stripe on the abdomen is yellowish gray. It is narrowed in front and the usual dark color outside of it forms at this part two indistinct black spots. Farther back where the middle stripe narrows again, there are two other black spots in the dark color, of various degrees of distinctness in different individuals, so that some specimens have four plain black spots on the abdomen. Toward the tail the middle stripe is narrow, and in some individuals crossed by transverse black marks, like *Linyphia*. The black and gray markings on the sides of the abdomen, which are irregular in most species, in this sometimes form distinct black spots. The sexes are much alike in color and size. The epigynum

has a small oval opening outside the fold. A short distance from the edge at the sides of the opening are two pits with thickened edges behind. The palpal organ, has the tube very short and out of sight. On the inner side of the bulb is a long horny piece, with two short teeth on it opposite the tube.

White Mountains.

Theridium zelotypum, new. Specimen named by Keyserling in Mus. Comp. Zool., Cambridge, Mass.

PLATE I, FIGURES 4, 4a.

Of this large species I have only females. They measure 4^{mm} or more in length. The cephalothorax is orange with a distinct dark stripe in the middle, and dark edges. The legs are orange, with brown rings at the ends and indistinct rings in the middle of each joint. The light stripe on the abdomen is distinctly herring-bone shaped, with the corners running down the sides of the body dividing the black stripes into several separate squarish spots. The middle of the abdomen is bright red. Underneath there is a black spot under the spinnerets, and the epigynum is brown. The epigynum has a single opening outside, some distance from the edge.

These spiders were found at Eastport and Portland, Me., Aug., 1872 and 1873, in spruce trees. The webs were large, supported between the branches by threads running upward to the branches above and furnishing lodging for numerous specimens of *Arygrodus trigonum*. The spider had usually a tent covered with dry spruce leaves, under which it hung with cocoons and young.

Theridium murarium, new.

PLATE I, FIGURES 5 TO 5b.

Length of female 3 to 4^{mm}. Legs of first pair nearly twice the length of the body. General color gray. An undulated stripe on the abdomen, white at the edges and reddish in the middle. On both sides of this stripe the abdomen is nearly black and becomes lighter toward the sides. Underneath the abdomen is light gray with a darker spot in the middle and over the epigynum. The cephalothorax is gray with a narrow black line in the middle and on each side. The sternum is light gray with a black edge and a black stripe in the middle. The legs are gray with blackish bands at the ends and middle of each joint. There is little difference in color or size between the sexes. This species lives usually under stones and fences, where it is well concealed by its color. It is also found on the dried tops of wild *Spiræa*.

The epigynum has two holes wide apart on the outside near the thickened edge. The palpal organ is small, with a short tube supported by a blunt spine at the tip. The palpal organ differs from that of *T. varians* chiefly in the shape of the spine at the side of the bulb.

Salem, Beverly and Danvers, Mass.; New Haven, Conn.; and Providence, R. I. Adults of both sexes found from June to August.

***Theridium puncto-sparsum*, new.** Specimen named by Keyserling in Mus. Comp. Zool., Cambridge, Mass.

PLATE I, FIGURES 6, 6a.

Females about 3^{mm} long. Abdomen dark gray, with white spots. The usual stripe is indicated by a large white spot in front and irregular lines of small white spots where the edge of the stripe is in other species. Under the abdomen and on the sides are larger white spots. The cephalothorax is dark yellow-brown, with a darker stripe in the middle and on each side. Sternum dark brown. Legs and palpi yellowish with wide dark brown rings at the ends and middle of each joint. The epigynum has a large oval opening outside near the edge. The male resembles the female very closely.

Common in the neighborhood of Salem and Boston, under stones in stone-walls and like shady places, with a small web. New Haven, Conn., under stones.

***Theridium sexpunctatum*, new.**

PLATE II, FIGURE 5.

Length 2^{mm}. Cephalothorax light yellow, with a gray and black stripe nearly as wide as the eyes, along the middle, and a narrow one on each side. The abdomen is light yellow and has six irregular black patches, in each of which is a round light spot. Fig. 5. There are other black markings on the sides and beneath. The sternum has a dark line on the edges. These markings are probably variable in shape and size. The legs are light yellow, with a dark ring at the end of each joint. The epigynum has a large oval opening on the outside, within which are two smaller ones apparently leading to the spermatheca. Fig. 5c.

The male has the cephalothorax and legs deeper yellow and with dark markings less distinct. Legs longer and abdomen smaller, as usual, the latter with markings similar to the female. The mandibles of the male are twice as long as those of the female, with a large tooth on the middle of the inner side. The claw of the mandible is

nearly as long as the basal joint, slender and straight in the middle and slightly curved inward at the tip. The palpal organ has a large two-toothed process at the tip, and a tube about half the length of the tarsus, supported by a stiff black spine inside and a thin appendage outside.

One female from English Head, Anticosti I., July 22, 1881, S. Henshaw. Several females and one male from Mt. Washington, N. H., June 11, 1877, in the highest trees.

Theridium tepidariorum C. Koch, *Die Arachniden*, 1841.

Theridion vulgare Hentz.

PLATE II, FIGURE 1.

This is one of the most common house spiders, but is seldom found on plants or far from houses. The female measures about 6^{mm} in length. The legs of 1st pair are nearly three times as long. The male is shorter and has proportionally longer legs. The legs are 1, 4, 2, 3 in females and 1, 2, 4, 3 in males. The color varies from dirty white with a few blackish spots, to almost black. The thorax is yellowish brown. The legs are light yellow with brownish or dusky rings at the ends and middle of the joints. In the males the legs are orange-brown, darker at the ends of the joints. The abdomen, in dark and well marked specimens, has on the hinder part six transverse black marks curved upward and thicker in the middle, and more or less connected together by black spots at the ends. These marks are most sharply defined on the hinder edge, where they are bordered by silvery white lines. The upper mark is the largest and forms a conspicuous black and white spot in the center of the abdomen. Just in front of this and at the sides are two large black spots much obscured by small black spots and lines. In lighter individuals these markings are smaller and less definite. The palpal organ has a short and stout tube supported by a grooved process roughened outside at the tip. These project beyond the end of the tarsus and are easily seen. The epigynum has a large oval opening outside. This common spider makes a large web, usually in a corner of a room, under furniture, behind the posts of fences, or in some such dry and shady place. It sometimes stands in the web in a thin tent toward which the web is closer than on the outside, but oftener makes its nest in a neighboring crack or corner. A male and female often occupy the same web. The eggs are laid in brownish, pear-shaped cocoons, several of which are made the same season by one

spider and hang in the web near the nest. It is found in Europe in plant-houses, and in South America and Australia. Its native country is unknown.

Theridium rupicola, new.

PLATE II, FIGURES 2 TO 2c.

This little species closely resembles *T. tepidariorum*, the females being easily mistaken for the young of that species. The females are 2.5^{mm} long and the males 2^{mm}. The colors are as in *tepidariorum*, though I have never seen such light individuals as in that species, nor do the colors of the male differ so much from the female, the legs being only slightly more orange and showing the brown rings distinctly. The abdomen has a pointed hump in the middle, partly covered by the middle black spot and partly bright white. The large lateral black spots have also white spots behind them, and sometimes the whole back part of the abdomen behind the hump is nearly white. The palpal organ differs plainly from *tepidariorum*. The epigynum has a narrower opening on a ridge just in front of the fold.

This spider lives under stones and among rocks where it builds webs like those of *tepidariorum*, often containing grains of sand, which look as though placed there purposely by the spider.

Eastern Massachusetts, and New Haven, Conn.

Theridium globosum Hentz, Boston Journal of Nat. Hist., vol. vi.

PLATE II, FIGURE 3.

This little spider is about 2^{mm} in length. The abdomen is somewhat flattened behind and 1.5^{mm} high, pointed toward the spinnerets. The hinder portion is white with a large spot in the middle, below which, in my specimen, is a smaller black spot. The front upper part of the abdomen is yellowish gray and the under part brown. The cephalothorax is orange brown, except the space between the eyes, which is black. The legs are also orange brown. The epigynum is dark brown and very prominent. The opening appears to be in front near the pedicel of the abdomen.

One female from tent in web. Readville, near Boston, Aug. 13, 1874. Hentz's description and figure in Boston Journal of Nat. His., vol. vi.

Another specimen, from New Haven, Conn., had the front part of the abdomen brown with a bright white line behind it over the back and down both sides.

Theridium unimaculatum, new.

PLATE II, FIGURES 4, 4a.

This species differs much in colors and markings from the others and may almost always be distinguished by the white abdomen with a black spot in the center of the back. The females are 2^{mm} long, the males a little smaller. The cephalothorax is orange with a blackish spot around the eyes and extending backward in a point as far as the dorsal groove; there is also a narrow black line along the edges. The legs are yellow or light orange in the female and orange brown in the male, the first and second pairs are also much stouter in the male. The sternum is orange with black edges. The abdomen is white with a black spot above and another around the spinnerets. The hinder edge of the epigynum is turned outward in the middle where it has a single small opening. Fig. 4b. The palpal organ has a short tube about half the length of the tarsus, supported by two flexible appendages. There is also a large two-pointed black tooth at the end of the palpal organ. Fig. 4a.

This spider is common in Eastern Massachusetts and Connecticut, on bushes in summer and under leaves in winter. I have not seen the web.

Theridium frondeum Hentz.*Phyllonethis placens* Keys., type in Mus. Comp. Zool., Cambridge, Mass.

PLATE III, FIGURES 1 to 1h.

Length of female 3 or 4^{mm}; length of first leg, 8 to 10^{mm}. The color is light yellow with markings which are very variable. Usually the thorax has two fine black lines from the eyes backward, uniting behind the dorsal groove, and black edges. The legs are usually darker at the ends of the joints. The abdomen has the undulated light band in the middle, as in other species of the genus, usually bordered by brownish transparent spaces with two black spots just over the spinnerets. Sometimes there are black spots in these transparent bands, especially toward the hinder end, and these may be united into two long black patches. Figs. 1b, 1c. In some individuals of both sexes the black on the cephalothorax forms a wide band in the middle almost covering the back, and a black stripe of similar width extends backward on the abdomen for half its length. Fig. 1e, 1f. These black striped individuals have all the other variations of color and markings. The males have all the colors and spots brighter and the legs longer than females. The mandibles of the males are longer and curved inward on the front and outer sides, and have at the base in front a low con-

ical point. The epigynum has the single opening on the outside and turned forward.

This is a very common spider on plants, from which it may be shaken at all times in the summer. White Mountains to Connecticut.

Theridium lineatum (Clerck), Thor., Synonyms of European Spiders.

PLATE III, FIGURES 2, 2a.

I have several times found at Beverly, Mass., spiders which appear to be the European *lineatum*. The colors are similar to *T. frondeum*, but the markings are different. The thorax has a fine black line in the middle and one on each side near the edge. The sternum has also black edges and a black line in the middle. The abdomen has six pairs of black spots, under which in some specimens were bright crimson bands. There are four black spots around the spinnerets and a black stripe under the abdomen.

All my specimens are young females from Beverly, Mass., and an island in Salem harbor.

Mimetus Hentz.

Boston Journal of Nat. Hist., vol. vi. Simon, Arachnides de France, vol. v.

This genus is much like *Ero*, but the cephalothorax is lower and long. The head is narrow and prolonged forward. The mandibles are long. The abdomen is high and wide in front and resembles *Epeira* in shape and markings. The legs are long and spiny as in *Ero*, but the rest of the body is less hairy. The palpi of the male have a long tube and a process at the base of the tarsus much as in *Ero*.

Mimetus intersector Hentz.

PLATE III, FIGURES 3 TO 3b.

Length about 5^{mm}, front legs 17^{mm}. Length of legs 1, 2, 4, 3. The cephalothorax is one and a half times as long as wide and widest near the hind end. The head is long and the front middle eyes extend slightly beyond the front edge. Fig. 3a. The mandibles are long and dark colored except a spot near the base. The cephalothorax is whitish with a broken stripe of brown on the head extending back to the dorsal groove. The abdomen is shaped like that of *Epeira angulata*, widest in front with two prominent corners. The markings are also *Epeira*-like, a central stripe with dark spots or points along the edges. The color is gray and brown in the darker portions. The legs are light yellow with dark brown rings at the

ends of the femora and patellæ of the first two pairs and less distinctly at the end of the other joints. There are long dark colored spines on the legs as in *Ero thoracica*. The epigynum is dark colored and the opening is under the end which extends backward over the fold.

The males are slightly smaller than the females but have similar colors and markings, quite different from the next species, though the palpi are much alike.

Eastern Massachusetts and New Haven, Conn., in low bushes in woods. I have found it often by sweeping and occasionally on fences, but have never found one in its web. Hentz describes what I suppose is this species from Alabama, where he says it lives in houses and preys on other spiders, making no web of its own. This species is said by Simon (*Arachnides de France*, vol. v), to occur in Southern Europe.

Mimetus epeiroides, new.

PLATE III, FIGURES 4 TO 4b.

The only adult, a male, is about 3^{mm} long. The cephalothorax in this and in young females is long and narrow in front, as in *interfector*, light yellow in color, with four fine black lines from the eyes back to the dorsal groove. The abdomen has the same epeiroid shape as in *interfector*. The general color of the abdomen is light yellow and there are white transverse bands on the front part. The black spots are small and irregular and arranged in pairs, which do not run together into stripes as in the other species. The sternum has four pairs of brown spots at the base of the legs. The femora of the two front pairs of legs have on the under side two fine black lines. The legs are yellowish white above without dark rings. The mandibles are white with a small black spot in front near the base. The palpal organ is large and has a long slender tube supported only at the end by short processes. Fig. 4b. The tarsus has a large curved process at the hinder corner on the outside, and two small slender processes at the end. The outer edge is finely toothed. The tibia and patella have long hairs.

Adult male from Essex, Mass., and young of both sexes from various places in eastern Massachusetts, and Providence, R. I.

Ero C. Koch.

These spiders have the cephalothorax very short and high in the middle, from which it slopes abruptly back under the abdomen, which is also high in front. The abdomen and legs are covered with long

hairs and the legs with long stiff spines, as in *Linyphia*, especially on the tibia and tarsi of the two front pairs of legs. Legs 1, 2, 4, 3.

Ero thoracica (Reuss) Thor., Synonyms of European Spiders.

Theridion leoninum Hentz.

PLATE III, FIGURES 5 TO 5d.

This spider resembles very much *Theridium tepidariorum* and *rupicola*, but has brighter colors and much longer and coarser hairs and spines. It is 3^{mm} or 4^{mm} long. The cephalothorax is nearly as high in the middle as long, and slopes at a sharp angle toward the abdomen. The head is slightly lower than the middle of the thorax and the front middle eyes project beyond its front. The abdomen is as high as long, Fig. 5, and has a pair of humps on the highest part. The cephalothorax is light yellow with a dark irregular stripe each side, and a middle line crossed by a crescent-shaped mark on the highest part. The abdomen is white with brown spots of various shapes. The front half of each tubercle is dark brown and a dark line extends from these down the sides. At the back of the abdomen there are usually several transverse stripes which are sometimes reddish, but I have never seen them bright red as figured by Blackwall. Stiff brown hairs are scattered all over the abdomen. The legs are ringed with brown and light yellow, and have coarse brown hairs and long spines on the tibia and tarsus. The outside of the epigynum has a wide middle lobe and narrow, dark-colored lateral ones. The male palpi have a long tibia and rounded tarsus, each of which has a strong process near the joint. Figs. 5b, 5c. The palpal organ has a long tube, the end of which rests between three short processes.

I have found this spider common under leaves in winter, in the neighborhood of Boston and New Haven, but have not seen its web. In Europe it is said to make small loose cocoons hanging by a long stem. I have often found such cocoons, but have not traced them to this or any other spider.

Steatoda Sund.

Eucharis Menge, Preussische spinnen.

Steatoda, Thorell's Genera of European Spiders.

These spiders are among the largest of the family, the common *S. marmorata* measuring 6^{mm} or 7^{mm} long. The legs are shorter and stouter than in *Theridium*. The abdomen is oval and usually

slightly flattened on the back. It is smooth and shining, the hairs being fine and scattered so as to be hardly visible. The thorax is thick and hard and in some species marked with hard teeth and depressions. The head is generally high and narrowed in front. The front middle eyes are in several species much larger than the others, and farther forward and wider apart. In others all the eyes are nearly of the same size. The webs of this genus consist of a flat sheet supported by threads. The spider stands under one side of the flat portion like *Linyphia*. This genus is divided by Menge and Simon into several: *S. guttata* belongs to *Crustulina* Menge, *S. corollata* to *Lithyphantes* Th., *S. serpentina* to *Teutana* Simon.

Steatoda borealis (Hentz).

Theridion boreale Hentz, Boston Journal of Nat. Hist., vol. vi.

PLATE IV, FIGURES 1 TO 1*d*.

This common spider resembles very closely *Theridium quadripunctatum* of Europe, from which it differs mainly in the palpal organs, see Menge's figures. The female is 6^{mm} long. The thorax is orange brown, darker in old than young specimens, and covered thickly with short and stiff dark brown hairs. The head is about one-third as wide as the thorax and more elevated, the eyes near together and the front pair projecting forward beyond the head. Fig. 1*c*. The legs are brown with faint darker rings and thickly covered with brown hairs. The abdomen is dark brown, sometimes without any light marks above, but usually there is a light line running round the forward half and another in the middle, extending half way back and sometimes farther and broken in several places. The four depressed spots on the abdomen are usually very distinct. Beneath there is a light band on each side of the abdomen connected together behind the spinnerets. The sternum and mouth parts are dark brown. The sexes are much alike in size and color. The palpi of the male are very large. Figs. 1*a*, 1*b*. They are the only palpi which are well figured by Hentz, Boston Journal of Nat. Hist., vol. vi. I have never seen a good web of this spider. It is found in corners and under fence rails, usually holding close to the wood with the legs drawn up against the body. In this position, under a fence cap, I have seen a pair in copulation in May, and again in April at New Haven, Conn. The pair stood head to head, as far apart as possible. The left palpus was kept in, an hour and a quarter after they were first seen. The male contracted his body suddenly and swelled up the base of the palpal organ once every two or three seconds. Two days afterward I saw

the right palpus used by the same pair for an hour. The adult males and females occur at all seasons. This species is found also under stones and logs, with more or less web, which becomes torn in finding them.

Eastport, Me.; Montreal, Canada; White Mountains; Massachusetts; Rhode Island and Connecticut.

Steatoda guttata (Reuss) Thor., Synonyms of European Spiders.

PLATE IV, FIGURES 2 TO 2b.

This spider is about 2^{mm} long. The cephalothorax and abdomen are about equal in length. The abdomen is nearly spherical and is hard at the forward end, where it has a horny ring around its attachment to the thorax. The thorax is high and spotted, Fig. 2, with large dark colored hairs, at the base of each of which is a horny ridge. Similar ridges occur on the sternum. There are two varieties of coloring which run into each other. In one variety the abdomen is yellow or orange, without markings, or only faint indications of them, the legs are yellow, and the thorax dark brown. In the other variety the thorax is dark brown, the legs are yellow, with indistinct rings at the ends of the joints, and the abdomen dark brown, somewhat like *borealis*, with light spots and several silvery white spots, usually two on each side, one in front, one behind, and one or two in the middle line. There are also light spaces around the four dorsal muscle-spots. Fig. 2. The two color varieties are equally common, but I have not found both in the same place. This species is common under stones at all seasons. Adult males and females found abundantly in April and May.

Steatoda marmorata (Hentz).

Theridion marmoratum Hentz.

Steatoda ruralis Keys., specimen named in Mus. Comp. Zool., Cambridge, Mass.

PLATE IV, FIGURES 3 TO 3f.

Both sexes 6^{mm} or 7^{mm} long. The cephalothorax and legs yellowish brown, dark in old specimens and light yellow in young. Legs covered with fine dark hairs. The markings on the abdomen are variable. The two extreme forms are shown in Figs. 3, 3a. In most specimens there is an oblong dark spot that nearly covers the back of the abdomen. Fig. 3a. This is darkest at the edges, especially the hinder edge, and is bordered outside by silvery white. The sides are usually more or less scalloped. The middle is lighter with a central dark stripe. In other individuals of either sex the dark

markings are broken up into four pairs of black spots more or less connected with a broken middle line, as in Hentz's figure. These spotted individuals are usually darker colored than the others. The head is wider and the eyes smaller and farther apart than in the other species and the front middle eyes are the smallest. The head is wider in males than females and the mandibles larger. There are two teeth under the claw of the mandible, Fig. 3e, which are much larger, especially the inner one, in the males. Fig. 3f. The maxillæ of males are longer and more pointed than in females. The epigynum has a small opening outside and a slight notch in the fold opposite to it. The palpal organ has a stout black tube covered at the end by two short processes. At the outer end the tarsus has a notch under which is a soft appendage of the palpal organ. The various parts are crowded together and not easily made out. The whole male palpus is about the length of the first femur.

Eastern Massachusetts; Montreal, Canada; New Haven, Conn. Adults of both sexes in May and June. It is common under stones at all seasons, under leaves, and occasionally on bushes.

Steatoda nigra, new.

PLATE IV, FIGURES 4 TO 4b.

Female 2.5^{mm} long. Male 1.5^{mm}. Abdomen black. Cephalothorax yellowish, covered with fine black hairs. Legs yellowish at the base and ends, but dark and covered with black hairs in the middle, except the third pair, which is yellow its whole length, or at least lighter than the other. The cephalothorax is as high as long. The front eyes largest and projecting forward. The males are much smaller than females. The palpal organs are simple, Fig. 4b, and the opening of the epigynum very small.

I have specimens from Portland, Me.; Beverly, Mass. and Holyoke, Mass.

Steatoda corollata (Linn.) Thor., Synonyms of European Spiders.

I have one ♀ spider from Malden, Mass., from H. L. Moody, which I believe belongs to this European species. It is rather larger than most females of *marmorata*, but the legs are shorter and stouter. The thorax is dark brown and the legs lighter brown with dark rings at the ends of the joints. The two basal joints are also dark brown. The abdomen is yellowish at the sides and has four or five irregular yellowish spots, or pairs of spots, along the middle of a blackish brown oval patch, which nearly covers the middle of the back. In

some European specimens the abdomen is almost black with pairs of small yellowish spots. The eyes are all nearly the same size, the front middle pair slightly larger and farther forward than the others. The epigynum is very different from the other species.

Steatoda triangulosa (Walck) Thor., Syn. European Spiders.

Theridion serpentinum Hentz.

Teutana triangulosa Simon, Arach. de France, vol. vi, pl. 3, fig. 6.

Female 4^{mm} long. Legs longer and more slender than in *S. boreale*. First pair twice as long as the body. Thorax orange-brown, slightly rough in females and with short ridges at the base of the hairs in males, as in other species. The front middle eyes are black and not larger than the others. The legs are light yellow with slightly darker rings at the ends of the joints. There are thickened brown spots at the base of the hairs all over the body. The abdomen is light grayish yellow with two irregular brown stripes nearly broken up into spots, sometimes connected with each other, and with brown markings on the sides. In the engraving of Hentz's figure these markings are much more serpentine than in the original painting, where they have a much more natural shape. The epigynum has a triangular opening behind which is a thick ridge. The palpi of the male are as long as the femur of the second legs. The tarsus is pointed at the tip and the palpal organ is shaped much as in the other species.

I have found this species at New Haven, Conn., in the museum, where it even lives in the glass cases. Mr. Marx has found it in Washington. Hentz had it from Georgia.

Asagena Sund.

This is much like *Steatoda*, but the body is more flattened, like *Drasside*. The abdomen is flat and widest behind the middle. The cephalothorax is long and narrowed in front. The eyes are small and near together, the hind middle pair larger than the others. The usual pattern of marking in *Steatoda* is entirely wanting in this genus; the colors are dark with bright white or yellow spots on the abdomen. The feet of the male are armed with strong teeth on the under side. Fig. 6b. These spiders are said to make a noise by rubbing the abdomen and thorax together near the stem, but I have never heard it in this or any other species.

Asagena Americana Keys.

PLATE IV, FIGURES 6 TO 6c.

4^{mm} long. Cephalothorax dark reddish brown, slightly rough in females and with sharp elevations along the sides and edge in males. Abdomen dark brown with two white spots across the middle. Legs yellow-brown, in the males, with two rows of teeth under each femur, largest on the hinder pair and near the end of the femur of the second pair. Sternum dark brown, rough, and covered with short hairs. The eyes are about equal in size and separated by their diameter from each other. The males differ from females in having the cephalothorax larger and legs stouter, and both rougher and more spiny than in females. The epigynum has a wide opening over the fold under a hard convex plate between the air sacs. The male palpus is large and the palpal organ has a long black tube supported by a hard process on the inside and a soft one near the tip.

Eastern Mass.; Williamstown, Mass., J. S. Kingsley. Schoharie, N. Y.; New Haven, Conn.; Washington, D. C., Geo. Marx. Usually under stones with some web. Females with round, loose cocoons, July 10, Salem. Males, May 10, in the Boston public garden, and Schoharie, N. Y., May 28. Young of both sexes are found under stones in winter.

Argyrodes Simon, Hist. Nat. des Araignees.

In this genus the abdomen is triangular or prolonged backward to a point far beyond the spinnerets. The cephalothorax is long and narrow. The head slopes forward in front of the eyes and the mandibles point obliquely forward. The legs are long and slender. The middle eyes of both rows are farther from each other than from the side eyes, and are somewhat larger. In *A. fictilium*, which belongs in *Ariannes* Th., the middle eyes are close to the lateral, forming two groups of four eyes each, which appears to be the only reason for separating this from *Argyrodes*.

Argyrodes trigonum.

Theridion trigonum Hentz, Boston Journ. Nat. Hist., vol. vi.

PLATE V, FIGURES 1 TO 1c.

This I suppose to be the *Theridion trigonum* of Hentz. It agrees in size and color with his description and figures, and in the arrangement of the eyes. It has also the peculiar cocoon described by Hentz. Large females measure 3^{mm} from head to spinnerets. The upper part

of the abdomen varies in length and shape, and is usually shorter in the young; seen from above the tip is two-lobed. The back of the abdomen is usually nearly straight, but it can be turned downward, as in Fig. 1. This is done when the spider is alarmed. The abdomen is light yellow, sometimes with a metallic luster. There is often a black spot each side and behind over the spinnerets, and sometimes the sides are reddish brown. The legs are yellow, covered with fine hairs. The thorax is yellow, sometimes with three brown bands that nearly cover it. The head of the female is high; the part bearing the eyes slightly raised and separated by a notch from the part over the mandible, which is somewhat farther advanced than the eyes. Fig. 1. In males each of these divisions of the front of the head gives rise to a horn. Fig. 1c. The males are darker colored and have the abdomen smaller and less angular than females. The middle eyes in both sexes are far apart, Fig. 1b, as is usual in spiders where the males have middle horns. The epigynum is dark brown and much raised. The palpal organs are simple and *Theridion*-like, Fig. 1d.

These spiders live among the the upper threads of the webs of *Agalena*, *Linyphia* and *Theridium*, and are most common in woods of pines and spruce. They look, in the web, like straws, or still more like the scales from pine buds, which are often caught in the same webs. I have seen them, however, in small webs, apparently made by themselves. When alarmed they draw the feet up close to the body and curl the abdomen under. The cocoons are of a peculiar bottle-shape, Fig. 1e, as described by Hentz, and are found in the borrowed webs in August. I have not seen them disturbed or noticed by the makers of the webs.

I have them from Eastport, Me.; New Haven, Conn.; and from Albany, N. Y., and they seem to be common wherever I have collected in summer. The young are found in winter under leaves.

Argyrodes fictilium.

Theridium fictilium Hentz, Boston Journ. Nat. Hist., vol. vi.

PLATE V, FIGURES 2, 2a.

This is a much more slender species than *trigonum*. The cephalothorax is 1^{mm} long, the abdomen 4^{mm}, in the largest specimen. The fourth legs are as long as the body, the first pair longer. The general color is light yellow. The abdomen is silvery and has a dark stripe on the back, wide at the forward end and tapering behind to a fine line. The thorax has three irregular blackish lines, the middle

one forked in front. The eyes are larger and closer than in *trigonum*, and are in two groups widely separated in the middle. The front of the head extends forward beyond the eyes, and the mandibles point forward at an angle of forty-five degrees with the edge of the thorax. The maxillæ, lip and sternum are also much lengthened forward. I have not seen the male, and have only two females from Essex and Danvers, Mass. They were shaken from bushes, and I have not seen the web. Hentz had it from Alabama. He says that the long hump can be bent nearly double, as in *trigonum*.

Theridula, new genus.

This genus includes *T. sphærule* (Hentz) and *T. gonygaster* Simon, from southern Europe. The cephalothorax is more narrowed in front than in *Theridium*. The legs are very short and slender. The abdomen is as wide or wider than long in the females. The color in both species is greenish gray, with bright black and white markings. The male palpi are very simple and differ greatly from any species of *Theridium*. The tibia laps over the tarsus half its length. The palpal organ projects very slightly from the bowl of the tarsus and appears to have no appendages except the short tube.

Theridula sphærule.

Theridion sphærule Hentz, Boston Journal of Nat. Hist., vol. vi.

PLATE V, FIGURES 3 TO 3b.

About 1.5^{mm} long and about the same in width. The abdomen is wider than long, yellowish gray, with a bright, greenish yellow spot in the middle and a black spot on a slight elevation each side. There is also a black spot around the spinnerets. The cephalothorax is yellow and has a wide black stripe in the middle. The legs are light yellow. In the male the legs and cephalothorax are more orange and the abdomen is less gray and the markings indistinct. The palpal organ is one of the simplest in this family and the shape of the palpus very peculiar, the tibia lapping over the tarsus half its length.

This spider is found from the White Mountains to Connecticut, on bushes in summer. Adult males and females in Danvers, Mass., June 30th. I have not seen its web.

Lasæola Simon.

Arachnides de France, vol. v.

Cephalothorax short, wide and high, nearly straight in front and inclined behind. Upper eyes large, equidistant or the middle pair farthest apart. Anterior eyes in a line curved strongly backward, the middle much the largest, wide apart, but almost touching the lateral eyes and raised on a slight ridge which projects forward. The lateral eyes are united in pairs. Abdomen high, rounded or oval, sometimes pointed behind beyond the spinnerets. Feet 1, 4, 2, 3, or 4, 1, 2, 3.

Lasæola cancellata.

Theridion cancellatum Hentz.

PLATE V, FIGURES 4, 4a.

The whole length is 1.5^{mm}. The cephalothorax is oval, about two-thirds as wide as long. The front middle eyes are the largest and are nearly twice as far apart as the hind middle eyes. The abdomen is rounded in front and widens backward for two-thirds of its length, where it abruptly narrows into a short hump that extends backward beyond the spinnerets. The cephalothorax is dark gray or black. The abdomen has several transverse white marks across the back and various whitish marks each side, the rest being black and gray in small spots of irregular shapes. The front legs are twice as long as the second or fourth and the patella, tibia and end of femur are gray, darker at the joints. The other legs are white with black rings. The palpi are colored in the same way and thickened at the ends. I have only one specimen, from New Haven, Conn., under a stone, April 3, 1881. Hentz describes it from Alabama.

Euryopis Menge.

These are short and stout spiders, marked with black and silvery white. The cephalothorax is short and wide. Head narrow and high. Upper eyes nearly the same size and equidistant. Front row curved with the middle eyes larger than the others and farther apart. Abdomen short and wide, pointed toward the spinnerets. Mandibles small. Feet slender, 4, 1, 2, 3. Palpi of female slightly thickened at the end.

Euryopsis funebris (Hentz).*Theridion funebre* Hentz.

PLATE V, FIGURES 6 TO 6b.

Length about 3^{mm}. Cephalothorax as wide as long. Front middle eyes larger, farther apart and farther forward than the others. Fig. 6a. Mandibles and maxillæ small. Abdomen flat and in the middle nearly as wide as long, truncated in front and tapering to a point behind. The legs are 4, 1, 2, 3. The general color is black or dark gray. The cephalothorax is yellowish gray, black about the eyes. The legs and palpi are light yellow with black rings on the tarsi and black stripes along the sides of the other joints connected here and there by grayish rings. The abdomen has a bright silver white stripe around the hinder half. Inside this the color is black, broken by light spots in the middle of the forward part. The sternum and middle of the abdomen are black. The male is slightly smaller and has a smaller abdomen and longer legs. The palpi of the males have the tarsus rounded and the tibia wider than long. The palpal organ has a short tube at the end supported by a process of about the same length, both resting in a groove at the end of the tarsus. Fig. 6b.

Mt. Washington, N. H.; Swampscott, Mass.; Mt. Tom, Holyoke, Mass.; New Haven, Conn. Hentz had it from Alabama.

Euryopsis argentea, new.

PLATE V, FIGURE 5.

Of this I have only young specimens. They are about 2^{mm} long. The abdomen is shaped much as in *funebre*, pointed behind and truncated in front, black with five or six pairs of white spots along the middle and others at the sides. The cephalothorax is not so much widened as in *funebris*. The forward half is black, while the rest, which is nearly covered by the abdomen, is light yellow, almost white. The legs are light yellow. The eyes are more nearly equal than in the other species, though the front middle pair are larger than the others.

Beverly and Milton, Mass., and New Haven, Conn. The largest were found in May, the others in winter, so that it probably matures in summer.

Spintharus Hentz, Boston Journal of Nat. Hist., vol. vi, 1850.

Cephalothorax short and round. Eyes nearly equal, the hind middle pair twice as far apart as the front middle. Abdomen long, narrowed behind and widest a little in front of the middle. Legs of 1st and 4th pairs equal and twice as long as the second pair.

Spintharus flavidus Hentz, Boston Journal Nat. Hist., vol. vi.

PLATE V, FIGURE 7.

About 4^{mm} long. Cephalothorax nearly circular, hind middle eyes twice as far apart as the front middle pair. Abdomen widest one-third its length from the front, tapering behind. The cephalothorax and legs are light yellow. Abdomen yellow below and at the sides. On the back it has two lateral white stripes and between these on each side a bright red band which becomes lighter toward the middle. Fig. 7. The middle of the abdomen is gray with two or three pairs of white spots, between which the red bands nearly meet. The first and fourth pairs of legs are twice as long as the second pair. The tibiae of the first and fourth legs are bright orange.

I have this from New Haven; and from Boston, S. Henshaw. Hentz found it in Alabama.

Ulesanis L. Koch.

Arachniden Australiens, pp. 242, 245.

Stegosoma Cambridge, Proc. Zool. Soc., London, 1873 and 1879.

Oroodes Simon, Mem. Soc. Roy. Liege, 2d series, vol. v, p. 127; and Arachnides de France, vol. v.

These are small spiders related to *Argyrodes* and *Euryopis*. The head is narrow and much elevated in both sexes. The abdomen is higher than long and extends forward over the thorax to the head. It is raised into a series of humps which are colored so as to resemble a seed or grain of dirt. A species is found in Europe and described by Simon under the name *Oroodes paralozeus*.

Ulesanis americana, new.

PLATE VI, FIGURES 1 TO 1g.

This little spider resembles a seed or lump of dirt. It measures 1.5^{mm} in length and about the same in breadth and height. The abdomen covers the cephalothorax nearly to the eyes. It has a prominent hump in the middle of the back and four or five others behind. Figs. 1, 1a. The ground-color of the abdomen is light yellow. It has a transverse brown stripe each side of the middle hump and

various other brown spots in front and at the sides. The abdomen is nearly covered by circular brown spots around the bases of the hairs, and among them are rows of larger and darker spots which mark the ends of muscles running through the abdomen. The thorax is as wide as long, but the head is narrow and twice as high as the thorax. The cephalothorax is dark brown above and below. The sternum is as wide as long and the fourth pair of legs are wide apart. Fig. 1*d*. The palpal organ has a long tube which starts at the middle of one side, passes round the base and to the outer end, where it is supported by a large tooth and several smaller appendages.

Beverly and Danvers, Mass., and New Haven, Conn., swept from bushes.

Pholcomma Thorell, Genera of European Spiders.

This genus was separated from *Theridium* by Thorell, for *P. gibbum* of Europe. This species has the hard skin on the back of the abdomen and around the spinnerets and respiratory openings as in *Ceratinella*. The body is short and round and the abdomen hairy. The eyes have an arrangement much like *Pholcus*, the front middle pair being very small. In the species which I here refer to this genus the eyes are all nearly of the same size. The abdomen has the hard pieces on the back and under side, at least in the males. The back is covered with scattered stiff hairs. The sternum is short and wide behind. The palpal organs of the males are Theridion-like, as in the European *P. gibbum*, and not like *Ceratinella*.

Pholcomma hirsutum, new.

PLATE VI, FIGURE 6.

About the size of *Ceratinella luteabilis*. The cephalothorax is yellowish brown, alike in both sexes. The sternum is the same color, and unusually wide at the hind end. The legs are yellow-brown, somewhat lighter than the thorax. The abdomen is whitish, covered with scattered long brown hairs. The males only have a hard spot on the back of the abdomen, as in *Ceratinella*. In some specimens the abdomen has some gray spots on the under side. The epigynum is slightly raised and shows the spermathecae through the skin. The palpal organs resemble those of *Theridium*. Figs. 6*e, f, g*. The tarsal hook is wanting. The tube is slender and is supported at the end by a short grooved appendage, which rests in a notch in the edge of the tarsus.

Common on Mt. Carmel, Hamden, Conn.; and found in the neighborhood of New Haven.

Pholcomma rostratum, new.

PLATE VI, FIGURE 5.

About 1^{mm} long. Cephalothorax almost as wide as long. Abdomen oval, extending over the thorax to the dorsal groove. The upper half of the abdomen is hard, as in *Ceratinella*, and covered with coarse stiff hairs, and there are also hard places around the stem of the abdomen and the spinnerets. The cephalothorax is very dark brown; the abdomen reddish brown above and darker on the thin skin at the sides. The legs are dirty brown, lightest toward the end. The cephalothorax is flat, but the head of the male is twice as high as the thorax behind it, and has a horn extending forward beyond the base of the mandibles, and having on its tip a bunch of hairs with flat, fan-shaped ends. The palpal organs have no resemblance to *Ceratinella*. The tibia is widened at the end and has two stout bristles on the under side. Fig. 5a. The tube of the palpal organ is stout, and coils around the end of the tarsus to a large soft appendage which supports it at the end.

A few specimens of both sexes under leaves at Waltham and Wattertown, Mass.

Pholcus Walck.

Pholcus phalangioides Fuessl.

PLATE VI, FIGURES 2, 2a.

This species is common in cellars and dark corners in rooms, but I have never seen it away from houses. It is readily distinguished by its long legs and large size from other cellar spiders. The body, in full-grown females, may be 7^{mm} or 8^{mm} long, and the front legs 4.5^{cm} to 5^{cm} long, though both sexes often mature much smaller. The color is pale, almost white, with pale gray spots on the middle of the thorax, the ends of the leg joints, and sometimes in pairs on the abdomen. On the back of the abdomen there is usually a dark transparent band over the dorsal vessel. The hairs are small and thinly scattered and light brown in color. The cephalothorax is nearly circular. The part of the head bearing the eyes is raised, and in the males separated by a deep constriction from the rest of the head. The abdomen is cylindrical except when swelled out in the middle by food or eggs. The front middle eyes are small and close together. The other eyes are in two clusters on each side of the

head. The maxillæ are inclined inward toward the lip. The mandibles are short, about two-thirds the height of the head, and have a prominent tooth on the inner corner. The male palpi are large and complicated. The tibia is swelled out almost spherical. The tarsus is round, with a long process on one side extending beyond the palpal organ. The bulb is round, and has beside the thin transparent tube a small stocking-shaped process and a larger blunt one roughened on the convex surface. Fig. 2a. The second joint of the palpus next the maxillæ has a tooth on the outer side about as long as the joint. The femur has also a blunt tooth near the middle on the under side.

This is a common European house spider, and is probably imported here. I have it from eastern Massachusetts; Albany, N. Y.; and New Haven, Conn. It builds a large web, consisting of a small, loose, flat sheet, from which irregular threads lead in all directions. When disturbed it hangs down by the legs as far as possible, and swings its body round in a small circle so rapidly that it cannot be seen distinctly. In the early part of summer the females lay their eggs in a very thin cocoon, through which they are plainly seen, and carry them about in their mandibles until the young hatch.

Spermophora Hentz.

Spermophora meridionalis Hentz.

PLATE VI, FIGURE 3.

This resembles a young *Pholcus*. It is about 1^{mm} long, with the front legs 5·5^{mm}. Color white, with pale gray spots on the thorax, and in two or three pairs on the abdomen. The six eyes are in two clusters like the lateral eyes of *Pholcus*. The cephalothorax is round as in *Pholcus*, but the abdomen is shorter and round, nearly as in *Theridium*, and covered with long fine hairs.

All my specimens are females found in closets and under furniture. I have not seen the web.

Salem and Boston, Mass., and New Haven, Conn.

Scytodes.

Scytodes thoracica (Latr.) Thorell, Synonyms of European Spiders.

Scytodes cameratus Hentz, Boston Journ. Nat. Hist., vol. vi.

PLATE VI, FIGURES 4, 4a.

Length of female 5^{mm} to 6^{mm}. Abdomen round. Cephalothorax very high behind and sloping forward to the mandibles. Cephalothorax light yellow with black markings of irregular shape in pairs.

Fig. 4. Legs light yellow with black rings, three on the femur, and three on the tibia. The abdomen is white with five or six pairs of black spots along the middle, from which lines of irregular spots extend obliquely down the sides. Beneath the abdomen is spotted and there are black spots on the sternum in the middle and at the bases of the legs. The mandibles and maxillæ are very small. There are only six eyes. The middle pair are close together near the front edge of the head over the mandibles. The lateral eyes are higher and farther back. The male differs but little from the female. The male's palpi are stouter than the female's. The tarsus has a long process on the upper side. The bulb is round with a narrow portion extending as far as the tarsal process and there narrowing into a fine long tube. The whole palpal organ is as long as the rest of the palpus.

This is another house spider, perhaps imported from Europe. It is found in cellars and shaded corners in rooms.

Ceratinella.

Ceratina Menge, Preussische Spinnen.

This genus, like *Pholcomma*, has the upper part of the abdomen thick and hard, and hard spots around the pedicel and the spinnerets, but this sometimes is only found in one sex. The cephalothorax and abdomen are both short and round. The heads of the males are usually higher than those of the females and in some species very large and raised into humps. The palpal organs are much alike throughout the genus. The tube is divided into two parts, appearing as if broken near the middle, and the corners near the break are sometimes lengthened into teeth of various shapes. At the base of the bulb is a long hard process, pointing backward. The tarsal hook is small and simple. The tibial hook is large and extends outward from the palpus, varying in shape according to the species. The length of the patella varies greatly in different species. All the species are very small, 1 to 3^{mm}, and are found either under leaves or in summer on low plants.

Ceratinella emertoni.

Erigone emertoni Camb., Proc. Zool. Soc. London, 1874.

PLATE VII, FIGURE 1.

This is of the same size and color as *C. fissiceps*, usually a little lighter orange with a smaller black mark on the head which seldom extends backward on the middle of the thorax as in *fissiceps*. The

head of the male is high and rounded and without humps, and the eyes are near each other on the upper part. Fig. 1. The palpal organ is very distinct from the allied species. The tube is like that of *fissiceps*, but the tooth at its base is much stouter and blacker and the upper portion of the bulb is stouter and blacker and has a long black tooth that extends nearly to the base of the slender tube. The tarsal hook is short and stout. Plate 7, figs. 1*a*, 1*c*. The epigynum is darker and wider than in *fissiceps*. Fig. 1*d*.

Eastern Massachusetts; Mount Tom, Mass.; New Haven, Conn., under leaves in winter and on low plants in summer.

Ceratinella fissiceps.

Erigone fissiceps Camb., Proc. Zool. Soc. London, 1874.

PLATE VII, FIGURE 2.

Length, 1.5^{mm}. Color light orange, the thickened circle on the abdomen very distinct, and more deeply colored than the parts around it. The head is black and a black line extends backward half the length of the thorax. The latter mark is found in both sexes and distinguishes the females of this species from *emertoni*, in which the black color is confined to the neighborhood of the eyes.

The head of the male is extended forward over the mandibles, carrying the front middle eyes, and has a hump above it with the hind middle eyes. Figs. 2*a*, 2*b*. The female has slight humps on the head. The epigynum is narrow and easily distinguished from that of *emertoni* which it resembles in size and color. The palpal organ is shown in fig. 2*c*. The slender spiral tube, with a black tooth at the base, resembles that of *C. alticeps*. The tibial hook is slender and has usually a short tooth near the base. Fig. 2. The tarsal hook is nearly straight and lies against the tarsus as in the two nearest species.

Eastern Massachusetts; Mt. Tom, Mass.; New Haven, Conn., in low bushes, May to August, and under leaves in winter.

Ceratinella bulbosa, new.

PLATE VII, FIGURE 3.

This species resembles *fissiceps* so closely that for a long time I thought it a variety of that species. The colors are the same and it is of the same size or slightly larger. The two humps of the head are swelled at the top and black. The lateral pairs of eyes are also raised on smaller humps on each side of the head. Figs. 3, 3*a*. The

male palpi resemble closely those of *fissiceps*; but the tibial hook is twice as wide, darker colored and has longer and sharper teeth at the end. Fig. 3c. I have not yet separated the females from those of *fissiceps*.

I have two males taken at different times in Pine Swamp, New Haven, Conn., under leaves in winter.

Ceratinella pygmæa, new.

PLATE VII, FIGURE 4.

The only specimen is little over 1^{mm} long. The colors are very light. Cephalothorax orange-yellow with a dark spot around the eyes from which a dark line tapers backward to the dorsal groove. The hard part of the abdomen is orange-yellow, the rest white. The head of the male is narrow and projects forward over the mandibles, but is not much elevated. Though the spider is smaller than *fissiceps*, the male palpi are as large as those of that species and resemble them very closely. The tibia, however, is larger and has the terminal tooth longer and sharper. The tube of the palpal organ is stouter than in *fissiceps*. The patella is nearly as long as the femur.

One male under leaves in Pine Swamp, New Haven, Conn., in October.

Ceratinella atriceps (Camb.).

Erigone atriceps Cambridge, Proc. Zool. Soc. London, 1874.

PLATE VII, FIGURES 5 TO 5d.

Length of male 1.6^{mm}. Cephalothorax orange, darker toward the humps, which are nearly black, the dark color sometimes extending backward on the middle line nearly to the dorsal groove. Abdomen dark gray, in alcohol greenish. The thickened spot on the back is often indistinct and sometimes absent, but when present is orange colored, darkened by the black hairs over it. The legs are colored like the abdomen, darker toward the tip. The ♂ palpi are lighter than the legs, except the tip which is almost black.

The head of the male is extended forward beyond the mandibles and has a hump above, bearing the posterior middle eyes. Fig. 5. The female has slight projections of the head at the same points. Fig. 5a. The ♂ copulating organs resemble closely those of *fissiceps*. Fig. 5b. The tibial hook is shorter and more curved.

May, June, July, on low bushes. Winter, in leaves on the ground. Mt. Washington, N. H., 4000 feet up; Eastern Massachusetts, common; New Haven, Connecticut.

Ceratinella læta (Camb.)

Erigone læta Cambr., Proc. Zool. Soc. London, 1874.

PLATE VIII, FIGURE 1.

Length 1.6^{mm}, slightly larger than *lætabilis*; both these species are found under leaves and probably live near the ground all the year, not spinning high like *fissiceps*. Color dark brown. The thickened spot only on the abdomen of the male. The abdomen of the female is sometimes almost black. Other individuals have a light stripe along the middle of the back with three or four cross stripes. The head is high behind the eyes, especially in the males. The tibia is short and the tibial and tarsal hooks both long. The tube is stout and black, broken in the middle, where each half has a short tooth.

Eastern Massachusetts; Mt. Tom, Mass.

Ceratinella lætabilis.

Erigone lætabilis Cambridge, Proc. Zool. Soc. London, 1874.

PLATE VIII, FIGURE 2.

Length, 1.5^{mm}, a little smaller than *C. læta*. Cephalothorax and sternum dark brown, legs dark orange. Thickened parts of the abdomen dark orange, brown, thinner parts gray, broken by lighter irregular spots. In the females, where the thickened circle on the abdomen is wanting, the whole back is dark gray with lighter patches and thickened spots at the ends of the vertical muscles. The head is slightly elevated behind the eyes, a little more in the male than female. The male has the thickened circle on the abdomen very hard and distinct. The female usually wants it altogether. The palpal organs distinguish this easily from *C. læta*. The tibial hook is short and wide and curved strongly inward. Fig. 2*b*. The tube is bent sharply at the middle as usual, and the outer edge of the basal half projects as a very distinct tooth. Fig. 2*a*.

The females are less easily distinguished from *C. læta*. They are a little smaller and lighter colored and the epigynum, Fig. 2*d*, has its opening shorter than the other species.

Mt. Washington, N. H., moss near Halfway House; Eastern Massachusetts; New Haven, Conn.

Ceratinella brunnea, new.

PLATE VIII, FIGURE 3.

Size of *C. leta*, but darker colored. Cephalothorax and thick spot on the abdomen dark brown, the thick spot present in both sexes. Legs lighter but not so bright orange as in other species. Abdomen below and at the sides dark gray.

The sexes much alike. The abdomen of ♂ slightly smaller and the thickened circle larger than in ♀. Head very little elevated in either sex. The tibial hook of the male palpi is long, Fig. 3, with a recurved tooth at the end. The palpal tube is very large, colored black, and with only a slight break in the middle. Fig. 3a. The epigynum has a wide oval opening.

Mt. Washington, from Glen to highest trees. Salem, April 20, under stone. Saugus marsh, Oct. 28. New Haven, Conn., winter.

Ceratinella minuta, new.

PLATE VIII, FIGURE 4.

About 1.2^{mm} long. One of the smallest spiders. Color uniform reddish brown on the cephalothorax and legs and the thickened spot on the abdomen. The thick spot is common to both sexes. The palpal organs have the tube very long, Fig. 4a, with only slight teeth at the break. The tibial hook is moderately long and sharp, and there is a peculiar blunt spur on the inner side of the tibia.

Common at New Haven, Conn., under leaves in winter. One male from West Quincy, Mass.

Ceratinella micropalpis, new.

PLATE VIII, FIGURE 5.

This species has the same colors as *C. minuta* and is a little larger, but the palpi are smaller. The shape of the tarsus is much like that of *C. minuta* but the hook is shorter. The tube is not more than half as long as in *minuta*. Pl. 8, figs. 5, 5a, 5b.

Only one male from West Quincy, Mass.

Ceratinopsis, new.

Except *interpres*, these spiders resemble *Ceratinella*, but do not have the thickened spot on the abdomen. Their colors are partly the same orange-red common in *Ceratina*, and their palpal organs have a similar structure, though the break is not so plain and the end of the tube is stouter. In *interpres* the legs are longer and the whole

appearance resembles *Cornicularia*. The head is high in front in all the species, and the eye-area is wide and black or darker than the rest of the cephalothorax.

Ceratinopsis interpres (Camb.).

Erigone interpres Camb., Proc. Zool. Soc. London, 1874.

PLATE IX, FIGURE 1.

This spider has a length of over 2^{mm}. The cephalothorax is bright orange with black around the eyes. Fig. 1. The legs are light yellow and long and slender, as in *Bathyphantes*. The abdomen is yellow or light orange, with black around the spinnerets. The head of the male is very high and has stiff hairs between the eyes. The male palpi are large, and light orange and black. The tarsus is nearly straight on the forward edge, and has a sharp, recurved, black point. The tarsal hook is short and has a few long hairs on its middle portion. The other parts of the palpal organ are large and strong. The epigynum is narrower than in *nigriceps* and runs farther forward.

Adult male and female and several young on Mt. Tom, Holyoke, Mass. Common at New Haven, Conn., on low bushes in summer.

Ceratinopsis nigriceps, new.

PLATE IX, FIGURE 2.

Length 1.5^{mm}. Cephalothorax orange with a well-defined black spot around the eyes, covering nearly the whole head. The head is wider in the females than the males, and in both sexes the lateral pairs of eyes are slightly raised on tubercles, giving the head a square appearance. The legs and palpi are light yellow, the latter darker. The abdomen is light yellow, slightly reddish toward the end, especially in the male. The sternum is orange-brown without the roughness of *laticeps*. The palpal organ is large with a large black tube like *nigripalpis*. The tibial hook is short and turned up toward the tarsus. Fig. 2a, 2b.

New Haven, Conn., and Dedham, Mass.

Ceratinopsis laticeps, new.

PLATE IX, FIGURE 3.

Length 1^{mm}. Thorax large and head wide, elevated in the middle over the eyes, and with a rounded hump in front below the eyes, Fig. 3a, which are widely separated. The cephalothorax is bright orange-brown, darker in front and black around the eyes.

Sternum orange with dark irregular markings. The abdomen is light yellow above and reddish at the hinder ends and sides. The legs are light yellow and the palpi are somewhat darker. The tarsus and tibia of the palpi are large. The tarsal hook has two strong black teeth. The palpal organ is much like *nigriceps*, but the tube is smaller. Fig. 3*b*.

I have two specimens from Danvers, Mass., and New Haven, Conn., both shaken from low bushes.

Ceratinopsis nigripalpis, new.

PLATE IX, FIGURE 4.

Length 1.5^{mm}. Cephalothorax orange except around the eyes, where it is black, extending backward a short distance on the middle line of the head. The femora are orange like the thorax, but the rest of the legs is gray. The terminal joints of the palpi are black. The abdomen is gray, lighter beneath. The palpal organ has a large black tube. The tibia of the palpus is short and has a short toothed hook. Fig. 4*b*. The tarsal hook is short and strongly curved.

Two males from New Haven, Conn., under leaves, in October.

Grammonota, new.

The species of this genus have the abdomen marked with light spots, in some forming a distinct pattern like *Anaurobius*. The head of the male is more or less raised behind the eyes. The palpal organ resembles that of *Ceratinella*.

Grammonota pictilis.

Erigone pictilis Camb., Proc. Zool. Soc. London.

PLATE X, FIGURE 4.

1.5^{mm} long. Cephalothorax dark yellow-brown. Legs lighter dull yellow. Abdomen gray with light yellow spots in two rows, the forward spots somewhat connected together. Fig. 4*a*. The head of the male is elevated into a rounded hump behind the eyes and a slight one between the front and hind eyes, both with hairs longer than the rest of the head. The palpal organs are of the same type as *Ceratinella*. Fig. 4*b*. The end of the tube is very long and slender, and coiled up in three or four spirals. The tibia has a sharp straight tooth on the outer side under the tarsal hook. The epigynum has very long tubes twisted in a double spiral, Fig. 4*e*, in correspondence with the long tube of the palpal organ.

This is a common spider on juniper and other evergreen trees. Portland, Me. ; eastern Massachusetts ; Mt. Tom, Holyoke, Mass. ; New Haven, Conn.

Grammonota ornata.

Erigone ornata Camb., Proc. Zool. Soc. London.

PLATE X, FIGURE 3.

Slightly smaller than *pictilis*, but with similar markings on the abdomen. Cephalothorax dark brown. Head of male slightly elevated behind the eyes, but no distinct hump, the elevated parts with similar stiff hairs as in *pictilis*. The palpal organ has the tube much shorter, and the tibial hook is curved forward and forked. Only males.

Near Boston, under leaves, not so common as the last.

Grammonota inornata, new.

PLATE X, FIGURE 5.

Length 2^{mm}. Cephalothorax dark brown, abdomen dark gray. Legs yellowish gray. Head of male slightly elevated behind the eyes. Male palpus with a short smooth hook on the tibia. The tarsal hook is large and so is the spur at the inner end of the palpal organ. The tube is stout and dark colored and the upper bend extends beyond the end of the palpus.

Two males from Saugus, Mass., under leaves, and two from New Haven, Conn., one under leaves, and one on a fence in October. Large numbers under dry eel-grass on the beach at Wood's Holl, Mass.

Spiropalpus, new genus.

This spider resembles closely those of the last genus, but has entirely different male palpi, with the tube long and stiff and coiled in a flat spiral, partly covered by the supporting appendage. The tibial hook is long and twisted.

Spiropalpus spiralis, new.

PLATE X, FIGURE 6.

Length, 2^{mm}. Somewhat lighter colored than the last. Cephalothorax, dark brown, lighter behind toward the abdomen and nearly black on the head. Abdomen dark or light gray, legs yellow. The sexes are alike in size and color. The epigynum is three-lobed with the small central lobe extending a little beyond the others. The dark brown spermathecae show through the skin. The palpal organ is very large, the tube is stiff and coiled in two large spirals which extend

over the edges of the tarsus, each side. A wide thin appendage starts near the base of the tube and lies over it as far as the end of the tarsus. The tibial hook is half as long as the tarsus and is bent toward the tarsal hook and appears twisted at the end.

Danvers, Essex and Cambridge, Mass., and New Haven, Conn.; in the latter place abundant on city fences in November.

Cornicularia Menge.

The spiders of this group are placed by Menge in several genera. The species which he refers to *Cornicularia* seems to be very near our *C. minuta*. Most of our species are large and brightly colored. The males and females differ but little. The males have a hump or horn on the front of the head between the eyes, and usually ornamented by flat stiff hairs. In several species there are two horns, the lower one being small and partly concealed by the upper. The male palpi have a stiff black tube curved once round the end of the bulb and supported by a thin appendage near the tip. The tarsus is round with a small, smooth tarsal hook at the base. The tibial hook is large and extends over the back of the tarsus. In several species it is a smooth pointed hook, but in others it has a smaller point on the inner side, or is modified in various ways according to the species. The epigynum has a wide and short middle lobe with openings at the corners. The cephalothorax is usually long, narrowing gradually toward the head. The eyes are nearly equal in size and close together, except where displaced by the horns of the males.

Cornicularia directa.

Erigone directa ♂ and *Erigone provida* ♀ Camb., Proc. Zool. Soc. London, 1874 and 1875.

PLATE XI, FIGURE 1.

The males and females of this species were described by Cambridge at different times, without opportunity to compare them, and were naturally supposed to be distinct species. I have since found both sexes together in considerable numbers, and am now sure that they belong together. The length is about 2^{mm}. Cephalothorax uniform chestnut-brown, from almost black to light yellow in different individuals. Sternum same color. Legs lighter. Abdomen gray with the muscular spots light. Both sexes about the same size and color. The male has two horns between the eyes, the lower slender and about half as long as the upper and lying close under it. The tibia of the male palpus has a smooth pointed hook over the tarsus.

Eastern Massachusetts; Mt. Tom, Mass.; Providence, R. I. In winter under leaves, and on fences in autumn.

Cornicularia tibialis, new.

PLATE XI, FIGURE 2.

This is a little smaller than *directa*. The colors are the same. The horn is shorter and thicker. The tibia of the male palpus is nearly as large as the tarsus. The hook has a large tooth in the middle, which is roughened on the edge and inside. Fig. 2*a*. Both sexes are alike in size and color.

From Mt. Tom, Holyoke, Mass.

Cornicularia communis, new.

PLATE XI, FIGURE 3.

Cephalothorax dark orange, darkened with brown toward the head and nearly black around the eyes. Legs brighter orange. Palpi same color, except the tibia and tarsus which are dark brown. Abdomen black with the muscular marks light yellow. Under side of abdomen same color. Sternum dark orange like the back of thorax.

Horn of male pointing forward, about as long as the distance between the front and back middle eyes, widened at the end where it is covered with stiff hairs directed upward and backward. Although it appears single, the horn really consists of two, pressed closely together, the upper or posterior one forming the greater part of it and bearing the terminal hairs. The anterior horn is entirely covered above by the other.

Mt. Washington, New Hampshire, and Eastern Massachusetts, under leaves; New Haven, Conn.

Cornicularia indirecta (Camb.)

Erigone indirecta Camb., Proc. Zool. Soc. London, 1874.

PLATE XI, FIGURE 4.

Cephalothorax and legs bright orange. Head black. Abdomen lighter orange than thorax, both above and below. This species differs from *communis* in the color of the abdomen and in having the dark spot on the head darker and more definite and the palpi and mandibles darker. Both sexes agree closely in size and color. The hinder middle eyes are farther back than in *communis*.

Horn of male like that of *communis*, Fig. 4, with recurved hairs on the end and along the upper side. The palpi of the males are much alike in these two species.

Eastern Massachusetts.

Cornicularia brevicornis new.

PLATE XI, FIGURE 5.

Length about 2^{mm}. Cephalothorax orange, a little darker on the head. Abdomen dark gray. Legs yellow. Palpi yellow with the hard parts near the end dark brown. The horn of the male is double, as in *directa* and *communis*, but much lower and shorter. The palpal organs differ but little from those of the other species. The plainest differences are the generally dull color and the short horn.

Two males from Pine Rock, New Haven, Conn.

Cornicularia minuta, new.

PLATE XI, FIGURE 6.

About 1.5^{mm} long. Color yellowish gray, almost white. One from the White Mountains, apparently of the same species, has the cephalothorax and legs brownish yellow and the abdomen almost black, much like *directa*. The horn is short, hardly longer than thick, and slightly divided on the end, where it has a tuft of short, stiff hairs. The tibia of the male palpus has the usual pointed hook, at the base of which is a shorter parallel process, covered at the end with stiff, black bristles. Figs. 6c, 6d. The palpal organ resembles those of the larger species.

Males only, from Mt. Carmel, Hamden, Conn., and Mt. Washington, N. H.

Cornicularia pallida, new.

PLATE XI, FIGURE 7.

2^{mm} long. Cephalothorax orange, with black around the eyes, extending backward along the middle line to the dorsal groove. The head is higher in the male and has a short hump about as high as wide between the eyes, Fig. 7, on which are stiff hairs, as in other species. Legs and palpi yellow or light orange. Abdomen white, with light gray hairs. Spinnerets and a ring around them gray or black. The palpal organs and the tibial hooks are much as in the other species. Fig. 7a. The only species with which this is likely to be confounded is *directa*, and from this it differs in both sexes in the lighter color, especially of the abdomen and legs, and the closer position of the eyes and shape of the head in males.

New Haven, Conn.

Cornicularia tricornis, new.

PLATE XI, FIGURE 8.

This resembles Menge's *Phalops furcillatus*, but the peculiar hump is much shorter and the upper eyes farther forward. The length is 1.5^{mm}. Cephalothorax dark brown, not much darker toward the head. Palpi same color. Legs orange. Abdomen dark gray or black. The lower horn is much as in *pallida*, with a few stiff bristles. The upper horn is forked at the forward end with bristles on the outer edges. The head behind the horn is abruptly raised, and carries the upper middle eyes. There is a sharp groove on each side of this ridge. Figs. 8, 8a.

Three males from Mt. Washington, N. H., June, 1877.

Cornicularia auranticeps, new.

PLATE VIII, FIGURE 6.

Smaller than the other bright colored species, about the length of *directa*, but stouter. Cephalothorax uniform bright orange. Legs orange toward the body, blackish toward the tips. Abdomen dark bluish black. The horn of the male is short and points upward, spreading into two short lobes at the tip, covered with short, recurved hairs. The palpal organ is much like that of the other species, but the tibia has two long, blunt teeth, Figs. 6, 6b, very different from the others.

Eastern Massachusetts and White Mountains, New Hampshire.

Cornicularia clavicornis, new.

PLATE VIII, FIGURE 7.

A small, dark colored species, about 2^{mm} long. Cephalothorax dark brown. Abdomen dark gray. Legs orange-brown. Head of male with a short horn swelled at the end. The tibial hook is long and has a smaller hook parallel and close to it. Fig. 7a.

One male from Mt. Washington, N. H.

Lophomma Menge.

The females resemble *Lophocarenum* and *Cornicularia*, but the males have the mandibles smaller and the head extended forward beyond them and divided into two humps; one carrying the front middle eyes and the other the hind middle pair. The front middle eyes are close together on the forward end of the hump, and over them are a few stiff hairs directed upward. The hinder hump has a crest of hairs directed forward. The tibia of the male palpus is very

long on the upper side, nearly covering the tarsus. The end has a long hook bent sidewise. Pl. X, figs. 1*b*, 2*c*. Menge includes in this genus several species with two humps on the head, but which have the holes behind the eyes and otherwise appear to belong with *Lophocarenum*.

Lophomma cristata.

Erigone cristata (Blk.) Thor., Synonyms of European Spiders.

Lophomma bicorne Menge.

PLATE X, FIGURE 1.

2^{mm} long. Cephalothorax dark brown. Abdomen dark gray. Legs yellowish brown. Both sexes alike in size and color. The eyes in the female are large and in two rows at about equal distances from each other. The head of the male is much raised and the lower part extended forward, Fig. 1, forming two horns. The eyes are smaller than in the female. The hind middle pair is on the upper horn, the front middle pair on the lower horn, and the side pairs separated far from them, below the hind pair. The male palpi have the tibia expanded as much as the tarsus, and a long hook with a sharp point bent across the end. Fig. 1*b*. The palpal organ is peculiar in having the tube short and not coiled as in most of the neighboring species. When in use this appears to be supported by a strong process near the end of the palpus and perhaps, also, by the tibial hook, which could be brought over it by a slight revolution of the tarsus.

I have specimens from Montreal, Canada, under leaves, in winter; Boston, Mass., on fences, in October; and Cambridge, Mass., under leaves.

Lophomma elongata, new.

PLATE X, FIGURE 2.

Same colors as *cristata*, but smaller, about 1.5^{mm} long. In the female the front middle eyes are more prominent and farther from the side pairs than in *cristata*. In the male the lower part of the head carrying the front middle eyes is much as in *cristata*, but the upper horn or hump is larger and lower and the eyes on the top of it are farther apart. The male palpi have the tibia similarly expanded, but the hook is longer and wider. The tube of the palpal organ is short and curved.

Salem, near floating bridge; Boston, swamp at Clarendon Hills; and Mt. Tom, Mass., under leaves.

Lophocarenum Menge.

These spiders form the greater part of the genus *Lophocarenum* of Menge, although some species are included in his *Lophomma* and *Tmeticus*. By Blackwall and Cambridge they are placed either in *Neriene* or *Walckenaera*, and by other authors, with the other small spiders of this family, in *Erigone*. I include in this genus only those spiders which have cavities in the heads of the males, opening by holes near the eyes. Pls. 12, 13. The heads of the males are usually high and furnished with humps of various shapes, according to the species. The head of the female usually shows some traces of the hump, and they resemble the males in color and form, so that after the males are known the females can usually be identified. Nearly all the species are small, 1 or 2^{mm} long, and dull colored. Most of them are short and stout with short legs. They live under leaves or on low plants, though some species, as *L. florens*, are found on high bushes in summer. The palpal organs are of various shapes, but the tube is usually smooth and slender and the appendages small. The tarsal hook is small. The tibia is large and of various shapes, according to the species.

Lophocarenum castaneum, new.

PLATE XII, FIGURE 1.

2.5^{mm} long. Cephalothorax dark reddish brown. Legs orange-brown. Abdomen black. The back part of the head is abruptly elevated and carries the hind middle eyes on the front. Each side of this hump is a groove in which are the holes leading to horn-shaped cavities in the head. The palpal organs resemble those of *Cornicularia*. The tarsal hook, Fig. 1e, is curved outward and has a notch near the middle when seen sidewise. The tube of the palpal organ is long and supported at the end by a flexible process. Fig. 1e.

Only males, from Beverly, Swampscott and Milton, Mass.

Lophocarenum montanum, new.

PLATE XII, FIGURE 2.

A little smaller than the last species, but resembling it very closely. The cephalothorax is slightly narrower than in the last species, the hump is indented in front below the upper eyes. The color is yellowish brown on the cephalothorax and gray on the abdomen. The palpi are much as in *castaneum*. Figs. 2b, 2f. The female is colored like the male, but has no elevation on the head. The epigynum is short, with an oblique groove each side. Fig. 2g.

Mt. Washington, N. H.

Lophocarenum florens.*Erigone florens* Camb., Proc. Zool. Soc. London, 1874.

PLATE XII, FIGURE 3.

This common species is the largest and most brightly colored of the genus. It is 2.5^{mm} long. The abdomen is bluish black, the cephalothorax, femora and palpi, bright orange, and the rest of the legs nearly black. The male has the head very high and slightly bilobed at the top of the hump. The hind middle eyes are nearly at the top and widely separated. The holes are just above and behind the lateral eyes. Fig. 3a. The male palpi are very large. The tibia has a long, flat hook, pointed at the tip. Figs. 3d, 3e. The tarsus has a hump on the upper side on which are a few stiff bristles. The tube is large and stiff and long enough to turn once around the palpal organ. It is supported at the end by a hard, twisted process. Fig. 3e. The head of the female is only slightly elevated at the back. The epigynum is large and open in the middle. Fig. 3f. The female is likely to be mistaken for *Cornicularia auranticeps*, but when full grown is larger and has the abdomen larger and thorax wider than the *Cornicularia*.

This is a very common spider in Eastern Massachusetts, on bushes in summer, but I have only found the adult male once, in June. Adult females are common through the summer. I have specimens from the White Mountains; Mt. Tom, Mass.; Albany, N. Y.; and New Haven, Conn.

Lophocarenum decem-oculatum, new.

PLATE XII, FIGURE 4.

This resembles *florens*, but is smaller and lighter colored. The cephalothorax and legs are yellow, the legs long, as in the male of *florens*, the abdomen dark gray. The hump of the male is as high as in *florens*, but the hind middle eyes are lower and closer than in that species and project forward as far as the lower middle pair. The holes in the hump are turned forward just above the side eyes, and look like an extra pair of eyes. Below the eyes there is a rounded forward projection of the head. The palpi of the male have a short truncated hook on the tibia. The tube is long enough to turn once around the palpal organ and is supported by a large twisted appendage, corresponding to the twisted spine of *florens*. This species is very near *Walckenaera bifrons* Blkw., but the patella of the male palpus is longer, and the tibia smaller. The black tooth on the

upper side of the tibia is also smaller and has less prominent corners in *bifrons*.

One male, from Mt. Washington, in moss, among the highest trees.

Lophocarenum spiniferum (Camb.)

Erigone spinifera Camb., Proc. Zool. Soc. London, 1875.

PLATE XIII, FIGURE 1.

Length 1.5^{mm}. Cephalothorax dark yellow-brown. Abdomen dark gray, legs and palpi yellow or orange. All the colors light. Cephalothorax nearly as wide as long. Head of male high in front. The hump is small and folds forward just behind the eyes, forming a crease across the head, at the ends of which are two round holes, which do not extend into the head beyond the depth of the crease. Fig. 1*a*. The male palpi have a large hook on the upper side of the tibiae. The tube of the palpal organ is long and stiff and extends downward beyond the palpus, the length of the tarsal joint.

This is near the English species, *Neriene incisus* Cambridge, Trans. Linn. Soc., vol. xxvii, 1870.

Under leaves in swamps, in Beverly and Salem, Mass., in winter, and on fences on Boston common, in November.

Lophocarenum montiferum, new.

PLATE XIII, FIGURE 2.

About 2^{mm} long. Cephalothorax dark yellow-brown. Abdomen dark gray. Legs orange-brown. The male has a hump half as large as the rest of the cephalothorax, Figs. 2, 2*a*, containing large cavities, which open by holes on either side, as large as the eyes, and are connected by a deep crease which runs around the front of the hump. The front middle eyes are near together in the middle of the head, in front of the hump. The other eyes are in two groups at the extreme corners of the head. In the female the back of the head is considerably elevated, and the hind middle eyes farther apart than usual. Figs. 2*c*, 2*d*. The mandibles of the male are smaller than the female's and are curved apart at the tips. The palpal organs have a tube curved in a half-circle and supported at the end by a short sharp spine and a long soft appendage. Fig. 2*f*. The tibia has a large blunt tooth and a short sharp one above.

In maple swamps, Brookline, Mass.; and Salem, Mass., near the floating bridge.

Lophocarenum quadricristatum, new.

PLATE XIII, FIGURE 3.

This is a small species, 1.5^{mm} long, and dull colored. The head has a peculiar hump extending back nearly to the middle of the thorax. Figs. 3*a*, 3*b*. The middle of this hump is occupied by four clusters of flat bristles, and the hind eyes are crowded back over the holes in the side of the head. The side eyes are larger than the others, and the front pair of these larger than the hind ones. On the male palpi the tibial hook is turned toward the side. Fig. 3*c*. The palpal organ has a long tube as in *Cornicularia*.

One male, from Mt. Washington, above trees. This species is very near *Walckenaera diceras* Camb., and may prove to be the same species.

Lophocarenum longitarsus, new.

PLATE XIII, FIGURE 4.

Length 1.5^{mm}. Cephalothorax dark reddish brown. Legs orange-brown. Abdomen gray. The head of the male is wide and not much elevated, and there is hardly a trace of a hump. The holes are just behind the eyes and the dark brown conical cavities extending from them toward the middle of the head can be seen through the skin. The absence of a hump leaves the eyes nearer together than in most species. The mandibles are wide at the tip and have the tooth near the inner angles longer than the others. Fig. 4*b*. The tibia of the male palpus has the front edge hard and finely toothed and a large tooth on the inner corner. The tarsal hook is large and sickle-shaped, with three stiff hairs in the bend. The tarsus is long, and so is the palpal organ. The tube is slender and long enough to go around the end of the palpus.

One male, White Mountains, near Mt. Washington.

Lophocarenum pallidum, new.

PLATE XIII, FIGURE 5.

1.3^{mm} long. Cephalothorax yellowish brown, a little darker toward the head. Legs light yellow. Abdomen yellowish gray. The hump of the male is farther back than in most species, and has a deep groove on each side. The holes in the head are just back of the lateral eyes. Fig. 5. Seen from in front the head is about as high as wide, and has the shape of a triangle with rounded corners. The tibia of the male palpus is short and has a short hook turned inward. The tube

of the palpus is long enough to turn one and a half times around the palpal organ, and the supporting appendages are thin and wide.

White Mountains, near Mt. Washington.

Lophocarenum longitubus, new.

PLATE XIII, FIGURE 6.

Length, 1.5^{mm}. Cephalothorax yellow-brown. Legs yellow. Abdomen dark gray. The hump is rounded and does not extend far back on the head. The hind middle eyes are on the front of the hump. Each side of the hump is a horizontal groove, in the middle of which are the holes in the head. The tibia of the palpus has two prominent black teeth. The tarsus is irregularly shaped and truncated at the outer end. The tube is long and stiff, and bends around the flat end of the tarsus.

Three males from moss, east side of Mt. Washington.

Lophocarenum rostratum, new.

PLATE XIV, FIGURE 1.

Length, 2^{mm}. Color light brownish yellow on the cephalothorax and legs, and gray on the abdomen. It varies in different individuals, some having the abdomen almost black and the other parts proportionally dark. The hump of the male extends forward beyond the front of the head. Fig. 1a. The hind middle eyes are on the top of the hump near the middle. The holes are in oval grooves just back of the side eyes. The tibia of the male palpus has a long and slender hook as long as the tarsus. The tube of the palpal organ passes round it once, and is supported at the end by a stout spine. The female is much like the male, but has no trace of the hump on the head.

New Haven, Conn., under leaves in woods, common.

Lophocarenum scopuliferum, new.

PLATE XIV, FIGURE 2.

This is a small dull-colored species, 1.5^{mm} long. The head is elevated about as much as in *spinifera*, and the holes are in grooves above the side eyes. The male palpi have the tibia as large as the tarsus, which it partly covers. On its outer side is a row of long stiff hairs curved forward toward the end of the joint. The palpal organ is simple, all the parts being very small and short. The female has the head slightly elevated at the back part, and is about the same size and color as the male.

Cambridge, Waltham and Roxbury, Mass., under leaves.

Lophocarenum erigonoides, new.

PLATE XIV, FIGURE 3.

Length, 1.5^{mm}. Cephalothorax yellow-brown. Legs same color but lighter. Abdomen dark gray. Thorax and abdomen both low, and head but little elevated and slightly narrowed at the sides. Figs. 3, 3*a*. The holes are close behind the lateral eyes and are not in grooves. The tibia of the male palpus extends over the tarsus, and has an oblique black tooth at the end and a rounded lobe below it. The tarsal hook is short and wide like *Erigone*. The tube is coiled half round the end of the palpus, along with a slightly longer flexible appendage. Fig. 3*b*.

Beverly, Mass., E. Burgess.

Lophocarenum latum, new.

PLATE XIV, FIGURE 4.

This is a short and wide species. The cephalothorax is nearly as broad as long. The grooves on the sides of the hump extend obliquely backward from the lateral eyes, and have the holes at the lower end. The tibia is widened and has a rounded tooth half its width at the end. Fig. 4*b*. The tube and its support are both small. Fig. 4*c*.

One male, Watertown, Mass., under leaves in winter.

Lophocarenum simplex, new.

PLATE XIV, FIGURE 5.

A small species, 1.5^{mm} long. Lighter colored than most species. Legs and cephalothorax light yellow-brown. Abdomen gray. Head slightly elevated. Holes behind and above the lateral eyes in shallow grooves, a slight depression in the front of the head below the upper eyes. The male palpus has the tibia extending half its length over the tarsus, and has a small hook at the end. The tube and appendages of the palpal organ are short. Figs. 5*c*, 5*d*.

One male under leaves in a maple swamp near the floating bridge, Salem, Mass.

Lophocarenum depressum, new.

PLATE XIV, FIGURE 6.

Length, 2^{mm}. Colors the usual dull brown and gray. The legs in my specimen are dark brown, but are probably discolored by drying or dirty alcohol. The ♂ cephalothorax is very low for this genus, and the hump just behind the eyes is lower in the middle than at the

sides, where it widens slightly over the lateral grooves, in which are the holes in the head. The male palpus has the tibial hook straight and toothed on the inner side toward the tip. The tube of the palpal organ is very small and is supported by a stout smooth spine.

One male from Mt. Washington, N. H., in moss.

Lophocarenum crenatum, new.

PLATE XIV, FIGURE 7.

Length, 2^{mm}. Cephalothorax dark brown. Abdomen black. Legs orange-brown. The cephalothorax is very hard and solid above and below, without the usual soft space between the legs. The head portion is much elevated in both sexes but slightly more in the male, where it is narrowed up behind the eyes, and has the usual holes in shallow oval grooves. The edge of the thorax is scolloped between the legs. Fig. 7. The palpi of the female have the two end joints twice as thick as the others. The abdomen of both sexes is short and pointed behind. The male palpi are not much larger than those of the female. The tibial joint is wide and truncated on the upper side, and the tarsus is short and round. Fig. 7c. The palpal organ itself has a very short tube and appendages.

This was found twice in Beverly, Mass., under leaves, and abundantly on fences in New Haven, Conn., during the autumn flights.

Lophocarenum vernale, new.

PLATE XIV, FIGURE 8.

About 1.5^{mm} long. Legs light yellow. Cephalothorax same color, a little darker. In the male the head is darkened with gray, and in the only specimen I have all the colors are deeper than in the female. The head of the male is but little elevated. The eyes are all below the hump and close together on the front of the head. Fig. 8. The holes in the head are very small and behind and above the lateral eyes in a dark brown stripe. The tube of the palpal organ is long and curved round the end of the tarsus. The tarsal hook is flat and sharply curved and has three stiff hairs in the bend. The tibia has a short straight hook where it reaches over the tarsus, and a thicker process farther back on the outer side. Figs. 8a, 8b. The epigynum is wide and the edges curve forward and inward at the sides. In the middle is an indistinct ridge which widens at the end like a middle lobe.

I found a male and female of this species under a stone together, in March, on Pine Rock, New Haven, Conn.

Tmeticus Menge.

These spiders are all small and dull colored, many of them appearing like young of larger species. They usually have short legs and a low body like the smaller species of *Linyphia*, between which and this genus it is hard to draw a line. The males do not have any horns or humps, though they sometimes differ in size from the females. The males of several species have a prominent tooth on the front of the mandibles near the inner corner. Plate XV. The male palpi have the tibiæ widened at the distal end and furnished with various teeth and hooks, the shape of which is characteristic of the various species, and is the plainest difference between this genus and the smaller *Linyphia*. The tarsal hook is smaller than in *Linyphia* and less variable. Plate XV. They are found under leaves in winter and but seldom on bushes even in summer.

This group corresponds tolerably well with Menge's *Tmeticus*, and I have accordingly adopted that name for it. It also includes many of Blackwall's *Neriene*.

Tmeticus probatus (Camb.)

Erigone probata Camb., Proc. Zool. Soc. London, 1875.

PLATE XV, FIGURE 1.

Length 1.5 to 1.8^{mm}. Cephalothorax yellowish brown. Legs dull yellow. Abdomen gray with five or six pairs of obscure yellowish transverse markings. The amount of color varies in different individuals, some being almost black and others very pale. The mandibles are longer than the head is high and taper slightly toward the tips. Except in the sexual organs, there is but little difference between the sexes. The male palpi are large and dark colored. The tibia is as wide as long with a hollow in the middle surrounded by various processes. Figs. 1, 1a. The tarsal hook is short and thick and partly covered by the teeth of the tibia. The tube of the palpal organ is short and surrounded by short and complicated appendages. Fig. 1a. The epigynum has a smooth edge just over the fold, and in light colored specimens the external parts show through the skin just in front of it.

This is found commonly on fences in autumn in Boston, Mass., and New Haven, Conn., and occurs under leaves in the neighborhood of both these places.

Tmeticus tridentatus, new.

PLATE XV, FIGURE 2.

Length, 2^{mm}. Legs orange-brown. Cephalothorax dark brown. Abdomen dark gray with five or six pairs of lighter spots. The mandibles of the male have a row of hooked teeth on the outer front edge. The female has slight traces of the same teeth. The male has a strong tooth on the front of the ends of the mandibles, which is wanting in the female. The male palpus has the tibia as wide at the outer end as long, with a wide tooth projecting over the tarsus. Fig. 2c. The palpal organ has three teeth attached by the base to a semicircular hard portion of the organ. Fig. 2e. The epigynum has the upper edges united in the middle and prolonged backward at the corners, forming a triangular opening over the rounded middle lobe.

Providence, R. I., and New Haven, Conn., under leaves; ♂ and ♀ on fences in November.

Tmeticus plumosus, new.

PLATE XV, FIGURE 3.

Length, 1.5^{mm}. Abdomen gray. Cephalothorax yellowish brown. Legs yellow, much like many other species. The male palpi have the tibiæ widened, and with several lobes and teeth on the edges. Fig. 3a. The tarsal hook is large and stout, with two teeth at the end. The palpal organ is of a complicated shape, but has in plain sight on the under side a peculiar appendage covered with stiff bristles. Fig. 3b. The mandibles have a small tooth in front.

Males only, from Montreal, Canada; Mt. Washington, N. H.; and Beverly, Mass.

Tmeticus trilobatus, new.

PLATE XV, FIGURE 4.

Length, 1.6 to 1.8^{mm}. Cephalothorax and legs dull yellow-brown, the legs a little lighter. Abdomen yellowish gray. The mandibles of the male have a tooth on the inner corner of the tip. The palpal organ is very similar to that of *tridentatus*. The tibial hook is narrower and more twisted. The three teeth on the palpal organ are not so distinctly united at their base to a horny ridge as in *tridentatus*. The outer edge of the epigynum, Fig. 4b, is deeply divided in the middle, showing the pointed middle lobe beneath. The two lobes of the upper edge extend backward half their length beyond the fold of the

abdomen. The colors and whole appearance of this spider make it resemble the young of larger species.

I have found it under leaves near Fresh Pond, Cambridge, Mass., and abundantly on fences at New Haven, Conn., during the autumn flights.

Tmeticus contortus, new.

PLATE XV, FIGURE 5.

This is another immature appearing species, slightly wider across the thorax than the last and darker colored. The shape of the palpus is very distinctive. Figs. 5, 5*a*. The tibia is turned aside at an angle of 45° with the rest of the palpus, and carries the triangular tarsus at the outer end. On the curved part of the tibia is a large and a small tooth. Fig. 5*a*.

Cambridge and Waltham, Mass.

Tmeticus longisetosus, new.

PLATE XVI, FIGURE 1.

About 2^{mm} long, light grayish yellow. The mandibles of the male have a prominent tooth on the inner corner projecting forward. Figs. 1*a*. The parts of the palpal organ are small but the tarsal hook is large with two teeth on the end, as in the preceding species. Near the base of the tarsal hook are two stout bristles as long as the tarsus and curved so as to fit against its edge. Figs. 1*b*, *c*, *d*.

New Haven, Connecticut, under leaves Oct. 15, 1880.

Tmeticus pertinens.

Erigone pertinens Camb., Proc. Zool. Soc. London, 1875.

PLATE XVI, FIGURE 2.

Length, 2.5^{mm}. Cephalothorax wide and palpi short. Cephalothorax yellow-brown, legs same color but lighter. Abdomen dark gray. The sexes are much alike. The male has the usual tooth on the front of the mandibles. The male palpi have the tibia expanded, with the two large teeth turned outward on the upper side. The tarsal hook is flat with two teeth. Fig. 2. The appendages of the palpal organ are large and conspicuous. The epigynum has the two upper lobes about as wide as the middle one and separated more than their width from each other. Fig. 2*c*.

Tmeticus montanus, new.

PLATE XVI, FIGURE 3.

About 1.5^{mm} long and dull colored. Abdomen dark gray. Cephalothorax yellow-brown. Legs same color, but paler. The cephalothorax has an indistinct dark stripe each side near the edge. Males a little smaller than females. Mandibles of male without teeth in front. Tibia of male palpus as wide as long with a short curved tooth on the upper side. Tarsal hook wide, like *Erigone*, with a tooth at the outer corner. The tube of the palpal organ is moderately long and supported only at the tip by a thin appendage. Fig. 3*b*. The epigynum is slightly raised and dark brown, the middle lobe very narrow and separated from the side lobes by shallow grooves ending in slight notches at the edge.

From moss on various parts of Mt. Washington, New Hampshire, from Hermit Lake to the highest trees.

Tmeticus pallidus, new.

PLATE XVI, FIGURE 4.

This spider is little over 1^{mm} long and very pale colored. Legs and cephalothorax light yellow. Abdomen pale gray, almost white. Eyes with black rings. Epigynum without any distinct grooves or notches and showing the dark brown spermathecae through the skin. The males are of the same size and color as the females. The mandibles have no prominent teeth in front. The tibia has a very long hook which extends nearly to the end of the tarsus. It has a wide tooth near the middle and a very narrow and slightly curved tip. The palpal organ has the tube and its appendages very narrow and simple. Fig. 4*a*.

New Haven, Conn., and neighborhood.

Tmeticus maximus, new.

PLATE XVI, FIGURE 5.

This is a large species nearly 3^{mm} long. The colors are dark. Cephalothorax yellowish brown, darker and reddish toward the head. Legs lighter yellowish brown. Abdomen gray. The mandibles have a prominent tooth on the front inner side. The tibia of the male palpus is small and has a short process roughened at the tip on the upper side. The tarsus is long. The tarsal hook is large and dark colored, with two teeth on the curved end. The palpal organ is large and dark brown, but the tube and its supporting appendages are small.

One male only, from Mt. Washington, New Hampshire, in moss, half way up.

Tmeticus tibialis, new.

PLATE XVI, FIGURE 6.

The cephalothorax, legs and palpi are of a nearly uniform light brownish yellow and the abdomen is nearly the same color. The male palpi are short. The tibial joint is short and wide and has a long curved process on the outer side nearly as long as the tarsus. The tarsus is short and truncated at the tip. The tarsal hook is wide at the base and turned abruptly backward at the end. The palpal organ is small. The tube is curved and supported by two short appendages. The female supposed to be of this species is about the same size and color. The epigynum is short and wide. The middle lobe covers over half the width and is slightly narrowed toward the edge. The side lobes are darker colored and thickened and separated by a shallow notch from the middle lobe.

A male and a female from the upper part of Mt. Washington, between it and Mt. Clay, in June.

Tmeticus bostoniensis, new.

PLATE XVII, FIGURE 1.

A large species, about 2.5^{mm} long. Cephalothorax yellowish brown. Legs yellow. Abdomen dark gray. Legs slender. Mandibles without the front tooth. Tibia of male palpus short with a large double process on the outside, half as long as the tarsus. The tarsal hook has a very peculiar shape, it is curved outward at the end as usual, but the end is nearly as wide as the hook is long and has two spreading teeth. The tube of the palpal organ is long and curves across the truncated end of the tarsus.

One male from a fence in Boston, in October.

Tmeticus bidentatus, new.

PLATE XVII, FIGURE 2.

Length, 1.5^{mm}. Cephalothorax yellowish gray. Legs same color, but lighter. Abdomen gray, darkest beneath, in some specimens dark, in others almost white. Cephalothorax oval. The small size and dull colors make the females look like young of some larger species. The tibia of the male palpus is wide and extends slightly over the tarsus, where it has two short rounded teeth. The outer

half of the tibia is dark colored. The tarsal hook is small and lies partly in a hollow in the edge of the tarsus.

Several places on Mt. Washington, N. H.

***Tmeticus concavus*, new.**

PLATE XVII, FIGURE 3.

Length, 1.5^{mm}. Abdomen gray. Cephalothorax brownish yellow with black edges. Legs dull yellow. Male palpi small. Tarsal hook half as long as the tarsus, with a hollow in the middle bounded by two ridges, one near the base of the hook and the other parallel to it just beyond the notch. The palpal organ has two sharp black points and a curved soft appendage at the end. The tarsus is much longer and thicker than the tibia.

Maple swamp at Clarendon Hills, near Boston, in large numbers. Pine swamp, New Haven.

***Tmeticus microtarsus*, new.**

PLATE XVII, FIGURE 4.

Length, 1.5^{mm}. Cephalothorax and legs dull grayish yellow. Abdomen gray. Male palpi very small, the tarsus oval and the palpal organ small and without any large projecting processes. The tarsal hook is flat and fits close against the palpal organ. It has a short hook at the end. The tibia is about half as long as the tarsus and at the outer end nearly as wide as the tarsus. Its edge has no teeth or large notches.

Mt. Washington, N. H., in moss, under the highest trees.

***Tmeticus truncatus*, new.**

PLATE XVII, FIGURE 5.

Length, about 2^{mm}. Cephalothorax and legs brownish yellow. Abdomen light gray. Head wide just behind the eyes. Eyes small, surrounded by black rings. The tibia of the male palpus is nearly as long as the tarsus. It is widened at the distal end, and as seen from above has a nearly straight front edge. On the outer side is a deep notch. The tarsus is short and blunt at the end.

Mt. Washington, in moss, under the highest trees.

***Tmeticus terrestris*, new.**

PLATE XVII, FIGURE 6.

Length, about 1.5^{mm}. Cephalothorax dark yellow-brown. Legs and palpi same color but lighter. Abdomen gray. The male palpi

are short and small. The tibia is widened at the end but does not extend much over the tarsus. The tarsal hook is flat and curved backward at the end, under which is a blunt tooth. The palpal organ is small.

Mt. Tom, Holyoke, Mass., and Salem, Mass., under leaves.

Tmeticus brunneus, new.

PLATE XVII, FIGURE 7.

Cephalothorax, 1.2^{mm} long and dark brown. The head is wide and round, and the eyes small. The mandibles are long and without a large tooth in front. The legs are stout and brownish yellow. The palpi are short, a little longer than the femur of the first legs. The tibia of the male palpus is short except on the upper side, where it extends over the tarsus. The tarsal hook is large and wide at the base, curving outward at the tip, which is slightly widened. The tarsus and palpal organ are dark brown and about as wide as long. The tube appears to be partly hidden under the edge of the tarsus and supported at the end by various short processes.

One male only, from Mt. Washington, N. H.

Erigone (Menge.)

In this genus I include only those spiders of which the males have long palpi with a tooth under the end of the patella. The maxillæ and the mandibles are much thickened at the base. The tarsus and palpal organ are small. The females differ but little from those of the related genera.

Erigone autumnalis, new.

PLATE XVII, FIGURE 8.

This is smaller than the other species, being little over a millimeter long. The colors are lighter than usual. The abdomen is yellowish gray, the legs orange-yellow, and the cephalothorax bright orange, especially on the head and mandibles. The eyes are surrounded with black. The bright color of the head makes this spider easy to recognize among the species which fly in autumn. The males and females are of the same size and color, though the latter are slightly paler. The mandibles of the male are large and have two rows of strong teeth inside the tip. The palpi have a long and pointed spur on the patella. Fig. 8*b*. The tibia is short but expanded as usual at the end. The palpal organ is much like the other species.

This species is common on fences in October and November, in

Boston, Mass., and New Haven, Conn. I have also found a few specimens under leaves in woods.

Erigone longipalpis?

PLATE XVII, FIGURES 9 AND 10.

Of this group, whatever it may be called, I have a large number of specimens, which I am unable to separate into distinct species, though there are great differences among them. The size varies from 1.5^{mm} to 2.5^{mm}. The color of the cephalothorax and legs varies from dark gray to bright orange-brown. The maxillæ are thickened at the base more in the males than in the females. The mandibles of the males are long and thick in the middle but narrowed toward the base. The male palpi are very long but the length and shape of the different joints varies greatly in different individuals. The most common form, an average specimen of which is drawn in Fig. 9, has the patella and tibia of nearly equal length and both together about as long as the femur. This, however, varies in different individuals. The palpal organ has the tube short with a curved tooth on the end beyond the opening. Near the tube are two soft appendages and various teeth and processes as in other varieties. I have found these abundant in Boston and New Haven on fences in November and October. They have been named *Erigone dentigera* by Cambridge, in Proc. Zool. Soc. London, 1874. With the above occurred another variety, Fig. 10, which Cambridge identified with the European *longipalpis*. It is somewhat larger and brighter colored on the cephalothorax and legs. The head is more abruptly elevated, the palpi are longer, and the teeth on the femur and around the edge of the thorax are larger. The palpal organ is longer and the tube has a longer and straight point, Fig. 10a, beyond its opening. A male from Essex, Mass., has the head higher and the palpi nearly as long, but the tibia is shorter and much widened at the end. Another male from Danvers, Mass., has the same flaring tibia and similar palpal organ, but is smaller and has much shorter palpi than most of the others. The epigynum in the most common form has a large opening covered by a projecting hood, around the edge of which is a thickened rim that may be mistaken for the tubes of the spermatheca. I have numerous females which I am unable to classify or to connect with the varieties of males.

Gonatium Menge.

Gonatium rubens (Menge.)

Neriene rubens Blk., Spiders of Great Britain.

Gonatium cheliferum Menge, Preuss. Spinn.

PLATE XXIII, FIGURE 6 TO 6c.

The males of this species are distinguished by the large femoral joints of the palpi. Fig. 6. Both sexes are 2.5^{mm} long. The cephalothorax is bright orange with a little black between the eyes, from which two or three indistinct lines run back to the dorsal groove. The head is slightly elevated in females and the front middle eyes project beyond the others. In males the part of the head about the eyes is narrowed and much higher. The legs and palpi are light yellow or orange, and the abdomen is gray, usually light, but in some specimens almost black. The epigynum is dark brown and raised slightly beyond the surface of the abdomen. Fig. 6c. The palpi of males are very stout. Figs. 6, 6b. The femora are thick and extend upward to a point opposite the eyes, and this point is covered with short black teeth. The patella and tibia are short; the latter has a long hook which bends over the tarsus. Fig. 6. The palpal organ, Fig. 6a, has a long slender tube supported by an equally slender process about half its length. Between these is a thin flat appendage, and near the tip several soft appendages with finely-cut edges. The front legs of the male are also modified. Fig. 6. The femur has a row of long hairs on the front or under side. The tibia is bent and has a line of long hairs on the under side. The metatarsus has a row of still stronger hairs on the under side and is slightly bent at the upper end.

I have not found this spider common anywhere but have specimens from Beverly, Salem, Lynn and Quincy, Mass., and Meriden, Conn. Some were sifted from leaves, others taken on fences in autumn.

Linyphia (Latr.) Menge.

These are the largest spiders in this sub-family. They live in comparatively open situations and are brightly colored. The cephalothorax is long and the legs long and slender with distinct spines. The abdomen is slightly flattened on the back except in *L. phrygiana*, and in *marmorata* and *communis* it is widest behind the middle. The epigynum has two large openings without any complicated parts over them. The tarsal hook of the male palpus is very small and sickle-shaped. The tube of the palpal organ is short and supported by a thick spirally-grooved process, except in *mandibulata*, which

has the tube extremely long. The males of several species differ greatly from the females.

***Linyphia marginata* C. Koch.**

Linyphia scripta Hentz, and probably *L. marmorata* Hentz.

PLATE XVIII, FIGURE 1.

Length of either sex about 4^{mm}. Cephalothorax of female yellowish brown with a light stripe on the edges each side. The abdomen is egg-shaped, thickest behind and somewhat flattened at both ends. In the middle of the back of the abdomen, Fig. 1, is a dark stripe consisting of several partly separate patches in which are two or three pairs of light spots. Each side of this stripe the back is yellowish white, and whitish and brown stripes extend irregularly down the sides. The under side of the abdomen is dark brown, with two rows of whitish spots along the sides. The sternum is also dark brown. The legs are light yellow with long, dark colored spines. The claws are slender with sharp teeth. They become stiff and brittle in alcohol. The front legs are 9^{mm} or 10^{mm} long. The males are about as long as the females, but have the thorax larger and abdomen smaller. The cephalothorax is redder and the lighter margins less distinct. The abdomen is dark brown or gray with the light markings almost covered up, except one spot on each side which is usually distinct. The eyes of the male are smaller than those of the female, but the head has nearly the same shape and height. The mandibles of the male are wider at the tip, with two prominent teeth, one at the inner corner and the other in the middle. Those of the female have three teeth near the inner corner. The male palpi have a slender sickle-shaped tarsal hook. Fig. 1j. The tube of the palpal organ is short and thick and it is accompanied by a thin forked appendage and a softer rough one, all of which rest against a large, dark brown, twisted process. Figs. 1g, 1h. Another process of the palpal organ has an irregular toothed edge where it approaches the spiral process and tapers backward to a point near the base of the tarsus. Fig. 1g. The epigynum has a very large opening directed backward, covered by a dark brown skin. The male and female may be seen pairing in the web in June, for hours at a time, the male taking out his palpus and putting it in again every minute or two. The web consists of a large irregular net of threads in which is a smooth and finer sheet, concave below and held by threads running in all directions. The spider stands under the middle of the concave part of the web and catches what falls down from the irregular

threads above. There is often an imperfect sheet of web below, which I suppose to be an abandoned web and not a necessary part of the one in use. The threads of this web often look purple in the sunlight. This is one of the most common spiders in the woods, making its webs among the underbrush, a foot or two from the ground. It also spins among rocks and in stone walls.

Common all over New England. Hentz found both *marmorata* and *scripta* in Alabama. It is also common in Europe.

Linyphia communis Hentz, Proc. Boston Soc. Nat. Hist., vol. vi.

PLATE XVIII, FIGURE 2.

The sexes of this spider differ greatly in size and color. The female is 3.5^{mm} to 4^{mm} long. Longest legs, 6^{mm}. The cephalothorax, mandibles, and sternum are yellowish brown. Legs and palpi dull yellow. Abdomen chocolate-brown above and below, with five pairs of white markings on the sides. The cephalothorax is high in front. The abdomen is proportionally larger than in *marmorata* and similarly truncated behind. The male is 2.5^{mm} long with legs as long as those of the female but more slender. The cephalothorax, mandibles and palpi are bright orange-brown, but the sternum is darker, like the female, as is the under side of the abdomen. The back of the abdomen is light yellow-brown, with indistinct markings on the sides similar to those of the female.

The web of this species consists of a net of irregular threads one foot or more high, under which is a closer flat sheet 4 to 5 inches wide, and convex below, where the spider stands. Below this, at a distance of 1 inch, is another similar sheet of web held in place by threads running in all directions. Small insects flying into the upper part of the web strike their wings against the threads and fall gradually down to the close web at the bottom, where they are caught and drawn through by the spider, as in the concave web of *marginata*. What the use of the lower sheet of web is, I have not seen. Males and females are found in the web together in July. The upper part of the web is often occupied by *Argyrodes trigonum*.

This spider is found from Mt. Washington, N. H., to New Haven, Conn. Hentz says it is common in the South.

Linyphia clathrata Sund. Thor. Synonyms European Spiders.

PLATE XVIII, FIGURE 3.

This species is 3^{mm} long. The cephalothorax is yellowish brown, with a darker stripe on the middle. The legs are yellow or orange

and shorter and stouter than in the other species. The abdomen is long-oval, light yellow above, with dark brown markings which sometimes nearly cover it. The under side of the abdomen and sternum are dark brown. The epigynum has a large opening in the middle. Fig. 3*d*. The palpal organ has a spiral spine at the end crossed by radiating lines. A large triangular appendage near the base shuts over the others. Figs. 3*b*, 3*c*. The tarsal hook is very small and slender. I have only a few specimens of this spider. The web is flat and near the ground. The spider stands at one side like *L. phrygiana*.

Eastern Massachusetts. I have compared the American specimens with a few European *clathrata* and believe they are the same.

Linyphia phrygiana C. Koch.

L. costata Hentz.

PLATE XIX, FIGURE 1.

Length, 5^{mm}. Cephalothorax light yellow, with a black line in the middle forked at the forward end, and a black line each side on the edge of the thorax. Legs light yellow, with a dark ring on the end of each joint and the middle of each tibia and metatarsus. The legs have also many dark spots, especially on the femora. The spines of the legs are black and conspicuous. The abdomen is yellowish with brown spots at the sides and beneath, and a dark brown or reddish herring-bone stripe along the middle of the back. The head of the male is twice as high as that of the female, and has a cluster of stiff hairs on the top. The male palpi have a long spur on the patella. The tarsal hook is longer than in the neighboring species but thin and sickle-shaped. The palpal organ itself is small and resembles that of *communis*. Fig. 1*e*. The epigynum has two openings partly covered by a triangular lobe, which extends backward over the middle of the epigynum. Fig. 1*h*.

This is a very common species, both in town and country. It builds in fences and low bushes a large flat web, and stands concealed under one corner of it, running out quickly if anything touches it.

Mt. Washington, N. H.; Eastport and Portland, Me.; Boston, Mass.; Albany, N. Y.; Connecticut. Probably all over the United States and Europe.

Linyphia mandibulata, new.

PLATE XIX, FIGURE 2.

About the same size as *communis*, or a little larger. The female resembles the other species, but the male differs from them in the great length of the mandibles and the tube of the palpal organs. It resembles closely *L. pusilla* of Europe, but in my specimens the males have the back of the cephalothorax straight, not arched as in *pusilla*. The mandibles are slightly longer and wider at the end and the four teeth are more prominent than in *pusilla*. The palpal organs are almost alike, but the epigynum of *pusilla* has two separate and moderately large openings, like *marginata*, while in *mandibulata* the openings are covered. Fig. 2*b*. The colors of the female are variable, but the light markings are smaller and the whole body darker than in *pusilla*. The cephalothorax is yellowish brown, without markings. The abdomen of the females is usually dark brown, almost black, with several light yellow spots, usually two across the front part of the back and several around the sides and behind, forming in some a continuous line around the middle of the abdomen. Fig. 2. The males are slightly smaller than the females and have the abdomen much smaller and narrower, with no light markings, except the spots on the front of the abdomen. The head of the male is much lengthened forward beyond the mouth, and the mandibles are very long and slant backward toward the maxillæ. Fig. 2*b*. At the ends the mandibles are widened and have four teeth on the inner corner. The mandibles have a large process in the middle on the inside Fig. 2*a*. The epigynum is simple externally the lateral lobes forming a notch over the middle one. The tube of the palpal organ is long and stiff, and turns one and a quarter times round the end of the palpus. Fig. 2*d*. The web is flat, in short grass, and males and females are found together there in the last of May.

Peak's Island, near Portland, Me.; Mt. Washington, N. H.; Quincy, Mass.; and Albany, N. Y.

Stemonyphantes Menge.*Stemonyphantes bucculentus* (Clerck) Thor., Syn. European Spiders.*S. trilineata* Menge.

PLATE XX, FIGURE 1.

Female, about 6^{mm} long. Color yellowish gray. Cephalothorax with a black stripe in the middle and one each side. Abdomen with three rows of black spots, more or less connected. Femur and tibia with black spots at the end and in the middle. The spots are bright-

est on the under sides of the legs. The sternum is black around the edge, and the abdomen has irregular black spots at the sides and beneath. The abdomen of the female is large and oval, slightly pointed behind. The epigynum is small, opening by deep notches at the sides of the short and wide middle lobe. The male is very much like the female, but the abdomen is smaller and the three teeth on the front of the mandibles are larger. The palpal organs are large and long, with three prominent spines at the end. Figs. 1*b*, 1*c*. The tarsal hook is flat and wide, and the forward corner of the base runs to a sharp point. The tibia is slightly widened at the end, and has several large hairs on the inner side.

This species lives under stones and logs, and I have occasionally found it under leaves in woods in winter. Salem, Mass.; Providence, R. I.; and New Haven, Conn. It is also a common European species.

Diplostyla.

Stylophora Menge.

These spiders resemble *Bathyphantes*, except in their copulatory organs. They are all small spiders, living under leaves and low plants. The tarsus of the male palpus is long and the tube of the palpal organ extends outward to its truncated tip, where the tube is coiled in a flat spiral. Pl. XX. The tarsal hook is large and curved forward. The tube is supported by several strong processes near its base, and has a soft fringed appendage near its tip. The epigynum has two large openings, between which two soft appendages project backward.

Diplostyla nigrina (Werst.) Thor.

Bathyphantes terricolus Menge.

PLATE XX, FIGURE 2.

This spider is about 2.5^{mm} long. Cephalothorax and legs yellow-brown. Abdomen black or dark gray, with five or six transverse light markings, usually in the male and sometimes in the female, broken into pairs of spots. The epigynum has long flexible processes, one from the upper and one from the under edge. The openings are at the base of these processes. Figs. 2*c*, 2*d*. The tarsus of the male palpus is truncated at the end and slightly narrowed in the middle. The tarsal hook is long and conspicuous. It is bent in a short curve at the end and is widened at the tip. The tube and one of its large appendages are twisted in a circle round the end of the tarsus,

with the ends of the soft appendages inside the circle and a stout straight appendage outside.

Mt. Washington, N. H.; Eastern Massachusetts; Providence, R. I., under leaves.

Diplostyla concolor (Reuss).

Stylophora concolor Menge.

PLATE XX, FIGURE 3.

Length about 2^{mm} in both sexes. Cephalothorax yellow-brown. Legs yellow. Abdomen dark gray or brownish. The copulatory organs are unlike any other native species. The epigynum has a long flexible process on the upper edge, extending back to the middle of the abdomen. Under the base of this process are the two holes of the epigynum, between which is another soft process more slender and half as long as the upper one. The tarsus of the male palpus is long and tapering. The tarsal hook is thickened at the base and extends half the length of the tarsus, it is curved outward at the end, and the tip is rounded and has a slight notch near the end. The tube and other appendages parallel with it curve upward from the base of the tarsus and extend in nearly a straight line to its extremity, over which this tube is twisted round in nearly a circle. The soft tips of the inner appendages are also twisted around with it.

This is common under leaves in winter. I have it from Cambridge and Salem, Mass.; Montreal, Canada; and New Haven, Conn.

Diplostyla canadensis, new.

PLATE XXI, FIGURE 1.

This species resembles *D. nigrina* but is smaller and has no markings on the abdomen. It is about 2^{mm} long. The cephalothorax and abdomen dark. Legs light yellow-brown. The male palpi are short and the palpal organ shorter than in *nigrina*. The tarsal hook is as long as in *nigrina*, but narrower at the end, one corner of which ends in a fine point. The tube is similar to that of *nigrina*.

One male from Montreal, Canada.

Drapetisca Menge.

Contains only *D. socialis*, which has long spines on the palpi and legs, the abdomen flat and wide behind with peculiar black and white markings. Pl. XXI. The male palpus has a large curved process at the base of the tarsus behind the tarsal hook. The epigynum, Fig. 2*b*, is long and not folded, and extends backward along the under side of the abdomen.

Drapetisca socialis (Sund.) Menge.

PLATE XXI, FIGURE 2.

Length, 2.5^{mm}. Cephalothorax white with black edges, a black spot in front under the eyes, and a black mark in the middle, from which indistinct dark lines radiate toward the edge. The abdomen is white with black or dark gray markings. On each side of the front of the abdomen is a distinct black stripe. In the middle is a row of irregular spots in pairs, connected together and with a middle line. The legs are white with dark rings at the end and middle of each joint; they have long spines. The under side of the body is white. The epigynum is long, widened toward the end, Fig. 2*b*, and not folded. Male with the usual differences from female. The tarsus of the male palpus has a long process curved behind it, besides the tarsal hook.

The mandibles have six teeth in front of the claw and several thick hairs at the upper part along the edge of two black marks.

Eastport, Me., on bark of spruce trees, which they closely resemble in color; Mt. Washington, in moss among highest trees; Beverly and Danvers, Mass., on bark and under leaves. It lives also in Europe. Menge found it common in Prussia on bark of spruce trees, without any web.

Helophora Menge.

Contains only *H. insignis*. The epigynum is long and straight, covered with hairs nearly to the end. The tube of the palpal organ is long and slender, supported by a short thin appendage at the end, and by a longer one which curves around the base of the palpal organ. The tarsal hook is small and the tibia has various spines and processes.

Helophora insignis (Blk.) Thor., Syn. Eur. Spiders.*Helophora pallescens* Menge.

PLATE XXI, FIGURE 3.

Length 3^{mm}. Cephalothorax and legs light yellow. Abdomen dark gray to white, without markings, or with gray stripes at the sides across the back. The cephalothorax is twice as wide across the middle as at the head. Legs without markings. Epigynum long and straight, reaching to the middle of the abdomen, with openings at the end, Fig. 3*b*, the tubes inside showing indistinctly through the skin. The palpal organ has a long curved tube, supported by a short thin appendage at the end, and both are nearly surrounded by a long thin appendage, under the end of which is a soft finger-like process.

The tarsal hook has two hard points near where it touches the tibia, one of which is curved outward. The tibia has just behind the tarsal hook three strong bristles, each of which is raised on a rounded process.

Beverly, Mass., in low bushes.

Bathyphantes Menge.

Including *Lepthyphantes* Menge.

This genus includes most of the small species of the old genus *Linyphia*. I do not see why the two species of *Lepthyphantes* should be separated from *Bathyphantes*, as they differ but little except in size. The abdomen in this genus is oval and high in front and pointed behind. The colors are usually gray and black, in transverse stripes or pairs of long spots, but some species have bright yellow or orange on the head and legs. The epigynum in this genus is long and folded, so that the end with the opening is partly concealed under the outer fold. This may be seen with the naked eye in the larger species. The male palpi have the tarsal hook very large and of complicated shapes. The tube of the palpal organ itself is short and thick, and usually hard to distinguish from the large appendages by which it is surrounded. The legs are long and slender, and the spines large and distinct. In the latter characters it differs from *Microneta*.

Bathyphantes minuta (Blk.) Thor., Syn. European Spiders.

Lepthyphantes muscicola Menge.

PLATE XXI, FIGURE 4.

This is 3^{mm} long, a little smaller than *nebulosa*. The cephalothorax is yellowish brown, darker at the edges but without any middle line. The dark markings on the abdomen nearly cover it, so that it appears dark gray with transverse light markings, or three or four pairs of white spots. The legs are light brownish yellow with dark rings on the ends and middle of the tibiae and femora. The epigynum is folded twice and when extended is as long as the abdomen. The palpal organ has the same long thin appendage, toothed at the end, as in *nebulosa*, and the swollen tube is plainly seen at its side. Fig. 4a. The tarsal hook is very large and has a narrow tip. At the base of the tarsal hook is a prominent ridge on the tarsus, and the tarsus has on the outer side, at the base, a conical point without hairs and roughened with short ridges. Fig. 4, x.

It lives in cellars and similar places, sometimes in company with *nebulosa*. Salem, Cambridge, and Beverly, Mass.

Bathyphantes nebulosa (Sund.) Thor., Syn. Eur. Spiders.*Lephyphantes crypticola* Menge.

PLATE XXII, FIGURE 1.

Perhaps *Linyphia autumnalis* Hentz. Length 4^{mm}. Color light brownish yellow with gray or blackish markings. Some specimens are almost white, others are very dark with the black spots covering a large part of the body. The cephalothorax has a forked dark stripe along the middle and dark stripes near the edge on each side. The abdomen has six or seven pairs of irregular dark spots more or less connected with a dark central line. The under side of the abdomen and sternum have black spots which in dark individuals are run together, making these parts entirely black. The legs have dark rings on the ends and middle of the femora and tibiae. The spines on the legs are long and darker yellow than the skin. The epigynum is folded twice over the middle lobe of the end, with its opening just visible beyond the outer fold. Fig. 2c. The palpal organ is one of the most complicated in the family, though the parts are folded together so closely that only the outer long appendage with a toothed end and the tips of the inner parts are visible. I have figured the palpus of this species, with the parts separated by pressure, in the reprint of Hentz's Araneides of the United States, under the name of *Linyphia autumnalis* Hentz. The tarsal hook is large and complicated, and the tibia has a hard process grooved and toothed at the end. (Fig. 1d.) I have found this spider in cellars and other damp and shady places about houses, with flat webs, under which they stood near the edge or corner. I have compared several European specimens and believe this to be the same as *Lephyphantes crypticola* Menge. This species is perhaps imported.

Salem and Cambridge, Mass., and Albany, N. Y.

Bathyphantes zebra, new.

PLATE XXII, FIGURE 2.

Length; 2^{mm}. Cephalothorax bright yellow-brown, with indistinct gray stripes in the middle and at the sides, and very black around the eyes. The abdomen is crossed above by five or six gray and whitish stripes, with scattered silvery white spots. Below, the thorax and abdomen are both dark gray. All the parts of the palpal organ are twisted across it. The tarsal hook has a very characteristic shape too complicated to describe. Fig. 2. The epigynum is short and wide, folded under except the tip. Fig. 2a. This is very near and possibly identical with *B. zebrius* Menge.

I have this from many places in Eastern Massachusetts and from New Haven, Conn., under leaves in woods.

Bathyphantes subalpina, *new*.

PLATE XXII, FIGURE 3.

Length, 2^{mm}. My specimen has been dried and kept for a long time in alcohol, so that the colors are darkened. The cephalothorax and legs were evidently light brownish yellow, and the abdomen whitish above, with five or six pairs of transverse black spots. The under side of the abdomen and the sternum are black. The male palpi are large. The patella has a large bristle on the upper side. The tarsal hook is wide and turned up at the end. Fig. 3. The long appendage of the palpal organ has a sharp bend at the part over the tibia and turns upward, covering a large part of the organ. This resembles *B. alpina*, but is larger and the hair on the patella and the three slits in the palpal organ are smaller.

Mt. Adams, White Mountains, N. H.

Bathyphantes alpina, *new*.

PLATE XXII, FIGURE 4.

About 2.5^{mm} long. The colors are bright. Cephalothorax light brownish yellow, slightly darker at the edges. Legs and palpi light yellow. Abdomen whitish above, with a black or dark band each side, irregularly scalloped on the inner edge. On the front of the abdomen is a dark median line, and behind it four or five pairs of black spots that do not extend quite to the tip. On the under side the abdomen is black, this color extending round the spinnerets. The sternum is also black. The epigynum is large and extends beyond the surface of the abdomen. The folded portion is small and narrow. Figs. 4*b*, 4*c*. The male palpi are short and light colored. The tibia is short and wide, with various short processes on the edge. The tarsal hook is wide at the base and curves outward. The tip is flat and widened, and below it are three or four blunt teeth. On the patella is a long serrated spine. The largest appendage of the palpal organ is wide and divided into three teeth at the end; it folds around the base of the palpal organ, and extends upward nearly to the end of the tarsus.

Mt. Washington; N. H., from Hermit Lake up to the highest trees.

Bathyphantes angulata, new.

PLATE XXII, FIGURE 5.

Length, 1^{mm}. Color dull gray, slightly tinged with yellow on the cephalothorax and legs. Palpal organ brownish. The tarsus of the male palpus has a prominent angle on the upper side and a short spur at the base where it overlaps the tibia. The tarsal hook is flat as in *B. micaria*, which this species much resembles in its palpal characters. I do not know the females.

Mt. Carmel, Hamden, Conn., and Mill Rock, New Haven.

Bathyphantes formica, new.

PLATE XXII, FIGURE 7.

This species resembles *B. micaria*, but is larger and darker colored. The male is 2^{mm} long. The cephalothorax is about two-thirds as wide as long. The front of the head is nearly as wide as the widest part of the thorax. The abdomen is long and narrow and slightly constricted in the middle. The cephalothorax, palpi, sternum and femora are dark brown. The two basal joints of all the legs are white and the rest of the legs beyond the femur light yellow. The abdomen is black above and below. The femora of the palpi have stout strong spines near the outer end, three on the outer side and two on the inner. Figs. 7, 7b. The tibia is short and wide and very irregular in shape. The tarsus is angular. The tarsal hook is flat as in *micaria*. Fig. 7a.

Adult male, on a fence at New Haven, Conn., May, 1882, and young males in the same place in October.

Bathyphantes micaria, new.

PLATE XXII, FIGURE 6.

Length, 1.5^{mm}. Legs long, the front pair twice as long as the body. Cephalothorax wide in front, yellow-brown, darkened at the sides with gray, black around the eyes. Abdomen long and narrow, whitish, with a transverse gray mark in front and two pairs of oblique gray stripes at the sides, grayish underneath. The legs are light yellow and grayish at the ends of the joints. The tarsus of the male palpus is angular, and has a sharp process half way between the most prominent corner and the tibia. The tarsal hook is flat and wide, with a thin sharp point. Fig. 6.

On fences in October, at New Haven, Conn. One adult male and several young.

Bathyphantes complicata, new.

PLATE XXIV, FIGURE 8.

Length, 1.2^{mm}. Cephalothorax and legs light orange. Abdomen gray. The most distinctive mark of this species is the complicated tarsal hook. Fig. 8. This has a short tooth in the upper and another in the lower side of the bend, and at the end has an oblique groove that makes it appear twisted. The palpal organ is also complicated, one long thin appendage bends around its base and extends nearly to its tip, where it meets the end of the tube which is short and thick.

Half way up Mt. Washington, N. H.

Bathyphantes bihamata, new.

PLATE XXIII, FIGURE 4.

Length, 1.5^{mm}. My specimen has been dried, so that the colors are not natural, but the cephalothorax appears to have been dark yellowish gray, the legs yellow, and the abdomen dark with indistinct light spots. The legs are long with some long spines. The male palpi are large. At the base of the the tarsus, near the tarsal hook, is a small process resembling the spur in several species of *Microneta*. The tarsal hook is large and bent around in a half circle. It has two small, thin teeth on the outer side. Fig. 4.

Lower part of Mt. Washington, N. H.

Bolyphantes (Koch.) Menge.

The following species belongs to this genus, as limited by Menge. The body is long and slender in both sexes. Menge figures the epigynum as folded or three-lobed, but this does not show in my specimens, which are probably immature. The male palpi have a large process on the tibia, which fits against the hinder edge of the tarsus, and has at its base a hollow into which fits the long spur of the tarsal hook, which extends backward nearly to the patella. The tube of the palpal organ is long and slender, but partly concealed by the long appendages over it. The heads of the males are high, and in some species with a distinct hump.

Bolyphantes drassoides, new.

PLATE XXIII, FIGURE 5.

Length, 1.8^{mm}. Abdomen long and straight. Cephalothorax and legs light yellow. Abdomen whitish with gray markings, a median

gray line on the front, extending half the length of the abdomen, beyond the end of which are two or three transverse pale gray markings, and another distinct one just over the spinnerets, extending nearly round them. Beneath are two longitudinal gray bands. The abdomen is covered* with long hairs which do not obscure the markings. The head of the male has a crest of stiff hairs just behind the eyes, the front one much larger than the others, and curving forward over the head. There is a slight hump on the head, which raises the bases of these hairs half their length above the eyes. Fig. 5. The epigynum is large and extends outward from the abdomen. The palpi of the male are very complicated. The tibia has a long process which bends round against the hinder edge of the tarsus. Fig. 5a. The tarsal hook has a long curved tooth that extends backward nearly to the base of the tibia, and a shorter tooth parallel to it nearer the base. The tube is long and slender, curving once round the palpal organ and nearly hidden by the other appendages.

Mt. Carmel, Hamden, Conn., under leaves in October.

Microneta Menge.

This group differs but little from *Bathypantes* on one side and *Tmeticus* on the other. The body is longer and lower than in *Bathypantes* and the legs shorter and stouter, as in *Tmeticus*. The colors are oftener brown than in that genus, and there are no distinct markings. The palpal organs are like *Bathypantes*. The tarsus usually has a spur at the base, which in some species extends backward over the tibia. Pl. XXIII. The tarsal hook is large and varies in shape according to the species. The tube is short and thick, with the same complicated appendages as in *Bathypantes*. The epigynum is also folded as in *Bathypantes*. Menge's genus *Microneta* consists almost entirely of these spiders, but other species are included in his genera *Micryphantes* and *Bathypantes*.

Microneta viaria.

Erigone viaria Camb., Proc. Zool. Soc. London, 1875.

Neriene viaria Blk.

Microneta quisquiliarum Menge.

PLATE XXIII, FIGURE 1.

This is one of the most common spiders under leaves in woods. Specimens from my collection were identified by Cambridge in 1875. It is 2^{mm} to 2.5^{mm} long. Cephalothorax and legs brownish yellow. Abdomen gray or brownish, darker than the thorax. The epigynum

is folded under so that only the end shows beyond the outer hairy portion. The tarsus of the male palpus has a short spur at the base. The tarsal hook is short and curved outward. Fig. 1, *ii*. The tube of the palpal organ is very large with two smaller appendages near its base. Fig. 1*a*, *r*.

Mt. Washington, N. H.; Montreal, Canada; Eastern Massachusetts; New Haven, Conn.; also common in Europe.

Microneta cornupalpis.

Erigone cornupalpis Camb., Proc. Zool. Soc. London, 1874.

PLATE XXIII, FIGURE 2.

Length, 2^{mm} in both sexes. Legs and cephalothorax brownish yellow. Abdomen dark gray. The basal part of the epigynum is two-lobed, and the narrow terminal finger extends between and below them. Fig. 2*b*. The tarsus of the male palpus has a long, slightly curved spur about as long as the rest of the tarsus. The tarsal hook has two teeth curved outward at the end, the upper one bilobed. Fig. 2, *ii*.

Waltham and Milton, Mass., under leaves; New Haven, Conn.

Microneta persoluta.

Erigone persoluta Camb., Proc. Zool. Soc. London.

PLATE XXIII, FIGURE 3.

Males about 1.5^{mm} long, some a little larger and others smaller. Cephalothorax and legs light brownish yellow, blackish between the eyes. Females collected at the same time and apparently the same species are considerably smaller, little over 1^{mm} long. The colors are the same in both sexes. The abdomen is dark gray with several pairs of indistinct light spots on the hinder part. The epigynum in my specimens is perhaps immature. Fig. 3*b*. It has a narrow finger in the middle, on each side of which is an oval, smooth brown spot. The palpus of the male has a short and small tibia. The tarsal hook is large, turning outward at the end without any sharp teeth. The tarsus has a short curved spur at the base. The basal part of the palpal organ, Fig. 3*a*, *x*, is curved half round the tarsus and colored dark brown. The appendages of the palpal organ, including the tube, are small and crowded together on the inner side.

Mt. Washington, N. H.; and Beverly, Lynn and Saugus, Mass.

Microneta discolor, new.

PLATE XXIV, FIGURE 1.

Length, 2.5^{mm} to 3^{mm}. Males larger than females. Cephalothorax and legs orange-brown. Abdomen whitish below and brownish gray above, darker toward the front. In some specimens the dark stripe on the back is very distinct. The mandibles of the male, Fig. 1, are larger and darker than those of the females and have a large tooth on the front inner corner. The tarsal hook of the male palpus is large and has a narrow point turned back nearly to the base. Fig. 1b. The epigynum is small and light colored, showing the inner tubes plainly through the skin. Fig. 1a.

Waltham, Mass., and New Haven, Conn., under leaves in winter.

Microneta quinquedentata, new.

PLATE XXIV, FIGURE 2.

Length, 2.5^{mm} to 3^{mm}. Legs and cephalothorax brownish yellow, cephalothorax with dark edges. Abdomen dark gray. A slightly larger and darker species than *viaria*. The upper fold of the epigynum is narrowed toward the end and transversely wrinkled like the hook of the epigynum of some *Epeira*. Fig. 2b. The male palpus has the tarsal hook wide and blunt with a curved ridge on which is a row of teeth. Fig. 2. The most characteristic part of the palpal organ is a row of five short teeth on the middle. Fig. 2a. Under this is the large, dark brown part, with a sharp spine directed forward and two blunt spines toward the base. The inflated tube lies between this and the tarsal hook.

Montreal, Canada; Mt. Washington, N. H.; Beverly, Swampscott and Quincy, Mass.

Microneta crassimanus, new.

PLATE XXIV, FIGURE 3.

Length, about 3^{mm}. Cephalothorax and legs light orange-brown. Abdomen gray. The eyes are small, and the head twice as wide as the eye-area and rounded in front. The femora of all the legs are stout. The tarsus of the male palpus has a prominent process on the edge just over the tarsal hook. The tibia is unusually thick and without any hook. The tarsal hook is large and strongly curved, the end is flat and wide, and divided into two teeth, one twice as large as the other. Over the hook is the end of a large appendage of the palpal organ fringed with fine teeth.

Hermit Lake, Mt. Washington, N. H.

Microneta latidens, new.

PLATE XXIV, FIGURE 4.

Length, 2^{mm} to 2.5^{mm}. Cephalothorax and legs light yellow-brown, or slightly reddish in dark-colored specimens in alcohol. Abdomen light gray, darkest toward the end. The tarsus of the male palpus is wide and angular at the base. The tarsal hook is as wide at the base as half the length of the tarsus. It turns outward at the end and has a deep bend with a sharp hook extending forward. Fig. 4. The palpal organ is small.

New Haven, Conn., in several places under leaves in winter.

Microneta furcata, new.

PLATE XXIV, FIGURE 5.

Length, 1.5^{mm}. Cephalothorax and legs yellow-brown, abdomen gray. The tibia of the male palpus is short and wide. The tarsal hook is wide at the base and deeply curved. It has a ridge on the outer end. One of the appendages of the palpal organ, with two sharp black points near the end, curves round its base near the end of the tarsal hook. The end of the palpal organ is much as in *longibulbus*.

White Mountains, N. H., on the ridge between Mt. Washington and Mt. Clay.

Microneta longibulbus, new.

PLATE XXIV, FIGURE 6.

Length, 2^{mm}. Cephalothorax and legs dull brownish yellow. Abdomen gray. The palpal organ extends back to the tibia, where its narrow end curves around toward the tarsal hook. Fig. 6a. Over the middle of the palpal organ is a small black process with a flat end, and at the top are two small hooked appendages. Fig. 6a. The tarsal hook is wide at the base and deeply curved. The end has an irregular ridge on the outer side. The tibia is short and as wide as long.

Milton, Mass., under leaves in winter.

Microneta olivacea, new.

PLATE XXIV, FIGURE 7.

Length, nearly 2^{mm}. Cephalothorax yellowish gray, darkest at the edges and in the front of the head. Abdomen darker gray, yellowish in front. Cephalothorax almost as wide as long, but the head is narrow and eyes close together. Legs and palpi pale. The tarsus of the male palpus is large and angular. When the palpi are curved downward in a natural position, a sharp corner of the tarsus is directed forward, and the inner sides are nearly flat and parallel. The tarsal hook is blunt with a short and wide tooth near the end. Fig. 7. The palpal organ is large and complicated. Over the tarsal hook is a hard appendage with two teeth.

Two males from the upper part of Mt. Washington, N. H., between it and Mt. Clay.

EXPLANATION OF PLATES.

PLATE I.

1. *Theridium differens*, dorsal markings of female $\times 8$; 1a, male $\times 8$; 1b, male palpus; τ , the tube; x , soft terminal appendage; y , hard roughened corner of the palpal organ; 1c, epigynum, outer side, showing no openings; 1d, epigynum made transparent, showing the openings xx on the under side, the spermathecae ss , the long tubes yy leading to the outer openings, and the short tubes leading to the oviduct.

2. *Theridium spirale*, dorsal markings of female $\times 8$; 2a, dorsal markings of male $\times 8$; 2b, male palpus; τ , the long tube; 2c, epigynum, showing the openings outside; 2d, epigynum made transparent, showing the spermathecae ss , the long tubes yy , and the short tubes zz .

3. *Theridium montanum*, dorsal markings of female $\times 8$; 3a, dorsal markings of male $\times 8$; 3b, male palpus, the hard toothed appendage of the palpal organ at the right; 3c, epigynum, showing the single hole in the middle and a hard depression each side.

4. *Theridium zelotypum*, dorsal markings of female $\times 8$; 4a, epigynum with a single opening and short tubes to the spermathecae.

5. *Theridium murarium*, dorsal markings of female $\times 8$; 5a, male palpus; τ , the tube. At the left of the tube is a hard tooth.

6. *Theridium puncto-sparsum*, dorsal markings of female $\times 8$; 6a, epigynum with a single opening partly divided at the hind edge.

PLATE II.

1. *Theridium tepidariorum* C. Koch, abdomen of female $\times 8$; 1a, male palpus; 1b, epigynum with a single opening partly divided at the forward edge.

2. *Theridium rupicola*, abdomen of female $\times 8$; 2a, male palpus; 2b, epigynum from below, showing a single opening covered by a horny ridge; 2c, epigynum from the right side.

3. *Theridium globosum* Hentz, side of female $\times 8$.

4. *Theridium unimaculatum*, side of female $\times 8$; 4a, male palpus; 4b, epigynum, showing a single opening near the edge, and the internal parts indistinctly through the skin.

5. *Theridium sexpunctatum*, dorsal markings of female $\times 8$; 5a, mandibles of male; 5b, male palpus; 5c, epigynum with a single large opening, through which the openings of the two tubes show indistinctly.

PLATE III.

1. *Theridium frondeum* Hentz, 1a to 1f, dorsal markings of females $\times 4$; 1g, cephalothorax of male $\times 8$, showing form of head and mandibles; 1g, male palpus; 1h, epigynum, showing the single opening directed forward.

2 and 2a. *Theridium lineatum*, dorsal and ventral markings of female $\times 4$.

3. *Mimetus intersector* Hentz, female $\times 4$; 3a, head; 3b, epigynum.

4. *Mimetes epeiroides*, dorsal markings of male $\times 4$; 4a, tarsus of male palpus; 4b, palpal organ, twisted to the right by contraction in alcohol.

5. *Ero variegata*, side of female $\times 8$; 5a, dorsal markings of female $\times 8$; 5b and 5c, male palpus; 5d, epigynum.

6. *Steatoda triangulosa*, dorsal markings of female $\times 6$; 6a, male palpus.

PLATE IV.

1. *Steatoda borealis*, dorsal markings of female $\times 4$; 1a and 1b, male palpus; 1c, eyes of female; 1d, epigynum.

2. *Steatoda guttata*, dorsal markings of female $\times 8$; 2b, male palpus.

3. *Steatoda marmorata*, 3 and 3a, dorsal markings of two varieties; 3b, eyes of male; 3c, male palpus; 3d, epigynum; 3e, ends of mandibles of female; 3f, end of mandible of male.

4. *Steatoda nigra*, head of female $\times 16$; 4a, epigynum with small central opening; 4b, male palpus.

5. *Steatoda corollata*, dorsal markings of female $\times 4$; 5a, eyes of female; 5b, epigynum.

6. *Asagena americana* Keys, dorsal markings of female $\times 8$; 6a, head of male; 6b, under side of sternum and femora of male; 6c, male palpus.

PLATE V.

1. *Argyrodes trigonum*, side of female; 1a, tip of abdomen seen from above; 1b, cephalothorax from above; 1c, side of cephalothorax of male; 1d, male palpus; 1e, egg-cocoon.

2. *Argyrodes ficitilium*, side of female; 2a, cephalothorax from above.

3. *Theridula sphaerula*, female $\times 8$; 3a, 3b, male palpus.

4. *Lasæola cancellata*, female $\times 20$; 4a, side of female $\times 20$.

5. *Euryopsis argentea*, dorsal markings of young female $\times 20$.

6. *Euryopsis funebris*, female $\times 4$; 6a, head of male; 6b, male palpus.

7. *Spintharus flavidus*, female $\times 4$.

PLATE VI.

1. *Utesanis americana*, side of female $\times 20$; 1a, female from above; 1b, side of male; 1c, cephalothorax of female; 1d, sternum of female; 1e, side of cephalothorax of female; 1f, 1g, male palpus.

2. *Pholcus phalangioides*, female and male natural size, and cephalothorax of female enlarged; 2a, palpus of male.

3. *Spermophora meridionalis*, cephalothorax of female enlarged.

4. *Scytodes thoracica*, cephalothorax of female; 4a, palpus of male.

5. *Pholcomma rostrata*, male; 5a, 5b, male palpus.

6. *Pholcomma hirsuta*, male; 6a, mandibles of female; 6b, sternum; 6c, 6d, epigynum; 6e, 6f, 6g, male palpus.

PLATE VII.

1. *Ceratinella emertoni*, side of male; 1a, 1b, male palpus; τ , the tube; Π , tarsal hook; *tib.*, tibia with tibial hook; 1c, tibial and tarsal hooks seen from above; 1d, epigynum.

2. *Ceratinella fissiceps*; 2, 2a, 2b, side of cephalothorax of male, showing variation in shape of the head; 2c, male palpus; Π , tarsal hook; *tib.*, tibial hook seen edgewise; 2d, palpal organ; 2e, tibial hook; 2f, epigynum.

3. *Ceratinella bulbosa*, side of male; 3a, cephalothorax of male from above; 3b palpal organ; 3c, tibial hook.

4. *Ceratinella pygmæa*, side of male; 4a, 4b, 4c, male palpus.

5. *Ceratinella atriceps*, side of male; 5a, side of cephalothorax of female; 5b, 5c, male palpus; 5d, epigynum.

PLATE VIII.

1. *Ceratinella leta*, side of male; 1a, 1b, male palpus; 1c, tube of palpal organ; 1d, epigynum.

2. *Ceratinella letabilis*, side of male: 2a, 2b, male palpus; 2c, tube of palpal organ; 2d, epigynum.

3. *Ceratinella brunnea*, male palpus; 3a, bend of tube of palpal organ; 3b, epigynum.

4. *Ceratinella minuta*; 4, 4a, male palpus; 4b, epigynum.

5. *Ceratinella micropalpis*, male palpus.

6. *Cornicularia auranticeps*, head of male seen from in front, showing horn, eyes, and top of palpi; 6a, side of head of male; 6b, tibia and tarsus of male palpus; 6c, male palpus, showing palpal organ; 6d, epigynum.

7. *Cornicularia claricornis*, side of cephalothorax of male; 7a, tarsus of male palpus; 7b, male palpus, showing palpal organ.

PLATE IX.

1. *Ceratinopsis interpres*, side of cephalothorax of male; 1a, eyes of male; 1b, head of male from the side; 1c, end of mandible of male; 1d, 1e, male palpus; 1f, tibial and tarsal hooks; 1g, epigynum.

2. *Ceratinopsis nigriceps*, head of female from above; 2a, 2b, male palpi; 2c, tibial and tarsal hooks; 2d, epigynum.

3. *Ceratinopsis laticeps*, male from above; 3a, cephalothorax of male from the side; 3b, 3c, male palpi.

4. *Ceratinopsis nigripalpis*; 4, side of male; 4a, 4b, 4c, male palpi.

PLATE X.

1. *Lophomma cristatum*, side of cephalothorax of male; 1a, male palpus, showing palpal organ; 1b, tibia and tarsus of male palpus.

2. *Lophomma elongatum*, side of cephalothorax of male; 2a, top of cephalothorax of male; 2b, head of male from in front; 2c, 2d, male palpus.

3. *Grammonota ornata*, side of cephalothorax of male; 3a, dorsal markings of abdomen; 3b, male palpus; 3c, tibial and tarsal hooks.

4. *Grammonota pictilis*, side of cephalothorax of male; 4a, abdomen, showing dorsal markings; 4b, male palpus, showing coiled tube near the top; 4c, tibial and tarsal hooks; 4d, epigynum and soft process in front of it; 4e, internal parts of epigynum, the tube *x* from the outer opening twists around twice to the point *z*, where it turns abruptly backward and makes two turns between the first back to the spermatheca *s*.

5. *Grammonota inornata*, cephalothorax of male; 5a, 5b, male palpus.

6. *Spiropalpus spiralis*, side of cephalothorax of male; 6a, male palpus, showing palpal organ; 6b, tibia and tarsus of male palpus; 6c, epigynum; 6d, abdomen of male, showing indistinct dorsal markings.

PLATE XI.

1. *Cornicularia directa*, side of male; 1a, side of head of male; 1b, top of head of male; 1c, tibial hook.
2. *Cornicularia tibialis*, side of cephalothorax of male; 2a, 2b, 2c, tibia and tarsus of male palpus.
3. *Cornicularia communis*, side of head of male; 3a, top of head of male; 3b, epigynum.
4. *Cornicularia indirecta*, side of head of male; 4a, top of head of male; 4b, epigynum.
5. *Cornicularia brevicornis*, side of head of male; 5a, tibial and tarsal hooks.
6. *Cornicularia minuta*, side of cephalothorax of male; 6a, front of head; 6b, top of head; 6c, male palpus; 6d, tibia and tarsus of male palpus.
7. *Cornicularia pallida*, side of head of male; 7a, tibia and tarsus of male palpus.
8. *Cornicularia tricornis*, top of head of male; 8a, side of head of male; 8b, tibia of male palpus.

PLATE XII.

1. *Lophocarenum castaneum*, cephalothorax of male; 1a, front of head of male; 1b, side of cephalothorax; 1c, male palpus; 1d, palpal organ; 1e, tibia of male palpus.
2. *Lophocarenum montanum*, side of cephalothorax of male; 2a, top of cephalothorax; 2b, front of head and palpi; 2c, front of head and mandibles of male; 2d, top of cephalothorax of female; 2e, front of head and mandibles of female; 2f, tibial hook; 2g, epigynum.
3. *Lophocarenum florens*, front of head of male; 3a, side of cephalothorax of male; 3b, top of head of female; 3c, side of head of female; 3d, 3e, male palpus; 3f, epigynum.
4. *Lophocarenum decemoculatum*, side of cephalothorax of male; 4a, front of head; 4b, tibia and tarsus of male palpus; 4c, palpal organ.

PLATE XIII.

1. *Lophocarenum spiniferum*, back of male; 1a, side of male; 1b, side of cephalothorax of female; 1c, back of cephalothorax of female; 1d, male palpus, showing inner side; at the top is the long stiff tube, below at the left, the tibial hook; 1e, male palpus, showing tarsal and tibial hooks; 1f, ventral side of epigynum; 1g, rear view of epigynum.
2. *Lophocarenum montiferum*, side of cephalothorax of male; 2a, top of cephalothorax of male; 2b, tibia of male palpus; 2c, 2d, cephalothorax of female; 2e, epigynum; 2f, palpal organ.
3. *Lophocarenum quadricristatum*, cephalothorax of male from above; 3a, head of male; 3b, side of head of male; 3c, tibia of male palpus; 3d, male palpus.
4. *Lophocarenum longitarsus*, back of cephalothorax of male; 4a, side of cephalothorax of male; 4b, mandibles of male; 4c, 4d, male palpus.
5. *Lophocarenum pallidum*, side of male; 5a, front of head; 5b, tibia and tarsal hook; 5c, tarsal hook from the side; 5d, palpal organ.
6. *Lophocarenum longitubus*, top of cephalothorax of male; 6a, side of cephalothorax of male; 6b, 6c, palpus of male.

PLATE XIV.

1. *Lophocarenum rostratum*, top of cephalothorax of male; 1a, side of cephalothorax of male; 1b, 1c, cephalothorax of female; 1d, tibia and tarsus of male palpus; 1e, palpal organ.

2. *Lophocarenum scopuliferum*, side of male; 2a, 2b, cephalothorax of female; 2c, male from above; 2d, 2e, 2f, male palpus.
3. *Lophocarenum erigonoides*, side of male; 3a, top of cephalothorax of male; 3b, palpal organ; 3c, tibia and tarsus of male palpus.
4. *Lophocarenum brevis*, top of cephalothorax of male; 4a, side of cephalothorax of male; 4b, tibia of male palpus; 4c, palpal organ.
5. *Lophocarenum simplex*, side of cephalothorax of male; 5a, top of cephalothorax of male; 5c, 5d, male palpus; 5e, tibia and tarsus of male palpus.
6. *Lophocarenum depressum*, side of cephalothorax of male; 6a, front of head; 6b, 6c, tibia of male palpus; 6d, palpal organ.
7. *Lophocarenum crenatum*, back of male; 7a, side of cephalothorax of male; 7b, palpal organ; 7c, tibia and tarsus of male palpus; 7d, epigynum; 7e, side of cephalothorax of female.
8. *Lophocarenum vernale*, side of cephalothorax of male; 8a, 8b, male palpus; 8c, epigynum; 8d, tibia of male palpus.

PLATE XV.

1. *Tmeticus probatus*, tibia and tarsus of male palpus; 1a, tibia, tarsal hook, and palpal organ; 1b, mandible of male; 1c, top of cephalothorax of female; 1d, epigynum.
2. *Tmeticus tridentatus*, side of cephalothorax of male; 2a, mandible of male; 2b, mandible of female; 2c, male palpus; 2d, tibia of male palpus from above; 2e, palpal organ; 2f, epigynum.
3. *Tmeticus plumosus*, male palpus, showing tarsal hook and feathered appendage of palpal organ; 3a, tibia and tarsus of male palpus; 3b, palpal organ.
4. *Tmeticus trilobatus*, mandible of male; 4a, mandible of female; 4b, epigynum; 4c, 4d, 4e, male palpus.
5. *Tmeticus contortus*, 5, 5a, male palpus.

PLATE XVI.

1. *Tmeticus longisetosus*, side of male; 1a, front of head and mandibles; 1b, tibia and tarsus of male palpus, at the left the tarsal hook with long bristles; 1c, 1d, male palpus.
2. *Tmeticus pertinens*, 2, 2a, male palpus.
3. *Tmeticus montanus*, male palpus, showing tarsal hook and palpal organ; 3a, tibia and tarsus of male palpus; 3b, male palpus.
4. *Tmeticus pallidus*, maxillae and mandibles from below; 4a, male palpus from below; 4b, tibia of male palpus; 4c, epigynum.
5. *Tmeticus marinus*, male palpus.
6. *Tmeticus tibialis*, 6, 6a, male palpus.

PLATE XVII.

1. *Tmeticus bostoniensis*, male palpus. The shaded appendage just above the tibia is the tarsal hook.
2. *Tmeticus bidentatus*, male palpus, showing tibia and tarsal hook.
3. *Tmeticus concavus*, male palpus.
4. *Tmeticus microtarsus*, 4, 4a, male palpus.
5. *Tmeticus truncatus*, tibia and tarsus of male palpus; 5a, palpal organ.
6. *Tmeticus terrestris*, male palpus.
7. *Tmeticus brunneus*, male palpus.

8. *Erigone autumnalis*, side of cephalothorax of male; 8a, mandibles, maxillæ, and sternum of male; 8b, palpus of male; 8c, epigynum.

9. *Erigone longipalpis*, side of male: 9a, palpus of male, showing palpal organ; 9b, epigynum; 9c, mandible and maxilla of female; 9d, mandible and maxilla of male.

10. *Erigone longipalpis*, male of another variety; 10c, palpus of same; 10a, cephalothorax from above; 10a. palpus of another male from Danvers, Mass.

PLATE XVIII.

1. *Linyphia marginata*, dorsal markings of female $\times 8$; 1a, head of female from above; 1b, front of head and mandibles of female; 1c, top of head of male; 1d, front of head and mandibles of male; 1e, maxillæ of female; 1f, epigynum; 1g, male palpus; 1h, end of palpal organ, showing the tube T, the large twisted appendage and two soft appendages; 1j, the tarsal hook.

2. *Linyphia communis*, dorsal markings of female $\times 8$; 2a, side of male; 2b, front of head and mandibles of male; 2c, front of head and mandibles of female; 2d, 2e, male palpus; 2f, epigynum.

3. *Linyphia clathrata*, markings of abdomen; 3a, front of head and mandibles of female; 3b, male palpus; 3c, largest appendage of palpal organ; 3d, epigynum.

PLATE XIX.

1. *Linyphia phrygiana*, dorsal markings of abdomen $\times 8$; 1a, head of male; 1b, head of female; 1c, mandible of female; 1d, mandible of male; 1e, male palpus; 1f, palpal organ; 1g, tarsal hook; 1h, epigynum.

2. *Linyphia mandibulata*, dorsal markings of female; 2a, front of mandibles of male; 2b, side of cephalothorax of male; 2c, epigynum; 2d, male palpus; H, the tarsal hook.

PLATE XX.

1. *Stemonyphantes trilineata*, dorsal markings of abdomen; 1a, mandible of female; 1b, 1c, male palpus; 1d, epigynum.

2. *Diplostyla nigrina*, dorsal markings of abdomen; 2a, male palpus; H, tarsal hook; T, end of tube of the palpal organ; 2b, palpal organ; T, the tube with soft appendages inside the coil; a, b, hard supporting appendages; H, the tarsal hook; 2c, epigynum from ventral side; c, c, openings; 2d, same from the side; a, outer, and b, inner soft appendages.

3. *Diplostyla concolor*, male palpus; T, the tube; 3a, male palpus from the side; T, the tube; H, tarsal hook; 3b, side of epigynum; a, b, soft appendages; 3c, epigynum from ventral side; a, outer soft appendage; c, c, openings.

PLATE XXI.

1. *Diplostyla canadensis*, male palpus.

2. *Drapetisca socialis*, dorsal markings of abdomen $\times 8$; 2a, front of head, mandibles, and palpi of female; 2b, epigynum; 2c, base of tarsus, showing at the left a curved process, and at the right the tarsal hook H.

3. *Helophora pallescens*, male palpus; 3a, tibia and tarsal hook; 3b, epigynum.

4. *Bathyphantes minuta*, male palpus; H, the tarsal hook; x, roughened corner of tarsus; 4b, epigynum from ventral side; 4c, side of epigynum partly unfolded.

PLATE XXII.

1. *Bathyphantes nebulosa*, dorsal markings of abdomen $\times 8$; 1a, mandible; 1b, side of epigynum; 1c, ventral view of epigynum; 1d, male palpus.
2. *Bathyphantes zebra*, male palpus; 2a, epigynum.
3. *Bathyphantes sub-alpina*, male palpus.
4. *Bathyphantes alpina*, male palpus; y, long, split appendage of palpal organ; x, spine on patella; 4a, male palpus; H, tarsal hook; 4b, epigynum, outside; 4c, epigynum, inner side.
5. *Bathyphantes angulata*, male palpus.
6. *Bathyphantes micaria*, male palpus.
7. *Bathyphantes formica*, male palpus; 7a, palpal organ; 7b, femur of male palpus, showing teeth on both sides.

PLATE XXIII.

1. *Microneta viaria*, male palpus; T, the tube; H, tarsal hook; 1a, male palpus, from inner side; T, the tube; x, spur at base of tarsus; 1b, epigynum folded up.
2. *Microneta coruipalpis*, male palpus; x, spur of the tarsus; H, tarsal hook; 2a, tarsus from above; 2b, epigynum.
3. *Microneta persoluta*, tarsus of male palpus; x, spur; 3a, palpal organ; H, tarsal hook; x, bulb of the palpal organ; 3b, epigynum.
4. *Bathyphantes bilamata*, male palpus.
5. *Bathyphantes drassoides*, side of male; 5a, tibia and tarsus of male palpus; H, tarsal hook; 5b, palpal organ; T, base of the tube; H, tarsal hook.
6. *Goniatium rubens*, side of male cephalothorax, front leg, and palpus; 6a, male palpus; T, the tube; x, process of tibia; 6b, palpus seen from in front, in natural position; 6c, epigynum.

PLATE XXIV.

1. *Microneta discolor*, side of cephalothorax of male; 1a, epigynum; 1b, male palpus.
2. *Microneta quinquedentata*, male palpus, showing tarsal hook; 2a, palpal organ; 2b, epigynum.
3. *Microneta crassimanus*, male palpus.
4. *Microneta lutidens*, male palpus.
5. *Microneta furcata*, male palpus.
6. *Microneta longibulbus*, male palpus; 6a, palpal organ.
7. *Microneta olivacea*, male palpus.
8. *Bathyphantes complicata*, male palpus.

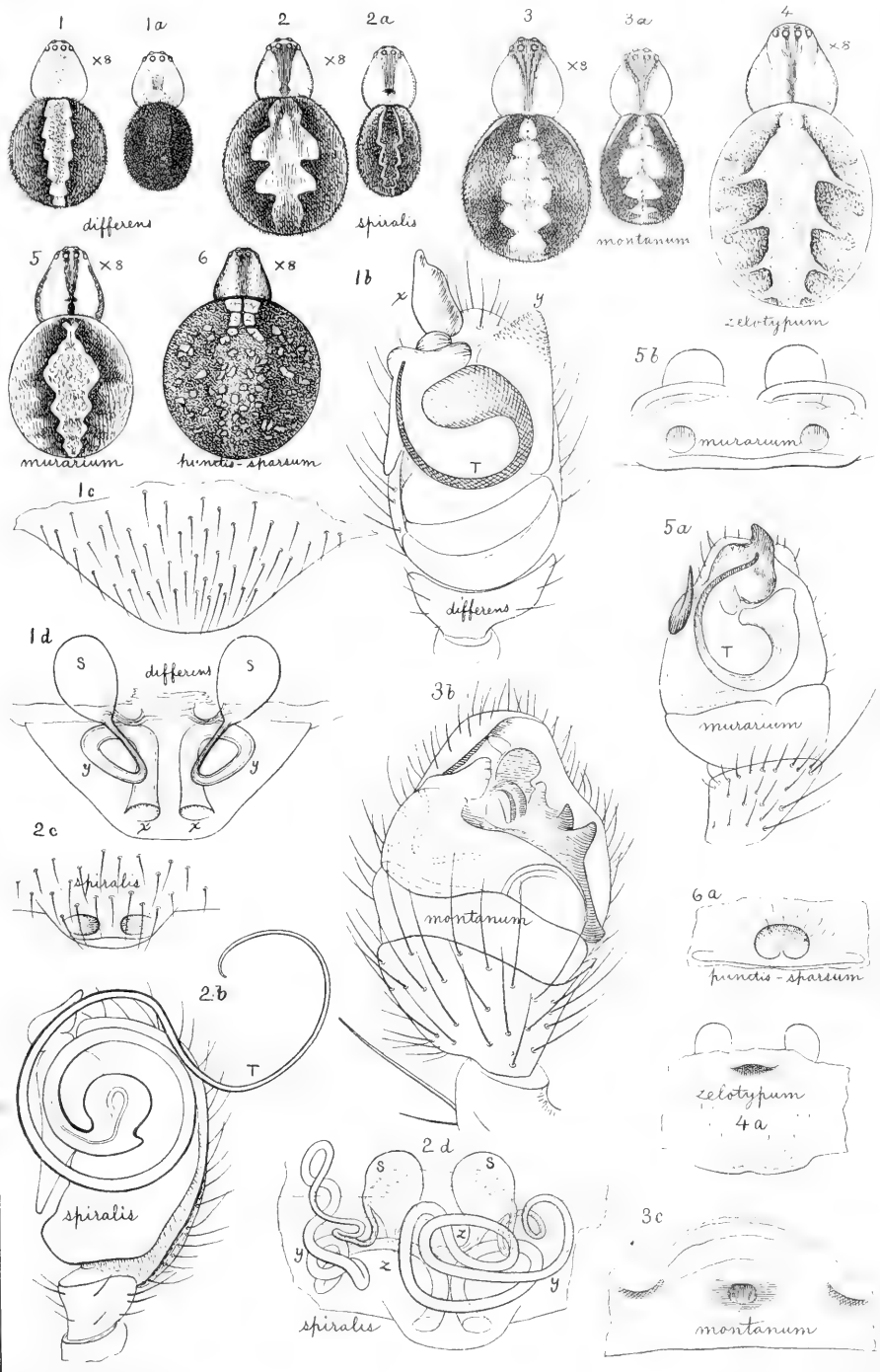

J. H. Emerton, from Nature

Photo. Lith. by E. Crisand, New Haven, Conn.

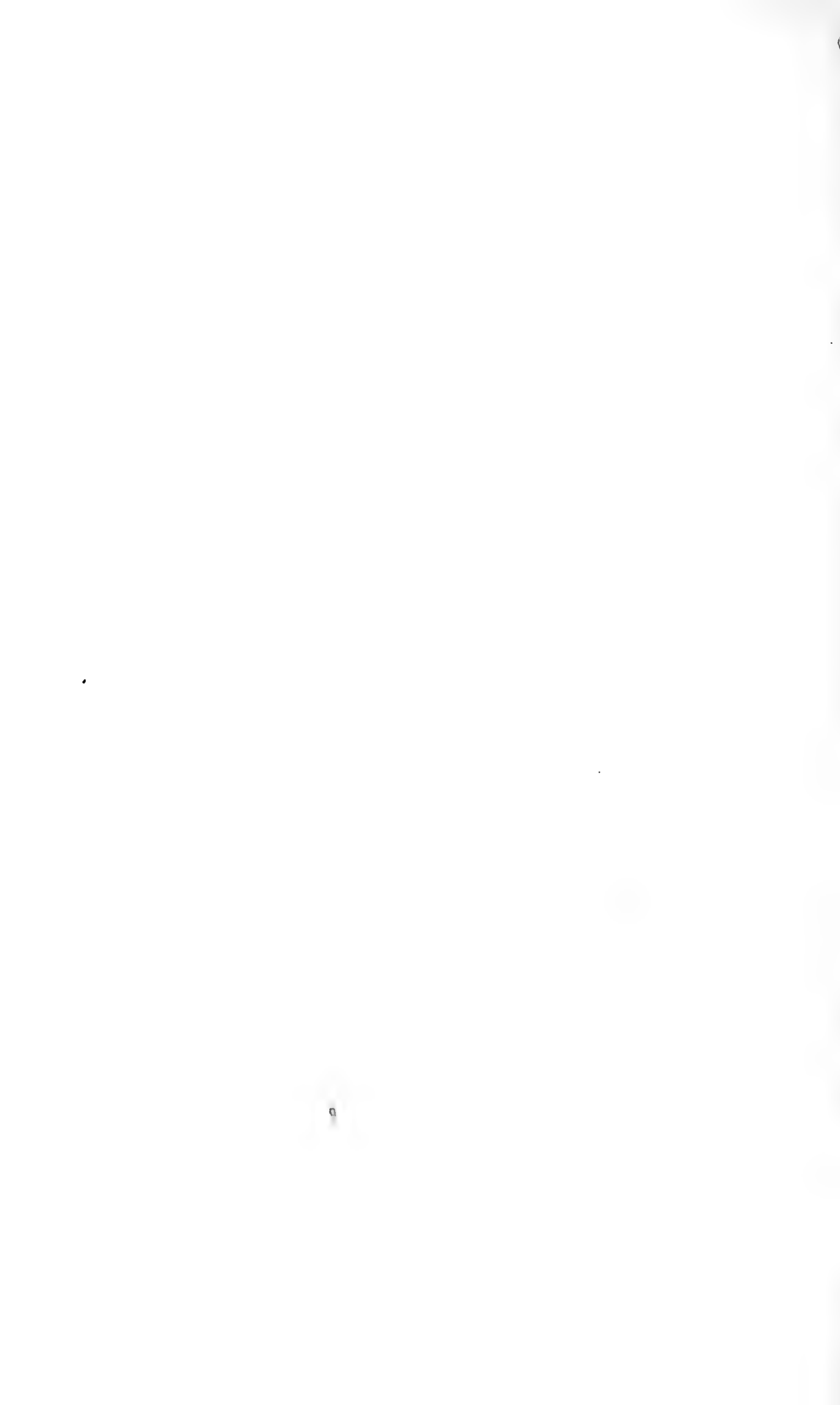

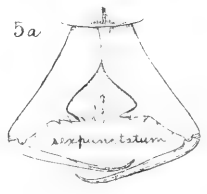
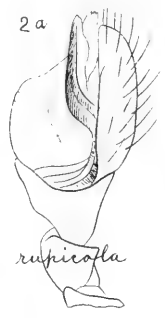
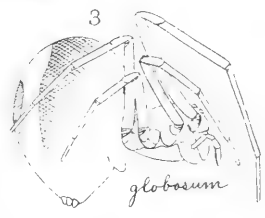
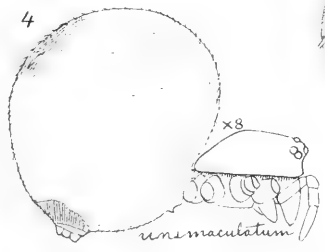
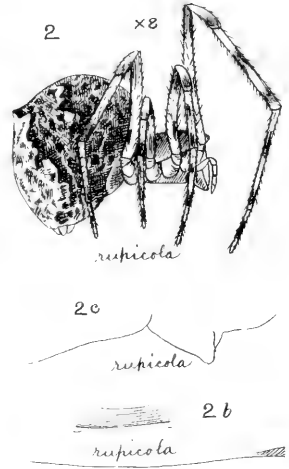
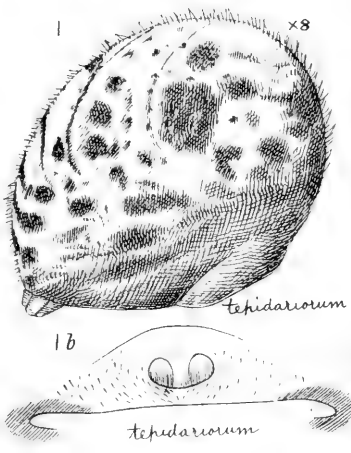

J. H. Emerton, from Nature

Photo. Lith. by E. Crisand, New Haven, Conn.

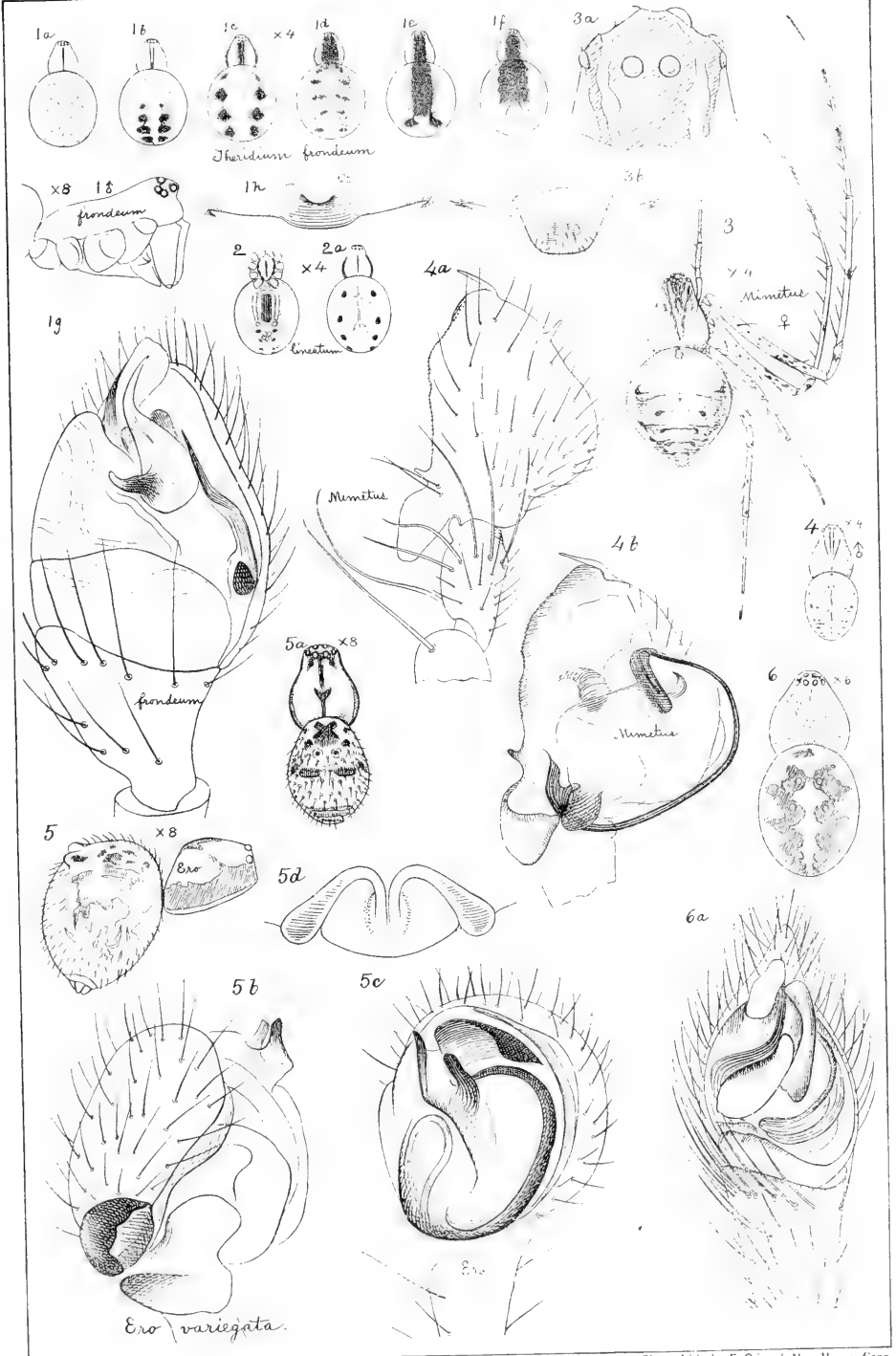

J. H. Emerton, from Nature.

Photo. Lith. by E. Crisand, New Haven, Conn.

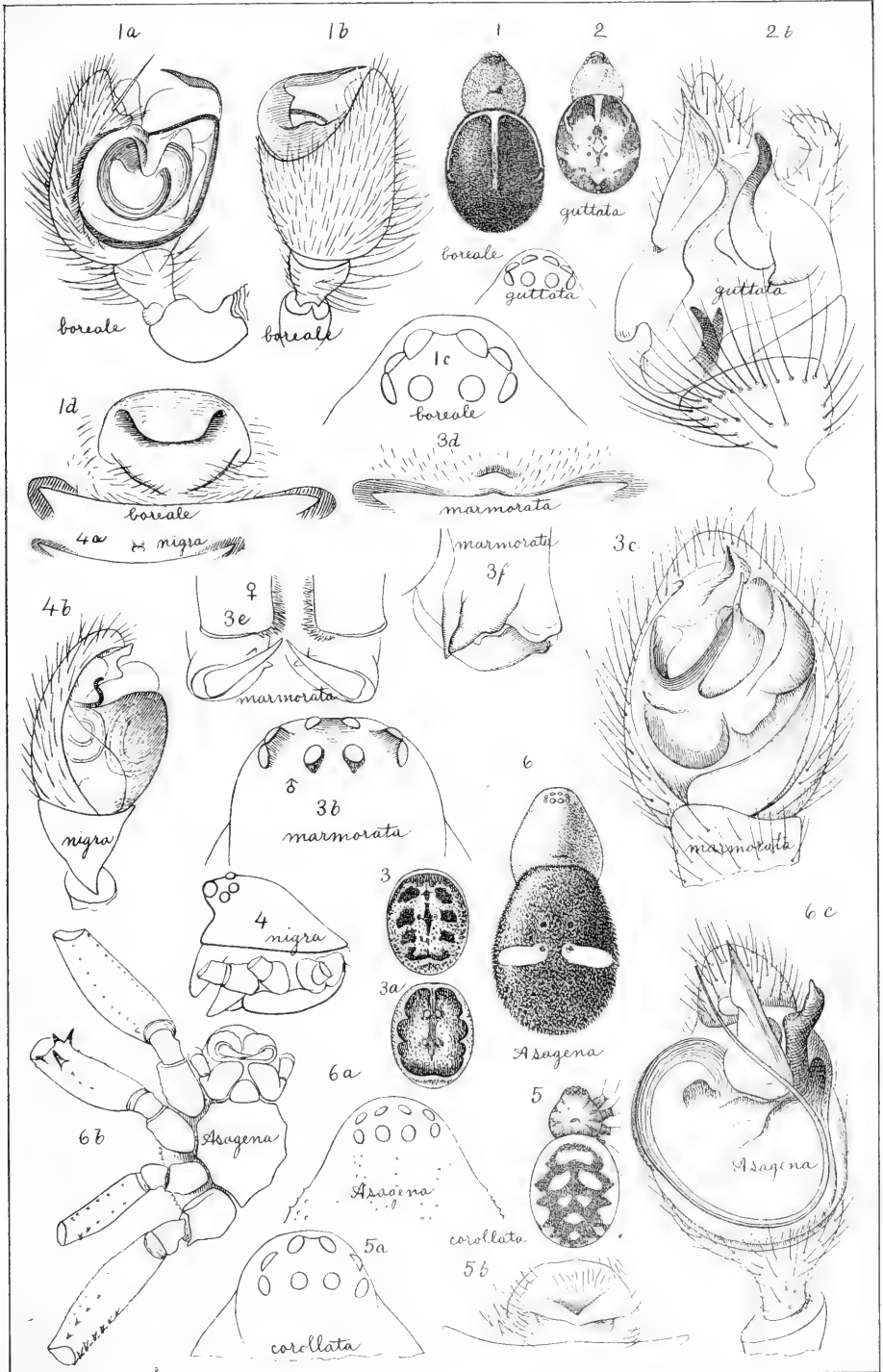

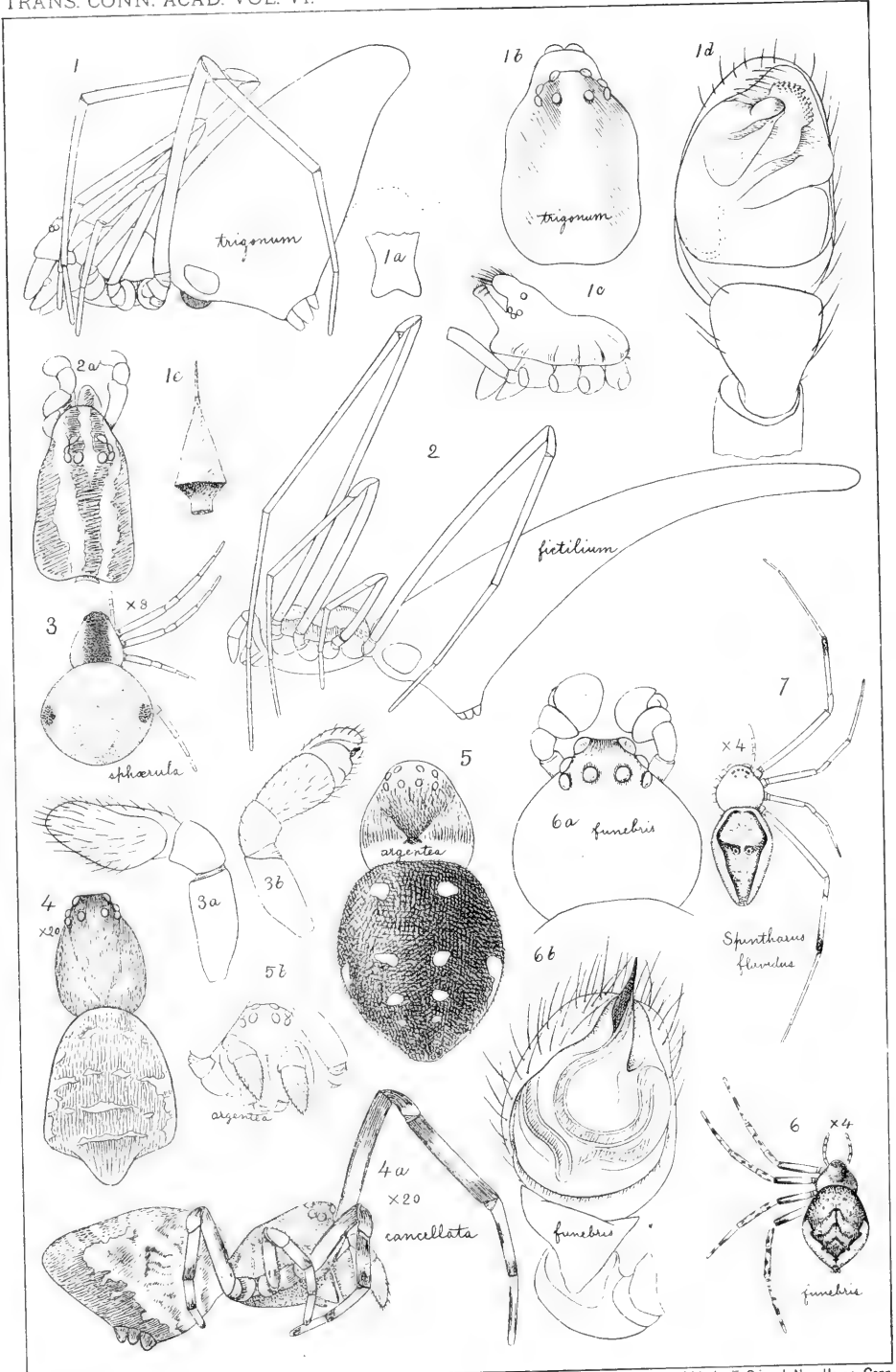

J. H. Emerton, from Nature.

Photo. Lith. by E. Crisand, New Haven, Conn.

ARGYRODES-THERIDULA-LASÆOLA-EURYOPIS-SPINTHARUS.



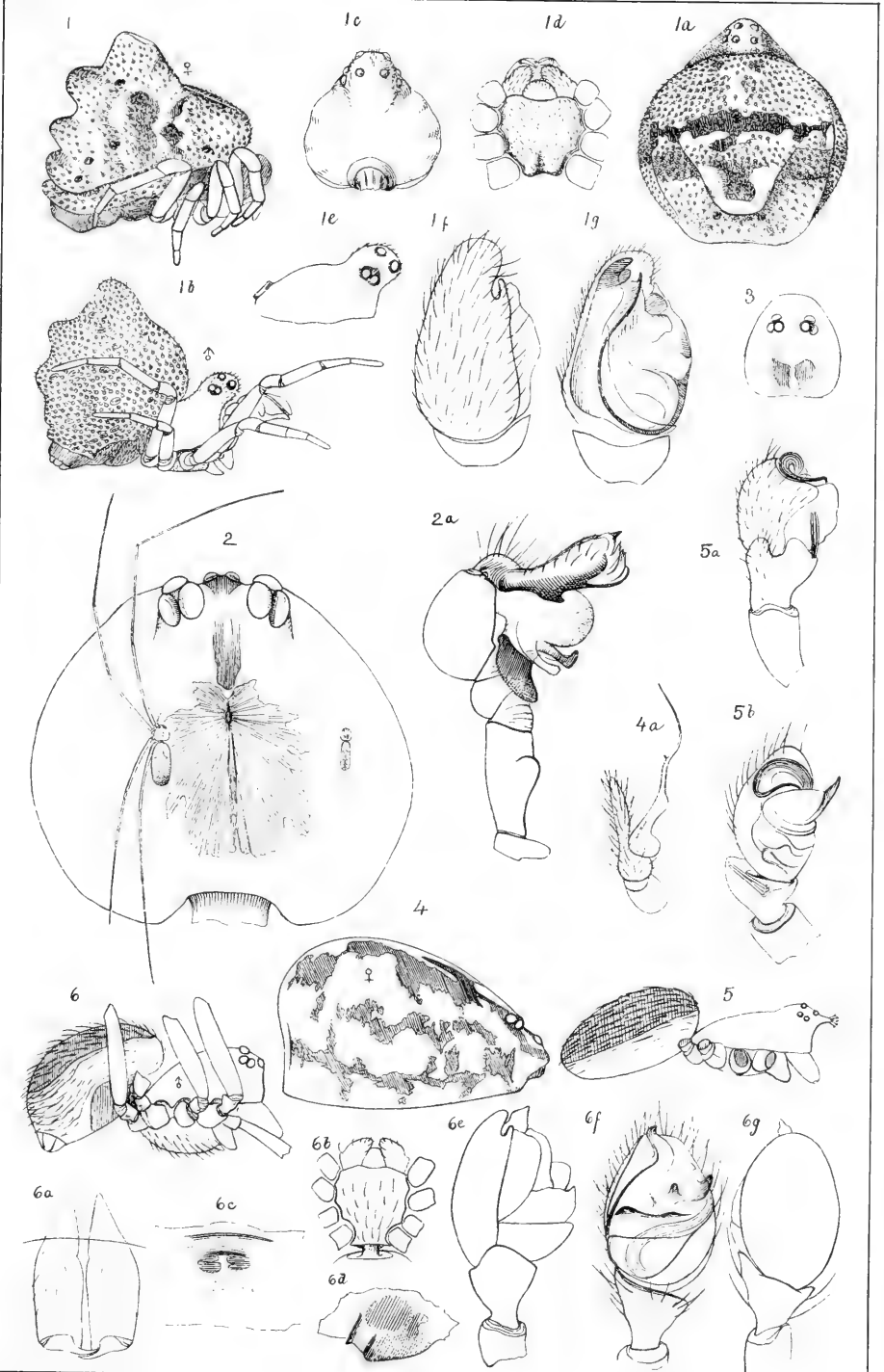

J. H. Emerton, from Nature

Photo. Lith. by E. Crisand, New Haven, Conn.



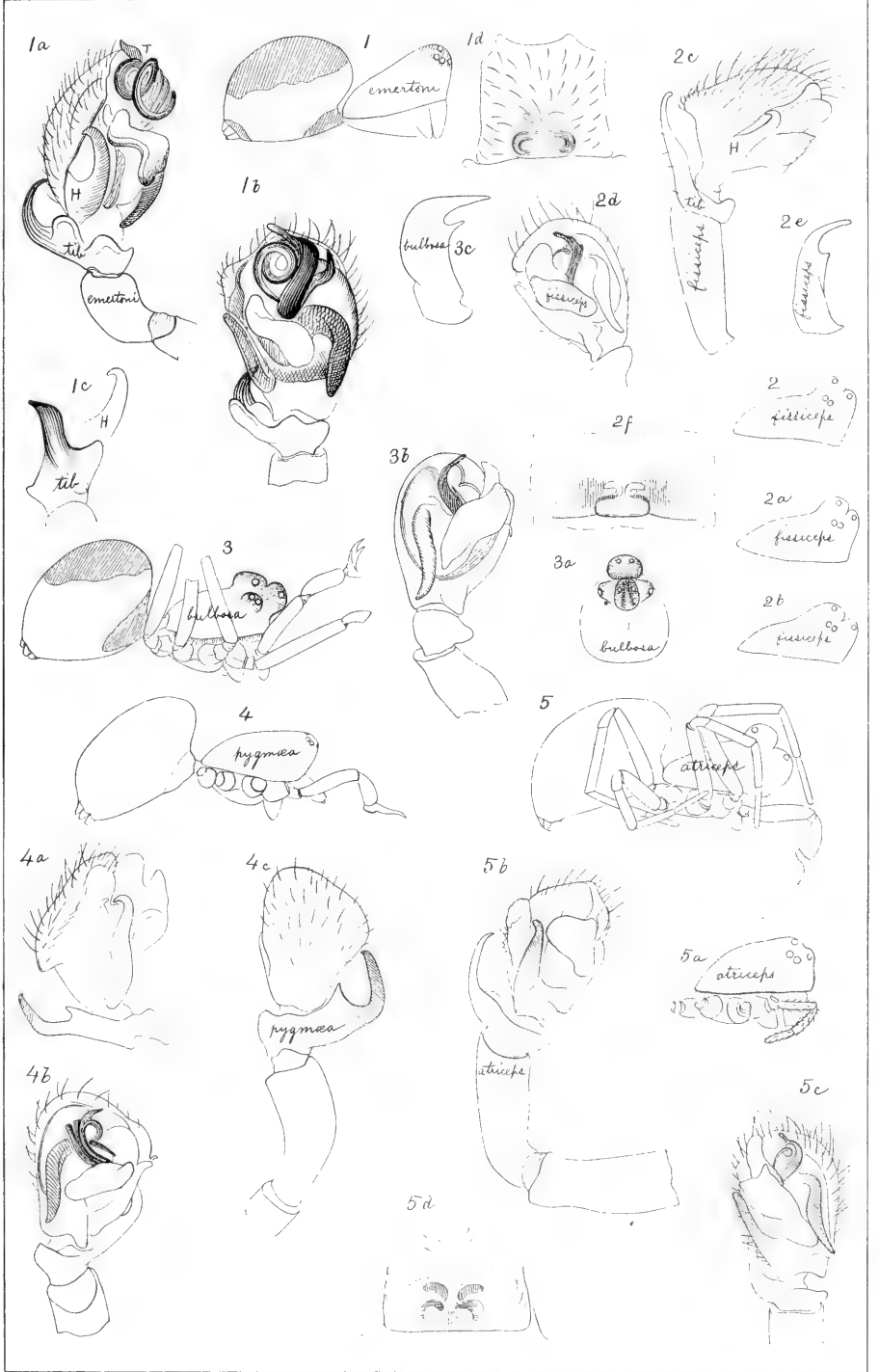

J. H. Emerton, from Nature.

Photo. Lith. by E. Crisand, New Haven, Conn.

CERATINELLA.



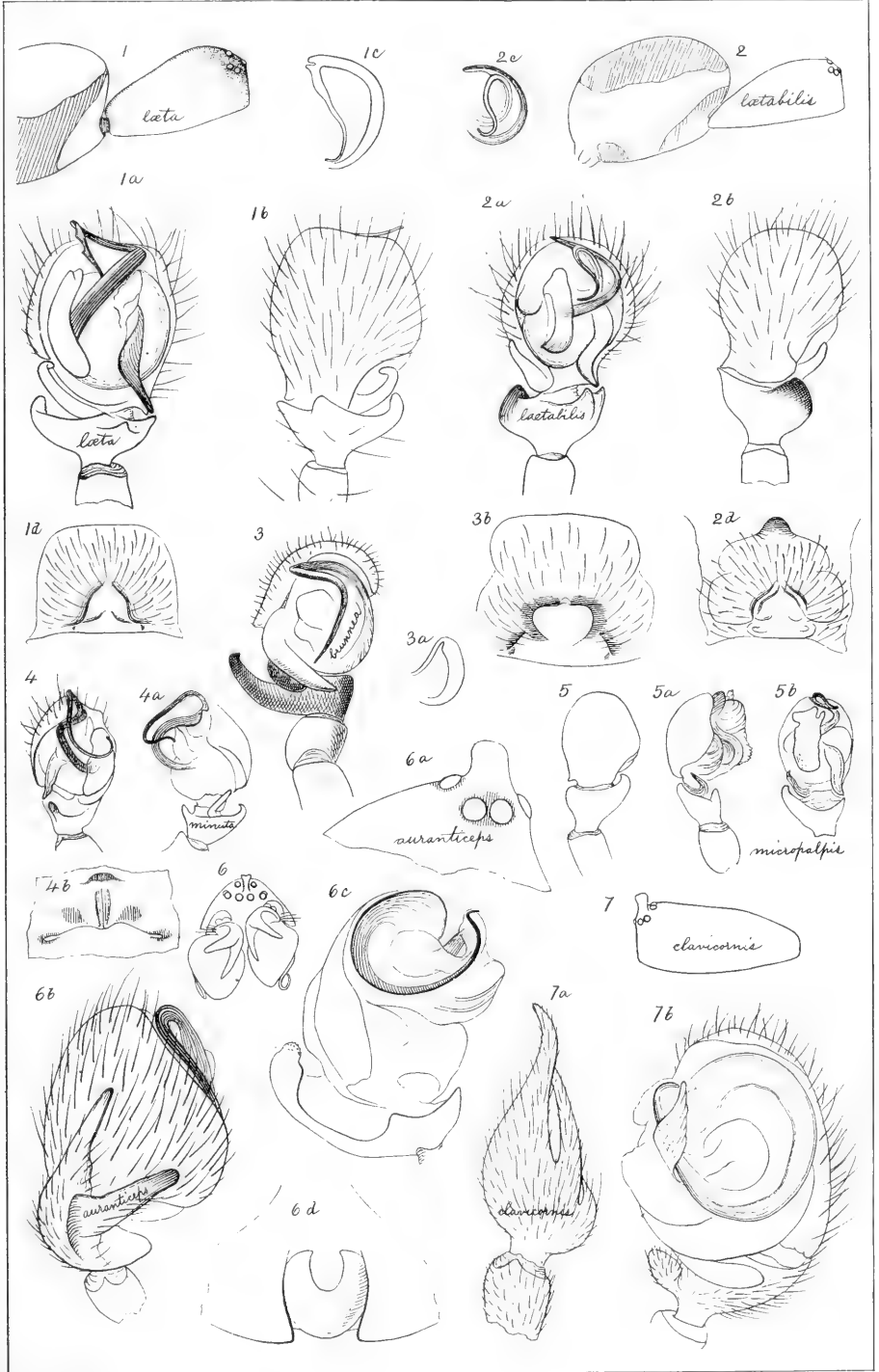

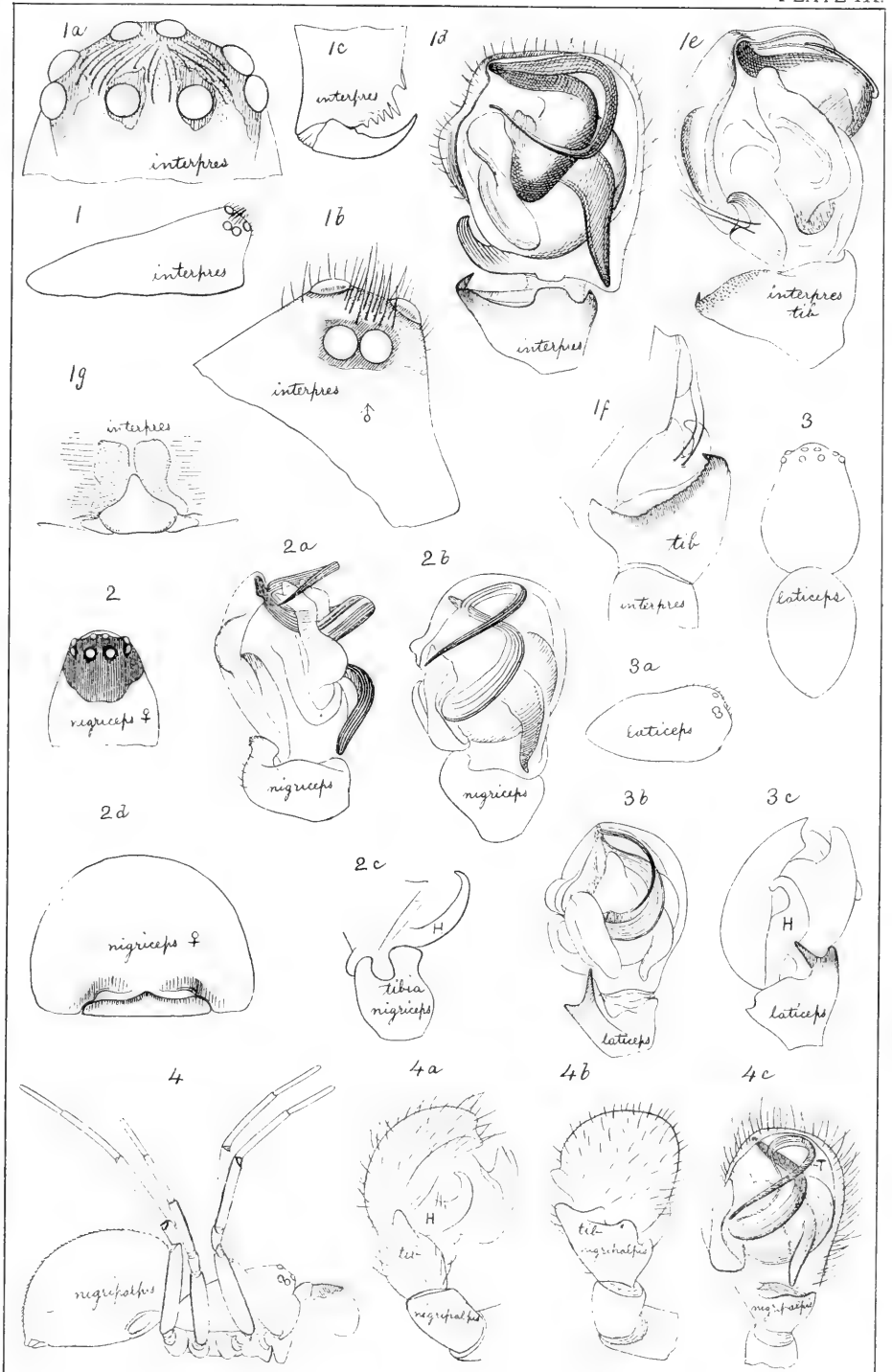

J. H. Emerton, from Nature.

Photo. Lith. by E. Crisand, New Haven, Conn.

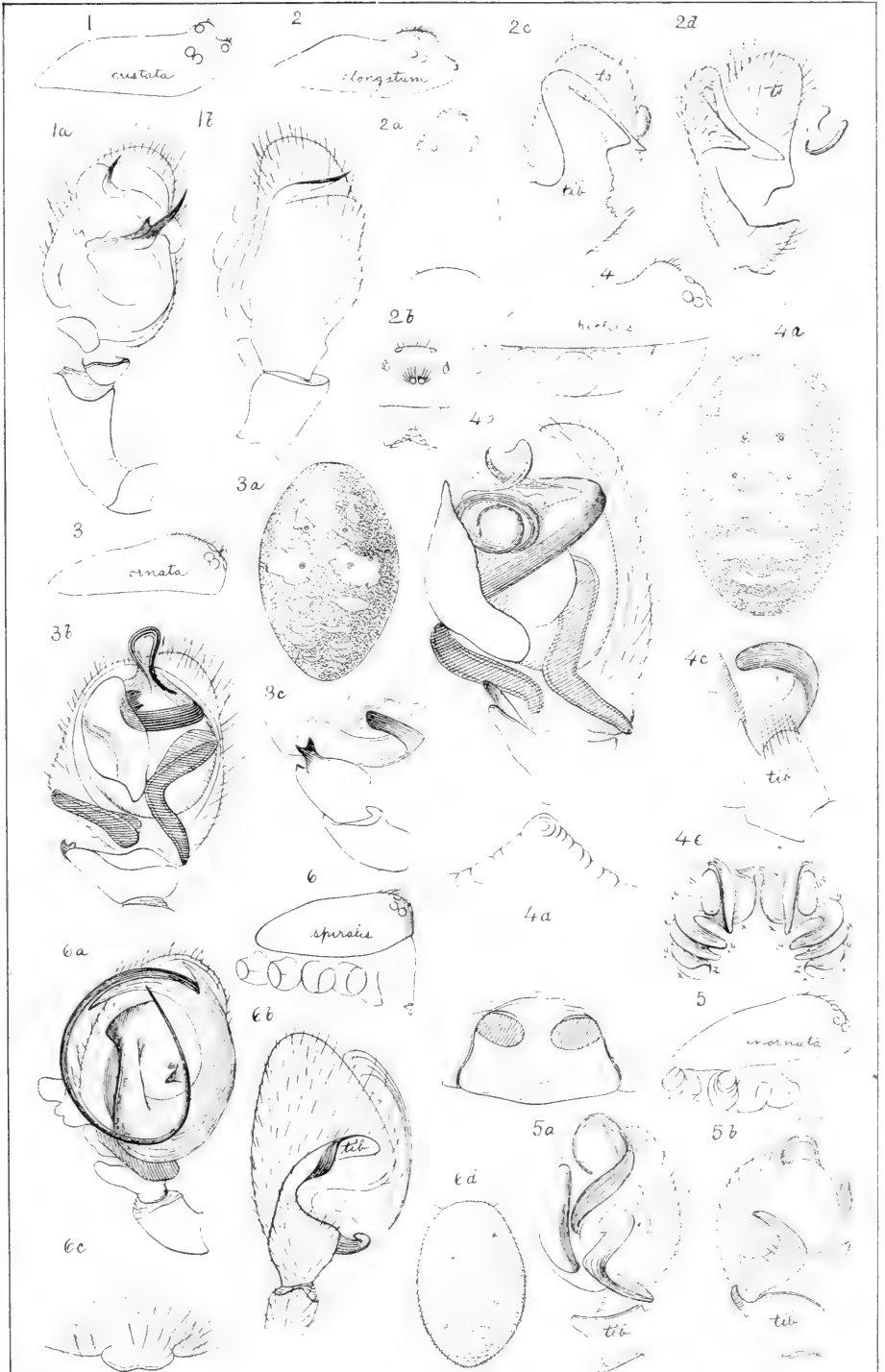

J. H. Emerton, from Nature

Photo. Lith. by E. Crisand, New Haven, Conn.

LOPHOMMA—GRAMMONOTA—SPIROPALPUS.

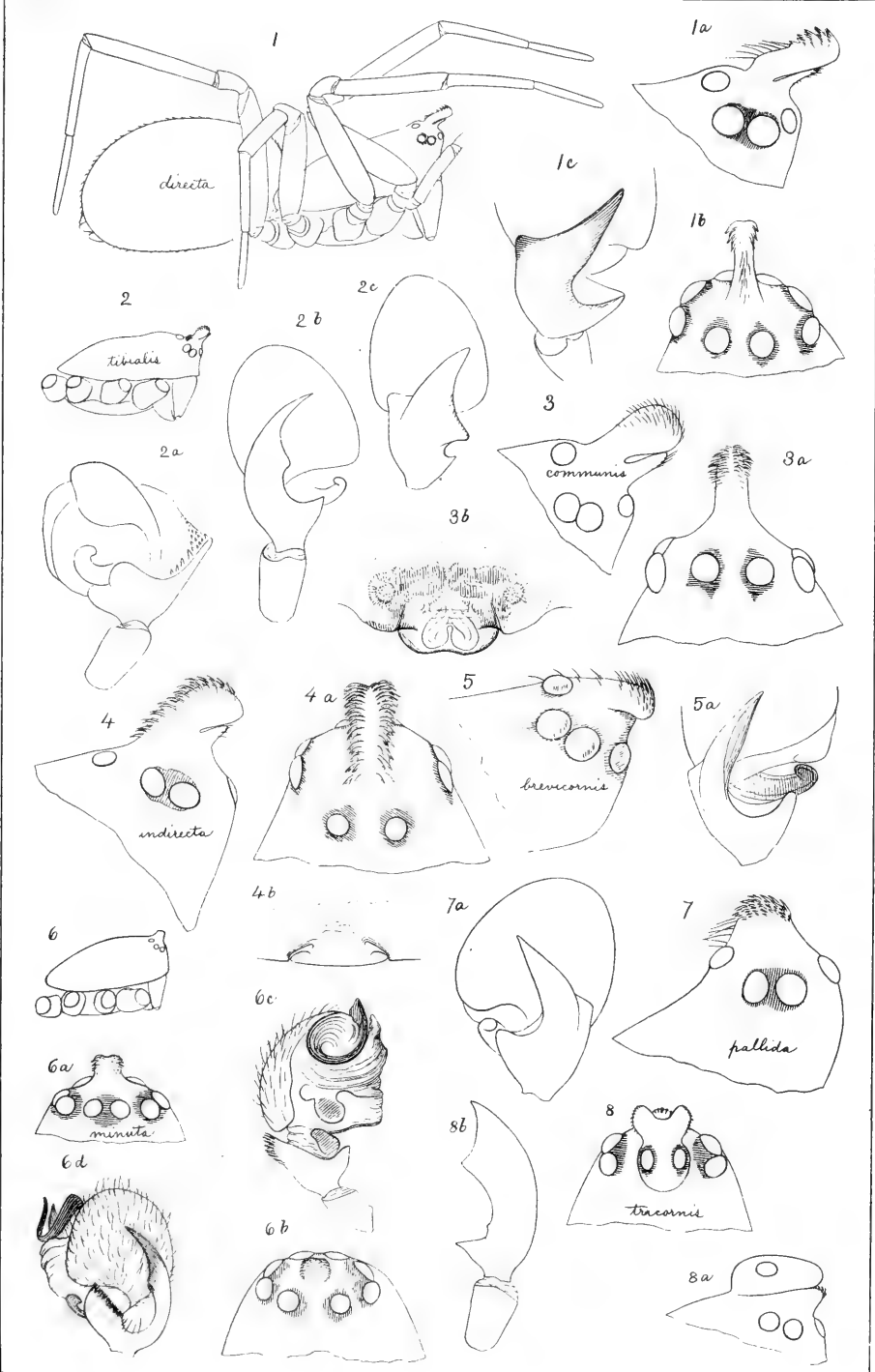

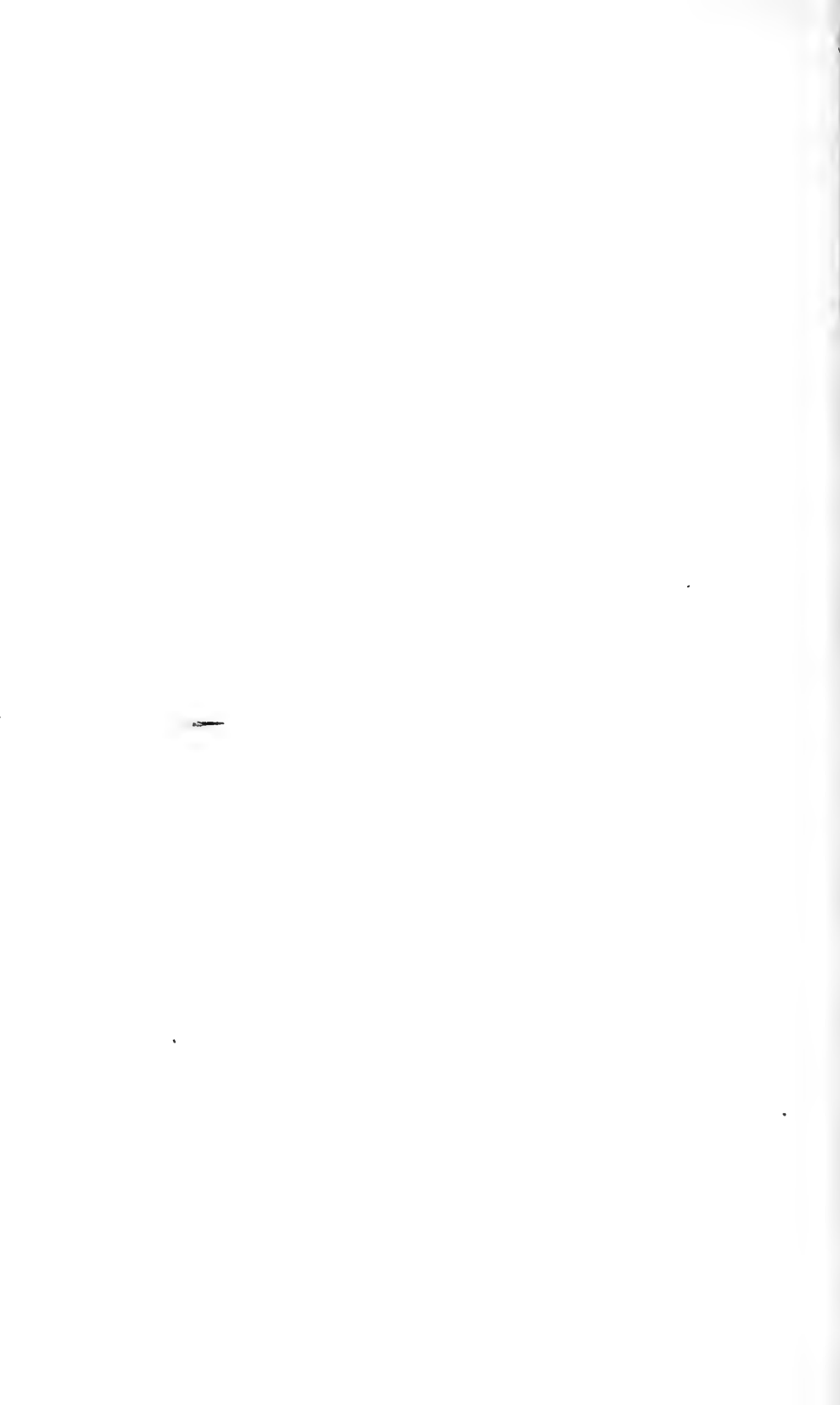

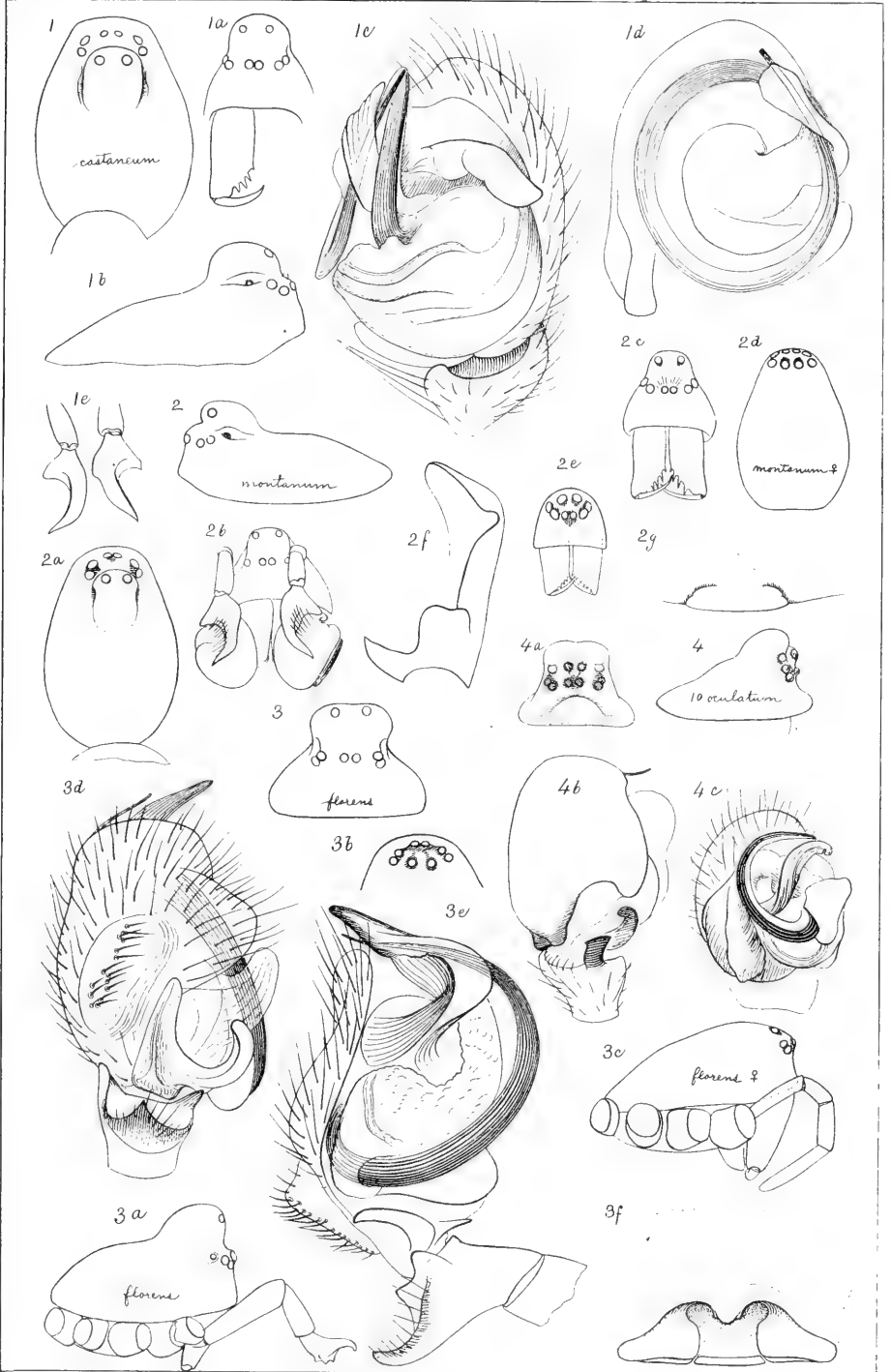

J. H. Emerton, from Nature.

Photo. Lith. by E. Crisand, New Haven, Conn.

LOPHOCARENUM.



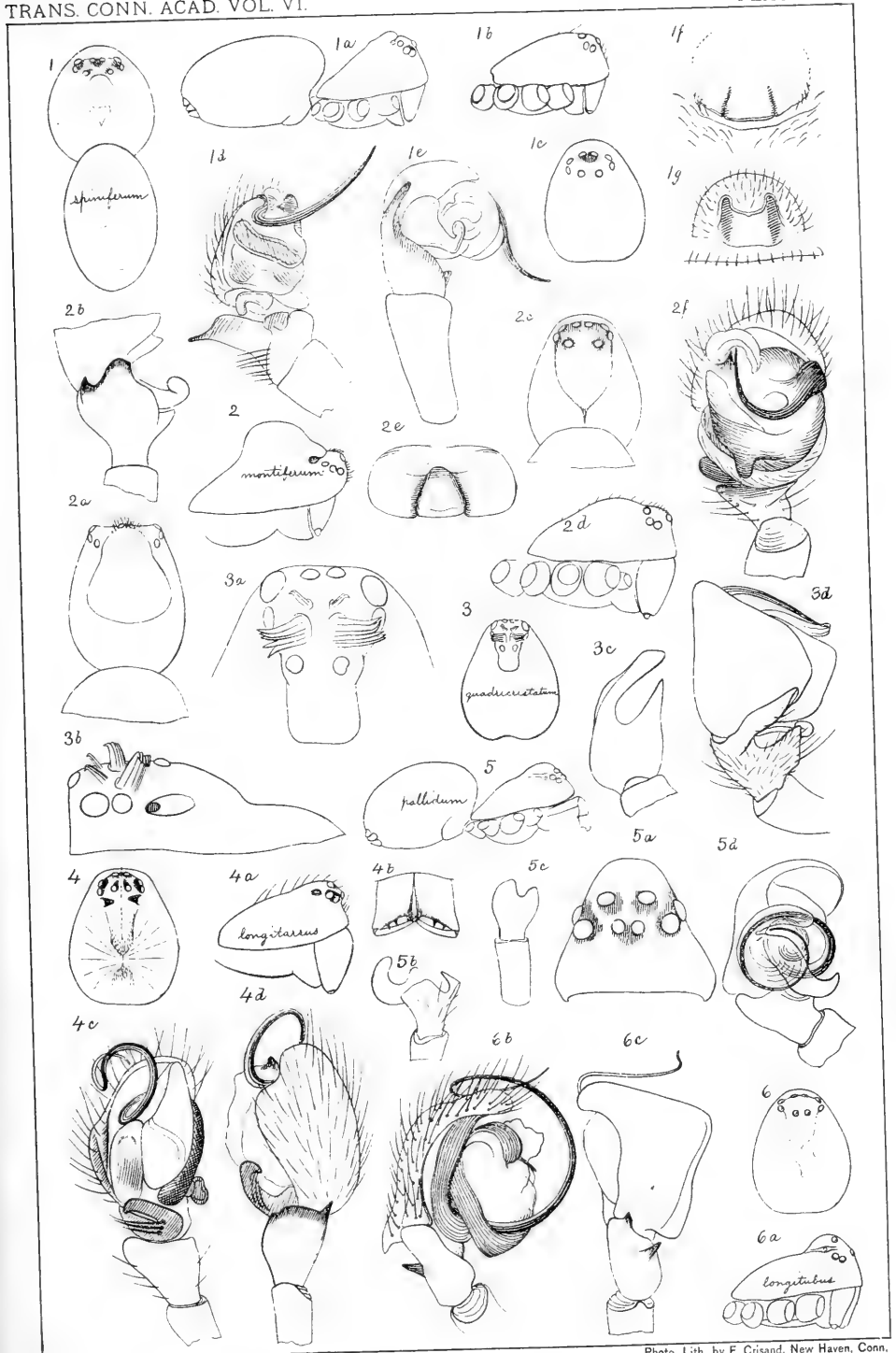

J. H. Emerton, from Nature.

Photo. Lith. by E. Crisand, New Haven, Conn.

LOPHOCARENUM.



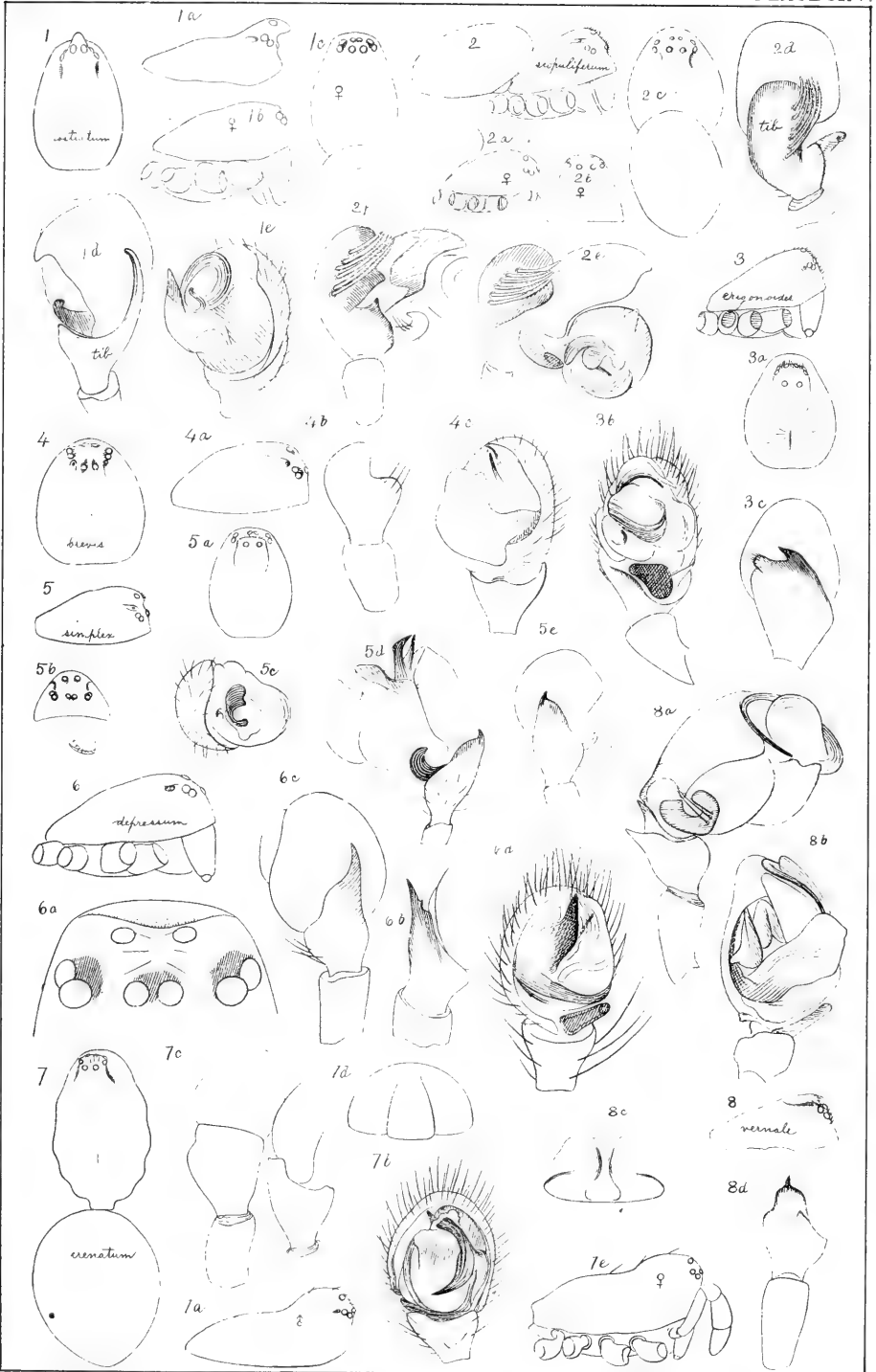

J. H. Emerton, from Nature.

Photo. Lith. by E. Crisand, New Haven, Conn.



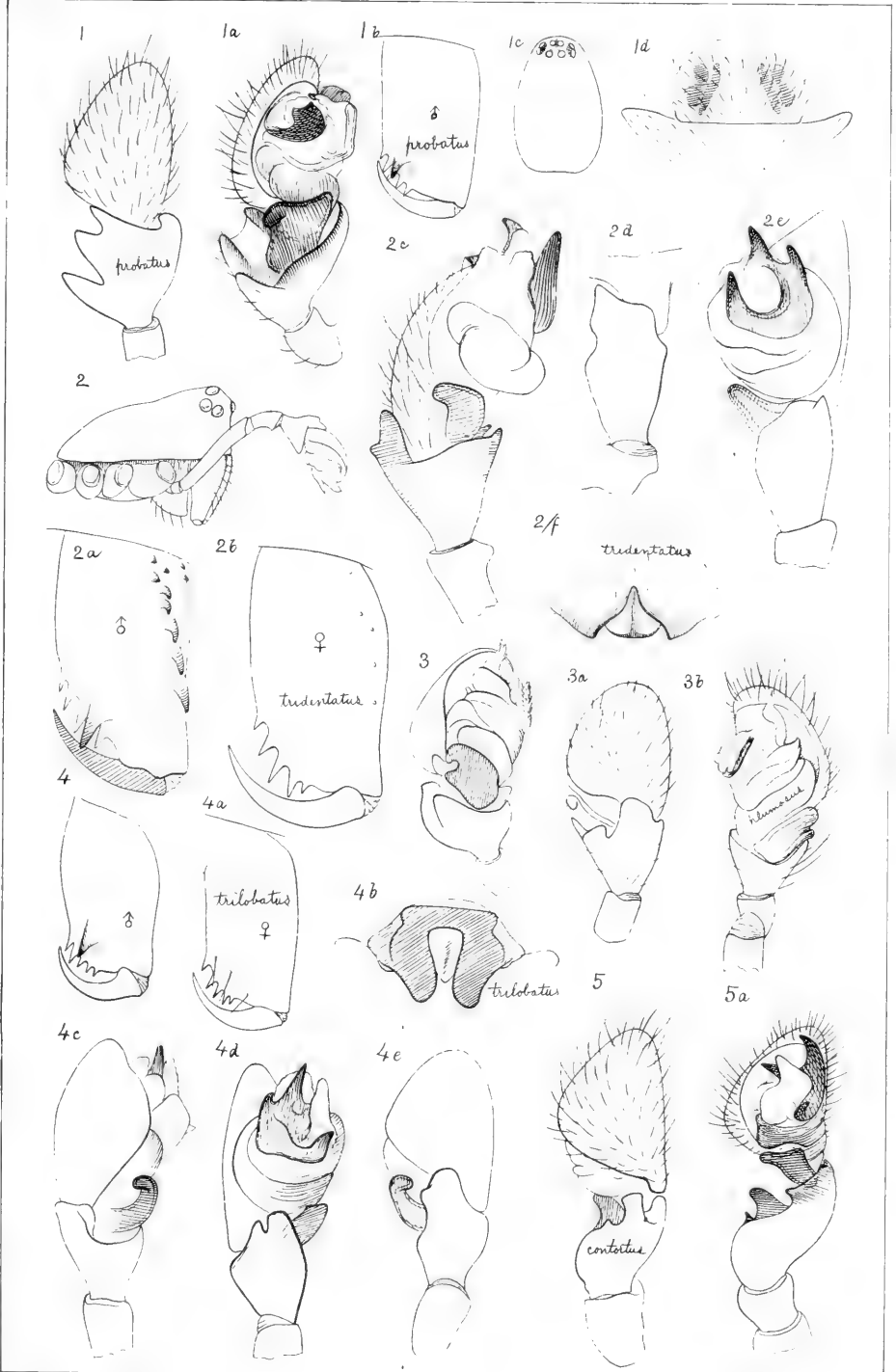

J. H. Emerton, from Nature

Photo. Lith. by E. Crisand, New Haven, Conn.

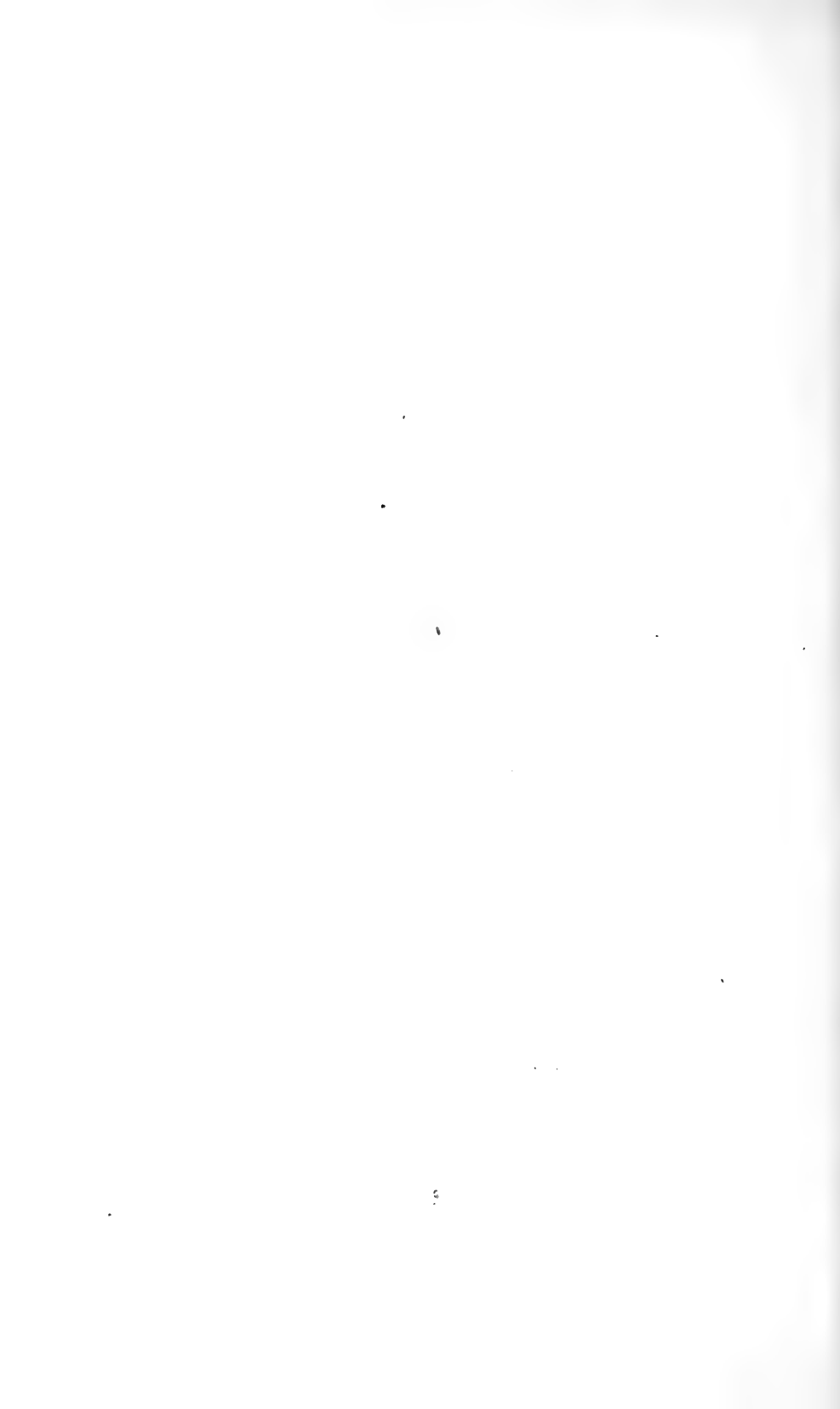

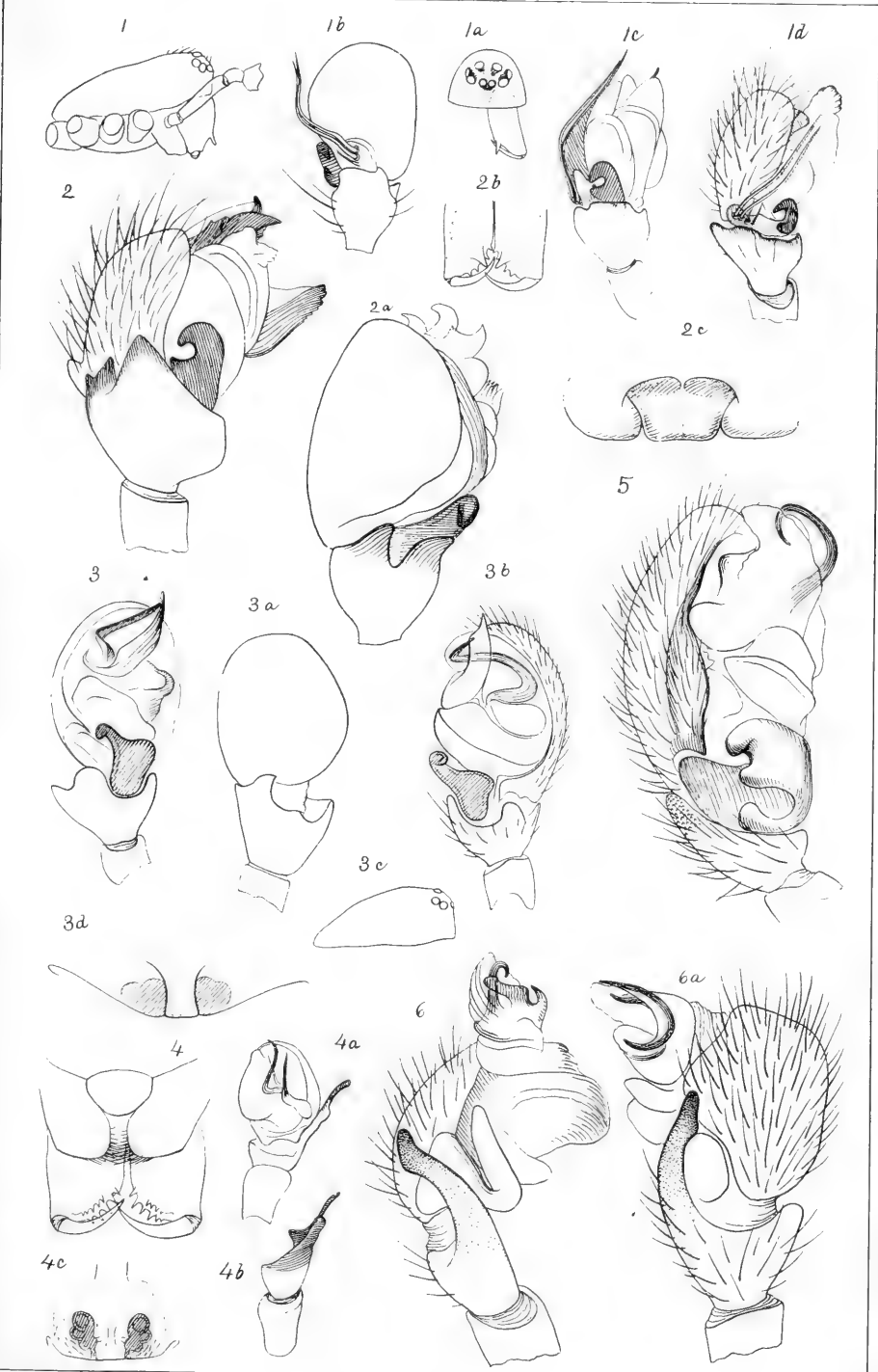

J. H. Emerton, from Nature.

Photo. Lith. by E. Crisand, New Haven, Conn.

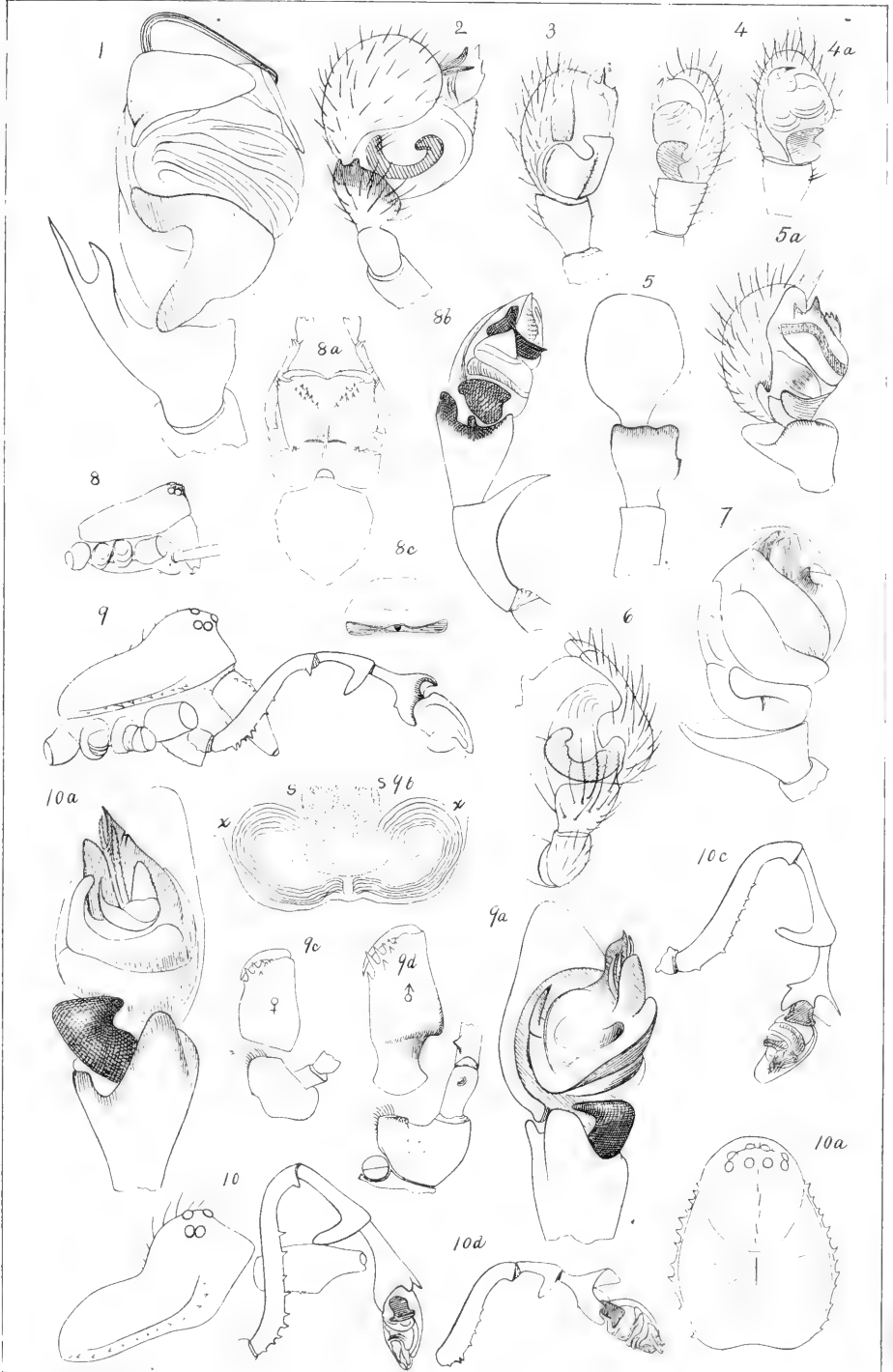

J. H. Emerton, from Nature.

Photo Lith. by E. Crisand, New Haven, Conn.

ERIGONE.



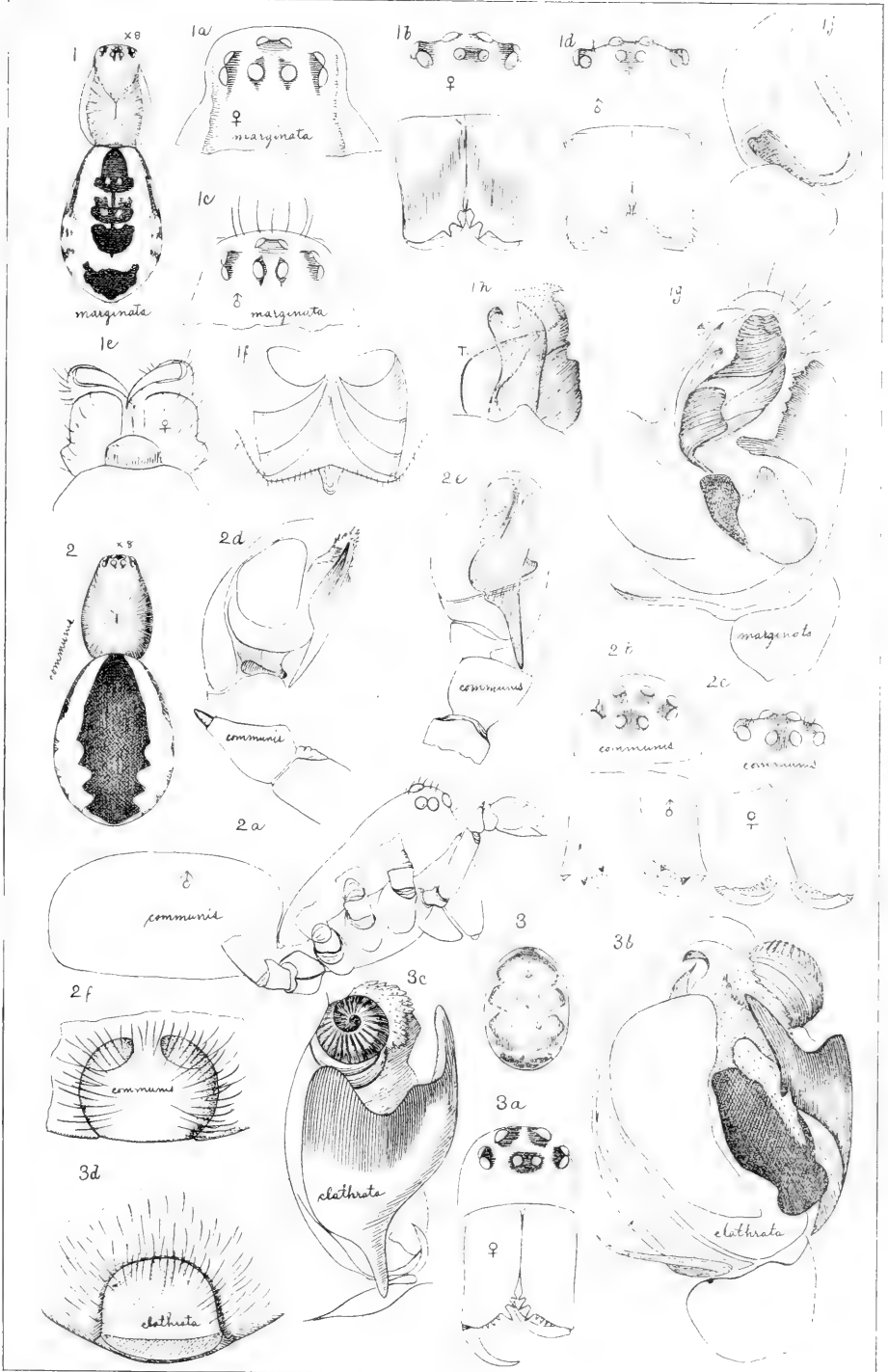

J. H. Emerton, from Nature

Photo Lith by E. Crisand, New Haven, Conn.

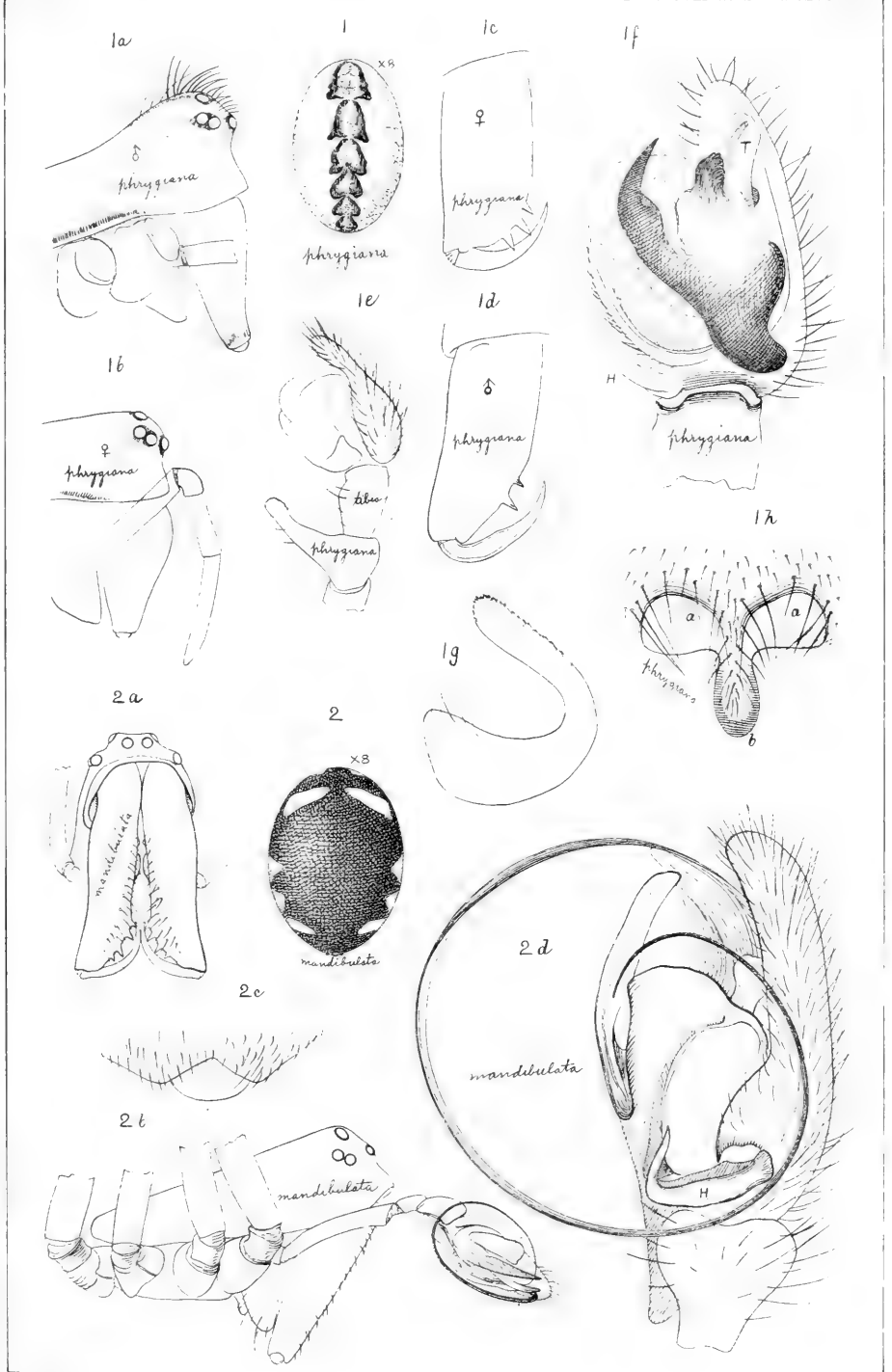

J. H. Emerton, from Nature.

Photo. Lith. by E. Crisand, New Haven, Conn.

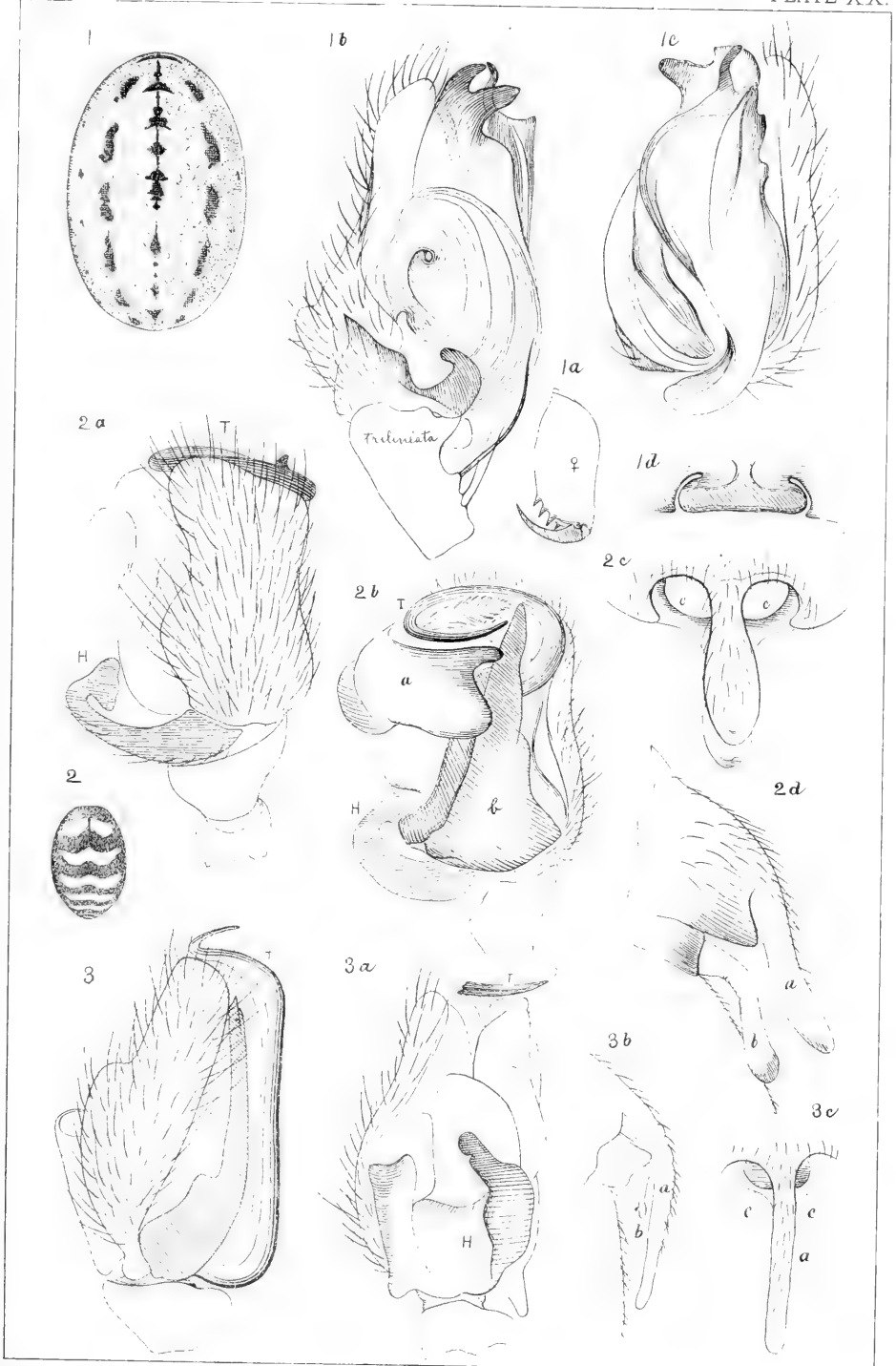

J. H. Emerton, from Nature

Photo. Lith. E. Crisand, New Haven, Conn.

BATHYPANTES.

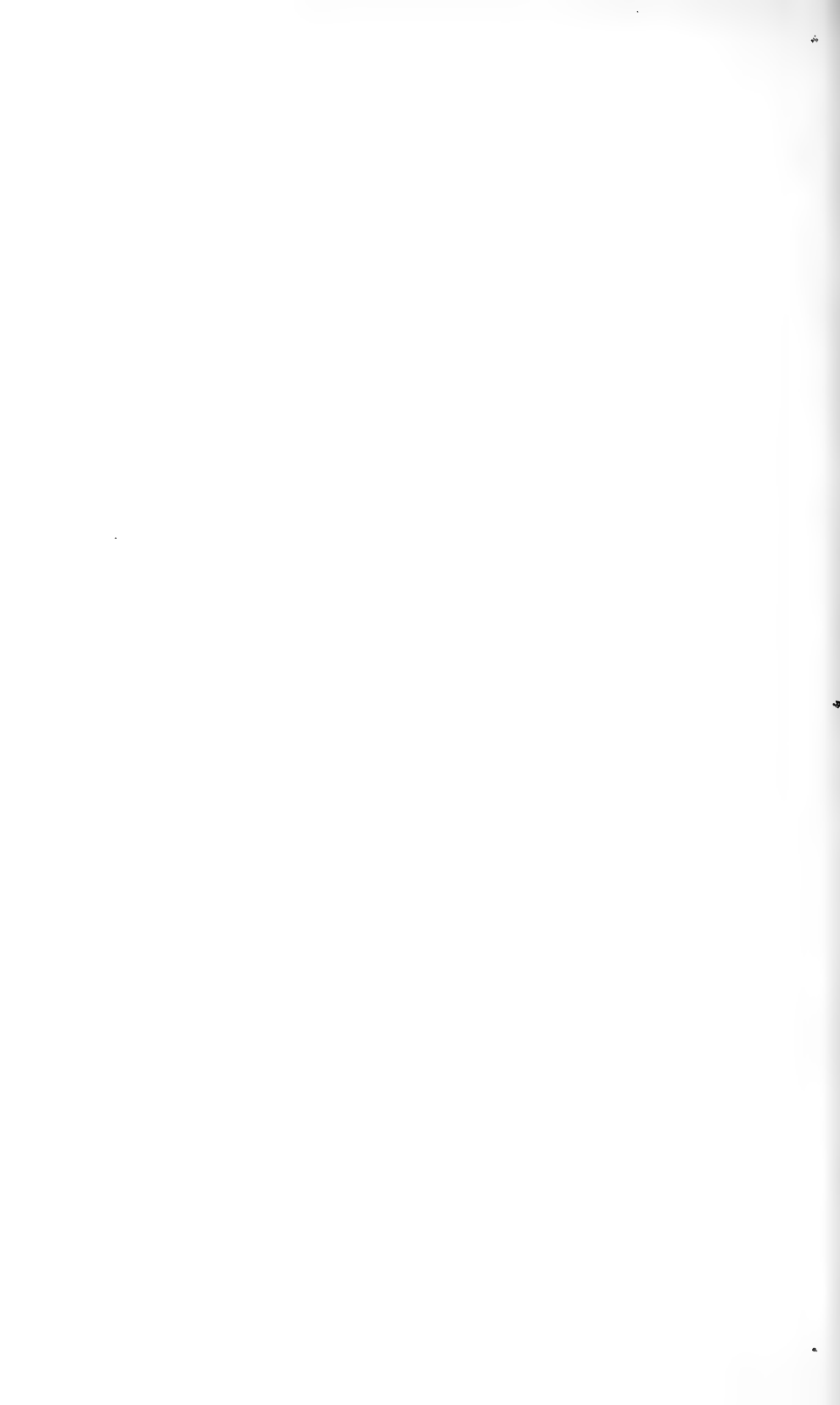

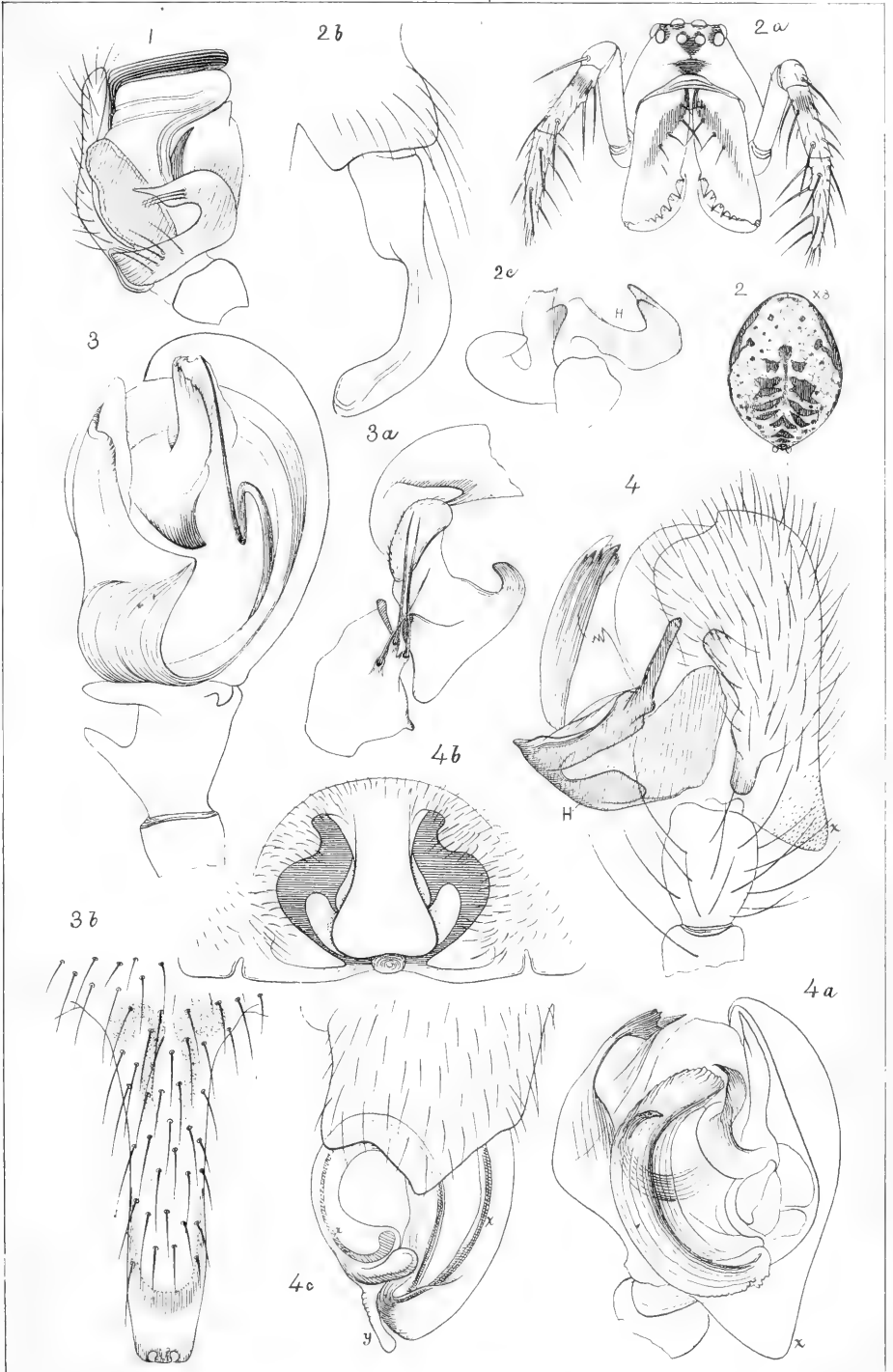

J. H. Emerton, from Nature.

Photo. Lith. by E. Crisand, New Haven, Conn.

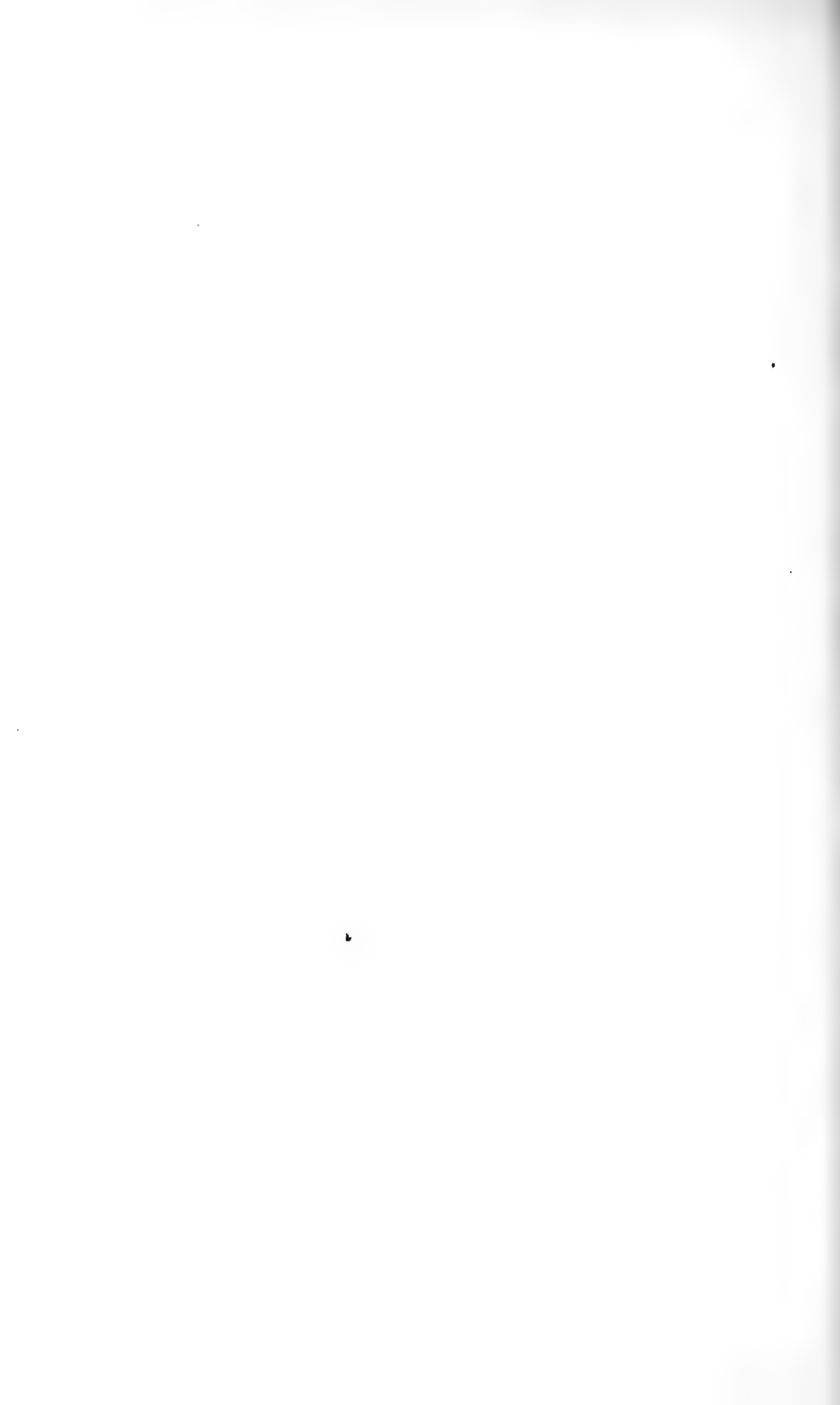

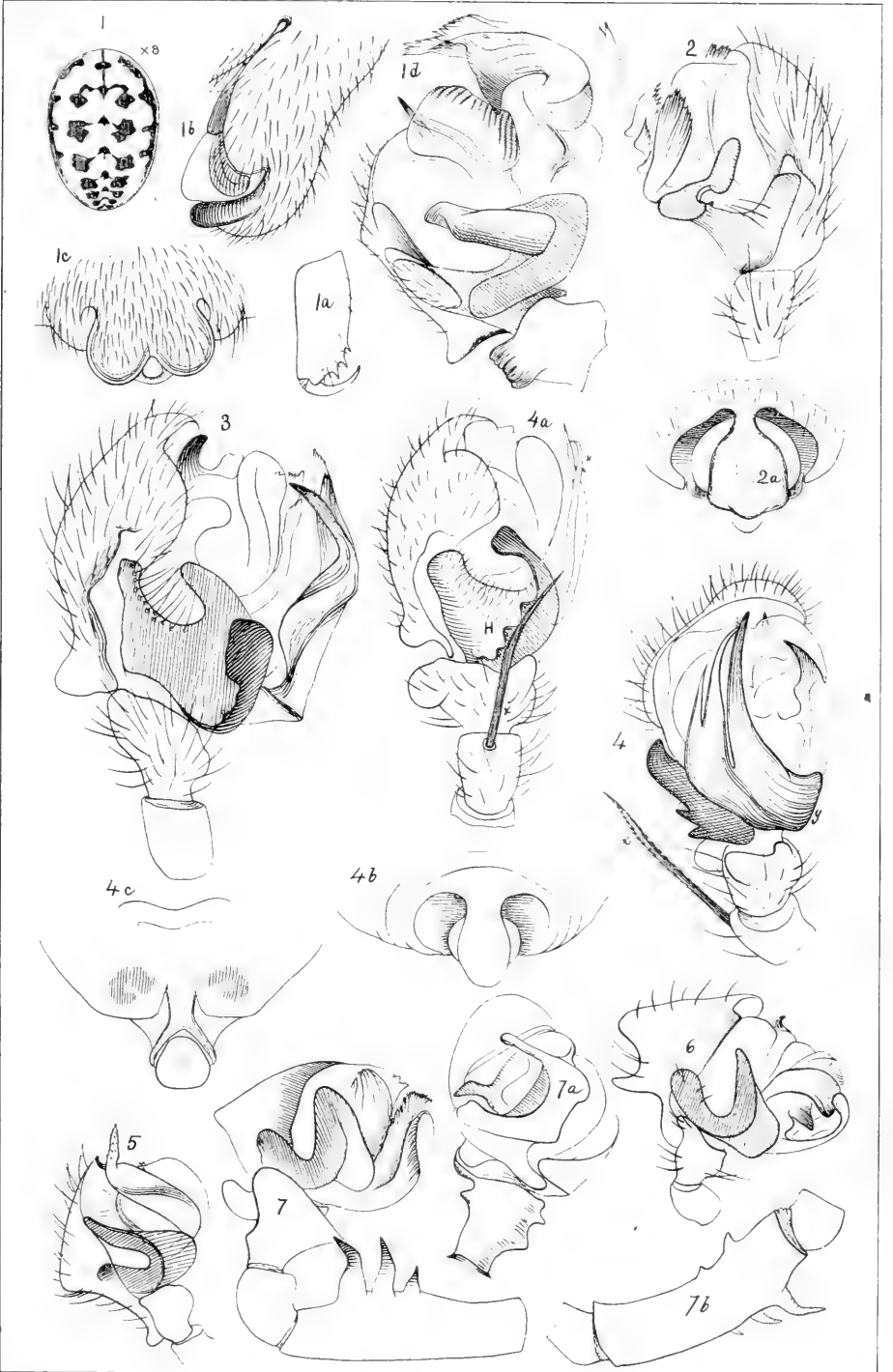

J. H. Emerton, from Nature.

Photo. Lith. by E. Crisand, New Haven, Conn.

BATHYPANTES.



J. H. Emerton, from Nature.

Photo. Lith. by E. Crisand, New Haven, Conn.

MICRONETA GONATIUM.







INDEX.

Argyrodes fctillum	24	Diplostyla concolor	66	Lepthyphantes crypticola	69
Argyrodes trigonum	23	Diplostyla nigrina	65	Lepthyphantes muscicola	68
Asagena americana	23	Drapetisca socialis	67	Linyphia clathrata	62
Bathyphantes alpina	70	Erigone atra	59	Linyphia communis	62
Bathyphantes angulata	71	Erigone atriceps	34	Linyphia costata	63
Bathyphantes bihamata	72	Erigone autumnalis	58	Linyphia mandibulata	64
Bathyphantes complicata	72	Erigone cornupalpis	74	Linyphia marginata	61
Bathyphantes formica	71	Erigone cristata	44	Linyphia marmorata	61
Bathyphantes micaria	71	Erigone dentigera	59	Linyphia phrygiana	63
Bathyphantes minuta	68	Erigone directa	40	Linyphia pusilla	
Bathyphantes nebulosa	69	Erigone emertoni	32	Linyphia scripta	61
Bathyphantes sub-alpina	70	Erigone fissiceps	33	Lophocarenum castaneum	45
Bathyphantes terricolus	65	Erigone florens	46	Lophocarenum crenatum	51
Bathyphantes zebra	69	Erigone indirecta	41	Lophocarenum 10-oculatum	
Bolyphantes drassoides	72	Erigone interpres	37		46
Ceratinella atriceps	34	Erigone læta	35	Lophocarenum depressum	
Ceratinella brunnea	36	Erigone lætabilis	35		50
Ceratinella bulbosa	33	Erigone multissima	4	Lophocarenum erigonoides	
Ceratinella emertoni	32	Erigone longipalpis	59		50
Ceratinella fissiceps	33	Erigone ornata	39	Lophocarenum florens	46
Ceratinella læta	35	Erigone persimilis	3	Lophocarenum latum	50
Ceratinella lætabilis	35	Erigone persoluta	74	Lophocarenum longitubus	49
Ceratinella micropalpis	36	Erigone pertinens	54	Lophocarenum longitarsus	
Ceratinella minuta	36	Erigone pictilis	38		48
Ceratinella pygmæa	34	Erigone probata	52	Lophocarenum montanum	45
Ceratinopsis interpres	37	Erigone provida	40	Lophocarenum montiferum	
Ceratinopsis laticeps	37	Erigone spinifera	47		47
Ceratinopsis nigriceps	37	Erigone viaria	73	Lophocarenum pallidum	48
Ceratinopsis nigripalpis	38	Ero thoracica	18	Lophocarenum quadricris-	
Cornicularia auranticeps	43	Eucharia	18	tatum	48
Cornicularia brevicornis	42	Euryopsis argentea	27	Lophocarenum rostratum	49
Cornicularia clavicornis	43	Euryopsis funebris	27	Lophocarenum scopulif-	
Cornicularia communis	41	Grammonota inornata	39	erum	49
Cornicularia directa	40	Grammonota pictilis	38	Lophocarenum simplex	50
Cornicularia indirecta	41	Grammonota ornata	39	Lophocarenum spiniferum	
Cornicularia minuta	42	Gonatium rubens	60		47
Cornicularia pallida	42	Gonatium cheliferum	60	Lophocarenum vernale	61
Cornicularia tibialis	41	Helophora insignis	67	Lophomma bicorne	44
Cornicularia tricornis	43	Helophora pallescens	67	Lophomma cristata	44
Diplostyla canadensis	66	Lasæola cancellata	26	Lophomma elongata	44

Microneta cornupalpis ..	74	Steatoda guttata	20	Theridium puncto-sparsum	
Microneta crassimanus ..	75	Steatoda marmorata	20		12
Microneta discolor	75	Steatoda nigra	21	Theridium sexpunctatum	12
Microneta furcata	76	Steatoda ruralis	20	Theridium spirale	10
Microneta latidens	76	Steatoda triangulosa	22	Theridium tepidariorum	13
Microneta longibulbus ..	76	Stegasoma	28	Theridium unimaculatum	15
Microneta olivacea	77	Stemonyphantes bucculen-		Theridium zelotypum ..	11
Microneta persoluta	74	tus	64	Theridula sphaerula	25
Microneta quisquiliarum	73	Stylophora concolor	66	Tmeticus bidentatus	56
Microneta 5-dentata	75	Teutana triangulosa	22	Tmeticus bostoniensis ..	56
Microneta viaria	73	Theridion boreale	19	Tmeticus brunneus	58
Mimetus epeiroides	17	Theridion cancellatum	26	Tmeticus concavus	57
Mimetus interfactor	16	Theridion fictilium	24	Tmeticus contortus	54
Nerieue rubens	60	Theridion frondeum	15	Tmeticus longisetosus ..	54
Nerieue viaria	73	Theridion funebre	27	Tmeticus maximus	55
Oroodes	28	Theridion globosum	14	Tmeticus microtarsus ..	57
Pholcomma hirsutum	29	Theridion leuinum	18	Tmeticus montanus	55
Pholcomma rostratum	30	Theridion marmoratum	20	Tmeticus pallidus	55
Pholcus atlanticus	30	Theridion serpentinum	22	Tmeticus pertinens	54
Pholcus phalangioides ..	30	Theridion sphaerula	25	Tmeticus plumosus	53
Phyllonethis lineata	16	Theridion trigonum	23	Tmeticus probatus	52
Phyllonethis placens	15	Theridion vulgare	13	Tmeticus terrestris	57
Scytodes cameratus	31	Theridium differens	9	Tmeticus tibialis	56
Scytodes thoracica	31	Theridium frondeum	15	Tmeticus tridentatus ..	53
Spermophora meridionalis	31	Theridium globosum	14	Tmeticus trilobatus	53
Spintharus flavidus	28	Theridium lineatum	16	Tmeticus truncatus	57
Spiropalpus spiralis	39	Theridium montanum	10	Ulesanis americana	28
Steatoda borealis	19	Theridium murarium	11		
Steatoda corollata	21	Theridium rupicola	14		



II.—DIPTEROUS LARVÆ FROM THE WESTERN ALKALINE LAKES AND THEIR USE AS HUMAN FOOD. By S. W. WILLISTON.

THROUGH the kindness of Professors G. J. Brush and S. I. Smith I have recently received a quantity of the larvæ and imagos of a dipterous insect that is of interest not only as one of the very few inhabitants of the strongly alkaline lakes of the West, but as forming an article of human food, the only instance that I am aware of in this order of insects. The specimens, belonging to the genus *Ephydra*, were received with a quantity of the rare mineral Gay-lussite from the Soda Lakes near Ragtown, Nevada. I find the following description of the larger lake by Arnold Hague in King's Descriptive Geology, vol. ii, pp. 746-749.

"The lake is about five-eighths of a mile in diameter, with water of a clear blue color, it has no outlet and is fed by a spring of cool fresh water. The water is highly charged with alkaline salts and is so dense that the human body floats in it without exertion, and, after drying, the skin is left with a thin white covering.

"The water appears to be wanting in animal life, with the exception of a minute fly, the larva of which is a small worm, accumulating in such large quantities as to form a belt a foot wide along the shore. It is occasionally gathered by the Pah-Ute Indians, and, after drying and pulverizing, made into a sort of meal or flour." From analyses of the water made by Professor Allen its specific gravity is 1.0975, the fixed residue in 1,000 parts being 114.7. This residue consists of common salt, 64.94; sulphate of soda (Glauber's salts), 13.76; carbonate of soda, 29.24; sulphate of potash, carbonate of magnesia, etc., 4.63.

By comparison of these larvæ with a number collected by Professor Silliman, from Lake Mono, and kindly lent me by Professor Verrill, I find them apparently quite the same. At my request Professor Wm. H. Brewer has kindly given me the following description of the lake and the flies, which will be read with interest.

"MY DEAR SIR:"

"You asked about the flies from Lake Mono, and, although I have a sufficiently vivid recollection of them, I have turned to a file of old letters written to my friends at home at the time and on the spot."

“At the time, I was first assistant on the State Geological Survey of California, and had charge of a party doing field work. In this work I camped with my party at Lake Mono, July 9th, 1863, and remained there several days visiting the islands in the lake, also a camp of Indians (July 11th) who were camped on the north shore gathering *koo-chah-bee*. Our guide called them Pah-Utes and said they were there at that particular time gathering the worms—an annual visit. They were one of the small tribes of Mono Indians (we saw others, also Monos) there for that purpose, the guide using the term Pah-Utes as a sort of generic term, including many of the Indians of the Basin.

“My letter, written on the spot, tells that it is a closed basin, altitude about 6,800 feet; the waters very saline from various salts, impregnated with soda, borax, and boracic acid, the latter doubtless from the hot springs in and about it. It is in a volcanic region. ‘The waters are clear, *very* heavy, have a nauseous taste, and when still, the lake has a look as of oil and is not easily disturbed. The water feels slippery to the touch, and will wash grease from the hands or from clothes, cold, more readily than common soap-suds will when hot. It is said that no fish or reptile lives in it, but it swarms with countless millions of larvæ, that develop into flies which rest on the surface of the water, as well as cover everything on the immediate shore. The number and quantities of these flies and larvæ are absolutely incredible. They drift up in heaps along the shore, and *hundreds of bushels* could be collected! They only grow at certain seasons of the year, and then Indians come from far and near to gather them for food. The worms are dried in the sun, the shell rubbed off by hand, when a yellowish kernel remains, like a small yellowish grain of rice. This is oily, very nutritious and not unpleasant to the taste, and, under the name of *koo-chah-bee* (so pronounced), forms a very important article of food. The Indians gave me some of it; it does not taste badly, and, if one were ignorant of its origin, it would make nice soup.’ It tastes more like patent ‘meat biscuit’ than anything else I can compare it with.

“I will say in addition that *koo-chah-bee* was rather palatable. The waves cast these larvæ in little windrows on the shore; the quantity is large, the chief difficulty in collecting is to get it as free from sand as is possible, and it is then dried on clothing or blankets. My guide, an old hunter there, told me that everything fattens in the season of the *koo-chah-bee*; that ducks get very fat, but their flesh

tastes unpleasantly from it, and that the Indians get fat and sleek. There are many gulls about the lake at that season.

“The flies settle on twigs, spires of grass, etc., until nothing of the perch can be seen, merely a wand of closely clinging flies. They also at times rest on the water in great numbers.”

In addition to these larvæ a Phyllopod crustacean belonging to the genus *Artemia* (*A. Monica* Verrill) is, according to Professor Verrill, found in large numbers in the waters of Lake Mono. This genus, like *Ephydra*, is, as stated by Professor Verrill, “remarkable for its habit of living and flourishing best in very saline and alkaline waters such as the natural salt lakes of Egypt, Utah, etc., and artificial brines.” (Am. Jour. Sci., xviii, p. 244, 1869, and Proc. Am. A. A. S., 1869.)

The fly is small, black, and scarcely more than the sixth of an inch in length. It belongs to the genus *Ephydra*, the larvæ of many species of which are known to inhabit saline or alkaline waters. The present species is perhaps new, but in deference to the opinion of Professor Packard, who compared these same Mono Lake larvæ with the larvæ he described and named from Clear Lake, California, I here describe the adult fly for the first time under the name of *E. Californica* Pack. In a large number of larvæ examined the differences were slight, the one here figured being one of the more slender.

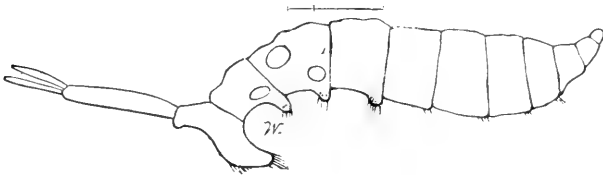

Larva of *Ephydra* (?) *Californica*.

By comparison with the figure given of *E. Californica* (Am. Jour. Sci., 3d ser., vol. i, p. 103) differences will be apparent. It differs from the description in that the anterior end tapers abruptly, not gradually, and the end is not truncate; the first four abdominal legs are scarcely apparent, their presence being only indicated by the short bristly hooklets. Their identity will only be determined by the comparison of the adults from Clear Lake. The description of the fly from the Soda Lakes is as follows:

Ephydra Californica.

? *Ephydra Californica* Packard, Am. Jour. Sci., 3d ser., vol. i, 103, 1871 (described in the larval and pupal stages only).

♂ ♀. Black, nearly opaque; third joint of antennæ without lateral pile, arista pubescent; epistoma of female with numerous lateral bristly hairs; in the male nearly bare. Length $3\frac{1}{4}$ – $3\frac{1}{2}$ ^{mm}.

Black, very slightly shining, nearly opaque, lightly cinereous pollinose, on the face somewhat ochraceous, apparently the same in both sexes. Front, except the lateral margins, shining, slightly greenish. Antennæ black, third joint bare; arista pubescent. Face with its greatest convexity in the lower part, in the females the sides above the oral margin with numerous long, black bristly hairs, in the male the face is almost wholly bare, except some short hairs in the middle above. Legs black, cinereous pollinose, the anterior and posterior tarsi with golden pubescence on the under sides. Wings with a grayish or blackish-gray tint, the veins black. Soda Lakes, Nevada.

This species must strikingly resemble *E. subopaca* Loew, from Connecticut, and it is not impossible that it is the same. The larvæ of two undescribed species of this genus have been taken by Professor Verrill from the sea-water of New England. *E. halophila* Pack. was bred from strong salt brine from salt works in Illinois. *E. gracilis* Pack. was described from larvæ from the great Salt Lake, Utah, where they also exist in great quantities. They will be readily distinguished from *E. Californica* by their greater slenderness and more elongate respiratory tube, which is two-thirds as long as the body or more.

Since writing the above I have had the pleasure of examining, through the kindness of Prof. Riley and Dr. E. A. Barber, specimens of another species of *Ephydra*, most probably *E. hians* Say, sent by Prof. Antonio Peñafiel from Mexico. In a letter just received from this gentleman, he says in regard to them: "Mosca que se encuentre en las orillas del Lago de Tetscoco, y cuyas larvas en cantidades verdaderamente asombrosas se desarrollan en una agua muy alcaline, que contiene grandes cantidades de sesquicarbonata de sosa."

III.—NORTH AMERICAN CONOPIDE: *Stylogaster*, *Dalmannia*,
Oncomyia.* BY S. W. WILLISTON, M.D.

THE following pages contain the result of studies made some time ago, the publication of which has been deferred in the hopes of adding the remaining species of the family belonging to the genera *Zodion* and *Myopa*. The greater difficulties that these genera present, however, will require for their elucidation a larger amount of material than is at present at my command. In a future paper I hope to complete the family, so far as it is at present known in North America. There must be many new species.

Stylogaster.

Macquart, Hist. Nat. des Dipt., ii, 38, 1835. Dipt. Exot., ii, 3, 17, 1845.

Stylomyia Westwood, Proc. Zool. Soc. London, 1850, p. 270.

Ptychoproctus Bigot, Revue et Mag. de Zool., No. 7, 1859, pl. xi, fig. 4.

But four species of this genus are known, so far as I can learn, from Africa, North and South America. The genus was first described by Macquart and figured from Wiedemann's description of *Myopa stylata* (Fab.) As might be expected, the figure is ludicrously incorrect, and his description not much better. Hence it was that Westwood described the genus more correctly as *Stylomyia*. The genus may be characterized as follows:

Antennæ with a subterminal arista; face carinate, narrow; eyes large, with an area of enlarged facets in front near the face; proboscis very long, twice bent; abdomen cylindrical, ending in the female in a long slender ovipositor; anal cell of the wing small, obtuse, not extending toward the border of the wing. Small slender species, in large part yellow.

Second joint of antennæ short; third elongate. *neglecta*, new.

Second joint nearly as long as the third. *biannulata*.

Stylogaster neglecta, new species.

♂ ♀. Eyes in life bright green, with an area of enlarged facets directly in front near the facial border. The eyes are separated by a

* On the N. A. species of *Conops*, see vol. iv, pp. 325-342.

nearly equal distance above and below, and narrowed in the middle of the profile to about one half. Face nearly perpendicular, silvery white, and with a well-pronounced median carina; below the eyes the cheeks are very narrow. Antennæ: first joint short, scarcely longer than broad, directed obliquely upward, usually of a light yellow color; second joint small, nearly equilaterally triangular; third joint somewhat falciform, about five times longer than wide, widest on its proximal half, reddish yellow, narrowly black along its upper border. Proboscis black; at base and tip whitish yellow. Front, when seen obliquely, with a somewhat grayish reflection, with two blackish opaque divergent stripes meeting each other at the yellow base of the antennæ and thence extending to the angles of the eyes, the enclosed triangle grayish or brownish; between the stripes and the eye the silver of the face (but less distinct) reaches to an acute point; in addition to the small bristles near the ocelli there are two strong vertical ones. Thorax black with black bristles and short recumbent golden pile; humeri and pleuræ, except a broad blackish stripe extending down from in front of the wings to the middle coxæ, light yellow. Abdomen mostly a reddish or brownish yellow with short black recumbent pile; first segment black above; third, fourth and fifth segments whitish with white pile on the anterior border; fourth and fifth segments usually quite brownish, sometimes blackish above; in the female the sixth segment is very short, the seventh continued into a long slender blackish ovipositor, quite as long as the body; at its base it is reddish, just before the tip conspicuously white annulate, at the extreme tip black. Legs: anterior and middle coxæ, femora, tibiæ, and metatarsi yellowish white, three last joints of tarsi blackish; hind coxæ blackish behind, hind femora yellow with short black pile and two brownish or blackish rings on basal and outer thirds; hind tibiæ straight and slender on the basal three-fifths, the distal portion somewhat thickened with a conspicuous white ring before the black tip, tarsi deep black. Wings hyaline, veins black, posterior cross-vein quite oblique, first posterior cell closed just before the tip. Length, $5\frac{1}{2}$ –6^{mm}; length of ovipositor, 6^{mm}.

This species I have found very common in the latter part of July in Connecticut. They frequent in numbers the flowers of the Button Ball (*Cephalanthus*).

Stylogaster biannulata (Say).

Myopa biannulata Say, J. Acad. Phil., 81, 3; Compl. Wr., ii, 72.

? *Stylogaster stylatus* (Fab.) Macq. Dipt. Exot., ii, 3, 17; tab. ii, f. 3; Fabricius, Syst. Antl., 177, 11 (*Conops*); Wied., Aus. Zw., ii, 243, 2 (*Myopa*).

Stylomyia confusa Westwood, Proc. Zool. Soc. London, 1850, p. 271.

♂. Rather larger than *S. neglecta*. Second joint of antennæ nearly as long as the third, the third scarcely three times longer than wide, blackish on outer part; face silvery white; front blackish, yellowish or silvery on the sides. Proboscis black, with whitish base and tip. Dorsum of thorax black, with black bristles, the sides and pleuræ whitish yellow. Abdomen yellow, on the posterior borders of the second to sixth segments brownish; pile blackish; hypopygium rather smaller than in *S. neglecta*. Anterior and middle coxæ and legs light yellow, two or three last joints of tarsi blackish; hind femora biannulate as in *S. neglecta*; on the under side of basal third there is a conspicuous brush of fine long black pile; hind tibiæ on basal three-fifths yellow, short black pilose at the base, whitish pilose near the middle, distinctly angulated and bent away on distal portion, blackish and with longer fine black pile, leaving a space, when tibiæ are flexed, that is filled by these brushes of pile; hind tarsi black. Wing distinctly broader than in *S. neglecta*, the posterior cross-vein less straight, the first posterior cell shorter and broader, and the last section of the fourth vein more deeply curved. Length, 7^{mm}. One specimen. Conn.

The present species has been the subject of no little confusion. Wiedemann, who considered Say's species a synonym of *Conops stylatus* Fab., evidently had two distinct species before him, as is evidenced by his description of the third joint of the female's antennæ, which he says was increased in size at the cost of the second joint. Numerous specimens of the preceding species have satisfied me that there is no such difference between the male and female antennæ. The type specimen of *Conops stylatus* Fab. was a female, and the North American specimen that Wiedemann had was a male, which from the smaller third antennal joint seems to have been this. As Wiedemann could not have had the same species as Fabricius' type, there is of course no evidence that the present is *S. stylata*, and indeed the probabilities are that it is not. Macquart's figure and descriptions are utterly worthless, as he evidently never saw a specimen nor even a figure of the insect.

Say's description of the third joint of the antennæ being yellowish rufous, the extreme joint dusky, the margins of the thorax and the

pleuræ being white, the abdomen reddish yellow, with the posterior margins of the segments brown, together with the length ($\frac{3}{16}$ of an inch), must apply to this and not to the preceding species. That it is also Westwood's *S. confusa* seems certain from the length of the second and third joints of the antennæ.

Dalmannia.

Dalmanoida Rob. Desvoidy, Ess. Myod., 248, 1830.

Dalmania id., Myopaires; Loew, Centuries.

Stachynia Macquart, Dipt. du Nord, 1830-34; Hist. Nat. des Dipt., ii, 36.

Third joint of the antennæ with a distinctly dorsal bristle; proboscis not longer than the body, bent near the middle, the terminal division folding back; abdomen moderately contracted toward the base, somewhat depressed, the ovipositor not as long as abdomen, incurved and folded up beneath the abdomen; anal cell short, but little longer than the second basal cell.

Shining black species with bright yellow markings.

Dalmannia picta, new species.

♀. Face and cheeks light yellow. Front blackish, yellow on the sides. Antennæ black, rather shorter than in *D. nigriceps*. Thorax black, shining; humeri, a small vittula in front of the wings, and tip of the scutellum bright yellow; pile white. Abdomen black, with white pile; first segment with a broad posterior yellow cross-band, broken up into three angles on its anterior part; third segment similar, but the angles developed into three processes, the middle one acute, the outer ones obtuse, rectangular; in the fourth segment these processes are produced nearly to the anterior border, the side ones larger and each enclosing a small black spot; fifth with a median triangle and two oblique side spots. Legs yellow; anterior femora above nearly the whole length, and the posterior above toward the end, deep black; tarsi black. Wings nearly hyaline. Length, $5\frac{1}{2}$ mm. One specimen. New Mexico.

This species agrees rather closely with *nigriceps*, but there can be no doubt of their distinctness. The male will probably show similar differences in the color of the legs and cheeks.

Dalmannia nigriceps.

Dalmannia nigriceps Loew, Centur., vii, 71.

♂. Black, moderately shining. Front opaque black, narrowly yellowish near the eyes, ocellar tubercle shining. Face and narrow posterior portions of the cheeks yellowish white, the cheeks broadly black.

Antennæ black, the second and third joints of nearly equal length; the divisions of proboscis rather longer than anterior tibiæ. Thorax with whitish pile; humeri, a small vittula in front of the root of the wings, and a circular spot near tip of scutellum yellow. Abdomen with similar whitish pile; first segment wholly black, second segment with a narrow posterior yellow border, slightly dilated in the middle; third and fourth segments similar except that the triangular is successively larger and acutely prolonged anteriorly; fifth segment with a narrow spot. Venter yellow, with a black basal triangle. Coxæ black. Legs yellow; anterior femora, except the apex, posterior femora with a rather broad subapical annulus, and all the tarsi black. Halteres yellow. Wings subinfuscated, lighter toward the base.

♀. Like the male, except that the front is more broadly yellow on the sides; the face, cheeks and anterior coxæ are yellow, and the black of the anterior femora confined to a subapical dorsal spot.

Length $6\frac{1}{2}$ mm. Connecticut, New York (Prof. Comstock).

In the absence of black on the head and legs, the female differs strikingly from the male. Specimens of both sexes were, however, taken at the same time and place, and doubtless belong together. Loew described the male.

Oncomyia.

Oncomyia Rob. Desvoidy, Dipt. des. Envir. de Paris, 50 (1853).

Oncomyia Loew, Centur., vii, 73.

Medium. size to small species, nearly bare, moderately shining, dark colored, very similar to *Zodion* in appearance. Face rather larger than in *Zodion*, along the oral margins with a row of hairs; cheeks narrower than the vertical diameter of the eyes. Second joint of antennæ elongate, third as long or shorter than the second, oval. Proboscis slender, elongate, with a hinge near the middle, the terminal portion folding back as in *Myopa*. Abdomen elongate, moderately narrowed toward the base, very convex above; process of the fifth segment below in the female large. Anal cell of the wing acute, extending toward the border.

The species of *Oncomyia* are very difficult to distinguish, and the coloration, especially of the legs, is variable. The only way that a certain knowledge of them will be obtained is by the study of large collections, made in the same localities, and properly labeled. For this reason I have not thought it desirable to describe isolated specimens, though by so doing several additional species would have been added.

Second joint of the antennæ but little or not at all longer than the third. Small species ($5-5\frac{1}{2}^{\text{mm}}$). *Baroni*, new.

Second joint of antennæ considerably longer than the third.

Large species ($8-9^{\text{mm}}$); femora and tibiæ wholly reddish yellow. *modesta*, new.

Smaller species ($5\frac{1}{2}-7^{\text{mm}}$); femora, or at least tibiæ, in large part blackish. *abbreviata*.

For *O. loraria* see below.

Oncomyia modesta, new species.

♂ ♀. Front reddish, black above at the vertex, below the vertex with a large blackish V-shaped spot. Face obscurely yellowish white, the excavated portion shining, the sides and cheeks with a silvery luster extending up along the eyes narrowly to the middle of the front. Cheeks scarcely as broad as the horizontal diameter of the eye. Antennæ: first joint blackish, second joint black on its upper half, yellowish red below; third joint black at its tip and upper border, yellowish red on its basal portion, more especially on the inner side, not more than two-thirds as long as second joint, scarcely more than once and a half longer than its width; the two joints of the proboscis of nearly equal length. Dorsum of thorax black, in well preserved specimens with whitish dust, leaving a median narrow blackish line. Abdomen black, with the same conspicuous dust on the sides of second and third segments and nearly covering the remainder; in the female the fifth and sixth segments are very short, the seventh wholly shining. Anterior coxæ mostly yellowish red, with silvery luster; middle and posterior coxæ black, the latter with silvery luster. Legs yellowish red, the tips of the tibiæ sometimes somewhat blackish. Tarsi blackish toward the tip. Wings with a distinct blackish shade, yellow at the base. Length $7\frac{1}{2}-9^{\text{mm}}$.

Eight specimens. Washington Territory. California (Baron).

A single female specimen from Mt. Washington (Mr. W. H. Patton) resembles the western specimens very closely, but the third joint of the antennæ is nearly as long as the second, and rather more than twice as long as wide. The femora are black on the distal and upper portions, the tibiæ are blacker at their tips and the tarsi almost wholly so. These differences make me very much inclined to believe that it is specifically distinct, but a single specimen is not sufficient to decide it.

Oncomyia abbreviata.

Oncomyia abbreviata Loew, Centur., vii, 73.

♂ ♀. Black with dilutely cinerous, subopaque pollen. Face and cheeks light yellowish, with a silvery luster on the sides, extending up narrowly on the sides of the front. Front lutescent, with a black V-shaped spot above, sometimes only blackish on the upper part. Antennæ red, black along the upper border, second joint nearly half as long again as the third. Second joint of the proboscis a little shorter than the first. Dorsum of thorax grayish pollinose, in well preserved specimens with two faint, more thickly pollinose, median, slender stripes on front part of thorax. Abdomen cinereous pollinose, more shiny along the middle. Legs, varying from blackish, except the bases of femora, tibiæ and tarsi, to yellowish red, with a blackish spot on the end of femora, the distal half of all the tibiæ and terminal joints of tarsi black. Wings lightly infuscate, veins obscurely fuscous, towards the base reddish. Length $5\frac{1}{2}$ –7^{mm}.

The hind femora always show the base more broadly reddish, and when the spot is confined to the tips of the femora it is only fuscous in the hind pair. These differences would make me doubt the unity of the species were it not that nearly a dozen specimens were taken at the same time and place (Conn., June 25). I do not think it at all doubtful that it is Loew's species; he had light colored specimens, in which the front was more reddish, and the faint dorsal stripes wholly imperceptible. A single specimen from Washington Territory I can in no wise distinguish unless, perhaps, the second antennal joint is a little shorter. Other specimens I have from New York, also District of Columbia (Lw.)

Oncomyia Baroni, new species.

♂ ♀. Closely related to *O. abbreviata*, but the second joint of the antennæ is shorter, scarcely longer than the third; the color is more shining black and the specimens are all distinctly smaller. Front blackish above, shiny, except two opaque elongate spots convergent in front, yellow on lower part. Antennæ black; the second joint below, and the third joint, except the upper anterior part, reddish. Second joint of proboscis shorter than the first. Legs in most of the specimens reddish yellow at the base of front and middle femora, basal half of hind femora, base of all the tibiæ and tarsi; the remain-

der blackish, in some specimens with less reddish. Wings infusate on outer part, yellowish toward the base. Length $5-5\frac{1}{2}^{\text{mm}}$.

Eight specimens from California (O. T. Baron) and one, which appears to be the same, from North Park, Colorado, (G. B. Grinnell).

Oncomyia loraria.

Oncomyia loraria Loew, Centur., vii, 74.

Translation: "♂ ♀. Black, lightly whitish pollinose, antennæ black, below red, legs in large part black, second joint of the proboscis exceeding the first a little in length. Long. corp. $1\frac{3}{4}-2\frac{1}{4}$ lines; of wings $1\frac{5}{8}-1\frac{3}{4}$ lines."

"Black, lightly whitish pollinose, moderately shining. Head dilutely yellowish, face with a white lustre. Front sordid reddish, near the vertex black-fuscous or black. Antennæ black, reddish below except the tip ('lateribus adversis præter marginem superum et præter apicem, aversis in margine infero rufis'). Second joint of proboscis a little longer than the first. Occiput black. On the dorsum of the thorax three lines denuded of pollen are indistinctly visible. Legs black, knees and base of posterior femora always, anterior coxæ, base of front and middle femora, and base of all the tibiæ and front joints of all the tarsi frequently testaceous. Wings cinereous, or dilutely infusate, base narrowly lutescent. (New Hampshire)."

A single specimen from Connecticut I would identify with this, except that the second joint of the proboscis is considerably shorter than the first, a character, however, that seems to be of little value; the smaller size, $2\frac{1}{2}-4\frac{1}{2}^{\text{mm}}$, would seem to prove its distinctness from *O. Baroni*.

IV.—ON THE ANATOMY OF *Libinia emarginata* Leach, THE SPIDER CRAB. By E. A. ANDREWS.

THE body of this common crab is spheroidal in form, prolonged in front so that this part has a triangular outline. It is covered with a firm chitinous shell, densely clothed with minute flattened processes, setæ, whose edges are armed with spines, and with longer, more hair-like, setæ, similarly armed. The dorsal surface bears also many stouter setæ with recurved tips. All these processes serve to entangle algæ, hydroids, and dirt.

The stout carapace completely covers the dorsal surface of the animal and is prolonged between the eyes to form the emarginate or slightly forked rostrum (*rs*, fig. 1). It is set with numerous blunt spines and divided by grooves into regions, which take their names from the internal organs lying below them. A short transverse groove, part of the cervical groove, near the center of the carapace separates a broad swollen anterior area, the gastric lobe, from a narrow central area, the cardiac lobe. The outward and forward prolongations of this transverse groove, together with a longitudinal groove extending back from each of its ends, separate the above mentioned lobes from the large lateral areas or branchial lobes. On either side of the anterior part of the gastric lobe a small swollen area marks the place of attachment of the large adductor of the mandible, but is known as the hepatic lobe. Above the bases of the legs the carapace is reflected inwards and, passing upwards as a thin, translucent, chitinous membrane (*c*, fig. 1), is attached to the upper edge of the flanks. A large branchial cavity is thus left on each side, between the flanks and the overhanging carapace. Posteriorly the carapace overhangs the basal portion of the abdomen, with the anterior edge of the dorsal surface of which its delicate reflected portion (*æ*, fig. 1) is continuous (*o*). In advance of the legs the reflected carapace forms on each side of the body a smaller, flattened cavity, the efferent canal (*f*, fig. 1), leading from the branchial cavity to the side of the mouth. The entire dorsal surface of the cephalothorax is thus protected by the carapace.

The abdomen is small and flat and closely bent under the body. It is composed of seven joints or segments whose integument is well

calcified in the exposed or true dorsal surface and less so on the protected or ventral surface.

In the male (fig. 2) the abdomen is narrow-triangular, and habitually lies in a correspondingly narrow groove on the ventral face of the thorax. The ventral surface is more membranous than in the female. The male abdomen is also peculiar in being held in position in the groove by means of a pair of small cavities (*o*) in the outer edges of the sixth segment, which fit upon a pair of pivot-like processes on the sternum of the second thoracic segment bearing ambulatory legs. The triangular terminal segment (*xxi*), however, which bears the anal opening, is free to move downward without the movement of the rest of the abdomen.

In the female (fig. 3), the abdomen is broad-ovate, and when not in use for carrying the eggs lies closely against the concave ventral surface of the thorax, almost completely covering the area between the ambulatory legs.

The abdomen may be raised till at right angles with the body. The muscles moving the segments of the abdomen are small and lie close to the upper and lower walls. The extensors on the dorsal surface extend from processes on the anterior edge of each segment to slight ridges in the preceding segment. Between each two successive segments there are two muscles, one on each side of the median line. The segments are connected by a flexible membrane, and also furnished with an articular process between each extensor and the outer edge of the segment. On the ventral surface the flexors of the abdomen are similarly arranged, joining chitinous ridges on the successive segments. The flexors of the first segment extend from the calcified ventral ridge to the integument of the thorax.

In front of the horizontal abdomen the ventral surface of the body rises at an obtuse angle and, becoming again horizontal, terminates in the rostrum. On this inclined surface a quadrangular depression, the peristome, bounded on either side by the pterygostomial plates or quadrant-shaped reflexed portions of the carapace is filled by the mouth appendages. On the sternal plastron (the sternal surface of the cephalothorax behind the peristome), four pairs of transverse grooves pass towards the center and indicate the boundaries of the five segments bearing the ambulatory legs. In the male a deep median groove separates the two halves of the sternal surface of the last of these segments. The inclined walls of the sides of the body forming the floors of the branchial cavity are also marked with faint corresponding lines or grooves. All these grooves are formed by

infoldings of the integument, which project into the body cavity as firm, thin, calcified partitions.

The partitions, or, apodemes, arising from the pleural region unite with those from the sternal region and form two tiers of apodemal cells or chambers, communicating with one another and with the central part of the body cavity. For each of the five segments bearing ambulatory legs, there are two of these cells, an upper and a lower one, except for the last segment, which, has only one. Since the pleural apodemes arise a little behind their corresponding sternal apodemes, each upper cell is a little behind the lower cell of the same segment; and in the first of these segments the lower cell is produced upward to the pleural wall of the body in front of its corresponding upper cell. The sternal apodemes, being as long as the grooves on the sternal plastron, pass nearer to the center of the body than do the pleural apodemes and terminate on sides of the swollen inner surface of the plastron. The two tiers are separated on the inner aspect by a broad chitinous band formed by the union of their walls, the posterior wall of the first lower cell being greatly produced backward and that of the fifth cell forward over the united intervening partitions. These bands are continuous posteriorly with the short median apodeme, which in the male is indicated by an external groove. In front of the ambulatory legs the apodemes are much smaller, forming, for the posterior three segments bearing mouth appendages, mere frameworks, still with upper and lower openings corresponding to the cells. The apodemes of the two preceding segments form, chiefly, two pairs of flat processes projecting into the body cavity and joined across it by tendinous bands. A pair of similar processes is formed by the apodemes between the second and third of the three segments just mentioned.

The chitinous covering of the body is lined by the true dermis (*d*, fig. 1), from which it is secreted, and which also envelops the apodemes and tendons. Over the dorsal surface and in the legs this skin is beautifully mottled with red, black and yellow.

The Appendages.—The various appendages of the crab may be distinguished according to their functions: as sense organs, belonging to the head; manducatory organs, belonging to the head and thorax; locomotive organs, belonging to the thorax; and the organs subservient to the reproductive function, which belong to the abdomen. Of these the last, those of the abdomen, differ greatly in the two sexes.

The abdomen of the male (fig. 2) bears two pairs of simple, three-

jointed, well calcified organs, arising from the first and second segments. The basal joint of the first pair (*b*, fig. 4) is large, triangular, immovably united to the sternum, and projects backward so that the following joint appears to arise from the second segment. The third joint (*d*) is a long, styliform organ, curving outward and bearing a small, membranous, triangular process (*p*) near the tip. The second joint (*c*) is small, and serves to make flexible connections between the first and third.

The second pair of appendages are much smaller than the first, and when at rest lie in cavities on the posterior face of the latter, at the base of the third joint. They have, like the first pair, an immovable basal joint (*b'*, fig. 4) followed by a small second joint; but the third joint (*d'*) is short, straight, and terminates in a membranous papilla (*p'*).

In the female there are four pairs of abdominal appendages (fig. 3) borne near the outer edges of the broad sterna of the second, third, fourth, and fifth abdominal segments. Each consists of two long slender branches (*ex*, *en*, fig. 5), articulated to the abdomen by a partially calcified membrane (*p''*) representing a basal joint. The outer branch, exopodite (*ex*), curves inwards and is densely covered with soft setæ on its outer face. The inner branch is composed of a shorter proximal and a longer distal portion freely articulated to the proximal. The distal portion stands nearly at right angles with the proximal, which is directed toward the medial line, and is divided into about fifteen imperfect joints by grooves on the upper or posterior face. A few similar grooves exist on the proximal portion; from the edges of all, long setæ arise. These appendages, like those of the male, are ordinarily turned backward against the sternal surface (fig. 3), and are concealed by the abdomen. They differ but little on the different segments, the length becoming less and the breadth of the outer branch greater toward the end of the abdomen. They are used for carrying the eggs.

The locomotive organs are five pairs of long, cylindrical, slender, six-jointed legs, attached between the edge of the carapace and that of the sternal plastron.

The annular basal joint (*c*, figs. 6, 7) moves horizontally on two pivot-like processes fitting into small cavities or sockets, a pivot on the lower edge (*x*) playing in a socket in the plastron, and a socket in the upper edge (*s*) receiving a pivot from the pleural wall, except on the fifth pair, where the upper socket is replaced by a pivot. Each of these joints is moved forward by powerful muscles attached to

the walls of the lower apodemal cell of its own segment and connected with the anterior edge of the joint by a chitinous, tendon-like process of that edge.

Backward movement is produced by muscles attached to the walls of the upper cell of the segment and similarly connected with the posterior edge of the joint. The articulations between the joints, except between the second and third, are similar pivot and socket arrangements, set at right angles to the plane of movement, which is alternately vertical and horizontal. With the exception of the third joint, each is moved by two sets of muscles connected with opposite edges of the proximal end by two tendons, and arising from the walls of the preceding segment, but the first joint being short the muscles of the second extend into the lower apodemal cell and are there attached. The articulation between the second and third joints is peculiar; they are united obliquely by a very firm membrane, which allows of a slight twisting or rotary motion of the third upon the second. The muscles arising from the walls of the second joint are connected by two short tendons with the posterior edge of the third joint.

The first pair of legs (fig. 7), which are not so truly locomotive in function as the others, differ in having the fifth joint enlarged, flattened, with the tip prolonged so as to form with the modified terminal joint a chela or claw, and in bearing a spine (*t*) on the proximal part of the third joint.

In the other legs (fig. 6) the terminal joint is conical and dark amber-colored at the tip. These chelate appendages differ, also, in the two sexes.

In the female (fig. 7) they are short, scarcely longer than the fifth or shortest pair of legs. In the male these chelate legs become nearly or quite as long as the second pair of legs and much stouter than in the female. The third and fifth joints are also longer in proportion to the length of the leg in the male than in the female, and the sockets at the proximal end of the fifth joint are not so prominent. These appendages present only slight and inconstant differences on the two sides of the body.

The manducatory appendages, which prepare the food and pass it to the mouth, are contained in the peristomial depression, and include one pair of mandibles and five pairs of flattened organs directed forward and overlapping one another. The densely calcified mandibles stand on either side of the mouth, at the center of the peristome, and bear two-jointed palpi on their anterior faces. The right mandi-

ble, which glides over the edge of the left in chewing, presents a slight tubercle at the apex of its curved cutting edge (*c*, fig. 8). Each mandible (fig. 8), projecting downward from the sternal wall, is articulated along its outer edge to the edge of the endostoma (*en*, fig. 20, this is the calcified sternal plate which forms the roof of the anterior part of the peristome and sends back a branch on either side of the mouth), while the inner edge (*a*, fig. 8) articulates posteriorly to a process from the sternum of the following segment.

Near this latter articulation a very long tendon (*t'*) arises from the edge of the mandible, and, passing obliquely upward by the side of the stomach, is connected with an adductor muscle (*m'*, fig. 1), originating from the carapace. The mandible is continued within the body cavity as a stout process, hollow on the posterior face, and is divisible into a vertical (*u*, fig. 8) and a horizontal or posterior branch (*m*). The former, extending up by the side of the stomach, is articulated externally to a large tendon (*t*), to which is attached the large triangular mass of abductor muscles extending outward and fastened to the carapace (*m*, fig. 1). From the inner face of this vertical process a large slender abductor muscle passes downward and inward in front of the long tendon of the smaller mandibular adductor, and is attached to the apodemal process arising between the first and second maxillæ. The posterior part of the process (*m*, fig. 8) is articulated with the anterior side of the framework to which the second maxilla is attached; and bears on its horizontal edge a slender tendon (*t''*) which arises vertically and is joined to the carapace by a small abductor muscle (*a, b*, fig. 1), which is accompanied by a long muscle running down to the first maxilla. The mandibles thus move transversely, with a slight rolling motion.

Inserted close behind and partly overlying the mandibles are the first pair of maxillæ (fig. 9), small delicate organs, divided into three lamelliform lobes or branches, the central and inner ones of which (*c, b*) bear stout bristle-like setæ. The external portion (*en*, fig. 9) bears only filiform setæ.

The second pair of maxillæ (fig. 10) are more important as accessory respiratory organs than as organs of mastication. They arise behind the first, but noticeably farther from the median line. The two lobes nearer the median line (*b, c, en*) are small and delicate, the outer (*b*) is cleft. The external lobe (*en*) bears long delicate setæ. Far the largest part of the appendage is the scaphognathite (*sg*), the large outer lobe which forms a curved lamina, prolonged longitudinally, and lying horizontally in the efferent canal. It acts con-

tinually, baling out the water from the branchial cavity through the efferent canal.

The pair of appendages arising behind the second maxillæ are the first pair or maxillipeds (fig. 11). Each bears two smaller lobes (*b*, *c*) near the median line: the innermost (*c*) which is much thickened, set with stout setæ, and projects forward from the side of the terminal point of the sternal plastron to the posterior edge of the mouth; and two long somewhat united lobes (*en*, *ex*), which run forward between the mandible and the opening of the efferent canal. The outermost of these latter lobes (*ex*) bears a slender palpus (*p*).

Still farther from the median line, the maxilliped gives rise to a long lamina (*ep*), which extends far back into the branchial cavity over the surface of the branchiæ and is called the epipodite or gill-scraper (*s*, fig. 1). Its basal part is much broadened and lies under the posterior half of the scaphognathite.

In the next pair of appendages, the second maxillipeds (fig. 12), the inner lobes (*b*, *c*) are less prominent, while the long external lobes (*ex*, *i-d*) are entirely separate. The epipodite bears on its basal stem-like portion a small, symmetrical branchia (*br*). This epipodite extends below the branchiæ, in the upper part of the branchial cavity (*s'*, fig. 1).

The most posterior of the mouth appendages, the third maxillipeds (fig. 13) resemble the second maxillipeds; but the two long lobes (*ex*, *i-d*) are much broader and thicker, forming a stout covering to all the preceding mouth parts. The long, stout stem of the epipodite bears an unsymmetrical branchia (*br*) and extends outward above the basal joint of the chelate leg, forming a sort of valve to the efferent opening of the branchial cavity, and then turns back nearly at right angles, as a lamina, under the branchiæ in the lower part of the branchial cavity (*s''*, fig. 1).

The appendages of the head, which bear the sense organs, are the pair of eye-stalks and the two pairs of antennæ or feelers. The most anterior, the eye-stalks (fig. 14), are short, cylindrical, two-jointed organs, arising side by side from the upper edge of the perpendicular portion of the sternal wall and directed outward (*e*, fig. 1). The basal joint (*a*, fig. 14) is imperfectly calcified on the posterior side, but the second joint (*b*) is well calcified, constricted about the middle, and terminates in a convex, transparent surface, serving as a cornea (*c*). The entire appendage lies in the orbit, a cavity formed by the union of processes of the rostrum and carapace with the basal joint of the second antenna, and when not in use its corneal surface

is concealed by being folded back against the concave surface of the process arising from the carapace, as at *e*, fig. 20.

The first pair of antennæ, or antennules (fig. 15), are inserted immediately below the eye-stalks, but are directed downward and forward. They lie in the antennular cavity, which is bounded below by the basal joint of the antenna on either side, and is roofed over above by the rostrum. The large cuboidal basal joints (*a*) nearly fill the upper part of the cavity, and are separated from one another by a median partition formed by a process of the rostrum and one from the epistoma or antennary sternum. Three joints bear, on the side farthest from the median line, a slight groove (*h*) marking the entrance to the auditory sac or ear. The remaining joints of the antennule may also be folded up within the cavity and thus protected. The second (*b*) and third (*c*) are more slender than the first, and cylindrical; the third bears at its extremity two short, jointed filaments (*f*, *g*). The lower or posterior filament (*g*) is composed of about nine joints; the anterior (*f*), of about twenty-nine, which, except the large basal one and the terminal three, are very short and bear on their lower sides light colored setæ with dark brown bases, forming a dense brush.

The second antennæ, or antennæ proper (fig. 16), arise below and exterior to the antennulæ and project forward horizontally (*a*, fig. 1). The basal joints (*a*, fig. 16) are very large, rectangular in outline, and are firmly soldered at their bases to the antennary sternum and at their tips to the rostrum, thus bridging over the passages joining the orbits with the antennular cavity. Near the base of each, is the opening of the duct of the green gland, which is closed by an elliptical plate (*a*, fig. 16), produced within the body cavity as a slender, chitinous process. The two following joints of the antennæ (*b*) are much smaller than the first, resembling the corresponding joints of the antennulæ, and lie by the edge of the rostrum. From the extremity of the third joint a single slender filament (*d*), composed of about fifteen joints, projects forward a little beyond the tip of the rostrum (fig. 1).

Alimentary System.—The alimentary canal (fig. 19) includes the œsophagus, stomach, and intestines, with their appendages.

The mouth is a longitudinal, quadrangular opening at the center of the peristome, bounded anteriorly by the large fleshy lobe, the labrum (*lb*, fig. 19), laterally by the mandibles, and posteriorly by the forked metastoma, a lobe of which lies in the cavity on the posterior face of each mandible.

From the mouth the short, wide œsophagus (*œ*) leads upward and slightly backward to the large stomach, which lies partly above the mouth and fills most of the cavity of the head region (*g*, fig. 1). The stomach includes a large spherical anterior portion (*e*, fig. 19), the cardiac region, and a smaller, cylindrical, posterior part (*p*), the pyloric region, which is inclined downward. Like the œsophagus it is lined with a thin chitinous cuticle continuous with the external chitinous body wall; and which in the pyloric and posterior part of the cardiac regions becomes folded and thickened to form the numerous chitinous ossicles and ridges which make up the complicated grinding and straining apparatus (figs. 17, 18).

On removing the muscular walls of the stomach the chitinous cuticle is seen to have a very irregular surface, the ossicles projecting and deep cavities corresponding to some of the internal projections. A deep dorsal, and deeper ventral cavity serve to make a constriction between the pyloric and cardiac regions.

The chief pieces of the grinding apparatus of the cardiac region are three stout ossicles bearing internal, dark-colored, toothed prominences. Of these a long, median one, the urocardiac ossicle (*uc*, fig. 18), extends along the dorsal surface from the dorsal cavity in front of the pylorus to near the center of the cardiac region, where it is closely united to a small triangular ossicle, the cardiac ossicle (*c*), which articulates on either side to a long transverse piece (*pt*), the pterocardiac ossicle, which at its outer end articulates to the supero-lateral cardiac ossicle (*sl*, figs. 17, 18, 19). This urocardiac ossicle bears at its posterior end a blunt median tooth-like process with a more acute one on either side of, and a little in advance of it (*l*, fig. 18). The two supero-lateral cardiac ossicles complete the main part of the grinding apparatus, being broad plates posteriorly produced within the cavity of the cardiac region as stout, horizontal, longitudinal ridges (*r*, fig. 17), armed with blunt, tooth-like prominences (*t*, fig. 18). These ridges may be made to meet one another and, with the toothed surface of the urocardiac ossicle which descends, must aid in crushing the food. The large lateral ossicles above mentioned articulate posteriorly with a pair of but slightly calcified plates, the pyloric ossicles (*po*, figs. 17, 18), which lie on the dorsal surface of the anterior part of the pylorus and serve to connect these lateral ossicles with the median, præpyloric ossicle (*p*). This latter ossicle forms the anterior face of the upper part of the pylorus and articulates at its lower end with the urocardiac ossicle. These three median ossicles and three pairs of paired ossicles (including the pyloric

ossicles) are the only ones visible on the dorsal surface of the cardiac region.

On the ventral surface a single median cartilaginous plate forms the posterior face of the cardiac region and projects as a tongue-shaped process into the mouth of the pylorus. This is the posterior cardiac ossicle, and leads from near the œsophagus to the opening into the pylorus where it is fringed with setæ. Between its forked lower extremity and the opening of the œsophagus a median lamella projects into the cardiac cavity. The posterior cardiac ossicle is closely united on each side to a slender ossicle (*ap*, fig. 17), which forms a rim along the lower posterior edge of the cardiac region. Each of the slender ossicles articulates at its upper posterior end with a slender vertical ossicle (*pl*, fig. 17), the postero-lateral, which joins above to the supero-lateral; and it is also joined to the lower anterior ossicle (*ip''*, fig. 17) of the pylorus. Just above and parallel to each of these rim-like ossicles (*ap*, fig. 17) a more slender ossicle (*il*), the infero-lateral, supports a delicate fringe of setæ lying parallel to the posterior cardiac plate and to a similar fringe arising just above the infero-lateral ossicle. The curved lower end of this ossicle (*a*, fig. 17) is attached to a papilliform process, covered with long setæ, which stands at the lower end of the double fringe. Its curved upper end (*b*) articulates to the lateral cardiac piece (*bc*). This is a small infolding of the cuticle projecting into the cardiac cavity as a five-clawed, calcified process, below the large toothed surface of the supero-lateral ossicle. It is joined to the latter ossicle by a long curved ossicle (*ac*), the accessory cardiac ossicle, which passes forward and upward and is connected by a short cartilaginous piece (*k*) with a projection on the slender anterior part of the supero-lateral ossicle.

There are thus twenty distinct ossicles visible on the external surface of the chitinous lining of the cardiac portion of the stomach, four median and sixteen in pairs. There are also two slightly calcified areas on either side above the œsophagus (*m*, *n*, fig. 17) which internally are covered with setæ. Moreover, behind each supero-lateral and each lateral toothed process, and on each side of the præpyloric ossicle, behind the urocardiac, a cushion-like process set with numerous setæ projects into the cavity of the stomach.

The chitinous cuticle of the pyloric region of the stomach is much compressed along its lower half; but its lower edge projects outward as a broad shelf, formed posteriorly by the well calcified lateral pouch (*o*, fig. 17) on either side. The upper more cylindrical portion

may be divided into three dilations or pouches. The most anterior of these and the largest, lies behind the præpyloric ossicle, and bears on its upper surface the two pyloric plates and on each lateral surface a slender ossicle (*s*, fig. 17) whose anterior end is inserted between the pyloric ossicle (*po*) and the supero-lateral cardiac ossicle (*sl*). The middle pouch is narrower and on a lower level than the first, it bears four meso-pyloric ossicles. A pair of these lie along the upper surface (*ms*, figs. 17, 18), one on either side of the median line, and articulate at their posterior ends with a pair of somewhat triangular transverse ossicles (*tu*). These latter are articulated to the upper posterior processes of the lateral pyloric ossicles (*lp*). This lateral pyloric ossicle on either side is a broad vertical piece, descending across the compressed part of the pylorus, and is articulated by a slender process at its lower anterior edge with the small plate (*z*, fig. 17) forming the upper surface of the anterior part of the shelf-like projection of the pylorus, while a process from the lower posterior end joins it to the postero-lateral pyloric plate (*pp*, fig. 17). At this point of union a delicate, spatulate process projects from the wall of the pylorus (*p*, fig. 18). The posterior pouch is formed by the origin of the chitinous lining of the intestine and is broader than the compressed part of the pylorus, projecting on either side. Its anterior edge is formed by an arch of five delicate uropyloric ossicles, a curved median dorsal one (*up*, fig. 17, 18) and two pairs of lateral ones (*up'*, *up''*), of which the lower are much the smaller. From this framework a delicate chitinous cuticle extends backward a short distance into the intestine in the form of a funnel (*f*) open on the lower side; it is then reflected back on itself for more than half its length and is attached to the muscular wall of the intestine. The folded portion, which thus projects freely into the intestine, must form a valve preventing the contents of the intestine from passing forward into the stomach. Below this posterior pouch the lateral pouches (*o*) connect with a pair of three-pronged ossicles (*d*, fig. 17) forming the posterior boundary of the pylorus and including between them the opening of the bile ducts into the posterior end of the pylorus (*h*). The horizontal upper surface of each lateral pouch or capsule is continuous with the broad, vertical, postero-lateral pyloric plate (*pp*) which forms part of the wall of the compressed lateral portion of the pylorus. These capsules are articulated anteriorly with a single median, transverse, infero-pyloric ossicle (*ip'*), the anterior edge of which articulates to a similar infero-pyloric ossicle (*ip*). This latter ossicle is larger and forms the posterior boundary of the deep cavity,

separating the lower part of the cardiac and pyloric regions, on the sides of which two processes (*ip''*) run forward to join the posterior cardiac ossicle, or rather the ossicles forming its rim. The principal chitinous pieces visible on the exterior of the pylorus are thus twenty-seven in number, three median and twenty-four in pairs.

The inner walls of the lateral pouches (*o*) are continued into the cavity of the pylorus as a stout median ridge, filling most of the narrow space between the postero-lateral pyloric plates (*pp*) and giving rise at its posterior edge to a transverse, lanceolate, valvular process which extends upward into the cavity and with the posterior pair of superior valves nearly closes the more open upper part of the pylorus. The two pairs of superior valves are lamelliform processes arising from the upper walls of the pylorus, fringed with setæ, and forming, when brought in contact, a straining apparatus. The anterior pair are prolonged backward from the upper wall of the middle pouch and have free triangular terminations. The posterior pair are curved ridges arising from the anterior edge of the third pouch. There is also a setose ridge on either side of the cavity of the pylorus, immediately above the postero-lateral plate, and a small setose papilla in advance of the origin of each antero-superior valve.

The chief muscles by which the chitinous skeleton is set in motion so as to bring the toothed processes in contact with one another, and which also aid in holding the stomach in place, are the anterior and the posterior gastric muscles (*ag*, *pg*, figs. 1, 19). The former pair extend from the cardiac and pterocardiac ossicles forward to a pair of lamelliform processes, arising from the sternal wall a little above the insertion of the optic peduncles. The pair of posterior gastric muscles pass back from the præpyloric and pyloric ossicles to the carapace, where they are attached to small transverse ridges on each side of the median line. There are also two other pairs of muscles on the dorsal face of the stomach, the cardio-pyloric (*cp*, fig. 1), extending from the pterocardiac ossicles to the præpyloric ossicle, and the supero-pyloric muscles (*sp*, fig. 1, 19), extending directly upward from the triangular mesopyloric ossicles to the carapace, where they are attached to a pair of disk-shaped processes.

On each lateral face of the stomach there are three extrinsic muscles: a stout, long muscle (*m*, fig. 19) extending from the interior of the two calcified areas on the side of the cardiac portion of the stomach forward to the roof of the efferent canal in advance of the mandible (*m*, fig. 20), and attached to a ridge on the surface; and two long, slender muscles (*m'*, *m''*, fig. 19), extending from the lower,

anterior edge of the pylorus downward and forward, and attached to the apodemal framework of the first maxilla. Among the intrinsic muscles on the lateral face, are four broad muscles (n, n', n'', n''' , fig. 19) arising from the posterior lower edge of the cardiac region. The upper two of these (n''', n'') are attached to the supero-lateral ossicle, the next (n') to the accessory cardiac ossicle, the lowest (n) to the calcified area on the side of the cardiac region. A pair of smaller muscles connect the posterior part of the cardiac with the anterior part of the pyloric region. From the latter, also, two muscles (o, o' , fig. 19) run upward on each side to the middle pyloric sac.

The œsophagus is connected with the endostoma by two muscles (l, l' fig. 19), on each side, one above and one below the commissure, and by a pair from the anterior face (a , figs. 19, 20). From the posterior face a pair of muscles (b) pass backward and outward to the points of attachment of the large mandibular abductors. The intrinsic muscles of the œsophagus may bring its walls in contact with one another, and valvular folds at the opening of the cardiac region act, in addition, to prevent the contents of the stomach from passing into the œsophagus.

The two ducts of the so-called 'liver' (l , fig. 1) enter the pylorus at its extreme lower posterior end (h , fig. 19). They divide into large branches with delicate walls at a short distance from their common opening; and the numerous branches ramify throughout the entire cephalothorax and basal portion of the abdomen, receiving the secretions of innumerable small, yellow, tubular sacs which make up the mass of the liver. The liver thus occupies all the spaces left between the other viscera and extends even a short distance into the apodemal cells.

The muscular wall of the stomach is continued posteriorly as the wall of the intestine (i , fig. 19). The latter viscus is a tubular organ extending back from the pylorus to the anus (an), which is on the ventral face of the telson, or seventh abdominal segment, without convolutions; but it is not entirely straight, bending down under the heart and then rising at the posterior part of the thorax on one side of the median line, and in the reflexed abdomen necessarily running forward.

The chitinous integument is continued inward at the anus as a delicate cuticle lining the intestine as far as into about the fourth abdominal segment where it terminates in a valvular arrangement formed by five thickened ridges. Corresponding to this valve there is a raised muscular ring (s) about the wall of the intestine

marking off the anterior portion (*i*), which is without chitinous lining, from the posterior, straight portion (*i'*) which is thus lined. The anterior portion receives the secretion of a pair of cylindrical glands or cæca (*u*, figs. 1, 19), which are coiled vertically, side by side, above the posterior part of the pylorus. They open into the origin of the intestine immediately behind the union of its muscular wall with the reflexed chitinous cuticle (*f*, figs. 17, 18), which forms the valve guarding the opening of the pylorus into the intestine. Slightly in advance of the valve separating the two regions of the intestine, a long tubular cæcum (*u'*, fig. 19) arises and runs forward, either on the right or the left of the intestine, and is coiled either horizontally or vertically by its side, in the upper posterior part of the thoracic cavity. On entering the intestine, its diameter is nearly half that of the latter, but it diminishes to a slender tube in the terminal coiled portion.

Reproductive System.—The internal reproductive organs are large and conspicuous, being of a clear white color in the male and bright red in the female, and lying partly exposed when the carapace and the underlying dermal covering are removed (*t*, fig. 1).

In the mature female the ovary consists of a pair of large cylindrical sacs filled with red ova, and which unite under the anterior edge of the heart. In advance of this union each lobe extends forward, by the side of the stomach, close to the carapace and then turns sharply back and extends upon the roof of the branchial cavity towards its apex. Behind the point of union the two lobes or sacs pass backward under the edges of the branchial cavities, and then turning downward unite with the posterior faces of two white sacs, the spermatheca. The spermatheca communicate with the exterior through cylindrical chitinous infoldings of the integument, the external openings of which are on the sternum of the third segment bearing ambulatory limbs. These two openings are on the anterior faces of two ridges or swellings of the integument at the inner ends of the grooves separating this segment from the preceding one. The ovary, before turning down to these spermatheca, sends back, either on the right or the left, a prolongation which extends into the abdomen and fills the median portion of its first two or three segments. Occasionally this backward prolongation is somewhat developed from both lobes of the ovary at the same time, and the organ then becomes more symmetrical.

In the male the generative organs occupy the same general position that the ovaries do in the female. The testes (*t*, fig. 1) are two very

long, slender tubules forming on either side of the stomach a much convoluted mass, which resembles in shape and position the corresponding lobe of the ovary and is like that united to its fellow under the anterior edge of the heart. Behind this union the tubules expand, forming on either side, beneath the heart, a convoluted tube (t' , fig. 1), which becomes posteriorly still larger and less convoluted and extends back to the opening in the chitinous roof of the posterior apodemal cell. Before passing through these openings these tubes or ducts receive the secretions of a pair of large glands (t'' , fig. 1) filling most of the space between the carapace and the posterior apodemal cells. These glands are composed of large, translucent, irregularly branched sacs or tubes containing a viscid adhesive substance. The ducts having passed into the posterior apodemal cells become much more slender, but have a much firmer wall. They pass forward and then turn backward through these cells and enter the basal joints of the posterior ambulatory legs, where their walls become continuous with the chitinous, cuticular covering of the penis. These organs are short papillæ arising from the lower inner edges of the basal segments of the posterior legs and are clothed with setæ on the side towards the median line. The tip can be somewhat invaginated.

Circulatory System.—The heart (h , fig. 1) is a large pentagonal disk lying in the pericardial sinus immediately under the central portion of the carapace, between the apices of the two branchial chambers. It communicates with the pericardium through six apertures, four on the upper surface and one on each of the antero-lateral faces, which are guarded by valves opening inward. It is held in place by three fibrous bands connecting its upper surface with the integument, by a similar band on each side connecting it with the edge of the branchial chamber, by its contact with the floor and anterior wall of the pericardium (ap , fig. 1) and by the arteries arising from it.

Of these arteries, three arise from the anterior angle of the heart. The median one (r'), the ophthalmic artery, runs straight forward close to the integument over the stomach, without giving off many branches, and passing between the anterior gastric muscles it extends down in front of that organ, giving branches to the eye-peduncles and to the rostrum. The other two (r), arising on either side of the median one, are the antennary arteries, and run forward and outward parallel to the stomach and close to the dermis till they meet the portions of the reproductive organs which turn outward; under these they pass and continue forward into the antennæ. From them

arise numerous branches which supply the dermis, reproductive organs, and the muscles of the stomach and mandibles. From the lower edge of the anterior face of the heart there arise two hepatic arteries, one between each antennary artery and the lateral side of the heart. These arteries and their branches have a yellow color which renders it easy to trace them. They descend into the mass of the liver and give off numerous branches, which ramify throughout the entire liver and cover the intestine in the thoracic cavity with numerous fine vessels.

From the posterior angle of the heart and a little to one side of the central line, the sternal artery (r'' , fig. 1), the largest of all, arises. From near its origin, between the cavity of the heart and the valves of the sternal artery preventing the blood from flowing back into the heart, there arises the slender superior abdominal artery (r'''). The sternal artery passes downward and slightly forward, sometimes on the right and sometimes on the left of the median line, till near the apodemal processes, when it sends off from its posterior side the slender inferior abdominal artery (r'''' , fig. 20), and passing between the two nervous cords which enter the abdomen, it turns forward parallel to and but little above the sternal surface of the body. From the descending portion a few delicate branches pass into the liver mass; and two long ones run forward under the floor of the pericardium. This large horizontal part of the sternal artery gives off six pairs of large branches (6-11, fig. 20), one to each segment bearing the ambulatory legs, and one to that bearing the third maxilliped. As the artery closely follows the sternal surface it rises with the cephalic flexure, and from this inclined portion gives off two pairs of smaller branches, the posterior (5, fig. 20) supplying the second maxillipeds, the anterior (3, 4, fig. 20) forking and supplying the first maxillipeds and the second maxillæ. Behind the mouth the artery forks, and each part giving off a branch to the first maxilla (2), goes forward around the œsophagus, giving off a branch into the mandible (1) and others to the muscles of the œsophagus, and forward over the *endostoma*. The six pairs of branches given off from the horizontal path of the sternal artery continue out through the apodemal cells into the appendages of the six posterior thoracic segments, but each gives off besides numerous small branches a large branch (7'-11', fig. 20) which subdivides and supplies the adductor and abductor in both cells of the same segments. The small superior abdominal artery (r''' , fig. 1), which arises on the inner side of the sternal artery at its origin, continues back close to the

carapace, through the thorax and enters the abdomen. It gives off two branches in the thorax and several small ones in the abdomen, along the dorsal part of which it passes a little to the left of the median line. The inferior abdominal artery (r''' , fig. 20) is of about the same size as the superior. It runs back along the sternal part of the abdomen, turning to one side of the median line, and gives branches to the flexor muscles. Near its origin a long slender branch passes up to the intestine on the surface of which it ramifies.

The blood from the arteries collects in sinuses and then in cavities under the branchiæ, whence it passes into the afferent vessels of those organs (af , fig. 1).

In each branchial chamber the branchiæ are nine in number; they form a conical mass, resting on the lateral walls of the body at an angle of about forty-five degrees. The four larger ones are attached in a longitudinal row, the posterior two (br 6, br 7, fig. 1), each to an opening in the pleural wall above the insertion of second and third ambulatory limbs respectively, the anterior two (br 4, br 5), to the articular membrane of the first or chelate leg. Three smaller branchiæ (br 1, br 2, br 3), the shortest of which does not extend quite to the apex of the branchial chamber, are attached in a transverse direction, owing to the constriction of the body in front of the ambulatory legs. The outer two (br^2 , br^3) are attached to the articular membrane of the third maxilliped; the innermost and smallest (br 1), to that of the second maxilliped. Closely applied to the bases of these branchiæ and filling out the general conical outline, are the two remaining branchiæ, which are much smaller and are attached to the epipodites of the first and second maxillipeds (br , figs. 12, 13).

Each branchia consists of an anterior and a posterior series of closely set horizontal laminae, connected by two vertical vessels, an outer, afferent (af , fig. 1), and an inner, efferent (ef , fig. 1), which communicate with cavities in each lamina. The whole has the shape of a quadrangular pyramid attached at its base. The integument of the branchiæ is a thin chitinous cuticle continuous with the integument of the body. To aerate the blood in the laminae water is constantly drawn into the chamber through the afferent opening just in advance of the basal joint of the chelate leg, being forced out through the efferent canal by the working of the scaphognathite (sg , fig. 10); and it is kept in motion by the epipodites (ep , figs. 11, 12, 13), within the chamber.

The efferent vessels of the branchiæ open into the branchio-cardiac

canals (*bc*, fig. 1) which run upward just beneath the floor of the branchial chamber and communicate with the pericardium. The canals from the posterior two branchiæ unite to form one, and those from the anterior branchiæ also unite. The two large canals thus formed have a common opening into the pericardium, nearly opposite to the lateral valve of the heart, and beneath the apex of the branchial chamber.

Nervous System.—The nervous system (fig. 20) comprises the two large ganglionic masses connected by commissures; the nerves emanating from them; and the stomato-gastric system connected with the commissures.

The thoracic ganglion (*tg*) is a large, flattened, oval mass, lying horizontally immediately above the sternal artery in the central part of the thorax. From its anterior end two stout commissural cords (*c*) run upward and forward to the cephalic ganglion (*cg*), passing on either side of the œsophagus (*œ*) just behind which they are connected by a transverse cord (*k*).

The cephalic ganglion is large, but much smaller than the thoracic ganglion, flattened, transversely elongated, and lies against the up-turned antennular sternum. From each outer anterior angle of this cephalic, or cerebral, ganglion, a large optic nerve (*o*) passes outward and forward into the ophthalmic peduncle; it is closely accompanied along its posterior side by a smaller motor nerve (*mo*) supplying the muscles of the peduncle. From the lower face of the ganglion, somewhat behind the origin of the optic nerves, a pair of smaller nerves pass downward and forward into the antennules. From each lateral edge a large nerve runs directly outward and forks near the edge of the carapace (*dn*), the anterior and posterior branches supplying the dermis. From the posterior edge the two circum-œsophageal commissures (*e*) pass back to the thoracic ganglion. Between the lateral dermal nerves and the commissures, but from a lower level, there arises on each side a nerve which passes downward and forward into the antenna (*iu*). Thus the cerebral ganglion gives off five pairs of nerves.

From the posterior end of the thoracic ganglion two nervous cords, unequal in size (*an*), run horizontally backward and enter the abdomen, passing on either side of the descending sternal artery (*r''*). In the abdomen the filaments of these cords become separated, some passing back toward the anus below and by the sides of the intestine, while each appendage receives one nerve which passes outward from near the median line.

From each side of this ganglion five large nervous cords (x-xiv, fig. 20) pass outward horizontally through the apodemal cells and into the five ambulatory legs where they supply the muscles moving the various joints. These cords are flattened and inclined, those to the first pair of ambulatory legs forward, those to the remaining ambulatory legs backward. A portion of each cord (x'-xiv') separates from the rest not far from its origin and continues upward into the apodemal cells as a smaller cord supplying the muscles of the two cells of the segment whose appendage the main part of the cord supplies. The quadrant which is left between the anterior of these five large nervous cords, on either side, and the commissure, is occupied by the delicate nerves radiating outward to the mandible, maxillæ, and maxillipeds (iv-ix). The most posterior of these is the largest (ix); it passes outward into the third maxilliped, and is divided into an upper (ix) and a lower portion (ix') which are separate almost from their origin. The smaller nerve (viii) in advance of this is likewise divided into an upper and lower part; it passes into the second maxilliped. The first maxilliped is supplied by a slender nerve (vii) passing forward and outward on the same low plane as those of the other maxillipeds and therefore below the nerve of the second maxilla. This nerve (vi), passing upward and forward, runs directly above the former and turns outward into the second maxilla between two of the apodemal processes. Between this nerve to the second maxilla and the commissure, and close to the latter, the delicate nerves pass forward to the mandible and first maxilla. That to the first maxilla (v) is similar to the nerve to the second maxilla, but nearer to the commissure; and it gives off near its origin a delicate branch which runs forward in close contact with the nerve to the mandible till opposite the first maxilla where it turns outward (v') and supplies the muscles of that appendage. The nerve to the mandible (iv) lies very close to the commissure and turns outward into the mandible between the œsophagus and the endostomal plate. A finer nervous filament (iv') lies between this last nerve and the commissure, and is continued outward by the side of the œsophagus to the abductor and the adductor muscles of the mandible.

The thoracic ganglion thus gives origin to a pair of single or double nerves, supplying each of the ten pairs of appendages of the cephalothorax, besides the pair of commissures connecting it with the cephalic ganglion and the double nerve extending back into the abdomen. In addition to these radiating horizontal nerves, a pair

of ascending nerves (*rc*) arises from the upper surface of the thoracic ganglion. These nerves arise behind the commissures, in advance of the point of origin of the nerves to the chelate feet, and are of about the same diameter as the commissures. They extend forward and upward and passing over the edge of the endostomal framework of the gnathites, turn back over the branchial cavity close to the membrane forming its roof as the recurrent cutaneous nerves, subdividing near the apex of that cavity. On turning backward each gives off a large branch which extends outward over the roof of the efferent canal.

The nerves supplying the third maxillipeds (vi, fig. 20), and the first ambulatory legs (vii) coincide in direction at their origin with the arterial branches lying beneath them and supplying the same appendages; but the nerves to the other appendages do not so coincide, the anterior ones (i-v) arising behind the origins of the corresponding arteries, the posterior ones (viii-xi) arising in front of them.

The stomato-gastric system comprises the delicate nervous filaments arising from the commissures and supplying the muscles of the stomach and œsophagus. There are three of these arising from a slightly swollen portion of each commissure (*g*, fig. 20) opposite the œsophagus. The smallest of these arises from the upper surface and passes up on the side of the œsophagus. A larger nerve passes downward from the lower surface and then forks, the longer fork running forward between the œsophagus and the endostoma towards the labrum. The third nerve passes from the under surface forward, around the œsophagus, just below the commissure, and, sending off two branches upward upon the œsophagus and stomach, unites with its fellow on the median line some distance in front of the œsophagus (*n*). From this union a median nerve passes forward under the cardiac region of the stomach till it meets the descending ophthalmic artery, to the lower or posterior surface of which it closely adheres, and thus passes up over the dorsal surface of the stomach, supplying the muscles there. From the same point of union a nerve passes downward and soon forks, the branches extending backward on each side of the lower part of the œsophagus.

EXPLANATION OF PLATES.

PLATE XXV.

FIG. 1.—Male, with the carapace removed; about natural size. On the left the dermis has been folded outward, as has also the cuticular lining of the posterior part of the branchial cavity. On the right these have been removed, and also the portion of the liver, testis and antennary artery, lying over the anterior part of the branchial cavity, and the branchiæ have been turned outward, showing the floor of the cavity. On this side, also, the carapace has been removed from about the eye and the attachment of the antero-gastric muscle:

a, antenna; *ab*, abductor of mandible and muscle from the first maxilla, here attached to the carapace; *af*, afferent vessel of branchia; *ag*, antero-gastric muscle; *ap*, anterior wall of the pericardium; *b*, muscular bands connecting the cuticular covering of the anterior part of the branchial cavity with the carapace; *bc*, branchio-cardiac canal; *br1-br7*, branchiæ; *c*, cuticular covering of the branchial chamber; *cp*, cardio-pyloric muscle; *d*, dermis; *e*, eye; *ef*, efferent vessel of branchiæ; *f*, roof of the efferent canal; *g*, stomach; *gg*, portion of the green gland; *h*, heart, with four orifices and five supporting bands; *i*, intestine; *l*, liver; *m, m'*, great and small adductors of the mandible; the latter, on the right, is separated from the postero-gastric muscle to show the testis passing below their common origin; *o*, line of union of the dorsal surface of the abdomen and the reflexed part of the carapace; *p*, prolongation of *o*, connecting it with the edges of the flanks; *pg*, postero-gastric muscle; *pt*, pterocardiac ossicle; *r*, antennary artery, with main branches; *r'*, ophthalmic artery; *r''*, origin of sternal artery; *r'''*, superior abdominal artery; *rs*, rostrum; *S, S', S''*, epipodites of the first, second and third maxillipeds; *sp*, supero-pyloric muscle; *t*, testis; *t'*, posterior, less convoluted portion; *u'*, accessory organ connected with the vas deferens; *u*, pyloric caecal appendage; *u'*, posterior unpaired caecal appendage; *w*, reflexed cuticular portion of the carapace covering the origin of the abdomen; *x*, muscular bands joining the upper inner edge of the apodemal framework of the carapace; *z*, muscles which appear to assist in respiration by raising the fold of the carapace, which partly closes the posterior opening of the branchial cavity.

FIG. 2.—Upper, or true ventral surface of male abdomen; about natural size. The first appendage has been removed on the right to show the second: *a*, anus; *b, c, d*, joints of the first appendage; *b', c', d'*, those of the second; *o*, cavity into which a projection of the thorax fits and holds the abdomen in place; *p*, process by which the abdomen is attached to the edge of the flanks; *xv-xxi*, seven terminal segments forming the abdomen.

FIG. 3.—Upper or true ventral surface of female; about natural size. The appendages of the right side have been removed: *en, ex, pr*, endopodite, exopodite and protopodite of the first appendage; other letters as in fig. 2.

FIGS. 4, 4a.—Appendages of the male abdomen; anterior face of the first and second appendage on the right side; enlarged about two diameters: *b, c, d, b', c', d'*, joints of the first and of the second appendages; *p*, membranous process near the tip of the first appendage; *p'*, membranous papilla-like termination of the second appendage.

FIG. 5.—Posterior face of the right abdominal appendage of the second pair; female; enlarged about two diameters: *ex*, exopodite; *en*, endopodite; *pr*, membranous articulating portion, representing the protopodite.

PLATE XXVI.

FIG. 6.—Anterior face of locomotive appendage of female; about natural size: *c*, coxa; *cp*, carpus; *bi*, joint representing the basis and ischium; *d*, dactylus; *pr*, propodus; *m*, merus; *s*, articular cavity; *x*, articular process.

FIG. 7.—Anterior face of right chelate appendage of female; about natural size: *t*, spine; other letters as in fig. 6.

FIG. 8.—Inner face of right mandible of male; enlarged about two diameters: *a*, inner edge to which is attached the cuticle bordering the mouth; *c*, cutting edge; *p*, two-jointed palpus; *n*, *m*, vertical and horizontal portions of the internal part of the mandible; *t*, *t'*, tendons of the large and small adductors; *t''*, tendon of ascending abductor.

FIG. 9.—Inner or posterior face of the first maxilla, right side; male; enlarged about two diameters: *b*, *c*, setose basis and coxa; *en*, endopodite.

FIG. 10.—Posterior face of the second maxilla, right side; male; enlarged about two diameters: *c*, coxa; *b*, basis; *en*, endopodite; *ex*, lobe, which may represent the exopodite; *sg*, scaphognathite.

FIG. 11.—Posterior face of the first maxilliped, right side; male; enlarged about two diameters: *b*, *c*, basis and coxa; *en*, endopodite; *ex*, exopodite, with its palpus, *p*; *ep*, epipodite.

FIG. 12.—Posterior face of second maxilliped, right side; male; enlarged about two diameters: *br*, branchia; *cp*, carpus; *d*, dactylus; *i*, ischium; *pr*, propodus; *m*, merus; other letters as in fig. 11.

FIG. 13.—Posterior face of the third maxilliped, right side; male; enlarged about two diameters. Letters as in fig. 12, but the portion, *b*, is not separated from *i*, even by a groove.

FIG. 14.—Upper face of eye-stalk, right side; male; enlarged about four diameters: *a*, basal joint, membranous on the posterior face; *b*, second joint, firmly calcified and terminating in the cornea, *c*.

FIG. 15.—Outer face of right antennule; male; enlarged about four diameters: *a*, *b*, *c*, joints, the distal bearing the filaments, *f*, *g*; *h*, opening to the auditory sac in the basal joint.

FIG. 16.—Lower surface of the right antenna; male; enlarged about four diameters: *a*, *b*, *c*, joints, and *d*, many jointed filament terminating the appendage; *o*, plate closing the opening of the duct of the green gland.

PLATE XXVII.

FIG. 17.—Lateral view of the right side of the chitinous lining of the stomach; enlarged about two diameters: *ac*, accessory cardiac ossicle; *ap*, ossicle forming a rim to the postero-cardiac ossicle; *bc*, lateral cardiac ossicle; *d*, three-pronged ossicle, surrounding with its fellow the opening of the bile ducts; *f*, funnel-shaped cuticular termination of the pylorus; *g*, cardiac region; *h*, opening for the bile ducts; *il*, infero-lateral cardiac ossicle, with its upper end, *b*, and its lower end united to the rim of a cavity, *a*, corresponding to the projection on the interior; *ip*, *ip'*, *ip''*, infero-pyloric ossicles; *k*, imperfectly calcified piece connecting the accessory and supero-lateral ossicles; *lp*, lateral pyloric ossicle: *m*, *n*, thickened areas set with setae; *ms*, longitudinal mesopyloric ossicle; *o*, lateral pouch or capsule; *æ*, œsophagus; *p*, prepyloric ossicle; *pl*, postero-lateral cardiac ossicle; *po*, pyloric ossicle; *py*, pylorus;

r, ridge forming the lower edge of the supero-lateral ossicle; *s*, imperfect ossicle on the side of the anterior pyloric pouch; *sl*, supero-lateral ossicle; *ta*, transverse mesopyloric ossicle; *up*, *up'*, *up''*, uropyloric ossicles; *x*, projecting spatulate process; *z*, small plate forming part of the rim at the lower edge of the pylorus.

FIG. 18.—Dorsal view of the cuticular lining of the stomach; enlarged about two diameters: *c*, cardiac ossicle; *l*, lateral tooth of the urocardiac ossicle; *pt*, pterocardiac ossicle; *t*, teeth of the supero-lateral cardiac ossicle; other letters as in fig. 17.

FIG. 19.—Right side of the alimentary canal; about natural size: *a*, one of the two anterior muscles of the œsophagus; *ag*, antero-gastric muscle; *an*, anus; *b*, one of the two posterior muscles of the œsophagus; *c*, cardiac region; *h*, opening of the left hepatic duct; *i*, anterior part of the intestine; *i'*, posterior part lined with a chitinous cuticle; *lb*, labrum; *l*, *l'*, lateral muscles of the œsophagus; *m*, *m'*, *m''*, lateral extrinsic muscles; *n*, *n'*, *n''*, *n'''*, lateral intrinsic muscles; *o*, *o'*, lateral intrinsic muscles of the pylorus; *p*, pylorus; *s*, muscular ring surrounding the valvular opening between the two portions of the intestine; *u*, left anterior caecal appendage; *u'*, posterior unpaired caecal appendage.

FIG. 20.—Somewhat diagrammatic view of the nervous system of a male; about natural size. The right side has been cut away to a lower level than the left and the nerves to the mouth parts, three of which are cut on the right, are farther apart than in nature: *a*, anterior extrinsic muscles of the œsophagus; *an*, nervous cords passing into the abdomen; *c*, commissure; *cg*, cephalic ganglion; *dn*, cephalic nerve supplying the dermis; *e*, orbit; *en*, endostomal plate; *g*, swollen portion of commissure; *gg*, green gland; *i*, intestine; *k*, nervous cord connecting the commissures; *l'*, superior lateral extrinsic muscle of the œsophagus; *m*, attachment of the large lateral cardiac muscle; *mo*, motor nerves of the eye-stalk; *n*, united pneumogastric nerves arising from *g*; *æ*, œsophagus; *r''*, sternal artery; *r'''*, inferior abdominal artery; *rc*, recurrent cutaneous nerves; *vd*, terminal portion of the vas deferens; 1-11, branches of the sternal artery supplying the appendages of the cephalothorax, with 1'-11', their upper branches, supplying the muscles of the apodemal cells; 1-XIV, nerves supplying the fourteen pairs of appendages of the cephalothorax.

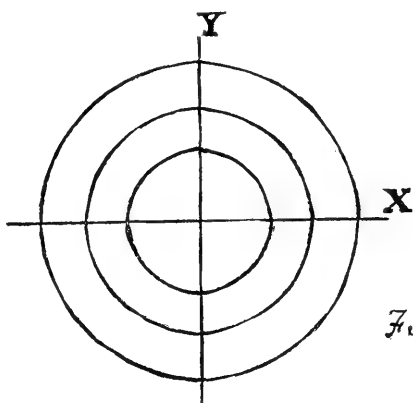

Fig. 1.

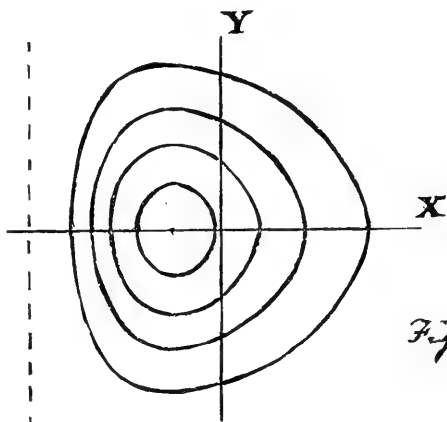

Fig. 2.

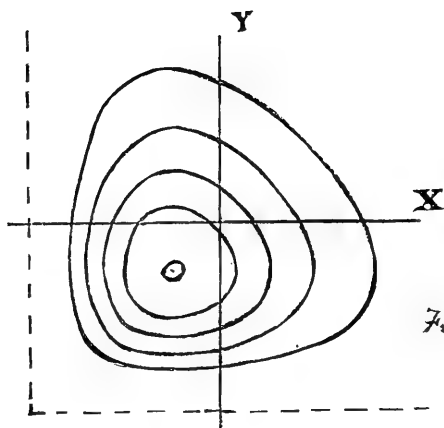
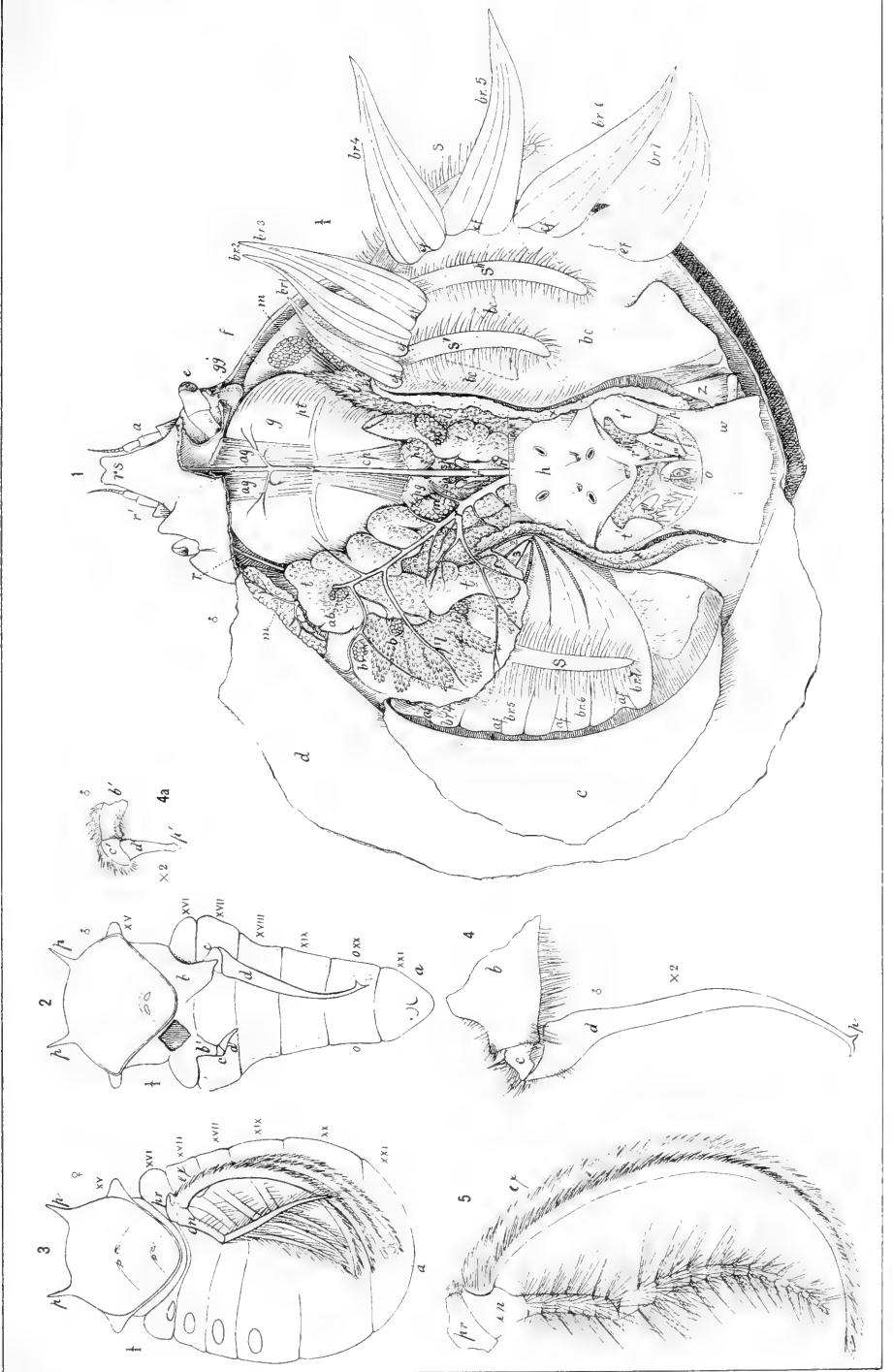

Fig. 3.



J. H. Emerton, from Nature

Photo Lith by L. S. Punderson, New Haven, Conn.

LIBINIA EMARGINATA.

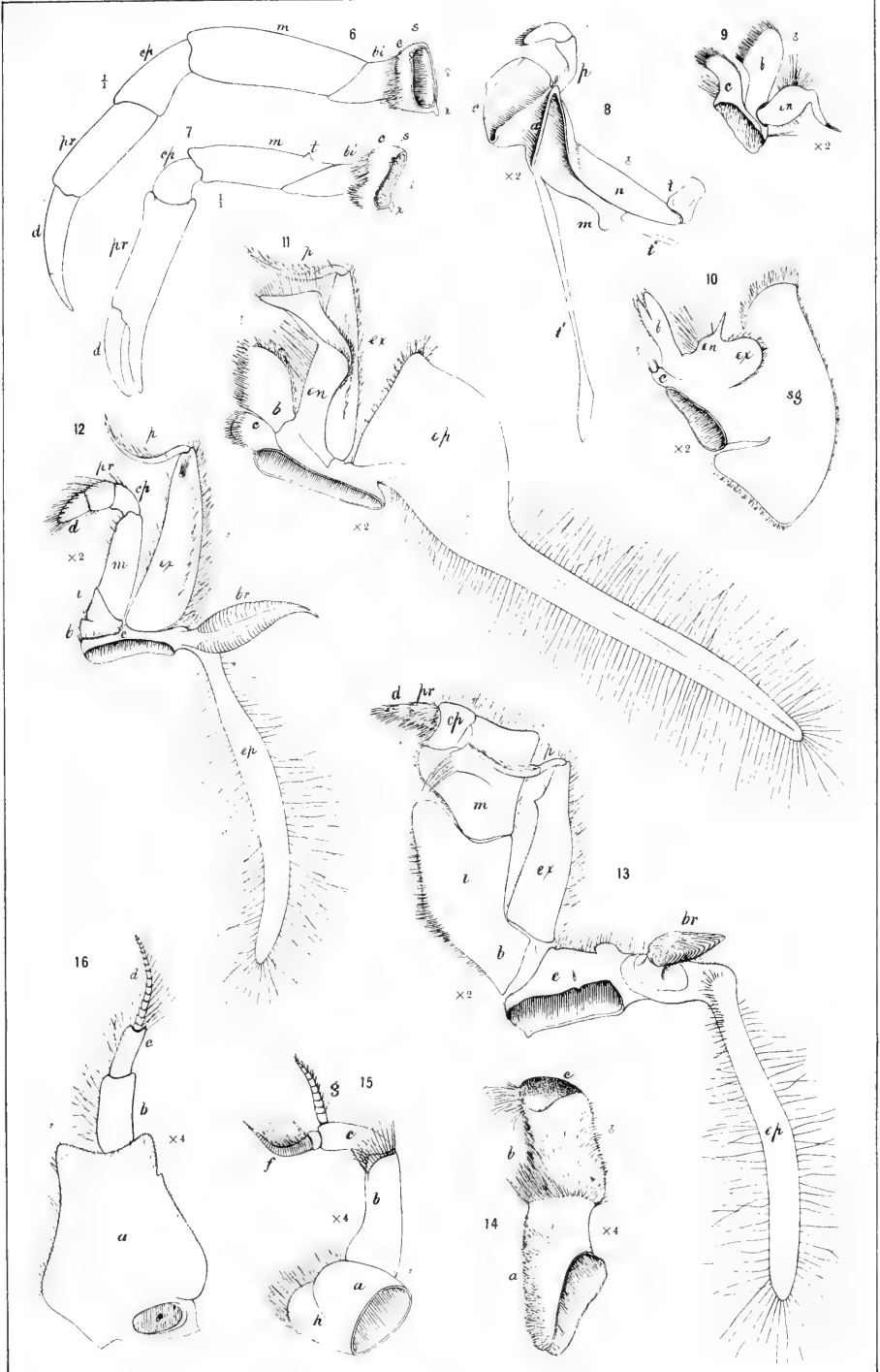

E. A. Andrews, from Nature.

Photo. Lith. by L. S. Punderson, New Haven, Conn.

LIBINIA EMARGINATA.

V.—ON AN UNSYMMETRICAL LAW OF ERROR IN THE POSITION OF A POINT IN SPACE. BY E. L. DE FOREST, WATERTOWN, CONN.

THE law for space of one dimension has been treated of in my articles "On an Unsymmetrical Probability Curve," which appeared in *The Analyst* (Des Moines, Iowa), vols. ix, p. 135, and x, p. 67. The curve was obtained as a limiting form of the series of coefficients in the expansion of a polynomial to a high power, special means being employed to secure close approximation. Its equation is

$$\left. \begin{aligned} Y &= \frac{1}{K\sqrt{(2\pi b)} \left(1 + \frac{x}{ab}\right)^{a^2b-1} e^{-ax}}, \\ K &= 1 + \frac{1}{12a^2b} + \frac{1}{288(a^2b)^2} - \text{etc.} \end{aligned} \right\} \quad (1)$$

When $a = \infty$, this curve becomes identical with the common or symmetrical probability curve,

$$Y = \frac{1}{\sqrt{(2\pi b)}} e^{-x^2 \div 2b}. \quad (2)$$

I had previously shown in the same journal, vols. vi, p. 140, viii, p. 3, and ix, p. 33, that the symmetrical law of error in the position of a point in space of one, two or three dimensions can be obtained as a first approximation to the limiting form of the system of coefficients in the expansion of a polynomial of one, two or three variables. In like manner the unsymmetrical law in space can be found by extension of the method so as to secure a closer approximation to the true form of the system of coefficients.

We will first consider space of two dimensions only. The known formula for symmetrical differences, where u is a function of an abscissa $a\Delta x$, is

$$u_a = u_0 + \frac{a}{1} \Delta_1 + \frac{a^2}{1.2} \Delta_2 + \frac{a(a^2-1^2)}{1.2.3} \Delta_3 + \frac{a^2.(a^2-1^2)}{1.2.3.4} \Delta^4 + \text{etc.} \quad (3)$$

Starting from the middle term u_0 in the series

$$\dots u_{-2}, u_{-1}, u_0, u_1, u_2, \dots$$

the common interval Δx between consecutive terms being the unit of abscissas, this formula gives any required term u_a , where a may be either a positive or a negative number. The differences Δ_1, Δ_2 , etc., of the function u are formed from terms similarly situated on either

side of u_0 . (*Analyst*, ix, 135.) If now u is a function of both an abscissa $a\Delta x$ and an ordinate $b\Delta y$, so that the terms form a double series or rectangular table, thus,

$$\left. \begin{array}{cccccc} \dots\dots\dots & & & & & \\ \dots\dots\dots & u_{-2,1}, & u_{-1,1}, & u_{0,1}, & u_{1,1}, & u_{2,1} & \dots\dots\dots \\ \dots\dots\dots & u_{-2,0}, & u_{-1,0}, & u_{0,0}, & u_{1,0}, & u_{2,0} & \dots\dots\dots \\ \dots\dots\dots & u_{-2,-1}, & u_{-1,-1}, & u_{0,-1}, & u_{1,-1}, & u_{2,-1} & \dots\dots\dots \\ \dots\dots\dots & & & & & & \end{array} \right\} \quad (4)$$

the formula for any desired term $u_{a,b}$ is

$$\left. \begin{aligned} u_{a,b} = & u_{0,0} + \frac{a}{1} \Delta_{1,0} + \frac{a^2}{1,2} \Delta_{2,0} + \frac{a(a^2-1^2)}{1,2,3} \Delta_{3,0} + \dots\dots\dots \\ & + \frac{b}{1} \Delta_{0,1} + \frac{ab}{1,1} \Delta_{1,1} + \frac{a^2b}{1,2,1} \Delta_{2,1} + \frac{a(a^2-1^2)b}{1,2,3,1} \Delta_{3,1} + \dots\dots\dots \\ & + \frac{b^2}{1,2} \Delta_{0,2} + \frac{ab^2}{1,1,2} \Delta_{1,2} + \frac{a^2b^2}{1,2,1,2} \Delta_{2,2} + \frac{a(a^2-1^2)b^2}{1,2,3,1,2} \Delta_{3,2} + \dots\dots\dots \\ & + \dots\dots\dots \end{aligned} \right\} \quad (5)$$

The coefficients of the differences in the upper row are the same as those in (3), and those in the left hand column likewise, only substituting b for a , while the coefficient for any other difference is the product of the corresponding ones in the upper row and the left hand column. For example, the coefficient of $\Delta_{3,2}$ is the product of those of $\Delta_{3,0}$ and $\Delta_{0,2}$. The reason is, that the values of u in (4) are supposed to represent ordinates to an algebraic surface, and consequently any one row or column will represent equidistant ordinates to an algebraic curve. Denoting any term in the middle column by $u_{0,b}$, its value by (3) is

$$u_{0,b} = u_{0,0} + \frac{b}{1} \Delta_{0,1} + \frac{b^2}{1,2} \Delta_{0,2} + \text{etc.}, \quad (6)$$

and the value of any term $u_{a,b}$ in the same row with $u_{0,b}$ is found by applying (3) to each term in the second member of (6), giving the expression (5). Any difference $\Delta_{m,n}$ is the result of differencing m times in the a direction and n times in the b direction, so as to keep $u_{0,0}$ always in the middle. If the difference in either the a or the b direction is of an odd order, we must take half the sum of the two nearest corresponding differences on either side of $u_{0,0}$; while if the difference in both directions is of an odd order, we take the mean of four differences nearest to $u_{0,0}$. For example,

$$\Delta_{3,2} = \frac{1}{2} \left\{ \begin{array}{l} u_{1,1} - 3u_{0,1} + 3u_{-1,1} - u_{-2,1} \\ -2u_{1,0} + 6u_{0,0} - 6u_{-1,0} + 2u_{-2,0} \\ + u_{1,-1} - 3u_{0,-1} + 3u_{-1,-1} - u_{-2,-1} \end{array} \right\} + \frac{1}{2} \left\{ \begin{array}{l} u_{2,1} - 3u_{1,1} + 3u_{0,1} - u_{-1,1} \\ -2u_{2,0} + 6u_{1,0} - 6u_{0,0} + u_{-1,0} \\ + u_{2,-1} - 3u_{1,-1} + 3u_{0,-1} - u_{-1,-1} \end{array} \right\} \quad (7)$$

In this way the symmetry with respect to $u_{0,0}$ is preserved, and $\Delta_{3,2}$ is supposed to be located at $u_{0,0}$.

Denoting by L the coefficients in a polynomial of two variables r and s , we locate these coefficients with reference to any assumed rectangular axes by coördinates proportional to the exponents of the variables, and give the polynomial a square form by adding terms with zero coefficients if necessary, so that the whole number of terms in it is $(2m+1)^2$. Denoting by l the coefficients in its expansion to the n th power, we locate them in like manner with reference to the same axes. The polynomial is supposed to have been originally divided through by the sum of its coefficients, so that $\sum L=1$ and $\sum l=1$. The first power and its expansion may be written

$$\sum_{b=-m}^{b=m} \sum_{a=-m}^{a=m} (L_{a,b} r^a s^b), \quad \sum_{b=-mn}^{b=mn} \sum_{a=-mn}^{a=mn} (l_{a,b} r^a s^b). \quad (8)$$

Then as shown in *Analyst*, viii, pp. 9 and 41, with only a change of notation, the coefficients l in any square group of $(2m+1)^2$ terms in the expansion will be connected with the coefficients L of the given polynomial by the relation

$$\left. \begin{aligned} \sum_{b=-m}^{b=m} \sum_{a=-m}^{a=m} (L_{-a,-b} l_{(i+a),(j+b)}) &= V, \\ \sum_{b=-m}^{b=m} \sum_{a=-m}^{a=m} (aL_{-a,-b} l_{(i+a),(j+b)}) &= \frac{-i}{n+1} V, \\ \sum_{b=-m}^{b=m} \sum_{a=-m}^{a=m} (bL_{-a,-b} l_{(i+a),(j+b)}) &= \frac{-j}{n+1} V. \end{aligned} \right\} \quad (9)$$

The common unit intervals between consecutive coefficients in the polynomial or its expansion are Δx and Δy , and a and b are integers which, used as sub-indices, locate any L at the distance $a\Delta x$ and $b\Delta y$ from the axes of reference, while i and j are similar integers used to fix the position of the middle coefficient of the supposed group of $(2m+1)^2$ terms in the expansion, with regard to the same axes. This middle coefficient then is $l_{i,j}$, and its coördinates are

$$x=i\Delta x, \quad y=j\Delta y. \quad (10)$$

When the exponent n is made very large, or infinite, the coefficients l become ordinates z to the surface which represents the limiting form of the expansion, and we suppose them to be set closer together so as to be consecutive. This Δx and Δy are reduced to dx and dy , and (10) becomes

$$x=idx, \quad y=jdy. \quad (11)$$

The extent of the group of $(2m+1)^2$ coefficients l under consideration is infinitesimal in comparison with that of the whole $(2mn+1)^2$ terms in the expansion, especially as we shall regard n as an infinity

of the second order, that is, of a magnitude comparable with the quotient arising from dividing a finite area by $(dx)^2$. This supposition extends the expansion to infinity throughout the plane XY, and the small portion of the limiting surface included within the group above mentioned might be regarded as approximately a plane surface. (*Analyst*, viii, p. 42.) But for greater accuracy, we will now suppose it to be a surface of the second order. Let z be restricted to mean the middle one of the coefficients in this group; we wish to find its relation to x and y . Let the first and second differentials of z in the x and y directions be written instead of the corresponding differences Δ in (5). Then for any coefficient whose coördinates reckoned from $z=l_{ij}$ are adx and bdy , we have the expression

$$z + ad_x z + bd_y z + \frac{a^2}{2} d_x^2 z + \frac{b^2}{2} d_y^2 z + abd_x d_y z, \tag{12}$$

and all the $(2m+1)^2$ coefficients in the group will be successively represented by assigning to a and b all the integral values between $-m$ and m . Suppose all the coefficients l in (9) to have their values thus expressed. Collect separately the coefficients of $z, d_x z, d_y z,$ etc., remembering that $\sum L=1$. Let α_1 and α_2 denote the sums of the products of each L into its first and second sub-indices respectively. Let β_1 and β_2 be the sums of the products of each L into the squares of its first and second sub-indices respectively. Let γ be the sum of the products of each L into the product of its two sub-indices. Let δ_1 and δ_2 be the sums of the products of each L into the cubes of its first and second sub-indices respectively. Let η_1 be the sum of the products of each L into the product of the second sub-index by the square of the first, and let η_2 be formed in like manner, from the products of the first sub-index into the square of the second. It will be found that (9) is now reducible to

$$\left. \begin{aligned} z - \alpha_1 d_x z - \alpha_2 d_y z + \frac{1}{2} \beta_1 d_x^2 z + \frac{1}{2} \beta_2 d_y^2 z + \gamma d_x d_y z &= V, \\ -\alpha_1 z + \beta_1 d_x z + \gamma d_y z - \frac{1}{2} \delta_1 d_x^2 z - \frac{1}{2} \eta_2 d_y^2 z - \eta_1 d_x d_y z &= \frac{-i}{n+1} V, \\ -\alpha_2 z + \gamma d_x z + \beta_2 d_y z - \frac{1}{2} \eta_1 d_x^2 z - \frac{1}{2} \delta_2 d_y^2 z - \eta_2 d_x d_y z &= \frac{-j}{n+1} V. \end{aligned} \right\} \tag{13}$$

These are the two differential equations of the limiting surface, $\alpha, \beta, \gamma,$ etc., are constant parameters.

When the coefficients L in the given polynomial are regarded as probabilities of error in the position of an observed point, then $L_{a,b}$ denotes the probability that an error which occurs will fall at the point $x=alx, y=bl_y$. We need not suppose, as was unnecessarily

done in *Analyst*, viii, p. 4, that the origin or place of $L_{0,0}$ is the true position of the observed point. If each L is also regarded as the mass of a material point, and the center of gravity of these points is taken as an origin, we shall evidently have $\alpha_1=0$ and $\alpha_2=0$. And if the coördinate axes passing through this origin are taken to coincide with the free axes of the system of masses L , we shall also have $\gamma=0$. By reasoning similar to that followed at *Analyst*, viii, pp. 44 to 47, it will appear that (9) and (13) still hold good after this change of axes, the constants α, β, γ , etc., referring to the new axes with the same meanings as before. Now in the expression for V in (13) let differentials of z of the second order be neglected in comparison with z , and we have $V=z$. Also let n be written instead of $n+1$, which is permissible because n is infinite. Then giving to i and j their equivalents from (11), we have (13) reduced to the form

$$\left. \begin{aligned} \frac{1}{z} \left\{ d_x z - \frac{1}{2}(\delta_1 \div \beta_1) d_x^2 z - \frac{1}{2}(\eta_2 \div \beta_1) d_y^2 z - (\eta_1 \div \beta_1) d_x d_y z \right\} &= \frac{-x dx}{n \beta_1 (dx)^2}, \\ \frac{1}{z} \left\{ d_y z - \frac{1}{2}(\delta_2 \div \beta_2) d_y^2 z - \frac{1}{2}(\eta_1 \div \beta_2) d_x^2 z - (\eta_2 \div \beta_2) d_x d_y z \right\} &= \frac{-y dy}{n \beta_2 (dy)^2}. \end{aligned} \right\} \quad (14)$$

If we also write

$$\left. \begin{aligned} A &= n \beta_1 (dx)^2, & B &= n \beta_2 (dy)^2, \\ A_1 &= n \delta_1 (dx)^3, & A_2 &= n \eta_2 dx (dy)^2, \\ B_1 &= n \delta_2 (dy)^3, & B_2 &= n \eta_1 (dx)^2 dy, \end{aligned} \right\} \quad (15)$$

(14) may be put in the form

$$\left. \begin{aligned} \frac{1}{2} A_1 \left(\frac{d^2 z}{dx^2} \right) + \frac{1}{2} A_2 \left(\frac{d^2 z}{dy^2} \right) + B_2 \left(\frac{d^2 z}{dx dy} \right) &= A \left(\frac{dz}{dx} \right) + xz, \\ \frac{1}{2} B_1 \left(\frac{d^2 z}{dy^2} \right) + \frac{1}{2} B_2 \left(\frac{d^2 z}{dx^2} \right) + A_2 \left(\frac{d^2 z}{dx dy} \right) &= B \left(\frac{dz}{dy} \right) + yz. \end{aligned} \right\} \quad (16)$$

It will be noticed that in the expressions for A and B , $\beta_1(dx)^2$ and $\beta_2(dy)^2$ represent the squared q. m. errors or deviations of the coefficients or masses L from the free X and Y axes respectively; or according to the nomenclature which I adopted in *Analyst*, x, p. 99, they are the x^2 and y^2 moments of the system of coefficients L about those axes. The moments for the n th power are n times as great as for the first power, so that the constants A and B represent the x^2 and y^2 moments of the system of coefficients l in the n th power; and when n becomes an infinity of the second order, they are the x^2 and y^2 moments of the ordinates z to the limiting surface, and are constant and finite areas. Likewise the constants A_1 and A_2 are the x^3 and xy^2 moments, and B_1 and B_2 are the y^3 and x^2y moments, of the ordinates z . The constants in (15) might therefore be expressed thus,

$$\left. \begin{aligned} A &= \frac{1}{dxdy} \iint x^2 z dx dy, & B &= \frac{1}{dxdy} \iint y^2 z dx dy, \\ A_1 &= \frac{1}{dxdy} \iint x^3 z dx dy, & A_2 &= \frac{1}{dxdy} \iint xy^2 z dx dy, \\ B_1 &= \frac{1}{dxdy} \iint y^3 z dx dy, & B_2 &= \frac{1}{dxdy} \iint x^2 yz dx dy. \end{aligned} \right\} \quad (17)$$

The differential equations (14) or (16) cannot, I believe, be integrated in their complete form. But if we neglect the inequalities η_1 and η_2 , (14) reduces to

$$\left. \begin{aligned} \frac{d_x z - \frac{1}{2}(\delta_1 \div \beta_1) d_x^2 z}{z} &= \frac{-x}{n\beta_1 dx}, \\ \frac{d_y z - \frac{1}{2}(\delta_2 \div \beta_2) d_y^2 z}{z} &= \frac{-y}{n\beta_2 dy}. \end{aligned} \right\} \quad (18)$$

These equations are of the same form as the one near top of p. 138 in my article on the Unsymmetrical Probability Curve. That equation was

$$\frac{dy - \frac{1}{2}(b_3 \div b_2) d^2 y}{y} = \frac{-x}{kb_2 dx} \quad (19)$$

If we write

$$kb_2(dx)^2 = b, \quad kb_3(dx)^3 = \frac{2b}{a}, \quad (20)$$

it becomes

$$\frac{d^2 y}{dx^2} - a \left(\frac{dy}{dx} \right) - \left(\frac{a}{b} \right) xy = 0, \quad (21)$$

a linear differential equation whose exact integral is of a highly transcendental form. (See Price's *Calculus*, vol. ii, p. 652). But as shown in my article, an approximate integration can be effected, with a comparatively simple result. In applying the method to (18), we transfer the origin to another point by putting

$$x - \frac{2n\beta_1^2 dx}{\delta_1} \quad \text{and} \quad y - \frac{2n\beta_2^2 dy}{\delta_2} \quad (22)$$

in place of x and y respectively, and write new constants

$$a_1 = \frac{2\beta_1(dx)^2}{\delta_1(dx)^3}, \quad a_2 = \frac{2\beta_2(dy)^2}{\delta_2(dy)^3}, \quad b_1 = n\beta_1(dx)^2, \quad b_2 = n\beta_2(dy)^2. \quad (23)$$

Thus (18) will reduce approximately to

$$\frac{d_x z}{z} = \frac{dx}{x} (a_1^2 b_1 - 1) - a_1 dx, \quad \frac{d_y z}{z} = \frac{dy}{y} (a_2^2 b_2 - 1) - a_2 dy, \quad (24)$$

and integration gives

$$z = Cx^{a_1 b_1 - 1} y^{a_2 b_2 - 1} e^{-a_1 x - a_2 y}. \quad (25)$$

To restore the two equations (24), we have only to differentiate (25) with respect to x and y separately, and divide the results by z .

The value of z becomes zero when we take either $x=0$ or $y=0$, or when $x=\infty$ or $y=\infty$. Hence, to determine C , since the sum of all the values of z is unity, we have

$$\int_0^\infty \int_0^\infty z dx dy = 1, \tag{26}$$

which is equivalent to

$$\frac{C \div (dx dy)}{a_1^{a_1^2 b_1} a_2^{a_2^2 b_2}} \int_0^\infty (a_1 x)^{a_1^2 b_1 - 1} e^{-a_1 x} d(a_1 x) \int_0^\infty (a_2 y)^{a_2^2 b_2 - 1} e^{-a_2 y} d(a_2 y) = 1, \tag{27}$$

or to

$$C I(a_1^2 b_1) I(a_2^2 b_2) = 1. \tag{28}$$

When the value of C obtained from this is substituted in (25), we get

$$z = \frac{a_1 a_2 dx dy}{I(a_1^2 b_1) I(a_2^2 b_2)} (a_1 x)^{a_1^2 b_1 - 1} (a_2 y)^{a_2^2 b_2 - 1} e^{-a_1 x - a_2 y}. \tag{29}$$

This is the approximate equation of the limiting surface. It will be most convenient if we restore the origin to the point where it was at first, the center of gravity of all the masses z , or in other words, the arithmetical mean of all the points of error, each taken with a weight proportional to the probability of its occurrence. Comparing (22) and (23), it appears that the origin was removed from this point by substituting

$$x - a_1 b_1 \quad \text{and} \quad y - a_2 b_2$$

in place of x and y , so that to restore it, we substitute

$$x + a_1 b_1 \quad \text{and} \quad y + a_2 b_2 \tag{30}$$

for x and y in (29). Employing also the known formula

$$I(n) = \left(\frac{n}{e}\right)^n \sqrt{\left(\frac{2\pi}{n}\right)} \left(1 + \frac{1}{12n} + \frac{1}{288n^2} - \text{etc.}\right), \tag{31}$$

with K_1 and K_2 as auxiliary letters

$$K_1 = 1 + \frac{1}{12 a_1^2 b_1} + \frac{1}{288 (a_1^2 b_1)^2} - \text{etc.},$$

$$K_2 = 1 + \frac{1}{12 a_2^2 b_2} + \frac{1}{288 (a_2^2 b_2)^2} - \text{etc.}, \tag{32}$$

we find that (29) reduces to

$$z = \frac{dxdy}{2\pi K_1 K_2 \sqrt{(b_1 b_2)}} \left(1 + \frac{x}{a_1 b_1}\right)^{a_1^2 b_1 - 1} \left(1 + \frac{y}{a_2 b_2}\right)^{a_2^2 b_2 - 1} e^{-a_1 x - a_2 y}, \quad (33)$$

and putting $z = Z dx dy$, we have

$$Z = \frac{1}{2\pi K_1 K_2 \sqrt{(b_1 b_2)}} \left(1 + \frac{x}{a_1 b_1}\right)^{a_1^2 b_1 - 1} \left(1 + \frac{y}{a_2 b_2}\right)^{a_2^2 b_2 - 1} e^{-a_1 x - a_2 y}. \quad (34)$$

This final equation of the surface sought is the product of two functions like Y in (1), one in x and the other in y . The intersection of the surface by any vertical plane parallel to either the X or the Y axis will be a curve whose ordinates have the form (1) multiplied by a constant. Differentiating (34) we get

$$\frac{dZ}{dx} = Z \left(\frac{a_1^2 b_1 - 1}{a_1 b_1 + x} - a_1 \right), \quad \frac{dZ}{dy} = Z \left(\frac{a_2^2 b_2 - 1}{a_2 b_2 + y} - a_2 \right). \quad (35)$$

These become zero for

$$x = -\frac{1}{a_1}, \quad y = -\frac{1}{a_2}, \quad (36)$$

at which point Z is a maximum. They are also zero when $Z = 0$, and this, as we know from the properties of the curve (1), will occur when $x = -a_1 b_1$ or when $y = -a_2 b_2$; or when $x = \pm \infty$, the + or - sign being taken according as a_1 is + or -; or when $y = \pm \infty$ according as a_2 is + or -. The intersection of the surface by any horizontal plane is a closed curve of contour surrounding the vertex-point (36). Denoting by Z' the height of this plane above the XY plane, and writing

$$c = 2\pi Z' K_1 K_2 \sqrt{(b_1 b_2)}, \quad (37)$$

the equation of the curve of contour, or of its projection on the XY plane, is

$$\left(1 + \frac{x}{a_1 b_1}\right)^{a_1^2 b_1 - 1} \left(1 + \frac{y}{a_2 b_2}\right)^{a_2^2 b_2 - 1} e^{-a_1 x - a_2 y} = c. \quad (38)$$

Neither the x nor the y can in general be explicitly expressed, one as a function of the other. But if a_1 or a_2 is infinite, the surface becomes symmetrical in the x or y direction respectively, and the form of the curve of contour is simplified. For instance, with $a_2 = \infty$, we have the identity

$$\left(1 + \frac{y}{a_2 b_2}\right)^{a_2^2 b_2 - 1} e^{-a_2 y} = e^{-y_2 \div 2b_2}, \quad (39)$$

(*Analyst*, ix, p. 165); and (38) may be reduced to

$$y^2 = 2b_2 \left\{ \frac{a_1^2 b_1 - 1}{\log e} \log \left(1 + \frac{x}{a_1 b_1}\right) - a_1 x - \frac{\log c}{\log e} \right\}. \quad (40)$$

If we have both $a_1 = \infty$ and $a_2 = \infty$, (34) becomes the ordinary symmetrical probability surface, and the curves of contour reduce to ellipses

$$\frac{x^2}{2b_1} + \frac{y^2}{2b_2} = -\frac{\log c}{\log e}. \tag{41}$$

To show the modifications of form which these curves undergo from the introduction of the unsymmetrical elements represented by the constants a_1 and a_2 , let us first consider the ellipses (41) as circles, with $b_1 = b_2 = 4$. Putting $x^2 + y^2 = r^2$, the squared radius of such a circle is

$$r^2 = -\frac{8 \log c}{\log e}. \tag{42}$$

Giving to Z' the values .01, .02, .03 in succession, remembering that $K_1 = 1$ and $K_2 = 1$, (37) gives for c the values

$$.25133, \quad .50266, \quad .75399,$$

and the corresponding radii r are by (42)

$$3.324, \quad 2.346, \quad 1.503,$$

with which the three concentric circles in Fig. 1 are described.

If we now suppose that there is a c. m. inequality in the x direction, so that a_1 has a finite value, for instance $a_1 = 1$, while b_1 and b_2 remain as before, then by (40) the equation of any curve of contour is

$$y^2 = 55.262 \log \left(1 + \frac{x}{4} \right) - 8x - 18.421 \log c. \tag{43}$$

Giving to Z' the values .01, .02, .03, .04 in succession, with

$$K_1 = 1.0211, \quad K_2 = 1,$$

the values of c are by (37)

$$.25663, \quad .51326, \quad .76991, \quad 1.0265,$$

which being substituted in (43), give us four equations by which the four curves of contour can be constructed as in Fig. 2. They surround the point $x = -1, y = 0$, for which Z is a maximum according to (36). The surface cannot extend beyond the dotted line drawn at the distance $x = -a_1 b_1 = -4$ from the Y axis, so that all the curves of contour lie wholly to the right of this line.

Again, suppose that while b_1, b_2 and a_1 remain as before, a_2 has also the finite value $a_2 = 1$ due to a c. m. inequality in the y direction. Then by (38) the equation of any curve of contour is

$$3 \log \left(1 + \frac{x'}{4} \right) + 3 \log \left(1 + \frac{y}{4} \right) - .43429(x+y) - \log c = 0. \quad (44)$$

Assigning to Z' the values .01, .02, .03, .04, .05 in succession, with

$$K_1 = K_2 = 1.0211,$$

the values of c are by (37)

$$.26205, \quad .52410, \quad .78615, \quad 1.0482, \quad 1.3102,$$

and substituting these in (44), we have the equations of five curves of contour surrounding the point $x = -1, y = -1$, at which the vertex of the surface is located. The curves can be constructed by approximation, and appear as in Fig. 3. The surface cannot extend beyond the dotted lines

$$x = -a_1 b_1 = -4, \quad y = -a_2 b_2 = -4,$$

and is tangent to the XY plane along them. The curves lie wholly within the angle formed by these lines.

In the foregoing examples we have supposed $b_1 = b_2$ and $a_1 = a_2$. But if these were not equal, or if a_1 or a_2 were negative, it is evident that considerable variety would be occasioned in the form and position of the curves of contour. Moreover, the value $a_1 = \pm 1$ or $a_2 = \pm 1$ is rather an extreme assumption, and implies a degree of c. m. inequality beyond anything that would be likely to occur in practical applications. The peculiarities in the form of the curves are thus exaggerated, merely to make them more readily visible.

To find the unsymmetrical law of error in the position of a point in space of three dimensions, the function which expresses the limiting form of the series of coefficients in a polynomial of three variables is to be obtained in a manner strictly analogous to the foregoing. Indeed, the processes for one or two dimensions are special cases of that for three dimensions, and might be demonstrated as such. The coefficients L , regarded as the masses of material points, are supposed to be arranged equidistantly in the directions of three rectangular axes, the common intervals between them being $\Delta x, \Delta y, \Delta z$, and the polynomial and its expansion to the n th power may be written

$$\left. \begin{aligned} \sum_{c=-m}^{c=m} \sum_{b=-m}^{b=m} \sum_{a=-m}^{a=m} (L_{a,b,c} x^a s^b t^c), \\ \sum_{c=-mn}^{c=mn} \sum_{b=-mn}^{b=mn} \sum_{a=-mn}^{a=mn} (L_{a,b,c} x^a s^b t^c). \end{aligned} \right\} \quad (45)$$

Then, as shown in *Analyst*, ix, p. 36, the relation between the whole $(2m+1)^3$ coefficients L in the first power, and any similar block of an equal number of coefficients l in the expansion, will be

$$\left. \begin{aligned} \sum_{c=-m}^{c=m} \sum_{b=-m}^{b=m} \sum_{a=-m}^{a=m} (L_{-a, -b, -c} l_{(i+a), (j+b), (k+c)}) &= V, \\ \text{“ “ “ } (aL_{-a, -b, -c} l_{(i+a), (j+b), (k+c)}) &= \frac{-i}{n+1} V, \\ \text{“ “ “ } (bL_{-a, -b, -c} l_{(i+a), (j+b), (k+c)}) &= \frac{-j}{n+1} V, \\ \text{“ “ “ } (cL_{-a, -b, -c} l_{(i+a), (j+b), (k+c)}) &= \frac{-k}{n+1} V. \end{aligned} \right\} (46)$$

The middle coefficient of this block is $l_{i, j, k}$ and its coördinates are

$$x=i\Delta x, \quad y=j\Delta y, \quad z=k\Delta z. \quad (47)$$

When the n is made an infinity of the second order, and the coefficients in the expansion are set close together so as to be consecutive, the expansion extends throughout infinite space, the intervals Δx , Δy , Δz become dx , dy , dz , the coefficient $l_{i, j, k}$ becomes the function w which represents the limiting form of the series of coefficients l , its coördinates become

$$x=idx, \quad y=jdy, \quad z=kdz, \quad (48)$$

and we wish to express w as a function of x , y , z . For this purpose, we regard the terms in the block as forming an algebraic triple series, whose first and second differences are to be taken into account, and the differences used are to be symmetrical.

The formula for symmetrical finite differences, where u is a function of the three variables $a\Delta x$, $b\Delta y$ and $c\Delta z$, is found in a manner quite similar to that employed in obtaining the formula (5) for two variables. The coefficients of the differences in the x direction are like those in (3), while those in the y and z directions are the same, only writing b and c instead of a . Then for some other difference, $\Delta_{2,3,4}$ for instance, the coefficient will be the product of the coefficients of $\Delta_{2,0,0}$, $\Delta_{0,3,0}$ and $\Delta_{0,0,4}$. The method of forming the differences so as to keep $u_{0,0,0}$ always in the middle, is analogous to that already explained in discussing formula (5). The formula now obtained, if we stop with second differences, will be

$$\begin{aligned} u_{a,b,c} = & u_{0,0,0} + \frac{a}{1} \Delta_{1,0,0} + \frac{b}{1} \Delta_{0,1,0} + \frac{c}{1} \Delta_{0,0,1} \\ & + \frac{a^2}{1,2} \Delta_{2,0,0} + \frac{b^2}{1,2} \Delta_{0,2,0} + \frac{c^2}{1,2} \Delta_{0,0,2} \\ & + \frac{ab}{1,1} \Delta_{1,1,0} + \frac{ac}{1,1} \Delta_{1,0,1} + \frac{bc}{1,1} \Delta_{0,1,1} \end{aligned} \quad (49)$$

Let the first and second differentials of w in the x , y and z directions be written here for the corresponding differences Δ . Then any

coefficient whose coördinates reckoned from $w=l_{i,j,k}$ are adx , bdy and cdz will be

$$w + ad_x w + bd_y w + cd_z w + \frac{a^2}{2} d_x^2 w + \frac{b^2}{2} d_y^2 w + \frac{c^2}{2} d_z^2 w + abd_x d_y w + acd_x d_z w + bcd_y d_z w, \quad (50)$$

and all the coefficients in the block will be successively represented by assigning to a , b and c all the integral values between $-m$ and m . Suppose that all the values of l in (46) have been thus represented. Collect the coefficients of w , $d_x w$, $d_y w$, etc., remembering that $\sum L = 1$. Let $\alpha_1, \alpha_2, \alpha_3$ denote the sums of the products of each L into its first, second and third sub-indices respectively. Let $\beta_1, \beta_2, \beta_3$ be the sums of the products of each L into the squares of its first, second and third sub-indices respectively. Let $\gamma_1, \gamma_2, \gamma_3$ be the sums of the products of each L into the product of its first and second, first and third, and second and third sub-indices respectively. Let $\delta_1, \delta_2, \delta_3$ be the sums of the products of each L into the cubes of its first, second and third sub-indices respectively. Let $\eta_1, \eta_2, \eta_3, \eta_4, \eta_5, \eta_6$ be the sums of the products of each L into the product of the second sub-index into the square of the first, the product of the third into the square of the first, that of the first into the square of the second, that of the third into the square of the second, that of the first into the square of the third, and that of the second into the square of the third, respectively. Let θ be the sum of the products of each L into the continued product of its three sub-indices. We can now bring (46) into the following form.

$$\left. \begin{aligned} w - \alpha_1 d_x w - \alpha_2 d_y w - \alpha_3 d_z w + \frac{1}{2} \beta_1 d_x^2 w + \frac{1}{2} \beta_2 d_y^2 w + \frac{1}{2} \beta_3 d_z^2 w \\ + \gamma_1 d_x d_y w + \gamma_2 d_x d_z w + \gamma_3 d_y d_z w = V. \\ - \alpha_1 w + \beta_1 d_x^2 w + \gamma_1 d_y w + \gamma_2 d_z w - \frac{1}{2} \delta_1 d_x^2 w - \frac{1}{2} \eta_3 d_y^2 w - \frac{1}{2} \eta_5 d_z^2 w \\ - \eta_1 d_x d_y w - \eta_2 d_x d_z w - \theta d_y d_z w = \frac{-i}{n+1} V. \\ - \alpha_2 w + \gamma_1 d_x w + \beta_2 d_y^2 w + \gamma_3 d_z w - \frac{1}{2} \eta_1 d_x^2 w - \frac{1}{2} \delta_2 d_y^2 w - \frac{1}{2} \eta_6 d_z^2 w \\ - \eta_3 d_x d_y w - \theta d_x d_z w - \eta_4 d_y d_z w = \frac{-j}{n+1} V. \\ - \alpha_3 w + \gamma_2 d_x w + \gamma_3 d_y w + \beta_3 d_z^2 w - \frac{1}{2} \eta_2 d_x^2 w - \frac{1}{2} \eta_4 d_y^2 w - \frac{1}{2} \delta_3 d_z^2 w \\ - \theta d_x d_y w - \eta_5 d_x d_z w - \eta_6 d_y d_z w = \frac{-k}{n+1} V. \end{aligned} \right\} \quad (51)$$

These equations may be simplified by a suitable choice of the coördinate axes. Any coefficient $L_{a,b,c}$ represents the probability that an error which occurs will fall at the point $x=a\Delta x$, $y=b\Delta y$, $z=c\Delta z$. If these coefficients are also regarded as the masses of material points, and their center of gravity is taken as an origin, we shall have $\alpha_1=0$,

$\alpha_2=0, \alpha_3=0$. If the coördinate axes through this origin are taken to coincide with the free axes of the system of masses L , we have also $\gamma_1=0, \gamma_2=0, \gamma_3=0$. By considerations like those employed at *Analyst*, ix, pp. 38 to 40, it will appear that formulas (46) and (51) still hold good, the constants α, β, γ , etc., referring to the new axes with the same meanings as before. Let us neglect second differentials of w in comparison with w in the expression for V in (51). This gives $V=w$. Also let n be written instead of $n+1$. Then giving to i, j, k their equivalents from (48), we reduce (51) to

$$\left. \begin{aligned} & \frac{1}{w^{\frac{1}{2}}} \left\{ d_x w - \frac{1}{2}(\delta_1 \div \beta_1) d_x^2 w - \frac{1}{2}(\eta_3 \div \beta_1) d_y^2 w - \frac{1}{2}(\eta_5 \div \beta_1) d_z^2 w \right. \\ & \left. - (\eta_1 \div \beta_1) d_x d_y w - (\eta_2 \div \beta_1) d_x d_z w - (\theta \div \beta_1) d_y d_z w \right\} = \frac{-x dx}{n \beta_1 (dx)^2} \\ & \frac{1}{w^{\frac{1}{2}}} \left\{ d_y w - \frac{1}{2}(\eta_1 \div \beta_2) d_x^2 w - \frac{1}{2}(\delta_2 \div \beta_2) d_y^2 w - \frac{1}{2}(\eta_6 \div \beta_2) d_z^2 w \right. \\ & \left. - (\eta_3 \div \beta_2) d_x d_y w - (\theta \div \beta_2) d_x d_z w - (\eta_4 \div \beta_2) d_y d_z w \right\} = \frac{-y dy}{n \beta_2 (dy)^2} \\ & \frac{1}{w^{\frac{1}{2}}} \left\{ d_z w - \frac{1}{2}(\eta_2 \div \beta_3) d_x^2 w - \frac{1}{2}(\eta_4 \div \beta_3) d_y^2 w - \frac{1}{2}(\delta_3 \div \beta_3) d_z^2 w \right. \\ & \left. - (\theta \div \beta_3) d_x d_y w - (\eta_5 \div \beta_3) d_x d_z w - (\eta_6 \div \beta_3) d_y d_z w \right\} = \frac{-z dz}{n \beta_3 (dz)^2} \end{aligned} \right\} \quad (52)$$

If we write

$$\left. \begin{aligned} A &= n\beta_1(dx)^2, & B &= n\beta_2(dy)^2, & C &= n\beta_3(dz)^2, \\ A_1 &= n\delta_1(dx)^3, & A_2 &= n\eta_3 dx(dy)^2, & A_3 &= n\eta_5 dx(dz)^2, \\ B_1 &= n\eta_1(dx)^2 dy, & B_2 &= n\delta_2(dy)^3, & B_3 &= n\eta_6 dy(dz)^2, \\ C_1 &= n\eta_2(dx)^2 dz, & C_2 &= n\eta_4(dy)^2 dz, & C_3 &= n\delta_3(dz)^3, \\ E &= n\theta dx dy dz, \end{aligned} \right\} \quad (53)$$

(52) may be put in the form

$$\left. \begin{aligned} & \frac{1}{2} A_1 \left(\frac{d^2 w}{dx^2} \right) + \frac{1}{2} A_2 \left(\frac{d^2 w}{dy^2} \right) + \frac{1}{2} A_3 \left(\frac{d^2 w}{dz^2} \right) + B_1 \left(\frac{d^2 w}{dx dy} \right) + C_1 \left(\frac{d^2 w}{dx dz} \right) \\ & + E \left(\frac{d^2 w}{dy dz} \right) = A \left(\frac{dw}{dx} \right) + w.x \\ & \frac{1}{2} B_1 \left(\frac{d^2 w}{dx^2} \right) + \frac{1}{2} B_2 \left(\frac{d^2 w}{dy^2} \right) + \frac{1}{2} B_3 \left(\frac{d^2 w}{dx dz} \right) + A_2 \left(\frac{d^2 w}{dx dy} \right) + E \left(\frac{d^2 w}{dx dz} \right) \\ & + C_2 \left(\frac{d^2 w}{dy dz} \right) = B \left(\frac{dw}{dy} \right) + w.y \\ & \frac{1}{2} C_1 \left(\frac{d^2 w}{dx^2} \right) + \frac{1}{2} C_2 \left(\frac{d^2 w}{dy^2} \right) + \frac{1}{2} C_3 \left(\frac{d^2 w}{dz^2} \right) + E \left(\frac{d^2 w}{dx dy} \right) + A_3 \left(\frac{d^2 w}{dx dz} \right) \\ & + B_3 \left(\frac{d^2 w}{dy dz} \right) = C \left(\frac{dw}{dz} \right) + w.z \end{aligned} \right\} \quad (54)$$

The constants A, B, C represent the squared q. m. errors or deviations of the coefficients or masses l in the n th power, from the X, Y and Z axes respectively. In other words, they are the x^2 , y^2 and z^2 moments of the system of coefficients l . When n becomes an infinity of the second order, they are the moments of the system of values of the limiting function w , and are constant and finite areas. Likewise the constants A_1 , B_1 , etc., are the x^3 , x^2y , etc. moments of the system of coefficients l in the n th power, all such moments being n times greater in the n th power than in the first power, as shown in my article already cited (*Analyst*, x, p. 97). When n becomes an infinity of the second order, A, A_1 , B_1 , etc., become the moments of the system of values of the limiting function w , and might be expressed thus:

$$\left. \begin{aligned} A &= \frac{1}{dxdydz} \iint \iint w \cdot x^2 \cdot dx dy dz, \\ A_1 &= \frac{1}{dxdydz} \iint \iint w \cdot x^3 \cdot dx dy dz, \\ B_1 &= \frac{1}{dxdydz} \iint \iint w \cdot x^2 y \cdot dx dy dz, \end{aligned} \right\} \quad (55)$$

and so on.

The differential equations (52) or (54) cannot be further simplified without impairing their generality. But as they apparently cannot be integrated in their complete form, we will neglect the seven η and θ inequalities, and thus reduce (52) to

$$\left. \begin{aligned} \frac{d_x w - \frac{1}{2}(\delta_1 \div \beta_1) d_x^2 w}{w} &= \frac{-x}{n\beta_1 dx}, \\ \frac{d_y w - \frac{1}{2}(\delta_2 \div \beta_2) d_y^2 w}{w} &= \frac{-y}{n\beta_2 dy}, \\ \frac{d_z w - \frac{1}{2}(\delta_3 \div \beta_3) d_z^2 w}{w} &= \frac{-z}{n\beta_3 dz}. \end{aligned} \right\} \quad (56)$$

These equations are of the same form as (18). We transfer the origin to another point by putting

$$x - \frac{2n\beta_1^2 dx}{\delta_1}, \quad y - \frac{2n\beta_2^2 dy}{\delta_2}, \quad z - \frac{2n\beta_3^2 dz}{\delta_3},$$

in place of x , y , z , and assume the new constants

$$\left. \begin{aligned} a_1 &= \frac{2\beta_1(dx)^2}{\delta_1(dx)^3}, & a_2 &= \frac{2\beta_2(dy)^2}{\delta_2(dy)^3}, & a_3 &= \frac{2\beta_3(dz)^2}{\delta_3(dz)^3}, \\ b_1 &= n\beta_1(dx)^2, & b_2 &= n\beta_2(dy)^2, & b_3 &= n\beta_3(dz)^2. \end{aligned} \right\} \quad (58)$$

The equations may thus be approximately reduced to

$$\left. \begin{aligned} \frac{d_x w}{w} &= \frac{d_x}{x} (a_1^2 b_1 - 1) - a_1 dx, & \frac{d_y w}{w} &= \frac{d_y}{y} (a_2^2 b_2 - 1) - a_2 dy \\ \frac{d_z w}{w} &= \frac{d_z}{z} (a_3^2 b_3 - 1) - a_3 dz, \end{aligned} \right\} \quad (59)$$

and integration gives

$$w = C x^{a_1^2 b_1 - 1} y^{a_2^2 b_2 - 1} z^{a_3^2 b_3 - 1} e^{-a_1 x - a_2 y - a_3 z} \quad (60)$$

The value of w becomes zero for $x=0$ or $y=0$ or $z=0$, or for $x=\infty$ or $y=\infty$ or $z=\infty$. Hence, to determine C , we have

$$\frac{1}{dxdydz} \int_0^\infty \int_0^\infty \int_0^\infty w dx dy dz = 1, \quad (61)$$

and as in the case of (26), this is shown to be equivalent to

$$\frac{C \Gamma(a_1^2 b_1) \Gamma(a_2^2 b_2) \Gamma(a_3^2 b_3)}{a_1^{a_1^2 b_1} a_2^{a_2^2 b_2} a_3^{a_3^2 b_3} dxdydz} = 1. \quad (62)$$

When C as thus obtained is substituted in (60), we get

$$w = \frac{a_1 a_2 a_3 dxdydz}{\Gamma(a_1^2 b_1) \Gamma(a_2^2 b_2) \Gamma(a_3^2 b_3)} (a_1 x)^{a_1^2 b_1 - 1} (a_2 y)^{a_2^2 b_2 - 1} (a_3 z)^{a_3^2 b_3 - 1} e^{-a_1 x - a_2 y - a_3 z} \quad (63)$$

Now let the origin be restored to the point where it was at first, the center of gravity of all the masses w , that is to say, the arithmetical mean of all the possible points of error, each taken with a weight proportional to the probability of its occurrence. It appears from (57) and (58) that the origin was removed from this point by substituting

$$x - a_1 b_1, \quad y - a_2 b_2, \quad z - a_3 b_3,$$

in place of x, y, z , so that we bring it back by substituting

$$x + a_1 b_1, \quad y + a_2 b_2, \quad z + a_3 b_3, \quad (64)$$

for x, y, z in (63). Employing also the value (31) for $\Gamma(n)$, and writing as in (32)

$$K_3 = 1 + \frac{1}{12 a_3^2 b_3} + \frac{1}{288 (a_3^2 b_3)^2} - \text{etc.}, \quad (65)$$

and putting $w = W dxdydz$, we find that (63) reduces to

$$W = \frac{1}{(2\pi)^{\frac{3}{2}} K_1 K_2 K_3 \sqrt{(b_1 b_2 b_3)}} \left(1 + \frac{x}{a_1 b_1}\right)^{a_1^2 b_1 - 1} \left(1 + \frac{y}{a_2 b_2}\right)^{a_2^2 b_2 - 1} \left(1 + \frac{z}{a_3 b_3}\right)^{a_3^2 b_3 - 1} e^{-a_1 x - a_2 y - a_3 z} \quad (66)$$

This final form is the product of three functions like Y in (1), one in x , one in y , and one in z . Differentiation gives

$$\left. \begin{aligned} \frac{dW}{dx} &= W \left(\frac{a_1^2 b_1 - 1}{a_1 b_1 + x} - a_1 \right), & \frac{dW}{dy} &= W \left(\frac{a_2^2 b_2 - 1}{a_2 b_2 + y} - a_2 \right), \\ \frac{dW}{dz} &= W \left(\frac{a_3^2 b_3 - 1}{a_3 b_3 + z} - a_3 \right). \end{aligned} \right\} \quad (67)$$

These become zero when we take

$$x = -\frac{1}{a_1}, \quad y = -\frac{1}{a_2}, \quad z = -\frac{1}{a_3}, \quad (68)$$

and at this point W is a maximum. They are also zero when $W=0$, and this occurs when $x = -a_1 b_1$, or when $y = -a_2 b_2$, or when $z = -a_3 b_3$, and also when either x , y or z are equal to $\pm\infty$, the + or - sign being taken according as a_1 , a_2 or a_3 are respectively + or - . If we suppose parallel planes to be drawn at the distances

$$-a_1 b_1, \quad -a_2 b_2, \quad -a_3 b_3,$$

from the YZ , XZ and XY planes respectively, the values of W will all be included within only one of the eight solid angles formed by the planes so drawn. In other words, the law of probability represented by (66) is such that any error which occurs must fall at some point within this portion of infinite space. But in the special cases when either a_1 , a_2 or a_3 is infinite, the limit of possible error is extended to infinity in the x , y or z direction respectively, and the function W becomes symmetrical in that direction, depending on x^2 , y^2 or z^2 , as (39) shows. If a_1 , a_2 , a_3 are all infinite, the errors may fall in any portion of infinite space, and (66) is reduced to the entirely symmetrical form

$$W = \frac{h_1 h_2 h_3}{\pi^{\frac{3}{2}}} e^{-h_1^2 x^2 - h_2^2 y^2 - h_3^2 z^2}, \quad (69)$$

where we have put

$$h_1^2 = \frac{1}{2b_1}, \quad h_2^2 = \frac{1}{2b_2}, \quad h_3^2 = \frac{1}{2b_3}. \quad (70)$$

Compare *Analyst*, vol. ix, p. 68. The expression (69) was there obtained as the limiting form of the system of coefficients in the expansion of a polynomial of three variables, when only first differences were taken into account. The same result would have been obtained here, if we had neglected the second differences of w in (50).

VI.—SECOND CATALOGUE OF MOLLUSCA RECENTLY ADDED TO THE FAUNA OF THE NEW ENGLAND COAST AND THE ADJACENT PARTS OF THE ATLANTIC, CONSISTING MOSTLY OF DEEP-SEA SPECIES, WITH NOTES ON OTHERS PREVIOUSLY RECORDED. BY A. E. VERRILL.

[Published by permission of the U. S. Fish Commission.]

THE following paper was originally intended to form merely a brief supplement to the Catalogue published by me, in 1882, in Vol. V. of these transactions, to include such corrections and additions as had been noticed up to date. But the discovery of a very large number of interesting additional species, many of them new, during the deep-sea dredging cruises of the Fish Commission Steamer, Albatross, in 1883, made it desirable to extend the paper so as to include many of the more important of these discoveries. This has caused delay in the printing of the paper and much increased its length, and, as I hope, its value. Many of the additions made in 1883 are from much deeper water than we had previously explored (1,000 to 2,900 fathoms), and consequently from a greater distance at sea; so that these cannot properly be regarded as pertaining particularly to the "New England fauna." They belong rather to the general deep-sea fauna of the western Atlantic. Others are from the deep waters of the continental slope, beneath the Gulf Stream, in 100 to 600 fathoms. As these deep-sea forms are likely to extend all along our coast, at similar depths, and even to foreign waters, I have not thought it desirable to exclude from this paper any deep water species because of its having been taken even as far south as off Cape Hatteras, which was nearly the southern limit of the dredgings of the Albatross in 1883. But I have excluded the strictly southern shallow water forms, dredged at moderate depths off the coasts of North Carolina and Virginia, though many of them are new additions to the fauna of our coast.

There are, doubtless, to be added to our list many species of small and difficult shells, belonging to certain groups that have not yet been fully examined, or of which we have taken only imperfect examples. These will chiefly belong to the *Bullidæ*, *Turbonilla*, *Odostomia*, *Cryptodon*, and *Yoldia*.

I am greatly indebted to the skill of Mr. J. H. Emerton for the unusually accurate illustrations, and to the U. S. Fish Commission for the privilege of using them in this place.

The original assorting and preservation of the deep-sea specimens taken by the Albatross was largely done by Mr. Sanderson Smith, who went on all the cruises of the Albatross, except a few of the earliest. He was assisted by several other members of the party, and especially by Ensign W. E. Safford, U. S. N.

My work has also been particularly facilitated by the care and skill with which the final assorting, cataloguing, and labeling of the large collections have been done by my assistant, Miss K. J. Bush, who has, also, made many identifications of the described species, and given aid in other ways.

When the various lots were first examined and assorted, at Wood's Holl, last summer, during the dredging season, many of the new species, especially the largest and most striking, were recognized as forms not before observed on our coast, both by Mr. Sanderson Smith, who had special charge of the shells, and myself. For such species, in this article, "Verrill and Smith" are usually given as authorities, but the writer is alone responsible for the descriptions of all the species, as in his previous papers on the same subject.

Some of the previously known species, first discovered on our coast last summer, were first identified by Mr. Smith, and others by Miss Bush, but the writer has independently examined and confirmed all such species, given in this paper.

CEPHALOPODA.

Leptoteuthis Verrill, gen. nov.

Body elongated and slender, pointed behind, with a well developed terminal fin. Head relatively large, much elongated. Eyes not exsert, with simple thin lids. Mantle free dorsally, with a special dorsal and two lateral connective cartilages; the lateral ones simple, tubercle-like, corresponding to a roundish cartilage-pit on each side of the siphon. Arms slender, the ventral ones much the largest and longest. Suckers depressed, in two rows. Tentacular arms rather long, slender, with a somewhat expanded terminal club, bearing simple suckers, and with a row of small sessile suckers and rounded warts along the whole length of the inner surface of the slender portion. Gills and viscera anteriorly situated. Stomach short, with a saccular appendage.

This genus has, hitherto, not been distinguished from *Leachia* and *Loligopsis*. From the typical forms of these groups it differs greatly in anatomical characters, as well as in external appearance. From

Taonius and *Desmoteuthis* it differs still more widely, and evidently has no near relationship with them. It shows more affinity with *Cheiroteuthis*, in the connective cartilages and many other respects, and like that genus has large ventral arms, with a special row of color spots on them; but there is nothing of the peculiar structure of the tentacular suckers seen in the latter. Its nearest allies appear to be *Calliteuthis* V. and *Brachioteuthis* V., from both of which it is clearly distinct generically. It may, therefore, be referred to the family *Cheiroteuthidae*, along with the two last-named genera.

Leptoteuthis diaphana Verrill, sp. nov.

PLATE XXXII, FIGURE 1.

A small, elongated, very slender, translucent species, with the head very large and long, as compared to the body, its length being more than half that of the body and tail taken together, and more than three-fourths that of the body to the caudal fin. Sessile arms slender, the ventral arms much larger and longer than the others, about equal in length to the head and body to the base of the tail. Tentacular arms long and slender. Caudal fin ovate, acutely pointed posteriorly.

Head elongated, cylindrical, smooth, and nearly transparent, except in the region of the eyes. The eyes are of moderate size, not very prominent, with a broad, thin lower eyelid, but without any distinct lachrymal sinus. Body, in front of the fin, slender anteriorly, about equal to the head in diameter, somewhat tapering backward to the base of the caudal fin, and then abruptly narrowing to a very slender caudal portion, running along the under surface of the fin like a mid-rib and terminating in a very slender, acute tip. Anterior edge of the mantle thin, very evenly truncated ventrally and laterally, but extending on the dorsal side into a broad, angular, obtusely pointed lobe. Caudal fin relatively large, elongated, ovate, decidedly broadest in the middle, narrowing distinctly anteriorly, with the anterior lobes small, rounded, and projecting only slightly forward beyond the insertion; posteriorly the fin narrows rapidly to a long, slender, acuminate tip. Siphon well developed, with the terminal portion elongated and free for some distance, strongly recurved in our specimen. Connective cartilages on the lateral base of the siphon small, elliptical, somewhat ear-shaped, with a continuous, raised rim, and with two small interior lobes, one of which is ventral and the other posterior, leaving between them a small, deep sinus, directed downward and backward. The corresponding cartilages on the inner surface of the mantle are small prominent, somewhat triquetral tubercles,

with the corners rounded and the obtuse tip a little prominent and directed posteriorly.

The arms increase in size and length from the dorsal to the ventral pairs. The dorsal arms are very slender and short, in length not half as long as the head; the second and third pairs are similar in form, but increase regularly in size and length, the third pair not being equal to the length of the head; the ventral arms are, on the contrary, very much larger and longer than the third pair, their length being nearly three times as great; the tentacular arms are very slender and considerably exceed the ventral arms in length when extended; the club is distinctly larger than the rest of the arm, a little flattened and expanded in a narrow lanceolate form, and covered by regular, minute suckers, arranged in about four rows along the middle portion. The slender portion of the arms bears a row of small sessile suckers and tubercles along nearly its whole length; these suckers are usually elliptical in form where the arm is extended, but circular when contracted; they are rather larger than the suckers of the club, but are only a little elevated, and are so numerous that the intervals between them are often not greater than their own diameter, but when the arms are fully extended these intervals are increased. On the ventral arms the suckers are small, oblique cups, constricted at the aperture and attached by very slender pedicels; they are arranged rather distantly in two alternating rows, which occupy only a narrow median band on the inner face of the arms; just exterior to the outer suckers, and alternating with them, there is a row of small, rounded, slightly raised, reddish brown warts, in diameter equal to or somewhat exceeding the suckers. On the other arms the suckers are relatively more numerous, and more closely arranged in two regular rows; on these arms they are about the same in size as on the ventral ones, but are flatter, less obliquely attached, and have the aperture less constricted and not so one-sided. On the inner surface of these arms there are two rows of brown spots, alternating with the suckers. Color of the body and head, in alcohol, pale, translucent bluish white, spotted along the middle of the dorsal surface with rather large chromatophores, which are not very numerous, and with fewer scattered ones on the sides and ventral surface. Caudal fin yellowish white, opaque (owing to the effect of the alcohol), with a median band of chromatophores along the dorsal surface and with very few beneath. On the dorsal side of the head, between the eyes, the chromatophores are more numerous than elsewhere; a row of similar chromatophores extends along the outer surface of each arm. Ten-

tacular arms and three upper pairs of sessile arms yellowish white and opaque. Ventral arms bluish white and translucent, like the head and body.

Length from tip of tail to base of dorsal arms, 74^{mm}; to anterior edge of mantle, 50^{mm}; to center of eyes, 64^{mm}; diameter of head across eyes, 8^{mm}; back of eyes, 7^{mm}; diameter of body, 5-7^{mm}; length of caudal fin, 23^{mm}; its breadth in the middle, 13^{mm}; breadth across anterior lobes, 6^{mm}; length of dorsal arms, 11^{mm}; of second pair, 14^{mm}; of third pair, 18^{mm}; of ventral arms, 42^{mm}; of tentacular arms, 60^{mm}; diameter of dorsal arms at base, about 1^{mm}; of third pair, 2^{mm}; of ventral arms, 3^{mm}; diameter of larger suckers, about .3^{mm}.

The gills and viscera are situated far forward. The gills are short, broad, blunt, with many crowded lamellæ. The stomach has a short, thick, tapering, saccular appendage. The liver is relatively large, short, rounded. Rectum slender, with two well-developed, spatulate anal papillæ. Branchial auricles well-developed, oblong. The pen is very thin and delicate.

Station 2037, in 1731 fathoms, N. latitude 38° 53', W. longitude 69° 23' 30". No. 38,242. Steamer Albatross, 1883.

The only described species which resembles this is *Loligopsis vermicolaris* Rup., but the latter, if the figures can be relied upon, differs in its proportions. It has a still longer and more slender head, while its caudal fin is much larger and has a distinctly cordate outline, broadest across the anterior lobes, which are much larger and broadly rounded. It is, however, evidently congeneric with our species, and should be called *Leptoteuthis vermicolaris*.

Our specimen has the reproductive organs but little developed, and is, therefore, probably immature.

Abralia megalops Verrill.

Amer. Journ. Sci., vol. xxiv, p. 364, 1882; Bulletin Mus. Comp. Zool., vol. xi, p. 105, pl. 3, fig. 4, 1883 (description of young).

PLATE XXVIII, FIGURE 2.

The following description is from the type-specimen, in alcohol.

Small, eyes large; caudal fin, about two-thirds as long as the mantle, and much broader than long, transversely elliptical; 2d and 3d pairs of arms equal; dorsal a little shorter; ventrals shortest. Sessile arms with two rows of hooks, which are replaced by small suckers on the distal third; tentacular clubs with two alternating rows of hooks, and with marginal suckers distally, on each side,

alternating with the median hooks, and with proximal and terminal groups of smaller suckers. Color pale, with numerous small dark brown chromatophores above, larger and more crowded on the head and on the bases of the arms; lower side with several larger, round, symmetrically placed, purplish brown spots, and with minute ones between them.

Length of mantle, 15^{mm}; diameter of body, 7^{mm}; length of fin, 11^{mm}; breadth across fins, 18^{mm}; breadth of head, 7^{mm}; diameter of eye, 4.5^{mm}; length of dorsal arms, 13^{mm}; length of second pair, 14^{mm}; of third pair, 14^{mm}; of tentacular arms, 25^{mm}; of ventral arms, 10^{mm}. Probably this specimen is immature.

The specimen described from the Blake collection is still younger, but the general figure referred to is from the original specimen, described above.

Off Martha's Vineyard, station 1137, in 173 fathoms, Fish Hawk, 1882. Off Barbados, station 294, in 137 fathoms, Blake Exped., 1878-9.

Eledonella Verrill, gen. nov.

General appearance similar to that of certain small species of *Octopus* and *Eledone*. Body oblong-ovate, soft and saccular, without fins. Mantle extending forward as far as the eyes. Gill-opening very wide, extending upward on the sides as far as the dorsal margin of the eyes, which may be partially concealed by the edge of the mantle. Arms slender, the upper ones shortest, the third pair largest. Suckers in a single row. Third arm of the right side hectocotylized by having the terminal half thickened and somewhat shortened, and bearing on its distal half a few very large urceolate suckers, very much larger than any of the others, and quite different in form. Interbranchial membrane short. Eyes well developed, nearly covered by the skin; a mucus-pore close to the anterior ventral border of the orbit. Siphon moderately developed, free only near the tip; posteriorly the basal part of the siphon extends into two commissural muscular bands on each side; the ventral one runs far back, while the lateral curves upward to join the mantle. There is a large median ventral commissure joining the mantle to the visceral mass; thus the gill-chamber is divided into right and left compartments, each of which is sub-divided into a superior and inferior portion. No special cartilages could be seen on the mantle, nor on the siphon. Reproductive organs large, highly colored with large orange chromatophores.

The principal character in which this genus differs from *Eledone* is the peculiar mode of hectocotylization of the third arm in the male. *Eledone* agrees essentially with *Octopus* in this respect.

Eledonella pygmæa Verrill, sp. nov.

PLATE XXXII, FIGURE 2.

Body smooth, oblong-ovate, somewhat depressed, bluntly rounded at the posterior end, narrowed a little anteriorly, back of the eyes. Head rather small, equal in width to the anterior part of the body. Mantle-edge thin, extending far forward, its lateral edge reaching as far as the pupil of the eye, and united to the dorsal integument of the head on a level with the upper surface of the eye. Eyes of moderate size, convex, but not very prominent. Arms rather short, except the third pair, which is much larger than the others; the dorsal pair is considerably smaller and shorter than the others; the second pair is a little longer and united to the first by a small interbrachial membrane, occupying about its basal third; the third arm on the left side, is about twice as long as the dorsal ones and much stouter, tapering to a slender, acute tip, and united to the second by the short interbrachial membrane, but with only a rudimentary membrane between it and the ventral arm; the ventral arms are much smaller and shorter, about equal in length to the second pair, and have no interbrachial web between them. The hectocotylized arm (fig. 2) is somewhat stouter than its mate, but decidedly shorter, though longer than any of the other arms; beyond its middle it bears four large urn-shaped suckers, quite different in size and form from those on the basal half; the first of these special suckers is decidedly the largest, the others decrease in size to the terminal one, which is quite small. These specialized suckers have a broad, swollen, and nearly round basal portion, in breadth exceeding the width of the arm, while toward the summit there is a distinct constriction, and the cup itself expands somewhat, but is decidedly narrower than the basal portion of the sucker; the border of the aperture is somewhat contracted and four-lobed. The basal suckers on this arm and all of those on the other arms are arranged in a single row. They are of moderate size, rather elevated, with the basal portion sessile and a little expanded. The number on each arm is from ten to twelve, besides a few minute ones at the tip; on the basal half of the hectocotylized arm there are four simple ones. Color, a pale bluish white, spotted with rather large purple-brown chromatophores, which are equally numerous above and below, and arranged somewhat in rows on the outer surfaces of the arms.

Length of the body and head, to base of arm, 27^{mm}; length of body to edge of mantle above, 20^{mm}; breadth across body, 14^{mm}; breadth of head across eyes, 11^{mm}; diameter of eye-ball, 4.5^{mm}; length of dorsal arms, 7^{mm}; length of second pair of arms, 9^{mm}; length of third pair, 14^{mm}; length of ventral arms, 7.5^{mm}; length of hectocotylized arm, 11^{mm}; height of largest specialized suckers, 3^{mm}; diameter, 3^{mm}.

Station 2099, N. latitude 37° 12' 20", W. longitude 69° 39', in 2949 fathoms, (No. 35,268 *). Steamer Albatross, 1883.

GASTROPODA.

Pleurotomella Verrill.

Amer. Jour. Science, v, p. 15, 1882; Catal. Marine Mollusca, these Trans., v, p. 453, 1882.

This genus was originally proposed for *P. Packardii*, first taken in deep water in the Gulf of Maine. This species is remarkable for the delicacy and beauty of its sculpture and the great depth of its subsutural sinus. The subsequent discovery of numerous other related species inhabiting the deep waters, off our coast and in other regions, has rendered it necessary to enlarge the limits of the genus and to modify its characters.

As at present understood, this genus is intended to include those species which have a rather broad and very distinct subsutural band, crossed by excurved lines of growth corresponding to the form of the posterior sinus of the lip, which is situated a little below the suture and is always pretty well-developed, but is sometimes broad and shallow, and at other times narrower and very deep. The outer lip is always thin and sharp, without any appearance of a varix, nor is there any deposit of callus on the body-whorl, in front of the aperture. The canal is well developed, generally constricted at the base and somewhat elongated, and usually but slightly curved. In a few of the species, doubtfully referred to the genus, it is short and wide. The columella-margin is more or less sinuous. The nucleus differs in sculpture, and usually in color, from the rest of the whorls, and is generally minutely cancellated by fine raised lines running obliquely in opposite directions. The remaining whorls are elegantly sculptured by longitudinal ribs and revolving cinguli, and usually have a distinct shoulder or carina, which is frequently nodulous, below the

* The numbers given in this paper are those used in the permanent catalogue of the mollusca, in the National Museum.

subsutural band. The animal is destitute of an operculum, and, in all the species hitherto examined, is without eyes. The dentition consists of rather strong uncini, usually with a barbed tip and broad base.

This genus, therefore, resembles very closely the shallow-water genus, *Defrancia*, to which many of the described species have been hitherto referred; but in *Defrancia* the outer lip is thickened, or has a distinct varix, and there is usually a deposit of callus on the body-whorl, especially posteriorly, opposite the sinus, while the animal, in the typical species at least, has well developed eyes.

Pleurotomella Bairdii Verrill and Smith, sp. nov.

PLATE XXXI, FIGURE 1.

Shell large, rather stout, fusiform, with an elevated, acute, turreted spire and eight or nine obtusely shouldered, angular whorls. The last whorl is large and somewhat inflated, with a broad, flattened or slightly concave, sloping subsutural band, which is covered with distinct, strongly receding lines of growth and with more or less evident, raised, spiral cinguli and grooves. Below the subsutural band the whorls are obtusely angulated, but without a distinct carina. Commencing at the shoulder and extending a short distance below it are numerous oblique, not very elevated, longitudinal ribs, which fade out before reaching the middle of the whorls. The whole surface of the whorls, including the ribs, is covered with conspicuous, raised, spiral cinguli, between which there are two or three smaller ones, separated by deep concave grooves of about the same breadth; the whole surface is covered by distinct, raised lines of growth. The aperture is oblong-ovate, rather large; the columella is nearly straight, somewhat prolonged, its inner edge forming a slight sigmoid curve; the canal is short, broad, narrowed at the tip and not recurved; the outer lip is sharp and thin; the posterior sinus is broad and rather deep, with regularly rounded margins, corresponding to the lines on the sub-sutural band; below the shoulder the lip projects considerably forward and then is somewhat flattened and recedes gradually to the base of the short and broad canal. The nuclear whorls are very small and generally eroded so far as to appear smooth.

The shell is white or grayish white, without any distinct epidermis; aperture clear white. The animal is destitute of operculum and eyes.

In the number of specimens examined there is considerable variation in the ratio of length and breadth, depending largely on the

sex; among the several specimens of which the sex was determined the females have the body-whorl slightly more swollen than the males.

Length of one of the largest female specimens, 55^{mm}; breadth, 26^{mm}; length of body-whorl to tip of canal, 40^{mm}; breadth of body-whorl, 22^{mm}; length of spire, 26^{mm}; length of aperture, 27^{mm}; its breadth, 12^{mm}.

It was taken at the following stations by the Albatross in 1883 :

Nat. Mus. No.	Station.	N. lat.	W. long.	Fathoms.	
37,824	2,037	38° 53' 00"	69° 23' 30"	1721	12 specimens, mostly living.
37,806	2,038	38 30 30	69 08 25	2033	1 specimen, dead.
37,814	2,041	39 22 50	68 25	1608	2 specimens, living.
35,253	2,097	37 56 20	70 57 30	1917	1 specimen, dead.
35,275	2,098	37 40 30	70 37 30	2221	1 specimen, dead.

This species is closely allied to *P. Agassizii*. It is a larger and stouter shell, with the whorls more angulated at the shoulder, and has a broader and more angular aperture. The sculpture differs considerably in details, and the columella is destitute of the pink or pale orange tint usually present in *P. Agassizii*.

Pleurotomella Benedicti Verrill and Smith, sp. nov.

PLATE XXXI, FIGURES 2, 2a.

Shell fusiform, moderately stout, with a high, regularly tapered spire, and very convex, shouldered whorls, which have strong, oblique, transverse ribs rendered nodulous by well-developed, raised cinguli.

Whorls six, below the chestnut-colored nucleus. The suture is deep, not very oblique. The subsutural band is rather broad, concave, nearly smooth, contrasting strongly with the rest of the whorls; its sculpture consists only of the deeply concave lines of growth, parallel with the notch in the lip. Below the subsutural band the whorls are abruptly swollen, forming a rounded shoulder. The transverse ribs, commencing at the shoulder, are prominently raised, rather oblique, and extend entirely across the whorls of the spire, becoming smaller next the suture; on the last whorl they extend to the base of the canal; they are obtuse at summit and separated by wider, deeply concave interspaces; on the last whorls there are about sixteen ribs. Both the ribs and interspaces are crossed by well marked, somewhat unequal, raised, revolving lines, separated by narrow grooves; these, in passing over the ribs, produce small, somewhat conical, unequal nodules, which give a somewhat rough appearance to the surface of

the shell. One of the spiral lines just above the suture and one or two of those at the shoulder are stronger than the rest. Between the ribs the revolving lines are roughened by fine lines of growth.

The four nuclear whorls (fig. 2*a*) are evenly rounded and in strong contrast with those that follow them. The first one is very minute, forming a very acute apex; the surface is finely cancellated by two sets of lines running obliquely in opposite directions. The aperture is elongated and rather broad in the middle; the outer lip has a deep and broad posterior sinus, below which it projects strongly forward and is regularly arched to the base of the canal; the canal is narrow, nearly straight, slightly prolonged; the columella is straight and tapered, with its inner edge forming a slightly sinuous curve; the inner lip is smooth and polished, with a thin coat of enamel which extends somewhat forward in a regular curve on the body-whorl. The color is white with a pale grayish tinge, with the exception of the nuclear whorls, which are deep chestnut-brown.

Length, 17^{mm}; greatest breadth, 8^{mm}; height of spire, 9.5^{mm}; length of aperture, 8^{mm}; breadth, 3.5^{mm}.

Station 2084, N. latitude 40° 16' 50", W. longitude 67° 05' 15", 1290 fathoms. Albatross, 1883. (No. 38,087).

This fine species has been dedicated to Mr. James E. Benedict, of the U. S. Fish Commission, Naturalist, in charge of the Zoological department on the Albatross.

Pleurotomella Sandersoni Verrill, sp. nov.

PLATE XXXI, FIGURES 3, 3*a*.

Shell small, delicate, fusiform, with an elevated and very acute spire and a slightly elongated, straight canal. Whorls angulated and turreted, sculptured with ribs and revolving lines, which form rows of small, sharp nodules at their intersection around the periphery, and especially at the shoulder. Whorls about four, below the nucleus, which is unusually elongated and composed of four pale chestnut-colored whorls, which are finely and regularly cancellated. The apical whorl is very minute and prominent, giving the spire a very acute tip. The nuclear whorls increase rapidly and regularly in size, and are regularly rounded. The sculpture passes somewhat gradually into that of the next lower whorl, which is distinctly ribbed and carinated, with a single row of sharp tubercles around the middle. The lower whorls of the spire have the shoulder at about the middle, and below it two or three raised cin-

guli, which form as many rows of small acute nodules in crossing the ribs; these are similar to those on the carina of the shoulder, but usually a little smaller. There is commonly another row of smaller tubercles of the same kind just above the shoulder. On the last whorl there are from fifteen to eighteen cinguli, which are unequal in size and decrease in prominence from the carina to the base of the canal; most of these form small, sharp nodules in crossing the ribs. The ribs are a little prominent, rather oblique, sharp at summit, and separated by concave interspaces of somewhat greater width; on the upper whorls they run from just above the shoulder forward to the suture; on the body-whorl they curve strongly forward in the middle and then recede and disappear before reaching the base of the canal. The subsutural band is very wide, strongly sloping, and somewhat concave just above the shoulder; it is covered with numerous, rather conspicuous, thin, raised riblets, which are strongly ex-curved in the middle and bend forward before reaching the suture. Two or sometimes three cinguli exist on the subsutural band; the uppermost of these is just below the suture and forms there a small carina, above which the suture is distinctly channeled. The surface between the ribs is everywhere covered by fine, distinct, flexuous lines of growth. The aperture is long-ovate, rather narrow, angulated externally; the outer lip is thin and sharp, with a broad, rounded posterior sinus, just above the shoulder and a little removed from the suture; below the shoulder the lip arches forward in a broad curve, and becomes incurved at the base of the canal, which is rather contracted and a little bent to the right and slightly everted at tip. Columella short and nearly straight, its inner edge forming a strong sigmoid curvature. Epidermis indistinct. Color white, with the exception of the light yellowish brown nucleus.

Length of one of the larger specimens, 6.5^{mm}; breadth, 3.5^{mm}; length of body-whorl and canal, 4^{mm}; length of aperture, 3^{mm}; its breadth, 1.25^{mm}.

Station 2038, N. latitude 38° 30' 30", W. longitude 69° 08' 25", in 2033 fathoms, living, (No. 34,841); Station 2043, N. latitude 39° 49', W. longitude 68° 28' 30", in 1467 fathoms, (No. 34,851); and station 2084, N. latitude 40° 16' 50", W. longitude 67° 05' 15", in 1290 fathoms, living, (No. 38,315). Albatross, 1883. The best specimens occurred at the last named station, in 1290 fathoms.

This species bears considerable resemblance to several others of the same group, but differs very decidedly from all the rest in the character of the nucleus, which is remarkable for its relatively large

size and the number of whorls of which it is composed, and for the sharpness of the tip, due to the prominence and minuteness of the apical whorl. The shell is more slender than most of the related forms and has a rougher appearance, owing to the sharp nodules along the spiral lines. In the latter character it most resembles *P. Benedicti*, but the latter is a much larger and stouter shell, with a coarser sculpture. *P. Saffordi* is a very much shorter and thicker shell, with much stronger sculpture and a very different nucleus.

This elegant species is dedicated to Mr. Sanderson Smith, for many years a member of the Fish Commission parties, and associated with the writer in the malacological work.

Pleurotomella Saffordi Verrill and Smith, sp. nov.

PLATE XXXI, FIGURES 4, 4a.

Shell small, thin, delicate, rather short, with very convex and strongly ribbed whorls, a wide, concave subsutural band, and a narrow elongated canal. Whorls five or more, below the nucleus, which consists of three small, chestnut-brown whorls, enlarging gradually, and having the surface covered with minute reticulated sculpture; its apex is slightly obtuse, owing to the first whorl being rounded and depressed, and but little smaller than the second. The whorls below the nucleus enlarge rapidly, the body-whorl being much larger than the others. The subsutural band is relatively wide, distinctly concave, and covered with fine, close, strongly receding, curved lines corresponding to the form of the posterior sinus of the lip; and not crossed by spiral sculpture. Below this band the whorls are suddenly swollen so as to produce a prominent rounded shoulder; the convex part of the whorl is crossed by twelve to fourteen prominent, rather acute, sinuous ribs, which are most prominent on the shoulder, where they bend obliquely forward. The concave interspaces are wider than the ribs. The whole surface below the subsutural band is covered by numerous fine, raised, spiral lines or cinguli of unequal size, and not closely crowded; these in crossing the ribs form minute, obtuse nodules. The ribs disappear at the base of the canal, but the spiral lines continue to its tip. The aperture is broad-ovate, somewhat angulated at the shoulder of the whorl and at the base of the columella. The posterior sinus is broad and moderately deep. The canal is rather elongated, narrow, and somewhat sinuous. The columella is nearly straight for a part of its length, and then its edge becomes strongly, spirally curved where it borders the canal. Shell

white and translucent, with the exception of the nucleus. Epidermis not apparent. Operculum wanting.

Length of one of the largest examples, 10^{mm}; greatest breadth, 5^{mm}; length of body-whorl to tip of canal, 7^{mm}; length of aperture, 5^{mm}; its breadth, 2.5^{mm}.

Stations 2041, 2042, 2043, 2076, 2084, and 2115, in 906 to 1608 fathoms. Albatross, 1883. The greatest number of living specimens occurred at station 2084, N. latitude 40° 16' 50", W. longitude 67° 05' 15", in 1290 fathoms, (No. 38,308).

This is a small and very elegant species, remarkable for the convexity of its whorls, and its very broad subsutural band. The canal is narrower and more constricted at its base than is usual in this genus. The sculpture is strongly marked, but does not give the rough appearance seen in *P. Benedicti*, which is also a longer and more fusiform shell, but has considerable resemblance in its sculpture. *P. Diomedææ* is also a more elongated shell, with less convex whorls, and its subsutural band is narrower and crossed by conspicuous prolongations of the ribs. It bears some resemblance to *P. formosa* (*Defrancia formosa* Jeff.), but that has less prominent ribs, less conspicuously shouldered whorls, and a differently shaped aperture.

This species is named in honor of W. E. Safford, Ensign U. S. N., who was a member of the Fish Commission party, in 1883.

Pleurotomella Diomedææ Verrill and Smith, sp. nov.

PLATE XXXI, FIGURES 5, 5a.

Shell white, delicate, rather small, fusiform, with an acute spire and distinctly angulated whorls, crossed by prominent flexuous ribs, which extend upward to the suture, and with rather coarse revolving lines, usually absent on the wide subsutural band, which is concave at a little distance from the suture. The posterior sinus is rather broad and deep, a little removed from the suture. Whorls four or five below the nuclear whorls, of which there are four. The body-whorl is large and moderately convex, strongly angulated at the shoulder, which is prominent and bears a series of small rounded nodules at the angle of the ribs; above the shoulder the whorls are decidedly concave in line with the posterior sinus, but have a narrow, convex band just below the suture. The subsutural band is crossed by thin but strongly raised continuations of the ribs, which recede in a strong curvature in crossing the concave portion, but advance abruptly and rise into small prominent, narrow or compressed tubercles in crossing the convex portion, close to the suture; at the shoulder the ribs be

come stouter and more prominent, each bearing a small rounded or angular nodule; below the shoulder the ribs are moderately stout, usually rounded or obtuse at summit, but sometimes, especially on the upper whorls, angular or subacute. They are slightly oblique or flexuous and cross the entire breadth of the upper whorls, but fade out about the middle of the last whorl. There are about twenty of these ribs on the last whorl. Strongly marked cinguli cover the whorls below the shoulder, these become coarser and more raised on the anterior part of the last whorl and on the canal, where they are separated by wider concave interspaces, and roughened by the distinct lines of growth crossing them; on the middle of the convexity of the whorl they are less conspicuous and but slightly raised, and not very close together; they are more conspicuous in the intervals between the ribs, the summit of the ribs being but slightly roughened by their crossing, except close to the shoulder, where they often form minute nodules; they are usually wanting on the subsutural band, but are sometimes faintly marked on that portion. Distinct lines of growth, parallel with the lip, cover the surface of the shell and are most distinct on the subsutural band, between the ribs. The aperture is narrow-ovate, angulated posteriorly. The outer lip is thin, projecting forward in the middle in a strong, regular curve, but greatly receding toward the shoulder. The sinus is rather deep and wide, situated just above the angle of the shoulder and separated from the suture by the convex portion of the subsutural band. The columella is sinuous; the canal is a little prolonged, rather narrow, and straight.

The four nuclear whorls are yellowish or pale horn-color, and form a very acute apex when perfect. The first is very minute and somewhat upturned and prominent; the second is also minute; the third and fourth increase rapidly; the first three, in our most perfect specimens, are smooth and somewhat glossy; the fourth is crossed by numerous, thin, delicate, raised longitudinal lines, which are a little oblique and recurved in the middle, but not crossed by another set, as seen in many other species. Color translucent white, sometimes faintly tinged with gray or pink, surface glossy. No epidermis. Operculum wanting.

One of the largest specimens is 11^{mm} long; breadth, 4.5^{mm}; length of body-whorl and canal, 7.5^{mm}; of aperture, 6^{mm}; its breadth, 2^{mm}. Other examples are more slender, with a narrower aperture.

Stations 2037, 2038, 2041, 2042, 2043, 2084, and 2096, in 1290 to 2033 fathoms. It occurred in the greatest numbers, living, at station

2038, N. latitude $38^{\circ} 30' 30''$, W. longitude $69^{\circ} 08' 25''$, in 2033 fathoms (No. 34,827); at station 2041, N. latitude $39^{\circ} 22' 50''$, W. longitude $68^{\circ} 25'$, in 1608 fathoms, (No. 34,828); and station 2096, N. latitude $39^{\circ} 22' 20''$, W. longitude $70^{\circ} 52' 20''$, in 1451 fathoms, (No. 37,790.) Albatross, 1883.

Named in commemoration of the steamer Albatross, (*Diomedea*).

Pleurotomella Emertoni Verrill and Smith, sp. nov.

PLATE XXXI, FIGURE 6.

Shell moderately large, stout, ovate, with the body-whorl very large in proportion to the rest of the shell, and with some of the upper whorls ribbed and nodulous, while the two lower whorls have only spiral lines and lines of growth. Whorls about eight, three of which form a chestnut-colored nucleus; about three whorls below the nucleus are covered with prominent, longitudinal ribs, which form a well marked shoulder and are crossed by several conspicuous, revolving cinguli and grooves, which render them decidedly nodulous. The subsutural band is broad, strongly concave, occupying nearly or quite half the breadth of the upper whorls, and crossed by strongly receding, raised lines, parallel with the lines of growth of the sinus, but without spiral lines. Body-whorl large and swollen, covered throughout with very evident lines of growth, which are crossed, except on the subsutural band, by conspicuous, revolving cinguli, which are separated by spaces considerably exceeding their own breadth. Aperture oblong-ovate, scarcely narrowed at the broad, short, open canal, and with a very wide and rather deep posterior sinus. The outer lip is thin and projects well forward beyond the sinus in a broadly rounded curve. The columella is straight, with a sinuous inner margin; the inner lip is marked by a narrow and thin enamel, which extends but little forward in a sinuous outline. The color is yellowish white under a thin, smooth, glossy, yellowish green epidermis.

Length, 22^{mm} ; greatest breadth, 11^{mm} ; length of aperture, 14^{mm} ; its breadth, 5^{mm} .

Station 2097, N. latitude $37^{\circ} 56' 20''$, W. longitude $70^{\circ} 57' 30''$, in 1917 fathoms (No. 35,232). Albatross, 1883.

This species very closely resembles the following, in size and form. It differs in having a wider canal, which is less differentiated from the aperture, and in having the upper whorls strongly ribbed and nodulous. They may possibly prove to be varieties of one species.

Pleurotomella Bruneri Verrill and Smith, sp. nov.

PLATE XXXI, FIGURES 7, 7a.

Shell stout-fusiform, with a rather short, regularly tapered spire, a broad and deep posterior sinus, and a very short and wide canal.

Whorls seven, moderately convex, with a wide, concave subsutural band, which is covered with regular, strongly receding, raised lines, but destitute of spiral sculpture. The shoulder is rather prominent where the concave band joins the convexity of the whorl; the rest of the surface is covered with conspicuous, raised, obtuse, unequal revolving cinguli, separated by deep interspaces of nearly the same breadth, on the spire; on the anterior part of the body-whorl the cinguli become broader and flatter, and separated by narrower grooves, which are covered by numerous rather close, raised, longitudinal lines, or lines of growth, which are less conspicuous where they cross the cinguli; this arrangement produces a finely cancellated structure, in which the spiral lines are much more distinct than the others. Aperture narrow-ovate, continuing backward in a broad and deep sinus next the body-whorl. The outer lip is thin and sharp, and projects obliquely forward in a broad curve. The canal is scarcely differentiated from the rest of the aperture; it is short and rather broad, and nearly straight. The columella is straight, with a sinuous inner margin. The inner lip extends forward on the body-whorl in a broad, regular curve, defined by a thin layer of enamel. Operculum apparently wanting. The nuclear whorls are eroded, but are small, regularly spiral, and without any strongly marked sculpture.

Color grayish white, with a pale yellowish green epidermis, which is easily deciduous.

Length 22^{mm}; greatest breadth, 11^{mm}; length of aperture, 14^{mm}; its breadth, 5^{mm}.

Station 2038, in 2033 fathoms (No. 34,846), and station 2041, N. latitude 39° 22' 50", W. longitude 68° 25', in 1608 fathoms (No. 34,834). Albatross, 1883.

This species is dedicated to Mr. H. L. Bruner, who has been a member of the U. S. Fish Commission parties, during the past three years.

Pleurotomella Catharinæ Verrill and Smith, sp. nov.

PLATE XXXI, FIGURES 9, 9a.

Shell thin, translucent, white, very slender, elongated, narrow, fusiform, with a long, narrow, tapered, nearly straight canal, and a tall, gradually tapered, acute spire. Whorls eight, evenly rounded,

but not very convex, with a distinct, flattened, smooth subsutural band. Suture well marked, but not deep, decidedly oblique. Surface everywhere covered with conspicuous, regular, raised, revolving cinguli, in some parts with one or more smaller revolving lines in the spaces between them. The cinguli are obtusely rounded and entirely smooth, as well as the spaces between them, which are of about the same breadth; on the penultimate whorl there are about fifteen cinguli, and on the upper whorls five or six.

The large, acute, brown nucleus consists of about four and a half whorls, which increase regularly; the apical whorl is small, rounded and prominent; the others are distinctly carinated and shouldered; the portion above the shoulder slopes at a wide angle and is a little convex and nearly smooth, except close to the carina; the part below the carina of the shoulder is flattened and nearly straight, or even narrowed toward the suture, and crossed by regularly spaced, thin, elevated transverse ribs, with wider intervals; these ribs extend a little above the carina and then fade out; they run nearly straight across all the whorls, except the first two, where they are more or less oblique; there is usually, on the larger whorls, a raised revolving line, or small carina, just above the suture.

The aperture is very elongated and narrowed at the base of the canal, which is much prolonged and slender, a little curved, owing to a slight sinuous curvature of the columella-margin. The posterior notch in the outer lip is rather deep and narrow, situated immediately at the suture. The subsutural band, corresponding to it, shows faint curved lines of growth, parallel with its margin. Color white, except the nucleus, which is pale chestnut-brown.

Length of one of the largest specimens, 23^{mm}; breadth, 6.5^{mm}; height of spire, 11^{mm}; length of aperture and canal, 11.5^{mm}; breadth of aperture, 3^{mm}.

Living specimens at station 2038, N. latitude 38° 30' 30", W. longitude 69° 08' 25", in 2033 fathoms (No. 34,845); station 2041, N. latitude 39° 22' 50", W. longitude 68° 25', in 1608 fathoms (No. 37,871); station 2084, N. latitude 40° 16' 50", W. longitude 67° 05' 15", in 1290 fathoms (No. 37,846); and at 2115, N. latitude 35° 49' 30", W. longitude 74° 34' 45", in 843 fathoms (No. 35,597). Albatross, 1883.

This elegant species is dedicated to Miss Katharine J. Bush, who has, for several years, acted as assistant in the working up of the large collections of mollusca, dredged by the U. S. Fish Commission,

and to whom the writer is indebted for important assistance in the preparation of this paper.

It is not very probable that this species properly belongs to *Pleurotomella*. I have placed it here, for the present, only provisionally.

Gymnobela Verrill, gen. nov.

Shell in form and general appearance like *Bela*. Spire generally rather short. Body-whorl swollen. Nucleus with fine cancellated sculpture. Subsutural band not strongly marked. Posterior notch of lip shallow and usually not very distinct. Operculum absent.

Gymnobela engonia Verrill, sp. nov.

Shell somewhat solid, white, more or less translucent, stout-fusi-form, with the aperture about equal in length to the spire, which is shouldered, decidedly turreted, and tapered regularly to an acute apex.

Whorls five below the nucleus, strongly angularly shouldered at about the middle, the portion above the shoulder forming a wide, abruptly sloping subsutural band, which is usually slightly concave in the middle, but swells a little where it joins the suture; the whorls are flattened below the shoulder and a little narrowed at the suture, which is strongly impressed. The sculpture on the subsutural band consists of numerous, close, revolving lines, most distinct towards the shoulder, and of small, slightly raised, thin riblets, which are most distinct close to the suture and strongly excurved in the middle of the band, but bend forward strongly to the angle of the shoulder, where most of them disappear or blend with the ribs and lines of growth a little farther forward. Below the shoulder the surface is covered by many, rather thin, closely arranged, revolving cinguli, which on the whorls of the spire are separated by interspaces about twice their own width, but become much closer on the middle of the last whorl, gradually becoming coarser and more widely separated as they approach the canal, those on the anterior part being also thicker and more obtuse. Numerous rather small and slightly elevated ribs commence at the shoulder and curve obliquely forward across the convex part of the whorls, extending to the suture on the upper whorls, but mostly fading out at the middle of the last whorl; these ribs are obtusely rounded and wave-like, the interspaces being shallow, concave, in breadth about equal to the ribs; on the last whorl there are from twenty-five to thirty. On the spire-whorls the

intersections of the cinguli and ribs, which are of about the same size, produce a pretty regularly cancellated structure, but on the last whorl the cinguli are more numerous and less prominent than the ribs. The nucleus is chestnut-brown and consists of about two and a half regularly increasing whorls, the apical one being very small and regularly coiled; this surface appears to have been minutely cancellated by microscopic lines. Aperture irregularly oblong or oblong-ovate, strongly angulated by the shoulder, and decidedly widest at the base of the columella. Canal short, somewhat constricted, nearly straight; outer lip thin, projecting forward below the shoulder, with a broad, rounded, rather shallow sinus at the middle of the subsutural band and a little removed from the suture. Operculum not present in the alcoholic specimens.

Length of one of the largest specimens, 17^{mm}; breadth, 10^{mm}; length of aperture, 10^{mm}; its breadth, 3.5^{mm}; length of body-whorl to tip of canal, 12^{mm}. Another more slender specimen is 15.5^{mm} long; 8^{mm} broad; length of aperture, 9^{mm}; its breadth, 3^{mm}.

Station 2041, N. latitude 39° 22' 50", W. longitude 68° 25', in 1608 fathoms (No. 34,835); and station 2084, N. latitude 40° 16' 50", W. longitude 67° 05' 15", in 1290 fathoms (No. 37,818).

Gymnobela curta Verrill, sp. nov.

PLATE XXXI, FIGURE 10.

Shell small, short, fusiform, or subovate, with a low spire and very large body-whorl, forming about three-fourths the total length. The surface is finely decussated by longitudinal and spiral lines of nearly equal size. Whorls four below the nucleus, very rapidly increasing, strongly convex, but frequently slightly flattened at the periphery, and sometimes distinctly angulated at the shoulder, but more commonly evenly rounded; last whorl very ventricose. Suture strongly impressed, often slightly channelled. The nucleus consists of two or three small, light chestnut-brown whorls, with very finely cancellated sculpture. The apical whorl is very small and regularly coiled. Sculpture on the rest of the shell consists of numerous, rather fine, thin, regular revolving cinguli, which are separated by interspaces about twice their own breadth on the lower whorls, but more crowded on the upper ones. Two or three of the cinguli on the shoulder are usually coarser and a little farther apart than the rest, and the largest of these often forms a slight carina around the most prominent part of the shoulder. On the subsutural band the cinguli are less distinct and less regular, and often partially obsolete. Anteriorly they cover

all the surface to the tip of the canal. The cinguli are everywhere crossed by very numerous and regular, thin, raised lines or riblets, which are usually of nearly the same size as the cinguli, but frequently are somewhat less conspicuous and a little farther apart. The riblets are nearly straight on the periphery of the whorls, but are somewhat angularly bent at the shoulder, and run obliquely forward across the subsutural band to the suture; on the subsutural band they are distinctly elevated, but rather thinner than elsewhere. By the crossing of these two sets of lines the surface is generally finely and regularly cancellated, except on the shoulder and subsutural band, where the cancellation becomes more or less irregular or indistinct. Aperture rather large, broad-ovate, a little angulated at the shoulder, and with a very slight constriction at the base of the very short and rather narrow canal. The posterior sinus is nearly obsolete, and indicated only by a shallow indentation just above the shoulder. Columella short, straight, its inner margin with a rather strong sigmoid curvature. The canal is nearly straight, very slightly recurved at the tip, narrowed by a slight constriction of the outer lip, at its base. Epidermis thin, not very distinct. Color of the fresh alcoholic specimens pale grayish or greenish white, more or less translucent.

Length of a medium sized specimen, 10^{mm}; breadth, 6^{mm}; length of body-whorl and canal, 8^{mm}; aperture, 6^{mm}; its breadth, 2.5^{mm}. One of the largest specimens is 16^{mm} in length; breadth, 9.5^{mm}; length of body-whorl and canal, 12^{mm}; aperture, 9^{mm}; its breadth, 4^{mm}.

Station 2043, in 1467 fathoms (No. 34,854); station 2076, in 906 fathoms (No. 37,812); station 2077, in 1255 fathoms (No. 37,798); station 2084, in 1290 fathoms (No. 37,795); and station 2097, in 1917 fathoms (No. 35,227, one dead specimen); station 2115, in 843 fathoms (No. 37,794). It occurred in the largest numbers at station 2084, N. latitude 40° 16' 50", W. longitude 67° 05' 15", in 1290 fathoms, (twenty specimens, living and dead); and at station 2076, N. latitude 41° 13', W. longitude 66° 00' 50".

Gymnobela curta, var. *subangulata* Verrill, nov.

Similar in form and size to the preceding, with which it is often associated. It differs in having the whorls more distinctly angulated at the shoulder, with one of the cinguli forming a distinct carina, which is surmounted by a row of small, often acute nodules, produced by the intersection of the longitudinal riblets. There is often another somewhat smaller spiral line below the carina, which also frequently

bears minute nodules. The rest of the surface is cancellated nearly as in the typical form, but the riblets are frequently more conspicuous than the cinguli. Forms intermediate between the variety and the type are of frequent occurrence.

This variety occurred, with the typical form, at stations 2043 and 2084, (No. 37,817 and 37,796). It was also taken at station 2038, in 2033 fathoms (No. 37,797, one dead); and at station 2096, in 1451 fathoms (No. 37,793, one living).

This species may readily be mistaken for *Bela hebes*, especially when somewhat broken and eroded. The nucleus, however, is entirely different and the aperture is narrower anteriorly and shows a more distinct constriction at the base of the siphon, which is narrower and less open than in the latter. The sculpture is also more distinctly and more regularly cancellated.

Bela subvitrea Verrill, sp. nov.

Shell translucent, white, thin but firm, fusiform, moderately stout, with a high, regularly tapered, acute spire, consisting of about six rounded whorls, which are crossed by rather thin, prominent ribs, strongly bent in a sigmoid curve, and having on the lower whorls rather faint spiral sculpture.

Whorls four to five below the nucleus, strongly convex and a little swollen at the rounded shoulder, which is rarely somewhat angulated, and without a definite subsutural band. Suture strongly impressed, the upper part of the whorl rising rather abruptly from it. The nucleus consists of about two small, prominent whorls; the first is small, rounded, slightly mamilliform, and a little prominent; the next, constituting the greater part of the nucleus, increases rapidly and is decidedly prominent and somewhat obliquely placed, and bears about four or five raised, revolving lines, which are sometimes crossed by distinct lines of growth. The suture between the last nuclear whorl and the next is strongly marked and more oblique than any of the others. The remaining whorls are crossed by rather conspicuous, sharp, and rather elevated ribs, which are strongly excurved at and just above the shoulder, curving forward rapidly to the suture, and bending forward more gradually below the shoulder, forming a distinct sigmoid curve. The interspaces between the ribs are much wider than the ribs themselves, distinctly concave, and crossed by rather feeble cinguli, which are usually not apparent on the ribs themselves. On the upper whorls the spiral lines are usually more conspicuous than on the lower ones, but are often indicated chiefly

by rather close, shallow furrows. On the last whorl the ribs extend to the base of the canal before they fade out, and the spiral sculpture becomes coarser and a little more evident on its anterior part and on the canal. The surface is also a little roughened by faint lines of growth, parallel with the ribs. Aperture oblong-ovate, rather narrow; outer lip sharp, thin, projecting forward in the middle in a broadly rounded curve, and slightly receding just above the shoulder, so as to form a broad and shallow sinus a little removed from the suture. Canal nearly straight, a little prolonged, distinctly constricted at its base by the incurvature of the outer lip. Columella straight, tapering anteriorly, its inner edge forming a well-marked sigmoid curve. Epidermis indistinct. Color translucent bluish white. The surface is not glossy, but the texture is more vitreous and delicate than in the more northern and shallow-water species of *Bela*.

Off Cape Hatteras, station 2115, N. latitude $35^{\circ} 49' 30''$, W. longitude $74^{\circ} 34' 45''$, in 843 fathoms (No. 35,601, twenty-five living and dead). Steamer Albatross, 1883.

Length of one of the larger specimens, 13.5^{mm} ; breadth, 6^{mm} ; length of body-whorl and canal, 9^{mm} ; length of aperture, 7^{mm} ; its breadth, 2.5^{mm} . Among the specimens collected there is some variation in portions; some individuals having the body-whorl relatively large, with the aperture broader and more ovate than in the specimen measured.

This species, in form and general appearance, bears some resemblance to *B. pleurotomaria*, but it is a thinner and more delicate shell, with a translucency not seen in the latter. The whorls are also more convex, the last more ventricose. The ribs are thinner, less numerous, and more strongly recurved below the suture; the spiral sculpture is not so strongly marked, and the nucleus is larger, with much finer spiral sculpture. The aperture and canal are similar in the two species, but somewhat narrower in *B. pleurotomaria*.

Bela subturgida Verrill, sp. nov.

Shell of moderate size, white, translucent, stout-fusiform, with swollen, angulated whorls, and a distinctly turreted, rapidly tapering spire, the sculpture consisting of rather distant ribs and much finer spiral cinguli.

The largest specimen, which is probably immature, has four whorls below the nucleus. The three upper whorls are abruptly angularly shouldered, the portion forming the subsutural band rising nearly at right angles to the shoulder, below which the whorls are flattened

and strongly ribbed by about sixteen prominent, rather narrow, obtuse, nearly straight ribs, which rise into angular points or small, obtuse nodules at the shoulder; the interspaces are wider than the ribs and strongly concave. The ribs and interspaces also extend across the subsutural band to the suture, becoming small above the shoulder. The whole surface is covered by rather slender revolving cinguli, in the form of thin, raised lines, which are most conspicuous in the interspaces and more or less obsolete on the ribs. On the subsutural band the spiral lines are finer and closer, and often indistinct toward the suture, but on the anterior part of the body-whorl they become somewhat coarser and wider apart. The last whorl is much swollen and has the shoulder somewhat rounded, while on the upper whorls there is often a distinct carina at the shoulder. The nucleus is small and prominent, smooth, and consists of about one and a half whorls, of which the apical is turned up obliquely and incurved. The aperture is ovate, broadly rounded externally, and more strongly excavated at the base of the columella. Canal a little elongated, narrow, constricted at the base by the incurvature of the outer lip, and with the opening oblique, owing to the form of the columella margin, but not bent. Columella nearly straight, its inner margin forming a well-marked sigmoid curve, and strongly obliquely twisted at the anterior end.

Length, 9^{mm}; breadth, 5^{mm}; body-whorl and canal, 6·3^{mm}; length of aperture, 5^{mm}; its breadth, 2^{mm}.

Station 2115, N. latitude 35° 49' 30", W. longitude 74° 34' 45", in 843 fathoms (No. 35,602, two specimens). Steamer Albatross, 1883.

This species has some resemblance to certain forms of the northern *Bela scalaris*. It is a thinner and much more delicate shell, with finer sculpture, and having the whorls less strongly angulated and the form of the aperture and canal somewhat different.

Spirotropis ephamilla Verrill, sp. nov.

Shell elongated-fusiform, with a high, somewhat turreted spire, and a moderately elongated, slightly curved canal. Posterior sinus situated considerably below the suture, close to the shoulder. Whorls moderately convex, strongly angulated near the middle. Below the suture is a broad, flattened or slightly concave subsutural band, covered with coarse and slightly raised spiral lines, with a series of small, rounded nodules close to the suture, and crossed by strongly excurved, sinuous lines of growth, parallel to the edge of the posterior sinus, and receding most at the shoulder, where there are usually two

raised cinguli, or small carinae, more strongly marked than the others, and bearing each a series of small, rounded nodules where they are crossed by the stronger lines of growth; sometimes these nodules are present only on the uppermost of these two carinae, which are separated by a narrow interspace. Below the carinae the whorl rapidly decreases in size, the anterior slope being nearly the same as the posterior one, and of about the same breadth on the spire; this portion of the whorl is crossed by three to five rather coarse, raised, irregular spiral lines, and numerous fine lines of growth, which bend abruptly forward at the shoulder and then curve obliquely downward and forward, crossing both the spiral lines and their interspaces, which are about the same in breadth. On the body-whorl the spiral lines cover the whole surface below the shoulder, becoming coarser and farther apart below the middle, and again becoming smaller and closer together on the base of the siphon. Aperture narrow-ovate and somewhat angulated by the shoulder. Outer lip sharp-edged, with a rather broad and deep posterior sinus, which is deepest at the shoulder; below the shoulder the lip projects forward in a broad even curve to near the base of the canal, where it is somewhat contracted. The canal is moderately long, somewhat contracted at the base, and a little sinuous. The columella has a strong sinuous curvature, and is strongly excavated at the widest part of the aperture. Upper whorls and nucleus eroded in our examples. Epidermis yellowish horn-color, closely adherent. Shell bluish white within the aperture. Operculum well-developed, ovate, dark horn-color.

Length of the shell without the tip, 25^{mm}; length of body-whorl to tip of canal, 17^{mm}; greatest breadth, 10^{mm}; length of aperture, 13.5^{mm}; its breadth, 5.5^{mm}.

No. 35,237, station 2098, N. latitude 37° 40' 30", W. longitude 70° 37' 30", in 2221 fathoms. One living specimen with only the four lower whorls present. No. 35,220, station 2097, N. latitude 37° 56' 20", W. longitude 70° 57' 30", in 1917 fathoms. Another similar specimen, but dead and much eroded.

Typhlomangelia Tanneri Verrill and Smith, sp. nov.

PLATE XXXI, FIGURE 8.

Shell long-fusiform, with a high, turreted, regularly tapered, acute spire, all the whorls having, at some distance below the suture, a well-marked, angular shoulder, which is crowned by a series of oblique nodular riblets on all the whorls except the last.

Whorls about eight, rather convex, strongly angulated, with a broad, concave subsutural band above the shoulder. The subsutural band is crossed by delicate, strongly excurved, distinctly raised lines of growth, which recede most at the middle of the band and bend far forward next the suture; a little below the suture there is usually a thin, raised spiral line; the rest of the band is destitute of spiral lines, except close to the shoulder. The upper whorls, just below the nucleus, are crossed by numerous very oblique, moderately elevated, but somewhat conspicuous ribs, of which the number is about eighteen to twenty, and these are separated by concave interspaces, about equal to their own breadth. The ribs terminate abruptly at the shoulder, so as to form there small, obtuse, somewhat angular nodules; but they decrease rapidly in crossing the whorls, and mostly fade out before reaching the suture. The spiral sculpture consists of numerous rather fine, thin, raised cinguli, which cross the ribs and interspaces alike, and are separated by intervals greater than their own breadth. On the last whorl the ribs disappear and only the spiral sculpture remains; the cinguli are here thicker and more elevated, and are roughened by numerous close, raised lines of growth, which cross both the cinguli and their interspaces; at the base of the canal the spiral lines become finer and closer. The nuclear whorls are somewhat eroded in our specimen. There are apparently two small, rather prominent, regularly spiral whorls. The aperture is narrow, oblong-ovate, strongly angulated at the shoulder and contracted above it, at the notch. The outer lip is thin and sharp, projecting considerably forward and broadly rounded below the shoulder. Posterior sinus a rather deep and very broad, well rounded notch, separated a little from the suture, the deepest part corresponding to the middle of the wide subsutural band. Canal rather broad and short, scarcely differentiated from the aperture. Columella nearly straight, its inner margin with a slight sigmoid curvature; inner lip somewhat excavated in the middle and covered by a thin layer of enamel. Color brownish white, without luster. Epidermis inconspicuous. Operculum dark horn-color.

Length of the single specimen obtained, 21^{mm}; breadth, 9^{mm}; length of body-whorl and canal, 14^{mm}; length of aperture, 10^{mm}; its breadth, 3^{mm}.

Station 2084, N. latitude 40° 16' 50", W. longitude 67° 05' 15", in 1290 fathoms. (One specimen, No. 38,067.)

This species bears considerable resemblance to *T. nivale* (Lov.) Sars, of Europe, but is distinct in the character of its sculpture. It

also resembles *Spirotropis ephamilla*, but the latter has a deeper notch, more remote from the suture, its subsutural band is broader, and the shoulder of the whorls less marked, while the canal is longer and more constricted at its base.

RACHIGLOSSA.

Marginella borealis Verrill, sp. nov.

Marginella carnea Verrill, Catal. Mar. Moll., Trans. Conn. Acad., v, p. 489, (*non* Storer.)

PLATE XXIX, FIGURE 4.

Shell of medium size, solid, smooth, somewhat shining, with a rather elevated, acute spire, showing all the whorls, of which there are about five. Last whorl somewhat swollen, with a slightly prominent, rounded shoulder, considerably below the suture.

The whorls of the spire increase regularly in size and are slightly convex; the nuclear whorls are smooth, polished, shining, evenly rounded. Suture distinct, though filled up with the thin coating of enamel that covers the spire, but does not conceal its structure. The aperture is narrow, expanding a little anteriorly, towards the canal, which is evenly rounded at the tip. The outer lip is thickened by a stout rib, evenly rounded externally, and faintly creulated on the inner margin, especially on the anterior half. The posterior sinus is distinctly marked as a smooth, rounded groove, surrounded by callus, at the junction of the lip with the body-whorl. The inner lip has a conspicuous, raised, ovate patch of white callus along the posterior half, covering the adjacent portion of the body-whorl, and extending backward more or less on the spire; on the anterior half there are four oblique, stout, prominent plications, nearly equal in height; the most anterior of these is formed by the twisted inner edge of the columella, forming the inner border of the canal; the most posterior is less oblique and often a little smaller than the others. The callus extends along the lower lip, outside of the plications, to the anterior border of the canal, sometimes, when best developed, forming by its outer margin a slight groove. Shell yellowish flesh-color, varied with whitish; sutural lines, callus deposits, plications, and inner margin of the outer lip, white; external surface of the thickened outer lip usually with three orange-yellow spots, the largest of which forms a narrow, elongated patch along the anterior and outer border of the canal, extending somewhat backward along the lip; the next is usually a broader, oblong patch, just below the shoulder; the third is a small, rounded spot close to the suture. Frequently the anterior

spot is divided into two by a patch or band of whitish at the base of the canal; sometimes the middle spot is also divided into two, and in other cases the posterior spot is as large as the middle one. There is usually a faint, whitish revolving band at the shoulder and another at the base of the canal. Interior salmon-colored.

Length, 14^{mm}; breadth, 7.5^{mm}; length of body-whorl, 12^{mm}; length of aperture, 10^{mm}; its breadth, about 1^{mm}.

Several perfect living specimens were taken by the Albatross, in 1883, at stations 2011 and 2012, in 81 and 66.5 fathoms, off Norfolk, Va. (Nos. 35,307 and 35,375.) Dead specimens were taken off Martha's Vineyard by the Fish Hawk, in 1880 and 1881, in 64.5 to 100 fathoms.

The occurrence, so far northward, of a large and well developed species of this almost tropical genus is remarkable. It inhabits, however, only the warm zone along the inner edge of the Gulf Stream, where it is associated with *Solarium*, *Dolium*, *Avicula*, and other southern genera.

This handsome species bears some resemblance to *M. carnea* and *M. roscida*, from our southern coasts, in size and color, but differs from both those species in having a much higher and more acute spire, with all the whorls distinctly visible, and in the form and arrangement of the plications.

This species is also related to *Marginella limatula* Conrad, of which I have examined several specimens from the Miocene of Pagan Creek, Va. The latter differs, however, in being a stouter and broader-shouldered shell, with a much lower spire, in which the sutures are more concealed by the deposit of callus. The fossil form is, therefore, evidently more closely related to, if not identical with, *M. apicina** and *M. roscida*, found in shallow water on our southern and Gulf coasts, than to the present species. The number and position of the plications on the columella and the crenulations on the outer lip are the same as in *M. borealis*.

Volutella lachrimula Gould.

Proc. Boston Soc. Nat. Hist., viii, p. 281, 1862; Otia Conch., p. 238.

Taken in considerable numbers at station 2109, off Cape Hatteras, in 142 fathoms, by the Albatross, 1883.

* This form seems to me essentially identical with *M. conoidalis* Kiener, of the West Indies. It seems to me probable that both are identical with the fossil *M. limatula*. *M. roscida* is probably only a local variety.

Originally described from off Georgia, in 400 fathoms. According to Mr. W. H. Dall, it is found in shallow water on the west coast of Florida (Proc. Nat. Mus., vol. vi, p. 324, 1883).

Buccinum abyssorum Verrill and Smith, sp. nov.

PLATE XXXI, FIGURES 11, 11a, 11b.

Shell thin, white, with a high, acute spire and strongly carinated whorls. Whorls seven to eight, strongly convex, angulated by the sharp revolving carinæ, of which there are usually three very prominent ones on the whorls of the spire. The upper one of these is situated at a considerable distance from the suture and forms a prominent shoulder, above which the surface of the whorl is somewhat concave and covered with several much finer, raised, spiral lines, of which one, usually at about the middle, is a little more prominent than the rest; the second carina is situated below the middle of the whorl and is separated from the upper one by a broad, concave interspace, which is covered by rather fine, distinct, raised spiral lines, separated by very distinct grooves of about the same breadth; the third carina is usually situated just above the suture, but is sometimes concealed by it; it is separated from the second carina by a concave, spirally lined interspace, a little narrower than that between the first and second carina. On the last whorl there are usually two or more similar, but somewhat less prominent, carinæ below the middle of the whorl, and the surface is everywhere covered by regularly spaced spiral lines or cinguli and grooves. Aperture rather small, somewhat semicircular; the outer lip is nearly regularly rounded from the suture to the base of the canal, but is slightly angulated at the carinæ. In some of the larger specimens it somewhat recedes, and is slightly everted just below the suture. The canal is short, somewhat narrowed, nearly straight, or sometimes with the anterior end a little everted. The columella is nearly straight, its inner margin having a slight sigmoid curvature; the inner lip is covered by a very thin coat of smooth enamel, which extends out only a slight distance beyond the edge of the lip, with a broadly curved outline. The nuclear whorls are small and regularly spiral, consisting of rather more than two turns, and have the surface smooth and glossy. On the succeeding whorl there are about four distinct carinæ. The epidermis is inconspicuous or wanting. The operculum is rounded-elliptical, considerably smaller than the aperture, with the nucleus situated near the outer edge, in front of the middle. The animal is destitute of eyes; the tentacles are long, slender, and gradually tapered.

Length of one of the largest specimens, a female, 43^{mm}; its breadth, 24^{mm}; length of spire, 25^{mm}; length of body-whorl to end of canal, 29^{mm}; length of aperture, 21^{mm}; breadth, 12^{mm}; length of operculum, 11^{mm}; breadth, 8^{mm}.

This species was taken at station 2051, in 1106 fathoms; 2052, in 1098 fathoms; 2074, in 1309 fathoms; 2076, in 906 fathoms; 2077, in 1255 fathoms; 2094, in 1022 fathoms; 2102, in 1209 fathoms; 2103, in 1091 fathoms; 2111, in 938 fathoms. It was most abundant at stations 2074, N. latitude 41° 43', W. longitude 65° 21' 50", where twenty-five living and seven dead specimens were taken (No. 38,319); station 2077, N. latitude 41° 09' 40", W. longitude 66° 02', eighteen specimens, nine living (No. 35,008); and station 2094, N. latitude 39° 44' 30", W. longitude 71° 04', twelve specimens, seven living, (No. 34,691).

This species shows considerable variation of length to breadth, many specimens being more slender than the one measured above. The carinæ also vary in prominence; in some specimens they are strongly raised and very conspicuous, and in others they are but little more elevated than the revolving lines that cover the rest of the surface. It shows scarcely any resemblance to the several species hitherto known from our coast. In general appearance it resembles the *Buccinopsis striata* Jeff., figured in the "Depths of the Sea," p. 464, fig. 76, but not described.

Sipho obesus Verrill, sp. nov.

Shell of moderate size, stout-fusiform, with a rather short, rapidly tapering and bluntly pointed spire, sculptured by many strong transverse ribs and numerous spiral lines. Epidermis with slender hairs along the spiral lines.

Whorls four to five, besides the nucleus, increasing rapidly, evenly rounded, but only moderately convex. On the upper whorl, next the nucleus, the spiral cinguli are somewhat prominent and nearly as broad as the concave interspaces; on the second whorl below the nucleus there are seven or eight cinguli, which are crossed by the conspicuous lines of growth and by distinct, but not very prominent ribs; on the next whorl the ribs are about sixteen in number, and become much more prominent, separated by concave interspaces, which about equal the ribs in breadth; the ribs are most prominent on the convex part of the whorls, where they are excurved. On the body-whorl the ribs become less conspicuous, but extend below the middle of the whorl, fading out towards the base of the canal.

The cinguli, which are very numerous on the lower whorls, are mostly thin, fine, and much elevated, but are rendered conspicuous by the close row of fine, sharp, epidermal hairs rising from each spiral line. The lines of growth are very numerous and close, thin, raised lamellæ. The suture is not very oblique and a little impressed, and has a wavy or crenulated outline, due to the ribs, which extend to the suture, both above and below. The nucleus is rather small, composed of about two whorls. The apical whorl is very small, smooth, and regularly coiled, but only a little exposed; the second whorl shows traces of spiral lines. The outer lip is sharp, thin, regularly curved, and not very convex. The columella-lip is strongly excavated in the middle, and the columella-margin has a strong sigmoid curvature and a spiral twist. The canal is rather broad, moderately long, rather strongly bent to the left, and a little turned up at the end. The aperture is elongated-ovate, with the inner margin a little more convex than the outer. The operculum is long-ovate, rounded posteriorly, but with the anterior end narrowed and a little incurved on the inner margin, near the anterior end, but somewhat dilated into a rounded lobe in the middle; the nucleus is situated on the inner margin, close to the anterior end. Epidermis distinct, finely hairy along the spiral lines, dull greenish yellow in color. In alcohol the shell is dull pinkish white, and the young specimens are more or less translucent.

Length of one of the larger specimens, 25^{mm}; breadth, 14^{mm}; length of body-whorl and canal, 19.5^{mm}; length of aperture, 15^{mm}; its breadth, 5.5^{mm}.

Station 2115, N. latitude 35° 49' 30", W. longitude 74° 34' 45", in 843 fathoms (No. 35,600). Many specimens, both young and adult, part of them living.

Some of the specimens show considerable variation from the type described. In some the spiral cinguli are larger, more prominent, and more unequal in size, three or more smaller ones being usually situated between the more prominent ones on the lower whorls. The suture in some cases is deeper and slightly channelled.

This species is more nearly related to *S. celatus*, var. *hebes*, than to any other described species, but it is a larger, much stouter and coarser species, with the spiral sculpture more conspicuously developed, and with a distinctly hairy epidermis. The canal is longer and much more bent. The nucleus is larger and somewhat different in form. The typical form of *S. celatus* is still more slender, and has a decidedly higher and more regularly tapered spire, with the suture much more impressed.

Sipho profundicola Verrill and Smith, sp. nov.

PLATE XXXI, FIGURE 13.

Shell thin, stout-fusiform, with very convex, evenly rounded whorls and a moderately elevated, somewhat acute, turreted spire, which occupies nearly one-half the length of the shell. Whorls six or seven, the apex eroded in all of our specimens, apparently with a small regularly spiral nucleus. The whorls increase rather rapidly and are separated by a deeply impressed suture. The sculpture on the two lower whorls consists of strongly marked, narrow, prominent spiral cinguli, which are somewhat unequal in size, and separated by wider, concave interspaces, which are crossed by distinctly raised, but delicate and close, lines of growth, due largely to the epidermis rising in scale-like forms. These lines of growth are less conspicuous over the spiral ribs, which they render somewhat uneven. The upper whorls have, in addition to the small spiral cinguli, a pretty distinctly marked carination at the shoulder, and are crossed by slightly elevated, longitudinal ribs or folds, which produce a series of slightly raised nodules where they cross the larger carina at the shoulder. On the penultimate whorl there are from fourteen to sixteen revolving cinguli. Aperture long-ovate, broadly rounded in the middle. The outer lip is thin and evenly rounded from the suture to the base of the canal, where it forms a sinuous curve. The canal is short, narrow, somewhat constricted at the base and nearly straight, except near the end, where it is slightly recurved. Columella not much bent, its inner edge with a slight sigmoid curvature. The operculum is thin, ovate, with the inner margin more convex than the outer, and with the posterior margin evenly rounded and the anterior end slightly curved to the obtuse tip, which shows no spiral structure. The operculum is rather small as compared with the size of the aperture. Epidermis is thin but distinct, not hairy, though rising into scale-like edges along the lines of growth. Its color is pale brownish yellow.

The only specimen with the animal is a male (from station 2038), the largest in the collection. The tentacles are long, slender, tapering to acute tips. No eyes can be detected in the preserved specimen. The other specimens show some variation in the proportion of length to breadth and in the size and closeness of the revolving cinguli, which are sometimes pretty regularly alternately larger and smaller.

Length of the largest specimen, male, 40^{mm}; breadth, 23^{mm}; length

of body-whorl and canal, 30^{mm}; length of aperture, 25^{mm}; its breadth, 12^{mm}; breadth of canal at base, 5^{mm}; height of spire, 18^{mm}; length of operculum, 12^{mm}; its breadth, 8^{mm}.

This species occurred at stations 2037, N. lat. 38° 53', W. long. 69° 23' 30", in 1731 fathoms, four dead (No. 37,999); station 2038, N. lat. 38° 30' 30", W. long. 69° 08' 25", in 2033 fath., one living specimen (No. 38,411); station 2097, N. lat. 37° 56' 20", W. long. 70° 57' 30", in 1917 fath., four dead (No. 35,250); and station 2106, N. lat. 37° 41' 20", W. long. 73° 03' 20", in 1497 fath., one dead (No. 35,465).

Sipho profundicola, var. *dispar*, nov.

Shell of medium size, stout-fusiform, with very convex, rounded whorls, the upper ones with both transverse ribs and spiral lines; the lower ones with spiral lines only. Whorls about six, besides the nucleus, which is eroded. They are slightly shouldered and somewhat turreted and increase rapidly in size. The upper ones have stout, raised spiral lines or cinguli, of unequal size, and mostly acute at summit, separated by wider, concave interspaces; they are also crossed by many rather feebly marked transverse ridges, most distinct at the shoulder; these disappear on the lower whorls, on which there are numerous, conspicuous, unequal, mostly strongly raised, spiral lines, which cover the whole surface. One of these, considerably larger than the rest, forms the angle of the shoulder; above this the whorls descend somewhat abruptly to the suture, but with a convex outline; just below the angle the whorls are a little flattened and then are convexly rounded. The more prominent of the cinguli are somewhat thickened and obtusely rounded; between these there are from three to five smaller and thinner ones. The interspaces are strongly concave and broader than the raised lines; both the cinguli and interspaces are crossed by crowded, thin, raised lines of growth, along which the epidermis rises into small, short hairs, or thin scales. Aperture ovate, rather broad, slightly angulated at the shoulder. Canal moderately long, rather narrow, somewhat bent to the left, and slightly turned up at the end. Columella strongly sinuous, with the inner margin sharp and decidedly twisted along the margin of the canal. Body-whorl decidedly excavated along the inner lip. Operculum broad-elliptical, with the nucleus at the anterior edge, yellowish horn-color. Shell internally bluish white. Epidermis pale greenish yellow.

Length of the largest specimen, 30^{mm}; breadth, 17^{mm}; length of body-whorl to tip of canal, 23^{mm}; length of aperture and canal, 19^{mm}; breadth of aperture, 8^{mm}.

A living specimen was obtained at station 2042, N. lat. 39° 33', W. long. 68° 26' 45", in 1555 fathoms (No. 37,955), by the Albatross.

This species bears little resemblance to any of those previously described from our coast. It is a larger and much stouter shell than *S. pygmaeus*, with much more convex whorls, and the latter species is without transverse ribs on the upper whorls. The last named character shows an affinity with *S. cælatus* and *S. glyptus*, but these are both smaller and more slender, and are ribbed in a much higher degree.

Sipho cælatus, var. *hebes* Verrill, nov.

This variety differs from the typical form in having the spire shorter, and more abruptly tapered toward the tip, and in having the whorls somewhat flattened, with the suture shallower, so as to give the shell a more cylindrical form. The ribs are numerous and well developed on all the whorls below the nucleus, and are distinctly excurved on the most convex part of the whorls. The lines of growth are thin and close, but are distinctly raised, and run parallel with the ribs. The spiral cinguli are very numerous, rather thin, not very prominent, often nearly obsolete on the last whorl. The operculum is ovate or pear-shaped, with the anterior end obtusely pointed and a little incurved, with the nucleus at the inner edge, near the anterior end, and showing a very slight tendency to the subspiral structure.

This form occurred at station 2003, N. lat. 37° 16' 30", W. long. 74° 20' 36", in 640 fathoms, three specimens, one living (No. 35,659); station 2077, N. lat. 41° 09' 40", W. long. 66° 02', in 1255 fath., one living specimen (No. 38,015) and station 2103, N. lat. 38° 47' 20", W. long. 72° 37', in 1091 fath., one living and one dead (No. 35,424).

Sipho (Mohnia) cælatulus Verrill, sp. nov.

Shell small, fusiform, with an elevated, acute spire, the lower whorls with transverse ribs and raised spiral lines, the upper ones usually without ribs; in general appearance resembling *S. cælatus*, but with the spire more elevated and acute and the ribs less strongly developed. Whorls about seven, moderately convex, not distinctly shouldered; suture rather deep, simple. The nucleus is small, smooth and little prominent, consisting of about two whorls; the api-

cal whorl is very small, closely and regularly coiled, largely covered by the next whorl, which is at first smooth, then shows delicate spiral lines which gradually become stronger; the next two whorls are covered with rather strong, elevated, spiral cinguli, unequal in size and obtuse at summit, separated by interspaces of about the same width. The first whorl below the nucleus has four or five cinguli; the next has one or more smaller lines in each of the interspaces between the primary ones; the succeeding whorl has about ten to twelve prominent cinguli, with some additional ones of smaller size; on the lower whorls the cinguli become much more numerous, covering the whole surface, the most prominent surrounding the periphery and having three to five smaller ones between them; just below the suture the cinguli are often less prominent than elsewhere, and are rendered wavy by transverse ribs. The two upper whorls, below the nucleus, are generally destitute of transverse ribs, or have them but slightly developed; on the succeeding whorls they become somewhat more conspicuous; they are broad, low, rounded at the summit, nearly straight, but a little receding just above the middle of the whorls, and are evenly spaced, having concave intervals about equal to their own breadth. On the lower whorls there are about twelve to fourteen of these ribs. Both the ribs and interspaces are equally crossed by the revolving cinguli, and their entire surface is covered by fine, close, raised or slightly lamelliform lines of growth. Outer lip sharp, thin, rather evenly rounded, contracted at the base of the canal, which is moderately long, narrow, twisted, and a little recurved. Aperture long-ovate, rather narrow, regularly incurved on the inside. Columella strongly bent and spirally twisted in a sigmoid curve. Operculum broad-ovate, obtusely rounded at the anterior end, with the nucleus situated slightly within the margin of the inner edge, from which the lines of growth diverge in a sub-spiral manner. There is often a slight notch on the inner margin, just back of the nucleus. Epidermis inconspicuous. Color, in alcohol, pale pink or pinkish white, translucent, usually white or yellowish white when dried.

Length of one of the larger specimens, 21^{mm}; breadth, 9^{mm}; length of body-whorl and canal, 14^{mm}; length of aperture, 10^{mm}; its breadth, 4^{mm}. Other specimens are decidedly stouter than the one measured.

Station 2048 (No. 34,832); sta. 2051 (No. 35,259); sta. 2052 (No. 35,229); sta. 2072 (No. 38,052); sta. 2076 (No. 35,149); sta. 2077 (No. 35,248); sta. 2084 (No. 35,185), in 547 to 1290 fathoms. It occurred in most abundance at stations 2076, N. lat. 41° 13', W,

long. $66^{\circ} 00' 50''$, in 906 fathoms, one hundred and twenty-five specimens, seventy-five living; station 2077, N. lat. $41^{\circ} 49' 40''$, W. long. $66^{\circ} 02'$, in 1255 fathoms, fifty-five specimens, twenty-five living; and station 2084, N. lat. $40^{\circ} 16' 50''$, W. long. $67^{\circ} 05' 15''$, in 1290 fathoms, one hundred and fifty specimens, seventy-five living.

This species might readily be mistaken for *S. celatus* V., but the latter has a shorter, less acute and more abruptly tapered spire, a shallower suture, and the transverse ribs are prominent even on the whorls next to the nucleus. The sculpture, however, on the lower whorls agrees very closely. The operculum differs in form and structure. *S. glyptus* has the spire longer and more acute, with the nucleus more prominent and different in form. Its spiral sculpture is more highly developed and quite distinct in appearance from that of the present species. Although this species is referred to the subgenus *Mohnia*, on account of the subspiral structure of the operculum, this feature is less marked than in *Mohnia Mohnii*, the type of the group, as established by Friele, in this respect agreeing nearly with *Sipho (Mohnia) parvus* V. and S. In fact, in respect to the operculum, it is somewhat intermediate between typical *Sipho* and *Mohnia*.

Sipho (Mohnia) simplex Verrill, sp. nov.

Shell small, short-fusiform, thin, delicate, somewhat translucent, with evenly convex whorls, and with numerous fine spiral lines and raised lines of growth, but without ribs. Canal short, nearly straight. Spire rather short, regularly tapered, acute. Whorls five or six, evenly rounded, rather convex. Suture well impressed, simple. The nucleus is very small, smooth, with the apical whorl minute, regularly spiral and largely concealed by the next whorl. Faint spiral lines commence on the second whorl. On the first whorl below the nucleus there are four or five thin, sharp cinguli; on the next these increase to ten or twelve, which are nearly equal, moderately raised, and separated by interspaces of about their own width; on the body-whorl the cinguli become very numerous and very regular, covering the whole surface to the base of the canal, but some of those around the periphery are somewhat thicker than the rest, with the summit somewhat obtuse or flattened; alternating with these are others of smaller size and thinner. The whole surface, both of the cinguli and interspaces, is crossed by very numerous, close, thin, raised, lamelliform lines of growth, which recede on the more convex part of the whorl, but bend forward toward the

suture. Aperture rather broad-ovate, narrowing gradually to the canal, without any marked constriction. Canal short, rather broad, wide at base, narrowing toward the tip. Columella nearly straight, slightly sigmoid toward the tip. Operculum small, pear-shaped, narrowed anteriorly, with the inner edge slightly incurved, and with a minute notch close to the tip, just behind the minute subspherical nucleus, which is situated just within the margin, much as in the preceding species and *S. parvus*. Epidermis thin, occasionally rising into minute scales and points along the lines of growth, especially near the suture. Color, in alcohol, dull pinkish white. Nuclear whorls pale brownish.

Length of one of the largest specimens, 14^{mm}; breadth, 7.5^{mm}; length of body-whorl and canal, 10^{mm}; length of aperture, 8^{mm}; its breadth, 3.5^{mm}.

Station 2115, N. lat. 35° 49' 30", W. long. 74° 34' 45", in 843 fathoms, three living specimens (No. 35,573); and station 2055, N. lat. 42' 32", W. long. 68° 17', in 99.5 fathoms, one dead specimen.

This species has some resemblance to *Mohnia Mohnii* Friele, for a specimen of which I am indebted to the kindness of Mr. Friele. The latter is a less delicate shell, with coarser spiral lines, and with much larger nuclear whorls, and the operculum is much more distinctly spiral, its nucleus being larger and farther from the edge.

S. concinnus (*Fusus concinnus* Jeff.), is also similar to our species in form and size.

Sipho leptaleus Verrill, sp. nov.

PLATE XXXI. FIGURE 14.

Shell small, fusiform, glossy white, with five whorls, which are very convex, slightly carinated and angulated in the middle, on the lower whorls. Suture well impressed. Spire elevated, regularly tapered, acute. The sculpture consists of numerous regular, thin, delicate, raised, longitudinal ribs, which are bent in a sigmoid curve, the part corresponding to the most prominent angle of the whorls strongly receding; and of fine, microscopic, wavy revolving lines between the ribs. There is usually a distinct internal line, just below the suture. Aperture irregularly ovate, rather narrow, elongated. Outer lip thin, rounded to the base of the canal, which is somewhat lengthened, oblique, and a little twisted. The columella-margin of the canal forms a sigmoid curve. Nucleus prominent, rounded, consisting of about one whorl and a half, covered with fine spiral lines.

Length, 3.5^{mm}; breadth, 2^{mm}; length of body-whorl and canal, 2.3^{mm}; length of aperture, 2^{mm}; its breadth, about 1^{mm}.

Off Martha's Vineyard, station 1143, in 452 fathoms, soft mud, 1882. One specimen.

The affinities of this shell are doubtful, as the animal and operculum are both unknown. The sculpture resembles that of some Pleurotomidæ.

Trophon Lintoni Verrill and Smith, MSS.

Verrill, Amer. Journ. Sci., vol. xxiv, p. 365, November, 1882.

PLATE XXIX, FIGURE 1.

Shell stout, rough, with six very convex, somewhat shouldered whorls, crossed by about nine very prominent, thick, obtuse ribs; whole surface covered with strong, elevated, obtuse, scaly, revolving cinguli, usually alternately larger and smaller, separated by narrow, deep grooves; they are crossed by arched scales or lines of growth. Aperture broad; canal short, narrow, a little curved; umbilical pit distinct, but small.

Length, 28^{mm}; breadth, 17^{mm}; length of canal and body-whorl, 19^{mm}; length of aperture, 15.5^{mm}; its breadth, 7.5^{mm}.

Named in honor of Professor E. Linton, a member of the Fish Commission parties in 1882 and 1883.

Off Martha's Vineyard, station 1118, in 70 fathoms, Fish Hawk, 1882. One specimen. No other example has been taken.

Trophon clavatus G. O. Sars.

Moll. Reg. Arct. Norvegie, p. 249, pl. 15, fig. 12; pl. 23, fig. 14, and pl. IX, fig. 17 (dentition).

This species is rather common in our deeper dredgings.

It agrees very well with Sars's descriptions and figures. Among our numerous specimens there is considerable variation in form, and in the number and prominence of the thin elevated ribs.

It occurred at station 2035, in 1362 fathoms; sta. 2037, in 1731 fath.; sta. 2038, in 2033 fath.; sta. 2041, in 1608 fath.; sta. 2042, in 55 fath.; sta. 2043, in 1467 fath.; sta. 2076, in 906 fath.; sta. 2084, in 1290 fath.; sta. 2096, in 1451 fath.; sta. 2115, in 843 fath.

It was most abundant at sta. 2038, N. lat. 38° 30' 30", W. long. 69° 08' 25", in 2033 fath., twenty specimens (No. 34,847); sta. 2076, N. lat. 41° 13", W. long. 66° 00' 50", in 906 fath. (No. 38,041),

eighteen living specimens; and sta. 2115, N. lat. $35^{\circ} 49' 30''$, W. long. $74^{\circ} 34' 45''$, in 843 fath. (No. 35,583), forty living. It was taken by Sars, off Lofoden, in 120 to 200 fath.

TÆNIOGLOSSA.

Benthodolium Verrill, gen. nov.

Shell rather large, shape somewhat intermediate between *Buccinum* and *Dolium*. Spire moderately elevated. Whorls convex, last one ventricose. Aperture large, broad, somewhat semicircular. Canal very short, scarcely differentiated from the aperture, formed chiefly by the eversion and turning up of the anterior end of the columella-margin. The columella-lip is thickened and sinuous, extending over the umbilical region. A distinct, well defined layer of enamel, on the body-whorl, connects the outer lip with the columella. No umbilicus. The operculum is large, moderately thick, horny, ovate or subcordate, with a large, spiral nucleus, situated a little within the margin of the broad anterior end, which is slightly emarginate in the middle, opposite the nucleus.

The animal, in alcohol, has a broad head, with large, stout, tapering, acute tentacles, apparently without any trace of eyes. Proboscis moderately long. The siphon is indicated only by a short rounded fold of the mantle-edge. The foot is short and broad, bluntly rounded behind, with a deep transverse groove in the front margin. Gills very unequal in size, the lower only about half the length of the upper.

The odontophore, in the type-species, is small and short, with teeth somewhat like those of *Dolium*. The rachidian tooth is broad, with a large, sharp central cusp and six or more small denticles on each side; the inner lateral tooth is large, strongly curved, with a sharp terminal cusp, and several small lateral denticles on the outer margin; the two outer rows are much alike; these teeth are long, slender, curved, with sharp tips. On each side of the cavity of the proboscis there is a chitinous patch, closely covered with small chitinous scales or denticles, which are closely crowded together and imbricated; the largest of these denticles are flattened and have their free end lanceolate and acute.

Benthodolium abyssorum Verrill and Smith, sp. nov.

PLATE XXXI, FIGURES 12, 12a, 12b.

Shell large, thin, stout, with inflated whorls, and a short, obtuse spire. Whorls five, below the nucleus, rapidly increasing, evenly

rounded, strongly convex, the last whorl occupying more than one-half the length of the shell. Suture deep, well impressed, the whorls rising abruptly from the suture produce a well rounded shoulder. Aperture broadly ovate; outer lip thin, sharp, with a nearly evenly rounded outline, the edge receding a little at the shoulder and slightly everted near its junction with the whorl; inner lip continued as a thin lustrous coat of white enamel on the previous whorl, becoming raised, sharp, and slightly sinuous in the umbilical region, and turning outward so as to nearly conceal a narrow umbilical chink. Columella short, not much thickened, with a slight sigmoid curvature. Canal very short, and wide, scarcely projecting beyond the margin of the outer lip, with which it is directly continuous. Sculpture consists of numerous small, but very distinct, elevated, spiral cinguli, somewhat unequal in size, but rather evenly spaced, and separated by much wider concave interspaces (about 1^{mm} broad), crossed by rather conspicuous and regular, raised lines of growth, which also cross the ribs. There is no indication of longitudinal ribs. Epidermis distinct, thin, brownish yellow, not hairy. The apical whorls are eroded. Operculum spiral, large, thin, ovate, inequilateral; the outer edge evenly rounded; the inner edge not so strongly convex and slightly sinuous posteriorly; the anterior edge slightly emarginate, where the spiral portion turns inward. The anterior portion shows a distinct spiral whorl, having its center a little distance from the anterior border, and the lines are curved radially from the center.

Color of the shell white and translucent beneath the yellowish epidermis. The operculum is horn-color, translucent.

The only specimen in the collection is a female. The tentacles are large, broad, stout, rapidly tapering to the acuminate tips. No eyes can be detected in the preserved specimen.

Length, 45^{mm}; breadth, 35^{mm}; length of spire, 18^{mm}; length of aperture, 37^{mm}; its breadth, 18^{mm}; length of operculum, 19^{mm}; breadth, 14^{mm}.

Station 2098, N. lat. 37° 40' 30", W. long. 70° 37' 30", in 2221 fathoms, one living specimen (No. 35,273), and station 2105, N. lat. 37° 50", W. long. 73° 03' 50", in 1395 fathoms, one dead specimen (No. 35,364).

Trichotropis inflata Friels.

Catalog norweg. Nordmeer-exp. Spitzbergen gefund. Mollusken, p. 275, 1879.

Shell small, ovate, with the last whorl large and somewhat ventricose, spire small, turreted, with a rather acute apex and a strongly

marked, somewhat impressed suture. Whorls four, increasing rapidly, rising abruptly from the suture to the strongly convex shoulder, and somewhat flattened at the periphery. The apical whorl is not very small, but rather prominent. The body-whorl forms much the larger part of the shell, and is rather evenly rounded in the middle, strongly produced anteriorly, and narrowed gradually to the tip of the short canal. The sculpture consists of very thin, raised, rather close and regularly spaced revolving cinguli, of which there are about twelve on the penultimate whorl; on one specimen one of these is a little more prominent than the rest. Fine, close, regular, and distinctly raised flexuous lines of growth also cover the whole surface of the lower whorls, crossing both the cinguli and their interstices, but most distinctly the latter; these lines of growth are much finer and more numerous than the cinguli; the two upper whorls are smooth. Aperture somewhat crescent-shaped, not very broad, pretty evenly rounded on the outside, prolonged anteriorly into a short rudimentary canal, and with the inner margin rather flexuous, the columella-margin being straight or a little convex in the middle, while there is a marked excurvature in the umbilical region; the lip is thin, simple, but striated within by revolving lines which show through. The canal is not differentiated from the aperture by any constriction, and ends in a simple and slightly prominent notch; the columella-lip is reflexed over the umbilicus, nearly concealing it in a front view. The umbilicus seen in an end view is narrow and deep.

Length, 6^{mm}; breadth, 3·8^{mm}; length of body-whorl, 5^{mm}; length of aperture, 3·5^{mm}; its breadth, 1·8^{mm}.

Station 2084, N. lat. 40° 16' 50", W. long. 67° 05' 15", in 1290 fathoms. Two living specimens (No. 38,077).

The original specimens described by Friele were from 223 and 656 fathoms, and from 650 fathoms, off Tromso.

This shell agrees closely with the description and figure quoted. It seems to me very doubtful whether it really belongs to the genus *Trichotropis*. It may prove to belong to *Admete*.

Cingula brychia Verrill, sp. nov.,

PLATE XXXII, FIGURE 9.

Shell brown, small, rather thick, short and stout, composed of about three rapidly increasing whorls, which are crossed by strong transverse ribs, but are destitute of spiral lines. The apical whorl is relatively rather large, regularly rounded, making a small, obtuse

tip. The second whorl is crossed by about twelve rather prominent and obtuse ribs, which are most elevated at the periphery; their interspaces are concave and wider than the ribs. On the last whorl, which forms the greater part of the shell, there are about fourteen ribs, most prominent on the shoulder, fading out a short distance below the periphery, and also disappearing close to the suture; the base is somewhat produced and is destitute of sculpture. There is a minute umbilical chink or groove, partially concealed by the edge of the lip. The suture is strongly impressed. Aperture rather large, obovate, broadly rounded posteriorly, narrowing nearly to a point anteriorly, at the junction of the outer lip and columella; the outer lip is rather thin, without a varix, strongly convex at the shoulder, and a little produced anteriorly, where it forms a distinct, prominent angle at its junction with the columella-margin, which is straighter than in most species, though somewhat excurved. In some specimens there appears to be a rudimentary notch at the anterior angle of the lip, somewhat like that of *Trichotropis* and *Litiopa*. The inner lip is usually not continuous on the body-whorl. Color dark reddish brown, varying to light brown and brownish yellow, frequently more or less coated with iron oxide.

Length, 2.3^{mm}; breadth, 2^{mm}; length of aperture, 1^{mm}.

Station 892, in 487 fathoms (No. 38,021), 1880; five living, one dead, station 1093 (No. 38,086), in 349 fathoms, 1882; dredged by the steamer Fish Hawk.

Stations 2072 (No. 38,089); 2076 (No. 38,073); 2078 (No. 38,074); and 2084 (No. 38,099), in 499 to 1290 fathoms, 1883, steamer Albatross.

In color and general appearance this species resembles the young of *C. Jan-Mayeni*. It is, however, a shorter and stouter species, and is destitute of the spiral lines, which render the ribs on the shoulder conspicuously nodulous in the latter.

Cingula syngenes Verrill, sp. nov.

PLATE XXXII, FIGURE 11.

Shell small, white, long-ovate, with a regularly tapering, blunt-tipped spire; a strongly impressed suture; and four to five evenly convex whorls, which are rather finely and regularly reticulated by transverse ribs and revolving cinguli of nearly equal strength, except on the base, which has only the spiral sculpture. Apical whorl relatively large, obtusely rounded, nearly smooth; on the second turn a

few revolving lines appear; the lower whorls are crossed by about fourteen to sixteen, regular, rather elevated, but not broad, rounded ribs, which are nearly straight and separated by pretty regular interspaces, usually about twice as broad as the ribs. On all except the last whorl, the ribs extend from suture to suture; on the last whorl they fade out a little below the periphery. The whole shell, except the nucleus, is covered with well developed, rather thin, revolving cinguli, which are about the same height as the ribs, though rather thinner, but in crossing the ribs they do not form nodules, so that the surface is cancellated with a regular net-work, of which the meshes are squarish, or elongated in the direction of the revolving lines, but below the periphery of the last whorl the cinguli become stronger and the ribs fainter, while the greater part of the base is occupied with cinguli only, which are here rather closely crowded. On the penultimate whorl there are about six or seven cinguli; on the body-whorl there are sixteen to nineteen, of which eight or nine are posterior to the lip, and six or seven anterior to it. The surface is also marked with very fine revolving striæ, visible under the microscope. Umbilicus none. Aperture rounded or very broadly ovate, usually slightly narrowed and obtusely angled posteriorly; broadly rounded and slightly flaring in front; outer lip sometimes thin and sharp, sometimes distinctly thickened, but without a varix; anteriorly it is slightly effuse, and sometimes forms there a faint rounded angle; the inner lip is continuous, forming a regular curve, but not quite so convex as the outer margin; the portion in contact with the body-whorl has a free edge, and in the umbilical region the margin is a little reflexed, often leaving a slight furrow beneath it.

Length, 3^{mm}; breadth, 1·6^{mm}; length of aperture, 1·2^{mm}; its breadth, ·8^{mm}. Other specimens are somewhat more slender than the one measured.

Station 2109, in 142 fathoms, off Cape Hatteras, N. lat. 35° 14' 20", W. long. 74° 59' 10". Several specimens, living and dead (No. 35,453).

This species belongs to the same group as *C. arenaria*, *C. carinata*, and *C. areolata* of our northern coasts. From all these it differs in having a finer and more regular sculpture, both the ribs and revolving lines being much more numerous and more regular. Nor do either of the northern species possess the microscopic striæ. In this last character it resembles *C. harpa* and *C. leptalea*; but *C. harpa* is a stouter shell, with much finer and more numerous revolving lines, which do not give it a cancellated appearance. *C. leptalea* is

entirely destitute of the transverse ribs. The present species also resembles *C. abyssicola* of northern Europe, as figured by G. O. Sars, but the latter has a stronger sculpture, with fewer revolving lines, and the outer lip has a distinct varix. *C. Jeffreysi* differs in nearly the same manner.

Cingula leptalea Verrill, sp. nov.

PLATE XXXII, FIGURE 10.

Shell of moderate size, thin, slender, composed of four very convex whorls separated by a deep suture, and with small spiral cinguli and microscopic, wavy, revolving lines. The apical whorl is rather large, smooth, regularly coiled, forming a small rounded apex. The lower whorls are covered with small, rounded cinguli, of which there are from eight to ten above the suture, on the penultimate whorl, those just below the suture becoming indistinct; on the body-whorl there are about twenty; they are separated by concave interspaces of somewhat greater width, the spaces becoming greater on the upper part of the whorl. Both the interspaces and cinguli are covered by very delicate, microscopic, raised lines, which are bent into minute, close waves, giving the whole surface a microscopically vermiculated appearance; of these wavy lines there are mostly from four to six in the interspaces and four or five on the cinguli. The whorls are crossed by raised lines of growth, which in some places are pretty regular and nearly as prominent as the cinguli, which they cross so as to produce a finely reticulated sculpture; this is seen most frequently near the shoulder, but is not constant, often fading out both near the suture and anteriorly. There are also more or less distinct microscopic lines of growth which cross the minute revolving lines, but are less distinct than the latter. The aperture is rather large, regularly ovate; the outer lip is a little thickened, but without a varix; it is regularly arched exteriorly and a little effuse in front; the inner lip is well developed and continuous, though closely adherent to the body-whorl. There is no umbilicus, but a small chink is formed by the eversion of the columella-lip. Color, in alcohol, pale yellowish white with a tinge of greenish, and translucent; when dry, white and opaque.

Length, 3^{mm}; breadth, 1.8^{mm}; length of aperture, 1^{mm}.

Station 2072, N. lat. 41° 53', W. long. 65° 35', in 858 fathoms (No. 38,060). One living specimen.

This species is easily distinguished by the peculiar, elegant, spiral microscopic lines, combined with the numerous spiral cinguli, visible under a lens. There are no regular transverse ribs.

Cingula apicina Verrill, sp. nov.

PLATE XXXII, FIGURE 8.

Shell conical, rapidly tapering to a very acute, sub-stiliform tip. Nuclear whorls about four, smooth, dark brown; the first is minute and obliquely incurved; the others very gradually increase, so as to form a slender, somewhat stiliform nucleus, below which the normal whorls increase much more rapidly. The normal whorls, of which there are five, are very convex, evenly rounded, with a strongly impressed suture, and everywhere crossed by fine, distinct, obliquely raised, slightly flexuous lines of growth, some of which often appear as distinct riblets, but without any distinct spiral lines. Aperture nearly round, faintly angulated, a little in advance of the middle, by a very slight and rather indistinct ridge, which surrounds the base near the periphery. Columella-margin thin and somewhat reflexed over the umbilical depression; inner lip short, formed by a thin layer of enamel closely adherent to the body-whorl. Umbilicus small and deep, partially concealed in a front view by the reflexed edge of the lip, but distinctly visible in an end view. Epidermis thin, closely adherent, light horn-color, without much luster, and having a distinctly fibrous appearance, under a lens. Shell grayish white. Operculum nearly round, very thin, pale horn-color, with very indistinct subspiral lines of growth.

Length, 7.6^{mm}; breadth, 5^{mm}; length of body-whorl and canal, 5^{mm}; length of aperture, 2.5^{mm}; its breadth, 2^{mm}.

Station 2041, N. lat. 39° 22' 50", W. long. 68° 25', in 1608 fathoms. Steamer. Albatross, 1883 (No. 38,070).

A single living specimen of this species was obtained. The animal, in alcohol, has rather short, stout, tapering tentacles, and is apparently without eyes. Its generic affinities are doubtful. It has some resemblance in sculpture and appearance to *Lacuna glacialis*, but the latter is a stouter shell, with a less distinct umbilicus, and without the peculiar stiliform nucleus seen in the present species. In the last character it approaches *Litiopa*, but it has not the notch, or rudimentary canal, characteristic of that genus.

Cithna tenella, var. *costulata* Jeff.

Lacuna tenella Jeffreys, Brit. Conch., p. 204, pl. 101, fig. 7.

Cithna tenella, var. *costulata* Jeffreys, Proc. Zool. Soc. London, 1883, p. 110.

This species was taken at station 2038, N. lat. $38^{\circ} 30' 30''$; W. long. $69^{\circ} 08' 25''$, in 2033 fathoms (No. 38,069). One living specimen.

It has been taken on the European coasts at several localities, in 114 to 2050 fathoms, from off the Faroe Islands to the Azores and Mediterranean. It was taken off Pernambuco, Brazil, and east of Japan by the Challenger (Jeffreys). It occurs in the Pliocene of Sicily and Calabria, according to Jeffreys.

Cithna cingulata Verrill, sp. nov.

PLATE XXXII, FIGURE 7.

Shell small, rather solid, depressed, with a low spire, and angulated, spirally striated whorls. Base broad, convex; umbilicus small and deep. The nucleus is relatively large, nearly smooth, glossy, deep chestnut-brown, composed of about three rapidly increasing whorls, the last of which is finely spirally striated; the apical whorl is minute and regularly coiled, not prominent; the change from the nucleus to the normal whorls is abrupt. Aside from the nucleus, there is rather more than one whorl, which increases rapidly and constitutes the bulk of the shell; this whorl is very convex at the periphery and more or less distinctly bicarinate; one carina surrounds the periphery; the other at a short distance above this forms a slight, rather indistinct shoulder; the band between the upper carina and the suture is slightly convex and joins the preceding whorl nearly at right angles, bending inward at the suture so as to form a narrow and rather deep sutural groove. The whole surface, below the nucleus, both above and below, is covered by numerous, pretty regular, close, spiral cinguli, separated by grooves of about the same breadth on the periphery, but more crowded on the base; the surface is also roughened by fine and minute lines of growth. On the last whorl there are four or five cinguli between the carinae. The umbilicus is regular, somewhat funnel-shaped, narrow and deep. The aperture is rather large, roundish, with the anterior and inner borders slightly patulous, and the outer border expanded and more or less angulated at the carinae; the inner lip is continuous, with a distinct edge along the narrow part, which is attached to the pillar. Columella-margin somewhat flat-

tened and a little effuse anteriorly. Color white, below the brown nucleus.

Height, 2.2^{mm}; breadth, 3.6^{mm}; breadth of aperture, 2^{mm}.

A young specimen, preserved in alcohol, and apparently of the same species, has a distinct epidermis, bearing small hair-like processes, most prominent on the carinæ. Its nucleus is somewhat smaller than in the specimen described above, but has the same form and color.

Station 2076, N. lat. 41° 13', W. long. 66° 00' 50", in 906 fathoms (No. 38,101); station 2084, N. lat. 40° 16' 50", W. long. 67° 05' 15", in 1290 fathoms (No. 38,105). The young alcoholic specimen referred to is from station 2043, in 1467 fathoms, N. lat. 39° 49', W. long. 68° 28' 30" (No. 38,104). Albatross, 1883. One specimen was taken at each locality.

Cithna (?) *olivacea* Verrill, sp. nov.

PLATE XXIX, FIGURE 5.

Shell thin, translucent, naticoid, as broad as high, subglobular, with about four rapidly expanding, rounded whorls. Suture distinct, scarcely impressed. Surface smooth, glossy, covered with a greenish yellow, thin, closely adherent epidermis. The upper whorls are obscured by a thin, smooth, chitinous deposit, which also fills the suture; beneath this the nuclear whorls appear to have a delicate sculpture, consisting of two or more revolving cinguli crossed by delicate lines of growth. Aperture very broad, ovate; the outer lip is evenly rounded, forming nearly a semicircle. Columella-lip nearly straight, a little excurved in the middle, with the edge everted and a little thickened, slightly effuse, and forming a distinct, rounded angle and a rudimentary notch, where it joins the outer lip. The inner lip is continued from the columella-margin to the outer lip by a very thin smooth deposit of enamel, without a free edge. Spire very short, apex obtuse. Umbilicus wanting.

Length, 4^{mm}; breadth, 4^{mm}; length of aperture, 2.25^{mm}; breadth, 2^{mm}.

Off Martha's Vineyard, station 1154, in 193 fathoms, 1882. An additional specimen from station 2084, in 1290 fathoms, 1883.

Both specimens were without the animal, though fresh in appearance. The affinities of this shell are, therefore, very doubtful.

FAMILY SEGUENZIDÆ.

The beautiful deep-sea shells included in the genus *Sequenzia*, with the closely allied forms (*Basilissa*, etc.), present several remarkable characters which ought, certainly, to entitle them to rank as a distinct family.

The shell is trochiform, with elegant revolving and transverse raised sculpture, and usually translucent, with more or less pearly luster, when fresh. Umbilicus open or closed. Aperture irregular, usually with a marked posterior sinus, a short or rudimentary canal, or anterior sinus, and sometimes with two anterior sinuses. Operculum thin, rounded-ovate or ear-shaped, with a subcentral nucleus and fine concentric lines. Jaws ovate, with tessellated surface and denticulated edge. Odontophoré (in *Sequenzia*) minute, *Tenioglossate*; the central tooth small, with one denticle; the inner laterals smaller, with curved unarmed tip; the two outer laterals slender, sharp, strongly curved.

By Jeffreys this group was placed near *Solarium* (*Ptenoglossa*); by Watson in the *Trochidae* (*Rhipidoglossa*).

It has really no affinity with either of those groups, but belongs to the *Tenioglossa*. It seems more nearly related to *Aporrhais* and allied forms, than to any of our other shallow water groups.

Sequenzia formosa Jeffreys.

Jeffreys, Proc. Roy. Soc. London, vol. xxv, pp. 200, 201, 1876 (wood-cuts); Ann. Mag. Nat. Hist., p. 319, April, 1876.

Boog Watson, Mollusca Challenger Exp., Part III, Journ. Linn. Soc., vol. xiv, p. 587, 1879.

PLATE XXXI, FIGURES 14, 14a, 14b.

Several living specimens were dredged by the Albatross in 1883, in 1290 to 2033 fathoms. Station 2037, N. lat. 38° 53', W. long. 69° 23' 30", in 1731 fathoms, one young specimen (No. 38,232); station 2038, N. lat. 38° 30' 30", W. long. 69° 08' 25", in 2033 fathoms, two living specimens (No. 38,078); station 2084, N. lat. 40° 16' 50", W. long. 67° 05' 15", in 1290 fathoms, two living specimens (No. 38,247).

These specimens show some variation in sculpture and in the presence or absence of a small umbilical perforation or channel.

In the typical form of *formosa* the body-whorl is surrounded by three principal carinæ, which are prominent and rather sharp. One of these, around the periphery, is coincident with the posterior angle of the aperture, and, therefore, with the suture, which it usually con-

ceals; both above and below this, at about equal distances, there is another less prominent carina, the lower one defining the basal area; the upper one is about midway between the median carina and the suture. The intervals between these carinæ are broadly concave and crossed by numerous pretty regularly spaced, thin, raised and curved riblets; those between the upper carina and the suture have their concave side toward the aperture and terminate posteriorly in a small, slightly prominent lobe or crest in crossing the sutural carina; those in the two peripheral zones have their convex side toward the aperture and do not cross the carinæ. On the base there are about seven to nine rather prominent revolving cinguli, besides the carina already referred to; the intervals between these are concave and variable in width, and are crossed by numerous, small, oblique riblets. The surface of the whorls between the riblets is covered by fine revolving lines, visible with a lens. The umbilicus is represented only by a narrow spiral groove or channel, nearly concealed by the strongly recurved or reflected margin of the columella-lip, and bounded outwardly by a spiral ridge. The aperture is rather large and angulated, or lobed, with a deep, rather broad posterior sinus, which is deepest just above the upper carina, where the corresponding riblets are most strongly excurved; below this the outer lip is thin, and bends outward and inward, corresponding to the external carinæ and their interspaces; below the periphery and opposite the most convex part of the base the outer lip bends outward and shows another shallow sinus; there is also a small sinus or rudimentary canal at the junction of the lip with the extremity of the columella, which terminates in a small, somewhat prominent angle. The columella-margin is strongly spirally twisted, much excurved opposite the umbilical region, beyond which it curves strongly forward and outward, forming there a small, prominent, sometimes slender tooth, which is often broken. The operculum is ear-shaped or broad-ovate, with an emargination on one side, thin, translucent, pale yellow, with a very delicate, concentric structure. The nucleus is sub-central; around it are numerous thin, close, concentric lines, most distinct about midway between the center and margin; the outer part is transparent and shows no distinct lines; the muscular attachment is ovate, not very large, and excentric to the center.

Jaws thin, brown, irregularly ovate, the outer half covered with small tessellated elevations, becoming more prominent, blunt or spatulate at the margin.

Odontophore very small and slender; median tooth minute, thin, with the tip bent forward and ending in a minute central denticle; inner laterals, with the tip small, curved forward, flat, unarmed, almost half as wide as the median; outer laterals long, slender, very acute, strongly curved.

Length of the largest specimen, 5^{mm}; breadth, 4^{mm}; breadth of aperture, 2^{mm}.

At station 2084, two younger specimens were obtained. These, while agreeing with the larger specimens in form and sculpture, have a narrow but deep umbilical perforation, which is only partially concealed by the reflexed columella-margin. One specimen has five, the other six spiral carinæ on the base. The columella-margin is thin and shows only a small tooth at its extremity. The nucleus, as in the typical form, is small, smooth, turned up obliquely, and somewhat prominent. The presence of the umbilical perforation seems to be due only to immaturity.

Seguenzia formosa, var. *nitida* Verrill, nov.

This shell agrees nearly in form and size with typical *S. formosa*, but is thinner, more translucent, with the spire a little less acute, and with more delicate sculpture. It differs chiefly in having more numerous and closer spiral lines on the base, the number below the median carina of the whorl being ten to twelve, the intervals between them diminishing as they approach the umbilical region. Our specimens have a narrow, spirally twisted, deep umbilical perforation and channel, mostly concealed in a front view by the reflexed edge of the columella-lip; the umbilical pore is bordered externally by the innermost spiral ridge. The columella is much excurved at base, strongly spirally twisted, and projects at the end in a somewhat prominent, excurved angle, forming a small canal, but has no distinct tooth on the inner margin like that seen in the typical *S. formosa*, but this may be due to injury; the outer lip is more regularly convex and has a less developed posterior sinus. The two principal carinæ on the whorls are elevated and rather prominent, with the edge a little thickened, often obtuse and finely spirally lined, not interrupted by the transverse riblets, which fade out at a little distance below the crest, except on the sutural carina, which they cross. The riblets are rather thinner, more delicate, and more numerous than in the typical *S. formosa*, and are less elevated. They are also more strongly curved and decidedly closer together, especially those between the two peripheral carinæ. There is, also,

in some cases, a distinct, subsutural raised line. The fine spiral lines between the carinæ are rather more regular and distinct than in the typical form. The nuclear whorl is a little prominent and turned up, rounded, smooth, glossy, and rather larger than in the latter.

Length, 5^{mm}; breadth, 4^{mm}; length of aperture, 2.3^{mm}; its breadth, 2^{mm}.

Station 2038, in 2033 fathoms, with *S. formosa*, three living examples (No. 38,078).

Seguenzia eritima Verrill, sp. nov.

PLATE XXXI, FIGURE 15.

Shell thin, delicate, stout-conical, with a rather high, regularly tapered, acute spire, a narrow, deep umbilical pore, and a somewhat produced base, which is sculptured by numerous (15 to 20) small, spiral cinguli.

Whorls seven, rapidly increasing, strongly angulated and carinated in the middle. Suture distinct, very slightly impressed, bordered below by a small, slightly raised, spiral ridge; from this the wide subsutural band rises, at an abrupt angle, to the carina of the shoulder, forming a flat or somewhat concave upper slope on the whorls. On the spire the shoulder is situated at about the middle of the whorls, and the periphery, below the carina, is flattened and descends nearly perpendicularly to the suture. On the last whorl a second sharp carina surrounds the periphery, the space between the two being a little greater than that above the first carina, the peripheral band being here somewhat concave. Below the peripheral carina the base is covered by fifteen to twenty smaller and distinctly raised, thin cinguli, of which the two or three outermost are but little smaller than the carinæ, and separated by spaces two or three times their own breadth; near the umbilicus the spirals again become a little stronger and wider apart, while over the greater part of the base they are slender and very close set, the grooves between being scarcely as wide as the lines; midway between the center and circumference there is a low, ill-defined spiral ridge, corresponding to the anterior sinus of the lip; the innermost spiral line forms a thickened border for the umbilicus. The spaces between the carinæ are crossed by numerous, very delicate, flexuous, raised riblets, which are close and very regularly spaced, and rather more prominent on the last whorl than on the spire; those on the subsutural

band, which are closer together than the others, are excurved in the middle, bending abruptly forward to join the shoulder-carina, which they do not cross, nor do they form prominences on the sutural carina; those of the peripheral band curve in the opposite direction, their convex side being toward the aperture. In the narrower spaces between the outer basal cinguli similar riblets are also present, but are here oblique, finer, and less distinct; the spaces between the carinæ are also marked by fine, raised spiral lines, visible with a lens, which do not interrupt the riblets; often some of these, near the median carina, are larger than the rest. The apical whorl is a little prominent, small, regular, smooth and glassy. The suture often appears slightly channeled, when the sutural carina is a little removed from it, owing to the fact that the peripheral carina of the previous whorl is nearly coincident with the suture. The carina defining the shoulder often appears double or grooved at its summit, on the last whorl. The umbilicus is narrow, but deep and spirally twisted, being more or less enroached upon by the incurved columella-edge. The aperture is irregularly angulated and somewhat three-lobed, with two distinct, somewhat produced, narrow sinuses in front; a deep, rather wide notch or posterior sinus corresponding to the subsutural band; and a strongly excavated, rounded sinus at the base of the columella. The outer lip is thin, sharp, angulated at the terminations of the carinæ, and projects strongly forward at the periphery and bends outward in the form of two very short, rather narrow, rounded canals anteriorly. These are nearly equal in size, the outermost corresponding to a slight convex ridge on the outer part of the base, the inner one corresponding to the termination of the columella-margin; the latter projects forward as a rudimentary canal. The columella-margin is short, somewhat thickened, very strongly spirally curved, and much excurved near its junction with the body-whorl, opposite the umbilicus, beyond which it bears a small, slightly prominent, obtuse tooth. Color translucent white, with a pearly luster or iridescence in fresh specimens. Operculum thin, pale yellowish horn-color.

Length, 4.5^{mm}; breadth, 3^{mm}; length of body-whorl and aperture, 3^{mm}; breadth of aperture, 1.7^{mm}.

One living specimen from station 2038, N. lat. 38° 30' 30", W. long. 69° 08' 25", in 2033 fathoms (No. 38,092), the figured type; four specimens from station 2084, N. lat. 40° 16' 50", W. long. 67° 05' 15", in 1290 fathoms (No. 38,249), one living; station 2043, in 1467 fathoms, one dead (No. 38,269).

In size, form, and the general character of the sculpture this species resembles *S. formosa* J., from which it differs mainly in the more delicate character of the sculpture, less acute carinæ, finer and closer riblets, and much more numerous and finer lines on the base. The typical form of *S. formosa* is destitute of an umbilicus, although a narrow one appears in some of the small specimens. This species seems to be a thinner and more delicate shell than any of the varieties of *S. formosa*, and has a more convex base and a smaller nucleus, but a less acute spire. From *S. carinata* Jeff. and *S. ionica* Watson it differs in having a higher and more acute spire, and decidedly in the sculpture and the narrowness of the umbilicus, which in this form is a deep, narrow, spiral perforation. I have seen no description of *S. elegans* Jeff., other than the statement that it is umbilicated.

Piliscus commodus (Middendorff.)

Pilidium commodum Middendorff, Beit. Malacozologia Rossica, pl. 17, figs. 4-11, 1847.

? *Pilidium radiatum* M. Sars; G. O. Sars, Moll. Reg. Arct. Norvegiæ, p. 144, pl. 8, figs. 6, *a-d*, pl. v, figs. 1, *a, b* (dentition).

Pilidium commodum Friele, Nyt. Mag. Naturvid., xxiii, 1877, [sep. copy, p. 2], pl., figs. 2, *2a*, dentition.

Shell very thin, translucent, bonnet-shaped, with the anterior slope rising gradually to the apex, which recurves and overhangs the posterior margin. Aperture very large, broad-ovate, a little narrowed posteriorly, broadly rounded in front. Apex prominent, situated near the posterior end, curved backward and inward, and twisted obliquely to the right; the extreme apex is rather large, bluntly rounded, incurved, and appressed against the body of the shell posteriorly; this nuclear portion expands at first only gradually, and appears to be minutely punctate under a lens. The body of the shell is covered with rather conspicuous, close, raised lines of growth, but is destitute of any radiating lines. The whole surface, except the apex, is covered with a thin, fibrous, concentrically corrugated, yellowish white epidermis, which easily peels off when dried. Margin very thin and sharp, flaring, especially in front. Internally the cavity of the shell corresponds closely with the exterior form, the apical portion running up into the nucleus of the shell and becoming subspiral. Muscular scars very indistinct. Posterior slope abrupt, almost perpendicular, and somewhat concave in a side view, and overarched by the projecting apex, which is situated rather to the

left of the central line, so that the shell is a little one-sided, with the lateral slope on the right side longer and more gently sloping than on the left.

Length of shell, across aperture, 20^{mm}; greatest breadth, 18^{mm}; height, 9^{mm}; front margin to apex, 20^{mm}.

The animal resembles that of *Capulus Hungaricus*, but the muscle by which it is united to the shell is far less developed. The tentacles are large, stout, blunt, with well developed eyes on a basal swelling. There are two large plumose gills situated in a large cervical cavity and attached on the left side, but extending entirely across the back of the neck, so that the tip of the larger gill is visible back of the right tentacle. The foot is rather small, in the alcoholic specimen, and has the anterior corners produced into short obtuse auricles. The dorsal part of the animal is moderately convex and does not show, in the preserved specimen, a subspiral form corresponding to that of the shell. The apical portion contains a large cluster of ova, which is distinctly visible through the integument.

Station 2062, near Le Have Bank, off N. S., on rocky bottom in 150 fathoms. One living specimen (No. 35,274). It was associated with *Prinnoa reseda* and other arctic forms.

This species has not been previously recorded as living in the North Atlantic, south of Iceland, unless *P. radiatum* Sars, from West Finmark, be a variety of it. It was originally described from Okhotsk. Friele records it from off Iceland, in 290 fathoms. It occurs in the post-pliocene at Uddevalla, and in the Coralline Crag of England (as *Capulus fallax* S. Wood, t. Jeffreys).

GYMNOGLOSSA.

Eulimella lucida Verrill, sp. nov.

PLATE XXXII, FIGURES 3, 3a.

Shell rather large for the genus, long and slender, with a tall, regularly tapered, acute spire, composed of about eleven whorls besides the nucleus, which is small, prominent and strongly upturned.

The whorls are much flattened and but little convex. The suture is distinct, but scarcely at all impressed, especially on the upper half of the spire, and not very oblique. The surface is everywhere very smooth and polished, with a very brilliant luster, without any sculpture whatever, and with exceedingly indistinct lines of growth. The aperture is almost regularly ovate, narrowed posteriorly, where

it ends in a slight sutural notch; anteriorly it is evenly and obtusely rounded. The outer lip is sharp, evenly arched, and projects considerably forward in the middle; in front it is somewhat produced and flaring, but passes into the columella-lip in a regular curve; the columella-lip is regularly excurved, with the outer margin somewhat everted. There is no umbilicus. Color translucent pinkish white.

Length, 8^{mm}; breadth, 2.3^{mm}.

Station 2038, N. lat. 38° 30' 30", W. long. 69° 08' 25", in 2033 fathoms. One living specimen.

This species is closely related to *E. charissa*, but it is larger and stouter, with a decidedly larger nucleus, and with more flattened whorls and a less distinct suture, and it has a smaller number of whorls in the same length. It is remarkable for its smoothness and brilliant polish, in this respect resembling *Eulima*.

Eulimella charissa Verrill, sp. nov.

PLATE XXXII, FIGURES 4, 4a, 4b.

Shell small and delicate, translucent white, very slender, with the spire attenuated toward the upper end and very acute, composed of about eleven whorls.

The apical whorl is very small, strongly upturned and reversed; the succeeding whorl is scarcely larger. The suture is slightly but distinctly impressed and not very oblique. The whorls are moderately convex in the middle, though somewhat flattened. The surface is nearly smooth and brilliantly polished, without sculpture, except fine, microscopic, and rather indistinct, flexuous lines of growth, usually most evident close to the suture. Aperture ovate, narrowed to a point posteriorly, where it terminates in a shallow, sutural notch; the outer lip is moderately and regularly convex, projecting forward in the middle, slightly produced and a little flaring in front; it blends with the columella-lip in a regular curve; the columella-margin is regularly excurved, and forms a sinuous curve with the edge of the body-whorl. No umbilicus. Color translucent white, sometimes with a tinge of pinkish.

Length, 5.6^{mm}; breadth, 1.8^{mm}. Other specimens are somewhat more slender than the one measured.

Station 2038, in 2033 fathoms, with the preceding species. Four specimens, three of them living.

This species is very similar to the preceding, but is distinguished by its smaller size and much more slender spire, having a greater

number of whorls in the same length, and by the smaller apical whorl. The whorls are also somewhat more convex and the suture more impressed. In one specimen the spire is somewhat crooked.

Eulimella nitida Verrill, sp. nov.

PLATE XXXII, FIGURE 5.

Shell smooth, polished, rather large for the genus, moderately elongated, with a tall, regularly tapering spire, of more than eight whorls (apex broken), separated by a well defined, somewhat impressed, rather oblique suture.

Whorls moderately and regularly convex. Last whorl much larger than the preceding ones, with the base produced. Aperture long-ovate, much narrowed posteriorly, and terminating in a narrow, rather deep sutural notch, regularly arched and somewhat flaring anteriorly; outer lip thin, sharp, receding in a rather deep notch where it joins the previous whorl, from which it projects forward in a rather strong regular curve, most prominent in the middle, from whence it recedes again anteriorly to the front margin, which is somewhat produced and distinctly effuse. The columella-margin is somewhat excurved, and joins the anterior margin without forming an angle. There is no umbilicus. The surface is everywhere smooth and polished, showing only very faint and indistinct lines of growth. The sutural line often appears double, owing to the inner edge of the suture showing through the translucent shell.

Length of the specimen, lacking the nuclear whorls, 6.5^{mm}; breadth, 2^{mm}.

Station 2038, N. lat. 38° 30' 30", W. long. 69° 08' 25", in 2033 fathoms. One specimen.

This species appears to be closely related to *E. lucida*, though the absence of the nucleus prevents a close comparison. It differs in the greater convexity of the whorls, in the more oblique and more impressed suture, the longer body-whorl, more produced anteriorly, and the narrower and more elongated aperture, which is more effuse anteriorly. From *E. charissa* it differs still more decidedly in most of these characters, and the latter is also a smaller and much more slender species, with more numerous whorls.

Eulimella (or *Menestho*) *lissa* Verrill, sp. nov.

PLATE XXXII, FIGURE 6.

Shell small, white, polished and somewhat lustrous, slender, somewhat obelisk-shaped, composed of about eight flattened whorls, without any sculpture. Apical whorl very small, abruptly up-turned, its diameter only about half that of the next whorl.

The succeeding whorls increase rapidly at first, but the later ones less rapidly, so that the shell has a somewhat Pupa-like form. The whorls are only slightly convex in the middle, but the suture is distinctly impressed. The aperture is irregular ovate, acutely angled posteriorly, broadly rounded anteriorly, with the inner margin sinuous and pretty strongly emarginate at the base of the columella. The outer lip is thin and sharp, only moderately convex in the middle, and projecting only slightly or not at all, there being no distinct sutural notch; anterior margin evenly rounded, only very slightly effuse, sometimes slightly flaring, at other times not at all so; columella-margin regularly excurved, passing into the anterior margin without forming an angle, its outer edge usually everted; the inner lip, at the junction of the columella-margin with the body-whorl, sometimes has a perceptible emargination, but in other examples a strongly excurved outline. The base of the shell is only moderately produced, without any sculpture, nor any trace of an umbilicus.

Length, 6^{mm}; breadth, 1.8^{mm}; length of body-whorl, 2.8^{mm}; length of aperture, 1.2^{mm}.

Station 2109, off Cape Hatteras, in 142 fathoms (No. 35,433), numerous specimens, living and dead. Steamer Albatross, 1883.

This species has the general appearance of certain species of *Odosomia*, but there is no trace of a tooth on the inner margin. It is remarkable for the small size of the apical, as compared with the succeeding whorls, and also for its pupiform or obelisk-shaped outline. In these characters it differs from the species of *Eulimella* herein described, and from those previously discovered on our coast. The aperture, also, is smaller than in most of the related species, and the outer lip projects less distinctly forward. It resembles in form species of *Menestho*, but has no spiral grooves. It seems to have been very abundant at the locality where these specimens were taken.

Odostomia tornata Verrill, sp. nov.

Shell small, conical, consisting of about six whorls, which are flattened and taper regularly to a very acute apex. Each whorl is surrounded by two very strongly marked, broad, revolving grooves, with nearly perpendicular edges; one of these is situated just above the suture; the other, which is somewhat broader, surrounds the middle of the whorl; the two are separated by a raised, flattened revolving band, about as wide as the grooves; a similar but somewhat wider raised band intervenes between the upper groove and the suture, which is not impressed and not very distinct, as it lies at the edge of the groove. The apical whorl is very minute and upturned.

The base of the shell is somewhat produced and nearly smooth. Aperture irregularly ovate, acute above, broadly rounded and flaring anteriorly. The outer lip is flattened laterally and a little produced and effuse anteriorly, forming a rounded angle where it joins the columella, which has a somewhat reflexed, nearly straight, outer margin. The inner lip has a strong, prominent, acute tooth or fold at the junction of the columella with the body-whorl. There is a narrow umbilical chink, somewhat concealed by the everted margin of the columella.

Length, 3^{mm}; breadth, 1.5^{mm}; length of aperture, 1^{mm}.

Station 2109, in 142 fathoms, off Cape Hatteras, 1883. One specimen.

This species is remarkable for the size and depth of the two revolving furrows.

Odostomia disparilis Verrill, sp. nov.

Shell elongated, slender, regularly tapering to an acute tip. Whorls about seven, moderately convex, or a little flattened in the middle. The whorls of the spire with both longitudinal ribs and revolving lines, while the last whorl is nearly smooth, having only very faint revolving lines.

Suture conspicuous, decidedly impressed. On the lower whorls of the spire the ribs are prominent, thick, and obtuse, about fourteen to sixteen in number, separated by intervals narrower than their own breadth, and running nearly straight across the breadth of the whorl; the narrow and deep interstices are crossed by numerous fine revolving lines, which are not distinct on the ribs. On the last whorl faint indications of ribs occasionally appear as subsutural crenulations, disappearing a short distance below the suture. Aperture rather

narrow-ovate, much narrowed posteriorly, and terminating in a slight sutural sinus; anteriorly broadly and evenly rounded, without any angle next the columella-margin; lip thin, broadly rounded on the outer margin, evenly rounded anteriorly, passing into the thin columella-margin in a regular curve; the inner lip is continuous, with a free margin along the body-whorl, which is oblique and almost in line with the columella-margin. This margin is interrupted by a small but distinct tooth, about at the middle, just opposite the minute umbilical chink, formed by the reflexed margin of the lip. Apical whorl broken.

Length, 3.2^{mm}; breadth, 1^{mm}; length of aperture, 0.8^{mm}.

Station 2109, in 142 fathoms, off Cape Hatteras, 1883. One specimen.

This is a very slender and delicate species, remarkable for the very sudden change in sculpture on the penultimate whorl. This, however, may not be a constant character of the species, but due to some injury to the single specimen we have had for examination. But in other respects the species is quite unlike any of those hitherto described from our coast. The aperture is remarkable for its evenly arched anterior and inner margins, which, with the free inner margin, gives it the form and appearance of certain species of *Cingula* (some varieties of *C. aculeus*). The presence of a distinct tooth shows, however, that it is undoubtedly a true *Odostomia*. The sculpture on the upper whorls is, however, more like that found in *Turbonilla*.

RHIPHIDOGLOSSA.

Leptothyra induta Watson.

Leptothyra (induta, var.) albida Dall, Bull. Mus. Comp. Zool., vol. ix, p. 48, 1881.

Several specimens of this species were taken at station 2109, off Cape Hatteras, in 142 fathoms (Nos. 35,369 and 35,385).

These have been identified by direct comparison with West Indian specimens given to me by Mr. Dall, with which they agree in all respects.

Very young specimens, about two millimeters in diameter, have a well developed spiral umbilicus; somewhat larger specimens have only a small perforation; while in all the mature specimens the umbilicus is entirely closed. The specimens recorded by Mr. Dall are from the Gulf of Mexico and West Indies, in 125 to 2805 fathoms.

Cyclostrema cingulatum Verrill, sp. nov.

PLATE XXXII, FIGURE 14.

Shell small, thin, translucent, spirally lined, depressed, with a low spire, an oblique base, a large funnel-shaped umbilicus, and a wide, oblique aperture.

Whorls about three and one-half. The nuclear whorl is smooth, small, rounded, a little prominent and incurved at tip; the next is strongly convex, swelling a little more strongly below the suture, which is decidedly impressed and slightly channeled. The body-whorl is very large, constituting the greater part of the shell, very convex, and more broadly rounded above than beneath, the most convex portion being on the base, below the periphery. The surface of the whorls, except the nucleus, is minutely roughened by fine, close, oblique and somewhat flexuous lines of growth, some of which are a little raised, especially near the suture, where they run obliquely backward, and have an indistinctly fibrous and wavy appearance. The upper whorls have no spiral lines, but the last whorl is surrounded by a number of thin, sharp, distinctly elevated, distant spiral cinguli, the intervals between them being from five to ten times their breadth; the uppermost is at some distance from the suture and there are only about six or seven above the periphery; below the periphery and on the base they become closer together and more numerous, eight to ten being visible in a view of the under surface; on the base the intervals between are mostly four or five times their breadth. The umbilicus is funnel-shaped, rather large and deep, and not defined by any definite border. The aperture is large and very oblique, broad-ovate, somewhat narrowed posteriorly, and broadly and evenly rounded in front; the outer lip is thin and sharp, evenly arched; the pillar-lip is attached only for a short distance to the body-whorl, and shows a thin, free edge. Color translucent grayish white. Animal not known.

Length, 2^{mm}; breadth, 2·2^{mm}; breadth of aperture, 1·2^{mm}.

Station 2048, N. lat. 40° 02', W. long. 68° 50' 30", in 547 fathoms (No. 38,100). One specimen.

This species is remarkable for its very oblique aperture; the wide, funnel-shaped umbilicus, and the peculiar, thread-like spiral lines, which surround the body-whorl and base. Whether it belongs to the genus *Cyclostrema* is somewhat doubtful.

Cyclostrema affine Verrill, sp. nov.

PLATE XXXII, FIGURE 15.

Shell rather large for the genus, with a moderately elevated spire, a prominent, convex base, a narrow umbilical perforation surrounded by spiral lines, and evenly rounded, nearly smooth whorls, separated by a distinctly impressed suture.

The nuclear whorl is moderately large, smooth, chestnut-brown, rounded, slightly prominent, and a little incurved. The succeeding whorls are evenly rounded, increasing rapidly, with a smooth and somewhat glossy surface, and marked by faint lines of growth, and occasionally with a few indistinct spiral lines below the suture, and by numerous thin, raised, and well defined cinguli on the base; the innermost of these, immediately around the umbilicus, are stoutest and most elevated, the size and elevation decreasing outwardly until they disappear, usually about midway between the umbilicus and the periphery; the inner ones are separated by intervals mostly about equal to twice their breadth; the outermost ones are relatively farther apart, while the intermediate ones are usually nearest together; sometimes one or two of those revolving within the umbilical depression are decidedly larger than any of the others, taking the appearance of small carinæ, but the outer ones are always fine and thread-like. The aperture is somewhat oblique, large and nearly round, but slightly flattened or indented opposite the body-whorl and umbilicus; the lip is thin and the inner portion is attached to the body-whorl for only a very short distance, and shows a distinct, free edge. The umbilicus is narrow, spirally twisted and often partially concealed by the margin of the inner lip. Color grayish white, often a little iridescent and somewhat lustrous. Operculum yellowish horn-color.

Length, 2^{mm}; breadth, 2.2^{mm}; breadth of aperture, 1.3^{mm}.

Station 2115, N. lat. 35° 49' 30", W. long. 74° 34' 45", in 843 fathoms, five living specimens.

This is closely allied to *C. basistriatum* J., and *C. rugulosum* Friele, of the European coasts.

Cyclostrema diaphanum Verrill, sp. nov.

PLATE XXXII, FIGURE 16.

Shell small, depressed, trochiform, thin, translucent, white, with a smooth shining surface, without sculpture except around the small umbilicus, where there are numerous fine, close, spiral lines.

Whorls about three and one-half, very convex and evenly rounded, separated by a deeply impressed suture. The nuclear whorl is very minute and regularly spirally coiled, slightly prominent. The last whorl constitutes the greater part of the shell and is shallow and very evenly rounded. The aperture is oblique and very nearly circular, with only a slight angle posteriorly. The outer lip is a little flaring and projects forward anteriorly. The columella-lip is as regularly curved as the outer margin; the inner lip is in contact with the body-whorl only for a short distance, and shows a distinct, continuous, thin edge. The umbilicus is very small, but deep, being scarcely more than a pore or perforation, and is partially overarched by the edge of the columella-lip. The umbilical area is covered by exceedingly fine, close, impressed lines, of which about twenty to twenty-five may be counted; the outermost being about midway between the center and margin of the base; elsewhere the surface is very smooth and polished, with only faint and indistinct lines of growth, except that in one case a very few fine, microscopic spiral lines were noticed just below the suture.

The operculum is thin, yellowish horn-color, circular, composed of many very narrow turns.

Length, 2.5^{mm}; breadth, 3^{mm}; breadth of aperture, 1.3^{mm}.

Station 2004, N. lat. 37° 19' 45", W. long. 74° 26', in 98 fathoms, 1883.

This species resembles the preceding in form, the small size of the umbilicus, and in having spiral lines around the umbilicus, with the surface elsewhere smooth. It differs, however, in being a thinner, more polished, translucent shell; in having the last whorl projecting more obliquely forward, and especially in the much smaller and more regularly coiled nuclear whorl.

From station 2038, N. lat. 38° 30' 30", W. long. 69° 08' 25", in 2033 fathoms (No. 35,165), there is a specimen of a similar shell of larger size, which is, perhaps, a distinct species. It has, like the species above described, a minute, regularly coiled nucleus and smooth rounded whorls, separated by an impressed suture, and with a very narrow umbilical perforation, but the spiral lines surrounding it are less numerous, less distinct, and farther apart. The aperture is large and nearly circular, but more distinctly angulated posteriorly.

Length, 3.25^{mm}; breadth somewhat greater.

Ganeza, sp.

A single specimen, referred to this genus, was found adhering to a *Gorgia*, taken by the Blake, off George's Bank, in 980 fathoms, in 1880.

The shell is small, white, smooth and glossy; the spire is moderately elevated and somewhat obtuse at the apex. Whorls four, very convex, with a deeply impressed suture. The nuclear whorl is small, regularly coiled, and not prominent. The base is somewhat produced and well rounded. There is no umbilicus, but its position is marked by a small depression, or slight groove. The aperture is regularly rounded, except on the side next the body-whorl and umbilical margin, where it is somewhat flattened; the lip is indicated on this side by a closely adherent and thin layer of enamel, which appears to be continuous. Sculpture none, except very fine and indistinct lines of growth.

Length, 2.5^{mm}; breadth, nearly 3^{mm}.

This form might be, with equal propriety, referred to *Cyclostrema*. The distinctions between the latter and *Ganeza* and *Tharsis* seem to me trivial, and no more than specific characters, at most.

Tharsis, sp.

Shell small, white, smooth and lustrous, composed of about three and one-half whorls, which increase very rapidly, the last whorl forming a very large part of the shell. The spire is moderately elevated and the whorls evenly convex, with an impressed suture. The base is considerably produced and convex, and the aperture is oblique. The umbilicus is represented by a small and narrow chink, behind the pillar-lip. Sculpture none, though a faint internal sub-sutural line is visible, and there are traces of microscopic lines of growth. Aperture broad-ovate, somewhat narrowed and angulated posteriorly, broadly rounded on the outer side, and a little produced and rounded in front. Columella-margin regularly excurved, while the portion that joins the body-whorl is decidedly flattened. The inner lip along the body-whorl is represented by a thin but continuous and closely adherent deposit of enamel, not showing a free edge; the lip anteriorly and on the columella-margin is distinctly thickened.

Length, 2.3^{mm}; breadth, 2^{mm}.

Station 2115, off Cape Hatteras, in 843 fathoms, one specimen (No. 38,244).

This species resembles the preceding in general appearance and in the smooth, polished surface, but it is not so broad in proportion; the aperture is more oblique, and ovate instead of circular, and there is a small umbilical perforation, not found in the other.

Cocculina leptalea Verrill, sp. nov.

PLATE XXXII, FIGURES 20, 20a, 20b.

Shell small, oblong-ovate, rather high, with a prominent, small compressed, strongly recurved, apex, with the tip small, strongly incurved, in eroded specimens becoming free and overarching, situated at about the posterior third of the shell.

The anterior slope of the shell is decidedly convex and considerably longer than the posterior slope, which is nearly straight, but a little concave beneath the apex; the side-slopes are moderately convex. The sculpture consists of strongly marked, raised, very thin, and pretty regular concentric cinguli, which usually become finer and much closer towards the apex, but continue nearly to the extreme tip in perfect specimens; the intervals on the lower part of the shell are four times as wide as the cinguli, and are crossed by numerous, fine, wavy, radiating lines, much finer and closer than the cinguli, but easily visible with a lens; in crossing the cinguli they become a little thickened and give the margin of the latter a slightly crenulated appearance when viewed from above. In some cases these slight thickenings have the appearance of minute beads strung along the upper margin of the cinguli. The aperture is oblong-ovate, a little narrower anteriorly, with the sides a little compressed, but still somewhat convex, and with the anterior and posterior margins bluntly rounded. The margin is thin, sharp and plain. Color pale yellowish white. Epidermis indistinct.

Length of the largest specimen, 4^{mm}; its breadth, 2.8^{mm}; height, 2.5^{mm}.

Station 2036, N. lat. 38° 52' 40", W. long. 69° 24' 40", in 1735 fathoms (No. 35,128), one dead; and station 2038, N. lat. 38° 30' 30", W. long. 69° 08' 25", in 2033 fathoms (No. 38,079), one in wood, living, figured type; and station 2105, N. lat. 37° 50', W. long. 73° 03' 50", in 1395 fathoms (No. 35,371), one living.

At station 2038 a specimen occurred in decayed wood which had been bored by *Xylophaga* or *Teredo*. It was associated with *Cocculina spinigera* Jeff. and *Idas argentea* Jeff.

The animal, in alcohol, has a large rounded foot, a broad head, with small tentacles and a large frontal area, extending back on each side in the form of a wide lobe. The mouth is conspicuous, with a swollen, fleshy lobe on each side, and one in front.

This species somewhat resembles *C. concentrica* Jeff., which occurred, according to Mr. Jeffreys, in the same way, in *Teredo*-bored wood, associated with *C. spinigera* and *Idas argentea*. But *C. concentrica* is both figured and described by Mr. Jeffreys as destitute of radiating lines between the concentric ribs, while in our species the radiating lines are distinctly visible on all parts, even close to the extreme tip; therefore it is probable that they are distinct, though closely related, species.

Cocculina spinigera Jeffreys.

Proc. Zool. Soc. London, p. 393, pl. 44, figs. 1-1c. June, 1883.

Shell small, thin, rather depressed, with the outline pretty regularly elliptical; apex moderately elevated, small, acute, curved backward, but not distinctly incurved, unless at the extreme tip, situated at about the posterior third of the shell. The sculpture consists of numerous fine radiating lines, which are more or less obscured by extraneous growths, but appear to bear, each, a row of minute epidermal spines, as described by Mr. Jeffreys. In our specimen, however, the spines are mostly concealed by minute sponges, etc., which cover the whole surface of the shell. The animal appears to resemble closely that of the preceding species.

Station 997, N. lat. $39^{\circ} 42'$, W. long. $71^{\circ} 32'$, in 335 fathoms, 1881, in *Teredo*-bored wood (Nos. 38,091 and 38,095), fifteen living; station 2115, N. lat. $35^{\circ} 49' 30''$, W. long. $74^{\circ} 34' 45''$, in 843 fathoms (No. 38,094), one living specimen, 1883.

This is a somewhat doubtful species. Mr. W. H. Dall, to whom I sent some of my specimens, thought that they might be the young of *C. Beanii* Dall.

Cocculina Dalli Verrill, sp. nov.

Shell moderately elevated, with the front slope long and convex; the apex is small, acute, situated far back, nearly over the posterior margin, and not turned to either side; the posterior slope is abrupt and concave. Aperture broad oblong-elliptical, with the margin sharp and plain, muscular scars distinct. The sculpture consists, on the anterior half, of numerous well-marked but small, raised, radiat-

ing ribs, which are crossed by thin, raised, concentric lines of growth, so as to form a row of small granules or vaulted scales along each rib. Along the sides the ribs are fainter, and posteriorly they are nearly obsolete, while the concentric lines remain distinct. Color grayish white.

Length of aperture, 6^{mm}; breadth, 4.3^{mm}; height, 3^{mm}; length of anterior slope, 6^{mm}.

Station 1096, in 317 fathoms, N. lat. 39° 53', W. long. 69° 47', 1882; one specimen (No. 38,081).

This species resembles *C. Beanii* in form, but has very different sculpture.

Cocculina conica Verrill, sp. nov.

Shell very small, thin, translucent, white, rather high, conical, with a very broad-ovate or nearly round base and a prominent, sub-spirally twisted apex, which is turned strongly backward, and obliquely to the left. The sub-spiral apex is relatively rather large, and the extreme tip seems to have been deciduous. The anterior slope of the shell rises at first rather abruptly, and then becomes very convex, forming the central and highest part of the shell, from which it descends a little to the apex; the posterior slope is concave under the overhanging apex, and then descends with a short, abrupt slope to the margin, which extends back but little beyond the apex. The sculpture consists only of rather irregular, concentric raised lines of growth, which run sub-spirally on the upper portion of the shell.

The animal, in alcohol, has a nearly round foot and two small, slender, cylindrical tentacles, and is apparently without eyes.

Length and breadth, about 1^{mm}; height, about the same.

Station 2078, in 499 fathoms, N. lat. 41° 12' 50", W. long. 66° 12' 20".

Puncturella (Fissurisepta) eritmeta Verrill, sp. nov.

PLATE XXXII, FIGURES 19, 19a.

Shell small, thin, delicate, translucent white, glossy, moderately elevated, with the base between elliptical and ovate, somewhat narrowed anteriorly, having both ends evenly rounded and the sides somewhat compressed, but still moderately convex. The apex is minute, nearly central, compressed, turned backward, but scarcely incurved, and with the extreme tip smooth and glossy. The pore is very small, situated very close to the apex, and it appears to be divided by a slight transverse septum, across the middle. The

sculpture consists of very numerous radiating striæ, which are decussated by fine and close, raised, regularly concentric lines of growth of about the same size as the radii on the upper portion, where the shell is minutely cancellated, but on the lower part of the shell the concentric lines become larger and more distant, and have the form of regular raised cinguli; the intervals between these, which are two or three times as wide as the ridges, are crossed by the much finer and closer radiating lines, which do not produce a regular cancellated appearance on this part. Both the radiating and longitudinal lines are so fine as scarcely to be visible without a lens. Internally the surface is nearly smooth and lustrous, and the external sculpture shows through the substance of the shell. In the apex there is a minute transverse lamina, forming a small flattened tube.

The anterior slope of the shell, seen in profile, is broadly rounded; the posterior slope falls off abruptly at first, near the apex, and then slopes regularly to the posterior margin, with a nearly straight, or but slightly convex outline. The side-slopes are steep, regularly and slightly convex.

Length, 5^{mm}; breadth, 3^{mm}; height, 2^{mm}.

Station 2096, N. lat. 39° 22' 20", W. long. 70° 52' 20", in 1451 fathoms (No. 35,174). One living specimen.

The animal has well developed, moderately stout, blunt tentacles; frontal disc broad, semicircular, with the lateral angles prolonged backward.

***Propilidium elegans* Verrill, sp. nov.**

Shell small, very thin and fragile, translucent bluish white, rather depressed, elongated-elliptical, with the recurved apex situated at about the posterior third. The nuclear whorl is very minute, smooth, glassy, compressed, strongly involute and turned a little to the left, forming a complete whorl, visible in a side view. The whole surface, under the microscope, has the appearance of a very fine shagreen. This is produced by very minute, short, wavy, raised lines, which are mostly arranged in zigzag or in herring-bone style; in some parts the two sets of lines, running obliquely, cross each other at nearly right angles; on other portions one or both sets are replaced by minute punctations, or granulations. This sculpture is visible only under a strong lens or with the compound microscope.

The internal lamina or septum is narrow, crescent-shaped, situated behind and some little distance below the extreme apex, and not

forming an elongated channel; it is distinctly visible from the outside, owing to the translucency of the shell.

Length of shell, 3.5^{mm}; breadth, 2.5^{mm}; height, about 1^{mm}.

Station 2105, N. lat. 37° 50', W. long. 73° 03' 50", in 1395 fathoms (No. 38,072). Two specimens, living.

The animal has a short, broad-ovate foot, subtruncate in front, with the edge frilled. Frontal disk rather large, broad, semicircular or crescent-shaped, with the angles extending back in a large obtuse lobe on each side. Buccal area semicircular; mouth surrounded with four convex elevations, one before and one behind it, and one on each side. Tentacles slender, tapering, acute. Eyes apparently wanting. No cirri on mantle.

POLYPLACOPHORA.

Placophora (Euplacophora) Atlantica Verrill and Smith, MSS.

Verrill, Amer. Journ. Sci., vol. xxiv, p. 365, Nov., 1882.

PLATE XXX, FIGURES 1, 1a, 1b.

Outline broad-ovate. Marginal membrane very broad anteriorly and narrow posteriorly. It increases gradually from the posterior end to a point opposite the fifth plate, where it suddenly expands into a broad round front, with the breadth one-third greater than the greatest breadth of the shell, and projecting forward to a distance equal to one-half the length of the shell. The marginal membrane is thick, leathery, and scabrous, everywhere closely covered with minute spinules; the lower surface anteriorly shows many radiating grooves (not distinct in the smaller examples); between these are rows of slightly raised small verrucæ, covered with small spinules. The inner edge, or mantle-border, is sharply defined, enclosing an elliptical area around the head and gills, with a well-marked posterior sinus; its front edge is divided into about seven digitations, the anterior ones rather long, tapering, and tentacle-like, but coriaceous and covered with fine spinules, like the rest of the marginal membrane. Cephalic hood large, broad-lunate; foot relatively small, ovate. Gills numerous (in the largest about sixteen on each side), extending nearly the whole length (more than two-thirds) of the foot, but reaching neither end of it.

The shell is broad-ovate, slightly carinated in the middle; valves short, broad, the posterior ones decreasing rapidly in breadth, the last one very small. Anterior valve short, very broadly rounded in front; posterior edge with a very obtuse reëntrant angle and a

slight, rounded, median notch; the surface is marked with faint radiating grooves, and is uniformly covered with small rounded granules. The succeeding valves have their posterior border nearly straight, with a slightly projecting, obtuse, median beak, from which run well-marked, elevated, rounded diagonal ribs; the lateral areas are somewhat raised, with a depression next the ribs, and their surface is covered with small, low rounded granules, more distinct than those on the median areas, which appear nearly smooth to the naked eye, but are crossed by evident transverse lines of growth. The posterior valve has the posterior edge a little upturned, and slightly emarginate in the middle, with a submarginal, raised rib near the posterior margin above; the upper edge overhangs the lower lamina but slightly, or not at all, in the smaller specimens, with a deep groove between; the lower lamina is more deeply emarginate, in the middle, than the upper one, with wider laminae each side of the notch, but in the largest example the upper portion is divided into several laminae, and projects decidedly beyond the lower, while the notch is obsolete. (Perhaps this is due to injury during life.)

When detached, the inserted edges of the valves are very narrow, the front edge of the anterior valve is narrower than the upper, lamina thickened and divided into numerous (about thirty) small, rough and unequal denticles, which become obsolete near the lateral angles. The median plates have the lateral insertion plates small, truncate, not projecting beyond the upper lamina, with a well-marked groove between, and separated from the anterior insertion plates by a deep narrow notch, in line with the diagonal ribs; the anterior plates are broadly rounded, not very wide, separated by a rather wide rounded median notch.

Color of marginal membrane dull rusty or yellowish brown; shell grayish white, stained with brown.

Length of the largest specimen, in alcohol, 32^{mm}; its greatest breadth, 26^{mm}; length of shell, 21^{mm}; greatest breadth, 18^{mm}; length of anterior valve, 4^{mm}; its breadth, 15.5^{mm}; length of exposed part of 3d valve, 4^{mm}; of posterior valve, 4.7^{mm}; its breadth, 8^{mm}; extent of marginal membrane beyond the shell, anteriorly, 12^{mm}; length of foot, 12^{mm}; breadth of foot, 8^{mm}; length of head, 3^{mm}; breadth, 7^{mm}.

A small specimen is 21^{mm} long; breadth, 16^{mm}; expanse of membrane in front of shell, 6.5^{mm}; length of shell, 16^{mm}; its breadth, 13.5^{mm}

When living the marginal membrane was relatively broader.

Station 1124, N. lat. $40^{\circ} 01'$, W. long. $68^{\circ} 54'$, in 640 fathoms, off Nantucket Island, 1882; station 2067, N. lat. $42^{\circ} 15' 25''$, W. long. $65^{\circ} 48' 40''$, in 122 fathoms, 1883.

Trachydermon exaratus (G. O. Sars).

Lophyrus exaratus G. O. Sars, Moll. Reg. Arct. Norvegiæ, p. 113, pl. 8, figs. 1, a-k, pl. 11, fig. 1 (dentition.)

Trachydermon exaratus Verrill, Amer. Journ. Sci., vol. xxiv, p. 365, Nov., 1882.

PLATE XXX, FIGURES 2, 2a, 2b.

Elongated, oblong-elliptical, strongly convex; valves distinctly obtusely carinated medially. Anterior valve nearly semi-circular in front; the posterior edge forming an obtuse reëntrant angle, with a rounded notch in the middle; surface distinctly radially grooved with single rows of rounded granules between the grooves, becoming larger toward the margin.

Median valves are moderately wide, nearly straight posteriorly, the hinder ones with a slight median beak with distinct diagonal furrows and ridges, dividing them into median and lateral areas; the median areas are covered, on the sides, with fine but very distinct longitudinal grooves, with the intervening ridges narrow and rounded, more or less confluent and broken up into granules, near the diagonal lines, toward the median ridge becoming finer and irregular, and finely granulous anteriorly and along the carina. The lateral areas are more elevated and covered with stronger radiating ridges, broken up into oblong and rounded, flattened granules, and separated by narrow radial furrows. The lateral insertion-plates of the median valves project but little beyond the upper lamina; they are subtruncate, with a thin notch or slit corresponding to the diagonal line above. The posterior valve is transversely elliptical, with the posterior edge evenly rounded; the front area as in the preceding ones; the posterior area is covered with fine radial and concentric grooves, dividing it into radiating rows of small rounded granules; the articulating plates of its front edge are rather wide, broadly rounded or subtruncate, and separated by a broad, rounded median sinus; posteriorly the inner surface is marked by about sixteen radiating lines, terminating in thin notches of the inserted edge, which is very narrow and simple.

The marginal membrane is rather narrow and covered with rather stout, prominent, oblong and obtuse spinules, regularly arranged in quincunx, their ends looking like granules; at the edge and on the lower side these are replaced by small, slender spinules.

Head rounded; hood large, the sides produced backward into rounded lobes. Foot long and rather narrow. Gills about twenty-four on each side, extending from the posterior end of the foot to about its anterior third.

Length, 17^{mm}; breadth, 8^{mm}; height, 5.5^{mm}; length of shell, 15.5^{mm}; breadth, 7^{mm}; length of 1st valve, 3^{mm}; breadth, 6^{mm}; length of 3d valve, exposed part, 2^{mm}; breadth, 7^{mm}; length of posterior valve, 3.5^{mm}; breadth, 6^{mm}.

Station 1120, in 194 fathoms, off Martha's Vineyard, 1882; station 2069, in 101 fathoms, N. lat. 41° 54' 50", W. long. 65° 48' 35", 1883.

This species is readily distinguished from *T. albus* by the very distinct differentiation of the valves into median and lateral areas, having lines of sculpture running in different directions, and by the much coarser granulation of their surfaces. In *T. albus* there are no distinct lateral areas; the radiating grooves and ridges are absent; and the granulation is so fine and obscure as to be scarcely visible without a lens. The spinulation of the marginal membrane is similar in the two species.

TECTIBRANCHIATA.

Scaphander nobilis Verrill, sp. nov.

PLATE XXXII, FIGURES 18, 18a, 18b, 18c, 18d.

Shell large, swollen, stout, broad-ovate in outline, thin, translucent, and of an exceedingly delicate texture. The body-whorl is very large in proportion to the rest of the shell. The aperture is large, broad-ovate in the anterior part, narrowed and curved posteriorly, extending to the apex of the shell, where it terminates in a notch, the outer lip extending back considerably beyond the notch. The aperture is much encroached upon by the convexity of the body-whorl, but about the middle the inner lip is strongly excavated and forms a broad and somewhat sinuous curve; the outer lip is very broadly and evenly rounded throughout most of its extent; anteriorly the curvature forms the arc of a circle; posteriorly it extends back beyond the apex of the shell in the form of an obtuse and slightly everted process, with its posterior margin concave, somewhat sinuous and spiral, and a little thickened. The surface is smooth and polished, somewhat shining, and everywhere covered by spiral lines formed by series of oblong dots, which are decidedly sunken below the surface, and separated by intervals about equal to or less than

their own length. The spiral lines are unequal in fineness, the broader ones alternating with finer ones in which the dots are very narrow; the intervals between the spiral lines are also variable in breadth. None of the specimens appear to have a distinct epidermis.

Length of shell to apex of one of the largest specimens, 35^{mm}; breadth, 25^{mm}; length of aperture, 37^{mm}; greatest breadth of aperture, 18^{mm}.

Off Martha's Vineyard, at stations 2052, in 1098 fathoms; 2074, in 1309 fathoms; 2076, in 906 fathoms; 2077, in 1255 fathoms; off Delaware Bay, stations 2102, in 1209 fathoms; and 2103, in 1091 fathoms (No. 35,374). It was most common at station 2102, N. lat. 38° 44', W. long. 72° 38', in 1209 fathoms, where thirteen specimens were taken, ten of them living (No. 35,641).

This species bears some resemblance to *S. punctostriatus* (Migh.) H. and A. Ad., but is much thinner, with a far more delicate texture. Its form is much shorter and more swollen in the middle, and the spiral lines are less numerous, with wider intervals, and have the punctations larger and not so close together, giving a much smoother appearance to the surface, although the punctate character is quite as evident. The aperture is also much broader, especially in its anterior half, while the body-whorl projects into it much more strongly. The inner lip is much thinner and shows only a slightly thickened fold along the columella-margin. Posteriorly the shell is not at all narrowed, but is evenly rounded instead of being pinched up as in *S. punctostriatus*. The posterior process of the outer lip is more flaring, and extends farther backward beyond the apex. The apex of the shell is nearly plain and smooth, though sometimes slightly indented, and does not have a thickened deposit of enamel extending beyond the edge of the notch, as in the latter.

Actæon melampoides Dall.

Bull. Mus. Comp. Zool., vol. ix, p. 95, 1881.

Station 2115, off Cape Hatteras, in 843 fathoms, one specimen (No. 35,565).

The original specimens, described by Mr. Dall, were from the Gulf of Mexico, in 310 fathoms, Blake Expedition. I have compared our example with Mr. Dall's specimens.

HETEROPODA.

Atlanta inclinata Souleyet.

Souleyet, *Voy. de la Bonite*, vol. ii, p. 375, atlas, pl. 19, figs. 9-15, 1852.

Station 2084, N. lat. $40^{\circ} 16' 50''$, W. long. $67^{\circ} 05' 15''$, at the surface, one living specimen (No. 38,227); station 2110, N. lat. $35^{\circ} 12' 10''$, W. long. $74^{\circ} 57' 15''$, three dead specimens (No. 35,493); station 2115, N. lat. $39^{\circ} 49' 30''$, W. long. $74^{\circ} 34' 45''$, one dead specimen (No. 38,316).

According to Souleyet, this species is found both in the Atlantic and Pacific Oceans.

Atlanta rosea Souleyet.

Souleyet, *Voy. de la Bonite*, vol. ii, p. 377, atlas, pl. 19, figs. 16-20, 1852.

Station 2084, with the preceding, one living specimen (No. 35,180); and station 2099, N. lat. $37^{\circ} 12' 20''$, W. long. $69^{\circ} 39'$, at the surface. One living specimen (No. 38,258).

This species is more common in the warmer parts of the Atlantic.

Atlanta Gaudichaudii Eydoux and Souleyet.

Voyage de la Bonite, Zool., vol. ii, p. 379, atlas, pl. 19, figs. 29-34, 1852.

Station 2038, N. lat. $38^{\circ} 30' 30''$, W. long. $69^{\circ} 08' 25''$, four living specimens (No. 38,372); station 2046, N. lat. $40^{\circ} 02' 49''$, W. long. $68^{\circ} 49'$, two living (No. 38,273); station 2100, N. lat. $39^{\circ} 22'$, W. long. $68^{\circ} 34' 30''$, two living (No. 38,369).

Atlanta Lamanonii Eydoux and Souleyet.

Voyage de la Bonite, Zool., vol. ii, p. 371, atlas, pl. 18, figs. 30-37, 1852.

Station 2037, N. lat. $38^{\circ} 53'$, W. long. $69^{\circ} 23' 30''$, one dead specimen (No. 38,366). A single dead specimen is referred to this species with some doubt, although it agrees pretty closely with the description and figures referred to.

Atlanta pulchella Verrill, sp. nov.

Shell minute, composed of about four whorls, very thin, transparent and lustrous, compressed, with a rather high, exceedingly thin keel, commencing just back of the notch of the aperture and extending around rather more than half the circumference of the last whorl.

The spire is small, scarcely oblique, slightly elevated, its apex not rising above the level of the last whorl. Suture of the last whorl, well marked. The umbilicus is small, and shows within it only about one and a half whorls. The extreme apex is smooth, but the succeeding two or three whorls are covered with four or five well marked, revolving lines, which fade out on the penultimate whorl. The last whorl, which constitutes the greater part of the shell, is a little inflated on the ventral side, with the sides slightly convex and the dorsal portion compressed; its surface is polished and marked by faint lines of growth, and sometimes shows faint, microscopic, spiral lines on the left side. The aperture is narrow-ovate, acute above and rounded below. The notch is rather wide and moderately deep.

Color, transparent white, with a faint, chestnut-brown, sutural line. In alcohol the animal shows several very distinct black spots.

Diameter, about 1.25^{mm}.

Taken in abundance, from the surface, at station 2100, off Delaware Bay, N. lat. 39° 22', W. long. 68° 34' 30", October 3rd, 1883 (No. 38,397), with the temperature of the surface water 69° F.; and in smaller numbers at station 2038, N. lat. 38° 30' 30", W. long. 69° 08' 25", July 26th, 1883 (No. 38,410), temperature of the surface water 76.5° F.

This minute shell is easily distinguished from our other species by its compressed form, with closely coiled whorls and small, erect spire, and especially by the distinct spiral sculpture of the earlier whorls. It appears to be the most abundant species off our northern coast.

Firola Keraudrenii Eydoux and Souleyet.

Voyage de la Bonite, Zool., vol. ii, p. 349, atlas, pl. 16, figs. 8-10, 1852.

Station 2038, N. lat. 38° 30' 30", W. long. 69° 08' 25", twenty-five living; station 2039, N. lat. 38° 19' 26", W. long. 68° 20' 20", five living. Also at other stations, usually in company with *Sagitta*.

PTEROPODA.

Cavolina quadridentata (Les.)

Hyalea quadridentata Rang and Souleyet, Hist. Nat. Moll. Pteropodes, p. 39, pl. 3, figs. 13-15.

Souleyet, Voy. de la Bonite, vol. ii, p. 147, atlas, pl. 4, figs. 25-32, 1852.

Station 2043, N. lat. 39° 49', West long. 68° 28' 30", (No. 34,878); station 2084, N. lat. 40° 16' 50", W. long. 67° 05' 15", (No. 38,260); and station 2109, N. lat. 35° 14' 20", W. long. 74° 59' 10", (No. 38,252).

Cavolina angulata (Souleyet.)

Hyalea angulata Souleyet, Voy. de la Bonite, vol. ii, p. 152, atlas, pl. 5, figs. 1-6, 1852.

Rang and Souleyet, Hist. Nat. Moll. Pteropodes, p. 42, pl. 12, figs. 3-4.

Station 2038, N. lat. $38^{\circ} 30' 30''$, W. long. $69^{\circ} 08' 25''$; one living specimen, (No. 38,251.)

Cavolina gibbosa (Rang.)

Hyalea gibbosa Rang and Souleyet, Hist. Nat. Moll. Pteropodes, p. 38, pl. 10, figs. 3, 4.

Souleyet, Voyage de la Bonite, p. 144, atlas, pl. 4, figs. 13-19, 1852.

Hyalea flava D'Orbigny, Voy., vol. v, p. 97, pl. 5, figs. 21-25, (t. Souleyet et.)

Dead specimens of this species occurred at stations 1154, 2052, 2096, 2115. The most northern was 1154, N. lat. $39^{\circ} 55' 31''$, W. long. $70^{\circ} 39'$, 1882.

Styliola subulata (Quoy and Gaimard.)

Cleodora subulata Quoy and Gaimard, Ann. des sc. nat., vol. x, p. 233, pl. 8, figs. 1-3.

Crescis spinifera Rang, Ann. des sc. nat., vol. xiii, p. 314, pl. 17, fig. 1.

Cleodora subulata Rang and Souleyet, Hist. Nat. Moll. Pteropodes, p. 55, pl. 6, figs. 2-6.

Cleodora subulata Souleyet, Voy. de la Bonite, vol. ii, p. 192, atlas, pl. 8, figs. 5-9, 1852.

Station 2039, N. lat. $38^{\circ} 19' 26''$, W. long. $68^{\circ} 20' 20''$, four living specimens (No. 35,151); station 2043, N. lat. $39^{\circ} 49'$, W. long. $68^{\circ} 28' 30''$, five specimens (No. 35,154); station 2108, N. lat. $35^{\circ} 16'$, W. long. $75^{\circ} 02' 30''$, one specimen; also at stations 2109 and 2115, off Cape Hatteras.

This species is common in the tropical parts of the Atlantic and in the Mediterranean.

Styliola virgula (Rang.)

Cleodora virgula Rang, Ann. des sc. nat., vol. xiii, p. 316, pl. 17, fig. 2.

Cleodora virgula Rang and Souleyet, Hist. Nat. Moll. Pteropodes, p. 57, pl. 6, fig. 2, pl. 13, figs. 20-24.

Souleyet, Voy. de la Bonite, vol. ii, p. 196, atlas, pl. 8, figs. 18-25, 1852.

Station 2038, N. lat. $38^{\circ} 30' 30''$, W. long. $69^{\circ} 08' 25''$, three living specimens (No. 38,236); station 2039, N. lat. $38^{\circ} 19' 26''$, W. long. $68^{\circ} 20' 20''$, five living specimens (No. 38,250); station 2099, N. lat.

37° 12' 20", W. long. 69° 39', one living specimen (No. 38,233); station 2100, N. lat. 39° 22', W. long. 68° 34' 30", eleven living specimens (No. 38,243).

Styliola virgula, var. **corniformis** (D'Orb.)

Hyalaea corniformis D'Orb., Voy., vol. v, p. 120, pl. 8, figs. 20-23, (t. Souleyet).

Cleodora virgula, var., Rang and Souleyet, Hist. Nat. Moll. Ptéropodes, p. 57, pl. 13, fig. 22.

Cleodora virgula, var., Souleyet, Voy. de la Bonite, atlas, pl. 8, fig. 24, 1852.

This shell is very similar to the preceding, except that the posterior part is strongly curved to one side.

Living specimens occurred at stations 2039 and 2100, with the normal form, as given above.

Triptera columnella (Rang.)

Cuvieria columnella Rang, Ann. des sc. nat., vol. xii, p. 323, pl. 45, figs. 1-8.

Rang and Souleyet, Hist. Nat. des Moll. Ptéropodes, p. 59, pl. 4, figs. 1-11, and plate 14, figs. 1-6, 1852.

Station 947, off Martha's Vineyard 89 miles, one dead specimen (No. 38,196), 1880; station 1095, N. lat. 39° 55' 28", W. long. 69° 47', one dead specimen (No. 38,163), 1882. Dead specimens were also dredged at stations 2041, 2043, 2084, 2096, 2109, 2110 and 2115. At the last named locality, off Cape Hatteras, twenty specimens occurred (No. 35,614). The most northern station was 2084, N. lat. 40° 16' 50", W. long. 67° 05' 15', where four specimens were taken. It is common in the tropical parts of the Atlantic.

Spirialis trochiformis Souleyet.

Atlanta trochiformis D'Orb., Voy., p. 177, pl. 12, figs. 29-31, (t. Souleyet).

Spirialis trochiformis Souleyet, Rev. Zool., p. 239; Voy. de la Bonite, vol. ii, p. 223, atlas, pl. 13, figs. 27-34, 1852.

Rang and Souleyet, Hist. Nat. Moll. Ptéropodes, p. 64, pl. 14, figs. 27-31.

Station 2100, N. lat. 39° 22', W. long. 68° 34' 30", at the surface, numerous living specimens, (No. 35,222).

This species is common throughout the warmer parts of the Atlantic. It is particularly abundant in the Gulf Stream, off the coast of Florida.

Spiralis bulimoides Souleyet.

Atlanta bulimoides D'Orb., Voy., p. 179, pl. 12, figs. 36-38.

Spiralis bulimoides Souleyet, Rev. Zool., p. 138; Voy. de la Bonite, vol. ii, p. 224, atlas, pl. 13, figs. 35-42, 1852.

Rang and Souleyet, Hist. Nat. Moll. Ptéropodes, p. 64, pl. 15, figs. 3-4.

Station 2100, N. lat. $39^{\circ} 22'$, W. long. $68^{\circ} 34' 30''$, at the surface, eight living specimens (No. 38,235).

This species occurs abundantly in all the tropical parts of the Atlantic, but has not previously been observed so far north, off the American coast.

Clione longicaudatus Souleyet.

Souleyet, Voyage de la Bonite, Zool., vol. ii, p. 286, atlas, pl. 14, figs. 17-21, 1852.

Rang and Souleyet, Hist. Nat. Moll. Ptéropodes, p. 80, pl. 15, figs. 28-32, 1852.

Station 2100, N. lat. $39^{\circ} 22'$, W. long. $68^{\circ} 34' 30''$, off Delaware Bay, eight living specimens (No. 38,367).

Trichocyclus Dumereilii (Oken) Esch.

Chenu, Man. Conch., i, p. 117, fig. 514.

Station 2100, N. lat. $39^{\circ} 22'$, W. long. $68^{\circ} 34' 30''$, off Delaware Bay, four living specimens (No. 38,379).

SCAPHOPODA.

Dentalium solidum Verrill, sp. nov.

Shell large, robust, thick and strong. Posterior third pretty regularly curved, but only moderately so; anterior half nearly straight, the amount of curvature varying in different individuals. Anterior aperture large, circular, moderately oblique, with the edge, when perfect, plain, thin and sharp, the shell rapidly increasing in thickness farther back, in the posterior half becoming very thick and solid. Posterior end tapering to a small extremity, the opening, when perfect, small, pear-shaped, with a moderately deep notch on the dorsal side and a shallower and more rounded one beneath. Surface, in perfect specimens, somewhat glossy, but covered with numerous close, very distinct, oblique lines of growth; the posterior half is also marked by shallow longitudinal striations, or small impressed grooves, which are separated by intervals usually much wider than the grooves, but variable in width, with the margins of the grooves well rounded; at about the middle of the shell these lines become

faint, or entirely disappear, though a part of them sometimes continue to the anterior end, where they are distant and appear only as slightly indented furrows or depressions; at about the posterior third the number of grooves varies from twenty to forty.

Color, usually grayish or slaty brown externally, bluish white within; more perfectly grown and younger specimens are white on the anterior portion and only faintly bluish white within.

Length of an average specimen, 82^{mm}; diameter, at the anterior end, 10^{mm}; at the posterior end, 2^{mm}. A more slender specimen is 75^{mm} long; diameter of the oral end, 9^{mm}; of the posterior end 1.4^{mm}.

This species was taken in considerable numbers at numerous stations by the Albatross. Station 2050, in 1050 fathoms; 2052, in 1098 fathoms; 2077, in 1255 fathoms, numerous specimens, living and dead (No. 34,904); 2083, in 959 fathoms, two specimens (No. 34,687); 2084, in 1290 fathoms, numerous specimens, living and dead (No. 34,911 and No. 34,688); 2102, in 1209 fathoms, one specimen; 2103, in 1091 fathoms, numerous living specimens (No. 35,636); 2104, in 991 fathoms, two dead; and off Cape Hatteras, at station 2111, in 938 fathoms, numerous living specimens (No. 35,635); 2115, in 843 fathoms, one fine specimen (No. 35,645).

This fine large species might readily be taken for a gigantic form of *D. striolatum* or *D. occidentale*. It is, however, a much stouter shell than either of these, of a thicker and firmer substance, and with a relatively larger aperture. It differs also in the character of the longitudinal sculpture. In *D. occidentale* the longitudinal grooves are more numerous, broader and deeper, having more the character of true furrows, with the intervening ridges mostly narrower than the grooves, from which they rise rather abruptly, with well-defined border, while in the present form the grooves are merely depressions in the general surface of the shell, with indefinite borders.

In *D. striolatum* the longitudinal sculpture is almost obsolete, except near the posterior end; and such lines as exist have the same character as in *D. occidentale*, though fainter, the two forms possibly being only varieties of one species. The most perfect specimens of *D. solidum* have also two posterior notches, while in *D. striolatum* there is usually a single notch on the dorsal side, but the character of the posterior aperture seems to be variable in most of the species of this group.

Dentalium occidentale, var. **sulcatum**, nov.

Shell of moderate size, thin, translucent white tinged with very pale yellowish or bluish, moderately curved, more decidedly behind the middle, tapering regularly and rather rapidly from the anterior to the very slender posterior end. The entire surface is covered by well marked, nearly regular, narrow raised ribs with nearly perpendicular sides and rounded summits, separated by well-defined, strongly marked, concave grooves, which are about twice the width of the ribs anteriorly, but posteriorly are of about the same width. The ribs and furrows show on the interior of the shell within the aperture, in reverse, the whole thickness of the shell conforming to the sculpture as if they were corrugations of its substance. The oral aperture is relatively large and circular, very little oblique, and usually with the very thin edge more or less broken. Posterior aperture very small, usually plain and without any notches, but in one of the most perfect specimens it has a slight lateral notch on each side; in others there is a small dorsal notch.

Length of one of the largest specimens, 20^{mm}; diameter at the anterior end, 3^{mm}; at the posterior end, .6^{mm}. Some specimens are slightly more slender than the one measured.

Station 2076, in 906 fathoms, one living specimen; station 2077, in 1255 fathoms, four living (No. 35,093), and station 2079, in 75 fathoms, one living specimen.

This variety resembles *D. candidum* Jeffreys in its form and longitudinal sculpture, but lacks the transverse lines between the ribs; the posterior end is also more slender and more curved than shown in his figure. It also closely resembles some young specimens of the typical *D. occidentale*, but the latter has not so strongly marked and regular ribs and grooves, nor does the sculpture extend entirely through the thickness of the shell so as to appear on the inside, as in the present form. Specimens often occur, however, that are evidently intermediate between the two forms, in the character of the sculpture and thickness of the shell.

Dentalium, sp. g.

Shell small, very slender, considerably curved. Surface covered with very numerous, regular, microscopic, longitudinal lines, separated by narrower striae. Anterior aperture circular, slightly oblique. Posterior aperture very small, squarely truncated in one specimen, oblique in the other, without any slit.

Length of the largest example, 6^{mm}; diameter of the oral end, .8^{mm}; posterior end, .3^{mm}.

Station 2037, in 1731 fathoms; and station 2038, in 2033 fathoms (No. 35,142).

These specimens are probably young, but differ from all of our recognized species in the peculiar sculpture, in the form of regular, microscopic, longitudinal striae. They may, however, prove to be the young of *D. capillosum* J., which we have not yet recognized among the specimens dredged on our coast. There is, also, a slender shallow-water species, from off Cape Hatteras, which has, when young, similar fine striations, but the lines are not so numerous and the shell is straighter.

Dentalium, sp. h.

Shell small, slender, nearly straight, or very gently curved. The sculpture consists of fifteen to twenty narrow, elevated, angular ribs, which diminish in size posteriorly and become nearly obsolete near the tip; anteriorly they are separated by much broader, clearly defined, concave grooves, the sculpture showing in reverse on the interior surface. Oral aperture circular, somewhat oblique. Posterior opening small, circular, squarely truncated.

Length, 15^{mm}; diameter at the oral end, 1.5^{mm}; at the posterior end, .8^{mm}.

Station 2038, in 2033 fathoms, three specimens (No. 35,165). One specimen, differing from those described in being more slender and having more numerous and finer longitudinal ribs, was taken at station 2115, in 843 fathoms.

These specimens are probably the young of one of the larger species. They resemble the young of some of the varieties of *D. occidentale*, except that they are more slender and straighter. It is not improbable, however, that they may prove to be forms of that variable species.

Siphodentalium teres Jeffreys.

Jeffreys, Proc. Zool. Soc. London, for 1882, p. 661, pl. 49, fig. 5.

Station 2072, in 858 fathoms (No. 38,088); station 2084, in 1290 fathoms (No. 38,084); and station 2115, off Cape Hatteras, in 843 fathoms (No. 35,625).

It was taken off the coast of Europe by the Porcupine Expedition, in 1870.

Cadulus grandis Verrill, sp. nov.

General appearance of the shell much like that of *C. Pandionis*, but more than twice as large, without the abrupt bulging at the largest part, which is a characteristic feature of the latter, and with a relatively larger posterior aperture.

The shell is, for the genus, large and strong, translucent bluish white when living, milk-white when dead, with a highly polished surface, only faintly marked by the lines of growth when perfect. The shell is moderately curved, the greater part of the curvature being behind the middle, and is largest at about the anterior third, the decrease being very gentle and regular in both directions, but a little more rapid towards the anterior end. The dorsal side is a little flattened towards the aperture, which is decidedly oblique and very broad-elliptical. The posterior aperture is relatively rather large, circular, with the edge a little thickened and divided into four rounded notches, the two upper ones being usually a little deeper and farther apart than the two ventral ones.

Length of one of the largest examples, 15^{mm}; greatest diameter, 3.5^{mm}; transverse diameter of the oral end, 3^{mm}; vertical diameter, 2.5^{mm}; diameter of the posterior end, 1.3^{mm}. Some specimens exceed these dimensions.

This species occurred at station 2052, in 1098 fathoms; station 2076, in 906 fathoms, sixteen specimens, mostly living (No. 34,735); station 2084, in 1290 fathoms, three specimens (No. 35,184); station 2103, in 1091 fathoms, one specimen; station 2111, in 938 fathoms, one dead specimen; station 2115, in 843 fathoms, six dead specimens. From station 2043, in 1467 fathoms, one large malformed specimen occurred, apparently belonging to this species (No. 38,116).

This species might readily be mistaken for a large form of *C. Pandionis*, but it differs from the latter in having a larger posterior aperture, a more nearly circular oral aperture, and especially in the absence of the abrupt bulging at the largest part. The form is usually less curved, although in this respect both species are somewhat variable. This shell is, however, much thicker and in every way more robust.

Cadulus Watsoni Dall.

Dall, Bull. Mus. Comp. Zool., vol. ix, p. 34, 1881.

The specimens referred to this species resemble, in size and general character, *C. Pandionis*, and, like that species, have the mouth

decidedly oblique and slightly elliptical, though somewhat more nearly circular than in the latter. The posterior portion is somewhat less tapered and has the terminal opening a little larger. Its border, when perfect, is usually furnished with four shallow notches, the two nearest the dorsal side being somewhat larger than the others. The most marked distinction is in the more gently tapered form and in the absence of any distinct gibbosity or swelling at the widest portion, the decrease in size being very gradual toward both ends, while in *C. Pandionis* the widest portion forms a somewhat abrupt enlargement, often amounting to a slight rounded angle when seen in a dorsal view. This feature, with its smoothness, renders it somewhat difficult to pick up fresh and moist specimens of the latter with forceps. Both species differ considerably in the amount of the curvature of the posterior part of the shell.

One of our larger specimens is 11^{mm} long; greatest diameter, 2·1^{mm}; transverse diameter at the anterior end, 1·9; diameter at the posterior end ·9^{mm}.

This species occurred at station 2048, in 547 fathoms, eight living specimens (No. 34,814); station 2092, in 197 fathoms, nine specimens (No. 38,122); and off Cape Hatteras, at station 2111, in 938 fathoms, one specimen (No. 35,765); and station 2115, in 843 fathoms, thirty-six specimens (No. 35,623).

This species is also closely related to a shallow-water species taken in abundance by the Albatross, off Cape Hatteras, in 14 to 48 fathoms. The latter is, however, a smaller species, with a more slender posterior portion and a perfectly circular aperture.

Cadulus cylindratus Jeffreys.

Jeffreys, Ann. Mag. Nat. Hist., February, 1877, p. 158; Proc. Zool. Soc. London, for 1882, p. 664, pl. 49, fig. 6.

The few specimens referred to this species show some variation in form, some being decidedly curved, others only very slightly so. The shell tapers very slightly from the middle toward both ends, which are very nearly equal in size, circular, and scarcely contracted. The oral aperture is slightly oblique. The posterior opening, in our specimens, is finely and irregularly notched, probably accidentally.

Length, 7·3^{mm}; greatest diameter, 1·7^{mm}; diameter of the oral end, 1·4^{mm}; posterior end the same.

Station 2041, in 1608 fathoms, three specimens (No. 38,030).

Off the coast of Europe, it was taken at several localities by the

Porcupine and Valorous Expeditions, and in the Bay of Biscay by the Travailleur Expeditions. It has occurred at depths ranging from 652 to 1450 fathoms.

LAMELLIBRANCHIATA.

Thracia nitida Verrill, sp. nov.

PLATE XXXII, FIGURE 22.

Shell thin, tumid, broad-ovate, gaping considerably posteriorly and slightly anteriorly. Umbos prominent, situated in advance of the middle, with the beaks strongly incurved and turned forward, leaving a broad, depressed, cordate lunular area, which is not defined by any definite boundary. The posterior dorsal margin descends slightly; the posterior margin is slightly prolonged and bluntly rounded; the ventral margin is broadly curved, becoming nearly straight in the middle; the anterior margin is obliquely rounded. The surface is nearly smooth, shining, and iridescent, marked with inconspicuous lines of growth, and covered with very minute, regularly scattered granule-like elevations, each of which bears a minute hair-like process, when not rubbed; towards the posterior end these are more numerous and conspicuous, and are arranged in regular delicate radiating lines, but over the greater part of the shell they are scarcely visible to the naked eye. Epidermis very thin, greenish yellow. Hinge-margin slender, somewhat thickened along the ligamental groove, and with a slight notch anteriorly for the reception of the minute cartilage. No ossicle was detected in the alcoholic specimen. Pallial and muscular impressions faint.

Length, 21^{mm}; height, 18^{mm}; thickness, 14^{mm}.

The animal has a circle of sixteen large, tapered, acute tentacles around the common base of the siphons, which are brown in alcohol. The efferent tube is somewhat prolonged in the contracted specimen, but the other is entirely withdrawn.

Station 2097, off Chesapeake Bay, in 1917 fathoms (No. 35,267).

Poromya sublevis Verrill, sp. nov.

PLATE XXXII, FIGURE 21.

Shell rather large for the genus, short, high, tumid, with prominent umbos and large beaks, which are curved inward and forward. The length of the shell is considerably less than the height from the beak to the ventral margin. Anteriorly the lunular region is large and some-

what excavated, rather indistinctly defined by feeble undulations. The anterior end is short, very obtusely rounded or subtruncate; the ventral margin is broadly rounded, slightly obliquely produced a little behind the middle, forming there a scarcely distinct, rounded angle, from which a posterior, ill defined, rounded ridge runs up to the beak; posterior end very obtusely rounded and somewhat oblique; posterior dorsal margin descending rapidly from the beak and slightly convex. Surface nearly smooth to the naked eye and covered with a very thin, pale yellowish epidermis; under a lens the whole surface, except on the umbos, is covered with very slight, rather distinct radiating lines of very minute pointed granules, which are pretty evenly spaced along the lines, rather distantly on the middle area of the shell, but becoming much more numerous toward the posterior end, where they are connected by distinct but very fine raised lines, which appear to be chiefly epidermal; one line, more distinct and more elevated than the rest, runs from behind the beak to the upper part of the posterior margin, defining a narrow posterior dorsal area. The minute granules scattered over the surface appear to be chiefly due to the epidermis, but where the surface is somewhat rubbed they still appear as minute specks, which become very fine and irregularly scattered on the umbos; where most perfect, each granule is surmounted by a minute sharp process of the epidermis. The margin is sharp and plain, with a thickened interior ridge a short distance within the edge. The hinge consists of a large, stout, obtuse tooth, just below the beak, which projects considerably inward and is divided at the summit into three low, rounded lobes or cusps, of which the most interior is the largest and most prominent, while the outermost is confluent with the lunular margin; a supporting ridge runs from the inner margin of the tooth both forward and backward to the margins; posteriorly, between this ridge and the margin, there is a very narrow and long, curved ligamental groove, running forward and terminating just under the beak above the center of the large tooth; a small, divergent, somewhat raised ridge-like process, grooved on top, intervenes between the anterior part of the ligamental furrow and the principal tooth. The inner surface of the shell is opaque white, and marked with slight irregular lines and grooves and with feeble undulations parallel with the lines of growth. Externally the shell is white beneath the thin, pale yellow epidermis.

Length, 13.5^{mm}; transverse breadth, 6^{mm}; height, from apex to ventral margin, 14.5^{mm}.

Station 2097, N. lat. 37° 56' 20", W. long. 70° 57' 30", in 1917 fathoms (No. 35,263), one dead but fresh specimen.

This species is very distinct from *P. granulata* and *P. rotundata* Jeff., both in form and in the character of the surface, which in both the latter forms is covered with comparatively large, rounded granules or small pustules, often closely crowded together, while in this species the granules are almost microscopic in size and separated by comparatively wide intervals, or they even appear remotely scattered on some parts, so that the shell presents a nearly smooth appearance to the naked eye, or when moderately magnified, which is strongly in contrast with both the other described forms. The form of the shell in this species is also much shorter and more tumid, with higher umbos and more prominent beaks. The character of the hinge, however, agrees pretty closely with that of *P. granulata*, but the tooth is larger and stronger.

Neæra undata Verrill, sp. nov.

A large species remarkable for its short broad form, its abbreviated siphon and the undulated character of the surface. Shell broad-ovate, not much swollen, with the beaks not far from the middle. The posterior dorsal margin descends rapidly in a nearly straight line; the posterior end is broadly, obtusely truncated and only slightly prolonged; the ventral margin is very broadly curved; the posterior margin less broadly rounded. The surface, especially anteriorly, is covered with undulations formed by narrow, raised, subtriangular ridges separated by rather wide, shallow, concave intervals, much as in most species of *Astarte*. These fade out, more or less, posteriorly and toward the ventral margin, where they are replaced by regular, concentric, raised lines. Hinge-margin of the right valve moderately thick. The cartilage-pit is not very large, descending, directed obliquely backward. Posterior lateral tooth is not very prominent, having the form of an elongated, thickened ridge, its most prominent point only a short distance back of the cartilage.

Length, 24^{mm}; height, 18^{mm}; thickness, 13^{mm}.

Station 2098, off Chesapeake Bay, in 2221 fathoms. A single valve, considerably broken, (No. 35,256).

Neæra gigantea Verrill, sp. nov.

Shell very large, thick and opaque, short, stout, with prominent umbos, and short, wide beak, with the muscular scars and pallial lines deeply sunken. The shell is swollen and broadly rounded in front, with the ventral edge broadly rounded, narrowing gradually to the

beak, which is scarcely differentiated from the ventral line of the shell. The beak is very short and broad, rapidly narrowing to the blunt tip, which is a little bent to one side; the dorsal line, behind the beaks, is nearly straight, sloping pretty regularly to the beak. The umbos are large, prominent, swollen, strongly incurved and turned somewhat backward. The cartilage-pit is of moderate size, ovate, and directed obliquely backward, its posterior border adherent to the posterior hinge-border, while its inner and anterior edges are more or less free. Lateral tooth apparently but little developed, but the left valve has the anterior hinge-line broken. There is a notch in the edge of the shell opposite the cartilage-pit, in each valve. The sculpture consists only of irregular, concentric, raised lines or ridges, most of which are not continuous; these become strong or more irregular on the beak; they are often crossed very obliquely by the finer, raised lines of growth.

Length, about 38^{mm}; height, about 26^{mm}; transverse breadth, 16^{mm}.

Station 2097, off Chesapeake Bay, in 1917 fathoms, (No. 35,255).

The only specimen obtained consists of both valves, but neither is entire, so that the measurements cannot be accurately made. In these the shell is remarkably thickened by a calcareous deposit on the inside of the shell, so that all the muscular scars appear as sunken pits; this great thickening of the shell, however, may be abnormal. This shell appears to be larger and more massive than any known species. It is remarkable for its short, swollen form, and short, broad beak. It has no radial sculpture.

Abra longicallis (Scacchi).

Tellina longicallis Scacchi, Not., p. 16, pl. 1, fig. 7, (t. Dall).

Abra longicallis G. O. Sars, Moll. Reg. Arct. Norvegiae, p. 74, pl. 6, fig. 3; pl. 20, fig. 4, 1878.

Syndosmya longicallis Dall, Bull. Mus. Comp. Zool., ix, p. 133.

Scrobicularia longicallis Jeffreys, Proc. Zool. Soc. London, for 1884, p. 145.

Station 2043, N. lat. 39° 49', W. long. 68° 29' 30", in 1467 fathoms, one valve.

The specimen referred to, I have compared with those taken by the "Blake" in the Gulf of Mexico, in 860 fathoms, and identified by Mr. Dall as this species. They do not differ in any respect. The shell of *Abra lioica* (Dall) is shorter, rounder, and more swollen.

Tellimya ferruginosa (Mont.)

Mya ferruginosa Montague, Test. Brit., p. 44, pl. 26, fig. 5.

Tellimya ferruginosa G. O. Sars, Moll. Reg. Arct. Norvegiæ, p. 70, pl. 20, figs. 1a-c.

PLATE XXX, FIGURE 13.

This species was taken living, in considerable numbers and on several occasions, at and just below low water mark, in sand and mud, at the Gutters, on Naushon Island, near Wood's Holl, August, 1883, by the Fish Commission parties. It had not previously been definitely determined as inhabiting the American coast.

On the European coast it occurs from the Gulf of Lyons to northern Norway, at Lofoten and West Finnmark, and from 7 to 85 fathoms in depth. It has also been found in the Coralline Crag in England, and in the Post-glacial deposits.

The animal is active and opens freely and widely. It often lies for a long time on the back with the valves gaping widely, the foot more or less extended and twisting about, and the elegantly frilled mantle edge broadly expanded and extending considerably beyond the edge of the shell, all around. Animal translucent white. The foot is long, ligulate, very flexible, in full extension longer than the shell, in partial contraction broad at base with a long groove on the edge and an ill-defined white stripe in the center. It can be flattened out so as to be used as a creeping foot. The foot issues from the middle of the ventral edge of the shell. Mantle with the outer edge broad and delicately frilled and undulated and with small papillæ. It projects all around the edge of the shell, except close to the hinge. Ventral opening for the foot long, and large, bordered with small papillæ. Posteriorly a pouch-like lobe of the mantle often protrudes below the anal opening, which is widely separated from the ventral slit; it is a simple opening of the mantle, often a little prominent, but more often not at all so. Several (7 or 8) large and small ones lived several days in confinement.

Montacuta tumidula Jeffreys.

Jeffreys, Brit. Conch., vol. v, p. 177, pl. 100, fig. 5, 1869.

G. O. Sars, Mol. Reg. Arct. Norvegiæ, p. 69, pl. 19, figs. 18a-b.

Station 2103, off Delaware Bay, in 1091 fathoms; and station 2115, off Cape Hatteras, in 843 fathoms, one specimen (No. 38,190).

Off Lofoten, 100-120 fathoms; off Hebrides and Shetland, 40-80 fathoms; Mediterranean.

Cryptodon tortuosus (Jeffreys.)

Axinus tortuosus Jeffreys, Proc. Zool. Soc. London, for 1881, p. 702, pl. 61, fig. 6.

Station 2078, in 499 fathoms, two specimens; station 2084, in 1290 fathoms, four living specimens (No. 38,175); and station 2115, off Cape Hatteras, in 843 fathoms, two living specimens (No. 35,611).

Off the European coast, it was taken by the Porcupine Expedition, in 1870, and by the Travailleur Expedition, in the Bay of Biscay. It occurred in 645 to 1012 fathoms.

Malletia obtusa (M. Sars) Mörch.

Yoldia obtusa G. O. Sars, Remarkable Forms of Animal Life, p. 23, pl. 3, figs. 16-20, 1872.

Malletia obtusa G. O. Sars, Moll. Reg. Arct. Norvegiæ, p. 41, pl. 19, figs. 3, a-b. Jeffreys, Proc. Zool. Soc. London, for 1879, p. 586.

This species occurred at stations 2018, 2041, 2042, 2043, 2076, 2077, 2084, 2095, 2096, 2102, 2105, 2106, 2110, 2115, in 516 to 1608 fathoms. It was most common at station 2043, N. lat. $39^{\circ} 49'$, W. long. $68^{\circ} 28' 30''$, in 1467 fathoms, fifteen specimens (No. 38,180); and at station 2096, N. lat. $39^{\circ} 22' 20''$, W. long. $70^{\circ} 52' 20''$, in 1451 fathoms, forty-five dead specimens (No. 34,782).

Yoldia hyperborea Torell.

Torell, Spitzbergens Molluskfauna, p. 149, pl. 2, figs. 6, a-b, 1859.

Yoldia limatula G. O. Sars, Moll. Reg. Arct. Norvegiæ, p. 40, pl. 4, figs. 12, a-b, 1878 (non Say).

This species is closely allied to *Yoldia limatula* and *Yoldia myalis*, but is evidently distinct from both. Hitherto it has not been recognized as an inhabitant of the American coast, but it is not uncommon off the coast of Nova Scotia.

It was dredged by the U. S. Fish Commission at station 55, in 33 fathoms; stations 61-63 and 63-67, in 20-41 fathoms, 1877.

Yoldia sericea Jeffreys, var. **striolata** J.

Jeffreys, Mollusca Valorous Expd., Ann. Mag. Nat. Hist., 1876, p. 432; Proc. Zool. Soc. London, for 1879, p. 579, pl. 46, fig. 1.

This species occurred at stations 2035, 2037, 2041, 2042, 2043, 2052, 2076, 2084, 2096, 2103, 2106, 2110, 2111, 2115, in 516 to 1731 fathoms. It occurred in greatest abundance at station 2076, N. lat. $41^{\circ} 13'$, W. long. $66^{\circ} 00' 50''$, in 906 fathoms, one hundred and sixty

specimens (No. 35,148); station 2084, N. lat. $40^{\circ} 16' 50''$, W. long. $67^{\circ} 05' 15''$, in 1290 fathoms, seventy specimens (No. 34,862); and at station 2115, off Cape Hatteras, N. lat. $35^{\circ} 49' 30''$, W. long. $74^{\circ} 34' 45''$, in 842 fathoms, fifty living specimens (No. 35,581).

It is recorded by Jeffreys, off the coast of Ireland, in 1366 to 1380 fathoms; off the coast of Portugal, in 740 to 1095 fathoms; and from the "Valorous Expedition," at station 12, in 1450 fathoms.

Our specimens are regularly concentrically sculptured with narrow grooves and raised lines. They agree closely with specimens labeled as *var. striolata*, in Mr. Jeffreys' collection, at the National Museum, with which I have compared them. They also resemble some of the varieties of *Y. pusio*.

Yoldia messanensis (Seguenza.) Variety.

Leda acuminata Jeffreys, Ann. Mag. Nat. Hist., July, 1870, p. 69 (*non* Von Buch).

Seguenza, Nuculidi terziarie merid. d'Ital., R. Acad. Lincei, 1877, p. 1175, pl. 3, figs. 15, 15a, 15e.

Leda messanensis Jeffreys, Proc. Zool. Soc. London, for 1879, p. 576.

The specimens referred to this species most resemble the variety *brevisrostris* Seguenza, and differ considerably from the typical form. Our specimens are small, broad-ovate, rather thick and swollen, with the beaks nearly central and a little prominent. The posterior end is somewhat acute, though blunt at tip, and a distinct, rounded ridge runs from the beaks to the posterior extremity, and just in front of this there is a distinct inflection of the surface and ventral margin, without definite boundaries; the rest of the ventral margin is evenly rounded and the anterior end is obtuse and regularly curved. On the posterior dorsal margin, above the extreme tip, there is a slight, rounded angle, and from thence to the beak the outline is nearly straight. The anterior dorsal margin is convex. The surface, when fresh, is somewhat lustrous and iridescent, and covered with a pale yellowish epidermis. The sculpture generally consists of very fine concentric lines of growth, but in some specimens there are, toward the margin, distinct concentric grooves and ridges, the grooves being shallow, concave, with the ridges much narrower. The hinge-margin is wide and strong, with large and broad teeth, of which there are about nine on each side of the center; the cartilage-pit is very small.

Length, 4^{mm}; ventral margin to beak, 3^{mm}.

Station 2038, in 2033 fathoms (No. 35,212), two dead; station 2041, in 1608 fathoms; station 2042, in 1555 fathoms; station 2043,

in 1467 fathoms, two living and three dead (No. 38,209); and station 2096, in 1451 fathoms, one dead (No. 38,211).

This species has been taken at numerous localities off the European coast by the Valorous, Porcupine and other expeditions, and between the Azores and Bermudas by the Challenger Expedition; its range being from 100 to 1750 fathoms.

It was also taken in the West Indies and Gulf of Mexico by the Blake Expeditions, in 100 to 1002 fathoms, according to Mr. Dall. It is also found in the Pliocene of southern Italy.

The specimens from the Blake Expedition, which I have examined, are much more acutely pointed posteriorly, and have much stronger concentric striations than our examples. It is quite possible that the two forms are not identical.

Yoldia regularis Verrill, sp. nov.

Shell small, nearly regularly oval, with both ends obtusely rounded, and with the ventral edge broadly and regularly curved. The posterior end is a little narrower and more tapered than the anterior. The posterior dorsal margin is convex and rounded about as much as the ventral edge. The anterior dorsal margin is distinctly concave in front of the beak, but there is no defined lunule. The umbos are somewhat prominent, of moderate size, and curved forward. The beak is situated at about the anterior third. The surface is smooth, polished and iridescent, without any sculpture except slight and irregular lines of growth. Epidermis is thin and yellowish white. The hinge-margin is rather strong and curved, the posterior portion much longer than the anterior, and bearing about eight rather large and stout, prominent teeth. The anterior portion is short and nearly straight, and bears four or five prominent, erect teeth, the last tooth situated only a short distance from the beak. The cartilage-pit is relatively large and oblique and extends back a little ways from the beak.

Length, 3.5^{mm}; height, 2.5^{mm}.

Station 1093, off Martha's Vineyard, in 349 fathoms, 1882. Three specimens (No. 38,420).

This small species differs from all others recognized from our coast in its very regular ovate form, with the beak directed anteriorly, so that it resembles externally a minute *Tapes* or *Mactra*, or a compressed species of *Callista*. It is also remarkable for the shortness of the anterior hinge-margin and the small number of anterior teeth, as well as for the unusually large cartilage-pit.

***Yoldia subequilatera* (Jeffreys.)**

Leda subequilatera Jeffreys, Proc. Zool. Soc. London, for 1879, p. 579, pl. 46, fig. 3.

Station 2037, in 1731 fathoms, eight living specimens (No. 35,201); station 2078, in 499 fathoms, twenty-five living specimens (No. 35,138); and station 2115, off Cape Hatteras, in 843 fathoms, one dead specimen (No. 38,191).

It has been taken by the Lightning, Porcupine, and Norwegian Expeditions, in 459 to 778 fathoms, and off the Azores, in 1622 fathoms, by the Talisman Expedition.

***Yoldia Jeffreysii* (Hidalgo.)**

Leda lata Jeffreys, Ann. Mag. Nat. Hist., Nov. 1876, p. 431.

Leda Jeffreysi Jeffreys, Proc. Zool. Soc. London, for 1879, p. 579, pl. 46, fig. 2.

Station 1093, in 349 fathoms, 1882; and station 2084, in 1290 fathoms, 1883, several fresh specimens (No. 38,415).

It has been taken at numerous localities off the coast of Europe, and between the Azores and Bermudas, at depths ranging from 452 to 2199 fathoms.

Our specimens are not full grown and have the hinge plate light and thin, with very slender teeth, but in other respects they agree well with Mr. Jeffreys' original specimens, with which I have compared them at the National Museum.

***Leda Bushiana* Verrill, sp. nov.**

Shell narrow-lanceolate in form, compressed, with the front end simple and bluntly rounded, much shorter than the posterior end, which tapers gradually and ends in a narrow, truncated tip, which is not upturned, or but very slightly so. The umbos are a little prominent and rather sharp. From the apex two rounded ridges run to the posterior end; the lower one, running to the lower angle of the tip, is pretty strongly marked, and causes a slight undulation of the surface and of the margin below it. The posterior dorsal margin is compressed, rising in the form of a sharp, smooth keel, which has usually a slightly convex outline. The dorsal area is pretty clearly separated from the rest of the surface by the upper angular ridge running from the beak. In front of the beak there is a small but pretty well defined lunule. The surface, in all but one specimen, is covered with rather strong, sharply defined, raised concentric lamellæ, which are separated by concave intervals of variable width, those towards the umbos being narrower than those near the margin. The

lamellæ in crossing the lower posterior ridge become a little more prominent, or form small crests, but fade out at the upper ridge. In one specimen, which does not differ in other respects, the sculpture is much more feeble, consisting of very numerous fine and close concentric lines, which are but little elevated, but some of these, at variable distances apart, are a little stronger than the rest; the posterior ridges are also nearly obsolete. The epidermis is thin, closely adherent, light yellowish green. The interior surface is bluish white and lustrous, the concentric ribs showing through by translucency. The teeth are prominent, sharp, rather slender, strongly compressed, and connected by a thin, well marked ridge along the inner edge. The anterior hinge-margin is gently curved, and bears, in the larger specimens, about twelve well-formed teeth, besides four or five minute ones close to the cartilage. Just in front of the small triangular cartilage-pit, a small, somewhat prominent, obtuse tooth is developed on the inner surface of the hinge-margin. The posterior hinge-margin is decidedly longer than the anterior, nearly straight, and bears about fifteen distinct teeth, besides a few minute ones close to the cartilage-pit. A distinct ridge runs from the beak to the lower angle of the posterior tip.

Length of the largest example, 15^{mm}; height, from ventral margin to beak, 7^{mm}; from beak to anterior margin, 6^{mm}; from beak to posterior end, 10^{mm}.

Station 2110, off Cape Hatteras, in 516 fathoms (No. 35,729).

This species somewhat resembles, in size and form, *L. tenuisulcata* and *L. minuta*, but it is a thinner, more compressed, and more delicate shell, and is quite distinct in its sculpture and in the structure of the hinge.

Phaseolus ovatus? (Jeff. MSS.)

Seguenza, *Nuculidi terz. mer. Italia*, R. Accad. Lincei, Ser. III, vol. i, p. 1182, pl. V, fig. 29-29c, 1877.

Station 2084, in 1290 fathoms, six living specimens.

Our specimens are small and shaped nearly like *Yoldia Jeffreysii*, with a smooth, lustrous, iridescent surface and yellowish green epidermis. The hinge-margin is thin, with a few very oblique and appressed, low, feeble teeth, three or four in front and four or five behind the small cartilage-pit. Its identification is doubtful.

Nucula cancellata Jeffreys.

Nucula reticulata Jeffreys, Ann. Mag. Nat. Hist., 1876, p. 429; Proc. Zool. Soc. London, for 1879, p. 583, pl. 46, fig. 7, (name preoccupied by Hinds).

Nucula cancellata Jeffreys, Proc. Zool. Soc. London, for 1881, p. 951.

This species occurred in great abundance at station 2076, N. lat. $41^{\circ} 13'$, W. long. $66^{\circ} 00' 50''$, in 906 fathoms (No. 34,765), and station 2084, N. lat. $40^{\circ} 16' 50''$, W. long. $67^{\circ} 05' 15''$, in 1290 fathoms (No. 34,860), one thousand specimens, living. It also occurred in less numbers at stations 2035, in 1362 fathoms; 2037, in 1731 fathoms; 2038, in 2033 fathoms; 2043, in 1467 fathoms, 2052, in 1098 fathoms; 2072, in 858 fathoms (one dead); 2096, in 1451 fathoms; 2102, in 1209 fathoms; 2103, in 1091 fathoms.

Off the European coast, it was taken by the Porcupine and Valorous Expeditions, in 420 to 1470 fathoms, and by the Challenger Expedition, off the Azores, in 1000 to 1100 fathoms.

Glomus nitens Jeffreys.

Jeffreys, Mollusca Valorous Exped., Ann. Mag. Nat. Hist., 1876, p. 433; Proc. Zool. Soc. London, for 1879, p. 573, pl. 45, fig. 5.

Station 2041, N. lat. $39^{\circ} 22' 50''$, W. long. $68^{\circ} 25'$, in 1608 fathoms, one dead specimen.

This species was taken by the Porcupine Expedition, in the North Sea, in 567 fathoms; off the coast of Ireland, in 1180 to 1476 fathoms, and at station 9, in 1750 fathoms.

Limopsis cristata Jeffreys.

Jeffreys, Ann. Mag. Nat. Hist., Nov. 1876, p. 434; Proc. Zool. Soc. London, for 1879, p. 585, pl. 46, fig. 8.

Station 2048, N. lat. $40^{\circ} 02'$, W. long. $68^{\circ} 50' 30''$, in 547 fathoms, two valves.

These specimens have been compared by me with types in the collection of Mr. Jeffreys at the National Museum. They appear to agree in all the essential characters.

It was taken, off the coast of Europe, by the Porcupine and Valorous Expeditions, in 292 to 1095 fathoms; and by Travailleur Expedition, in the Bay of Biscay, in 341 to 1693 fathoms.

Limopsis tenella Jeffreys.

Jeffreys, Ann. Mag. Nat. Hist., Nov. 1876, p. 433.

Station 2037, N. lat. $38^{\circ} 53'$, W. long. $69^{\circ} 23' 30''$, in 1731 fathoms; and 2038, N. lat. $38^{\circ} 30' 30''$, W. long. $69^{\circ} 08' 25''$, in 2033 fathoms.

I have compared these specimens with types in Mr. Jeffreys' collection at the National Museum.

It was first taken by the Valorous Expedition, in 1450 fathoms.

Pecten leptaleus Verrill, sp. nov.

Shell small, thin, delicate, well rounded, resembling *P. pustulosus* in form, but with much finer sculpture. The umbos small, pointed. The anterior ear is prominent with a rather deep, rounded notch in the upper valve and a narrower and deeper notch in the lower valve; the posterior ear is small and short. The sculpture on the upper valve consists of numerous, thin, rather close, concentric riblets which become fewer and less elevated toward the umbos of which the most prominent part is nearly smooth; these concentric lines continue over the ears, becoming quite prominent on the anterior ear, but fine and close on the posterior one. The intervals between the concentric lamellæ are crossed by numerous, very thin, raised lines which become obsolete on the umbos, and nearly so on the anterior ear. These radiating lines in crossing the concentric lamellæ form minute, rounded granules which are most distinct on those near the margin, where they are very numerous, appearing like strings of minute beads along the lamellæ. The lower valve is smaller and less convex than the upper, with the outer portion of its margin bent downward. The sculpture consists only of a very fine, close, concentric lines, except on the ears which are covered with numerous, close, radiating lines, which are roughened by the concentric lines. Color yellowish white.

Length, 7^{mm}; height from ventral margin to dorsal edge, 6.5^{mm}; length of dorsal margin, 4^{mm}.

Two specimens were taken, off Cape Hatteras, at station 2109, in 142 fathoms (No. 38,413).

Pecten fragilis Jeffreys.

Jeffreys, Ann. Mag. Nat. Hist., Nov., 1876, p. 424; Proc. Zool. Soc. London, for 1879, p. 561, pl. 45, fig. 1.

Station 2115, off Cape Hatteras, in 843 fathoms, two specimens (No. 35,566).

It has been taken off the European coast by the Porcupine and Valorous Expeditions, in 1450 to 1750 fathoms; and by the Norwegian Arctic Expedition, in 656 to 1353 fathoms.

Pecten striatus Müller.

Müller, Zool. Dan. Prodr., No. 2994 (t. Jeffreys).

Jeffreys, Brit. Conch., vol. ii, p. 69; vol. v, p. 168, pl. 23, fig. 4.

One valve, which has been identified as this species by Mr. Dall, occurred off Martha's Vineyard, at station 949, in 100 fathoms, 1881 (No. 38,179). No other similar specimen has been taken by us.

Avicula squamulosa? Lam.

A small *Avicula*, taken alive at the surface at station 2099 (No. 34,781), is referred to this species with some doubt. The shell is rather broad and rounded for the genus, and but little oblique. The tail (cauda) is almost obsolete, forming only a slightly prominent angle, shorter than the body of the shell, and separated from it only by a slight emargination. The anterior auricle is small and rounded. The byssal notch is narrow and moderately deep. The body of the shell is ornamented with from twelve to fourteen radiating rows of long, narrow and slender scales, which are transversely banded with purple and white. The lines of growth are slightly lamellose toward the margin and the whole surface appears under a lens to be minutely punctate. The color is light yellow, becoming white on the umbos, and irregularly and concentrically streaked with reddish brown. The lower valve is concave toward the margin, but has scales and coloration similar to the upper valve.

Total length, 15^{mm}; length of hinge line, 12^{mm}; height from the ventral to dorsal margin, 11^{mm}.

BRACHIOPODA.

Discina Atlantica King.

King, Proc. Nat. Hist. Soc. Dublin, 1868, vol. v, p. 170.

Jeffreys, Ann. Mag. Nat. Hist. for 1876, p. 252; Proc. Geol. Soc. London, for 1878, p. 415, pl. 23, fig. 7.

Several specimens of this species were taken by the Albatross in 1883. I have identified these with specimens in Mr. Jeffreys' collection, now in the U. S. National Museum.

Station 2043, in 1467 fathoms, two specimens (No. 38,429); station 2096, in 1251 fathoms, ten specimens (No. 35,170).

According to Jeffreys, this species has been taken off the European coast, in 690 to 1450 fathoms. North Atlantic, on telegraph cable, in 2400 fathoms; near St. Paul Island, in 1850 fathoms; off Bermuda, in 2180 fathoms; and in the North Pacific, in 1875 and 2050 fathoms; off the coast of North Australia, in 200 to 1400 fathoms (Challenger Expedition).

Waldheimia cranium (Müller) Davidson.

Terebratula cranium Müller, Zool. Dan. Prodr., p. 249, 1776.

Jeffreys, Brit. Conch., vol. ii, p. 11; vol. v, p. 163, pl. 19, fig. 1, 1a; Proc. Zool. Soc. London, for 1878, p. 405.

Waldheimia cranium Friele, The Development of the Skeleton in the Genus Waldheimia, in Archiv. Math. Naturvid., pp. 380-386, pls. 1-3, 1877.

A single living specimen, which Mr. W. H. Dall has identified as this species, was taken by the Albatross, at station 2035, off Martha's Vineyard, in 1362 fathoms. When first taken it was supposed to belong to *W. tenera* Jeffreys. No authentic instance of the occurrence of this species on the N. American coast has been recorded. On the coast of Europe it is not uncommon in 30 to 700 fathoms, and ranges from Norway to France. It has also been recorded from Greenland, Northern Asia and Japan.

The following two species have not yet been taken south of Labrador, but may be regarded as belonging to the North American fauna.

Waldheimia tenera (Jeffreys).

Terebratula tenera Jeffreys. Ann. Mag. Nat. Hist., Sept., 1876, p. 250; Proc. Zool. Soc. London, for 1878, p. 405, pl. 22, fig. 7.

This species was taken by the Valorous Expedition, far off the coast of Labrador, in 1450 fathoms, N. lat. $56^{\circ} 11'$, W. long. $37^{\circ} 41'$. It has not yet been recorded from any other locality, but is likely to occur off our coast at similar depths.

Atretia quomon Jeffreys.

Ann. Mag. Nat. Hist., Sept., 1876, p. 251; Proc. Zool. Soc. London, for 1878, p. 412, pl. 23, fig. 4.

This species was recorded by Jeffreys, from off the coast of northern Labrador, N. lat. $59^{\circ} 10'$, W. long. $50^{\circ} 25'$, in 1750 fathoms, and also from N. lat. $56^{\circ} 11'$, W. long. $37^{\circ} 41'$, in 1450 fathoms.

On the European coast it has been taken, according to Jeffreys, at several localities, in 650 to 1750 fathoms, and off Marocco and the Azores, in 1192 to 2199 fathoms.

ADDENDA.

After the preceding pages were mostly in type, an additional lot of mollusca, dredged in 1883, by the Albatross, mostly from off Cape Hatteras, was received from the National Museum. It contained many additions to the list. A few of the most important ones are here included.

Octopus Carolinensis Verrill, sp. nov.

Body, in the alcoholic specimen, rather small, somewhat oblong, obtusely rounded posteriorly and slightly emarginate beneath. Head large, and with the basal web larger than the body. Eyes large and prominent, occupying nearly the whole of the sides of the head, and in contact, or nearly so, dorsally. Entire surface of the body, head and upper surface of the umbrella and arms covered with minute but prominent verrucæ, which are somewhat larger and more crowded on the back than beneath. There are no cirri on the back nor above the eyes, but the upper eyelid is covered with small verrucæ like those of the back, and is marked with radiating wrinkles. Siphon moderately long and rather slender. Arms angular, long, slender; the two lateral pairs about equal in length; the ventral and dorsal pairs about equal in length and slightly shorter than the lateral; the ventral arms are a trifle longer than the dorsal and appear to have the suckers a little larger. The web is more than one-fourth the length of the dorsal arms, and extends farther out between the lateral arms than between the ventral or dorsal. A rather wide marginal membrane runs along the arms, even to the tips; it is most developed on the lower side of the lateral arms. The suckers are moderately large, rather closely arranged in two regular rows, and diminish very regularly from near the base to the very slender tips of the arms.

Length of body, 22^{mm}; its breadth, 20^{mm}; breadth of the head, the same; length from the posterior end of the body to edge of web between dorsal arms, 45^{mm}; length of dorsal arms from mouth, 64^{mm}; of 2d pair, 72^{mm}; of 3d pair, 70^{mm}; of 4th pair, 66^{mm}; diameter of dorsal and lateral arms, 4.5^{mm}; diameter of largest suckers, 2^{mm}.

Color, in alcohol, rather dark purplish brown above, due to abundant, closely crowded, minute chromatophores; lower surface, yellowish white, rather thickly specked with orange and brown chromatophores. Inner surface of arms, suckers and eyelids white.

Station 2109, off Cape Hatteras, in 142 fathoms (No. 35,673). One female.

Octopus gracilis Verrill, sp. nov.

Size of our only specimen small. Body slender, elongated, broadest just back of the gill openings, obtusely rounded posteriorly. Whole surface, above and beneath, smooth, with neither cirri nor verrucæ. Head moderately large. Eyes rather large and prominent, with smooth lids. Umbrella small, the web extending only a short distance and about equally between the dorsal and lateral arms. Arms very slender, elongated, tapering to very thin tips, the third pair much longer than the two upper pairs, but all of about the same thickness at base. The dorsal arms are not half the length of the third pair; the second pair is but little longer than the dorsal and about the same in thickness; the ventral arms are both broken off near the base. The suckers are small and diminish very regularly from the base to the tip of the arms. Those on the two lower pairs of arms are rather more openly arranged, the spaces between the consecutive suckers, being about double that on the upper arms, while the two rows are closer together; on each of these arms three to five of the suckers near the base stand nearly in a median line, which is not the case on the upper pairs of arms.

Length of body, 11^{mm}; greatest breadth, 7^{mm}; breadth of head, 6.5^{mm}; from posterior end of body to edge of web between the arms, 17^{mm}; length of dorsal arms from mouth, 19^{mm}; diameter near base, 1.3^{mm}; length of 2nd pair, 21^{mm}; length of 3rd pair, 42^{mm}.

Color, in alcohol, yellowish white, covered with large purplish brown chromatophores, darkest on the upper surface of the head, between the eyes. Inner surface of the arms and suckers yellowish white with a purplish spot in front and behind the base of each sucker.

Station 2084, in 1290 fathoms, one specimen, female (No. 38,431).

This specimen is probably young of a species that grows to a larger size. It differs, however, from all described species in the remarkable elongation of the third pair of arms compared with the first and second pairs; all the arms are also remarkably slender, and the body is peculiarly elongated and smooth. It is very certain that it is not the young of any of the known species.

Bela Rathbuni Verrill, sp. nov.

Shell large, rather stout, sub-fusiform, with an elevated acute spire, forming more than half the total length of the shell. Whorls seven besides the nucleus, moderately convex, with an impressed, not very oblique suture. The whorls of the spire are pretty strongly angulated or carinated a little above the middle by a revolving

carina, which appears double at the summit, and slightly nodulous where it is crossed by the longitudinal lines. Above the carina there is a rather wide, sloping, flattened or slightly concave subsutural band, which is crossed by somewhat raised, moderately excurved lamellæ, parallel with the lines of growth and with the sinus in the lip; there is also a rather faint revolving cingulus a little below the middle of the band. Below the principal carina there is a rather wide concave interspace, which surrounds the middle or most prominent part of the whorls, and is bounded below by a carina like the upper one, but not quite so strong; anterior to this there are, on the body-whorl and siphon, numerous similar double revolving cinguli, decreasing in size and becoming closer anteriorly; of these there are about twelve above the base of the siphon; the concave interspaces between the upper ones are about equal in width to the cinguli. The whole surface is covered by numerous slightly raised, longitudinal lines, which are parallel with the lines of growth and are most conspicuous in the interspaces between the cinguli. The apex, in our single specimen, is badly eroded. The aperture is narrow-ovate, not very large, with a distinct obtuse angle at the base of the columella, which is rather short and nearly straight. The siphon is short and straight, distinguished from the body-whorl only by a slight undulation. The canal is short, straight and rather open.

Length, without the nuclear whorls, 27^{mm}; breadth, 13^{mm}; length of aperture, 13^{mm}; its breadth, 5^{mm}.

Station 2105, off Chesapeake Bay, in 1395 fathoms (No. 35,704), one dead specimen.

The single specimen of this species is considerably eroded, so that the sculpture, especially the longitudinal lines, appears more strongly marked than it would in a fresh specimen. Perhaps the double character of the revolving carinæ is more obvious for the same reason. They may originally have been more elevated and sharper. The species bears but little resemblance to any other known from our coast, but the character of the sculpture is not unlike *B. bicarinata*, but the largest specimens of the latter are pygmies, in comparison with the present species.

Urosalpinx Carolinensis Verrill, sp. nov.

Shell small, pretty regularly fusiform, with an elevated, rather acute spire, which forms nearly one-half the total length of the shell. Whorls six to seven moderately convex, with an impressed suture. The sculpture consists of about twelve rather prominent, stout longi-

tudinal ribs, which run nearly straight across the whorls, and on the last whorl extend to the base of the siphon; these are separated by deeply concave intervals of about the same width. The whole surface is covered by strongly marked revolving cinguli, which cross both the ribs and their interspaces, and thicken so as to form small, rounded nodules where they cross the ribs; these are separated by interspaces of about the same width, in the middle of which there is a much smaller, thin revolving cingulus, alternating pretty regularly with the larger ones around the periphery. On the anterior part of the body-whorl, and sometimes at the periphery, there are two or three small revolving cinguli in some of the interspaces. On the penultimate whorl there are usually five to seven of the primary cinguli, and on the body-whorl and siphon there are about eighteen to twenty. The whole surface is also covered, in perfect specimens, with fine, slightly elevated, wavy lines of growth, which are most conspicuous on the intervals between the ribs; they are usually worn off from the more prominent parts of the ribs and nodules. The nucleus consists of about two and one half regularly coiled whorls; the first two are small, smooth, translucent and somewhat lustrous; the last is covered with rather faint revolving lines, crossed by the lines of growth, which gradually merge into the longitudinal sculpture of the normal whorls, there being no very distinct demarcation between the nucleus and the next whorl. The apical whorl is minute, regularly increasing. Aperture elongated, ovate-fusiform; outer lip thin, sharp, regularly curved; inner margin regularly arched. Collumella somewhat elongated, its margin sinuous and somewhat excurved at the tip. Canal narrow and somewhat elongated, a little curved. Color bluish white. Epidermis very thin, pale grayish or yellowish white.

Length of one of the largest specimens, 15^{mm}; breadth, 7^{mm}; length of aperture, 8^{mm}; its breadth, 3^{mm}.

This species was taken, off Cape Hatteras, at station 2109, in 142 fathoms, in considerable abundance (No. 35,735); station 2110, in 516 fathoms (one dead); and station 2111, in 938 fathoms, one living (No. 35,764). Possibly the two latter specimens may be due to accidental misplacement.

This species bears considerable general resemblance to the shallow-water species (*U. cinerea*), but it is a much smaller and more slender species, with a narrower aperture and longer canal. The sculpture is more simple, there being usually but two sets of revolving cinguli, the larger and smaller ones alternating pretty regularly.

Urosalpinx macra Verrill, sp. nov.

The shell is nearly regularly fusiform, consisting of seven whorls, separated by an impressed suture. The spire is somewhat elongated, regularly tapered, and forms one-half the length of the shell. The nucleus is mamilliform, consisting of about two regularly coiled, convex, rounded whorls, of which the first is nearly as large as the second. The lower whorls are crossed by about ten broad, strongly marked, nodulous ribs. The spiral sculpture consists of stout, rounded, rather elevated, revolving cinguli, which rise into oblong nodules or tubercles in crossing the ribs; of these there are about eight on the body-whorl, besides five or six on the siphon without nodules. On the penultimate whorl there are five or six primary cinguli, of which two or three around the periphery are considerably larger and farther apart than the others; one, below these, is coincident with the suture and makes it undulating. Between the primary cinguli there are three to five much smaller rounded cinguli, separated by thin, incised grooves; these cinguli are about equally prominent on the ribs and interspaces and do not form nodules. The surface is also covered with fine, close, raised lines of growth, except on the nodules, which are smooth at summit. The aperture is ovate, continued anteriorly in a rather long, narrow canal, and having a slight posterior notch or sinus at the suture. The outer lip is sharp and regularly arched; the inner lip is strongly excavated, its curvature posteriorly being greater than that of the outer lip. Columella rather elongated, straight, with a somewhat sinuous inner margin. The canal is straight, somewhat elongated and constricted. Color yellowish white; interior grayish white.

Length, 13^{mm}; breadth, 5.5^{mm}; length of aperture, 7.5^{mm}; its greatest breadth, 2.5^{mm}.

Off Cape Hatteras, station 2109, in 142 fathoms (No. 35,772), one fresh specimen.

Sipho hispidulus Verrill, sp. nov.

Shell small, short, broad-ovate, with a rather short, bluntly tapered spire, obtusely rounded at the tip, and with a swollen body-whorl, constituting the greater part of the shell. Whorls four, rapidly enlarging, convex, with a distinctly carinate, angular shoulder above the middle, above which there is a concave subsutural band, separated from the suture by an angular, interrupted revolving ridge, next the suture. Besides these two nodose, revolving carinae, there

are two additional ones, nearly as strong, around the periphery, and one or two faint ones on the subsutural band. On the last whorl there are eight or nine revolving carinæ below the shoulder, besides six or seven on the siphon. The longitudinal sculpture consists of numerous, rather narrow, angular, longitudinal ribs, which run nearly straight across the whorls, parallel with the lines of growth, which are rather conspicuous, distinctly raised and lamelliform, covering both the ribs and their interspaces. The ribs in crossing the revolving carinæ form small, rounded or subconical nodules, of which those on the shoulder and on the sutural carina are the most prominent and most compressed. The ribs are continued across the subsutural band, on the lower whorls, in the form of thin, raised lamellæ, somewhat larger than the intervening lines of growth; but on the upper whorls the ribs, across the entire breadth, are thin, lamelliform, and bent forward, rising in the form of small angles in crossing the revolving cinguli. The surface is covered by a closely adherent epidermis, which bears minute, sparsely scattered hairs, especially along the summits of the revolving cinguli. The nucleus is minute, regularly coiled, depressed, and largely covered by the succeeding whorl. The first or apical whorl is smooth and translucent, but on the second the normal sculpture is gradually developed. The aperture is rather broad-ovate, more than half the length of the shell. Columella is straight, with a strongly sinuous inner margin. The canal is rather short and broad, not constricted. The operculum is thin, yellowish white, translucent, ovate, somewhat pointed posteriorly, and slightly truncated on the posterior part of the outer margin; the nucleus is at the extreme posterior tip. Color of the shell white, with a pale flesh-colored tint on the spire.

Length, 7.5^{mm}; breadth, 4^{mm}; length of aperture, 5^{mm}; its breadth, 2^{mm}.

Station 2038, N. lat. 38° 30' 30", W. long. 69° 08' 25", in 2033 fathoms, one living specimen (No. 34,840).

The generic relations of this shell are somewhat doubtful. In general appearance and sculpture it resembles certain species of *Bela*, but the character of the nucleus and the hairy epidermis, together with the character of the operculum, indicate that it belongs to or near *Sipho*. This is also indicated by the fact that there is no distinct sinus in the outer lip, nor are the lines of growth distinctly excurved in crossing the subsutural band. In size and shape the shell resembles *Bela hebes* and *Gymnobela curta*, var. *angulata*, from both of which it differs decidedly in sculpture. The specimen described may, however, be the young of a much larger species.

Cingula Sandersoni Verrill, sp. nov.

Shell moderately large for the genus, thin, fragile, long-ovate, with a rather tall, somewhat turreted, acute spire. Whorls six to seven, strongly and evenly convex, separated by a deep, impressed, simple suture. Body-whorl large, rather swollen, well rounded, and constituting more than one-half the length of the shell. Nuclear whorl small, smooth, somewhat prominent, regularly coiled. Base rather strongly produced, destitute of an umbilicus, but sometimes with a slight chink, produced by the everted edge of the inner lip. Aperture pretty regularly ovate, rather broad, obtusely rounded in front, and with the posterior end narrowed and sometimes forming a slight sutural sinus; outer lip thin and regularly curved; inner lip continuous, usually with a thin, free edge along the body-whorl. The sculpture consists of very fine, close revolving lines, visible with a lens, and of still finer, but usually distinct lines of growth, which interrupt, more or less, the spiral lines.

Color white in our specimens, all of which appear to have been dead when dredged.

Length, 4^{mm}; breadth, 2^{mm}; length of body-whorl, 2.5^{mm}; length of aperture, 1.8^{mm}. A large specimen, with broken apex, is 2.7^{mm} broad; length of body-whorl 3.5^{mm}. Most of the specimens are smaller than those measured, and some are more slender in proportion.

Station 2109, off Cape Hatteras, in 142 fathoms, numerous specimens (No. 35,447).

In form, this species resembles *C. turricula* Lea, but the latter is described and figured as smooth and umbilicated. It is evidently allied to *C. aculeus*, but differs in its stouter form, deeper suture, and much finer sculpture. The sculpture is somewhat similar to that of *C. leptalea*, but the latter is very different in the form of the shell and aperture. Dedicated to Mr. Sanderson Smith, by whom it was dredged.

Rotella cryptospira Verrill, sp. nov.

Shell minute, strongly depressed, with the spire not at all elevated and mostly concealed by the overlapping of the last whorl. Surface smooth and polished, without any lines of growth. The last whorl constitutes nearly the entire shell, overlapping and nearly concealing the previous whorls, but sometimes leaving a slight central depression in which the minute spire is imperfectly visible. Base flattened or but slightly convex; the umbilical region is completely covered by a

small smooth callus. The aperture is oblique, nearly circular, encroached upon a little by the body-whorl. The lip is slightly thickened, with the margin rounded. In some specimens there is a slight, angular, posterior sinus, at the suture, and sometimes the inner lip is a little thickened in the umbilical region. Color of all our specimens white, but none of them appear to have been living, although many are fresh and have a polished surface.

Greatest diameter, 2.5^{mm}; height, 1.5^{mm}; diameter of the aperture, about 1^{mm}.

Off Cape Hatteras, station 2109, in 142 fathoms (No. 35,731), about thirty specimens.

This species bears some resemblance to *R. anomala* D'Orb., but is peculiar in having the whorls of the spire concealed, or nearly so, by the last whorl.

Ethalia multistriata Verrill, sp. nov.

Rotella striata? D'Orbigny, Moll. Cuba, atlas, pl. 18, figs. 29-31.

This shell, although resembling in most respects that figured by D'Orbigny, differs in being more depressed, with a lower spire and less prominent base. The spiral lines are much finer and more numerous, and the inner lip is distinctly thickened opposite the umbilicus.

Shell small, much depressed, with the spire rising but very little above the body-whorl, and with the base distinctly flattened. Whorls about three and one half, separated by a distinct and slightly impressed suture. The upper side of each whorl is depressed, but the periphery is very convex and obtusely rounded. The nuclear whorl is moderately large, smooth, translucent, and regularly coiled. The entire upper surface, below the nucleus, and most of the base, are covered by very numerous fine, impressed, revolving lines, with interspaces which are a little wider than the lines themselves. On the inner half of the base, around the umbilicus, the spiral lines are obsolete. Just below the suture there is a stronger groove or slight depression, defining a small, subsutural, slightly raised ridge. The surface is also covered with very fine, but distinct, impressed lines of growth, which, in crossing the spiral lines, give them a slightly wavy or punctate appearance, and sometimes produce a minute and feeble reticulated structure. The aperture is very oblique, broader than long, with the anterior border somewhat flattened, the outer side very convex, and with a slight, angular, posterior corner, or sutural sinus, below which the body-whorl projects slightly into the aperture,

while the columella-margin is regularly excurved. The inner lip is continued across the body-whorl in the form of a thin, closely adherent callus deposit; the columella-margin, in advance of the umbilicus, is distinctly thickened, but does not form a tooth, nor a distinct angle. The umbilicus is moderately large and deep, showing part of the whorls.

Height of the largest specimen, 2.5^{mm}; breadth, 4.5^{mm}; length of aperture, 1.7^{mm}; breadth, 2^{mm}.

Off Cape Hatteras, station 2109, in 142 fathoms, sixteen specimens, all dead, but fresh (No. 35,733).

This species resembles *Rotella striata* D'Orb. It is a much more depressed shell than he figures, and the spiral lines appear to be much more numerous and finer, nor does his figures show any distinct thickening of the columella-margin.

NOTES ON SPECIES PREVIOUSLY RECORDED.

Mastigoteuthis Agassizii Verrill.

Bull. Mus. Comp. Zool., vol. viii, p. 100, pl. 1, fig. 1; pl. 2, figs. 2, 3-3e, 1881.

These Transactions, vol. v, p. 297, pl. 47, pl. 49, figs. 2, 3-3e, 1881.

Additional specimens of this species were taken in 1883, at station 2050, in 1050 fathoms; station 2072, in 858 fathoms; station 2076, in 906 fathoms.

It had not previously been taken by the Fish Commission.

Chiroteuthis lacertosa Verrill.

These Transactions, vol. v, pages 299, 408, 450, pl. 47, figs. 1, 1b; pl. 56, figs. 1-1f.

Additional specimens of this species have been taken at station 2074, in 1309 fathoms; station 2098, in 2221 fathoms; station 2094, in 1022 fathoms, and mutilated arms from a fish stomach, from station 2099, in 2949 fathoms.

Calliteuthis reversa Verrill.

These Transactions, vol. v, p. 295, pl. 46, figs. 1-1b, 1881.

Additional specimens of this species were taken in 1883, at station 2034, in 1346 fathoms; station 2039, in 2369 fathoms; station 2041, in 1608 fathoms (head only); station 2076, in 906 fathoms.

The young specimen of this species, from station 2076, has one of the tentacular arms preserved. These arms have been absent in all the other specimens that I have examined, and seem to be very easily detached. In this example the tentacular arm is long, very slender,

being about twice the length of the sessile arms, and not half as thick at the base as the smallest of the sessile arms. The proximal half is strongly flattened, and tapers from the base outwardly. The distal half is much more slender and is somewhat angular or triquetral, becoming somewhat sub-cylindrical and very slender toward the club, which is well developed, narrow-lanceolate in form, somewhat expanded toward the base, and gradually tapered to the tip. The slender distal half of the arm bears a row of very small, rather distant, smooth edged, sessile suckers, alternating with minute tubercles on its inner surface; these are evidently intended, as in allied genera, for attaching the two arms together. Close to the base of the club, these sessile suckers become closer and more numerous. The club itself bears, on its broader, basal portion, about six rows of suckers. One row, which is nearly central, consists of about seven, rather broad, cup-shaped suckers, decidedly larger than any of the others, and of these, three central ones are decidedly the largest; their horny rings are very finely and sharply denticulate around the entire margin, which is but little oblique; just below the horny ring there is a constriction, and the body of the sucker is considerably swollen. Alternating with these are other similar, but smaller, suckers, forming a second median row; on each side of these are two marginal rows of still smaller and somewhat more oblique, cup-shaped suckers. The distal half of the club is crowdedly covered with numerous, small suckers, which are apparently arranged in six rows, and decrease gradually in size to the tip of the club, the number of rows apparently decreasing to four, and the size becoming very minute near the tip, which is very narrow, simple, and, in this specimen, strongly curled spirally. These tentacular arms differ in color from the rest of the arms, the inner surface being orange, the edges yellowish white, and the outer surface covered with definite orange-brown chromatophores, while the other arms are darker externally, owing to the much more crowded chromatophores, and are covered with prominent verrucæ, each of which is marked on one side with dark brown, while the tip is white; the inner surface of the sessile arms is deep brown, and the suckers are white at base, tinged with orange-brown near the margin. The general color of the body and head is like that of the outer surface of the arms, but as in the original specimen, the color is much deeper and the verrucæ more numerous on the ventral surface than above. The caudal fin is thin, translucent, and destitute of color, except close to the base, where there are a few orange-brown chromatophores. The lobes of the fin extend back

considerably beyond the end of the body on each side, but are united to its extreme tip, leaving a distinct notch beyond the end of the tail. Each half of the caudal fin, taken by itself, is somewhat triangular in form, with the angles rounded, or rather it is between semi-circular and triangular, the length longitudinally being decidedly greater than the distance from the base to the lateral border.

The specimen above described is 27^{mm} long, from the end of the body to the front edge of mantle, above; length, from end of body to base of dorsal arms, 34^{mm}; breadth of body and head, 12^{mm}; breadth across caudal fin, 18^{mm}; length of caudal fin, 9^{mm}; length of third pair of arms, 20^{mm}; length of tentacular arm, 67^{mm}.

Brachioteuthis Beanii Verrill.

These Transactions, vol. v, p. 406, pl. 50, figs. 3-3*b*; pl. 56, figs. 2-2*a*, 1881.

An additional specimen, considerably mutilated and apparently from a fish stomach, was taken at station 2115, off Cape Hatteras, in 843 fathoms.

Desmoteuthis tenera Verrill.

These Transactions, vol. v, p. 412, pl. 55, figs. 2-2*d*; pl. 56, fig. 3, 1881.

An additional specimen of this species was obtained in 1883, at station 2034, in 1346 fathoms.

The original specimen was taken in 388 fathoms.

Rossia megaptera Verrill.

These Transactions, vol. v, p. 349, pl. 38, fig. 1; pl. 46, fig. 6, 1881.

Body large, stout, swollen, well rounded posteriorly, longer than broad; integument entirely smooth and soft, but not flabby; fins large, not very prominent, most so in front of the center, thick, soft, and fleshy, colored like the body; the line of attachment extends from near the front edge of the mantle to about the posterior fifth of the body, the anterior end being more dorsal than the posterior; the front end of the fin is free at base and projects forward considerably beyond the edge of the mantle in a broad, rounded lobe; the outer edge of the fin forms a very broad, even curve, narrowing backward and closely adherent to the body posteriorly. The front dorsal edge of the mantle extends forward in the middle region in a very obtuse angle, and receding in a broad, sinuous curve behind the eyes, it advances again below the eyes, and recedes to form a broad ventral notch below the siphon. The head is very large, as broad as

the body, or even broader, with very large prominent eyes; lower lid prominent, a little everted, not much thickened; pupils large, surrounded with a black circle in the preserved specimen. Siphon large, stout at base, rapidly tapering to a small tip. The basal web between the arms is short, extending farthest between the 3d and 4th pairs of arms. The arms are rather large, stout, well-rounded externally; those of the 3d and 4th pairs are larger than the others; the 1st and 2d pairs nearly equal; all the arms bear two crowded rows of suckers, which are similar in size and arrangement on all the arms, and decrease regularly to the tips. These suckers are moderately large, oblong, very oblique, with a very small orifice; the suckers are thickly specked with small chromatophores, except on the under surface. Alternating with the suckers, on each side there are rather large, fleshy, triangular, oblique, marginal lobes, the acute inner ends running in between the suckers. The tentacular arms are large, rather long and stout, but more slender than the other arms, triquetral, with rounded corners, and nearly destitute of chromatophores; the terminal club is scarcely as wide as the rest of the arm, rather long, narrow-lanceolate in form, tapering to a blunt tip; along the upper margin of the arm, opposite the commencement of the suckers, but well separated from them, there is a sharp, elevated crest or keel, which does not extend to the tip of the arm; the suckers are very small, much smaller than those of the sessile arms, cup-shaped, nearly equal, very numerous, forming eight or more indistinct, crowded rows.

The color is nearly the same over all parts of the body, head and outer surfaces of the sessile arms, except on the lower surface of the head around the base of the siphon, where it is paler. This color in alcoholic specimens is dark brownish purple, due to large numbers of rather large irregular chromatophores scattered on a yellowish white ground-color. The surface in many parts, especially around the eyes and on the dorsal surface of the body, has a glaucous blue tint; the under surface of the head, around the siphon, the tip of the siphon, and the inner surfaces of the arms and suckers are yellowish white, with small scattered chromatophores, which become more numerous on the exposed surfaces of the suckers; outer surfaces of the arms like the body. The tentacular arms throughout are yellowish white, with the exception of a few scattered chromatophores on the outer surface.

Measurements.

Length to end of sessile arms.....	123 ^m .	Length of dorsal arms	43 ^m .
Length of body.....	52	Length of 2d pair.....	45
Length of head to base of dorsal arms.....	24	Length of 3d pair.....	50
Breadth across body and fins.....	76	Length of 4th pair.....	49
Breadth of body.....	40	Length of tentacular arms.....	75
Breadth of head.....	44	Length of club.....	18
Diameter of eyes.....	25	Breadth of club.....	4
Diameter of pupil.....	8	Diameter of tentacular arms.....	4 to 5
Length of fins, longitudinally.....	40	Diameter of largest suckers of sessile arms.....	1.5
Length of insertion of fins.....	35	Diameter of dorsal arms.....	6
Breadth of fins, transversely.....	18	Diameter of lateral arms.....	6.5
Insertion of fin to front edge of mantle.....	9	Diameter of largest suckers.....	2

Station 1124, in 640 fathoms, off Martha's Vineyard, 1882.

The only specimen previously known was from off Newfoundland, in about 150 fathoms, probably from a fish stomach.

***Alloposus mollis* Verrill.**

American Journ. Sci., vol. xx, p. 394, 1880; these Transactions, vol. v, p. 366, pl. 50, figs. 1, 1a, 2, 2a, pl. 51, figs. 3, 4.

This species was taken by the Albatross, in 1883, at station 2034, in 1346 fathoms, one young; station 2036, in 1735 fathoms, fragments; station 2037, in 1731 fathoms (one arm).

At station 2034, in 1346 fathoms, a very young female specimen of this species was taken by the Albatross in 1883. In form and general appearance it differs but little from the large specimens described and figured by me. But the body is relatively shorter and broader, and the chromatophores are larger, more regularly scattered and more distinct.

Total length, 29^{mm}; length of mantle beneath, 10^{mm}; length of body and head to front side of eye, 17^{mm}; breadth of body, 13^{mm}.

***Argonauta argo* Linné.**

Verrill, these Transactions, vol. v, pp. 364, 420.

PLATE XXVIII, FIGURES 1, 1a, 1b.

A young living specimen of this species was captured while swimming at the surface, about 100 miles south of the eastern end of Long Island, by Dr. Kite, surgeon of the Fish Hawk. From this specimen, after it had been in too strong alcohol for two or three days, the figures on Plate xxviii were made. Owing to the strength of the

alcohol the expanded distal portion of the dorsal arms were very badly shriveled. The color of this example, in alcohol, was deep purplish brown above, paler beneath, the chromatophores being most crowded on the upper surface and having a tendency to be arranged so as to form small ocellated spots or circles, which, however, were not very distinct in the preserved specimen.

Octopus piscatorum Verrill.

American Journ. Sci., vol. xviii, p. 470, 1879; these Transactions, vol. v, p. 377, pl. 36, figs. 1, 2, 1881.

A good specimen of this species was taken by the Albatross at station 2035, in 1362 fathoms.

Previously all the specimens known had been received from the Gloucester fishermen, who had taken them on the banks off Nova Scotia and Newfoundland.

Eledone verrucosa Verrill.

Bull. Mus. Comp. Zool., vol. viii, p. 105, pls. 5 and 6, 1881; these Transactions, vol. v, p. 380, pls. 52 and 53, 1881.

A large male was taken by the Fish Hawk in 1882, at station 1123, off Nantucket, in 787 fathoms. It was taken in 1883 by the Albatross at station 2050, in 1050 fathoms; station 2051, in 1106 fathoms; station 2077, in 1255; station 2102, in 1209 fathoms.

The male, from station 1123, which is larger than the one originally described, had lost the left arms of the 1st and 2d pairs; the former was in process of being reproduced in the form of a small, conical, white process, with a small row of minute suckers.

The body, while still living, was provided with a fold of skin along the sides and around the posterior end; the back was covered with small papillæ, not very distinct while living, and not so large as in the original specimens. The arms were nearly smooth. The lower eyelid was papillose and dark purple in color. The web between the arms, while living, was broader than described in the original examples; the marginal membrane extended to the tips of the arms, and was broadest on the ventral side, so that the tips of the arms were strongly curled by the contraction of the membrane. The hectocotylized arm bears but thirty-nine suckers proximal to the modified tip; the papilla at the base of the modified tip is prominent, conical, with a white groove; the terminal appendage is crossed by about seven faint transverse folds. The color was dark purplish brown, with obscure roundish lighter spots on the dorsal

surface, mostly surrounding the verrucæ. Although still alive, when brought on deck, this specimen was, of course, much injured, and lived only for a short time.

Three of the specimens taken by the Albatross are smaller than any previously seen, but have the same general character as the large ones. In life the verrucæ showed but slightly.

Measurements of the large male specimen above described :

Total length	292 ^{mm}	Length of hectocotylized arm...	157
From tip of body to center of eye	78	Length of modified tip.....	11
Breadth of the body.....	75	Length of spoon-shaped organ ..	7
Breadth of head across the eyes..	72	Length of ventral arms.....	197
Length of dorsal arms from mouth	235	Greatest breadth of the lateral	
Length of 2nd pair of arms.....	250	arms.....	15
Length of 3rd pair of arms (left		Diameter of the largest sucker..	5
side.....	222		

Stauroteuthis syrtensis Verrill.

American Journ. Sci., vol. xviii, p. 468, 1879; these Transactions, vol. v, p. 382, pl. 32, figs. 1-5, 1881.

The Albatross took a very young specimen of this remarkable species at station 2034, in 1346 fathoms.

The total length of this specimen is 21^{mm}; length of head and body, 11^{mm}; length of one of the fins, from base to tip, 9^{mm}; from front to back edge, 3^{mm}. In all essential characters this young specimen agrees well with the larger mutilated specimen originally described by me. The siphon and branchial opening have the same remarkable form and structure. The interbrachial membrane is nearly as broad as the length of the arms, and as a broad margin, extends to their tips.

The only specimen previously known was taken by the Gloucester fishermen, on Banquereau, off Nova Scotia, in about 250 fathoms.

Bela mitrula Lovén.

Bela concinnula Verrill, these Transactions, vol. v, p. 468, pl. 43, fig. 15; pl. 57, fig. 11.

Bela mitrula Bush, Proc. U. S. Nat. Mus., vol. vi, p. 237, 1883.

Dr. H. Friele has sent me typical specimens of *Bela mitrula* Lovén, from the coast of Norway, which appear to be perfectly identical with my *Bela concinnula*, var. *acuta*, which is found on the American coast from off Cape Cod to Labrador. Since the typical *concinnula* seems to be only a variety of the same species, it may be best to designate it as *Bela mitrula*, var. *concinnula*.

Bela Sarsii Verrill.

Verrill, these Transactions, vol. v, p. 484, 1881.

Bush, Proc. U. S. Nat. Mus., vol. vi, p. 237, pl. 9, fig. 8, 1883.

Miss Bush has recorded this species from Labrador, at Forteau Bay, L'anse au Loup, in 10 to 20 fathoms, and from Murray Bay, mouth of the St. Lawrence River.

These specimens agree well with those from the Norwegian coast.

This species is closely allied to *B. impressa* Mörch, from Spitzbergen.

Pleurotomella bandella (Dall).

Pleurotoma (Mangilia) bandella Dall, op. cit., p. 59, 1881.

Pleurotomella Diomedæ Verrill, this volume, p. 152, 1884.

PLATE XXXI, FIGURES 5, 5a.

After the earlier pages of this article had been printed I had an opportunity to compare our species of *Pleurotomidæ* with those obtained by the Blake Expedition in the West Indian seas, and now in the hands of Mr. Dall, who has described most of them, and who kindly aided me in making the comparisons.

The species described above as *P. Diomedæ* appears, on comparison of the type-specimens, to be identical with *P. bandella* Dall. The other species described by Mr. Dall all appear to be distinct from those described by me, but our *P. Emertoni* (p. 154) is identical with one of his undescribed species.

Mangilia cerina (Kurtz and Stimpson) Verrill.

These Transactions, vol. v, p. 488, fig. 1, 1881.

PLATE XXIX, FIGURES 16, 16a.

Animal translucent white, with flake-white specks on the foot and other parts. Foot short, truncate, or obtusely rounded in front, with the angles little or not at all prominent. Tentacles rather long, very slender, with conspicuous black eyes close to the ends, the tips extending slightly beyond the eyes, as small papillæ. Head small. No operculum.

Found living in Buzzard's Bay, at Quisset, Mass., in 3-5 fathoms, Sept. 4, 1882.

Taranis Morchii, var. **tornatus** Verrill, nov.

Two specimens from station 2077, in 1255 fathoms, are somewhat stouter than those previously obtained, and have the principal carina, forming the shoulder, larger and more prominent than usual, but it bears only very minute tubercles, corresponding to the very fine and close riblets which cross the wide and abruptly sloping subsutural band obliquely, and are about twice as numerous and much finer than in the ordinary variety. On the last whorl there are about six prominent, distant, revolving cinguli below the shoulder, besides some faint ones on the base of the canal; the space between the uppermost of these and the shoulder-carina is greater than usual. The lines of growth are much finer than in the ordinary form and do not take the appearance of riblets on the last whorl, nor do they render the cinguli nodulous. The suture is sharply impressed, and the raised revolving line usually present just below the suture is absent. This form, therefore, is characterized by the relative predominance of the spiral sculpture over the transverse, and by the absence of distinct nodules at the crossing of the two systems of lines.

Length, 5^{mm}; breadth, 3^{mm}; length of aperture, 2·6^{mm}; its breadth, 1^{mm}.

Sipho lividus (Mörch).

Verrill, these Transactions, vol. v, p. 507, 1881

Bush, Proc. U. S. Nat. Mus., vol. vi, p. 238, pl. 9, fig. 12, 1883.

Miss Bush has recorded this species from Labrador, at Henley Harbor and Dead Island, in 1 to 8 fathoms.

The figure referred to represents the same form as that which was described by me from the Gulf of St. Lawrence, and which has been referred by Whiteaves and others to *S. Spitzbergensis*.

Tritonofusus cretaceus (Reeve.)

Tritonofusus Krøyeri Verrill, these Transactions, vol. v, p. 510 (*non* Möller.)

Tritonofusus cretaceus Bush, Proc. U. S. Nat. Mus., vol. vi, p. 238, 1883.

Miss Bush has recorded this species from Labrador, in 3 to 10 fathoms.

A comparison of our American shell with specimens of the true *T. Krøyeri*, from the coast of Norway, sent to me by Dr. Friele, shows that they are two entirely distinct species.

Volutopsius Norvegicus (Chemn.) Mörch.

Verrill, these Transactions, vol. v, p. 511, 1881.

Shell ovate in outline, with a large expanded mouth. Spire short; whorls five, rapidly enlarging. Nuclear whorls smooth, rather large, mammilliform, making the spire obtuse at tip, the two first whorls increasing but little in breadth. The body-whorl is very large, with the shoulder well rounded, suture well-marked. Aperture large, almost semicircular, the outer lip regularly curved, the margin everted and sharp. Columella with a concave bend in the middle and a slightly prominent twisted lobe at the base of the siphon, which is short, broad, open, and but slightly curved. No obvious sculpture, except rather conspicuous lines of growth, parallel with the edge of the lip. A large, smooth, glazed area in front of the columella on the body-whorl. Color externally white, tinged with brown; nucleus yellowish; interior pink, the edge of the lip flesh-color.

Length, 72^{mm}; breadth, 44^{mm}; length of aperture, 54^{mm}; its breadth, 24^{mm}; diameter of the first nuclear whorl, 6^{mm}.

From the Flemish Cap, E. of Grand Bank, in 75 fathoms, Wm. Garrett, 1878.

Buccinum Tottenii Stimpson.

Verrill, these Transactions, vol. v, p. 496, 1881.

Bush, Proc. U. S. Nat. Mus., vol. vi, p. 239, pl. 9, fig. 13, 1883.

This species has been recorded by Miss Bush from Henley Harbor and Temple Bay, Labrador, in 8 to 15 fathoms.

The excellent figure referred to, illustrates the typical, well developed form of this species.

Anachis Haliæti (Jeffreys).

Columbella haliæti Jeffreys, Brit. Conch., iv, p. 356, 1867.

Anachis Haliæti Verrill, Amer. Jour. Sci., vii, pp. 405, 503, 1874.

Pyrene costulata G. O. Sars, Moll. Reg. Arct. Norvegiæ, p. 252, pl. 23, fig. 16 (*non*

Fusus costulatus Cantraine.)

Anachis costulata Verrill, these Transactions, vol. v, p. 513, pl. 43, fig. 7.

Columbella haliæti Jeffreys, Proc. Zool. Soc. London, for 1883, p. 392 (synonymy.)

Although Mr. Jeffreys, in some of his recent papers, followed Monterosato and G. O. Sars in the identification of this species with the *Fusus costulatus* of Cantraine, in the paper last quoted he states that the true *F. costulatus* belongs to the genus *Pleurotoma*. He therefore restores the name, *Haliæti*, for this species. I have no

reason to doubt the correctness of this decision, and therefore follow him in making this change.

Dolium Bairdii Verrill and Smith (MSS.)

Verrill, these Transactions, vol. v, p. 515.

PLATE XXIX, FIGURES 2, 2a, 2b.

This species was taken in 1882 at station 1092, in 202 fathoms, one young dead; station 1097, in 158 fathoms, two young dead, with large fragments; station 1109, in 89 fathoms, one young dead; station 1113, in 192 fathoms, one living; and fragments were also taken at stations 1117, 1120, 1121, and 1154, in 89 to 234 fathoms. An unusually large living specimen was taken by the Albatross at station 2004, N. lat. $37^{\circ} 19' 45''$, W. long. $74^{\circ} 26'$, in 98 fathoms, March 23d, 1883 (No. 35,655).

Mr. Dall thinks this species is identical with one from the Mediterranean.

Assiminia modesta (Lea) Verrill.

Cingula modesta H. C. Lea, Proc. Boston Soc. Nat. Hist., i, p. 205, 1845; Boston Journ. Nat. Hist., v, p. 288, pl. 24, fig. 5, 1845.

Assiminia Grayana Verrill, Amer. Journ. Sci., xx, p. 250, September, 1880 (*non* Leach); Trans. Conn. Acad., v, p. 525, pl. 58, fig. 7, 1882.

Shell small, conical, with a regularly tapering, acute spire, with a smooth, somewhat glossy surface, usually light chestnut-brown in color. Whorls about six in the largest specimens, moderately convex, with the suture well impressed, but not deep, usually showing by translucency an internal sutural line just below the suture. There is no distinct sculpture unless microscopic and very indistinct lines of growth. Apical whorl very minute, regularly spirally coiled, slightly prominent, so as to produce a very acute apex. Last whorl very large, somewhat swollen, forming more than half the length of the shell. Base moderately produced, without any umbilicus, and destitute of sculpture. Aperture short-ovate, with an acute angle posteriorly, broadly rounded in front, with the inner margin oblique and only slightly sinuous; the outer lip is thin and sharp, convex and evenly rounded; the columella-margin is excurved, with the edge thickened and slightly everted, closely covering the umbilical region; it joins the anterior margin in a regular curve and continues along the margin of the body-whorl in a slightly sinuous line, forming there a distinct but closely adherent inner lip, consisting of a thin deposit continuous with the deposit of the umbilical region. Operculum subspiral, translucent, chestnut-brown. The shell is

usually light chestnut-brown, more or less lustrous, somewhat translucent, but it is sometimes tinged with greenish or grayish brown, in color conforming to the sea-weeds on which it lives.

Length of the largest specimens, about 3^{mm}; breadth, 2^{mm}; length of body-whorl, about 2^{mm}; of aperture, about 1^{mm}.

Newport, R. I., at high water mark, among decayed sea-weed, 1880; Huntington, L. I., between tides, (coll. Telkampff); near Brooklyn (Lea.)

This species, when found by me in 1880, was identified with *A. Grayana*, but the specimens obtained at that time were immature. An examination of larger and more mature specimens, from Huntington, L. I., and a direct comparison with a series of specimens of *A. Grayana*, sent to me by the Rev. A. M. Norman, has convinced me that, though closely related, they must be considered distinct species, unless *A. Grayana* be more variable than is indicated by European writers. Our species, when with the same number of whorls, is less than half the size of *A. Grayana*, and it has, proportionally, a much more slender form, with a more acute spire and more minute nucleus. The aperture is much smaller and narrower and the whole shell is much more delicate in form and texture. The color is a clearer chestnut-brown than any of the European specimens which I have seen, though this is, perhaps, a character of no great importance. In habits and in the situations in which it is found, it agrees precisely with the European species, with which it also agrees in the structure of the soft parts, as shown by the figure formerly published by me.

Eulima stenostoma Jeffreys.

Verrill, these Transactions, vol. v, p. 536.

This species, not previously known on our coast south of the Gulf of St. Lawrence, was taken in 1883 by the Albatross at stations 2043, 2076, 2084, 2096, 2103, in 906 to 1467 fathoms, and at station 2115 off Cape Hatteras, in 843 fathoms.

Margarita regalis Verrill.

These Transactions, vol. v, p. 530, pl. 57, fig. 37.

Specimens of this species were taken by the Albatross considerably exceeding in size those originally described by me. By Jeffreys (Proc. Zool. Soc. London for 1883, p. 98) this species has been identified as *Trochus Ottoi* Philippi,* which he also considers identical

* *Trochus Ottoi* Philippi, Moll. Sic., vol. ii, p. 227, pl. 28, fig. 9.

with *T. rhysus* and *T. ægleës* Watson and *T. Vaillanti* Fischer. The first named is fossil in the Pliocene of Calabria and Sicily. The recent form has been taken off the European coast, from off the Faroe Islands to the Bay of Biscay and Mediterranean, and by the Challenger in the West Indies, off St. Thomas.

The typical specimen of *T. ægleës* Watson, which I have examined, although having some resemblance to our shell, differs so much in many respects that, considered by themselves, they certainly appear to me very distinct species. I have not seen the fossil *T. Ottoi*, and am, therefore, unable to express any decided opinion as to the identity of the recent and fossil forms, especially as Mr. Jeffreys himself admits a considerable amount of variation in respect to the sculpture and umbilicus. These forms are doubtless closely allied, if not identical. *T. ægleës* appears to be nearer our *M. lamellosa*, with which Mr. Dall has even united it.

Cyclostrema Dalli Verrill, var. **ornatum**, nov.

Cyclostrema Dalli Verrill, these Transactions, vol. v, p. 513, pl. 57, fig. 39.

PLATE XXXII, FIGURE 17.

Among the specimens of this species there is one from station 2115, in 843 fathoms (No. 35,610) which, although agreeing in form and condition of the umbilical region with the original type, is very peculiarly marked on the base by thin, impressed lines, running obliquely and crossing the concentric spiral lines at a large angle, so as to produce a sort of "herring-bone" pattern as shown in our figure. This form, if persistent, should undoubtedly receive a varietal name. It may therefore be designated provisionally as var. *ornatum*.

This species would probably belong to the genus *Tharsis*, according to Jeffreys' classification, but as already stated, I doubt the validity of that generic division.

Fissurella Tanneri Verrill.

Proc. U. S. National Mus., vol. v, p. 333, 1882.

PLATE XXIX, FIGURES 13, 13a.

This species is closely allied to *Fissurella redimicula* Say,* originally described from the Miocene of Maryland. The latter, however, judging from three specimens which I have examined, is distinct, although it is probably the direct ancestral form from which the modern species has been derived. The fossil specimens are

* Journ. Acad. Nat. Sci. Phil., iv, p. 132, pl. 8, fig. 1, 1824.

relatively shorter and broader and more regularly elliptical than the recent ones, as well as higher and more conical; they also have the aperture more central. In sculpture the two forms are very similar, but the fossil specimens have the sculpture decidedly coarser, with the radiating lines stouter, more elevated, and more unequal, one stronger rib alternating usually with three to five smaller ones, while in *F. Tanneri* no such marked inequality exists. The apical pore and the internal callus are very similar in the two shells, but the pore is perhaps a little larger in the living form. A larger series of both the living and the fossil form might, however, show that they are both variable, and possibly grade into one another.

Addisonia paradoxa Dall.

Verrill, these Transactions, vol. v, p. 533.

PLATE XXIX, FIGURES 10, 11, 11a, 11b.

Mr. Dall has called my attention to the remarkable peculiarities in the structure of the animal of the male, which differs widely in appearance from the female (see our fig. 11b), owing to the fact that the large verge is closely united at base with the right tentacle.

Additional specimens were taken in 1882, living, at stations 1098, 1109, 1110, 1124, in 89 to 640 fathoms; and in 1883, at station 2011, in 81 fathoms, off Chesapeake Bay.

Choristes elegans, var. *tenera* Verrill.

These Transactions, vol. v, p. 541, pl. 58, figs. 27, 27a.

PLATE XXIX, FIGURES 9, 9a, 9b.

This species was taken in 1882 at station 1096, in 317 fathoms; station 1124, in 640 fathoms; and 1154, in 193 fathoms (one dead).

At station 1124 about twenty-five living specimens occurred in the empty egg-case of a skate (*Raia* sp.), in the same manner as those taken in 1881. They were associated with a limpet, *Propilidium pertenuis*? Jeffreys.

Young specimens of various sizes occurred in these instances with the adults. Three of these young specimens are figured on our plate 29. The youngest examples noticed consisted of about one and a half whorls; these are very small, white, regularly coiled, with the whorls well-rounded and increasing rapidly in size. The aperture is nearly round and somewhat oblique, with the lip perfectly continuous. The umbilicus is rather large and open and shows the previous whorls to the apex.

Cadulus Jeffreysii? Monterosato.

Verrill, these Transactions, vol. v, p. 559, 1882.

A number of good specimens, referred to this species with doubt, were taken off Cape Hatteras, at station 2115, in 843 fathoms. These are pretty regularly fusiform and taper gradually to both ends, the posterior end being decidedly smaller than the anterior. The inner or ventral side is usually nearly straight, but often somewhat concave, while the outer or dorsal side is pretty strongly and nearly regularly curved. The aperture is decidedly obliquely truncated, but is nearly circular in a direct end-view. These specimens differ, therefore, from *C. Jeffreysii*, as figured and described by Jeffreys, in being less swollen medially, and more regularly tapered posteriorly, and especially in not being suddenly contracted and curved near the posterior end, as figured by him. It is possible, however, that these differences may be only unimportant variations, and I therefore refer this shell, for the present, to the European species.

Our specimens are mostly 5^{mm} in length, and about 1^{mm} broad, in the middle.

Cadulus propinquus? G. O. Sars.

Verrill, these Transactions, vol. v, p. 558, pl. 58, figs. 31, 32, 1882.

This species, like the last, is referred to the corresponding European form with much doubt. It differs especially in having the oral aperture decidedly obliquely truncated, while in the European *R. propinquus* it is described as not at all oblique, and this character is made an important one by Mr. Jeffreys. Our specimens are considerably smaller, more swollen dorsally, and relatively stouter than those we have referred to *Jeffreysii*.

The shell is short-fusiform, considerably swollen in the middle, and nearly evenly curved on the dorsal side, while the ventral side is usually nearly straight, but sometimes slightly concave, and usually slightly convex in the middle. The anterior end is gradually tapered from the middle to the aperture, which is rather large, decidedly oblique, nearly round in a front view, though often slightly compressed laterally. Behind the middle the shell tapers more rapidly to the posterior aperture, which is about two-thirds the diameter of the oral. Usually the posterior opening is simple, or nearly so, and transversely truncated, but in some specimens there is a shallow lateral notch on each side. The surface is polished and lustrous.

Length, 3^{mm}; greatest diameter, .8^{mm}. Some specimens are more slender than the ones measured.

No additional specimens have been taken since those already recorded from the collections of 1880 and 1881.

Mytilimeria flexuosa Verrill and Smith, MSS.

Verrill, Amer. Journ. Sci., xxii, p. 306, 1881; xxiv, p. 365, 1882; these Transactions, vol. v, p. 567, pl. 58, fig. 38, 1882.

The animal of this shell, in alcohol, has a small and short anal tube, surrounded by small papillæ, and a very much larger incurrent orifice, occupying a ventral position and surrounded by numerous long and large tentacle-like papillæ; the orifice for the foot is small; the edge of the mantle is bordered by very small papillæ. There is a slender, translucent byssus. The hinge-ligament is strengthened by a distinct ossicle, placed lengthwise, more or less ovate in form, with the smaller end next to the hinge-teeth, and somewhat truncated.

Additional specimens were taken at station 1093, in 349 fathoms, 1882 (two living), and at station 2079, in 75 fathoms, 1883 (one large dead shell).

Pecchiolia gemma Verrill.

These Transactions, vol. v, p. 565, 1882.

PLATE XXX, FIGURES 7, 8.

Ossicle longitudinal, with the posterior end broadest and notched in the middle, the narrower anterior end truncated.

Three additional specimens of this species were taken at station 1093, in 349 fathoms, 1882; living specimens were also taken in 1883 at stations 2076 and 2078, in 906 and 499 fathoms; and dead valves at station 2077, in 1255 fathoms; station 2084, in 1290 fathoms; and station 2079, in 75 fathoms.

Venericardia granulata Say.

Say, Journ. Acad. Nat. Sci., vol. iv, p. 142, pl. 12, fig. 1, 1824.

Cardita granulata Conrad, Fossils of the Medial Tertiary of the U. S., p. 12, pl. 7, fig. 1, 1838.

Cardita borealis Conrad, Amer. Mar. Conch., p. 39, pl. 8, fig. 1, 1831.

Gould, Invert. Mass., Binney's edition, p. 146, fig. 455.

A direct comparison of fossil specimens from the Miocene of Virginia with a large series of recent specimens from various localities along our coast, both northern and southern, shows that the fossil

form cannot be regarded as specifically distinct from the recent shells. The latter show much greater differences among themselves than those that distinguish the fossil from the ordinary form, known as *V. borealis*, while all the variations are connected together by intermediate forms.

I also consider *V. Novangliae* Morse, a mere variation of this common and variable species, hardly to be distinguished as a variety. It differs mainly in its thinner texture, lighter hinge-plate, and more transverse form—characters that are due partly to immaturity and partly to unfavorable conditions of growth.

Living shells, of the typical form of *V. borealis*, have been dredged by the U. S. Fish Commission, off the eastern coast of Virginia, where it is not uncommon, at moderate depths (57 to 150 fathoms).

Loripes lens Verrill.

These Transactions, vol. v, p. 569, 1882.

Jeffreys, in Proc. Zool. Soc. London, for 1882, p. 685, identifies our species with the *Loripes lacteus* of Europe. I am unable to accept this identification. Although allied forms, they seem to me as distinct as other species of this group.

Leda acuta (Conrad).

Nucula acuta Conrad, Amer. Mar. Conch., pl. 6, fig. 3.

Leda unca Verrill, Proc. U. S. Nat. Mus., iii, p. 401, 1880; these Transactions, v, p. 572, pl. 58, fig. 41, 1882 (? non Gould).

Leda acuta Tryon, Amer. Mar. Conch., p. 182, pl. 38, fig. 496 (poor).

? *Leda commutata* Philippi.

PLATE XXX, FIGURE 15.

Although this species was referred by me to *Leda unca* Gould, later investigations have rendered this identification doubtful. It is, however, as indicated in my former papers, probably identical with *L. acuta* Conrad, which was described much earlier. By Jeffreys it has been referred to *L. fragilis* (Chemn., sp.), which he considers identical with *L. commutata* Philippi. The identification of Chemnitz's figure is doubtful, and moreover he was not a binomial writer; it is therefore useless to attempt to restore his name. Not having seen authentic specimens of *L. commutata* (*L. fragilis* Jeffreys) from Europe, I am unable to express any decided opinion as to its identity with our shell. In any case, *acuta* seems to be the oldest available name for our shell.

In this shell the posterior dorsal area, when seen from the dorsal

side, is regularly elliptical and pretty clearly defined by the ridges running from the beak to the posterior tip; this area is covered by rather prominent, thin, or somewhat lamelliform, divergent ribs, which are regularly and rather closely arranged and somewhat narrower than their interspaces, distally; these ribs usually cover the whole surface, close up to the dorsal edge, which forms a somewhat prominent, sharp and nearly straight carina, but is not compressed and thin, as in some other related species. Within the dorsal area there is no circumscribed area, such as figured by D'Orbigny in *L. Jamaicensis*, with which Mr. Dall identifies our shell. Moreover, the anterior lunule, represented as very distinct in the latter, is obscure and often entirely wanting in our shell. When visible at all, the lunular area is narrow, elongated and defined only by the interruption of the concentric ribs, just before reaching the hinge-margin, leaving a nearly smooth dorsal area between the umbos. Moreover, on the anterior end of the shell there are two rather faint, slightly raised ridges, or waves, a short distance apart, extending from the beak to the anterior ventral margin, and having the area between them slightly concave, corresponding to a flattened or slightly concave space on the margin, where it terminates; this slight undulation, bordered by two small crests, is, however, usually less distinct than represented in our figure. The posterior end is decidedly acute with a distinct emargination below it, but the ridge, which runs from the beak to the posterior tip, though somewhat prominent, is obtusely rounded and decidedly less developed than in *L. Jamaicensis*. The concentric ribs are clearly defined, usually very regular, obtusely rounded, or frequently with the edge reflexed anteriorly, and often rising into little angles or points in crossing the posterior ridge; the interspaces are rather deep, nearly smooth, and usually about twice the breadth of the ribs on the sides of the shell. The epidermis is closely adherent and usually dark olive-green.

Well-grown specimens are frequently 13^{mm} long; 8^{mm} broad; and 6^{mm} thick; from the beak to the posterior tip, 8^{mm}.

A species closely related to this, but evidently distinct, which is most likely the true *L. unca* Gould, was dredged by the Albatross off Cape Hatteras in 14 to 48 fathoms, in considerable numbers.

This shell is more solid, more ovate, and more swollen medially, with the beak nearly central, the posterior end very acute, and the posterior dorsal margin slightly concave, while the concave dorsal area is defined by a rounded and not very prominent ridge. The umbos are nearly smooth, polished and lustrous in the adult dead

shells, but concentrically lined in the young. The surface is elsewhere covered with pretty regular and not very close, slightly elevated concentric lamellæ, which are sometimes more or less reflexed at the anterior end, while on the posterior dorsal area they are thin, more elevated, nearly straight and divergent. There is no distinctly defined lunular area, nor any definite radiating ridges running from the beak to the anterior margin, though a very indistinct undulation may sometimes be detected. The ventral margin is pretty regularly curved and shows no indentation below the acute posterior tip.

Amussium, sp.

Amussium fenestratum Verrill, these Transactions, vol. v, p. 582 (non Forbes).

Mr. W. H. Dall has called my attention to the fact that the American specimens formerly referred by me to the species quoted are specifically distinct from the European types. I have been able to confirm this opinion by direct comparison of our shell with typical specimens sent to me by the Marquis de Monterosato. Our shell has a peculiar transverse striation on the hinge-margin not seen in the European specimens, and not more than two internal ribs, one on each side. The sculpture, also, is finer.

Pecten pustulosus Verrill.

Pecten Hoskynsi and var. *pustulosus* Verrill, these Transactions, vol. v, p. 581, pl. 42, figs. 22, 22a; pl. 44, fig. 11 (non *P. Hoskynsi* Forbes).

By Mr. W. H. Dall, who has made a special study of the shells of this group, our American species is believed to be distinct from the typical Mediterranean form, with which he has been able to compare them directly. Although they are closely similar in form and external sculpture, our specimens differ in the hinge and in the absence of internal radiating ribs, characteristic of the genus *Amussium*, and which are present in the true *A. Hoskynsi*.

Possibly *P. imbrifer* Lovén may be identical with *P. pustulosus*, and not with *A. Hoskynsi*, to which it has been referred. In that case Lovén's name would have priority.

Pecten Clintonius Say.

Pecten Clintonius Say, Journ. Acad. Nat. Sci. Phil., iv, p. 124, 1824, pl. 9, fig. 2.

Pecten tenuicostatus Mighels, Proc. Bost. Soc. Nat. Hist., i, p. 49, 1841 (young).

Pecten principoides Emmonds, Report N. C. Geol. Survey, 1858, p. 280, fig. 198.

A comparison of specimens of this Miocene species, from Surrey, Va., with the more strongly ribbed, deep-water form hitherto

recorded by me as *Pecten tenuicostatus*, var. *aratus*, shows that they are in all respects essentially identical. In the fossil specimens the ribs are much stronger and more regular than in ordinary specimens of *P. tenuicostatus*, but not more so than in many deep-water specimens taken in 65 to 125 fathoms, off Martha's Vineyard; while among the numerous specimens dredged by us, all gradations between the strongly ribbed form and those forms, common in shallow water, in which the ribs are much more slender, indistinct, or almost obsolete. The forms of the main shell and of the auricles are the same, however, in all these varieties. The fossils, like all the recent specimens, show the peculiar, fine, oblique striæ or vermiculations between the ribs, both on the body of the shell and on the auricles. In the fossil specimens the ribs, especially those towards the ends of the shell and on the auricles, are crossed by the raised lines of growth in such a way as to form small, rather close, distinctly arched, raised scales; this character, which is not usually seen in the smoother, shallow-water form, is found in many of the deep-water specimens quite as prominently, or even more so, than in the fossil.

There being no doubt, therefore, of the identity of the fossil and recent shells, the name, *Clintonius*, should be adopted for the species, on account of its priority, while the name, *tenuicostatus*, may well be retained to designate the ordinary smoothish, mostly shallow-water variety, found on the New England coast. This name was originally given by Dr. Mighels to very young specimens of this smoothish variety, under the impression that they were a distinct species, but he afterwards recognized the fact that they were only the young of the common species, at that time generally known as *Pecten Magellanicus* Lam.

The following species should have been inserted on page 206.

Propilidium pertenuæ? Jeffreys.

Proc. Zool. Soc. London, for 1882, p. 674, pl. 50, fig. 7.

Four or five specimens of a small limpet occurred at station 1124, in 640 fathoms, in the egg-case of a species of *Raia*, associated with *Choristes elegans*. These agree in most respects with *P. pertenuæ* Jeff., but the beak is nearer to the posterior margin, and the shell is thin and opaque white, without much luster, even when living, but the surface is nearly smooth, though showing slight but distinct lines of growth and sometimes faint traces of microscopic radiating lines, in this respect and the position of the beak resembling more *P. compressum* Jeff.

The form is pretty regularly elliptical. The apex is situated near the posterior margin, prominent, acute, and directed strongly backward; it consists of rather more than one small coil, which is regularly incurved and not distinctly turned to one side. The internal septum is narrow and transverse.

Although not agreeing exactly with either of Jeffreys' species, I refer it doubtfully to *P. pertenuē*.

List of Deep-water and Surface Mollusca taken off the East Coast of the United States by the U. S. Fish Commission steamers, Fish Hawk and Albatross, 1880 to 1883.

The following list includes all the species hitherto dredged along the Gulf Stream slope, from off Cape Hatteras to Nova Scotia, except a small number of minute species, not yet fully identified. In general, those species that have not occurred below 60 fathoms are omitted. But the surface species of Heteropoda, Pteropoda, etc., belonging to the Gulf Stream region, are included, whether taken living at the surface or dead from the bottom.

The "Bathymetrical range" refers only to the range as actually observed in this region by the Fish Commission, unless otherwise stated. The geographical distribution is indicated, in a general way, by the abbreviations following the range in depth, but it is not intended to be complete in this respect. Owing to the uncertainty in respect to the alleged identity of the species recorded from other regions with our own, and to the incompleteness of the published lists of species collected by various recent dredging expeditions, the knowledge of the foreign distribution of many of these species is still very imperfect and sure to be largely increased within a few years, so that any facts of this kind that can now be given will have, at best, only a temporary value. The abbreviations are as follows: N. = northern, indicates that the species ranges northward along the American coast, beyond New England waters; S., = southern, southward beyond Cape Hatteras; Arc., = Arctic; Eu., = European; Med., = Mediterranean; Af., = West African; P., = North Pacific; As., = North Asia; Cb., = Caribbean Sea and West Indies; Oc., = Oceanic or pelagic.

After the names, references are given to the pages and plates where the species are described or figured in this volume (vi) or the

preceding volume (v) of these Transactions. As it is always important, in giving the bathymetrical distribution of shells, to distinguish between those taken alive and those of which only dead shells are obtained (which may have been carried by fishes and various other agencies far from their true habitats), an asterisk (*) is added to designate living specimens; while a dagger (†) indicates dead shells. When no sign is added, it is to be understood that the specimens were living.

In the preparation of the following list I have been greatly aided by my assistant, Miss K. J. Bush, who has been engaged for several years in cataloguing and tabulating the shells collected by the Fish Commission.

CEPHALOPODA.

- Lestoteuthis Fabricii* (Licht.) V. v, 291, 390, pl. 45, f. 1-2*d*; pl. 46, f. 1-1*f*; pl. 55, f. 1-1*d*.
Bathymetrical range, 255 to 906 fathoms. N., Arc., P.
- Abralia megalops* V. vi, 143, pl. 28, f. 2.
B. range, 173 f. Cb.
- Ommastrephes illecebrosus* (Les.) V. v, 268, pls. 28, 29, 37, 38, 39.
B. range, 0 to 1022 f.; beaks 1091 to 1917 f. N.
- Sthenoteuthis Bartramii* V. v, 288.
Surface.* Southern. Oc.
- Mastigoteuthis Agassizii* V. v, 297, pl. 48; pl. 49, f. 2, 3-3*g*; vi, 243.
B. range, 640 to 1050 f.
- Chiroteuthis lacertosa* V. v, 299, 408, pl. 47, f. 1-1*b*, pl. 56, f. 1-1*f*; vi, 243.
B. range, 435 to 2221 f. (2949, arms). N.
- Leptoteuthis diaphana* V. vi, 141, pl. 32, f. 1.
B. range, 1731 f.
- Brachioteuthis Beanii* V. v, 406, pl. 55, f. 3-3*b*; pl. 56, f. 2-2*a*; vi, 245.
B. range, 183 to 843 f.
- Calliteuthis reversa* V. v, 295, pl. 46, f. 1-1*b*; vi, 243.
B. range, 365 to 2369 f.
- Histioteuthis Collinsii* V. v, 234, 300, 404, pl. 22; pl. 27, f. 3-5; pl. 37, f. 5.
B. range, 372 f. (beaks). Northern.
- Desmoteuthis hyperborea* (Steenst.) V. v, 302, pl. 27, f. 1-2; pl. 39, f. 1.
B. range, 641 f., off Chesapeake Bay. N., Arc.
- Desmoteuthis tenera* V. v, 412, pl. 55, f. 2-2*d*; pl. 56, f. 3; vi, 245.
B. range, 369 to 1346 f.
- Stoloteuthis leucoptera* V. v, 347, 418, pl. 31, f. 4-5; pl. 54, f. 4.
B. range, 182 to 640 f. N. of Cape Cod.
- Rossia megaptera* V. v, 349, pl. 38, f. 1; pl. 46, f. 6; vi, 245.
B. range, 640 f. Northern.
- Rossia Hyatti* V. v, 351, pl. 27, f. 8, 9; pl. 30, f. 1; pl. 31, f. 1, 2; pl. 46, f. 5.
B. range, 44 to 317 f. N. of Cape Cod. Northern.

- Rossia sublevis* V. v, 354, 419, pl. 30, f. 2; pl. 31, f. 3; pl. 46, f. 4; pl. 47, f. 2-4.
 B. range, 115 to 640 f. N.
- Heteroteuthis tenera* V. v, 357, 419, pl. 46, f. 2-2d, 3-3b; pl. 47, f. 5-5b.
 B. range, 18 to 301 f., eggs 317 f.
- Argonauta argo* Linné. v, 364, 420; vi, 247, pl. 28, f. 1-1b.
 B. range, shells, 64 to 1917 f.; living at surface. Oc., Cb., S., Med.
- Alloposus mollis* V. v, 366, 420, pl. 50, f. 1-2a; pl. 51, f. 4; vi, 247.
 B. range, 238 to 1346 f.; frag. 1735 f.
- Octopus Bairdii* V. v, 368, 421, pl. 33, f. 1, 1a; pl. 34, f. 5, 6; pl. 36, f. 10; pl. 38, f. 8; pl. 49, f. 4, 4a; pl. 51, f. 1, 1a.
 B. range, 85 to 843 f.; 28 to 300 f. N. of Cape Cod. N., Eur.
- Octopus piscatorum* V. v, 377, pl. 36, f. 1, 2; vi, 248.
 B. range, 1362 f. Northern.
- Octopus lentus* V. v, 375, pl. 35, f. 1, 2; pl. 51, f. 2.
 B. range, 120 to 603 f. (Blake Exp.) Northern.
- Octopus Carolinensis* V. vi, 235.
 B. range, 142 f., off Cape Hatteras.
- Octopus gracilis* V. vi, 236.
 B. range, 1290 f.
- Eledone verrucosa* V. v, 380, pls. 52, 53; vi, 248.
 B. range, 787 to 1255 f.
- Eledonella pygmaea* V. vi, 145, pl. 32, f. 2.
 B. range, 2949 f., off Chesapeake Bay.
- Stauroteuthis syrtensis* V. v, 382, pl. 32, f. 1-5; vi, 249.
 B. range, 499 f., off Nova Scotia. N.

GASTROPODA.

TOXOGLOSSA.

- Admete Couthouyi* Jay (= *A. viridula* Gld.)
 B. range, 155 to 1255 f. N., Arc., Eu.
- Pleurotoma Dalli* V. and S. v, 451, pl. 57, f. 1-1a.
 B. range, 94 to 142 f.*; 146 f.†
- Pleurotoma Carpenteri* V. and S. v, 452, pl. 57, f. 2.
 B. range, 86 f.†; 100 to 155 f.*
- Pleurotoma comatotropis* Dall. v, 452.
 B. range, 100 f.† Cb.
- Daphnella limacina* (Dall.) v, 452.
 B. range, 368 f. Cb.
- Pleurotomella Packardii* V. v, 453, pl. 43, f. 9; pl. 57, f. 5.
 B. range, 193 f.†; 85 to 110 f. N. of Cape Cod.
- Pleurotomella Agassizii* V. and S. v, 454, pl. 57, f. 3, 3a.
 B. range, 39 to 1309 f.*; 1608 f.†
- Pleurotomella Bairdii* V. and S. vi, 147, pl. 31, f. 1.
 B. range, 1608 to 1731 f.*; 2221 f.†
- Pleurotomella Pandionis* V. v, 456, pl. 57, f. 4, 4a.
 B. range, 238 to 310 f.†; 319 f.*

- Pleurotomella Benedicti* V. and S. vi, 148, pl. 31, f. 2, 2a.
B. range, 1290 f.
- Pleurotomella Sandersoni* V. vi, 149, pl. 31, f. 3, 3a.
B. range, 1290 to 2033 f.
- Pleurotomella Saffordi* V. and S. vi, 151, pl. 31, f. 4, 4a.
B. range, 843 to 1608 f.
- Pleurotomella bandella* Dall=*P. Diomedæ* V. vi, 152, 250, pl. 31, f. 5-5a.
B. range, 1290 to 2033 f. Cb.
- Pleurotomella Emertoni* V. and S. vi, 154, pl. 31, f. 6.
B. range, 1917 f.† Off Chesapeake Bay. Cb.
- Pleurotomella Bruneri* V. and S. vi, 155, pl. 31, f. 7, 7a.
B. range, 1608 f.*; 2033 f.†
- Pleurotomella Catharinae* V. and S. vi, 155, pl. 31, f. 9, 9a.
B. range, 843 to 2033 f.
- Gymnobela engonia* V. vi, 157.
B. range, 906 to 1451 f.†; 1608 f.*
- Gymnobela curta* V. vi, 158, pl. 31, f. 10.
B. range, 813 to 1290 f.*; 1467 to 1917 f.†
- Gymnobela curta*, var. *subangulata* V. vi, 159.
B. range, 197 to 2033 f.†; 1290 to 1451 f.*
- Bela* (?) *tenuilirata* Dall. v, 463.
B. range, 365 f.† P.
- Bela hebes* V. v, 459, pl. 57, f. 7.
B. range, 252 to 906 f.*; 1290 to 2033 f.†
- Bela pygmaea* V. v, 460, pl. 57, f. 8.
B. range, 312 to 1290 f. N.
- Bela incisula* V. v, 461, pl. 43, f. 12; pl. 57, f. 14.
B. range, 18 to 480 f.† N.
- Bela Gouldii* V. v, 465, pl. 57, f. 6, 6a.
B. range, 300 f.† (6½ to 122 f., N. of Cape Cod). N.
- Bela mitrula*, var. *concinnulla* V. v, 468, pl. 43, f. 15; pl. 57, f. 11; vi, 249.
B. range, 100 f.†; 252½ to 487 f.* N., Eu.
- Bela harpularia* (Couth.) H. and A. Ad. v, 473, pl. 43, f. 14; pl. 57, f. 9.
B. range, 10 to 28½ f.*; 368 f.† N.
- Bela cancellata* (Mighels) Stimpson. v, 475, pl. 43, f. 10, 11; pl. 57, f. 13.
B. range, 126 to 547 f.† N., Arc., Eu.
- Bela pleurotomaria* (Couthouy) Adams. v, 478.
B. range, 16 to 208 f.† N., Arc., Eu.
- Bela Rathbuni* V. vi, 236.
B. range, 1395 f.† Off Cape Hatteras.
- Bela subvitrea* V. vi, 160.
B. range, 843 f. Off Cape Hatteras.
- Bela subturgida* V. vi, 161.
B. range, 843 f. Off Cape Hatteras.
- Spirotropis ephamilla* V. vi, 162.
B. range, 1917 f.†; 2221 f.* Off Chesapeake Bay.
- Typhlomangilia Tanneri* V. and S. vi, 163, pl. 31, f. 8.
B. range, 1290 f.

- Taranis Mörchii* (Malm) Jeffreys. v, 486, pl. 57, f. 18.
 B. range, 365 f. †; 368 to 858 f.* N., Arc., Eu. Cb.
Taranis Mörchii, var. *tornatus* V. vi, 251.
 B. range, 1255 f. Off Nova Scotia.
Taranis pulchella V. v, 487, pl. 57, f. 17; vi, pl. 29, f. 8.
 B. range, 349 to 487 f.

RACHIGLOSSA.

- Marginella borealis* V. vi, 165, pl. 29, f. 4.
 B. range, 64 to 100 f. †; 66½ to 81 f.*
Volutella lachrimula Gld. vi, 166.
 B. range, 142 f.*; 516 f. † Off Cape Hatteras. S.
Buccinum Sandersoni V. v, 490, pl. 58, f. 9.
 B. range, 156 f. †; 208 to 264 f.*
Buccinum undatum Linné. v, pl. 58, f. 10.
 B. range, 6 to 123 f.*; 142½ to 843 f. † N., Arc., Eu.
Buccinum cyaneum Brug. v, 492, pl. 43, f. 5; pl. 58, f. 11.
 B. range, 101 to 150 f., off Cape Cod. N., Arc., Eu.
Buccinum abyssorum V. and S. vi, 167, pl. 31, f. 11–11b.
 B. range, 49 f. †; 906 to 1309 f.*
Sipho Stimpsonii Mörch. v, 499, pl. 57, f. 24.
 B. range, 16 to 300 f. N.
Sipho Stimpsonii, var. *liratus* V. v, 500.
 B. range, 18 f. †; 55 to 319 f.* N.
Sipho pubescens V. v, 501, pl. 43, f. 6; pl. 57, f. 25.
 B. range, 18 to 179 f. †; 192 to 640 f.* N.
Sipho pygmaeus (Gld.) V. v, 501, pl. 57, f. 21.
 B. range, 12 to 640 f. N.
Sipho pygmaeus, var. *planulus* V. v, 505 (note).
 B. range, 20 to 350 f. N.
Sipho parvus V. and S. v, 504, pl. 57, f. 20–20b.
 B. range, 193 to 906 f.
Sipho obesus V. vi, 168.
 B. range, 843 f. Off Cape Hatteras.
Sipho profundicola V. and S. vi, 170, pl. 31, f. 13.
 B. range, 1497 to 1917 f. †; 2033 f.*
Sipho profundicola, var. *dispar* V. vi, 171.
 B. range, 1555 f.
Sipho glyptus V. v, 505, pl. 57, f. 22; pl. 58, f. 1, 1a.
 B. range, 193 to 547 f.
Sipho cælatus V. v, 506, pl. 57, f. 19, 19a.
 B. range, 75 to 616 f. †; 302 to 516 f.*
Sipho cælatus, var. *hebes* V. vi, 172.
 B. range, 640 to 1255 f.
Sipho (Mohnia) *cælatus* V. vi, 172.
 B. range, 516 to 547 f. †; 906 to 1290 f.*

- Sipho* (*Mohnia*) *simplex* V. vi, 174.
B. range, 99½ f. †; 843 f.*
- Sipho* (?) *leptaleus* V. vi, 175, pl. 31, f. 16.
B. range, 452 f. †
- Sipho* (?) *hispidulus* V. vi, 239.
B. range, 2033 f.* Off Delaware Bay.
- Neptunea despecta* (Linné) Ad., var. *tornata* (Gld.)
B. range, 69 to 100 f. † off George's Bank. N., Arc., Eu.
- Neptunea decemcostata* (Say) H. and A. Ad.
B. range, 6 to 322 f. †; 41 to 86 f.* N.
- Nassa nigrolabra* V. v, 512, pl. 58, f. 12.
B. range, 155 f.*; 349 f. †
- Trophon Lintoni* V. and S. vi, 176, pl. 29, f. 1.
B. range, 70 f. †
- Trophon clavatus* Sars. vi, 176.
B. range, 843 to 2033 f. Eu.
- Urosalpinx Carolinensis* V. vi, 237.
B. range, 142 to 516 f. †; 938 f.* Off Cape Hatteras.
- Urosalpinx macra* V. vi, 239.
B. range, 142 f. †
- Anachis Haliæti* (Jeff.). v, 513, pl. 43, f. 7; vi, 252.
B. range, 79 f. †; 115 to 640 f.* N., Arc., Eu.
- Astyris diaphana* V. v, 513, pl. 58, f. 2.
B. range, 64 f. †; 100 to 487 f.*
- Astyris zonalis* (Lins.) V. v, 515.
B. range, 9 to 202 f. N.
- Astyris pura* V. v, 515.
B. range, 71 f. †; 100 to 1255 f.*

TÆNIOGLOSSA.

- Dolium Bairdii* V. and S. v, 515; vi, 253, pl. 29, f. 2-2b.
B. range, 89 to 234 f. †; 98 to 202 f.*
- Benthodolium abyssorum* V. and S. vi, 177, pl. 31, f. 12-12b.
B. range, 1395 f. †; 2221 f.* Off Chesapeake Bay.
- Natica clausa* Brod. and Sowerby.
B. range, 13 to 1255 f. †; 238 to 843 f.* N., Arc., Eu.
- Lunatia nana* (Möll.) Sars. v, 516, pl. 42, f. 9.
B. range, 27 to 28 f.*; 430 f. † N., Arc., Eu.
- Lunatia heros* (Say) H. and A. Adams.
B. range, 0 to 238 f. N., S.
- Lunatia Grönlandica* (Möll.) Ad.
B. range, 12½ to 65 f. †; 75 to 1290 f.* N., Arc., Eu.
- Lamellaria pellucida* V. v, 518, pl. 58, f. 4, 5, 5a.
B. range, 86 to 787 f.
- Lamellaria pellucida*, var. *Gouldii* V. v, 518, pl. 58, f. 3.
B. range, 44 to 1497 f.
- Piliscus commodus* (Midd.) vi, 191.
B. range, 150 f., off Nova Scotia. Arc., Eu.

- Capulus Hungaricus* (Linné). v, 519; vi, pl. 29, f. 6.
 B. range, 71* to 458 f. Eu.
- Crucibulum striatum* (Say) H. and A. Adams.
 B. range, 3 to 65 f.*; 100 f.† N.
- Crepidula plana* Say.
 B. range, 0 to 55 f.*; 155 to 487 f.† N., S.
- Velutina lævigata* (L.) Gld.
 B. range, 15½ to 86 f.*; 100 to 130 f.† N., Arc., Eu.
- Torellia fimbriata* V. and S. v, 520, pl. 57, f. 27, 27a.
 B. range, 142½ to 321 f.
- Torellia fimbriata*, var. *tiarella* V. v, 521.
 B. range, 182 f.
- Torellia vestita* Jeff. v, 521, pl. 42, f. 5.
 B. range, 4½ to 86 f.†; 146 to 317 f.* N., Eu.
- Trichotropis (?) inflata* Friele. vi, 178.
 B. range, 1290 f. Arc.
- Litiopa bombyx* Rang. v, 523.
 Surface.* S., O.
- Cingula Jan-Mayeni* (Friele) V. v, 524, pl. 42, f. 8.
 B. range, 238 to 1290 f. N., Arc.
- Cingula brychia* V. vi, 179, pl. 32, f. 9.
 B. range, 349 to 1290 f.
- Cingula carinata* Migh.
 B. range, 4 to 25 f.*; 18 to 355 f.† N., Arc.
- Cingula syngenes*, V. vi, 180, pl. 32, f. 11.
 B. range, 142 f.† Off Cape Hatteras.
- Cingula leptalea* V. vi, 182, pl. 32, f. 10.
 B. range, 858 f. Off Nova Scotia.
- Cingula apicina* V. vi, 183, pl. 32, f. 8.
 B. range, 1608 f.
- Cingula Sandersoni* V. vi, 241.
 B. range, 142 f.† Off Cape Hatteras.
- Cingula aculeus* Gld.
 B. range, 0 to 349 f. N., Arc., Eu.
- Cingula turgida?* (Jeff.) V. v, 524.
 B. range, 487 f.† Eu.
- Cingula harpa* V. v, 523, pl. 58, f. 6.
 B. range, 319 to 487 f.†
- Cingula areolata* (Stimp.) V. v, 524, pl. 43, f. 2.
 B. range, 134 to 349 f. N.
- Cithna tenella*, var. *costulata* Jeff. vi, 184.
 B. range, 2033 f. Off Delaware Bay. Eu., Med., Azores.
- Cithna cingulata* V. vi, 184, pl. 32, f. 7.
 B. range, 906 to 1290 f.†; 1467 f.*
- Cithna (?) olivacea* V. vi, 185, pl. 29, f. 5.
 B. range, 193 to 1290 f.†
- Fossarus elegans* V. and S. v, 522, pl. 57, f. 28.
 B. range, 100 to 142 f.†

Sequenzia formosa Jeff. vi, 186, pl. 31, f. 14-14b.

B. range, 1290 to 2033 f. Eu.

Sequenzia formosa, var. *nitida* V. vi, 188.

B. range, 2033 f. Off Delaware Bay.

Sequenzia eritima V. vi, 189, pl. 31, f. 15.

B. range, 1290 to 2033 f.

Cerithiella Whiteavesii V. v, 522, pl. 42, f. 7.

B. range, 238 to 843 f. N.

Aporrhais occidentalis Beck.

B. range, 34½ to 1000 f.†; 115 to 349 f.* N.

PTENOGLOSSA.

Scalaria Dalliana V. and S. v, 527, pl. 57, f. 33.

B. range, 85 f.†; 115 to 193 f.*

Scalaria Pourtalesii V. and S. v, 527, pl. 57, f. 32.

B. range, 85 to 146 f.

Scalaria Leeana V. v, 526, pl. 57, f. 34.

B. range, 146 f.†

Scalaria Andrewsii V. v, 526, pl. 57, f. 35.

B. range, 100 f.†; 547 f.*

Acirsa gracilis V. v, 528, pl. 57, f. 31.

B. range, 349 to 843 f.†; 487 to 547 f.*

Aclis striata V. v, 528, pl. 58, f. 13.

B. range, 100 f.

Aclis Walleri J. v, 528, pl. 57, f. 36.

B. range, 349 f.†; 365 to 938 f.* Eu.

Aclis tenuis V. v, 528, pl. 58, f. 19.

B. range, 100 f.

Solarium boreale V. and S. v, 529, pl. 57, f. 29, 30.

B. range, 115 f.*; 146 to 193 f.†

Ianthina fragilis Desh.

Surface.† S., O.

RHIPHIDOGLOSSA.

Rotella cryptospira V. vi, 241.

B. range, 142 f.† Off Cape Hatteras.

Ethalia multistriata V. vi, 242.

B. range, 142 f.† Off Cape Hatteras.

Leptothyra induta Watson. vi, 197.

B. range, 142 f.† Off Cape Hatteras.

Calliostoma occidentale (Migh.).

B. range, 207 f.†; 365 to 640 f.* N., Arc., Eu.

Calliostoma Bairdii V. and S. v, 530, pl. 57, f. 26.

B. range, 56 to 640 f.†; 64 to 192 f.* Cb.

Margarita regalis V. and S. v, 530, pl. 57, f. 37; vi, 254, pl. 29, f. 14.

B. range, 64 to 173 f.†; 193 to 1555 f.*

Margarita lamellosa V. and S. v, 530, pl. 57, f. 38.

B. range, 100 to 192 f.†

- Machæroplax obscura* (Couth.) Friele.
 B. range, 12½ to 487 f. N., Arc., Eu.
- Machæroplax obscura*, var. *carinata* V. v, 532.
 B. range, 100 to 208 f.†; 266 to 335 f.* N.
- Cyclostrema Dalli* V. v, 532, pl. 57, f. 39; vi, pl. 29, f. 15.
 B. range, 487 to 858 f.
- Cyclostrema Dalli*, var. *ornatum* V. vi, 255, pl. 32, f. 17.
 B. range, 843 f.
- Cyclostrema cingulatum* V. vi, 198, pl. 32, f. 14.
 B. range, 547 f.†
- Cyclostrema affine* V. vi, 199, pl. 32, f. 15.
 B. range, 365 to 858 f.†; 843 f.*
- Cyclostrema diaphanum* V. vi, 199, pl. 32, f. 16.
 B. range, 1290 f.*; 2033 f.†
- Tharsis*, sp. vi, 201.
 B. range, 843 f.† Off Cape Hatteras.
- Ganeza*, sp. vi, 201.
 B. range, † (Blake Exp.)
- Scissurella crispata* Flem. v, 533.
 B. range, 238 or 365 f.† N., Eu., Med.
- Fissurella Tanneri* V. vi, 255, pl. 29, f. 13, 13a.
 B. range, 104 f.*; 142 f.† Southern.
- Puncturella noachina* (L.) Lowe.
 B. range, 16 f.†; 34 to 640 f.* N., Arc., Eu.
- Puncturella* (*Fissurisepta*) *eritmeta* V. vi, 204, pl. 32, f. 19, 19a.
 B. range, 1451 f.
- Propilidium elegans* V. vi, 205.
 B. range, 1395 f. Off Chesapeake Bay.
- Propilidium pertenu* Jeff. (?), vi, p. 262.
 B. range, 640 f. Eu.
- Addisonia paradoxa* Dall. v, 533; vi, 256, pl. 29, f. 10, 11–11b.
 B. range, 66½ to 202 f.†; 71 to 156 f.* (? Eu., Med.)†
- Cocculina Rathbuni* Dall. v, 534.
 B. range, 100 to 616 f.
- Cocculina Dalli* V. vi, 203.
 B. range, 317 f.†
- Cocculina Beanii* Dall. v, 533; vi, pl. 29, f. 12.
 B. range, 365 f.† Cb.
- Cocculina leptalea* V. vi, 202, pl. 32, f. 20–20b.
 B. range, 1395 to 2033 f. Southern.
- Cocculina spinigera* Jeff. vi, 203.
 B. range, 335 to 843 f. Eu.
- Cocculina conica* V. vi, 204.
 B. range, 499 f. Off Nova Scotia.
- Lepetella tubicola* V. and S. v, 534, pl. 58, f. 29–29a.
 B. range, 142 to 547 f.†; 134 to 396 f.* Eu.

† By Mr. Jeffreys this species is identified with *A. eccentrica* Jeff. = *Gadina excentrica* Tib., of the Mediterranean. (Proc. Z. Soc. London, 1882, p. 673.)

POLYPLACOPHORA.

- Hanleyia mendicaria* (Migh.) Carp. v, 534.
 B. range, 49 to 317 f. N., Arc., Eu., Med.
- Trachydermon albus* (Linné.) Carp.
 B. range, 99½ f., off Nova Scotia. Arc., Eu.
- Trachydermon exaratus* (Sars). vi, 208, pl. 30, f. 2-2b.
 B. range, 101 to 194 f. Eu.
- Leptochiton alveolus* (Sars) Lovén. v, 534.
 B. range, 99½ to 640 f. N., Eu.
- Placophora* (Euplacophora) *Atlantica* V. and S. vi, 206, pl. 30, f. 1, 1b.
 B. range, 122 to 640 f.

GYMNOGLOSSA.

- Stilifer Stimpsoni* V. v, 535, f. 2.
 B. range, 6 to 1255 f. N.
- Stilifer curtus* V. v, 535.
 B. range, 410 to 1255 f.
- Eulima intermedia* Cantr. v, 535, pl. 58, f. 20.
 B. range, 85 to 155 f. Eu.
- Eulima distorta* Desh. v, 536.
 B. range, 115 f. Eu.
- Eulima stenostoma* Jeff. v, 536; vi, 254.
 B. range, 843 to 1451 f.*; 1467 f.† N., Eu.
- Turbonilla Emertoni* V. v, 536, pl. 58, f. 14, 14a.
 B. range, 238 f.
- Turbonilla nivea* (St.) Ad.
 B. range, 100 to 157 f.† N.
- Turbonilla Rathbuni* V. and S. v, 536, pl. 58, f. 15.
 B. range, 64 to 1395 f.†; 100 to 365 f.*
- Turbonilla Bushiana* V. v, 537, pl. 58, f. 16.
 B. range, 365 to 1290 f.*; 1451 to 1467 f.†
- Eulimella Smithii* V. v, 538, pl. 58, f. 18.
 B. range, 85 to 120 f.*; 146 f.†
- Eulimella lucida* V. vi, 192, pl. 32, f. 3, 3a.
 B. range, 2033 f.
- Eulimella chariessa* V. vi, 193, pl. 32, f. 4-4b.
 B. range, 2033 f.
- Eulimella nitida* V. vi, 194, pl. 32, f. 5.
 B. range, 2033 f.†
- Eulimella* (or *Menestho*) *lissa* V. vi, 195, pl. 32, f. 6.
 B. range, 142 f. Off Cape Hatteras.
- Menestho sulcata* V. v, 539, pl. 58, f. 17.
 B. range, 115 to 365 f.†
- Menestho Bruneri* V. v, 539.
 B. range, 487 f.
- Odostomia unidentata* (Mont.)
 B. range, 100 to 115 f.† Eu.

- Odostomia tornata* V. vi, 196.
 B. range, 142 f.† Off Cape Hatteras.
Odostomia disparilis V. vi, 196.
 B. range, 142 f.† Off Cape Hatteras.
Odostomia, sp. v, 539.
 B. range, 365 f.†

TECTIBRANCHIATA.

- Actæon nitidus* V. v, 540, pl. 58, f. 21.
 B. range, 238 to 843 f.*; 1451 f.†
Actæon melampoides Dall. vi, 210.
 B. range, 843 f.† Off Cape Hatteras. Cb.
Ringicula nitida V. v, 540.
 B. range, 100 to 547 f.†; 120 to 487 f.* Cb.
Choristes elegans, var. *tenera* V. v, 541, pl. 58, f. 27, 27a; vi, 256, pl. 29,
 f. 9-9b (young).
 B. range, 193 f.†; 255 to 640 f.* Fossil in Canada.
Scaphander nobilis V. vi, 209, pl. 32, f. 18-18d.
 B. range, 906 f.†; 1091 to 1309 f.*
Scaphander puncto-striatus (Migh.) Ad.
 B. range, 46 to 1255 f.*; 1362 to 1467 f.† N., Arc., Eu.
Philine quadrata (Wood) Forb. and Han.
 B. range, 20 to 266 f.†; 312 to 480 f.* N., Arc., Eu.
Philine Finmarchica Sars. v, 544.
 B. range, 86 f. N., Eu.
Philine cingulata Sars. v, 544.
 B. range, 155 to 487 f. Eu.
Philine, sp.
 B. range, 100 f.
Philine amabilis V. and S. v, 544, pl. 58, f. 23, 24.
 B. range, 120 to 156 f.
Philine tinctoria V. v, 544.
 B. range, 67 f.
Amphisphyra globosa Lovén. v, 543.
 B. range, 115 to 155 f.†; 319 to 843 f.* N., Eu.
Amphisphyra pellucida (Brown) Lovén.
 B. range, 120 f.†; 20 to 365 f.* N., Arc., Eu.
Diaphana gemma V. v, 543, pl. 58, f. 22.
 B. range, 100 to 2033 f.
Diaphana conulus (Desh.) V. v, 543, pl. 58, f. 25.
 B. range, 100 f.†; 155 f.* Eu., Med.
Diaphana nitidula (Lov.) v, 543.
 B. range, 155 to 906 f. Eu.
Diaphana pertenuis (Mighels).
 B. range, 20 f.†; 319 to 386 f.* N., Arc., Eu.
Cylichna alba (Brown) Lovén.
 B. range, 12 to 1091 f.*; 1290 f.† N., Arc., Eu.

- Cylichna* (?) *Dalli* V. v, 542; vi, pl. 29, f. 15.
 B. range, 452 to 906 f. †; 938 to 1290 f. *
Cylichna occulta (Migh.) Ad.
 B. range, 100 to 1467 f. *; 1608 f. † N., Arc., Eu.
Pleurobranchæa tarda V. v, 546, pl. 58, f. 26.
 B. range, 28 to 640 f.
Koonsia obesa V. v, 545; vi, pl. 28, f. 7.
 B. range, 192 to 312 f.

NUDIBRANCHIATA.

- Heterodoris robusta* V. and Em. v, 549, pl. 58, f. 35, 35a, 35b; vi, pl. 28, f. 5, 5a.
 B. range, 458 f.
Issa ramosa V. and Em. v, 547, pl. 58, f. 36, 36a.
 B. range, 100 to 321 f.
Doris complanata V. v, 549, pl. 58, f. 34-34b; vi, pl. 28, f. 6.
 B. range, 86 to 194 f.
Seyllæa Edwardsii V. v, 550, pl. 43, f. 10.
 Surface. Wood's Hole; off Cape Hatteras. Oc.
Dendronotus robustus V. v, 550.
 B. range, 28 to 317 f. N., Eu.
Dendronotus arborescens Ald. and Han.
 B. range, 13 to 351 f. N., Arc., Eu.
Dendronotus, sp.
 B. range, 146 f.
Doto coronata (Gm.) Ald. and Han.
 B. range, 0 to 10 f. Surface. N., Eu.
Fiona nobilis Ald. and Han. v, 551.
 Surface. Oc., Eu.
Eolis papillosa (Linné) Forb. and Han.
 B. range, 0 to 208 f. N., Arc., Eu.
Coryphella, sp.
 B. range, 30 to 168 f.
Tergipes despectus (Johnst.) Ald. and Han.
 B. range, 0 to 10 f. Surface. N., Eu.
Facelina p̄lata (Gld.) V.
 B. range, l. w. to 146 f. Surface.

HETEROPODA.

- Carinaria Atlantica* Ad. and R. v, 529.
 B. range, 65 f. † Oc.
Atlanta Peronii Les. v, 529; vi, pl. 28, f. 4, 4a.
 B. range, 15½ to 1608 f. † Oc.
Atlanta Gaudichaudii Eyd. and Soul. vi, 211.
 Surface.* Oc.
Atlanta rosea Soul. vi, 211.
 B. range, 843 to 2369 f. †; surface.* Oc.

Atlanta Lamanonii Eyd. and Soul. vi, 211.

B. range, 1731 f.† Oc.

Atlanta pulchella V. sp. nov. vi, 211.

Surface.* Oc.

Atlanta inclinata Soul. vi, 211.

B. range, 516 to 843 f.†; surface.* Oc.

Firola Keraudrenii E. and S. vi, 212.

Surface.* Oc.

PTEROPODA.

Cymbulia calceolus V. v, 553, pl. 58, f. 33.

B. range, 18 to 1467 f.†; surface.* Oc.

Cavolina tridentata Gray. v, 554, f. 6, 7.

B. range, 45 to 2033 f.†; surface.* Oc.

Cavolina uncinata (D'Orb.) Gray. v, 554.

B. range, 64 to 1608 f.†; surface.* Oc.

Cavolina longirostris Les. v, 555.

B. range, 64 to 2033 f.†; surface.* Oc.

Cavolina gibbosa (Rang.) vi, 213.

B. range, 193 to 1451 f.† Oc.

Cavolina quadridentata (Leseur) vi, 212.

B. range, 142 to 1467 f.† Oc.

Cavolina angulata (Soul.) vi, 213.

Surface.* Oc.

Cavolina inflexa (Les.) Gray. v, 555.

B. range, 487 to 1467 f.† Oc.

Pleuropus Hargerii V. v, 555; vi, pl. 28, f. 3.

Surface.* Oc.

Diacria trispinosa Gray.

B. range, 64 to 1451 f.†; surface.* Oc.

Clio pyramidata Linné. v, 555.

B. range, 64 to 2033 f.† Oc.

Balantium recurvum Children. v, 556.

B. range, 64 to 1917 f.† Oc.

Triptera columnella (Rang.) v, 557; vi, 214.

B. range, 142 to 1608 f.† Oc., S.

Styliola virgula (Rang.) vi, 213.

Surface.* Oc., S.

Styliola virgula, var. *corniformis* (D'Orb.) vi, 214.

Surface.* Oc., S.

Styliola subulata (Quoy and Gaimard) vi, 213.

B. range, 15† to 1467 f.†; surface.* Oc., S.

Styliola recta Blainv. v, 556.

Surface.* Oc., S.

Spirialis retroversus (Flem.), var. *MacAndrei* Forbes. v, 557.

Surface. Oc., Eu., Med.

- Spirialis Gouldii* St. (? *S. balea* Möll., var.).
Surface. Oc., N., Eu.
- Spirialis bulimoides* Soul. vi, 215.
Surface.* Oc., S.
- Spirialis trochiformis* Soul. vi, 214.
Surface.* Oc., S.
- Clione papilionacea* Pallas.
Surface.* Oc., N., Arc., Eu.
- Clione longicaudata* Soul. vi, 215.
Surface.* Oc.
- Trichocyclus Dumereillii* (Oken.) Esch. vi, 215.
Surface.* Oc.

SOLENOCONCHA.

- Dentalium solidum* V. vi, 215.
B. range, 843 to 1309 f.
- Dentalium striolatum* Stimp.
B. range, 25 to 115 f.†; 146 to 1255 f.* N., Eu.
- Dentalium occidentale* Stimp. v, pl. 42, f. 16-18.
B. range, 26 to 115 f.†; 146 to 1255 f.* N., Eu.
- Dentalium occidentale*, var. *sulcatum* V. vi, 217.
B. range, 75 to 1255 f.*
- Dentalium*, sp., *g.* vi, 217.
B. range, 1731 to 2033 f. Southern.
- Dentalium*, sp., *h.* vi, 217.
B. range, 843 f.†; 2033 f.* Southern.
- Siphodentalium vitreum* M. Sars. v, 557, pl. 42, f. 19.
B. range, 100 f.†; 349 to 1290 f.* N., Arc., Eu.
- Siphodentalium teres* Jeff. vi, 218.
B. range, 843 f.†; 858 to 1290 f.* Eu.
- Siphonentalis affinis* (Sars). v, 558, pl. 42, f. 20, *a, b.*
B. range, 349 to 365 f.†; 499 to 1731 f.* N., Eu., Azores.
- Siphonentalis Lofotensis* Sars. v, 558.
B. range, 115 f.*; 365 to 480 f.† N., Eu.
- Cadulus Pandionis* V. and S. v, 558, pl. 58, f. 30, 30a.
B. range, 85 to 487 f.*; 516 f.† (? Eu., Med., Af.)
- Cadulus Watsoni* Dall. vi, 219.
B. range, 197 to 938 f.†; 547 to 843 f.* Cb.
- Cadulus grandis* V. vi, 219.
B. range, 843 to 1467 f.†; 906 to 1098 f.*
- Cadulus Jeffreysii* ? (Monteros.) v, 559; vi, 257.
B. range, 115 f.*; 516 to 843 f.† Eu., Azores.
- Cadulus propinquus* ? G. O. Sars. v, 558, pl. 58, f. 31, 32; vi, 257.
B. range, 100 to 115 f.† Eu., Med.
- Cadulus cylindratus* Jeff. vi, 220.
B. range, 1608 f. Eu.

LAMELLIBRANCHIATA.

Teredo megotara Hanley.

B. range, 55 f.†; 100 to 1467 f.*; surface* in wood. S., O., Eu.

Xylophaga dorsalis (Turt.) F. and Han. v, 559, pl. 44, f. 9.

B. range, 32 to 2033 f. N., Eu., Med.

Ensatella Americana (Gld.) V.

B. range, 0 to 28½ f.*; 64 to 89 f.† N., S.

Mya truncata Linné.

B. range, 15 to 110 f.† N., Arc., Eu., P.

Saxicava Norvegica (Speng.) Woodw.

B. range, 20 to 506 f.†; 300 f.* N., Arc., Eu., P.

Cyrtodaria siliqua (Speng.) Woodw.

B. range, 28 to 258 f.† N., Arc.

Poromya granulata (Nyst.) F. and Han. v, 564, pl. 44, f. 3, 4.

B. range, 64 to 146 f.†; 93 to 120 f.* N., Eu., Med., Cb.

Poromya granulata, var. *rotundata* (J.) v, 565.

B. range, 64 to 115 f. N., Eu.

Poromya sublevis V. vi, 221, pl. 32, f. 21.

B. range, 1917 f.† Off Chesapeake Bay.

Neæra obesa Lovén. v, 563, pl. 44, f. 10, c.

B. range, 192 to 1290 f.; 20 to 150 f. N. of Cape Cod. N., Arc., Eu., Azores.

Neæra glacialis G. O. Sars. v, 562, pl. 44, f. 10, a, b.

B. range, 64 to 547 f. N., Arc., Eu.

Neæra rostrata (Speng.) Lovén. v, 562, pl. 58, f. 39.

B. range, 65 to 487 f.†; 85 to 155 f.* N., Eu., Med., Af., Azores, Cb., Patagonia.

Neæra lamellosa M. Sars. v, 561; vi, pl. 30, f. 3.

B. range, 319 to 547 f. Eu., Med., Af.

Neæra multicostata V. and S. v, 559, pl. 58, f. 40.

B. range, 85 to 158 f. (? Arc., Eu., Med.)

Neæra multicostata, var. *curta* (J.) v, 560.

B. range, 115 to 120 f.† Eu., Azores, Bermudas, P.

Neæra perrostrata (Dall.) v, 561.

B. range, 85 to 325 f. Cb.

Neæra gigantea V. vi, 223.

B. range, 1917 f.† Off Chesapeake Bay.

Neæra undata V. vi, 223.

B. range, 2221 f.† Off Chesapeake Bay.

Neæra, sp.

B. range, 142 f. Off Cape Hatteras.

Kennerlia glacialis (Leach) Carp. v, 567.

B. range, 63 to 100 f. N., Arc., Eu.

Clidiophora trilineata (Say) Carp.

B. range, 0 to 29 f.*; 45 to 126 f.† N., S.

Periploma papyracea (Say) Con.

B. range, 7 to 1255 f. N.

Cochlodesma Leanum Couth.

B. range, 2 to 20 f.*; 65 f.† S.

Thracia Conradi Couth.

B. range, 4½ to 193 f.†; 34 f.* N.

Thracia nitida V. vi, 221, pl. 32, f. 22.

B. range, 1917 f. Off Chesapeake Bay.

Pecchiolia abyssicola Sars. v. 565.

B. range, 192 to 487 f.*; 516 to 1290 f.† N., Arc., Eu.

Pecchiolia gemma V. v, 565; vi, 258, pl. 30, f. 7, 8.

B. range, 75 to 1290 f.†; 499 to 906 f.*

Verticordia calata V. v, 566; vi, pl. 30, f. 9, 9a.

B. range, 100 f.†

Mytilimeria flexuosa V. and S. v, 567, pl. 58, f. 38; vi, 258.

B. range, 75 to 319 f.†; 349 f.*

Pholadomya arata V. and S. v, 567, pl. 58, f. 37; vi, pl. 30, f. 4-6.

B. range, 71 to 134 f.† Eu.

Spisula solidissima Gray.

B. range, 0 to 192 f.†; 0 to 18 f.* N., S.

Spisula ovalis Gould.

B. range, 5 to 71 f.†; 8½ to 15 f.* N.

Ceronia aretata (Con.) Ad.

B. range, 0 to 183 f.†; 0 to 2 f.* N.

Abra lioica (Dall) V. v, 568; vi, 224.

B. range, 100 f.*; 115 f.† Cb.

Abra longicallis (Scacchi). vi, 224.

B. range, 1467 f.† Eu., Med., Canaries, Af., Azores, Cb.

Macoma sabulosa (Speng.) Mörch.

B. range, 30 to 208 f.†; 29 to 1255 f.* N., Arc., Eu., P., As.

Macoma, sp.

B. range, 100 f.†

Callista convexa (Say) Ad.

B. range, 0 to 21¼ f.*; 85 f.† N., S.

Cyprina Islandica (Linné) Lam.

B. range, 8 to 128 f.*; 130 to 349 f.† N., Arc., Eu.

Astarte castanea Say.

B. range, 0 to 100 f.*; 142 to 435 f.† N., S.

Astarte quadrans Gld.

B. range, 11 to 100 f. N.

Astarte undata Gld.

B. range, 8 to 480 f. N.

Astarte crenata Gray.

B. range, 34½ to 640 f. N., Arc., Eu., As.

Venericardia granulata (Say) = *borealis* Con. v, 572; vi, 258.

B. range, 8 to 435 f.†; 9 to 192 f.* N.

Cardium pinnulatum Conrad.

B. range, 1 to 266 f. N.

Cardium peramabilis Dall. v, 569.

B. range, 115 f.† Cb.

- Loripes lens* V. and S. v, 569; vi, 259.
 B. range, 5 to 192 f.†; 120 f.* N.
- Lucina filosa* Stimp.
 B. range, 4 to 349 f.†; 20 to 30 f.* N.
- Cryptodon subovatus* (J.) V. v, 570.
 B. range, 480 f.†; 499 f.* Eu., Af.
- Cryptodon Gouldii* (Phil.) Stimp.
 B. range, 6 to 1467 f. N., Eu.
- Cryptodon obesus* V. v, 569.
 B. range, 12 to 100 f.†; 115 to 1290 f.* N.
- Cryptodon ferruginosus* (Forbes). v, 570.
 B. range, 100 to 1467 f. N., Arc., Eu., Med.
- Cryptodon tortuosus* (Jeff.). vi, 226.
 B. range, 499 to 1290 f. Eu.
- Axinopsis*, sp. nov.
 B. range, 1451 f.
- Diplodonta turgida* V. and S. v, 569, pl. 58, f. 42; vi, pl. 30, f. 10, 11.
 B. range, 65 to 98 f.†
- Montacuta ovata* Jeff. v, 571.
 B. range, 8½ to 157 f.† Eu.
- Montacuta tumidula* Jeff. vi, 225.
 B. range, 843 to 1091 f. Southern. Eu.
- Kelliella*, sp. nov.
 B. range, 2033 f.
- Solemya velum* Say.
 B. range, 0 to 10 f.*; 9 to 115 f.† N., S.
- S. velum*, var. *borealis* (Totten).
 B. range, 1 to 349 f.†; 56 to 300 f.* N., S.
- Yoldia thraciformis* (Storer) Stimp.
 B. range, 29 to 182 f.†; 192 to 906 f.* N.
- Yoldia sapotilla* (Gld.) Stimp.
 B. range, 4½ f.†; 12½ to 321 f.* N., Arc.
- Yoldia limatula* (Say) Woodw.
 B. range, 3½ to 252 f. N., S.
- Yoldia expansa* Jeff.
 B. range, 365 f.*; 1451 to 1467 f.† Eu.
- Yoldia lucida* Lovén. v, pl. 44, f. 1.
 B. range, 29 to 1608 f.†; 115 to 1290 f.* N., Arc., Eu., Med.
- Yoldia frigida* Torell. v, 573, pl. 44, f. 2.
 B. range, 157 to 1255 f. N., Arc., Eu., Med., As.
- Yoldia Jeffreysi* (Hidalgo). vi, 229.
 B. range, 349 f.*; 499 to 1290 f.† Eu., Med., Af., Azores, Cb.
- Yoldia subequilatera* (Jeff.). vi, 229.
 B. range, 499 to 1731 f. Eu., Arc.
- Yoldia regularis* V. vi, 228.
 B. range, 349 f.†
- Yoldia sericea* Jeffreys, var. *striolata* J. vi, 226.
 B. range, 516 to 1731 f. Eu.

- Yoldia Messanensis* (Seguenza), var. vi, 227.
B. range, 1451 to 2033 f.†; 1467 f.* Eu., Med., Azores, Cb.
- Leda acuta* (Conrad). v, 572, pl. 58, f. 41; vi, 259, pl. 30, f. 15.
B. range, 64 to 225 f.†; 65 to 115 f.* S. (? Eu., Med.)
- Leda Bushiana* V. vi, 229.
B. range, 516 f. Off Cape Hatteras.
- Leda pernula* (Müll.). v, 572; vi, pl. 30, f. 14, 14a.
B. range, 216 f.†; 300 to 349 f.* N., Arc., Eu., P.
- Leda tenuisulcata* (Couth.) Stimp.
B. range, 25 to 120 f.†; 640 f.* N.
- Phaseolus ovatus* ? (Jeff. MSS.). vi, 230.
B. range, 1290 f. (? Eu.)
- Malletia obtusa* (M. Sars) Mörch. vi, 226.
B. range, 516 f.†; 788 to 1608 f.* Eu., Med.
- Glomus nitens* Jeff. vi, 231.
B. range, 1608 f.† Eu.
- Nucula delphinodonta* Mighels.
B. range, 10 to 1290 f. N., Arc., Eu.
- Nucula proxima* Say.
B. range, 3½ to 302 f.*; 310 to 516 f.† S.
- Nucula tenuis* (Mont.) Turton.
B. range, 75 to 266 f.†; 302 to 1255 f.* N., Arc., Eu., Med., Cb., P., As.
- Nucula cancellata* Jeff. vi, 231.
B. range, 858 f.†; 906 to 2033 f.* Eu., Azores.
- Nucula granulosa* Verrill, sp. nov.†
B. range, 487 to 858 f.*
- Arca pectunculoides* Sc. v, 573, pl. 44, f. 6.
B. range, 79 to 640 f. N., Eu., Med., Cb.
- Arca pectunculoides*, var. *septentrionalis* Sars. v, 573.
B. range, 79 to 640 f. N., Arc.
- Arca pectunculoides*, var. *Frielei* (Jeff.). v, 574.
B. range, 156 to 487 f. N., Eu., Med.
- Arca pectunculoides*, var. *crenulata* V. v, 575.
B. range, 85 to 120 f.
- Limopsis minuta* (Phil.). v, 576.
B. range, 64 to 115 f.†; 120 to 2221 f.* N., Arc., Eu., Med., Af., Azores.
- Limopsis cristata* Jeff. v, 577; vi, 231.
B. range, 549 f.† Eu., Med.
- Limopsis*, sp.
B. range, 197 to 2221 f.

† *Nucula granulosa* V. A small species, 2.5^{mm} long, 2^{mm} broad, broad ovate, with the beaks anterior and turned forward, posterior end rounded, anterior tip angularly truncated, a well defined and rather large lunule bordered by an angular ridge. Surface greenish yellow, dull, closely covered with microscopic granules, and with fine lines of growth. Margin plain, thickened. Hinge-margin rather stout, curved, with about 5 anterior and 7 posterior teeth, which are relatively strong. Cartilage-pit large. Stations 892, 1880; 2072, 1883.

- Limopsis tenella* Jeff. vi, 232.
 B. range, 1731 to 2033 f. Eu.
- Mytilus edulis* Linné.
 B. range, 0 to 57½ f.* (perhaps from surface *Fuci*); 1608 f.† Oc., S., N., Arc., Eu., Med., P., Antarctic.
- Modiola modiolus* (Linné) Turton.
 B. range, 0 to 115 f.*; 202 f.† N., Arc., Eu., P., As.
- Modiolaria nigra* (Gray) Lovén.
 B. range, 0 to 27½ f.*; 31 to 65 f.† N., Arc., Eu., P.
- Modiolaria discors* (Linné) Lovén.
 B. range, 15 to 90 f. N., Arc., Eu., Med., P., As.
- Modiolaria corrugata* (Stimp.) Mörch.
 B. range, 18 to 45 f.*; 20 to 25 f.† N., Arc., Eu.
- Modiolaria polita* V. and S. v, 578; vi, pl. 30, f. 12.
 B. range, 238 to 321 f. Cb., Eu.
- Crenella glandula* (Totten) Ad.
 B. range, 0 to 11 f.†; 5 to 100 f.* N.
- Crenella decussata* (Mont.) Macg. v, 578, pl. 44, f. 7.
 B. range, 5 f.†; 11 to 115 f.* N., Arc., Eu., Cb., P.
- Idas argenteus* Jeff. v, 579; vi, pl. 30, f. 16, 16a.
 B. range, 335 to 2033 f.* on wood. Surface? (on wood). Eu.
- Dacrydium vitreum* (Möll.) Torrell. v, 579, pl. 44, f. 8, 8a.
 B. range, 300 f.†; 312 to 1555 f.* N., Arc., Eu., Med., Af., Azores.
- Pecten Clintonius* Say. vi, 261.
 B. range, 8 to 349 f.†; 13 to 146 f.* N.
- Pecten Islandicus* Müller.
 B. range, 33 to 122 f.*; 124 to 194 f.† N., Arc., Eu., P., As.
- Pecten glyptus* V. v, 580.
 B. range, 69 to 156 f.†
- Pecten striatus* Müller. vi, 233.
 B. range, 100 f.† Eu., Med.
- Pecten vitreus* (Gmel.) Wood. v, 581, pl. 42, f. 21.
 B. range, 57½ to 64 f.†; 100 to 787 f.* N., Arc., Eu., Med., Af.
- Pecten pustulosus* V. v, 581, pl. 42, f. 22, 22a; vi, 261.
 B. range, 99½ to 321 f.*; 365 to 547 f.† N., Eu.?
- Pecten leptaleus* V. vi, 232.
 B. range, 142 f. Off Cape Hatteras.
- Pecten fragilis* Jeff. vi, 232.
 B. range, 843 f. Off Cape Hatteras. Arc., Eu., Azores.
- Amussium*, sp. nov. v, 582; vi, 261.
 B. range, 79 f.†; 86 to 317 f.*
- Limæa subovata* (Jeff.) Monteros. v, 580.
 B. range, 100 to 1362 f.†; 252½ to 1290 f.* Eu., Arc., Med., Azores.
- Avicula hirundo* (L.). v, 582.
 B. range, 71 f.*; 89 f.† Eu., Med., Can., Azores, Cb., Oc.
- Avicula hirundo*, var. *nitida* V. v, 582, pl. 58, f. 43.
 B. range, 64 to 192 f. Oc.
- Avicula squamulosa*? Lam. vi, 233.
 Surface.* S., Oc.

Anomia aculeata Müll.

B. range, 4 to 640 f. N., Arc., Eu.

BRACHIOPODA.

Terebratulina septentrionalis (Couth).

B. range, 16 to 396 f. N., Arc., Eu., Af.

Waldheimia cranium (Müller) Davidson. vi, 234.

B. range, 1362 f.† Arc., Eu., P.

Discina Atlantica King. vi, 233.

B. range, 1251 to 1467 f.† Eu., Arc., Med., Australia.

List of Species found between 1000 and 2000 fathoms.

The following list comprises those of the species above enumerated which we have dredged between 1000 and 2000 fathoms, with the observed bathymetrical range in this region. Those printed in Italics have not been taken by us in less than 1000 fathoms.

CEPHALOPODA.

	Fathoms.		Fathoms.
<i>Ommastrephes illecebrosus</i> V.	0-1022	<i>Desmoteuthis tenera</i> V.	369-1346
<i>Mastigoteuthis Agassizii</i> V.	640-1050	<i>Alloposus mollis</i> V.	298-1735
<i>Chiroteuthis lacertosa</i> V.	435-2221	<i>Octopus piscatorum</i> V.	1362
<i>Leptoteuthis diaphana</i> V.	1731	<i>Octopus gracilis</i> V.	1290
<i>Calliteuthis reversa</i> V.	365-2369	<i>Eledone verrucosa</i> V.	787-1255

GASTROPODA.

TOXOGLOSSA.		TOXOGLOSSA.	
	Fathoms.		Fathoms.
<i>Admete Couthouyi</i> (Jay) Ad.	155-1255	<i>Bela pygmæa</i> V.	312-1290
<i>Pleurotomella Agassizii</i> V.	39-1608	<i>Bela Rathbuni</i> V.	1395
<i>Pleurotomella Bairdii</i> V.	1608-2221	<i>Spirotropis ephamilla</i> V.	1917-2221
<i>Pleurotomella Benedicti</i> V. & S.	1290	<i>Typhlomangilia Tanneri</i> V. & S.	1290
<i>Pleurotomella Sandersoni</i> V.	1290-2033	<i>Taranis Mörchii</i> , v. <i>tornatus</i> V.	1255
<i>Pleurotomella Saffordi</i> V. & S.	843-1608		
<i>Pleurotomella bandella</i> Dall	1290-2033	RACHIGLOSSA.	
<i>Pleurotomella Emertoni</i> V.	1917	<i>Buccinum abyssorum</i> V. & S.	49-1309
<i>Pleurotomella Bruneri</i> V.	1608-2033	<i>Sipho profundicola</i> V. & S.	1497-2033
<i>Pleurotomella Catharinæ</i> V.	843-2033	<i>Sipho profundicola</i> , var.	
<i>Gymnobela engonia</i> V.	906-1608	<i>dispar</i> V.	1555
<i>Gymnobela curta</i> V.	843-1917	<i>Sipho cælatus</i> , var. <i>hebes</i> V.	640-1255
<i>Gymnobela curta</i> , var. <i>subangulata</i> V.	197-2033	<i>Sipho</i> (<i>Mohnia</i>) <i>cælatululus</i> V.	516-1290
<i>Gymnobela hebes</i> V.	252-2033	<i>Trophon clavatus</i> Sars	843-2033
		<i>Astyris pura</i> V.	71-1255

TÆNIOGLOSSA.		Fathoms.		Fathoms.
Benthodolium abyssorum V.			<i>Puncturella (Fissurisepta)</i>	
& S.	1395-1231		<i>eritmeta V.</i>	1451
Natica clausa Bröd. & Sowerby	13-1255		<i>Propulidium elegans V.</i>	1395
Lunatia Groenlandica (Möll.)			<i>Cocculina leptalea V.</i>	1495-2033
H. & A. Ad.	12½-1290		GYMNOGLOSSA.	
Lamellaria pellucida, var. Gouldii V.	44-1497		<i>Stilifer Stimpsoni V.</i>	13-1255
<i>Trichotropis inflata</i> Friele	1290		<i>Stilifer curtus V.</i>	410-1255
<i>Cingula Jan-Mayeni V.</i>	238-1290		<i>Eulima stenostoma Jeff.</i>	843-1467
<i>Cingula apicina V.</i>	1608		<i>Turbonilla Rathbuni V.</i>	64-1395
<i>Cingula brychia V.</i>	349-1290		<i>Turbonilla Bushiana V.</i>	365-1467
<i>Cithna cingulata V.</i>	906-1467		TECTIBRANCHIATA.	
<i>Cithna (?) olivacea V.</i>	193-1290		<i>Actæon nitidus V.</i>	238-1451
<i>Aporrhais occidentalis Beck.</i>	34-1000		<i>Scaphander nobilis V.</i>	906-1309
<i>Sequenzia formosa Jeff.</i>	1290-2033		<i>Scaphander puncto-striatus</i>	
<i>Sequenzia eritima V.</i>	1290-2033		(Migh.) H. & A. Ad.	46-1467
			<i>Diaphana gemma V.</i>	100-2033
			<i>Cylichna alba (Brown) Lovén</i>	12-1290
			<i>Cylichna Dalli V.</i>	452-1290
			<i>Cylichna occulta (Migh.) H.</i>	
			& A. Ad.	100-1608

SCAPHOPODA.

	Fathoms.		Fathoms.
<i>Dentalium solidum V.</i>	843-1309	<i>Siphonodentalium vitreum</i>	
<i>Dentalium striolatum Stimp.</i>	25-1255	M. Sars	100-1290
<i>Dentalium occidentale Stimp.</i>	26-1255	<i>Siphonodentalium teres Jeff.</i>	843-1290
<i>Dentalium occidentale, var. sulcatum V.</i>	75-1255	<i>Siphonentalis affinis (Sars)</i>	349-1731
<i>Dentalium, sp. g.</i>	1731-2033	<i>Cadulus grandis V.</i>	843-1467
<i>Dentalium, sp. h.</i>	843-2033	<i>Cadulus cylindratus V.</i>	1608

LAMELLIBRANCHIATA.

	Fathoms:		Fathoms.
<i>Teredo megotara Han.</i> surface		<i>Cryptodon Gouldii (Phil.)</i>	
and	55-1467	Stimp.	6-1467
<i>Xylophaga dorsalis F. & Han.</i>	32-2033	<i>Cryptodon obesus V.</i>	12-1290
<i>Poromya sublevis V.</i>	1917	<i>Cryptodon ferruginosus</i>	
<i>Neæra gigantea V.</i>	1917	(Forbes)	100-1467
<i>Neæra obesa Lovén</i>	20-1290	<i>Axinopsis, sp. nov.</i>	1451
<i>Periploma papyracea (Say)</i>		<i>Montacuta tumidula Jeffreys</i>	843-1091
Con.	7-1255	<i>Malletia obtusa (M. Sars)</i>	
<i>Thracia nitida V.</i>	1917	Mörch.	516-1608
<i>Pecchiolia abyssicola Sars</i>	192-1290	<i>Nucula delphinodonta Mighels</i>	9-1290
<i>Pecchiolia gemma V.</i>	75-1290	<i>Nucula tenuis (Mont.) Turton</i>	75-1255
<i>Abra longicallis (Scacchi)</i>	1467	<i>Nucula cancellata Jeffreys</i>	858-2033
<i>Macoma sabulosa (Speng.)</i>		<i>Yoldia Messanensis (Seguenza),</i>	
Con.	29-1255	variety	1451-2033
<i>Cryptodon tortuosus Jeff.</i>	499-1290	<i>Yoldia expansa Jeffreys</i>	365-1467

	Fathoms.		Fathoms.
<i>Yoldia sericea</i> , var. <i>striolata</i>		<i>Glomus nitens</i> Jeffreys	1608
Jeffreys	516-1731	<i>Limopsis minuta</i> (Phil.)	64-2221
<i>Yoldia lucida</i> Lovén	29-1608	<i>Limopsis</i> , sp.	197-2221
<i>Yoldia frigida</i> Torell	157-1255	<i>Limopsis tenella</i> Jeffreys	1731-2033
<i>Yoldia subequilatera</i> (Jeff.)	499-1731	<i>Idas argenteus</i> Jeff.	335-2033
<i>Yoldia Jeffreysii</i> (Hidalgo)	349-1290	<i>Dacrydium vitreum</i> (Möll.)	300-1555
<i>Phaseolus ovatus</i> ? (Jeff. MSS.)	1290	<i>Limæa subovata</i> (Jeffreys)	100-1362

BRACHIOPODA.

	Fathoms.		Fathoms.
<i>Discina Atlantica</i> King	1251-1467	<i>Waldheimia cranium</i> (Müller)	
		Davidson	1362

List of Species dredged by the U. S. Fish Commission at depths exceeding 2000 fathoms.

Those species in *Italic type* were not taken in less than 2000 fathoms. A dagger (†) after a depth indicates that the specimens were dead shells only.

CEPHALOPODA.

	Fathoms.		Fathoms.
<i>Chiroteuthis lacertosa</i> V.	435-2221	<i>Calliteuthis reversa</i> V.	365-2369
	(2949)	<i>Eledonella pygmaea</i> V.	2949

GASTROPODA.

TOXOGLOSSA.		TÆNIOGLOSSA.	
	Fathoms.		Fathoms.
<i>Pleurotomella Bairdii</i> V. & S.	1608-2221†	<i>Benthodolium abyssorum</i> V. & S.	1395-2221
<i>Pleurotomella Sandersoni</i> V.	1290-2033	<i>Cithna tenella</i> , var. <i>costulata</i> Jeff.	2033
<i>Pleurotomella bandella</i> D.	1290-2033	<i>Seguenzia formosa</i> Jeffreys	1290-2033
<i>Pleurotomella Bruneri</i> V.	1608-2033	<i>Seguenzia formosa</i> , var. <i>nitida</i> V.	2033
<i>Pleurotomella Catharinae</i> V.	843-2033	<i>Seguenzia eritima</i> V.	1290-2033
<i>Gymnobela curta</i> , var. <i>subangulata</i> V.	197-2033†	RHIPIDOGLOSSA.	
<i>Gymnobela hebes</i> V.	252-2633†	<i>Cyclostrema diaphanum</i> V.	1290-2023†
<i>Spirotropis ephamilla</i> V.	1917-2221	<i>Cocculina leptalea</i> V.	1395-2033
		GYMNOGLOSSA.	
		<i>Eulimella chariessa</i> V.	2033
		<i>Eulimella lucida</i> V.	2033
		<i>Eulimella nitida</i> V.	2033†
		TECTIBRANCHIATA.	
		<i>Diaphana gemma</i> V.	100-2033
RACHIGLOSSA.			
<i>Sipho profundicola</i> V. & S.	1497-2033		
<i>Sipho hispidulus</i> V.	2033		
<i>Trophon clavatus</i> Sars	843-2033		

SCAPHOPODA.

	Fathoms.		Fathoms.
Dentalium, sp. g.	1731-2033		Dentalium, sp. h. 843-2033

LAMELLIBRANCHIATA.

	Fathoms.		Fathoms.
Xylophaga dorsalis F. & Han.	32-2033		Nucula cancellata Jeffreys 858-2033
Neæra undata V.	2221†		Limopsis minuta Phil. 64-2221
Kelliella, sp. nov.	2033		Limopsis, sp. 197-2221
Yoldia Messanensis (Se- guenza)	1451-2033†		Limopsis tenella Jeffreys 1731-2033
			Idas argenteus Jeff. 335-2033

Species also taken by the Blake Expeditions in the Gulf of Mexico, Caribbean Sea, or Straits of Florida.

The following species have been recognized by Mr. Dall, among the Blake shells, or else have been identified by the writer with those recorded by him, or by personal comparison of specimens. Probably other cases of identity will occur when the whole of the Blake collections shall have been fully studied. The identity of some of these is still doubtful.

<p>Abralia megalops Verrill. Pleurotoma comatotropis Dall. Daphnella limacina (Dall). Pleurotomella bandella Dall. Pleurotomella Emertoni Verrill. Taranis Mörchii (Malm) Jeffreys. Seguenzia formosa Jeffreys. Actæon melampoides Dall. Ringicula nitida Verrill. Leptothyra induta Watson. Calliostoma Bairdii Verrill & Smith. ?Margarita lamellosa Verrill & Smith (?= M. ægleës Watson, Dall). Cadulus Watsoni Dall. Poromya granulata (Nyst) Forbes & Hanley. Neæra perrostrata Dall. ?Neæra multicostata Verrill & Smith (?= N. alternata (D'Orb.) Dall.</p>	<p>Neæra rostrata (Spengler) Lovén. Abra longicallis (Scacchi). Abra lioica (Dall) V. Cardium peramabilis Dall. ?Cryptodon obesus Verrill. ?Leda acuta Conrad (=? L. Jamaicensis Dall). Yoldia Messanensis (Seguenza). Yoldia Jeffreysii (Hidalgo). Arca pectunculoides Scacchi. Nucula tenuis (Mont.) Turton. Limopsis minuta (Philippi). Limopsis tenella Jeffreys. Limopsis cristata Jeffreys. Modiolaria polita Verrill and Smith. Crenella decussata (Mont.) Macg. Ammusium, sp. nov.</p>
---	--

I.—Summary of Mollusca included in the preceding lists.

Named varieties are here counted as if distinct species.		Cephalopoda.	Gastropoda.	Pteropoda.	Scaphopoda.	Lamelli-branchiata.	Brachiopoda.	Total.
Shallow water species inhabiting the zone between 60 and 200 fathoms..		2	35		2	46	1	86
"	" " 200 " 500 "	2	31		2	27	1	63
"	" " 500 " 1000 "	1	11		2	16		30
"	" " 1000 " 1500 "	1	7		2	9		19
Deep water species		8	89		7	39		143
"	" " 200 " 500 "	13	76		7	32		128
"	" " 500 " 1000 "	14	65		10	29		118
"	" " 1000 " 2000 "	9	49		9	27	2	96
"	" " 2000 " 3000 "	3	22		2	8		35
Total deep water species		23	166		14	68	2	273
Total shallow water species (4 are also pelagic).....		2	38		2	46	1	89
Total surface or pelagic species.....		2	14	23		3		42

II.—Table illustrating Bathymetrical Distribution.

All the species and named varieties are counted together, whether of shallow or deep water origin, except in the second column. Those species that have not been found in this region in more than 60 fathoms are not included in the eighth column, otherwise the entire molluscan fauna, living between the shore and 60 fathoms, would have to be enumerated.

Species and varieties.	Total species.	Depth (fathoms)						At surface.	
		2000-3000 f.	1000-2000 f.	500-1000 f.	300-500 f.	60-300 f.	0-60 f.		
CEPHALOPODA	27	27	3	10	15	15	10	2	2
GASTROPODA	216	205	22	56	76	107	124	38	14
<i>Toxoglossa</i>	36	34	8	19	13	15	12	4	0
<i>Rachiglossa</i>	33	29	3	7	16	21	25	7	0
<i>Teniglossa</i>	38	35	5	13	11	20	23	11	1
<i>Ptenoglossa</i>	10	10	0	0	3	3	7	0	1
<i>Rhipidoglossa</i>	30	28	2	5	13	17	14	2	0
<i>Gymnoglossa</i>	20	20	3	5	5	8	11	1	0
<i>Tectibranchiata</i>	23	23	1	7	13	15	19	5	0
<i>Nudibranchiata</i>	13	13	0	0	0	5	8	7	4
<i>Polyplacophora</i>	5	5	0	0	2	3	5	1	0
<i>Heteropoda</i>	8	8							8
PTEROPODA	24	23							23
SOLENOCONCHA	16	15	2	11	12	9	8	2	0
LAMELLIBRANCHIATA	115	107	8	36	45	59	85	46	3
BRACHIOPODA	3	3	0	2	0	1	1	1	0
Total Mollusca and Brachiopoda	401	380	35	115	148	191	228	89	42

III.—Table showing the Progress of Discovery of our deep water Mollusca.

	Cephalopoda.	Toxoglossa.	Rachiglossa.	Teniglossa.	Ptenoglossa.	Rhipidoglossa.	Polyplacophora.	Gymnoglossa.	Tectibranchiata.	Nudibranchiata.	Heteropoda.	Pteropoda.	Scaphopoda.	Lamellibranchiata.	Brachiopoda.	Total.
Species and named varieties in list	27	36	33	38	10	30	5	20	23	13	8	24	16	115	3	401
Recorded before 1880	11	5	11	13	1	4	2	2	8	6	1	5	3	52	1	125
Added since 1880	16	31	22	25	9	26	3	18	15	7	7	19	13	63	2	276
Added in 1883	4	17	13	14	0	15	0	7	2	0	5	10	8	24	2	121
Described as new by the writer since 1880	15	26	21	18	8	18	1	13	9	3	1	2	4	19	0	158
Described as new by the writer since 1883	4	16	11	10	0	11	0	6	1	0	1	0	3	9	0	72

In the above list are included 380 species and 21 named varieties. But of these, at least 42 are pelagic species, taken either alive at the surface or dead at the bottom, viz: Cephalopoda, 2; Tænioglossa, 1; Ptenoglossa, 1; Nudibranchiata, 4; Heteropoda, 8; Pteropoda, 23; Lamellibranchiata, 3. Possibly a few other species, now considered as deep-water forms, may be pelagic, for it is difficult to tell at what depths free-swimming species of Cephalopods are taken, unless they also occur in the stomachs of deep sea fishes. Many small Gastropods, etc., living habitually on floating *Fucus* and *Sargassum*, are caught with these sea-weeds in the trawl, on its way up or down, and mingling with the shells from the bottom may give rise to errors of this kind. Thus some of the species of *Rissoa*, *Cingula*, *Cithna*, etc., may not really live at the depths recorded, but at the surface. When satisfied of this accidental occurrence of some of the common shore species (*Littorina*, etc.), I have omitted them from the list, but have included the strictly pelagic forms, like *Litiopa*, for convenience.

Of the 343 species and 19 named varieties regarded as living at the bottom, 89 are also shallow-water species, living habitually in less than 60 fathoms, on this part of the coast. A considerable number, now considered as deep-water species in this region, occur in shallow water north of Cape Cod, and some of them may eventually be found to occur in the cold belt, off Martha's Vineyard, in 25 to 60 fathoms.

Of the 89 shallow-water species, 63 occur also between 200 and 500 fathoms, and 19 below 1000 fathoms. Some of these have a remarkably great range geographically, as well as in depth.

Of the 259 species and 14 varieties regarded as belonging to the deep-water fauna, in this region, 143 occur in the comparatively warm zone, between 60 and 200 fathoms. A considerable number of these have been taken only in the more southern dredgings, off Chesapeake Bay and Cape Hatteras, and some of them only in depths not much exceeding 100 fathoms, where the Gulf Stream has the greatest effect. In this zone the southern genera, *Dolium*, *Marginella*, *Solarium*, *Avicula*, etc. occur. The number that occupy the zone between 200 and 500 fathoms is 128, besides 63 shallow-water species, while 118 inhabit the depths between 500 and 1000 fathoms, associated with 30 shallow-water forms, and 96 have been taken between 1000 and 2000 fathoms, associated with 19 shallow-water ones. Although but five of our dredgings have been in more than 2000 fathoms, we are able to record 35 species from between 2000 and 3000 fathoms, which is a much greater number than has hitherto been recorded from such depths in the north Atlantic.

The different groups of mollusca differ greatly in the relative proportion of deep and shallow-water species, as shown by the following tables. Thus the deep-water Cephalopods are 23, against 4 shallow-water and surface species. The Gastropods exclusively deep-water are 166, against 38 of shallow-water origin. The shallow-water Lamellibranchs, however, seem to have a much greater tendency to range into deep-water, for of these there are but 68 deep-water species, associated with 46 shallow-water ones.

The species and varieties described as new, in this paper, are 72, as follows: Cephalopoda, 4; Gastropoda, 56; Solenoconcha, 3; Lamellibranchiata, 9. The total number of species of mollusca added to the fauna of this region by the Fish Commission dredgings, since 1880, is about 300, but only 276 of these are included in the above list; of these 121 were obtained in 1883.

Among the peculiarities of the deep-water mollusca the occurrence of an unusual proportion of Toxoglossa, many of which are handsomely sculptured and of large size, is a noteworthy feature. Tectibranchs are also abundant and some of them large. Rhipidoglossa are also relatively abundant and present some striking and elegant forms of Trochidæ, while there are 13 limpet-like forms belonging to this group, including the genera *Cocculina*, *Addisonia*, *Lepetella*, *Propilidium*. The Solenoconcha or Scaphopoda are relatively much more abundant, and some of the species are much larger in 500 to 2000 fathoms than in shallow-water. This must be regarded as mainly a deep-sea group.

Among Lamellibranchs the groups that are relatively most numerously represented are the Anatinidæ and Corbulidæ, (especially the genus *Neera*); the Nuculidæ, including the genera *Nucula*, *Leda*, *Yoldia*, *Malletia* *Glomus*, etc.; and the Arcidæ, including *Arca* and *Limopsis*. The Lucinidæ and Pectenidæ are also well represented.

ERRATA.

- Page 152, line 23, for Diomedæe, read *bandella* Dall (see p. 250).
Page 160, line 9, and page 226, line 23, for *Bela hebes* read *Gymnobela hebes*. An examination of the animal shows that this species has no operculum. The nucleus is imperfect in all of our specimens. It is closely allied to *G. curta*. The latter may prove to be only a variety, when larger series can be compared.
Page 163, line 34, for Typhlomangelia read Typhlomangilia.
Page 175, line 26, for figure 14, read figure 16.
Page 193, lines 10 and 15, and page 194, line 33, for *charissa*, read *chariessa*.
Page 218, line 23, for 35165, read 35163.
Page 238, line 6, for 306, read 302.
Page 250, lines 2 and 25, for 1881, read 1882.

ERRATA FOR VOL. V.

- The following errata have been noticed in the former catalogue.
Page 448, line 15, for Sept. 15, read Sept. 13.
Page 511, line 7 from bottom, for Mörch, read Möll.
Page 520, line 23, for umbibical, read umbilical.
Page 523, lines 1, 2, for *bombix*, read *bombyx*.
Page 529, lines 27, 28, for *Atalanta*, read *Atlanta*.
Page 529, last line, for Bolton, read Bolten.
Page 535, line 21, add off Halifax, 190 fath.; off Block I, 6-15 fath., 1874.
Page 539, line 9, for *Plasianella*, read *Phasianella*.
Page 540, last line, for *perisotraca*, read *periostraca*.
Page 551, line 8, read Cape Breton Island.
Page 553, line 12, for Galvinia, read Galvina.
Page 567, line 31, before Leche, insert Nova Zembla and Kara Sea.
Page 572, line 9, for *Nova-angliæ*, read *Novaigliæ*.
Page 578, line 18, for *mytilus*, read *Mytilus*.

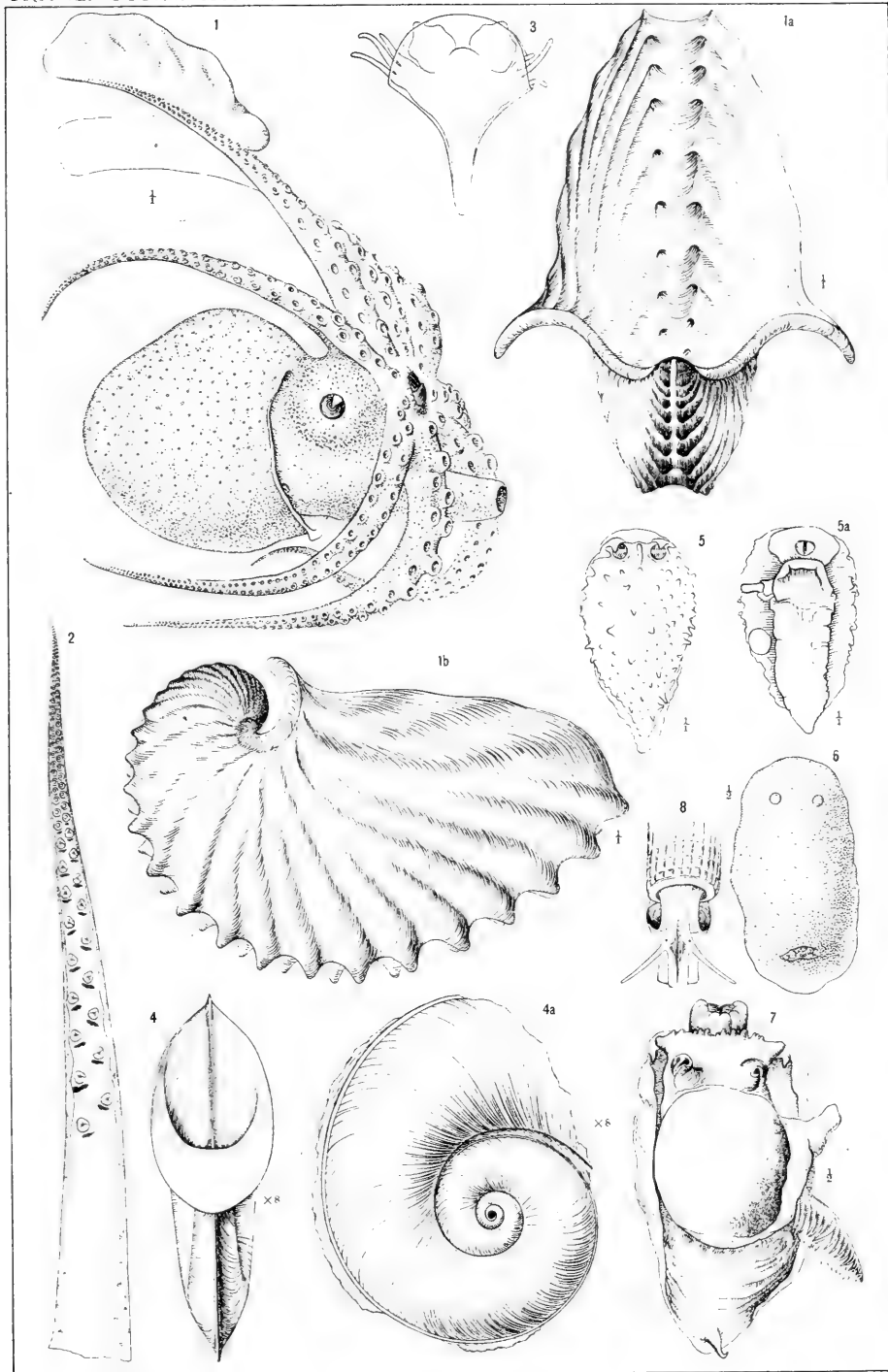

J. H. Emerton, from Nature.

Photo Lith. by L. S. Ponderson, New Haven, Conn.



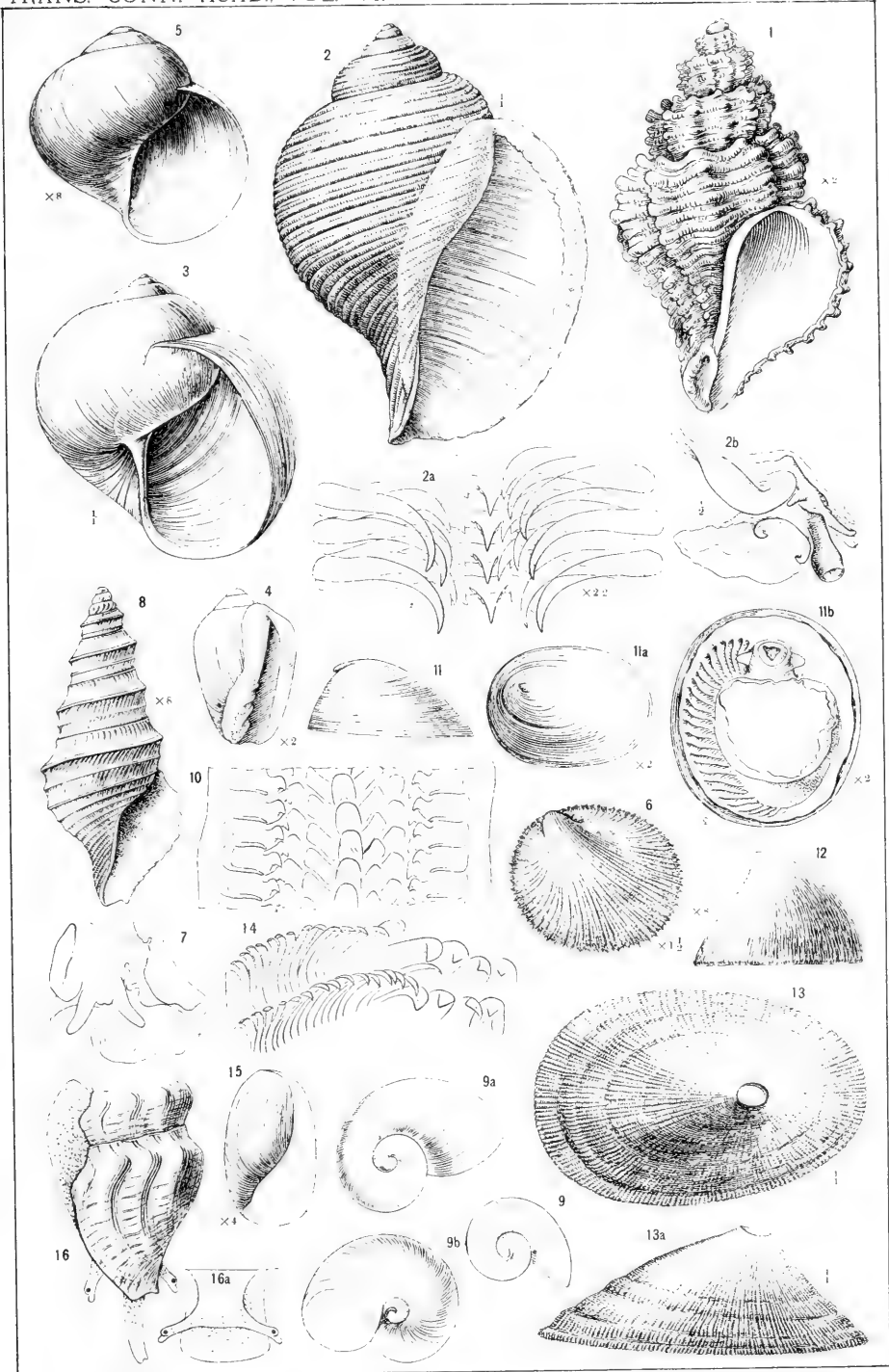

J. H. Emerton, from Nature.

Photo. Lith by L. S. Ponderson, New Haven, Conn.

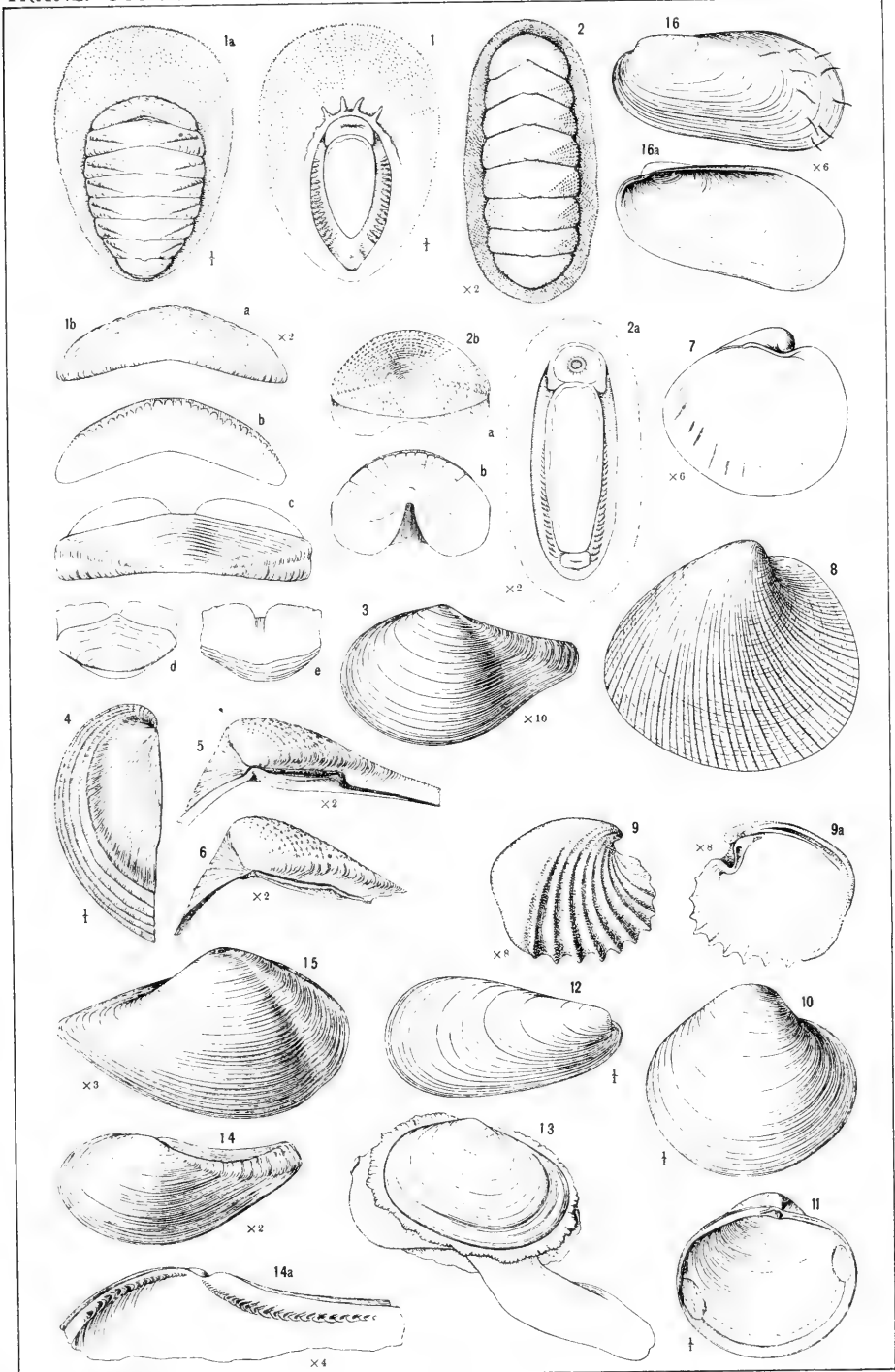

J. H. Emerton, from Nature.

Photo. Lith. by L. S. Ponderson, New Haven, Conn.

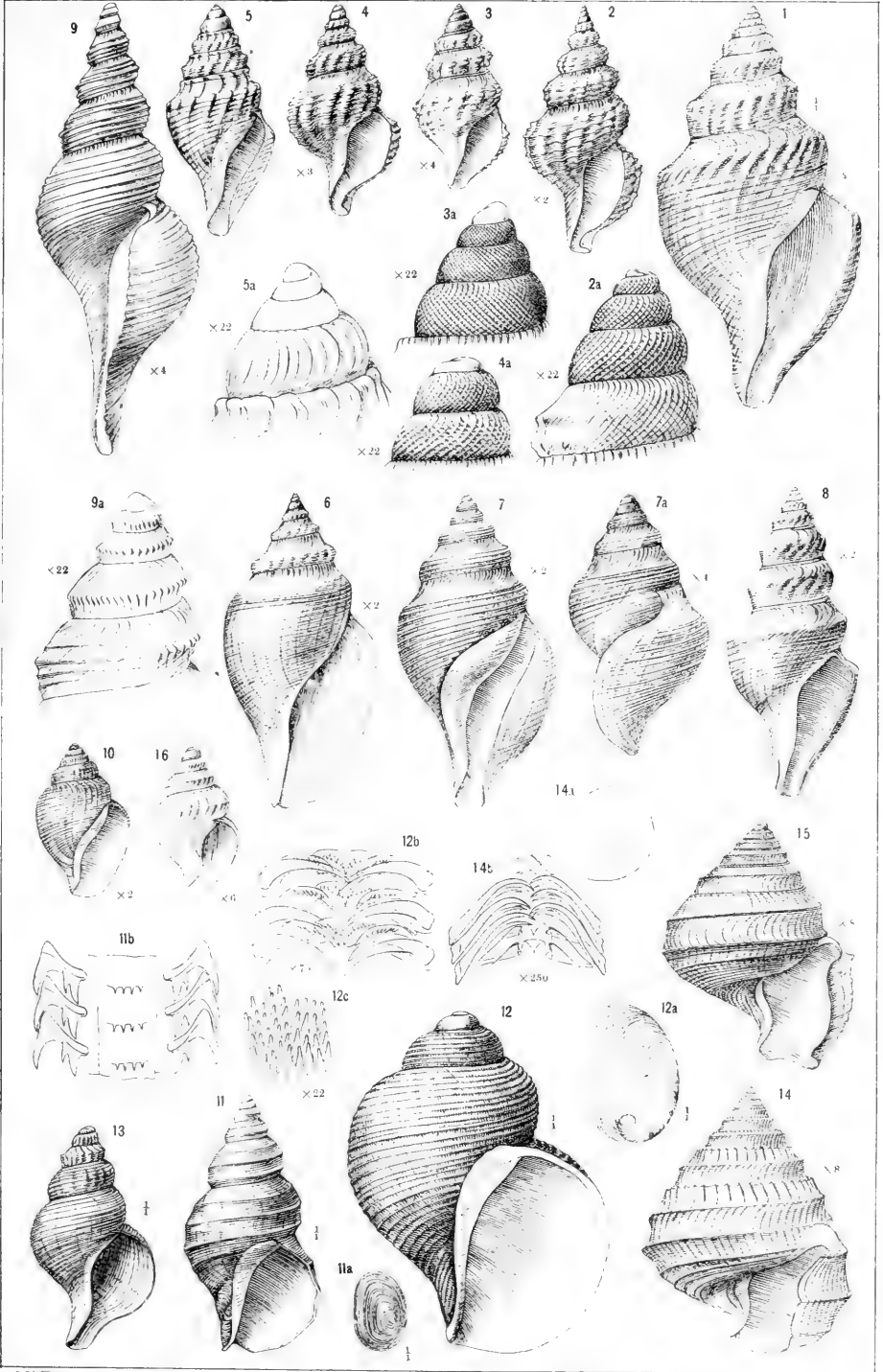

J. H. Emerton del. & sculp.

A. Anderson Photo Lith. New Haven.

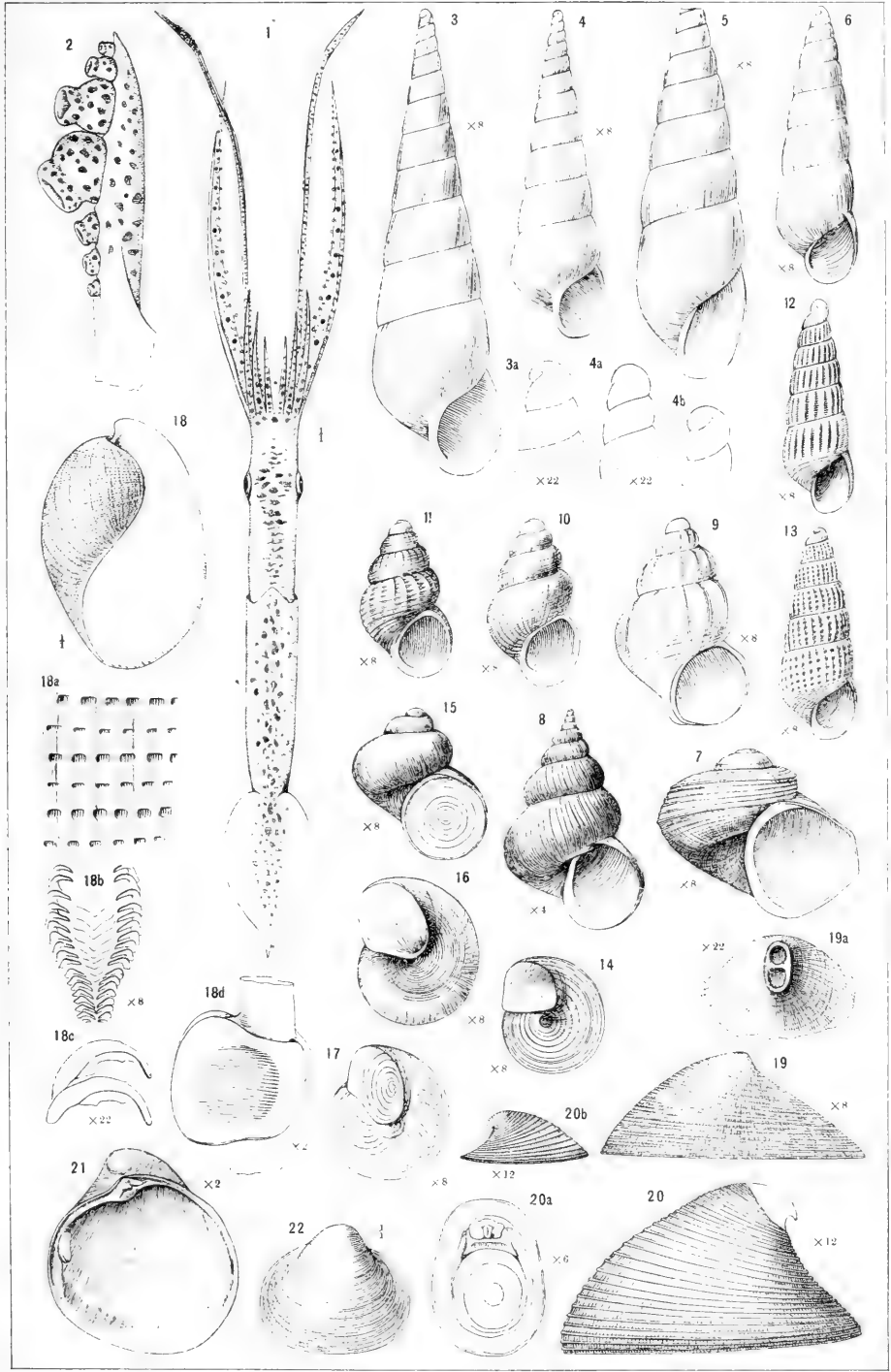

J.H. Emerton from nature

W. S. Hudson sculp. Photo lith. New Haven.



EXPLANATION OF THE PLATES.

PLATE XXVIII.

- Figure 1.—*Argonauta argo* Linné, p. 247. From an alcoholic specimen taken off Long Island. Side view; natural size.
- Figure 1a.—Front view of the shell of the same specimen; natural size.
- Figure 1b.—Side view of the same shell.
- Figure 2.—*Abralia megalops* V., p. 143. Type specimen. Front view of one of the sessile arms; $\times 2$ diameters.
- Figure 3.—*Pleuropus Hargerii* V., p. 275. Type specimen. Side view of the shell and animal in alcohol; enlarged.
- Figure 4.—*Atlanta Peronii* Les., p. 274. Side view of a large but somewhat broken specimen; $\times 8$ diameters.
- Figure 4a.—The same. Front view; $\times 8$ diameters. The nucleus is broken.
- Figure 5.—*Heterodoris robusta* V. and E., p. 274. Type specimen. Dorsal view natural size.
- Figure 5a.—The same. Ventral view; natural size.
- Figure 6.—*Doris complanata* V. and E., p. 274. Dorsal view of a specimen having the gills partially retracted; one-half natural size.
- Figure 7.—*Koonsia obesa* V., p. 274. Dorsal view of a specimen a short time in alcohol, but having the dorsal portion of the body much contracted, while the gill and reproductive organs are more displayed than usual; one-half natural size.
- Figure 8.—*Cæcum Cooperi* Smith. Dorsal view of the extended animal and front part of the shell from a living specimen; enlarged about 12 diameters.

PLATE XXIX.

- Figure 1.—*Trophon Lintoni* V., p. 176. Type specimen. Front view; $\times 2$ diameters.
- Figure 2.—*Dolium Bairdii* V. and S., p. 253. Front view; natural size.
- Figure 2a.—The same. Part of the odontophore; $\times 22$ diameters.
- Figure 2b.—The same. Dorsal view of the partially contracted animal preserved in alcohol.
- Figure 3.—*Lunatia levicula* V. Front view of one of the largest specimens taken; natural size.
- Figure 4.—*Marginella borealis* V., p. 165. Front view of one of the first specimens taken, which was dead and somewhat eroded; $\times 2$ diameters.
- Figure 5.—*Cithna* (?) *olivacea* V., p. 185. Front view of the type specimen; $\times 8$ diameters.
- Figure 6.—*Capulus Hungaricus* (Linné), p. 269. Dorsal view of the largest specimen; $\times 1\frac{1}{2}$ diameters.

- Figure 7.—*Pleurotomella Packardii* V., p. 265. Dorsal view of the anterior part of the animal from an alcoholic specimen, male; enlarged about 4 diameters.
- Figure 8.—*Taranis pulchella* V., p. 267. Front view of the largest specimen taken; $\times 8$ diameters.
- Figure 9.—*Choristes elegans* Carp., var. *tenera* V., p. 256. Top view of a very young specimen; much enlarged.
- Figure 9a.—The same. Top view of a somewhat older specimen, enlarged to the same extent.
- Figure 9b.—The same. Basal view of a still older specimen, enlarged the same.
- Figure 10.—*Addisonia paradoxa* Dall, p. 256. Part of the odontophore; much enlarged.
- Figure 11.—The same. Side view; $\times 2$ diameters.
- Figure 11a.—Dorsal view of the same specimen; $\times 2$ diameters.
- Figure 11b.—The same. Ventral view of the animal and shell of a larger specimen in alcohol; $\times 2$ diameters.
- Figure 12.—*Cocculina Beanii* Dall, p. 271. Side view; $\times 8$ diameters.
- Figure 13.—*Fissurella Tanneri* V., p. 255. Type specimen. Top view; natural size.
- Figure 13a.—The same specimen, side view.
- Figure 14.—*Margarita regalis* V. and S., p. 254. Part of one side of the odontophore; much enlarged.
- Figure 15.—*Cylichna Dalli* V., p. 274. Type specimen. Front view; $\times 4$ diameters.
- Figure 16.—*Mangilia cerina* V., p. 250. View of a portion of the shell and extended animal from a living specimen; enlarged about 8 diameters.
- Figure 16a.—The same. Dorsal view of the head and front part of the foot, more extended.

PLATE XXX.

- Figure 1.—*Placophora Atlantica* V. and S., p. 206. Ventral view of the type specimen; natural size.
- Figure 1a.—Dorsal view of the same specimen.
- Figure 1b.—The same. Detached valves; *a*, dorsal side of the anterior valve; *b*, ventral side of the same valve; *c*, dorsal side of one of the middle valves; *d*, dorsal side of the posterior valve, and *e*, ventral side of the same valve; $\times 2$ diameters.
- Figure 2.—*Trachydermon exaratus* (Sars), p. 208. Dorsal view; $\times 2$ diameters.
- Figure 2a.—Ventral view of the same specimen.
- Figure 2b.—The detached anterior valve of the same specimen; *a*, dorsal side; *b*, ventral side; $\times 4$ diameters.
- Figure 3.—*Neera lamellosa* M. Sars, p. 277. Side view; $\times 10$ diameters.
- Figure 4.—*Pholadomya arata* V. and S., p. 278. Anterior view of a large left valve; natural size.
- Figures 5, 6.—The same. View of the beak and hinge of two specimens to show variations in the hinge; $\times 2$ diameters.
- Figure 7.—*Pecchiolia gemma*, vi, p. 258. Type specimen. View of the interior of the left valve, $\times 6$ diameters.
- Figure 8.—The same. View of the exterior of the right valve of a larger example.
- Figure 9.—*Verticordia calata* V., p. 278. Type specimen. View of the exterior; $\times 8$ diameters.
- Figure 9a.—The same valve, view of the interior; $\times 8$ diameters.

- Figure 10.—*Diplodonta turgida* V. and S., p. 279. View of the exterior of the right valve; natural size.
- Figure 11.—The same. View of the interior of a somewhat smaller valve; natural size.
- Figure 12.—*Modiolaria polita* V. and S., p. 281. Type specimen. Side view of a small specimen; natural size.
- Figure 13.—*Tellimya ferruginosa* (Mont.). Side view of a living specimen with the animal fully extended; enlarged about 8 diameters.
- Figure 14.—*Leda pernula* (Müll.), p. 280. Side view of a specimen having the beak curved more than usual; $\times 2$ diameters.
- Figure 14a.—The same specimen. View of the hinge; $\times 4$ diameters.
- Figure 15.—*Leda acuta* V., p. 259. Side view; $\times 3$ diameters.
- Figure 16.—*Idas argenteus* Jeff., var. *lamellosa* V., p. 281. Side view; $\times 6$ diameters.
- Figure 16a.—The same. View of the interior of the right valve; $\times 6$ diameters.

PLATE XXXI.

- Figure 1.—*Pleurotomella Bairdii* V. and S., p. 147. Front view of one of the stouter specimens, ascertained to be a female by examination of the animal; natural size.
- Figure 2.—*Pleurotomella Benedicti* V. and S., p. 148; $\times 2$ diameters.
- Figure 2a.—The same. Apical whorls; $\times 22$ diameters.
- Figure 3.—*Pleurotomella Sandersoni* V., p. 149; $\times 4$ diameters.
- Figure 3a.—The same. Nuclear whorl; $\times 22$ diameters.
- Figure 4.—*Pleurotomella Saffordi* V. and S., p. 151; $\times 3$ diameters.
- Figure 4a.—The same. Nuclear whorls; $\times 22$ diameters.
- Figure 5.—*Pleurotomella vandella* (Dall) = *P. Diomedæ* V. and S., pp. 152 and 250; $\times 3$ diameters.
- Figure 5a.—The same. Nuclear whorls; $\times 22$ diameters.
- Figure 6.—*Pleurotomella Emertoni* V. and S., p. 154; $\times 2$ diameters.
- Figure 7.—*Pleurotomella Bruneri* V. and S., p. 155; $\times 2$ diameters.
- Figure 7a.—The same. Profile view of a younger specimen; $\times 4$ diameters.
- Figure 8.—*Typhlomangilia Tanneri* V. and S., p. 163; $\times 2$ diameters.
- Figure 9.—*Pleurotomella Catharinæ* V. and S., p. 155; $\times 4$ diameters.
- Figure 9a.—The same. Nuclear whorls; $\times 22$ diameters.
- Figure 10.—*Gymnobela curta* V., p. 158; $\times 2$ diameters.
- Figure 11.—*Buccinum abyssorum* V. and S., p. 167; natural size.
- Figure 11a.—The same. Operculum of another specimen; natural size.
- Figure 11b.—The same. Dentition.
- Figure 12.—*Benthodolium abyssorum* V. and S., p. 177; natural size.
- Figure 12a.—The same specimen. Operculum; natural size.
- Figure 12b.—The same specimen. Dentition; $\times 75$ diameters.
- Figure 12c.—The same. Marginal portion of one of the jaws; $\times 22$ diameters.
- Figure 13.—*Sipho profundicola* V. and S., p. 170; natural size.
- Figure 14.—*Sequenzia formosa* Jeffreys, p. 186; $\times 8$ diameters.
- Figure 14a.—The same. Operculum; more enlarged.
- Figure 14b.—The same. Dentition; $\times 250$ diameters.
- Figure 15.—*Sequenzia eritima* V., p. 189; $\times 8$ diameters.
- Figure 16.—*Sipho leptaleus* V., p. 175; $\times 6$ diameters.

PLATE XXXII.

- Figure 1.—*Leptoteuthis diaphana* V., p. 141. Dorsal view; natural size.
- Figure 2.—*Eledonella pygmaea* V., p. 145. Side view of the hectocotylyzed arm; enlarged about five diameters.
- Figure 3.—*Eulimella lucida*, V., p. 192; $\times 8$ diameters.
- Figure 3a.—The same. View of the upper whorls; $\times 22$ diameters.
- Figure 4.—*Eulimella chariessa* V., p. 193; $\times 8$ diameters.
- Figure 4a, b.—The same. Different views of the upper whorls; $\times 22$ diameters.
- Figure 5.—*Eulimella nitida* V., p. 194; $\times 8$ diameters.
- Figure 6.—*Eulimella tissa* V., p. 195; $\times 8$ diameters.
- Figure 7.—*Cithna cingulata* V., p. 184; $\times 8$ diameters.
- Figure 8.—*Cingula apicina* V., p. 183; $\times 4$ diameters.
- Figure 9.—*Cingula brychia* V., p. 179; $\times 8$ diameters.
- Figure 10.—*Cingula leptalea* V., p. 182; $\times 8$ diameters.
- Figure 11.—*Cingula syngenes* V., p. 180; $\times 8$ diameters.
- Figure 12.—*Turbonilla costulata* V. One of the original type-specimens from Vineyard Sound, shallow water; $\times 8$ diameters.
- Figure 13.—*Turbonilla areolata* V. One of the original type-specimens from Vineyard Sound; $\times 8$ diameters.
- Figure 14.—*Cyclostrema cingulatum* V., p. 198. Basal view of the type specimen; $\times 8$ diameters.
- Figure 15.—*Cyclostrema affine* V., p. 199; $\times 8$ diameters.
- Figure 16.—*Cyclostrema diaphanum* V., p. 199. Basal view; $\times 8$ diameters.
- Figure 17.—*Cyclostrema Dalli* V., p. 255. Basal view of a peculiarly sculptured specimen (var. *ornatum*) from station 2115; $\times 8$ diameters.
- Figure 18.—*Scaphander nobilis* V., p. 209. Front view of a medium sized specimen; natural size.
- Figure 18a.—The same. View of a portion of the surface to show the character of the punctations; much enlarged.
- Figure 18b.—The same. Dentition; $\times 8$ diameters.
- Figure 18c.—The same. Side view of two of the teeth; $\times 22$ diameters.
- Figure 18d.—The same. Gizzard, side view; $\times 2$ diameters.
- Figure 19.—*Fissurisepta eritneta* V., p. 204. Side view of the type-specimen; $\times 8$ diameters.
- Figure 19a.—The same. Posterior view of the apex; $\times 22$ diameters.
- Figure 20.—*Cocculina leptalea* V., p. 202. Side view of the largest specimen with the apex eroded; $\times 12$ diameters.
- Figure 20a.—The same. Basal view of the shell containing the animal preserved in alcohol; $\times 6$ diameters.
- Figure 20b.—The same. Side view of a much younger specimen with the apex perfect; $\times 12$ diameters.
- Figure 21.—*Poromya sublevis* V., p. 221. Interior of the right valve; $\times 2$ diameters.
- Figure 22.—*Thracia nitida* V., p. 221; natural size.

ART. VII.—NEW ENGLAND SPIDERS OF THE FAMILY EPEIRIDÆ.

BY J. H. EMERTON.

ON account of their bright colors and conspicuous webs, the Epeiridæ are better known than the other families of spiders and many of our species have been already described. The general works of Koch, 1831 to 1848, and Walckenaer, 1837 to 1847, contain descriptions of many American spiders, which cannot however be identified with much certainty. The descriptions of Araneides of the United States by N. M. Hentz, published in the Journal of the Boston Society of Natural History from 1842 to 1850, are largely of southern spiders. I have however identified twenty New England species with Hentz's descriptions. Since Hentz a few northern spiders of this family have been described in the following papers.

- Giebel: Illinois Spiders. Zeitschrift für Gesamten Naturwissenschaften, 1869.
J. Blackwall: Spiders from Canada. Ann. and Mag. of Nat. Hist., vol. xvii, p. 77.
O. P. Cambridge: Newfoundland Spiders. Proc. Royal Phys. Soc. Edinb., 1881.
T. Thorell: Labrador Spiders collected by Packard. Proc. Boston Soc. of Nat. Hist., vol. xvii, 1875.
T. Thorell: Bulletin of Hayden's U. S. Survey of the Territories. Spiders collected by Packard in Colorado, 1877.
E. Keyserling: Beschreibungen neuer und wenig bekannter Arten Orbitele. Sitzungsberichte der Isis, Dresden, 1863.
Beiträge zur Kenntniss der Orbitele Latr. Verhandlungen der Zool. Botan. Gesellschaft in Wien, 1865.
Neue Spinnen aus Amerika. Zool. Bot. Gesellschaft in Wien, 1879, 1880, 1881, 1882.
H. C. McCook: Epeira radiosa. Proc. Phil. Acad. Nat. Sci., 1881, p. 163.
Webs of *E. triaranea* and other new species. Proc. Phil. Acad., 1876.
Webs of Epeiridæ. Proc. Phil. Acad., 1881, p. 431 and 173; 1878, p. 124.

Besides these species described from American spiders, several of our common Epeiridæ are also found in Europe and have there long been known and described. In identifying these I have been much helped by European specimens determined for me by Messrs. Thorell, Cambridge, Simon and Koch. In naming European species I have followed as closely as possible Thorell's Synonyms of European Spiders, and have given the synonyms used by Simon, Blackwall and Menge.

The spiders which I have examined are chiefly from the same localities as the Therididæ described in *Trans. Conn. Acad.*, vol. vi, pp. 1 to 80, but owing to the greater ease of finding Epeiridæ, the common species have been taken at many more places and I have had much more help from other collectors. Besides my own collection I have examined those of Bowdoin College, Cornell University, Yale College, H. C. McCook of Philadelphia and Geo. Marx of Washington. I have also received specimens from J. B. Tyrrell, Toronto, Canada. From the Adirondacks and Rocky Mountains from F. A. Bowditch of Boston. From the neighborhood of Boston from S. Henshaw, and from many other places and persons.

The Epeiridæ are distinguished from other spiders by their round webs formed of radiating threads crossed by others which are covered when fresh with a sticky fluid that collects on them in drops. These webs and the way in which they are made have been often described. The radiating lines are first spun and tightened by many irregular short cross lines at the center. Then a spiral line is begun passing around the center, at first with the whorls very close together, then suddenly widening it is continued to the outside of the web with the whorls as far apart as the spider can reach. The sticky spirals are then begun at the outside close together and as they cross the line of the first spiral, the latter is bitten away, leaving in the finished web only little thickened spots on the rays to show its course. Pl. XL, fig. 1. Toward the center of the web the sticky spirals are usually a little closer until about the length of the spider's longest legs from the center, where they stop, leaving a ring without cross lines around the closer part of the first spiral. When the web is finished the spider is thus left in the center where it can hold itself without interfering with the sticky threads until something is caught.

The Epeiridæ usually have the abdomen large, short and thick, so that they walk awkwardly on a flat surface, their natural position being back downward holding to the web by their feet.

The cephalothorax is usually wide and the head low with the eyes around the front, not over the back as in some families. The lateral eyes are usually very close together, and separated far from the middle pairs.

The mouth parts are short and stout, except in Tetragnatha, the maxillæ and labium rounded at the tips. Pl. XL, fig. 6.

The markings of the abdomen usually form, as in some Therididæ, a wide scolloped stripe which has been called the "folium," usually bordered by a dark and light stripe and enclosing one or more pairs

of spots on each segment; those of the two front segments being usually larger and brighter than the others. These markings can be seen on the figures on Plates xxxiii and xxxiv.

Like Theridiidæ the Epeiridæ have three claws on the feet and, under the claws, stiff toothed hairs. The middle claw is shorter than the others and has two or three short teeth. The lateral claws have more and larger teeth varying in different individuals, on different feet and according to the species. The inner claw also differs from the outer as shown on Pl. xl, figs. 3, 4, 5. The toothed spines have also a definite number and arrangement.

The spinnerets are short and closed together when not in use so that the middle pair are concealed. Between the front pair of spinnerets is a short process covered with hairs but without spinning tubes.

The males are smaller than the females and have a smaller abdomen and longer legs some of which are often thickened or otherwise modified in shape. The difference between the sexes is greatest in the genus *Argiope*, in which the females become very large about the time for laying eggs.

The copulating organs are described in the following descriptions of the two sub-families.

The genera *Uloborus* and *Hyptiotes*, which have been placed in this family by Thorell and others on account of the resemblance of their webs to those of Epeiridæ, seem to me to belong more properly with the Cniflonidæ with which they agree in having the calamistrum and cribellum and in the structure of the adhesive thread by which their webs are crossed. This classification is followed by Simon in *Arachnides de France* and by Bertkau in *Archiv für Naturgeschichte*, 1882. Leaving out these I divide the family into the two following sub-families.

Epeirinae.

This group includes all the family except *Tetragnatha* and *Pachygnatha*. They are generally short and stout spiders with the abdomen round and plainly marked. The head is low and wide. The maxillæ and labium are short and rounded. The mandibles are short and stout. The male palpi are large without a movable hook on the tarsi. The palpal organs are generally rounded and have a short tube but long terminal hook and other appendages. The epigynum varies greatly in different genera but always has external hard parts.

The following genera belong in this sub-family. *Epeira*, *Singa*, *Zilla*, *Micropeira*, *Cyclosa*, *Aerosoma*, *Cyrtarachne*, *Argiope*, *Argyropeira*,

Tetragnathinæ.

These differ considerably from the other Epeiridæ. The maxillæ and labium are shaped at the end as in the Epeirinae but are much longer. The mandibles, especially in the males, are very long and toothed on the inner edge. The eyes are on the front of the head in two rows, the lateral pairs not so distinctly separated from the others as in Epeirinae. The epigynum is internal, consisting only of a pouch with simple spermathecae. Pl. XL, fig. 7. The palpal organs are not enclosed by the tarsus and the tarsus has a long movable hook jointed to its base. Pl. XL, figs. 5 and 6. The colors are light, usually yellowish with gray markings and silvery spots and bands. Genera *Tetragnatha*, *Pachygnatha*.

Epeira.

In Epeira the front of the head is low and the lateral eyes are much farther from the middle ones than these are from each other. The abdomen is usually round, or short oval, sometimes widened and thickened a little at the front end with two humps or horns on the back. The epigynum is covered by a hook or finger which is sometimes narrow and soft and placed between two elevations, and sometimes wide enough to cover all the other parts as in *E. domiciliorum* and *trivittata*. The males are always somewhat smaller than the females and have longer legs, the second pair of which are often thickened or curved. The palpal organs are large and have a short tube with a large terminal hook and large hard processes at the base. The tarsus has a short curved spur at the base. The tibia and patella of the male palpi are usually short.

Epeira nordmanni, *cinerea*, *silvatica*, *angulata*, *solitaria* and *corticaria*.

All these spiders have two slight humps on the front of the abdomen, which is a little wider and thicker in front than in other species. The colors are generally dark. Most of the spiders grow to a large size and are generally found in woods of large trees. *Silvatica*, *angulata* and *solitaria* resemble each other closely and may be mistaken one for the other. In *angulata* the sternum has a yellow middle stripe and the abdomen yellow spots between the spinnerets and epigynum. In *silvatica* the sternum is brown and the abdomen brown beneath with only indistinct markings. The male *angulata* has a large spine on the coxæ of the second legs, while in *silvatica* this spine is very small. The enlarged tibia of the second legs in the male *angulata* is nearly as long as tibia of the first legs. In *silvatica* the second tibia is more slender and much shorter than the tibia of the first pair. The folium of *silvatica* has a row of oblique black markings along the edge on each side, while in *angulata* it is evenly notched. The male *solitaria* is much larger than the other species. It has the spines on the second coxæ very large and smaller ones on the first coxæ. The under side of the abdomen and sternum are black and the folium indistinct. *E. corticaria* may be mis-

Epeira angulata (Clerck, 1757) Thor., Blk., Menge.PLATE XXXIII, FIGURES 12, 12*a*. PLATE XXXV, FIGURE 2.

The adult female is 16^{mm} long. The colors are brighter than in *silvatica*. The dark brown rings on the legs are darker and more distinct. The sternum has a bright yellow line in the middle. The under side of the abdomen is black. Between the epigynum and spinnerets are several irregular yellow spots as in some specimens of the European *angulata*. The abdomen is nearly as wide as long with two large humps on the first segment. The front of the abdomen, including the front half of the humps, is dark brown except a bright yellow mark in the middle and a few small light spots. The rest of the back of the abdomen is lighter. The folium is dark brown at the sides and deeply scolloped. The edge is marked by a dark and light line which is not broken into short black lines as in *silvatica*. Pl. XXXIII, fig. 12, 12*a*.

The males are colored in the same way. The tibia of the second legs is thickened and the metatarsus curved. The coxa of the second pair has a conical spine near the base.

The epigynum is small but the finger is thicker than in *silvatica*. The palpal organs are large with the terminal hook short and sharp, shorter than in *silvatica*. Pl. XXXV, fig. 2.

Two males were found in woods on Mt. Tom, Holyoke, Mass., near a large web across a path. The females could not be found. A female was found in a large web eight feet from the ground between two trees six feet apart in Beverly, Mass.

Adult ♀ from Illinois, Knox Co., Cornell Univ. Collection.

Epeira solitaria, new.

PLATE XXXIII, FIGURE 11. PLATE XXXV, FIGURE 3.

This large spider, of which I have only seen one male, is 14^{mm} long with the front legs 28^{mm}. The general appearance is like that of the male *angulata*. The conical spines on the second coxæ are very large and there are smaller ones on the first coxæ. The palpal organ has a very long black terminal hook. Pl. XXXV, fig. 3. The sternum, the coxæ and the under side of the abdomen are black. The cephalo-

taken for the young of other species on account of its small size. The colors are however lighter and the rings on the legs narrower and more numerous. The epigynum is nearly as large as that of *silvatica* and differently shaped. Pl. XXXV, fig. 9. The finger is liable to be broken off.

thorax is dark brown. The usual yellow spot on the first segment of the abdomen is large and bright. There are two humps as in *angulata*. The folium is black with a few yellow spots and the side areas are covered with irregular spots of black and yellow. The legs and palpi are marked as in the male *angulata* but the femora are darker. The tibia of the second pair is enlarged as in the allied species.

This spider was found on the fence of the reservoir below Spring pond in Peabody, Mass., Sept. 20, 1869.

Epeira corticaria, new.

PLATE XXXIII, FIGURE 14. PLATE XXXV, FIGURE 9.

This little spider may easily be mistaken for the young of *angulata*. It is 6^{mm} long, light reddish brown in color with lighter dull yellow markings. The cephalothorax has a wide middle dark stripe divided in front behind the eyes. It is also dark on the edges. The legs are dull yellow, with wide brown rings at the end and middle of each joint. The abdomen is widest at the first segment and has there two horns. The front of the abdomen is dark reddish brown with light spots in the middle and a light line along the hinder edge from one horn to the other. Behind this dark area the abdomen is lighter and covered with fine spots. The folium is distinct but not very dark and has oblique dark brown lines along the edges like *silvatica*. The sternum is dark brown. The epigynum is large and has a thick finger widened near the base. In three out of four of my specimens the finger is broken off.

Beverly, Mass., and Adirondack Mts., N. Y.

Epeira silvatica, new.

PLATE XXXIII, FIGURES 13, 13a. PLATE XXXV, FIGURES 1, 4, 5, 6.

Length of female from Beverly, 16^{mm}; first leg, 23^{mm}.

The abdomen is nearly as wide as long and has on the first segment two prominent humps. The cephalothorax is dark brown with indistinct darker lines in the middle and on each side. The legs are brown with dark rings at the ends of the joints and less distinct ones in the middle. The abdomen has a bright yellow spot on the front, behind which is a median row of smaller light spots. The greater part of the abdomen is of a light brown color. The front around the yellow spot is darker and so is the folium which is marked on the edges by five pairs of oblique black lines surrounded by a lighter border. The under side of the abdomen is dark brown without markings in the adult female but young females and males have two

distinct yellow spots in the middle and two smaller ones near the breathing holes. The epigynum is small for so large a spider. The finger is long and slender as in *angulata*. Young specimens apparently of the same species are more distinctly marked. They have the dark markings on the middle and sides of the head much plainer than the adults and the yellow spots under the abdomen.

The male is about half as large as the female. (The largest, one from Beverly, is 10^{mm} long, 1st leg 21^{mm}) with the front legs proportionately much longer. The tibiae of the second pair are thickened and have the spines larger and more numerous than in the female. The coxa of the second pair has a short conical point near its base and the coxa of the first pair a hook on the under side near the outer edge. These modifications of the front coxæ are found in several species. The colors are similar to those of the female. The dark rings near the ends of the joints of the legs do not extend quite to the end, the joint having a lighter tip. The folium is more regular than in the female and the humps are absent. The sternum is black. The under side of the abdomen has four yellow spots more or less united at the sides.

Beverly, Mass., E. Burgess; Mt. Jefferson, N. H.; Chateaugay Lake, Adirondack Mts., N. Y., from F. A. Bowditch; Ithaca, N. Y., Cornell Univ. Collection.

Epeira nordmanni Thorell. Synonyms of European Spiders.

PLATE XXXIII, FIGURES 6, 6a, 6b.

Female, 11^{mm} long; first leg, 18^{mm}.

The colors are white and gray or black. The cephalothorax is gray, in alcohol yellow, darkest toward the sides. The legs have a dark ring at the end and a less distinct one in the middle of each joint. The sternum is light brown or black. The abdomen is narrower than that of *angulata*, but has two humps on the first segment like that species. The folium is narrow and truncated in front in line with the second pair of muscular spots. The edges of the folium are marked with five pairs of very black lines converging backward. The light stripes at the sides of the folium are wide and the lateral dark markings sharply defined. In front there is a central white mark, on each side of which are dark areas that extend back so far as to cover half of the humps and enclose a large spot between them. In some specimens the folium and other dark markings are nearly uniform black with sharply marked edges and with some white spots in the center. In one female from Western New York apparently

of this species the dorsal markings are very obscure, and the light areas of a reddish color like old specimens of *Epeira trivittata*. The ventral markings are as distinct as usual. The under side of the abdomen has a middle dark area from the sternum to the spinnerets. In this area are four yellow spots, two just behind the respiratory openings and two farther back. In some these spots are connected by the light stripe along the sides of the dark area. The finger of the epigynum is widened at the base somewhat as in *corticaria*.

I have adult females from Quohang Bay, 20 miles east of Portland, Me., where they were abundant on low bushes in September, and young from Eastport, Me., and the White Mts. Huntington, Mass., young; Philadelphia, H. C. McCook; Western New York, E. P. Van Duzee. I have compared specimens from Norway from Thorell's collection.

Epeira cinerea, new.

PLATE XXXIII, FIGURE 10. PLATE XXXV, FIGURES 7, 8.

Female 18^{mm} long; cephalothorax, 6·5^{mm}; first leg, 26^{mm}.

The color is dirty white with grayish markings. Long white hairs are scattered all over the body. The cephalothorax is a little darker at the sides. The legs have gray rings at the end and middle of each joint which are hardly visible in very light individuals and nearly black in dark ones. The abdomen has two slight humps on the first segment. The folium and other markings are like those of *angulata* and allied species but very pale and indistinct. The sternum is dark brown. The under side of the abdomen has a central dark stripe bordered by light yellow curved markings. The epigynum is small and has a wide finger turned up at the end, behind which is a slight hollow.

The male has the same colors and markings as the female. The tibiae of the second pair of legs are not thickened.

This spider is common about barns and fences in Maine. Mr. Howard of New Haven, found it very abundant at Upton, Maine, near Umbagog lake. I have it also from Bethel, Me., Gorham, N. H., and Au Sable chasm, northern New York. I have never seen it in other parts of New England nor farther south, except from Carter County, Kentucky, where it was collected by F. G. Sanborn for the Kentucky Geological Survey.

Epeira sclopetaria, *E. patigiata* and *E. stric*.

These three house spiders resemble each other closely in size, color and habits, and are easily mistaken one for the other. *Ep. sclopetaria* is the most common house

Epeira scolopetaria (Clerck) Thorell, Menge.

E. sericata Blk.

PLATE XXXIII, FIGURE 4. PLATE XXXV, FIGURE 10.

Large female, from Salem, 15^{mm} long; 1st leg, 24^{mm}. Average female, Essex Bridge, Salem, 11^{mm} long; 1st leg, 18^{mm}.

The whole body is covered with light gray hairs which obscure the color and markings of the skin. When wet in alcohol the dark markings appear dark brown, and the lighter parts dull yellow. The cephalothorax is dark brown or gray without markings. The legs are marked with light and dark rings. The femur has the inner half light and the outer half dark. The patella is darkest toward the tip. The tibia and the metatarsus are dark at both ends and have a dark ring near the middle. The sternum is dark brown with a roundish light spot in the middle and the coxæ light. The top of the abdomen is dull yellow with dark brown or black markings. The folium has a distinct dark and light line around the scalloped edges, broken on each side between the first and second segments. These breaks are usually distinct and distinguish this spider from *patagiata*, *strix* and other related species in which the edge of the folium is usually entire. The median dark spot at the front of the abdomen is large and plain in this species and is followed by a line

Epeira in Europe and America. It lives in barns and windows of houses and on fences, and between the timbers of wharves and bridges, but is rarely found on plants or away from houses. *Ep. patagiata* is occasionally found about houses in the same way in both countries and also on plants. It appears to be a northern species and is not found, as far as I know, south of New England nor in southern Connecticut. *Ep. strix* is an American species usually found on plants but sometimes about houses like *scolopetaria*. The colors and markings of these three species are usually distinctive, but occasional individuals of *scolopetaria* and *patagiata* resemble each other very closely. In *scolopetaria* the colors are gray inclining to yellow. The edges of the folium are broken on the first segment, which is not the case in the other species. The colors of *E. patagiata* incline to red, especially in alcohol. The abdomen is usually flatter than in *scolopetaria* and the folium wide and unbroken at the edges. In *strix* the colors are more as in *scolopetaria*, the abdomen very oval, the folium narrow and the sides of the abdomen much lighter colored. The legs of *scolopetaria* are the longest and those of *strix* shortest. The males can be easily distinguished by their palpi. In *scolopetaria* the fork at the base of the palpal organ is slender and the terminal hook long and blunt. In *strix* the fork is also slender, the outer tooth longer than in *scolopetaria* and the terminal hook is stouter but with a sharp point. The fork in *patagiata* is short and twice as thick as in the other species, both teeth turned up at the ends, and the terminal hook is long like *scolopetaria* but pointed at the tip. The finger of the epigynum of *patagiata* is flat and widened at the tip, while in *scolopetaria* and *strix* it is round as usual.

of smaller median triangular spots. The dark portions of the folium on the first segment are distinctly separated from the rest by the gaps in the edges of the folium and a light area extending back to the second pair of muscular spots. The dark areas at the sides of the folium on the hinder segments are broken by lighter transverse stripes on each segment. Beneath the abdomen are the usual semi-circular bright yellow markings, partly enclosing a dark spot which extends back to the spinnerets. Very dark individuals have the dark markings of the abdomen black and the lighter marks bright white, and very light individuals have all the markings light yellowish brown and indistinct. This is the most common *Epeira* about barns and fences and especially on wharves and bridges, but is seldom found on plants and never far from houses. It seems to be common all over the country, and equally so in Europe. It makes its web usually toward evening and remains in it during the night, but in the daytime hides in some crack near by where it makes a slight shelter of silk. It sometimes holds a thread leading to the center of the web. Adults are found at all seasons but most abundantly in the summer. I have seen the cocoons in June.

The male differs from the female chiefly in greater length of the front legs and smaller size of the abdomen. The palpi are short. The tarsus has a slight notch at the base behind which a blunt process turns up toward the end of the palpus. The palpal organ is twisted together and partly enclosed in the tarsus. The tube is very short and simple, near the middle of the palpal organ under the ends of the other appendages. The largest of these is a hard forked process near the base of the bulb. Beyond this and near the tube is a thin, flat appendage, and at the end of the organ beyond the tube is a large hook with a shorter roughened process at its base.

The epigynum has two hard prominences between which is a flexible, finger-like appendage. In *sclopetaria* and *striv* this finger is narrow and usually turned up at the end. In *patagiata* the finger is wide and flat, and dark colored at the end.

Under the name of *Epeira vulgaris*, Hentz probably included this and other allied species. The picture from which his figure of *E. vulgaris* is engraved may be from this species, but quite as likely from some southern spider not described here.

Epeira patagiata (Clerck) Thor., Blk., Menge.*Ep. formosa* Keys., Zool. Botan. Gesellsch., Wien, 1865.*Ep. hilaris* Camb., from Newfoundland, Proc. Roy. Phys. Soc., Edinburgh, 1881.

PLATE XXXIII, FIGURES 3, 3a, 3b, 3c. PLATE XXXV, FIGURE 11.

Female, from Salem, 9^{mm} long; 1st leg, 15^{mm}. Female, from Mt. Washington, 11^{mm}; 1st leg, 14^{mm}. Female, from Beverly, 10^{mm} long; 1st leg, 15^{mm}.

This spider is slightly smaller than *sclopetaria* and like that species varies greatly in size and the length of the legs. The abdomen is nearly round, as in *sclopetaria*, but slightly flatter on the back. The colors are lighter than those of *sclopetaria* and the light markings have a reddish color, especially in alcohol, in place of the dull yellow of *sclopetaria*. The cephalothorax is light brownish yellow with light hairs. The legs are ringed with dark and light, as in *sclopetaria*, but the dark parts are brighter reddish brown. The abdomen is marked with various shades of brown. The folium has the edges plainly marked and not broken on the second segment as in *sclopetaria*. The color of the folium is usually broken by lighter transverse bands and spots. The light bands on the second segment are often very large and united with the light markings on the first segment while behind they are separated by a sharp line from the darker part of the folium. Some dark specimens have the folium of a uniform dark brown color, broken only by irregular small light spots. Figs. 3, 3a, 3b, 3c.

This species is abundant in the White Mountains and the Adirondacks where it lives on plants away from houses. In Montreal, Canada; Albany, New York; Eastport and Portland, Me.; Ithaca, N. Y., Cornell University Collection; and in eastern Massachusetts it is a common house and fence spider, and is also found on bushes. I have not found it in several seasons' collecting at New Haven, Conn., nor on Cape Cod and Martha's Vineyard, nor is it among a large lot of house *Epeira* from Noank, Conn. Mr. McCook, in Philadelphia, and Mr. Marx, of Washington, have not found it in their southern collecting, so that it is probably not common south of Massachusetts and New York. It is a common European species.

Epeira strix Hentz.*Ep. apoclisu* Giebel, Illinois spiders, Zeitschrift für Gesamten Naturwiss., 1869.Probably *E. affinis* Blk., from Canada. Ann. and Mag. of Nat. Hist., vol. xvii.

PLATE XXXIII, FIGURE 5. PLATE XXXV, FIGURE 12.

10^{mm} long; 1st leg, 14^{mm}.

This species usually differs considerably in its general appearance

from *patagiata* and *sclopetaria*. It resembles the lighter individuals of *sclopetaria* in color, but differs in form. The abdomen is longer and the legs shorter and stouter and the whole body is less hairy. The cephalothorax is reddish brown with a dark stripe each side and a less distinct one in the middle. The legs are light brownish yellow with a dark ring at the end of each joint. The sides of the abdomen are light. The folium is not much wider in front than behind, and seldom has larger spots or other irregular markings at the front end. The folium is dark brown with a light stripe along the middle, in which is a darker line indistinct except at the forward end.

This species is found from Massachusetts to Maryland. It lives occasionally with *sclopetaria* about houses, bridges and fences but more commonly on low bushes. In the daytime it seldom lives in its web nor does it hide in a nest near it, but oftener goes down to the ground or to a distant part of the plant. It is often found under stones. It becomes adult late in the summer. Young are found under leaves during the winter. I once saw the process of laying the eggs and making the cocoon by this species. The spider first made a bunch of loose silk under which it held itself and forced the eggs upward into the middle of it. The eggs were soft and adhered together and to the silk enough to stay in place while the spider spun silk over them till they were entirely concealed.

The male differs but little from the female, less than in the two related species.

Epeira trifolium Hentz.

PLATE XXXIII, FIGURES 8, *Sa*, *Sb*. PLATE XXXV, FIGURES 13, 14, 21, 22.

Large female from Salem, Mass., 18^{mm} long; first leg, 27^{mm}.
Average female from Salem, Mass., 13^{mm} long; first leg 18^{mm}.

The colors of the female are very variable, some having the abdomen dark reddish brown, sometimes with a purplish tinge and others various shades of gray to almost white without any markings on the abdomen. White specimens kept in confinement have changed in a few days to the usual reddish brown. The usual markings on the abdomen are four white spots near the four muscular pits, a median row of white spots and several irregular transverse rows, all trace of the edges of the folium being absent except in young individuals. The under side of the abdomen is dark brown even in light colored individuals, and the semicircular bright yellow marks are absent except in the young where they sometimes show. The cephalothorax

is white with three wide dark brown lines. The legs are white with a dark brown ring at the end of each joint and in the middle of the fourth femur. The sternum is dark brown with sometimes a light stripe in the middle.

The male is not more than 6 or 7^{mm} long, and light colored. The markings are similar to those of the female but all fainter or indistinct. The legs are long, and the spines long and black. The tibiae of the second legs are not modified as in some species. The palpal organ of the male is small with a short, stout terminal hook and a small basal process with a long black curved tooth.

The males are found in August and September and the females get their full size and lay eggs in October.

They live on bushes, oftenest on small alders around the borders of open, wet ground. They seldom stand in the web in the daytime but occupy a tent made of two or three living leaves drawn together and lined with silk. The spider holds a thread leading to the center of the web.

Hentz's *E. obesa* and *E. aureola* are probably light individuals of this species, and *E. septima* may be an old female of large size with the colors faded and abdomen shrunken after laying her eggs. I have seen a few in this condition, in which the light markings were all browner and the dark markings paler than in younger spiders.

The resemblance between the females of this species and the European *E. quadrata* is very close. Usually the abdomen of *trifolium* is rounder, the white markings smaller, and the edges of the folium less distinct than in *quadrata*. The finger of the epigynum of *trifolium* is not widened at the base but is of about the same size from base to tip. The finger of the epigynum of *quadrata* is wide at the base and tapers toward the tip. Plate xxxv, figs. 19, 20, 21, 22.

The male of *trifolium* is much smaller than that of *quadrata*. The tibia of the second legs is not thickened. The palpi are not more than half as large and the process at the base of the palpal organ is small as in most species, while in *quadrata* it is very large, nearly as long as the rest of the palpal organ. Plate 3, fig. 15.

Canada, New England, New York and southward.

Epeira marmorea (Clerck) Thor.

PLATE XXXIII, FIGURE 2. PLATE XXXV, FIGURE 17.

Female 10 or 12^{mm} long; first leg 15^{mm}. The cephalothorax is dull yellow with indistinct darker lines in the middle and at the sides. The femur of each leg is yellow or oftener bright orange with a

darker ring at the end and sometimes around the middle. The patella is the same color darker toward the tip. The other joints are white with orange or dark brown rings at the end. The sternum is dark brown, rarely with an indistinct light mark in the middle. The abdomen is marked on the back with a folium extending its whole length or with the front portion indistinct or absent in very light specimens. The light parts are white, yellow or occasionally orange, the dark parts gray or light brown. The two light spots near the muscular marks on the first segment and the median stripe form a cross-shaped marking in the front of the abdomen. The spots on the other segments decrease in size backward. The edges of the folium are dark with a narrow light line outside. The sides of the abdomen are marked with oblique dark stripes not sharply separated from the lighter spaces between. The under side of the abdomen has the usual dark area in the middle with a semicircular yellow marking each side of it. I have never found any marked like *E. pyramidata* of Europe, which is supposed to be a variety of *marmorea*.

A male from Beverly, Mass., measures 8^{mm} long; first leg 16^{mm}. A larger male from Mt. Tom, Mass., is 10^{mm} long; first leg 18^{mm}. The only European specimen that I have is 8^{mm} long. The colors and markings are like those of the female. The tibiae of the second legs are much enlarged and the spines on the inner side are short and stout. The coxae of the second pair have a long conical spine near the base. The palpal organ is large and dark colored. At the base of the bulb there is the usual process with a blunt tooth at the outer corner, and a short sharp one just under the end of the tube and terminal hook. The terminal hook is not so darkly colored as the other appendages. It is long enough to cover the whole width of the organ. The tube is short and can be distinguished by its dark color under the end of the terminal hook. The tube has a large flat process near the tip which cannot be easily seen without pressing the appendages apart.

In Beverly, Mass., this species is as common as *insularis* and lives in the same places on bushes near meadows. From the woods on Mt. Tom, Holyoke, Mass., I have two adult males and several immature females taken in July, 1873, all very large specimens and very pale, showing hardly any trace of the folium or the rings on the legs. I have it also from Eastport, Me., and western Massachusetts. A male and female from Chateaugay lake, Adirondack Mts., from F. A. Bowditch; Canada, J. B. Tyrrell.

Epeira insularis Hentz.

E. annulipes Geibel, Illinois spiders, Zeitschrift für Gesamten Naturwissenschaften, 1869.

PLATE XXXIII, FIGURE 1. PLATE XXXV, FIGURE 18.

The females are usually larger and the males smaller than in *marmorea*. The largest female I have seen, a bright orange one from New Haven, Conn., measured 19^{mm} long; first leg 24^{mm}. One of the usual size measured 13^{mm} long; first leg 17^{mm}. The cephalothorax is dull yellow with slightly darker lines in the middle and at the sides as in *marmorea*. The femur and patella of all the legs are bright orange, darker toward the ends with sometimes a darker ring in the middle of the femur. The other joints are white with brown ends as in *marmorea*. The sternum is light brown on the edges and bright yellow in the middle. The light markings of the abdomen are bright yellow or occasionally deep orange. The dark markings are dark brown or purplish. The markings are all sharply defined. The folium is deeply scolloped and bordered by a wide yellow line, outside of which is a row of irregular yellow spots. The spots inside the folium are in the same positions as in *marmorea* but are much larger. The wider side of the abdomen is marked as in *marmorea*.

The males are 7^{mm} long, first leg 13^{mm} and marked like the females. The dark stripes on the cephalothorax and the rings on the legs are plainer than on the female. The coxæ of the second legs have only a slight hump in place of the spine. The tibiæ of the second pair are enlarged and spiny as in *marmorea*.

This species is more common in Massachusetts and Connecticut than *marmorea*. It lives with *trifolium* on high bushes three or four feet from the ground, usually near water. It makes a tent under which it is usually found holding a thread leading from the center of the web. The males are found near the tents of the females in August and September. This species was found by Hentz in Alabama.

Epeira thaddeus Hentz.

PLATE XXXIII, FIGURE 9.

This species may readily be mistaken for young *insularis*. It is 7^{mm} long, with a wide, round, white or yellow abdomen, with two dark stripes extending from near the middle of the front around the sides under the abdomen nearly to the spinnerets. Under the abdomen there is a light spot just back of the epigynum surrounded by a large dark area which extends back nearly to the spinnerets. The epigy-

num is very small and light colored. On some specimens there are indistinct spots and other traces of the folium toward the end of the abdomen. The cephalothorax is yellow with sometimes dark spots at the sides. The two front pairs of legs have the femur, patella and tibia orange, darker at the ends. The tarsi are white with brown tips. The other legs have the femur and patella orange and the other joints white with dark rings at the ends. The tibia of the fourth pair has a wide dark ring at the tip.

These spiders live in tents near the web, like *marmorea* and *insularis*, and are often found on fences. Around New Haven, Conn., they are common, and I have them from several places in Eastern Massachusetts. Hentz's original painting had the colors much brighter than any specimen I have seen.

Epeira pratensis Hentz.

PLATE XXXIII, FIGURES 15, 15a. PLATE XXXVI, FIGURE 9.

Adult females from Chelsea marshes, Mass., are 8^{mm} long. The cephalothorax and abdomen are both rather longer and narrower than in *trivittata*. The colors are yellow and yellowish brown with, in some specimens, bright red marks on the edges of the middle stripe. The cephalothorax is dull yellow with a middle and two lateral stripes slightly darker but these are often absent in light specimens. The legs are dull yellow, slightly darker at the ends of the joints. The abdomen has a middle dark stripe, at the sides of which are two narrow bright yellow lines which are sometimes bordered with red near the front of the abdomen. Outside of the middle stripes are six pairs of black spots partly surrounded by yellow which are the only traces of the edges of the folium. The

Epeira pratensis, *trivittata* and *domiciliorum*.

These three species resemble each other closely and some individuals of either species may be mistaken for one of the others. They resemble each other most in autumn when the colors of all three are darker and the markings more obscure. The palpal organs are so much alike that they give no help in distinguishing the species. Females of *domiciliorum* are larger than the other species and early in the summer can usually be distinguished by their markings. The males of this species differ from those of *trivittata* in having the tibiae of the second legs a little less curved and in darker colors. The markings of females of *trivittata* and *pratensis* are often much alike, but *pratensis* has generally a longer abdomen and less distinct folium than *trivittata*. The males of *pratensis* have the cephalothorax longer and the head more prominent than in the other species. *Trivittata* is the most common of the three species and the most variable. *Domiciliorum* is most common on fences and in gardens.

colors grow darker with age, and in September and October old females are sometimes found of a dark reddish brown color with hardly a trace of the summer markings. The sternum is brown with a yellow stripe in the middle. The under side of the abdomen has a dark area with two yellow curved marks which may be broken into four spots. There are also two yellow spots each side of the spinnerets. The external part of the epigynum is a large hook flattened at the end. The single opening is directed backward under the hook. The male has the spots on the abdomen plainer than the female. The femur of the second leg is thicker than the others and the tibia is somewhat thickened and curved and has short and stout spines on the inner side. The palpal organ is small and simple. Plate xxxvi, figure 9.

This is found in many places in Eastern Massachusetts, but not as commonly as *domiciliorum*. It is very abundant on grass on the Chelsea salt marshes in company with *trivittata*, where it becomes adult in the latter part of July.

Epeira trivittata Keyserling, Sitzungsberichte der Isis, Dresden, 1863.

PLATE XXXIII, FIGURES 16, 16a. PLATE XXXVI, FIGURES 2, 3, 5, 8.

This is one of the most common spiders in New England. It lives usually in grass and low bushes, but seldom on trees or fences. It varies much in size, the large females measuring about 7^{mm} long, and the first leg 12^{mm}. Adults however occur not more than half as large. The color is light yellow with brownish rings on the legs at the end of each joint and three indistinct dark stripes on the cephalothorax. The back of the abdomen has a row of light spots in the middle sometimes nearly united into a stripe. Four light spots on the front of the abdomen are more or less connected with the middle row. The edge of the folium is marked by rows of dark brown spots partly surrounded with yellow, and between these and the middle spots the folium is dark brown. The sternum is bright yellow in the middle and the under side of the abdomen is marked as in *domiciliorum* with a dark center and four or six yellow spots. The epigynum is covered by a strong hook, with the opening under it directed backward.

The males resemble the females in color and markings. On the under side of each femur is a single row of long spines. The tibia of the second pair is strongly curved, Plate xxxvi, fig. 2, and has strong spines on the inner side, those near the base being much longer than the others. The palpal organs of *trivittata*, *pratensis* and *domicili-*

orum are much alike. The tube and all the appendages are small and crowded together near the end of the organ. The plainest difference between this and the male *domiciliorum* is in the shape of the tibia of the second pair of legs. Plate XXXVI, figs. 1, 2.

This species seems to mature earlier in the summer than *domiciliorum*, adults of both sexes being abundant from June to August. In open places and especially toward the latter part of the summer the colors become darker and it resembles the next species.

White Mountains; Massachusetts; Connecticut and southward.

Epeira domiciliorum Hentz.

Probably *E. Hentzii* Keys., Sitzungsberichte der Isis, Dresden, 1863.

PLATE XXXIII, FIGURE 17. PLATE XXXVI, FIGURES 1, 4.

This species is larger than *trivittata* and measures 10 to 12^{mm} in length, and the first legs 15 to 20^{mm}. The cephalothorax has three dark stripes more distinct than in *trivittata*. The femora are orange red and the other joints light yellow with wide dark brown rings at the ends and middle of each joint. The abdomen has a straight light stripe along the middle of the back from which a pair of less distinct branches extend at right angles on each segment as far as the edges of the folium. In the end of each of these light branches is a black spot and between them dark brown areas which become lighter toward the sides where they divide into fainter branches. In the autumn the colors become darker and in some individuals the light markings are hardly visible and occasionally the back is almost white with the brown marks on the sides very faint. The sternum is black with a bright yellow middle stripe. The under side of the abdomen is black in the middle, with four bright yellow spots and two fainter ones near the spinnerets. The epigynum is covered by a large hook with the opening on its under side, as in *trivittata*.

The male is marked like the female with the dark markings usually more distinct. The palpi are like those of *trivittata*. The plainest difference between this and *trivittata* is in the shape of the tibia of the second pair of legs. In *trivittata* this joint is strongly curved outward, while in *domiciliorum* it is nearly straight. In *domiciliorum* the thick spines on the inner side are nearly all of the same size, while in *trivittata* the spines near the basal end are much longer than the others. Pl. xxxvi, figs. 1 and 2.

This spider inhabits fences and plants in gardens much more commonly than *trivittata* and is also found in open woods on low trees, but seldom in grass. Massachusetts and Connecticut and southward.

Epeira displicata Hentz.

PLATE XXXIV, FIGURE 4. PLATE XXXVI, FIGURE 20.

Full grown females are sometimes 7 or 8^{mm} long, but usually smaller. The cephalothorax and legs are brownish yellow. The abdomen is light yellow or crimson. The latter color is more common in young individuals and becomes brighter in alcohol. Sometimes there are two white lines in the middle. At the sides of the hinder half of the abdomen are three pairs of round black spots surrounded by lighter rings. The under side of the abdomen is colored like the upper with no distinct markings. The sternum is yellow like the legs. The legs have no dark rings but are darker toward the ends and in some individuals, especially males, on the ends of the joints. The epigynum is small and dark colored with a small and slender finger.

The male has the legs and cephalothorax darker brown than the female and the black spots on the abdomen larger and surrounded more distinctly with white which sometimes forms a stripe on each side. Each femur has a single row of spines on the under side. The tibiæ of the second legs are not thickened. The palpal organs are dark colored. The double terminal hook is long and the other appendages are stout and hard.

This is a common species from the White Mountains to Connecticut and southward. It is often found on fences without any web. The web is usually small, among the leaves of plants.

Epeira juniperi, new.

PLATE XXXIV, FIGURE 6. PLATE XXXVI, FIGURES 14, 15, 16.

Length of female 5·5^{mm}. The abdomen is nearly as broad as long, bright green with three white longitudinal stripes on the back. The cephalothorax and legs are light yellowish brown, without dark rings. The male has the same colors, is slightly smaller and has longer legs. The epigynum has a short wide finger curved toward one side and widened at the end, which lies between the dark brown openings.

The palpal organ has a long pointed basal hook and a short dark colored terminal hook under which is the curved black tube. At the side is a large white process with a tooth on the outer side.

A male and female from a spruce tree on Peak's Island near Portland, Me., July 13, one from Wood's Holl, Mass., in August.

Epeira alboventris, new.

PLATE XXXIV, FIGURE 5. PLATE XXXVI, FIGURE 12.

Length 4^{mm}. Abdomen as broad as long, widest in front. The whole body is white except a triangular purple spot on the back of the abdomen. The hairs on the legs are long and white. The spines are light brown. The eyes are colorless but have some dark color around them. The epigynum is light brown and has a short white finger broad and rounded at the end. Plate XXXVI, figure 12. A spider from Western New York, perhaps of this species, has the whole upper side of the abdomen veined with light red and eight darker red spots along the sides.

One from Peabody, Mass., near Ship rock, one from the north of Maine from F. W. Putnam.

Epeira labyrinthea Hentz.

PLATE XXXIV, FIGURE 8. PLATE XXXVI, FIGURE 11.

Female about 5^{mm} long. The cephalothorax is much longer than wide, dark brown except a white spot around the eyes and several smaller spots along the sides. The legs are white with narrow dark brown rings at the ends of the joints and wider rings of a lighter yellowish brown on the ends of the femora, tibiæ and the patellæ of the first two pairs. There is a small black spot around the base of each spine on the legs of the first two pairs. The abdomen is whitish marked by a distinct black or dark brown folium on the hinder half and including four white spots on the first and second segments, which are more or less connected with each other toward the middle. The mandibles and maxillæ are dark brown. The sternum is dark brown with a white middle stripe. The under side of the abdomen is dark brown with a middle white stripe and indistinct light spots along the edges of the dark area. The male is much like the female but with longer legs and smaller body as usual.

Besides the usual round web, this species makes on one side and above it an irregular web like that of *Theridium* in which is a deep tent with the opening directed toward the center of the round web with which it is connected by a thread. In the autumn the eggs are laid in several flat cocoons which are fastened near the top of the tent, and partly concealed by pieces of leaves and other rubbish fastened to the web. After the leaves have fallen and the webs are destroyed by the weather the string of cocoons and rubbish remains fastened, usually to several twigs, by strong threads.

This species is abundant at New Haven, Conn., and Mr. McCook finds it equally so at Philadelphia. I have one from Lynn, Mass., but none from farther north.

***Epeira triaranea* McCook.**

Proc. Phil. Acad. Nat. Sci., 1876, p. 200 = *E. globosa* McCook, 1878, p. 124 = probably *E. baltimoriensis* or *E. globosa* Keyserling.

PLATE XXXIV, FIGURE 9. PLATE XXXVI, FIGURES 6, 7.

Length five or six millimeters. The cephalothorax is light yellowish brown with a fine dark median line from the eyes to the dorsal groove and indistinct dark marks on the sides of the head. The first and second pairs of legs have indistinct dark rings at the end and middle of each joint. The third and fourth pairs have darker rings at the ends of the joints only and the tibia of the fourth pair is half black. The abdomen is as broad as long or broader. The front half of the folium is covered by four large white, yellow or reddish spots partly united together into a squarish figure surrounded by an irregular black line. The hinder half of the folium has a pair of black spots on each segment between which are light brown markings. The sternum is yellow. The under side of the abdomen has a black spot around the spinnerets and another transverse dark mark just behind the middle, the rest is light yellowish. The epigynum is small with a short blunt finger.

The male is smaller than the female but marked in the same way. The tibiae of the second pair are slightly thickened and curved and have large spines on the inner side.

The spider makes a very large funnel-shaped tent out of which a thread runs to the center of the web, somewhat as in *Ep. labyrinthea*.

Salem and other places in Eastern Massachusetts; New Haven, Conn.; Philadelphia, Pa., McCook.

***Epeira carbonaria* Koch.**

Beitrag z. Kenntniss d. Arachniden fauna Tirols. Zeitschrift d. Ferdinandeums, Innsbruck, 1869 = *Epeira packardii* Thorell, Proc. Boston Soc. Nat. Hist., vol. xvii, 1875.

PLATE XXXIII, FIGURE 18. PLATE XXXVI, FIGURES 18 and 19.

This is an alpine species from the White Mountains. The female measures 8^{mm} long, cephalothorax 3^{mm}, 1st leg 12^{mm}. The head is about half as wide as the thorax and light colored. The thorax is black or dark brown. The legs are ringed with black and white, the black rings usually twice as wide as the white. The coxæ are light

colored and the sternum black or dark brown. The abdomen is black with five or six pairs of white spots down the middle, in some individuals united into a folium. At the sides are other small irregular white spots running into two indistinct stripes underneath. The middle of the under side of the abdomen is black, with a central white strip running from the epigynum half way to the spinnerets. The abdomen is oval, narrower but not pointed behind. The whole body is covered with long black and white hairs. The epigynum projects considerably beyond the body, and the middle is covered by a long finger running out to a fine point, and usually turned outward at the end.

The male differs but little from the female in color and markings, but has the usual longer legs and longer spines.

These spiders live among the bare stones on the upper part of high mountains, above trees. On Mt. Washington, New Hampshire, they are common on the large slopes of bare rock above the Ledge. The spiders described by Thorell were found by Packard in Labrador. F. A. Bowditch has found the same on Mt. Lincoln in the Rocky Mountains, most of them much larger than the White Mt. specimens. *Ep. carbonaria* of the Alps seems to me to be the same species. I have compared many females and find no constant difference, but have no males of *carbonaria* for comparison.

In the valleys of the Alps and all over southern Europe there occurs a closely related species, *Ep. ceropegia*, with similar marking, but bright colors, yellow and brown in place of the black and white. I have not seen any similar species from the White Mountains, but in the Rocky Mountains there is a species or variety very much like *Ep. ceropegia*, and some females from Mt. Lincoln have colors and markings between these two varieties.

Epeira placida Hentz.

PLATE XXXIV, FIGURE 2. PLATE XXXVI, FIGURES 10, 13.

Length of female 3 or 4^{mm}. The cephalothorax is brownish yellow with three brown stripes and black spots around the eyes. The legs are the same color, a little darker at the ends of the joints. All the legs have long dark colored spines. The abdomen is longer than wide, sometimes egg-shaped with the narrow end in front. In the middle is a brown stripe, with black spots along the edges. This stripe is narrow in front but wider behind the second pair of muscular spots and continues the same width to the spinnerets. On the third segment there is a pair of white spots in the brown band. The

rest of the top of the abdomen is white with sometimes light brown oblique lines across the hinder part. The sides and under part of the abdomen are dark brown with oblique whitish spots on the sides, two white stripes below, and four white spots around the spinnerets. The male differs but little from the female in the usual way. The finger of the epigynum is short and blunt between two lobes which extend slightly beyond the edge of the fold. The palpal organs are large for the size of the spider, and the shape of the hard parts characteristic, fig. 10.

Massachusetts, and New Haven, Conn.

Epeira gibberosa Hentz:

Ep. maculata Keyserling, Zool. Botan. Gesellsch., Wien, Aug. 2, 1865.

PLATE XXXIV, FIGURES 1, 1a. PLATE XXXVI, FIGURE 17.

Female 4 or 6^{mm} long. The cephalothorax is dull yellow with a narrow black stripe in the middle from the eyes to the dorsal groove. The legs are dull yellow with long black spines and sometimes narrow longitudinal dark stripes. The abdomen is gray, thickly covered with yellowish spots. In the hinder part are two black lines partly broken into spots, and there are black spots and irregular oblique lines at the sides. The under side of the abdomen is brown with two white lines and four or six spots around the spinnerets very much as in *E. placida*. The epigynum has a short blunt finger much like that of *E. placida*.

The male is somewhat smaller than the female. The palpal organs are large and the appendages long and distinct. The basal process is widened at the end and has a long tooth at each corner, with several shorter ones between. Near the basal process is a narrow, soft appendage which extends outward nearly to the terminal hook. The other appendages are the tube and a black process of nearly the same size just below it, and a short black process on the opposite side of the organ.

Massachusetts; Providence, R. I.; New Haven, Conn.

Epeira parvula Keys., Sitzungsberichte der Isis, Dresden, 1863.

PLATE XXXIV, FIGURES 12, 12a, 12b, 12c. PLATE XXXVII, FIGURES 1 AND 2.

Adult female from Mt. Tom, Mass., 8^{mm} long. Male from New Haven, 6^{mm} long.

The abdomen is widest in front at the second segment. The back is flat with a slight hump behind, which projects backward beyond

the spinnerets, giving a triangular appearance to the abdomen. The folium is widest on the first segment and tapers backward to a narrow stripe. The colors are variable. Usually there are two white spots in the first segment of the folium, and behind this the folium is dark gray, darkest at the edges, and surrounded by a white line. The sides of the abdomen are lighter gray with dark oblique lines. In the middle of the folium are often several light spots in pairs. In some specimens the folium is light colored and surrounded by darker gray. Some specimens have the folium and all the markings on the back indistinct except a black stripe down the middle. The sternum is light in the middle and there is a light spot just behind the epigynum. The cephalothorax is gray, darker at the sides and behind. The legs are gray with indistinct darker rings at the ends and middle of each joint. At the end of each femur is a wide dark ring. The epigynum in the only adult female is covered by a wide finger tapering to a point.

The male is smaller and darker and has longer spines and wider dark rings on the legs. The palpal organ has a very large terminal hook and a large rough process at its base, both of which are folded down against the palpal organ. On the outer side of the organ is the tube and a hard curved process which supports the tip.

The adults are found in June and July and great numbers of young in the autumn and winter. They live in all sizes of shrubs and bushes and in low trees.

White Mountains; Massachusetts and Connecticut.

Epeira foliata Hentz.

PLATE XXXVII, FIGURES 6, 7, 8, 9, 10.

This spider resembles *Ep. parvula* but the legs are longer and the abdomen less triangular. The female measures 6^{mm} long and the first leg 12^{mm}. The second leg is nearly as long but the fourth is much shorter. The cephalothorax and legs are grayish or greenish yellow, darker toward the ends of the joints. The first and second legs are darker and have dark rings in the middle of the tibia and tarsus. The abdomen is gray. The folium is slightly darker at the edges and is bordered by a white line. In the middle is a darker stripe ending in a point at the third segment, and also bordered by a black and white line. Beneath the body is dull yellow. The epigynum has a finger which is so wide at the base as to cover it. The tip of the finger is curved backward and slightly flattened.

The male is a little smaller but otherwise resembles the female.

The tibia of the second pair is widened in the middle and has four large spines on the inner side. The palpus has a flat hook at the base of the tarsus, ending in two teeth. The parts of the palpal organ are small except the basal process, which is very large and wide with two prominent teeth.

Swept from bushes in June, New Haven, Conn.

Epeira stellata Hentz.

PLATE XXXIV, FIGURE 17. PLATE XXXVII, FIGURES 3, 4, 5.

Female 12^{mm} long. The abdomen has a sharp hump on the front, one behind and five on each side. The hinder hump has a smaller one under it and the lateral humps on the first segment are sometimes double. The colors are light and dark brown, somewhat modified by the gray and white hairs. The markings resemble those of *Ep. angulata*. The edges of the folium run out toward the humps. The cephalothorax is wide and the corners of the head are extended forward a little beyond the eyes. The legs have dark rings at the end and middle of each joint. The sternum has a light stripe in the middle. The under side of the abdomen is wrinkled and has several oblique dark stripes. The epigynum is covered by a hooked finger, as in *domiciliorum*.

The male is slightly smaller but otherwise much like the female. The palpal organ is small with short appendages.

A common spider in Massachusetts and Connecticut on grass and low bushes; Dublin, N. H., July, 1882.

Epeira infumata Hentz.

E. ectypa Keyserling, Sitzungsberichte der Isis zu Dresden, 1863.

PLATE XXXVII, FIGURES 11, 12, 12a, 12b, 13.

This spider when it draws up its feet has the appearance of a lump of dirt. The color is dark brown with various black and white markings and reddish spots on the back of the abdomen. The cephalothorax is about 2^{mm} long. The head is high and flat in front, bringing the upper middle eyes directly over the front pair, while the lateral pairs are turned around so as to lie in a horizontal line. The upper middle eyes are much larger than any of the others.

The abdomen extends forward over the thorax and is very high in front, where it has a pair of humps. At the middle the abdomen is nearly as wide as long and nearly flat on the back from the humps to the hinder end. The abdomen is marked with a tolerably distinct folium, with the hinder segments marked by pairs of oblique black

spots. Toward the front, the folium is a little reddish and at the sides yellow. The legs are yellowish, nearly covered by irregular dark rings and spots. The sternum is bright yellow in the middle and black around the edge. The abdomen is black beneath. Another specimen is much paler with the legs almost white, and the markings of the back broken up into a few gray spots.

Both specimens are females.

New Haven, Conn., June and July.

Microepeira, new.

This genus is distinguished by its small size and large epigynum and palpal organs, and also by its web, which according to McCook has the rays united in groups of three or four, and is drawn into a conical shape by a thread attached to the center.

Microepeira radiosa (McCook). Proc. Phil. Acad. Nat. Sci., 1881.

PLATE XXXIV, FIGURE 7. PLATE XXXVIII, FIGURES 1, 2, 3, 4.

This spider is only 2^{mm} long. The cephalothorax is gray without any distinct markings, except black rings round the eyes and slightly darker stripes on the thorax. The legs are yellowish white, darker at the ends of the joints. The abdomen is nearly spherical. The back is white with brown markings. The folium is not well defined but is plainer behind than in front, and consists of two rows of irregular brown spots, the pair on the first segment being separate from the others. In the middle is an irregular brown line. The sternum has a light stripe in the middle and is brown at the sides. The under side of the abdomen is dark. The epigynum is very large and triangular seen from behind. The opening is round and partly covered by a thin plate that extends across the abdomen just behind the epigynum.

The male differs but little in size and color from the female. The palpal organs are very large. The tube is black and long, supported by a hard brown appendage. Fig. 1.

I have this species from the White Mountains, N. H., and from Waverly near Boston, Mass.; and from H. C. McCook from Philadelphia, Pa.

I have never noticed the web, but according to Mr. McCook (Proc. Phil. Acad. Nat. Sci., 1881) the rays instead of all pointing to one center are united in groups of three or four, each group connected with the center by a single thread. The web is drawn into the shape of an inverted umbrella by a thread extending from the center to a

neighboring twig and held tight by the spider, who releases it suddenly to aid in entangling insects in the web.

Cyclosa Menge.

Preussische Spinnen, 1866. Simon, Arachnides de France.

Cyclosa conica (Pallas) Menge = *Ep. caudata* Hentz = *Ep. conica* Blk.

PLATE XXXIV, FIGURES 3, 3a. PLATE XXXVIII, FIGURE 11.

This spider is about 6^{mm} long. The color is white and gray, varying from almost white to almost black. The abdomen of the female has a prominent hump at the hinder end varying in size in different individuals. In the male there is only a slight trace of the hump. The cephalothorax is longer than wide and highest behind the middle. The color of the cephalothorax is dark gray or black with sometimes a light area just behind the eyes. The legs are white with dark rings at the end of each joint and in the middle of each joint except the femora on which there is only a mark on the under side. On the first and second femora the dark ring is very wide, covering sometimes more than half the joint. In light individuals the markings on the abdomen are obscure, but in well marked specimens there is a dark folium widest near the base of the hump and broken in two places at the sides. The sides of the abdomen and the back part between the hump and the spinnerets are marked with irregular black and white or yellow lines. The under side is black with a pair of very distinct light spots across the middle. The sternum is dark.

The male is smaller than the female, has a smaller hump and a wider and darker thorax. The palpi are large. The tarsus is small and pointed at the end and does not cover the large palpal organ. The tube is long and hair-like, supported at the end by a stout hooked process. Fig. 11. The epigynum is nearly all external. It is widest at the outer end and has a small finger.

Mt. Washington, N. H.; Eastport, Me.; Albany, N. Y.; Eastern Massachusetts; and New Haven, Conn.

This species seems to live all the time in the web. Across the web there is usually a line of dead insects and other rubbish fastened together with a quantity of loose web in which the cocoons are also concealed. The spider standing in the middle of this band where it crosses the center of the web looks like part of the rubbish.

Singa.

In *Singa* the metatarsi of the first and second feet have only very small spines or none. The eyes are smaller than in *Zilla* and the

head higher. The colors are orange, brown and black, usually bright. They live on low plants in open fields near water.

Singa variabilis, new.

PLATE XXXIV, FIGURES 16, 16a, 16b, 16c. PLATE XXXVII, FIGURES 19, 20, 21.

Female 4^{mm} long, a little smaller than *pratensis*. The legs and cephalothorax are light orange except the front of the head around the eyes which is black. The abdomen varies considerably in color. In a large proportion of them it is entirely black. In others there are two white stripes of various lengths along the sides, all the rest being black. Others have a light stripe in the middle in addition to the side stripes. Still lighter individuals have a white stripe in the middle and others at the sides. Between these are brownish areas in which are two or three black patches of various sizes and shapes. These latter individuals resemble in markings the other species. The males are smaller but similarly marked. The palpal organs are black.

This is found in grass in wet meadows with the other species, all varieties of color occurring together.

Peak's Island, Portland, Me.; Eastern Massachusetts; New Haven, Conn.

Singa pratensis, new.

PLATE XXXIV, FIGURES 15, 15a. PLATE XXXVII, FIGURES 14, 15, 16, 17.

Female 5 or 6^{mm} long; cephalothorax 2^{mm}; first leg 5^{mm}. Cephalothorax light yellow in the middle and on the head, brownish at the sides. Legs dull yellow, darker at the ends of the joints. Abdomen light brown with a double white stripe in the middle and a white stripe each side. Underneath there is a brown patch in the middle with a yellow stripe each side and small yellow spots around the spinnerets. The sternum is dark brown. The abdomen is large and regularly oval. The legs are short and small. The metatarsi of the first and second pairs have only very small and few spines. The epigynum is small.

The male has the abdomen much smaller than the female and the markings less distinct. The cephalothorax is as large as that of the female, but the head is a little narrower and the middle eyes a little farther advanced. The legs are stouter than in the female and have much longer spines especially on the tibiae.

In grass on wet ground, Salem and Holyoke, Mass., and New Haven, Conn.

Singa maculata, new.

PLATE XXXVII, FIGURE 18.

Length 3^{mm}. The head is as high as wide, narrowed a little around the eyes. The front middle eyes project forward over the mandibles in both sexes. The front half of the head is black, the rest of the cephalothorax and legs orange. The abdomen in my specimens is orange with indistinct blackish markings across the hinder part, but the pattern is probably variable as in other species. Beneath, the colors are pale brown and orange. The epigynum resembles that of *S. variabilis*.

Male and female, New Haven, Conn., June 24.

Zilla.

These spiders resemble *Steatoda*. The abdomen is large oval and smooth and the legs short. The head is narrow and the lateral eyes as near the middle pairs as these are to each other. The colors are dull, black, gray and white.

The webs have a segment without cross lines in which a stout thread runs from the center to the nest. Insects caught in the web are rolled up in silk; attached to the spinnerets and carried along the thread to the nest. Plate XL, fig. 2.

Zilla montana C. Koch.

PLATE XXXIV, FIGURE 14. PLATE XXXVII, FIGURES 22, 23, 26, 28.

Length of female 6 or 7^{mm}. Cephalothorax yellowish white with dark edges and an indistinct gray stripe in the middle with radiating branches to the legs and side eyes. The legs are the same color with dark rings at the end of each joint and less distinct rings in the middle of each joint. The abdomen is oval and flat above like that of *Steatoda* and the markings resemble those of *Steatoda marmorata*. The folium is black at the edges but nearly white in the middle where there is a median dark line or row of spots. On the front end of the abdomen is a white spot surrounded by black which indents the sides and front end. The folium is broken near the hinder end as in *Steatoda marmorata*. The sternum is dark with a middle yellow stripe. The under side of the abdomen has a black stripe in the middle with a yellow stripe on each side. The male has longer legs with longer and darker spines but otherwise resembles the female.

I have this spider from the White Mountains and young from the Adirondaeks. The web has a narrow segment without cross lines, Plate XL, figure 2, in which is a single thread by which the spider passes from the center of the web to the nest. Near Hermit Lake on Mt. Washington I saw one of these spiders capture a fly and after tying it up with silk carry it along the thread to its nest.

I have compared the females with one from Switzerland with which it agrees very closely, but have not compared males. In the male characters it agrees with descriptions of *Z. montana*.

Zilla X-notata C. Koch.

PLATE XXXIV, FIGURE 13. PLATE XXXVII, FIGURES 24, 25, 27. PLATE XL, FIG. 2.

This species is about the same size as *Z. montana* and similarly colored. The legs are whitish with dark rings at the ends of the joints, and less distinct ones in the middle. The spines of the legs are black with black spots around the base. The cephalothorax is whitish with a fine black line on each side and a wide dark stripe in the middle of the head and nearly covering it, and tapering to a point near the dorsal groove. In this dark stripe are three black lines converging behind. The abdomen is marked with a grayish folium scolloped at the edges, which are black in irregular spots. The middle of the folium is whitish, lightest in front, where it is bordered by black. In the hinder part are two or three pairs of black spots which are sometimes united into transverse black stripes, in front of each of which is a white line or pair of spots. Outside the folium is a white line, and beyond this the sides are covered with oblique black bands that in some individuals nearly touch each other. Under the abdomen is a middle black stripe from the stem to the spinnerets. The epigynum is black and much smaller than in *Z. montana*. The males have the first and second pairs of legs much longer than the female, the palpal organs are smaller than those of *montana*, and the tibia of the palpus is more slender.

This spider was abundant at Wood's Holl, Mass., in the summer of 1883, chiefly under the Light House wharf, where it lived in company with *Epeira sclopetaria* in about equal numbers. The nest is a tube usually open at both ends attached in a crack or corner. The webs were of the usual *Zilla* pattern with a vacant segment near where the thread passes to the center from the nest. Where the nest was so placed that this thread formed a large angle with the plane of the web, the web was sometimes complete as in *Epeira*.

The web is begun like that of an *Epeira*, but after the smooth

spirals have been placed over about a quarter of the web the spider begins to turn back on reaching the ray next the thread to the nest and passes around to the next on the opposite side. When the final spirals are put on, this segment is left open from the circumference to the center. After catching and tying up an insect she attaches it to the spinnerets and carries it to the nest.

Many trees have been brought to Wood's Holl from the north of Europe for cultivation, so that it is possible for these spiders to be imported. I have not seen them nor heard of their presence elsewhere in New England.

Cyrtarachne Thorell.

Voyage of the Swedish frigate, *Eugenie*, 1868 = *Cyrtogaster* Keyserling, Sitzungsberichte der Isis, Dresden, 1863.

The name *Cyrtogaster* was used earlier for a genus of *Hymenoptera*.

These spiders are all short with the abdomen wide in front and partly covering the thorax and usually have spines on both thorax and abdomen.

Cyrtarachne bisaccata, new.

PLATE XXXIV, FIGURES 11, 11a.

Female 8^{mm} long. Abdomen 8^{mm} wide. The head is low and wide. The eyes all small, the four middle forming nearly a square on a slight elevation. The head is slightly narrowed behind the eyes. The cephalothorax is slightly scolloped at the sides. It rises from the eyes backward and has at the highest part behind the middle two large horns. The back is covered with conical scattered points. The cephalothorax is light brown darkest in front. The abdomen is wider in front than long and extends over the thorax as far as the two horns. The four principal muscular spots are large and dark brown. The front of the abdomen is light brown with various whitish irregular markings, the back part is yellowish white. The under side of the body and legs are white except the ends of the first and second femora which are grayish.

Only one specimen of this was found on a beech tree at New Haven, Conn., Oct. 22, 1882, with two cocoons. These were dark brown, as dark as the bark of the tree and as hard. Around the middle of each was a circle of irregular points. Pl. xxxiii, fig. 12. One of the cocoons was attached by a strong stem to the bark and the other was attached in a similar way to the first cocoon. The spider held on to one of the cocoons. The following spring another similar pair of cocoons were found on a low oak tree in Pine Swamp,

New Haven, still firmly attached to the bark. From these the young came out in June.

Acrosoma Perty.

These spiders have the abdomen flattened on the back and surrounded by several pairs of spines of various sizes and shapes. The abdomen is large and extends backward beyond the spinnerets which appear to be in the middle of the under side. The cephalothorax is not as wide as long. The legs are slender and the hinder pair as long as the first or longer. The colors of the abdomen are bright. The males differ much from the females, resembling the young in form and color.

Acrosoma rugosa = *Epeira rugosa* Hentz.

PLATE XXXVIII, FIGURE 10.

This is about the same size as *A. spinea*. The legs are shorter and stouter. The cephalothorax has three dark stripes. The legs and cephalothorax are both covered with short hairs at the base of each of which is a slight elevation. The abdomen is higher than in *spinea* and dull yellow with irregular black spots above and below. The abdomen extends backwards half its length beyond the spinnerets. It is square at the posterior end and has five pairs of spines of which three pairs are along the edges of the flat upper side and two pairs behind.

The male is described by Hentz, who saw them pairing. It differs very much from the female, having a long narrow abdomen without any humps or spines.

This species is evidently not common in New England, the only one I know is in the museum of Yale College from New Haven, Conn. The figure is from a specimen from Indiana.

Acrosoma spinea = *Epeira spinea* Hentz.

PLATE XXXVIII, FIGURES 5, 6, 7, 8.

The adult female of this species is distinguished from all the other native *Epeiridae* by its triangular abdomen with the hinder angles extended to two sharp spines half as long as the rest of the abdomen. The abdomen is bright yellow or white above. The spines are black at the tip and reddish or orange at the base. There are two black spots at the front end of the abdomen and the muscular spots are black. Besides the two posterior spines there are two

other pairs, one pair near the front end of the abdomen and another smaller on the sides half way back. The body of a full grown female is about 7^{mm} long, and the distance between the tips of the spines is equal to the length of the body. The legs and cephalothorax are yellowish brown, the latter with whitish edges. Underneath, the abdomen is strongly wrinkled and marked with black bands and yellow spots. The posterior spines are lighter on the under side. The young differ greatly from the adult female. The abdomen is longer than wide. The posterior spines are short and blunt and the general color of the body is dark brown. There are two light spots just in front of the base of the spines and other smaller ones on various parts of the abdomen. The two hinder pairs of legs are whitish with longitudinal dark stripes. The first and second pairs are dark toward the base and white at the tips.

The males resemble the young. They are about 4^{mm} long. The abdomen is long and widest behind and truncate without any spines except slight humps. On each side of the abdomen are three black spots in which are slight humps. Across the hinder part of the abdomen are four light spots as in the young. The cephalothorax is dark brown and the legs light yellow with dark markings as in the young.

They become adult the last of July and are found till October. They are common in Massachusetts and Connecticut. The webs are usually in low bushes and the adult females seem to hang all the time in the webs.

Acrosoma mitrata = *Epeira mitrata* Hentz.

PLATE XXXVIII, FIGURE 9.

This is a much smaller species than *spinea*, measuring 4 or 5^{mm} long. The abdomen of the female extends forward so as to cover half the cephalothorax. It is three-fourths as wide as long and square at the hinder end where it has two pairs of spines. The abdomen is white or yellow above. There is a dark spot of variable size and shape over the first segment and a dark middle stripe between the hinder spines. There are also numerous black muscular spots. Below the abdomen is wrinkled and marked with black and yellow very much as in *spinea*. The cephalothorax and legs are brownish yellow. The cephalothorax is shorter than in *spinea*, the front of the head square and the sternum nearly circular.

Common at New Haven, Conn. I have not found it in Eastern Massachusetts nor farther north.

Meta.

I use this genus for *Meta menardi*, *merianæ* and the like, not including the slender bright colored species placed here by Keyserling which, as suggested by Thorell, better form another genus. They have longer mouth parts than *Epeira* and the abdomen is deeper, more like *Theridium*. They live in caves or shady places.

Meta menardi (Latr.) Thorell = *Epeira fusca* Blkw.

PLATE XXXIV, FIGURES 18, 18a. PLATE XXXVII, FIGURE 33.

Adult female, 14^{mm} long; cephalothorax, 5^{mm} long, 4^{mm} wide; first leg, 28^{mm}. The hinder part of the cephalothorax is as high as the head except a deep pit in the middle. The legs are yellow with wide dark-brown rings at the end and middle of each joint. The cephalothorax is brownish yellow, darker in the middle and at the sides. The abdomen is high in front and pointed behind, as in *Theridium tepidariorum*. It is dark brown and dull yellow. At the front end are two dark-brown patches, between which is a light stripe which spreads out toward the four principal muscular spots. Behind this are several light cross lines. Underneath the abdomen is brown with two yellow stripes. The epigynum is covered by a wide, short and thick hook turned backward. The cocoon is large but so loose that the eggs can be seen through it. The webs are horizontal or inclined, with a hole through the center.

The male is about half as large as the female and colored the same. Both patella and tibia of the male palpi are wide as long. The tarsus is large and nearly as wide in the middle as long. At the base is a large hard process turned upward, and on the outer side of this is a light colored branch covered with hairs. The palpal organ itself does not fill the hollow of the tarsus. The tube is straight and lies by the side of a hard process of equal length. At the base of the tube is a shorter rough process.

This species lives in caves and other damp and shady places, Berlin Falls, N. H., Boston, Mass. Caves in Kentucky and Virginia.

Argiope.

In *Argiope* the eyes and mouth parts are as in *Epeira*. The abdomen is longer than wide and pointed behind. The sexes differ greatly in size, the males being extremely small. The females live all the time in the web having no nest or tent. The thorax and, in the young, the abdomen are covered with silvery hairs. The colors of the abdomen are very bright often black cross stripes on a yellow

ground, or as in *riparia* the middle portions of these stripes are united together into a longitudinal black middle band. The webs are crossed in the middle by a wide zigzag white band that partly conceals the spider when young. The cocoons are large and stiff like paper on the outer surface. The eggs are laid in autumn, and the young hatch during the winter and leave the cocoons early in the summer, becoming adult in August.

Argiope riparia = *Epeira riparia* Hentz and *E. sutrix* Hentz

PLATE XXXIV, FIGURE 19. PLATE XXXVIII, FIGURES 13, 14, 19.

This is one of the largest and most conspicuous native species of the family. A large female measured 20^{mm} long; cephalothorax, 8^{mm}; first legs, 30^{mm}. The cephalothorax is nearly as wide as long and covered with silvery white hairs, except around the eyes where it is black. The front legs are entirely black, the others have the femora reddish or yellow and the rest black. The abdomen is oval, a little pointed behind and slightly notched in front, with two humps at the corners. The folium is black, narrowed between the humps, and widening again around the large yellow spots of the second segment. It extends to the end of the body about the same width, with scollops and branches on each segment. Along the sides of the folium are two bright yellow longitudinal bands or rows of irregular spots, and in the folium are two pairs of rounded yellow spots on the second and third segments. Underneath the color is black with a yellow stripe on the sternum, and four pairs of small yellow spots in the middle and two wide yellow stripes on the sides of the abdomen. Around the spinnerets are two large triangular yellow spots and one or two pairs of smaller ones. The sides of the abdomen below the large yellow spots are marked with irregular oblique lines of black and yellow. The epigynum is covered by a long brown process directed backward and covering the openings entirely.

The young of this species differ considerably from the adult. Until nearly full grown the legs are distinctly marked with dark rings on the ends and middle of each joint, the ground color being white or pale yellow. When very young the abdomen is more slender, the color is pale yellow, and the markings gray without any of the strong black and yellow of the adult. Hentz's *Epeira sutrix* is perhaps the young *riparia* at this stage.

The male differs greatly from the female. It is only 5 or 6^{mm} long. The colors and markings resemble those of the female but are gener-

ally less bright and sharp. The dark marks on the sides of the thorax, which are nearly concealed by the hairs in the female, are more distinct in the male and cover a large part of the thorax. The legs are dark brown, lighter toward the tips and covered with dark hairs and black spots. The palpi are very large in proportion to the size of the spider. The palpal organ is large and nearly all exposed outside the tarsus. The tube is flat and slightly barbed at the end, and is supported by a long, thin paddle-shaped appendage, and a shorter one with a thin tooth on one side. Fig. 14.

This species makes a strong web, usually more or less inclined, in grass or low bushes, generally near water or on wet ground. The middle of the web is usually crossed by a white zigzag band of silk, which is of no apparent use to the adult spider, but when young helps to conceal it, especially when the web is much inclined. On one or both sides of the round web and within an inch or two of it, the spider often makes a loose irregular web. The female seems to remain all the time in the center of the web, making no tent or nest for concealment. The male often occupies a corner of the female's web, among the irregular threads to which he perhaps adds some of his own. In copulation the male lays flat against the under side of the female's abdomen, clasping his legs around it. While seeking to do this he runs about lightly over the female, and if attacked by her drops off the web to the ground.

In September the female lays in a large pear-shaped cocoon with a brown paper-like surface hung by numerous threads in grass or bushes. Inside the papery surface is a mass of loose web surrounding the eggs, which are packed closely together under a cup-shaped cover attached to a thick stem of silk running through the middle of the cocoon. From cocoons found unfinished it appears that the stem and cup are first made and the eggs attached in a lump underneath, and afterward covered with the loose thread. The young hatch in the fall or winter but remain in the cocoon until May or June.

Common in Massachusetts and southward.

Argiope transversa = *Epeira fasciata* Hentz.

PLATE XXXIV, FIGURES 20, 20a. PLATE XXXVIII, FIGURES 15, 16, 17, 18.

This species is somewhat smaller than *riparia*. The cephalothorax is 5^{mm} long and the whole body measures 15 to 20^{mm}. The first leg is 25^{mm} long. The abdomen is more pointed behind than in *riparia* and the markings very different. The ground color is white or

yellow and is crossed by a great number of black transverse lines, three on each segment, which are sometimes obscured, especially in young spiders, by a thick covering of silvery white hairs. The cephalothorax is covered with white hairs through which the dark markings on the sides of the thorax show indistinctly. The legs are light yellow with black bands around the ends and middle of each joint. The femora of the first legs are sometimes entirely black. The epigynum is uncovered, showing two openings separated by a slight ridge. The colors and markings under the body are like those of *A. riparia*. The young of this species have the back entirely white until nearly full grown.

The male is about 5^{mm} long. The legs and cephalothorax are yellowish and the abdomen white. The markings underneath are similar to those of the female but paler. The legs are yellowish, marked with black spots but no rings. The cephalothorax is rather wider than in the male of *riparia* and does not have the dark marks along the sides. The palpi are very different from those of *riparia*. The tube is coiled once around the end of the bulb, the tip turned slightly outward. It is accompanied by two hard appendages, as in *riparia*, but these are shorter and somewhat twisted with the tube.

This has the same habits as *riparia*, and is found with it in the same bushes. It remains in its webs rather later in the fall than the other species. The cocoons are flat on top, not narrowed into a stem.

I have females from the Adirondack Mountains, collected by F. A. Bowditch, and from Ottawa, Canada, J. B. Tyrrell. In Eastern Massachusetts it is very common, especially near the sea-shore. Near New Haven, Conn., it is found with *riparia* but neither is common. It extends southward probably as far as Florida.

This species was called *Epeira fasciata* by Hentz, who supposed that it might be identical with the *Epeira fasciata* or *bruennichii* of Europe. The differences in the epigynum and male palpi are enough to separate the two species. In *bruennichii* the epigynum is covered by a process directed backward as in *riparia*, while in *transversa*, the two openings are uncovered. The males of *bruennichii* are proportionately larger than those of *transversa* and have more distinct markings on the abdomen and thorax. The tube of the palpal organ is less twisted than in *transversa*.

Argyropeira, new.

These spiders have long slender legs like *Tetragnatha*. The abdomen is long and round but often thicker in the middle and never as

slender or long as in *Tetragnatha*. The colors are bright green and yellow with black and silvery markings on the abdomen. The maxillæ are long as in *Meta*. The lateral eyes are widely separated from the middle ones. The male palpi are long and the palpal organ large and rounded and only partly covered by the tarsus. Keyserling includes these in the genus *Meta*, and Walckenaer in *Tetragnatha*, 2nd family.

Argyropeira hortorum (Hentz) = *Epeira hortorum* Hentz.

PLATE XXXVII, FIGURES 29, 30, 31, 32.

Length 5 or 6^{mm}; first leg 14^{mm}. The abdomen is round and about twice as long as wide and nearly as thick at the hinder end as in front. The abdomen is silvery with transparent marks over the dorsal vessel and its branches. Sometimes there is a black line along the middle and another each side. On each side there is also sometimes a bright yellow stripe. Underneath the body is black mixed with greenish spots. The legs are green or yellowish with narrow black rings at the end of each joint. The cephalothorax is green or yellow with a fine black line on each side. The epigynum is dark brown and only very slightly raised and divided at the edge of the fold into three parts by shallow grooves.

The male is about half as large as the female, with the legs much longer, the first pair being 17^{mm} long. The male palpi are longer than the cephalothorax. The patella is about as short as thick, and the patella and tibia together are nearly as long as the femur. The tarsus is small and oval. The other appendages of the palpal organ project beyond the tip.

New Haven, Conn.; Milton, Mass.

Tetragnatha.

In *Tetragnatha* the body is long and slender. The eyes are in two rows variously curved. The legs are long and slender, and when the spider rests in the web, are extended in front and behind parallel with the body. The colors are light brown and yellow with silvery spots and bands above and darker with yellow stripes beneath. Sometimes the whole body is bright green with white and red markings. The mandibles are long, and longer in males than females. Besides the teeth on the inner side of the mandibles, the males have an additional tooth on the upper side near the tip which curves forward and is usually forked at the end. The webs are often inclined or horizontal and are usually near water on low plants.

Tetragnatha vermiformis.

PLATE XXXIX, FIGURES 12, 13, 14.

The females of this species have the abdomen long and straight and measure 10 or 12^{mm} long, cephalothorax 3^{mm}, mandibles 2^{mm}, first leg 21^{mm}.

The upper row of eyes is curved backward as in *laboriosa*. The front lateral eyes are widely separated from all the others, twice as far from the middle pair as these are from each other. The cephalothorax is dull yellow with dark stripes in the middle and on the edges. The abdomen has a distinct folium with scolloped edges and a light line in the middle.

The male is smaller than the female. The mandibles are not much longer than those of the female, and the teeth are not much larger.

Beverly, and Middleton, Mass.

Tetragnatha extensa Linn., Thorell, etc.

PLATE XXXIX, FIGURES 9, 10.

Length of female 7 to 10^{mm} according to size of abdomen, cephalothorax 3^{mm}, mandibles 2^{mm}, front legs 20^{mm}, palpi 5^{mm}.

The legs and cephalothorax are browner yellow than in most species and sometimes the cephalothorax has three indistinct brown stripes and the legs brown spots at the ends of the joints, and around the bases of the hairs. The sternum is the same color as the legs, occasionally showing a lighter stripe in the middle. The abdomen has various dark and light brown markings, sometimes forming a narrow folium on a light ground, on each side of which is a dark and light line. The abdomen is comparatively short, being $\frac{1}{3}$ to $\frac{1}{4}$ as wide as long. The rows of eyes are only slightly curved backward. The lateral eyes are nearer together than the middle ones, and are usually surrounded by black rings so that they appear to touch each other. The mandibles are two-thirds as long as the cephalothorax, and not much inclined forward.

The male is somewhat smaller and more slender than the female, but the legs are no shorter, and the mandibles slightly longer and more slender. The palpi are 4^{mm} long, the femur 2^{mm}. The tibia is nearly twice as long as the patella. The second tooth on the upper side of the claw groove of the mandibles is much longer than the others.

Northern New York; White Mts.; Massachusetts and Connecticut.

It appears to be the species common all over Europe. I have compared specimens from France and Germany.

Tetragnatha grallator Hentz.

T. grallator Keyserling, Beitrage zur Kenntniss der Orbitularia Verhandlungen Zool. Bot. Gesellschaft, Wien, 1865.

T. elongata (Walck.) Thorell in Bulletin of Hayden's U. S. Geological Survey of the Territories, vol. iii, no. 2. Thorell describes several varieties and thinks it probable that this is the same as the European *T. extensa*.

PLATE XXXIX, FIGURES 1, 2, 3, 4, 5, 6.

T. grallator is the largest New England species. The female is 10 or 12^{mm} long, cephalothorax 3½^{mm}, mandibles as long as the cephalothorax, front legs 35^{mm} long. Colors as in *extensa*, varying from light yellow to dark brown. In dark individuals, three stripes on the cephalothorax and the markings on the abdomen are very distinct. The abdomen is often twice as wide near the front end as farther back. The mandibles are turned forward in some individuals nearly horizontal. On the upper edge of the mandibles are two teeth near the end, one large and one small, and seven small ones toward the basal end of the claw groove. The lateral eyes are close together.

The male is somewhat smaller, and has jaws longer than the cephalothorax. The spines on the under side of the claw groove are very small except one near the end, which is curved forward. On the upper side of the groove the second tooth is large and prominent. Behind this are five teeth of the usual size, followed by five or six very small ones close together. Palpi 6^{mm} long, tibia twice as long as the patella and both together as long as the femur.

Eastern Massachusetts; Central New York.

Tetragnatha laboriosa Hentz.

Keyserling, Zool. Botan. Gesellschaft in Wien, 1865.

PLATE XXXIX, FIGURES 7, 8, 11, 19. PLATE XL, FIGURE 7.

Length of female about 7^{mm}. Smaller than *extensa* and *grallator*. Cephalothorax 2–2½^{mm}; first leg 12–17^{mm}. Mandibles short, about half as long as the cephalothorax. Lateral eyes as far apart as the middle ones. The legs and cephalothorax are light yellow. The abdomen is dark beneath with two light stripes. The back of the abdomen is sometimes silvery white with transparent stripes over the dorsal vessel. In other individuals there is a very plain folium with dark and light stripes along the sides. A few, apparently of this species, had the abdomen bright green with a white stripe each

side of the folium along the lower edge of which and on the front end of the abdomen were irregular red spots. They were found in white pine trees, Essex, Mass.

The males are a little smaller and have the abdomen more cylindrical. The mandibles are two-thirds as long as the cephalothorax. The tibia of the palpus is short, not much longer than the patella, and both together are a little more than half as long as the femur.

The second tooth on the upper side is the longest, and from this four or five other teeth decrease gradually in length to the base.

White Mountains to Connecticut.

Tetragnatha straminea, new.

PLATE XXXIX, FIGURES 15, 17, 20, 21.

Female 10^{mm} long; cephalothorax 2½^{mm} long, 1½^{mm} wide; first leg 22^{mm}; mandibles 1½^{mm}.

The hinder row of eyes is curved backwards more than in *laboriosa*, and the lateral eyes are farther apart. The abdomen is silvery white above and dark beneath with two light stripes. The cephalothorax is light yellow with two parallel gray stripes. The legs are light brownish yellow. The abdomen extends backward about half its diameter beyond the spinnerets. It is long and slender, thickest toward the front end and seldom swelled out in the middle as in *laboriosa*.

The males are smaller and more slender but their legs are no shorter than those of the females. The palpi are longer than those of *laboriosa*. The tibia is as long as the tarsus and nearly twice as long as the patella. The mandibles are about two-thirds as long as the cephalothorax. The arrangement of the teeth differs but little from that of *laboriosa*.

Eastern Massachusetts; New Haven, Conn. Adults from May to July.

Tetragnatha caudata, new.

PLATE XXXIX, FIGURES 16, 22.

Two females from Malden and Dedham, Mass., resemble very closely *T. straminea*, except in the shape of the abdomen, which is longer and has a tail about a quarter its length, extending backward beyond the spinnerets. The shape of the abdomen of *straminea* seems to be very constant, so that this is probably another species.

Pachygnatha.

The genus *Pachygnatha* has been generally classed with the *Therididæ* near *Steatoda* and *Erigone* on account of its terrestrial habits and the absence of any apparent web. In structure it however resembles *Tetragnatha*, especially in the copulatory organs of both sexes. It resembles *Tetragnatha* also in the large mandibles and in the colors and markings. It does not, however, spin a geometrical web, nor apparently any web, but is always found under leaves and stones near the ground. The feet do not have toothed hairs under the claws. In general appearance these spiders resemble *Steatoda*. The abdomen is oval and rounded and smooth on the back. The cephalothorax is widened in the middle. The sternum is wide and hard.

Pachygnatha brevis Keys.

Zool. Bot. Gesellschaft, Wien, 1883 = *Pachygnatha tristriata* Keys., Zool. Bot. Gesellschaft, Wien, 1882,

PLATE XXXIV, FIGURE 21. PLATE XL, FIGURES 8, 10.

This is the common large and light colored species. The whole body is 5 or 6^{mm} long, the abdomen and cephalothorax about equal in length. The legs and cephalothorax are light brownish yellow, the latter with three dark brownish bands. The abdomen is light yellow with an indistinct grayish folium, in the middle of which is a white band. The mandibles, maxillæ and sternum are dark reddish brown. The under side of the abdomen is gray except two yellow longitudinal stripes. There is but little difference between the sexes in size, color or the general shape of the body. The middle eyes nearly form a square, the hinder pair being slightly the farthest apart. The lateral eyes almost touch each other. The mandibles are stout and in both sexes more than half as long as the cephalothorax and as far apart at the tips as they are long. Under the claw groove are three or four small spines and above the groove three larger ones which are larger and the terminal one more prominent in the males. The maxillæ are obliquely truncated at the ends as in *Erigone*, and thickly haired on the inner edges beyond the lip. The lip is shorter than wide. The sternum is in front nearly as wide as long but tapers backward so that the coxæ of the hind legs almost touch. The opening of the reproductive organs is just back of the spiracles in the male, but as far back as the middle of the abdomen in the female.

Males and females are found under leaves in damp woods at all seasons and occasionally under stones without webs.

Montreal, Canada; Eastern Mass.; New Haven, Conn.

Pachygnatha autumnalis Keys.

Zool. Bot. Gesellsch., Wien, 1883.

PLATE XXXIV, FIGURE 22. PLATE XL, FIGURE 9.

This is smaller than the other species, measuring about 4^{mm} in length. The markings are similar but the colors are brighter. The cephalothorax is narrower than in *brevis* and the front part of the head including the upper middle eyes is abruptly raised in both sexes. The three dark stripes on the cephalothorax are united together toward the head which is nearly black especially in the males. The folium is dark brown on the edges and has a light stripe in the middle which is yellow along the edges and sometimes bright red in the middle. The upper middle eyes are much larger than the others and on the sides of a hump in both sexes. The legs are stout and stiff and brownish yellow in color, the front pair the darkest.

Beverly, Cambridge and Lexington, Mass., and New Haven, Conn. Keyserling's specimen came from Pennsylvania.

EXPLANATION OF THE PLATES.

PLATE XXXIII.

1. *Epeira insularis*, dorsal markings of female $\times 2$.
2. *Epeira marmorea*, dorsal markings of female $\times 2$.
- 3, 3a, 3b, 3c. *Epeira patagiata*, dorsal markings of female $\times 2$.
4. *Epeira scolopetaria*, dorsal markings of female $\times 2$.
5. *Epeira strix*, dorsal markings of female $\times 2$.
- 6, 6a. *Epeira nordmanni*, dorsal markings of female; 6b, ventral markings $\times 2$.
7. *Epeira insularis*, male $\times 2$.
8. *Epeira trifolium*, female $\times 2$; 8a, abdomen of light colored female with indistinct markings $\times 2$; 8b, male $\times 2$.
9. *Epeira thaddeus*.
10. *Epeira cinerea*, dorsal markings of female $\times 2$.
11. *Epeira solitaria*, male $\times 2$.
12. *Epeira angulata*, female $\times 2$; 12a, male $\times 2$.
13. *Epeira silvatica*, male $\times 2$; 13a, abdomen of female $\times 2$.
14. *Epeira corticaria*, female $\times 4$.
15. *Epeira pratensis*, abdomen of female $\times 4$; 15a, male $\times 4$.
- 16, 16a. *Epeira trivittata*, dorsal markings of female $\times 4$.
17. *Epeira domiciliorum*, dorsal markings of female $\times 4$.

PLATE XXXIV.

- 1 and 1a. *Epeira gibberosa*, markings of female $\times 8$.
2. *Epeira placida*, markings of female $\times 8$.
- 3 and 3a. *Cyclosa conica* $\times 4$.
4. *Epeira displicata*, dorsal markings of abdomen $\times 4$.
5. *Epeira albocentris*, dorsal markings $\times 4$.
6. *Epeira juniperi*, dorsal markings $\times 4$.
7. *Microepeira radiosa* $\times 16$.
8. *Epeira labyrinthica* $\times 4$.
9. *Epeira triaranea*, dorsal markings $\times 4$.
10. *Epeira foliata* $\times 4$.
- 11 and 11a. *Cyrtarachne bisaccata* $\times 4$.
- 12, 12a, 12b, 12c. *Epeira parvula*, dorsal markings.
13. *Zilla X-notata*, dorsal markings $\times 4$.
14. *Zilla montana*, dorsal markings $\times 4$.
15. *Singa pratensis*, female; 15a, male $\times 4$.
- 16, 16a, 16b. *Singa variabilis*, female $\times 4$; 16c, male $\times 4$.
17. *Epeira stellata*, female $\times 4$.

- 18 and 18a. *Meta menardi*, female $\times 4$.
19. *Argiope riparia*, female, natural size, dorsal markings.
- 20 and 20a. *Argiope transversa*, female, natural size.
21. *Pachygnatha brevis*, male $\times 8$.
22. *Pachygnatha autumnalis*, male $\times 8$.

PLATE XXXV.

1. Male palpus of *Epeira silvatica*.
2. Male palpus of *Epeira angulata*.
3. Male palpus of *Epeira solitaria*.
4. 1st and 2d coxæ of *Epeira silvatica*.
- 5 and 6. Epigynum of *Epeira silvatica*.
- 7 and 8. Epigynum of *Epeira cinerea*.
9. Epigynum of *Epeira corticaria*.
10. Male palpus of *Epeira scolopetaria*.
11. Male palpus of *Epeira potaginata*.
12. Male palpus of *Epeira stris*.
- 13 and 14. Male palpus of *Epeira trifolium*.
- 15 and 16. Male palpus of *Epeira quadrata*; same scale as 13.
17. Male palpus of *Epeira marmorea*.
18. Male palpus of *Epeira insularis*; same scale as 17.
- 19 and 20. Epigynum of *Epeira quadrata*.
- 21 and 22. Epigynum of *Epeira trifolium*.

PLATE XXXVI.

1. Second tibia of *Epeira domiciliorum*.
2. Second tibia of *Epeira tricittata*.
3. Male palpus of *Epeira tricittata*.
4. Male palpus of *Epeira domiciliorum*.
5. End of palpal organ of *Epeira tricittata*.
6. Palpal organ of *Epeira triaranea*.
7. Epigynum of *Epeira triaranea*.
8. Epigynum of *Epeira tricittata*.
9. Male palpus of *Epeira pratensis*.
10. Male palpus of *Epeira placida*.
11. Male palpus of *Epeira labyrinthea*.
12. Epigynum of *Epeira alboventris*.
13. Epigynum of *Epeira placida*.
- 14 and 15. Male palpus of *Epeira juniperi*.
16. Epigynum of *Epeira juniperi*.
17. Male palpus of *Epeira gibberosa*.
- 18 and 19. Male palpus of *Epeira carbonaria*.
20. Male palpus of *Epeira displicata*.

PLATE XXXVII.

1. Male palpus of *Epeira parvula*.
2. Epigynum of *Epeira parvula*.
- 3 and 4. Male palpus of *Epeira stellata*.
5. Epigynum of *Epeira stellata*.
6. Eyes of *Epeira foliata*.
- 7 and 8. Male palpi of *Epeira foliata*.
9. Epigynum of *Epeira foliata*.
10. Second tibia of male *Epeira foliata*.
11. Side of *Epeira infumata*.
12. Abdomen of *Epeira infumata*.
- 12a and 12b. Epigynum of *Epeira infumata*.
13. Eyes of *Epeira infumata*.
- 14 and 15. Tibia of male palpus of *Singa pratensis*.
16. Epigynum of *Singa pratensis*.
17. Male palpus of *Singa pratensis*.
18. Epigynum of *Singa maculata*.
19. Epigynum of *Singa variabilis*.
- 20 and 21. Male palpus of *Singa variabilis*.
- 22 and 23. Male palpus of *Zilla montana*.
- 24 and 25. Male palpus of *Zilla X-notata*.
26. Eyes of *Zilla montana*.
27. Epigynum of *Zilla X-notata*.
28. Epigynum of *Zilla montana*.
29. *Argyropeira hortorum*, male.
30. *Argyropeira hortorum*, female.
31. Male palpi of *Argyropeira hortorum*.
32. Epigynum of *Argyropeira hortorum*.
33. Male palpus of *Meta menardi*.

PLATE XXXVIII.

1. *Micræpeira radiosa*, male.
2. *Micræpeira radiosa*, female.
- 3 and 4. Epigynum of *Micræpeira radiosa*.
5. *Acrosoma spinea*, female.
6. *Acrosoma spinea*, male.
7. *Acrosoma spinea*, young female.
8. *Acrosoma spinea*, male palpus.
9. *Acrosoma mitrata*.
10. *Acrosoma rugosa*.
11. Male palpus of *Cyclosa conica*.
12. Cocoon of *Cyrtarachne bisaccata*.
13. *Argiope riparia*, male.
14. *Argiope riparia*, male palpus, upper and under sides.
15. *Argiope transversa*, male.

- 16 and 17. *Argiope transversa*, male palpus.
18. *Argiope transversa*, epigynum.
19. Epigynum of *Argiope riparia*.

PLATE XXXIX.

1. *Tetragnatha gallator*, mandible of female, under side.
2. *Tetragnatha gallator*, mandible of male, under side.
3. *Tetragnatha gallator*, mandible of small male.
4. *Tetragnatha gallator*, mandible and eyes of male, upper side.
5. *Tetragnatha gallator*, maxille of male.
6. *Tetragnatha gallator*, maxille of female.
7. *Tetragnatha laboriosa*, eyes of female, from above.
8. *Tetragnatha laboriosa*, mandibles and eyes of male.
9. *Tetragnatha extensa*, mandibles and eyes of male.
10. *Tetragnatha extensa*, mandibles of female.
11. Male palpus of *Tetragnatha laboriosa*.
12. *Tetragnatha vermiformis*, male mandibles.
13. *Tetragnatha vermiformis*, male palpus.
14. *Tetragnatha vermiformis*, female mandibles.
15. *Tetragnatha straminea*, male mandibles and eyes.
16. *Tetragnatha caudata*.
17. *Tetragnatha straminea*, mandibles of female.
18. *Tetragnatha straminea*, eyes from above.
19. *Tetragnatha laboriosa*, female mandibles.
20. *Tetragnatha straminea*, male palpus.
21. *Tetragnatha straminea*, abdomen.
22. *Tetragnatha caudata*.

PLATE XL.

1. Part of web of *Epeira scolopetaria*.
2. Part of web of *Zilla X-notata*.
3. *Epeira scolopetaria*, foot of first or second pair, showing two teeth on the front or inner claw longer than the others.
4. *Epeira scolopetaria*, foot of third pair, showing two longer teeth on inner hind claw.
5. *Epeira scolopetaria*, foot of fourth pair, showing two long teeth on hind or inner claw.
6. Maxille of *Epeira insularis*.
7. Internal epigynum of *Tetragnatha laboriosa*.
8. Internal epigynum of *Pachygnatha tristriata*.
9. Male palpi of *Pachygnatha autumnalis*.
10. Male palpi of *Pachygnatha brevis*.

I N D E X .

Acrosoma mitrata	327	Epeira pratensis	310
Acrosoma rugosa	326	Epeira radiosa	320
Acrosoma spinea	326	Epeira riparia	329
Argiope	328	Epeira rugosa	326
Argiope transversa	330	Epeira sclopetaria	303
Argiope riparia	329	Epeira silvatica	300
Argyropeira	331	Epeira solitaria	299
Argyropeira hartorum	332	Epeira spinea	326
Cyclosa conica	321	Epeira stellata	319
Cyrtarachne bisaccata	325	Epeira strix	305
Epeira	298	Epeira thaddeus	309
Epeira alboventris	314	Epeira triaranea	315
Epeira angulata	299	Epeira trifolium	306
Epeira carbonaria	315	Epeira trivittata	311
Epeira caudata	321	Epeira vulgaris	303
Epeira cinerea	302	Epeirinae	297
Epeira corticaria	300	Meta menardi	328
Epeira displicata	313	Micropeira radiosa	320
Epeira domiciliorum	312	Pachygnatha autumnalis	337
Epeira fasciata	330	Pachygnatha brevis	336
Epeira foliata	318	Singa	321
Epeira gibberosa	317	Singa maculata	323
Epeira hortorum	332	Singa pratensis	322
Epeira infumata	319	Singa variabilis	322
Epeira insularis	309	Tetragnatha	332
Epeira juniperi	313	Tetragnatha caudata	335
Epeira labyrinthea	314	Tetragnatha extensa	333
Epeira marmorea	307	Tetragnatha grillator	334
Epeira mitrata	327	Tetragnatha laboriosa	334
Epeira nordmanni	301	Tetragnatha straminea	335
Epeira packardii	315	Tetragnatha vermiformis	333
Epeira parvula	317	Tetragnathinae	298
Epeira patagiata	305	Zilla montana	323
Epeira placida	316	Zilla X-notata	324

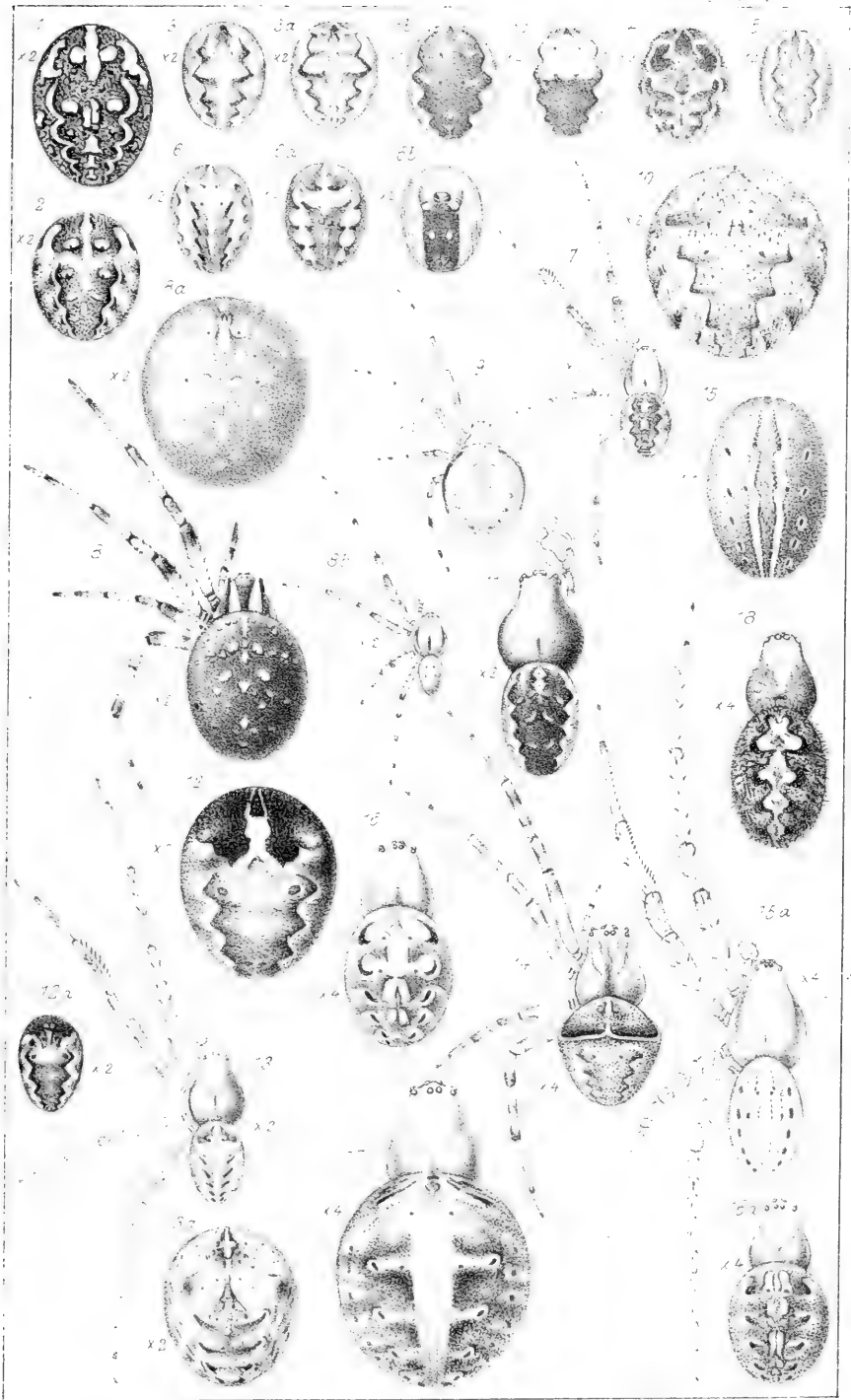

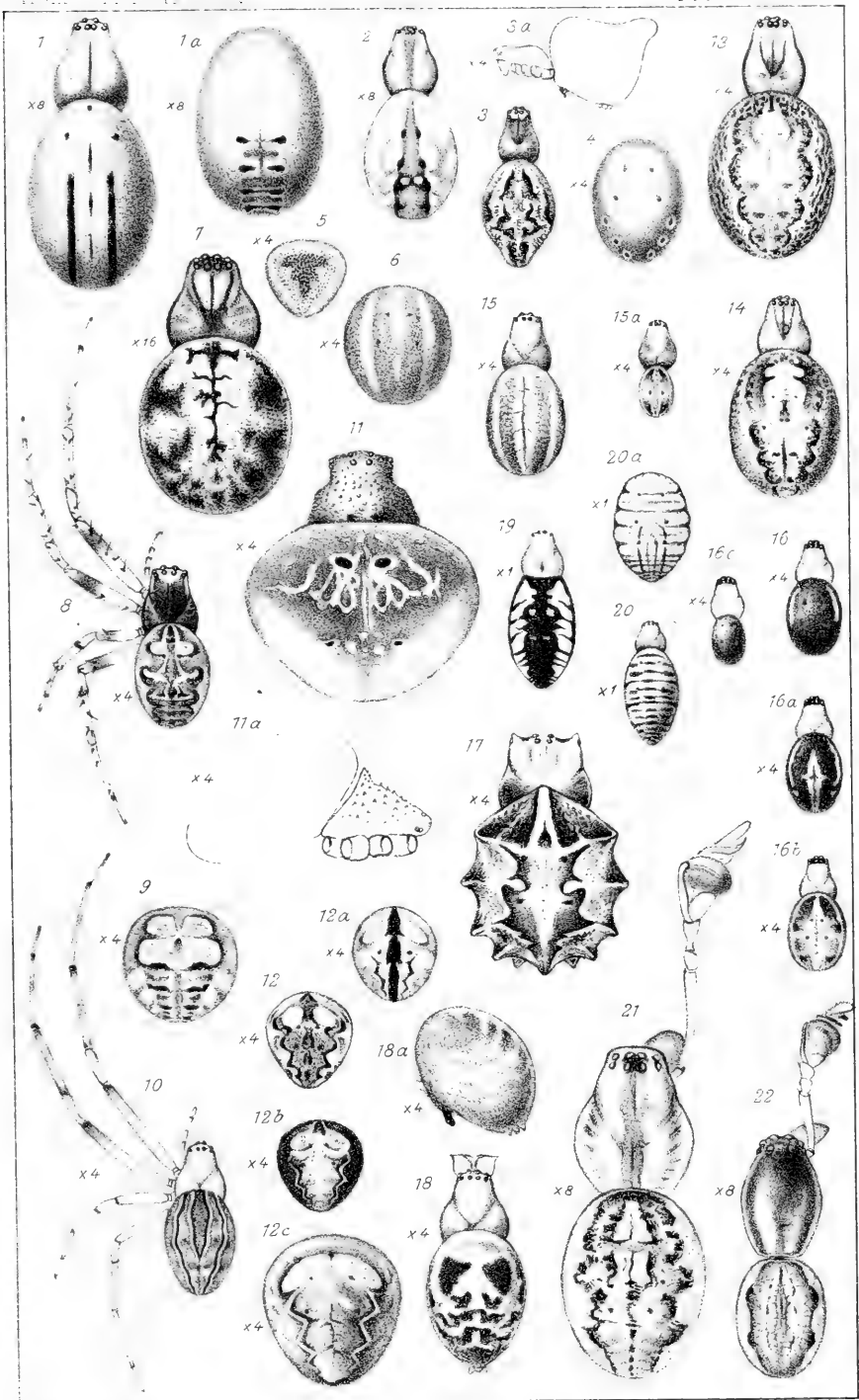



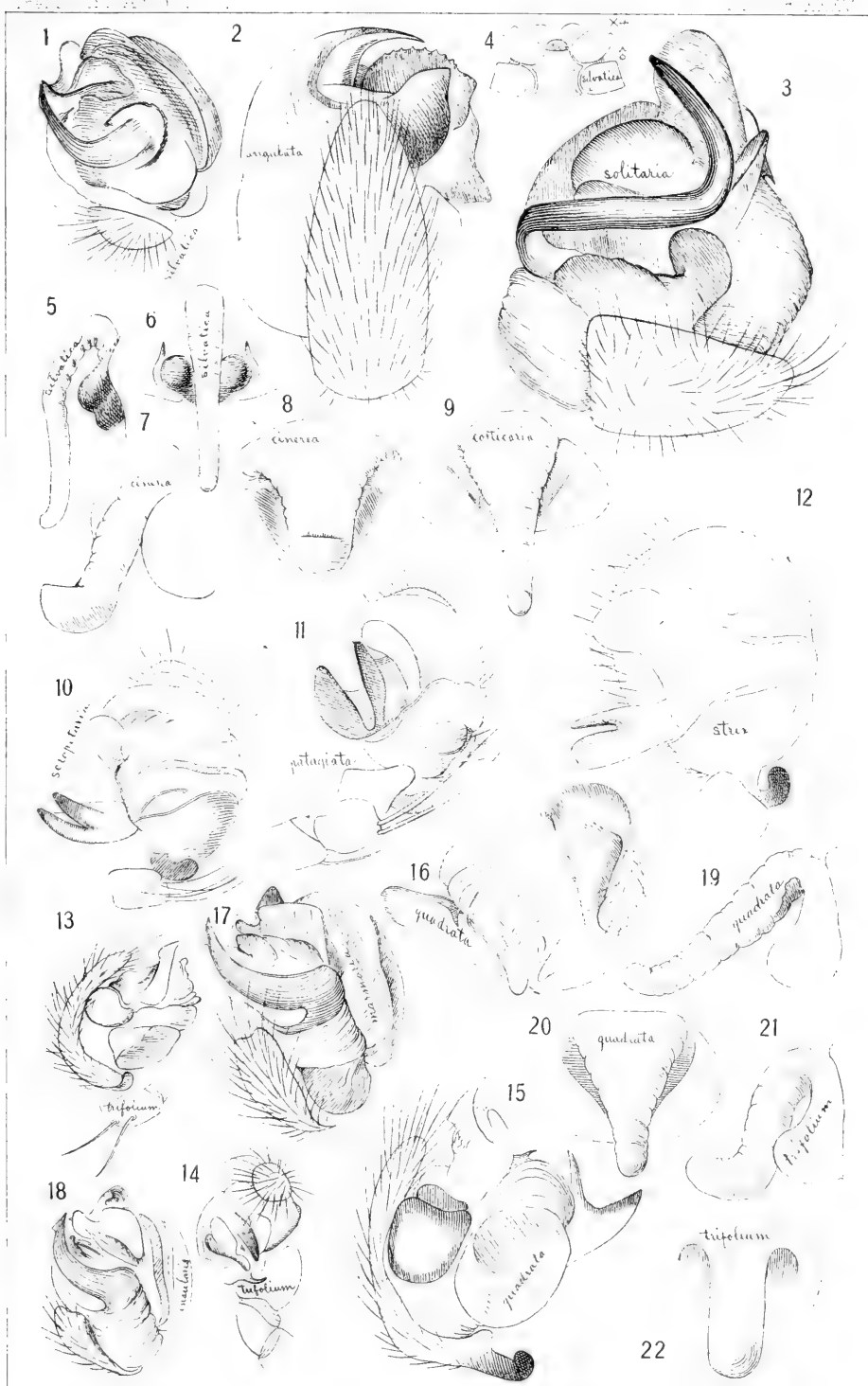

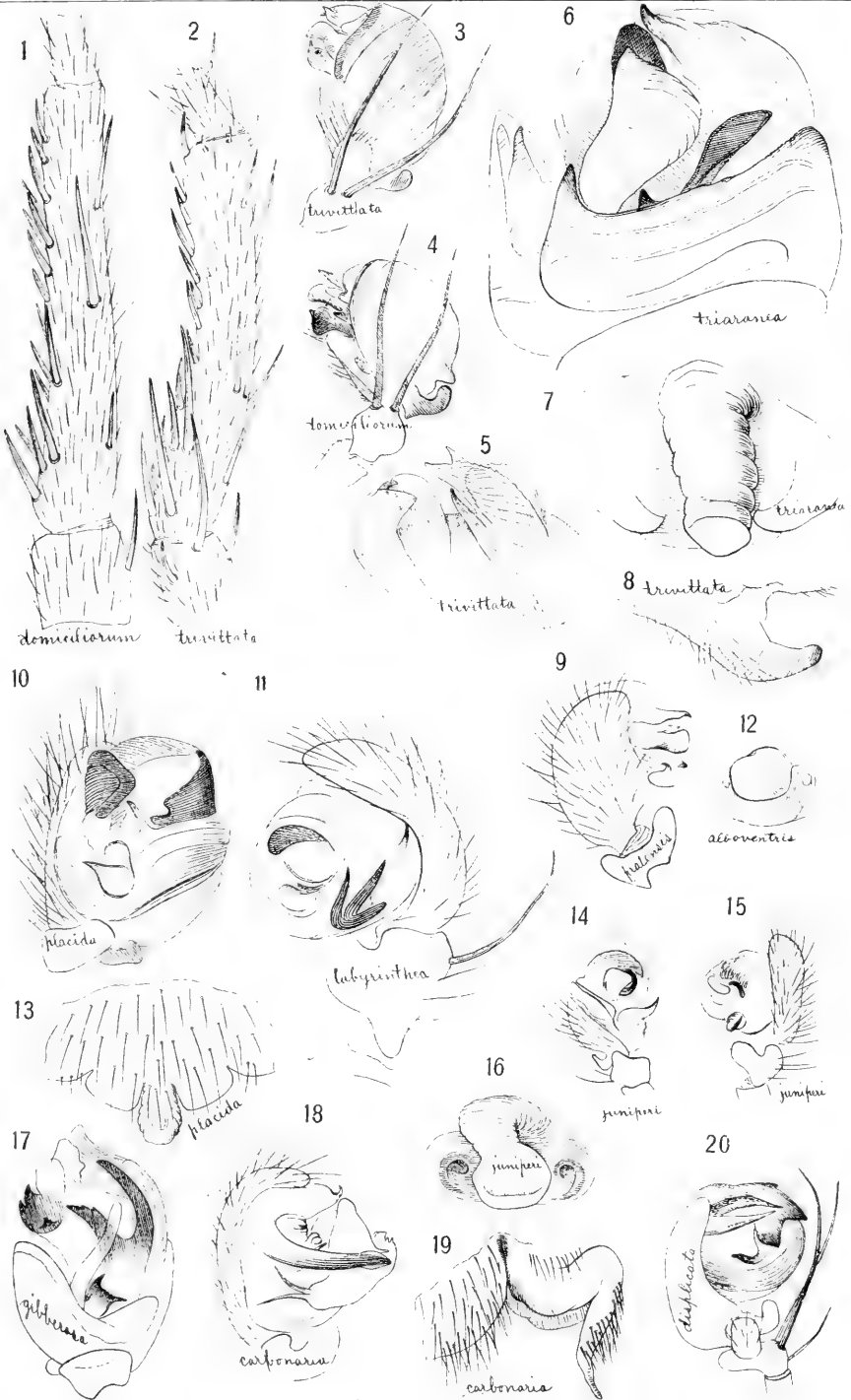

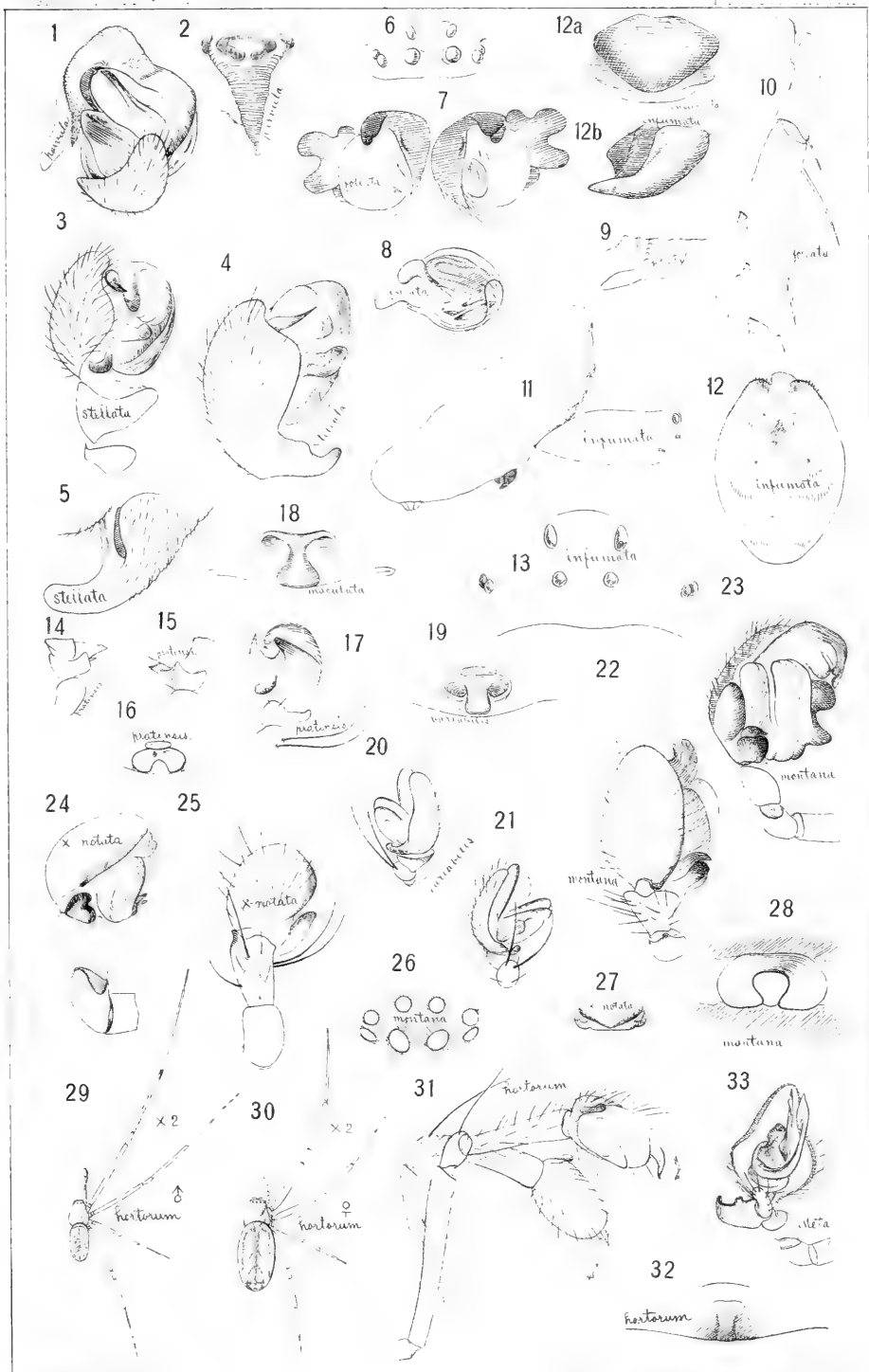

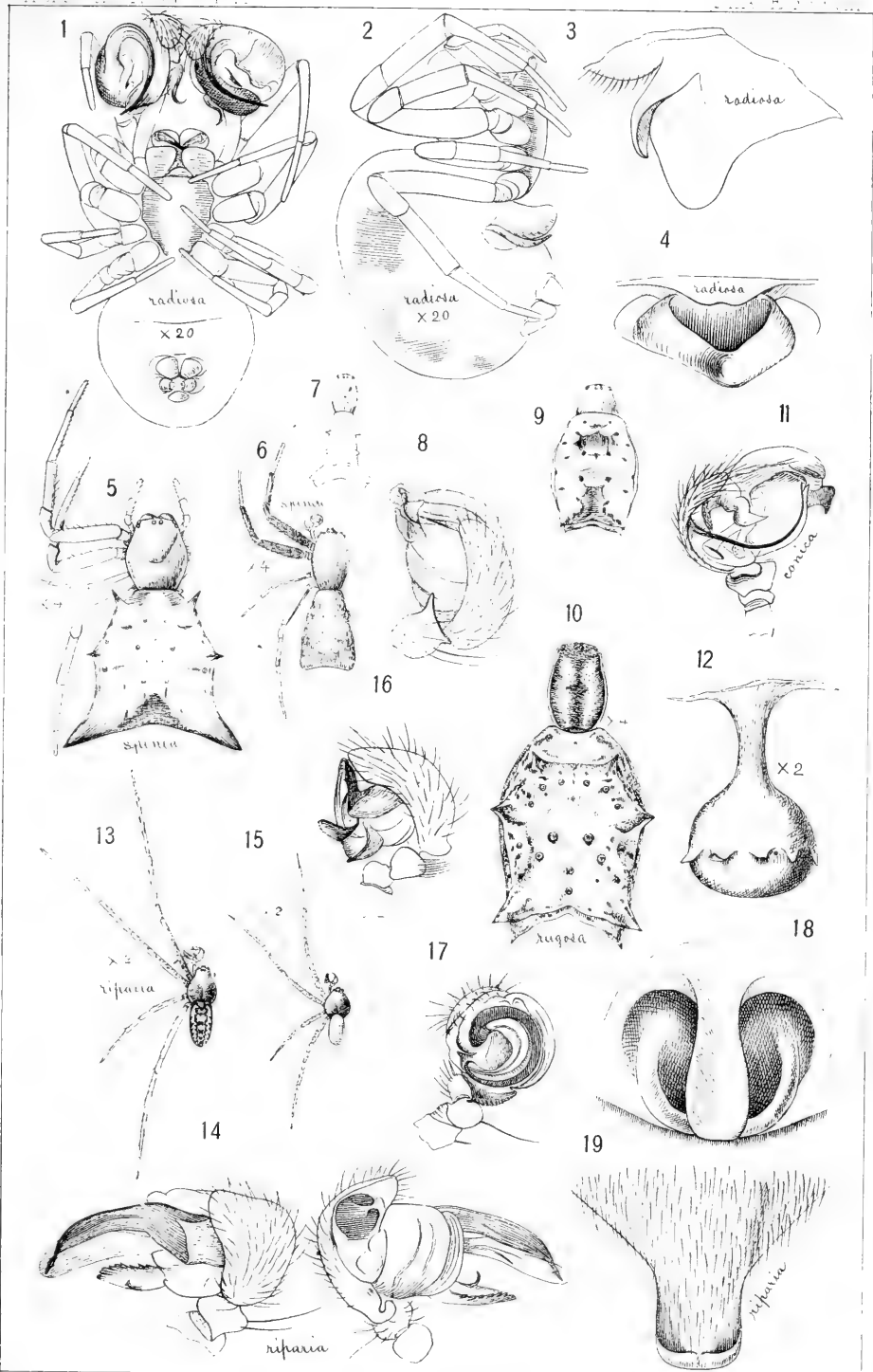

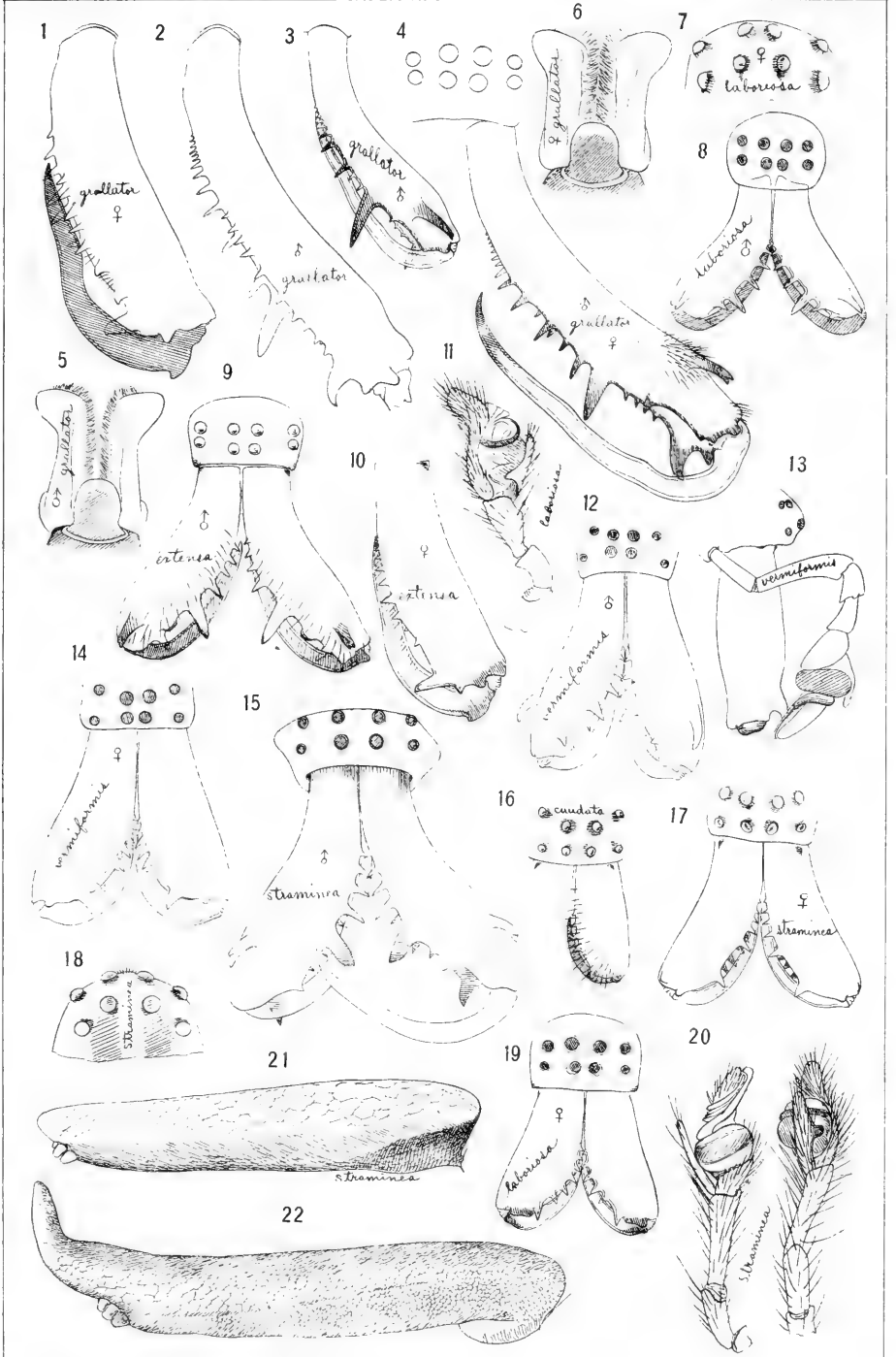

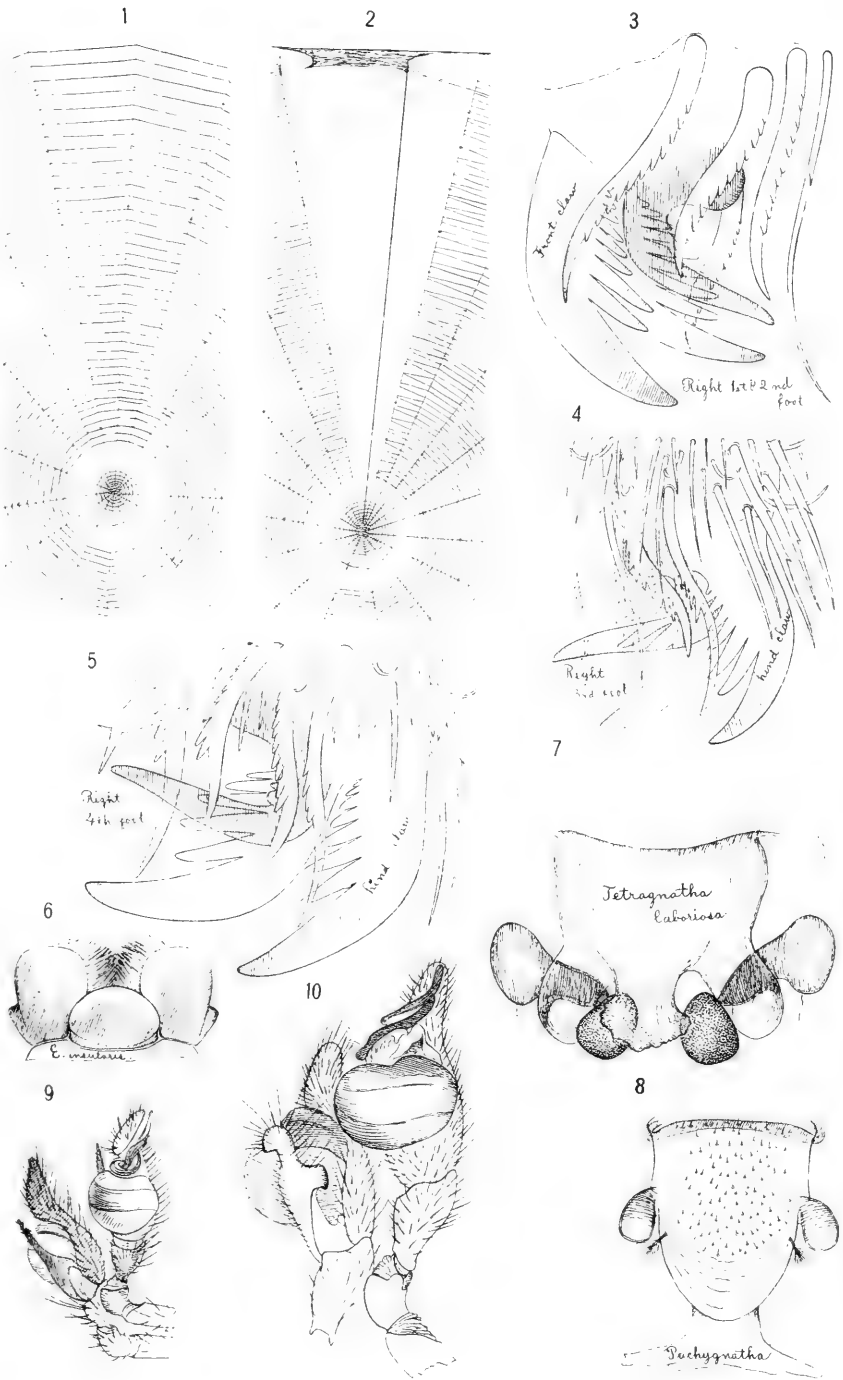

VIII.—THE DIASTATIC ACTION OF SALIVA, AS MODIFIED BY VARIOUS CONDITIONS, STUDIED QUANTITATIVELY. BY R. H. CHITTENDEN AND HERBERT E. SMITH.

THE chemical changes resulting from the action of unorganized ferments are among the most interesting and important of those which occur in the animal organism. Ferment action plays such an important part in the chemical processes incident to life that definite knowledge of the conditions favorable and inimical to the action of any ferment occurring in the animal body must necessarily be of great physiological value.

Since Leuchs in 1831 discovered the diastatic action of saliva much has been learned regarding this digestive fluid, both as to its chemical action and the nature of the products formed. Still there has been lacking, until recently, definite knowledge of the conditions which influence the diastatic action of the salivary ferment, and it has been the object of the present investigation, taking advantage of previously acquired knowledge, to ascertain the exact influence of those conditions which suggest themselves as being most important in view of the destination of the ptyalin, and concerning which there has been of late a lack of agreement.

Method used in determining the rate of diastatic action.

In testing the rate of action of the salivary ferment we have in all cases employed quantitative methods, similar in their general nature to those previously used by one of us.* The amount of reducing substances formed by the amyolytic action of the ferment, which for the sake of convenience we have calculated as dextrose, admit of accurate determination by means of the improved Allihn's† method, and thus enable us to give a concise expression of the relative diastatic action, even in those cases where the differences are very slight. As recent experiments‡ have plainly indicated, the ultimate product of the dias-

* Chittenden and Griswold, Amer. Chem. Jour., iii, 305. Chittenden and Ely, *ibid.*, iv, 107.

† Zeitschrift für analytische Chemie, 22 Jahrgang, p. 448.

‡ v. Mering and Musculus, Zeitschrift für physiologische Chemie, i, 395. O. Sullivan and E. Schultze, Berichte d. deutsch. Chem. Gesell., vii, 1047. Musculus and Gruber, Zeitschrift für physiolog. Chemie, ii, 177. v. Mering, Zeitschrift für physiolog. Chem., v, 196.

tatic action of ptyalin is dextrose; the sugar intermediate between this body and the dextrans, and which is formed in much larger quantity is maltose, with a relative reducing power of 66 as compared with dextrose, 100; while the achroodextrans and other intermediate products have very small reducing power; consequently the reducing power of a digestive mixture must necessarily express the relative diastatic action of the ferment present, since increased action means an increased formation of reducing bodies, of which the final product has the highest reducing power. In this connection it is well to remember that diastase and ptyalin both convert only a limited quantity of starch into sugar or reducing bodies,* and that no matter how great the excess of ferment or the length of time the action is continued, the percentage of starch changed into sugar does not ordinarily exceed 53 per cent.† The general method employed in our work for testing the diastatic action of saliva was as follows: the volume of the digestive mixture was in every instance 100 c.c.; the amount of starch‡ present, 1 or 2 grams, previously boiled in a definite amount of water; the temperature of digestion 38–40° C.; the length of time generally 30 minutes. When the digestion was finished, diastatic action was at once stopped by boiling the mixture; when cold, the mixture was diluted with distilled water to 200 c.c. and filtered; 25 c.c. of the filtrate or $\frac{1}{4}$ th of the entire fluid was then precipitated with Fehling's solution according to Allihn's§ data and method; the reduced copper was filtered through an asbestos filter in a small weighed glass tube and ignited directly in a current of hydrogen gas and weighed as metallic copper. By means of Allihn's tables of reduction equivalents the corresponding amount of sugar, calculated as dextrose, is easily obtained, from which the percentage amount of starch converted into reducing bodies can be computed, calling dextrose $C_6H_{12}O_6$, and the starch $C_6H_{10}O_5$.|| The following experiment illustrates the accuracy of the method and the reliance which can be placed upon it; two solutions of 100 c.c., each containing 2 grams of starch and 4 c.c. of

* Schulze and Märker, Chem. Centralbl. 1872, 823. Chittenden and Ely, Amer. Chem. Jour., iv, 120.

† Musculus and v. Mering, Zeitschrift für Physiolog. Chem., ii, p. 415.

‡ The starch was exactly neutral; made so by long and thorough washing with pure water.

§ Loc. cit.

|| The actual amount of starch changed is, however, somewhat greater than would appear by this equation, since, as has already been mentioned, considerable of the sugar formed is maltose, which has only two-thirds the reducing power of dextrose.

filtered saliva were warmed at 40° C. for 4 hours, then examined with the following results:

	Wt. Cu in one-eighth.	Total amount of sugar.	Starch converted into sugar.
I.	0·1530 gram.	0·6248 gram.	28·13 per cent.
II.	0·1523	0·6216	27·91

Relation of dilution to diastatic action.

It is a fact well understood that the chemical action of a ferment is out of all proportion to the amount of ferment present; indeed, a given solution of a ferment can be diluted again and again without any marked difference in its chemical activity, or at least none at all proportionate to the degree of dilution. It is only when the dilution has been carried to the extreme limit that the relative power of the mixture can be taken as a measure of the amount of ferment present.

The following experiments illustrate the foregoing statement. Each digestive mixture was 100 c.c. in volume, and was warmed at 40° C. for 30 minutes. The only variations in the different mixtures consisted in the amount of saliva and starch.

SERIES I.

With 1 per cent. starch.			
	Wt. Cu in one-eighth.	Total amount of sugar.	Starch converted into sugar.
20 c.c. saliva,	0·0951 gram.	0·3872 gram.	34·87 per cent.
10	0·0878	0·3584	32·26
5	0·0809	0·3296	29·67
4	0·0710	0·2904	26·14
3	0·0635	0·2608	23·48
2	0·0452	0·1880	16·92
1	0·0178	0·0792	7·23
$\frac{1}{2}$	0·0080	0·0408	3·66

With 2 per cent. starch.			
	Wt. Cu in one-eighth.	Total amount of sugar.	Starch converted into sugar.
20 c.c. saliva,	0·1784 gram.	0·7304 gram.	32·87 per cent.
10	0·1641	0·6704	30·18

SERIES II.

a. with 1 per cent. starch and 30 minutes at 40° C.

	Wt. Cu in one-eighth.	Total amount of sugar.	Starch converted into sugar.
4 c.c. saliva,	0·0721 gram.	0·2944 gram.	26·50 per cent.
2	0·0480	0·1992	17·93
1	0·0211	0·0920	8·28

b. with 2 per cent. starch and 30 minutes at 40° C.

4 c.c. saliva,	0·1006 gram.	0·4088 gram.	18·40 per cent.
2	0·0408	0·1704	7·67
1	trace		

c. with 1 per cent. starch and 10 minutes at 40° C.

	Wt. Cu in one-eighth.	Total amount of sugar.	Starch converted into sugar.
4 c.c. saliva.	0.0573 gram.	0.2352 gram.	21.15 per cent.
2	0.0213	0.0928	8.35
1	0.0091	0.0456	4.11

SERIES III.

a. with 1 per cent. starch and 30 minutes at 40° C.

	Wt. Cu in one-eighth.	Total amount of sugar.	Starch converted into sugar.
4 c.c. saliva,	0.0650 gram.	0.2664 gram.	23.98 per cent.
2	0.0313	0.1336	12.01
1	0.0139	0.0644	5.79

b. with 2 per cent. starch and 30 minutes at 40° C.

4 c.c. saliva.	0.0769 gram.	0.3136 gram.	19.26 per cent.
2	0.0250	0.1080	4.86
1	0.0103	0.0504	2.27

c. with 2 per cent. starch and 4 hours at 40° C.

4 c.c. saliva,	0.1530 gram.	0.6248 gram.	28.13 per cent.
2	0.1058	0.4312	19.41
1	0.0681	0.2784	12.53

From these results it is seen that only when the dilution of normally alkaline saliva is as 1 : 50 or 100 does the diastatic action at all correspond to the amount of ferment present. The same is to be noticed in Grützner's* experiments, where the principle employed by Gruenhagen in the estimation of pepsin was used; the amount of starch dissolved by the saliva being directly proportional to the amount of ferment only when very small quantities of saliva were employed and the time limited to 10 or 15 minutes. Increasing the amount of starch beyond 1 per cent. tends to diminish somewhat the amount of sugar formed in a given time, when the dilution of the saliva is as 1 : 50 or 100, which fact agrees well with what we already know concerning the influence on ferment action of the clogging of digestive fluids in general by the products of digestion, or by the substance to be digested; series III, *a* and *b*. Increasing the length of time for the ferment to act, however, causes a corresponding increase in the amount of sugar formed, as is well seen in series III, *c*. It would not be at all impossible therefore by suitable dilutions to use this method as a means of determining the relative amounts of ptyalin present in different salivary or pancreatic secretions. The following results, taken from those already given, in addition to others, lends favor to this view. All the experiments were made in

* Pflüger's Archiv der Physiologie, xii, p. 294.

the usual way, and the results are expressed in percentage of starch converted into sugar.

	1	2	3
2 c.c. saliva,	12.01 per cent.	8.35 per cent.	4.73 per cent.
1	5.79	4.11	2.21
	4	5	6
1 c.c. saliva,	6.93 per cent.	26.81 per cent.*	24.00 per cent.*
$\frac{1}{2}$	3.56	13.72	11.34

The degree of dilution to be employed depends, of course, upon the amount of ferment present. We have usually diluted the saliva 5 or 10 times, and then added an amount of the diluted fluid corresponding to 0.5–2.0 c.c. of saliva, which in the 100 c.c. of digestive mixture makes a dilution of from 50 to 200. As we shall have occasion to state later on, neutralized saliva needs even a greater dilution. The method certainly appears as advantageous as that proposed by Dr. Roberts† a few years ago, and has the advantage of giving gravimetric results, instead of being dependent upon the disappearance of a shade of color. In using the method with different solutions it will always be found necessary to exactly neutralize the ptyalin-containing solutions, before diluting them, since variations of alkalinity, even though infinitesimal in amount, may produce discordant results. Moreover, it is better to warm the ptyalin solution with the starch for not longer than 30 minutes.

The amount of dilution which saliva will endure and still show diastatic action depends naturally upon the amount of ptyalin present in the secretion and also upon the reaction of the fluid, whether it be alkaline or neutral. The following series of experiments show the average of our results on this point.

SERIES IV.

	Normally alkaline saliva, 1 per cent. starch.		
	Wt. Cu in one-eighth.	Total amount of sugar.	Starch converted into sugar.
1 c.c. saliva,	0.0152 gram.	0.0704 gram.	6.33 per cent.
$\frac{1}{2}$	0.0057	0.0272	2.44
$\frac{1}{4}$	0.0037	0.0176	1.59
$\frac{1}{10}$	trace	} less than 1 per cent. of starch converted.	
$\frac{1}{20}$	trace		

It is thus seen that when the dilution is as 1 : 250, an appreciable

* Neutralized saliva.

† William Roberts: *Jahresbericht für Theirchemie*, 1881, 290.

‡ To ensure greater accuracy the saliva was diluted ten times and amounts of the diluted fluid added corresponding to the above.

amount of starch is converted into sugar in 30 minutes at 40° C. Even with a dilution of 1:1000 or 2000, a recognizable amount of sugar is formed under these conditions. This degree of dilution, however, cannot be considered as being the limit at which diastatic action will show itself, for with even greater dilutions, the starch is converted into soluble modifications, colored blue by iodine, without giving any recognizable amount of reducing substance; that is, in $\frac{1}{3}$ th of the digestive mixture. Longer continued action at 40° C. might yield some reducing substance; it would seem, however, from our experiments, that when a certain degree of dilution is reached, the action of the small amount of ferment, in contact with the larger amount of starch (1 gram) is devoted exclusively to converting the granulose into soluble starch or other like body with non-reducing action. This agrees with the results obtained by Grütznér,* who found that the nature of the products obtained by the action of ptyalin was dependent upon the intensity of the ferment action; with a small amount of ferment, erythrodextrin was the main product, while with a large amount of ferment, sugar was mainly formed. Diminishing the amount of starch in large dilutions of the saliva tends, as might be expected, to increase the amount of sugar formed.

Comparison of the diastatic action of neutralized and normally alkaline saliva.

Human mixed saliva, when freshly secreted, almost invariably possesses a distinctly alkaline reaction. Some time ago one of us published a series of experiments† on this point, in which it was shown that the average alkalinity of 51 samples of human mixed saliva, expressed as sodium carbonate, was 0.080 per cent. The extreme variations of alkalinity in the saliva from 14 individuals amounted to 0.085 per cent. calculated as sodium carbonate (0.144–0.059 per cent).

We have had occasion to make determinations of alkalinity in 15 additional samples of saliva, all collected by one person. We give the results here, as affording additional data regarding the average alkalinity of this secretion. The alkalinity is calculated, as heretofore, in the form of sodium carbonate.‡ The indicator used was delicate litmus paper.

* Pflüger's *Archiv der Physiologie*, xii, p. 297.

† Chittenden and Ely, *Amer. Chem. Jour.*, iv, 329.

‡ Undoubtedly the alkaline reaction of saliva is due in part to alkaline phosphates, and probably the percentages given are only an approximation to the truth.

Filtered saliva.	0.2 per cent. HCl used in neutralizing.	Amount of alkalinity.
20 c.c.	6.25 c.c.	0.091 per cent.
40	10.70	0.078
40	12.00	0.087
25	9.10	0.116
20	6.00	0.087
20	6.25	0.091
20	6.75	0.098
20	5.30	0.077
40	12.50	0.091
20	7.00	0.102
40	12.20	0.088
20	7.80	0.113
20	6.80	0.099
20	8.30	0.120
20	7.60	0.110

Average alkalinity of the 15 samples, 0.097 per cent.

It was demonstrated some time ago by one of us* that neutralized saliva had as great a diastatic power as the unneutralized or normally alkaline. In fact, the single result which we recorded plainly indicated a greater diastatic power on the part of the neutralized saliva, since from the digestion with normally alkaline saliva, one-tenth of the mixture gave 0.0905 gram metallic copper, while the same quantity of the saliva neutralized, gave under like conditions 0.0943 gram copper; thus showing that the alkaline saliva had converted 41.58 per cent. of the starch into sugar, while the same quantity neutralized had changed 43.28 per cent. In these two experiments, however, the amount of saliva used was large, being one-fourth of the entire digestive mixture, viz., 25 c.c.

Recently Langley and Eves† have made the statement that "neutralized saliva converts starch into sugar much more actively than unneutralized saliva," without, however, giving any data. These are the only two statements recorded bearing on the relative diastatic action of the neutralized and normally alkaline secretion.

Our experiments, however, show that there is a very great difference in the action of ptyalin in neutralized and unneutralized saliva; a difference which is more manifest when the saliva is greatly diluted and seemingly out of all proportion to the amount of alkali present, in cases where the dilution is 1:100 or more. The following experiments show the amount of difference.

* Chittenden and Ely, *Amer. Chem. Jour.*, iv, 112.

† On certain conditions which influence the amylolytic action of saliva. *Journal of Physiology*, vol. iv, No. 1.

SERIES V.

The saliva used in this series contained 0.091 per cent. alkali, calculated as sodium carbonate:

20 c.c. of the saliva were diluted to 100 c.c. and used in *a*.

20 c.c. of the same saliva were neutralized and then diluted to 100 c.c. and used in *b*.

<i>a</i> , normally alkaline saliva.			
	Wt. Cu in one-eighth.	Total amount of sugar.	Starch converted into sugar.
4 c.c. saliva,	0.0652 gram.	0.2672 gram.	24.05 per cent.
2	0.0282	0.1208	10.37
1	0.0094	0.0464	4.17
<i>b</i> , neutralized saliva.			
4 c.c. saliva,	0.0867 gram.	0.3536 gram.	31.83 per cent.
2	0.0730	0.2984	26.72
1	0.0373	0.1560	14.04

The difference in diastatic action in this instance, particularly where the dilution is as 1 : 50 and 100, is very great, yet in the case of the greatest dilution of the unneutralized saliva the alkalinity of the digestive mixture is but 0.00091 per cent. calculated as alkaline carbonate. Moreover, there is a greater proportional diminution of diastatic action in this case, and also in the next greatest dilution where the amount of alkalinity is 0.00182 per cent., than in the presence of 0.00364 per cent.; a fact due either to the greater susceptibility of the ferment to alkaline carbonate in a dilute solution or else to some modifying influence of the larger amount of albuminous matter present, a point which we shall return to later.

Carrying the dilution of the saliva still further we find that the difference between the diastatic action of the neutralized and unneutralized fluid, shows itself to the limit of decisive diastatic action.

SERIES VI.

This sample of saliva contained 0.116 per cent. of alkali calculated as sodium carbonate. The percentages of starch converted into sugar during 30 minutes at 40° C. alone are given.

Amount of saliva.	Alkali in the 100 cc. of digestive mixture.	Alkaline saliva.	Neutralized saliva.
1 c.c.	0.00116 per cent.	6.33 per cent.	16.34 per cent.
$\frac{1}{2}$	0.00058	2.44	6.62
$\frac{1}{4}$	0.00029	1.54	2.07
$\frac{1}{10}$	0.00011	trace	result lost.
$\frac{1}{20}$	0.00005	trace	1.25 per cent.

Thus in a dilution of 1 : 2000 in the case of neutralized saliva, dias-

tatic action is still sufficiently pronounced to convert 1.25 per cent. starch into sugar during 30 minutes warming at 40° C.

The above results, indicative of such a marked susceptibility of the ferment in a dilute solution to the action of the alkali naturally present in saliva, suggest the possibility of there being a direct connection between the alkalinity of the natural secretion and its diastatic power. While the results already given plainly indicate that very slight changes in the alkalinity, everything else being equal, materially modify the diastatic power of the fluid; still the amount of ferment itself, as well as the amount of proteid matter, may vary in different salivas so much as to counterbalance the direct influence of changes in the alkalinity.

This, the results of our experiments seem to indicate, as we have been unable to trace out any direct connection between the natural variations of alkalinity and diastatic action.*

Influence of different percentages of sodium carbonate on the diastatic action of saliva.

In 1882, while studying the influence of peptones on the diastatic action of alkaline saliva,† data were then obtained showing a constant diminution of diastatic action in the presence of the alkaline carbonate: the conversion of starch into sugar being diminished in proportion as the percentage of alkali was increased. The digestions at 40° C. were then continued for 45 minutes and the ptyalin was present in large amount, 25 of the 100 c.c. of digestive mixture being undiluted, unneutralized saliva, thus making a very powerful diastatic fluid. We give the data then obtained in the percentage of starch or glycogen converted into sugar.

a. Influence of 0.05 per cent. sodium carbonate.			
	Saliva alone.	Saliva + Na ₂ CO ₃ = 0.05%.	Difference.
Glycogen,	28.68 per cent.	20.20 per cent.	8.48 per cent.
b. Influence of 0.15 per cent. sodium carbonate.‡			
	Saliva alone.	Saliva + Na ₂ CO ₃ = 0.15%.	Difference.
Starch,	40.23 per cent.	17.48 per cent.	22.75 per cent.
"	37.15	14.72	22.43
"	37.55	15.48	22.07
"	38.36	13.57	24.79
Glycogen,	28.68	9.40	

* Compare Chittenden and Ely, Amer. Chem. Jour., iv, 329.

† Chittenden and Ely, Amer. Chem. Jour., iv, 121.

‡ The alkalinity is somewhat greater, owing to the unneutralized alkali of the saliva.

c. Influence of 0.30 per cent. sodium carbonate.

	Saliva alone.	Saliva + Na ₂ CO ₃ = 0.30%.	Difference.
Starch,	40.27 per cent.	10.83 per cent.	29.44 per cent.
"	40.23	9.87	30.36
"	37.15	9.52	27.63
"	38.80	9.79	29.01
"	37.55	10.01	27.54
"	38.36	9.60	28.76
Glycogen,	29.11	6.93	

The action of the sodium carbonate is here very marked and very constant.

We have repeated this series of experiments in part, varying the conditions only by using neutralized saliva, so that the percentages of alkali present might be exact.*

SERIES VIII.

Per cent. Na ₂ CO ₃ .	Starch converted.	Difference.
0	41.16 per cent.	
0.005	39.47	1.69 per cent.
0.025	34.84	6.32
0.050	29.81	11.35
0.150	17.88	23.28
0.300	10.88	30.28

It is evident from these results that the presence of a definite percentage of sodium carbonate will produce approximately a constant diminution in the diastatic action of the saliva. This result, however, is constant only when the saliva acts in the above dilution. Diminish the amount of ferment—or rather dilute the saliva—and then the above percentages of alkali produce quite a different result. The above results were obtained where the dilution of the saliva was as 1 : 4. Adding now neutralized saliva to the alkaline mixtures of starch and water in such proportion that 10 c.c. of the original saliva are present in 100 c.c. of digestive mixture; i. e., a dilution of 1 : 10, the results are different.

The following figures were obtained with the above dilution, the mixtures being warmed at 40° C. for 30 minutes.

SERIES IX.

Per cent. Na ₂ CO ₃ .	Wt. Cu in one-eighth.	Total amt. sugar formed.
0	0.0998 gram.	0.4064 gram.
0.005	0.0898	0.3664
0.025	0.0437	0.1816
0.050	0.0277	0.1184
0.100	0.0182	0.0808
0.300	0.0105	0.0504
0.500	0.0051	0.0448

* The standard solutions of sodium carbonate were made from the chemically pure, anhydrous salt.

These figures lead to the following percentages of starch converted into sugar under the different degrees of alkalinity.

Per cent. Na_2CO_3 .	Starch converted.	Difference.
0	36.57 per cent.	
0.005	32.98	3.59, per cent.
0.025	16.35	20.22
0.050	10.66	25.91
0.100	7.27	29.30
0.300	4.53	32.04
0.500	4.03	32.54

By comparing the two preceding columns of differences it is very manifest that the alkaline carbonate has a much greater retarding action on the more dilute saliva than on the stronger solution; very noticeably so in the mixtures containing 0.025 and 0.050 per cent. of the alkaline salt.

By diluting neutralized saliva still more, and then using quantities of the fluid equal to 2 c.c. of the original saliva, making in the 100 c.c. of digestive mixture a dilution of 1:50, even 0.005 per cent. of sodium carbonate is sufficient to retard the diastatic action of the ferment almost completely; thus, in one experiment with the above amount of saliva in the presence of 0.005 per cent. sodium carbonate but 4.03 per cent. of the starch was converted into sugar in 30 minutes at 40° C., while the same amount of saliva alone converted 27.08 per cent. of the starch into sugar. By increasing the percentage of alkaline carbonate the diastatic action was stopped completely.

It is thus evident that the percentage of alkaline carbonate which absolutely or to a certain extent hinders the diastatic action of saliva can be designated only for a definite mixture, and not in a general sense. Langley and Eves* state that sodium carbonate of 0.0015 per cent. causes a retardation in the action of ptyalin; our experiments with unneutralized saliva diluted, plainly show that even much smaller percentages of alkalinity may decidedly retard the action of the ferment, while in similarly diluted saliva 0.005 per cent. of sodium carbonate may prevent diastatic action almost entirely.

Again Langley and Eves† state that the "amylolytic action of saliva becomes less the more alkaline salt there is in the solution, the rate of decrease is, however, slow compared with that which occurs when hydrochloric acid is added in similarly increasing quantities." The rate of decrease, however, as our experiments plainly show, is dependent greatly upon the amount of dilution.

* Journal of Physiology, vol. iv, No. 1.

† Ibid.

Destruction of salivary ptyalin by sodium carbonate.

To how great an extent is the retarding influence of sodium carbonate due to destruction of the ferment? Langley and Eves* state that "sodium carbonate has a very slight destructive action on ptyalin, its retarding power is out of all proportion to its power of destruction."

The following experiments demonstrate the exact action of the sodium carbonate.

SERIES X.

70 c.c. of filtered saliva (the same saliva as used in Series IX), were exactly neutralized with 0.2 per cent. HCl and diluted to 140 c.c.

The following mixtures were then prepared :

	1	2	3	4	5
Diluted saliva,	20 c.c.	20 c.c.	20 c.c.	20 c.c.	20 c.c.
Na ₂ CO ₃ sol.,	0	20 " 0.1%	10 " 0.6%	20 " 0.6%	20 " 1%
H ₂ O,	20 "	0	10 "	0	0
Per cent. Na ₂ CO ₃ ,	0	0.05	0.15	0.30	0.50

These were warmed at 40° C. for 30 minutes, then neutralized with the amounts of dilute acid given below, water and starch added, and the mixtures again warmed at 40° C. for 30 minutes.

	1	2	3	4	5
HCl 0.2 per cent.,	0	6.88 c.c.	20.6 c.c.	41.3 c.c.	68.8 c.c.
Starch + H ₂ O,	60 c.c.	53.20	39.4	18.7	20.0
	100 c.c.	100 c.c.	100 c.c.	100 c.c.	128.8 c.c.

	Wt. Cu in one-eighth.	Total amount sugar.	Starch converted.
1	0.0998 gram.	0.4064 gram.	36.59 per cent.
2	0.0991	0.4032	36.30
3	0.0992	0.4040	36.40
4	0.0474	0.1968	17.71
5	0.0278	0.1192	10.73

In the above digestive mixtures the ultimate dilution of the saliva is the same as in series IX, 1 : 10, and being the same saliva, the above results are directly comparable with those of series IX. Warming saliva of the above strength with 0.05 and 0.15 per cent. sodium carbonate for 30 minutes causes no destruction of the ptyalin whatever, as the results of experiments 2 and 3 indicate, consequently any diminished diastatic action in the presence of the above percentages of alkaline carbonate must be due to a simple retardation of

* Journal of Physiology, vol. iv, No. 1.

the action of the ferment and not to its destruction. On the other hand, 0.3 and 0.5 per cent. sodium carbonate under like conditions and with the same strength of saliva cause a marked destruction of the ferment, as the results of experiments 4 and 5 plainly show.

We have repeated the above series of experiments with a saliva, neutralized and diluted 5 times, using in each experiment 10 c.c. of the diluted fluid, equal to 2 c.c. of the original saliva. The only other deviation from the conditions already given consisted in warming the saliva with the alkaline carbonate for 1 hour instead of 30 minutes. We will not give the details of the experiment, as the results were mostly negative. With this amount of saliva, 0.15 per cent. sodium carbonate almost completely destroyed the ferment in 1 hour's warming at 40° C., and even 0.05 per cent. of the alkaline carbonate showed under these conditions a very great destructive action; thus, after heating the diluted saliva with 0.05 per cent. sodium carbonate for 1 hour at 40° C., and then neutralizing the mixture it was able in 30 minutes to convert but 5.69 per cent. of starch into sugar, while the same quantity of saliva simply warmed with water, converted under like conditions 27.08 per cent. of starch into sugar.* Under these circumstances, then, the destructive action of dilute sodium carbonate is very great. To what is due this great difference in the action of sodium carbonate of the same strength? Probably to the presence of the larger amount of albuminous matter which in the less diluted saliva possibly combines with the alkaline carbonate. It would follow, moreover, from our results, that any proteid compound formed, has in itself no destructive action on the ferment, even to a slight extent. 0.005 per cent. sodium carbonate causes no destruction of the ferment in 1 hour's warming at 40° C.; that is, in saliva of this dilution.

Influence of proteid matter on the diastatic action of saliva in neutral solutions.

It was formerly demonstrated by one of us† that the presence of 1 per cent. peptone tended to increase the diastatic action of saliva in a neutral solution to such an extent that on an average about 4 per

* The amount of destruction produced in saliva of this solution by the above percentage of sodium carbonate does not appear to be constant, since we have found in several cases a much greater diastatic action after an hour's warming at 40° C. than in the above instance, due probably to the larger amount of ptyalin or proteid matter present.

† Chittenden and Ely, Amer. Chem. Jour., vol. iv, 107.

cent. more starch was converted into sugar during 45 minutes at 40° C.; this with 25 c.c. of saliva in 100 c.c. of the digestive mixture. This effect we attributed to a direct stimulating action on the part of the proteid matter. Langley and Eves,* however, object to this conclusion, although they bring forward no facts to prove the contrary. Considering that litmus will not detect less than 0.001 per cent. acid or alkali they state that there may be in the neutralized fluid an excess of acid or alkali to this extent, and if, as may well be the case, ptyalin acts best in a neutral solution, the effect of the peptone might be due to its putting *hors de combat* the slight excess of acid or alkali which remains on apparent neutralization. But as Langley himself has shown, the proteid matter naturally present in 25 c.c. saliva, or even much less, is far more than sufficient to combine with and render inert any such amount of free acid or alkali. We see no other possible explanation of the action of peptones on the diastatic action of saliva in a neutral solution than a direct stimulation of the ferment. Moreover, Langley and Eves have found that when neutralized saliva is diluted a hundred times, peptone is still able to increase the rate at which it converts starch into sugar, from which they are forced to conclude that the small amount of acid or alkali which may be present, cannot exert, in such a dilution, any retarding influence. We present the following additional results confirmatory of our previous experiments.

In our present experiments we have, however, used much less saliva, and also smaller percentages of peptone.

SERIES XI.

20 c.c. of filtered saliva were neutralized and then diluted to 100 c.c.

0.8 gram of pure albumin-peptone was dissolved in water, made exactly neutral with Na_2CO_3 and the solution diluted to 100 c.c.

10 c.c. of the diluted saliva were employed in each digestion, and of the peptone solution quantities equivalent to 0.05, 0.1, and 0.2 gram of peptone. Length of digestion, 30 minutes.

Per cent. peptone.	Wt. Cu in one-eighth.	Total amt. sugar.	Starch converted.
0	0.0834 gram.	0.3400 gram.	30.61 per cent.
0.05	0.0875	0.3568	32.11
0.10	0.0868	0.3544	32.01
0.20	0.0873	0.3560	32.04

Here, with the smaller amount of ferment, the increase is not so great as with the larger quantity of saliva and with the longer

† Journal of Physiology, vol. iv, No. 1.

period of digestion; still, the amount of starch converted is increased on an average about 1.50 per cent. It is interesting to note that under these conditions the full effect of the proteid matter is produced by even 0.05 per cent. Laugley and Eves found the maximum effect with saliva ten times diluted to be produced by about 0.1 per cent. peptone. In our experiment, however, the dilution of the saliva in the digestive mixture is 1 : 50.

Influence of proteid matter on the diastatic action of saliva in alkaline solutions.

It was previously demonstrated by one of us that the presence of 1 per cent. peptone in a digestive mixture containing 25 per cent. saliva and 0.3 and 0.15 per cent. sodium carbonate respectively, tended to nearly double the diastatic action, bringing it up almost to the action of saliva unmixed with alkaline carbonate.

We give here a few additional experiments bearing on this point.

The very noticeable difference in the action of small percentages of sodium carbonate on the diastatic activity of moderately dilute and very dilute saliva at once suggests the possibility of some connection between the dilution and the reduced percentage of proteid matter. What, now, is the influence of small amounts of peptone on very weak alkaline solutions of saliva? We will give the results of one series of experiments in answer to this question.

SERIES XII.

20 c.c. of saliva with an alkalinity equal to 0.110 per cent. sodium carbonate were diluted to 100 c.c., 10 c.c. of the diluted saliva were used in each digestion of 100 c.c.; consequently the alkalinity of the digestive mixture was equal to 0.0022 per cent. sodium carbonate. Neutral peptone was added in varying quantities. The mixtures were warmed at 40° C. for 30 minutes.

Per cent. peptone.	Wt. Cu in one-eighth.	Total amt. sugar.	Starch converted.
0	0.0761 gram.	0.3104 gram.	27.94 per cent.
0.05	0.0823	0.3352	30.18
0.10	0.0841	0.3424	30.82
0.20	0.0853	0.3480	31.33

The same saliva neutralized converted 30.61 per cent. of the starch into sugar; consequently the neutral peptone (0.2 per cent.) caused the alkaline saliva to show a diastatic action considerably greater than the neutral saliva, but not equal in this case to the action of the same percentage of peptone on the neutralized saliva. Compare series xi, made with the same saliva.

Still other experiments of the same nature have shown like results, and even more marked. Thus, while neutral saliva without peptone converted in one instance 18·16 per cent. starch into sugar, a like quantity of the normally alkaline saliva ($=0\cdot002$ per cent. Na_2CO_3 in the digestive mixture) with 0·1 per cent. peptone converted 31·90 per cent. starch into sugar.

Increasing the percentage of carbonate to a point where previous experiment had shown almost complete stopping of the action of the ferment, it was found that 0·1 per cent. of neutral peptone would, in the above dilution, bring the diastatic action up, almost to that of the neutral saliva.

SERIES XIII.

Thus, 20 c.c. of saliva were neutralized and diluted to 100 c.c., 10 c.c. used in each digestion.

	0 Na_2CO_3	0·005% Na_2CO_3	0·005% Na_2CO_3
	0 Peptone.	0 Peptone.	0·10% Peptone.
Wt. Cu in one-eighth,	0·0803 gram.	0·0181 gram.	0·0708 gram.
Total amt. sugar,	0·3272	0·0800	0·2896
Starch converted,	29·45 per cent.	7·20 per cent.	26·07 per cent.

With 0·025 and 0·050 per cent. sodium carbonate, 0·1 per cent. peptone availed but little: there was slight diastatic action, but not enough sugar formed to make the determination of it of any value. These results would seem to indicate that one action of the peptone in an alkaline solution is to combine with the alkaline carbonate and form a compound of quite different power: thus, with 0·050 per cent. sodium carbonate a corresponding larger percentage of peptone is required to increase the diastatic power. In addition to this action, however, there is still manifest the direct stimulating action of the proteid matter on the ferment; seen in one case in the increased percentage of sugar formed in the alkaline solution over the amount formed in neutral solution by the same saliva under like conditions.

As to the union of peptone and the alkaline carbonate we have a strong indication of a combination in that the presence of peptone tends to diminish somewhat the destructive action of small percentages of sodium carbonate in diluted saliva.

Thus, while 10 c.c. of neutralized, dilute saliva (1 : 5) warmed for 1 hour with 0·05 per cent. sodium carbonate converted after neutralization 25·05 per cent. starch into sugar, the same amount of saliva warmed for the same length of time with the same percentage of sodium carbonate, plus 0·4 per cent. peptone converted after neutralization 32·68 per cent. of the starch.

The peptone present had evidently in some way prevented the destructive action of the alkaline carbonate, and the most plausible explanation seems to be the probable formation of an alkaline-proteid body.

Influence of free acid and of acid-proteid matter on the diastatic action of saliva.

The influence of dilute acid solutions on the diastatic action of saliva is naturally a point of considerable physiological importance. In view of the rapid passage of the salivary secretions into the stomach, we need to have accurate knowledge of the exact influence of free acid and acid-reacting fluids on the ferment and its diastatic activity.

In considering this question we do not need now to take into account the older observations of Jacobowitsch, Lehmann, Schiff, Watson, Brücke, Hammarsten and others, since these led to no agreement of opinion and more recently acquired knowledge has rendered necessary different methods of procedure.

In 1881 it was announced by one of us* that the ferment of saliva was destroyed on being warmed for two hours with gastric juice containing 0.2 per cent. hydrochloric acid; also that the same treatment with 0.2 per cent. hydrochloric acid alone caused great destruction of the ferment, so that on neutralization diastatic action was greatly diminished. At the same time it was pointed out that much smaller percentages of acid, even 0.025 per cent.,† diminished the diastatic action of the ferment very materially. Shortly after this, similar results were obtained independently by Langley,‡ who in an interesting paper on the destruction of ferments in the alimentary canal, pointed out that ptyalin from the parotids of a rabbit was destroyed by digestion with a small amount of gastric juice, and also that weak solutions of the ferment were more or less destroyed by heating at 40° C. with 0.014 per cent. hydrochloric acid. In comparing these latter experiments with the preceding it is to be remembered that the former were made with 25 c.c. of filtered human saliva, a much stronger solution doubtless, both as regards the ferment and the albuminous matter present.

Later it was pointed out by one of us,§ that peptones have a very

* Chittenden and Griswold, Amer. Chem. Jour., vol. iii, 305.

† Irrespective of the proteid matter.

‡ Journal of Physiology, vol. iii, No. 3.

§ Chittenden and Ely, Amer. Chem. Jour., vol. iv, 114.

decided influence on the diastatic action of saliva in acid solutions; that while the presence of 0.025 per cent. hydrochloric acid prevented the conversion of but 3.50 per cent. of the starch into sugar, the presence of 1 per cent. peptone allowed the conversion of 48.85 per cent. of the starch, 7 per cent. more than the saliva alone would convert under like conditions; a fact which would indicate something more on the part of the proteid matter, than a mere union of the peptone and acid. Undoubtedly there was a combination of the peptone and acid, but in addition there was manifested the direct stimulating action of the proteid matter. At the time these experiments were made, however, we were unaware of Danilewsky's* method of testing for free acid with tropæolin 00, by which he proved the union of acids with various forms of proteid matter; compounds acid to test papers, but not containing free acid. Falk† likewise noticed the influence of peptones on diastatic action, in an acid solution of malt infusion; thus by adding a small amount of 0.0135 per cent. hydrochloric acid to an infusion of malt and this to some starch paste, no reaction for sugar could be obtained, but by adding the same proportion of acid and some peptone, then the sugar reaction soon appeared. This fact Falk considered as evidence of the union of the acid and peptone.

In view of these results we have repeated some of our previous work, under different conditions, trying many additional experiments, especially as in a recent paper on the amyolytic action of saliva, Langley and Eves‡ have arrived at some conclusions not in accord with our results.

a. Influence of acid-proteid matter.

We have used the tropæolin test for the detection of free acid, whenever it has been necessary in our work, employing the method as recommended by Danilewsky. The tropæolin 00 was dissolved in methyl alcohol (saturated solution) and when a test for free acid was to be made, drops of the alcoholic solution were allowed to evaporate on a porcelain plate at 40° C., and then while still at 40° C., a drop of the fluid to be tested was added and allowed to dry. Free hydrochloric acid causes the dry residue to take on a violet color. We have made a number of trials to ascertain how small a percentage of free hydrochloric acid can be detected by this test. Using a

* Centralbl. Med. Wiss., 1880.

† Virchow's Archivs, lxxxiv, 1881, p. 130.

‡ Loc. cit.

standard solution of hydrochloric acid of known strength,* we have found that 0.003 per cent. of this acid can be detected with certainty, a drop of such a mixture giving a distinctly recognizable violet color. A smaller percentage cannot be recognized and we have therefore invariably deducted the above amount in our various tests for free acid.

The amount of proteid matter naturally present in saliva and which is capable of combining with acids, is apparently quite constant. Langley and Eves found as a mean of several observations that 5 c.c. of filtered, neutralized saliva contained proteids capable of combining with 2 c.c. of 0.1 per cent. hydrochloric acid. We have found as a mean of eight determinations that 20 c.c. of filtered, neutralized saliva contained proteids capable of combining with 7.74 c.c. 0.1 per cent. hydrochloric acid. In an attempt to ascertain approximately how much proteid matter this amount of acid signified, we took the results of our experiments with peptones, in which we found that 1 gram of pure neutral peptone required 48.0 c.c. 0.1 per cent. hydrochloric acid to saturate it. Consequently 1 c.c. of 0.1 per cent. acid would combine with 0.0208 gram peptone, and assuming that the combining power of the proteids present in saliva is the same as that of peptones, the 20 c.c. of saliva would contain 0.16099 gram proteid matter, equal to 0.804 per cent.; a result which at once shows that the combining power of the proteids of saliva and peptone must be quite different, or as is more probable, that considerable of the acid added, is used up in reacting with the phosphates of the alkalis present in the saliva.

Saliva, as a rule, does not contain much more than 0.5 per cent. solid matter, and Hammerbacher has found in human mixed saliva 0.139 per cent. albumin and ptyalin.†

A comparison of the diastatic action of neutral saliva considerably diluted, and similarly diluted saliva in which the proteids present have been saturated with acid, shows at once that acid-proteid matter, even though present in but small quantity, has a distinctly stimulating action on the salivary ferment.

The following experiments will illustrate this point and also show the extent of the stimulation.

SERIES XIV.

A. 40 c.c. filtered saliva were neutralized and then diluted to 200 c.c.

* All of our standard acid solutions were of exactly the strength specified, as was proved by titration with standard solution of silver nitrate.

† Jahresbericht für Thierheime. 1881, 269.

B. 40 c.c. of the above diluted saliva required 6.8 c.c. 0.05 per cent. HCl to saturate the proteids present = 0.0074 per cent. combined HCl.

Two digestions each were made with *A* and *B*, using quantities of the above salivas equivalent to 4 and 2 c.c. of the original saliva.

	Wt. Cu in one-eighth.	Total amt. sugar formed.
20 c.c. <i>A</i> ,	0.0913 gram,	0.3720 gram.
23.4 <i>B</i> ,	0.0987	0.4016
10 c.c. <i>A</i> ,	0.0850 gram.	0.3472 gram.
11.7 <i>B</i> ,	0.0940	0.3832

	Starch converted.		Starch converted.
20 c.c. <i>A</i> ,	33.49 per cent.	10 c.c. <i>A</i> ,	31.26 per cent.
23.4 <i>B</i> ,	36.15	11.7 <i>B</i> ,	34.49
Increase,	2.66 per cent.	Increase,	3.23 per cent.

It is seen that the addition of the acid in this instance causes a very decided increase in the diastatic activity of the saliva. The amount of combined acid present in the 100 c.c. of digestive mixture in the two cases was 0.0017 and 0.0008 per cent. respectively, yet the presence of this small amount of combined acid manifestly acts as a stimulant to the diastatic ferment.* Even still smaller percentages of acid-proteid matter have an equally decided action on the salivary ptyalin. The following series of experiments illustrate this point and at the same time are confirmatory of the preceding one.

SERIES XV.

A. 40 c.c. filtered saliva were neutralized and diluted to 200 c.c.

B. 50 c.c. of the above diluted saliva required 4.75 c.c. 0.05 per cent. HCl to saturate the proteids. The solution was distinctly acid to litmus paper and contained 0.0043 per cent. combined HCl.

Four digestions were made with both *A* and *B*, using quantities of saliva in each case equivalent to 4, 2, 1 and 0.5 c.c. of the original saliva.

	Wt. Cu in one-eighth.	Total amt. sugar formed.
20 c.c. <i>A</i> ,	0.0925 gram.	0.3768 gram.
21.9 <i>B</i> ,	0.0959	0.3912
10 c.c. <i>A</i> ,	0.0827 gram.	0.3368 gram.
10.95 <i>B</i> ,	0.0876	0.3576
5 c.c. <i>A</i> ,	0.0671 gram.	0.2744 gram.
5.5 <i>B</i> ,	0.0751	0.3064
2.5 c.c. <i>A</i> ,	0.0305 gram.	0.1296 gram.
2.75 <i>B</i> ,	0.0375	0.1568

* Doubtless these percentages of combined acid are too high, since as before mentioned some of the acid added probably reacts with the phosphates naturally present in the saliva.

	Starch converted.		Starch converted.
20 c.c. <i>A</i> ,	33.85 per cent.	10 c.c. <i>A</i> ,	30.32 per cent.
21.9 <i>B</i> ,	35.22	10.95 <i>B</i> ,	32.19
	<hr/>		<hr/>
Increase,	1.37 per cent.	Increase,	1.87 per cent.
5 c.c. <i>A</i> ,	24.69 per cent.	2.5 c.c. <i>A</i> ,	11.68 per cent.
5.5 <i>B</i> ,	27.58	2.75 <i>B</i> ,	14.10
	<hr/>		<hr/>
Increase,	2.89 per cent.	Increase,	2.42 per cent.

Here the same results are to be seen as in the preceding experiment, although the amount of proteid matter is much less. In both series of experiments it is to be noticed that as the percentage of combined acid is diminished the difference between the diastatic activity of the neutral solution and the corresponding acid solution is increased, at the same time it is to be seen that in the first series of experiments where the percentage of proteid matter is larger there is a greater increase in the conversion of starch with the 23.4 c.c. of acid-reacting saliva than with the 21.9 c.c. of the acid-reacting fluid of the second series of experiments with its smaller percentage of proteid matter.

In the last series of experiments where 21.9 c.c. of *B* are used the amount of combined acid in the digestive mixture is but 0.00094 per cent. HCl, so that where the smaller amounts of acid-reacting saliva are used the percentage amount of combined acid is very small indeed.

Increasing the amount of saliva used and thereby the percentage of acid-proteid matter brought us finally to a point where the acid-proteid matter failed to stimulate the diastatic action of the ferment and even began to show a tendency to retard its action. The following series of experiments, using saliva wholly undiluted, illustrates this point.

SERIES XVI.

100 c.c. of filtered saliva were neutralized requiring 32 c.c. 0.2 per cent. HCl=*A*.

52.8 c.c. *A*=40 c.c. of the original saliva required 12.15 c.c. 0.1 per cent. HCl to combine with the proteids, making saliva *B*; the fluid was distinctly acid to litmus and contained 0.0187 per cent. combined acid. Three digestions were made with both *A* and *B*, using quantities of the fluids equal to 20, 10 and 5 c.c. respectively of the original saliva.

	Wt. Cu in one-eighth.	Total amt. sugar.
26.4 c.c. <i>A</i> ,	0.1083 gram.	0.4408 gram.
32.48 <i>B</i> ,	0.1065	0.4336
13.2 c.c. <i>A</i> ,	0.1024 gram.	0.4168 gram.
16.24 <i>B</i> ,	0.1087	0.4424
6.6 c.c. <i>A</i> ,	0.0948 gram.	0.3864 gram.
8.12 <i>B</i> .	0.1031	0.4192

	Starch converted.	Combined HCl in the 100 c.c. digestive mixture.
26.4 c.c. A,	39.68 per cent.	0
32.48 B,	38.96	0.00608 per cent.
Decrease,	0.72 per cent.	
13.2 c.c. A,	37.52 per cent.	0
16.24 B,	39.73	0.00304 per cent.
Increase,	2.21 per cent.	
6.6 c.c. A,	34.79 per cent.	0
8.12 B,	37.74	0.00152 per cent.
Increase,	2.95 per cent.	

In this series of experiments where the percentage of combined acid in the digestive mixture is much greater than before, the same increase in diastatic action is noticed. With the largest quantity of saliva however where the amount of combined acid is 0.006 per cent. we seem to have reached a point where the acid-proteid matter ceases to stimulate and begins to retard the action of the ferment. That this is actually the case we have proved by another experiment confirmatory of the preceding one, using in the digestion however two grams of starch instead of one.

Thus while an amount of neutral saliva, equal to 20 c.c. of the original secretion converted 39.08 per cent. starch into sugar, the same amount of saliva having all of its proteid matter combined with acid converted under the same conditions 38.21 per cent. of the starch, a decrease of 0.87 per cent; in this case however the amount of combined acid present in the 100 c.c. of digestive mixture was 0.008 per cent.

It thus seems plainly proven that up to a certain percentage the presence of acid-proteid matter in the saliva tends to decidedly stimulate its diastatic action. We cannot therefore agree with Langley and Eves that ptyalin acts best in every instance in a neutral solution, for our results certainly show an increased action of the ferment in the presence of the acid-proteids, except where the latter are present in comparatively large amount.

The only possible fallacies which suggest themselves here are traces of undetectable alkali in the starch and the presence of phosphates of calcium or magnesium. This result moreover makes clear many statements previously recorded which would otherwise be difficult of explanation. Thus it has been recorded by Astaschewsky,* that the saliva of the parotid gland possesses a very faint acid reac-

* Centralbl. med. Wiss., 1875, 15.

tion and that the maximum of the diastatic action of parotid saliva corresponds with the strongest acid reaction; but in these observations doubtless the acid reaction was in every case due to acid-proteids and not to free acid. Again it was found by one of us* that the presence of 0.005 per cent. HCl decidedly increased the diastatic action of saliva, but while the observation was correct the result was wrongfully attributed to 0.005 per cent. free acid when it should have been attributed to the same percentage of combined acid, where doubtless the proteid matter was not wholly saturated. Likewise Watson's† oft-quoted result, where the addition of a drop of strong acid to saliva gave him an increased diastatic action, was doubtless due to the acid-proteid matter formed and not to free acid, though it may have been due to partial or complete neutralization.

We endeavored to ascertain whether the acid-proteid matter formed by the addition of acid to undiluted saliva would have any destructive action on the diastatic ferment when warmed at 40° C. Of course only a slight action, if any could be expected, still it seemed of sufficient importance to warrant the experiment. Accordingly two mixtures were prepared as follows:

	<i>A.</i>	<i>B.</i>
Saliva,	20 c.c.	20 c.c.
HCl 0.2% to neutralize,	6.8	6.8
“ “ combine with proteids,		3.2
H ₂ O,	13.2	10
	40.0 c.c.	40.0 c.c.
	Neutral.	0.016% HCl combined

These two solutions were warmed at 40° C. for 1 hour, then neutralizing and equalizing‡ mixtures were added, after which starch and water to 100 c.c. The results were in *A* a conversion of 38.68 per cent. of the starch into sugar, and in *B* a conversion of 38.26 per cent., so that while there may have been some little destruction of the ferment, it is plain that the diminished action noticed in the two preceding cases in the presence of the larger percentages of acid-proteid matter was probably due to simple retardation, since the percentage of combined acid was not more than half that in the above experiment.

We have studied the influence of acid-proteid matter on salivary

* Chittenden and Griswold, Amer. Chem. Jour., vol. iii, 312.

† Jour. Chem. Soc., 1879, 543.

‡ Equivalent amounts of standard acid and sodium carbonate solutions, so that *A* for example might contain the same amount of sodium chloride as *B*.

digestion still further by experimenting likewise with peptones, and in studying the influence of acid-peptones on the action of the ferment we have been impressed with the striking effect of very minute quantities of acid on the ordinary action of peptones, increasing it very decidedly. It has already been shown that the presence of 0.05, 0.1 and 0.2 per cent. of neutral peptone produces, in neutral solutions, a like increased diastatic action; with 0.5 per cent. peptone the increase is as much as with 0.2 per cent.; that is, in the case of saliva considerably diluted. With acid-peptones, however, the effect produced is quite different, and the amount of combined acid necessary to produce this different effect is quite small.

Peptones as usually prepared contain a small amount of combined acid. The sample we used required per gram 0.014 gram Na_2CO_3 to make it neutral; this would be equivalent to 0.00964 gram HCl . Consequently the percentage of combined acid in the peptone, assuming it to be hydrochloric acid, would be 0.964 per cent. With such an acid-peptone the following experiments were tried.

SERIES XVII.

20 c.c. saliva were neutralized and diluted to 100 c.c.; of this solution 10 c.c., equal to 2 c.c. of original saliva were used in each digestion. Four experiments were tried, in three of which 0.050 gram, 0.100 gram and 0.200 gram of the above acid-peptone were added. Following are the results, after warming the mixtures at 40°C . for 30 minutes.

Per cent. peptone.	Wt. Cu. in one-eighth.	Total amt. sugar formed.	Starch converted.
0	0.0766 gram.	0.3128 gram.	28.16 per cent.
0.05	0.0873	0.3560	32.05
0.10	0.0897	0.3656	32.91
0.20	0.0929	0.3784	34.21

Comparing these results with those obtained by similar percentages of neutral peptone the difference is sufficiently striking, and yet the percentage of combined acid in the digestive mixture, where there is present 0.20 gram of acid-peptone, is but 0.0019 per cent. calculated as HCl .

Experimenting with peptones completely saturated with acid, and in this case with what was known to be hydrochloric acid, results similar to the above were obtained, with, however, several suggestive deviations. The following series of experiments will serve to illustrate the main points of interest.

SERIES XVIII.

40 c.c. filtered saliva were neutralized and diluted to 200 c.c. ; 10 c.c. of this diluted fluid were used in each experiment.

A standard solution of peptone saturated with hydrochloric acid was also prepared.

The following percentages of peptone and combined acid were contained in the different digestive mixtures of 100 c.c.

	1	2	3	4	5	6	7
Peptone,	0	0	0.01%	0.020%	0.040%	0.060%	0.080%
Combined HCl,	0	0.0006%*	0.00057%	0.00115%	0.0023%	0.00345%	0.0046%

Following are the results of the digestions :

No. 1	Wt. Cu in one-eighth.	Total amt. sugar.	Starch converted.
1	0.0872 gram.	0.3560 gram.	31.85 per cent.
2	0.0896	0.3656	32.91
3	0.0901	0.3672	33.06
4	0.0935	0.3808	34.28
5	0.0892	0.3640	32.77
6	0.0775	0.3160	28.45
7	0.0495	0.2048	18.43

It is to be noticed, first, that in this series of experiments the peptones, being completely saturated with acid, are present in much smaller percentages proportionally than the combined acid is, and the effect produced is a diminished diastatic action in the case of Nos. 6 and 7, in the presence of an amount of combined acid which, in the case of the proteids naturally present in saliva, has no retarding action whatever, but on the contrary a stimulating action. The addition of a larger amount of peptone to Nos. 5, 6 and 7, for example, the percentage of acid remaining the same, tends to bring up the diastatic action very decidedly.

It would appear from these results, moreover, assuming that the combining power of peptone is the same as the proteids present in saliva, that the presence of say 0.003 per cent. combined HCl in the form of saturated acid-peptone has a retarding action, while the same percentage of combined HCl in the form of saturated salivary proteids, has, in the case of saliva of the same dilution, a decided stimulating action. At the same time it is to be remembered that when acid is added to saliva some considerable acid may be used by the inorganic salts with formation of acid phosphates, for example. These results, moreover, indicate that such is doubtless the case. Increasing the percentage of peptone to say 1 per cent. admits of the addition of larger amounts of hydrochloric acid, without partic-

* To saturate the proteids naturally present in the saliva.

ularly retarding the action of the ferment; thus, as Langley and Eves state, "0.0075 per cent. hydrochloric acid may be added to saliva diluted 10 or 20 times, provided 1 per cent. peptone be present, and yet its action on starch be about equal to that of the saliva without peptone or acid."

Again it would appear that small percentages of acid-proteid matter, either peptones or the albuminous bodies present in saliva, tend to increase the diastatic action not only beyond the natural action of the saliva, but also somewhat beyond the action of the saliva plus the same percentage of neutral peptone. Thus, while the presence of a few hundredths of 1 per cent. of neutral peptone in saliva diluted 1:50 caused about 1.5 per cent. increased conversion of starch, acid-peptone caused in 30 minutes 2.17 per cent. increased conversion. Again, as has been seen, the acid-proteids of saliva cause a like increase. Large percentages of acid-proteids, however, in which the albuminous matter is completely saturated, distinctly retard the diastatic action.

These results harmonize in a general way with the previous results obtained by one of us,* in which it was found that the presence of 1 per cent. peptone in an acid-reacting fluid, which by itself almost completely stopped the diastatic action of the saliva, increased the diastatic action of the ferment above the action of the neutral saliva and also above the action of the neutral saliva plus the 1 per cent. of neutral peptone.

We next endeavored to ascertain how much of the retarding action of the acid-peptone is due to destruction of the ferment. Without giving details we have found that with saliva ten times diluted there is a noticeable destruction of the ferment in the presence of 0.028 per cent. of combined acid, although it is not great. In this case it is to be understood that the amount of peptone present is only such as would furnish this percentage of combined acid. The following percentages of starch converted (after neutralization and equalization) show the amount of destruction under the different conditions.

SERIES XIX.

Length of time at 40° C.	Per cent. combined HCl.	Per cent. peptone.	Starch converted.
	0	0	31.65 per cent.
30 min.	0.014	0.25	31.18
30	0.028	0.50	30.82
60	0.028	0.50	29.74
30	0.057	1.00	27.73

* Chittenden and Ely, loc. cit.

It is thus manifest from our results that the retarding influence of the larger percentages of acid-peptones is out of all proportion to their power of destruction. Still larger percentages of acid-saturated peptones produce a much greater destruction. Thus, by warming 10 c.c. of a neutral dilute saliva (1 : 5) with a solution of peptone saturated with acid, in such proportion that the mixture contained 0.430 per cent. combined HCl, there was in 30 minutes an almost complete destruction of the ferment.

b. Influence of free acid.

In view of the fact that some time ago one of us* was of the opinion that small percentages of acid† tended to increase the diastatic action of saliva, it was of especial interest now to ascertain definitely whether free acid* when present in small percentages does invariably retard diastatic action. Langley and Eves state that "although saliva neutralized to litmus sometimes shows an increase of action on the addition of 0.0005 to 0.001 per cent. HCl; yet if the proteids of the saliva be saturated with acid, there is a diminution of its amyolytic action, although no free acid is present in the saliva." This we cannot regard as correct without qualification, since our experiments appear to show that saliva with its proteid matter saturated with acid has a greater diastatic action in a given time than saliva simply neutralized, provided the percentage of acid-saturated proteids is not too large. The same investigators further state "that 0.0015 per cent. HCl distinctly diminishes the amyolytic action of pytaline," and "since 0.0015 per cent. HCl increases amyolytic action it seems very unlikely that 0.005 per cent. should increase it;" but as Langley and Eves, in studying the influence of free acid, apparently used diluted, neutralized saliva, in which the proteids present were not combined with acid, depending simply upon dilution to avoid the influence of these bodies, it seems to us a little uncertain whether their results are strictly accurate on this point, since saliva even very much diluted does contain some proteid matter. They, however, state in this connection that "we have often found that solutions which we have thought carefully neutralized have been increased in action by the presence of still smaller percentages of acid, viz: 0.0005 to 0.0010 per cent." Here, however, so far as their results show, the observed increase of activity may have been due

* Chittenden and Griswold, loc. cit.

† Considered as 0.005 per cent., although we now know the above figure could not represent free acid, owing to the proteid matter of the saliva.

to the small amount of acid-proteid matter present, certainly could not have been due wholly to free acid.

We have tried a large number of experiments on this point in a variety of ways, all of which tend to show that a very small trace of free acid, when the amount of acid-proteids is not large, does, seemingly, slightly increase the diastatic action of the ferment. It is, perhaps, questionable, however, whether in the use of such small percentages of acid, the results are to be strictly depended upon. The presence of a small amount of phosphate in the starch or a trace of alkali, not to be detected by litmus, might easily neutralize the small amount of acid added. Again, non-saturation of the proteids to only a very slight extent might effect the result. We subjoin two or three of our experiments.

SERIES XX.

20 c.c. filtered saliva were neutralized and then sufficient acid added to combine with the proteids present; the mixture then diluted to 100 c.c. The solution contained 0.0114 gram combined HCl, but no free acid. *A*.

20 c.c. of the same filtered saliva neutralized, and the proteids just saturated with acid. 3.1 c.c. 0.1 per cent. HCl were then added and the mixture diluted to 100 c.c. The solution contained 0.0114 gram combined HCl, and in addition 0.0031 gram free HCl. The solution gave a distinct violet with tropaeolin 00. *B*.

Digestions were made, using 1 gram starch in a volume of 100 c.c. Time, 30 minutes. Following are the results.

Amount diluted saliva.	<i>A.</i>		<i>B.</i>	
	Wt. Cu in one-eighth.	Total amt. sugar.	Wt. Cu in one-eighth.	Total amt. sugar.
20 c.c.	0.0988 gram.	0.4024 gram.	0.0972 gram.	0.3960 gram.
10	0.0917	0.3736	0.0921	0.3752
5	0.0826	0.3368	0.0861	0.3512
	Starch converted.			
Amount diluted saliva.	<i>A.</i>	<i>B.</i>	Free HCl in <i>B.</i>	
20 c.c.	36.23 per cent.	35.65 per cent.	0.00062 per cent.	
10	33.53	33.78	0.00031	
5	30.32	31.62	0.00015	

Here there can be no question but that there was free acid in *B*. The saliva gave a distinct reaction with tropaeolin 00 and the starch used was apparently neutral. In this instance 0.0006 per cent. free acid slightly diminished the diastatic action, while 0.0003 per cent. slightly increased it.

A second experiment of like nature gave the following results :

SERIES XXI.

20 c.c. filtered saliva were neutralized and the proteids exactly saturated with HCl, then diluted to 100 c.c. The solution contained 0.0073 per cent. combined HCl, but no free acid. *A*.

20 c.c. of the same saliva neutralized and the proteids saturated by the addition of the same amount of acid as in *A*; 1.2 c.c. 0.1 per cent. HCl were then added, so that a distinct tropaeolin reaction could be obtained in the 41 c.c. of fluid. The fluid was diluted to 100 c.c. and then contained 0.0012 per cent. free HCl. *B*.

20 c.c. of the same saliva, neutralized and the proteids exactly saturated with acid; then enough more acid added to give a distinct tropaeolin reaction, after which the solution was diluted to 100 c.c. The 100 c.c. of fluid contained exactly 0.003 gram HCl. *C*.

A drop of the latter fluid on being tested gave a distinct violet with tropaeolin 00.

Following are the results of digestions made with the foregoing solutions of saliva.

Amount of diluted saliva.	Starch converted.		
	<i>A</i> .	<i>B</i> .	<i>C</i> .
20 c.c.	35.65 per cent.	35.58 per cent.	35.36 per cent.
10	33.71	33.27	34.14
5	28.81	29.53	30.32

Here it is seen, as before, that the smaller percentages of free acid arising from the use of 5 and 10 c.c. of saliva, show a distinctly increased diastatic activity, while with 20 c.c. the results are very nearly identical; too large an amount of free acid to increase the action and yet not enough to materially diminish it.

We next tried the influence of *increased* percentages of free acid on the action of ptyalin.

SERIES XXII.

30 c.c. filtered saliva were neutralized and the proteids just saturated with acid, then diluted to 150 c.c.; 10 c.c. of this diluted saliva equal to 2 c.c. of the original saliva were used in each digestion. Following are the results, after warming with starch at 40° C. for 30 minutes in the presence of the percentages of free acid specified. The acid solutions were mixed with the starch previous to the addition of the saliva.

Per cent. free acid.	Wt. Cu in one-eighth.	Total amt. sugar.	Starch converted.
0	0.0919 gram.	0.3744 gram.	33.71 per cent.
0.0006	0.0924	0.3768	33.92
0.0010	0.0773	0.3152	28.37
0.0020	0.0166	0.0744	6.69
0.0030	trace		

Here a slight increase is noticed with 0.0006 per cent. followed at 0.002 per cent. by a rapid fall in diastatic action.

With stronger solutions of ptyalin, like results were obtained as follows :

SERIES XXIII.

Filtered saliva was neutralized and the proteids just saturated with HCl. An amount of this fluid equivalent to 5 c.c. of the original saliva was used in each digestion. In this amount there was present 0.00266 gram combined HCl, but no free acid whatever.

Following are the results of digestions with this saliva in the presence of the percentages of free acid specified.

Per cent. free acid.	Wt. Cu in one-eighth.	Total amt. sugar.	Starch converted.
0	0.0956 gram.	0.3896 gram.	35.07 per cent.
0.0005	0.0966	0.3936	35.43
0.0010	0.0867	0.3536	31.80
0.0020	0.0162	0.0728	6.55
0.0030	trace		

Increasing now the amount of saliva still further, so that the percentage of combined acid reaches a point where its retarding influence begins to be felt, the presence of the smallest amount of free acid then causes at once a decided decrease in diastatic action. Thus, using the same saliva as was employed in the preceding series, only in such quantity that 20 c.c. of original saliva were present in each digestive mixture, it was found that the free acid produced a much greater retarding effect than before. The percentage of combined hydrochloric acid, in the form of acid-proteids, contained in each digestive mixture was 0.01064 per cent. Following are the results of the diastatic action.

Per cent. free acid.	Wt. Cu in one-eighth.	Total amt. sugar.	Starch converted.
0	0.0972 gram.	0.3960 gram.	35.65 per cent.
0.0005	0.0830	0.3384	30.46
0.0010	0.0410	0.1712	15.41
0.0020	0.0061	0.0328	2.95
0.0030	trace		

This result accords with the statement made by Langley and Eves, "that if the proteids of saliva be saturated with acid there is a diminution of its amylolytic action, although no free acid is present in the saliva. This diminution is made more marked by the addition of the smallest quantity of hydrochloric acid." The above quantitative results plainly testify to the accuracy of the latter part of their statement. As to the action of the acid-saturated proteids that is wholly dependent upon the percentage present.

c. *Destructive action of free acid.*

It has been clearly shown* that acid approximating to the strength of the acid of the gastric juice has a destructive action on the salivary ferment. Smaller percentages of acid have a like destructive action. It has at the same time been shown that the presence of very much smaller percentages of free acid stops the amylolytic action of the ferment. Is this stopping of the amylolytic action in every case due to destruction of the ferment, or simply to the retarding action of its presence? Langley, by using an aqueous extract of the parotid of rabbits, with but little proteid matter, concluded that the presence of 0.014 per cent. hydrochloric acid is sufficient to destroy all but the merest trace of ferment in five minutes at 39° C. This before the action of acid-proteids was known. Chittenden and Ely by experimenting with human saliva came to the conclusion "that there may be in the presence of a *very dilute* acid, a simple stopping of the diastatic action, without destruction of the ferment;" in other words, the retarding influence of very small percentages of free acid is not necessarily due to destruction of the ferment. Langley and Eves criticising this conclusion state "that since Chittenden and Ely apparently used unneutralized saliva and took no account of the proteids present, it seems to us probable that not only was there no free hydrochloric acid in their experiments, but that even the proteids were not saturated with acid." In the article to which they refer it is, however, explicitly stated in a foot note† that the saliva was neutralized and then an amount of acid added to equal 0.025 per cent. Unfortunately, we did not then know of the action of acid on the proteids of the saliva; consequently, the above percentage must have been mainly in the form of combined acid. Still, the smaller percentages of free acid do not show great destructive action; their power of retarding the action of the ferment is out of all proportion to their power of destruction. Amylolytic action is almost entirely stopped by the presence of 0.002 per cent. free hydrochloric acid, but warming saliva at 40° C. with 0.002 or even 0.005 per cent. hydrochloric acid for 30 minutes causes little if any destruction of the ferment. On neutralization, diastatic action goes on as vigorously as ever.

This is well illustrated by the following experiments:

* Chittenden and Griswold, loc. cit.; Chittenden and Ely, loc. cit.; Langley, loc. cit.

† Amer. Chem. Jour., vol. iv, p. 119.

SERIES XXIV.

20 c.c. of filtered saliva were neutralized, the proteids just saturated with acid and the mixture diluted to 100 c.c. The solution contained 0.007 per cent. combined HCl.

10 c.c. of this diluted saliva were warmed with the specified percentages of acid for a definite time, then neutralizing and equalizing mixtures were added and the diastatic action determined.

Following are the results.

Length of time at 40° C.	Per cent. of free HCl.	Starch converted.
30 minutes,	0	32.63 per cent.
30	0.001	34.08
30	0.002	31.38
60	0.002	32.48
30	0.005	31.27
30	0.010	4.60
30	0.030	Complete destruction.

Although the results are for some reason a little irregular it is very evident that up to 0.005 per cent. of free acid there is, under these conditions, no particular destruction of the ferment. With 0.010 per cent. on the other hand the destruction is very great.

As to the bearing which these results have on the possible amyolytic action of saliva in the stomach, it is plain that when the fluids of the stomach acquire an acid reaction due to the presence of free hydrochloric acid ptyalin will soon be destroyed. In the first stage of digestion, however, when there is no free acid, the conversion of starch into sugar can undoubtedly go on, and at this stage of the process the proteid matter present may act as a shield to protect the ptyalin and at the same time to stimulate it in its action, but as the acid-proteids increase in amount and come nearer and nearer to their saturation point it is possible that diastatic action may entirely stop even before free acid makes its appearance. Certainly all salivary ptyalin must ultimately be destroyed in the stomach.

General conclusions.

1. The diastatic action of saliva can be taken as a definite measure of the amount of ferment present only when the dilution of the saliva in the digestive mixture is as 1:50 or 100. The limit of dilution at which decisive diastatic action will manifest itself with formation of reducing bodies is 1:2000-3000, under the conditions previously given.

2. The diastatic action of neutralized saliva is greater than that of normally alkaline saliva. The difference is particularly noticeable

where the dilution is as 1 : 50 or 100, and is apparently out of all proportion to the amount of alkalinity.

3. Sodium carbonate retards the diastatic action of ptyalin in proportion to the amount of alkaline carbonate present. The percentage of alkaline carbonate, however, which hinders diastatic action can be designated only for definite mixtures and not in a general sense, being dependent upon the dilution of the saliva and the consequent change in percentage of proteid matter.

4. The destructive action of sodium carbonate is modified materially by the dilution of the saliva; becoming greater the more the fluid is diluted. This result is due not to simple dilution but doubtless to the diminished amount of proteids.

5. Neutral peptone has a direct stimulating effect on the diastatic action of neutral saliva.

6. The presence of small percentages of neutral peptone tends to raise the diastatic action of normally alkaline saliva, to a point even beyond the action of the neutralized fluid; due in part doubtless to a loose combination of the alkali with the proteid matter, and also to a direct stimulation of the ferment. Likewise peptone tends to diminish in a similar manner the retarding action of the various percentages of sodium carbonate. To accomplish this, however, the amount of peptone must be proportionate to the percentage of alkaline carbonate.

7. Peptone tends to prevent the destructive action of dilute sodium carbonate on salivary ptyalin, thus giving proof of the probable formation of an alkaline-proteid body.

8. Saliva with its proteid matter saturated with acid appears to have a greater diastatic action than when simply neutralized; except when the acid-proteids thus formed are above a certain percentage. Small percentages of peptone saturated with acid, similarly increase the diastatic action of neutralized saliva up to a certain point. Increasing the percentage of acid-proteids finally causes a diminution of diastatic activity.

9. The retarding influence of acid-proteids is out of all proportion to their power of destruction. Large percentages however of acid-proteids may cause almost complete destruction of the ferment.

10. The most favorable condition for the diastatic action of ptyalin, under most circumstances, appears to be a neutral condition of the fluid together with the presence of more or less proteid matter. The addition of very small amounts of hydrochloric acid, however, to dilute solutions of saliva, giving thereby a *small percentage* of acid-

proteids, appears to still further increase diastatic action. Under *such conditions* a minute trace of free acid appears to still further increase the action.

11. 0.003 per cent. free hydrochloric acid almost completely stops the amylolytic action of ptyalin. The larger the amount of saturated proteids the more pronounced becomes the retarding action of free acids.

12. The retarding effects of the smaller percentages of free acid are not due wholly to destruction of the ferment. Pronounced destruction takes place with 0.005–0.010 per cent. free hydrochloric acid.

13. Proteid matter, in influencing the diastatic activity of salivary ptyalin, acts not only by combining with acids and alkalies, but apparently also by direct stimulation of the ferment.

Sheffield Laboratory of Yale College, Jan., 1885.

IX.—NORTH AMERICAN CONOPIDÆ: *Conclusion*.* BY DR.
S. W. WILLISTON.

THE present paper completes a monographic review of this small family of parasitic diptera, with a synopsis of the family, generic, and specific characters. Forty-three species, six of which are more or less doubtful, comprise the entire number now known from North America—more than half as many as are known to occur in Europe, and about a fifth of the entire number known throughout the world. Nine genera only are recognized in this family, two of which have not, so far, been detected in North America, viz: *Sicus* and *Glossigona*. Only one genus does not appear in Europe, *Stylogaster*, which is here considered the type of a distinct sub-family. None of our species are known with certainty to occur elsewhere. The species are probably all parasitic, living within the bodies of other insects till ready to escape as imagoes. In some cases they show a remarkable mimicry of certain hymenoptera.

CONOPS.

Conops gracilis, n. sp.

♂. Length, 12^{mm}. Face and cheeks yellow; facial grooves wholly yellow. Proboscis reddish, black at the end, base moderately swollen, scarcely once and a half the length of the head. Antennæ black, the first joint and the base of the third red, the second joint reddish brown; first joint more than half as long as the second, the second and third of nearly equal length; process of second joint of style small, third joint moderately long, the attenuated portion about as long as the thickened part. Front yellow, brownish immediately above the base of the antennæ and near the middle. Occiput and vertex reddish, the under part of the former like the face; posterior orbits with a narrow border of light yellow dust. Thorax red, the dorsum with three broad coalescent black stripes, the middle one abbreviated behind, the outer ones both in front and behind; disk of metanotum blackish; a small spot on the inner side of each humerus yellow pollinose; the moderately

* For the preceding papers on this family see vol. iv, pp. 325-342, and vii, pp. 91-98 (published as separata, pp. 5-12).

broad pleural stripe, distinctly limited and not narrowed above, upper border of disk of metanotum, extending broadly on the sides, whitish pollinose. Abdomen red, the first, fourth, and fifth segments blackish above; the four anterior segments rather broadly bordered posteriorly with golden or grayish yellow pollen, and nearly the whole upper surface of the fifth and sixth segments thickly dusted with the same. Legs red; basal half of the tibiæ yellow, coxæ and outer distal part of the four front tibiæ with silvery luster; tarsi black, the metatarsi somewhat reddish. Wings brown in front, hyaline behind; costal cell, sub-hyaline; first basal cell, and the discal cell, except a brown streak in front of the fifth vein, hyaline.

Hab. Arizona!

One specimen, from Professor Comstock.

Conops fronto, n. sp.

♂ ♀. Length, $11\frac{1}{2}$ — 13^{mm} . Face, cheeks, and front uniformly light yellow, a minute spot, immediately above the base of the antennæ, black; face with a silvery luster, extending narrowly along the orbits of the front. Antennæ blackish, with a reddish cast, the first joint yellowish red; first joint about two-fifths the length of the second, the third very distinctly shorter than the second; attenuated portion of the style short, the second joint considerably projecting. Eyes with a noticeable triangular smooth space behind, above the middle. Occiput reddish yellow, the upper part and the vertex more obviously reddish; pollen light yellow, varying in different reflections. Proboscis about once and a half the length of the head, black, with a deep reddish cast, base swollen. Thorax light red; dorsum with a white reflection in certain lights, with three broad, more or less coalescent, black stripes, the middle one abbreviated posteriorly, the lateral ones both in front and behind; disk of the metanotum and the metasterna, black, dust of the humeri and the vertical stripe of the pleuræ indistinct; dust of the metathorax behind light grayish yellowish. Abdomen slender in both sexes; red, the disks of the third and fourth segments more or less black; posterior margin of the second segment and the anterior part of the third yellow; third segment with a narrow posterior band, fourth with a broad one, evanescent anteriorly, and the remainder of the dorsum, thickly golden yellow pollinose; process of the fifth segment below in the female of moderate size. Legs red; base of all the tibiæ yellow, tip of the hind tibiæ and all the tarsi black, pulvilli and the claws, except their tip, light yellow; coxæ and outer

side of the four front tibiae with light golden luster. Wings with a brown cloud, reaching to the extremity of the submarginal cell; costal cell and a streak running over the fourth longitudinal vein light yellow; the brown does not encroach upon the first basal cell, except at the base.

Hab. Western Kansas!

Three specimens, August.

ZODION.

Small to rather large species, nearly bare, black or reddish yellow. Face bare, somewhat receding in profile; cheeks narrower than the vertical diameter of the eyes. First joint of antennae short, the second and third of nearly equal length. Proboscis slender, elongate, directed forward, not bent near its middle. Abdomen moderately long, arched above, curved downward at its tip, moderately narrowed at the base. Femora thickened, the hind pair but little longer than the others. Wings without distinct picture.

Zodion pictulum, n. sp.

♂ ♀. Length, $7\frac{1}{2}$ — $8\frac{1}{2}$ mm. Head yellow, cheeks with obscure, indefinite, brownish spots; proboscis black, about as long as the hind femora. Antennae yellow, the third joint reddish or somewhat brownish, second and third joints of equal length. Face with a silvery white reflection. Front opaque yellow, blackish at the vertex, with a triangular expansion in the middle in front; below the middle, on each side near the orbit, with a small blackish or brownish spot. Occiput black, with black pile; and with silvery pollen, changeable in different reflections. Thorax and abdomen black, thickly light gray pollinose, leaving deep black opaque spots as follows: On the dorsum of the thorax with two slender stripes, broadly separated and interrupted or abbreviated on the posterior part; on the inner side of each with an elongate spot, sometimes obsolete, situated near the posterior part of a dark, not opaque, stripe; on each side with two large spots, one before, the other behind the suture; a spot on the humeri, the outer end of the suture, the post-alar callosity, the tip of scutellum, and an additional smaller one on each side; the pleurae with several less definite ones; the dorsum of the abdomen with irregular, rather large spots on the anterior corners of the second segment and on the posterior part of the second and following segments. Scutellum projecting, nearly triangular in shape. Ovipositor shining black. Legs yellow,

whitish pollinose; the upper side of all the femora more or less broadly black, a spot on the under side of each femur, near the outer part, and two narrow rings on each tibia, black, the basal one of the hind tibiæ more brownish; tip of claws black. Wings distinctly tinged with brownish in front, sub-hyaline behind, yellow at the immediate base, the anterior cross-vein lightly clouded.

Hab. New Mexico!

Two specimens (G. F. Gaumer).

Zodion leucostoma, n. sp.

♂ ♀. Length, 9–11^{mm}. Face yellowish white, silvery; front light yellow below, reddish above; antennæ light red; occiput, except the vertex and the sides below, blackish, with light colored pollen. Thorax red, the pleuræ more or less, and the metanotum, black or blackish; dorsum, except the sides and behind, black or brown, visible as a more or less distinct narrow median stripe, and a lateral stripe or large elongated spot: in the middle there is a pair of gray pollinose stripes, confluent in front and reaching to beyond the middle; on the sides of the dorsum the same pollen is to be seen, encroaching more or less upon the black or brown; margin of the scutellum broadly pollinose. Abdomen yellow or red, or more or less blackish, but characteristically marked with light gray pollen as follows: On the second segment, forming a broad band, leaving the anterior corners and two more or less confluent oval spots behind; third segment with an oblique spot on each side, and the narrow hind margin; the fourth segment, except an oval spot on each side and the anterior corners; fifth and sixth segment wholly. Legs yellowish red, the tip of hind tibiæ behind and the tip of the tarsi blackish. Wings with a brownish tinge.

Hab. Western Kansas, Montana, Arizona!

Three specimens, Montana, Arizona (Professor Comstock), and Western Kansas, August. In the specimen from Montana the second abdominal segment is marked like the third.

Zodion fulvifrons Say.

♂ ♀. Length, 6–9^{mm}. Face yellowish white, silvery dusted; front reddish yellow, often brownish above; antennæ red, the second joint, and the third joint at the base, often blackish. Occiput black, whitish pollinose. Thorax black, thickly gray pollinose, the dorsum with two abbreviated, rather distant, slender blackish stripes; in addition there is often the beginning of two median ones in front

and two abbreviated and interrupted ones exteriorly; pile black, rather long, on the border of the scutellum with a row of hairs. Abdomen often black, gray pollinose, leaving a pair of median, interrupted, indistinct blackish stripes and minute blackish dots; frequently the sides and tip of the abdomen are reddish or yellowish, and not infrequently the entire abdomen is reddish or even yellow. Legs yellow or reddish yellow, the femora often on the upper side blackish or black. Wings with a brownish tinge, at the immediate base yellow.

Hab. New England, New Mexico, California, Washington Territory!

Numerous specimens. This species is very variable. In the vicinity of New Haven, and at the same time, I have captured specimens with a yellow abdomen, much smaller than others with the abdomen entirely black. The different forms insensibly merge into one another. From this fact, and because I have seen specimens from the Pacific coast showing all these variations, I must consider Say's *Z. abdominale* as nothing more than a variety.

Zodion pygmæum, n. sp.

♂ ♀. Length, $3\frac{1}{2}$ –4^{mm}. Face light yellow; cheeks narrow, not a third of the vertical diameter of the eyes. Antennæ blackish, the third joint at the base broadly red; third joint longer than the second. Front blackish above, yellow below. Occiput black, grayish pollinose. Thorax black, thickly gray pollinose, in the middle with two slender stripes, and on each side with two small spots, opaque black. Abdomen black, on the sides and the venter yellow, thickly covered above with gray pollen, leaving opaque black spots as follows: Two small, triangular spots (sometimes obsolete) on the posterior part of the second segment, two similar but very large ones on the third segment, usually nearly completely coalescent; two pairs, successively smaller, on the fourth and fifth segments; posterior margins of all the segments narrowly gray pollinose; hypopygium black; in the female the spots on the second, third, and fourth segments larger, the fifth segment very short and the spots wanting, the ovipositor shining reddish yellow. Legs brownish, whitish pollinose; the under side and tip of femora, the base of tibiæ, and the base of all the tarsi, yellowish. Wings hyaline.

Hab. California and Colorado!

Ten specimens from California (O. T. Baron) and one from North Park, Colorado (G. B. Grinnell). All males but one from California.

Zodion nanellum, Loew.

Translation. "♀. Length, $2\frac{5}{8}$ mm. Very small, black-cinereous. Occiput blackish; front orange colored, near the vertex fuscous; antennæ fuscous, on the sides, except the tip, rufous; face and cheeks dilutely yellowish, the latter narrower, the eyes proportionally larger than in other species; thorax black-cinereous, pleuræ a little lighter; dorsal stripes black, narrowly interrupted, abbreviated at both ends. First four abdominal segments above black, opaque, the posterior margins very narrowly, the sides broadly, cinereous pollinose; fifth segment very short, fusco-testaceous; sixth segment testaceous, lightly pollinose, sub-shining; seventh segment wholly destitute of pollen, shining, testaceous, the tip, however, black; ventral valve rather large. Legs sub-fuscous; coxæ, tip of the femora and base of tibiæ pallid reddish. Halteres white. Wings cinereous-hyaline, veins black."

Hab. District of Columbia (Lw.).

This species must resemble *Z. pygmæum*, but differs in the greater extent of the opaque black on the dorsum of the abdomen.

MYOPA.

Rather large to rather small species. Head large, swollen. Antennæ of moderate length, the second and third joints of nearly equal length, the third joint oval. Face very large, cheeks very broad, at least as broad as the vertical diameter of the eyes. Proboscis always with a hinge near its middle, the terminal portion folding backward. Front broad, produced somewhat conically for the antennæ. Thorax short; scutellum semioval. Abdomen short, depressed, oval, the terminal part always curved downward and inward, the ovipositor not elongated. Legs rather stout, the hind femora scarcely elongated. First posterior cell of wings sometimes closed, the anal cell acute, extending toward the border of the wing.

Myopa pictipennis, n. sp.

♀. Length, 8mm. Face and cheeks yellowish white, on each side of the face in front with some small, black spots (probably somewhat variable); above them, in front of the lower part of the eye, another blackish spot, separated from the blackish color above the base of the antennæ, which extends outward to the orbit; lower part of the occiput on the sides much inflated; cheeks with a fringe

of white pile below; proboscis black, the basal joint rather longer than the femora; front brownish yellowish. Eyes small, their vertical diameter less than the width of the cheeks. Antennæ reddish brownish. Pile of the front short, sparse, black. Thorax black, the sides and hind part of the dorsum, the scutellum, and the larger part of the pleuræ reddish; dorsum with two slender, indistinct stripes in front, and two spots in front of the scutellum, brownish yellowish pollinose; pile black, rather abundant and long, especially on the post-alar callosities and border of the scutellum. Abdomen not very broad, shining black, the terminal segments above, in part red; second and following segments white pollinose, in the form of a large triangle, which in front may be truncate or emarginate; pile black, rather conspicuous on the sides in front. Legs stout, black, with black pile; the tip of all the femora, the base and tip and a median ring of all the tibiæ, and the first four joints of all the tarsi yellow, last joint of the tarsi brown. Wings in front rather strongly and broadly clouded with brown, the immediate base and a transverse spot at the origin of the third vein yellow, a blackish cloud on the anterior cross-vein and brownish spots in the first and second posterior cells.

Hab. Arizona and California!

One specimen from Professor Comstock, and four specimens from Mr. D. W. Coquillet.

Myopa pilosa, n. sp.

♂. Length, 6^{mm}. Face yellowish white; reddish on the sides above; cheeks rather thickly white pilose below, in width rather greater than the vertical diameter of the eyes; proboscis black, the basal joint very distinctly shorter than the femora; antennæ red, the second joint brownish above. Front reddish yellow, the upper part of the occiput similarly colored, with more or less brownish; pile of the front long and abundant, black. Thorax black, the humeri, lateral margins of the dorsum, the posterior part in front of the scutellum, and the scutellum wholly, red; pleuræ reddish, but with ill-defined blackish spots; dorsum with two faintly perceptible whitish stripes in front, pile long and black. Abdomen rather narrow, black toward the front, the hind segments becoming wholly red; the anterior segments behind on each side, the posterior ones wholly lightly yellowish white pollinose; pile of the whole abdomen long, erect, abundant, and black. Legs yellowish red; rather thickly black pilose; the femora with an incomplete ring near tip and the

tibiæ with two narrow rings, black. Wings brownish in front, subhyaline behind, the anterior cross-vein with a blackish, the posterior cross-vein with a brown cloud; first posterior cell open.

Hab. California!

One specimen (H. K. Morrison). This species is related to *pictipennis*, but may be distinguished by its shorter proboscis, and the greater pilosity of the front and abdomen; it is also smaller.

Myopa vesiculosa Say.

♂ ♀. Length, 6^{mm}. Face and cheeks yellowish white. Antennæ red, the second joint brownish. Front blackish, lighter on the sides below. First joint of proboscis not as long as front femora, and scarcely twice as long as the palpi. Thorax black, the humeri, the sides of the dorsum, the scutellum, and pleuræ, deep red; pile of dorsum short, inconspicuous, chiefly black. Abdomen rather broadly oval, black, shining, the lateral margins and posterior segments red; pile short, recumbent, white; the posterior angles of the second and third segments, the sides of the fourth segment, and all the remaining segments yellowish gray pollinose. Base and tip of femora, base of tibiæ, and the tarsi yellow, elsewhere brownish red, the femora more or less blackish. Wings strongly infuscated, except at the base, where they are light yellow; first posterior cell closed.

Hab. Atlantic States!

Two specimens, White Mountains (Dr. Diammock) and Georgia (Morrison). A specimen from Virginia agrees, except that the short pile of the abdomen is black. It is possible that the next species may not be distinct.

Myopa plebeia, n. sp.

♂ ♀. Length, 8–9^{mm}. Head light yellow; front and upper part of occiput ferruginous red; antennæ red; proboscis black, the basal joint shorter than the front femora, scarcely twice the length of the palpi; the short sparse pile of the vertex black. Thorax dark red, dorsum with three obscure black stripes, the lateral ones abbreviated and interrupted, the middle one abbreviated behind; pile short, black. Abdomen oval, black, with short black pile; lateral margins and posterior segments red; posterior angles of the second and third segments, the fourth segment on the sides, extending across narrowly on the hind margin, and all of the succeeding segments

covered with rather dense yellowish gray pollen. Legs red, the knees and the tarsi more yellowish. Wings lightly infuscated with brown, the base yellow.

Hab. Arizona!

Three specimens, male and female, from Professor Comstock.

Myopa clausa Loew.

♂ ♀. Length, 6-7^{mm}. Face and cheeks light yellow. Antennæ red, the second joint distinctly longer than the third. Front darker yellow, with a large Y-shaped brown marking, expanding transversely above the base of the antennæ. Upper part of the occiput red, below yellow like the antennæ. Dorsum of thorax darker red, usually in the middle in front (extending more or less back) with a broad black stripe, often also on either side, near the middle, with a black spot; pile short, sparse, black. Abdomen lighter red; on each side of the posterior margin of the second, third, and fourth segments with an oval white pollinose spot; fifth and sixth segments with the same pollen, except a semioval space in front. Legs red; hind trochanters, base of hind femora, and base of all the tibiæ, and the tarsi wholly, yellow. Wings moderately infuscated, base yellow; first posterior cell usually closed.

Hab. New England!

Eight specimens, Massachusetts and Connecticut. In one the third joint of the antennæ is as long as the second. The third joint is often yellowish. In a specimen from Montana the antennæ are very distinctly longer, the second joint being elongate; in another from California the antennæ are short, the second and third joints being of nearly equal length; otherwise these specimens seem to show no differences from the eastern ones. Other specimens from Arizona, Montana, Wyoming, California, Washington Territory, etc., show great variations in size (up to nine or ten mm.) in depth of color, and even in the more oval abdomen, but I am utterly at a loss to find distinctive characters.

Myopa obliquofasciata Macquart.

"*Testacea. Thorace dorso nigro vittis duabus albis. Abdomine oblique albo-fasciata.*

Long. 4 l. ♂. Face et front jaunes; la première à duvet blanc; vertex fauve. Antennes: les deux premiers articles fauves; le troisième manque. Thorax à dos noir, avec deux bandes longitudi-

nales de duvet blanc; épaules, côtés, bord postérieur et écusson testacés, à léger duvet blanc. Abdomen testacé; deuxième, troisième et quatrième segments à band oblique de duvet blanc de chaque côté; les suivants couverts de duvet blanc. Pieds testacés; jambes à duvet blanc en avant. Ailes à base fauve et extrémité brunâtre.

Du Texas, Galveston."

Myopa longicornis Say.

"Body black, hairy; wings dusky, pale at base: antennæ as long as the head."

"Antennæ pale on the inner side and beneath; hypostoma [face] pale with a silvery reflection; front and vertex dusky; proboscis black; thorax with two obsolete pale lines; wings blackish, pale towards the base; poisers whitish; anterior pairs of feet with the thigh beneath, at base and leg [tip], pale; anterior pairs of trochanters pale, with a silvery reflection; posterior feet, thighs pale on the basal moiety; abdomen clavate and hamate at tip."

"Inhabits Missouri!"

"Length about three-tenths of an inch." Say.

Translation: "Blackish, abdomen on each side transversely spotted with white, legs leather-yellow, the femora black above. Length, $2\frac{3}{4}$ lines.—From Pennsylvania."

"Antennæ black, on the lower border luteous. Face yellowish, with silvery luster. Front yellowish brownish; occiput nearly hair-gray, on the upper border blackish. The thorax shows in certain reflections a broad hair-gray stripe, divided in its middle by a linear black stripe; also the humeri and spots on the pleuræ have a hair-gray luster. Abdomen blackish, with hair-gray glistening posterior borders; second and third segments on each side behind with a hair-gray spot, broader outwardly. Wings a little infuscated; halteres yellowish. Hind femora on the basal half wholly leather-yellow; tibiæ in the middle brown-blackish." Wiedemann.

This species is unknown to me, but I believe it will be recognized by the above descriptions. Wiedemann's geographical knowledge of America was not always accurate; the species probably occurs in the region east of the Rocky Mountains.

Myopa vicaria Walk.

"*Ferruginea, capite fulvo, thoracis disco picco, abdomine maculis cano-pubescentibus ornato, antennis pedibusque ferrugineis, tarsis fulvis, alis fulvo cinereoque variis, venis transversis fusco nebulosis.*"

“Body ferruginous, clothed with black hairs: head tawny, clothed with black hairs, very large, pale yellow, and covered with whitish hairs about the mouth: eyes pitchy: mouth black: feelers ferruginous; first and second joints clothed with short black hairs; bristle pitchy towards the tip: disk of the chest pitchy: abdomen longer than the chest, adorned with patches of hoary down: legs ferruginous, slightly covered with white bloom, clothed with black hairs; feet tawny; claws black, tawny at the base; foot-cushions yellow: wings tawny along the borders of the veins; disks of the areolet slightly gray; wing ribs and poisers pale tawny; veins tawny; cross-veins clouded with brown. Length of the body 3 lines. Nova Scotia.” Walker.

CONOPIDÆ.

Characters of the family.—Thinly pilose or nearly bare species. Face nearly vertical or gently retreating. Head broader than the thorax. Oral opening large; proboscis slender, more or less elongate, sometimes very much so, directed forwards, often with a joint in the middle, the distal portion folding back. Front broad in both sexes. Eyes bare. Antennæ more or less elongated, usually angulated at the base of the second joint, with a dorsal arista or terminal style. Thorax large, short; scutellum small; tegulæ small. Abdomen of six or seven segments. Legs simple. Wings elongate; third longitudinal vein simple; three posterior cells, the first closed or much narrowed at the border; anal cell closed.

Conopinæ.—Head large, swollen; face with median divaricate grooves, large; cheeks moderately broad; vertical callosity swollen; ocelli present; antennæ elongate, the third joint not compressed; elongate, with a terminal, three-jointed style. Abdomen pedicellate or much constricted at the base, club-like at the end, the terminal segments bent downward, the fifth segment in the female with a more or less conspicuous process below. Legs moderately stout. Auxiliary vein of wings connected at its tip by a small cross-vein with the first longitudinal vein; anal cell acute.

Small cross-vein of wings nearly opposite the tip of the auxiliary vein and near the middle of the discal cell;* femora and tibiæ not thickened or dilated, or if so, the thickening is regular; third joint of antennæ usually as long as the second (plate xli, fig. 1).

Conops.

* I am not aware that this character has hitherto been made use of. It is, I believe, of greater value than the structure of the legs, and will probably be found to apply equally well to exotic species. The structure of the antennæ is of less value generically.

Small cross-vein of wings near the outer third of discal cell; hind femora irregularly thickened toward the base, the tibiæ with irregular outlines, third joint of antennæ shorter than the second (plate xli, fig. 2).

Physocephala.

Myopinæ.—Head large, inflated. Face with median grooves; cheeks broad or very broad; third joint of the antennæ oval, with a short, thickened, two-jointed, median dorsal arista; vertical callosity not swollen. Abdomen somewhat narrowed at the base, the terminal part always curved under; fifth segment of abdomen usually with a more or less conspicuous process below; the ovipositor rarely elongated and bent forward beneath the abdomen. Legs stout. Auxiliary vein of the wing sometimes connected at its tip by a small cross-vein with the first longitudinal vein.

- 1.—Proboscis directed forward, not bent near its middle (plate xli, figs. 3 and 4).

Zodion.

Proboscis bent near its middle, the terminal portion folding back.

2.

- 2.—Anal cell short, rectangular; ovipositor elongate (plate xli, fig. 5).

Dalmania.

Anal cell elongate, acute.

3.

- 3.—Cheeks not as broad as the vertical diameter of the eye (plate, xli, fig. 6).

Oncomyia.

Cheeks as broad or broader than the vertical diameter of the eye (plate xli, fig. 7).

Myopa.

Stylogastrinæ.—Face narrow, carinate, without or with very indistinct grooves; proboscis elongate, the distal part folding back; cheeks narrow; antennæ with a subterminal arista, the third joint more or less elongate; ocellar tubercle small, ocelli present. Abdomen slender, not narrowed at the base, the tip not curved forward; female ovipositor extraordinarily elongated, directed backward. Legs slender, tibiæ with spurs. Auxiliary vein of the wings not connected at its tip with the first longitudinal; anal cell small, obtuse (plate xli, fig. 8).

Stylogaster.

Larval characters.—“Larvæ amphipneustic (perhaps during parasitism metapneustic), the anterior stigmata very small, point-like, scarcely perforate, rudimentary. Form of body variable, the anterior segments, however, thinner than the posterior ones, the larvæ hence oval or pear-shaped, with distinctly differentiated segments, which may be contracted and extended, as in mature Hypoderma larvæ. Antennæ wart-shaped, with two ocelli-like chitinous rings at the end. Mouth hooklets strongly bent, with an obtuse downwardly directed basal process and with thin slender points, thus, in fact, like Cephænomyia larvæ, two-armed (zwei-armig). Œsophagus

distinct, as in general all the organs are visible through the skin, which is roughened with small spines. On the under side, from the third segment, distinct lateral swellings are distinguishable. On the last segment are two large, round or kidney-shaped stigmatic surfaces, which are strongly convex, like a watch glass, and on those inner border the false stigma openings appear as a clear disk. Sometimes these surfaces are beset thickly with small conical warts. The anus lies below. The larva lies with the posterior stigmata against the base of the abdomen of the insect in which it is parasitic. Between the mouth hooklets appear, sometimes, two additional chitinous points. The larva pupigera is oval, with button-like, slightly projecting anterior stigmata and with the described stigmatic plates at the posterior end. Segments not sharply distinguished, skin rough and with folds.”*

The larvæ are parasitic upon other insects, living within the abdomen and consuming the non-vital parts. The pupal transformation occurs also here, in which stage they pass the winter, escaping the following spring or summer through an opening made between the dorsal segments of the abdomen. From my own observations I had come to the conclusion that the eggs of the parent were laid directly upon the body of the insect during flight, and I afterward learned that Robineau-Desvoidy had long before observed, as I had done in *Conops tibialis*, a species of *Conops* following a *Bombus*, and repeatedly flying against it. They are usually parasitic upon Hymenoptera, and especially the genus *Bombus*. The following is a list of the genera upon which they have been observed.† *Conops* upon *Oedipoda*, *Eucera*, *Halictus*, *Bombus*, *Osmia*, *Vespa*, *Odynerus*, *Pompilus*, *Sphex* and *Bembex*; *Myopa* upon *Andrena* and *Vespa*; *Zodion* upon *Hyleus*; *Stylogaster*, it is thought, may be parasitic upon Termites.

CONOPS.

- Conops* Linné, Fauna Suecica, p. 1797, 1761.
Leopoldius Rondani, Nuov. Ann. Sc. Nat. Bologna, x, 35, 1843.
Conopæus Rondani, Gen. Ital. Conop., 1845.
Pleurocina Macquart, Dipt. Exot., iv, Suppl., 164, 1850.
Conopilla Rondani, Dipt. Ital. Prod., i, 56, 1856.
Spyxosoma Rondani, Dipt. Ital. Prod., i, 56, 1856.
Brachyglossum Rondani, Dipt. Ital. Prod., i, 69, 1856.
Bombidia Lioy, Acta Venet., 3 Ser., ix, 1326, 1864.
Cylindrogaster Lioy, (non Rond.), l. c.

* Brauer, Denkschr. der math.-natur. Classe der kais. Acad. d. Wissensch., Band xlvii, p. 38, 1883.

† Brauer, l. c., pp. 83, 84.

- 1.—Third joint of the antennæ distinctly shorter than the second. 2.
Third joint of antennæ nearly or quite as long as the second;
brown of anterior portion of the wings with distinct outlines. 3.
- 2.—Wings blackish in front, sub-hyaline behind, picture indistinct;
black species. **brachyrhynchus.**
Picture of wings distinct; front yellow; red species. **fronto.**
- 3.—Attenuated portion of antennal style short, proboscis short;
a hyaline cross-band before the tip of the wing; shining
black, dust grayish, front blackish or black. **sylvosus.**
Attenuated portion of style long; proboscis considerably longer
than the head; the brown not interrupted before the tip of
the wing. 4.
- 4.—Stripe of dust on upper half of pleuræ indistinct or without
distinct borders. Front black, cheeks brown behind; probos-
cis about once and a half the length of the head. Dark col-
ored species. **bulbistrotris.**
Stripe of dust on upper half of pleuræ as sharply defined as on
the under half. 5.
- 5.—Proboscis twice the length of head, stripe on upper half of
pleuræ narrow. Reddish species. **excisus.**
Proboscis scarcely once and a half the length of the head;
pleural stripe not narrowed above; face, cheeks and under
part of front pale yellow. 6.
- 6.—Facial grooves with a black spot on each side of the middle.
Black species. **xanthopareus.**
Facial grooves wholly yellow. Red species. **gracilis.**

brachyrhynchus Macquart, Dipt. Exot., ii, 3, 15, 13, tab. i, fig. 8; Williston, these Trans., iv, 341 (reproduction of the original).—Va., S. C., Ga., Mass., Kans.

Conops obscuripennis Williston, these Trans., iv, 328.

fronto Williston, these Trans., ante, p. 378.

sylvosus Williston, these Trans., iv, 329.—Mass., Conn., Kans.

excisus Wiedemann, Auss. Zw. Ins., ii, 234; Loew, Neue Beitr., etc., i, 28; Williston, these Trans., iv, 330.—Ga., Fla., N. C.

Conops sugens Wiedemann, Auss. Zw. Ins., ii, 236, 3.

bulbistrotris Loew, Neue Beitr. etc., i, 30; Williston, these Trans., iv, 331.—Ga., N. C.

xanthopareus Williston, these Trans., iv, 332.—Conn.

gracilis Williston, these Trans., ante, p. 377.

Unrecognized species of doubtful position.

pictus Fabricius, Ent. Syst., iv, 391, 3; Syst. Antl., 176, 5; Macquart, Dipt. Exot., ii, 3, 13, 9 (ex parte); Williston, these Trans., iv, 340 (reproduction of the original).

Conops Ramondi Bigot, in Ramon de la Sagra, etc., 808; tab. xx, fig. 6; Williston, these Trans., iv, 340 (reproduction of the original).

flaviceps Macquart, Dipt. Exot., ii, 3, 15, 14; Williston, these Trans., iv, 341 (reproduction of the original).

fulvipennis Macquart, Dipt. Exot., ii, 3, 13, 10; tab. i, fig. 9; Williston, these Trans., iv, 341 (reproduction of the original).

PHYSOCEPHALA.

Physocephala Schiner, Wien. Entomol. Monatschrift, v Band, 1861; Fauna Austr., i, 375.

- 1.—The brown of the wing fills out the discal cell to beyond the great cross-vein. 2.
Outer portion of discal cell from near the small cross-vein distinctly lighter or hyaline. 3.
- 2.—Cheeks uniformly black; dust on the humeri indistinct.

tibialis.

Cheeks with a yellow spot in the middle, brown in front and behind; humeri with distinct yellow dust. **sagittaria.**

- 3.—Cheeks uniformly black or brown; basal joint of antennæ very short. 4.

Cheeks with a yellow spot in the middle; first joint of antennæ about as long as the third. 5.

- 4.—Front with deep black transverse and median divaricate stripes; Dark colored species. **furcillata.**

Front with narrow reddish stripes or wholly yellow; dorsum of thorax with a broad, median, posteriorly abbreviated black stripe. Reddish species. **Burgessi.**

- 5.—Ultimate section of fourth vein but little or not at all longer than the penultimate. 6.

Ultimate section nearly twice as long as the penultimate; dorsum of thorax with a narrow, median black stripe. Reddish species. **Texana.**

- 6.—Facial grooves and frontal stripes black. Dark colored species. **marginata.**

Facial grooves but little or not at all darkened; frontal stripes nearly or quite obsolete; dorsum of thorax with three black stripes, narrowly separated or confluent, the median one more abbreviated behind. **affinis.**

tibialis Say, Jour. Acad. Phil., vi, 171; Comp. Wr., ii, 363 (*Conops*); Williston, these Trans., iv, 333 (id.).—Atlantic States.

Conops nigricornis Wiedemann, Auss. Zw. Ins., ii, 236, 4; Loew, Neue Beitr. etc., i, 31.

sagittaria Say, Jour. Acad. Phil., iii, 83, 2; Comp. Wr., ii, 73 (*Conops*); Williston, these Trans., iv, 334 (id.).—Penn., Mass., Conn., N. C.

Conops genualis Loew, Neue Beitr. etc., i, p. 32; Williston, these Trans., iv, 335 (translation of the original).

furcillata Williston, these Trans., iv, 336 (*Conops*).—N. H., Can. ? *Conops æthiops* Walker, List, etc., iii, 671.

Burgessi Williston, these Trans., iv, 337 (*Conops*).—Col., Cal.

Texana Williston, these Trans., iv, 338 (*Conops*).—Tex.

marginata Say, Journ. Acad. Phil., iii, 82, 1; Compl. Wr., ii, 73 (*Conops*); Wiedemann, Auss. Zw. Ins., ii, 240, 9 (id.); Loew, Neue Beitr. etc., i, 34 (id.); Williston, these Trans., iv, 338 (id.).—Penn., N. H.

affinis Williston, these Trans., iv, 339 (*Conops*).—Kans., Cal., Wash. Terr.

Unrecognized species.

castanoptera Loew, Neue Beitr., etc., i, 33 (*Conops*); Williston, these Trans., iv, 336 (translation of the original).

ZODION.

Zodion Latreille, Précis des caract. géner. d. ins., 1796.

- 1.—Scutellum triangular; thorax and abdomen with opaque black spots. **pictulum.**
Scutellum oval. 2.
- 2.—Very small species, cheeks narrow; abdomen with opaque black triangular spots. **pygmæum.**
Not very small species; abdomen without such spots. 3.
- 3.—Thorax with a pair of median pollinose stripes; abdomen with oblique pollinose spots on the third segment at least. **leucostoma.**
Thorax pollinose, with at least two slender black stripes, abdomen more uniformly pollinose. **fulvifrons.**
- “♀. Very small, black cinereous, abdomen opaque, the sides and a median longitudinal line of the sixth segment cinereous pollinose, sixth and seventh segments reddish. Length, $1\frac{1}{3}$ lin.” (about 3^{mm}). **nanellum.**

nanellum Loew, Centur., viii, 75; Williston, these Trans., ante, p. 382. D. C. (Lw.).

? *Zodion Occidentis* Walker, List, etc., iii, 676.—Ohio.

pygmæum Williston, these Trans., ante, p. 381.—Cal., Col.

pictulum Williston, these Trans., ante, p. 379.—N. M.

fulvifrons Say, Jour. Phil. Acad. N. Sc., iii, 83; Compl. Wr., ii, 74; Wiedemann, Auss. Zw. Ins., ii, 241, 1; Williston, these Trans., ante, p. 380.—New Eng., Cal., Wash. Terr., Ariz.

Zodion abdominale Say, Jour. Acad. Phil., iii, 84, 2; Compl. Wr., ii, 74; Wiedemann, Auss. Zw. Ins., ii, 242, 2 (translation of the original).

? *Myopa rubrifrons* Robineau Desvoidy, Essai Myod., 247, 17.

leucostoma Williston, these Trans., ante, p. 380.—Mont., Kau., Ariz., Wash. Ty.

Unrecognized Species.

Americanum Wiedemann, Auss. Zw. Ins., 242, 3.—Montevideo.

splendens Jænnicke, Neue Exot. Dipt., 97.—Mexico.

ONCOMYIA.

Oconomyia Robineau Desvoidy, Dipt. des environs de Paris, Myopaires, 50, 1853.

Thecophora Rondani, Dipt. Ital. Prod., i, 58, 1856.

Oncomyia Loew, Centur., vii, 73.

i.—Second joint of the antennæ but little or not at all longer than the third. **Baroni.**

Second joint of the antennæ considerably longer than the third. 2.

- 2.—Large species (8–9^{mm}). 3.
Smaller species; femora, or at least tibiæ, in large part blackish. 4.
- 3.—Femora and tibiæ wholly reddish yellow. **modesta.**
Femora, at least on outer part, black; eastern.
Var. **melanopoda.**
- 4.—Species 5–7^{mm} long. **abbreviata.**
Very small species (4–5^{mm}). **loraria.**

Baroni Williston, these Trans., vi, 97 (11).—Cal., Col.

abbreviata Loew, Centur., vii, 73; Williston, these Trans., vi, 97 (11).—New Eng., ? Cal.

modesta Williston, these Trans., vi, 96 (10).—Cal.

Var. *melanopoda* Williston, supra et vi, 96.—White Mountains.

loraria Loew, Centur., vii, 74; Williston, these Trans., vi, 98 (12); (translation of the original).—New Eng.

MYOPA.

Myopa Fabricius, Syst. Entom., 798, 1775.

Phorosia Robineau-Desvoidy, Fam. d. Myopaires, 1853.

Myopella Rob.-Desvoidy, l. c.

Purplella Rob.-Desvoidy, l. c.

Haustella Rob.-Desvoidy, l. c.

Myopina Rob.-Desvoidy, l. c.

Fairmairia Rob.-Desvoidy, l. c.

Lonchopalpus Rob.-Desvoidy, l. c.

Pictina Rob.-Desvoidy, l. c.

Gonirhynchus Rondani, Dipt. Ital. Prod., i, 58, 1856.

Arpagita Lioy, Acta. Venet., 3 Ser., ix, 1327, 1864.

Ischiodonta Lioy, l. c.

- 1.—Cheeks below very distinctly fringed with pile; wings with spots. 2.
Cheeks not fringed with pile below. 3.
- 2.—Face with black spots. **pictipennis.**
Face without black spots, pile of abdomen long. **pilosa.**
- 3.—Abdomen chiefly black. 4.
Abdomen red. **clausa.**
- 4.—Pile of abdomen light yellow. **vesiculosa.**
Pile of abdomen black. **plebeia.**

pictipennis Williston, these Trans., ante, p. 382.—Ariz.

pilosa Williston, these Trans., ante, p. 383.—Cal.

vesiculosa Say, Jour. Acad. Nat. Sci. Phil., iii, 80, 1; Compl. Wr., ii, 72; Wiedemann, Auss. Zw. Ins., ii, 245, 3; Williston, these Trans., ante, p. 384.—Penn., N. H., Mass., Ga.

? *Myopa apicalis* Walker, List, etc., iii, 679.

plebeia Williston, these Trans., ante, p. 384.—Ariz.

conjuncta Thomson, Eugen. Resa, Dipt., 515.—Cal.

clausa Loew, Centur., vii, 72.—New Eng., Montana.

Unrecognized species.

- longicornis** Say, Jour. Acad. Nat. Sci. Phil., iii, 83; Compl. Wr., ii, 72; Wiedemann, Auss. Zw. Ins., ii, 245, 4; Williston, these Trans., ante, p. 386 (reproduction of Say's and Wiedemann's descriptions).—Mo.
- obliquefasciata** Macquart, Dipt. Exot. 1er Suppl., 141, 1; Williston, these Trans., ante, p. 385.—"Texas."
- bistria** Walker, List, etc., iii, 679.—N. Am. (A doubtful species.)
- vicaria** Walker, List, etc., iii, 679.—Nova Scotia.

DALMANNIA.

- Dalmannia* Robineau-Desvoidy, Essai sur les Myodaires, 248, 1830.
- Stachynia* Macquart, Dipt. du Nord, 1833.
- Dalmania* Rob.-Desvoidy, Myopaires, 1853.

Second, third and fourth segments of the abdomen with broad yellow hind margins, each with three projections directed forward.

Segments of the abdomen with narrow hind margin, each of which sends but a single median anterior projection. **nigriceps**.

picta Williston, these Trans., vi, 94 (8).—Ariz.

nigriceps Loew, Centur., vi, 71; Williston, these Trans., vi, 94 (8).—Conn., N. Y., D. C., Mont.

STYLOGASTER.

- Stylogaster* Macquart, Hist. Nat. des Dipt., ii, 38, 1835; Dipt. Exot., ii, 3, 17, 1845.
- Stylomyia* Westwood, Proc. Zool. Soc. London, 1850, p. 270.
- Ptychoproctus* Bigot, Revue et Magaz. de Zool., No. 7, 1859.

Second joint of antennæ short, third elongate.

Second joint nearly as long as the third.

neglecta.

biannulata.

biannulata Say, Jour. Acad. Nat. Sci. Phil., iii, 81, 3; Compl. Wr., ii, 72 (*Myopa*); Williston, these Trans., vi, 93.—Penn., Conn.

Myopa stylata Wiedemann, Auss. Zw. Ins., ii, 243, 2 (ex parte).

Stylomyia confusa Westwood, Proc. Zool. Soc. Lond., 1850, p. 271.

neglecta Williston, these Trans., vi, 91 (5).—Conn.

EXPLANATION OF PLATE XLI.

- Fig. 1.—*Conops xanthopareus* Will., female.
 2.—*Physocephala tibialis* Say, male.
 3.—*Zodion fulvifrons* Say, female.
 4.—*Zodion pygmæum* Will., male.
 5.—*Oncomyia modesta* Will., female.
 6.—*Myopa clausa* Loew, female.
 7.—*Dalmannia picta* Will., female.
 8.—*Stylogaster neglecta* Will., female.

ERRATA.

Vol. vi, p. 94, line 22, for "first," read second. Same page, fourth line from bottom, for "*Dalmannia*" read *Dalmania*. Page 95, line 7, for "triangular is" read triangles are.

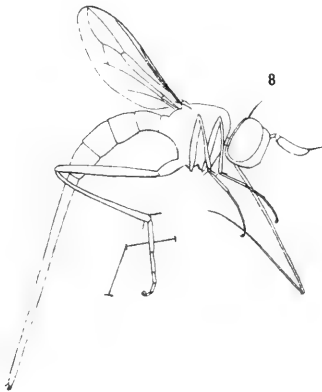
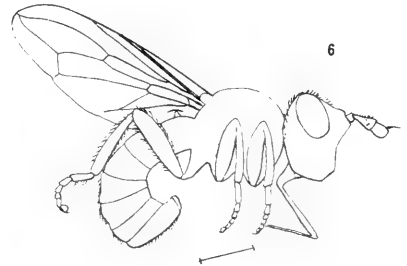
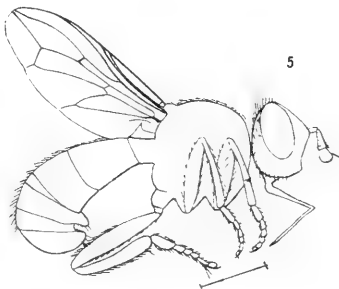
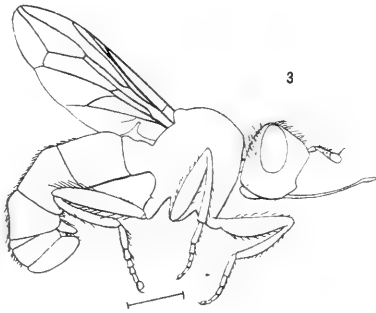
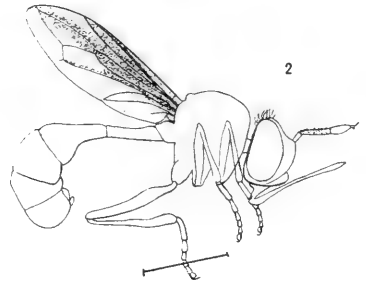
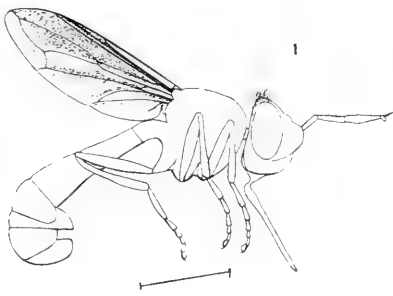

S.W. Williston's measure

L. S. Funderburk, Photo Lith. New Haven.

X.—THIRD CATALOGUE OF MOLLUSCA RECENTLY ADDED TO THE FAUNA OF THE NEW ENGLAND COAST AND THE ADJACENT PARTS OF THE ATLANTIC, CONSISTING MOSTLY OF DEEP-SEA SPECIES, WITH NOTES ON OTHERS PREVIOUSLY RECORDED. BY A. E. VERRILL.

[Published by permission of the U. S. Commission of Fish and Fisheries.*]

THE exploration of the Gulf Stream region was continued last season, under nearly the same conditions† as in 1883, by the U. S. Fish Commission steamer Albatross, Lieut. Z. L. Tanner, commander. The total number of stations occupied during the season was 141.‡ During the five trips, between July 20 and Sept. 28, ninety-three dredgings (at stations 2170 to 2262) were made. In most of these, a large beam-trawl was used very successfully, even at great depths.

Of these dredgings, 5 were in depths between 2000 and 2600 fathoms (4 successful); 20 were between 1000 and 2000 fathoms; 29 between 500 and 1000 fathoms; 8 between 300 and 500 fathoms; 16 between 75 and 300 fathoms; and 20 between 18 and 75 fathoms. The first trip was made while the steamer was on her way north from Norfolk, Va., and some of those stations were off the coast of Maryland, the most southern being in N. lat. $37^{\circ} 57'$, but most of the others were situated in the region south and southeast of Martha's Vineyard, though some of them were a long way off the coast. The five stations in depths below 2000 fathoms were more

* Number 1 of this series was published in these Transactions, vol. v, pp. 447-587, 1882; Number 2, in vol. vi, pp. 139-294, 1883.

† The naturalists associated with the writer in the work, in 1884, were Professor S. I. Smith, Mr. Sanderson Smith, Mr. Richard Rathbun, Professor L. A. Lee, Mr. B. F. Koons, Professor Edwin Linton, Mr. H. L. Bruner, Mr. J. H. Blake (as artist), Mr. J. E. Benedict (naturalist attached to the steamer), Mr. A. Baldwin, W. E. Safford, Ensign U. S. N., Mr. William Nye, and others. Mr. Peter Parker and R. H. Miner, Ensign U. S. N., worked on the fishes. The parties who went out dredging on the steamer varied from time to time. Usually not more than three or four naturalists besides Mr. Benedict were sent out.

‡ A complete list of these stations, with their location, temperatures, etc., has been published by me in the American Journal of Science, for February, 1885, vol. xxix, p. 154.

than half way to the Bermudas, and nearly east of the coast of Virginia, between N. lat. $36^{\circ} 05' 30''$ and $37^{\circ} 48' 30''$; and between W. long. $68^{\circ} 21'$ and $71^{\circ} 55'$.

At the end of the season, while on his way south, Capt. Tanner made another trip for the special purpose of exploring the shallow water regions in the vicinity of Cape Hatteras, where a very interesting fauna had been discovered by the Albatross in 1883. On this trip the first three hauls (stations 2263 to 2265) were made off Chesapeake Bay, Oct. 18, in 70, 167, and 430 fathoms, with interesting results; and 45 stations (2266 to 2310) were occupied October 19 to 21, in the region off Cape Hatteras. Of these, one (No. 2300) was in 671 fathoms; four were in depths between 111 and 322 fathoms (Nos. 2266, 2299, 2306, 2310); six were between 50 and 80 fathoms; eight were between 30 and 50 fathoms; three, between 20 and 30 fathoms; and twenty-three, between 7 and 20 fathoms. This shallow water region yielded a rich harvest of shells and crustacea unknown on our Atlantic coast, including a considerable number of new forms. In the following list these shallow water mollusca, from less than 60 fathoms, are not included, but many of them will be enumerated in a subsequent paper by Miss K. J. Bush, who has been able to determine a large proportion of them. But there is still a large quantity of fine mixed bottom materials to be examined from the shallower dredgings.

The results this year were highly satisfactory, both in the way of physical observations and zoological discoveries. Large numbers of additions were made to the fauna, including representatives of nearly all classes of deep-sea animals. Many pelagic species were also secured in the surface nets, and especially in the trawl-wings. Among these there are some new forms and many others, including some Pteropoda and Heteropoda, that have not previously been observed so far north in the Gulf Stream.

Character of the deep-sea deposits.

Some very interesting and important discoveries were made in regard to the nature of the materials composing the sea-bottom under the Gulf Stream at great depths. These observations are very important, as regards the distribution of the animal life, which often depends directly upon the nature of the bottom, and of great interest from a geological point of view. Some of these observations are contrary to the experience of other expeditions, and not in

accordance with the generally accepted theories of the nature of the deposits far from land.

The bottom between 600 and 2000 fathoms, in other regions, has generally been found to consist mainly of "globigerina ooze," or, as in some parts of the West Indian seas, of a mixture of globigerina and pteropod ooze. Off our northern coasts, however, although there is a more or less impure globigerina ooze, at such depths, in most localities beneath the Gulf Stream, this is by no means always the case. The ooze is always mixed with some sand and frequently with much clay-mud.

In a number of instances* the bottom between 500 and 1200 fathoms has been found to consist of tough and compact clay, so thoroughly hardened that many large angular masses, sometimes weighing more than fifty pounds, have been brought up in the trawl, and have not been washed away appreciably, notwithstanding the rapidity with which they have been drawn up through about two miles of water. In fact, these masses of hard clay resemble large angular blocks of stone, but when cut with a knife they have a consistency somewhat like hard castile soap, and in sections are mottled with lighter and darker tints of dull green, olive, and bluish gray. When dried they develop cracks and break up into angular fragments. This material is genuine clay, mixed with more or less sand, showing under the microscope grains of quartz and feldspar with some scales of mica. More or less of the shells of *Globigerina* and other Foraminifera are contained in the clay, but they make up a very small percentage of the material.

In other localities, in 1000 to 1600 fathoms,† the bottom is covered

* The following are some of the special localities where these clay masses were taken:

Station 2192, in 1060 fathoms, N. lat. 39° 46' 30", W. long. 70° 14' 45". Large blocks of sandy clay, some weighing about 100 pounds. It was estimated that about a ton was brought up.

Station 2230, in 1168 fathoms, N. lat. 38° 27', W. long. 73° 02'. Large quantity of masses of hard, but sticky greenish blue clay, some masses varying to yellowish and buff colors.

Station 2171, in 444 fathoms, N. lat. 37° 59' 30", W. long. 73° 48' 40". Large lumps of bluish gray sandy mud.

† The following are some of the localities where such materials occurred:

Station 2208, in 1178 fathoms, N. lat. 39° 33', W. long. 71° 16' 15". Large quantities of hard, crusty ferruginous clay. Also a rounded granite bowlder, weighing over 20 pounds.

Station 2228, in 1582 fathoms, N. lat. 37° 25', W. long. 73° 06'. Large quantity

with, or largely composed of, hard, very irregular, flattened, crust-like concretions of clay and iron-oxide, with more or less manganese-oxide in the crevices and worm-burrows with which they are filled. At some localities a barrelful, or more, of such masses was brought up. They vary in size from a few ounces up to 20 pounds or more in weight, and from one inch to six inches in thickness. These masses afford attachments to many kinds of animals, including several species of *Brachiopods*, *Chitons*, and other shells, which could not exist on bottoms of soft ooze or mud.

Rounded boulders and pebbles of granite, gneiss and other crystalline rocks occurred at a number of stations. These, like the concretions of clay, etc., often afford attachment for deep-sea *Brachiopods* and other shells, as well as for corals, gorgonians, hydroids, sponges, etc. One boulder, station 2208, is referred to above. The following are other localities: station 2195, in 1058 fathoms, N. lat. $39^{\circ} 44'$, W. long. $70^{\circ} 03'$. A rounded granite boulder, about four inches in diameter. Its surface was covered with adherent species of foraminifera and some annelid-tubes. Station 2226, in 2021 fathoms, N. lat. $37^{\circ} 00'$, W. long. $71^{\circ} 54'$. A large number of pebbles and small, rounded boulders of granite, porphyry, etc., and some coal cinders. The pebbles were more or less covered with adherent forminifera, bryozoa, etc. Scattered boulders and pebbles have also occurred at many other localities along the inner edge of the Gulf Stream. These have probably all been carried out there by the ice floating away from the adjacent coasts in spring.*

of irregular crusty and cavernous concretions and masses of ferruginous clay, with considerable black manganese-oxide lining the holes and cracks. The lower side of many of the masses consisted of sticky bluish clay. It was estimated that about a ton of this material came up. There were adhering to these hard masses some corals, gorgonians, hydroids and bryozoa, with the brachiopods, *Discina Atlantica* and *Waldheimia cranium*, in considerable numbers.

* A curious instance, quite unique in our experience, of the occurrence of abundant relics of human handiwork was observed this year. At station 2222, in 1537 fathoms, N. lat. $39^{\circ} 03' 15''$, W. long. $70^{\circ} 50' 45''$, beneath the Gulf Stream, a large quantity of common bricks, with mortar and soot still adhering to them, was brought up in the trawl. Some were nearly entire, but most were in fragments. Annelid tubes, brachiopods, and other forms of deep-sea life were attached to them in small quantities, showing that they had not been on the bottom very long. One of the Brachiopods, which occurred on the bricks in considerable numbers, is *Atretia gnomon* J., which had not been previously recorded from off our coast. These bricks may have come from a wreck, or they may have formed the deck-furnace of some whaling vessel, thrown overboard on the homeward trip. At any rate, the accident of hitting

In all our ten localities between 2000 and 3000 fathoms, the bottom has been "globigerina ooze." We have never met with the "red clay" which ought to occur at such depths, according to the observations made on the cruise of the Challenger.

The temperatures observed with the improved thermometers now used on the Albatross were between $36^{\circ}4$ and $37^{\circ}00$ F., in 2000 to 2600 fathoms. But temperatures essentially the same as these were also taken in 1000 to 1500 fathoms, and even in 965 fathoms one observation gave $36^{\circ}8$ F. It follows from these observations that nearly the minimum temperature is reached at about 1000 fathoms in this region.

CEPHALOPODA.

Ancistrocheirus megaptera Verrill, sp. nov.

PLATE XLII, FIGURES 1, 1a.

Body small, rather short, with an acute posterior end, extending a little beyond the posterior border of the fin. Fins very large, thick and strong, attached nearly the entire length of the body, and together forming a broad, rhombic figure, with the outer angles behind the middle; anteriorly the attachment of the fin does not reach quite to the edge of the mantle, and the front edge forms a slight rounded lobe in front of the attachment; posteriorly the fins are nearly united, across the back, but leave the acute, posterior tip of the body free for a short distance. The front edge of the mantle recedes in a broad curve ventrally, but has slightly prominent lateral lobes and a broad obtuse dorsal angle, which extends farther forward than the lateral ones. The head is rather large, with large eyes, furnished with thin free lids. The siphon is rather large, with two small dorsal bristles. The connective cartilages on its base are rather small, ear-shaped, much as in *Ommastrephes*. The arms are rather large, not very unequal in size, the dorsal ones slightly smaller than the others; all are unusually rounded and most of them, in our specimen, have lost their tips. They all bear two alternating rows of small, prominent sharp claws, which are not very closely arranged. The inner face is not separated from the sides by a distinct margin. The tentacular

upon the precise locality of such relics is very curious. Otherwise than in this instance we have rarely found in deep water any human traces except coal cinders from steamers.

arms are wanting. Color, in alcohol, orange-brown, due to numerous purple and brown specks scattered pretty uniformly over the surface, both above and below; the outer portions of the fins appear to have been transparent; the surface of the body appears to have been entirely smooth and destitute of tubercles, although the specimen is so much injured as to make this a little uncertain.

Length of body to front edge of mantle, 44^{mm}; length of free caudal portion, 6^{mm}; length of the attachment of fin, 34^{mm}; from front margin of fin to mantle edge, 3.5^{mm}; breadth across fins, 56^{mm}; length of head, from dorsal cartilage to base of dorsal arms, 19^{mm}; length of dorsal arms, 24^{mm}; diameter at base, 3.5^{mm}; diameter of lateral arms, 4^{mm}.

A single mutilated specimen (No. 40,128) was taken at station 2235, in 707 fathoms, 1884.

This species closely resembles *A. Veranyi*, recorded from the Indian Ocean, but it apparently differs from the latter in having larger fins and in being destitute of the rows of tubercles on the mantle; the arms also appear to differ in their proportions.

Teleoteuthis (Onychia) agilis Verrill, sp. nov.

PLATE XLII, FIGURES 2, 2a.

Body elongated, rather slender, with a rather small caudal fin, which is confined to about the posterior third of the body, and has a transversely rhombic form, with rounded angles and margins, the posterior edge is continuous across the end of the body, without any notch, and united to the body to its extreme tip. The dorsal mantle-edge is cut nearly square across, with only a faint angle in the middle; below each eye there is a somewhat prominent angle and the ventral side is regularly concave. The head is moderately large and the eyes are not very prominent. The arms are relatively long, prismatic, nearly equal in size and length, but the dorsal ones are somewhat shorter than the others. The third pair of arms are compressed and have a somewhat prominent keel on the distal half. The arms bear two regular, well separated rows of moderately large, suckers, largest along the middle of the arms, becoming smaller proximally, and disappearing above the base. The suckers are swollen in the middle and the somewhat contracted horny rim has the margin entire or nearly so. The sucker-bearing face of the arms is rather broad and margined on each side by a narrow but distinct membrane. The tentacular arms are slender, longer than the sessile

arms, with the terminal club elongated and somewhat expanded. The club bears two central rows of prominent, incurved hooks, about twelve in each row, not counting the very small ones near the tips; the hooks in the lower row are much larger than those in the upper; alternating with these, along each margin, there is a row of small suckers, which extend to the extreme tip, becoming there very minute; towards the tips the hooks are reduced to a single median row. At the base of the club there is a group of six to eight small smooth suckers intermixed with small rounded tubercles. The inner face of the arm below the suckers is flat and white.

The color, in alcohol, is rather deep purplish brown, both above and below, but paler beneath; it is due to rather large, rounded and very distinct, brown, orange and purple chromatophores. Similar chromatophores cover the outer surfaces of the arms, while the inner surfaces are specked with very dark brown ones.

Length from end of body to base of arms, 43^{mm}; to edge of mantle, 46^{mm}; to front margin of fin, 16^{mm}; breadth across fin, 21^{mm}; length of dorsal arms, 25^{mm}; length of second pair, 28^{mm}; length of third pair, 28^{mm}; length of ventral arms, 28^{mm}; length of tentacular arms, 30^{mm}; length of club, 12^{mm}; its breadth, 2^{mm}.

The name *Teleoteuthis* was proposed by me in 1881, in place of *Onychia* Les., because the latter was preoccupied for a genus of insects by Hubner in 1816.

One specimen (No. 40,129), was taken at the surface at station 2225, off Chesapeake Bay.

Benthoteuthis, gen. nov.

Body rather short, well-rounded, oblong, blunt posteriorly. Fins small, rounded, with a narrow insertion, situated close to the posterior end. Head broad. Eyes large, with distinct lids and small anterior sinus. Siphon short and wide, in a smooth groove, without bridles, internal valve well-developed. The dorsal mantle-edge is free, with an obtuse median angle, projecting over the back of the head. Arms small and short, the dorsal ones shortest; the lateral ones keeled externally; web rudimentary; marginal membranes on the inner angles narrow. Suckers small, crowded, apparently in four rows. Tentacular arms long and slender, the sucker-bearing portion scarcely enlarged, bearing numerous minute, subequal suckers in many rows.

The pen is very thin, expanded into a broad lanceolate blade posteriorly, very slender, with the edges incurved so as to form a groove

in the middle portion, becoming gradually a little wider to the anterior end, which is thin and pen-like in form. The posterior tip is imperfect in the specimen dissected.

The connective cartilages on the sides of the mantle are simple, elongated, broadest posteriorly, tapering anteriorly, and somewhat curved downward in the middle, with a long, narrow, simple central fosse. The connective cartilages on the sides of the mantle are low, simple, longitudinal ridges, running back from the lateral angles of the mantle-edge. In the female there are two pairs of oblong, flattened nidamental glands, one pair on the ventral side below the heart, the other pair a little farther forward, lying between the gills and intestines and surrounding the oviducts, which are symmetrically developed, one on each side. The ovary is large, occupying the posterior ventral portion of the body-cavity.

This interesting genus shows, in several respects, marked embryonic or primitive characters, recalling the young stages of *Ommastrephes* and *Loligo*. These are seen especially in the small size, posterior position and form of the fins; in the form of the body, head and mantle; in the small short arms, with the dorsal pair shortest; in the small simple suckers; in the want of differentiation of the tentacular club and the uniformity of its minute suckers. The affinities of the genus are probably with the group represented by *Ommastrephes*, as shown by the distinct eye-lids and sinus, and by the character of the connective cartilages of the mantle. The pen, however, is somewhat like that of *Loligo* in form, but the form of the pen appears to be of little value in determining the affinities of the squids.

Benthoteuthis megalops Verrill, sp. nov.

PLATE XLIV, FIGURE 1.

Body rather short, thick, rounded, tapering slightly from the anterior margin backward; posterior extremity bluntly rounded; fins small, situated close to the end of the body, attached by rather short bases to the sides of the body, nearest the dorsal side, but not united to the end of the body posteriorly. The fins are somewhat rounded in outline, projecting both forward and backward beyond their basal or attached portion, the free posterior margin extending backward as far as or beyond the end of the body, which shows, in a dorsal view, as a rounded lobe between the fins. The anterior margin of the mantle extends far forward over the back of the head, which it partially conceals; on the dorsal side there is a slightly prominent,

angular, median lobe; at the eyes the lateral margin recedes in a broad curve, but projects forward in an angular point below each eye, while the ventral portion is cut away in a broad curve, so as to expose the tip of the siphon. The head is short, broad, swollen laterally, owing to the large size of the eyes, which are furnished with free lids, having a small angular sinus in front. The siphon is short and broad, with a smooth, shallow cavity behind it, without any distinct bristles; within, it has a well-developed valve.

The arms are small and short, the ventral ones largest and longest; the two lateral pairs are nearly equal; the dorsal pair decidedly the shortest and smallest. The arms are united at the base by a rudimentary web; they are somewhat angular at base and taper somewhat rapidly to slender tips; the inner surface is thickly covered with very small suckers, which appear to form about four irregular rows. The lateral arms have a narrow, membranous keel along the outer side, and all have narrow marginal membranes along the sucker-bearing surface. The tentacular arms are very long and slender, many times the length of the sessile arms, but more slender; they are rounded and of nearly uniform size throughout; the sucker-bearing portion is neither expanded into a club nor distinctly flattened, but bears a large number of very minute suckers arranged in many rows along the inner surface, the number of rows diminishing proximally.

Color, in alcohol, dark reddish brown over the entire surface of the body, head, and sessile arms, with the tentacular arms yellowish white. The color is due to very numerous and densely crowded chromatophores of rather large size. The color is most intense on the upper surfaces of the head and sessile arms; the lower side of the body is somewhat paler than the upper side. The eyeballs outside of the pupil are dull blue.

Length of a female specimen, from the posterior end to the anterior dorsal edge of the mantle, 57^{mm}; from the posterior end of the body to the anterior insertion of fins, 9^{mm}; to the posterior insertion, 2.5^{mm}; length of fin, 7^{mm}; breadth across both fins, about 26^{mm}; breadth across mantle anteriorly, 21^{mm}; length of head from dorsal cartilage to base of dorsal arms, 17^{mm}; from anterior edge of mantle to base of dorsal arms, 8^{mm}; length of dorsal arms, 20^{mm}; length of second pair, 23^{mm}; length of third pair, 23^{mm}; length of ventral arms, 25^{mm}; length of tentacular arms, 85^{mm}; greatest diameter, 2^{mm}; length of sucker-bearing portion, 13^{mm}; its diameter, about 1^{mm}.

Off Martha's Vineyard, at stations 2189 and 2205, in 600 and 1,073 fathoms (Nos. 39,967 and 39,968).

Cirrhoteuthis plena Verrill, sp. nov.

PLATE XLII, FIGURE 3.

Body broad, thick and short, broadly rounded posteriorly, with the lateral fins inserted well forward, just behind the eyes, their front edges a little behind the gill-opening. The fins are large, thin and broad, with the edges nearly parallel to near the end, which is broadly rounded. The head is as broad as the body and very short. The eyes are relatively small, wide apart, situated in line with the siphon transversely; the lids, in alcohol, are slightly thickened and surround a small elliptical opening. The siphon-tube is small, but prominent and well-developed, expanding to the base. The gill-opening is small and simple, in breadth only slightly exceeding the breadth of the basal part of the siphon.

The arms are long, rather stout, the four upper ones decidedly longer than the four lower, the ventral ones shortest. They are united by a thick, strong web, which, on the upper side between the dorsal arms, extends about two-thirds the length of the arms. It decreases in width between the lateral arms. Between the third and fourth pairs it is about one-half the length of the ventral arms, and between the ventrals about one-third their length. The suckers are rather large for the group, largest at about the basal third, those near the mouth becoming very small. They are arranged rather close together in a single linear series, but sometimes show a slight tendency to become alternate at the basal third of the lateral arms; they are usually separated along the center of the arms by spaces about equal to their own diameter. There are about fifty-five suckers on the dorsal arms, of which about thirty occupy the portion within the web. The tips of the arms, when perfect, are rapidly tapered, rather thin and not much elongated, and bear fifteen to twenty small suckers, which are here nearly in contact. The cirri are rather short, tapered, acute, and usually stand nearly opposite the suckers, forming a row on each side, along the inner face of the arm.

The color of the body and external surface of the web, in alcohol, is a yellowish flesh-color, with a somewhat translucent, gelatinous appearance, with the darker internal organs showing through more or less distinctly. The fins are deep brown, darker towards the tips. The inner surfaces of the arms and web with the cirri, are dark purplish brown, while the suckers are dull brownish yellow.

Total length, 185^{mm}; length of body to gill-opening, 57^{mm}; length to base of ventral arms, 70^{mm}; breadth of body between bases of

fins, 58^{mm}; length of fins, 32^{mm}; their breadth near base, 24^{mm}; total breadth from tip to tip of fins, 130^{mm}; diameter of eye, 12^{mm}; breadth of gill-opening, 12^{mm}; length of siphon, 14^{mm}; length of dorsal arms, 125^{mm}; length of web between dorsal arms, 70^{mm}; length of second pair of arms, 120^{mm}; length of web between dorsal and first lateral arms, 60^{mm}; length of the third pair, 110^{mm}; length of web between third and fourth pairs of arms, 55^{mm}; length of fourth pair of arms, 95^{mm}; breadth of web between the ventral arms, 35^{mm}; diameter of largest suckers, 2.5^{mm}; length of longest cirri, 3 to 4^{mm}.

A single specimen in good condition was taken at station 2205, N. lat. 37° 35', W. long. 71° 18' 45", in 1,073 fathoms, gray ooze, bottom temperature 38° F., August 20, 1884. (No. 39,908.)

Cirrhoteuthis megaptera Verrill, sp. nov.

PLATE XLIII, FIGURES 1, 2.

Body small, very short, depressed, broadly rounded posteriorly, broader than long. Fins very long and narrow, their length considerably exceeding the breadth of the body, in alcoholic specimens; toward the base they are much thickened and supported by an internal cartilage, which does not appear to be continuous with the thin cartilage that extends across the body, just behind the fins. The fins are inserted just behind the eyes, and their breadth is somewhat greater in the middle than at the base; they narrow but little toward the tip, which is obtusely rounded. Head large and broad, exceeding the body in size and thickness in the preserved specimens, the greatest thickness being at the base of the arms. Eyes small, lateral, very far apart, the distance between them being, on the dorsal side, more than twice their diameter. Siphon short, conical, with a broad base. Gill-opening small, simple, only a little broader than the base of the siphon. Arms long, thick and strong, the dorsal ones a little longer than the others, which decrease successively to the ventral pair, which are, however, but little shorter than the third pair. The arms are thick and well rounded, especially on the basal portion, with the inner surface elevated along the median line, on which the suckers are arranged in a simple row; the marginal angles are but slightly indicated, and bear a row of small, slender, tapering cirri, alternating with the suckers, which are very small, urceolate, strongly elevated above the surface of the arms, and of a light yellow color, in strong contrast with the chocolate-brown of the arms. The distance between the suckers along the middle portion of the arm usually

considerably exceeds, and is often double their diameter, but varies with the state of contraction of the arms; at the base of the arms they diminish in size and become more crowded; towards the ends they diminish very gradually, finally becoming very small and closely arranged. The web between the arms is very thick, swollen at the base, and on the dorsal side extends more than half the length of the arms; it is successively a little shorter between the lateral arms, and still shorter between the ventral ones. The color of the body and fins in the alcoholic specimens is bluish white, covered with rather large and irregularly arranged specks and spots of purplish brown. The same color extends more or less on the head, becoming paler and more gelatinous or translucent on the web at the base of the arms, through which the dark brown color of the arms can be distinctly seen. The arms, the outer portion of the web, and its entire inner surface are dark chocolate-brown. The suckers are yellowish white, with brown rims.

Total length, in alcohol, 107^{mm} ; length of body to gill-opening, 25^{mm} ; breadth of body at base of fins, 20^{mm} ; total breadth across outstretched fins, 68^{mm} ; length of fins from base to tip, 24^{mm} ; breadth across middle, 9^{mm} ; at base, 8^{mm} ; breadth of head at the eyes, 27^{mm} ; across base of arms, 30^{mm} ; diameter of eyes, 9^{mm} ; breadth of gill-opening, 8^{mm} ; length of siphon, 8^{mm} ; length of dorsal arms, 95^{mm} ; breadth in middle, 6.7^{mm} ; diameter of largest suckers, 1^{mm} ; length of the longest cirri, 2^{mm} ; length of second pair, 85^{mm} ; third pair, 80^{mm} ; ventral pair, 78^{mm} ; extent of web between dorsal arms, 45^{mm} ; between first and second pairs, 42^{mm} ; between the third and fourth, 32^{mm} . The other specimen of this species has the body and head of nearly the same size, but these parts may be more contracted by the alcohol; the fins and arms are somewhat longer and larger. The length of one of the fins is 33^{mm} ; its greatest breadth, 11^{mm} ; breadth across eyes, 27^{mm} ; diameter of eye, 8^{mm} ; diameter of largest sucker, less than 1^{mm} .

The sex of the two specimens described above is uncertain. There is no positive appearance of hectocotylization in any of the arms, but in the specimen first described the left arm of the second pair has a blunt, pale tip, before which the suckers cease abruptly, yet this is most likely due to the early stages of the reproduction of a new tip.

Sketches of this species were made by Mr. A. Baldwin, on the steamer, when the specimens first came up and had some life. From his sketches the figures on plate xliii have been made.

In the living state, according to these and other sketches, the fins

are much larger and broader, with the end more rounded; and the anterior edge is thinner and more convex, than after preservation in alcohol, though the length is not much greater in proportion. The web appears broader, and the arms longer. In one specimen, from station 2224, the body is more elongated behind the fins than in the others, while the long and very broad fins are placed some distance back from the eyes, or about midway between the eyes and the end of the body, and the web does not extend half the length of the arms. It was at first thought that this individual might represent another species, but these creatures are evidently capable of changing their forms and proportions to a great extent, according to the state of contraction of their various parts.

Both the larger specimens of this species have a curious appendage on most, if not all, of the arms. This is a fleshy, tentacle-like process, with a somewhat thickened base, and a tapering, acute tip. It is situated at about the distal third of the arm, on the posterior side, near the edge of the web, and diverges widely from the arm. In one specimen this is present on all the arms of the left side and on two of those on the right side. On the other arms they probably have been destroyed, the arms being injured. The length of this organ is about equal to the breadth of the arms. When perfect these organs, which are muscular, were probably united to the web, and served to support or strengthen it. I am not aware that an organ of this kind has before been observed among the Cephalopods. But it may, perhaps, correspond to one of the transverse supports of the marginal membranes of *Sthenoteuthis* and *Ommastrephes*.

Two specimens (No. 39,963) were taken at station 2,225, N. lat. $36^{\circ} 05' 30''$, W. long. $69^{\circ} 51' 45''$, in 2,512 fathoms, on yellow ooze, bottom temperature 37° F.; and two at station 2,224, N. lat. $36^{\circ} 16' 30''$, W. long. $68^{\circ} 21'$, in 2,574 fathoms, globigerina ooze.

A small specimen, from station 2,220, appears to be a younger stage of this species, with which it agrees, in the small, short body; the narrow, elongated fins, and the comparatively small eyes, as well as in the chocolate-brown color of the inner surfaces of the arms and web; but the external surfaces of the body, web and arms are also strongly colored with deep brown. The arms in this specimen are nearly equal in length, the ventral ones, being a little shorter than the others. The web appears to extend farther toward the tips of the arms than in the larger examples, but this may be due to better preservation. The suckers are small, prominent, and closely arranged.

The total length of this specimen is 43^{mm}; posterior end of body to gill-opening, 13^{mm}; breadth of body at fins, 13^{mm}; length of fins, 9^{mm}; breadth, 4.5^{mm}; breadth of head across eyes, 17^{mm}; diameter of eye, 7^{mm}; from center of eye to tip of dorsal arms, 34^{mm}; to edge of web between dorsal arms, 23^{mm}; to tip of lateral arms, 31^{mm}; to edge of lateral web, 21^{mm}.

Station 2,220, N. lat. 39° 43' 30", W. long. 69° 23', in 1,054 fathoms, (No. 39,916).

This species appears to be closely related to *C. plena* in most respects, but has a very much smaller and shorter body, larger and relatively much longer fins, and the eyes are relatively smaller. The suckers are also smaller, more prominent, and less closely arranged, while the cirri are somewhat longer and more slender. The color of the body and arms is also much darker, and the texture less gelatinous.

Opisthoteuthis Agassizii Verrill.

Supplement to the Cephalopoda of the Blake Exp., p. 113, pl. 1, fig. 1, pl. 2, fig. 1, Bull. Mus. Comp. Zool., vol. xi, No. 6, 1883.

A specimen apparently belonging to this remarkable species was taken at station 2,196, N. lat. 39° 35', W. long. 70° 03', in 1,058 fathoms, green mud and stones (No. 39,915). Although in good condition when taken, it was accidentally left too long in sea-water until decomposition had commenced, consequently the greater part of the body and the contained viscera were destroyed. The body seems to have been short and rounded. The lateral fins are narrow, elongated, slightly broadest in the middle, tapered to the blunt tips, with the edges thin. They are situated just behind and in contact with the posterior side of the eyes. The eyes are exceedingly large, occupying nearly the whole breadth of the head, nearly spherical, with the external opening rather large, and with a thin lid on the lower side. The siphon is prominent, elongated, somewhat tapered, and projects backward and upward behind the posterior end of the body. The gill-opening is moderate in size, simple, with a thin, brown margin, and is situated between the siphon and the postero-ventral surface of the body, so that it opens upward and backward, when the creature is in a creeping position. The arms are nearly equal in size and length, not very long, but with slender tips, moderately stout, especially toward the base, well rounded, the inner face without any well-defined margins. The web, as preserved in alcohol, extends

about half the length of the arms, and is nearly equal all around, but is, perhaps, a little broader between the dorsal arms. The suckers are small, yellowish white, a little prominent, arranged rather closely in a single median row. The largest ones are near the base of the arms, about the fifth to the eighth from the base; beyond these they decrease regularly to the tips of the arms, where they become small and close. The cirri are rather small, tapered, acute, placed alternately with the suckers and not very far from them, the interval being about equal to the diameter of the suckers; they commence between the fifth and sixth suckers, and apparently continue to the tips of the arms, becoming gradually very small. On each of the arms there are thickened muscular appendages, similar to those of the preceding species, but shorter and broader. They arise from the posterior face of the arm, nearly at right angles, at the point near where the interbrachial web joins (or becomes) the marginal membrane of the arm, and are closely united to the web, apparently serving to strengthen it. Their length is about equal to the breadth of the arm.

The color, so far as preserved in alcohol, is deep chocolate-brown on the inner surface of the arms and web, with a median band of somewhat darker brown occupying the inner face of the arms. On the upper surface of the web, head, and body the color is destroyed, but it appears to have been brown.

Length of longest arms, 66 to 70^{mm}; breadth of arms near base, 7^{mm}; breadth of head across eyes, 26^{mm}; diameter of eyes, 14^{mm}; length of fins, 11^{mm}; breadth, 6^{mm}; length of arms from edge of intermediate web, 35^{mm}; diameter of largest sucker, 1^{mm}; length of cirri, 2^{mm}.

Stauroteuthis syrtensis Verrill.

Amer. Journ. Sci., xviii, p. 468, 1879, Trans. Conn. Acad., v, p. 382, pl. 32, figs 1—5, 1881; vi, p. 249, 1883.

A small specimen, apparently identical with this species, was taken at station 2,180. In this the body is small, narrow, somewhat elongated or ovate in form, while the arms are very much elongated, with a very broad, loose web extending nearly to the end. The cirri are very long and slender, thread-like. The suckers are rather small, little elevated, and wide apart. The fins are relatively large, broadest at the base, which is placed well forward, lanceolate in form, tapering toward the end, which is blunt. The eyes are moderately large,

not very far apart, the head being narrower than in most of the related forms. The gill-opening is a small, rounded pore, with a thickened margin, situated about opposite the eyes. The siphon is not visible; it may have been broken off, or may be retracted. The whole texture is extremely soft and gelatinous. The color of the external surfaces is translucent dull bluish gray; the inner surfaces of the arms are tinged with chocolate-brown.

The total length is about 125^{mm}; posterior end of body to gill-opening, 20^{mm}; breadth of body at fins, 14^{mm}; breadth across eyes, 14^{mm}; diameter of eyes, 6^{mm}; length of fins, 12^{mm}; breadth at base, 9^{mm}; length of longest arms from center of eye, 107^{mm}; to edge of web, 74^{mm}; length of cirri, about 10^{mm}.

Station 2,180, N. lat. 39° 25' 50", W. long. 71° 49' 30", in 523 fathoms, bottom temperature, 39° F. (No. 39,965).

Eggs of Cirrhoteuthis or Stauroteuthis.

Very peculiar eggs, belonging to cephalopods of this group, have often been dredged by us in deep water. They are usually attached to the stem or branches of *Acanella Normani* or other gorgonians. Similar eggs were often found attached to the same corals brought in from the deep water of the northern fishing banks by the Gloucester halibut fishermen, since 1879. None of these contained embryos sufficiently developed to render their identification possible, until some were dredged last summer, at station 2209, in 1,080 fathoms (No. 39,961), containing well-formed embryos, so far developed as to show that they belong to *Cirrhoteuthis* or some closely allied genus. These embryos have a well-developed body, rounded behind, with relatively large, rather broad lateral fins, having the outer ends broadly rounded, situated far forward and as long as the breadth of the body. The eyes are relatively large and prominent, or somewhat stalked. The arms are slender, rounded, with a simple close median row of small suckers. The web is but little developed, the arms being free nearly to the base. The siphon-tube is prominent and the gill-opening is simple and small, but relatively larger than in *Stauroteuthis syrtensis*. It is probable, therefore, that this embryo belongs to one of the species of *Cirrhoteuthis* described above. The eggs may belong to more than one species, but show no tangible external differences.

These eggs are contained in a strong but flexible case, about an inch long, elliptical in form, but often somewhat irregular on the

sides that are attached to the coral-branches which are usually so deeply imbedded that they seem to pass through the side of the case. The inner surface of the case is smooth, but the outer surface is more or less rough and uneven, and usually covered with a thin adherent coat of greenish mud. The egg itself is much smaller than the interior of the case. It is covered with a firm, smooth, transparent shell. The form is usually a pretty regular ellipsoid, sometimes varying to ovate. The color is orange or salmon.

The egg-cases are from 20^{mm} to 26^{mm} long; 14 to 17^{mm} broad. The eggs in alcohol are 15^{mm} long; diameter, 12^{mm}. Another one is 16^{mm} long; 11^{mm} in diameter.

These eggs have been dredged at stations 2051, 2072, 2205, 2209, 2210, 2212, and in other localities, in 428 to 1,106 fathoms.

GASTROPODA.

Pleurotomella Jeffreysii Verrill, sp. nov.

- PLATE XLIV, FIGURE 3.

Shell rather large, elongated fusiform, with a tall, acute, turreted spire, consisting of about seven whorls besides the nucleus, which contains about four brown whorls. The whorls have a rather conspicuous shoulder, below which they are flattened, but above it they have a broad, sloping, decidedly concave, subsutural band. The suture is distinct, but not at all impressed, owing to the flattening of the whorls. The sculpture consists of a row of prominent, oblique, elongated nodules at the shoulder; those on the upper whorls relatively more prominent and angular than on the lower ones; these nodules are continued downward in the form of slightly raised, obliquely curved ribs, which extend nearly across the upper whorls, but fade out a short distance below the suture on the lower ones. The whorls are also crossed by distinct lines of growth which curve strongly forward on the middle of the last whorl and recede in a strong regular curve on the subsutural band, where they are numerous and fine, but on the upper whorls part of them become more prominent near the suture. The whorls below the shoulder are also covered with numerous, impressed, regular, revolving grooves, separated by intervals of somewhat greater width; these revolving furrows are crossed by the lines of growth in such a way as to make them wavy or crinkled. The revolving lines are mostly absent above the

shoulder. The nucleus, which consists of four whorls, is chestnut-brown in color, large, regularly tapered, very acute, the apical whorl being very minute, but regularly coiled; the three lower nuclear whorls are very minutely decussated by two sets of very fine, oblique lines. The aperture is long, rather narrow, with the posterior end acutely angled; the siphon is nearly straight, rather long and narrow. The columella is nearly straight; the outer lip curves strongly forward in the middle and has a rather broad and deep, rounded sinus situated a little below the suture.

The entire shell below the nucleus is translucent bluish white in live specimens, and the surface is lustrous.

Length of the largest specimen, 52^{mm}; breadth, 18^{mm}; length of last whorl in front, 36^{mm}; length of aperture, 27^{mm}; its greatest breadth, 8^{mm}; length of nucleus, 2^{mm}.

The largest specimen, which was dead, occurred at station 2,230, in 1,168 fathoms (No. 44,650); a smaller, living specimen (No. 44,649), was taken at station 2,222, in 1,537 fathoms.

This fine species is named in honor of Mr. George Gwyn Jeffreys, the distinguished conchologist.

Pleurotomella tincta Verrill, sp. nov.

PLATE XLIV, FIGURE 4.

Shell moderately large, somewhat stout, nearly regularly fusiform, rather thin, delicate and translucent in texture, in the living specimens having a light chestnut-brown color and a lustrous surface. The spire is rather short, rapidly tapered, acute. The largest specimen consists of five whorls besides the nucleus, which apparently contains about two and one-half whorls, but is eroded in both of our specimens.

The whorls of the spire have a distinct, nodulous shoulder and a broad, sloping, concave subsutural band, occupying about one-half the breadth of the whorls; on the last whorl the shoulder is convexly rounded and destitute of nodules, but is crossed by numerous, distinct, flexuous lines of growth which rise into distinct, sharply raised riblets on the subsutural band just below the suture; the surface is also covered, except on the subsutural band, by numerous small, regular, sharply impressed grooves, which appear a little wavy or crinkled, owing to the crossing of the lines of growth; the grooves are separated by smooth, flattened interspaces exceeding their own width. On the preceding whorls the nodules on the shoulder are

prolonged downward obliquely in the form of small riblets, which, on the subsutural band, become strongly excurved, thinner and more sharply raised; these whorls are also sculptured by a few, distinct, raised, spiral lines, both below the shoulder and on the lower part of the broad subsutural band. The nucleus appears to have been regularly tapered and finely cancellated, but is eroded in both specimens. The aperture is rather large, elongated, fusiform, with an acute posterior angle and a short, straight canal a little constricted at the base; the columella is nearly straight, with its edge only slightly sinuous.

The color of the shell within is dull flesh-color, with a patch of brown on the columella; externally the color is brownish salmon or pale chestnut-brown.

Length of the largest specimen, 22^{mm}; greatest breadth, 11^{mm}; length of body-whorl in front, 17^{mm}; length of aperture, 14^{mm}; greatest breadth, 4^{mm}.

The living specimen (No. 44,652), described above, was taken at station 2,225, in 2,512 fathoms, N. lat. 36°, 05', 30"; W. long. 69°, 51', 45". A smaller, dead specimen (No. 44,651), occurred at station 2,224, in 2,574 fathoms.

This species bears considerable resemblance to *P. Emertoni* V. in form and general appearance, but differs very decidedly in color and the details of its sculpture.

Pleurotomella Frielei Verrill, sp. nov.

PLATE XLIV, FIGURE 5.

Shell of moderate size, rather thick and solid, elongate-ovate or subfusiform, with a rather long, regularly tapered spire, consisting of about six whorls below the nucleus, which is small and consists of two or more whorls, eroded in our specimens. The whorls of the spire are a little convex and slightly angulated or shouldered just above the middle, and have a rather broad, slightly concave subsutural band; the last whorl is more evenly convex and the shoulder is rounded and rather indistinct.

The surface is covered with numerous rather fine, flexuous riblets, parallel with the lines of growth; these curve forward on the middle of the whorl below the shoulder, but are strongly excurved in crossing the subsutural band, and become thin and more prominent just below the suture, which is distinctly impressed. The surface is also covered with very numerous thin, revolving cinguli, which are sepa-

rated by intervals of about the same width; these extend over the subsutural band, but are there a little less prominent; on the convex part of the whorls they are wavy and irregularly decussated by the lines of growth; on the spire the two sets of lines produce a cancellated structure. The aperture is short and rather broad, with an acute angle posteriorly and a short, broad, straight canal in front; the columella is short, nearly straight, with the inner edge strongly sinuous and obliquely cut away at the end. The inner lip is strongly excavated at the base of the columella; the outer lip is regularly curved, except above the shoulder, where it is slightly flattened and sloping; in the middle it projects considerably forward in a broad curve, but the posterior sinus is broad, rather deep, well-rounded, and deepest just above the shoulder.

Color, grayish or yellowish white externally, bluish white within; in one specimen with a conspicuous reddish brown patch on the columella margin.

Length, 22^{mm}; greatest breadth, 10^{mm}; length of body-whorl, in front, 15^{mm}; length of aperture, 11^{mm}; breadth of aperture, 5^{mm}.

Two living specimens (No. 44,653), were taken at station 2,208, in 1,178 fathoms, N. lat. 39° 33'; W. long. 71° 16' 15".

This species is named in honor of Mr. Herman Friele, the able conchologist of the Norwegian Arctic expeditions.

Pleurotomella vitrea Verrill, sp. nov.

PLATE XLIV, FIGURE 6.

Shell small, thin, delicate, translucent bluish white, rather stout, fusiform, with angular whorls and an acute spire. Whorls four and one-half, besides the nucleus, which is small, acute and consists of about three chestnut-brown whorls. The whorls of the spire are angulated and somewhat carinated at about the middle, where there is a band of angular tubercles. The subsutural band is broad, sloping, flattened or sometimes distinctly concave, and occupies more than half the breadth of the whorls.

The sculpture consists of about twelve to fourteen oblique, somewhat angular and prominent transverse ribs, separated by broader, concave intervals, rising at the shoulder into small angular tubercles, on the subsutural band becoming much smaller and strongly excurved in the middle, like the lines of growth, and rising into small, sharp lamellæ just below the suture. The surface is also covered with very distinct, raised, revolving cinguli, separated by

intervals usually considerably exceeding their breadth, but becoming narrower at the base of the canal, much smaller and less distinct on the subsutural band and usually absent on its upper part. On the lower whorls of the spire there are usually about four of the larger revolving cinguli, of which the uppermost forms the carina at the shoulder; they cross alike the ribs and their intervals, often rising into little tubercles in crossing the ribs. The nucleus is small, regularly tapered, very acute, the first whorl being very minute; its whorls are minutely reticulated by two sets of fine, oblique lines. The aperture is fusiform, with an acute posterior angle and a strongly excavated inner margin; the outer lip is thin, somewhat angulated at the shoulder, with a broad, shallow sinus just above it. The canal is a little elongated, tapered, slightly constricted at its base by the slight incurvature of the outer lip. The columella is nearly straight, with a strongly sinuated inner margin. The surface is lustrous and the texture somewhat vitreous, with a bluish white tint. There is no operculum.

Length, 8^{mm}; breadth, 5^{mm}; length of aperture, 5^{mm}; its breadth, 2^{mm}. A somewhat more slender specimen measures in length, 9^{mm}; in breadth, 4.6^{mm}; length of body-whorl, 7^{mm}; length of aperture, 5.5^{mm}; breadth, 2.3^{mm}.

Station 2,212, in 428 fathoms, one living specimen (No. 44,654); station 2,213, in 384 fathoms, two living specimens (No. 40,472).

This delicate species has a general resemblance to several others of this genus, such as *P. bandella* Dall., *P. Sandersoni* V., and the young of *P. Agassizii*, but it differs from all these in its more delicate texture, greater transparency, and small, very acute nucleus, as well as in the details of its sculpture. Its subsutural band is unusually broad, and the whorls are decidedly angulated in the middle.

Pleurotomella Lottæ Verrill, sp. nov.

PLATE XLIV, FIGURE 7.

Shell small, short, ovate-fusiform, moderately stout, with slightly shouldered, convex whorls, and a regularly tapered, acute spire. Suture shallow, but well-marked. Whorls about four and one-half, besides the large nucleus, which consists of about three and one-half gradually increasing whorls. The whorls of the spire are obscurely shouldered at about the middle, above which the broad, sloping subsutural band is slightly concave.

The sculpture on the penultimate whorl consists of about six elevated, rounded, revolving cinguli, with some much finer intermediate

ones; some of the smaller cinguli are also found on the subsutural band. The transverse sculpture consists of fine, slightly flexuous lines of growth, crossing both the cinguli and their intervals, and on the subsutural band becoming more prominent in the form of oblique, recurved riblets, which do not take the form of nodules. On the last whorl the revolving cinguli continue at about uniform distances over the entire whorl and canal, but anteriorly the cinguli thicken and are wider than the grooves, while on the convex part of the whorl they are narrower than the intervals.

The aperture is broad-ovate, rather large, acute posteriorly; the outer lip is thin, strongly convex in the middle, with a broad and shallow posterior sinus above the shoulder. The canal is short, straight, not contracted at the base. The columella is straight in the middle, with an oblique anterior edge; the inner margin of the aperture is strongly excavated and subangular at the base of the columella. Umbilicus none. The animal is destitute of an operculum.

The nuclear whorls are deep chestnut-brown, very minutely reticulated by oblique lines running in two directions. The whorls are regularly convex, the apical ones minute and a little prominent, so that the apex is acute.

Color of the shell below the brown nucleus translucent bluish white, with a somewhat glossy surface; when dead, yellowish white.

Length of the type-specimen, 11^{mm}; breadth, 7^{mm}; length of body-whorl and canal, 7·5^{mm}; length of aperture, 6^{mm}; its breadth, 2·8^{mm}. Another somewhat larger and stouter specimen is 11·5^{mm} long; breadth, 7·5^{mm}; length of body-whorl and canal, 8^{mm}; length of aperture, 6·3^{mm}; its breadth, 3·8^{mm}.

Station 2,221, N. lat. 39° 05' 30", W. long. 70° 44' 30", in 1,525 fathoms; two specimens (No. 40,498).

This shell bears little resemblance to any of our other species except *P. Bruneri*. It differs from the latter in having a higher and more acute spire, with the whorls less strongly shouldered and the subsutural band much less convex; the canal is shorter; the aperture relatively broader, and the inner margin more excavated at the base of the columella; the spiral cinguli are fewer, stronger, more prominent, and more sharply cut; the transverse lines are less strongly recurved in crossing the subsutural band, but become more prominent close to the suture; the posterior sinus of the lip is much shallower and less distinct; the nucleus is similar in the two forms, but is a little more acute in the present species. From all the other species it differs so widely that no detailed comparison is necessary.

This beautiful and delicate species is named in honor of Miss Charlotte E. Bush, one of the excellent assistants who have aided me in my work on the conchological collections of the U. S. Fish Commission.

Gymnobela brevis Verrill, sp. nov.

Shell small, short, stout, with a short, turreted spire, having squarely shouldered lower whorls. The nucleus is eroded in all of our specimens, but apparently consist of three whorls, which rapidly enlarge, the third having its surface covered with regular spiral lines crossed by slight thin ribs; on the next whorl the revolving lines become more prominent, about four of them situated below the shoulder, which is sloping, and one or two above it; these are crossed by longitudinal ribs of about the same size, producing a decussated structure. On the last whorl the spiral lines become thicker and stronger and the ribs become stouter, more elevated and obtuse, separated by wider intervals, and run down somewhat obliquely and fade out at about the middle of the whorl; the spiral lines form minute nodules in crossing the ribs; above the shoulder, which is strongly angular, the ribs are thin, only little raised, and bend obliquely forward without much curvature on the subsutural band, which rises abruptly from the suture, sloping but little, and is somewhat concave in the middle and a little swollen close to the suture.

The aperture is short and broad, angulated at the shoulder, strongly excurved at the base of the columella, which is short and straight, with a strongly sinuous inner margin; the posterior sinus is broad, shallow and inconspicuous. The canal is very short and broad, not constricted, rounded at the end. Color, white.

Length, 8^{mm}; breadth, 5.5^{mm}; length of body-whorl, 6^{mm}; length of aperture, 5^{mm}; its breadth 2.20^{mm}.

Station 2,041, in 1,608 fathoms, one specimen (No. 34,838); and station 2,084, in 1,290 fathoms, 1883. Station 2,229, in 1,423 fathoms, 1884.

Bela Blakei Verrill, sp. nov.

PLATE XLIV, FIGURE 8.

Shell of good size for the genus, stout, fusiform, with turreted spire and shouldered whorls, having a circle of nodules just below the suture and another at the shoulder. Whorls about five and a

half, of which three belong to the nucleus, which is rather large, regularly coiled, the apical whorl rather small, a little depressed, white and polished; the second whorl is also polished, but crossed by very fine lines of growth; the last nuclear whorl has about five raised, revolving cinguli in addition to the lines of growth.

The lower whorls are crossed by numerous rather straight, obtuse ribs, separated by intervals of about their own breadth; of these there are about twenty-four on the last whorl. Each of these ribs rises into a rounded, rather prominent tubercle at the shoulder; they are faintly marked and oblique on the concave subsutural band, but form another circle of obtuse tubercles just below the suture; anteriorly they fade out at about the middle of the body-whorl. The suture itself is impressed and undulated. The surface, both of the ribs and intervals, is covered by close but distinct lines of growth. At the shoulder a distinct revolving carina connects the tubercles together; below this there are pretty regular, well-developed revolving cinguli, which are rounded and separated by rather wide intervals, and cross both ribs and interspaces, but in crossing the ribs they become more prominent and form oblong nodules on the upper part of the whorl; on the lower part of the whorl and siphon they are a little wider, more spaced, and roughened only by the raised lines of growth. On the penultimate whorl there are three or four revolving cinguli below the carina. The subsutural band is strongly marked, broad and decidedly concave, and is covered with slightly curved, oblique lines of growth and faint ribs, and has a single, small, revolving cingulus in the middle. The aperture is long, ovate-fusiform, angulated at the outer lip, and with an acute posterior angle; anteriorly it is narrowed into the moderately long straight canal; the posterior sinus is nearly obsolete. Columella straight, with a sinuous inner margin. Operculum greenish yellow, ovate, obtusely rounded posteriorly, subspiral anteriorly, with the nucleus near the inner anterior edge. Epidermis pale yellow, thin, closely adherent. Color of the shell within, bluish white; nucleus white.

Length, 16^{mm}; breadth, 8^{mm}; length of body-whorl in front, 7^{mm}; length of aperture, 5^{mm}; its breadth, 3.5^{mm}; length of operculum, 4.5^{mm}; its breadth, 3^{mm}.

A single living specimen (No. 44,655), was taken at station 2,226, in 2,021 fathoms, N. lat. 37° 00', W. long. 71° 54'.

This fine species has some resemblance to the northern *B. scalaris*, but has a finer and more regular sculpture, and is easily distinguished by the distinct circle of nodules just below the suture, a peculiarity

which is also found in many species of *Pleurotomella*. The character of the nucleus and the presence of an operculum shows that this is a true *Bela*.

This shell has been named in honor of Mr. J. H. Blake, who was a member of the U. S. Fish Commission Party in 1874, 1875 and 1884.

Bela tenuicostata G. O. Sars.

Moll. Arcticae Norvegiae, p. 237, pl. 17, figs. 1, *a*, *b*, pl. ix, fig. 6 (dentition), 1878.

This species occurred living at station 2076, in 906 fathoms; station 2084, in 1,290 fathoms, one living specimen (No. 35,179); and at station 2115, in 843 fathoms, one living example (No. 35,595).

These appear to be in all respects like the European form, which is, apparently, a valid species, belonging to the deep sea fauna. The form referred by me in the first Catalogue Marine Mollusca (these Trans., v, p. 481), to this species, which was then regarded by me as a variety of *B. decussata*, is coarser in sculpture, and is doubtless a variety of the latter.

The true *B. tenuicostata* now recorded is remarkable for its delicate texture and fine reticulated sculpture.

Admete nodosa Verrill and Smith, sp. nov.

PLATE XLIV, FIGURE 9.

Shell rather small, thick and solid, short, stout, with coarsely ribbed and rudely nodulous, convex whorls. The spire is short and rapidly tapered, with the apex apparently blunt, but eroded in both of our specimens. Whorls apparently four to five; the last two whorls are strongly convex with a well impressed suture. The last whorl is surrounded by five rows of rather large and coarse, prominent nodules, joined together by low, revolving ridges and situated upon about twelve, broad, low, rounded or wave-like ribs. On the penultimate whorl the ribs are more prominent and continue across the whorl and bear about three rows of nodules. The aperture is short, broad-ovate, more acute behind than in front; the canal is very short and broad flaring, widely opened and twisted a little to the left, but does not cause any interruption or constriction of the outer lip which is regularly arched, forming nearly a semi-circle and has a thin flaring edge which is strongly thickened a short distance within the aperture, anteriorly the outer lip continues round in a regular curve and joins the columella without a distinct notch; posteriorly there is a distinct rounded groove within the aperture at the

junction of the lip with the body-whorl; the columella is strongly sinuous and twisted, its anterior margin forms a distinct ridge or fold and another similar fold is situated at about the middle; the inner lip is excavated in the middle and is thickened by a layer of white enamel, which is continuous from the outer lip around to the anterior margin. There is no operculum. Color white.

Length, 12^{mm}; greatest breadth, 8^{mm}; length of body-whorl in front, 10^{mm}; length of aperture, 7^{mm}; its breadth, 4^{mm}.

A living specimen (No. 44,646), was taken at station 2,234, in 816 fathoms, N. lat. 39° 09', W. long. 72° 03' 15". Another specimen, but dead, was taken at station 2,217, in 924 fathoms.

The last named specimen differs from the type in having the nodules smaller and less prominent on the last whorl, while there are six distinct but not very prominent revolving ridges; but the ribs and nodules are sufficiently prominent on the preceding whorls.

This species is remarkable for its solidity and the coarseness of its ribs and nodules. It can easily be distinguished from all our other shells by the character of the aperture, and especially by the columella-folds.

Marginella Virginiana Verrill, sp. nov.

Shell very small, rather slender, fusiform, with an elevated spire, composed of three to four whorls, regularly tapered, with a subacute tip, formed by a small, rounded, prominent nuclear whorl. Suture distinct. Body-whorl elongated, fusiform, with the basal part much tapered. Aperture small, oblique, narrow behind, wider in front, canal a little expanded at the tip. Outer lip thickened within and without, usually a small denticle stands close to the posterior sinus. Pillar with four thin prominent folds, the posterior one nearly transverse; the anterior very oblique. Surface and somewhat polished.

The color is plain, but varies from grayish or yellowish-white to cream-color and pale chestnut-brown, rarely slightly flecked or faintly banded with lighter and darker tints.

The largest example from station 2307, in 43 fathoms, is 5^{mm} long; breadth, 2.6^{mm}; length of aperture, 3^{mm}. Many specimens are more slender than this. A small one from station 2265, is 2^{mm} long; breadth, 1^{mm}.

This species occurred in considerable numbers at station 2272, off Cape Hatteras, in 15 fathoms (No. 44,834); also at station 2307, in 43 fathoms; and at station 2265, off Chesapeake Bay, in 70 fathoms, one example.

Trophon abyssorum Verrill, sp. nov.

Trophon clavatus Verrill, these Traus., vi., p. 176, 1884 (*non* Sars).

Shell rather small, stout-fusiform, with strongly angulated whorls and a long, slender, straight canal. The spire consists of three or four whorls besides the nucleus, which is rather large, consisting of about two prominent, smooth whorls. Below the nucleus the whorls are strongly shouldered a little above the middle, the carination of the shoulder being sharply angulated and usually surmounted by a circle of strong, acute, hollow spines, usually eight to ten in number, which sometimes project at right angles, but frequently curve upward more or less strongly. The suture is impressed and the upper slope of the whorl rises rather abruptly from the suture and is usually flattened and somewhat concave near the shoulder, but sometimes a little convex; below the shoulder the whorl slopes rapidly to the suture. The last whorl is large and convex below the shoulder, and slopes rapidly to the base of the canal, which is long, narrow, nearly straight, but often a little upturned near the tip. The sculpture consists of more or less distinct lamellæ, corresponding with the lines of growth, and at the shoulder forming the prominent spines. Sometimes the lamellæ are prominent and distinct entirely across the whorls, and to the base of the canal on the body-whorl, in other cases they are nearly obsolete except close to the spines. The aperture is elongated, strongly angulated at the shoulder of the last whorl and constricted anteriorly at the base of the canal.

The color is translucent bluish white in alcohol, with the nucleus sometimes pale flesh-color.

Length of a medium sized example, 8^{mm}; breadth, including spines, 5^{mm}; not including spines, 3·5^{mm}; length of aperture, 5^{mm}; its breadth, 1·5^{mm}; length of canal, 2·5^{mm}.

Variety, **limicola** Verrill, nov.

In this variety the transverse lamellæ on the whorls are more numerous and much closer together, but in crossing the shoulder they do not form spines of so large size, frequently rising into sharp scales or small spinules, but at other times they assume the character of spines, more nearly approaching the form already described. The number of lamelliform ribs amounts frequently to eighteen or twenty. In shape the shell is very nearly like that of the typical form with the canal long, narrow and pinched up at the base, but the aperture is more rounded externally, owing to the less angulated shoulder.

The nucleus appears to be a little larger and more prominent than in the other form. Some of the specimens of this variety are larger than the typical ones. One of the largest measures 11^{mm}; breadth without spines, 5^{mm}; length of aperture, 7^{mm}; of canal, 4^{mm}.

This variety might readily have been taken for a distinct species if intermediate forms had not occurred. Both varieties have been dredged in many localities, in considerable numbers, and many intermediate forms have been met with. The less spinose forms generally come from the deeper waters, but in some cases both forms occur together.

This species ranges in depth from 843 to 2,033 fathoms. It was taken at ten stations in 1883, and at five stations in 1884. The typical form was most abundant at station 2115, in 843 fathoms, where over forty specimens occurred (No. 35,583), and at station 2076, in 906 fathoms, over twenty specimens (No. 38,041). Variety *limicola* occurred most abundantly at station 2221, in 1,525 fathoms, where nearly one hundred specimens were taken, alive and dead; and at station 2038, in 2,033 fathoms, twenty specimens (No. 34,847); the largest example of this variety occurred at station 2084, in 1,290 fathoms (No. 38,039).

This species resembles *T. clavatus* G. O. Sars, to which I formerly referred it, but both Dr. H. Friele and Mr. Gwyn Jeffreys, to whom I afterwards sent specimens, considered it a distinct species.

Jumala brychia Verrill and Smith, sp. nov.

PLATE XLIV, FIGURES 10, 10a.

Shell rather slender, elongated, fusiform, with a tall tapering spire, consisting of more than seven whorls (apex eroded). The body-whorl is somewhat swollen and much larger than the preceding. The lower whorls are slightly shouldered; the upper ones distinctly so. Below the shoulder the lower whorls are somewhat flattened, but distinctly convex, while the upper whorls are distinctly angulated at the shoulder and scarcely convex below it. On the body-whorl the sculpture consists of well-marked, distinctly raised, revolving cinguli, separated by intervals about twice as wide, one or two of those at the shoulder being a little more prominent than the rest, while above the shoulder they are fewer and less distinct. On the upper whorls the cinguli are more prominent, one at the shoulder forming a distinct carina, above which there are six or eight somewhat smaller ones, while one quite prominently developed is situated

just below the suture. The upper whorls are also crossed by numerous, regular, nearly straight, narrow, longitudinal ribs which, with the revolving lines, produce a cancellated structure and at the shoulder they rise into small, rounded nodules, and form another row of smaller nodules in crossing the subsutural line. On the lower whorls the ribs disappear or become indistinguishable from the lines of growth which cover the whole surface. The aperture is narrow-elliptical; the outer lip is regularly arched, except at the shoulder, where it is slightly angulated; the columella is excurved and has a distinct, oblique spiral fold at about the middle; the canal is very short, broad and open, without any constriction. The shell is translucent bluish white internally. The epidermis is pale, yellowish green, thin, firm and close, a little roughened by the fine lines of growth. The operculum is well-developed, but smaller than the aperture, elongated and irregularly ovate, nearly straight on the outer margin, convex on the inner, bluntly rounded posteriorly, terminating anteriorly in a narrow point, which is slightly falcate, but not spiral; color yellowish green.

Length of the shell (consisting of only the five lower whorls), 41^{mm}; the eroded apical whorls may have been 4 or 5^{mm} additional; greatest breadth, 37^{mm}; length of body-whorl in front, 20^{mm}; length of aperture, 22^{mm}; its breadth, 8.5^{mm}; length of operculum, 13^{mm}; breadth, 6^{mm}.

A single living specimen was taken at station 2224, in 2,574 fathoms, N. lat. 36° 16' 30", W. long. 68° 21' 00". (No. 44,647.)

This species appears to be related to *J. Ossian-Sarsii* Friele. It is at least probably congeneric with the latter, but is a much more slender and delicate shell and quite different in its sculpture and form.

Omalaxis nobilis Verrill, sp. nov.

PLATE XLIV, FIGURE 12.

Shell strong, coiled closely in a flat spire, which is nearly plain on the upper or right hand surface and strongly concave on the left or base. The shell consists of five visible whorls, the apical whorl being small and concealed by the succeeding one. The whorls are strongly angulated, nearly quadrangular, with two strong, prominent, rounded carinæ at the periphery, one at each angle, the upper one somewhat more prominent than the other. The surface of the periphery, between these carinæ, is concave and sculptured by several small, spiral ribs, one of which, next the upper carina, is double, while two or

three are near the lower carina, leaving a comparatively smooth, depressed central area around the periphery; small spiral lines also appear on the surface of the large carinæ. The upper surface of the whorls is nearly flat and distinctly depressed below the level of the outer carina, which is often made double by a groove on its upper side; close to the suture there is also a slightly raised spiral ridge rising abruptly from the suture, which is narrow but distinct. The double peripheral carina appears on the preceding whorls close to the suture. On the lower side the whorl is strongly depressed next the outer carina and then slopes inward with a slightly convex surface, which is covered with fine spiral striæ, and has a slightly raised spiral ridge near the inner angle; this ridge and also the outer carina are visible on the whorls within the broad umbilical depression; the nuclear whorls appear to be smooth so far as they are visible. The whorls are crossed by very distinct, close, raised lines of growth, which become prominent and form transverse nodules in crossing the principal carinæ, but are elsewhere fine and close. On some parts the remnants of the epidermis can be seen, which appears to have been raised into fine lamellæ along the lines of growth. The aperture is four-sided and somewhat trapezoidal, with the outer corners squarely angled and the inner ones rounded; the outer side is flattened, while the inner side is pretty well rounded. The operculum is thin, horny, multispiral, somewhat concave and dark brown in color. The color of the living shell is pale chestnut-brown, irregularly and indistinctly banded with yellowish white.

Greatest diameter, 11^{mm}; height, or breadth of last whorl, 3^{mm}; diameter of aperture, 2.5^{mm}.

One living and one dead specimen occurred at station 2265, off Chesapeake Bay, in 70 fathoms (No. 41,481).

Delphinula nitida Verrill and Smith, sp. nov.

PLATE XLIV, FIGURE 11.

Shell small, fragile, very delicate, with a slight silvery iridescence.

Our specimen, which has lost the apex, consists of three gradually enlarging whorls entirely disconnected with each other and nearly round in a cross section. When perfect the spire, must have been rather elevated, gradually tapering to an acute tip. The surface is sculptured by thin, elevated riblets, crossed by distinctly raised, revolving lines of about the same size, producing a pretty regularly cancellated or reticulated sculpture, in which the meshes are mostly elongated in the direction of the spire, around the periphery, but in

the opposite direction on the lateral and inner surfaces; the transverse riblets are most elevated on the upper sides of the whorls, where they rise into small, thin lamellæ; they also form similar lamellæ on the inner and lower surfaces; the revolving lines are most conspicuous around the periphery; minute but distinctly raised lines of growth also cross the intervals between the riblets. In a front view of the base the shell appears umbilicated and the upper whorls can be partially seen within the umbilicus. Color silvery white, slightly iridescent.

Length (including only the three last whorls), 5^{mm}; breadth, 4^{mm}; diameter of aperture, 1.6^{mm}.

Station 2229, in 1,423 fathoms, one dead but fresh specimen. (No. 44,648).

This singular shell bears no resemblance to any other known from this region. The soft parts and operculum being unknown, it is referred to this genus only provisionally, but its form and the pearly structure of the shell indicate that this is probably its proper place.

Margarita, sp. nov. . . .

A broken specimen of a large and handsome species was taken at station 2265, in 70 fathoms, off Chesapeake Bay. The shell is moderately elevated, with rather convex whorls and a narrowly canaliculate suture. The umbilicus is deep and moderately large, crenulated within by several spiral ribs. On the outer and lower surfaces of the whorls there are several sharply cut, elevated spiral cinguli, with deep furrows between. These are crossed by strong, oblique, raised lines of growth, which produce small nodules on the upper ones, and above the shoulder take the form of oblique riblets, running down from the suture. The upper whorls are broken off.

Puncturella abyssicola Verrill, sp. nov.

Shell moderately large, elliptical or ovate in outline, a little narrowed anteriorly, evenly convex along the sides, and rounded posteriorly, moderately elevated, with the apex small, not very prominent, acute and curved backward and inward, situated a little behind the middle. The posterior slope is at first a little concave, owing to the position of the beak; the anterior slope is gently convex. The foramen is elongated fusiform, broadest in the middle, tapering both ways to acute points, but most acute anteriorly; its posterior end does not reach the vertex, and terminates some distance from the

apex; it is thickened and partially filled up within. A slightly elevated ridge runs from the anterior end of the opening to the front edge of the shell, but is scarcely larger than the other ribs. The sculpture consists of about forty rounded, moderately elevated, nodulous, radiating ribs, with an alternating series of similar but smaller ribs on the lower half. The surface is covered with concentric, raised lines, which are nearly as prominent as the radii, producing a cancellated structure and forming the small, rounded nodules where they cross. The internal septum is highly developed, large, strong and tubular, extending down in front farther than the foramen, with narrow lateral ridges extending nearly to the front edge of the shell. The edge of the shell is thin and slightly crenulated by the ribs.

Length, 10^{mm}; greatest breadth, 7^{mm}; height, 5^{mm}; anterior edge to apex, 8^{mm}; posterior edge to apex, 4.5^{mm}; length of foramen, 1.6^{mm}.

One dead specimen was taken at station 2222, N. lat. 39° 03' 15", W. long. 70° 50' 45", in 1,537 fathoms, gray ooze, with pebbles, concretions and cinders.

This species differs from *P. noachina* in being much less elevated, with the sides not flattened; in having the apex less prominent and farther back; in the distinctly and rather coarsely cancellated structure; and in having a broader and more fusiform foramen, situated more anteriorly and not extending so far toward the apex; the internal septum is larger and more flattened and prolongations extend from its anterior edges nearly to the anterior edge of the shell. It seems to be very distinct from all the species described by Watson, Jeffreys, and Dall.

Cocculina reticulata Verrill, sp. nov.

Shell small, high, with a short-elliptical aperture, slightly flattened at the sides, but well-rounded in front and behind. The vertex is near the center, but the apex curves strongly backward, with a minute, smooth, prominent, spiral, incurved nucleus, not distinctly turned to either side. The posterior slope is concave and steep, owing to the incurvature of the apex; the anterior slope is longer and convex, especially toward the summit. The surface is finely and regularly reticulated by radiating and concentric raised lines of nearly equal size, scarcely visible without a lens. The radiating lines may be a little stronger on the sides. Color pale yellowish white.

Length of an ordinary specimen, 2.6^{mm}; breadth, 1.8^{mm}; height, 2^{mm}.

Station 2265, off Chesapeake Bay, in 70 fathoms, several living specimens.

This species resembles in form *Tectura galeola* Jeffreys, but differs in its sculpture.

Turbonilla perlepida Verrill, sp. nov.

Shell long, slender, very glossy, translucent, and snow-white in color. Whorls twelve, moderately convex, with the suture well-impressed, narrow, deep, rather oblique. The upper end of the spire is very slender, regularly coiled, with the apical whorl rather large, prominent, reversed, and strongly incurved. The sculpture consists of about twenty transverse ribs on the lower whorls, which are rounded, not very prominent, and extend across the whorls; on the upper whorls these ribs become less numerous and less distinct, but are more or less evident on all the whorls below the nucleus, which is smooth. The aperture is short and broad-ovate, with the outer lip well-rounded laterally and in front; inner edge somewhat angulated at the base of the columella, which is a little excurved. On the body-whorl the transverse ribs do not extend below the periphery, so that the base is smooth. Umbilicus absent or represented by a minute depression.

Length, 7^{mm}; diameter, 1.5^{mm}; length of aperture, 1.1^{mm}.

Station 2265, off Chesapeake Bay, in 70 fathoms, one living specimen (No. 44,790).

This elegant species is more slender and delicate, and also more lustrous, than any of the allied forms.

Turbonilla grandis Verrill, sp. nov.

Shell very large for the genus, with a long, gradually tapering spire composed of many whorls. Suture a little impressed, shallow, narrow, not very oblique. The whorls are comparatively short, rather flattened, and crossed by slightly raised, rather indefinite, and somewhat irregular ribs, which generally extend entirely across the upper whorls, but fade out above the middle of the body-whorl. The ribs are more regular and more elevated on the upper half of the spire than on the lower half. The surface between the ribs is destitute of spiral sculpture, but is marked by fine and nearly regular lines of growth. The base is smooth and there is no umbilicus. The aperture is short and broad, with an acute angle posteriorly and a decided angle at the base of the columella, which is nearly straight

and has a large, obtuse, rounded spiral fold above the middle. There is also a slight, rounded angle, formed by the junction of the columella with the lip in front.

Length of the seven lower whorls, 18^{mm}; greatest breadth, 6^{mm}; length of body-whorl in front, 7.5^{mm}; length of aperture, 4.5^{mm}; its breadth, 2.5^{mm}. All the upper whorls are broken off.

Station 2228, in 1582 fathoms, one dead specimen (No. 44,791).

This species most resembles *T. Rathbuni*, but it is larger, with more flattened whorls, and has a distinct fold on the columella.

Actæon hebes Verrill, sp. nov.

PLATE XLIV, FIGURE 15.

Shell not very small, short, stout and swollen, broad-ovate in form, with a short spire, (the apex is eroded in both our specimens). The body-whorl is large, swollen, and constitutes the greater part of the shell. The suture is deeply impressed or slightly channeled, the whorl just below it rising abruptly with a convex outline. The penultimate whorl is short, convex, and is surrounded by about three or four punctate grooves. The body-whorl is strongly convex, but very slightly flattened in the middle, its upper portion decidedly swollen; it is covered by about twenty well-marked, revolving grooves, which are closely and very distinctly punctate, the punctations arranged very close together or in contact, and nearly uniform in size; the intervals between the grooves are rather broad and even, with a somewhat lustrous, nearly smooth surface, crossed by slightly sinuous lines of growth. The aperture is ear-shaped, rather broad, narrowed and rounded at the posterior angles, broadly rounded in front, with the inner margin sinuous and strongly excavated at the base of the columella, on which there is an oblique, slightly elevated, obtuse fold. Our specimens, both of which are dead, are white.

Length of the largest specimen, consisting only of the last two whorls, 8^{mm}; breadth, 6.5^{mm}; length of the last whorl, 7.5^{mm}; length of aperture, 6.2^{mm}; its breadth, 3^{mm}.

Station 2224, in 2,574 fathoms. (No. 44,656.)

Cylichna eburnea Verrill, sp. nov.

PLATE XLIV, FIGURE 14.

Shell moderately large for the genus, firm, solid and thick for a shell of this group. The shell is somewhat elongated, broadest in

the middle, tapering toward the posterior end and broadly rounded in front, so that the outline is somewhat conical, but truncated posteriorly. At the tip there is a small, but rather deep pit. The outer lip is thickened, somewhat constricted below the middle and then slightly expanded and broadly rounded anteriorly; posteriorly it bends inward and projects slightly beyond the tip of the shell, and forms a distinct, rounded, posterior sinus. The columella-margin is thickened, without a fold, and moderately excurved. The umbilicus is narrow but deep. The aperture, in front of the middle, is moderately broad and ovate, but farther back it is much narrowed and encroached upon by the body-whorl. The surface is smooth and polished, without any sculpture except a few faint spiral lines close to the posterior end and others which are wavy and even less distinct at the anterior end. Color of the type-specimen, pure white, with a very thin yellowish white epidermis on some parts.

Length, 6^{mm}; greatest breadth, 4^{mm}; length of aperture equal to that of the shell; its greatest breadth, 1·8^{mm}.

Station 2265, off Cape Hatteras, in 70 fathoms. (No. 44,657.)

This species is readily distinguished from all others of our coast by its thickness and solidity, by its distinct umbilicus, and by the evident pit at the posterior end. In form it somewhat resembles *Diaphana conulus*, but it is less narrowed posteriorly, besides being a much larger and stouter shell.

Pleurobranchus Americanus Verrill, sp. nov.

PLATE XLIV, FIGURE 13.

In alcohol the body is oblong, higher than wide, with the mantle extending over the greater part of the shell. The foot is large, thick, with short, rounded, grooved auricles in front, its lateral surfaces, like those of the mantle, covered with small projecting spicules. Head bluntly rounded, with two broad, leaf-like oral tentacles and two smaller and narrower posterior tentacles, which are flattened and folded; on the left side there is a conspicuous dark blue eye behind the base of the dorsal tentacle, but on the right side the eye is concealed or wanting, in our specimen. The gill occupies the groove below the mantle on the right side, and is nearly one-third the length of the shell; just in front of the gill there is a low rounded prominence, with a central orifice. The shell is thin, translucent, pale yellowish white, oblong, with the sides nearly parallel and the anterior end bluntly rounded. The spire is a little prominent, ter-

minal, and strongly curved to the left, with the nucleus smooth, glassy, and incurved, situated at some distance from the margin. The surface of the shell is covered with numerous strong, irregular, concentric undulations, and by much smaller and finer lines of growth, which are crossed by microscopic, interrupted, radiating lines, giving a very finely reticulated appearance.

Length of the shell, 13.5^{mm}; breadth, 8.5^{mm}.

Station 2262, off Martha's Vineyard, N. lat. 39° 54' 45"; W. long. 69° 29' 45", in 250 fathoms, green mud and sand; bottom temperature 42° F. One living specimen. (No. 40,503.)

Glaucus margaritaceus (Bosc).

Glaucus Boscii Lesson, Voyage, la Coquille, Zoologie, vol. ii, p. 288, 1830.

Station 2221, N. lat. 39° 05' 30"; W. long. 70° 44' 30". One immature specimen. Station 2224, N. lat. 35° 16' 30", W. long. 68° 21'. One adult and three young.

This species agrees very closely with the description of Bosc, as quoted by Lesson, op. cit., p. 283.

HETEROPODA.

Firolloidea Lesueurii (D'Orb.) Eydoux and Souleyet.

Voyage, La Bonite, Zoologie, p. 343, atlas, pl. 16, figs. 5-7.

Station 2038, 25 specimens; 2039, 5 spec., 1883; 2174, 2 spec.; 2194, 12 spec.; 2207, 6 spec.; 2235, 1 spec., 1884. The most northern locality was 2194, N. lat. 39° 43' 45"; W. long. 70° 07'.

Oxygyrus Keraudrenii (Lesueur).

Edoux and Souleyet, Voyage, la Bonite, Zoologie, p. 364, atlas, pl. 18, figs. 1-17.

Oxygyrus Keraudrenii H. and A. Adams, Genera Recent Moll., vol. ii, p. 92; vol. iii, pl. 69, figs. 6-6b.

Station 2195, N. lat. 39° 44', W. long. 70° 03', 1884. One living specimen of good size, at the surface.

PTEROPODA.

Styliola striata (Rang).

Creseis striata Rang, Ann. des sci. nat., vol. xiii, p. 315, pl. 17, fig. 3.

Cleodora striata Rang and Souleyet, Hist. Nat. Moll. Pteropodes, p. 55, pl. 6, fig. 3, 1852.

Souleyet, Voyage, la Bonite, Zoologie, vol. ii, p. 191, atlas, pl. 8, figs. 1-4.

Station 2,204, N. lat. $39^{\circ} 30' 30''$, W. long. $71^{\circ} 44' 30''$. One living specimen (No. 38,513) was taken at the surface.

This species is not uncommon off the eastern coast of Florida. It has also been recorded from the Mediterranean and Indian Ocean.

Spirialis rostralis Souleyet, 1840.

Rang, Hist. Nat. Moll. Pteropodes, p. 62, pl. 14, figs. 7-12.

Eydoux and Souleyet, Voyage, la Bonite, Zoologie, p. 216, atlas, pl. 13, figs. 1-10.

Of this species, living specimens were taken in the trawl-wings at stations 2,219, 2,229, 2,235, 2,236. The most northern was station 2,229, N. lat. $37^{\circ} 38' 40''$, W. long. $73^{\circ} 16' 30''$.

Spirialis reticulata (D'Orb.) Rang.

Atlanta reticulata D'Orb., Voyage, p. 178, pl. 12, figs. 32-35 (teste Souleyet).

Spirialis clathrata? Rang and Souleyet, Hist. Nat. Moll. Pteropodes, p. 64, pl. 14, figs. 24-26.

Eydoux and Souleyet, Voyage, la Bonite, Zoologie, p. 229, atlas, pl. 13, figs. 17-19.

A single living specimen occurred at station 2,227, N. lat. $36^{\circ} 55' 23''$, W. long. $71^{\circ} 55'$.

Pneumodermon Peronii Lam.

Rang, Hist. Nat. Moll. Pteropodes, p. 75, pl. 9, figs. 1-9; pl. 11, figs. 14-19.

Eydoux and Souleyet, Voyage la Bonite, Zoologie, p. 274, atlas, pl. 14, figs. 7-16.

Station 2,210, N. lat. $39^{\circ} 37' 45''$, W. long. $71^{\circ} 18' 45''$. Three specimens.

SCAPHOPODA.

Dentalium laqueatum Verrill, sp. nov.

PLATE XLIV, FIGURE 18.

Shell rather large, thick, and strong, moderately stout, gradually tapered, gently curved, chiefly behind the middle. The sculpture consists of about eleven strong, prominent, broad, obtuse, longitudinal ribs, separated by deep, concave interspaces, which are wider than the ribs in the middle of the shell and of about the same breadth posteriorly; at about the anterior third the ribs decrease in prominence, fading out, or becoming flattened into mere obtuse angles at the anterior end; along the middle of the shell a smaller rib intervenes between part of the larger ones; four of the ribs on the convex side are closer together and narrower than the rest, while those on the

concave side are widest apart. Between the ribs the whole surface is covered with regular, fine and close, microscopic longitudinal lines, which also cover the ribs where they are not worn. Distinct and rather close lines of growth cover the surface and in some places make, with the longitudinal striæ, a fine reticulated structure. Anterior aperture nearly round, but slightly angulated in line with the principal ribs; edges thin, but the shell is thickened and the interior is circular farther back. The posterior end is rather small, with a very small aperture, the shell being thickened, but the tip is so eroded as to render uncertain the existence of a slight notch.

Color dull grayish white.

Length, 45^{mm}; diameter of large end, 6^{mm}; of small end, 3^{mm}.

Station 2,268, off Chesapeake Bay, in 68 fathoms, one living specimen (No. 44,671).

This species is easily distinguished from all others of our coast, by the very large and strong longitudinal ribs, and the fine longitudinal striæ between them.

Dentalium ensiculus Jeffreys.

Dentalium ensiculus Jeffreys, Ann. Mag. Nat. Hist., Feb. 1877, p. 154; Proc. Zool. Soc. London, 1882, p. 660, pl. 49, fig. 4.

Station 2,174, off Chesapeake Bay, N. lat. 38° 15', W. long. 72° 03', in 1,594 fathoms, two living specimens (No. 38,635); and station 2,221, N. lat. 39° 05' 30", W. long. 70° 44' 30", in 1,525 fathoms, two specimens, one living (No. 38,636).

This species is easily recognized by its strongly flattened form, with a sharp edge along the convex side. It is rather strongly curved and has a deep posterior notch on the convex side.

Mr. Jeffreys records it from off the European coast, taken by the Poreupine Expedition in 1869 and '70; by the Valorous Expedition, in 1,450 and 1,785 fathoms; and from the Challenger Expedition, in 470 fathoms, off St. Thomas, W. I.

Cadulus spectabilis Verrill, sp. nov.

PLATE XLIV, FIGURE 19.

Shell very large for the genus, rather strongly curved, especially behind the middle, swollen and somewhat angular and gibbous a short distance back of the aperture. The gibbosity or swelling affects most the dorsal side, but is distinct, also, on the sides and ven-

trally; in advance of this swollen part the shell narrows rapidly to the aperture, the decrease being much the greatest on the dorsal side. The aperture is oblique and elliptical in outline, the dorsal margin being distinctly flattened. From the anterior swelling the shell tapers regularly and gradually backward, with an increasing curvature. The posterior opening is not very large, a little flattened, and its margin, when perfect, has a moderately deep notch on each side and a shallower one both above and below. The shell is translucent, and the surface is everywhere smooth and polished, but shows irregular alternating bands of lighter and darker shade, due to greater or less transparency of the substance, and there are also faint longitudinal whitish lines visible in the substance of the shell, but not affecting the surface.

Length, 22^{mm}; greatest diameter, 4^{mm}; breadth of the oral aperture, 2^{mm}; diameter of posterior aperture, 1^{mm}.

Station 2,043, in 1,467 fathoms, 1883, (No. 38,116); stations 2,174, 2,221, 2,222, 2,228, in 1,525 to 1,594 fathoms, 1884. Taken in the largest numbers at station 2,221, where about twenty-five specimens occurred, part of them living, (No. 40,498).

This species is remarkable for its great size, exceeding even *C. grandis*; for its gibbous swelling close to the anterior end; and for the rapid and strongly marked contraction of the oral aperture. By the last named feature it is readily distinguished from *C. grandis*. (See plate xlv, fig. 17).

LAMELLIBRANCHIATA.

Periploma undulata Verrill, sp. nov.

Shell thin, translucent, rather small, compressed, long-ovate, with the beaks a little prominent, situated somewhat in advance of the middle. The anterior end is broadest, somewhat produced and obtusely rounded, with a slight undulation running from the beak to the anterior ventral margin, which is evenly convex in the middle, but is so drawn in as to form a slight emargination at the commencement of the posterior portion; a rather broad, shallow, but well-defined groove runs from the beak to the basal emargination; back of this the posterior portion is rapidly narrowed to the rather small, subtruncate tip; a slightly elevated and roughened ridge runs from the beak to the lower angle of the posterior end; and several finer, radiating lines cover the posterior surface above it. The anterior dorsal margin is convex, and slopes very gradually; the posterior

dorsal margin is nearly straight and slopes more rapidly than the anterior. The sculpture consists of slightly raised but very evident concentric undulations, which, like their concave intervals, are covered with very fine lines of growth. The radial sculpture consists of the anterior and posterior undulations already referred to, and of the thin, raised, radiating lines on the posterior area, above described. The hinge consists of a small, somewhat spoon-shaped cartilage-plate, free at the end, projecting inward nearly at right angles to the margin, and supporting a small, somewhat triangular cartilage-pit. From the posterior margin of this plate a slightly developed, supporting rib, or buttress runs downward and backward for a short distance. A well-defined, narrow, incised notch extends at right angles from the hinge-margin into the center of the beak, just in front of the cartilage-plate. The hinge-margin itself is very thin. The inner surface of the shell is smooth, but wavy, and the muscular scars are indistinct. The epidermis is very thin, tinged with rusty brown toward the margins, showing lines of growth; it is slightly roughened and wrinkled along the posterior radii. Color, pale grayish white.

Length, 13^{mm}; height, 10^{mm}; thickness, about 5.5^{mm}.

Station 2,234, N. lat. 39° 09', W. long. 72° 03' 15", in 816 fathoms (No. 44,840).

This species bears some resemblance to *P. papyracea*, but it is a narrower and more elongated shell, with the posterior end more produced, and with concentric and radiating undulations not seen in the latter. The cartilage-plate is smaller, and the supporting rib much less developed and more oblique than in *P. papyracea*.

Pecchiolia granulifera Verrill, sp. nov.

Shell small, thin, delicate, somewhat three lobed or triangular-cordate, with the anterior and posterior ends a little produced and obtusely rounded, while the ventral margin is more produced and more broadly rounded; the dorsal margin is gently convex behind the beak, and decidedly concave in front of it. The beak is a little prominent, acute, and turned strongly forward. The umbos are rather prominent, and a rounded, ill-defined ridge runs to the postero-ventral margin. The whole surface is closely covered with very small, rough granules, to which minute grains of sand and foraminifera frequently adhere. On the anterior half there are also thin, feebly marked, raised radiating lines, more or less obscured by the granules; anteriorly these become more distinct. Internally the shell is smooth and pearly, but covered with minute white specks. The hinge-margin

is thin, but bears, just in front of the beak, a large, strong, crescent-shaped tooth, convex within, projecting upward nearly at right angles to the margin, and hollowed out on its upper side, at the lunular depression, so that the entire thickness of the tooth is situated within the outline of the edge; another very much smaller, triangular tooth is situated under and behind the beak, within and below the margin. The exterior ligament is small and thin.

Length, 8^{mm}; height, the same.

Station 2,229, off Chesapeake Bay, in 1,423 fathoms. One dead specimen (No. 44,838.)

Tapes, sp.

At station 2,206, in 1,043 fathoms, a single, somewhat eroded left valve of a *Tapes* was dredged, which agrees very closely in size, form and general appearance with *T. virginicus* of Europe. It is, perhaps, a little more oblong, or less convex ventrally, and the concentric ridges are finer, closer, and less raised, or more like lines of growth. The hinge-margin is thicker and stronger. The pallial sinus is smaller, narrower and more pointed.

Length, 38^{mm}; breadth, 22^{mm} (No. 40,108.)

Choristodon (?) cancellatus Verrill, sp. nov.

Shell rather small, swollen, triangular-ovate, with the umbos prominent and swollen, and the beaks large, subspiral, and turned forward, so that in a front view the shell has a strongly cordate form. The anterior end is short and broadly rounded; the posterior end is longer and narrower, somewhat tapered, obtusely rounded at the end. The posterior dorsal margin slopes rapidly, and is subparallel with the ventral margin. There is a small, depressed, distinct, but not much differentiated lunular area in front of the beaks. The sculpture consists of numerous narrow, nearly equal, sharply cut, radiating grooves, separated by wider raised ridges, which are decussated by thin, sharp, raised, concentric lines; these two sets of lines, in crossing each other, produce a rather fine cancellated structure over the entire surface. The hinge consists of two strong central teeth just below the beak, separated by a triangular pit, and supported on a rather broad plate, extending inward from within the thickened margin; the posterior of the two teeth is largest and thickest, and may have been slightly bilobed when perfect. A thin, incised ligamental groove runs from under the beak backward in a curved line between the thickened inner and outer shell-margins. Muscular and pallial scars are not visible, owing to erosion.

Length, 8^{mm}; height, 7^{mm}; thickness, 6^{mm}; beak to posterior end, 7^{mm}; to anterior end, 2^{mm}.

Station 2,265, off Chesapeake Bay, in 70 fathoms. One dead and somewhat eroded left valve (No. 44,839).

The precise generic position of this shell is doubtful, owing to the imperfect preservation of the specimen, which does not show the muscular and pallial scars.

Cryptodon grandis Verrill and Smith, sp. nov.

PLATE XLIV, FIGURE 22.

Shell rather large, thick, angular, remarkably high, owing to the great prominence of the ventral margin and the elevation of the beaks, and with the surface strongly undulated by median and posterior folds. The beaks are high, acute and strongly incurved and turned forward. The lunule is large, cordate, sunken, and defined by a prominent ridge. The posterior dorsal margin has a long, narrow, fusiform ligamental area, bordered by a prominent, rounded ridge. Another larger and more prominent ridge extends from the beaks to the angle, leaving a sunken concave area behind it, and terminating in a prominence or lobe at the margin. Another broad and distinctly elevated, rounded ridge runs from the beak to the ventral margin, which projects downward in a prominent, rounded angle; this median ridge is divided into two parts by a slight furrow just behind the middle. Anteriorly there is a ridge, not very well marked, running from the beaks outside the lunular area and terminating in a rounded projection of the anterior margin. Thus the margin has an anterior and two posterior prominences, besides the great median lobe, while the anterior margin, in the lunular region, is strongly concave and the posterior dorsal margin is convex. The surface is dull grayish white, and closely covered with prominent and often sharply raised lines of growth, which are irregular and wavy or fibrous in appearance. The hinge-margin is thin, with a narrow, elongated ligamental groove, which is strengthened by a narrow buttress within; there are rudiments of teeth.

Length of the largest specimen, 21^{mm}; height, from beak to ventral margin, 24^{mm}; breadth 15^{mm}.

A large living specimen was taken at station 2,231, in 965 fathoms, N. lat. 38° 29', W. long. 73° 00'. Five valves, some of them nearly as large, were taken at station 2,228, in 1,582 fathoms. A small dead specimen (No. 35,757) was taken in 1883, at station 2,111, off Cape Hatteras, in 938 fathoms.

Cryptodon plicatus Verrill, sp. nov.

Shell not very small, somewhat swollen, and rather thick for the genus; triangular-cordate in form, with very high and acute beaks, which curve forward but little. The anterior dorsal margin is nearly straight, but a little concave opposite the rather large, depressed lunular area; the posterior dorsal margin is broadly convex and rendered irregular by the strong plications of the margin; the ventral margin is well-rounded, strongly angulated or lobed by the plications, and a little produced in the middle, in a line with the median ridge. The shell is remarkable for the unusual number of plications and undulations of its surface. Posteriorly there are two very large, much raised, sharply angulated plications, with a very deep concave depression between them, and a deep furrow between the hindermost and the edge of the shell; the second and larger fold is separated from a rounded or obtusely angulated median ridge by a broader concave depression. This median ridge is large and very distinct, and somewhat angular ventrally; farther forward there is a similar, but less marked, ridge, extending to the anterior part of the ventral margin. Anteriorly there is a very large, long-cordate, nearly smooth, concave lunule, which is bounded by two small, distinct posterior ridges, which are near together and run to the antero-ventral angle. The surface is covered by irregular and rather strong lines of growth, which become somewhat lamellose in crossing the strong plications. The hinge-margin is considerably thickened behind the beak, with a deep and conspicuous, curved ligamental groove, back of which the edge becomes thin and flaring. The interior is angulated, corresponding to the exterior plications, and is marked by irregular radial striæ near the ventral margin.

Length of the largest specimen, 11^{mm}; height, 13^{mm}; thickness, 8^{mm}.

The largest and most typical example is a valve from station 2,193, N. lat. 39° 44' 30", W. long. 70° 10' 30", in 1,122 fathoms (No. 44,825). A young living specimen, apparent identical, was taken at station 2,205, in 1,073 fathoms (No. 44,826).

This species is closely related to *C. grandis* V., but it has more numerous and more strongly developed plications; its beaks are more elevated and less curved forward, so that the form is more triangular; the ventral margin is less produced in the line of the median ridge; the shell also appears to be thicker and more swollen.

Kelliella nitida Verrill, sp. nov.

Shell thin, delicate, translucent white, swollen, subcordate in a side view; in a front view regularly broad-cordate. Umbos swollen; beaks strongly curved forward; lunular area broad-cordate, running up between the beaks and bounded by a definitely impressed line. The posterior dorsal outline is sloping and slightly convex, forming a slight angle where it joins the broadly rounded ventral margin; in the middle of the ventral margin there is a slightly marked, broadly rounded angle, from which a faint but perceptible ridge runs up to the umbos. The surface is everywhere covered with fine, close, very regular raised lines, and usually has an iridescent luster. The hinge in the right valve consists of a long, thin, flexuous lamina, separated by a groove from the margin, rising into two somewhat thickened and more elevated lobes opposite the beaks, and with a small, thin, partially detached, tooth-like process farther forward. The two anterior lobes, viewed in some directions, appear like two small, thin teeth, separated by a notch, and projecting somewhat downward. In the left valve the lamina is more complicated, just behind the beak it splits into two portions, leaving a groove between; the anterior portion forms a long, flexuous lobe opposite the beak, the anterior end expanding slightly and rising above the margin like a small curved tooth; farther forward and separated by a notch, it forms another similar tooth-like lobe. The ligament is light yellow and occupies a short, well-marked groove, behind and under the beak.

Length of the largest specimens, 5.5^{mm}; height, 5^{mm}; thickness, 4.5^{mm}.

Station 2221, in 1,525 fathoms, about a dozen specimens, alive and dead (No. 40,498). Station 2038, in 2,033 fathoms, one dead specimen (No. 35,217.)

This species is closely related to *K. miliaris* of Europe, but is larger, more angular, and more distinctly and regularly sculptured. The European species has been regarded by Jeffreys as the young of *Isocardia cor*, but G. O. Sars and others consider it a distinct form. On the American side no species of *Isocardia* is known, which renders it probable that the present shell is an adult form.

Nucula trigona Verrill, sp. nov.

Shell of moderate size, rather thick and solid, conspicuously triangular, with the beaks high, forming an acute angle. The surface is smooth and lustrous, marked only with very faint lines of growth.

The anterior margin is nearly straight, the posterior dorsal margin is slightly convex; the two form an acute angle, while the ventral margin is broadly rounded, or sometimes subtruncate in the middle, so that the anterior and posterior angles are obtusely rounded, the posterior end being a little more prominent. The shell is somewhat swollen in the larger specimen. The beaks are small and curve directly inward. The hinge-margin is stout, with a rather large cartilage-pit. The anterior row includes about eight elevated, acute teeth, nearly in a straight row; the posterior row is a little curved, and includes about ten similar teeth. The interior is pearly, with strongly marked muscular scars. The margin is plain. The epidermis is firm, smooth, closely adherent, and light greenish yellow in color.

Length of the largest specimens, 1.5^{mm}; height, 5^{mm}; breadth, 3^{mm}. Younger specimens are not quite so high in proportion to their length.

Station 2,194, in 1,140 fathoms, one valve; station 2,228, in 1,582 fathoms, one live specimen; and station 2,229, in 1,423 fathoms, N. lat. 37° 38' 40", W. long. 73° 16' 30", six live specimens.

This species is remarkable for its triangular form and the acute angle formed by its dorsal margins, as well as for its smooth and lustrous exterior. In all these characters it differs widely from all our other species.

Arca profundicola Verrill and Smith, sp. nov.

PLATE XLIV, FIGURES 23, 23a.

Shell rather small, elongated, angular and oblique, very inequilateral, with the posterior end elongated and expanded; the anterior end short and oblique, angulated above; the ventral margin oblique and incurved in front of the middle.

The shell is covered with a rather coarse, dark brown epidermis, rising into elongated and conspicuous scales and lamellæ, which become longer and more conspicuous posteriorly, where they form a fringe beyond the margin. Beneath the epidermis the sculpture consists of small, wavy, concentric ridges, parallel with the lines of growth, and of rather fine, regular, radiating grooves, separated by rather wider, rounded interspaces, which are often a little nodulous in crossing the concentric ridges. The beaks are prominent, angular, curved inward and a little forward, and somewhat flattened in the middle. A flattened or somewhat indented area extends from the beaks to the margin. The dorsal margin is straight and is about

two-thirds the length of the shell; the ligamental area is narrow-lanceolate, becoming long and narrow posteriorly; its surface has only faint lines of growth, but its margins are clearly defined. The posterior margin descends obliquely, or with a slight incurvature, and then expands in a rounded curve. The ventral margin is gently convex, except where slightly indented by the byssal sinus. The anterior end is very short and narrow, ending superiorly in a small, obtuse angle. The inner margin is simple and plain, without any crenulations. The hinge-margin is thin and the teeth are small and rather inconspicuous; the posterior ones are eight or nine in number, in the form of very oblique, slightly raised ridges or folds, the two or three most posterior becoming less oblique and more conspicuous; the short anterior portion bears about six small but prominent teeth, which stand nearly transverse to the margin.

Length, 12^{mm}; height, 7^{mm}; thickness, 5^{mm}.

Station 2,226, in 2,021 fathoms, N. lat. 37°, W. long. 71° 54'; seven living specimens (No. 44,501).

This species is much more elongated and more expanded posteriorly than any form of *A. pectunculoides*, and the beaks are more prominent and nearer the anterior end. It is a much larger species.

Limopsis aurita ? Jeffreys.

? *Arca aurita* Brocchi, *Conch. foss. Subap.*, ii, p. 485, pl. 11, fig. 9, (t. Jeffreys.)

Limopsis aurita Jeffreys, *British Conch.*, ii, p. 161, pl. 4, fig. 3; vol. v, pl. 30, fig. 1.

Shell large for the genus, compressed, very oblique, somewhat rhomboidal, with rounded corners, and the posterior ventral margin much produced and broadly rounded. The umbos are not prominent; the beaks are small, acute and curve directly inward. The dorsal margin is nearly straight, with rounded ends, and is much shorter than either of the other sides, its length being less than one-fourth the circumference of the shell. The ligament-area is very narrow and long, extending nearly the whole length of the dorsal margin. The cartilage is rather small and triangular. The hinge-plate is not very broad, considerably curved within, very narrow, and destitute of teeth at the center, opposite the cartilage-pit. It expands regularly and about equally on each side, and bears about six moderately stout, somewhat oblique, rounded teeth on the posterior side, and six or seven thinner, closer, and more transverse teeth on the anterior side, the two outer ones becoming more distant and much more oblique than the rest. The posterior margin is nearly straight for the greater part of its length, and the anterior margin is

nearly parallel with it, though longer and more broadly rounded, passing insensibly into the curvature of the ventral margin; the entire margin is flat, beveled, and perfectly plain, with a simple but distinctly angulated inner rim. Externally the shell, when fresh, is covered with a thick, lamellose, and fringed, light yellowish brown epidermis; over the central portion the epidermal processes are long, thin, and hair-like, and arranged in radiating lines; toward the margin, especially ventrally and posteriorly, they become long, flat, thin and deeply lacerate or fringed at the end; on the umbos the processes become small and ciliated with a distinct radial arrangement.

Beneath the epidermis the shell is everywhere covered with pretty regular concentric undulations, formed by thin, rather sharp, raised lines, separated by regular concave intervals; anteriorly the ridges become less evident and very close; small, but distinct, radiating striae cross the ridges over the central parts of the shell and are deeper or incised in crossing the summits of the ridges; anteriorly the radiating striae entirely disappear; toward the posterior end they become stronger and on the posterior area they are gradually replaced by elevated radii which in crossing the concentric lines produce a distinctly granulated appearance.

The inner surface is nearly smooth and somewhat lustrous, but sometimes minutely radially striated. The muscular scars are small, but distinct.

Length of the largest specimens, including epidermis, 22^{mm}; without the epidermis, 19^{mm}; height from beak to ventral margin, 17^{mm}; length of dorsal margin, 9^{mm}; transverse breadth, 10^{mm}.

Station 2228, in 1,582 fathoms, two living specimens (No. 44,822); and station 2221, in 1,525 fathoms. One dead specimen (No. 40,498.)

This shell is larger, more oblique, and has a thinner hinge-plate than the form described and figured by Jeffreys. Whether it be identical with the original fossil shell, described by Brocchi, may be questionable.

***Limopsis plana* Verrill, sp. nov.**

Shell rather large for the genus, broad, moderately compressed, decidedly oblique, with a thin, straight hinge-margin and a wide, elongated fusiform ligamental area, interrupted in the middle by a large, triangular cartilage-pit. The straight dorsal margin is less than one-fifth the circumference of the shell, and does not extend so far forward as the convexly rounded anterior margin; the ventral margin is regularly rounded and considerably produced backward;

the posterior margin is decidedly oblique and nearly straight, forming a distinct angle where it joins the dorsal margin. The umbos are a little prominent; the beaks are directly incurved, small, and situated at about the middle of the dorsal margin. The exterior of the shell is rather smooth beneath the epidermis, but covered with numerous small, somewhat irregular undulations or ridges, and by smaller lines of growth; the radiating lines are very faint or almost entirely obsolete over the greater part of the shell, but in fresh specimens are indicated by the rows of slender epidermal hairs. The epidermis is light brown, thin, easily removed, and bears numerous radiating rows of fine slender hairs, which become longer and more crowded near the margin. The thin hinge-plate is nearly straight on the inside, and bears about three or four teeth on each side of the ligament-pit; three of those on the posterior side being larger and more distinct than the rest, while on the anterior side the three larger ones are but little prominent and decidedly oblique. The inner surface is smooth, and the margin is thin and plain, slightly beveled close to the edge.

Length, 14^{mm}; height, 14^{mm}; thickness, 8^{mm}; length of hinge-margin, 8.5^{mm}; breadth of ligament area, on one valve, 2^{mm}.

Station 2098, in 2,221 fathoms, two living specimens. (No. 35, 238.)

This species resembles, in size and form, the shell which we here refer to *L. aurita*, with which it also agrees in having a plain margin, but it differs decidedly in having a much broader ligament area, and a much larger cartilage-pit. Its hinge-margin is very much thinner, and the teeth fewer, less prominent, and more oblique. Externally the surface is much smoother, the concentric lines smaller, and less elevated, while the radial lines are much less distinct. The epidermis is thinner and less densely covered with hairs and scale-like processes.

Limopsis affinis Verrill, sp. nov.

Shell of moderate size, rather swollen, very oblique, with a broad and rather short ligamental area, and a short, curved hinge-margin, with few teeth.

The shell is subovate and very oblique; the dorsal margin is rather short and nearly straight, joining the anterior and posterior margins with obtusely rounded angles; the anterior margin is rounded and projects beyond the anterior angle, and then strongly recedes in a broad regular curve, the posterior ventral margin is obtusely rounded

and strongly produced backward; the posterior margin is very broadly rounded, its direction nearly parallel to the opposite part of the anterior margin. The edge of the shell is crenulated with a row of small rounded tubercles situated just within the margin, the largest along the ventral edge, disappearing toward the anterior end. Small radial grooves run inward from between these tubercles for a short distance. The ligament-area is unusually wide, somewhat concave, with a large cartilage-pit in the middle, which is elongated in a direction transverse to the ligament, with the sides parallel and the apex triangular. The hinge-plate is thin in the middle, becoming rather broad at each end, so that the inner margin is curved or angulated in the middle. The anterior end bears about four prominent rounded teeth, the outermost the largest. The posterior end has four or five prominent teeth, increasing in size outwardly; the last two are decidedly larger than the rest and somewhat oblique. The umbos are rather prominent and the beak curves directly inward towards the cartilage-pit, and is situated some distance from the margin, owing to the breadth of the ligamental area. The surface is covered with small, rather regular concentric undulations or ridges, which are crossed by radiating lines that are not very distinct over the greater part of the shell, and become nearly or quite obsolete on the umbos. The epidermis is light yellowish brown, and rises into series of slender hair-like processes along the radiating lines; these epidermal hairs become longer and crowded toward the margin, where they are more or less united and form a marginal fringe.

Length, 10.5^{mm}; height, 11^{mm}; thickness, 8^{mm}; length of dorsal margin, 5^{mm}; breadth of ligament-area, 2^{mm}.

Station 2092, in 197 fathoms; two living specimens (No. 44,829.)

This species resembles *L. minuta* in size and general appearance, but it is more oblique and more produced ventrally, and is widely different from that and all our other species, except *L. plana*, in having a broad ligamental area and large cartilage-pit. It is also peculiar in the character of its hinge-margin, and in its teeth, which are few in number, prominent, rounded, and scarcely oblique, except the outer ones on the posterior side. Externally the surface is smoother than in most species, the radial lines being but little evident when the epidermis is off. Although resembling *L. plana* in its broad ligament-area, it differs in having the ventral margin strongly crenulated, instead of plain, and in form it is a narrower, more oblique, and more swollen shell.

Crenella fragilis Verrill, sp. nov.

Shell large for the genus, very thin and fragile, translucent, iridescent within, in form oblong-ovate, very oblique, the anterior end short, a little expanded and broadly rounded, while the shell is very much swollen and prolonged ventrally. The posterior side falls off rapidly from the beak and is only a little convex, so that the margin of the valve has a nearly elliptical outline, with the longer axis extending from the beak to the ventral margin. The umbos are prominent and the beaks are strongly incurved and turned forward, and separated from the margin of the shell by a deep, narrow ligamental groove. The hinge-margin is thin and nearly plain, without any denticles. The ligament is long and extends from the front of the beak back more than a third of the length of the posterior margin. The sculpture consists of very regular, fine, radiating, raised lines, scarcely visible without a lens, separated by furrows a little wider; these are more or less interrupted by numerous fine but irregular raised lines of growth. The epidermis is very thin, smooth, pale olive.

Height of the smaller example, from beak to ventral margin, 14^{mm}; length from anterior to posterior margins, 9^{mm}; thickness, 12^{mm}. A broken specimen from the same locality is more than twice as large as the one measured.

Station 2,265, off Chesapeake Bay, N. lat. 37° 07' 40", W. long. 74° 35' 40", in 70 fathoms, green mud, gravel, and broken shells; bottom temperature 63° F. Two dead but fresh specimens (Nos. 40,676 and 41,543).

This species is remarkable for its large size, compared with other species; the extreme thinness and translucency of the shell; and for the fine and regular radiating lines that cover the entire surface.

Pecten undatus Verrill and Smith, sp. nov.

PLATE XLIV, FIGURE 21.

Shell small, oblique, very thin, fragile and translucent. The valves are similar in form and sculpture, but the left is a little more convex. Both are regularly undulated and everywhere covered by numerous, rather fine and regular raised radiating lines. In the right valve the anterior ear is considerably prolonged; with a deep acute notch below it; in the other valve the ear is less elongated and the notch is shallow and broadly concave; the posterior ear in both valves is

short-triangular, subacute, with a shallow concave notch. The ligament-pit is small and triangular. The hinge-margin is thin and simple. Beaks small, rising slightly above the margin in the left valve, and not quite reaching the margin in the right valve. The anterior margin of the shell projects considerably forward in a broad curve; the ventral margin is broadly and regularly arched, but projects downward a little more strongly behind the middle; the posterior margin is much less convex than the anterior, and in its upper part somewhat straightened. The concentric undulations of the surface are broad and regular, the depressions about equal to the undulations; they become much broader in proportion as they recede from the umbos, the last four occupying about one-half the breadth of the shell. The radiating lines are very thin, but distinctly elevated and roughened, or rendered slightly irregular by the very fine microscopic lines of growth, which everywhere cover the shell. The radiating lines are readily visible without a lens. Color translucent bluish white.

Length, 19^{mm}; height, 20^{mm}; breadth, 5^{mm}.

The single living specimen was taken at station 2229, in 1,423 fathoms, N. lat. 37° 38' 40", W. long. 73° 16' 30", (No. 44,827); a fragment occurred at station 2221, in 1,525 fathoms (No. 44,828.)

BRACHIOPODA.

Atrertia gnomon Jeffreys.

Ann. Mag. Nat. Hist., Sept., 1876, p. 251; Proc. Zool. Soc. London, for 1878, p. 412, pl. 23, fig. 4.

Verrill, Trans., Conn. Acad., vol. vi, p. 234, 1884.

This species was included in my preceding catalogue as one of those which had been taken off the coast of Labrador (Valorous Exp.), but not from off the coast of the United States. In 1884, however, it was taken in large numbers at station 2221, N. lat. 39° 05' 30", W. long. 70° 44' 30", in 1,525 fathoms (two hundred and twenty-five specimens, mostly living.) A few specimens also occurred at the adjacent station, 2222, in 1,537 fathoms; and a single living specimen was taken at station 2174, N. lat. 38° 15', W. long. 72° 03', in 1,594 fathoms.

These specimens agree perfectly with north European specimens sent by Dr. Friele.

Discina Atlantica King.

Verrill, Trans. Conn. Acad., vol. vi, p. 233, 1884.

PLATE XLIV, FIGURE 24.

Living specimens of this species were taken in considerable numbers at station 2226, in 2,021 fathoms; and 2229, in 1,423 fathoms. A few living specimens also occurred at station 2208, in 1,178 fathoms; and 2228, in 1,582 fathoms.

In most cases it was found adhering to hard concretions of clay, consolidated by oxide of iron, etc.

List of deep water species added to the fauna during the summer of 1884.

The following list is supplementary to the list of 1883 (see p. 264) and is written in the same form. An asterisk (*) indicates living specimen; a dagger (†) dead specimens.

CEPHALOPODA.

- Ancistrocheirus mcgaptera* V. sp. nov. vi, 399, pl. 42, f. 1, 1a.
Bathymetrical range, 707 fathoms.
- Teleoteuthis (Onychia) agilis* V. sp. nov. vi, 400, pl. 42, f. 2, 2a.
Surface.
- Benthoteuthis megalops* V. gen. and sp. nov. vi, 402, pl. 44, f. 1.
B. range, 600 to 1073 f.
- Cirrhoteuthis plena* V. sp. nov. vi, 404, pl. 42, f. 3.
B. range, 1073 f.
- Cirrhoteuthis mcgaptera* V. sp. nov. vi, 405, pl. 43, f. 1, 2.
B. range, 1054 to 2574 f.
- Opisthoteuthis Agassizii* V. vi, 408.
B. range, 1230 f. Cb.

GASTROPODA.

TOXOGLOSSA.

- Pleurotomella Jeffreysii* V. sp. nov. vi, 411, pl. 44, f. 3.
B. range, 1168 f.†; 1525 to 1537 f.*
- Pleurotomella tineta* V. sp. nov. vi, 412, pl. 44, f. 4.
B. range, 2512 f.*; 2574 f.†
- Pleurotomella Frickei* V. sp. nov. vi, 413, pl. 44, f. 5.
B. range, 1168 f.†; 1178 f.*

Pleurotomella vitrea V. sp. nov. vi, 414, pl. 44, f. 6.

B. range, 428 f.

Pleurotomella Lottæ V. sp. nov. vi, 415, pl. 44, f. 7.

B. range, 1525 f.

Gymnobela brevis V. sp. nov. vi, 417, pl. 44, f. 8.

B. range, 1290 to 1608 f.*; 1423 f.†

Bela Blakei V. sp. nov. vi, 417.

B. range, 2021 f.

Bela tenuicostata G. O. Sars. vi, 419.

B. range, 843 to 1290 f.

Admete nodosa V. and S. sp. nov. vi, 419, pl. 44, f. 9.

B. range, 816 f.*; 924 f.†

RACHIGLOSSA.

Marginella Smithii V. = *M. Virginiana* V., non Con. vi, 420, 452.

B. range, 15 to 70 f.†; 16 f.* S.

Trophon abyssorum V. sp. nov. vi, 176, 421.

B. range, 843 to 1731 f.*; 1467 to 1555 f.†

Trophon abyssorum, var. *limicola* V. nov. vi, 421.

B. range, 1178 to 1423 f.†; 1290 to 2033 f.*

Jumala brychia V. and S. sp. nov. vi, 422, pl. 44, f. 10, 10a.

B. range, 2574 f.

Omataxis nobilis V. sp. nov. vi, 423, pl. 44, f. 12.

B. range, 70 f.

RHIPHIDOGLOSSA.

Delphinula nitida V. and S. sp. nov. vi, 424, pl. 44, f. 11.

B. range, 1423 f.†

Margarita, sp. nov. vi, 425.

B. range, 70 f.†

Lepeta cæca (Müll) Gray.

B. range, 250 f. N., Arc., Eu.

Puncturella abyssicola V. sp. nov. vi, 425.

B. range, 1537 f.†

Cocculina reticulata V. sp. nov. vi, 426.

B. range, 70 f.

GYMNOGLOSSA.

Turbonilla perlepidæ V. sp. nov. vi, 427.

B. range, 70 f.

Turbonilla grandis V. sp. nov. vi, 427.

B. range, 1582 f.†

TECTIBRANCHIATA.

Actæon hebes V. sp. nov. vi, 428, pl. 44, f. 15.

B. range, 2574 f.†

Cyllichna eburnea V. sp. nov. vi, 428, pl. 44, f. 14.

B. range, 70 f.†

Pleurobranchus Americanus V. sp. nov. vi, 429, pl. 44, f. 13.

B. range, 250 f.

NUDIBRANCHIATA.

- Glaucus margaritaceus* (Bosc.) vi, 430.
Surface.

HETEROPODA.

- Firolioidea Lesueurii* (D'Orb.) Eyd. and Soul. vi, 430.
Surface.
Oxygyrus Keraudrenii (Les.) vi, 430.
Surface.

PTEROPODA.

- Styliola striata* (Rang.) vi, 430.
Surface.
Spirialis rostralis Soul. vi, 431.
Surface.
Spirialis reticulata (D'Orb.) Rang. vi, 431.
Surface: 2109 f.†
Pneumodermon Peronii Lam. vi, 431.
Surface.

SOLENOCONCHA.

- Dentalium laqueatum* V. sp. nov. vi, 431, pl. 44, f. 18.
B. range, 68 f.†
Dentalium ensiculus Jeff. vi, 432.
B. range, 1525 to 1594 f. Eu.
Cadulus spectabilis V. sp. nov. vi, 432, pl. 44, f. 19.
B. range, 1467 to 1582 f.†; 1525 to 1594 f.*

LAMELLIBRANCHIATA.

- Periploma undulata* V. sp. nov. vi, 433.
B. range, 816 f.†
Pecchiolia granulifera V. sp. nov. vi, 434.
B. range, 1423 f.†
Tapes sp. vi, 435.
B. ranges, 1043 f.†
Choristodon ? cancellatus V. sp. nov. vi, 435.
B. range, 70 f.†
Cryptodon grandis V. and S. sp. nov. vi, 436, pl. 44, f. 22.
B. range, 938 to 1582 f.†; 965 f.*
Cryptodon plicatus V. sp. nov. vi, 437.
B. range, 1073 to 1122 f.†
Kelliella nitida V. sp. nov. vi, 438.
B. range, 1525 to 2033 f.
Nucula trigona V. sp. nov. vi, 438.
B. range, 1140 f.†; 1423 to 1582 f.*

- Limopsis plana* V. sp. nov. vi, 441.
 B. range, 2221 f.
Limopsis aurita ? (Brocchi.) Jeff. vi, 440.
 B. range, 1525 to 1582 f. Eu.
Limopsis affinis V. sp. nov. vi, 442.
 B. range, 142 f.
Arca profundicola V. and S. sp. nov. vi, 439, pl. 44, f. 17, 18.
 B. range, 2021 f.
Crenella fragilis V. sp. nov. vi, 444.
 B. range, 70 f.
Pecten undatus V. and S. sp. nov. vi, 444, pl. 44, f. 21.
 B. range, 1423 to 1525 f.

BRACHIOPODA.

- Atretia gnomon* Jeff. vi, 445.
 B. Range, 1525 to 1594 f. N., Eu.

List of species found between 1000 and 2000 fathoms, additional to those recorded in the list of 1883. (See p. 282.)

Those species printed in italics have not been taken by us in less than 1000 fathoms.

CEPHALOPODA.

	Fathoms.		Fathoms.
Benthoteuthis megalops V.	600-1073	<i>Cirrhoteuthis megaptera</i> V.	1054-2574
<i>Cirrhoteuthis plena</i> V.	1073	<i>Opisthoteuthis Agassizii</i> V.	1230

GASTROPODA.

TOXOGLOSSA.			Fathoms.
	Fathoms.	<i>T. abyssorum</i> , var. <i>limicola</i> V.	1178-2033
<i>Pleurotomella Jeffreysii</i> V.	1168-1537	<i>Anachis Haliæti</i> (Jeff.) V.	48-1537
<i>Pleurotomella Frielei</i> V.	1168-1178	TÆNIOGLOSSA.	
<i>Pleurotomella Lotte</i> V.	1525	<i>Lamellaria pellucida</i> V.	43-2574
<i>Gymnobela brevis</i> V.	1290-1608	<i>Cerithiella Whiteavesii</i> V.	238-1594
<i>Bela tenuicostata</i> G. O.		RHIPHIDOGLOSSA.	
Sars.	843-1290	<i>Delyhinula nitida</i> V. and S.	1423
RACHIGLOSSA.		<i>Puncturella abyssicola</i> V.	1537
<i>Sipho cælatus</i> V.	75-1537	GYMNOGLOSSA.	
<i>Sipho hispidus</i> V.	1525-2033	<i>Turbonilla grandis</i> V.	1582
<i>Trophon abyssorum</i> V.	843-1731		

SCAPHOPODA.

	Fathoms.		Fathoms.
<i>Dentalium ensiculus</i> Jeff.	1525-1594	<i>Cadulus Watsoni</i> Dall.	70-1537
<i>Cadulus spectabilis</i> V.	1467-1594	<i>Cadulus Jeffreysii</i> ? (Monteros.)	115-1122

LAMELLIBRANCHIATA.

	Fathoms.		Fathoms.
<i>Pecchiolia granulifera</i> V.	1423	<i>Nucula trigona</i> V.	1140-1582
<i>Tapes</i> , sp. nov.	1043	<i>Limopsis cristata</i> Jeff.	64-1525
<i>Cryptodon grandis</i> V. and S.	938-1582	<i>Limopsis aurita</i> ? Jeff.	1525-1582
<i>Cryptodon plicatus</i> V.	1073-1122	<i>Pecten fragilis</i> Jeff.	578-1525
<i>Solemya velum</i> *	1-1600	<i>Pecten undatus</i> V. and S.	1423-1525
<i>Kelliella nitida</i> V.	1525-2033		

BRACHIOPODA.

	Fathoms.
<i>Atretia gnomon</i> Jeff.	1525-1594

List of species found at depths exceeding 2000 fathoms, additional to those recorded in the list of 1883. (See p. 284.)

CEPHALOPODA.

	Fathoms.		Fathoms.
<i>Mastigoteuthis Agassizii</i> V.	640-2516	<i>Cirrroteuthis megaptera</i> V.	1054-2574

GASTROPODA.

TOXOGLOSSA.		TÆNIGLOSSA.	
	Fathoms.		Fathoms.
<i>Pleurotomella tineta</i> V.	2512-2574	<i>Lamellaria pellucida</i> V.	43-2574
<i>Bela Blakei</i> V.	2021		
RACHIGLOSSA.		TECTIBRANCHIATA.	
<i>Nassa nigrolabra</i> V.	155-2574	<i>Actæon hebes</i> V.	2574
<i>Trophon abyssorum</i> , var. <i>limicola</i> V.	1178-2033		
<i>Jumala brychia</i> V. and S.	2574		

LAMELLIBRANCHIATA.

	Fathoms.		Fathoms.
<i>Abra longicallis</i> (Scacchi.)	924-2574	<i>Arca profundicola</i> V. and S.	2021
<i>Kelliella nitida</i> V.	1525-2033	<i>Limopsis plana</i> V.	2221

BRACHIOPODA.

	Fathoms.
<i>Discina Atlantica</i> King.	1178-2021

* Living specimens have not been taken below 300 fathoms. The specimen from 1600 fathoms is fragmentary and its occurrence is probably accidental. The next deepest locality is 384 fathoms.

EXPLANATION OF PLATES.

PLATE XLII.

- Figure 1.—*Ancistocheirus megaptera* (p. 399.) Dorsal view. Natural size. Part of the arms are mutilated.
- Figure 1a.—The same. Front view of a part of one of the lateral arms; $\times 4$.
- Figure 2.—*Teleoteuthis agilis* (p. 400.) Dorsal view of the type specimen; $\times 2$.
- Figure 2a.—The same. Club of one of the tentacular arms; $\times 4$.
- Figure 3.—*Cirrhoteuthis plena* (p. 404.) Ventral view. One-half natural size.
- Figure 4.—*Octopus Carolinensis* (p. 235.) Dorsal view of the type specimen. Natural size.
- Figure 5.—*Octopus piscatorum* (p. 248.) Male. The hectocotyliized arm; $\times 2$. From station 2035.

Figure 3 was drawn by Mr. J. H. Blake; the others by Mr. J. H. Emerton. All the figures are from alcoholic specimens.

PLATE XLIII.

- Figure 1.—*Cirrhoteuthis megaptera* (p. 405.) Dorsal view. One-half natural size.
- Figure 2.—The same. Ventral view. One-half natural size.

Both figures are copied from sketches made on shipboard by Mr. A. Baldwin from the living specimens, when first taken.

PLATE XLIV.

- Figure 1.—*Benthoteuthis megalops* (p. 402.) Dorsal view of one of the type specimens. Natural size.
- Figure 2.—*Abralia megalops* (p. 143.) Ventral view of the largest specimen. Natural size. This example has raised verrucae on the ventral side.
- Figure 2a.—The same. Right tentacular arm. Front view; $\times 4$.
- Figure 3.—*Pleurotomella Jeffreysii* (p. 411.) Male. From station 2222. Front view. Natural size.
- Figure 4.—*Pleurotomella tineta* (p. 412.) Station 2225. Front view. Natural size.
- Figure 5.—*Pleurotomella Frielei* (p. 413.) Front view of the type specimen. Natural size.
- Figure 6.—*Pleurotomella vitrea* (p. 414.) Front view; $\times 4$.
- Figure 7.—*Pleurotomella Lottæ* (p. 415.) Front view of the type specimen; $\times 2$.
- Figure 8.—*Gymnobela brevis* (p. 417.) Front view of the type specimen; $\times 4$.
- Figure 9.—*Admete nodosa* (p. 419.) Front view of the type specimen; $\times 2$.
- Figure 10.—*Jumala brychia* (p. 422.) Front view of type specimen. Natural size.
- Figure 10a.—The same. Operculum; $\times 2$.

Figure 11.—*Delphinula nitida* (p. 424.) Front view of the type specimen; $\times 4$.

Figure 12.—*Omalaxis nobilis* (p. 423.) Front view of the best specimen; $\times 2$.

Figure 13.—*Pleurobranchus Americanus* (p. 429.) Side view of the type-specimen as preserved in alcohol; $\times 2$.

Figure 14.—*Cylichna eburnea* (p. 428.) Front view of the type-specimen; $\times 3$.

Figure 15.—*Acteon hebes* (p. 428.) Front view of the type-specimen; $\times 2$.

Figure 16.—*Dentalium solidum* (p. 215.) Side view of a medium sized specimen. to show the outline, most of the longitudinal lines are omitted. Natural size.

Figure 17.—The same. Side view of a young specimen. Natural size.

Figure 18.—*Dentalium laqueatum* (p. 431.) Transverse section across the middle to show the size and arrangement of the ribs; $\times 2\frac{1}{2}$.

Figure 19.—*Cadulus spectabilis* (p. 423.) Side view of one of the type-specimens; $\times 2$

Figure 20.—*Cadulus grandis* (p. 219.) Side view of one of the type-specimens; $\times 2$.

Figure 21.—*Pecten undatus* (p. 444.) Type-specimen. Natural size.

Figure 22.—*Cryptodon grandis* (p. 436.) One of the type-specimens. Natural size.

Figure 23.—*Arca profundicolu* (p. 439.) Type-specimen; $\times 2$.

Figure 23a.—The same. View of the interior of a valve; $\times 2$.

Figure 24.—*Discina Atlantica* (pp. 233, 446.) View of one of the most perfect examples; $\times 4$.

Figures 1, 2, 2a and 24 were drawn by Mr. J. H. Blake; figures 12, 14 and 18 by the author; the rest of the figures by Mr. J. H. Emerton.

ADDITIONS AND CORRECTIONS.

Page 408, line 20, for 1058, read 1230.

Page 409, line 31, for 1883, read 1884.

Bela Blakei, p. 417, line 4 from bottom. The figure referred to (pl. 44, fig. 8), really represents *Gymnobela brevis* V., same page.

Marginella Smithii V. This name is proposed as a substitute for *M. Virginiana* (p. 420), preoccupied by Conrad for a fossil. It is dedicated to Mr. Sanderson Smith.

Skenea (?) *lirata* V. = *Omalaxis* (?) *lirata* V., vol. v, p. 529. This species is common in 10 to 43 fathoms off Cape Hatteras, but has not been preserved with the animal, so that the genus is still uncertain.

Lepeta cæca (Müll.) Gray. This species was taken alive at station 2262, in 250 fathoms.

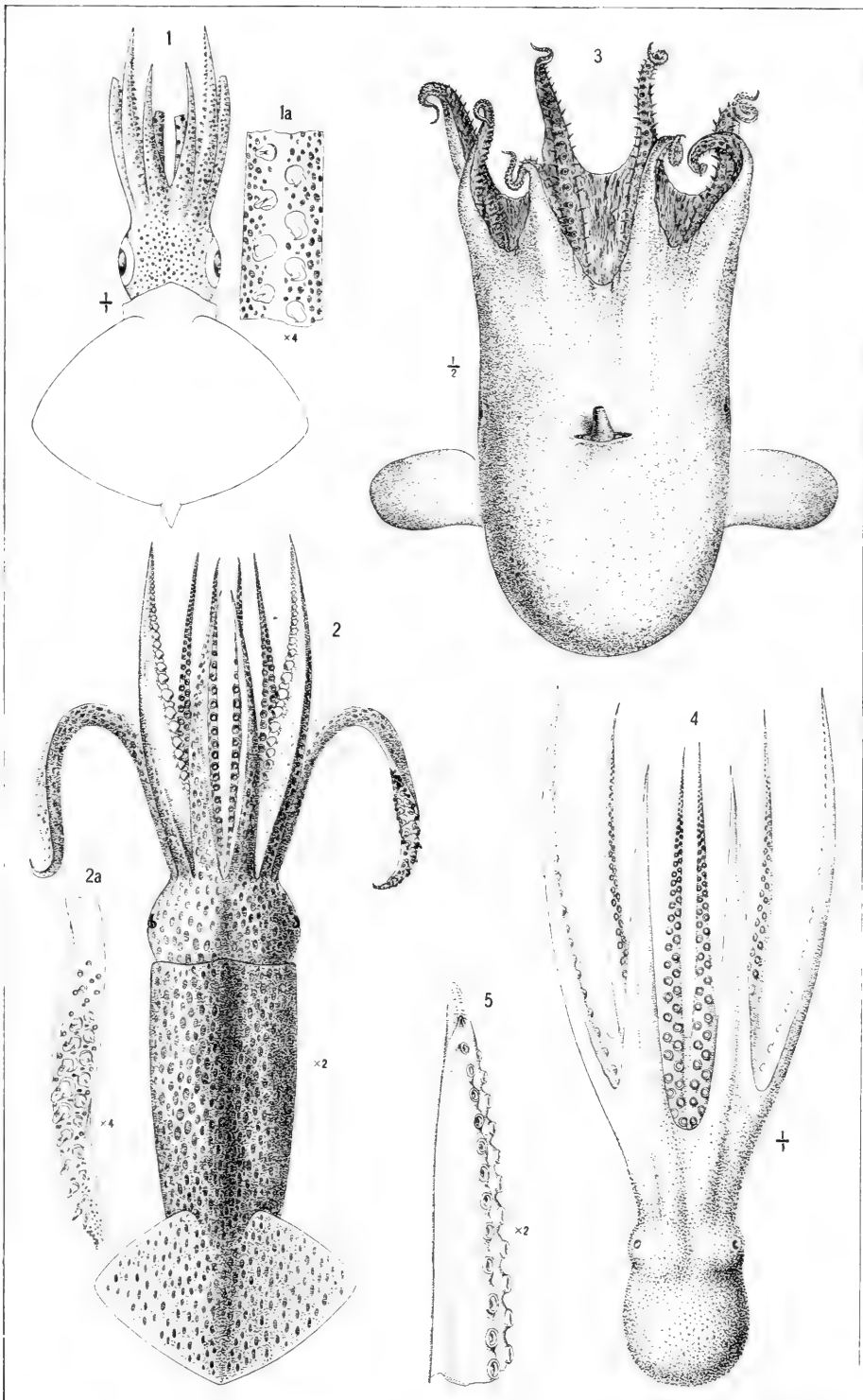

1



2

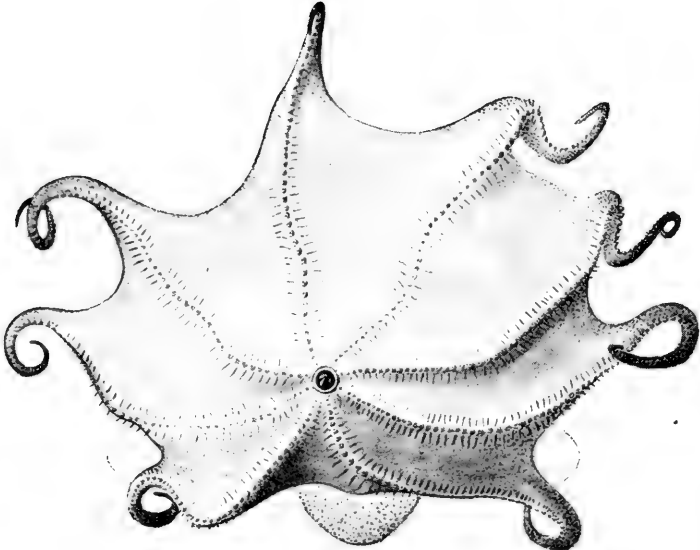

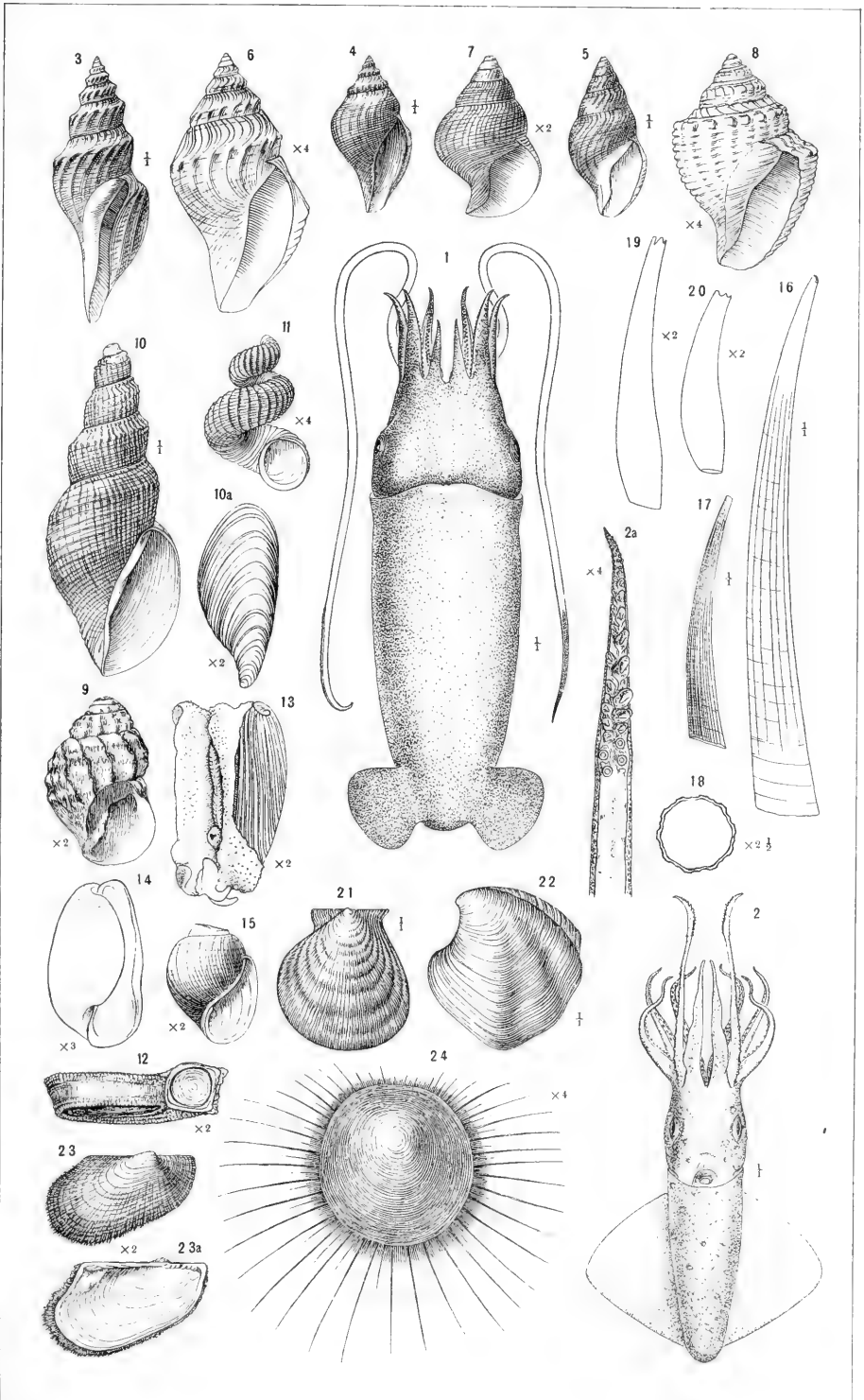



XI.—ADDITIONS TO THE SHALLOW-WATER MOLLUSCA OF CAPE HATTERAS, N. C., DREDGED BY THE U. S. FISH COMMISSION STEAMER "ALBATROSS," IN 1883 AND 1884. BY KATHARINE J. BUSH.

[Published by permission of the U. S. Fish Commission.]

THE following list is intended to include only species not previously recorded from the region off Cape Hatteras, between low-water mark and 50 fathoms; although in one or two instances recorded species are mentioned, where there is some variation from the original description, or doubt as to their identity. It is by no means complete, as there are still a number of species which have not been satisfactorily identified. There is also a large amount of fine shell-sand, which has not yet been assorted.

The lists used for comparison are "Mollusca of Beaufort, N. C.," by Dr. Wm. Stimpson, published in the American Journal of Science, vol. xxix, p. 44, 1860; "Natural History of Fort Macon, N. C., and Vicinity (No. 2), by Dr. Elliott Coues, published in Proc. Acad. Nat. Sci. Philadelphia, p. 120, July, 1871; "American Marine Conchology," by Geo. W. Tryon, Jr., 1873; and "Natural History of Fort Macon, N. C., and Vicinity" (No. 5), by Drs. Elliott Coues and H. C. Yarrow, published in Proc. Acad. Nat. Sci. Phila., p. 1, August, 1878.

At the end, a list is given of deeper-water species, found in not less than 40 fathoms, many of which have not before been found so far south. Such northern species have an *n* before them.

To Prof. A. E. Verrill my thanks are especially due for valuable advice in the preparation of this paper and for kindness in furnishing books of reference.

GASTROPODA.

TOXOGLOSSA.

Conus Delessertii (?) Recluz.

Conus Delessertii Recluz, Magasin de Zoologie, pl. 72, 1843.

Kiener, Coues, p. 156, pl. 23, fig. 2.

Chenu, Manuel de Conchyliologie, vol. i, p. 345, fig. 1476, 1859.

Bush, Report U. S. Com. Fish and Fisheries, p. 77, for 1883, 1885.

?*Conus Floridanus* Gabb, Amer. Journ. Conch., vol. iv, p. 195, pl. 15, fig. 4, 1868.

A single living specimen (No. 35,676) taken at station 2108, in 48 fathoms, although agreeing closely with the description and figure of

the above species, as given by Kiener, is referred to it with considerable doubt, as it is recorded by him as having been found only in the southern part of the Red Sea.

This species agrees also, in most respects, with *C. Floridanus* Gabb, from Tampa Bay, Fla., but differs in having the outline of the

List of shallow-water stations in the vicinity of Cape Hatteras, N. C., occupied by the Albatross in 1883 and 1884.

Station.	Locality.		Fath.	Bottom.	Temp. F.		Hour.	Date.
					Bot- tom.	Sur- face.		
	N. Nat.	W. Long.						1883.
2007	35° 17' 00"	75° 13' 00"	15	fne. S.	68	56	8.00 A. M.	Apr. 27
2108	35 16 00	75 02 30	48	bu. M., crs. S.	66	78½	-----	Nov. 9
2112	35 20 50	75 18 00	15½	S., bk. Sp.	73½	70	-----	" 10
2113	35 20 30	75 19 00	15	M., bk. S.	72½	70	-----	" 10
2114	35 20 00	75 20 00	14	"	72	70	-----	" 10
								1884.
2269	35 12 30	75 05 00	48	crs. G.	76	75	8.46 A. M.	Oct. 19
2270	35 14 15	75 07 00	32	fne. gy. S.	--	75	9.40 "	" 19
2271	35 16 00	75 09 00	26	-----	--	75	10.45 "	" 19
2272	35 20 10	75 14 00	15	S. bk. Spk.	--	75	11.57 "	" 19
2273	35 20 30	75 17 30	17	"	72	72	12.45 P. M.	" 19
2274	35 20 35	75 18 05	16	"	--	71	1.22 "	" 19
2275	35 20 40	75 18 40	16	"	--	71	1.43 "	" 19
2276	35 20 45	75 19 15	16	"	--	71	2.08 "	" 19
2277	35 20 50	75 19 50	16	"	--	71	2.21 "	" 19
2278	35 20 55	75 20 20	16	"	--	71	2.45 "	" 19
2279	35 20 55	75 20 55	16	"	--	71	3.36 "	" 19
2280	35 21 00	75 21 30	16	"	--	70	4.15 "	" 19
2281	35 21 05	75 22 05	16	"	--	70	4.35 "	" 19
2282	35 21 10	75 22 40	14	bk. S.	--	70	5.13 "	" 19
2283	35 21 15	75 23 15	14	gy. S.	--	70	5.41 "	" 19
2284	35 21 20	75 23 50	13	crs. gy. S.	--	70	6.09 "	" 19
2285	35 21 25	75 24 25	13	"	--	70	6.40 "	" 19
2286	35 21 30	75 25 00	11	"	--	70	7.13 "	" 19
2287	35 22 30	75 26 00	7	"	--	69	6.15 A. M.	" 20
2288	35 22 40	75 25 30	7	S., brk. Sh.	--	69	6.45 "	" 20
2289	35 22 50	75 25 00	7	"	--	69	7.15 "	" 20
2290	35 23 00	75 24 30	10	"	--	69	7.45 "	" 20
2291	35 25 30	75 20 30	15	"	--	69	8.45 "	" 20
2292	35 27 20	75 16 30	17	"	--	70	9.32 "	" 20
2293	35 29 10	75 12 30	18	crs. S.	--	71	10.25 "	" 20
2294	35 31 00	75 08 30	19	crs. gy. S.	--	71	11.18 "	" 20
2295	35 32 41	75 04 30	22	"	--	73	12.03 P. M.	" 20
2296	35 35 20	74 58 45	27	"	--	71	1.15 "	" 20
2297	35 38 00	74 53 00	49	M., brk. Sh.	--	73	2.18 "	" 20
2302	35 14 00	75 03 00	49	S., C.	71	77	6.45 A. M.	" 21
2303	35 17 00	75 01 00	41	fne. S.	--	77	7.11 "	" 21
2304	35 19 00	74 58 00	37	"	--	77	7.40 "	" 21
2307	35 42 00	74 54 30	43	gy. & bk. S.	57	70	4.11 P. M.	" 21
2308	35 43 00	74 53 30	45	"	--	71	5.17 "	" 21

whorls concave with rounded angles, and in its coloring, the characters which Mr. Gabb mentions as belonging especially to *C. Desertii* Recluz. Both may be only variations of the same species.

Shell of medium size. Spire elevated, one-third the length of the shell, turreted, abruptly tapered to a small, very acute apex. Whorls nine (tip broken), concave, distinctly angulated just above the suture, forming a prominent, rounded keel, which is nodulous on the upper whorls, becoming smooth on the lower ones. The broad, concave, subsutural band is crossed by numerous, very fine, very much curved lines of growth and several unequal, and unequally separated, impressed, revolving lines and microscopic striæ. Body-whorl long, diminishing regularly toward the anterior end, and nearly straight along the sides, angulated considerably below the suture with a prominent, rounded keel, above which there is a wide, concave subsutural band, corresponding to that of the whorls of the spire. There are about twelve broad, deep, revolving grooves near the anterior end of the whorl, the spaces between them decreasing anteriorly; the rest of the surface is covered by unequal, wavy, impressed, revolving lines and microscopic striæ, crossed by the fine, flexuous lines of growth. Aperture narrow, of nearly uniform width; outer lip thin, very much curved forward from the broad, deep, posterior sinus. Interior glossy, bluish white, the exterior coloring showing distinctly along the edge. Epidermis light yellowish brown, raised in small, distinct scales along the lines of growth. Color light yellow, banded with white and marked with irregular chestnut-brown spots. On the body-whorl, commencing at the shoulder, there are three broad light yellow bands, ornamented with irregular, longitudinal, chestnut-brown spots, alternating with white bands, ornamented with three or four rows of smaller chestnut-brown, rounded and quadrangular spots. On the spire, the shoulder of the whorls is white, and with the subsutural band is ornamented with irregular, transverse spots of chestnut-brown.

Length, 51^{mm}; breadth, 24^{mm}; height of spire, 18^{mm}; length of aperture, 38^{mm}; its breadth, 4^{mm}.

Mangilia psila, sp. nov.

PLATE XLV, FIGURE 2.

Shell of moderate size, slender, rather thick, very plain, yellowish white, with a dull, lusterless surface. Whorls about six and a half elongated, decidedly angulated, forming an elongated, blunt spire.

Suture defined by an indistinct, undulating line. A very few prominent, narrow, straight ribs (six on the body-whorl) cross the whorls from suture to suture, separated by very wide, concave interspaces; a single rounded thread revolves on the periphery at the shoulder of the whorls, scarcely visible on the interspaces, but forming conspicuous, oblong nodules on the ribs. On the body-whorl the ribs continue to the end of the canal curving in from its base, towards the aperture. On the ventral surface of the canal there are five or six very indistinct, oblique striæ. The surface is everywhere crossed by conspicuous, flexuous lines of growth. Nucleus rather large, composed of two and a half regularly coiled, nearly smooth, somewhat shining whorls, the second having a row of minute nodules or beads on the periphery. Aperture long, narrow, of nearly uniform width; outer lip thin, nearly straight, broadly rounded anteriorly, with a decided sinus just below the suture; within the aperture, underneath the first external rib, there is a line of small, oblong nodules. Inner lip continuous with the outer, with a thin, free edge. Columella very slightly curved, with a small horizontal fold or tooth about the posterior third.

Length, 6^{mm}; breadth, 2.5^{mm}; length of aperture, 3^{mm}; its breadth, about .8^{mm}. A single dead specimen (No. 44,756) was taken at station 2269, in 48 fathoms.

Mangilia eritima, sp. nov.

Shell large for the genus, composed of eight very angular whorls, which form a sharp pointed, regularly tapered, turreted spire. Nucleus very small, regularly coiled, consisting of two and a half shining, light yellow whorls in striking contrast to the dull, rough surface peculiar to the rest of the shell. The first one and a half turns are perfectly smooth, while the last one is crossed by minute, transverse riblets. Suture marked by a conspicuous, rounded, undulating cingulus or thread on the preceding whorl. The sculpture consists of prominent, straight, angular, alternating ribs (nine on the body-whorl), forming a conspicuous node at the angle, extending from suture to suture. These, with their deeply concave interspaces, are crossed by unequal, conspicuous, well-rounded, granulated cinguli and microscopic threads. The first cingulus, defining the shoulder of the whorls, is double with the upper half slightly the larger, the sutural one is the next in size, while between these there are two still finer ones; these are unequally distant from each other, the first and second being much

closer together than the others, and the intervening surfaces are covered by unequal, microscopic threads. Above the angle of the whorls the threads alone occur and number about nine. This inequality in the spiral sculpture makes the edges of the transverse ribs very rough and jagged. On the body-whorl there are about thirteen cinguli below the shoulder, unequal in size and unequally separated, those on the canal larger and closer together than those just above it, while the fourth one below the angle is so prominent as to make a slight angle in the outline of the whorl. Below this angle the transverse ribs curve in toward the columella following the outline of the outer lip, and extend to the end of the canal, the curvature being most noticeable in a dorsal view. Very fine striæ intersect the cinguli and the threads in the direction of the lines of growth, rendering them granular and give the appearance to the shell, when dry, of being covered with a fine, gray dust. Aperture long, narrow-ovate, with a moderately long, rather narrow canal. Outer lip not thickened, with a comparatively thin edge and a broad, moderately deep sinus extending from the suture to the angle. Columella slightly curved; inner lip marked by a narrow stripe of conspicuous red enamel. Color light yellow-brown; interior of aperture of the same conspicuous red color as the inner lip. In young specimens this coloring is wanting.

Length, nearly 8^{mm}; breadth, 3^{mm}; length of aperture, 3.5^{mm}; its breadth, 1^{mm}.

One adult and four young specimens were taken in 14 to 17 fathoms.

Mangilia ephamilla Bush.

Report U. S. Com. Fish and Fisheries, p. 78, for 1883, 1885.

PLATE XLV, FIGURES 4, 4a.

Shell of moderate size, rather stout, with a regularly tapered, acute spire of about five sharply angulated whorls, besides the nucleus. Suture marked by a distinctly raised, rounded, undulating spiral thread. The nucleus is small, prominent, semi-transparent and glassy, composed of about two and a half turns. The apical whorl is small, rather prominent and with the second is very smooth; the third is crossed by delicate, curved, transverse riblets rendered somewhat nodulous by the intersection of a single, faint, revolving, median thread; on the other whorls there are about nine, broad, prominent, acute, straight, longitudinal ribs extending from suture to suture, and separated by deep, concave interspaces about equal in

width to the ribs. The whole surface is covered with distinctly raised, rounded cinguli and microscopic threads roughened by the fine lines of growth, and have the appearance, under the microscope, of being covered with minute grains of sand. The cingulus at the centre and defining the shoulder of the whorls is the most conspicuous; above this there are about five finer ones, and below, on the whorls of the spire, two or three, the number increasing to ten or twelve on the body-whorl. The aperture is a little less than half the length of the shell, narrow, oblong, broadest at its posterior third, pinched up anteriorly into a straight, slightly elongated canal. Outer lip thin, with a sharp edge and a shallow sinus just below the suture; inner lip inconspicuous. No operculum.

Color, in alcohol, deep yellow with white ribs and canal, changing in adult specimens to deep brown with yellow ribs and canal.

Length, 6.5^{mm}; breadth, 3^{mm}; length of aperture, 3^{mm}; its breadth, .5^{mm}.

Several specimens both living and dead, in 14 to 48 fathoms.

This species is closely allied to *M. cerina*, but differs in having a stouter form, more angularly shouldered whorls and especially in having acute, very prominent, straight ribs extending from suture to suture.

Mangilia ceroplasta, sp. nov.

Shell of medium size, stout, waxen-yellow, with an abruptly tapered, blunt spire, less than half the length of the shell, composed of six and a half well rounded whorls. Nucleus large, regularly coiled, rather blunt, somewhat lustrous, of two and a half whorls; the second is crossed by four unequal, equally distant, nodulous carinæ, the first, just below, and the fourth, just above the suture, are very fine and quite indistinct. Below this the whorls are crossed from suture to suture, by little elevated, rounded, straight ribs separated by intervals about equal to their own width; both of these are intersected by a distinct median carina and three or four less conspicuous equally distant ones below it. On the body whorl there are about sixteen smaller ones, somewhat crowded anteriorly. Very fine microscopic threads cover the intervening surface and all are roughened, or rendered granulous, by the intersection of the fine striæ in the direction of the lines of growth. Aperture broad-ovate; outer lip thin, broadly curved posteriorly, with a very slight inbending anteriorly. Columella slightly curved. Inner lip shown by a narrow strip of dark colored enamel. Color light yellow with a narrow band of dark red-

brown just below the suture, and a similar one on the middle of the body-whorl.

Length, 5.5^{mm}; breadth, 3^{mm}; length of aperture, 3^{mm}; its breadth, 1^{mm}.

A few dead specimens, in 10 to 17 fathoms.

Mangilia melanitica Dall, variety **oxia** Bush.

Report U. S. Com. Fish and Fisheries, p. 78, 1883, for 1885.

PLATE XLV, FIGURES 3, 3a.

Shell small, slender, fusiform, lustrous, transparent, glassy, with a tall, regularly tapered, acute spire. Whorls eight slightly convex, angulated and carinated. Suture defined by a distinct, smooth, rounded thread. Nucleus large, acute, nearly smooth, of three and a half rapidly tapering coils, with a small, very prominent, decidedly upturned apical whorl; the two lower whorls have a distinct median keel. The sculpture consists of about seventeen very thin, slightly raised, strongly recurved riblets extending from suture to suture, rendered nodulous by the intersection of a rather broad, smooth, rounded, median carina. The greatest curvature of the transverse riblets is above the carina on the wide, slightly concave, subsutural band, which is crossed also by the lines of growth, and in some specimens, by numerous, microscopic, revolving striae. On the body-whorl, from the posterior end of the aperture to the end of the canal, there are about twelve rather fine, smooth, rounded cinguli. The first, a little wider and more prominent than the others, situated just above the suture, is rendered nodulous by the crossing of the riblets at which they abruptly end, and is separated from the second by a quite wide, smooth space; the distance between the others decreases so that, on the canal, they are quite close together. On some of the specimens there is an additional line midway between the carina and the first cingulus; and three or four of the riblets, and rarely all of them, on the dorsal surface extend, as nearly straight lines, to the base of the canal. The aperture, in immature specimens, is rather broad-ovate, with a thin, slightly curved outer lip with a very shallow, wide posterior sinus and the columella has a slight, sigmoid curvature, while in more mature specimens the aperture is very narrow, oblong, with a very much thickened outer lip, forming a conspicuous varix with a thin, brown edge bending in, partly closing the aperture, and with a deep, narrow, oblique sinus considerably below the suture. The outer lip also increases posteriorly and joins the inner

lip a little below the suture, thus considerably shortening the aperture. Some specimens have about four smooth, raised, rounded, revolving threads on the interior of the aperture, which form, by their abrupt termination, conspicuous nodules within the margin of the outer lip. Columella, nearly straight, and has, just within the thin, free edge of the inner lip, a row of from four to six very minute, white crenulations. Canal very short, narrow at its base, but suddenly widened by the abrupt, outward turning of the lip.

Color of fresh specimens amber, with lighter tinted carina, and red-brown edged aperture; some specimens are irregularly spotted with red-brown.

Length of a medium sized mature specimen, 5^{mm}; its breadth, 2^{mm}; length of aperture, 1.75^{mm}; its breadth, .5^{mm}. A specimen of the same length without the thickened lip, has an aperture 2^{mm} long and nearly 1^{mm} broad.

Very abundant, both living and dead, in 7 to 48 fathoms.

Mr. W. H. Dall considers this shell identical with a species from Florida to which he has given the name, *melanitica* (MSS.), but admits a varietal difference.

Mangilia oxytata Bush.

Report U. S. Com. Fish and Fisheries, p. 80, for 1883, 1885.

PLATE XLV, FIGURE 1.

At station 2108, in 48 fathoms a single dead specimen (No. 35,395), somewhat resembling the preceding, was taken.

It consists of about eight whorls; those of the spire strongly angulated just below the middle, and ornamented with about nine rather prominent, straight, transverse ribs, commencing at the periphery and extending to the suture; these, with their wide, concave interspaces, are crossed by three rather strong, nearly smooth, rounded, equally distant carinae, the third defining the suture. Smooth, oblong nodules are formed by the intersection of these with the ribs, those on the periphery being the most conspicuous, as the first carina is slightly wider than the other two. The subsutural band is wide, slightly concave, crossed by delicate, ex-curved, raised lines or riblets, extending from the suture to the median carina; and by three or four fine, slightly raised, equally distant, revolving threads. The nucleus is large, semi-transparent, shining, of four and a half turns, with a small, exceedingly prominent, decidedly upturned, apical whorl, which, with the two following, is smooth and glassy; the next two have a

fine, smooth, median carina. On the body-whorl the ribs continue nearly to the base of the canal and are crossed by small, nearly smooth, rounded, equally distant cinguli, which commence a little below the third principal carina and continue to the end of the canal. The entire surface is covered with very minute, microscopic granules. Aperture narrow-ovate, pinched up anteriorly into a short, rather narrow, straight canal. Outer lip very much thickened, with a conspicuous varix, and a thick, smooth, rounded, very irregularly curved, light brown edge, and a deep, narrow sinus considerably below the suture, at the angle of the shoulder; inner lip inconspicuous; columella slightly curved.

Color yellowish white, tinged with brown just below the suture, and on the anterior part of the body-whorl.

Length, 5^{mm}; breadth, 2.5^{mm}; length of aperture, 2^{mm}; its breadth, 1^{mm}.

This species, although closely resembling the preceding, is sufficiently characterized in having a much stouter form, more acute apex, more angularly shouldered whorls, fewer and more prominent ribs, more numerous cinguli, and especially in having its entire surface microscopically granulated.

Mangilia (?) glypta Bush.

Report U. S. Com. Fish and Fisheries, p. 80, for 1883, 1885.

PLATE XLV, FIGURES 5, 5a.

Shell small, semi-transparent, fusiform, with about five slightly convex whorls, below the nucleus, which consists of three and a half smooth, transparent, white, glassy, regularly increasing turns. The apical whorl is small, not very prominent, somewhat oblique. The sculpture consists of about ten rather indistinct, narrow, longitudinal ribs, and broad, rounded, very conspicuous cinguli, which, in crossing the ribs, form prominent, smooth, white, oblong beads or nodules; there are three rows of these on the whorls of the spire, and five or six on the body-whorl; the second and third are the most prominent and farther apart than the first two. Cinguli without nodules continue to the end of the canal, the transverse ribs disappearing at its base. Aperture a little more than one-third the length of the shell, narrow-ovate, pinched up anteriorly into a very narrow, short canal; outer lip thickened, forming a slight varix, with a thin, white edge and a shallow sinus close to the suture, with one or two, minute, white crenulations just within its posterior edge; there are also about

five similar but much larger crenulations on the inner margin of the lip, extending from the sinus to the base of the canal. Inner lip continuous with the outer, with a free, thin, white edge, having four or five minute white crenulations just within its inner margin. Canal short, narrow, bent slightly backwards at its anterior end, with a decided, but shallow notch. Epidermis raised in conspicuous folds along the lines of growth.

Color, of fresh specimens, light yellowish brown under a lighter yellow epidermis.

Length of a specimen with imperfect nucleus, 5^{mm}; its breadth, 2.5^{mm}; length of aperture, 2.5^{mm}; its breadth, 1^{mm}.

Two fresh and several worn specimens, in 16 to 48 fathoms.

The conspicuous epidermis prevents this species being rightly placed in the *Mangilia* group, but as no specimens with the animal have as yet been found, its position cannot be determined with certainty, although in its general appearance and lamelliform epidermis it closely resembles a *Pisania*.

Acus protextus (Conrad) Dall.

Cerithium protextum Conrad, Proc. Acad. Nat. Sci. Phil., vol. iii, p. 26, 1846.

Acus protextus Dall, Proc. U. S. Nat. Mus., vol. vi, p. 325, 1883.

Three dead specimens (No. 35,383), station 2108, in 48 fathoms.

RACHIGLOSSA.

Marginella Smithii Verrill.

These Transactions, vol. vi, pp. 420, 452, 1885.

A number of specimens, in 15 to 43 fathoms.

Nassa consensa Rav.

Ravenel, Proc. Acad. Nat. Sci. Phil., vol. xiii, p. 43, 1861.

Tryon, Amer. Mar. Conch., p. 35, 1873.

Rather common in 10 to 49 fathoms.

Astyris pura Verrill.

These Transactions, vol. v, p. 515, 1882.

Two specimens, living and dead, in 14 and 15 fathoms.

TENIOGLOSSA.

Cyphoma gibbosa (Linné) Adams.

H. & A. Adams, Genera, vol. i, p. 271, pl. 28, fig. 8, 1858.

Chenu, Manuel de Conchyliologie, vol. i, p. 273, fig. 1790, 1859.

One dead specimen (No. 40,766) occurred at station 2280, in 16 fathoms.

Lunatia heros (Say) H. & A. Adams.

Gould, *Invert. Mass.*, Binney's ed., pp. 338-340, figs. 608-610, 1870.

Verrill, *Invert. Anim. Vineyard Id.*, p. 646, pl. 23, figs. 133-136, 1874.

A few dead specimens, in 16 to 68 fathoms.

Sigaretus maculatus Say.

Say, *Amer. Conch.*, vol. iii, pl. 25, 1831; *Conch. U. S.*, p. 176, pl. 25, 1858.

Tryon, *Amer. Mar. Conch.*, p. 61, pl. 10, fig. 106, 1873.

Two dead specimens (No. 38,750), station 2276, in 16 fathoms.

Cerithiopsis Emersonii Adams.

Gould, *Invert. Mass.*, p. 387, fig. 649, 1870.

Verrill, *Invert. Anim. Vineyard Id.*, p. 648, pl. 24, fig. 151, 1874.

Rather common in 14 to 16 fathoms.

Triforis turris-thomæ (D'Orb.) Dall.

Cerithium turris-thomæ D'Orbigny, *Moll. Cuba*, vol. ii, p. 155, atlas, pl. 23, figs. 10-12, 1853.

Triforis turris-thomæ Dall, *Bull. Mus. Comp. Zool.*, vol. ix, p. 81, 1881.

PLATE XLV, FIGURE 6.

One dead specimen (No. 35,807), station 2114, in 14 fathoms.

Cæcum pulchellum Stimp.

Gould, *Invert. Mass.*, p. 315, fig. 583, 1870.

Verrill, *Invert. Anim. Vineyard Id.*, p. 649, pl. 24, fig. 158, 1874.

Common in 14 to 17 fathoms.

Cæcum Cooperi Smith.

Verrill, *Invert. Anim. Vineyard Id.*, p. 649, 1874; these *Transactions*, vol. v, p. 525, 1882; vol. vi, pl. 28, fig. 8, 1884.

A few specimens were found with the preceding.

Cithna (?) olivacea V.

These *Transactions*, vol. vi, p. 185, pl. 29, f. 5, 1884.

A single dead specimen occurred at station 2273, in 17 fathoms.

Skeneia trilix, sp. nov.

Bush, Report U. S. Com. Fish and Fisheries, p. 82, for 1883, 1885.

PLATE XLV, FIGURES 7, 7a.

Shell small, disk-shaped, with the spire nearly flat, but with the nuclear whorls rising a little above the level of the last whorl. Whorls four or more, the body-whorl strongly tricarinate, one carina at the periphery, one around the base and one around the shoulder, the spaces between them equal, convex and nearly smooth. The upper carina shows on all except the nuclear whorls and the one next following; above this carina the whorl is flattened or slightly concave, joining the preceding whorl nearly at right angles, but swelling a little close to the suture; on this band four or five faint spiral striae sometimes occur; more rarely traces of them are found below the carina and on the base. On the basal side, the last whorl is pretty regularly rounded and strongly convex and the umbilical depression is large and deep, funnel-shaped, extending to the apex. Within this, the whorls are distinctly spirally grooved and sometimes its border is defined by a small, distinctly raised carina. Aperture nearly circular though slightly angulated at the carinae. Lip a little thickened, slightly expanded next the body-whorl; inner lip represented only by a thin, closely adherent layer of enamel. Nucleus small, a little prominent, smooth, glossy and subvitreous, the apical whorl minute and slightly turned up. Surface of the shell lustrous and usually nearly smooth though often showing faint, flexuous lines of growth.

Dry specimens are more or less opaque, yellowish white.

Fresh specimens, preserved in alcohol, are very thin, nearly transparent, the animal matter showing distinctly beneath. The entire surface of these is crossed by numerous, very delicate, regular, equally distant, microscopic lines in the direction of the lines of growth.

Operculum very thin, horny, light yellow, round, of about five equal whorls, nucleus at the center.

Animal with short, stout tentacles; prominent eyes situated at their bases; and a rather broad, bilobed snout.

Breadth, 3^{mm}; height, 1^{mm}.

Very abundant, both alive and dead, in 7 to 17 fathoms.

Skeneia lirata V.

Omalaxis (?) *lirata* Verrill, these Transactions, vol. v, p. 529, 1882; vol. vi, p. 452, 1885.

Several specimens were found in 10 to 17 fathoms.

PTENOGLOSSA.

Scalaria leptalea, sp. nov.

Shell comparatively thin and delicate, rather stout, large, composed of about ten regularly tapered, very convex whorls. The nucleus is small, and consists of two and a half smooth, shining whorls; below this the surface is crossed by delicate, thin, slightly raised, reflected, oblique ribs, between which there are very numerous, exceedingly fine cinguli, about fifteen to the millimeter. On the upper whorls the ribs are very numerous, exceedingly fine and very close together, becoming less numerous, coarser and farther apart on the lower ones. The number decreases in a ratio of ten, there being thirty-six on the eighth whorl, twenty-six on the ninth, and sixteen on the body-whorl. Aperture ovate; outer lip thin with a reflected edge; inner lip thickened and reflected anteriorly.

Color bluish white.

Length of the largest specimen, with imperfect nucleus, 15.5^{mm} ; breadth, 5.5^{mm} ; length of aperture, 4^{mm} ; its breadth, about 3^{mm} .

One adult and several young specimens, in 14 to 16 fathoms.

Scalaria teres, sp. nov.

PLATE XLV, FIGURE 8.

Shell very small and slender, thin, delicate, semi-transparent, very shining. Whorls about nine, very convex, regularly coiled, crossed by numerous (about twenty-seven on the body-whorl) very thin, delicate, slightly raised, a little oblique ribs, having an almost imperceptible angle just below the suture. Nucleus large, delicate pink, consisting of three and a half perfectly smooth, shining whorls. Aperture oval; inner lip thickened, slightly reflected at the base. Color bluish white with a delicate pink apex.

Length, 4^{mm} ; breadth, 1.5^{mm} ; length of aperture, about 1^{mm} ; its breadth, about $.5^{\text{mm}}$.

This species can be readily recognized by its size, delicacy and very brilliant luster.

Two living specimens from stations 2275 and 2276, in 16 fathoms.

GYMNOGLOSSA.

Niso ægleës Bush.

Report U. S. Com. Fish and Fisheries, p. 83, for 1883, 1885.

PLATE XLV, FIGURES 10, 10a.

Shell of moderate size, regularly tapered, conical, thin, semi-transparent, smooth, shining, consisting of about twelve, closely coiled,

flattened whorls, with the suture indistinct defined by a thread of dark chestnut-brown, above and below which there is an indefinite band of yellowish white, gradually shading, towards the centre of the whorls, into light yellow or brown, sometimes mingled with purple. The nucleus is small, consisting of about three regularly coiled whorls of a light purple or amethystine color. Base prominent, angulated, with a moderately large and deep umbilicus, margined by a dark chestnut-brown thread. Aperture nearly quadrangular, the angles being formed at the termination of the dark threads, defining the base and the umbilical region, somewhat produced at the anterior angle, forming an indistinct notch. Outer lip thin, with a dark chestnut-brown edge; inner lip regularly curved, slightly reflected over the umbilicus, with a somewhat thickened, dark chestnut-brown edge; just back of this there runs across the base, from within the umbilicus to the sutural thread, a thread or streak of the same dark chestnut-brown color, and throughout the entire length of the shell, with the exception of the nucleus, similarly colored streaks occur, crossing the whorls at irregular intervals. In specimens somewhat eroded, fine but distinct lines of growth cross the whorls at pretty regular intervals, and occasionally even in fresh specimens indications of them are seen. Operculum horny, very thin, light yellow.

Length of the largest specimen, 7.5^{mm}; breadth, 3.5^{mm}; length of aperture, 2.5^{mm}; its breadth, 2^{mm}.

Common in 7 to 32 fathoms.

Odostomia engonia, sp. nov.

Shell long, rather stout, white, lustrous, obelisk-shaped, consisting of seven and a half flattened whorls, distinctly chamfered above the suture which is canaliculate. The surface is apparently smooth except a rather prominent, rounded, revolving thread at the angle of the whorls, but under the microscope it is covered with numerous, unequal, indistinct striæ. Nucleus very small, just showing above the first whorl. Body whorl distinctly angulated at the periphery where there is a prominent, rounded thread, with a somewhat elongated, rounded base. Umbilicus small, deep, nearly concealed by the reflected inner lip. Aperture oval, anteriorly considerably produced beyond the base. Columella with a small, distinct fold within the aperture not seen in a front view.

Length, 5^{mm}; breadth, 2^{mm}; length of aperture, 1.8^{mm}; its breadth, 1^{mm}. A more mature specimen from Beaufort, N. C., is 6.5^{mm} long; 2.8^{mm} broad; with an aperture 2^{mm} long and 1^{mm} broad.

One living and a few dead specimens, in 15 and 16 fathoms.

Odostomia engonia, var. *teres* nov.

PLATE XLV, FIGURE 9.

A similar but much more slender shell was found with the preceding.

The whorls are more flattened and have a distinct, impressed, spiral line just below the angle. The nucleus is large and very oblique. The aperture is not so much produced anteriorly. In young specimens the fold is very conspicuous.

A specimen with the same number of whorls as the one measured above is 4.5^{mm} long; 1.5^{mm} broad; aperture, 1^{mm} long and about .8^{mm} broad.

Odostomia cancellata (D'Orb.)

Chemnitzia cancellata D'Orbigny, Moll. Cuba, vol. i, p. 225, atlas, pl. 17, figs. 1-3, 1853.

A few specimens were found in 11 to 16 fathoms.

TECTIBRANCHIATA.

Actæon puncto-striatus (Adams) Stimp.

Tornatella puncto-striata Gould, Invert. Mass., p. 224, fig. 515, 1870.

Actæon puncto-striata Verrill, Invert. Anim. Vineyard Sd., p. 664, pl. 25, fig. 165, 1874.

PLATE XLV, FIGURE 17.

A number of specimens were found in 7 to 17 fathoms, but they are much larger than the typical form from Vineyard Sound and have finer and more closely punctate spiral sculpture, a more conspicuous fold on the columella, and some specimens have three distinct bands of delicate pink color on the body-whorl, and one on the preceding whorl.

Philine Sagra (D'Orb.)

Bulla Sagra D'Orbigny, Moll. Cuba, vol. i, p. 123, atlas, pl. 4, figs. 5-8, 1853.

PLATE XLV, FIGURES 16, 16a.

Two dead specimens (No. 38,442), station 2113, in 15 fathoms.

Cylichna biplicata (Lea).

Bulla biplicata Lea, Proc. Bost. Soc. Nat. Hist., p. 204, 1844.

Utriculus biplicatus Tryon, Amer. Mar. Conch., p. 104, pl. 13, fig. 213, 1873.

PLATE XLV, FIGURE 14.

Very abundant in 7 to 17 fathoms; rare in 48 fathoms.

Cylichna cælata, sp. nov.

PLATE XLV, FIGURE 15.

Shell rather thick, opaque white, with a slightly lustrous surface, of moderate size, somewhat conical in shape, with a truncated tip and an elongated, tapering base. Spire concealed within a very deep pit; the two or three whorls are distinctly visible in an end view and are crossed by numerous, delicate, little curved riblets which curve over the top of the body-whorl extending down a short distance, and gradually blend with the flexuous lines of growth. Commencing about the middle of the whorl and covering the base there are numerous, fine, punctate, spiral lines, very much crowded anteriorly. Aperture very narrow, expanded anteriorly; outer lip a little produced at the top, bending round somewhat abruptly, then following the outline of the body-whorl, and joining the inner lip in a regular curve; inner lip much thickened at its base with a minute umbilical chink behind it. Color yellowish white.

Length, 3^{mm}; greatest breadth, 1.5^{mm}.

Rare in 15 to 43 fathoms.

Bulla Candeï D'Orb.

Moll. Cuba, vol. i, p. 128, atlas, pl. 4, figs. 1-3, 1853.

PLATE XLV, FIGURE 13.

Very common in 7 to 48 fathoms.

Volvula oxytata, sp. nov.

Volvula, sp., Bush, Report U. S. Com. Fish and Fisheries, p. 84, for 1883, 1885.

PLATE XLV, FIGURE 12.

Shell rather small, somewhat cylindrical, with a sharp, spike-like apex and a tapering, rounded, anterior end, rather thin, semi-transparent, somewhat lustrous, with four or five very fine, indistinct, punctate, spiral lines on each end and very indistinct, microscopic striae on the intervening surface. Aperture long, very narrow, expanded anteriorly; outer lip thin, following the curvature of the body-whorl to just below the middle where it continues in a straight line and joins the inner lip in a broad curve; inner lip very thin, slightly reflected anteriorly over a slight umbilical chink. Color bluish-white under a pale yellow epidermis.

Length of one of the largest specimens, 4^{mm}; breadth, 1.5^{mm}.

Not uncommon in 7 to 17 fathoms.

***Volvula minuta*, sp. nov.**

PLATE XLV, FIGURE 11.

Shell very small, spindle-shaped, thin, semi-transparent, white, destitute of sculpture with the exception of three or four very indistinct, punctate, spiral lines on the base. Aperture very narrow, gradually expanding anteriorly from about the middle, with a regularly curved outer lip. Columella with a slight twist or fold, with a very small umbilical chink behind it. Epidermis indistinct.

Length of the largest specimen, 2.5^{mm}; breadth, 1^{mm}.

A few specimens occurred in 14 to 16 fathoms.

***Pleurophyllidia Cuvieri* Meckel.**

Chenu, Manuel de Conchyliologie, vol. i, p. 399, figs. 3024, 3025, 1859.

Two specimens occurred in 15 and 27 fathoms.

NUDIBRANCHIATA.

***Scyllæa Edwardsii* V.**

These Transactions, vol. v, p. 550, pl. 43, f. 10, 1882.

Several young specimens were taken, at the surface, near station 2108.

HETEROPODA.

***Atlanta Peronii* Les.**

Verrill, these Transactions, vol. v, p. 529, 1882; vol. vi, pl. 28, figs. 4, 4a, 1884.

Several dead specimens, in 15 to 843 fathoms.

***Atlanta inclinata* Soul.**

Verrill, these Transactions, vol. vi, p. 211, 1884.

A few dead specimens, in 48 to 843 fathoms. Alive at the surface.

PTEROPODA.

***Cavolina tridentata* Gray.**

Verrill, Invert. Anim. Vineyard Id., p. 669, pl. 25, fig. 177; these Transactions, vol. v, p. 554, figs. 6, 7, 1882

A few dead specimens, in 16 to 843 fathoms.

***Cavolina uncinata* (D'Orb.) Gray.**

Verrill, these Transactions, vol. v, p. 554, 1882.

Common in 16 to 843 fathoms.

Cavolina longirostris Les.

Verrill, these Transactions, vol. v, p. 555, 1882.

Very abundant in 14 to 938 fathoms.

Cavolina quadridentata (Les.)

Verrill, these Transactions, vol. vi, p. 212, 1884.

A few specimens, in 15 to 142 fathoms.

Cavolina inflexa (Les.) Gray.

Verrill, these Transactions, vol. v, p. 555, 1882.

One specimen, in 48 fathoms.

Diacria trispinosa Gray.

Verrill, Invert. Anim. Vineyard Sd., p. 669, 1874.

Common in 15 to 938 fathoms.

Clio pyramidata Linné.

Verrill, these Transactions, vol. v, p. 555, 1882.

Rather common in 16 to 938 fathoms.

Styliola virgula (Rang.)

Verrill, these Transactions, vol. v, p. 557, 1882; vol. vi, p. 213, 1884.

One specimen, in 15 fathoms.

Styliola subulata (Quoy and Gaimard).

Verrill, these Transactions, vol. vi, p. 213, 1884.

A few specimens, in 15 to 843 fathoms.

SOLENOCONCHA.

Dentalium leptum Bush.

Report U. S. Com. Fish and Fisheries, p. 84, for 1883, 1885.

PLATE XLV, FIGURES 18, 18a.

Shell of moderate size, very slender, slightly curved posteriorly, rather thin and delicate, with a very smooth and glossy surface, destitute of sculpture, except at the posterior end, which is covered with numerous, crowded, very fine, raised, longitudinal lines visible only under the lens. Anterior aperture round, with a sharp, thin edge; posterior aperture somewhat thickened, very small, round, slightly oblique, with a very deep, narrow, dorsal notch. Color delicate sal-

mon, or yellow, gradually shading into white toward the anterior end. Very young specimens are white, very thin and glassy.

Length, 31.5^{mm} ; diameter of anterior aperture, 2^{mm} ; of posterior aperture, about $.5^{\text{mm}}$.

Common in 7 to 48 fathoms.

Cadulus Carolinensis Bush.

Report U. S. Com. Fish and Fisheries, p. 85, for 1883, 1885.

PLATE XLV, FIGURE 19.

Shell of medium size, semi-transparent (perfectly fresh specimens are almost transparent and glassy, showing the animal quite distinctly) very glossy, white, circular throughout its entire length. Greatest diameter at about the anterior third, diminishing slightly to the round, very oblique, anterior aperture, and backward to the posterior end, at first very gradually and farther back very rapidly. Curvature well marked in some specimens, very slight in others, nearly uniform dorsally, but ventrally, most decided in the posterior third. Posterior aperture very small, round, a little oblique, with four small, distinct notches, two on each side.

Length, 9.5^{mm} ; greatest diameter, about 2^{mm} ; diameter of anterior aperture, 1^{mm} ; posterior aperture, $.4^{\text{mm}}$.

Very abundant in 7 to 48 fathoms.

Cadulus incisus, sp. nov.

PLATE XLV, FIGURE 20.

Shell rather small, slender, somewhat cylindrical, slightly contracted dorsally, just back of the anterior aperture, tapering and curving gradually from about the middle toward the posterior end. It is thin, semi-transparent and very lustrous. The anterior aperture is oval, and a little oblique; the posterior aperture is very oblique with four narrow, very deep notches, two on each side, forming four conspicuous points on the end of the shell.

Length of largest specimen, 8^{mm} ; diameter anterior aperture, 1^{mm} ; posterior aperture, $.5^{\text{mm}}$. The other specimen is smaller and more slender, measuring 7^{mm} in length; with the anterior aperture $.8^{\text{mm}}$ in diameter and the posterior less than $.5^{\text{mm}}$.

LAMELLIBRANCHIATA.

Martesia cuneiformis (Say).

Pholas cuneiformis Say, Journ. Phil. Acad., vol. ii, p. 322, 1822; Conch. U. S., p. 108, 1858.

Martesia cuneiformis Tryon, Amer. Mar. Conch., p. 127, pl. 17, figs. 267, 268, 1873.

A single valve (No. 40,800) was found at station 2276, in 16 fathoms, and living specimens occurred, imbedded in wood, at Beaufort, N. C.

Diplothyra Smithii Tryon.

Proc. Phil. Acad., 1862; Amer. Mar. Conch., p. 128, pl. 17, fig. 269, 1873.

A single living specimen, imbedded in limestone, was found in shallow water at Beaufort, N. C.

Siliqua costata (Say), H. & A. Ad.

Machera costata Gould, Invert. Mass., p. 47, fig. 370, 1870.

Siliqua costata Verrill, Invert. Anim. Vineyard Id., p. 675, pl. 32, p. 244, 1874.

A fragment was found at station 2277, in 16 fathoms.

Corbula Swiftiana C. B. Adams.

Contributions to Conchology, vol. i, p. 236, 1852.

Separate valves were found in very great abundance, in 7 to 48 fathoms and a few living specimens, in 16 to 48 fathoms.

Corbula disparilis D'Orbigny.

La Isla de Cuba, v, Moluscos, p. 322, pl. 27, figs. 1-4, 1845.

Separate valves were very common in 14 to 48 fathoms.

Neæra costata Bush.

Report U. S. Com. Fish and Fisheries, p. 85, for 1883, 1885.

PLATE XLV, FIGURE 21.

Shell moderately thick, compressed, triangular-ovate, with a contracted and somewhat elongated rostrum, and with three or four very prominent, curved, distant, radiating ribs on the convex part of the valves, and a few smaller and closer ones anteriorly. Umbos high, smooth; beaks somewhat curved backward. The dorsal margin, from the beaks to the end of the rostrum, is strongly and regularly concave, the rostrum being a little upturned or straight at the tip; anteriorly,

the dorsal margin is convex, and falls off abruptly to the obtusely rounded anterior end. The ventral margin is broadly rounded and projects outward in an acute angle, at the projection of each of the principal ribs; the intervals between these angles are usually concave, and beyond the last rib the outline recedes in a concave curve to the origin of the rostrum, which is rapidly narrowed to near the tip. Of the three principal radiating ribs, the middle one runs from the beak nearly to the middle of the ventral margin, curving a little backward; the posterior one terminates about midway between the former and the end of the rostrum, curving strongly backward; the most anterior one ends about midway between the middle one and the anterior end of the shell; midway between this and the middle one, there is a smaller secondary rib. These three primary ribs are strongly elevated, not very broad, with the summits rather thin, finely notched by the concentric lines of growth; the most posterior one is the largest and highest, and projects the most at the margin. Between these ribs the spaces are wide and strongly concave, marked by numerous and regular lines of growth. On the anterior end of the shell there are two or three smaller radiating ribs, which are separated by intervals about equal to their own breadth, and give the margin a slightly crenulated appearance. The rostrum is narrow, strongly compressed, with both the dorsal and ventral outline concave. Two small ridges run from the beak to the tip of the rostrum, separated by a very narrow, flattened area. The right valve has two well-marked lateral teeth, the posterior one considerably longer and larger than the anterior; between these there is a small, ovate cartilage pit. The inner surface of the valves shows deeply indented grooves corresponding to the primary external ribs. Color, opaque white. Epidermis indistinct.

Length of the largest specimen, 6^{mm}; height, 4^{mm}; thickness, 4^{mm}.

Four living and two dead specimens were found at stations 2108 and 2269, in 48 fathoms.

This species bears considerable resemblance to *N. ornatissima* D'Orb., but the ribs are less numerous, more curved, and the primary ones are much larger and more widely separated, and the shell is less convex.

Neæra paucistriata Dall. MSS.

Three living specimens, found in 16 and 17 fathoms, were identified by Mr. Dall as this species.

Pandora Carolinensis, sp. nov.

Pandora, sp., Bush., Report U. S. Com. Fish and Fisheries, p. 86, for 1883, 1885.

Shell of moderate size, triangular-ovate, with a short, acutely angled posterior end and an elongated, slightly rostrated anterior end. Valves very unequal, overlapping; the superior one very convex; the inferior one flat or slightly concave. Beaks very small, curved inward and backward, situated near the posterior end. Anterior dorsal margin very straight; posterior very oblique, slightly concave just behind the beaks; ventral margin much swollen along the middle, pretty regularly curved to near the anterior end where it is slightly contracted and forms a short, narrow rostrum. Right valve the larger, very convex, moderately thick, with a dull surface, roughened by the irregular, sinuous lines of growth. Extending from the beaks perpendicularly across the valve is a distinct, though slight, depression in the surface, in crossing which the lines of growth abruptly curve downward. A prominent, rounded ridge runs from the beaks to the anterior ventral margin, forming a narrow dorsal area crossed by the lines of growth. Below the ridge the surface is a little concave and forms a slight contraction in the margin, more apparent in some specimens than in others. Anterior hinge plate is a little thickened, very narrow ledge, on which the left valve rests, extending nearly the entire length of the dorsal margin; behind the beaks is a thick, conspicuous, triangular process or tooth, which is concave next the margin of the valve; in front of this, directly under the beaks, is a narrow, oblique cavity, with the very narrow cartilage-pit in front of it. Left valve considerably smaller and very thin, with a conspicuous furrow running out from beak, corresponding to the ridge in the opposite valve, above which the valve bends slightly outward. Besides the irregular lines of growth the surface is cut by numerous, about fourteen, unequally distant, impressed, radiating lines. In front of the beaks the edge of the valve is bent in at right angles, forming a gradually widening area which laps over the opposite valve; directly under the beak is a thick, prominent, elongated, oblique tooth, and a very much thinner, longer, less elevated, more oblique, wedge-shaped one in front of it with the narrow cartilage-pit between; extending from behind the beaks along the dorsal margin is a rather delicate ridge, which in some specimens shows only as a slight thickening of the edge, and in others it is separated from it and shows as a ridge or tooth. Pallial impression well marked; pallial line formed by a line of indistinct dots. Interior of the shell very pearly.

Length of one of the largest specimens, 16^{mm}; height, across center, 8^{mm}; thickness, about 3^{mm}.

Separate valves were very abundant in 7 to 48 fathoms; and a few young living specimens were found in 15 to 17 fathoms.

Clidiophora, sp. indet.

A single left valve, (No. 45,202), quite distinct from *C. trilineata*, or any species known to me, occurred at station 2275, in 16 fathoms.

Valve small, thin, very much distorted. Beaks minute, bending strongly outward, situated far over toward the posterior end; anterior dorsal margin curving abruptly upward from the beak and then continuing in a straight line; posterior dorsal margin very short, oblique and slightly concave, forming an acute angle at its junction with the ventral margin. Ventral margin much curved, the greatest curvature near the anterior end, where it bends inward toward the beaks, forming a very slight rostrum. Surface very rough. Two distinct, impressed lines or grooves, parallel to the dorsal margin, extend from the beaks to the anterior end; above the second there is a broad, nearly flat, dorsal area; below it the valve is very convex and the surface is cut by from thirteen to fifteen very conspicuous, unequal, and unequally distant, concentric grooves, becoming deeper and farther apart toward the ventral margin and scarcely visible on the posterior surface, which is concave and roughened by the lines of growth. Interior lustrous and very pearly. The two exterior, dorsal grooves show as two distinct ridges, and four of the deepest, exterior, concentric grooves appear as elevated lines, with broad, concave interspaces. The edge of the valve along the entire length of the anterior dorsal margin is bent in at right angles and forms a gradually widening area. Hinge consists of three distinct, thin, oblique, unequal, divergent teeth. The first is a very oblique, long and narrow, angular ridge, having a shallow, elongated cartilage-pit in its posterior side. The second, directly under the beaks, is very much shorter, broader, more elevated, and less oblique, and the third is a very slightly elevated ridge extending from the beak to the posterior muscular scar. Scars rather distinct, pallial line not visible.

Macha Cumingiana (?) Dkr.

Macha Cumingiana Dunker, Proc. Zool. Soc. London, p. 425, 1861.

Macha strigillata (Linné), var. (?) Bush, Report U. S. Com. Fish and Fisheries, p. 86, for 1883, 1885.

Shell moderately large, thin, convex, long and narrow, with broadly

rounded ends and with the opposite margins nearly parallel. Beaks very small, incurved, situated near the anterior third; the dorsal margin in front of the beaks, straight, and behind them slightly oblique. Surface somewhat lustrous, roughened by the irregular lines of growth and cut by numerous, fine, wavy, diagonal lines, the first one commencing just behind the beaks, and extending to the anterior ventral margin; near the posterior end of the shell, over the portion radiating from the beaks to the posterior ventral margin, they abruptly turn down in the opposite direction. In a specimen about an inch long there are about thirty-six of these lines. Extending from the beaks obliquely backward across the shell there are two very faint, slightly raised, narrow, divergent rays. The hinge in the right valve consists of two unequal, prominent, divergent teeth. The first one, directly under the beak, is a three-sided, pointed tooth, projecting inward and upward like a hook; immediately back of this is a very narrow, gradually widening, sharp-edged, very oblique ridge, which forms the second tooth. Back of these, curving strongly inward and upward, is a short, high, angulated, tooth-like process, to the very concave exterior surface of which the ligament is attached. In the left valve, immediately under the beak, attached to the end of the ligamental process, there is a prominent, very thin, leaf-like tooth, curving strongly upward and backward.

In young specimens the lines of growth and the oblique markings show very distinctly on the interior, but in more mature examples these are concealed by a layer of smooth, very lustrous, pure white enamel. Pallial line distinct, with a broad, deep, very conspicuous sinus.

Color, opaque bluish white, under a thin, closely adherent, lustrous, light yellow epidermis.

Length of the largest perfect specimen, 30^{mm}; height, 13^{mm}; thickness, about 4^{mm}.

Several valves of young specimens were found in 15 to 17 fathoms. At station 2273 a fragment occurred showing the shell to be large and very thick when full grown.

Tellina lintea Conrad.

Journ. Acad. Nat. Sci. Philadelphia, vol. vii, p. 259, pl. 20, fig. 3, 1837.

Common in 10 to 26 fathoms.

Semele lata C. B. Adams.

One valve (No. 40,600) agreeing perfectly with specimens labelled as this species in the Peabody Museum of Yale College, was found at station 2290, in 10 fathoms.

Dosinia obovata Conrad.

Cytherea obovata Conrad, Fossils Tertiary Form. U. S., p. 14, pl. 8, fig. 4, 1838.

Dosinia obovata Conrad, Amer. Journ. Conch., vol. vi, p. 77, 1870-71.

Bush, Report U. S. Com. Fish and Fisheries, p. 87, for 1883, 1885.

Very abundant in 7 to 17 fathoms.

Chione alveata (Conrad).

Venus alveata Conrad, Journ. Acad. Nat. Sci. Phila., vol. vi, p. 264, pl. 11, fig. 19, 1831; Fossils Tertiary Form. U. S., p. 9, pl. 5, fig. 2, 1838. (*non* Say.)

Common in 10 to 48 fathoms.

Cardium pinnulatum Conrad.

Gould, Invert. Mass., p. 141, fig. 452, 1870.

Verrill, Invert. Anim. Vineyard Sd., p. 683, pl. 29, fig. 209, 1874.

Common in 15 to 142 fathoms.

Cyprina Islandica (Linné) Lam.

Gould, Invert. Mass., p. 129, fig. 443, 1870.

Verrill, Invert. Anim. Vineyard Sd., p. 683, pl. 28, fig. 201, 1874.

A few valves occurred in 27 to 49 fathoms.

Astarte undata Gld.

Gould, Invert. Mass., p. 119, fig. 432, 1870.

Verrill, Invert. Anim. Vineyard Sd., p. 684, pl. 29, fig. 203, 1874.

Separate valves occurred in 27 to 48 fathoms and living specimens, in 43 to 49 fathoms.

Crassatella (Eriphyla) lunulata Conrad.

Gouldia mastracea Gould, Invert. Mass., p. 128, fig. 442, 1870.

Verrill, Invert. Anim. Vineyard Sd., p. 685, pl. 29, figs. 206, 207, 1874.

Crassatella (Eriphyla) lunulata Dall, Proc. U. S. Nat. Mus., vol. vi, p. 340, 1883.

Several valves occurred in 7 to 43 fathoms.

Crassatella, sp.

A single valve (No. 40,590) occurred at station 2307, in 43 fathoms. It measures 28^{mm} in length; 20^{mm} in height; 6^{mm} in thickness.

Venericardia granulata (Say.)

Cardita borealis Gould, Invert. Mass., p. 146, fig. 455, 1870.

Cyclocardia borealis Verrill, Invert. Anim. Vineyard Sd., p. 683, pl. 29, fig. 216, 1874.

Venericardia granulata Verrill, these Transactions, vol. vi, p. 258, 1884.

A few valves occurred in 27 to 49 fathoms.

Venericardia obliqua, sp. nov.

Shell small, moderately thick, compressed, somewhat triangular, very oblique, much produced anteriorly. Beaks small, acute, curved inward and very much forward. Surface crossed by from twelve to fourteen principal radiating ribs and two or three smaller ones on either side. The ribs are broad, flat, roughened by the lines of growth and separated by narrow, rather deep, unequal grooves. Interior smooth, very lustrous, semi-transparent, the external ribs showing distinctly through, and at their termination, forming broad crenulations in the margin. Hinge plate very broad, with a single prominent, slightly oblique, wedge shaped, bilobed tooth directly under the beak, in the right valve, with a deep triangular cavity on either side; and in the left valve two stout, divergent, wedged shape teeth, with a deep, triangular cavity between. Color dirty white with a broad, median, concentric band of yellow-brown.

Length of a medium sized specimen, 6^{mm}; height, 6.5; thickness, 3^{mm}.

One living specimen and a few single valves, in 7 to 10 fathoms.

Chama congregata Conrad.

Fossils Tertiary Form. U. S., p. 32, pl. 17, fig. 2, 1838.

Separate valves occurred in 7 to 27 fathoms and living specimens, in 16 fathoms.

Lucina filosa Stimp.

Gould, Invert. Mass., p. 98, fig. 404, 1870.

Verrill, Invert. Anim. Vineyard Sd., p. 686, pl. 29, fig. 212, 1874.

A number of valves occurred in 27 to 80 fathoms.

Lucina nassula Conrad.

Amer. Journ. Sci., vol. ii, p. 394, 1846.

Proc. Acad. Nat. Sci. Phil., vol. iii, p. 24, 1846.

Rather common in 7 to 48 fathoms.

Lucina trisulcata Conrad.

Amer. Journ. Sci., vol. xli, p. 346.

Fossils Tertiary Form. U. S., p. 71, pl. 40, fig. 5, 1838.

A single valve (No. 40,598) occurred at station 2290, in 10 fathoms.

Cryptodon obesus Verrill.

Invert. Anim. Vineyard Sd., p. 393, pl. 29, fig. 214, 1874; these Transactions, vol. v, p. 569, 1882.

A few valves were found in 15 to 48 fathoms.

Diplodonta turgida Verrill and Smith.

Verrill, Amer. Journ. Sci., vol. xxii, p. 303, 1881; these Transactions, vol. v, p. 569, pl. 58, fig. 42, 1882.

Common in 27 to 68 fathoms.

Montacuta bidentata (Montagu).

Verrill, these Transactions, vol. v, p. 571, 1882.

Single specimens were found in 16 and 48 fathoms.

Leda unca Gld.

Gould, Proc. Boston Soc. Nat. Hist., vol. viii, p. 282, 1862.

Tryon, Amer. Mar. Conch., p. 183, 1873.

Verrill, these Transactions, vol. vi, p. 260, 1884.

Very abundant in 7 to 48 fathoms.

Pectunculus tricenarius Conrad.

Fossils Tertiary Form. U. S., p. 63, pl. 35, fig. 1, 1838.

One valve (No. 40,614), station 2296, in 27 fathoms.

Crenella glandula (Totten) Ad.

Gould, Invert. Mass., p. 194, fig. 492, 1870.

Verrill, Invert. Anim. Vineyard Sd., p. 695, pl. 31, fig. 233, 1874.

Single valves occurred in 16 and 48 fathoms.

Pecten Clintonius Say.

Pecten tenuicostatus Gould, Invert. Mass., p. 196, fig. 494, 1870.

Pecten Clintonius Verrill, these Transactions, vol. vi, p. 261, 1884.

Several specimens occurred in 16 to 49 fathoms.

Anomia aculeata Müll.

Gould, Invert. Mass., p. 204, fig. 498, 1870.

Verrill, Invert. Anim. Vineyard Sd., p. 697, pl. 32, figs. 239, 240, 240a, 1874.

Several specimens occurred in 16 to 142 fathoms.

List of species found between 40 and 50 fathoms.

GASTROPODA.

Marginella borealis V.

Volutella lachrimula Gld.

n. Siphio pygmaeus (Gld.) V.

n. Anachis Haliaëti (Jeff.) V.

n. Astyris zonalis (Lins.) V.

Lamellaria pellucida V.

LAMELLIBRANCHIATA.

Saxicava arctica (Linné) Desh.

n. Thracia Conradi Couth.

Astarte castanea Say.

n. Astarte crenata Gray.

Leda acuta (Conrad).

n. Nucula delphinodonta Migh.

GASTROPODA—continued.	LAMELLIBRANCHIATA—cont.
<i>n. Crucibulum striatum</i> (Say) H. and A. Ad.	<i>n. Modiolaria nigra</i> (Gray) Lovén.
<i>n. Cingula carinata</i> Migh.	<i>n. Modiolaria corrugata</i> (Stimp.) Mörch.
<i>n. Aelis tenuis</i> V.	<i>Crenella decussata</i> (Mont.) Macg.
<i>Ethalia multistriata</i> V.	<i>Amussium</i> , sp. nov.
<i>Calliostoma Bairdii</i> V. & S.	
<i>Cocculina reticulata</i> V.	
<i>n. Eulimella Smithii</i> V.	

EXPLANATION OF PLATE XLV.

- Figure 1.—*Mangilia oxytata*, sp. nov. (p. 460), × 10.
 Figure 2.—*Mangilia psila*, sp. nov. (p. 455), × 5.
 Figure 3.—*Mangilia melanitica* Dall., var. *oxia*, nov. (p. 459), × 10.
 Figure 3a.—The same. Nuclear whorls, × 30.
 Figure 4.—*Mangilia ephamilla*, sp. nov. (p. 457), × 5.
 Figure 4a.—The same. Nuclear whorls, × 25.
 Figure 5.—**Mangilia* (?) *glypta*, sp. nov. (p. 461), × 10.
 Figure 5a.—The same. Nuclear whorls, × 15.
 Figure 6.—*Triforis turris-thomæ* (D'Orb.) Dall (p. 463), × 10.
 Figure 7.—*Skenea trilix*, sp. nov. (p. 464), × 10.
 Figure 7a.—The same. View of the base, × 10.
 Figure 8.—*Scalaria teres*, sp. nov. (p. 465), × 6.
 Figure 9.—*Odostomia engonia*, var. *teres*, nov. (p. 467), × 6.
 Figure 10.—*Niso aegleës*, sp. nov. (p. 465), × 5.
 Figure 10a.—The same. Nuclear whorls, × 30.
 Figure 11.—*Volvula minuta*, sp. nov. (p. 469), × 20.
 Figure 12.—*Volvula oxytata*, sp. nov. (p. 468), × 10.
 Figure 13.—*Bulla Candei* D'Orb. (p. 468), × 10.
 Figure 14.—*Cylichna biplicata* (Lea) (p. 467), × 10.
 Figure 15.—*Cylichna cælata*, sp. nov. (p. 468), × 6. The lines denoting the sculpture are much too heavy.
 Figure 16.—*Philine Sagra* (D'Orb.) (p. 467), × 10.
 Figure 16a.—The same. To show sculpture, × 50.
 Figure 17.—*Acteon puncto-striatus* (Adams) Stimp. (p. 467), × 10.
 Figure 18.—*Dentalium leptum*, sp. nov. (p. 470), × 2½.
 Figure 18a.—The same. Dorsal view of posterior end to show notch, × 10.
 Figure 19.—*Cadulus Carolinensis*, sp. nov. (p. 471), × 8.
 Figure 20.—*Cadulus incisus*, sp. nov. (p. 471), × 4.
 Figure 21.—*Nææra costata*, sp. nov. (p. 472), × 10.

Figures 2, 3a, 4a, 5a, 8, 9, 15, 16a, 20 are camera-lucida drawings by the author; the others are drawn by Mr. J. H. Emerton, from nature.

* The specimen figured has an imperfect nucleus and is destitute of the epidermis found on perfectly fresh specimens.

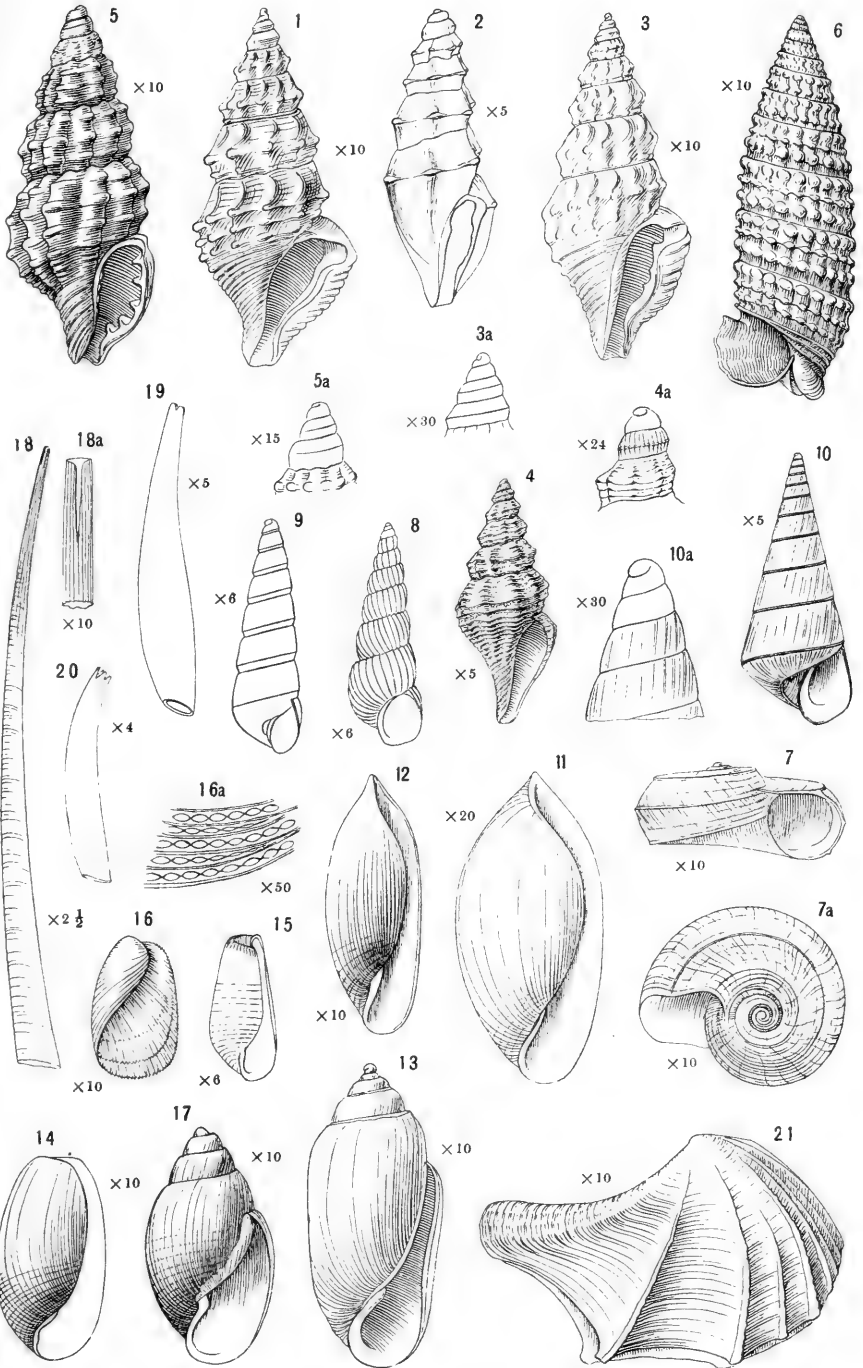

XII.—NEW ENGLAND LYCOSIDÆ. BY J. H. EMERTON.

THE Lycosidæ have the abdomen and usually the cephalothorax considerably longer than broad and the legs long, the fourth pair longest, with long movable spines. The feet have three claws, the lateral ones long with numerous teeth, and the middle one short without teeth or with only one or two. The tarsi are sometimes thickly covered with hairs concealing the claws, but there are no toothed hairs under the claws as in the spiders that live in webs.

The eyes are in three rows. The front row consists of four small eyes nearly of the same size, the second row of two large eyes on the front of the head and the third row of two eyes a little smaller than the last, a little farther apart and farther back on the head.

The body is hairy all over and a large part of the markings are formed by colored hairs and change considerably when the spider is wet. The markings consist usually of three longitudinal light lines on the cephalothorax, different parts of which are obscured in different species, and a middle stripe of various shapes on the abdomen.

The palpi of the males are comparatively simple. The patella and tibia are but little modified except in Dolomedes. The tarsus is long and pointed. The tube of the palpal organ is usually short and lies across the middle of the bulb. On the middle or base of the bulb is a large process, the shape of which distinguishes many species. The external part of the epigynum consists usually of a middle lobe widened at the end and hard side lobes.

The Lycosidæ live on the ground, running after their prey and making no cobwebs. Several species make holes in the ground, which they line with silk and use for shelter but not as traps.

The females carry the cocoon attached to the spinnerets and the young mount on the female's abdomen and are carried for a time after leaving the cocoon.

Dolomedes and Ocyale carry the cocoon in their jaws and spin a large irregular web in bushes for the use of the young.

Many of the species of Lycosidæ are very difficult to distinguish, and I have been unable to identify many of them with published descriptions. I have compared mine with a large collection of European Lycosidæ and find very few species common to both countries. The following papers contain descriptions of American Lycosidæ.

E. Keyserling. Americanische Citigradæ in Verhandlungen der zool. botan. Gesellsch., Wien, 1876.

Geo. Marx. American Naturalist, vol. xv, May, 1881. On some new tube-constructing spiders.

S. H. Scudder. Psyche. Vol. ii, page 2, 1877. *Lycosa arenicola*.

T. Thorell. Notice of some spiders from Labrador. Proc. Boston Soc. Nat. Hist., vol. xvii, 1875.

N. M. Hentz. Araneides of the U. S. Boston Journal of Nat. Hist., vols. iv and v.

Mary Treat. Harper's Magazine, April and May, 1880.

H. C. McCook. Habits of *Lycosa nidifex*, Proc. Phil. Acad. Nat. Sci., June, 1883.

In the classification of this family I have followed the arrangement and names used by Simon in Arachnides de France, except that I have included *Oxyopes*, as was done by older writers. The family includes three sub-families, *Lycosinæ*, including *Lycosa*, *Pirata*, *Pardosa* and *Aulonia*; *Dolomedinæ*, including *Dolomedes* and *Ocyale*; *Oxyopinæ*, including *Oxyopes*.

Lycosa Latr.

Tarentula Thorell; Keyserling, Americanische Citigradæ, zool. botan. Ges., Wien, 1876.

Lycosa Simon, including *Trochosa* and *Arctosa* Koch.

This genus includes the largest spiders found in the Northern States, and most of the species are of large size and covered with hair. The legs are stout and thickly covered with hairs on the tarsi. The front row of eyes is nearly straight and as long as the second row or longer, the middle pair usually a little larger than the others. The second eyes are the largest and about their diameter apart. The dorsal eyes are smaller and farther apart. The spinnerets are short, the hinder pair no longer than the anterior. Several species dig deep holes or make shallow nests under stones, where they hide while molting or carrying their young.

Lycosa nidicola, new.

PLATE XLVI, FIGURES 1, 1a, 1b, 1c, 1d.

Large female, 18^{mm} long. Cephalothorax, 9^{mm} long, 7^{mm} wide; 1st leg, 22^{mm}; 4th leg, 28^{mm}.

Color yellowish brown. The cephalothorax has a light middle line, narrow between the eyes and a little wider behind, with a fine dark

line along the dorsal groove. On each side of the thorax, near the edge, is a light line about as wide as the median one. The legs are yellowish brown, without rings, and darker or lighter according to the age of the spider. On the front of the abdomen is a middle stripe, darkest at the edges, which tapers to a point about the middle of the back. On each side of this are light stripes, which unite and become a narrow middle stripe on the hinder part of the abdomen. At the sides of the middle stripe are slightly darker and lighter oblique lines. The under side of the abdomen has irregular dark spots on a light ground, sometimes arranged in oblique lines at the sides and two or three longitudinal lines in the middle. The male is about half as large as the female and similarly marked. The tarsus of the male palpus is long, about twice the length of the palpal organ and has several straight spines at the end. The palpal organ has a large barbed process across the base below the tube; above the tube is a thin sharp process about the same length and at its base a shorter one. The epigynum is about as wide as long and shaped like the letter T.

This is one of the most common species. It is oftenest found under stones where the female makes a hollow in the ground lined thinly with silk in which she stands with her cocoon of eggs early in the summer.

Massachusetts; Providence, R. I.; New Haven and Noank, Conn.; Indianapolis, Indiana.

Lycosa pratensis, new.

PLATE XLVI, FIGURES 4, 4a, 4b.

Length, 10^{mm}. Cephalothorax, 5^{mm} long, 3^{mm} wide.

The colors are dark and light yellowish brown, browner than *L. nidicola*, which species it much resembles. The middle of the cephalothorax is light, broken by faint grayish stripes. Behind the middle the light area narrows and extends back to the end of the thorax. The abdomen is grayish, marked by two rows of light spots, indistinctly connected in pairs by cross lines. When wet the markings appear more complicated, as in the figure. On the front of the abdomen is the usual light stripe with dark edges over the dorsal vessel.

The front row of eyes is hardly longer than the second row, which distinguishes this species from *polita*.

The epigynum is shaped like that of *lineata*, but is shorter and wider. The palpal organ has the processes which support the tube, wider and more curved than in *lineata*.

This is the most common species under stones and under leaves in winter. Eastern Mass.; Mt. Tom, Mass.; New Haven, Conn.; Mt. Washington, N. H.

Lycosa polita, new.

PLATE XLVI, FIGURES 2, 2a, 2b, 2c.

Female, 12^{mm} long. Cephalothorax, 5½^{mm} long, 4^{mm} wide; 1st leg, 11^{mm}; 4th leg, 13^{mm}.

This is a small, short-legged species, like the last. The cephalothorax is reddish brown, dark at the sides and light in the middle, the two colors spreading into each other by several irregular notches around the dorsal groove. The hairs of the cephalothorax are very short and the whole surface looks as if polished. The legs are colored like the cephalothorax but have longer hairs and dark spines. The abdomen is light yellowish, with dark gray or black markings, resembling those of *Tegenaria*. On the front end is a light middle patch partly divided into three, and behind this are five or six herringbone markings broken by irregular light spots. Under the abdomen is a dark middle line, which widens at the ends around the epigynum and the spinnerets. At the sides of this line and in front the abdomen is yellowish white, except irregular dark gray lines, which extend down the sides from above. The sternum and under sides of the legs are dark like the back of the thorax.

Another variety has dark markings on the cephalothorax and legs. The legs are marked with broken dark rings, two or three on each joint. The head and middle of the thorax are light, with some faint dark spots. On each side of this light area are two irregular dark bands not extending to the edge of the cephalothorax, which is marked by broken spots of light and dark.

The front row of eyes is much wider than the second row.

The epigynum is short and wide and has a peculiar shape characteristic of this species, see fig. 2c.

Eastern Mass.; Albany, N. Y.; New Haven, Conn.; under stones in summer and under leaves in winter. Eggs in June and July.

Lycosa frondicola, new.

PLATE XLVI, FIGURES 3, 3a, 3b.

Female, 14^{mm} long. Cephalothorax, 7^{mm} long, 5^{mm} wide; a little smaller than *lineata*.

The colors are gray and brown, like dead leaves among which it lives. The cephalothorax is dark brown at the sides and has a wide gray stripe in the middle.

The abdomen is similarly marked with a wide gray band in the middle and dark brown at the sides. In the gray band are some faint darker markings and an indistinct middle line in front tapering to a point near the middle of the back. The legs are dark gray. The sternum is dark gray. The under side of the abdomen has a wide dark stripe in the middle with irregular edges.

The epigynum is as wide as long. The middle lobe is very narrow in front and widens suddenly at the end into a shape like the letter T.

Lycosa pictilis, new.

PLATE XLVI, FIGURES 5, 5a, 5b.

13^{mm} long. Cephalothorax, 5.5^{mm} long, 4^{mm} wide.

The cephalothorax is brown at the sides and has a wide middle stripe from between the eyes to the abdomen. Just back of the eyes the stripe widens, forming a square figure with corners pointing toward the sides. The back of the abdomen has in front two orange-colored spots. Following these is a row on each side of white spots surrounded by black, and between them a middle row of light angular markings. The legs are marked with alternate light and dark brown rings. The dark rings do not extend around the under side of the legs.

The epigynum is small. The middle lobe is widened and rounded at the end. The tube of the male palpus is short and partly concealed by the basal process, which extends across the tarsus and curves backward at the end.

This very distinct species is abundant among the moss and low shrubs on the upper part of Mt. Washington, N. H., and the neighboring mountains.

Lycosa kochii Keyserling, Verhandlungen zool. botan. Gesells., Wien, 1877.

PLATE XLVI, FIGURES 6, 6a, 6b, 6c.

Length of female 14^{mm}. Cephalothorax 6^{mm} long, 4.5^{mm} wide. The cephalothorax is dark brown at the sides and light brown or grayish in the middle. The middle of the abdomen is grayish brown with black muscular spots and bordered at the sides with darker brown, which forms two almost black spots on the front corners of the abdomen. The legs are light gray at the base and darker toward the tips. Beneath the color is lighter than on the back.

The colors and markings of the back are nearly the same as those of a smaller and shorter-legged species *L. frondicola*, but it may be easily distinguished by the epigynum, and by the light color of the under side of the body.

A soft and dark-colored specimen, probably lately molted, has the rings on the legs and all the dark markings more distinct and the epigynum smoother and less shrunken than usual, with the front part of the middle lobe nearly straight and with parallel edges not contracted in the middle as in most specimens.

The epigynum is very different from those of the related species. The anterior pit is single and the middle lobe is narrow in front and widened behind into a triangular and thickened end.

The palpal organ has the barbed process across the base of the bulb rather small and black. The tube is long and curved around the end of the hollow of the tarsus. At its base is a hard process extending across the bulb parallel to the barbed appendage. A thin process extends around parallel with the tube to its end.

This species lives in woods running among the dead leaves, which it much resembles in color. It matures in spring and carries its cocoons in May and June.

New Haven, Conn. ; Boston, Mass.

Lycosa carolinensis Hentz.

PLATE XLVII, FIGURES 1, 1a, 1b.

A large female is 30^{mm} long. Cephalothorax, 13^{mm} long, 10^{mm} wide; 1st leg, 35^{mm}, 4th leg, 48^{mm}.

The male is more slender. One measures 18^{mm} long. Cephalothorax, 10^{mm} long, 7.5^{mm} wide; 1st leg, 33^{mm}, 4th leg, 37^{mm}.

The whole body and legs are mouse color above, light in males and darker in females. The joints of the legs are darker towards the tips and the spines are black. The abdomen is indistinctly marked above. The markings of the under side are much brighter. The under side of the abdomen, sternum and coxæ are deep black, the femora light mouse color with a black ring at the end. The tibiae are gray in the middle and black at the ends. The mandibles are black with orange hairs on the front. All these markings are much less distinct in the female than male.

The whole body is thickly covered with short hair. The tarsi are very hairy, especially on the under side, covering up the claws except the tips.

Half-grown females in Sept., at New Haven, running in dry pastures, are very brightly marked, nearly black on the back of the abdomen, with the segments distinct.

This species digs a hole six or eight inches deep, but is often found under stones or running in fields and occasionally in houses all over

New England. The eggs are laid in July. The young after leaving the cocoon gather on the abdomen of the female which then looks as large as a mouse.

The palpal organ is small for so large a spider. The tube and the supporting appendage are short and thin. The basal process is short and black, slightly forked at the end. The epigynum resembles that of *pratensis* and *nidifex*.

Lycosa vulpina, new.

PLATE XLVII, FIGURE 2.

A large female measures 23^{mm} long. Cephalothorax, 12^{mm} long, 9^{mm} wide; 1st leg, 31^{mm}; 4th leg, 36^{mm}.

The general color, in alcohol, is dark brown, with light gray or white markings. The colors are all probably lighter in life. The cephalothorax has a narrow light line in the middle, widest behind, and wider and less distinct lines at the sides. The abdomen is indistinctly figured with spots of dark brown on a lighter ground, or the markings run together into a nearly uniform dark brown. The legs are dark with light rings which are wider and more distinct on the inner joints and absent on the tarsi and metatarsi. The sternum, coxæ and maxillæ are all dark brown. The epigynum is shorter than in *carolinensis* and the end thicker.

This species is about as large as *L. carolinensis* and has a general resemblance to that species. It is easily distinguished by the rings on the legs, the less distinct black markings on the under side, and the shape of the epigynum.

Mt. Tom, Mass.; New Jersey, McCook.

Lycosa nidifex Marx, American Naturalist, May, 1881.

Lycosa arenicola Seudder, Psyche, vol. ii, page 2, 1877.

PLATE XLVII, FIGURES 4, 4a, 4b.

Length of female, 21^{mm}. Cephalothorax, 10^{mm} long, 7^{mm} wide; 1st leg, 22^{mm}; 4th leg, 25^{mm}.

The cephalothorax is dark gray with a wide light band in the middle. The abdomen is light gray with a dark band in the middle, which follows the shape of the dorsal vessel in front and incloses in the hinder half 3 or 4 pairs of white spots. The legs increase in thickness and the color becomes darker from the fourth to the first pair. The first legs are dark brown covered with gray hairs, the hind legs light gray or yellowish with black spines. The first and second legs are black beneath except the tarsi. The sternum is dark.

est at the front end. The mandibles are covered with light gray hairs on the front.

Two old females taken at New Haven, Conn., Oct. 4th, had all the colors faded to nearly uniform dark brown, the dark parts lighter and the light parts darker than in younger individuals and the hairs on the legs shorter.

The epigynum is T-shaped, with the cross piece short and thick.

The males are a little smaller than the females. The palpal organs resemble those of *lineata*, but the tube is shorter and the terminal process which supports it is short and thick and tapers to a narrow point.

This species makes holes six inches to a foot deep, lined with silk and with a ring of rubbish fastened together with silk around the mouth. The habits are described by Scudder in *Psyche*, vol. ii, p. 2; George Marx in *Am. Naturalist*, May, 1881; and H. C. McCook in *Proc. Phil. Acad. Nat. Sci.*, June, 1883.

Albany, N. Y.; New Haven, Conn.; Cape Cod, Martha's Vineyard and Nantucket, Mass.; Long Island, usually in sandy fields.

Lycosa cinerea F.

PLATE XLVII, FIGURES 3, 3a, 3b.

Male, 13^{mm} long; 1st leg, 18^{mm}; 4th leg, 23^{mm}; palpi, 8^{mm}.

The cephalothorax is yellowish white with indistinct radiating markings about the dorsal groove. The space between the eyes is black. The legs are whitish with indistinct brownish rings and black spines. The ends of the legs and palpi are darker. The abdomen is white with irregular gray markings. The mandibles are dark brown. The under side of the whole body is yellowish white. The whole body is covered with long white or gray hairs.

The male palpi are long. The tarsus is slender and pointed and twice as long as the palpal organ, which is small and closely folded together.

On sandy fields and beaches, Eastern Massachusetts; Martha's Vineyard; New Haven, Conn.; Indianapolis, Indiana. It has several times been found on beaches where it appeared to have been covered by the tide. It is also a common spider in Europe.

Lycosa nigroventris, new.

PLATE XLVII, FIGURES 5, 5a, 5b.

Length, 12^{mm}. Cephalothorax, 6^{mm}; 4th leg, 20^{mm}. Color: gray and dark brown. In the middle of the cephalothorax is a straight gray

stripe as wide as the eye-area. The edges of the thorax are also light. Between these the sides of the cephalothorax are dark brown, almost black near the edges of the middle stripe.

The abdomen is light gray in the middle. At the sides in front are two dark spots, darkest in front, extending back half the length of the abdomen and between them are two small dark spots near the muscular spots on the first segment. The hinder half of the abdomen is marked by scalloped transverse dark lines. The legs are covered with gray hairs and scattered dark spines.

The sternum is dark brown and the coxæ nearly as dark. In the middle of the under side of the abdomen is a black marking more than half as wide as the body extending from the spiracles to the spinnerets. The front part of the abdomen is brown like the coxæ. The mandibles are dark brown with a few light hairs on the front near the base. The palpi are a little longer than the first femur and light gray, except the tarsus which is a little darker. The palpal organ is moderately large, the tube and its support much longer than in *carolinensis*, but proportionally shorter than in *pratensis*, etc.

Near Chebacco pond, Essex, Mass., Aug., 1877.

Lycosa communis, new.

PLATE XLVII, FIGURES 6, 6a, 6b, 6c, 6d.

Length, 10^{mm}. Cephalothorax, 5^{mm} long, 4^{mm} wide; 1st leg, 14^{mm}; 4th leg, 17^{mm}.

The colors and markings are very variable in this species. The most distinctly marked individuals are very dark brown or black with light gray and yellow markings and dark rings on the legs. The lighter specimens have the legs light gray and all the darker parts of the body of the same color. In the dark variety the cephalothorax is dark brown with a narrow light gray stripe in the middle and on each side. The middle stripe divides into three in front, the middle part extending forward between the eyes to the front of the head, while the side branches end in front of the hinder eyes. The abdomen is dark brown with two bright yellow stripes on the front part that unite into one behind the middle and are indistinctly divided into segments by grayish lines. Along the sides of the yellow lines are several pairs of irregular black spots. The legs are ringed with gray and dark brown. The under side of the abdomen is gray, with a black stripe each side, which unite in front of the spinnerets and sometimes are connected in front by a black transverse line be-

hind the epigynum. The sternum is dark brown with sometimes a light mark in the middle. In some light colored individuals the space between the two yellow bands on the abdomen is much lighter, so that it forms with them a wide yellowish middle stripe. Fig. 6*b*.

This is a slender species with long legs. The front row of eyes is shorter than the second row and a little curved upward. The eyes of the second row are about their diameter apart. The epigynum is T-shaped. There are two pits near together in front. The anterior part of the epigynum is widened in the middle. The cross-piece is scalloped at the ends. The male palpi are long and slender. The palpal organ has a thick process at the base with a large tooth. The terminal process which seems to support the tube is short and curved upwards at the end. Near its base is a small hook. The tarsus is about twice as long as the palpal organ and not very sharp at the end, where there are several thick spines.

They run in grass in open fields or hide under stones, especially when about to molt or to lay eggs. When surprised in open ground they sometimes lie flat and appear dead.

Eastern Mass.; Providence, R. I.; New Haven, Conn.

Lycosa punctulata Hentz.

PLATE XLVIII, FIGURES 1, 1*a*, 1*b*.

The largest female measures 16.5^{mm} long. Cephalothorax, 7.5^{mm} long, 5.5^{mm}; 1st leg, 19^{mm}; 4th leg, 22^{mm}.

The cephalothorax is whitish with two distinct dark brown stripes. The abdomen has a dark brown middle band with a narrow white stripe on each side, beyond which the sides of the abdomen are brownish, darkest towards the front end. The under side of the abdomen is light or with some irregular dark patches and has several black spots irregularly arranged and differing in size and number in different individuals. The legs are without rings but the ends of the joints are darker than the rest. The cephalothorax and abdomen are narrower than in most species.

The epigynum is narrow and convex in the middle, the middle lobe only slightly elevated and a little widened in front. At the hinder end is a short transverse piece.

Woodbridge, Conn.; Sherborn, Mass., from A. L. Babcock; Providence, R. I.; Indianapolis, Indiana. Hentz's specimens were from Pennsylvania and Alabama.

Lycosa scutulata Hentz.

PLATE XLVIII, FIGURES 2, 2a.

Female, 16^{mm} long. Cephalothorax, 7.5^{mm} long, 5.5^{mm} wide; 1st leg, 22^{mm}; 4th leg, 28^{mm}.

This species resembles *punctulata*, but the legs are proportionately longer. The cephalothorax has two dark longitudinal stripes along the middle and finer dark lines near the edges. The abdomen has a dark middle stripe broken by two notches near the front third and including three or four pairs of light spots in the hinder half. The under side is light without markings. The legs are light with the ends of the joints darker.

The epigynum is shorter and wider than in *punctulata* and less convex. The transverse end of the middle lobe is wider.

New Haven, Conn., under stones along roads. A female found Sept. 15th, was in a shallow hole lined with silk, with young on her back.

Lycosa ocreata Hentz, Boston Journal of Nat. Hist., vol. iv.Probably *Lycosa ocreata* Keyserling, zool. botan. Gesells., Wien, 1876.

PLATE XLVIII, FIGURES 6, 6a, 6b.

Males, 6 to 7^{mm} long; 1st leg, 10 to 12^{mm}. Small female, 8^{mm} long. Cephalothorax, 3.5^{mm}.

The cephalothorax has a light gray stripe in the middle from the second row of eyes backward. At the sides the cephalothorax is dark brown. The abdomen is dark brown at the sides and has a light grayish figure in the middle indistinctly divided into segments on the hinder half. Fig. 6. The legs are yellowish, indistinctly ringed with gray on the femora. The hairs are long all over the body and the spines on the legs are also long. In the male the cephalothorax is wide behind and the legs are longer and stouter. The tibiae of the front legs are thickly covered with dark brown hairs which stand out at right angles to the leg and make it appear thickened. The male palpi are thickened toward the end. The tibia is as wide as long and the patella is also short and thick. The palpal organ has a long thin process at the end which lies across the tarsus and makes it appear twisted. The front row of eyes is shorter than the second row and the eyes are small with the lateral not much larger than the middle. The eyes of the second row are large and about their diameter apart.

New Haven, Conn., common in open woods among dead leaves. Adult about June 1st.

Pirata Snd.

The front row of eyes nearly straight. The second eyes very large and not more than their diameter apart, usually nearer together. The hinder eyes are farther forward and wider apart than in *Lycosa*. The hinder spinnerets are twice as long as the front pair. The thorax is usually marked by a median light stripe, which spreads into three toward the eyes. The dark lateral areas are more or less broken by radiating light lines.

Pirata piraticus Clerck.

PLATE XLVIII, FIGURES 7, 7a, 7b, 7c, 7d.

Length of female, 7.5^{mm}; cephalothorax, 3.5^{mm} long, 2.5^{mm} wide.

Yellow, with black or gray markings. The cephalothorax has a light narrow line in the middle and one on each side a short distance from the edge. In the middle of the front of the abdomen is a black-edged stripe which tapers backward to a point or fine line beyond the middle. On the sides of this are light stripes which unite into a single middle line, behind and outside of these a row of dark marks which extend down the sides, becoming gradually narrower. The legs and the under side of the body are light yellow. The mandibles are brown and the eyes are surrounded by black. The front row of eyes is of the same length as the second row, and the four eyes are nearly of the same size. The second row of eyes are large and about their diameter apart.

The epigynum has a small triangular opening behind, within which two round holes are visible; in front of the opening is a round swelling over the epigynum.

The males are a little smaller and brighter than the females.

The middle process of the palpal organ is large, wide at the base and ends in front in a sharp hook.

Salem, Massachusetts; New Haven, Conn.; in wet fields and under leaves in winter.

Pirata insularis, new.

PLATE XLVIII, FIGURES 8, 8a.

Length of female, 8^{mm}; cephalothorax, 3.3^{mm} long; 4th leg, 13^{mm}.

Colors dirty white and gray, somewhat like *Tegenaria medicinalis*. In the middle of the cephalothorax is a light line from the eyes to the dorsal groove. Two light lines extend from the hind eyes backward and unite into one behind the dorsal groove. At the sides are two other light lines. The abdomen has a light middle stripe on the

front half and the rest is nearly black with scattered small white spots. The femora are marked with three or four light and dark rings, and rings show indistinctly on the other joints in some specimens.

The sternum is dark with three indistinct light lines. The abdomen is dark beneath with many small light spots in oblique rows.

The epigynum is dark brown, divided at the edge into two lobes. Long Lake, Adirondack Mountains, N. Y.

***Pirata montanus*, new.**

PLATE XLVIII, FIGURE 9.

Length, 5^{mm}; 4th leg, 10^{mm}. The legs are yellowish white, with very faint grayish rings near the ends of the joints and dark spines. The sternum and coxæ are white. The cephalothorax is gray at the sides and has a wide light stripe in the middle, which is as wide as the head in front and tapers to half as wide behind. In the front half of this stripe are two dark lines, widest near the eyes and converging behind to the dorsal groove. The region around the eyes is black and the front of the head and mandibles dark. The sternum, front half of the abdomen and spinnerets are white.

The back of the abdomen is brown, with an indistinct row of small white spots each side. On the front end is a middle stripe with dark edges which tapers to a point near the middle of the abdomen. On the hinder segments are several dark and light transverse lines not forming any distinct figure.

The front row of eyes is considerably shorter than the second row, extending from the middle of one second eye to the middle of the other.

The hinder spinnerets are twice as long as the front pair and extend behind the abdomen.

The epigynum appears very simple externally, the spermatheca showing through the skin just in front of the edge of the fold in which appears to be the opening.

All the specimens are females, one from the White Mountains in July, with eggs, and two from Long Lake in the Adirondack Mountains, N. Y.

***Pirata minutus*, new.**

PLATE XLVIII, FIGURES 10, 10a, 10b, 10c.

Length of male, 3^{mm}. Cephalothorax gray, with a light line near the edge of the thorax and several radiating lines. Legs white or light yellow. The femora of the front legs darker and the rest of the leg

lighter than the others. The abdomen is gray, marked by bright white spots. In the middle of the hinder half is a row of short transverse white lines, and at the sides of these two rows of white dots. At the sides of the front of the abdomen are several oblique white lines. The upper spinnerets are twice as long as the lower. The upper eyes are large and prominent and surrounded by black.

The male palpi are light colored and not much thickened. The palpal organ has small appendages which are all near the outer end of the tarsus. The middle process is a large hook with a smaller and shorter one turned in the opposite direction at its base.

Salem and Roxbury, Mass. ; Meriden, Conn.

Pardosa C. Koch, Simon.

Lycosa Thorell = *Lycosa* Keyserling, Americanische Citigradæ, zool.-botan. Ges., Wien, 1876.

PLATE XLIX, FIGURES 1, 1a, 1b, 1c, 1d.

Head high and the second eyes large and as far apart as their diameter, or farther. The front row of eyes is straight or a little curved upward and shorter than the second row. The dorsal eyes are a little farther apart and nearly as far from the second eyes as from each other. The mandibles are small and weak compared with those of *Lycosa*. The legs are long and slender, less hairy than in *Lycosa*, but with very long spines, which lie flat against the skin when at rest and are turned out when the spider is active. The spinnerets are short and the posterior pair are a little the longest. The species are all small and brightly marked and live among grass, especially in open, wet ground, making no nests.

Pardosa lapidicina, new.

PLATE XLVIII, FIGURES 5, 5a, 5b, 5c.

8^{mm} long. Cephalothorax, 3.5^{mm} long; 1st leg, 11^{mm}; 4th leg, 14^{mm}.

The general color is black or dark gray, covered with long hairs. The markings show plainer when wet with alcohol. The cephalothorax has an irregular light patch around the dorsal groove and small light spots around the edges. The legs are marked with light and dark rings, the width of the light rings increasing and the dark decreasing toward the tips. The back of the abdomen is marked with irregular rows of light spots, somewhat as in *L. cinerea*. The under side has some irregular light spots, sometimes a light spot in the middle with a black ring around it. Others have the whole abdomen black.

The palpal organs resemble those of *L. cinerea*. The epigynum is small with a single pit in front.

This species lives among stones in the driest places, and runs with great speed.

Salem, Mass. ; Meriden, Conn.

Pardosa brunnea, new.

PLATE XLVIII, FIGURES 4, 4a, 4b.

Length of ♀, 8.5^{mm}. Cephalothorax, 4^{mm} long, 3.3^{mm} wide.

Colors dark brown with light markings. The head between the eyes is very dark, almost black. The middle of the cephalothorax is light, except a dark line which extends back as far as the dorsal groove. There is a narrow light stripe on each side a short distance from the edge. The legs are dark brown with some irregular longitudinal light stripes, and lighter toward the ends, especially in males. The abdomen is dark brown, except a light pointed marking over the dorsal vessel and a row of irregular black spots each side. The sternum is brown, with sometimes an indistinct light line in the middle and on the edges. The under side of the abdomen has a light stripe in the middle, from the epigynum to the spinnerets. The sides are brown in irregular spots. The male palpus is short and stout. The tibia is a little thickened and covered with long hairs that make it look still thicker. The tarsus is nearly as wide as long, and the palpal organ is large and black. Fig. 4a. The epigynum has a peculiar shape, fig. 4b, and varies somewhat in different individuals in the shape of the middle lobe.

Mt. Washington ; Dublin, N. H. ; Eastern Massachusetts ; New Haven, Conn.

Pardosa albomaculata, new.

PLATE XLVIII, FIGURES 3, 3a, 3b.

Female, 11^{mm} long. Cephalothorax, 5^{mm} long, 4^{mm} wide ; 1st leg, 15^{mm} ; 4th leg, 20^{mm}.

Color deep black, with spots of white hairs. On the abdomen are two rows of distinct spots, and there are less definite ones on the legs and around the thorax. The whole body is covered with long hairs, and only when these are wet are the markings on the skin visible. There are light rings on the legs and indistinct light spots on the thorax as in the related species.

The middle ridge of the epigynum is narrow, only slightly widened

at the end. At the sides are prominent ridges over the openings. Fig. 3a.

The male palpi are large and stout. The tibial joint is as wide as long. The tarsal joint is short and wide. The palpal organ is large and complicated and very different from that of the nearest species.

Bare rocks on the upper part of the White Mountains, running very rapidly and dodging under stones at slight alarm.

Pardosa pallida, new.

PLATE XLIX, FIGURES 3, 3a, 3b, 3c, 3d, 3e.

Length, 5^{mm}; 1st leg, 6^{mm}; 4th leg, 10^{mm}.

The general color is light yellow with brown markings. The cephalothorax is yellow with two brown stripes, which unite and become black between the middle eyes. There is a fine black line near the edge of the thorax on each side. The abdomen has a light middle band not much widened in front, where it includes a light stripe with dark brown edges, which tapers to a point about the middle of the abdomen. The hinder part of the middle stripe is indistinctly divided into four or five segments. At the sides of the middle stripe the abdomen is dark brown or black in small irregular spots and becomes gradually lighter toward the sides. The sternum is light, with a black line or row of spots around each side and two similar lines near the middle uniting into one behind. On the under side of the abdomen are two black lines from the spiracles to the spinnerets. The legs are light yellow, with a few irregular black streaks, especially on the inner joints.

The ends of the male palpi are black and the front legs and head are a little darker in the male than in the female, but otherwise there is not much difference between them. The shape of the epigynum is characteristic of this species. Fig. 3c. The middle process of the palpal organ is very long and wide and curved obliquely across the bulb. Fig. 3e.

New Hampshire; Massachusetts; New Haven, Conn.

Pardosa bilineata, new.

PLATE XLIX, FIGURES 4, 4a, 4b.

This species resembles closely *P. pallida*, but is much larger, the markings of the under side less distinct and the epigynum very different, being T-shaped and much shorter than in *pallida*.

The female is 7^{mm} long. The cephalothorax, 3.5^{mm}; 4th leg, 12^{mm}. The markings of the back are similar to those of *P. pallida*. The legs

are light yellow, a little brownish toward the end. The sternum is light with a dark edge and a row of dark spots on each side meeting behind. The under side of the abdomen is indistinctly marked with four longitudinal lines converging behind.

The epigynum is of the common T-shape, about as wide as long.

East Rock, New Haven, Conn.

Pardosa albopatella, new.

PLATE XLIX, FIGURES 2, 2a, 2b.

Male, 4^{mm} long. Cephalothorax, 2.5^{mm} long, 2^{mm} wide. The cephalothorax has a light stripe along each side covered in life with white hairs which extend to the edge of the thorax and make the stripe appear wider than in alcohol. In the middle of the thorax is a light spot which tapers behind to a point near the hinder end of the thorax and fades in front into the dark markings of the head. The rest of the cephalothorax is black, blackest toward the front. The male palpi are black, except the patellæ, which are bright white. The legs are light at the ends with white and gray hairs and black spines. The femora are darker, the hinder ones ringed with gray, and the front pair entirely black. The abdomen is gray with an indistinct light stripe in the middle of the front part, extending back only half the length of the abdomen. The sternum is black. The under side of the abdomen is gray with a black line in the middle and on each side.

The middle process of the palpal organ is long and curves obliquely across the bulb its whole width. The tarsus of the palpus is long and slender. Fig. 2b.

In the female the light markings are smaller and less distinct than in *nigropalpis*.

Ipswich and Roxbury, Mass. New Haven, Conn. May and June.

Pardosa nigropalpis, new.

PLATE XLIX, FIGURES 1, 1a, 1b, 1c, 1d.

Males, 5^{mm}; females, 6^{mm} long; 4th leg of female, 12^{mm}.

Cephalothorax of male black with a light band in the middle from the posterior eyes to the abdomen. This band widens just behind the eyes and suddenly narrows again about the middle of the cephalothorax. It widens again around the dorsal groove and narrows behind. Around the edge of the thorax are narrow light stripes or rows of irregular spots.

A light band about as wide as that on the thorax continues back-

ward along the middle of the abdomen. It widens in front and tapers backward nearly to the middle, behind which it is broken up into a series of four or five transverse spots edged with deep black and including some fine black spots. Legs yellowish, ringed with gray on the femur and less distinctly on the patella and tibia. In a fresh young female the general color is gray. The gray band on the cephalothorax extends forward covering the area between the eyes to the front of the head. This part of the band is a little darker than the rest. The edges of the cephalothorax are a little lighter than the rest but the light markings only show when wet. The legs are plainly ringed with gray on all the joints and the palpi are light.

The sternum is black in the middle and light at the sides. The coxæ are light and the under side of the legs lighter than the upper. The under side of the abdomen is sometimes entirely gray, or there is a middle lighter area with a dark stripe running back from the epigynum nearly to the spinnerets. The male palpi are black at the end and the other joints are darkened by scattered black hairs.

The middle process of the male palpi is short and sharply bent toward the side and the small hook at its base is very small. Fig. 1c. Massachusetts and Connecticut.

Pardosa montana, new.

PLATE XLIX, FIGURES 5, 5a.

♀, 6^{mm} long; ♂, 5^{mm}. In alcohol, at least, the colors are duller and the markings less distinct than in the other species in both sexes. The legs are more distinctly ringed on the femur and tibia, all the legs nearly alike. The light markings on the middle of the thorax and abdomen are large like *P. albopatella*, but not brightly colored. There is little difference in the markings between the sexes. The epigynum is wide with a small narrow middle lobe. The anterior pits are large and wide apart. The male palpi are long and the joints are not much thickened. The middle process of the palpal organ is short and stout, with the end curved backward into a short hook. Fig. 5.

Mt. Washington, N. H., June. Mt. Tom, Mass., April 4, 1878.

Aulonia C. Koch.

The head is high and wide. The middle and posterior eyes are very large, and seen from above form almost a square covering the whole top of the head. The front row of eyes is much shorter than the second row and slightly curved upward. The second row are

less than their diameter apart. The posterior eyes are turned outward and backward. The hinder spinnerets are about twice as long as the front pair, but when folded together are not conspicuous. The species are small and slender, as in *Pardosa*.

Aulonia aurantiaca, new.

PLATE XLIX, FIGURES 6, *Ga*, *Gb*.

Female, 3^{mm} long; 4th leg, 5^{mm}. Male a little smaller. The abdomen is brownish orange-color with a yellow spot in the middle tapering to a row of smaller spots behind. The cephalothorax has a yellow spot behind, just under the front end of the abdomen, and a narrow bright yellow stripe on each side. The middle is yellowish without any definite stripe or spots. The rest of the cephalothorax is black. The legs of the female vary from dark brown on the front pair to light yellow on the hinder pair. In the male the legs are whiter with the femora of the first and second pairs black, or partly spotted with black. The male palpi are black, except the tips, which are partly white. The white parts turn yellowish in alcohol.

The front eyes are smaller and the whole row not much more than half as wide as the second row; it is slightly curved upward and the middle eyes are a little larger than the lateral.

The palpal organ is large and the tarsus wide and short. In the middle is a long appendage, thick and rounded at the front end and sharply pointed behind. Fig. 6*a*.

Eastern Massachusetts; New Haven, Conn.

Ocyale Aud., in Sav.

The cephalothorax is a little more elongated than in *Dolomedes*, and the head more distinctly separated by grooves. The eyes differ but little in size, and the hinder pair are not much farther back than the second.

Ocyale undata.

Micrommata undata, serrata and *carolinensis* Hentz, Boston Journal of Nat. Hist., vol. v.

PLATE XLIX, FIGURES 7, *7a*.

This species resembles *Ocyale mirabilis* of Europe, but the body is less narrowed behind and the eyes are more like *Dolomedes*.

The female is 13^{mm} long. Cephalothorax, 5^{mm} long, 5^{mm} wide; 1st, 2d, and 4th legs, 25^{mm} long.

The cephalothorax and abdomen are flat and the cephalothorax is as wide behind as it is long. In old females the legs are reddish

brown without any rings or other markings. In the middle of the cephalothorax is a longitudinal stripe about a third its width, of the same color as the legs. The sides of the cephalothorax are light yellow, darkest toward the edges. The brown middle stripe continues along the abdomen with the edges a little irregular but with no distinct teeth or undulations. Young individuals have all the colors lighter and yellower, the legs more or less ringed and the middle stripe of the abdomen distinctly undulated. Along the edges of the middle stripe there is usually a fine white line which is sometimes broken up into a row of spots, as in Hentz's *M. carolinensis*. In very young spiders the abdominal stripe is distinctly serrated, as in Hentz's *M. serrata*, the stripe on the thorax divided into two and the whole body less flattened.

The male palpi are long. The tarsus is pointed but nearly as wide as long. The middle process of the palpal organ is flat and thin, spreading out over the greater part of the bulb. At one side it is narrowed into a fine point which supports the end of the long slender tube, the ends of both resting on a short process at the base of the bulb. On the under side of the end of the tibia is a wide flat process extending up to the palpal organ, and on the outer side is a long tooth slightly notched at the end.

From July to September the females may be found under large bunches of web four or five inches across, in grass or low bushes in meadows. The cocoon is placed in this bunch of web, and the young after hatching scatter themselves through it.

Eastern Massachusetts; New Haven, Conn.

Dolomedes.

In this genus the cephalothorax is about as wide as long, and rounded on the back, with but little separation between the head and thorax. The head is wide and nearly straight in front. The front row of eyes is composed of four small ones as in *Lycosa*. The second row are larger, but not larger than those of the third row, which are twice as far apart and a little farther back. The legs are long, and the first, second and fourth, are nearly equal in length. The feet are thickly covered with fine hairs. The abdomen is a little flattened and a little pointed behind. The tibia of the male palpus has a large process on one side. They live near water on which they run easily. The female carries the cocoon in her mandibles until the young are ready to hatch, and then fastens it in a bush with many irregular threads, among which the young remain a short time after leaving the cocoon.

Dolomedes sexpunctatus Hentz, Boston Journal of Nat. Hist., vol. iv.

PLATE XLIX, FIGURES 8, 8a.

Female, 13^{mm} long. Cephalothorax, 5.5^{mm} long, 5^{mm} wide. The cephalothorax is not as wide in proportion to its length as in the other species. The color is dark olive or gray and yellow. The cephalothorax is dark yellowish brown with a very bright white line on each side extending forward to the front of the mandibles. The abdomen is dark gray, darkest in the middle, with two rows of small white spots. The legs and palpi are greenish yellow with dark spines. The under side is lighter yellow. On the sternum are six black spots, sometimes very distinct, in other individuals hardly visible.

This species lives near water, on which it runs easily. Eastern Massachusetts; Albany, N. Y.; New Haven, Conn. Though it is common, I have only found one adult female and no males.

Dolomedes tenebrosus Hentz.

PLATE XLIX, FIGURES 9, 9a, 9b, 9c.

Length of female, 18^{mm}; 1st leg, 33^{mm}; 4th leg, 37^{mm}; cephalothorax, 9^{mm} long, 8^{mm} wide.

Male, 16^{mm} long; cephalothorax, 9^{mm} long, 8^{mm} wide; 1st leg, 44^{mm}; 4th leg, 48^{mm}.

This is one of our largest spiders, some males spreading four inches. The colors are dark brown and light gray, turning darker and yellower in alcohol. The cephalothorax has a light stripe on each side. The abdomen is marked with five or six dark brown angular stripes across the hinder half. These are darkest around the edges and bordered by lighter lines. The legs are marked with dark and light rings, which are plainer in the male than female. The markings on the abdomen are also somewhat different in the male, being more united into a middle band bordered by lateral bright white or yellow ones. The femora of the fourth pair have near the end on the under side an oblique cluster of black spines on a slight elevation. The male palpi have the tibia widened at the end, and a large process on the outer side near the middle, consisting of a large hook with a smaller one at its base and above it. The tarsus is large and the palpal organ complicated with a long slender tube.

These spiders live on bushes near water. The female makes a large mass of web in which she places the cocoon of eggs, and in which the young live for some time after hatching.

Massachusetts. New Haven, Conn.

Dolomedes fontanus, new.

PLATE XLIX, FIGURE 10.

This spider resembles closely *D. tenebrosus*, but is a little smaller. Length, 14^{mm}; longest leg, 36^{mm}. There are no tufts of bristles on the hind femora. The male palpi are much like those of *tenebrosus*, but the process on the tibia has two small hooks of nearly equal length. The abdominal markings and the indistinct rings on the legs are like those of the male *tenebrosus*.

One male. Dublin, N. H., near water.

Oxyopes Latr.

This genus is often placed in a separate family from the Lycosidæ, on account of the great difference in the arrangement of the eyes caused by the lateral eyes of the front row being placed wide apart at the sides of the head and above the eyes of the second row. This places the eyes in four rows, the first of two small eyes near together, the second of two large eyes as in *Lycosa*, the third of two small eyes wide apart, and the fourth of two small eyes on the top of the head. The head is very high and wide on the lower edge. The abdomen is wide and pointed behind. The legs are very slender and tapering and have long spines.

Oxyopes scalaris Hentz, Boston Journal Nat. History, vol. v.

PLATE XLIX, FIGURES 11, 11a.

6^{mm} long; cephalothorax, 2.5^{mm}.

The cephalothorax is wide in front and as high as wide, the head narrowing a little upward toward the eyes. The abdomen is wide in the middle and pointed behind. The general color in alcohol is dark brown covered with gray and yellow hairs. The middle of the cephalothorax is light with irregular edges. The abdomen has a row of light spots in the middle and a less distinct row each side. The under side of the abdomen has a dark stripe in the middle, on each side of which is a bright yellow stripe. The legs are slender and tapering, with very long spines. They are marked with dark rings or spots at the end and middle of each joint.

The eyes are in four rows. The lower row consists of two very small eyes, about half way between the mandibles and the top of the head; the next, of two larger eyes, the largest of all, about their diameter apart; the third, of two small eyes twice as far apart as the second; and the fourth, of two eyes a little smaller than the second and a little farther apart, on the top of the head.

The mandibles are small and tapering and shorter than the height of the head. Nashua, N. H., running on a fence.

EXPLANATION OF PLATES.

PLATE XLVI.

- Figure 1.—*Lycosa nidicola*. Female.
Figure 1a.—The same. Male.
Figure 1b.—The same. Under side of abdomen of female.
Figure 1c.—The same. Palpus of male.
Figure 1d.—The same. Epigynum.
Figure 2.—*Lycosa polita*. Female, common variety of marking.
Figure 2a.—The same. Female, variety with brighter markings.
Figure 2b.—The same. Eyes.
Figure 2c.—The same. Epigynum.
Figure 3.—*Lycosa frondicola*. Female.
Figure 3a.—The same. Female, under side of abdomen.
Figure 3b.—The same. Epigynum.
Figure 4.—*Lycosa pratensis*. Female.
Figure 4a.—The same. Epigynum.
Figure 4b.—The same. Male palpus.
Figure 5.—*Lycosa pictilis*. Female.
Figure 5a.—The same. Male palpus.
Figure 5b.—The same. Epigynum.
Figure 6.—*Lycosa kochii*. Female.
Figure 6a.—The same. Epigynum.
Figure 6b.—The same. Male palpus.
Figure 6c.—The same. Maxilla of female.

PLATE XLVII.

- Figure 1.—*Lycosa carolinensis*, under side of female.
Figure 1a.—The same. Epigynum.
Figure 1b.—The same. Male palpus.
Figure 2.—*Lycosa vulpina*. Epigynum.
Figure 3.—*Lycosa cinerea*. Female.
Figure 3a.—The same. Male palpus.
Figure 3b.—The same. Eyes.
Figure 4.—*Lycosa nidifex*. Female.
Figure 4a.—The same. Epigynum.
Figure 4b.—The same. Male palpus.
Figure 5.—*Lycosa nigroventris*. Female.
Figure 5a.—The same. Female, under side.
Figure 5b.—The same. Male palpus.

- Figure 6.—*Lycosa communis*. Female.
 Figure 6a.—The same. Under side of female.
 Figure 6b.—The same. Another variety of dorsal marking.
 Figure 6c.—The same. Epigynum.
 Figure 6d.—The same. Male palpus.

PLATE XLVIII.

- Figure 1.—*Lycosa punctulata*. Female; $\times 4$.
 Figure 1a.—The same. Under side of abdomen.
 Figure 1b.—The same. Epigynum.
 Figure 2.—*Lycosa scutulata*. Female.
 Figure 2a.—The same. Epigynum.
 Figure 3.—*Pardosa albomaculata*. Female from alcohol.
 Figure 3a.—The same. Epigynum.
 Figure 3b.—The same. Male palpus.
 Figure 4.—*Pardosa brunnea*. Female; $\times 4$.
 Figure 4a.—The same. Male palpus.
 Figure 4b.—The same. Epigynum.
 Figure 5.—*Pardosa lupidicina*. Female; $\times 4$, from one in alcohol.
 Figure 5a, 5b.—The same. Male palpus.
 Figure 5c.—The same. Epigynum.
 Figure 6.—*Lycosa ocreata*. Male; $\times 4$.
 Figure 6a.—The same. Front of head and eyes.
 Figure 6b.—The same. Male palpus.
 Figure 7.—*Pirata piraticus*. Female; $\times 4$.
 Figure 7a.—The same. Eyes.
 Figure 7b.—The same. Epigynum.
 Figure 7c, 7d.—The same. Male palpus.
 Figure 8.—*Pirata insularis*. Female; $\times 8$.
 Figure 8a.—The same. Epigynum.
 Figure 9.—*Pirata montanus*. Female; $\times 8$.
 Figure 10.—*Pirata minutus*. Front of head and eyes of female.
 Figure 10a.—The same. Male palpus.
 Figure 10b, 10c.—The same. Spinnerets.

PLATE XLIX.

- Figure 1.—*Pardosa aigropalpis*. Female; $\times 8$.
 Figure 1a.—The same. Male; $\times 8$.
 Figure 1b, 1c.—The same. Male palpus.
 Figure 1d.—The same. Epigynum.
 Figure 2.—*Pardosa albopatella*. Female; $\times 8$.
 Figure 2a.—The same. Male; $\times 8$.
 Figure 2b.—The same. Male palpus.
 Figure 3.—*Pardosa pallida*. Female; $\times 8$.
 Figure 3a.—The same. Male; $\times 8$.
 Figure 3b.—The same. Under side of female.
 Figure 3c.—The same. Epigynum.

- Figure 3*d*.—The same. Top of head and eyes.
Figure 3*e*.—The same. Male palpus.
Figure 4.—*Pardosa bilineata*. Female.
Figure 4*a*.—The same. Under side.
Figure 4*b*.—The same. Epigynum.
Figure 5.—*Pardosa montana*. Male palpus.
Figure 5*a*.—The same. Epigynum.
Figure 6.—*Aulonia aurantiaca*. Cephalothorax of female; $\times 20$.
Figure 6*a*.—The same. Male palpus.
Figure 6*b*.—The same. Epigynum.
Figure 7.—*Ocyale undata*. Back of female; $\times 4$.
Figure 7*a*.—The same. Male palpus.
Figure 8.—*Dolomedes sexpunctatus*. Female.
Figure 8*a*.—The same. Under side of thorax.
Figure 9.—*Dolomedes tenebrosus*. Dorsal markings of young.
Figure 9*a*, 9*b*.—The same. Male palpus.
Figure 9*c*.—The same. Epigynum.
Figure 10.—*Dolomedes fontanus*. Male palpus.
Figure 11.—*Oxyopes scalaris*. Female; $\times 8$.
Figure 11*a*.—The same. Front of head, eyes and mandibles.

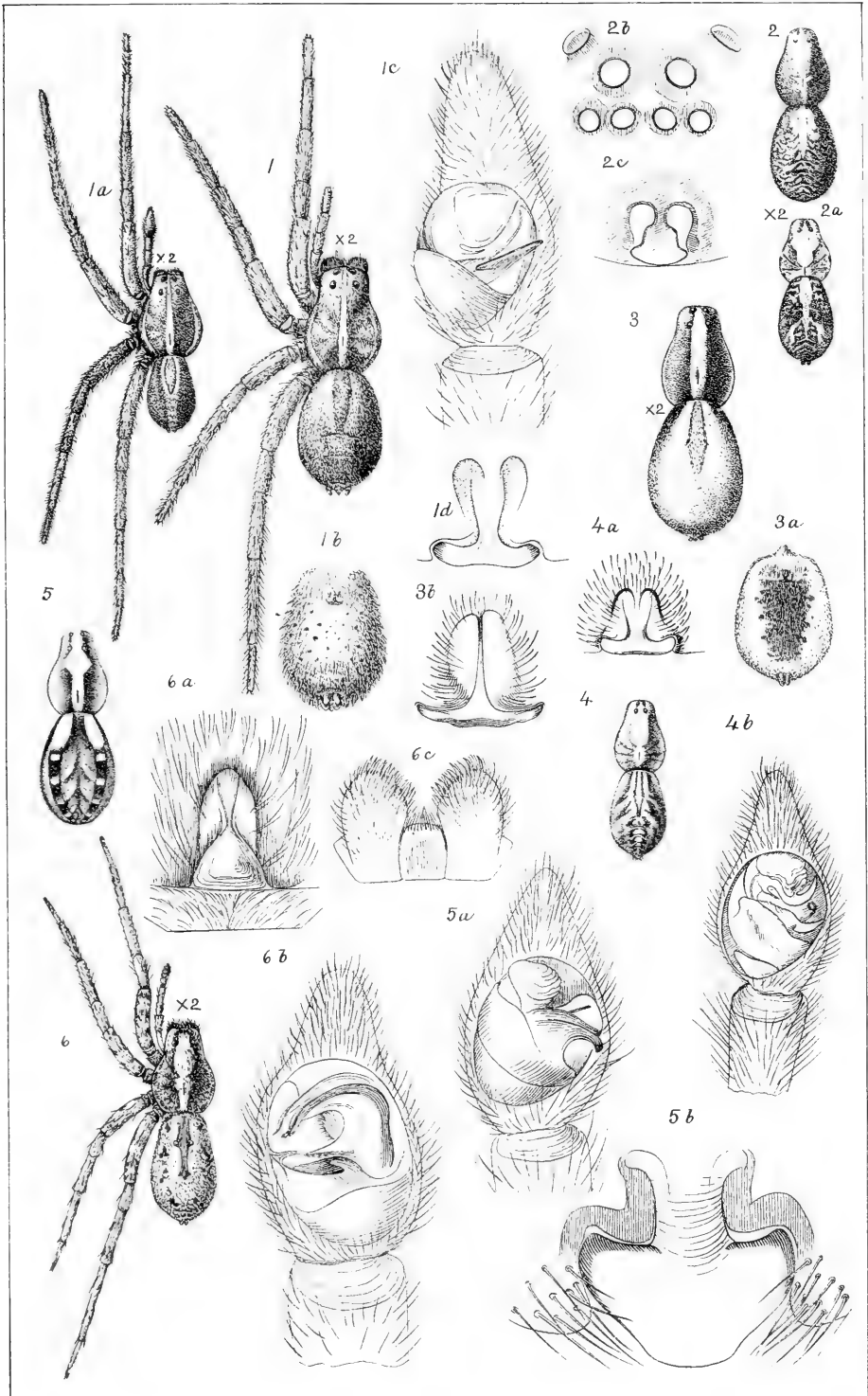

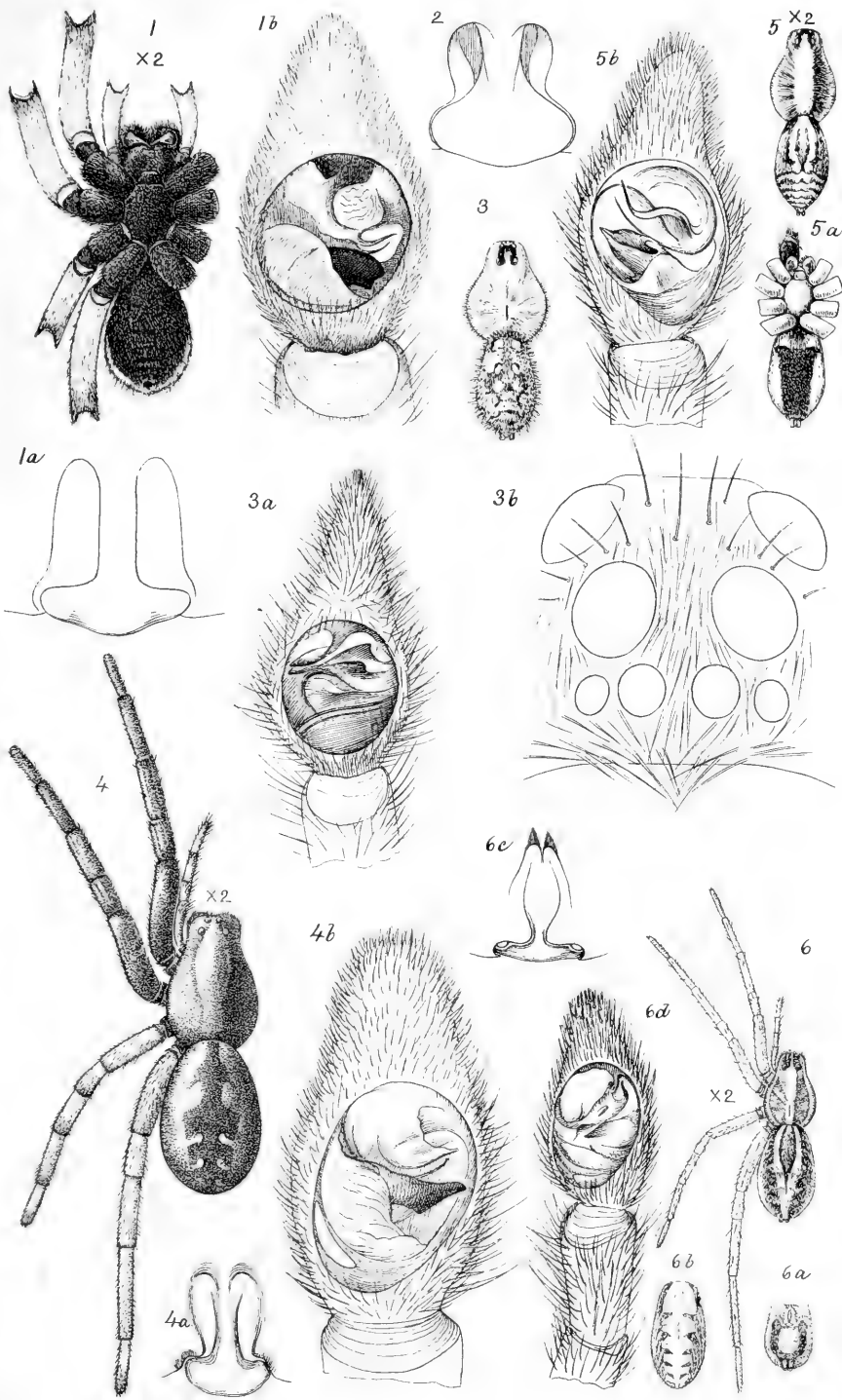

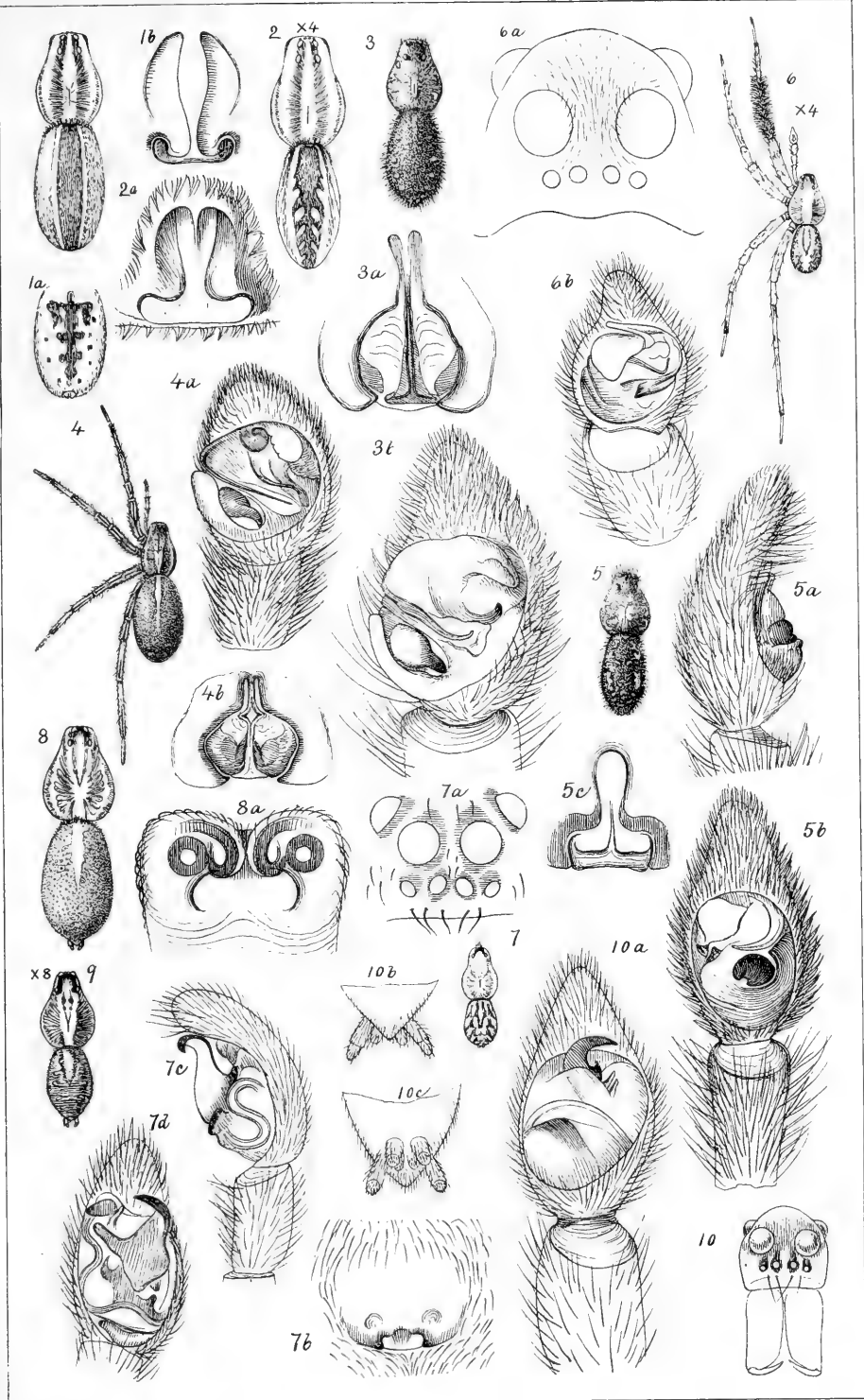





I N D E X .

- Abralia megalops*, 143, 264, 285.
Abra lioica, 224, 278, 285.
 longicallis, 224, 278, 283, 285.
Acanella Normani, 410.
Aclis striata, 270.
 tenuis, 270, 480.
 Walleri, 270.
Acirsa gracilis, 270.
Acrosoma, 297, 326.
 mitrata, 327.
 rugosa, 326.
 spinea, 326.
Actæon hebes, 428, 447.
 melampoides, 210, 273, 285.
 nitidus, 273, 283.
 puncto-striatus, 467.
Aeus protextus, 462.
Addisonia paradoxa, 256, 271.
 eccentros, 271.
 Additions to the Shallow-water Mollusca of Cape Hatteras, N. C., dredged by the U. S. Fish Commission Steamer "Albatross," in 1883 and 1884, 453-480.
Admete Couthouyi, 265, 282.
 nodosa, 419, 447.
 viridula, 265.
Agalena, 24.
Alloposus mollis, 247, 265, 282.
Amaurobius, 38.
Amphisphyræ globosa, 273.
 pellucida, 273.
Amussium, 261, 281, 285, 480.
 fenestratum, 261.
 Hoskynsi, 261.
Anachis costulata, 252.
 Haliæeti, 252, 268, 479.
 Anatomy of *Libinia emarginata* Leach, the Spider Crab, 99-122.
Ancistrocheirus megaptera, 399, 446.
 Veranyi, 400.
Andrena, 389.
 Andrews, E. A., On the Anatomy of *Libinia emarginata* Leach, the Spider Crab, 99-122.
Anomia aculeata, 282, 479.
Aporrhais occidentalis, 270, 283.
Arca aurita, 440.
Arca petunculoides, 280, 285, 440.
 var. crenulata, 280.
 var. Frielei, 280.
 var. septentrionalis, 280.
 profundicola, 439.
Arctosa, 482.
Argiope, 328.
 riparia, 329.
 transversa, 330.
Argonauta arge, 247, 265.
Argyrodes, 7, 23.
 ficilium, 2, 24.
 trigonum, 2, 11, 23, 62.
Argyropeira, 297, 331.
 hortorum, 332.
Ariamnes, 23.
Arpagita, 393.
Artemia, 89.
 Monica, 89.
Asagena, 7, 22.
 americana, 4, 23.
Assiminia Grayana, 253.
 modesta, 253.
Astarte castanea, 278, 479.
 crenata, 278, 479.
 quadrans, 278.
 undata, 477.
Astyris diaphana, 268.
 pura, 268, 282, 462.
 zonalis, 268, 479.
Atlanta bulimoides, 215.
 Gaudichaudii, 211, 274.
 inclinata, 211, 275, 469.
 Lamanonii, 211, 275.
 Peronii, 274, 469.
 pulchella, 211, 275.
 reticulata, 431.
 rosea, 211, 274.
 trochiformis, 214.
Atretia gnomon, 234, 398, 445.
Aulonina, 498.
 aurantiaca, 499.
Avicula hirundo, 281.
 var. nitida, 281.
 squamulosa, 233, 281.
Axinopsis, 279, 283.
Axinus tortuosus, 226.

- Balantium recurvum*, 275.
Bathyphantes, 8, 68.
 alpina, 7^a.
 angulata, 71.
 bilhamata, 72.
 complicata, 72.
 formica, 71.
 micaria, 71.
 minuta, 3, 68.
 nebulosa, 3, 69.
 sub-alpina, 70.
 terricola, 65.
 zebra, 69.
 zebrinus, 69.
Bela Blakei, 417, 447, 452.
 cancellata, 266.
 concinna, 249.
 decussata, 419.
 Gouldii, 266.
 harpularia, 266.
 hebes, 160, 240, 266, 290.
 impressa, 250.
 incisula, 266.
 mitrula, 249.
 var. concinna, 249, 266.
 pleurotomaria, 161, 266.
 pygmaea, 266, 282.
 Rathbuni, 236, 266, 282.
 Sarsii, 250.
 scalaris, 162, 418.
 subturgida, 161, 266.
 subvitrea, 160, 266.
 tenuicostata, 419, 447.
 tenuilirata, 266.
Bembex, 389.
Benthodolium, 177.
 abyssorum, 177, 268, 283, 284.
Benthoteuthis, 401.
 megalops, 402, 446.
Bolyphantes, 8, 72.
 drassoides, 72.
Bombidia, 389.
Bombus, 389.
Brachiotenthis Beanii, 245, 264
Brachyglossum, 389.
Buccinopsis striata, 168.
Buccinum abyssorum, 167, 266, 282.
 cyaneum, 266.
 Sandersoni, 267.
 Tottenii, 252.
 undatum, 267.
Bulla biplicata, 467.
 Candei, 468.
 Sagra, 467.
Bush, Katharine J., Additions to the Shallow-water Mollusca of Cape Hatteras, N. C., dredged by the U. S. Fish Commission Steamer "Albatross," in 1883 and 1884, 453-480.
Cadulus Carolinensis, 471.
 cylindricus, 220, 276, 283.
 grandis, 219, 276, 283, 433.
 incisus, 471.
 Jeffreysii, 257, 276.
 Pandionis, 219, 276.
 propinquus, 257, 276.
 spectabilis, 432.
 Watsoni, 219, 276, 285.
Cæcum Cooperi, 291, 463.
 pulchellum, 463.
Calliostoma Bairdii, 270, 285, 480.
 occidentale, 270.
Callista convexa, 278.
Calliteuthis reversa, 243, 264, 282, 284.
Capulus fallax, 192.
 hungaricus, 192, 269.
Cardita borealis, 258, 477.
 granulata, 258.
Cardium peramabilis, 278, 285.
 pinnulatum, 278, 477.
Carinaria Atlantica, 274.
Cavolina angulata, 213, 275.
 gibbosa, 213, 275.
 inflexa, 275, 470.
 longirostris, 275, 470.
 quadridentata, 212, 275, 470.
 tridentata, 275, 469.
 uncinata, 275, 469.
Ceratina, 32.
Ceratinella, 8, 32.
 atriceps, 3, 34.
 brunnea, 36.
 bulbosa, 33.
 emertoni, 3, 32.
 fissiceps, 3, 33.
 keta, 3, 35.
 ketabilis, 3, 35.
 micropalpis, 36.
 minuta, 36.
 pygmaea, 34.
Ceratinopsis, 8, 36.
 interpres, 3, 37.
 laticeps, 37.
 nigriceps, 37.
 nigripalpis, 38.
Cerithiella Whiteavesii, 270.
Cerithiopsis Emersonii, 463.
Cerithium protextum, 462.
 turris-thomæ, 463.
Ceronia areolata, 278.
Chama congregata, 478.
Chemnitzia cancellata, 467.
Chione alveata, 477.
Chiroteuthis lacertosa, 243, 264, 282, 284.
Chittenden, R. H., The Diastatic Action of Saliva, as Modified by various conditions, studied Quantitatively, 343-376.
Choristes elegans, var. tenera, 256, 273.
Choristodon? cancellatus, 435.
Cingula abyssicola, 182.
 aculeus, 241, 269.
 apicina, 183, 269, 283.
 arenaria, 181.
 arcolata, 181, 269.
 basistriatum, 199.
 brychia, 179, 269, 283.

- Cingula carinata*, 181, 269, 480.
harpa, 181, 269.
Jan-Mayeni, 180, 269, 283.
Jeffreysi, 182.
modesta, 253.
leptalea, 182, 269.
Sandersoni, 241, 269.
syngenes, 180, 269.
turgida, 269.
turricula, 241.
- Cirrhoteuthis*, eggs of, 410.
megaptera, 405, 446.
plena, 404, 446.
- Cithna cingulata*, 184, 269, 283.
olivacea, 185, 269, 283, 463.
tenella, var. *costulata*, 184, 269, 284.
- Clidiophora*, 475.
trilineata, 277, 475.
- Clione longicaudata*, 215, 276.
papilionacea, 276.
- Clio pyramidata*, 275, 470.
- Cleodora striata*, 430.
subulata, 213.
virgula, 213.
virgula, var., 214.
- Cocculina Beanii*, 203, 204, 271.
concentrica, 203.
conica, 204, 271.
Dalli, 203, 271.
leptalea, 202, 271, 283, 284.
Rathbuni, 271.
- Cocculina reticulata*, 426, 447, 480.
spinigera, 203, 271.
- Cochlodesma Leanum*, 278.
- Columbella haliaceti*, 252.
- Conopeæjus*, 389.
- Conopidae*, 387.
- Conopilla*, 389.
- Conopinae*, 387.
- Conops*, 91, 377, 387, 389, 391.
æthiops, 391.
brachyrhynchus, 390.
bulbirostris, 390.
excisus, 390.
flaviceps, 390.
fronto, 378, 390.
fulvipennis, 390.
genualis, 391.
gracilis, 377, 390.
nigricornis, 391.
obscuripennis, 390.
pictus, 390.
Ramondi, 390.
stylatus, 93.
sugens, 390.
sylvosus, 390.
tibialis, 389.
xanthopareus, 390.
- Conus Delessertii*, 453.
Floridanus, 453.
- Corbula disparilis*, 472.
Swiftiana, 472.
- Cornicularia*, 8, 40.
- Cornicularia auranticeps*, 43, 46.
brevicornis, 42.
clavicornis, 43.
communis, 41.
directa, 3, 40.
indirecta, 3, 41.
minuta, 42.
pallida, 42.
tibialis, 41.
tricornis, 43.
- Coryphella*, 274.
- Crassatella*, 477.
- Crassatella (Eriphyla) lunulata*, 477.
- Crenella decussata*, 281, 285, 480.
fragilis, 444.
glandula, 281, 479.
- Crepidula plana*, 269.
- Creseis spinifera*, 213.
striata, 430.
- Crucibulum striatum*, 269, 480.
- Crustulina*, 19.
- Cryptodon ferruginosus*, 279, 283.
Gouldii, 279, 283.
grandis, 436.
obesus, 279, 283, 285, 478.
plicatus, 437.
subovatus, 279.
tortuosus, 226, 249, 283.
- Cuvieria columnella*, 214.
- Cyclocardia borealis*, 477.
- Cyclosa*, 297, 321.
conica, 321.
- Cyclostrema affine*, 199, 271.
cingulatum, 198, 271.
Dalli, 255, 271.
var. ornatum, 255, 271.
diaphanum, 199, 271, 283, 284.
rugulosum, 199.
- Cylichna alba*, 273, 283.
biplicata, 467.
celata, 468.
Dalli, 274, 283.
eburnea, 428, 447.
occulta, 274, 283.
- Cylindrogaster*, 389.
- Cymbulia calceolus*, 275.
- Cyphoma gibbosa*, 462.
- Cyprina Islandica*, 278, 477.
- Cyrtarachne*, 297, 325.
bisaccata, 325.
- Cyrtogaster*, 325.
- Cytherea obovata*, 477.
- Cyrtodaria siliqua*, 277.
- Daerydium vitreum*, 281, 283.
- Dalmanina*, 94, 388, 394.
nigriceps, 94, 394.
picta, 94, 394.
- Daphnella limacina*, 265, 285.
- DeForest, E. L. On an Unsymmetrical Law of Error in the Position of a Point in Space, 123-138.
- Defrancia formosa*, 152.

- Delphinula nitida*, 424, 447.
Dendronotus, 274.
 arborescens, 274.
Dentalium, sp. g., 217, 276, 283, 285.
Dentalium, sp. h., 217, 276, 283, 285.
 candidum, 217.
 capillosum, 218.
 ensiculus, 432.
 laqueatum, 431.
 leptum, 470.
 occidentale, 216, 218, 276, 283.
 var. *sulcatum*, 217, 276, 283.
 solidum, 215, 276, 283.
 striolatum, 216, 276, 283.
Dendronotus robustus, 274.
Desmoteuthis hyperborea, 264.
 tenera, 245, 264, 282.
Diacria trispinosa, 275, 470.
Diaphana conulus, 273, 429.
 gemma, 273, 283, 284.
 nitidula, 273.
 pertenuis, 273.
 Diastatic Action of Saliva, as Modified by various Conditions, studied Quantitatively, 343-376.
Diplodonta turgida, 279, 479.
Diplostyla, 8, 65.
 canadensis, 66.
 concolor, 3, 66.
 nigrina, 3, 65.
Diplothyra Smithii, 472.
 Dipterous Larvæ from the Western Alkaline Lakes and their uses as Human Food, 87-90.
Discina Atlantica, 233, 282, 284, 398, 446.
Dolium Bairdii, 253, 268.
Dolomedes, 500.
 fontanus, 502.
 sexpunctatus, 501.
 tenebrosus, 501.
Doris complanata, 274.
Dosinia obovata, 477.
Doto coronata, 274.
Drapetisca, 8, 66.
 socialis, 3, 67.

*Eledone*lla, 144.
 pygmaea, 145, 265, 284.
Eledone verrucosa, 248, 265, 282.
 Emerton, J. H., New England Lycosidae, 482-505.
 New England Spiders of the Family Epeiridae, 295-341.
 New England Spiders of the Family Therididae, 1-86.
Ensatella Americana, 277.
Eolis papillosa, 274.
Epeira, 297, 298.
 affinis, 305.
 alboventris, 314.
 angulata, 298, 299.
 annulipes, 309.
 apoclista, 305.

Epeira aureola, 307.
 baltimorensis, 315.
 brueinichii, 331.
 carbonaria, 315.
 caudata, 321.
 ceropegia, 316.
 cinerea, 298, 302.
 conica, 321.
 corticaria, 298, 300.
 displicata, 313.
 domicili, 298.
 domiciliorum, 310, 312.
 cetypa, 319.
 fasciata, 330.
 foliata, 318.
 formosa, 305.
 fusca, 328.
 gibberosa, 317.
 globosa, 315.
 Hentzii, 312.
 hilaris, 305.
 hortorum, 332.
 infumata, 319.
 insularis, 309.
 juniperi, 313.
 labyrinthea, 314.
 maculata, 317.
 marmorea, 307.
 mitrata, 327.
 nordmanni, 298, 301.
 obesa, 307.
 packardii, 315.
 parvula, 317.
 patagiata, 302, 305.
 placida, 316.
 pratensis, 310.
 pyramidata, 308.
 quadrata, 307, 339.
 riparia, 329.
 rugosa, 326.
 sclopetaria, 302, 303.
 sericata, 303.
 septima, 307.
 silvatica, 298, 300.
 solitaria, 298, 299.
 spinea, 326.
 stellata, 319.
 strix, 302, 305.
 sutrix, 329.
 thaddeus, 309.
 triarmea, 315.
 trifolium, 306.
 trivittata, 298, 310, 311.
 vulgaris, 304.
Epeirinae, 297.
Ephydra, 87, 89.
 Californica, 89, 90.
 gracilis, 90.
 halophila, 90.
 hians, 90.
 subopaca, 90.
Erigone, 8, 58.
 atra, 3, 59.

- Erigone atriceps*, 3, 34.
autumnalis, 58.
cornupalpis, 4, 74.
cristata, 3, 44.
dentigera, 3, 59.
directa, 3, 40.
emertoni, 3, 32.
fissiceps, 3, 33.
florens, 4, 46.
indirecta, 3, 41.
interpres, 3, 37.
leta, 3, 35.
lietabilis, 3, 35.
longipalpis, 3, 59.
multissima, 4.
ornata, 3, 39.
persimilis, 3.
persoluta, 4, 74.
pertinens, 3, 54.
pictilis, 3, 38.
probata, 3, 52.
provida, 3, 40.
spiuifera, 3, 47.
variata, 4, 73.
 Erigoninae, 7.
Ero, 7, 17.
thoracica, 2, 18.
variegata, 79.
Ethalia multistriata, 242, 270, 480.
Eucera, 389.
Eucharia, 18.
Eulima distorta, 272.
intermedia, 272.
stenostoma, 254, 272, 283.
Eulinella chariessa, 193, 272, 284.
lucida, 192, 272, 284.
 (or *Menestho*) *lissa*, 195, 272.
nitida, 194, 272, 284.
Smithii, 272, 480.
Euryopsis, 7, 26.
argentea, 27.
funebria, 2, 27.

Facelina pilata, 274.
Fairmairia, 393.
Fiona nobilis, 274.
Firola Keraudrenii, 212, 275.
Firolaidea Lesueurii, 430.
Fissurella redimicula, 255.
Tanneri, 255, 271.
Fossarus elegans, 269.
Fusus concinnus, 175.
costulatus, 252.

Gadinia excentrica, 271.
Ganesa, 201, 271.
Glaucus Boscii, 430.
margaritaceus, 430.
Glomus nitens, 231, 280, 284.
Glossigona, 377.
Gonatum, 8, 60.
cheliferum, 60.
rubens, 60.

Gonirhynchus, 393.
Gouldia mactracea, 477.
Grammonota, 8, 38.
inornata, 39.
ornata, 3, 39.
pictilis, 3, 38.
Gymnobela, 157.
brevis, 417, 447, 452.
curta, 158, 266, 282.
var. subangulata, 159, 240, 266, 282, 284.
engonia, 157, 266, 282.
hebes, 282, 284, 290.

Halictus, 389.
Hanleyia mendicaria, 272.
Haustella, 393.
Helophora, 8, 67.
insignis, 3, 67.
pallescens, 67.
Heterodoris robusta, 274.
Heteroteuthis tenera, 265.
Histioteuthis Collinsii, 264.
Hyalea angulata, 213.
corniformis, 214.
flava, 213.
gibbosa, 213.
quadridentata, 212.
Hylaes, 389.

Ianthina fragilis, 270.
Idas argenteus, 202, 281, 284, 285.
Ischiodonta, 393.
Isocardia cor., 438.
Issa ramosa, 274.

Jumala brychia, 422, 447.

Kelliella, 279, 285.
miliaris, 438.
nitida, 438.
Kennerlia glacialis, 277.
Koonsia obesa, 274.

Lacuna glacialis, 183.
tenella, 184.
Lamellaria pellucida, 268, 479.
var. Gouldii, 268, 283.
Laseola, 7, 26.
cancellata, 2, 26.
Leda acuminata, 227.
acuta, 259, 280, 285, 479.
Bushiana, 229, 280.
commutata, 259.
fragilis, 259.
Jamaicensis, 260, 285.
Jeffreysi, 229.
lata, 229.
messanensis, 227.
minuta, 230.
pernula, 280.
subequilatera, 229.
tenuisulcata, 230, 280.
unca, 259, 479.

- Leopoldius, 389.
 Lepeta caeca, 447, 452.
 Lepetella tubicola, 271.
 Lephyphantes, 68.
 crypticola, 69.
 musciola, 68.
 Leptochiton alveolus, 272.
 Leptoteuthis, 140.
 diaphana, 141, 264, 282.
 Fabricii, 264.
 vermicolaris, 143.
 Leptothyra induta, 197, 270, 285.
 (induta, var.) albida, 197.
 Libinia emarginata, 99.
 Linæa subovata, 281, 284.
 Limopsis, 280, 284, 285.
 affinis, 442.
 aurita, 440.
 cristata, 231, 280, 285.
 minuta, 280, 284, 285, 443.
 plana, 441.
 tenella, 232, 281, 284, 285.
 Linyphia, 8, 60.
 autumnalis, 69.
 clathrata, 3, 62.
 communis, 2, 62.
 costata, 2, 63.
 mandibulata, 64.
 marginata, 2, 3, 61.
 marmorata, 2, 61.
 nebulosa, 4.
 phyrgiana, 2, 63.
 pusilla, 64.
 scripta, 2, 61.
 Linyphiæ, 8.
 Lithyphantes, 19.
 Litiopa bombyx, 269.
 Loligopsis vermicolaris, 143.
 Lonehopalpus, 393.
 Lophocarenum, 8, 45.
 brevis, 82.
 castaneum, 45.
 crenatum, 51.
 decemoculatum, 46.
 depressum, 50.
 erigonoides, 50.
 florens, 4, 46.
 latum, 50.
 longitubus, 49.
 longitarsus, 48.
 montanum, 45.
 montiferum, 47.
 pallidum, 48.
 quadricristatum, 48.
 rostratum, 49.
 scopuliferum, 49.
 simplex, 50.
 spiniferum, 3, 47.
 vernale, 51.
 Lophomma, 8, 43.
 bicornis, 44.
 cristata, 2, 3, 44.
 elongata, 44.
 Lophyrus exaratus, 208.
 Loripes lacteus, 259.
 lens, 259, 279.
 Lucina filosa, 279, 478.
 nassula, 478.
 trisulcata, 478.
 Lunatia Grönlandica, 268, 283.
 heros, 268, 463.
 levicula, 291.
 nana, 268.
 Lycosa, 482, 494.
 arenicola, 487.
 carolineensis, 486.
 cinerea, 488.
 communis, 489.
 frondicola, 484.
 kochii, 485.
 nidicola, 482.
 nidifex, 487.
 nigroventris, 488.
 occeata, 491.
 pictilis, 485.
 polita, 484.
 pratensis, 483.
 punctulata, 490.
 scutulata, 491.
 vulpina, 487.
 Macoma, 278.
 sabulosa, 278, 283.
 Macha Cumingiana, 475.
 strigillata, var., 475.
 Machæra costata, 472.
 Machæroplax obscura, 271.
 var. carinata, 271.
 Malletia obtusa, 226, 280, 283.
 Mangilia cerina, 250, 458.
 ceroplasta, 458.
 ephamilla, 457.
 eritima, 456.
 glypta, 461.
 melanitica, var. oxia, 459.
 oxytata, 460.
 psila, 455.
 Margarita, 425, 447.
 ægleës, 285.
 lamellosa, 255, 270, 285.
 regalis, 254, 270, 283.
 Marginella apicina, 166.
 borealis, 165, 267, 479.
 carnea, 165.
 conoidalis, 166.
 limatula, 166.
 roscida, 166.
 Smithii, 447, 452, 462.
 Virginiana, 420, 452.
 Martesia cuneiformis, 472.
 Mastigoteuthis Agassizii, 243, 264, 282.
 Menestho Bruneri, 272.
 sulcata, 272.
 Meta, 328.
 menardi, 328.
 Micropeira, 297, 320.

- Micropeira radiosa*, 320.
Micrommata carolinensis, 499.
 serrata, 499.
 undata, 499.
Microneta, 8, 73.
 cornupalpis, 4, 74.
 crassimanus, 75.
 discolor, 75.
 furcata, 76.
 latidens, 76.
 longibulbus, 76.
 olivacea, 77.
 persoluta, 4, 74.
 quinquedentata, 75.
 quisquiliarum, 73.
 varia, 3, 4, 73.
Mimetus, 7, 16.
 epeiroides, 17.
 interceptor, 2, 4, 16.
Modiola modiolus, 281.
Modiolaria corrugata, 281, 480.
 discors, 281.
 nigra, 281, 480.
 polita, 281, 285.
Mohnia Mohnii, 174.
Montacuta bidentata, 479.
 ovata, 279.
 tumidula, 225, 279, 283.
Mya ferruginosa, 225.
 truncata, 277.
Myopa, 382, 388, 389, 393.
 apicalis, 393.
 biannulata, 93.
 bistria, 394.
 clausa, 385, 393.
 conjuncta, 393.
 longicornis, 386, 394.
 obliquofasciata, 385, 394.
 pictipennis, 382, 393.
 pilosa, 383, 393.
 plebeia, 384, 393.
 rubrifrons, 392.
 stylata, 91, 394.
 vesiculosa, 384, 393.
 vicria, 386, 394.
Myopella, 393.
Myopina, 393.
Myopinae, 388.
Mytilimeria flexuosa, 258, 278.
Mytilus edulis, 281.

Nassa consensa, 462.
 nigrolabra, 268.
Natica clausa, 268, 283.
Neæra, 277.
 alternata, 285.
 costata, 472.
 gigantea, 223, 277, 283.
 glacialis, 277.
 lamellosa, 277.
 multicostata, 277, 285.
 var. curta, 277.
 obesa, 277, 283.

Neæra ornatissima, 473.
 paucistriata, 473.
 perrostrata, 277, 285.
 rostrata, 277, 285.
 undata, 223, 277, 285.
Neptunea decemcostata, 268.
 despecta, var. *tornata*, 268.
Nerience, 45, 52.
 incisa, 47.
 rubens, 60.
 varia, 73.
New England Lycosidae, 482-505,
New England Spiders of the family
 Epeiridae, 295-341.
New England Spiders of the family
 Theridiidae, 1-86.
Niso ægleës, 465.
North American Conopidae, 91-98.
Nucula acuta, 259.
 cancellata, 231, 280, 283, 285.
 delphinodonta, 280, 283, 479.
 granulosa, 280.
 proxima, 280.
 reticulata, 231.
 tenuis, 280, 283, 285.
 trigona, 438.

Ocemyia, 95, 392.
Octopus Bairdii, 265.
 Carolinensis, 235, 265.
 gracilis, 236, 265, 282.
 lentus, 265.
 piscatorum, 248, 265, 282.
Ocyale, 499.
 mirabilis, 499.
 undata, 499.
Odostomia, 273.
 caucellata, 467.
 disparilis, 196, 273.
 engonia, 466.
 var. teres, 467.
 tornata, 196, 273.
 unidentata, 272.
Odynerus, 389.
Oedipoda, 389.
Omalaxis (?) lirata, 452, 464.
 nobilis, 423, 447.
Ommastrephes illecebrosus, 264, 282.
Oncomyia, 95, 388, 392.
 abbreviata, 96, 97, 393.
 Baroni, 96, 97, 392.
 loraria, 98, 393.
 modesta, 96, 393.
 var. melanopoda, 393.
Opisthoteuthis Agassizii, 408, 446.
Oroodes, 28.
 paradoxus, 28.
Osmia, 389.
Oxygyrus Keraudrenii, 430.
Oxyopes, 502.
 scalaris, 502.

Pachygnatha, 298, 336.

- Pachygnatha autumnalis*, 337.
 brevis, 336.
 tristriata, 336, 341.
Pandora, 474.
 Carolinensis, 474.
Pardosa, 494.
 albomaculata, 495.
 albopatella, 497.
 bilineata, 496.
 brunnea, 495.
 lapidicina, 494.
 montana, 498.
 nigropalpis, 497.
 pallida, 496.
Pecchiola abyssicola, 278, 283.
 gemma, 258, 278, 283.
 grauulifera, 434.
Pecten Clintonius, 261, 281, 479.
 fragilis, 232, 281.
 glyptus, 281.
 Hoskynsi, 261.
 imbrifer, 261.
 Islandicus, 281.
 leptaleus, 232, 281.
 Magellanicus, 262.
 principoides, 261.
 pustulosus, 232, 261, 281.
 striatus, 233, 281.
 teuicostatus, 261, 479.
 var. *aratus*, 262.
 undatus, 444.
 vitreus, 281.
 var. *pustulosus*, 261.
Pectunculus tricenarius, 479.
Periploma papyracea, 277, 283, 434.
 undulata, 433.
Phalops furcillatus, 43.
Phaseolus ovatus, 230, 280, 284.
Philine, 273.
 amabilis, 273.
 cingulata, 273.
 Pumarchica, 273.
 quadrata, 273.
 Sagra, 467.
 tineta, 273.
Pholadomya arata, 278.
Pholas cuneiformis, 472.
Pholcomma, 7, 29.
 gibbum, 29.
 hirsutum, 29.
 rostratum, 30.
Pholeus, 7, 30.
 atlanticus, 2.
 phalangioides, 2, 30.
Phorosa, 393.
Phyllonethis lineata, 4, 16.
 placens, 4, 15.
Physocephala, 388, 391.
 affinis, 391.
 Burgessi, 391.
 castanoptera, 392.
 furcillata, 391.
 marginata, 391.
Physocephala sagittaria, 391.
 Texana, 391.
 tibialis, 391.
Pictina, 393.
Pilidium commodum, 191.
 radiatum, 191.
Piliscus commodus, 191, 268.
Pirata, 492.
 insularis, 492.
 mnutus, 493.
 montanus, 493.
 piraticus, 492.
Placophora (Euplacophora) Atlantica, 206, 272.
Pleurobranchæa tarda, 274.
Pleurobranchus Americanus, 429, 447.
Pleurocina, 389.
Pleurophyllidia Cuvieri, 469.
Pleuropus Hargerii, 275.
Pleurotoma Carpenteri, 265.
 comatotropis, 265, 285.
 Dalli, 265.
 (*Mangilia*) *bandella*, 250.
Pleurotonella, 146.
 Agassizii, 148, 265, 282, 415.
 Bairdii, 147, 265, 282, 284.
 bandella, 250, 266, 282, 284, 285, 415.
 Benedicti, 148, 151, 152, 266, 282.
 Bruneri, 155, 266, 282, 284, 416.
 Catharinae, 155, 266, 282, 284.
 Diomedæe, 152, 250, 266.
 Emertoni, 154, 250, 266, 282, 285, 413.
 formosa, 152.
 Frielei, 413, 446.
 Jeffreysii, 411, 446.
 Lotte, 415, 447.
 Packardii, 146, 265.
 Pandionis, 265.
 Saffordi, 151, 266, 282.
 Sandersoni, 149, 266, 282, 284, 415.
 tineta, 412, 446.
 vitrea, 414, 447.
Pneumodermon Peronii, 431.
Pompilus, 389.
Poromya granulata, 223, 277, 285.
 var. *rotundata*, 277.
 rotundata, 223.
 sublevis, 221, 277, 283.
Primnoa reseda, 192.
Propilidium compressum, 262.
 elegans, 205, 271, 283.
 pertenuis, 262, 271.
Ptychoproctus, 91, 394.
Puncturella abyssicola, 425, 447.
 (*Fissurisepta*) *eritneta*, 204, 271, 283.
 noachina, 271, 426.
Purpurella, 393.
Pyrene costulata, 252.
Ringicula nitida, 273, 285.
Rossia Hyatti, 265.
 megaptera, 245, 264.
 sublevis, 265.

- Rotella anomala*, 242.
 cryptospira, 241, 270.
 striata, 242.
- Saxicava arctica*, 479.
 Norvegica, 277.
- Scalaria Andrewsii*, 270.
 Dalliana, 270.
 Leana, 270.
 leptalea, 465.
 Pourtalesii, 270.
 teres, 465.
- Scaphander nobilis*, 209, 273, 283.
 puncto-striatus, 210, 273, 283.
- Scissurella crispata*, 271.
- Scrobicularia longicallus*, 224.
- Seyllæa Edwardsii*, 274, 469.
- Scytodes*, 7, 31.
 cameratus, 2, 31.
 thoracica, 2, 31.
- Scytodinae*, 7.
- Second Catalogue of Mollusca recently added to the Fauna of the New England Coast and the adjacent parts of the Atlantic, consisting mostly of Deep-Sea Species, with Notes on others previously recorded, 139-294.
- Seguenzia*, 186.
 carinata, 191.
 elegans, 191.
 critina, 189, 270, 283, 284.
 formosa, 186, 270, 283, 284, 285.
 var. *nitida*, 188, 270, 284.
 ionica, 191.
- Seguenzidae*, 186.
- Semele lata*, 476.
- Sicus*, 377.
- Sigaretus maculatus*, 463.
- Siliqua costata*, 472.
- Singa*, 321.
 maculata, 323.
 pratensis, 322.
 variabilis, 322.
- Sipho cælatus*, 169, 172, 267.
 var. *hebes*, 172, 267, 282.
 concinus, 175.
 glyptus, 172, 174, 267.
 hispidulus, 239, 268, 284.
 leptaleus, 175, 268.
 hvidus, 251.
 (*Mohnia*) *cælatus*, 172, 267, 282.
 (*Mohnia*) *parvus*, 174.
 (*Mohnia*) *simplex*, 174, 268.
 obesus, 168, 267.
 parvus, 267.
 profundicola, 170, 267, 282, 284.
 var. *dispar*, 171, 267, 282.
 pubescens, 267.
 pygmæus, 172, 267, 479.
 var. *planulus*, 266.
 Spitzbergensis, 251.
 Stimpsonii, 267.
 var. *liratus*, 267.
- Siphodentalium feres*, 218, 276, 283.
 vitreum, 276, 283.
- Siphonentalis affinis*, 276, 283.
 Lofotensis, 276.
- Skenea lirata*, 452, 464.
 trilix, 464.
- Smith, Herbert E., Diastatic Action of Saliva, as modified by various Conditions, studied Quantitatively, 343-376.
- Solarium boreale*, 270.
- Solemya velum*, 279.
 var. *borealis*, 279.
- Spermophora*, 7, 31.
 meridionalis, 2, 31.
- Sphex*, 389.
- Spintharus*, 7, 28.
 flavidus, 2, 28.
- Spirialis balea*, var., 276.
 bulimoides, 215, 276.
 clathrata, 431.
 Gouldii, 276.
 reticulata, 431.
 retroversus, var. *MacAndrei*, 275.
 rostralis, 431.
 trochiformis, 214, 276.
- Spiropalpus*, 8, 39.
 spiralis, 39.
- Spirotropis ephamilla*, 162, 266, 282, 284.
- Spisula ovalis*, 278.
 solidissima, 278.
- Spyxosoma*, 389.
- Stachynia*, 94, 394.
- Stauroteuthis*, eggs of, 410.
 syrtensis, 249, 265, 409.
- Statoda*, 7, 8, 18.
 borealis, 2, 4, 19.
 corollata, 2, 19, 21.
 guttata, 1, 19, 20.
 marmorata, 2, 5, 20, 323.
 nigra, 21.
 ruralis, 4, 20.
 serpentina, 19.
 triangulosa, 2, 4, 22.
- Stegasoma*, 28.
- Stemonyphantes*, 8, 64.
 bucculentus, 3, 64.
 trilineata, 64, 83.
- Sthenoteuthis*, *Bartramii*, 264.
- Stilifer curtus*, 272, 283.
 Stimpsoni, 272, 283.
- Stoloteuthis leucoptera*, 264.
- Stylogaster*, 91, 377, 388, 389, 394.
 biannulata, 91, 93, 394.
 neglecta, 91, 394.
 stylatus, 93.
- Stylogastrinae*, 388.
- Stylonyia*, 91, 394.
 confusa, 93, 394.
- Styliola recta*, 275.
 striata, 430.
 subulata, 213, 275, 470.
 virgula, 213, 275, 470.
 var. *corniformis*, 214, 275.

- Stylophora*, 65.
 concolor, 66.
Syndosmya longicallis, 224.
- Tapes*, 435.
 virgineus, 435.
- Taraxis Mörchii*, 267, 285.
 var. *torvatus*, 251, 267, 282.
 pulchella, 267.
- Tarentula*, 482.
- Tectura galeola*, 427.
- Tegenaria medicinalis*, 492.
- Teloteuthis (Onychia) agilis*, 400, 446.
- Tellina ferruginosa*, 225, 293.
- Tellina lutea*, 476.
 longicallis, 224.
- Terebratulina cranium*, 234.
 tenera, 234.
- Terebratulina septentrionalis*, 282.
- Teredo megotara*, 277, 283.
- Tergipes despectus*, 274.
- Tetragnatha*, 298, 332.
 caudata, 335.
 clongata, 334.
 extensa, 333, 334.
 grallator, 334.
 laboriosa, 334.
 straminea, 335.
 vermiformis, 333.
- Tetragnathinae*, 298.
- Teutana*, 19.
 triangulosa, 22.
- Tharsis*, 201, 271.
- Thecophora*, 392.
- Therididae*, 4.
- Theridinae*, 7.
- Theridion boreale*, 2, 4, 19.
 cancellatum, 2, 26.
 fictilium, 2, 24.
 frondeum, 2, 4, 15.
 funebre, 2, 27.
 globosum, 2, 14.
 leoninum, 2, 18.
 marmoratum, 2, 4, 20.
 serpentinum, 2, 4, 22.
 sphaerula, 2, 25.
 trigonum, 2, 23.
 vulgare, 2, 13.
- Theridium*, 7, 8.
 differens, 9.
 frondeum, 2, 5, 15.
 globosum, 2, 14.
 lineatum, 2, 16.
 montanum, 10.
 murarium, 11.
 punctis-sparsum, 4, 12.
 quadripunctatum, 19.
 rupicola, 14.
 sexpunctatum, 12.
 spirale, 10.
 spidarium, 2, 4, 13, 328.
 unimaculatum, 15.
- Theridium varians*, 12.
 zelotypum, 4, 11.
- Theridula*, 7, 25.
 gonygaster, 25.
 sphaerula, 2, 25.
- Third Catalogue of Mollusca recently added to the Fauna of the New England Coast and the adjacent parts of the Atlantic, consisting mostly of Deep-sea Species, with Notes on others previously recorded, 395-452.
- Thracia Conradi*, 278, 479.
 nitida, 221, 278, 283.
- Tmeticius*, 52.
 bidentatus, 56.
 hostoniensis, 56.
 brunneus, 58.
 concavus, 57.
 contortus, 54.
 longisetosus, 54.
 maximus, 55.
 microtarsus, 57.
 montanus, 55.
 pallidus, 55.
 pertinens, 3, 54.
 plumosus, 53.
 probatus, 3, 52.
 terrestris, 57.
 tibialis, 56.
 tridentatus, 53.
 trilobatus, 53.
 truncatus, 57.
- Torellia fimbriata*, 269.
 var. *tiarella*, 269.
 vestita, 269.
- Tornatella puncto-striata*, 467.
- Trachydermon albus*, 209, 272.
 exaratus, 208, 272.
- Trichoecyclus Dumercillii*, 215, 276.
- Trichotroptis (?) inflata*, 178, 269, 283.
- Triforis turris-thomae*, 463.
- Tripitera columnella*, 214, 275.
- Tritonofusus cretaceus*, 251.
 Kröyeri, 251.
- Trochosa*, 482.
- Trochus aegleës*, 255.
 Otto, 254.
 rhysus, 255.
 Vaillant, 255.
- Trophon abyssorum*, 421, 447.
 var. *limicola*, 421, 447.
 clavatus, 176, 268, 282, 284, 421.
 Lintoni, 176, 268.
- Turbonilla areolata*, 294.
 Bushiana, 272, 283.
 costulata, 294.
 Emertoni, 272.
 grandis, 427, 447.
 nivea, 272.
 perlepada, 427, 447.
 Rathbuni, 272, 283, 428.
- Typhlomangilia nivale*, 164.
 Tanneri, 163, 266, 282.

- Ulesanis*, 7, 28.
 americana, 28.
 Unsymmetrical Law of Error in the Position of a Point in Space, 123-138.
Urosalpinx Carolinensis, 237, 268.
 cinerea, 238.
 macra, 239, 268.
Utriculus biplicata, 467.

Velutina levigata, 269.
Venericardia borealis, 259, 278.
 granulata, 258, 278, 477.
 Novangliæ, 259.
 obliqua, 478.
Venus alveata, 477.
 Verrill, A. E., Second Catalogue of Mollusca recently added to the Fauna of the New England Coast and the adjacent parts of the Atlantic, consisting mostly of Deep-Sea Species, with Notes on others previously recorded, 139-294.
 Third Catalogue of Mollusca, 395-452.
Verticordia celata, 278.
Vespa, 389.
Volutella lachrimula, 166, 266, 479.
Volutopsis Norvegicus, 252.
Volvula, 468.
 minuta, 469.
 oxytata, 468.

Walckenæra, 45.
 bifrons, 46.
 diceræ, 48.
Waldheimia cranium, 234, 282, 284, 398.
 tenera, 234.
 Williston, S. W., Dipterous Larvæ from the Western Alkaline Lakes and their use as Human Food, 87-90.
 North American Conopidae, 91-98, 377-394.
Xylophaga dorsalis, 277, 283, 285.

Yoldia expansa, 279, 283.
 frigida, 279, 284.
 hyperborea, 226.
 Jeffreysi, 229, 279, 284, 285.
 limatula, 226, 279.
 lucida, 279, 284.
 Messanensis, var., 227, 280, 283, 285.
 var. *brevirostris*, 227.
 myalis, 226.
 obtusa, 226.
 pusio, 227.
 regularis, 228, 279.
 sapotilla, 279.
 sericea, var. *striolata*, 226, 279, 284.
 subequilatera, 229, 279, 284.
 thraciformis, 279.

Zilla, 297, 323.
 montana, 323.
 x-notata, 324.
Zodion, 95, 379, 388, 389, 392.
 abdominale, 381, 392.
 Americanum, 392.
 fulvifrons, 380, 392.
 leucostoma, 380, 392.
 nanellum, 382, 392.
 occidentis, 392.
 pictulum, 379, 392.
 pygmæum, 381, 392.
 splendens, 392.

ERRATA TO VOL. VI.

- Page 27, line 26, for *funebre*, read *funbris*.
Page 49, line 31, for *spinifera*, read *spiniferum*.
Page 80, lines 29 and 31, for *cristatum*, read *cristata*.
Page 85, line 38, for 61 (end of line), read 51.
Page 86, line 19, *Pholcus atlanticus* should be omitted.
Page 201, line 1, for Ganeza, read Ganesa.
Page 201, line 3, for *Gorynia* read *Gorgonia*.
Page 202, line 38, for *argentea*, read *argenteus*.
Page 203, line 7, for *argentea*, read *argenteus*.
Page 215, line 11, for *longicaudatus*, read *longicaudata*.
Page 229, line 10, for *Jeffreysii*, read *Jeffreysi*.
Page 230, line 33, for *Jeffreysii*, read *Jeffreysi*.
Page 233, line 31, for Geol. read Zool.
Page 257, line 24, for *R*, read *C*.
Page 261, line 37, for Emmonds read Emmons.
Page 271, line 17, for *Ganeza*, read *Ganesa*.
Page 271, next to last line, for *Gadina* read *Gadinia*.
Page 275, line 20, for Leseur read Lesueur.
Page 276, line 11, for *Dumercillii* read *Dumercilii*.
Page 284, line 6, for *Jeffreysii*, read *Jeffreysi*.
Page 284, line 30, for Seguenizia read Seguenzia.
Page 285, last line, for Ammusium read Amussium.
Page 285, line 27, for *Jeffreysii*, read *Jeffreysi*.
Page 289, next to last line, insert comma after *Malletia*.
Page 289, last line, for Pectenidae read Pectinidae.
Page 297, line 40, for *Micropeira*, read *Micropeira*.
Page 302, line 38, for *patogiata*, read *patagiata*.
Page 303, line 19, for *patogiata*, read *patagiata*.
Page 342, line 9, for hartorum, read hortorum.
Page 342, line 19, for Micropeira, read Micropeira.
Page 392, line 39, for *Occomyia*, read *Occomyia*.
Page 394, line 6, for obliquefasciata, read obliquo-fasciata.
Page 451, line 16, for dorsal, read ventral.

Q
11
C9
v. 6

Connecticut Academy of Arts
and Sciences, New Haven
Transactions

Physical &
Applied Sci.
Serials

PLEASE DO NOT REMOVE
CARDS OR SLIPS FROM THIS POCKET

UNIVERSITY OF TORONTO LIBRARY

STORAGE

